



DATI TECNICI

- ***valvole riceventi***
- ***cinescopi***
- ***quarzi***

DATI TECNICI

Technical data

- **Valvole riceventi Americane-Europee**
USA-European receiving tubes

- **Valvole riceventi Europee-Americane**
European-USA receiving tubes

- **Cinescopi**
Television Picture Tubes

- **Quarzi**
Quartz crystal units

F I V R E

Fabbrica Italiana Valvole Radio Elettriche
Azienda della F.I. Magneti Marelli S.p.A.

27100 PAVIA (Italy) - Via Fabio Filzi, 1 - tel. 31144/5 - 26791
telegrammi: Catodo - Pavia
cabla: Catodo - Pavia (Italy)

edizione settembre 1968/XII (ampliata)

Il presente Catalogo annulla e sostituisce la precedente edizione ottobre 1966/XI

SIMBOLI E PRINCIPALI INDICAZIONI USATE NELLE TABELLE

Symbols used

Anodo <i>Anode</i>	a	Non connesso <i>No connection</i>	n.c.
Griglia <i>Grid</i>	g	Triodo <i>Triode</i>	T
Catodo <i>Cathode</i>	k	Tetrodo <i>Tetrode</i>	Q
Filamento <i>Filament or heater</i>	f	Pentodo <i>Pentode</i>	P
Diodo <i>Diode</i>	D	Esodo-Eptodo <i>Esode-Heptode</i>	H
Deflettore <i>Deflector</i>	Defl.	Sezione 1 <i>Section N. 1</i>	sez. 1
Anodo luminescente <i>Luminescent screen</i>	al	Sezione 2 <i>Section N. 2</i>	sez. 2
Tratto luminoso <i>Shadow length</i>	L	Ingresso <i>input</i>	i
Schermo interno <i>Internal shield</i>	s	Uscita <i>output</i>	o
		Non esiste <i>omitted</i>	n. e.
Tensione <i>Voltage</i>			V (Volt)
Tensione alimentazione <i>Voltage Supply</i>			V _b (Volt)
Tensione trasformatore <i>Voltage Transformer</i>			V trasf. (Volt)
Corrente <i>Current</i>			I (Amper)
Dissipazione/potenza <i>Dissipation/power</i>			W (Watt)
Resistenza <i>Resistance</i>			R (Ohm)
Capacità <i>Capacitance</i>			C (Farad)
Capacità filtro <i>Capacitor filter</i>			C filtr. (Farad)

Trasconduttanza <i>Transconductance</i>	S ($\mu\text{A/V}$) (mA/V)
Trasconduttanza conversione <i>Conversion transconductance</i>	S_c ($\mu\text{A/V}$)
Distorsione <i>Distortion factor</i>	d (%)
Coefficiente amplificazione <i>Amplification factor</i>	μ —
Tempo di riscaldamento <i>Warm-up time</i>	TR (sec.)

CAPACITA' (1)

Capacitances

Anodo - tutti escluso griglia 1 (uscita) <i>Anode to all other electrodes except grid N. 1 (output)</i>	C_a
Anodo-griglia <i>Anode to grid</i>	C_{a-g}
Anodo-catodo <i>Anode to cathode</i>	C_{a-k}
Griglia - tutti escluso anodo (ingresso) <i>Grid to all other electrodes except Anode (input)</i>	C_g
Griglia 1-griglia 2 <i>Grid N. 1 to grid N. 2</i>	C_{g1-g2}
Griglia-catodo <i>Grid to cathode</i>	C_{g-k}
Catodo-filamento <i>Cathode to filament</i>	C_{k-f}

CINESCOPI

Television Picture Tubes

Elettrodo comando <i>Grid N. 1</i>	g_1
Elettrodo acceleratore <i>Grid N. 2</i>	g_2
Elettrodo focalizzazione <i>Focusing electrode</i>	g_4

(1) Le capacità sono misurate direttamente tra gli elettrodi indicati, con gli altri elettrodi e schermi a massa.
Capacitances are directly measured between the specified electrodes with other electrodes and shields grounded.

Elettrodo anodico <i>Anode</i>	a
Rivestimento esterno <i>External conductive coating</i>	m

COMBINAZIONI - Esempi:

Combinations - Examples

Tensione anodica esodo <i>Esode plate voltage</i>	V_{aH}
Corrente griglia n. 2 e n. 4 <i>Grid N. 2 and N. 4 current</i>	I_{g2-4}
Capacità griglia n. 1 e anodo <i>Grid N. 1 to plate capacitance</i>	C_{g1-a}
Potenza di uscita <i>Power Output</i>	W_o
Dissipazione anodica <i>Plate dissipation</i>	W_a
Tensione tra filamento e catodo <i>Heater-cathode voltage</i>	V_{f-k}

Dati condensati - Valvole riceventi
Condensed data section - Receiving Tubes

Tipo Type	Classe Class	Dimens. Outline Ø h mm.	Base Basing	Accens. Filament supply		Impiego Use	Anodo Plate		Schermo Screen		Vg1	Ri	S	μ	Ra	Wo
				V	A		V	mA	V	mA		kΩ	μA/V		kΩ	W
<u>DAF91</u> 1S5	Di. Pent.	19 48	44	1,4	0,05	Riv. Ampl.	90	2,7	90	0,5	0	500	720	—	—	—
<u>DAF92</u> 1U5	Di. Pent.	19 48	45	1,4	0,05	Riv. Ampl.	90	2,7	90	0,5	0	500	720	—	—	—
<u>DCC90</u> 3A5	d. Tri.	19 48	47	1,4	0,22	Ampl. RF	90	3,7	—	—	2,5	8,3	1800	15	—	—
				2,8	0,11	Ampl. pot. RF	135	30†	—	—	20†	—	—	—	—	2†
<u>DF91</u> 1T4	Pent.	19 48	40	1,4	0,05	Ampl. RF	90	3,5	67,5	1,4	0	500	900	—	—	—
<u>DF92</u> 1L4	Pent.	19 48	40	1,4	0,05	Ampl. RF	90	4,5	90	2	0	350	1025	—	—	—
<u>DF904</u> 1U4	Pent.	19 48	40	1,4	0,05	Ampl. RF	90	1,6	90	0,5	0	1500	900	—	—	—
<u>DK91</u> 1R5	Ept.	19 48	46	1,4	0,05	Convert.	90	1,5	67,5	3,5	—	400	—	—	—	—
							Vg3=0		lg1=0,25 mA			Rg1=100 kΩ				
<u>DL92</u> 3S4	Pent.	19 48	41	1,4	0,1	Ampl. pot.	90	7,4	67,5	1,4	7	100	1575	—	8	0,27
				2,8	0,05	Ampl. pot.	90	6,1	67,5	1,1	7	100	1425	—	8	0,235
<u>DL94</u> 3V4	Pent.	19 48	42	1,4	0,1	Ampl. pot.	90	9,5	90	2,1	4,5	100	2150	—	10	0,27
				2,8	0,05	Ampl. pot.	90	7,7	90	1,7	4,5	120	2000	—	10	0,24
<u>DL95</u> 3Q4	Pent.	19 48	41	1,4	0,1	Ampl. pot.	90	9,5	90	2,1	4,5	100	2150	—	10	0,27
				2,8	0,05	Ampl. pot.	90	7,7	90	1,7	4,5	120	2000	—	10	0,24
<u>ECC84</u> 6CW7	d. Tri.	22 50	55	6,3	0,33	Ampl. RF	90	12	—	—	1,5	—	6000	24	—	—
<u>ECC91</u> 6J6	d. Tri.	19 48	53	6,3	0,45	Ampl. RF	100	8,5	—	—	(Rk=)	7,1	5300	38	—	—
											(50Ω)					

Dati condensati - Valvole riceventi
Condensed data section - Receiving Tubes

Tipo Type	Classe Class	Dimens. Outline Ø h mm.		Base Basing	Accens. Filament supply V A		Impiego Use	Anodo Plate V mA		Schermo Screen V mA		-Vg1	Ri	S	μ	Ra	Wo
		kΩ	μA/V		kΩ	W											
EF95 6AK5	Pent.	19	38	51	6,3	0,175	Ampl. RF	180	7,7	120	2,4	(Rk = 200 Ω)	690	5100	—	—	—
EL41 6CK5	Pent.	22	70	31	6,3	0,71	Ampl. pot.	250	36	250	5,2	(Rk = 170 Ω)	40	10000	—	7	3,9
EM80 6BR5	Ind. sint.	22	60	56	6,3	0,3	—	250	0,37	250	2	1	(angolo = 5°)	—	—	—	—
								250	0,01	250	2,3	14	(angolo = 50°)	—	—	—	—
PCC84 7AN7	d. Tri.	22	50	55	7	0,3	Amp. RF	Per gli altri dati riferirsi al tipo ECC84/6CW7 See type ECC84/6CW7									
1A3	Di.	19	48	48	1,4	0,15	Riv.	117e 0,5φ									
1A7GT	Ept.	30	77	23	1,4	0,05	Convert.	90	0,6	45	0,7	0	600	—	—	—	—
								Vg2=90 V		Ig2=1,2 mA			Rg1=200 kΩ				
1H5GT	Di. Tri.	30	77	17	1,4	0,05	Riv. ampl.	90	0,15	—	—	0	240	275	—	—	—
1L4	Pent.	19	48	40	1,4	0,05	Ampl. RF	90	4,5	90	2	0	350	1025	—	—	—
1LD5	Di. Pent.	30	57	18	1,4	0,05	Riv. ampl.	90	0,6	45	0,1	0	750	575	—	—	—
1N5GT	Pent.	30	77	20	1,4	0,25	Ampl. RF	90	1,2	90	0,3	0	1500	750	—	—	—
1Q5GT	Pent.	30	80	19	1,4	0,1	Ampl. pot.	90	9,5φ	90	1,3φ	4,5	75	2200	—	8	0,27
1R5	Ept.	19	48	46	1,4	0,05	Convert.	90	1,5	67,5	3,5	—	400	—	—	—	—
								Vg3=0		Ig1=0,25 mA			Rg1=100 kΩ				
1S5	Di. Pent.	19	48	44	1,4	0,05	Riv. Ampl.	90	2,7	90	0,5	0	500	720	—	—	—
1T4	Pent.	19	48	40	1,4	0,05	Ampl. RF	90	3,5	67,5	1,4	0	500	900	—	—	—
1U4	Pent.	19	48	40	1,4	0,05	Ampi. RF	90	1,6	90	0,5	0	1500	900	—	—	—
1U5	Di. Pent.	19	48	45	1,4	0,05	Riv. Ampl.	90	2,7	90	0,5	0	500	720	—	—	—
2A3	Tri.	51	123	1	2,5	2,5	Ampl. pot.	250	60	—	—	45	0,8	5250	4,2	2,5	3,5

Dati condensati - Valvole riceventi
Condensed data section - Receiving Tubes

Tipo Type	Classe Class	Dimens. Outline Ø h mm.	Base Basing	Accens. Filament supply		Impiego Use	Anodo Plate		Schermo Screen		Vg1	RI	S	μ	Ra	Wo	
				V	A		V	mA	V	mA		kΩ	μA/V	kΩ	W		
2A5	Pent.	46 109	7	2,5	1,75	Ampl. pot.	250	34φ	250	6,5φ	16,5	80	2500	—	7	3,2	
							285	38φ	285	7φ	20	78	2550	—	7	4,8	
2A6	d. Di. Trl.	39 104	5	2,5	0,8	Riv. Ampl.	250	0,9	—	—	2	91	1100	100	—	—	
2A7	Ept.	39 104	13	2,5	0,8	Convert.	Per gli altri dati riferirsi al tipo 6A7 See type 6A7										
2B7	d. Di. Pent.	39 104	11	2,5	1	Riv. Ampl.	250	10	125	2,3	3	600	1325	—	—	—	
3A4	Pent.	19 48	43	2,8	0,1	Ampl. pot.	150	13,3φ	90	2,2φ	8,4	100	1900	—	8	0,6	
				1,4	0,2												
3A5	d. Trl.	19 48	47	1,4	0,22	Ampl. RF	90	3,7	—	—	2,5	8,3	1800	15	—	—	
				2,8	0,11	Ampl. pot. RF	135	30φ	—	—	20φ	—	—	—	—	—	—
3D6	Pent.	30 57	21	2,8	0,11	Ampl. pot.	135	9,8φ	90	1,2φ	4,5	—	2400	—	12	0,5	
				1,4	0,22		150	9,9	90	1	4,5	—	2400	—	14	0,5	
3Q4	Pent.	19 48	41	1,4	0,10	Ampl. pot.	90	9,5	90	2,1	4,5	100	2150	—	10	0,27	
				2,8	0,05	Ampl. pot.	90	7,7	90	1,7	4,5	120	2000	—	10	0,24	
3Q5GT	Pent.	30 70	22	2,8	0,05	Ampl. pot.	85	7	85	0,8	5	70	1950	—	9	0,25	
				1,4	0,1		90	9,5	90	1,3	4,5	90	2200	—	8	0,27	
3S4	Pent.	19 48	41	1,4	0,1	Ampl. pot.	90	7,4	67,5	1,4	7	100	1575	—	8	0,27	
				2,8	0,05	Ampl. pot.	90	6,1	67,5	1,1	7	100	1425	—	8	0,235	
3V4	Pent.	19 48	42	1,4	0,1	Ampl. pot.	90	9,5	90	2,1	4,5	100	2150	—	10	0,27	
				2,8	0,05	Ampl. pot.	90	7,7	90	1,7	4,5	120	2000	—	10	0,24	
5R4GY	d. Di.	52 123	14	5	2	Rett.	750• 250φ										
5U4GA	d. Di.	37 107	14	5	3	Rett.	450• 250φ										
5Y3GR	d. Di.	46 109	14	5	1	Rett.	350• 100φ										
5Y4G	d. Di.	45 103	15	5	2	Rett.	350• 125φ										
6A6	d. Trl.	45 109	9	6,3	0,8	Ampl.	cl. B	300	35φ	—	—	0	—	—	—	8	10φ
							cl. A	294	7	—	—	6	11	3200	35	—	—

Dati condensati - Valvole riceventi
Condensed data section - Receiving Tubes

Tipo Type	Classe Class	Dimens. Outline Ø h mm.		Base Basing	Accens. Filament supply V A		Impiego Use	Anodo Plate V mA		Schermo Screen V mA		-Vg1	RI	S	μ	Ra	Wo
										kΩ	μA/V		kΩ	W			
6A7	Ept.	41	95	13	6,3	0,3	Convert. Vg4=-3 V Vg2=250 V	250	3,5	100	2,7	—	360	—	—	—	—
													Rg1=50 kΩ				
6AB7GM	Pent.	28	56	30	6,3	0,45	Ampl. RF	300	12,5	200	3,2	3	700	5000	—	—	—
6AC7GM	Pent.	28	56	30	6,3	0,45	Ampi. RF	300	10	150	2,5	(Rk=)	1000	9000	—	—	—
													(160Ω)				
6AG5	Pent.	19	48	51	6,3	0,3	Ampl. RF	250	6,5	150	2,0	(Rk=)	800	5000	—	—	—
													(160Ω)				
6AH6	Pent.	19	48	52	6,3	0,45	Ampi. RF	300	10	150	2,5	(Rk=)	500	9000	—	—	—
													(160Ω)				
6AK5	Pent.	19	38	51	6,3	0,175	Ampl. RF	180	7,7	120	2,4	(Rk=)	690	5100	—	—	—
													(200Ω)				
6AU5	Pent. Beam	30	76	28	6,3	1,25	Ampl. Pot. Defles. Oriz.	Massima tensione anodica = 5500 V (picco positivo) <i>Maximum Plate Voltage (peak positive)</i> Massima corrente anodica = 110 mA <i>Maximum Plate Current</i> Massima dissipazione anodica = 10 W <i>Maximum Plate Dissipation</i> Massima dissipazione di schermo = 2,5 W <i>Maximum Screen Dissipation</i>									
6AW5G	d. Di.	39	104	16	6,3	0,6	Rett.	450 70φ									
6AW5GT		30	68														
6B6G	d. Di. Tri.	39	104	25	6,3	0,3	Riv. ampl.	250	0,9	—	—	2	91	1100	100	—	—
		30	68														
6B7	d. Di. Pent.	39	104	11	6,3	0,3	Riv. ampl.	Per gli altri dati riferirsi al tipo 2B7 <i>See type 2B7</i>									
6B8G	d. Di. Pent.	39	104	33	6,3	0,3	Riv. ampl.	Per gli altri dati riferirsi al tipo 2B7 <i>See type 2B7</i>									
6B8GT		30	68														
6BL7GT	d. Tri.	30	70	26	6,3	1,5	Ampi. defl. V.	250	40	—	—	9	2,15	7000	15	—	—

Dati condensati - Valvole riceventi
Condensed data section - Receiving Tubes

Tipo Type	Classe Class	Dimens. Outline		Base Basing	Accens. Filament supply		Impiego Use	Anodo Plate		Schermo Screen		Vg1 —	Ri	S	μ	Ra	Wo	
		\varnothing h mm.	h mm.		V	A		V	mA	V	mA		k Ω	μ A/V		k Ω	W	
6BN8G 6BN8GT	d. Di. Pent.	39	104	33	6,3	0,3	Riv. ampl.	250	8,5	100	1,9	3	610	1150	—	—	—	
6BQ7A	d. Tri.	22	49	54	6,3	0,4	Ampl. RF	150	9	—	—	(Rk = 220 Ω)	5,9	6400	38	—	—	
6BR5	Ind. sint.	22	60	56	6,3	0,3	—	250	0,37	250	2	1	(angolo = 5°)		—	—	—	
								250	0,01	250	2,3	14	(angolo = 50°)		—	—	—	
6C5G	Tri.	39	95	24	6,3	0,3	Ampl. BF	250	8	—	—	8	10	2000	20	—	—	
6C6	Pent.	39	104	8	6,3	0,3	Ampl. RF	250	2	100	0,5	3	1000	1225	—	—	—	
6CK5	Pent.	22	70	31	6,3	0,71	Ampl. pot.	250	36	250	5,2	(Rk = 170 Ω)	40	10000	—	7	3,9	
6CW7	d. Tri.	22	50	55	6,3	0,33	Ampl. RF	90	12	—	—	1,5	—	6000	24	—	—	
6D6	Pent.	39	104	8	6,3	0,3	Ampl. RF	250	8,2	100	2	3	800	1600	—	—	—	
6D8G 6D8GT	Ept.	34	92	35	6,3	0,15	Convert.	250	3,5	100	2,6	3 \downarrow	400	550*	—	—	—	
		30	77					Vg2=250 V		Rg2=20 k Ω			I _{g2} =4,3 mA					
6EA7G 6EA7GT	Ept.	39	104	34	6,3	0,3	Convert.	Per gli altri dati riferirsi al tipo 6SA7GT										See type 6SA7GT
6F7	Trl. Pent.	39	104	12	6,3	0,3	Ampl. (Pent.) Ampl. (Tri.)	250	6,5	100	1,5	3	850	1100	—	—	—	
								100	3,5	—	—	3	16	500	8	—	—	
6FX4	d. Di.	19	60	49	6,3	0,8	Rett.	350 \bullet	90 ϕ									
6G6G 6G6GT	Pent.	46	103	29	6,3	0,1	Ampl. pot.	135	11,5 ϕ	135	2 ϕ	6	175	2100	—	12	0,6	
		30	77															
6H6G 6H6GT	d. Di.	39	95	16	6,3	0,3	Riv. Rett.	150 \bullet	8 ϕ									
		30	70															
6J6	d. Tri.	19	48	53	6,3	0,45	Ampl. RF	100	8,5	—	—	(Rk = 50 Ω)	7,1	5300	38	—	—	
6K6G 6K6GT	Pent.	39	95	29	6,3	0,4	Ampl. pot.	250	32 ϕ	250	5,5 ϕ	18	90	2300	—	7,6	3,4	
		30	77															

Dati condensati - Valvole riceventi
Condensed data section - Receiving Tubes

Tipo Type	Classe Class	Dimens. Outline Ø h mm.		Base Basing	Accens. Filament supply V A		Impiego Use	Anodo Plate V mA		Schermo Screen V mA		-Vg1	Ri	S	μ	Ra	Wo	
					V	A		V	mA	V	mA		kΩ	μA/V		kΩ	W	
6K8G	Tri. Eso.	39	104	39	6,3	0,3	Conv. (Eso.) (Tri.)	250 100	2,5 3,8	100 Rg=50 kΩ	6 3	3	600	350*	—	—	—	
6K8TE	Tri. Eso.	30	77	39	6,3	0,3	Conv. (Eso.) (Tri.)	250 100	3,7 3,4	100 Rg=50 kΩ	3,8 3,8	2	1000	650*	—	—	—	
6L7G 6L7GT	Ept.	39 30	104 77	36	6,3	0,3	Mescol. Ampl.	250 250	3,3 5,3	150 100	9,2 6,5	6 3	1000 600	350* 1100*	Vg3=-15 V Vg3=-3 V	—	—	—
6NK7GT	Pent.	30	77	32	6,3	0,3	Ampl.	250	5	100	1,65	2	1000	2300	—	—	—	
6P7G	Tri. Pent.	39	104	37	6,3	0,3	Ampl.	Per gli altri dati riferirsi al tipo 6F7 <i>See type 6F7</i>										
6S7G 6S7GT	Pent.	34 30	92 77	32	6,3	0,15	Ampl.	250	8,5	100	2	3	1000	1750	—	—	—	
6SH7GT	Pent.	30	70	30	6,3	0,3	Ampl.	250	10,8	150	4,1	1	900	4900	—	—	—	
6T7G 6T7GT	d. Di. Tri.	34 30	92 77	25	6,3	0,15	Riv. Ampl.	250	1,2	—	—	3	62	1050	65	—	—	
6TE9	Tri. Eso.	22	60	57	6,3	0,3	Conv. (Eso.) (Tri.)	180 100	2,1 3,4	75 Rg=50 kΩ	4,5	1	1000	700*	—	—	—	
6U7G	Pent.	39	104	32	6,3	0,3	Ampl.	250	8,2	100	2	3	800	1600	—	—	—	
6W7G 6W7GT	Pent.	34 30	92 77	32	6,3	0,15	Ampl.	250	2	100	0,5	3	1000	1225	—	—	—	
7AN7	d. Tri.	22	50	55	7	0,3	Ampl. RF	Per gli altri dati riferirsi al tipo <i>See type 6CW7/ECC84</i>										
12A6GT	Pent. Beam	30	76	29	12,6	0,15	Ampl. pot.	250	30	250	3,5	12,5	70	3000	—	7,5	3,4	
12AQ5	Pent.	19	60	50	12,6	0,225	Ampl. pot.	Per gli altri dati riferirsi al tipo 6AQ5 <i>See type 6AQ5</i>										
12C8GT	d. Di. Pent.	30	77	33	12,6	0,15	Riv. Ampl.	250	10	125	2,3	3	600	1325	—	—	—	
12EA7GT	Ept.	30	77	34	12,6	0,15	Convert.	Per gli altri dati riferirsi al tipo 6SA7GT <i>See type 6SA7GT</i>										
12J7GT	Pent.	30	68	32	12,6	0,15	Ampl. B.F.	250	2	100	0,5	3	1000	1225	—	—	—	
12NK7GT	Pent.	30	77	32	12,6	0,15	Ampl.	Per gli altri dati riferirsi al tipo 6NK7GT <i>See type 6NK7GT</i>										

Dati condensati - Valvole riceventi
Condensed data section - Receiving Tubes

Tipo Type	Classe Class	Dimens. Outline Ø h mm.		Base Basing	Accens. Filament supply V A		Impiego Use	Anodo Plate		Schermo Screen		Vg1	RI	S	μ	Ra	Wo
					V	A		V	mA	V	mA		kΩ	μA/V	kΩ	W	
12TE8GT	Tri. Eso.	30	60	38	12,6	0,15	Conv. (Eso.) (Tri.)	250 3,7 100 3,4	100 3,8 — —	2 Rg=50 kΩ	—	650 I _{g1} =0,2 mA	—	—	—	—	—
12TE9	Tri. Eso.	22	60	57	12,6	0,15	Convert.	Per gli altri dati riferirsi al tipo 6TE9 See type 6TE9									
24A	Tetr.	45	118	3	2,5	1,75	Ampl.	250 4	90 1,7	3	600	1050	—	—	—	—	—
27	Tri.	39	95	2	2,5	1,75	Ampl.	250 5,2	— —	21	9,25	975	—	—	—	—	—
35	Tetr.	46	118	3	2,5	1,75	Ampl. RF	250 6,5	90 2,5	3	400	1050	—	—	—	—	—
35B5	Pent.	19	60	50	35	0,15	Ampl. pot.	110 40φ	110 3φ	7,5	—	5800	—	2,5	1,5	—	—
36	Tetr.	39	104	3	6,3	0,3	Ampl. RF	250 3,2	90 1,7	3	550	1080	—	—	—	—	—
37	Tri.	39	95	2	6,3	0,3	Ampl.	250 7,15	— —	18	8,4	1100	9,2	—	—	—	—
41	Pent.	39	95	7	6,3	0,4	Ampl. pot.	250 32φ	250 5,5φ	18	90	2300	—	7,6	3,4	—	—
43	Pent.	45	109	7	25	0,3	Ampl. pot.	160 33φ	120 6,5φ	18	42	2375	—	5	2,2	—	—
45	Tri.	45	109	1	2,5	1,5	Ampl. pot.	250 34	— —	50	1,61	2175	—	3,9	1,6	—	—
47	Pent.	51	123	4	2,5	1,75	Ampl. pot.	250 31	250 6	15,3	60	2500	—	7	2,7	—	—
53	d. Tri.	45	109	9	2,5	2	Ampl. pot.	Per gli altri dati riferirsi al tipo 6A6 See type 6A6									
56	Tri.	39	95	2	2,5	1	Riv. ampl.	250 5	— —	13,5	9,5	1450	13,8	—	—	—	—
57	Pent.	39	104	8	2,5	1	Ampl.	250 2	100 0,5	3	1000	1225	—	—	—	—	—
58	Pent.	39	104	8	2,5	1	Ampl. RF	250 8,2	100 2	3	800	1600	—	—	—	—	—
75	d. Di. Tri.	39	104	5	6,3	0,3	Riv. Ampl.	250 0,9	— —	2	91	1100	100	—	—	—	—
76	Tri.	39	95	2	6,3	0,3	Ampl.	250 5	— —	13,5	9,5	1450	13,8	—	—	—	—
77	Pent.	29	104	8	6,3	0,3	Ampl.	250 2,3	100 0,5	3	1000	1250	—	—	—	—	—
78	Pent.	39	104	8	6,3	0,3	Ampl. RF	250 7	100 1,7	3	800	1450	—	—	—	—	—
79	d. Trl.	39	104	6	6,3	0,6	Ampl. cl. B	250 5,3φ	— —	0	—	—	—	14	8,0φ	—	—
85	d. Di. Tri.	39	104	5	6,3	0,3	Riv. Ampl.	250 8	— —	20	7,5	1100	8,3	20	0,35	—	—
89	Pent.	39	104	8	6,3	0,4	Ampl. pot.	250 32φ	250 5,5φ	25	70	1800	—	6,75	3,4	—	—

Dati condensati - Valvole riceventi
Condensed data section - Receiving Tubes

Tipo Type	Classe Class	Dimens. Outline Ø h mm.		Base Basing	Accens. Filament supply V A		Impiego Use	Anodo Plate	Schermo Screen	-V _{g1}	Ri	S	μ	Ra	Wo
		V	mA		V	mA		kΩ	μA/V		kΩ	W			
1603 T	Pent.	30	94	8	6,3	0,3	Ampl. BF basso ronzio	Per gli altri dati riferirsi al tipo 77							See type 77
1625	Pent.	52	130	10	12,6	0,45	Ampl. pot.	Per gli altri dati riferirsi al tipo 807							See type 807
1629	Ind. sint.	30	69	27	12,6	0,15		Per gli altri dati riferirsi al tipo 6E5							See type 6E5

13

Abbreviazioni: d. = doppio Di. = diodo Tri. = triodo Tetr. = tetrodo
Abbreviation double diode triode tetrode

Pent. = pentodo Eso. = esodo Ept. = eptodo Riv. = rivelatore Ampl. = amplificatore
pentode esode heptode detector amplifier

Pot. = di potenza RF = Radio Frequenza Convert. = convertitore Mesc. = mescolatore
power amplifier Radio Frequency converter mixer

Riferimenti: † senza segnale • massima tensione efficace † massima corrente continua
Notes without signal maximum effective voltage maximum direct current

★ trasconduttanza di conversione † leggere -V_{g3} anzichè -V_{g1} † con le due sezioni in controfase
conversion transconductance intended -V_{g3} instead of -V_{g1} Push-pull of two sections

CONNESSIONI AGLI ZOCCOLI DELLE VALVOLE RICEVENTI ELENcate NELLA TABELLA DEI DATI CONDENSATI

Base diagrams for receiving tubes included in the condensed data section

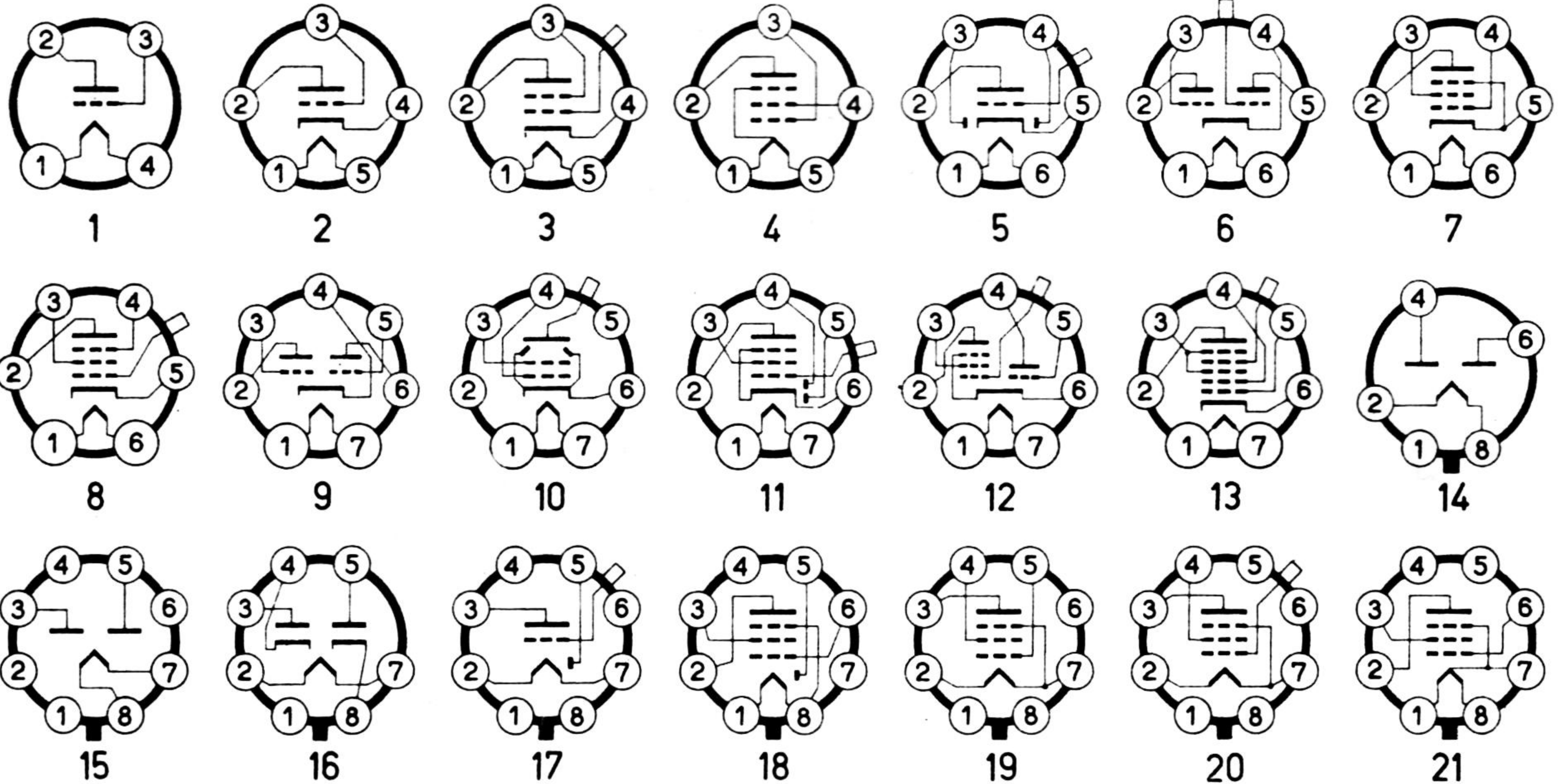

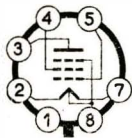

22



23



24



25

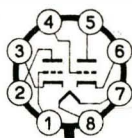

26

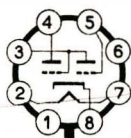

27

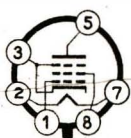

28

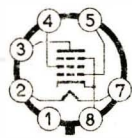

29

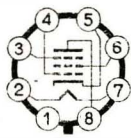

30

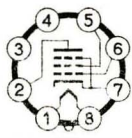

31



32

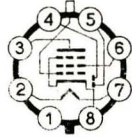

33



34



35



36



37

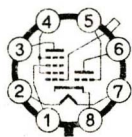

38

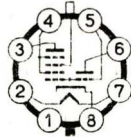

39



40



41



42



43

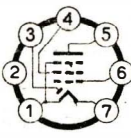

44



45

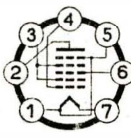

46

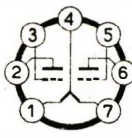

47



48

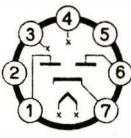

49

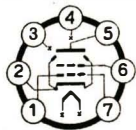

50

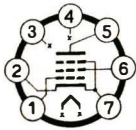

51

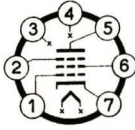

52

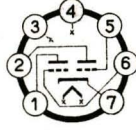

53

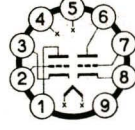

54

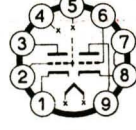

55

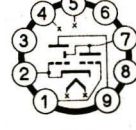

56



57

**Valvole di tipo
U.S.A.**

*U.S.A. types
receiving tubes*

**Valvole di tipo
Europeo**

*European types
receiving tubes*

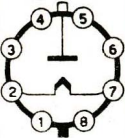
TIPO <i>Type</i>	Limiti massimi <i>Maximum ratings</i>	Capacità in pF <i>Capacitances</i>	Caratteristiche e funzionamento tipico <i>Typical operation</i>
<p>1A3</p> <p>Accensione Heater supply 1,4 V — 0,15 A</p>			<p>(Vedi dati condensati) (See condensed data section)</p>
<p>1G3GT 1B3GT</p>  <p>Ingombro Outline Ø=30 h=89</p> <p>Accensione Filament supply 1,25 V — 0,2 A</p>	<p>Nota: Solo i piedini 4 e 6 possono essere usati come punti di ancoraggio.</p> <p>Notes: Socket terminals 4 and 6 may be used as tie points.</p>	<p>$C_{a-f} = 1,3$</p>	<p>Massima corrente continua di uscita = 0,5 mA <i>Maximum DC Output Current</i></p> <p>Massima ampiezza della tensione inversa anodica = 21000 V <i>Maximum Peak Inverse Plate Voltage</i></p> <p>Picco massimo della corrente anodica = 50 mA <i>Maximum Peak Plate Current</i></p> <p>Caduta interna di tensione a 7 mA = 100 V <i>Plate Voltage Drop (for 7 mA)</i></p> <p>Diodo rettificatore per alta tensione in TV. <i>Half-Wave Rectifier designed for use as high voltage rectifier in television receivers.</i></p>

1L4**DF92**

Accensione
Filament supply
1,4 V — 0,05 A

(Vedi dati condensati)
(See condensed data section)

1LD5

Accensione
Filament supply
1,4 V — 0,05 A

(Vedi dati condensati)
(See condensed data section)

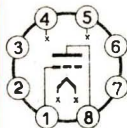
1M3**DM70**

Ingombro
Outline
 $\varnothing=10$ h=45
Accensione
Filament supply
1,4 V — 0,025 A

$V_b = 300$ V
 $V_a = 150$ V
 $V_a(\text{min.}) = 45$ V
 $W_a = 75$ mW
 $I_k = 0,6$ mA
 $R_g = 10$ M Ω

Alimentazione con batteria
Battery supply

V_b	=	67,5	90	V
V_a	=	60	85	V
V_g	=	0	0	V
I_a	=	105	170	μ A
pin	=	4	5	a massa grounded

Indicatore di sintonia
Tuning indicator

TIPO <i>Type</i>	Limiti massimi <i>Maximum ratings</i>	Capacità in pF <i>Capacitances</i>	Caratteristiche e funzionamento tipico <i>Typical operation</i>
1R5 <hr/> DK91 Accensione Filament supply 1,4 V — 0,05 A			(Vedi dati condensati) (See condensed data section)
1S2 <hr/> DY86 Accensione Heater supply 1,4 V — 0,55 A			Senza trattamento speciale sulla superficie del vetro. Without the envelope special treatment. Riferirsi al tipo: $\frac{1S2A}{DY87}$ See Type

1S2A

DY87



Ingombro
Outline
 $\varnothing=22$ h=67

Accensione
Heater supply
1,4 V — 0,55 A

$C_a = 1,55$
senza schermo
*without external
shield*

Massima corrente continua di uscita = 0,5 mA
Maximum DC Output Current

Massima ampiezza della tensione
inversa anodica (componente con-
tinua) = 22000 V
Maximum Peak Inverse Plate Voltage

Picco massimo della corrente ano-
dica = 40 mA
Maximum Peak Plate Current

Diodo, rettificatore per alta tensione in TV.
*Half-Wave Rectifier designed for use as high
voltage rectifier in television receivers.*

1U4

DF904

Accensione
Filament supply
1,4 V — 0,05 A

(Vedi dati condensati)
(See condensed data section)

TIPO <i>Type</i>	Limiti massimi <i>Maximum ratings</i>	Capacità in pF <i>Capacitances</i>	Caratteristiche e funzionamento tipico <i>Typical operation</i>
<p>1X2B</p>  <p>Ingombro Outline $\varnothing=22$ h=65</p> <p>Accensione Filament supply 1,25 V — 0,2 A</p>		<p>$C_{a-f} = 1$</p>	<p>Massima corrente continua di uscita = 0,5 mA <i>Maximum DC Output Current</i></p> <p>Massima ampiezza della tensione inversa anodica = 18000 V <i>Maximum Peak Inverse Plate Voltage</i></p> <p>Picco massimo della corrente anodica = 45 mA <i>Maximum Peak Plate Current</i></p> <p>Caduta interna di tensione a 7 mA = 100 V <i>Plate Voltage Drop (tor 7 mA)</i></p> <p>Diodo rettificatore per alta tensione TV. <i>Half-Wave Rectifier designed for use as high voltage rectifier in television receivers.</i></p>
<p>2A6</p> <p>Accensione Heater supply 2,5 V — 0,8 A</p>			<p>(Vedi dati condensati) (See condensed data section)</p>

2A7

Accensione
Heater supply
2,5 V — 0,8 A

(Vedi dati condensati)
(See condensed data section)

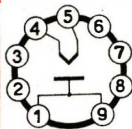
2AV2

Ingombro
Outline
Ø=22 h=50

Accensione
Filament supply
1,8 V — 0,22 A

Note: I terminali n. 2, 3, 6, 7, 8 non possono essere usati come punti di ancoraggio per componenti esterni al circuito.

Notes: Socket terminals 2, 3, 6, 7 and 8 should not be used as tie points for external-circuit components.

 $C_{a-f} = 0,8$

Massima corrente continua di uscita = 0,6 mA
Maximum DC Output Current

Massima ampiezza della tensione inversa anodica (componente continua) = 7000 V
Maximum Peak Inverse Plate Voltage

Picco massimo della corrente anodica = 50 mA
Maximum Peak Plate Current

Caduta interna di tensione e (per $I_a = 1$ mA) = 20 V
Plate Voltage Drop (for $I_a = 1$ mA)

Diodo rettificatore per alta tensione in TV portatili a transistori e per tensione di focalizzazione nei TV colore.

Half-Wave Rectifier. Focus-Rectifier in Color TV Receivers.

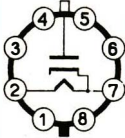
TIPO Type	Limiti massimi Maximum ratings	Capacità in pF Capacitances	Caratteristiche e funzionamento tipico Typical operation
<p>2B7</p> <p>Accensione Heater supply 2,5 V — 1 A</p>			<p>(Vedi dati condensati) (See condensed data section)</p>
<p>3A3A</p>  <p>Ingombro Outline Ø=30 h=82</p> <p>Accensione Heater supply 3,15 V — 0,22 A</p>	<p>Note: Solo i piedini 4 e 6 possono essere utilizzati come punti di ancoraggio con potenziale vicino a quello catodico. Notes: Socket terminals 4 and 6 may be used as tie points at or near cathode potential.</p>	<p>$C_{a-k} = 1,5$</p>	<p>Massima corrente continua di uscita = 2 mA <i>Maximum DC Output Current</i></p> <p>Massima ampiezza della tensione inversa anodica = 30.000 V <i>Maximum Peak Inverse Plate Voltage</i></p> <p>Picco massimo della corrente anodica = 100 mA <i>Peak Plate Current</i></p> <p>Caduta interna di tensione a 7 mA = 100 V <i>Plate Voltage Drop (for 7 mA)</i></p> <p>Diodo rettificatore per alta tensione per TV colore. <i>Half-Wave Rectifier. Designed as high voltage pulse rectifier for use in the scanning systems of color television receivers.</i></p>

3A5

DCC90

**Accensione
in serie
Filament
series supply
2,8 V — 0,11 A**

**Accensione
in parallelo
Filament
parallel supply
1,4 V — 0,22 A**

(Vedi dati condensati)
(See condensed data section)

3D6

**Accensione
in serie
Filament
series supply
2,8 V — 0,11 A**

**Accensione
in parallelo
Filament
parallel supply
1,4 V — 0,22 A**

(Vedi dati condensati)
(See condensed data section)

TIPO <i>Type</i>	Limiti massimi <i>Maximum ratings</i>	Capacità in pF <i>Capacitances</i>	Caratteristiche e funzionamento tipico <i>Typical operation</i>
<p>3S4</p> <hr/> <p>DL92</p> <p>Accensione in serie <i>Filament series supply</i> 2,8 V — 0,05 A</p> <p>Accensione in parallelo <i>Filament parallel supply</i> 1,4 V — 0,1 A</p>			<p>(Vedi dati condensati) <i>(See condensed data section)</i></p>
<p>3V4</p> <hr/> <p>DL94</p> <p>Accensione in serie <i>Filament series supply</i> 2,8 V — 0,05 A</p> <p>Accensione in parallelo <i>Filament parallel supply</i> 1,4 V — 0,1 A</p>			<p>(Vedi dati condensati) <i>(See condensed data section)</i></p>

4CM4
PC86 S

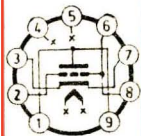

Ingombro
Outline

$\varnothing=22$ h=49

Accensione
Heater supply
3,8 V — 0,3 A

TR=14,5 sec.

$V_a = 220$ V
 $V_{g_1} = -50$ V
 $W_a = 2,2$ W
 $I_k = 20$ mA
 $R_{g_1} = 1$ M Ω

$C_{a-g} = 2$
 $C_{a-k} = 0,2$
 $C_{g-k} = 3,6$
 $C_{g-i} = 0,3$

senza schermo
*without external
shield*

Amplificatore con griglia a massa
As grounded grid amplifier

$V_a = 175$ V
 $V_{g_1} = -1,5$ V
 $I_{g_1} = 12$ mA
S = 14 mA/V
 $\mu = 68$
 $R_k = 125$ Ω

Oscillatore miscelatore
As self-oscillating mixer

$V_a = 220$ V
 $R_{a_1} = 5,6$ k Ω
 $R_{g_1} = 47$ k Ω
 $I_{g_1} = 12$ mA
 $I_{g_2} = 50$ μ A

Triodo amplificatore UHF, oscillatore o miscelatore per le bande IV e V.

Triode intended for use as grounded grid UHF, amplifier, oscillator or mixer for bands IV and V.

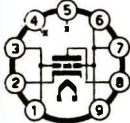
TIPO <i>Type</i>	Limiti massimi <i>Maximum ratings</i>	Capacità in pF <i>Capacitances</i>	Caratteristiche e funzionamento tipico <i>Typical operation</i>
<p>4DL4 PC88 S</p>  <p>Ingombro Outline Ø=22 h=44</p> <p>Accensione Heater supply 3,8 V — 0,3 A</p> <p>TR=14,5 sec.</p>	<p>$V_a = 174 \text{ V}$ $V_g = -50 \text{ V}$ $W_a = 2 \text{ W}$ $I_k = 13 \text{ mA}$ $R_g = 1 \text{ M}\Omega$</p>	<p>$C_{g-a} = 1,2$ senza schermo <i>without external shield</i></p>	<p>$V_a = 160 \text{ V}$ $R_k = 100 \Omega$ $I_a = 12,5 \text{ mA}$ $S = 13,5 \text{ mA/V.}$ $\mu = 65$</p> <p>Triodo amplificatore UHF con griglia a massa, per le bande IV e V. <i>Triode intended for use as grounded grid UHF amplifier for bands IV and V.</i></p>
<p>4ER5 PC95</p> <p>Accensione Heater supply 3,7 V — 0,3 A</p>			<p>Riferirsi al tipo: $\frac{6ER5}{EC95}$ <i>See Type</i></p>

4HA5
PC900 S



Ingombro
Outline
Ø=19 h=35

Accensione
Heater supply
4 V — 0,3 A

TR=14,5 sec.

$V_a = 200$ V
 $W_a = 2,2$ W
 $I_a = 20$ mA
 $V_g = -50$ V

$C_g = 4,3$
 $C_a = 2,9$
 $C_{g-a} = 0,36$
con schermo
with external
shield

Amplificatore in classe A_1
Class A_1 Amplifier

$V_a = 135$ V
 $V_g = -1$ V
 $I_a = 11,5$ mA
 $S = 14,5$ mA/V
 $\mu = 72$

Triodo, amplificatore a RF per sintonizzatori TV-VHF.
Triode intended for use as RF amplifier in VHF television tuners.

5AF4AS

Accensione
Heater supply
4,7 V — 0,3 A

TR=14,5 sec.

Riferirsi al tipo: 6AF4A
See Type

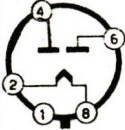
TIPO Type	Limiti massimi Maximum ratings	Capacità in pF Capacitances	Caratteristiche e funzionamento tipico Typical operation
<p>5AS4A</p>  <p>Ingombro Outline Ø=40 h=116</p> <p>Accensione Filament supply 5 V — 3 A</p>			<p>Massima corrente continua di uscita = 275 mA <i>Maximum DC Output Current</i></p> <p>Massima ampiezza della tensione inversa anodica = 1550 V <i>Maximum Peak Inverse Plate Voltage</i></p> <p>Massima tensione anodica alternata = 450 V_{eff} <i>Maximum AC Plate Supply Voltage</i></p> <p>Picco massimo della corrente anodica (per diodo) = 1000 mA <i>Maximum Peak Plate Current (Each Plate)</i></p> <p>Caduta interna di tensione a 275 mA = 50 V <i>Plate Voltage Drop (for 275 mA)</i></p> <p>Doppio diodo, raddrizzatore delle due semionde. <i>Full-Wave Rectifier.</i></p>

5FY5
PC97 S

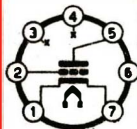

Ingombro
Outline
 $\varnothing=19$ h=48

Accensione
Heater supply
5 V — 0,3 A

TR=14,5 sec.

$V_a = 200$ V
 $V_g = -50$ V
 $W_a = 2,2$ W
 $I_k = 20$ mA
 $R_g = 1$ M Ω

$C_g = 5,0$
 $C_a = 4,3$
 $C_{a-g} = 0,48$
con schermo
with external
shield

Amplificatore in Classe A₁
Class A₁ Amplifier

$V_a = 135$ V
 $V_g = -1$ V
 $I_a = 11$ mA
S = 13 mA/V
 $\mu = 65$
 $R_i = 5$ k Ω

Triodo, amplificatore a RF per TV/VHF.
Triode intended for use as RF amplifier in VHF
television tuners.

5U4G

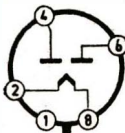

(segue)
(follow)

Massima corrente continua di uscita = 225 mA
Maximum DC Output Current

Massima ampiezza della tensione
Inversa anodica = 1550 V
Maximum Peak Plate Voltage

Massima tensione anodica alternata = 450 V_{eff}
Maximum AC Plate Supply Voltage

TIPO <i>Type</i>	Limiti massimi <i>Maximum ratings</i>	Capacità in pF <i>Capacitances</i>	Caratteristiche e funzionamento tipico <i>Typical operation</i>
<p>5U4G <i>(seguito)</i> <i>(following)</i></p> <p>Ingombro <i>Outline</i> $\varnothing=52$ h=123</p> <p>Accensione <i>Filament supply</i> 5 V — 3 A</p>			<p>Picco massimo della corrente anodica (per diodo) = 800 mA <i>Maximum Peak Plate Current (Each Plate)</i></p> <p>Caduta interna di tensione a 225 mA = 44 V <i>Plate Voltage Drop (for 225 mA)</i></p> <p>Doppio diodo, raddrizzatore delle due semionde. <i>Full-Wave Rectifier.</i></p>
<p>5U4GB</p> <p>Ingombro <i>Outline</i> $\varnothing=40$ h=107</p> <p>Accensione <i>Filament supply</i> 5 V — 3 A</p>			<p>Massima corrente continua di uscita = 275 mA <i>Maximum DC Output Current</i></p> <p>Massima ampiezza della tensione inversa anodica = 1550 V <i>Maximum Peak Inverse Plate Voltage</i></p> <p>Massima tensione anodica alternata = 450 V_{eff} <i>Maximum AC Plate Supply Voltage</i></p> <p>Picco massimo della corrente anodica (per diodo) = 800 mA <i>Maximum Peak Plate Current (Each Plate)</i></p> <p>Caduta interna di tensione a 225 mA = 44 V <i>Plate Voltage Drop (for 225 mA)</i></p> <p>Doppio diodo, raddrizzatore delle due semionde. <i>Full-Wave Rectifier.</i></p>

5R4GY

Accensione
Filament supply
5 V — 2 A

(Vedi dati condensati)
(See condensed data section)

5V4G

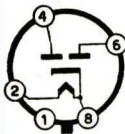

Ingombro
Outline
 $\varnothing=46$ h=106

Accensione
Heater supply
5 V — 3 A

Massima corrente continua di uscita = 175 mA
Maximum DC Output Current

Massima ampiezza della tensione
inversa anodica = 1400 V
Maximum Peak Inverse Plate Voltage

Massima tensione anodica alternata = 375 V_{eff}
Maximum AC Plate Supply Voltage

Picco massimo della corrente ano-
dica (per diodo) = 525 mA
*Maximum Peak Plate Current (Each
Plate)*

Caduta interna di tensione a 175 mA = 25 V
Plate Voltage Drop (for 175 mA)

**Doppio diodo, raddrizzatore delle due se-
mionde.**

Full-Wave Rectifier.

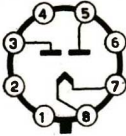
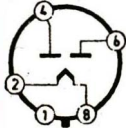
TIPO <i>Type</i>	Limiti massimi <i>Maximum ratings</i>	Capacità in pF <i>Capacitances</i>	Caratteristiche e funzionamento tipico <i>Typical operation</i>
<p>5X4G</p>  <p>Accensione <i>Filament supply</i> 5 V — 3 A</p>			<p>Riferirsi al tipo: 5U4G <i>See Type</i></p>
<p>5Y3G/GT</p>  <p>Ingombro <i>Outline</i> $\varnothing = 30$ h = 70 <i>(segue)</i> <i>(follow)</i></p>			<p>Massima corrente continua di uscita = 125 mA <i>Maximum DC Output Current</i></p> <p>Massima ampiezza della tensione inversa anodica = 1400 V <i>Maximum Peak Inverse Plate Voltage</i></p> <p>Massima tensione anodica alternata = 350 V_{eff} <i>Maximum AC Plate Supply Voltage</i></p> <p>Picco massimo della corrente anodica (per diodo) = 440 mA <i>Maximum Peak Plate Current (Each Plate)</i></p>

5Y3G/GT

(seguito)
(following)

Accensione
Filament supply
5 V — 2 A

Caduta internad i tensione a 125 mA = 50 V
Plate Voltage Drop (for 125 mA)

**Doppio diodo, raddrizzatore delle due se-
mionde.**
Full-Wave Rectifier.

5Z3

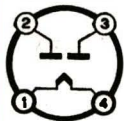

Accensione
Filament supply
5 V — 3 A

Riferirsi al tipo: 5U4G
See Type

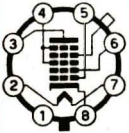
TIPO Type	Limiti massimi Maximum ratings	Capacità in pF Capacitances	Caratteristiche e funzionamento tipico Typical operation
<p>6A8G/GT</p>  <p>Ingombro Outline $\varnothing=30$ h=68</p> <p>Accensione Heater supply 6,3 V — 0,3 A</p>	<p> $V_a = 300$ V $V_{g^{3-5}} = 100$ V $V_{g^2} = 250$ V $V_{g^4} = 0$ V $I_k = 14$ mA $W_a = 1,0$ W $W_{g^{3-5}} = 0,3$ W $W_{g^2} = 0,75$ W </p>	<p> $C_{g^1} = 6$ $C_{g^2} = 4,6$ $C_{g^1-g^2} = 1,1$ $C_{g^4} = 9,5$ $C_{i1} = 12$ $C_{3-a} = 12$ $C_{g^1-g^4} = 0,16$ </p>	<p>Convertitore di frequenza <i>Converter</i></p> <p> $V_a = 250$ V $V_{g^{3-5}} = 100$ V $V_{g^2} = 250$ V $V_{g^4} = -3$ V $R_{g^1} = 50$ kΩ $I_a = 3,5$ mA $I_{g^{3-5}} = 2,7$ mA $I_{g^2} = 4,0$ mA $I_{g^1} = 0,4$ mA $R_i \sim 360$ kΩ $S_c = 550$ μA/V </p> <p>Eptodo, convertitore di frequenza. <i>Pentagrid Converter.</i></p>

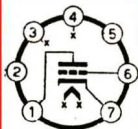
6AB4**EC92****Ingombro**

Outline

Ø=19 h=48

Accensione

Heater supply

6,3 V — 0,15 A

$$\begin{aligned} V_a &= 300 \text{ V} \\ W_a &= 2,5 \text{ W} \\ V_g &= -50 \text{ V} \end{aligned}$$

$$\begin{aligned} C_g &= 2,2 \\ C_a &= 1,4 \\ C_{g-a} &= 1,5 \end{aligned}$$

con schermo
with external
shield

Amplificatore in classe A₁
Class A₁ Amplifier

$$\begin{aligned} V_a &= 250 & 100 \text{ V} \\ R_k &= 200 & 270 \ \Omega \\ I_a &= 10 & 3,7 \text{ mA} \\ R_i &\sim 10,9 & 15 \text{ k}\Omega \\ S &= 5500 & 4000 \ \mu\text{A/V} \\ \mu &= 60 & 60 \end{aligned}$$

Triodo, amplificatore a RF.
Triode, RF Amplifier.

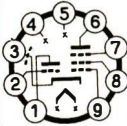
TIPO Type	Limiti massimi Maximum ratings	Capacità in pF Capacitances	Caratteristiche e funzionamento tipico Typical operation																																										
<p>6AB8 ECL80</p>  <p>Ingombro Outline Ø=22 h=61</p> <p>Accensione Heater supply 6,3 V — 0,43 A</p> <p>(segue) (follow)</p>	<p>Pentodo <i>Pentode Unit</i></p> <p>$V_a = 400 \text{ V}$ V_a (picco/peak) $= 1200 \text{ V (1)}$ $= -500 \text{ V}$</p> <p>$V_{g2} = 250 \text{ V}$ $W_a = 3,5 \text{ W}$ $W_{g2} = 1,2 \text{ W}$ $I_k = 25 \text{ mA}$ I_k (picco/peak) $= 350 \text{ mA (1)}$ $R_{g1} = 2 \text{ M}\Omega$</p> <p>Triodo/Triode Unit</p> <p>$V_a = 200 \text{ V}$ $W_a = 1 \text{ W}$ $I_k = 8 \text{ mA}$ $R_g = 3 \text{ M}\Omega (2)$ $1 \text{ M}\Omega (3)$</p>	<p>Pentodo <i>Pentode Unit</i></p> <p>$C_{g1} = 4,3$ $C_a = 4,8$ $C_{g1-a} < 0,2$</p> <p>Triodo <i>Triode Unit</i></p> <p>$C_g = 2,1$ $C_a = 0,8$ $C_{g-a} = 0,9$</p>	<p>Amplificatore in classe A₁ <i>Class A₁ Amplifier</i></p> <table border="0"> <thead> <tr> <th></th> <th>Pentodo <i>Pentode Unit</i></th> <th>Triodo <i>Triode Unit</i></th> </tr> </thead> <tbody> <tr> <td>$V_b =$</td> <td>—</td> <td>170 V</td> </tr> <tr> <td>$V_a =$</td> <td>170</td> <td>— V</td> </tr> <tr> <td>$R_a =$</td> <td>11</td> <td>100 kΩ</td> </tr> <tr> <td>$V_{g3} =$</td> <td>0</td> <td>— V</td> </tr> <tr> <td>$V_{g2} =$</td> <td>170</td> <td>— V</td> </tr> <tr> <td>$V_{g1} =$</td> <td>-6,7</td> <td>-3,5 V</td> </tr> <tr> <td>$I_a =$</td> <td>15</td> <td>1 mA</td> </tr> <tr> <td>$I_{g2} =$</td> <td>2,8</td> <td>— mA</td> </tr> <tr> <td>$R_{g1} =$</td> <td>—</td> <td>330 kΩ</td> </tr> <tr> <td>$S =$</td> <td>3200</td> <td>— $\mu\text{A/V}$</td> </tr> <tr> <td>$R_i =$</td> <td>150</td> <td>— kΩ</td> </tr> <tr> <td>$W_o =$</td> <td>1</td> <td>— W</td> </tr> <tr> <td>$d =$</td> <td>10%</td> <td>—</td> </tr> </tbody> </table>		Pentodo <i>Pentode Unit</i>	Triodo <i>Triode Unit</i>	$V_b =$	—	170 V	$V_a =$	170	— V	$R_a =$	11	100 k Ω	$V_{g3} =$	0	— V	$V_{g2} =$	170	— V	$V_{g1} =$	-6,7	-3,5 V	$I_a =$	15	1 mA	$I_{g2} =$	2,8	— mA	$R_{g1} =$	—	330 k Ω	$S =$	3200	— $\mu\text{A/V}$	$R_i =$	150	— k Ω	$W_o =$	1	— W	$d =$	10%	—
	Pentodo <i>Pentode Unit</i>	Triodo <i>Triode Unit</i>																																											
$V_b =$	—	170 V																																											
$V_a =$	170	— V																																											
$R_a =$	11	100 k Ω																																											
$V_{g3} =$	0	— V																																											
$V_{g2} =$	170	— V																																											
$V_{g1} =$	-6,7	-3,5 V																																											
$I_a =$	15	1 mA																																											
$I_{g2} =$	2,8	— mA																																											
$R_{g1} =$	—	330 k Ω																																											
$S =$	3200	— $\mu\text{A/V}$																																											
$R_i =$	150	— k Ω																																											
$W_o =$	1	— W																																											
$d =$	10%	—																																											

6AB8

ECL80

(seguito)
(following)

- (1) Massima durata dell'impulso pari al 10% di un periodo e non superiore a 2 msec.
Valid for application in frame output circuits where the max. pulse duration is 10% of a cycle with a max. of 2 ms.
- (2) Polarizz. autom.
Automatic bias.
- (3) Polarizz. fissa.
Fixed bias.

Triodo-pentodo, amplificatore di BF, oscillatore, separatore di sincronismi, ecc.
Triode-pentode. Audio amplifier, Oscillator, Sync separator, ...

TIPO Type	Limiti massimi Maximum ratings	Capacità in pF Capacitances	Caratteristiche e funzionamento tipico Typical operation
<p>6AF4A</p> <p>Ingombro Outline Ø=19 h=38</p> <p>Accensione Heater supply 6,3 V — 0,225 A</p>	<p>$V_a = 135 \text{ V}$ $V_g = -45 \text{ V}$ $W_a = 2,25 \text{ mA}$ $I_k = 22 \text{ mA}$ $I_g = 1,8 \text{ mA}$</p>	<p>$C_{g_g} = 2,2$ $C_{a_a} = 1,4$ $C_{g-a} = 1,9$</p>	<p>Amplificatore in classe A₁ <i>Class A₁ Amplifier</i></p> <p>$V_a = 80 \text{ V}$ $R_k = 150 \Omega$ $\mu = 13,5$ $R_i = 2100 \Omega$ $S = 6500 \mu\text{A/V}$ $I_a = 17,5 \text{ mA}$</p> <p>Oscillatore UHF a 1000 MHz <i>UHF Oscillator at 1000 MHz</i></p> <p>$V_a = 100 \text{ V}$ $R_a = 220 \Omega$ $R_g = 10 \text{ k}\Omega$ $I_a = 17 \text{ mA}$ $I_g = 750 \mu\text{A}$</p> <p>Triodo a medio «μ» per l'uso come oscillatore UHF. <i>Medium-Mu triode designed for UHF oscillator service.</i></p>

6AJ8**ECH81****Ingombro**

Outline

 $\varnothing=22$ h=60**Accensione**

Heater supply

6,3 V — 0,3 A

(segue)

(follow)

Eptodo
Heptode Unit

V_a	=	300	V
$V_{g^{2-4}}$	=	125	V
W_a	=	1,7	W
$W_{g^{2-4}}$	=	1,0	W
I_k	=	12,5	mA

Triodo
Triode Unit

V_a	=	250	V
W_a	=	0,8	W
I_k	=	6,5	mA

Eptodo
Heptode Unit

C_{g^1}	=	4,8
C_a	=	7,9
C_{g^1-a}	<	0,006
C_{g^3}	=	6
$C_{g^1-g^3}$	<	0,3

Triodo
Triode Unit

C_g	=	2,6
C_a	=	2,1
C_{g-a}	=	1

Amplificatore in classe A_1
*Class A_1 Amplifier*Eptodo
Heptode Unit

Triodo

Triode Unit

V_a	=	250	100	V
$V_{g^{2-4}}$	=	100	—	V
V_{g^1}	=	-2	0	V
V_{g^3}	=	0	—	V
I_a	=	6,5	13,5	mA
$I_{g^{2-4}}$	=	3,8	—	mA
R_i	~	700	5,9	k Ω
S	=	2400	3700	μ A/V
μ	=	—	22	

Convertitore di frequenza (1)
Frequency Converter (1)

V_{aH}	=	250	V
$V_{g^{2-4}}$	=	100	V
V_{g^1}	=	-2	V
I_{aH}	=	3,25	mA
$I_{g^{2-4}}$	=	6,7	mA
S_{cH}	=	775	μ A/V
R_{iH}	=	1	M Ω
V_{aT}	=	100	V
V_g	=	0	V
R_g	=	47	k Ω

TIPO Type	Limiti massimi Maximum ratings	Capacità in pF Capacitances	Caratteristiche e funzionamento tipico Typical operation
<p>6AJ8</p> <hr/> <p>ECH81</p> <p>(seguito) (following)</p>			<p> $I_g = 200 \mu A$ $I_{aT} = 4,5 \text{ mA}$ </p> <p>(1) Griglia triodo collegato a g_3 eptodo. <i>Grid triode connectet to grid No. 3 Heptode.</i></p> <p>Triodo eptodo, amplificatore a RF e FI, convertitore per ricevitori MA/MF. <i>Triode-Heptode. RF or IF amplifier, frequency converter in AMIFM receivers.</i></p>
<p>6AK5</p> <hr/> <p>EF95</p> <p>Accensione Heater supply 6,3 V — 0,175 A</p>			<p>(Vedi dati condensati) (See condensed data section)</p>

6AK8**EABC80**

Ingombro

Outline

 $\varnothing=22$ h=60

Accensione

Heater supply
6,3 V — 0,45 A

Diodi

Diodes Units V_a inv. = 350 V

peak negative

 I_{D_2} med. = 10 mA (1)

d.c. component

 I_{D_1} med. = 1 mA (2)

d.c. component

 I_{D_3} med. = 10 mA (3)

d.c. component

Triodo

Triode Unit V_a = 300 V W_a = 1 W I_k = 5 mA

(1) piedino/pin n° 2

(2) piedino/pin n° 6

(3) piedino/pin n° 1

Diodi

Diodes Units C_{D_1} = 0,8 C_{D_2} = 4,8 C_{D_3} = 4,8

senza schermo

without external

shield

Triodo

Triode Unit C_g = 1,9 C_a = 1,4 C_{g-a} = 2,0Amplificatori in classe A_1 *Class A_1 Amplifier* V_a = 100 250 V V_g = -1 -3 V I_a = 0,8 1 mA R_i = 48 50 k Ω S = 1450 1400 μ A/V μ = 70 70

Tripla diodo-triodo per uso in radiorecettori MF o MA/MF come discriminatore e rivelatore. In TV come rivelatore video e discriminatore audio.

Triple diode-triode intended for FM and AM signal detection, video-detection and audio-discriminator.

6AL3**EY88**

Accensione
Heater supply
6,3 V — 1,55 A

Riferirsi al tipo:

See Type

 $\frac{30AE3}{PY88} S$

TIPO <i>Type</i>	Limiti massimi <i>Maximum ratings</i>	Capacità in pF <i>Capacitances</i>	Caratteristiche e funzionamento tipico <i>Typical operation</i>
<p data-bbox="98 176 189 212">6AL5</p> <p data-bbox="83 222 204 259">EAA91</p>  <p data-bbox="83 497 219 569">Ingombro <i>Outline</i> $\varnothing = 19 \text{ h} = 38$</p> <p data-bbox="68 590 219 657">Accensione <i>Heater supply</i> 6,3 V — 0,3 A</p>		<p data-bbox="567 181 733 238">Per sezione <i>Each Unit</i></p> <p data-bbox="567 248 763 279">$C_k = 3,6$</p> <p data-bbox="567 279 763 310">$C_a = 3,2$</p> <p data-bbox="567 310 763 341">$C_{a1-a2} < 0,026$</p> <p data-bbox="567 352 740 440">con schermo <i>with external shield</i></p>	<p data-bbox="808 181 1436 238">Massima corrente continua di uscita = 9 mA <i>Maximum DC Output Current</i></p> <p data-bbox="808 248 1436 341">Massima ampiezza della tensione inversa anodica = 330 V <i>Maximum Peak Inverse Plate Voltage</i></p> <p data-bbox="808 352 1436 409">Massima tensione anodica alternata = 117 V_{eff} <i>Maximum AC Plate Supply Voltage</i></p> <p data-bbox="808 419 1436 538">Picco massimo della corrente anodica (per diodo) = 54 mA <i>Maximum Peak Plate Current (Each Plate)</i></p> <p data-bbox="808 549 1436 611">Caduta interna di tensione a 60 mA = 10 V <i>Plate Voltage Drop (for 60 mA)</i></p> <p data-bbox="808 642 1436 766">Doppio diodo, rivelatore o discriminatore per ricevitori MA e MF. <i>Twin Diode with separate cathodes designed for high frequency operation.</i></p>

6AM8



Ingombro
Outline
Ø=22 h=49

Accensione
Heater supply
6,3 V — 0,45 A

$$\begin{aligned} V_a &= 330 \text{ V} \\ V_{g2} &= 330 \text{ V} \\ W_a &= 3,2 \text{ W} \\ W_{g2} &= 0,55 \text{ W} \end{aligned}$$

Pentodo
Pentode Unit

$$\begin{aligned} C_{g1} &= 6,5 \\ C_a &= 2,6 \\ C_{g1-a} &< 0,015 \end{aligned}$$

Diodo
Diode Unit

$$\begin{aligned} C_i &= 1,8 \\ C_k &= 3,0 \end{aligned}$$

con schermo
with external shield

Amplificatore in classe A₁
Class A₁ Amplifier

$$\begin{aligned} V_a &= 125 \text{ V} \\ V_{g2} &= 125 \text{ V} \\ V_{g3} &= 0 \text{ V} \\ R_k &= 56 \ \Omega \\ I_a &= 12,5 \text{ mA} \\ I_{g2} &= 3,2 \text{ mA} \\ S &= 7800 \ \mu\text{A/V} \\ R_k &\sim 0,3 \text{ M}\Omega \end{aligned}$$

Diode pentodo progettato per l'uso combinato come rivelatore video e stadio finale FI.
Diode-pentode designed for use as combined video detector and final IF stage.

6AQ5

EL90

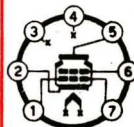

(segue)
(follow)

Amplif. classe A₁
Class A₁ Amplifier

$$\begin{aligned} V_a &= 250 \text{ V} \\ V_{g2} &= 250 \text{ V} \\ W_a &= 12 \text{ W} \\ W_{g2} &= 2 \text{ W} \end{aligned}$$

$$\begin{aligned} C_{g1} &= 8 \\ C_a &= 8,5 \\ C_{g1-a} &= 0,4 \end{aligned}$$

senza schermo
without external shield

Amplificatore in classe A₁
Class A₁ Amplifier

Colleg. pentodo <i>Pentode operation</i>		Colleg. a triodo <i>Triode operation</i>	
V_a	= 180 250	250	V
V_{g2}	= 180 250	—	V
V_{g1}	= -8,5 -12,5	-12,5	V
I_a	= 29 45	49,5	mA
I_{g2}	= 3 4,5	—	mA
R_i	~ 58 52	1,97	kΩ

TIPO Type	Limiti massimi Maximum ratings	Capacità in pF Capacitances	Caratteristiche e funzionamento tipico Typical operation					
6AQ5	Amplif. defl. vert. (coli. a triodo)		S	=	3700	4100	4800	$\mu\text{A/V}$
EL90	Vert. defl. amplif. (Triode operation)		R_a	=	5,5	5	—	k Ω
(seguito) (following)	V_a = 250 V V_a (picco/peak) = 1100 V		W_o	=	2	4,5	—	W
Ingombro Outline $\varnothing=19$ h=60	V_{g1} = -250 V W_a = 9 W I_k (media/d.c. comp.) = 35 mA		d	=	8	8	—	%
Accensione Heater supply 6,3 V — 0,45 A			μ	=	—	—	9,5	
			<p>Amplificatore in classe AB₁ (Valori per due valvole) Class AB₁ Amplifier (Values are for 2 tubes)</p> <p>V_a = 250 V V_{g2} = 250 V V_{g1} = -15 V I_a = 70 mA I_{g2} = 5 mA R_a = 10 kΩ W_o = 10 W d = 5 %</p> <p>Tetrodo a fascio, amplificatore di potenza a BF ed amplificatore finale di deflessione verticale. <i>Beam Power Tube intended for service as general purpose audio power amplifier or vertical deflection amplifier in television receiver sweep circuit.</i></p>					

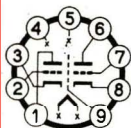
6AQ8**ECC85****Ingombro**

Outline

Ø=22 h=49

Accensione

Heater supply

6,3 V — 0,435 APer sezione
Each Unit

$V_a = 300 \text{ V}$

$W_a = 2,5 \text{ W}$

$I_k = 15 \text{ mA}$

$V_g = -100 \text{ V}$

$R_g = 1 \text{ M}\Omega$

Per sezione
Each Unit

$C_g = 3$

$C_a = 1,2$

$C_{g-a} = 1,5$

$C_{a-k} = 0,18$

Amplificatore RF
R.F. Amplifier

$V_a = 250 \text{ V}$

$V_g = -2 \text{ V}$

$R_a = 1,8 \text{ k}\Omega$

$R_k = 200 \Omega$

$I_a = 10 \text{ mA}$

$S = 6 \text{ mA/V}$

$R_i \sim 9,7 \text{ k}\Omega$

Mescolatore oscillatore
Oscillating mixer

$V_{ba} = 250 \text{ V}$

$R_a = 12 \text{ k}\Omega$

$R_g = 1 \text{ M}\Omega$

$V_{osc} = 3 \text{ V}_{eff}$

$I_a = 5,2 \text{ mA}$

$S_c = 2,3 \text{ mA/V}$

$R_i \sim 22 \text{ k}\Omega$

Doppio triodo, amplificatore a RF e mescolatore oscillatore in ricevitori MA/MF.*Twin triode intended for use as RF amplifier and self oscillating mixer.*

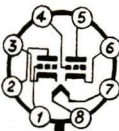
TIPO Type	Limiti massimi Maximum ratings	Capacità in pF Capacitances	Caratteristiche e funzionamento tipico Typical operation
<p>6AS7GA</p>  <p>Ingombro Outline Ø=40 h=89</p> <p>Accensione Heater supply 6,3 V — 2,5 A</p>	<p>Per sezione Each unit</p> <p>$V_a = 250 \text{ V}$ V_a (picco inverso) <i>(peak inverse anode voltage)</i> = 1700 V $I_a = 125 \text{ mA}$ $W_a = 13 \text{ W}$</p>	<p>Per sezione Each unit</p> <p>$C_g = 6,5$ $C_a = 2,2$ $C_{g-a} = 7,5$ senza schermo <i>without external shield</i></p>	<p>Per sezione Each unit</p> <p>$V_{ba} = 135 \text{ V}$ $R_k = 250 \ \Omega$ $\mu = 2$ $R_i \sim 280 \ \Omega$ $S = 7000 \ \mu\text{A/V}$ $I_a = 125 \text{ mA}$</p> <p>Doppio triodo a basso «μ», regolatore in serie per alimentatori di potenza in continua o triodo survolto. <i>Twin Power Triode. This tube can be used in any application requiring high plate current at low plate voltages. It has found wide use in electronically regulated power supplies.</i></p>

**6AT6
EBC90**

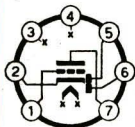

Ingombro
Outline
Ø=19 h=48

Accensione
Heater supply
6,3 V — 0,3 A

$$\begin{aligned} V_a &= 300 \text{ V} \\ V_{g_1} &= 0 \text{ V} \\ W_a &= 0,5 \text{ W} \\ I_D &= 1 \text{ mA} \end{aligned}$$

$$\begin{aligned} C_g &= 2,2 \\ C_a &= 1,2 \\ C_{g-a} &= 2,0 \end{aligned}$$

Amplificatore in classe A_1
Class A_1 Amplifier

$$\begin{aligned} V_a &= 100 \quad 250 \quad \text{V} \\ V_{g_1} &= -1 \quad -3 \quad \text{V} \\ \mu &= 70 \quad 70 \\ R_i &\sim 54 \quad 58 \quad \text{k}\Omega \\ S &= 1300 \quad 1200 \quad \mu\text{A/V} \\ I_a &= 0,8 \quad 1 \quad \text{mA} \end{aligned}$$

Doppio diodo-triodo, rivelatore e amplificatore a BF.

Twin diode-triode. Detector and audio amplifier.

6AU4GTA

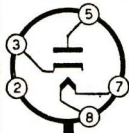

(segue)
(follow)

Massima corrente continua di uscita = 210 mA
Maximum DC Output Current

Massima ampiezza della tensione inversa anodica = 4500 V
Maximum Peak Inverse Plate Voltage

Picco massimo della corrente anodica = 1300 mA
Maximum Peak Plate Current

TIPO <i>Type</i>	Limiti massimi <i>Maximum ratings</i>	Capacità in pF <i>Capacitances</i>	Caratteristiche e funzionamento tipico <i>Typical operation</i>
<p>6AU4GTA</p> <p>(seguito) (following)</p> <p>Ingombro Outline Ø=30 h=83</p> <p>Accensione Heater supply 6,3 V — 1,8 A</p>			<p>Massima tensione continua tra filamento e catodo = 900 V <i>Maximum DC Heater-Cathode Voltage</i></p> <p>Caduta interna di tensione a 350 mA = 25 V <i>Plate Voltage Drop (for 350 mA)</i></p> <p>Diodo smorzatore per circuiti di deflessione orizzontale in TV. <i>Half-Wave Rectifier for television damper service.</i></p>
<p>6AU5GT</p> <p>Accensione Heater supply 6,3 V — 1,25 A</p>			<p>(Vedi dati condensati) (See condensed data section)</p>

6AU6 S

EF94



Ingombro
Outline
Ø=19 h=48

Accensione
Heater supply
6,3 V — 0,3 A
TR=14,5 sec.

$V_a = 300$ V
 $V_{g^2} = 150$ V
 $V_{g^1} = 0$ V
 $W_a = 3$ W
 $W_{g^2} = 0,65$ W

$C_{g^1} = 5,5$
 $C_a = 5,0$
 $C_{g-a} < 0,0035$

Amplificatore in classe A₁
Class A₁ Amplifier

Colleg. pentodo <i>Pentode operation</i>		Colleg. triodo <i>Triode operation</i>	
V_a	= 100 250	250	V
V_{g^2}	= 100 150	—	V
R_k	= 150 68	330	Ω
I_a	= 5 10,6	12,2	mA
I_{g^2}	= 2,1 4,3	—	mA
R_i	~ 500 1000	—	kΩ
S	= 3900 5200	4800	μA/V
μ	= — —	36	

Pentodo, amplificatore a RF e FI.
Pentode intended for use as RF and IF amplifier.

6AU7

Accensione in serie
Heater series supply
6,3 V — 0,3 A

Accensione in parallelo
Heater parallel supply
3,15 V — 0,6 A

Riferirsi al tipo: $\frac{12AU7}{ECC82}$
See Type

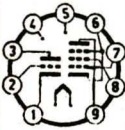
TIPO Type	Limiti massimi Maximum ratings	Capacità in pF Capacitances	Caratteristiche e funzionamento tipico Typical operation																		
<p>6AU8</p>  <p>Ingombro Outline Ø=22 h=60</p> <p>Accensione Heater supply 6,3 V — 0,6 A</p>	<p>Pentodo <i>Pentode Unit</i></p> <p>$V_a = 300$ V $V_{g2} = 150$ V $V_{g1} = 0$ V $W_a = 3$ W $W_{g2} = 1$ W</p> <p>Triodo <i>Triode Unit</i></p> <p>$V_a = 300$ V $V_g = 0$ V $W_a = 2,5$ W</p>	<p>Pentodo <i>Pentode Unit</i></p> <p>$C_{g1} = 7,5$ $C_a = 2,4$ $C_{g1-a} = 0,044$</p> <p>Triodo <i>Triode Unit</i></p> <p>$C_g = 2,6$ $C_a = 0,34$ $C_{g-a} = 2,2$</p>	<p>Amplificatore in classe A₁ <i>Class A₁ Amplifier</i></p> <table border="0"> <tr> <td>Pentodo <i>Pentode Unit</i></td> <td>Triodo <i>Triode Unit</i></td> </tr> <tr> <td>$V_a = 200$</td> <td>150 V</td> </tr> <tr> <td>$V_{g2} = 125$</td> <td>— V</td> </tr> <tr> <td>$R_k = 82$</td> <td>150 Ω</td> </tr> <tr> <td>$I_a = 17$</td> <td>9,5 mA</td> </tr> <tr> <td>$I_{g2} = 3,6$</td> <td>— mA</td> </tr> <tr> <td>$R_i \sim 140$</td> <td>7,2 kΩ</td> </tr> <tr> <td>$S = 8$</td> <td>5,6 mA/V</td> </tr> <tr> <td>$\mu = —$</td> <td>40</td> </tr> </table> <p>Triodo-pentodo. Triodo: separatore di sincronismi. Pentodo: amplificatore video.</p> <p><i>Triode-pentode.</i> <i>The triode section is designed for operation as sync separator.</i> <i>The pentode section is designed for operation as video amplifier.</i></p>	Pentodo <i>Pentode Unit</i>	Triodo <i>Triode Unit</i>	$V_a = 200$	150 V	$V_{g2} = 125$	— V	$R_k = 82$	150 Ω	$I_a = 17$	9,5 mA	$I_{g2} = 3,6$	— mA	$R_i \sim 140$	7,2 kΩ	$S = 8$	5,6 mA/V	$\mu = —$	40
Pentodo <i>Pentode Unit</i>	Triodo <i>Triode Unit</i>																				
$V_a = 200$	150 V																				
$V_{g2} = 125$	— V																				
$R_k = 82$	150 Ω																				
$I_a = 17$	9,5 mA																				
$I_{g2} = 3,6$	— mA																				
$R_i \sim 140$	7,2 kΩ																				
$S = 8$	5,6 mA/V																				
$\mu = —$	40																				

6AV5GT

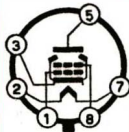

Ingombro
Outline
Ø=30 h=70

Accensione
Heater supply
6,3 V — 1,2 A

$V_a = 550 \text{ V}$
 V_a impulsiva
Pulse Plate Voltage
(picco positivo)
(peak positive)

$= 5500 \text{ V}$
 $V_{g2} = 150 \text{ V}$
 V_{g1} (c.c./d.c.)
 $= -50 \text{ V}$

V_{g1} (picco negat.)
(peak negative)
 $= 150 \text{ V}$

$W_a = 11 \text{ W}$
 $W_{g2} = 2,5 \text{ W}$
 $I_k = 110 \text{ mA}$

$C_{g1} = 14$
 $C_a = 7$
 $C_{g1} = 0,5$

Amplificatore deflessione orizzontale.
Horizontal deflection amplifier.

$V_a = 250 \text{ V}$
 $V_{g2} = 150 \text{ V}$
 $V_{g1} = -22,5 \text{ V}$
 $I_a = 55 \text{ mA}$
 $I_{g2} = 2,1 \text{ mA}$
 $R_i \sim 20 \text{ k}\Omega$
 $S = 5500 \mu\text{A/V}$
 $\mu_{g2-g1} = 4,5$

Tetrodo a fascio, amplificatore di deflessione orizzontale in TV.

Beam Power tube for use as horizontal deflection amplifier in television receivers.

6AV6

EBC91

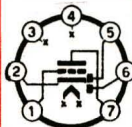

(segue)
(follow)

$V_a = 300 \text{ V}$
 $V_{g1} = 0 \text{ V}$
 $W_a = 0,5 \text{ W}$
 $I_D = 1 \text{ mA}$

$C_{g1} = 2,2$
 $C_a = 1,2$
 $C_{g-a} = 2$
 $C_{g-D2} < 0,04$

Amplificatore in classe A_1
Class A_1 Amplifier

$V_a = 100 \quad 250 \quad \text{V}$
 $V_g = -1 \quad -2 \quad \text{V}$
 $\mu = 100 \quad 100$
 $R_i \sim 80 \quad 62,5 \quad \text{k}\Omega$
 $S = 1250 \quad 1600 \quad \mu\text{A/V}$
 $I_a = 0,5 \quad 1,2 \quad \text{mA}$

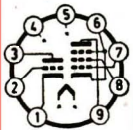
TIPO Type	Limiti massimi Maximum ratings	Capacità in pF Capacitances	Caratteristiche e funzionamento tipico Typical operation																																	
6AV6 EBC91 (seguito) (following) Ingombro Outline $\varnothing=19$ h=49 Accensione Heater supply 6,3 V — 0,3 A			Doppio diodo-triodo, rivelatore amplificatore a BF. <i>Twin diode-triode designed for second detector-audio amplifier use in radio receivers.</i> <i>il triodo è elettricamente simile ad ogni sezione della ECC83/12 AX7.</i>																																	
6AW8A  Ingombro Outline $\varnothing=22$ h=60 Accensione Heater supply 6,3 V — 0,6 A (segue) (follow)	Pentodo <i>Pentode Unit</i> $V_a = 330$ V $V_{g2} = 330$ V $W_a = 3,75$ W $W_{g2} = 1,1$ W $R_{g1} = 0,25$ M Ω (1) 1 M Ω (2) $V_{f-k} = 200$ V Triodo <i>Triode Unit</i> $V_a = 330$ V	Pentodo <i>Pentode Unit</i> $C_{g1} = 10$ $C_a = 3,6$ $C_{g1-a} = 0,05$ Triodo <i>Triode Unit</i> $C_g = 3,2$ $C_a = 1,8$ $C_{g-a} = 2,2$	Amplificatore in classe A₁ Class A₁ Amplifier <table border="0"> <thead> <tr> <th colspan="2">Pentodo <i>Pentode Unit</i></th> <th>Triodo <i>Triode Unit</i></th> </tr> </thead> <tbody> <tr> <td>$V_a = 65$</td> <td>150</td> <td>200 V</td> </tr> <tr> <td>$V_{g2} = 50$</td> <td>150</td> <td>— V</td> </tr> <tr> <td>$V_{g1} = 0$</td> <td>—</td> <td>—2 V</td> </tr> <tr> <td>$I_a = 46$</td> <td>15</td> <td>4 mA</td> </tr> <tr> <td>$I_{g2} = 15$</td> <td>3,5</td> <td>— mA</td> </tr> <tr> <td>$R_k = —$</td> <td>150</td> <td>— Ω</td> </tr> <tr> <td>$S = —$</td> <td>9500</td> <td>4000 μA/V</td> </tr> <tr> <td>$\mu = —$</td> <td>—</td> <td>70</td> </tr> <tr> <td>$R_i = 200$</td> <td>—</td> <td>17,5 kΩ</td> </tr> <tr> <td>$V_{g1} = —$</td> <td>—8</td> <td>—5 V (3)</td> </tr> </tbody> </table>	Pentodo <i>Pentode Unit</i>		Triodo <i>Triode Unit</i>	$V_a = 65$	150	200 V	$V_{g2} = 50$	150	— V	$V_{g1} = 0$	—	—2 V	$I_a = 46$	15	4 mA	$I_{g2} = 15$	3,5	— mA	$R_k = —$	150	— Ω	$S = —$	9500	4000 μ A/V	$\mu = —$	—	70	$R_i = 200$	—	17,5 k Ω	$V_{g1} = —$	—8	—5 V (3)
Pentodo <i>Pentode Unit</i>		Triodo <i>Triode Unit</i>																																		
$V_a = 65$	150	200 V																																		
$V_{g2} = 50$	150	— V																																		
$V_{g1} = 0$	—	—2 V																																		
$I_a = 46$	15	4 mA																																		
$I_{g2} = 15$	3,5	— mA																																		
$R_k = —$	150	— Ω																																		
$S = —$	9500	4000 μ A/V																																		
$\mu = —$	—	70																																		
$R_i = 200$	—	17,5 k Ω																																		
$V_{g1} = —$	—8	—5 V (3)																																		

6AW8A

(seguito)
(following)

$$W_a = 1,1 \text{ W}$$

$$R_g = 0,5 \text{ M}\Omega \text{ (1)}$$

$$1 \text{ M}\Omega \text{ (2)}$$

$$V_{f-k} = 200 \text{ V}$$

(1) Polarizzazione
fissa.

Fixed bias.

(2) Polarizzazione
automatica.

Automatic bias.

(3) Per $I_a \cong 20 \mu\text{A}$.

For $I_a \cong 20 \mu\text{A}$.

Triodo-pentodo.

Triodo: amplificatore di tensione o separatore di sincronismo.

Pentodo: amplificatore video.

Triode-pentode.

Triode Unit: designed for operation as a sync separator.

Pentode Unit: designed for operation as a video amplifier.

6AX4GT



Ingombro

Outline

$\varnothing=30 \text{ h}=70$

(segue)
(follow)

Massima corrente continua di uscita = 125 mA
Maximum DC Output Current

Massima ampiezza della tensione inversa anodica = 4400 V
Maximum Peak Inverse Plate Voltage

Massima tensione anodica alternata = 750 V_{eff}
Maximum AC Plate Supply Voltage

Picco massimo della corrente anodica = 900 mA
Maximum Peak Plate Current

Caduta interna di tensione a 250 mA = 32 V
Plate Voltage Drop (for 250 mA)

TIPO <i>Type</i>	Limiti massimi <i>Maximum ratings</i>	Capacità in pF <i>Capacitances</i>	Caratteristiche e funzionamento tipico <i>Typical operation</i>
6AX4GT <i>(seguito)</i> <i>(following)</i> Accensione Heater supply 6,3 V — 1,2 A			Diodo smorzatore per circuito di deflessione orizzontale in TV. <i>Half-Wave Rectifier for television damper service.</i>
6AX4GTB  Ingombro Outline $\varnothing=30$ h=70 Accensione Heater supply 6,3 V — 1,2 A			Massima corrente continua di uscita = 150 mA <i>Maximum DC Output Current</i> Massima ampiezza della tensione inversa anodica = 4500 V <i>Maximum Peak Inverse Plate Voltage</i> Massima tensione anodica alternata = 910 V _{eff} <i>Maximum AC Plate Supply Voltage</i> Picco massimo della corrente anodica = 900 mA <i>Maximum Peak Plate Current</i> Caduta interna di tensione a 250 mA = 32 V <i>Plate Voltage Drop (for 250 mA)</i> Diodo smorzatore per circuito di deflessione orizzontale in TV. <i>Half-Wave Rectifier for television damper service.</i>

6AX5GT

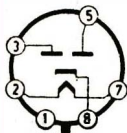

Ingombro
Outline
 $\varnothing=30$ h=70

Accensione
Heater supply
6,3 V — 1,2 A

Massima corrente continua di uscita = 125 mA
Maximum DC Output Current

Massima ampiezza della tensione inversa anodica = 1250 V
Maximum Peak Inverse Plate Voltage

Massima tensione anodica alternata = 350 V_{eff}
Maximum AC Plate Supply Voltage

Picco massimo della corrente anodica (per diodo) = 375 mA
Maximum Peak Plate Current (Each Plate)

Caduta interna di tensione a 125 mA = 50 V
Plate Voltage Drop (for 125 mA)



Massima tensione continua tra filamento e catodo = 450 V
Maximum DC Heater-Cathode Voltage

Doppio diodo raddrizzatore delle due semionde.
Full-Wave Rectifier.

6B8G/GT

Accensione
Heater supply
6,3 V — 0,3 A

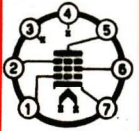
(Vedi dati condensati)
(See condensed data section)

TIPO Type	Limiti massimi Maximum ratings	Capacità in pF Capacitances	Caratteristiche e funzionamento tipico Typical operation
<p>6BA6</p> <p>EF93</p>  <p>Ingombro Outline Ø=19 h=48</p> <p>Accensione Heater supply 6,3 V — 0,3 A</p>	$V_a = 300 \text{ V}$ $V_{g^2} = 125 \text{ V}$ $V_{g^1} = -50 \div 0 \text{ V}$ $W_a = 3 \text{ W}$ $W_{g^2} = 0,6 \text{ W}$	$C_{g^1} = 5,5$ $C_a = 5,0$ $C_{g^1-a} < 0,0035$ senza schermo <i>without external shield</i>	<p>Amplificatore in classe A₁ Class A₁ Amplifier</p> $V_a = 100 \quad 250 \quad \text{V}$ $V_{g^2} = 100 \quad 100 \quad \text{V}$ $R_k = 68 \quad 68 \quad \Omega$ $I_a = 10,8 \quad 11 \quad \text{mA}$ $I_{g^2} = 4,4 \quad 4,2 \quad \text{mA}$ $R_i = 250 \quad 1000 \quad \text{k}\Omega$ $S = 4300 \quad 4400 \quad \mu\text{A/V}$ <p>Pentodo, amplificatore a RF e FI. <i>Pentode intended for use as RF and IF amplifier.</i></p>
<p>6BE6</p> <p>EK90</p>  <p>(segue) (follow)</p>	$V_a = 300 \text{ V}$ $V_{g^2-4} = 100 \text{ V}$ $V_{g^3} = 0 \text{ V}$ $W_a = 1 \text{ W}$ $W_{g^2-4} = 1 \text{ W}$ $I_k = 14 \text{ mA}$	$C_{g^3-a} < 0,3$ $C_{g^1-k} = 3$ $C_{g^1-g^3} < 0,15$ $C_{g^1-a} = 0,1$ $C_{g^2} = 7$ $C_{g^1} = 5,5$ senza schermo <i>without external shield</i>	<p>Convertitore di frequenza Frequency converter</p> $V_a = 100 \quad 250 \quad \text{V}$ $V_{g^2-4} = 900 \quad 100 \quad \text{V}$ $V_{g^3} = -1,5 \quad -1,5 \quad \text{V}$ $R_{g^1} = 20 \quad 20 \quad \text{k}\Omega$ $I_{g^1} = 0,5 \quad 0,5 \quad \text{mA}$ $I_a = 2,6 \quad 2,9 \quad \text{mA}$ $I_{g^2-4} = 6,0 \quad 6,8 \quad \text{mA}$

6BE6**EK90***(seguito)*
*(following)***Ingombro**
Outline

Ø=19 h=48

Accensione
Heater supply
6,3 V — 0,3 A

$$R_i = 0,4 \quad 1 \text{ M}\Omega$$

$$S_c = 455 \quad 475 \mu\text{A/V}$$

Eptodo, convertitore per ricevitori MA/MF, separatore sincronismi antidisturbo in TV. Pentagrid Converter Tube designed for AM/FM radioreceivers, sync separation, sync amplification and noise suppression.

6BK4B**Ingombro**
Outline

Ø=40 h=110

Accensione
Heater supply
6,3 V — 02, A*(segue)*
(follow)

$$V_a = 27000 \text{ V}$$

$$V_g = -135 \text{ V}$$

$$V_g \text{ (picco/peak)} = -440 \text{ V (1)}$$

$$I_a = 1,6 \text{ mA}$$

$$W_a = 40 \text{ W}$$

$$R_{g1} = 3 \text{ M}\Omega$$

$$C_g = 2,6$$

$$C_a = 1$$

$$C_{g-a} = 0,03$$

senza schermo
without external
shield

(1) Per un tempo di 20 sec. durante l'accensione

$$V_a = 30000 \text{ V}$$

Variazione di tensione di griglia per una variazione di corrente anodica.

Grid-Voltage change for d.c. Plate Current change.
da 0,1 a 1 mA = 9 V
from 0,1 to 1 mA = 9 V

Tensione di griglia per $I_a = 1 \text{ mA}$
Grid-Voltage for $I_a = 1 \text{ mA}$
— $V_g > 7 \text{ V}$

Tensione di griglia per $I_a = 100 \mu\text{A}$
Grid Voltage for $I_a = 100 \mu\text{A}$
— $V_g < 40 \text{ V}$

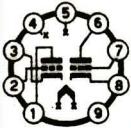
TIPO Type	Limiti massimi Maximum ratings	Capacità in pF Capacitances	Caratteristiche e funzionamento tipico Typical operation
6BK4B (seguito) (following)	(1) For 20 seconds <i>maximum duration during equipment warm-up period.</i>		<p>Nota: Usare una schermatura protettiva per raggi X emessi dalla valvola. <i>An adequate shielding against X-rays is required.</i></p> <p>Triodo a fascio, regolatore d'alta tensione per impiego in TV colore. <i>High-Voltage Beam Triode for DC Power Supply in Color-TV Receivers.</i></p>
6BK7A  Ingombro Outline $\varnothing=22$ h=49 Accensione Heater supply 6,3 V — 0,45 A	$V_a = 300$ V $V_{g1} = -50$ V $W_a = 2,7$ W	Sez. n° 1 2 <i>Unit N.</i> $C_g = 3,0$ 3,0 $C_a = 1,0$ 0,9 $C_{g-a} = 1,8$ 1,8 $C_{g-g} < 0,004$ $C_{a-a} < 0,075$ con griglia a massa <i>with grounded grid</i> $C_g = 6,0$ $C_a = 2,4$ $C_{k-a} = 0,22$ senza schermo <i>without ext. shield.</i>	Amplificatore in classe A_1 (per sezione) <i>Class A_1 Amplifier (Each Unit)</i> $C_a = 150$ V $R_k = 56$ Ω $I_a = 18$ mA $R_i \sim 4,6$ k Ω $S_c = 9300$ μ A/V $\mu = 43$ Doppio triodo, in amplificatori a RF cascode e amplificatore a larga banda (BF video). <i>Twin Triode designed for use as a cascode amplifier.</i>

6BL8**ECF80**

Ingombro
Outline

$\varnothing = 22$ h = 49

Accensione
Heater supply
6,3 V — 0,43 A

Pentodo*Pentode Unit*

$$\begin{aligned} V_b &= 550 \text{ V} \\ V_a &= 250 \text{ V} \\ V_{g^2} &= 175 \text{ V} \\ (I_k &= 14 \text{ mA}) \\ W_a &= 1,7 \text{ W} \\ W_{g^2} &= 0,5 \text{ W} \\ (W_a > &1,2 \text{ W}) \\ R_{g^1} &= 0,5 \text{ M}\Omega \text{ (1)} \\ R_{g^1} &= 1 \text{ M}\Omega \text{ (2)} \end{aligned}$$

Triodo*Triode Unit*

$$\begin{aligned} V_b &= 550 \text{ V} \\ V_a &= 250 \text{ V} \\ I_k &= 14 \text{ mA} \\ W_a &= 1,5 \text{ W} \\ R_{g^1} &= 0,5 \text{ M}\Omega \text{ (3)} \end{aligned}$$

- (1) Polarizz. fissa.
Fixed bias.
- (2) Polarizz. autom.
Automatic bias.
- (3) Polarizz. fissa o
automatica.
*Fixed/Automatic
bias.*

Pentodo*Pentode Unit*

$$\begin{aligned} C_{g^1} &= 5,2 \\ C_a &= 3,4 \\ C_{g^1-a} &< 0,025 \end{aligned}$$

Triodo*Triode Unit*

$$\begin{aligned} C_g &= 2,5 \\ C_a &= 1,8 \\ C_{g-a} &= 1,5 \end{aligned}$$

Amplificatore in classe A₁*Class A₁ Amplifier***Pentodo***Pentode Unit*

$$\begin{aligned} V_a &= 170 \\ V_{g^2} &= 170 \\ V_{g^1} &= -2 \\ I_a &= 10 \\ I_{g^2} &= 2,8 \\ S &= 6200 \\ \mu_{g^2-g^1} &= 47 \\ \mu &= - \\ R_i &= 0,4 \end{aligned}$$

Triodo*Triode Unit*

$$\begin{aligned} 100 &\text{ V} \\ - &\text{ V} \\ -2 &\text{ V} \\ 14 &\text{ mA} \\ - &\text{ mA} \\ 5000 &\mu\text{A/V} \\ - & \\ 20 & \\ - &\text{ M}\Omega \end{aligned}$$

Triodo-pentodo.**Triodo a medio « μ ».****Pentodo ad interdizione rapida.****Amplificatore FI, convertitore, ecc.***Triode-pentode.**Medium-μ Triode.**Sharp Cutoff Pentode.**IF Amplifier, converter, ...*

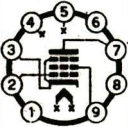
TIPO <i>Type</i>	Limiti massimi <i>Maximum ratings</i>	Capacità in pF <i>Capacitances</i>	Caratteristiche e funzionamento tipico <i>Typical operation</i>																																																																																																					
6BM8 <hr/> ECL82 Accensione Heater supply 6,3 V — 0,78 A			Riferirsi al tipo: 16A8 <i>See Type</i> PCL82																																																																																																					
6BQ5 <hr/> EL84  Ingombro Outline $\varnothing=22$ h=70 Accensione Heater supply 6,3 V — 0,76 A <i>(segue)</i> <i>(follow)</i>	$V_a = 300$ V $V_{g^2} = 300$ V $V_{g^1} = -100$ V $W_a = 12$ W $W_{g^2} = 2$ W $I_k = 65$ mA	$C_{g^1} = 11$ $C_a = 6$ $C_{g^1-a} = 0,5$	<table border="0"> <thead> <tr> <th></th> <th colspan="3">Classe/Class A₁ (un tubo - <i>one Tube</i>)</th> <th colspan="3">Classe/Class AB₁ (in controfase - <i>Push-pull</i>)</th> </tr> </thead> <tbody> <tr> <td>V_a</td> <td>= 250</td> <td>250</td> <td>300</td> <td>V</td> <td></td> <td></td> </tr> <tr> <td>V_{g^2}</td> <td>= 250</td> <td>250</td> <td>300</td> <td>V</td> <td></td> <td></td> </tr> <tr> <td>V_{g^1}</td> <td>= -7,3</td> <td>—</td> <td>—</td> <td>V</td> <td></td> <td></td> </tr> <tr> <td>R_k</td> <td>= —</td> <td>130</td> <td>130</td> <td>Ω</td> <td></td> <td></td> </tr> <tr> <td>I_a</td> <td>= 48</td> <td>62</td> <td>72</td> <td>mA</td> <td></td> <td></td> </tr> <tr> <td>I_{g^2}</td> <td>= 5,5</td> <td>7</td> <td>8</td> <td>mA</td> <td></td> <td></td> </tr> <tr> <td>S</td> <td>= 11,3</td> <td>—</td> <td>—</td> <td>mA/V</td> <td></td> <td></td> </tr> <tr> <td>$U_{g^2-g^1}$</td> <td>= 19</td> <td>—</td> <td>—</td> <td></td> <td></td> <td></td> </tr> <tr> <td>R_i</td> <td>\sim 38</td> <td>—</td> <td>—</td> <td>kΩ</td> <td></td> <td></td> </tr> <tr> <td>R_a</td> <td>= 5,2</td> <td>—</td> <td>—</td> <td>kΩ</td> <td></td> <td></td> </tr> <tr> <td>R_{a-a}</td> <td>= —</td> <td>8</td> <td>8</td> <td>kΩ</td> <td></td> <td></td> </tr> <tr> <td>W_o</td> <td>= 5,7</td> <td>11</td> <td>17</td> <td>W</td> <td></td> <td></td> </tr> <tr> <td>d</td> <td>= 10</td> <td>3</td> <td>4</td> <td>%</td> <td></td> <td></td> </tr> </tbody> </table>					Classe/Class A₁ (un tubo - <i>one Tube</i>)			Classe/Class AB₁ (in controfase - <i>Push-pull</i>)			V_a	= 250	250	300	V			V_{g^2}	= 250	250	300	V			V_{g^1}	= -7,3	—	—	V			R_k	= —	130	130	Ω			I_a	= 48	62	72	mA			I_{g^2}	= 5,5	7	8	mA			S	= 11,3	—	—	mA/V			$U_{g^2-g^1}$	= 19	—	—				R_i	\sim 38	—	—	k Ω			R_a	= 5,2	—	—	k Ω			R_{a-a}	= —	8	8	k Ω			W_o	= 5,7	11	17	W			d	= 10	3	4	%		
	Classe/Class A₁ (un tubo - <i>one Tube</i>)			Classe/Class AB₁ (in controfase - <i>Push-pull</i>)																																																																																																				
V_a	= 250	250	300	V																																																																																																				
V_{g^2}	= 250	250	300	V																																																																																																				
V_{g^1}	= -7,3	—	—	V																																																																																																				
R_k	= —	130	130	Ω																																																																																																				
I_a	= 48	62	72	mA																																																																																																				
I_{g^2}	= 5,5	7	8	mA																																																																																																				
S	= 11,3	—	—	mA/V																																																																																																				
$U_{g^2-g^1}$	= 19	—	—																																																																																																					
R_i	\sim 38	—	—	k Ω																																																																																																				
R_a	= 5,2	—	—	k Ω																																																																																																				
R_{a-a}	= —	8	8	k Ω																																																																																																				
W_o	= 5,7	11	17	W																																																																																																				
d	= 10	3	4	%																																																																																																				

6BQ5**EL84***(seguito)*
(following)

Connesso a Trlodo (1)

Triode Operation

Classe/Class A_1	Classe/Class AB_1		
(un tubo - one Tube)	(in controfase - Push-pull)		
$V_a = 250$	250	300	V
$R_k = 270$	270	270	Ω
$V_i = 6,7$	8,3	10	V_{eff}
$I_a = 36$	43,4	52	mA
$R_a = 3,5$	—	—	k Ω
$R_{a-a} = —$	10	10	k Ω
$W_o = 1,95$	3,4	5,2	W
$d = 9$	2,5	2,5	%

(1) g_s e anodo collegati insieme.*Grid No. 2 connected to plate.*

Pentodo, amplificatore di potenza a BF ed amplificatore di deflessione verticale in TV.
Pentode Power Tube intended for service as general purpose audio amplifier or vertical deflection amplifier in television receivers sweep circuit.

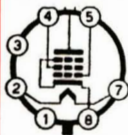
6BQ6GT*(segue)*
(follow)

$V_a = 550$	V
V_a impulsiva (picco positivo)	
<i>Peak Positive-Pulse Plate Voltage</i>	
$= 5500$	V
$V_{g^2} = 175$	V

$C_{g1} = 14$	
$C_a = 9,5$	
$C_{g1-a} = 0,95$	
senza schermo <i>without external shield</i>	

Amplificatore deflessione orizzontale
Horizontal-Deflection Amplifier

$V_a = 60$	250	V
$V_{g^2} = 150$	150	V
$V_{g1} = 0$	-22,5	V
$I_a = 225$	55	mA
$I_s = 25$	2,1	mA
$R_i \sim$	—	20 mA

TIPO Type	Limiti massimi Maximum ratings	Capacità in pF Capacitances	Caratteristiche e funzionamento tipico Typical operation
<p>6BQ6GT</p> <p>(seguito) (following)</p> <p>Ingombro Outline Ø=30 h=84</p> <p>Accensione Heater supply 6,3 V — 1,2 A</p>	<p>V_{g1} (c. c./d. c.) = -50 V</p> <p>W_a = 11 W</p> <p>W_{g2} = 2,5 W</p>		<p>S = — 5500 μV/A</p> <p>Tetrodo a fascio, particolarmente progettato per l'uso come amplificatore di deflessione orizzontale in TV. <i>Beam Power Tube designed for service as horizontal amplifier in television receivers.</i></p>
<p>6BQ7A</p> <p>Accensione Heater supply 6,3 V — 0,4 A</p>			<p>(Vedi dati condensati). (See condensed data section).</p>

6BR5**EM80**

Accensione
Heater supply
6,3 V — 0,3 A

(Vedi dati condensati)
(See condensed data section)

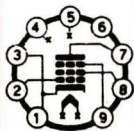
6BX6**EF80****S****Ingombro**

Outline

Ø=22 h=60

Accensione
Heater supply
6,3 V — 0,3 A

TR=14,5 sec.

(segue)

(follow)

$$\begin{aligned} V_a &= 300 \text{ V} \\ V_{g^2} &= 300 \text{ V} \\ W_a &= 2,5 \text{ W} \\ W_{g^2} &= 0,7 \text{ W} \\ I_k &= 15 \text{ mA} \\ R_{g^2} &= 1 \text{ M}\Omega \end{aligned}$$

$$\begin{aligned} C_{g^1} &= 6,9 \\ C_a &= 3,1 \\ C_{g^1-a} &< 0,007 \end{aligned}$$

Amplificatore in classe A_1
Class A_1 Amplifier

V_a	=	170	200	250	V
V_{g^2}	=	0	0	0	V
V_{g^2}	=	170	200	250	V
V_{g^1}	=	-2	-2,55	-3,5	V
I_a	=	10	10	10	mA
I_{g^2}	=	2,5	2,6	2,8	mA
S	=	7400	7100	6800	$\mu\text{A/V}$
R_i	\sim	0,5	0,55	0,65	$\text{M}\Omega$
$\mu_{g^2-g^1}$	=	50	50	50	
R_{eq}	=	1	1,1	1,2	$\text{k}\Omega$
r_{g^1}	=	10	12	15	$\text{k}\Omega$ (1)

(1) Resistenza d'ingresso a 50 MHz; piedini 1 e 3 connessi.

Grid No. 1 input resistance $f = 50 \text{ MHz}$, pin 1 connected to pin 3.

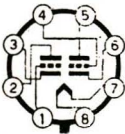
TIPO <i>Type</i>	Limiti massimi <i>Maximum ratings</i>	Capacità in pF <i>Capacitances</i>	Caratteristiche e funzionamento tipico <i>Typical operation</i>
6BX6 EF80 S (seguito) (following)			Pentodo, amplificatore a RF e FI; amplificatore video. <i>Pentode intended for use as RF, IF or video amplifier.</i>
6BX7GT  Ingresso Outline $\varnothing = 30$ h=70 Accensione Heater supply 6,3V — 1,5 A (segue) (follow)	$V_a = 500$ V V_a impulsiva (picco positivo) <i>Peak Positive-Pulse</i> $= 2000$ V $V_g = 0$ V V_{g1} (picco negativo) <i>Peak Negative-Pulse</i> $= 500$ V $W_a = 10$ W $I_k = 60$ mA $R_g = 2,2$ M Ω I_k (picco/peak) $= 180$ mA	Sezione 1 (1) <i>Section No. 1 (1)</i> $C_g = 4,4$ $C_a = 1,1$ $C_{g-a} = 4,2$ Sezione 2 (2) <i>Section No. 2 (2)</i> $C_g = 4,8$ $C_a = 1,2$ $C_{g-a} = 4,0$ $C_{g-g} = 0,11$ $C_{a-a} = 1,5$ senza schermo <i>without external shield</i>	Amplificatore in classe A₁ (per sezione) <i>Class A₁ Amplifier (Each Section)</i> $V_a = 100 \quad 250$ V $R_k = 0 \quad 390$ Ω $I_a = 80 \quad 42$ mA $S = \quad \quad 7600$ μ A/V $\mu = \quad \quad 10$ $R_i \sim \quad \quad 1,3$ k Ω Amplificatore di deflessione verticale - Sez. 2 <i>Vertical Deflection Amplifier - Section No. 2</i> $V_a = 170$ V $R_k = 170$ Ω Tensione d'ingresso (circa): <i>Grid input voltage (approx):</i> — componente a dente di sega $= 41$ V <i>sawtooth component</i>

6BX7GT

(seguito)
(following)

(1) piedini 4, 5
e 6
pins 4, 5 and
6.

(2) piedini 1, 2
e 3.
pins 1, 2 and
3.

— ampiezza del guizzo negativo = 70 V
peak negative pulse component

Tensione di uscita (circa):
Plate output voltage (approx):

— componente a dente di sega = 160 V
sawtooth component

— ampiezza del guizzo positivo = 840 V
peak positive pulse component

I_k (media/DC component) = 24 mA

I_k (picco/peak) = 65 mA

**Doppio triodo amplificatore di deflessione
verticale e oscillatore di quadro in TV.**

Twin triode designed for use as a vertical amplifier or oscillator in television receivers.

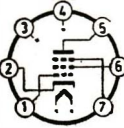
TIPO <i>Type</i>	Limiti massimi <i>Maximum ratings</i>	Capacità in pF <i>Capacitances</i>	Caratteristiche e funzionamento tipico <i>Typical operation</i>
<p>6BY7 EF85</p>  <p>Ingombro Outline Ø=22 h=60</p> <p>Accensione Heater supply 6,3 V — 0,3 A</p>	<p> $V_a = 250 \text{ V}$ $V_{g2} = 250 \text{ V}$ $W_a = 2,5 \text{ W}$ $W_{g2} = 0,65 \text{ W}$ $I_k = 15 \text{ mA}$ $R_{g1} = 3 \text{ M}\Omega$ </p>	<p> $C_{g1} = 6,9$ $C_a = 3,2$ $C_{a-g1} < 0,007$ </p>	<p>Amplificatore in classe A_1 <i>Class A_1 Amplifier</i></p> <p> $V_a = 250 \text{ V}$ $V_{g2} = 0 \text{ V}$ $V_{g3} = 100 \text{ V}$ $V_{g1} = -2 \text{ V}$ $I_a = 10 \text{ mA}$ $I_{g2} = 2,5 \text{ mA}$ $S = 6000 \mu\text{A/V}$ $R_i = 0,6 \text{ M}\Omega$ $\mu_{g2-g1} = 26$ </p> <p>Pentodo a pendenza variabile, amplificatore RF o FI a larga banda. <i>RF pentode with variable transconductance intended for use as wide-band amplifier.</i></p>
<p>6BZ6</p>  <p>(segue) (follow)</p>	<p> $V_a = 330 \text{ V}$ $W_a = 2,3 \text{ W}$ $W_{g2} = 0,5 \text{ W}$ </p>	<p> $C_{g1} = 7$ $C_a = 2$ $C_{g1-a} < 0,025$ senza schermo <i>without external shield</i> </p>	<p>Amplificatore in classe A_1 <i>Class A_1 Amplifier</i></p> <p> $V_a = 125 \text{ V}$ $V_{g2} = 125 \text{ V}$ $R_k = 56 \Omega$ $R_i \sim 260 \text{ k}\Omega$ $S = 8000 \mu\text{A/V}$ </p>

6BZ6

(seguito)
(following)

Ingombro
Outline
Ø=19 h=48

Accensione
Heater supply
6,3 V — 0,3 A

$$I_a = 14 \text{ mA}$$
$$I_{g3} = 3,6 \text{ mA}$$

Pentodo a «μ» semifisso ed elevata trasconduttanza per stadi amplificatori a IF in TV.

Semi-Remote Cutoff Pentode designed for use as IF amplifier in television receivers.

6BZ7

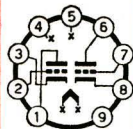

Ingombro
Outline
Ø=22 h=49

Accensione
Heater supply
6,3 V — 0,4 A

(segue)
(follow)

Per ogni sezione
Each Section

$$V_a = 250 \text{ V}$$
$$W_a = 2 \text{ W}$$
$$I_k = 20 \text{ mA}$$
$$V_{g-k} = 200 \text{ V}$$
$$R_g = 0,5 \text{ M}\Omega$$

Sezione 1 (1)
Section No. 1 (1)

$$C_g = 2,6$$
$$C_a = 1,2$$
$$C_{g-a} = 1,2$$
$$C_{f-k} = 2,6$$

Sezione 2 (2)
Section No. 2 (2)

$$C_{g-a} = 1,2$$
$$C_{f-k} = 2,6$$

Amplificatore in classe A₁ (per sezione)
Class A₁ Amplifier (Each Section)

$$V_a = 150 \text{ V}$$
$$I_a = 10 \text{ mA}$$
$$R_k = 220 \Omega$$
$$S = 6800 \mu\text{A/V}$$
$$\mu = 36$$
$$R_i = 5300 \Omega$$
$$V_{g1} = -7 \text{ V con } I_a = 100 \mu\text{A}$$

Doppio triodo a basso fruscio, per impiego in circuiti cascode nei sintonizzatori VHF.

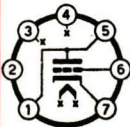
TIPO Type	Limiti massimi Maximum ratings	Capacità in pF Capacitances	Caratteristiche e funzionamento tipico Typical operation
6BZ7 (seguito) (following)		(1) piedini 6, 7 e 8. pins 6, 7 and 8. (2) piedini 1, 2 e 3. pins 1, 2 and 3.	<i>Twin Triode designed for use in low noise VHF amplifier applications and particularly for cascode operation.</i>
6C4 EC90  Ingombro Outline $\varnothing = 19$ h = 48 Accensione Heater supply 6,3 V — 0,15 A	Amplific. Telegraf. <i>Telegraphy Amplifier</i> Classe A Classe C <i>Class A Class C</i> $V_a = 300$ 300 V $V_g = -$ -50 V $W_a = 3,5$ 5 W $I_a = -$ 25 mA $I_g = -$ 8 mA <i>E' elettronicamente misce le aut. sp. reg. nel della ecc 82/13 AU7</i>	$C_g = 1,8$ $C_a = 2,5$ $C_{g-a} = 1,4$ con schermo <i>with external shield</i>	Amplificatore in classe A_1 <i>Class A_1 Amplifier</i> $V_a = 100$ 250 300 V $V_g = 0$ -8,5 -27 V $I_a = 11,8$ 10,5 25 mA $I_g = -$ - ~7 mA $R_i \sim 6250$ 7700 - Ω $S = 3100$ 2200 - $\mu A/V$ $\mu = 19,5$ 17 - $W_i = -$ - ~0,35 W $W_o = -$ - ~5,5 W $f = -$ - 50 MHz Triodo, amplificatore ed oscillatore. <i>Triode intended for service as an oscillator, a detector or amplifier.</i>

6CA4**EZ81****Ingombro**

Outline

 $\varnothing=22$ h=71**Accensione**

Heater supply

6,3 V — 1 A

6CA7**EL34**

(segue)

(follow)

V_a	=	800 V
V_{g2}	=	500 V
W_a	=	27,5 W
W_{g2}	=	8 W
I_k	=	150 mA
R_{g1}	=	0,7 M Ω

C_{g1}	=	15,2
C_a	=	8,4
C_{g1-a}	<	1,1

Massima corrente continua di uscita = 150 mA
Maximum DC Output Current

Massima ampiezza della tensione inversa anodica = 1000 V
Maximum Peak Inverse Plate Voltage

Massima tensione anodica alternata = 350 V_{eff}
Maximum AC Plate Supply Voltage

Picco massimo della corrente anodica (per diodo) = 450 mA
Maximum Peak Plate Current (Each Plate)

Maximum Peak Plate Current (Each Plate)

Caduta interna di tensione a 150 mA = 20 V
Plate Voltage Drop (for 150 mA)

Doppio diodo, rettificatore delle due semionde.

Full-Wave Rectifier.

Amplificatore in classe A₁
Class A₁ Amplifier

V_a	=	265	300	V
V_{g2}	=	250	300	V
V_{g1}	=	-13,5	—	V
R_k	=	—	190	Ω
I_a	=	100	83	mA
I_{g2}	=	15	13	mA
S	=	11000	—	μ A/V

TIPO Type	Limiti massimi Maximum ratings	Capacità in pF Capacitances	Caratteristiche e funzionamento tipico Typical operation			
6CA7			$R_i = 15 \text{ — } k\Omega$			
EL34			$R_a = 2 \quad 3,5 \quad k\Omega$			
			$W_o = 11 \quad 11 \quad W$			
(seguito) (following)			$d = 10 \quad 10 \quad \%$			
Ingombro Outline $\varnothing=33 \text{ h}=98$			Controfase in classe AB₁			
Accensione Heater supply 6,3 V — 1,5 A			Class AB₁ Push-pull Power Amplifier			
			$V_a = 375 \quad 450 \quad 400 \quad V$			
			$V_{g^2} = 375 \quad 450 \quad 400 \quad V$			
			$R_{g^2} = 470 \quad 1000 \quad 800 \quad \Omega$			
			$V_{g^1} = \text{—} \quad \text{—} \quad -36 \quad V$			
			$R_k = 130 \quad 232 \quad \text{—} \quad \Omega$			
			$I_a (1) = 150 \quad 120 \quad 60 \text{ mA}$			
			$I_a (2) = 188 \quad 143 \quad 221 \text{ mA}$			
			$I_{g^2} (1) = 25 \quad 20 \quad 9 \text{ mA}$			
			$I_{g^2} (2) = 39 \quad 44 \quad 46 \text{ mA}$			
			$R_{a1} (3) = 3,5 \quad 6,5 \quad 3,5 \quad k\Omega$			
			$W_o = 35 \quad 40 \quad 54 \quad W$			
			$d = 1,7 \quad 5,1 \quad 1,6 \quad \%$			
			Controfase - Connessioni a Triodo			
			Push-pull Power Amplifier-Triode Operation			
			$V_a = 400 \quad V$			
			$I_a (1) = 130 \text{ mA}$			
			$I_a (2) = 142 \text{ mA}$			
			$R_k = 220 \quad \Omega$			

6CA7**EL34***(seguito)
(following)*

$$R_a(3) = 5 \text{ k}\Omega$$

$$W_o = 16,5 \text{ W}$$

$$d = 3 \%$$

- (1) In assenza di segnale.
Zero-Signal.
- (2) Con il massimo segnale.
Max.-Signal.
- (3) Tra anodo e anodo.
Plate to plate.

Pentodo amplificatore di potenza in BF.
Power Pentode for BF Power Amplifier.

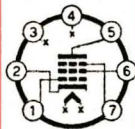
6CB6

Ingombro
Outline

$\varnothing=19 \text{ h}=48$

Accensione
Heater supply
6,3 V — 0,3 A

$$V_a = 300 \text{ V}$$

$$V_{g2} = 150 \text{ V}$$

$$W_a = 2 \text{ W}$$

$$W_{g2} = 0,5 \text{ W}$$

$$C_{g1} = 6,5$$

$$C_a = 2$$

$$C_{g1-a} = 0,02$$

senza schermo
*without external
shield*

Amplificatore in classe A₁
Class A₁ Amplifier

$$V_a = 125 \quad 200 \quad \text{V}$$

$$V_{g2} = 125 \quad 150 \quad \text{V}$$

$$R_k = 56 \quad 180 \quad \Omega$$

$$R_i \sim 280 \quad 600 \quad \text{k}\Omega$$

$$S = 8000 \quad 6200 \quad \mu\text{A/V}$$

$$I_a = 13 \quad 9,5 \quad \text{mA}$$

$$I_{g2} = 3,7 \quad 2,8 \quad \text{mA}$$

Pentodo, amplificatore a FI in TV.
*Pentode intended for use as IF amplifier or RF
amplifier VHF television tuners.*

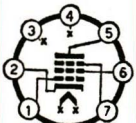
TIPO Type	Limiti massimi Maximum ratings	Capacità in pF Capacitances	Caratteristiche e funzionamento tipico Typical operation
<p>6CF6</p>  <p>Ingombro Outline Ø=19 h=48</p> <p>Accensione Heater supply 6,3 V — 0,3 A</p>	<p> $V_a = 330$ V $V_{g^2} = 330$ V $W_a = 2,3$ W $W_{g^2} = 0,55$ W $V_{g^1} = 0$ V $V_{f-k} = 200$ V </p>	<p> $C_{g^1} = 6,5$ $C_a = 2$ $C_{g^1-a} = 0,015$ </p>	<p>Amplificatore in classe A_1 <i>Class A_1 Amplifier</i></p> <p> $V_a = 125$ V $V_{g^2} = 125$ V $I_a = 12,5$ mA $I_{g^2} = 3,7$ mA $R_k = 56$ Ω $S = 7800$ μA/V $R_i = 300$ kΩ $V_{g^1} = -6$ con $I_a = 20$ μA $V_{g^1} = -3$ con $I_a = 2,2$ mA senza resistenza catodica <i>cathode resistor = 0 ohms.</i> </p> <p>Pentodo amplificatore FI in TV. <i>Pentode intended for use in gain controlled IF amplifier or VHF tuners.</i></p>
<p>6CG7</p> <p>Accensione Heater supply 6,3 V — 0,6 A</p>			<p>Per gli altri dati riferirsi al tipo: 12CG7 S <i>See Type</i></p>

6CG8A



Ingombro
Outline
Ø=22 h=49

Accensione
Heater supply
6,3 V — 0,45 A

Triodo (oscillatore) *Triode Unit (oscill.)*

$V_a = 250 \text{ V}$
 $V_g = -40 \div 0 \text{ V}$
 $W_a = 1,5 \text{ W}$

Pentodo (miscelat.) *Pentode Unit (mixer)*

$V_a = 250 \text{ V}$
 $V_{g^2} = 250 \text{ V}$
 $V_{g^1} = -40 \div 0 \text{ V}$
 $W_a = 2 \text{ W}$

Triodo *Triode Unit*

$C_g = 2,6$
 $C_a = 0,05$
 $C_{g-a} = 1,5$

Pentodo *Pentode Unit*

$C_{g^1} = 4,8$
 $C_a = 0,9$
 $C_{g^1-a} < 0,03$
senza schermo
without external shield

Convertitore *Converter*

Triodo oscillatore <i>Triode Unit Oscillat.</i>	Pentodo mescolatore <i>Pentode Unit Mixer</i>
--	--

$V_a = 150$	150 V
$V_{g^2} = -$	150 V
$V_{g^1} = -$	-3,5 V
$V_{g^1} = -$	2,6 V_{eff}
$R_g = 2700$	— Ω
$S_c = -$	2100 $\mu\text{A/V}$
$I_a = 13$	6,2 mA
$I_{g^2} = -$	1,8 mA
$I_g = 3,6$	— mA
$I_{g^1} = -$	2 μA
$W_o \sim 0,5$	— W

Triodo-pentodo, progettato per l'uso come convertitore in ricevitori TV o MF.

Triode-Pentode designed primarily for service as VHF oscillator and mixer in TV receivers utilizing an IF in the order of 40 MHz.

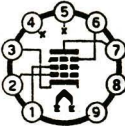
TIPO Type	Limiti massimi Maximum ratings	Capacità in pF Capacitances	Caratteristiche e funzionamento tipico Typical operation
6CK5 EL41 Accensione Heater supply 6,3 V — 0,71 A			(Vedi dati condensati). (See condensed data section)
6CK6 EL83  Ingombro Outline $\varnothing=22$ h=71 Accensione Heater supply 6,3 V — 0,71 A	$V_a = 300$ V $V_{g^2} = 300$ V $W_a = 9$ W ~ $W_{g^2} = 2$ W $I_k = 70$ mA $R_{g^1} = 1$ M Ω (1) $R_{g^1} = 0,5$ M Ω (2) (1) Polarizzazione automatica. <i>Automatic bias.</i> (2) Polarizzazione fissa. <i>Fixed bias.</i>	$C_{g^1} = 10,8$ $C_a = 6,6$ $C_{g^1-a} = 0,1$ senza schermo <i>without external shield</i>	Amplificatore in classe A_1 <i>Class A_1 Amplifier</i> $V_a = 250$ V $V_{g^3} = 0$ V $V_{g^2} = 250$ V $V_{g^1} = -5,5$ V $I_a = 36$ mA $I_{g^2} = 5$ mA $S = 10000$ μ A/V $\mu_{g^1-g^2} = 24$ $R_i = 0,13$ M Ω Pentodo, finale video. <i>Pentode Power Tube intended for use as video output.</i>

6CL6

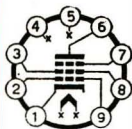

Ingombro
Outline

$\varnothing=22$ h=60

Accensione
Heater supply
6,3 V — 0,65 A

$$\begin{aligned} V_a &= 300 \text{ V} \\ V_{g^2} &= 300 \text{ V} \\ V_{g^1} &= -50 \div 0 \text{ V} \\ W_a &= 7,5 \text{ W} \\ W_{g^2} &= 1,7 \text{ W} \end{aligned}$$

$$\begin{aligned} C_{g^1} &= 11 \\ C_a &= 5,5 \\ C_{g^1-a} &= 0,12 \end{aligned}$$

senza schermo
without external
shield

Amplificatore in classe A₁
Class A₁ Amplifier

$$\begin{aligned} V_a &= 250 \text{ V} \\ V_{g^2} &= 150 \text{ V} \\ V_{g^1} &= -3 \text{ V} \\ R_i &= 150 \text{ k}\Omega \\ S &= 11000 \text{ }\mu\text{A/V} \\ I_a &= 30 \text{ mA} \\ I_{g^2} &= 7 \text{ mA} \\ R_a &= 7500 \text{ }\Omega \\ W_o &= 2,8 \text{ W} \\ d &= 8 \text{ \%} \end{aligned}$$

Pentodo di potenza per BF ed amplificatore finale video.

Pentode Power Amplifier designed primarily for use as video output amplifier in television receivers.

6CM4

EC86

Accensione
Heater supply
6,3 V — 0,175 A

Riferirsi al tipo: $\frac{4CM4}{PC86} S$
See Type

TIPO Type	Limiti massimi Maximum ratings	Capacità in pF Capacitances	Caratteristiche e funzionamento tipico Typical operation																																													
6CM5 EL36 Accensione Heater supply 6,3 V — 1,25 A			Riferirsi al tipo: $\frac{25E5}{PL36}$ S See Type																																													
6CS6 S EH90  Ingombro Outline $\varnothing=19$ h=48 Accensione Heater supply 6,3 V — 0,3 A TR=14,5 sec.	$V_a = 300$ V $V_{g^{2-4}} = 100$ V $W_a = 1$ W $W_{g^{2-4}} = 1$ W $I_k = 14$ mA	$C_{g^1} = 5,5$ $C_{g^3} = 7,0$ $C_a = 7,5$ $C_{g^1-a} < 0,07$ $C_{g^3-a} < 0,36$ $C_{g^1-g^3} < 0,22$ senza schermo <i>without external shield</i>	Separatore sincronismi <i>Sync. separator</i> <table border="0"> <tr> <td>V_a</td> <td>= 10</td> <td>100</td> <td>100</td> <td>V</td> </tr> <tr> <td>$V_{g^{2-4}}$</td> <td>= 30</td> <td>30</td> <td>30</td> <td>V</td> </tr> <tr> <td>V_{g^3}</td> <td>= 0</td> <td>-1</td> <td>0</td> <td>V</td> </tr> <tr> <td>V_{g^1}</td> <td>= 0</td> <td>0</td> <td>-1</td> <td>V</td> </tr> <tr> <td>R_i</td> <td>~</td> <td>—</td> <td>0,7</td> <td>1 MΩ</td> </tr> <tr> <td>S_{g^3}</td> <td>= —</td> <td>1500</td> <td>—</td> <td>μA/V</td> </tr> <tr> <td>S_{g^1}</td> <td>= —</td> <td>—</td> <td>1100</td> <td>μA/V</td> </tr> <tr> <td>I_a</td> <td>= 2</td> <td>0,8</td> <td>1</td> <td>mA</td> </tr> <tr> <td>$I_{g^{2-4}}$</td> <td>= 4,5</td> <td>5,5</td> <td>1,3</td> <td>mA</td> </tr> </table> Eptodo, separatore sincronismi antdisturbo in TV. <i>Heptode designed for television service as a combined sync separator and sync clipper.</i>	V_a	= 10	100	100	V	$V_{g^{2-4}}$	= 30	30	30	V	V_{g^3}	= 0	-1	0	V	V_{g^1}	= 0	0	-1	V	R_i	~	—	0,7	1 M Ω	S_{g^3}	= —	1500	—	μ A/V	S_{g^1}	= —	—	1100	μ A/V	I_a	= 2	0,8	1	mA	$I_{g^{2-4}}$	= 4,5	5,5	1,3	mA
V_a	= 10	100	100	V																																												
$V_{g^{2-4}}$	= 30	30	30	V																																												
V_{g^3}	= 0	-1	0	V																																												
V_{g^1}	= 0	0	-1	V																																												
R_i	~	—	0,7	1 M Ω																																												
S_{g^3}	= —	1500	—	μ A/V																																												
S_{g^1}	= —	—	1100	μ A/V																																												
I_a	= 2	0,8	1	mA																																												
$I_{g^{2-4}}$	= 4,5	5,5	1,3	mA																																												

6CS7

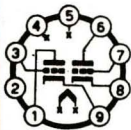

Ingombro
Outline
 $\varnothing=22$ h=60

Accensione
Heater supply
6,3 V — 0,3 A

Sezione 1 Section No. 1

$V_a = 500$ V
 V_{g1} (picco/peak) = -400 V
 $W_a = 1,25$ W
 $I_k = 20$ mA
 I_k (picco/peak) = 70 mA
 $R_g = 2,2$ M Ω

Sezione 2 Section No. 2

$V_a = 500$ V
 V_a (picco/peak) = 2200 V
 V_{g2} (picco/peak) = -250 V
 $W_a = 6,5$ W
 $I_k = 30$ mA
 I_k (picco/peak) = 105 mA
 $R_g = 2,2$ M Ω

Sezione 1 Section No. 1

$C_g = 1,8$
 $C_a = 0,5$
 $C_{g-a} = 2,6$
 senza schermo
without external shield

Sezione 2 Section No. 2

$C_g = 3$
 $C_a = 0,5$
 $C_{g-a} = 2,6$
 senza schermo
without external shield

Amplificatore in classe A₁ Class A₁ Amplifier

Sezione 1 Section No. 1	Sezione 2 Section No. 2
$V_a = 250$	250 V
$V_g = -8,5$	-10,5 V
$I_a = 10,5$	19 mA
$S = 2200$	4500 μ A/V
$R_i \sim 7,7$	3,45 k Ω
$\mu = 17$	15,5

Doppio triodo, sezione 1 (connessione 6-7-8), oscillatore di deflessione verticale; sezione 2 (connessioni 1-3-9), amplificatore di deflessione verticale.

Twin Triode. Section No. 1 connected to pins 6, 7 and 8, intended for operation as a Vertical-Deflection oscillator and Section No. 2 connected to pins 1, 3 and 9, as a vertical deflection amplifier.

TIPO <i>Type</i>	Limiti massimi <i>Maximum ratings</i>	Capacità in pF <i>Capacitances</i>	Caratteristiche e funzionamento tipico <i>Typical operation</i>
6CU6 Accensione Heater supply 6,3 V — 1,2 A			Riferirsi al tipo: 6BQ6GT <i>See Type</i>
6CW5 EL86 Accensione Heater supply 6,3 V — 0,76 A			Riferirsi al tipo: $\frac{15CW5}{PL84}$ S <i>See Type</i>
6CW7 ECC84 Accensione Heater supply 6,3 V — 0,33 A			(Vedi dati condensati) (See condensed data section)

6DA4

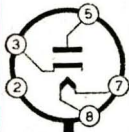

Ingombro

Outline

Ø=30 h=70

Accensione
Heater supply
6,3 V — 1,2 A

Massima corrente continua di uscita = 145 mA
Maximum DC Output Current

Massima ampiezza della tensione in-
versa anodica = 4400 V
Maximum Peak Inverse Plate Voltage

Picco massimo della corrente ano-
dica = 900 mA
Maximum Peak Plate Current

Caduta interna di tensione a 250 mA = 22 V
Plate Voltage Drop (for 250 mA)

Massima tensione continua tra fila-
mento e catodo = 900 V
*Maximum DC Voltage Heater to Ca-
thode.*

**Diode smorzatore per circuito di deflessio-
ne orizzontale in TV.**
Half-Wave Rectifier for television damper service.

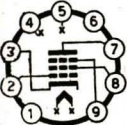
TIPO <i>Type</i>	Limiti massimi <i>Maximum ratings</i>	Capacità in pF <i>Capacitances</i>	Caratteristiche e funzionamento tipico <i>Typical operation</i>																																			
<p>6DA5</p> <p>EM81</p>  <p>Ingombro <i>Outline</i> $\varnothing=22$ h=60</p> <p>Accensione <i>Heater supply</i> 6,3 V — 0,3 A</p>	<p>$V_a = 300$ V</p> <p>$W_a = 0,2$ V</p> <p>$V_{al} = 300$ V</p> <p>$V_{al} = 165$ V min.</p> <p>$I_k = 3$ mA</p> <p>$R_g = 3$ MΩ</p>		<p>$V_b = 250$ V</p> <p>$V_{al} = 250$ V</p> <p>$R_a = 0,5$ MΩ</p> <p>$R_g = 3$ MΩ</p> <p>$V_g =$ da -1 a -10,5 V</p> <p>$\alpha =$ da 65° a 5°</p> <p>$I_a = 0,37$ 0,02 mA</p> <p>$I_{al} = 2$ 2,3 mA</p> <p>Indicatore di sintonia. <i>Tuning Indicator with triode unit.</i></p>																																			
<p>6DA6</p> <p>EF89</p>  <p>(segue) <i>(follow)</i></p>	<p>$V_a = 300$ V</p> <p>$V_{g2} = 300$ V</p> <p>$W_a = 2,25$ W</p> <p>$W_{g2} = 0,45$ W</p> <p>$I_k = 16,5$ mA</p>	<p>$C_{g1} = 5,5$</p> <p>$C_a = 5,1$</p> <p>$C_{g1-a} < 0,002$</p> <p>$C_{g1-f} = 0,05$</p> <p>senza schermo <i>without external shield</i></p>	<p>Amplificatore in classe A₁ <i>Class A₁ Amplifier</i></p> <table data-bbox="813 699 1323 906"> <tr> <td>V_a</td> <td>= 250</td> <td>250</td> <td>170</td> <td>V</td> </tr> <tr> <td>V_{g2}</td> <td>= 100</td> <td>85</td> <td>100</td> <td>V</td> </tr> <tr> <td>V_{g3}</td> <td>= 0</td> <td>0</td> <td>0</td> <td>V</td> </tr> <tr> <td>I_a</td> <td>= 9</td> <td>9</td> <td>12</td> <td>mA</td> </tr> <tr> <td>V_{g1}</td> <td>= -1</td> <td>-1,2</td> <td>-1,2</td> <td>V</td> </tr> <tr> <td>I_{g2}</td> <td>= 3</td> <td>3,2</td> <td>4,4</td> <td>mA</td> </tr> <tr> <td>S</td> <td>= 3600</td> <td>4000</td> <td>4400</td> <td>μA/V</td> </tr> </table>	V_a	= 250	250	170	V	V_{g2}	= 100	85	100	V	V_{g3}	= 0	0	0	V	I_a	= 9	9	12	mA	V_{g1}	= -1	-1,2	-1,2	V	I_{g2}	= 3	3,2	4,4	mA	S	= 3600	4000	4400	μ A/V
V_a	= 250	250	170	V																																		
V_{g2}	= 100	85	100	V																																		
V_{g3}	= 0	0	0	V																																		
I_a	= 9	9	12	mA																																		
V_{g1}	= -1	-1,2	-1,2	V																																		
I_{g2}	= 3	3,2	4,4	mA																																		
S	= 3600	4000	4400	μ A/V																																		

6DA6**EF89***(seguito)*
*(following)***Ingombro**
Outline
Ø=22 h=55**Accensione**
Heater supply
6,3 V — 0,2 A

$$R_i = 0,9 \quad 0,75 \quad 0,4 \quad M\Omega$$

$$\mu_{g^2-g^1} = \quad - \quad 19 \quad -$$

Pentodo, amplificatore a RF e FI.
*Pentode intended for use as RF and IF amplifier.***6DC8****EBF89****Ingombro**
Outline
Ø=22 h=60*(segue)*
*(follow)***Pentodo**
Pentode Unit

$$V_a = 300 \text{ V}$$

$$V_{g^2} = 300 \text{ V}$$

$$W_a = 2,25 \text{ W}$$

$$W_{g^2} = 0,45 \text{ W}$$

$$I_k = 16,5 \text{ mA}$$

$$R_g = 3 \text{ M}\Omega$$

$$V_{f-k} = 100 \text{ V}$$

Pentodo
Pentode Unit

$$C_{g^1} = 5$$

$$C_a = 5,2$$

$$C_{g^1-a} < 0,0025$$

Diodi
Diodes

$$C_{D_1} = 2,5$$

$$C_{D_2} = 2,5$$

$$C_{D_1-D_2} < 0,25$$

Amplificatore in classe A₁
Class A₁ Amplifier

$$V_a = 250 \quad 200 \quad \text{V}$$

$$R_{g^2} = 62 \quad 30 \quad \text{k}\Omega$$

$$V_{g^1} = -1 \quad -1,5 \quad \text{V}$$

$$V_{g^2} = 0 \quad 0 \quad \text{V}$$

$$I_a = 9 \quad 11 \quad \text{mA}$$

$$I_{g^2} = 2,7 \quad 3,3 \quad \text{mA}$$

$$S = 4500 \quad 4500 \quad \mu\text{A/V}$$

$$R_i = 0,9 \quad 0,6 \quad \text{M}\Omega$$

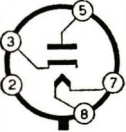
TIPO Type	Limiti massimi Maximum ratings	Capacità in pF Capacitances	Caratteristiche e funzionamento tipico Typical operation
<p>6DC8</p> <hr/> <p>EBF89 (seguito) (following)</p> <p>Accensione Heater supply 6,3 V — 0,3 A</p> <p>Connessioni Connections</p> <p>Piedino Pin 7=D₁</p> <p>Piedino Pin 8=D₂</p>	<p>Diodi (ogni unità) Diodes (each unit)</p> <p>$I_D = 0,8 \text{ mA}$</p> <p>I picco (peak) = 5 mA</p>		<p>Amplificatore RF e FI a pendenza variabile, doppio diodo rivelatore. <i>Twin diode-pentode. Pentode intended for use as RF or IF amplifier. Diodes for detector.</i></p>
<p>6DE4</p>  <p>(segue) (follow)</p>			<p>Massima corrente continua di uscita = 160 mA <i>Maximum DC Output Current</i></p> <p>Massima ampiezza della tensione inversa anodica = 4500 V <i>Maximum Peak Inverse Plate Voltage</i></p> <p>Picco massimo della corrente anodica = 1000 mA <i>Maximum Peak Plate Current</i></p>

6DE4

(seguito)
(following)

Ingombro
Outline
 $\varnothing=30$ h=83

Accensione
Heater supply
6,3 V — 1,6 A

Caduta interna di tensione a 250 mA = 25 V
Plate Voltage Drop (for 250 mA)

Massima tensione continua tra filamento e catodo = 900 V
Maximum DC Voltage Heater to Cathode

Diodo smorzatore per circuito di deflessione orizzontale in TV.
Half-Wave Rectifier for television damper service.

6DJ8 ECC88

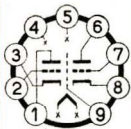

Ingombro
Outline
 $\varnothing=22$ h=49

Accensione
Heater supply
6,3 V — 0,365 A

Per sezione
Each Unit

$V_a = 130$ V
 $W_a = 1,8$ W
 $I_k = 25$ mA
 $V_g = -50$ V
 $R_g = 1$ M Ω

Per sezione
Each Unit

$C_g = 3,3$
 $C_a = 2,5$
 $C_{g-a} = 1,4$
con schermo
with external shield

Amplificatore in classe A_1 (per sezione)
Class A_1 Amplifier (each unit)

$V_a = 90$ V
 $V_g = -1,3$ V
 $I_a = 15$ mA
 $S = 12,5$ mA/V
 $\mu = 33$
 $R_{eq} = 300$ Ω

Doppio triodo ad alta pendenza e basso fruscio per circuiti cascode in TV.
Twin triode intended for use as cascode amplifier in television tuners.

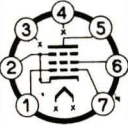
TIPO Type	Limiti massimi Maximum ratings	Capacità in pF Capacitances	Caratteristiche e funzionamento tipico Typical operation
<p>6DL4 EC88</p>  <p>Ingombro Outline Ø=22 h=44</p> <p>Accensione Heater supply 6,3 V — 1,165 A</p>	$V_a = 175 \text{ V}$ $V_{g_1} = -50 \text{ V}$ $W_a = 2 \text{ W}$ $I_k = 13 \text{ mA}$ $R_{g_1} = 1 \text{ M}\Omega$	$C_{g-a} = 1,2$ senza schermo <i>without external shield</i>	<p>Amplificatore in classe A_1 <i>Class A_1 Amplifier</i></p> $V_a = 160 \text{ V}$ $R_k = 100 \Omega$ $I_a = 12,5 \text{ mA}$ $S = 13,5 \text{ mA/V}$ $\mu = 65$ <p>Triodo amplificatore UHF con griglia a massa per le bande IV e V. <i>Triode intended for use as grounded grid UHF amplifier for bands IV and V.</i></p>
<p>6DL5 EL95</p>  <p>(segue) (follow)</p>	$V_a = 300 \text{ V}$ $V_{g_2} = 300 \text{ V}$ $W_a = 6 \text{ W}$ $W_{g_2} = 1,25 \text{ W}$ $I_k = 35 \text{ mA}$ $R_{g_1} = 2 \text{ M}\Omega$ (1) (1) Polarizzazione automatica. <i>Automatic bias.</i>	$C_{g_1} = 5,3$ $C_a = 3,5$ $C_{g_1-a} < 0,4$	<p>Amplificatore in classe A_1 <i>Class A_1 Amplifier</i></p> $V_a = 200 \quad 250 \text{ V}$ $V_{g_2} = 200 \quad 250 \text{ V}$ $I_a = 23 \quad 24 \text{ mA}$ $I_{g_2} = 4,2 \quad 4,5 \text{ mA}$ $R_k = 230 \quad 320 \Omega$ $R_a = 8 \quad 10 \text{ k}\Omega$ $W_o = 2,3 \quad 3 \text{ W}$

6DL5**EL95***(seguito)*
*(following)***Ingombro**
Outline
 $\varnothing=19$ h=53**Accensione**
Heater supply
6,3 V — 0,2 A

$$\begin{aligned} V_i &= 4,5 & 5 V_{\text{eff}} \\ d &= 4,5 & 5 \% \end{aligned}$$

Controfase in classe AB
Class AB Push-pull Power Amplifier

$$\begin{aligned} V_a &= 200 & 250 & \text{V} \\ V_{g^2} &= 200 & 250 & \text{V} \\ I_a &= 2 \times 20 & 2 \times 26 & \text{mA} \\ I_{g^2} &= 2 \times 5,2 & 2 \times 7,5 & \text{mA} \\ R_k &= 180 & 180 & \Omega \\ R_a (2) &= 10 & 10 & \text{k}\Omega \\ W_o &= 4,1 & 7 & \text{W} \\ d &= 4,5 & 5 & \% \end{aligned}$$

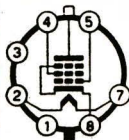
(2) Tra anodo e anodo.
*Plate to plate.***Pentodo amplificatore finale di potenza.**
*Power Pentode for Power Amplifier.***6DQ6A***(segue)*
*(follow)***Ampl. di deflessione**
orizzontale
Horizontal-Deflect.
Amplifier

$V_a = 700 \text{ V}$

$C_{g^1} = 15$

$C_a = 7$

$C_{g^1-a} = 0,55$

senza schermo
without external
*shield***Amplificatore in classe A₁**
Class A₁ Amplifier

$$\begin{aligned} V_a &= 60 & 250 & \text{V} \\ V_{g^2} &= 150 & 150 & \text{V} \\ V_{g^1} &= 0 & -22,5 & \text{V} \\ R_i &\sim & 20 & \text{k}\Omega \\ S &= & 6600 & \mu\text{A/V} \end{aligned}$$

TIPO <i>Type</i>	Limiti massimi <i>Maximum ratings</i>	Capacità in pF <i>Capacitances</i>	Caratteristiche e funzionamento tipico <i>Typical operation</i>
<p>6DQ6A</p> <p><i>(seguito)</i> <i>(following)</i></p> <p>Ingombro Outline Ø=40 h=90</p> <p>Accensione Heater supply 6,3 V — 1,2 A</p>	<p>V_a (picco positivo-impulsivo) <i>(peak positive-pulse)</i> = 6000 V</p> <p>V_a (picco negativo impulsivo) <i>(peak negative-pulse)</i> = 1375 V</p> <p>V_{g2} = 200 V</p> <p>V_{g1} = -50 V</p> <p>V_{g1} (picco negativo) <i>(peak negative)</i> = 300 V</p> <p>I_k = 140 mA</p> <p>I_k (picco/peak) = 440 mA</p> <p>W_a = 15 W</p> <p>W_{g2} = 3 W</p>		<p>I_a = 300 75 mA</p> <p>I_{g2} = 27 2,4 mA</p> <p>μ_{g2-g1} = — 4,1</p> <p>Pentodo di potenza, amplificatore di deflessione orizzontale in TV. <i>Beam Power Tube designed for service as horizontal deflection amplifier.</i></p>

6DQ6B

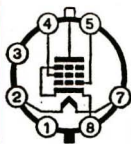

Ingombro
Outline

Ø=40 h=94

Accensione
Heater supply
6,3 V — 1,2 A

Ampl. di defless.
orizzontale
*Horizontal-Deflect.
Amplifier*

$V_a = 700 \text{ V}$
 V_a (picco positivo
impulsivo)
(*peak positive-
pulse*)
 $= 6000 \text{ V}$

V_a (picco negativo
impulsivo)
(*peak negative-
pulse*)
 $= 1350 \text{ V}$

$V_{G2} = 200 \text{ V}$

$V_{G1} = -50 \text{ V}$

V_{G1} (picco negativo)
(*peak negative*)

$= 300 \text{ V}$

$I_k = 160 \text{ mA}$

I_k (picco/peak)
 $= 500 \text{ mA}$

$C_{G1} = 15$
 $C_a = 7,0$
 $C_{G1-a} = 0,5$
senza schermo
*without external
shield*

Amplificatore in classe A_1
Class A_1 Amplifier

V_a	= 60	250	V
V_{G2}	= 150	150	V
V_{G1}	= 0	-22,5	V
R_i	= —	20	k Ω
S	= —	6600	$\mu\text{A/V}$
I_a	= 345	75	mA
I_{G3}	= 33	2,4	mA

Pentodo di potenza, amplificatore di deflessione orizzontale in TV.
Beam Power Tube designed for service as horizontal deflection amplifier.

TIPO
Type
Limiti massimi
Maximum ratings
Capacità in pF
Capacitances
Caratteristiche e funzionamento tipico
Typical operation
6DR7

Ingombro

Outline

 $\varnothing = 22$ h = 60

Accensione

Heater supply

6,3 V — 0,9 A

Sezione 1
Section No. 1

Oscillat./Oscillator

 $V_a = 300$ V

 V_{g1} (picco negativo)
 (peak negative)

 $= 360$ V

 $W_a = 0,9$ W

 $I_k = 18$ mA

Sezione 2
Section No. 2

Amplif./Amplifier

 $V_a = 250$ V

 V_a (picco/peak)
 $= 1500$
 V_{g1} (picco negativo)
 (peak negative)

 $= 225$ V

 $W_a = 6,3$ W

 $I_k = 45$ mA

Sezione 1
Section No. 1
 $C_g = 2,2$
 $C_a = 0,34$
 $C_{g-a} = 4,5$
Sezione 2
Section No. 2
 $C_g = 5,5$
 $C_a = 1,0$
 $C_{g-a} = 8,5$
Amplificatore in classe A₁
Class A₁ Amplifier
Sezione 1
Section No. 1
 $V_a = 250$
 $V_g = -3$
 $I_a = 1,4$
 $S = 1600$
 $\mu = 68$
 $R_i \sim 40000$
Sezione 2
Section No. 2
 150 V

 $-17,5$ V

 35 mA

 6500 μ A/V

 6
 925 Ω

Doppio triodo con sezioni disuguali. La sezione 1 (piedini 6, 7 e 8) è progettata per funzionare come oscillatore di deflessione verticale, mentre la sezione 2 (piedini 1, 2 e 3) come amplificatore di deflessione verticale in TV.

Twin Triode. Section No. 1 connected to pins 6, 7 and 8 intended for operations as a vertical-Deflection Oscillator and Section No. 2 connected to pins 1, 2 and 3 as a Vertical-Deflection Amplifier.

6DT6S



Ingombro

Outline

$$\varnothing = 19 \text{ h} = 48$$

Accensione

Heater supply
6,3 V — 0,3 A

TR=14,5 sec.

V_a	=	300	V
V_{g^2}	=	300	V
V_{g^3}	=	25	V
V_{g^1}	=	0	V
W_a	=	9,5	W

C_{g^1}	=	5,8
C_{g^1-a}	=	0,02
$C_{g^1-g^3}$	=	0,1
C_{g^3}	=	6,1
C_{g^3-a}	=	1,4

con schermo
with external
shield

Amplificatore in classe A₁
Class A₁ Amplifier

V_a	=	150	V
V_{g^2}	=	100	V
V_{g^3}	=	0	V
R_k	=	560	Ω
I_a	=	1,1	mA
I_{g^3}	=	2,1	mA
S_{g^1-a}	=	800	$\mu\text{A/V}$
S_{g^3-a}	=	515	$\mu\text{A/V}$
R_i	\sim	0,15	M Ω

Pentodo, progettato per l'uso come rivelatore MF.

Pentode designed for FM detector service.

6DW4B

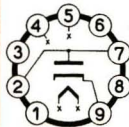

(segue)
(follow)

Massima corrente continua di uscita = 250 mA
Maximum DC Output Current

Massima ampiezza della tensione inversa anodica = 5500 V
Maximum Peak Inverse Plate Voltage

Picco massimo della corrente anodica = 1300 mA
Maximum Peak Plate Current

TIPO <i>Type</i>	Limiti massimi <i>Maximum ratings</i>	Capacità in pF <i>Capacitances</i>	Caratteristiche e funzionamento tipico <i>Typical operation</i>
<p>6DW4B</p> <p><i>(seguito)</i> <i>(following)</i></p> <p>Ingombro Outline Ø=30 h=60</p> <p>Accensione Heater supply 6,3 V — 1,2 A</p> <p>Base: Novar</p>			<p>Caduta interna di tensione a 350 mA = 25 V <i>Plate Voltage Drop (for 350 mA)</i></p> <p>Massima tensione continua tra filamento e catodo = 900 V <i>Maximum DC Voltage Heater-Cathode</i></p> <p>Diodo smorzatore per circuito di deflessione orizzontale in TV colore. <i>Half-Wave Rectifier for color television damper service.</i></p>
<p>6DX8</p> <hr/> <p>ECL84</p> <p>Accensione Heater supply 6,3 V — 0,72 A</p>			<p>Riferirsi al tipo: $\frac{15DQ8}{PCL84} S$ <i>See Type</i></p>

6E5



Ingombro

Outline

$\varnothing=30$ h=94

Accensione

Heater supply

6,3 V — 0,3 A

Nota: Lo schermo fluorescente è connesso al piedino n. 4.

Luminescent screen is connected to pin No. 4.

Riferirsi al tipo: 6E5GT

See Type

6E5GT

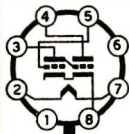

Ingombro

Outline

$\varnothing=30$ h=70

Accensione

Heater supply

6,3 V — 0,3 A

$V_a = 250$ V

$V_{al} = 250$ V max

$V_{al} = 125$ V min

Nota: Lo schermo (al) fluorescente è connesso al piedino n. 4.

Luminescent screen is connected to pin No. 4.

$V_a = 200$ 250 V

$V_{al} = 200$ 250 V

$R_a = 1$ 1 M Ω

$I_a = 0,19$ 0,24 mA

$I_l = 3$ 4 mA

V_g per α ombra = 0° = -6,5 -8 V

for shadow sector of = 0°

V_g per α ombra = 90° = 0 0 V

for Shadow sector of = 90°

Indicatore di sintonia a raggi catodici.

Tuning indicator with triode unit.

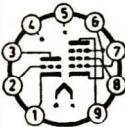
TIPO <i>Type</i>	Limiti massimi <i>Maximum ratings</i>	Capacità in pF <i>Capacitances</i>	Caratteristiche e funzionamento tipico <i>Typical operation</i>																		
6EA7GT Accensione Heater supply 6,3 V — 0,3 A			(Vedi dati condensati) (See condensed data section)																		
6EA8 Accensione Heater supply 6,3 V — 0,45 A			Riferirsi al tipo: 9AE8 S See Type																		
6EB8  Ingombro Outline $\varnothing=22$ h=60 (segue) (follow)	Pentodo <i>Pentode Unit</i> $V_a = 300$ V $V_{g1} = 0$ V $W_a = 4,5$ W $W_{g2} = 1,1$ W Triodo <i>Triode Unit</i> $V_a = 300$ V $V_g = 0$ V	Pentodo <i>Pentode Unit</i> $C_{g1} = 11$ $C_a = 4,2$ $C_{g1-a} = 0,1$ Triodo <i>Triode Unit</i> $C_g = 2,4$ $C_a = 0,36$	Amplificatore in classe A₁ <i>Class A₁ Amplifier</i> <table border="0"> <thead> <tr> <th>Pentodo</th> <th>Triodo</th> </tr> <tr> <th><i>Pentode Unit</i></th> <th><i>Triode Unit</i></th> </tr> </thead> <tbody> <tr> <td>$V_a = 200$</td> <td>250 V</td> </tr> <tr> <td>$V_{g2} = 125$</td> <td>— V</td> </tr> <tr> <td>$V_{g1} = —$</td> <td>—2 V</td> </tr> <tr> <td>$R_k = 68$</td> <td>— Ω</td> </tr> <tr> <td>$I_a = 25$</td> <td>2 mA</td> </tr> <tr> <td>$I_{g2} = 7$</td> <td>— mA</td> </tr> <tr> <td>$S = 12500$</td> <td>2700 μA/V</td> </tr> </tbody> </table>	Pentodo	Triodo	<i>Pentode Unit</i>	<i>Triode Unit</i>	$V_a = 200$	250 V	$V_{g2} = 125$	— V	$V_{g1} = —$	—2 V	$R_k = 68$	— Ω	$I_a = 25$	2 mA	$I_{g2} = 7$	— mA	$S = 12500$	2700 μ A/V
Pentodo	Triodo																				
<i>Pentode Unit</i>	<i>Triode Unit</i>																				
$V_a = 200$	250 V																				
$V_{g2} = 125$	— V																				
$V_{g1} = —$	—2 V																				
$R_k = 68$	— Ω																				
$I_a = 25$	2 mA																				
$I_{g2} = 7$	— mA																				
$S = 12500$	2700 μ A/V																				

6EB8*(seguito)
(following)***Accensione**
Heater supply
6,3 V — 0,75 A

$$W_a = 0,9 \text{ W}$$

 $C_{a-g} = 4,4$
senza schermo
*without external
shield*

$$\mu = \text{—} \quad 100$$

 $R_i \sim 75 \quad 37 \text{ k}\Omega$

Triodo-pentodo. Triodo, amplificatore di tensione o separatore di sincronismo; pentodo amplificatore video.*Triode-Pentode. The triode section is designed to be used as a voltage amplifier or sync separator. The pentode section is designed for video amplifier service.***6EH7**
EF183**S****Ingombro**
Outline
 $\varnothing=22 \text{ h}=55$ **Accensione**
Heater supply
6,3 V — 0,3 A**TR=14,5 sec.**

$$V_a = 250 \text{ V}$$



 $V_{g^2} = 250 \text{ V}$
 $W_a = 2,5 \text{ W}$
 $W_{g^2} = 0,65 \text{ W}$
 $I_k = 20 \text{ mA}$

 $C_{g^1} = 9,5$
 $C_a = 3$
 $C_{g-a} < 0,0055$
senza schermo
*without external
shield***Amplificatore in classe A₁**
Class A₁ Amplifier

$$V_a = 200 \text{ V}$$

 $V_{g^3} = 0 \text{ V}$
 $V_{g^2} = 90 \text{ V}$
 $V_{g^1} = -2 \text{ V}$
 $I_a = 12 \text{ mA}$
 $I_{g^2} = 4,5 \text{ mA}$
 $S = 12500 \mu\text{A/V}$
 $R_i = 500 \text{ k}\Omega$

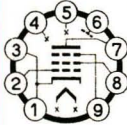
Pentodo, amplificatore a FI per TV.*Pentode intended for use as IF amplifier in television receivers.*

TIPO <i>Type</i>	Limiti massimi <i>Maximum ratings</i>	Capacità in pF <i>Capacitances</i>	Caratteristiche e funzionamento tipico <i>Typical operation</i>
<p>6EJ7</p> <p>EF184</p>  <p>Ingombro Outline Ø=22 h=55</p> <p>Accensione Heater supply 6,3 V — 0,3 A TR=14,5 sec.</p>	$V_a = 250 \text{ V}$ $V_{g2} = 250 \text{ V}$ $W_a = 2,5 \text{ W}$ $W_{g2} = 0,9 \text{ W}$ $I_k = 25 \text{ mA}$	$C_{g1} = 10$ $C_a = 3$ $C_{a-g1} < 0,0055$ senza schermo <i>without external shield</i>	<p>Amplificatore in classe A_1 <i>Class A_1 Amplifier</i></p> $V_a = 200 \text{ V}$ $V_{g3} = 0 \text{ V}$ $V_{g2} = 200 \text{ V}$ $V_{g1} = -2,5 \text{ V}$ $I_a = 10 \text{ mA}$ $I_{g2} = 4,1 \text{ mA}$ $S = 15 \text{ mA/V}$ $R_i = 280 \text{ k}\Omega$ $\mu_{g2-g1} = 60$ <p>Pentodo, amplificatore a FI per TV. <i>Pentode intended for use as IF amplifier in television receivers.</i></p>
<p>6EM5</p>  <p>(segue) (follow)</p>	<p>Amplificatore di deflessione vertic. <i>Vertical-Deflection Amplifier</i></p> $V_a = 315 \text{ V}$	$C_{g1} = 10$ $C_a = 5,1$ $C_{g1-a} < 0,7$	<p>Amplificatore in classe A_1 <i>Class A_1 Amplifier</i></p> $V_a = 60 \quad 250 \quad \text{V}$ $V_{g2} = 60 \quad 250 \quad \text{V}$ $V_{g1} = 0 \quad -18 \quad \text{V}$ $\mu = \quad \quad \quad 8,7$ $S = \quad \quad \quad 5100 \text{ } \mu\text{A/V}$

6EM5

(seguito)
(following)

Ingombro
Outline
Ø=22 h=71

Accensione
Heater supply
6,3 V — 0,8 A

V_a (picco positivo
impulsivo)

(*peak positive-
pulse*)

$$= 2200 \text{ V}$$

V_{g2}

$$= 285 \text{ V}$$

V_{g1} (picco negativo)

(*peak negative*)

$$= -250 \text{ V}$$

I_k

$$= 60 \text{ mA}$$

I_k (picco/peak)

$$= 210 \text{ mA}$$

W_a

$$= 10 \text{ W}$$

W_{g2}

$$= 1,5 \text{ W}$$

$$I_a = 180 \quad 35 \text{ mA}$$

$$I_{g2} = 30 \quad 3 \text{ mA}$$

**Pentodo, amplificatore di deflessione verti-
cale.**

*Beam Power Tube designed for service as ver-
tical deflection amplifier.*

6EM7

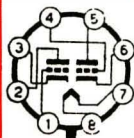

Ingombro
Outline
Ø=30 h=60

(segue)
(follow)

Sezione 1 (oscillat.)
Section N. 1 (oscill.)

$$V_a = 330 \text{ V}$$

$$W_a = 1,5 \text{ W}$$

V_g (picco negativo)

(*negative peak*)

$$= 400 \text{ V}$$

I_k

$$= 22 \text{ mA}$$

I_k (picco/peak)

$$= 77 \text{ mA}$$

$$R_g = 2,2 \text{ M}\Omega$$

Sezione 1
Section N. 1

$$C_g = 2,2$$

$$C_a = 0,6$$

$$C_{g-a} = 4,8$$

Sezione 2
Section No. 2

$$C_g = 7$$

$$C_a = 1,8$$

$$C_{g-a} = 10$$

Amplificatore in classe A_1
Class A_1 Amplifier

Sezione 1

Section No. 1

$$V_a = 250$$

$$V_g = -3$$

$$I_a = 1,4$$

$$S = 1600$$

$$\mu = 68$$

$$R_i = 40000$$

Sezione 2

Section No. 2

$$150 \text{ V}$$

$$-20 \text{ V}$$

$$50 \text{ mA}$$

$$7200 \mu\text{A/V}$$

$$5,4$$

$$750 \quad \Omega$$

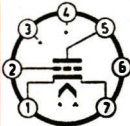
TIPO Type	Limiti massimi Maximum ratings	Capacità in pF Capacitances	Caratteristiche e funzionamento tipico Typical operation
<p>6EM7</p> <p>Accensione Heater supply 6,3 V — 0,925 A</p> <p>(seguito) (following)</p>	<p>Sezione 2 (amplif.) Section No. 2 (ampl.)</p> <p>$V_a = 330 \text{ V}$ $W_a = 10 \text{ W}$ V_a (picco positivo) (peak positive) $= 1500 \text{ V}$ V_g (picco negativo) (peak negative) $= 250 \text{ V}$ $I_k = 50 \text{ mA}$ I_k (picco/peak) $= 175 \text{ mA}$ $R_g = 2,2 \text{ M}\Omega$</p>		<p>Doppio triodo con sezioni disuguali. La sezione 1 (piedini 4, 5 e 6) è progettata per funzionare come oscillatore di deflessione verticale, mentre la sezione 2 (piedini 1, 2 e 3) come amplificatore di deflessione verticale in TV.</p> <p><i>TwIn Triode - Section No. 1 connected to pins 4, 5 and 6 is intended for operation as a Vertical-Deflection Oscillator and Section No. 2 connected to pins 1, 2 and 3 as a Vertical-Deflection Amplifier.</i></p>
<p>6ER5 EC95</p>  <p>(segue) (follow)</p>	<p>$V_a = 250 \text{ V}$ $W_a = 2,2 \text{ W}$ $I_k = 20 \text{ mA}$ $V_g = -50 \text{ V}$ $R_g = 1 \text{ M}\Omega$</p>	<p>$C_g = 4,4$ $C_a = 3,0$ $C_{a-g} = 0,38$ senza schermo Without external shield</p> <p>$C_g = 4,4$ $C_a = 4,0$</p>	<p>Amplificatore in classe A_1 Class A_1 Amplifier</p> <p>$V_a = 200 \text{ V}$ $V_g = -1,2 \text{ V}$ $I_a = 10 \text{ mA}$ $S = 10500 \mu\text{A/V}$ $\mu = 80$ $R_i = 8 \text{ k}\Omega$</p>

<p>6ER5 EC95</p> <p><i>(seguito)</i> <i>(following)</i></p> <p>Ingombro Outline Ø=19 h=48</p> <p>Accensione Heater supply 6,3 V — 0,18 A</p>		<p>$C_{a-g} = 0,36$ con schermo with external shield</p>	<p>Triodo, amplificatore a RF per TV-VHF. <i>Triode intended for use as RF amplifier in VHF television receivers.</i></p>
<p>6ES8 ECC189</p> <p>Accensione Heater supply 6,3 V — 0,365 A</p>			<p>Riferirsi al tipo: $\frac{7ES8}{PCC189}$ S <i>See Type</i></p>

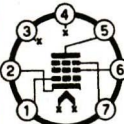
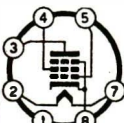
TIPO Type	Limiti massimi Maximum ratings	Capacità in pF Capacitances	Caratteristiche e funzionamento tipico Typical operation
<p>6EW6</p>  <p>Ingombro Outline Ø=30 h=48</p> <p>Accensione Heater supply 6,3 V — 0,4 A</p>	<p>$V_a = 330$ V $V_{g1} = 0$ V $W_a = 3,1$ W $W_{g2} = 0,65$ W</p>	<p>$C_{g1} = 10$ $C_a = 3,4$ $C_{g1-a} = 0,03$ con schermo <i>with external shield</i></p> <p>$C_{g1} = 10$ $C_a = 2,4$ $C_{g1-a} = 0,04$ senza schermo <i>without external shield</i></p>	<p>Amplificatore in classe A_1 <i>Class A_1 Amplifier</i></p> <p>$V_a = 125$ V $V_{g2} = 125$ V $R_k = 56$ Ω $R_i \sim 200$ kΩ $S = 14$ μA/V $I_a = 11$ mA $I_{g2} = 3,2$ mA</p> <p>Pentodo, amplificatore a FI per TV. <i>Pentode intended for use as IF amplifier in television receivers.</i></p>
<p>6F6GT</p>  <p>(segue) (follow)</p>	<p>$V_a = 375$ V $V_{g2} = 285$ V $W_a = 11$ W $W_{g2} = 3,75$ W</p>	<p>$C_{g1} = 8,0$ $C_a = 6,5$ $C_{g1-a} = 0,5$ con schermo connesso all'anodo <i>with external shield connected to the plate</i></p>	<p>Amplificatore in classe A_1 <i>Class A_1 Amplifier</i></p> <p>$V_a = 250$ 285 V $V_{g2} = 250$ 285 V $V_{g1} = -16,5$ -20 V $I_a = 34$ 38 mA $I_{g2} = 6,5$ 7 mA $R_i \sim 80$ 78 kΩ $S = 2500$ 2550 μA/V $R_a = 7$ 7 kΩ</p>

6F6GT

(seguito)
(following)

Ingombro

Outline
 $\varnothing=30$ h=78

Accensione
Heater supply
6,3 V — 0,7 A

W_o	=	3,2	4,8	W
d	=	8	9	%

Amplificatore controfase classe A_1
(Valori per due valvole)

Push-Pull - Class A_1
(Values are for 2 tubes)

V_a	=	315	V
V_{g2}	=	285	V
V_{g1}	=	-24	V
I_a	=	62	mA
I_{g2}	=	12	mA
R_{a-a}	=	10	k Ω
W_o	=	11	W
d	=	4	%

Pentodo, amplificatore di potenza a BF.
Pentode Power Tube intended for use as Power Amplifier.

6FD5

Accensione
Heater supply
6,3 V — 0,9 A

Riferirsi al tipo: 6QL6
See Type

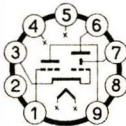
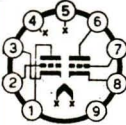
TIPO Type	Limiti massimi Maximum ratings	Capacità in pF Capacitances	Caratteristiche e funzionamento tipico Typical operation
<p>6FG6 EM84</p>  <p>Ingombro Outline Ø=22 h=66</p> <p>Accensione Heater supply 6,3 V — 0,21 A</p>	<p>$V_a = 300 \text{ V}$ $V_{\text{defl}} = 300 \text{ V}$ $V_{\text{al}} = 300 \text{ V}$ $V_{\text{al}} = 170 \text{ V min.}$ $W_a = 0,5 \text{ W}$ $I_k = 3 \text{ mA}$ $R_g = 3 \text{ M}\Omega$</p>		<p>(piedini 7 e 9 collegati esternamente) (Pins 7 and 9 external together connected)</p> <p>$V_b = 250 \text{ V}$ $V_{\text{al}} = 250 \text{ V}$ $R_{\text{a+defl}} = 470 \text{ k}\Omega$ $R_g = 3 \text{ M}\Omega$ $V_g = 0 -22 \text{ mA}$ $I_a = 0,45 \text{ mA}$ $I_{\text{al}} = 1,8 \text{ mA}$ $L = \sim 21 \text{ mm}$</p> <p>Indicatore di sintonia. Tuning indicator with triode unit.</p>
<p>6FQ7</p>  <p>(segue) (follow)</p>		<p>Sezione 1 (1) Section No. 1</p> <p>$C_g = 2,4$ $C_a = 0,34$ $C_{g-a} = 3,6$</p> <p>Sezione 2 (2) Section No. 2</p> <p>$C_g = 2,4$</p>	<p>Riferirsi al tipo: 12CG7 See Type</p>

<p>6FQ7</p> <p>(seguito) (following)</p> <p>Ingombro Outline Ø=22 h=60</p> <p>Accensione Heater supply 6,3 V — 0,3 A</p>		<p>$C_a = 0,26$ $C_{g-a} = 3,8$</p> <p>(1) piedini 6, 7 e 8. pins 6, 7 and 8.</p> <p>(2) piedini 1, 2 e 3. pins 1, 2 and 3.</p>	<p>Doppio triodo oscillatore di deflessione orizzontale o verticale in TV. <i>Twln Triode intended for operation as a Horizontal-Deflection Oscillator or as Vertical Deflection Oscillator.</i></p>
<p>6FY5</p> <hr/> <p>EC97</p> <p>Accensione Heater supply 6,3 V — 0,215 A</p>			<p>Riferirsi al tipo: $\frac{5FY5}{PC97}$ <i>See Type</i></p>
<p>6GB5</p> <hr/> <p>EL500</p> <p>Accensione Heater supply 6,3 V — 1,38 A</p>			<p>Riferirsi al tipo: $\frac{27GB5}{PL500} S$ <i>See Type</i></p>

TIPO Type	Limiti massimi Maximum ratings	Capacità in pF Capacitances	Caratteristiche e funzionamento tipico Typical operation												
<p>6GF7A</p>  <p>Ingombro Outline Ø=30 h=50</p> <p>Accensione Heater supply 6,3 V — 0,98 A</p> <p>Base: Novar</p>	<p>Triodo 1 (1) <i>Triode No. 1</i></p> <p>$V_a = 330 \text{ V}$ $W_a = 1,5 \text{ W}$ $I_a = 22 \text{ mA}$ I_a (picco/peak) $= 77 \text{ mA}$ $R_g = 2,2 \text{ M}\Omega$</p> <p>Triodo 2 (2) <i>Triode No. 2</i></p> <p>$V_a = 330 \text{ V}$ $W_a = 11 \text{ W}$ $I_a = 50 \text{ mA}$ I_a (picco/peak) $= 175 \text{ mA}$ $R_g = 2,2 \text{ M}\Omega$</p> <p>(1) piedini 1, 8 e 9. <i>pins 1, 8 and 9.</i></p> <p>(2) piedini 2, 3 e 6. <i>pins 2, 3 and 6.</i></p>	<p>Triodo 1 (1) <i>Triode No. 1</i></p> <p>$C_g = 2,4$ $C_a = 0,26$ $C_{ag} = 4,6$</p> <p>Triodo 2 (2) <i>Triode No. 2</i></p> <p>$C_g = 6,5$ $C_a = 1,4$ $C_{g-a} = 9$</p>	<p>Amplificatore in classe A₁ <i>Class A₁ Amplifier</i></p> <table border="0"> <tr> <td>Triodo 1 (1) <i>Triode No. 1</i></td> <td>Triodo 2 (2) <i>Triode No. 2</i></td> </tr> <tr> <td>$V_a = 250$</td> <td>60 150 250 V</td> </tr> <tr> <td>$V_g = -3$</td> <td>0 -20 -28 V</td> </tr> <tr> <td>$I_a = 1,4$</td> <td>95 50 10 mA</td> </tr> <tr> <td>$\mu = 64$</td> <td>— 5,4 —</td> </tr> <tr> <td>$R_i = 4000\Omega$</td> <td>— 750 — Ω</td> </tr> </table> <p>Doppio Triodo con sezioni disuguali. La sezione 1 è progettata per funzionare come oscillatore di deflessione verticale, mentre la sezione 2 come amplificatore di deflessione verticale in TV colore. <i>Twin Triode. Section No. 1 is intended for operation as a Vertical-Deflection Oscillator and Section No. 2 as a Vertical-Deflection Amplifier for color television service.</i></p>	Triodo 1 (1) <i>Triode No. 1</i>	Triodo 2 (2) <i>Triode No. 2</i>	$V_a = 250$	60 150 250 V	$V_g = -3$	0 -20 -28 V	$I_a = 1,4$	95 50 10 mA	$\mu = 64$	— 5,4 —	$R_i = 4000\Omega$	— 750 — Ω
Triodo 1 (1) <i>Triode No. 1</i>	Triodo 2 (2) <i>Triode No. 2</i>														
$V_a = 250$	60 150 250 V														
$V_g = -3$	0 -20 -28 V														
$I_a = 1,4$	95 50 10 mA														
$\mu = 64$	— 5,4 —														
$R_i = 4000\Omega$	— 750 — Ω														

6GH8A



Ingombro
Outline
Ø=22 h=49

Accensione
Heater supply
6,3 V 0,45 A

Pentodo *Pentode Unit*

$V_a = 350 \text{ V}$
 $V_{g^2} = 330 \text{ V}$
 $W_a = 2,5 \text{ W}$
 $W_{g^2} = 0,55 \text{ W}$
 $I_k = 20 \text{ mA}$
 $I_k \text{ (picco/peak)} = 300 \text{ mA}$
 $R_{g^1} = 2,2 \text{ M}\Omega \text{ (1)}$

Triodo *Triode Unit*

$V_a = 33 \text{ V}$
 $W_a = 2,5 \text{ W}$
 $R_g = 2,2 \text{ M}\Omega \text{ (1)}$

(1) Polarizzazione
fissa o autom.
*Automatic/Fixed
bias.*

Pentodo *Pentode Unit*

$C_{g^1} = 5,5$
 $C_a = 2,6$
 $C_{g^1-a} = 0,02$

Triodo *Triode Unit*

$C_g = 3,4$
 $C_a = 1,7$
 $C_{g-a} = 1,6$

Amplificatore in classe A₁ *Class A₁ Amplifier*

Pentodo *Pentode Unit*

$V_a = 125$
 $V_{g^2} = 125$
 $V_{g^1} = -1$
 $I_a = 12$
 $I_{g^2} = 4$
 $S = 7500$
 $R_i = 200$
 $\mu = -$
 $V_{g^1} = -8$

(2) per I_a 10 μA .

Triodo *Triode Unit*

125 V
 $-$ V
 -1 V
 13,5 mA
 $-$ mA
 8500 $\mu\text{A/V}$
 5,4 k Ω
 46
 -8 V (2)

**Triodo Pentodo per impiego in TV: Multi-
vibratore, oscillatore di deflessione verti-
cale, AGC, separatore sincronismi.**

*Triode-Pentode designed for television service:
Multivibrator-Type, Horizontal-Deflection Oscilla-
tor, AGC Amplifier, and sync-separator applica-
tions.*

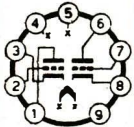
TIPO Type	Limiti massimi Maximum ratings	Capacità in pF Capacitances	Caratteristiche e funzionamento tipico Typical operation
6GJ7 ECF801 Accensione Heater supply 6,3 V — 0,41 A			Riferirsi al tipo: $\frac{8GJ7}{PCF801} S$ See Type
6GU7  Ingombro Outline $\varnothing=22$ h=60 Accensione Heater supply 6,3 V — 0,6 A (segue) (follow)	Per ciasc. sezione Each Section $V_a = 300$ V $V_g = 0$ V $W_a = 3$ W $R_g = 1$ M Ω	Sezione 1 (1) Section No. 1 $C_g = 3,4$ $C_a = 0,44$ $C_{g-a} = 3$ Sezione 2 (2) Section No. 2 $C_g = 3,6$ $C_a = 0,34$ $C_{g-a} = 3$ (1) piedini 6, 7 e 8. pins 6, 7 and 8.	Amplificatore in classe A_1 (per ciascuna sezione) Class A_1 Amplifier (Each Section) $V_a = 250$ V $V_g = -10,5$ V $I_a = 11,5$ mA I_a (per $V_g = -14$ V) = 4 mA $S = 3100$ $\mu A/V$ $R_i = 5500$ Ω $\mu = 17$

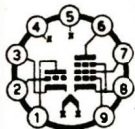
6GU7*(seguito)
(following)*(2) piedini 1, 2
e 3.
*pins 1, 2 and
3.***Doppio triodo a medio « μ » per circuiti di
matrizzazione in TV colore.**
*Medium-mu Twin Triode for use in the matrix-
ing circuits of color TV receivers.***6GV7****ECF805****Accensione**
Heater supply
6,3 V — 0,35 ARiferirsi al tipo: $\frac{7GV7}{PCF805} S$
*See Type***6GV8****ECL85****Ingombro**
Outline
 $\varnothing=22$ h=71
Accensione
Heater supply
6,3 V — 0,9 A*(segue)
(follow)***Pentodo**
Pentode Unit $V_a = 250$ V
 $V_{g2} = 250$ V
 $W_a = 7$ W
 $W_{g2} = 1,5$ W
 $I_k = 75$ mA**Triodo**
Triode Unit $V_a = 250$ V
 $W_a = 0,5$ W
 $I_a = 15$ mA $C_{g1-aP} < 0,6$
 $C_{gT-aP} < 0,03$
 $C_{gP-aT} < 0,08$
 $C_{g-fT} < 0,15$
 $C_{g1-f} < 0,2$ **Pentodo**
Pentode Unit $V_a = 50$
 $V_{g2} = 170$
 $V_{g1} = -1$
 $I_a = -$
 I_a (picco/peak)
 $= 200$
 I_{g2} (picco/peak)
 $= 35$ $S = -$
 $R_i = -$
 $\mu = -$ **Triodo**
Triode Unit 100 V
 $-$ V
 0 V
 10 mA
 10 mA
 $-$ mA
 $5,5$ mA/V
 9 k Ω
 50

TIPO Type	Limiti massimi Maximum ratings	Capacità in pF Capacitances	Caratteristiche e funzionamento tipico Typical operation
6GV8 ECL85 (seguito) (following)			Triodo-pentodo, finale deflessione verticale e oscillatore verticale o amplificatore d'impulsi in TV. <i>Triode-Pentode.</i> <i>Triode intended for use as frame oscillator or pulse amplifier. Pentode intended for use as frame output tube.</i>
6GW8 ECL86 Accensione Heater supply 6,3 V — 0,7 A			Riferirsi al tipo: $\frac{14GW8}{PCL86} S$ <i>See Type</i>
6GX6  (segue) (follow)	$V_a = 275 \text{ V}$ V_{g2} (picco positivo) (peak positive) $= 23 \text{ V}$ V_{g3} (picco negativo) (peak negative) $= -90 \text{ V}$ $V_{bg2} = 275 \text{ V}$ $V_{g1} = -45 \div 0 \text{ V}$	$C_{g1} = 8$ $C_{g3} = 6 \div 7,5$ $C_{g1-a} < 0,026$ $C_{g3-a} = 1,6$ $C_{g1-g3} < 0,12$ senza schermo <i>without external shield</i>	Amplificatore in classe A₁ <i>Class A₁ Amplifier</i> $V_a = 150 \text{ V}$ $V_{g3} = 0 \text{ V}$ $V_{g2} = 100 \text{ V}$ $R_k = 180 \Omega$ $I_a = 3,7 \text{ mA}$ $I_{g2} = 3 \text{ mA}$ $S_{g1} = 3,7 \text{ mA/V}$

6GX6

(seguito)
(following)

Ingombro
Outline
Ø=19 h=48

Accensione
Heater supply
6,3 V — 0,45 A

$$W_a = 1,5 \text{ W}$$
$$W_{g^3} = 0,1 \text{ W}$$

$$S_{g^3} = 0,75 \text{ mA/V}$$
$$R_i \sim 140 \text{ k}\Omega$$

Pentodo, rivelatore MF e preamplificatore BF audio.

Pentode for FM Sound-Detector service and AF pre-amplifier.

6HA5

EC900



Ingombro
Outline
Ø=19 h=35

Accensione
Heater supply
6,3 V — 0,18 A

$$V_a = 200 \text{ V}$$
$$W_a = 2,2 \text{ W}$$
$$I_a = 20 \text{ mA}$$
$$V_g = -50 \text{ V}$$

$C_g = 4,3$
 $C_a = 2,9$
 $C_{g-a} = 0,36$
con schermo
With external shield

Amplificatore in classe A₁
Class A₁ Amplifier

$$V_a = 135 \text{ V}$$
$$V_g = -1 \text{ V}$$
$$I_a = 11,5 \text{ mA}$$
$$S = 14,5 \text{ mA/V}$$
$$\mu = 72$$

Triodo, amplificatore a RF per sintonizzatori TV-VHF.

Triode intended for use as RF amplifier in VHF television tuners.

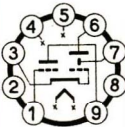
TIPO Type	Limiti massimi Maximum ratings	Capacità in pF Capacitances	Caratteristiche e funzionamento tipico Typical operation
<p>6HU6</p> <hr/> <p>EM87</p>  <p>Ingombro Outline Ø=22 h=66</p> <p>Accensione Heater supply 6,3 V — 0,3 A</p>	<p>$V_a = 300 \text{ V}$</p> <p>$V_{\text{defl}} = 300 \text{ V}$</p> <p>$V_{\text{al}} = 300 \text{ V}$</p> <p>$V_{\text{al}} = 170 \text{ min.}$</p> <p>$W_a = 0,6 \text{ W}$</p> <p>$I_k = 5 \text{ mA}$</p> <p>$R_g = 3 \text{ M}\Omega$</p>		<p>(piedini 7 e 9 collegati esternamente) (Pins 7 and 9 external together connected)</p> <p>$V_b = 250 \text{ V}$</p> <p>$V_{\text{al}} = 250 \text{ V}$</p> <p>$R_{a+\text{Defl}} = 100 \text{ k}\Omega$</p> <p>$R_g = 3 \text{ M}\Omega$</p> <p>$V_g = 0 \quad -10 \quad -15 \text{ V}$</p> <p>$I_{a+\text{Defl}} = 2 \quad 0,5 \quad 0,2 \text{ mA}$</p> <p>$I_{\text{al}} = 1 \quad 1,8 \quad 2 \text{ mA}$</p> <p>$L = 21 \quad 0 \quad -1,5 \text{ mm (1)}$</p> <p>(1) I valori negativi indicano la sovrapposizione del tratto luminoso «L». Negative values of the shade length («L») mean overlapping.</p> <p>Indicatore di sintonia. Tuning indicator with triode unit.</p>

6J5GT

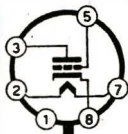

Ingombro

Outline

Ø=30 h=70

Accensione

Heater supply

6,3 V — 0,3 A

V_a	=	300	V
V_{g1}	=	0	V
W_a	=	2,5	W
I_k	=	20	mA
R_g	=	1	MΩ

C_g	=	4,2
C_{a1}	=	5
C_{g-a}	=	3,8

Amplificatore in classe A₁

Class A₁ Amplifier

V_a	=	90	250	V
V_g	=	0	-8	V
I_a	=	10	9	mA
R_i	~	6,7	7,7	kΩ
S	~	3000	2600	μA/V
μ	=	20	20	

Triodo, amplificatore a BF rivelatore ed oscillatore.

Triode intended for use as a detector or audio amplifier.

6J6

ECC91

Accensione
Heater supply
6,3 V — 0,45 A

(Vedi dati condensati)
(See condensed data section)

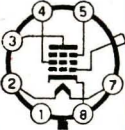
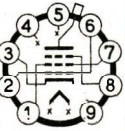
TIPO Type	Limiti massimi Maximum ratings	Capacità in pF Capacitances	Caratteristiche e funzionamento tipico Typical operation					
<p>6J7GT</p>  <p>Ingombro Outline Ø=30 h=68</p> <p>Accensione Heater supply 6,3 V — 0,3 A</p>	<p> $V_a = 300 \text{ V}$ $V_{g^2} = 125 \text{ V}$ $V_{g^1} = 0 \text{ V}$ $W_a = 0,75 \text{ W}$ $W_{g^2} = 0,10 \text{ W}$ </p> <p>Collegato a Triodo <i>Triode operation</i></p> <p> $V_a = 250 \text{ V}$ $W_a = 1,75 \text{ W}$ </p>	<p> $C_{g^1} = 4,6$ $C_a = 12$ $C_{g^1-a} = 0,005$ </p> <p>con schermo <i>with external shield</i></p>	<p style="text-align: center;">Amplificatore in classe A₁ <i>Class A₁ Amplifier</i></p> <table border="0" style="width: 100%;"> <tr> <td style="width: 50%; vertical-align: top;"> <p>Collegato a Pentodo <i>Pentode operation</i></p> <p> $V_a = 100$ $V_{g^2} = 100$ $V_{g^1} = -3$ $I_a = 2$ $I_{g^2} = 0,5$ $R_i \sim 1000$ $S = 1185$ $\mu = -$ </p> </td> <td style="width: 50%; vertical-align: top;"> <p>Collegato a Triodo <i>Triode operation</i></p> <p> 250 100 -3 2 $0,5$ 1000 1225 $-$ </p> <p> 250 V V V $6,5 \text{ mA}$ mA $10,5 \text{ k}\Omega$ $1900 \mu\text{A/V}$ 20 </p> </td> </tr> </table> <p>Pentodo, amplificatore a BF. <i>Pentode intended for use as audio amplifier.</i></p>				<p>Collegato a Pentodo <i>Pentode operation</i></p> <p> $V_a = 100$ $V_{g^2} = 100$ $V_{g^1} = -3$ $I_a = 2$ $I_{g^2} = 0,5$ $R_i \sim 1000$ $S = 1185$ $\mu = -$ </p>	<p>Collegato a Triodo <i>Triode operation</i></p> <p> 250 100 -3 2 $0,5$ 1000 1225 $-$ </p> <p> 250 V V V $6,5 \text{ mA}$ mA $10,5 \text{ k}\Omega$ $1900 \mu\text{A/V}$ 20 </p>
<p>Collegato a Pentodo <i>Pentode operation</i></p> <p> $V_a = 100$ $V_{g^2} = 100$ $V_{g^1} = -3$ $I_a = 2$ $I_{g^2} = 0,5$ $R_i \sim 1000$ $S = 1185$ $\mu = -$ </p>	<p>Collegato a Triodo <i>Triode operation</i></p> <p> 250 100 -3 2 $0,5$ 1000 1225 $-$ </p> <p> 250 V V V $6,5 \text{ mA}$ mA $10,5 \text{ k}\Omega$ $1900 \mu\text{A/V}$ 20 </p>							
<p>6JE6A</p>  <p>(segue) (follow)</p>	<p> $V_a = 990 \text{ V}$ V_a (picco positivo) <i>(peak positive)</i> $= 7500 \text{ V}$ V_a (picco negativo) <i>(peak negative)</i> $= 1100 \text{ V}$ $V_{g^2} = 220 \text{ V}$ </p>	<p> $C_{g^1} = 22$ $C_a = 11$ $C_{g^1-a} = 0, 56$ </p>	<table border="0" style="width: 100%;"> <tr> <td style="width: 50%; vertical-align: top;"> <p> $V_a = -$ V_a (picco/peak) $= 5000$ $V_{g^3} = 30$ $V_{g^2} = 125$ $V_{g^1} = -$ $I_a = -$ $I_{g^2} = -$ </p> </td> <td style="width: 50%; vertical-align: top;"> <p> 55 175 V V 30 125 0 580 40 </p> <p> 175 V V 30 V 125 V V -25 V 130 mA $2,8 \text{ mA}$ </p> </td> </tr> </table>				<p> $V_a = -$ V_a (picco/peak) $= 5000$ $V_{g^3} = 30$ $V_{g^2} = 125$ $V_{g^1} = -$ $I_a = -$ $I_{g^2} = -$ </p>	<p> 55 175 V V 30 125 0 580 40 </p> <p> 175 V V 30 V 125 V V -25 V 130 mA $2,8 \text{ mA}$ </p>
<p> $V_a = -$ V_a (picco/peak) $= 5000$ $V_{g^3} = 30$ $V_{g^2} = 125$ $V_{g^1} = -$ $I_a = -$ $I_{g^2} = -$ </p>	<p> 55 175 V V 30 125 0 580 40 </p> <p> 175 V V 30 V 125 V V -25 V 130 mA $2,8 \text{ mA}$ </p>							

6JE6A

(seguito)
(following)

Ingombro
Outline
 $\varnothing=40$ h=100

Accensione
Heater supply
6,3 V — 2,5 A

Base: Novar

V_{g3}	=	75 V
V_{g1} (picco negativo)		(peak negative)
	=	330 V
W_a	=	30 W
W_{g2}	=	5 W
I_k	=	350mA
I_k (picco/peak)		(picco/peak)
	=	1200mA
R_{g1}	=	0,47 M Ω
		10 M Ω (1)

(1) Per funzionam.
impulsivo
anodico
*For plate-pulsed
operation.*

V_{g1}	=	-120	—	-54	V (2)
S_{g1}	=	—	—	9600	$\mu A/V$
R_i	=	—	—	5800	Ω

(2) Per $I_a = 1$ mA
For plate = 1 mA.

**Pentodo finale di deflessione orizzontale
per TV colore.**

Beam Power Tube for color TV Horizontal-Deflection-Amplifier applications.

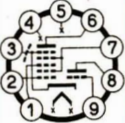
TIPO Type	Limiti massimi Maximum ratings	Capacità in pF Capacitances	Caratteristiche e funzionamento tipico Typical operation																		
<p>6JX7 ECH84</p>  <p>Ingombro Outline $\varnothing=22$ h=60</p> <p>Accensione Heater supply 6,3 V — 0,3 A</p> <p>TR=14,5 sec.</p>	<p>Eptodo <i>Heptode Unit</i></p> <p>$V_a = 250$ V $V_{g2-4} = 250$ V $W_a = 1,7$ W $W_{g3-4} = 0,8$ W $-V_{g1} = 150$ V $-V_{g3} = 150$ V $I_k = 12,5$ mA</p> <p>Triodo <i>Triode Unit</i></p> <p>$V_a = 250$ V $W_a = 1,3$ W $-V_g = 200$ V $I_k = 10$ mA</p>	<p>Eptodo <i>Heptode Unit</i></p> <p>$C_{a-g} < 0,009$</p> <p>Triodo <i>Triode Unit</i></p> <p>$C_g = 3$ $C_a = 1,1$</p>	<p>Amplificatore in classe A₁ <i>Class A₁ Amplifier</i></p> <table border="0"> <tr> <td>Eptodo <i>Heptode Unit</i></td> <td>Triodo <i>Triode Unit</i></td> </tr> <tr> <td>$V_a = 135$</td> <td>50 V</td> </tr> <tr> <td>$V_{g2-4} = 14$</td> <td>— V</td> </tr> <tr> <td>$V_{g3} = -2$ (1)</td> <td>— V</td> </tr> <tr> <td>$V_{g1} = -1,9$ (2)</td> <td>0 V</td> </tr> <tr> <td>$I_a = 1,7$</td> <td>3 mA</td> </tr> <tr> <td>$I_{g2-4} = 0,9$</td> <td>— mA</td> </tr> <tr> <td>S = 2200</td> <td>3700 μA/V</td> </tr> <tr> <td>$\mu = —$</td> <td>50</td> </tr> </table> <p>(1) $V_{g1} = 0$; $I_a = 20$ μA (2) $V_{g3} = 0$; $I_a = 20$ μA.</p> <p>Triodo-Eptodo separatore di sincronismi e oscillatore. <i>Triode-Heptode intended for use as pulse separator, noise inverter and sync amplifier.</i></p>	Eptodo <i>Heptode Unit</i>	Triodo <i>Triode Unit</i>	$V_a = 135$	50 V	$V_{g2-4} = 14$	— V	$V_{g3} = -2$ (1)	— V	$V_{g1} = -1,9$ (2)	0 V	$I_a = 1,7$	3 mA	$I_{g2-4} = 0,9$	— mA	S = 2200	3700 μ A/V	$\mu = —$	50
Eptodo <i>Heptode Unit</i>	Triodo <i>Triode Unit</i>																				
$V_a = 135$	50 V																				
$V_{g2-4} = 14$	— V																				
$V_{g3} = -2$ (1)	— V																				
$V_{g1} = -1,9$ (2)	0 V																				
$I_a = 1,7$	3 mA																				
$I_{g2-4} = 0,9$	— mA																				
S = 2200	3700 μ A/V																				
$\mu = —$	50																				

6K7G

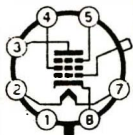

Ingombro
Outline
Ø=39 h=95

Accensione
Heater supply
6,3 V — 0,3 A

V_a	=	300	V
V_{g2}	=	125	V
V_{g1}	=	0	V
W_a	=	2,75	W
W_{g2}	=	0,35	W

C_{g1} = 5
 C_a = 12
 C_{g1-a} = 0,007
con schermo
with external shield

Amplificatore in classe A₁

Class A₁ Amplifier

V_a	=	100	250	250	V
V_{g2}	=	100	100	125	V
V_{g1}	=	-3	-3	-3	V
I_a	=	6,5	7,0	10,5	mA
I_{g2}	=	1,6	1,7	2,6	mA
R_i	~	250	800	600	kΩ
S	=	1325	1450	1650	μA/V

Pentodo, amplificatore a RF e FI.

Pentode intended for use as RF or IF amplifier.

6K7GT

Ingombro
Outline
Ø=30 h=68

C_{g1} = 4,6
 C_a = 12
 C_{g1-a} = 0,005
con schermo
with external shield

Riferirsi al tipo: 6K7G

See Type

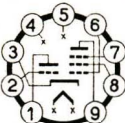
TIPO <i>Type</i>	Limiti massimi <i>Maximum ratings</i>	Capacità in pF <i>Capacitances</i>	Caratteristiche e funzionamento tipico <i>Typical operation</i>																														
<p>6KA8</p>  <p>Ingombro Outline Ø=22 h=60</p> <p>Accensione Heater supply 6,3 V — 0,6 A</p>	<p>Pentodo <i>Pentode Unit</i></p> <p>$V_a = 300 \text{ V}$ $V_{g^2} = 300 \text{ V}$ $V_{g^1} = 50 \text{ V}$ $W_a = 2 \text{ W}$ $W_{g^2} = 1,1 \text{ W}$ $R_{g^1} = 0,5 \text{ M}\Omega \text{ (1)}$ $1 \text{ M}\Omega \text{ (2)}$</p> <p>Triodo <i>Triode Unit</i></p> <p>$V_a = 300 \text{ V}$ $V_g = 50 \text{ V}$ $W_a = 1,1 \text{ W}$ $R_g = 0,25 \text{ M}\Omega \text{ (1)}$ $1 \text{ M}\Omega \text{ (2)}$</p> <p>(1) Polarizzazione fissa. <i>Fixed bias.</i> (2) Polarizzazione automatica. <i>Automatic bias.</i></p>	<p>Pentodo <i>Pentode Unit</i></p> <p>$C_{g^1} = 9,5$ $C_{g^1-a} = 0,1$ $C_{g^1-g^3} = 0,5$ $C_{g^3-a} = 2,2$</p> <p>Triodo <i>Triode Unit</i></p> <p>$C_g = 2,8$ $C_a = 2,2$ $C_{g-a} = 2,2$</p>	<p>Amplificatore in classe A₁ <i>Class A₁ Amplifier</i></p> <table border="0"> <thead> <tr> <th data-bbox="831 227 937 290">Pentodo <i>Pentode Unit</i></th> <th data-bbox="1239 227 1330 290">Triodo <i>Triode Unit</i></th> </tr> </thead> <tbody> <tr> <td>$V_a = 150$</td> <td>200 V</td> </tr> <tr> <td>$V_{g^3} = 0$</td> <td>— V</td> </tr> <tr> <td>$V_{g^2} = 100$</td> <td>— V</td> </tr> <tr> <td>$V_{g^1} = 0$</td> <td>—2 V</td> </tr> <tr> <td>$R_k = 180$</td> <td>— Ω</td> </tr> <tr> <td>$I_a = 4$</td> <td>4 mA</td> </tr> <tr> <td>$I_{g^2} = 2,8$</td> <td>— mA</td> </tr> <tr> <td>$V_g = —$</td> <td>—5 V (1)</td> </tr> <tr> <td>$V_{g^1} = -4 (2)$</td> <td>— V</td> </tr> <tr> <td>$V_{g^3} = -7 (2)$</td> <td>— V</td> </tr> <tr> <td>$S = 4400$</td> <td>4000 $\mu\text{A/V}$</td> </tr> <tr> <td>$S_{g^3-a} = 600$</td> <td>— $\mu\text{A/V}$</td> </tr> <tr> <td>$R_i = 100$</td> <td>17,5 kΩ</td> </tr> <tr> <td>$\mu = —$</td> <td>70</td> </tr> </tbody> </table> <p>Note/Notes: (1) Per (for) $I_a=10 \mu\text{A}$ (2) Per (for) $I_a=20 \mu\text{A}$</p> <p>Pentodo a interdizione rapida. Triodo ad alto «μ». Invertitore di sincronismi, AGC e antidisturbo in TV. <i>Sharp-cutoff pentode. High-μ triode. Noise inverter, AGC amplifier in television receivers.</i></p>	Pentodo <i>Pentode Unit</i>	Triodo <i>Triode Unit</i>	$V_a = 150$	200 V	$V_{g^3} = 0$	— V	$V_{g^2} = 100$	— V	$V_{g^1} = 0$	—2 V	$R_k = 180$	— Ω	$I_a = 4$	4 mA	$I_{g^2} = 2,8$	— mA	$V_g = —$	—5 V (1)	$V_{g^1} = -4 (2)$	— V	$V_{g^3} = -7 (2)$	— V	$S = 4400$	4000 $\mu\text{A/V}$	$S_{g^3-a} = 600$	— $\mu\text{A/V}$	$R_i = 100$	17,5 k Ω	$\mu = —$	70
Pentodo <i>Pentode Unit</i>	Triodo <i>Triode Unit</i>																																
$V_a = 150$	200 V																																
$V_{g^3} = 0$	— V																																
$V_{g^2} = 100$	— V																																
$V_{g^1} = 0$	—2 V																																
$R_k = 180$	— Ω																																
$I_a = 4$	4 mA																																
$I_{g^2} = 2,8$	— mA																																
$V_g = —$	—5 V (1)																																
$V_{g^1} = -4 (2)$	— V																																
$V_{g^3} = -7 (2)$	— V																																
$S = 4400$	4000 $\mu\text{A/V}$																																
$S_{g^3-a} = 600$	— $\mu\text{A/V}$																																
$R_i = 100$	17,5 k Ω																																
$\mu = —$	70																																

6L6G



Ingombro

Outline

Ø=51 h=123

Accensione

Heater supply

6,3 V — 0,9 A

V_a	=	360	V
V_{g2}	=	270	V
W_a	=	19	W
W_{g2}	=	2,5	W

C_{g1}	=	11,5	
C_a	=	9,5	
C_{g1-a}	=	0,9	

Amplificatore in classe A_1 Class A_1 Power Amplifier

V_a	=	250	350	250	300	V
V_{g2}	=	250	250	250	200	V
V_{g1}	=	-14	-18	—	—	V
R_k	=	—	—	170	220	Ω
I_a	=	72	54	75	51	mA
I_{g2}	=	5	2,5	5,4	3	mA
R_i	~	22,5	33	—	—	kΩ
S	=	6000	5200	—	—	μA/V
R_a	=	2,5	4,2	2,5	4,5	kΩ
W_o	=	6,5	10,8	6,5	6,5	W
d	=	10	15	10	11	%

Amplificatore in classe A_1 Class A_1 Power amplifier

Collegato a triodo - Triode operation

V_a	=	250	250	V
V_g	=	-20	—	V
R_k	=	—	490	Ω
I_a	=	14,1	14,1	mA
R_i	~	1,7	—	kΩ
μ	=	8	—	
S	=	4700	—	μA/V
R_a	=	5	6	kΩ
W_o	=	1,4	1,3	W
d	=	5	6	%

(segue)

(follow)

TIPO Type	Limiti massimi Maximum ratings	Capacità in pF Capacitances	Caratteristiche e funzionamento tipico Typical operation																																																												
6L6G (seguito) (following)			Amplificatore controfase in classe A ₁ Class A ₁ Push-pull Power Amplifier																																																												
			<table> <tr><td>V_a</td><td>=</td><td>250</td><td>270</td><td>250</td><td>270</td><td>V</td></tr> <tr><td>V_{g²}</td><td>=</td><td>250</td><td>270</td><td>250</td><td>270</td><td>V</td></tr> <tr><td>V_{g¹}</td><td>=</td><td>-16,5</td><td>-17,5</td><td>—</td><td>—</td><td>V</td></tr> <tr><td>R_k</td><td>=</td><td>—</td><td>—</td><td>125</td><td>125</td><td>Ω</td></tr> <tr><td>I_a</td><td>=</td><td>120</td><td>134</td><td>120</td><td>134</td><td>mA</td></tr> <tr><td>I_{g²}</td><td>=</td><td>10</td><td>11</td><td>10</td><td>11</td><td>mA</td></tr> <tr><td>R_{a-a}</td><td>=</td><td>5</td><td>5</td><td>5</td><td>5</td><td>kΩ</td></tr> <tr><td>W_o</td><td>=</td><td>14,5</td><td>17,5</td><td>13,8</td><td>18,5</td><td>W</td></tr> <tr><td>d</td><td>=</td><td>2</td><td>2</td><td>2</td><td>2</td><td>%</td></tr> </table>	V _a	=	250	270	250	270	V	V _{g²}	=	250	270	250	270	V	V _{g¹}	=	-16,5	-17,5	—	—	V	R _k	=	—	—	125	125	Ω	I _a	=	120	134	120	134	mA	I _{g²}	=	10	11	10	11	mA	R _{a-a}	=	5	5	5	5	kΩ	W _o	=	14,5	17,5	13,8	18,5	W	d	=	2	2
V _a	=	250	270	250	270	V																																																									
V _{g²}	=	250	270	250	270	V																																																									
V _{g¹}	=	-16,5	-17,5	—	—	V																																																									
R _k	=	—	—	125	125	Ω																																																									
I _a	=	120	134	120	134	mA																																																									
I _{g²}	=	10	11	10	11	mA																																																									
R _{a-a}	=	5	5	5	5	kΩ																																																									
W _o	=	14,5	17,5	13,8	18,5	W																																																									
d	=	2	2	2	2	%																																																									
(segue) (follow)			Amplificatore controfase in classe AB ₁ Class AB ₁ Push-pull Power Amplifier																																																												
			<table> <tr><td>V_a</td><td>=</td><td>360</td><td>360</td><td>360</td><td>V</td></tr> <tr><td>V_{g²}</td><td>=</td><td>270</td><td>270</td><td>270</td><td>V</td></tr> <tr><td>V_{g¹}</td><td>=</td><td>-22,5</td><td>-22,5</td><td>—</td><td>V</td></tr> <tr><td>R_k</td><td>=</td><td>—</td><td>—</td><td>250</td><td>Ω</td></tr> <tr><td>I_a</td><td>=</td><td>88</td><td>88</td><td>88</td><td>mA</td></tr> <tr><td>I_{g²}</td><td>=</td><td>5</td><td>5</td><td>5</td><td>mA</td></tr> <tr><td>R_{a-a}</td><td>=</td><td>6,6</td><td>3,8</td><td>9</td><td>kΩ</td></tr> <tr><td>W_o</td><td>=</td><td>26,5</td><td>18</td><td>24,5</td><td>W</td></tr> <tr><td>d</td><td>=</td><td>2</td><td>2</td><td>2</td><td>%</td></tr> </table>	V _a	=	360	360	360	V	V _{g²}	=	270	270	270	V	V _{g¹}	=	-22,5	-22,5	—	V	R _k	=	—	—	250	Ω	I _a	=	88	88	88	mA	I _{g²}	=	5	5	5	mA	R _{a-a}	=	6,6	3,8	9	kΩ	W _o	=	26,5	18	24,5	W	d	=	2	2	2	%						
V _a	=	360	360	360	V																																																										
V _{g²}	=	270	270	270	V																																																										
V _{g¹}	=	-22,5	-22,5	—	V																																																										
R _k	=	—	—	250	Ω																																																										
I _a	=	88	88	88	mA																																																										
I _{g²}	=	5	5	5	mA																																																										
R _{a-a}	=	6,6	3,8	9	kΩ																																																										
W _o	=	26,5	18	24,5	W																																																										
d	=	2	2	2	%																																																										

6L6G

(seguito)
(following)

Amplificatore controfase in classe AB_2
Class AB_2 Push-pull Power Amplifier

V_a	=	360	360	V
V_{g^2}	=	225	270	V
V_{g^1}	=	-18	-22,5	V
I_a	=	78	88	mA
I_{g^2}	=	3,5	5	mA
R_{a-a}	=	6	3,8	k Ω
W_o	=	31	47	W
d	=	2	2	%

Tetrodo a fascio, amplificatore di grande potenza a BF.

Beam Power Tube for Power Amplifier.

6L6GB

Accensione
Heater supply
6,3 V — 0,9 A

Riferirsi al tipo: 6L6G
See Type

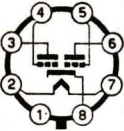
TIPO <i>Type</i>	Limiti massimi <i>Maximum ratings</i>	Capacità in pF <i>Capacitances</i>	Caratteristiche e funzionamento tipico <i>Typical operation</i>
<p>6N7GT</p>  <p>Ingombro <i>Outline</i> $\varnothing=30$ h=70</p> <p>Accensione <i>Heater supply</i> 6,3 V — 0,8 A</p>	<p>$V_a = 300$ V $I_a = 125$ mA $W_a = 5,5$ W</p>		<p>Controfase in classe B Amplific. classe A₁ <i>Push-pull - Class B</i> <i>Class A₁ Amplifier</i> (valori per le due unità) (sezioni in parallelo) <i>(values are for 2 sections)</i> <i>(two sections parallel connected)</i></p> <p>$V_a = 300$ V 294 V $V_g = 0$ V -6 V $V_{\text{picco}} = 58$ V $I_a = 35$ mA $I_a \text{ con segnale} = 70$ mA $R_{a-a} = 8$ kΩ $W_o = 10$ W $d = 4$ % $R_i \sim -$ 11 kΩ $S = -$ 3200 μA/V</p> <p>Doppio triodo, amplificatore di potenza. <i>Twin triode designed for use as Power Amplifier.</i></p>
<p>6NK7GT</p> <p>Accensione <i>Heater supply</i> 6,3 V — 0,3 A</p>			<p>(Vedi dati condensati) <i>(See condensed data section)</i></p>

6Q7G

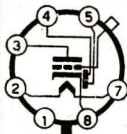

Ingombro

Outline

Ø=39 h=92

Accensione

Heater supply

6,3 V — 0,3 A

$$V_a = 300 \text{ V}$$

$$I_D = 0,9 \text{ mA}$$

$$C_g = 3,2$$

$$C_a = 5$$

$$C_{g-a} = 1,5$$

con schermo
with external
shield

Amplificatore in classe A₁

Class A₁ Amplifier

V_a	=	100	100	250	V
-------	---	-----	-----	-----	---

V_g	=	0	-1	-3	V
-------	---	---	----	----	---

I_a	=	2,3	0,8	1	mA
-------	---	-----	-----	---	----

μ	=	60	70	70	
-------	---	----	----	----	--

R_i	~	43	58	58	kΩ
-------	---	----	----	----	----

S	=	1400	1200	1200	μA/V
---	---	------	------	------	------

Doppio diodo-triodo, amplificatore a BF e rivelatore.

Twin diode-triode. Detector and audio amplifier.

6Q7GT

Ingombro

Outline

Ø=30 h=60

$$C_g = 2,2$$

$$C_a = 5$$

$$C_{g-a} = 1,6$$

con schermo
with external
shield

Riferirsi al tipo: 6Q7G

See Type

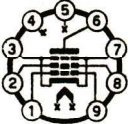
TIPO Type	Limiti massimi Maximum ratings	Capacità in pF Capacitances	Caratteristiche e funzionamento tipico Typical operation																																													
<p>6QL6</p>  <p>Ingombro Outline Ø=22 h=60</p> <p>Accensione Heater supply 6,3 V — 0,9 A</p>	<p>$V_a = 250$ V $V_{g2} = 250$ V $W_a = 9,5$ W $W_{g2} = 4$ W</p>	<p>$C_{g1} = 12,5$ $C_a = 6$ $C_{g-a} = 1,5$ senza schermo <i>without external shield</i></p>	<p>Amplificatore in classe A₁ <i>Class A₁ Amplifier</i></p> <table border="0"> <tr> <td>$V_a =$</td> <td>105</td> <td>120</td> <td>180</td> <td>V</td> </tr> <tr> <td>$V_{g2} =$</td> <td>105</td> <td>120</td> <td>180</td> <td>V</td> </tr> <tr> <td>$V_{g1} =$</td> <td>-6</td> <td>-7</td> <td>-11,5</td> <td>V</td> </tr> <tr> <td>$I_a =$</td> <td>32</td> <td>36</td> <td>52</td> <td>mA</td> </tr> <tr> <td>$I_{g2} =$</td> <td>5,75</td> <td>6,7</td> <td>10</td> <td>mA</td> </tr> <tr> <td>$R_i \sim$</td> <td>18</td> <td>17</td> <td>18</td> <td>kΩ</td> </tr> <tr> <td>$S =$</td> <td>8300</td> <td>8800</td> <td>9500</td> <td>μA/V</td> </tr> <tr> <td>$R_a =$</td> <td>3</td> <td>3</td> <td>3</td> <td>kΩ</td> </tr> <tr> <td>$W_o =$</td> <td>1,4</td> <td>2</td> <td>5</td> <td>W</td> </tr> </table> <p>Pentodo, amplificatore di potenza a BF. <i>Pentode designed for use as Power Amplifier.</i></p>	$V_a =$	105	120	180	V	$V_{g2} =$	105	120	180	V	$V_{g1} =$	-6	-7	-11,5	V	$I_a =$	32	36	52	mA	$I_{g2} =$	5,75	6,7	10	mA	$R_i \sim$	18	17	18	kΩ	$S =$	8300	8800	9500	μA/V	$R_a =$	3	3	3	kΩ	$W_o =$	1,4	2	5	W
$V_a =$	105	120	180	V																																												
$V_{g2} =$	105	120	180	V																																												
$V_{g1} =$	-6	-7	-11,5	V																																												
$I_a =$	32	36	52	mA																																												
$I_{g2} =$	5,75	6,7	10	mA																																												
$R_i \sim$	18	17	18	kΩ																																												
$S =$	8300	8800	9500	μA/V																																												
$R_a =$	3	3	3	kΩ																																												
$W_o =$	1,4	2	5	W																																												
<p>6S2</p> <hr/> <p>EY86</p> <p>Accensione Heater supply 6,3 V — 0,09 A</p>			<p>Senza trattamento speciale sulla superficie del vetro. <i>Without the envelope special treatment.</i></p> <p>Riferirsi al tipo: $\frac{1S2A}{DY87}$ See Type</p>																																													

6S2A**EY87**

Accensione
Heater supply
6,3 V — 0,09 A

Riferirsi al tipo: $\frac{1S2A}{DY87}$
See Type

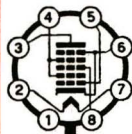
6SA7GT

Ingombro
Outline
 $\varnothing=30$ h=70

Accensione
Heater supply
6,3 V — 0,3 A

V_a	=	300 V
$V_{g^{2-4}}$	=	100 V
V_{g^3}	=	0 V
W_a	=	1 W
$W_{g^{2-4}}$	=	1 W
I_k	=	14 mA

C_{g^3} - tutti = 11
(to all other electrodes)

C_a - tutti	=	11
C_{g^3-a}	=	0,5
C_{g^1} - tutti	=	8
$C_{g^1-g^3}$	=	0,4
C_{g^1-a}	=	0,2

con schermo
collegato al
catodo
with external
shield connected
to cathode

Convertitore di frequenza
Converter service

V_a	=	100	250	V
V_{g^2}	=	100	100	V
V_{g^3}	=	-2	-2	V
I_a	=	3,3	3,5	mA
$I_{g^{2-4}}$	=	8,5	8,5	mA
I_{g^1}	=	0,5	0,5	mA
I_k	=	12,3	12,5	mA
S_c	=	425	450	μ V/A
R_i	\sim	0,5	1	k Ω
R_{g^1}	=	20	20	k Ω

Eptodo, convertitore.
Pentagrid Converter.

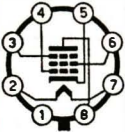
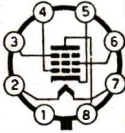
TIPO Type	Limiti massimi Maximum ratings	Capacità in pF Capacitances	Caratteristiche e funzionamento tipico Typical operation																																																						
<p>6SJ7GT</p>  <p>Ingombro Outline Ø=30 h=70</p> <p>Accensione Heater supply 6,3 V — 0,3 A</p>	<p>Collegam. Pentodo <i>Pentode operation</i></p> <p>$V_a = 300$ V $V_{g2} = 125$ V $V_{g1} = 0$ V $W_a = 2,5$ W $W_{g2} = 0,7$ W</p> <p>Collegam. Triodo <i>Triode operation</i></p> <p>$V_a = 250$ V $V_{g1} = 0$ V $W_a = 2,5$ W</p>	<p>Coll. Pentodo <i>Pentode operation</i></p> <p>$C_{g1} = 7$ $C_a = 7$ $C_{g1-a} = 0,005$</p> <p>Collegam. Triodo <i>Triode operation</i></p> <p>$C_g = 11$ $C_a = 3,4$ $C_{g1-a} = 2,8$</p>	<p>Amplificatore in classe A₁ <i>Class A₁ Amplifier</i></p> <table border="1" data-bbox="805 218 1388 533"> <thead> <tr> <th colspan="2"></th> <th colspan="2">Colleg. Pentodo <i>Pentode operation</i></th> <th colspan="2">Colleg. Triodo <i>Triode operation</i></th> </tr> </thead> <tbody> <tr> <td>V_a</td> <td>=</td> <td>100</td> <td>250</td> <td>180</td> <td>250 V</td> </tr> <tr> <td>V_{g2}</td> <td>=</td> <td>100</td> <td>100</td> <td>—</td> <td>— V</td> </tr> <tr> <td>V_{g1}</td> <td>=</td> <td>—3</td> <td>—3</td> <td>—6</td> <td>—8,5 V</td> </tr> <tr> <td>I_a</td> <td>=</td> <td>2,9</td> <td>3</td> <td>6</td> <td>9,2 mA</td> </tr> <tr> <td>I_{g2}</td> <td>=</td> <td>0,9</td> <td>0,8</td> <td>—</td> <td>— mA</td> </tr> <tr> <td>R_i</td> <td>~</td> <td>700</td> <td>> 1000</td> <td>8,25</td> <td>7,6 kΩ</td> </tr> <tr> <td>S</td> <td>=</td> <td>1575</td> <td>1650</td> <td>2300</td> <td>2500 μA/V</td> </tr> <tr> <td>μ</td> <td>=</td> <td>—</td> <td>—</td> <td>19</td> <td>19</td> </tr> </tbody> </table> <p>Pentodo, amplificatore a BF. <i>Pentode intended for use as audio amplifier.</i></p>			Colleg. Pentodo <i>Pentode operation</i>		Colleg. Triodo <i>Triode operation</i>		V_a	=	100	250	180	250 V	V_{g2}	=	100	100	—	— V	V_{g1}	=	—3	—3	—6	—8,5 V	I_a	=	2,9	3	6	9,2 mA	I_{g2}	=	0,9	0,8	—	— mA	R_i	~	700	> 1000	8,25	7,6 kΩ	S	=	1575	1650	2300	2500 μA/V	μ	=	—	—	19	19
		Colleg. Pentodo <i>Pentode operation</i>		Colleg. Triodo <i>Triode operation</i>																																																					
V_a	=	100	250	180	250 V																																																				
V_{g2}	=	100	100	—	— V																																																				
V_{g1}	=	—3	—3	—6	—8,5 V																																																				
I_a	=	2,9	3	6	9,2 mA																																																				
I_{g2}	=	0,9	0,8	—	— mA																																																				
R_i	~	700	> 1000	8,25	7,6 kΩ																																																				
S	=	1575	1650	2300	2500 μA/V																																																				
μ	=	—	—	19	19																																																				
<p>6SK7GT</p>  <p>(segue) (follow)</p>	<p>$V_a = 300$ V $V_{g2} = 125$ V $V_{g1} = 0$ V $W_a = 4,0$ W $W_{g2} = 0,4$ W</p>	<p>$C_{g1} = 6,5$ $C_a = 7,5$ $C_{g1-a} = 0,005$</p>	<p>Amplificatore in classe A₁ <i>Class A₁ Amplifier</i></p> <table border="1" data-bbox="805 754 1183 912"> <tbody> <tr> <td>V_a</td> <td>=</td> <td>100</td> <td>250</td> <td>V</td> </tr> <tr> <td>V_{g2}</td> <td>=</td> <td>100</td> <td>100</td> <td>V</td> </tr> <tr> <td>V_{g1}</td> <td>=</td> <td>—1</td> <td>—3</td> <td>V</td> </tr> <tr> <td>I_a</td> <td>=</td> <td>13</td> <td>9,2</td> <td>mA</td> </tr> <tr> <td>I_{g2}</td> <td>=</td> <td>4</td> <td>2,6</td> <td>mA</td> </tr> </tbody> </table>	V_a	=	100	250	V	V_{g2}	=	100	100	V	V_{g1}	=	—1	—3	V	I_a	=	13	9,2	mA	I_{g2}	=	4	2,6	mA																													
V_a	=	100	250	V																																																					
V_{g2}	=	100	100	V																																																					
V_{g1}	=	—1	—3	V																																																					
I_a	=	13	9,2	mA																																																					
I_{g2}	=	4	2,6	mA																																																					

6SK7GT

(seguito)
(following)

Ingombro
Outline
 $\varnothing=30$ h=70

Accensione
Heater supply
6,3 V — 0,3 A

$R_i \sim 120 \quad 800 \quad k\Omega$
 $S = 2350 \quad 2000 \quad \mu A/V$

Pentodo, amplificatore a RF e FI.

Pentode intended for use as RF or IF amplifier.

6SL7GT

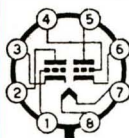

Ingombro
Outline
 $\varnothing=30$ h=70

Accensione
Heater supply
6,3 V — 0,3 A

(segue)
(follow)

$V_a = 300 \quad V$
 $V_g = 0 \quad V$
 $W_a = 1 \quad W$

Sezione 1 (1)
Section No. 1

$C_g = 3$
 $C_a = 3,8$
 $C_{g-a} = 2,8$

Sezione 2 (2)
Section No. 2

$C_g = 3,4$
 $C_a = 3,2$
 $C_{g-a} = 2,8$

con schermo
with external
shield

Amplificatore in classe A_1
Class A_1 Amplifier

$V_a = 250 \quad V$
 $V_g = -2 \quad V$
 $I_a = 2,3 \quad mA$
 $\mu = 70$
 $R_i \sim 44 \quad k\Omega$
 $S = 1600 \quad \mu A/V$

Doppio triodo, amplificatore a BF e invertitore di fase.

Twin Triode designed for service as resistance coupled amplifiers or phase inverters.

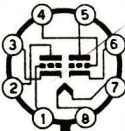
TIPO Type	Limiti massimi Maximum ratings	Capacità in pF Capacitances	Caratteristiche e funzionamento tipico Typical operation
6SL7GT (seguito) (following)		(1) piedini 4, 5 e 6. pins 4, 5 and 6. (2) piedini 1, 2 e 3. pins 1, 2 and 3.	
6SN7GT  Ingombro Outline $\varnothing = 30$ h = 70 Accensione Heater supply 6,3 V — 0,6 A (segue) (follow)	$V_a = 300$ V $V_g = 0$ V $W_a = 2,5$ V $I_k = 20$ mA	Sezione 1 (1) Section No. 1 $C_g = 3,2$ $C_a = 3,4$ $C_{g-a} = 4,0$ Sezione 2 (2) Section No. 2 $C_g = 3,8$ $C_a = 2,6$ $C_{g-a} = 4,0$ con schermo with external shield	Amplificatore in classe A_1 Class A_1 Amplifier $V_a = 90$ 250 V $V_g = 0$ -8 V $I_a = 10$ 9 mA $S = 3000$ 2600 $\mu A/V$ $\mu = 20$ 20 $R_i = 6,7$ 7,7 k Ω Doppio triodo, amplificatore a BF e invertitore di fase. <i>Twin triode designed for service as resistance coupled amplifiers or phase inverters.</i>

6SN7GT

(seguito)
(following)

- (1) piedini 4, 5 e 6.
pins 4, 5 and 6.
- (2) piedini 1, 2 e 3.
pins 1, 2 and 3.

6SN7GTA

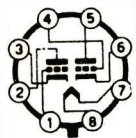

Ingombro
Outline
Ø=30 h=70

Accensione
Heater supply
6,3 V — 0,6 A

(segue)
(follow)

Amplif. classe A₁
Class A₁ Amplifier

$$V_a = 450 \text{ V}$$

$$W_a = 5 \text{ W}$$

$$I_k = 20 \text{ mA}$$

Amplif. deflessione
verticale

*Vertical deflection
amplifier*

$$V_a = 450 \text{ V}$$

$$V_a = 1500 \text{ V(1)}$$

$$V_g = 250 \text{ V(2)}$$

$$W_a = 5 \text{ W}$$

$$W_a = 7,5 \text{ W(3)}$$

$$I_k = 20 \text{ mA}$$

Sezione 1 (1)
Section No. 1

$$C_g = 2,2$$

$$C_a = 0,7$$

$$C_{g-a} = 4$$

Sezione 2 (2)
Section No. 2

$$C_g = 2,6$$

$$C_a = 0,7$$

$$C_{g-a} = 3,8$$

Amplificatore in classe A₁
Class A₁ Amplifier

V_a	=	90	250	V
V_g	=	0	-8	V
I_a	=	10	9	mA
R_i	~	6,7	7,7	kΩ
S	=	3000	2600	μA/V
μ	=	20	20	

TIPO <i>Type</i>	Limiti massimi <i>Maximum ratings</i>	Capacità in pF <i>Capacitances</i>	Caratteristiche e funzionamento tipico <i>Typical operation</i>
6SN7GTA <i>(seguito)</i> <i>(following)</i>	Note/Notes: (1) Impulsiva, picco positivo. <i>Peak positive pulse.</i> (2) Picco negativo. <i>Peak negative.</i> (3) Per 2 anodi. <i>For two plate.</i>	(1) piedini 4, 5 e 6. <i>pins 4, 5 and 6.</i> (2) piedini 1, 2 e 3. <i>pins 1, 2 and 3.</i>	Doppio triodo, oscillatore ed amplificatore di deflessione in TV. <i>Twin triode designed for use as combined vertical oscillators and vertical deflection amplifier in television receivers or in audio amplifier service.</i>
6SN7GTB Accensione Heater supply 6,3 V — 0,6 A			Riferirsi al tipo: 6SN7GTA <i>See Type</i>

6SQ7GT

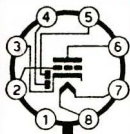

Ingombro
Outline

Ø=30 h=70

Accensione
Heater supply
6,3 V — 0,3 A

V_a	=	300 V
V_g	=	0 V
W_a	=	0,5 W
I_D	=	1 mA

C_g	=	4,2
C_a	=	3,4
C_{g-a}	=	1,8

senza schermo
without external shield

Amplificatore in classe A_1
Class A_1 Amplifier

V_a	=	100	250	V
V_g	=	-1	-2	V
I_a	=	0,4	0,9	mA
S	=	900	1100	$\mu A/V$
μ	=	100	100	
R_i	~	110	91	k Ω

Doppio diodo-triodo, amplificatore a BF rivelatore.

Twin diode-triode.

Detector and audio amplifier.

6T8



Ingombro
Outline

Ø=22 h=49

Accensione
Heater supply
6,3 V — 0,45 A

V_a	=	300 V
W_a	=	1 W
I_D	=	5 mA

Triodo
Triode Unit

C_g	=	1,6
C_a	=	1,1
C_{g-a}	=	1,8

Diodi - *Diodes*

C_{D1}	=	3,8
C_{D2}	=	4,5
C_{D3}	=	3,8

senza schermo
without external shield

Amplificatore in classe A_1
Class A_1 Amplifier

V_a	=	100	250	V
V_g	=	-1	-3	V
I_a	=	0,8	1,0	mA
R_i	~	54	58	k Ω
S	=	1300	1200	$\mu A/V$
μ	=	70	70	

Tripla diodo-triodo, amplificatore a BF, rivelatore e discriminatore per ricevitori MA e MF.

Triple-diode triode. High- μ triode designed for use in AM/FM receivers.

TIPO Type	Limiti massimi Maximum ratings	Capacità in pF Capacitances	Caratteristiche e funzionamento tipico Typical operation				
6TE8GT	$V_{aH} = 300 \text{ V}$ $V_{g^{2-4}} = 100 \text{ V}$ $V_{g^{1H}} = 0 \text{ V}$ $V_{aT} = 125 \text{ V}$ $I_k = 16 \text{ mA}$	Esodo <i>Esode Unit</i> $C_{g^1} = 4,6$ $C_a = 11,6$ $C_{g^1-a} = 0,002$ $C_{g^1-g^3} = 0,25$ $C_{g^3-a} = 0,3$	Convertitore di frequenza (1) <i>Converter service</i>				
	Ingombro <i>Outline</i> $\varnothing=30 \text{ h}=60$ Accensione <i>Heater supply</i> $6,3 \text{ V} - 0,3 \text{ A}$	Triodo <i>Triode Unit</i> $C_{g-a} = 2$	$V_{aH} = 100 \quad 250 \quad \text{V}$ $V_{g^{2-4H}} = 55 \quad 100 \quad \text{V}$ $V_{aT} = 100 \quad 100 \quad \text{V}$ $V_{g^{1H}} = -1,25 \quad -2 \quad \text{V}$ $I_{aH} = 1 \quad 3,7 \quad \text{mA}$ $I_{g^{2-4H}} = 2,6 \quad 3,8 \quad \text{mA}$ $I_{aT} = 3,4 \quad 3,4 \quad \text{mA}$ $I_{gT} = 0,200 \quad 0,200 \quad \text{mA}$ $R_{gT} = 50 \quad 50 \quad \text{k}\Omega$ $S_c = 450 \quad 650 \quad \mu\text{A/V}$ $R_{iH} = 1 \quad 1 \quad \text{M}\Omega$ $I_k = 7,2 \quad 10,5 \quad \text{mA}$				
(segue) (fo/low)			(1) Piedini 1 e 5 collegati insieme. <i>Pins 1 and 5 connected together.</i>				
			Amplificatore in classe A₁ <i>Class A₁ Amplifier</i>				
			Esodo <i>Esode Unit</i>		Triodo <i>Triode Unit</i>		
			$V_a = 100$	250	250	250	V
			$V_{g^{2-4}} = 50$	100	—	—	V
			$V_{g^1} = -1$	-2	-2	-4	V

6TE8GT

(seguito)
(following)

V_{g^3}	=	0	0	—	—	V
I_a	=	2,35	6,7	1	0,86	mA
I_{g^3}	=	1,1	1,5	—	—	mA
R_i	=	360	600	—	—	k Ω
S	=	1800	2600	—	—	μ A/V
R_a	=	—	—	200	200	k Ω
μ	=	—	—	15	12	

Triodo-esodo, convertitore ed amplificatore a FI per ricevitori MA/MF.

Triode-esode designed for use as converter service and as IF amplifier in MA/MF receivers.

6U8

ECF82



Ingombro
Outline
 $\varnothing=22$ h=49

(segue)
(follow)

Pentodo
Pentode Unit

V_a	=	300	V
V_{g^1}	=	0	V
W_a	=	2,8	W
W_{g^2}	=	0,5	W

Triodo
Triode Unit

V_a	=	300	V
V_g	=	0	V
W_a	=	2,7	W

Pentodo
Pentode Unit

C_{g^1}	=	5
C_a	=	3,5
C_{g^1-a}	=	0,006

Triodo
Triode Unit

C_g	=	2,5
C_a	=	1
C_{g-a}	=	1,8

Amplificatore in classe A_1
Class A_1 Amplifier

Pentode
Pentode Unit

V_a	=	230
V_{g^2}	=	110
R_k	=	68
I_a	=	10
I_{g^2}	=	3,5
R_i	=	400
S	=	5200
μ	=	—

Triodo
Triode Unit

V_a	=	150	V
V_g	=	—	V
R_k	=	56	Ω
I_a	=	18	mA
I_{g^2}	=	—	mA
R_i	=	5	k Ω
S	=	8500	μ A/V
μ	=	40	

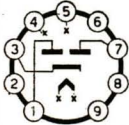
TIPO Type	Limiti massimi Maximum ratings	Capacità in pF Capacitances	Caratteristiche e funzionamento tipico Typical operation
<p>6U8</p> <hr/> <p>ECF82</p> <p>(seguito) (following)</p> <p>Accensione Heater supply 6,3 V — 0,45 A</p>		<p>con schermo connesso al catodo with external shield connected to the cathode</p>	<p>Triodo-pentodo, oscillatore e mescolatore in circuiti TV e MF. Triode-pentode designed for use as local oscillator-pentode mixer and other combined functions in FM and TV receivers.</p>
<p>6V4</p> <hr/> <p>EZ80</p>  <p>Ingombro Outline Ø=22 h=61</p> <p>Accensione Heater supply 6,3 V — 0,6 A</p>			<p>Massima corrente continua di uscita = 90 mA Maximum DC Output Current</p> <p>Massima tensione anodica alternata = 2 × 350 V_{eff} Maximum AC Plate Supply Voltage</p> <p>Tensione tra filamento e catodo (picco) = 500 V Cathode to heater voltage (peak)</p> <p>Resistenza in serie agli anodi = 2 × 300 Ω (min.) Protecting resistance</p> <p>Capacità d'ingresso del filtro = 50 μF Input capacitor of smoothing filter</p> <p>Doppio diodo, rettificatore delle due semionde. Full-Wave Rectifier.</p>

6V6GT

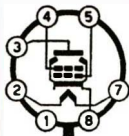

Ingombro

Outline

Ø=22 h=76

Accensione

Heater supply

6,3 V — 0,45 A

V_a	=	315 V
V_{g_2}	=	285 V
W_a	=	12 W
W_{g_2}	=	2 W

Amplif. deflessione
verticale.
*Vertical deflection
amplifier.*

(collegato a triodo)
(Triode connected)

V_a	=	315 V
V_a (picco positivo)	=	1200 V
V_{g_1} (picco negativo)	=	250 V

(picco negativo)
(peak negative)

W_a	=	9 W
I_k	=	35 mA
I_k (picco/peak)	=	105 mA

C_{g_1}	=	9
C_a	=	7,5
C_{g_1-a}	=	0,7

senza schermo
*without external
shield*

Amplificatore in classe A_1
Class A_1 Amplifier

V_a	=	180	250	315	V
V_{g_2}	=	180	250	225	V
V_{g_1}	=	-8,5	-12,5	-13	V
I_a	=	29	45	34	mA
I_{g_2}	=	3	4,5	2,2	mA
R_i	=	50	50	80	kΩ
S	=	3700	4100	3750	μA/V
R_a	=	5,5	5	8,5	kΩ
W_o	=	2	4,5	5,5	W
d	=	8	8	12	%

Amplificatore controfase in classe AB_1
Class AB_1 Push-pull power amplifier

V_a	=	250	285	V
V_{g_2}	=	250	285	V
V_{g_1}	=	-15	-19	V
I_a	=	70	70	mA
I_{g_2}	=	5	4	mA
R_{a-a}	=	10	8	kΩ
W_o	=	10	14	W
d	=	5	3,5	%

(segue)
(follow)

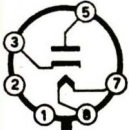
TIPO <i>Type</i>	Limiti massimi <i>Maximum ratings</i>	Capacità in pF <i>Capacitances</i>	Caratteristiche e funzionamento tipico <i>Typical operation</i>
6V6GT (seguito) (following)			<p>Amplificatore in classe A₁ - Collegato a triodo <i>Class A₁ Amplifier - Triode operation.</i></p> <p> $V_a = 250 \text{ V}$ $V_{g1} = -12,5 \text{ V}$ $I_a = 49,5 \text{ mA}$ $S = 5000 \mu\text{A/V}$ $\mu = 9,8$ $R_i = 1,96 \text{ k}\Omega$ </p> <p>Tetrodo a fascio, amplificatore di potenza a BF oppure amplificatore di deflessione verticale in TV. <i>Beam Power Pentode intended for service as a general purpose audio power amplifier or vertical deflection amplifier in television receivers sweep circuits.</i></p>
6W4GT  (segue) (follow)			<p>Massima corrente continua di uscita = 125 mA <i>Maximum DC Output Current</i></p> <p>Massima ampiezza della tensione inversa anodica = 3850 V <i>Maximum Peak Inverse Plate Voltage</i></p> <p>Picco massimo della corrente anodica = 750 mA <i>Maximum Peak Plate Current</i></p>

6W4GT

(seguito)
(following)

Ingombro
Outline
 $\varnothing = 30$ h = 70

Accensione
Heater supply
6,3 V — 1,2 A

Caduta interna di tensione a 250 mA = 21 V
Plate Voltage Drop (for 250 mA)

Diodo, raddrizzatore di una semionda o smorzatore (damper) in circuiti TV.
Half-Wave Rectifier for television damper service.

6W6GT

Accensione
Heater supply
6,3 V — 1,2 A

Riferirsi al tipo: 50L6GT
See Type

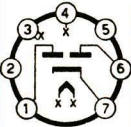
TIPO <i>Type</i>	Limiti massimi <i>Maximum ratings</i>	Capacità in pF <i>Capacitances</i>	Caratteristiche e funzionamento tipico <i>Typical operation</i>
6X4			
<p data-bbox="128 222 204 248">EZ90</p>  <p data-bbox="105 492 226 559">Ingombro Outline Ø=19 h=60</p> <p data-bbox="90 585 241 652">Accensione Heater supply 6,3 V — 0,6 A</p>			<p data-bbox="831 176 1451 233">Massima corrente continua di uscita = 70 mA <i>Maximum DC Output Current</i></p> <p data-bbox="831 243 1451 331">Massima ampiezza della tensione inversa anodica = 1250 V <i>Maximum Peak Inverse Plate Voltage</i></p> <p data-bbox="831 347 1451 404">Massima tensione anodica alternata = 325 V_{eff} <i>Maximum AC Plate Supply Voltage</i></p> <p data-bbox="831 419 1451 533">Picco massimo della corrente anodica (per diodo) = 210 mA <i>Maximum Peak Plate Current (Each Plate)</i></p> <p data-bbox="831 549 1451 606">Caduta interna di tensione a 70 mA = 22 V <i>Plate Voltage Drop (for 70 mA)</i></p> <p data-bbox="831 642 1451 730">Doppio diodo, raddrizzatore delle due semionde. <i>Full-Wave Rectifier.</i></p>

6X5GT

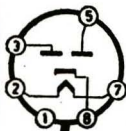

Ingombro
Outline
 $\varnothing=19$ h=60

Accensione
Heater supply
6,3 V — 0,6 A

Massima corrente continua di uscita = 70 mA
Maximum DC Output Current

Massima ampiezza della tensione inversa anodica = 1250 V
Maximum Peak Inverse Plate Voltage

Massima tensione anodica alternata = 325 V_{eff}
Maximum AC Plate Supply Voltage

Picco massimo della corrente anodica (per diodo) = 210 mA
Maximum Peak Plate Current (Each Plate)

Caduta interna di tensione a 70 mA = 22 V
Plate Voltage Drop (for 70 mA)

Doppio diodo raddrizzatore delle due sezioni.
Full-Wave Rectifier.

7AN7

PCC84

Accensione
Heater supply
7 V — 0,3 A

(Vedi dati condensati)
(See condensed data section)

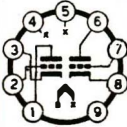
TIPO Type	Limiti massimi Maximum ratings	Capacità in pF Capacitances	Caratteristiche e funzionamento tipico Typical operation
7DJ8 PCC88 Accensione Heater supply 7 V — 0,3 A			Riferirsi al tipo: $\frac{6DJ8}{ECC88}$ See Type
7ES8 PCC189 S  Ingombro Outline $\varnothing=22$ h=49 Accensione Heater supply 7,2 V — 0,3 A TR=14,5 sec.	$V_a = 130$ V $W_a = 1,8$ W $V_g = -50$ V $R_g = 1$ M Ω $I_k = 22$ mA	Per sezione (each section) $C_g = 3,5$ $C_a = 2,3$ $C_{a-g} = 1,9$ con schermo with external shield $C_g = 3,5$ $C_a = 1,7$ $C_{a-g} = 1,9$ senza schermo without external shield	Amplificatore in classe A ₁ Class A ₁ Amplifier (valori per ciascuna sezione) (values for each section) $V_a = 90$ 90 90 V $V_g = -1,4$ -5 -9 V $I_a = 15$ — — mA $S = 12500$ 625 125 μ A/V $R_i = 2,5$ — — k Ω Doppio triodo a «μ» variabile e basso fruscio, amplificatore per TV-VHF. <i>Twin triode with variable transconductance intended for use as VHF cascode amplifier in television tuners.</i>

7GV7
PCF805 S



Ingombro
Outline
Ø=22 h=49

Accensione
Heater supply
7,4 V — 0,3 A

TR=14,5 sec.

Pentodo
Pentode Unit

V_a	=	250 V
V_{g2}	=	230 V
W_a	=	2 W
W_{g2}	=	0,5 W
I_k	=	18 mA

Triodo
Triode Unit

V_a	=	250 V
W_a	=	2 W
I_k	=	15 mA

Pentodo
Pentode Unit

C_{g1} -tutti	=	6,7
C_{g1} to all other electrodes		
C_a -tutti	=	2,7
C_a to all other electrodes		
C_{g1-a}	=	0,007

Triodo
Triode Unit

$C_{g-a} = 2$
con schermo
with external
shield

Amplificatore in classe A₁
Class A₁ Amplifier

Pentodo <i>Pentode Unit</i>	Triodo <i>Triode Unit</i>
V_a	= 125 V
V_{g2}	= 125 V
V_{g1}	= -1,5 V
I_a	= 10 mA
I_{g2}	= 3,1 mA
S	= 11 5,5 mA/V
μ_{g2-g1}	= 50
μ	= — 17

Triodo-pentodo, oscillatore e miscelatore per TV-VHF.

Triode-Pentode.

High transconductance triode and RF pentode intended for use as frequency changer in VHF-TV tuners.

TIPO <i>Type</i>	Limiti massimi <i>Maximum ratings</i>	Capacità in pF <i>Capacitances</i>	Caratteristiche e funzionamento tipico <i>Typical operation</i>																									
<p>7HG8 PCF86</p>  <p>Ingombro <i>Outline</i> Ø=22 h=49</p> <p>Accensione <i>Heater supply</i> 8 V — 0,3 A</p> <p>TR=14,5 sec.</p>	<p>Pentodo <i>Pentode Unit</i></p> <p>$V_a = 250 \text{ V}$ $V_{g2} = 150 \text{ V}$ $W_a = 2 \text{ W}$ $W_{g2} = 0,5 \text{ W}$ $I_k = 18 \text{ mA}$ $R_{g1} = 500 \text{ k}\Omega (1)$ $250 \text{ k}\Omega (2)$</p> <p>Triodo <i>Triode Unit</i></p> <p>$V_a = 125 \text{ V}$ $W_a = 1,5 \text{ W}$ $I_k = 15 \text{ mA}$ $R_g = 500 \text{ k}\Omega$</p> <p>(1) Polarizz. autom. <i>Automatic bias.</i></p> <p>(2) Polarizzaz. fissa. <i>Fixed bias.</i></p>	<p>Pentodo <i>Pentode Unit</i></p> <p>$C_{g1} = 6$ $C_a = 3,6$ $C_{g1-a} < 0,012$</p> <p>Triodo <i>Triode Unit</i></p> <p>$C_g = 2,4$ $C_a = 1,1$ $C_{g-a} = 2$</p>	<table border="0"> <tr> <td>Pentodo <i>Pentode Unit</i></td> <td>Triodo <i>Triode Unit</i></td> </tr> <tr> <td>$V_a = 190$</td> <td>190 V</td> </tr> <tr> <td>$V_{bg2} = 190$</td> <td>— V</td> </tr> <tr> <td>$R_a = —$</td> <td>8,2 kΩ</td> </tr> <tr> <td>$R_{g2} = 18$</td> <td>— kΩ</td> </tr> <tr> <td>$R_{g1} = 100$</td> <td>10 kΩ</td> </tr> <tr> <td>$I_a = 8,5$</td> <td>12 mA</td> </tr> <tr> <td>$I_{g2} = 2,7$</td> <td>— mA</td> </tr> <tr> <td>$R_i = 0,6$</td> <td>— MΩ</td> </tr> <tr> <td>S conv. = 4500</td> <td>— $\mu\text{A/V}$</td> </tr> <tr> <td>V oscill. = —</td> <td>4,5 V_{eff}</td> </tr> <tr> <td>S = —</td> <td>3500 $\mu\text{A/V}$</td> </tr> </table> <p>Triodo-pentodo oscillatore e miscelatore per TV-VHF. <i>Triode-pentode intended for use as frequency changer in VHF television tuners.</i></p>		Pentodo <i>Pentode Unit</i>	Triodo <i>Triode Unit</i>	$V_a = 190$	190 V	$V_{bg2} = 190$	— V	$R_a = —$	8,2 k Ω	$R_{g2} = 18$	— k Ω	$R_{g1} = 100$	10 k Ω	$I_a = 8,5$	12 mA	$I_{g2} = 2,7$	— mA	$R_i = 0,6$	— M Ω	S conv. = 4500	— $\mu\text{A/V}$	V oscill. = —	4,5 V _{eff}	S = —	3500 $\mu\text{A/V}$
Pentodo <i>Pentode Unit</i>	Triodo <i>Triode Unit</i>																											
$V_a = 190$	190 V																											
$V_{bg2} = 190$	— V																											
$R_a = —$	8,2 k Ω																											
$R_{g2} = 18$	— k Ω																											
$R_{g1} = 100$	10 k Ω																											
$I_a = 8,5$	12 mA																											
$I_{g2} = 2,7$	— mA																											
$R_i = 0,6$	— M Ω																											
S conv. = 4500	— $\mu\text{A/V}$																											
V oscill. = —	4,5 V _{eff}																											
S = —	3500 $\mu\text{A/V}$																											

8GJ7
PCF801 S



Ingombro
Outline
 $\varnothing=22$ h=44

Accensione
Heater supply
8,5 V — 0,3 A

TR=14,5 sec.

Pentodo
Pentode Unit

V_a	=	250 V
V_{g^2}	=	250 V
V_{g^1}	=	-50 V
W_a	=	2 W
W_{g^2}	=	0,3 ÷ 0,45 W
I_k	=	18 mA

Triodo
Triode Unit

V_a	=	125 V
V_g	=	-50 V
W_a	=	1,5 W
I_k	=	20 mA

Pentodo
Pentode Unit

C_{g^1}	=	6,2
C_a	=	3,5
C_{g^1-a}	=	0,009

Triodo
Triode Unit

C_g	=	3,3
C_a	=	1,7
C_{g-a}	=	1,8

con schermo
with external
shield

Pentodo
Pentode Unit

V_a	=	170
V_{g^2}	=	120
V_{g^1}	=	-1,2
I_a	=	10
I_{g^2}	=	3
S	=	11
R_i	>	350
$\mu_{g^2-g^1}$	=	55
R_{eq}	=	1,5

Triodo
Triode Unit

	=	100 V
	=	— V
	=	-3 V
	=	15 mA
	=	— mA
	=	9 mA/V
	=	— k Ω
	=	—
	=	— k Ω

Triodo-pentodo, oscillatore e miscelatore per TV-VHF.

Triode-pentode.

High transconductance triode and RF pentode intended for use as frequency changer in VHF TV tuners.

TIPO Type	Limiti massimi Maximum ratings	Capacità in pF Capacitances	Caratteristiche e funzionamento tipico Typical operation																				
<p>9A8 PCF80</p>  <p>Ingombro Outline Ø=22 h=49</p> <p>Accensione Heater supply 9 V — 0,3 A</p> <p>TR=14,5 sec.</p> <p>(segue) (follow)</p>	<p>Pentodo <i>Pentode Unit</i></p> <p>$V_b = 550 \text{ V}$ $V_a = 250 \text{ V}$ $V_{g2} = 175 \text{ V}$ $(I_k = 14 \text{ mA})$ $W_a = 1,7 \text{ W}$ $W_{g2} = 0,5 \text{ W}$ $(W_a > 1,2 \text{ W})$ $R_{g1} = 0,5 \text{ M}\Omega(1)$ $R_{g1} = 1 \text{ M}\Omega(2)$</p> <p>Triodo <i>Triode Unit</i></p> <p>$V_b = 550 \text{ V}$ $V_a = 250 \text{ V}$ $I_k = 14 \text{ mA}$ $W_a = 1,5 \text{ W}$ $R_{g1} = 0,5 \text{ M}\Omega(3)$</p> <p>(1) Polarizzaz. fissa. <i>Fixed bias.</i></p> <p>(2) Polarizz. autom. <i>Automatic bias.</i></p>	<p>Pentodo <i>Pentode Unit</i></p> <p>$C_{g1} = 5,2$ $C_a = 3,4$ $C_{g1-a} < 0,025$</p> <p>Triodo <i>Triode Unit</i></p> <p>$C_g = 2,5$ $C_g = 1,8$ $C_{g-a} = 1,5$</p>	<p>Amplificatore in classe A₁ <i>Class A₁ Amplifier</i></p> <table border="0"> <thead> <tr> <th data-bbox="817 236 1105 291">Pentodo <i>Pentode Unit</i></th> <th data-bbox="1109 236 1460 291">Triodo <i>Triode Unit</i></th> </tr> </thead> <tbody> <tr> <td>$V_a = 170$</td> <td>100 V</td> </tr> <tr> <td>$V_{g2} = 170$</td> <td>— V</td> </tr> <tr> <td>$V_{g1} = -2$</td> <td>-2 V</td> </tr> <tr> <td>$I_a = 10$</td> <td>14 mA</td> </tr> <tr> <td>$I_{g2} = 2,8$</td> <td>— mA</td> </tr> <tr> <td>S = 6200</td> <td>5000 $\mu\text{A/V}$</td> </tr> <tr> <td>$\mu_{g2-g1} = 47$</td> <td>—</td> </tr> <tr> <td>$\mu = —$</td> <td>20</td> </tr> <tr> <td>$R_i = 0,4$</td> <td>— MΩ</td> </tr> </tbody> </table> <p>Triodo-pentodo. Triodo a medio «μ». Pentodo ad interdizione rapida. Amplificatore FI, convertitore, ecc. <i>Triode-Pentode.</i> <i>Medium-μ triode.</i> <i>Sharp Cutoff Pentode.</i> <i>IF Amplifier, converter, ...</i></p>	Pentodo <i>Pentode Unit</i>	Triodo <i>Triode Unit</i>	$V_a = 170$	100 V	$V_{g2} = 170$	— V	$V_{g1} = -2$	-2 V	$I_a = 10$	14 mA	$I_{g2} = 2,8$	— mA	S = 6200	5000 $\mu\text{A/V}$	$\mu_{g2-g1} = 47$	—	$\mu = —$	20	$R_i = 0,4$	— M Ω
Pentodo <i>Pentode Unit</i>	Triodo <i>Triode Unit</i>																						
$V_a = 170$	100 V																						
$V_{g2} = 170$	— V																						
$V_{g1} = -2$	-2 V																						
$I_a = 10$	14 mA																						
$I_{g2} = 2,8$	— mA																						
S = 6200	5000 $\mu\text{A/V}$																						
$\mu_{g2-g1} = 47$	—																						
$\mu = —$	20																						
$R_i = 0,4$	— M Ω																						

<p>9A8 PCF80 (seguito) (following)</p>	<p>(3) Polarizz. fissa o automatica. <i>Fixed or automatic bias.</i></p>		
<p>9AK8 PABC80 ^S</p> <p>Accensione Heater supply 9,5 V — 0,3 A</p> <p>TR=14,5 sec.</p>			<p>Riferirsi al tipo: $\frac{6AK8}{EABC80}$ See Type</p>
<p>9AM8</p> <p>Accensione Heater supply 9,5 V — 0,3 A</p> <p>TR=14,5 sec.</p>			<p>Riferirsi al tipo: 6AM8 See Type</p>

TIPO Type	Limiti massimi Maximum ratings	Capacità in pF Capacitances	Caratteristiche e funzionamento tipico Typical operation
9AQ5 Accensione Heater supply 9,45 V — 0,3 A			Riferirsi al tipo: 6AQ5 <i>See Type</i>
9AQ8 PCC85  Ingombro Outline $\varnothing=22$ h=49 Accensione Heater supply 9 V — 0,3 A TR=14,5 sec. (segue) (follow)	Per sezione <i>Each Unit</i> $V_a = 300$ V $W_a = 2,5$ W $I_k = 15$ mA $V_g = -100$ V $R_g = 1$ M Ω	Per sezione <i>Each Unit</i> $C_g = 3$ $C_a = 1,2$ $C_{g-a} = 1,5$ $C_{a-k} = 0,18$	Amplificatore RF <i>RF Amplifier</i> $V_a = 250$ V $V_g = -2$ V $R_a = 1,8$ k Ω $R_k = 200$ Ω $I_a = 10$ mA $S = 6$ mA/V $R_i \sim 9,7$ k Ω Mescolatore oscillatore <i>Oscillating mixer</i> $V_{ba} = 250$ V $R_a = 12$ k Ω $R_g = 1$ M Ω $V_{osc} = 3$ V _{eff} $I_a = 5,2$ mA

9AQ8			$S_c = 2,3 \text{ mA/V}$ $R_i \sim 22 \text{ k}\Omega$
PCC85 <i>(seguito)</i> <i>(following)</i>			Doppio triodo, amplificatore a RF e mescolatore oscillatore in ricevitori MA-MF. <i>Twin triode intended for use as RF amplifier and self oscillating mixer.</i>
9BK7A Accensione Heater supply 9,45 V — 0,3 A			Riferirsi al tipo: 6BK7A <i>See Type</i>
9CG8S Accensione Heater supply 9,45 V — 0,3 A TR=14,5 sec.			Riferirsi al tipo: 6CG8A <i>See Type</i>

TIPO Type	Limiti massimi Maximum ratings	Capacità in pF Capacitances	Caratteristiche e funzionamento tipico Typical operation																		
<p>9EA8S</p>  <p>Ingombro Outline Ø=22 h=49</p> <p>Accensione Heater supply 6,3 V — 0,45 A</p> <p>TR=14,5 sec.</p>	<p>Pentodo <i>Pentode Unit</i></p> <p>$V_a = 300$ V $V_{g1} = 0$ V $W_a = 2,8$ W $W_{g2} = 0,5$ W</p> <p>Triodo <i>Triode Unit</i></p> <p>$V_a = 300$ V $V_g = 0$ V $W_a = 2,7$ W</p>	<p>Pentodo <i>Pentode Unit</i></p> <p>$C_{g1} = 5$ $C_a = 3,4$ $C_{g1-a} < 0,01$</p> <p>Triodo <i>Triode Unit</i></p> <p>$C_g = 3,2$ $C_a = 1,1$ $C_{g-a} = 1,7$ con schermo <i>with external shield</i></p>	<p>Amplificatore in classe A₁ <i>Class A₁ Amplifier</i></p> <table border="0"> <thead> <tr> <th data-bbox="807 225 1130 283">Pentodo <i>Pentode Unit</i></th> <th data-bbox="1146 225 1462 283">Triodo <i>Triode Unit</i></th> </tr> </thead> <tbody> <tr> <td>$V_a = 125$</td> <td>150 V</td> </tr> <tr> <td>$V_{g2} = 125$</td> <td>— V</td> </tr> <tr> <td>$R_k = —$</td> <td>56 Ω</td> </tr> <tr> <td>$I_a = 12$</td> <td>18 mA</td> </tr> <tr> <td>$I_{g2} = 4$</td> <td>— mA</td> </tr> <tr> <td>$R_i \sim 80$</td> <td>5 kΩ</td> </tr> <tr> <td>$S = 6400$</td> <td>8500 μA/V²</td> </tr> <tr> <td>$\mu = —$</td> <td>40</td> </tr> </tbody> </table> <p>Triodo-pentodo a sezioni separate, progettato per l'uso combinato, sezione triodo come oscillatore e sezione pentodo come mescolatore in TV. <i>Triode-pentode with separate cathodes intended for use as frequency changer in television receivers.</i></p>	Pentodo <i>Pentode Unit</i>	Triodo <i>Triode Unit</i>	$V_a = 125$	150 V	$V_{g2} = 125$	— V	$R_k = —$	56 Ω	$I_a = 12$	18 mA	$I_{g2} = 4$	— mA	$R_i \sim 80$	5 kΩ	$S = 6400$	8500 μA/V ²	$\mu = —$	40
Pentodo <i>Pentode Unit</i>	Triodo <i>Triode Unit</i>																				
$V_a = 125$	150 V																				
$V_{g2} = 125$	— V																				
$R_k = —$	56 Ω																				
$I_a = 12$	18 mA																				
$I_{g2} = 4$	— mA																				
$R_i \sim 80$	5 kΩ																				
$S = 6400$	8500 μA/V ²																				
$\mu = —$	40																				

9GX6S Accensione Heater supply 9,45 V — 0,3 A TR=14,5 sec.			Riferirsi al tipo: 6GX6 <i>See Type</i>
9T8 Accensione Heater supply 9,45 V — 0,3 A			Riferirsi al tipo: 6T8 <i>See Type</i>
9U8 <hr/> PCF82 Accensione Heater supply 9,45 V — 0,3 A			Riferirsi al tipo: $\frac{6U8}{ECF82}$ <i>See Type</i>

TIPO <i>Type</i>	Limiti massimi <i>Maximum ratings</i>	Capacità in pF <i>Capacitances</i>	Caratteristiche e funzionamento tipico <i>Typical operation</i>
12A6GT Accensione Heater supply 12,6 V — 0,15 A			(Vedi dati condensati) (See condensed data section)
12A8GT Accensione Heater supply 12,6 V — 0,15 A			Riferirsi al tipo: 6A8G/GT See Type
12AJ8 HCH81 Accensione Heater supply 12,6 V — 0,15 A			Riferirsi al tipo: $\frac{6AJ8}{ECH81}$ See Type

12AL5

Accensione
Heater supply
12,6 V — 0,15 A

Riferirsi al tipo: $\frac{6AL5}{EAA91}$
See Type

12AT6**HBC90**

Accensione
Heater supply
12,6 V — 0,15 A

Riferirsi al tipo: $\frac{6AT6}{EBC90}$
See Type

12AT7**ECC81**

(segue)
(follow)

$V_a = 300 \text{ V}$
 $V_g = -50 \text{ V}$
 $W_a = 2,5 \text{ W}$

Sezione 1 (1)
Section No. 1

$C_g = 2,2$
 $C_a = 1,2$
 $C_{g-a} = 1,5$

Sezione 2 (2)
Section No. 2

$C_g = 2,2$
 $C_a = 1,5$

Amplificatore in classe A_1
Class A_1 Amplifier

$V_a = 100 \quad 250 \quad \text{V}$
 $R_k = 270 \quad 200 \quad \Omega$
 $I_a = 3,7 \quad 10 \quad \text{mA}$
 $R_i \sim 15 \quad 10,9 \quad \text{k}\Omega$
 $S = 4000 \quad 5500 \quad \mu\text{A/V}$
 $\mu = 60 \quad 60$
 $R_a = 27 \quad 25 \quad \text{k}\Omega$

TIPO <i>Type</i>	Limiti massimi <i>Maximum ratings</i>	Capacità in pF <i>Capacitances</i>	Caratteristiche e funzionamento tipico <i>Typical operation</i>
<p>12AT7 ECC81 (seguito) (following) Ingombro Outline Ø=22 h=49 Accensione in serie Heater series supply 12,6 V — 0,15 A Accensione in parallelo Heater parallel supply 6,3 V — 0,3 A</p>		<p>$C_{g-a} = 1,5$ co schermo with external shield</p> <p>(1) piedini 6, 7 e 8. pins 6, 7 and 8.</p> <p>(2) piedini 1, 2 e 3. pins 1, 2 and 3.</p>	<p>Doppio triodo, amplificatore a RF con griglia a massa e convertitore per frequenze fino a 300 MHz. <i>Twin triode designed for use as a grounded grid amplifier at frequencies up to 300 MHz.</i></p>
<p>12AU6 HF94 Accensione Heater supply 12.6 V — 0,15 A</p>			<p>Riferirsi al tipo: $\frac{6AU6}{EF94} S$ See Type</p>

12AU7 ECC82

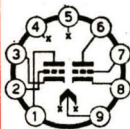

Ingombro
Outline

Ø=22 h=49

Accensione
in serie
Heater

series supply
12,6 V — 0,15 A

Accensione
in parallelo
Heater

parallel supply
6,3 V — 0,3 A

Amplif. classe A₁
Class A₁ Amplif.

$$V_a = 300 \text{ V}$$

$$W_a = 2,75 \text{ W}$$

$$I_k = 20 \text{ mA}$$

Amplific. defless.
verticale

Vertical deflection
amplifier

$$V_a = 300 \text{ V}$$

V_a (impulsiva)
(pulse)

$$= 1200 \text{ V}$$

$$W_a = 2,75 \text{ W}$$

$$I_k = 20 \text{ mA}$$

I_k (picco/peak)

$$= 60 \text{ mA}$$

Per sezione
Each section

$$C_g = 1,8$$

$$C_a = 2,0$$

$$C_{g-a} = 1,5$$

Amplificatore in classe A₁
Class A₁ Amplifier

(valori per sezione)

(values are for Each Section)

$$V_a = 100 \quad 250 \quad \text{V}$$

$$V_g = 0 \quad -8,5 \quad \text{V}$$

$$I_a = 11,8 \quad 10,5 \quad \text{mA}$$

$$R_i = 6,5 \quad 7,7 \quad \text{k}\Omega$$

$$S = 3100 \quad 2200 \quad \mu\text{A/V}$$

$$\mu = 20 \quad 17$$

$$R_{ab} = 8,5 \quad 23,8 \quad \text{k}\Omega$$

Doppio triodo, amplificatore a BF, amplificatore finale deflessione verticale, invertitore di fase, multivibratore ed oscillatore. (Ogni sezione è elettricamente simile al tipo 6C4)

Twin triode intended primarily for service as horizontal or deflection oscillators, vertical deflection amplifiers and Class A₁ resistance coupled amplifiers.

(Each section of these types is electrically similar to the Type 6C4).

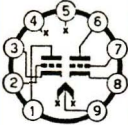
TIPO <i>Type</i>	Limiti massimi <i>Maximum ratings</i>	Capacità in pF <i>Capacitances</i>	Caratteristiche e funzionamento tipico <i>Typical operation</i>
12AU8 Accensione Heater supply 12,6 V — 0,3 A			Riferirsi al tipo: 6AU8 <i>See Type</i>
12AV6 HBC91 Accensione Heater supply 12,6 V — 0,15 A			Riferirsi al tipo: 6AV6 <i>See Type</i> EBC91
12AX7 ECC83  <i>(segue)</i> <i>(follow)</i>	Per sezione <i>Each section</i> $V_a = 300 \text{ V}$ $V_g = -50 \div 0 \text{ V}$ $W_a = 1 \text{ W}$	Per sezione <i>Each section</i> $C_g = 1,8$ $C_a = 1,9$ $C_{g-a} = 1,7$	Amplificatore in classe A_1 <i>Class A_1 Amplifier</i> (valori per ogni sezione) <i>(values are for each section)</i> $V_a = 100 \quad 250 \quad \text{V}$ $V_g = -1 \quad -2 \quad \text{V}$ $I_a = 0,5 \quad 1,2 \quad \text{mA}$ $R_i \sim 80 \quad 62,5 \quad \text{k}\Omega$ $S = 1250 \quad 1600 \quad \mu\text{A/V}$ $\mu = 100 \quad 100$ $R_a = 200 \quad 208 \quad \text{k}\Omega$

12AX7

ECC83

(seguito)
(following)

Ingombro
Outline
 $\varnothing=22$ h=49

Accensione
in serie
Heater
series supply
12,6 V — 0,15 A

Accensione
in parallelo
Heater
parallel supply
6,3 V — 0,3 A

12BA6

HF93

Accensione
Heater supply
12,6 V — 0,15 A

Doppio triodo, amplificatore a BF, invertitore di fase, separatore e multivibratore in circuiti TV (ogni sezione ha caratteristiche elettriche uguali al tipo 6AV6).

TwIn triode designed for service as an audio voltage amplifier or phase inverters in portable or compact equipment.

(Each section of these types has identical electrical characteristics to the Type 6AV6).

Riferirsi al tipo: $\frac{6BA6}{EF93}$
See Type

TIPO <i>Type</i>	Limiti massimi <i>Maximum ratings</i>	Capacità in pF <i>Capacitances</i>	Caratteristiche e funzionamento tipico <i>Typical operation</i>
12BE6 <hr/> HK90 Accensione Heater supply 12,6 V — 0,15 A			Riferirsi al tipo: $\frac{6BE6}{EK90}$ <i>See Type</i>
12BH7  Ingombro Outline $\varnothing=22$ h=60 Accensione in serie Heater supply series 12,6 V — 0,3 A (segue) (follow)	Amplif. classe A_1 <i>Class A_1 Amplifier</i> $V_a = 300$ V $W_a = 3,5$ W $I_k = 20$ mA Amplif. deflessione verticale <i>Vertical deflection amplifier</i> $V_a = 450$ V V_a (picco positivo) (peak positive) $= 1500$ V	$C_{a1-a2} = 0,8$ Sezione 1 (1) <i>Section No. 1</i> $C_g = 3,2$ $C_a = 0,5$ $C_{g-a} = 2,6$ Sezione 2 (2) <i>Section No. 2</i> $C_g = 3,2$ $C_a = 0,4$ $C_{g-a} = 2,6$ senza schermo <i>without external shield</i>	Amplificatore in classe A_1 <i>Class A_1 Amplifier</i> (valore per ciascuna sezione) (values are for each section) $V_a = 250$ V $V_g = -10,5$ V $\mu = 16,5$ $R_i \sim 5,3$ k Ω $S = 3100$ $\mu A/V$ $I_a = 11,5$ mA Doppio tripdo, amplificatore finale deflessione verticale ed oscillatore verticale. <i>Twln triode designed for use as a vertical deflection amplifier or vertical deflection oscillator.</i>

12BH7

(seguito)
(following)

**Accensione
in parallelo**
Heater
parallel supply
6,3 V — 0,6 A

V_g (picco negativo)
(peak negative)

$$= 250 \text{ V}$$

$$W_a = 3,5 \text{ W}$$

$$I_k = 20 \text{ mA}$$

I_k (picco/peak)
 $= 70 \text{ mA}$

(1) piedini 6, 7
e 8.
pins 6, 7 and
8.

(2) piedini 1, 2
e 3.
pins 1, 2 and
3.

12C8GT

Accensione
Heater supply
12,6 V — 0,225 A

(Vedi dati condensati)
(See condensed data section)

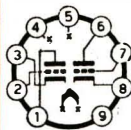
12CG7S

(segue)
(follow)

Amplific. classe A₁
Class A₁ Amplifier
(per sezione)
(each section)

$$V_a = 300 \text{ V}$$

$$V_g = 0 \text{ V}$$

$$W_a = 3,5 \text{ W}$$

$$C_g = 2,3$$

$$C_a = 2,2$$

$$C_{g-a} = 4$$

senza schermo
without external
shield

Amplificatore in classe A₁ (per sezione)
Class A₁ Amplifier (each section)

$$V_a = 90 \quad 250 \quad 250 \quad \text{V}$$

$$V_g = 0 \quad -12,5 \quad -8 \quad \text{V}$$

$$\mu = 20 \quad - \quad 20$$

$$R_i = 6700 \quad - \quad 7700 \quad \Omega$$

$$S = 3000 \quad - \quad 2600 \quad \mu\text{A/V}$$

$$I_a = 10 \quad 1,3 \quad 9 \quad \text{mA}$$

TIPO <i>Type</i>	Limiti massimi <i>Maximum ratings</i>	Capacità in pF <i>Capacitances</i>	Caratteristiche e funzionamento tipico <i>Typical operation</i>
<p>12CG7S</p> <p><i>(seguito)</i> <i>(following)</i></p> <p>Ingombro Outline Ø=22 h=60</p> <p>Accensione Heater supply 12,6 V — 0,3 A</p> <p>TR=14,5 sec.</p>	<p>W_a totale = 5 W</p> <p><i>(Both plates)</i></p> <p>I_k = 20 mA</p> <p>Oscillatore verticale <i>Vertical deflection oscillator</i></p> <p>V_a = 300 V</p> <p>V_g (picco/peak) = -400 V</p> <p>W_a = 3,5 W</p> <p>$W_{tot.}$ = 5 W</p> <p><i>(Both plates)</i></p> <p>I_k = 20 mA</p> <p>Oscillat. orizzontale <i>Horizontal deflection oscillator</i></p> <p>V_a = 300 V</p> <p>V_g (picco/peak) = -600 V</p> <p>W_a = 3,5 W</p> <p>W_a tot. = 5 W</p> <p><i>(Both plates)</i></p> <p>I_k = 20 mA</p>		<p>Doppio triodo, oscillatore di deflessione orizzontale e verticale. <i>Twin triode designed for use as a vertical deflection oscillator or horizontal deflection oscillator.</i></p>

12DQ6B

Accensione
Heater supply
12,6 V — 0,6 A

Riferirsi al tipo: 6DQ6B
See Type

12HG7

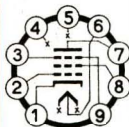

Ingombro
Outline
Ø=30 h=65

Accensione
in serie
Heater
series supply
12,6 V — 0,26 A

Accensione
in parallelo
Heater
parallel supply
6,3 V — 0,52 A

$$\begin{aligned}V_a &= 400 \text{ V} \\V_{g2} &= 330 \text{ V} \\V_{g1} &= 0 \text{ V} \\W_a &= 10 \text{ W} \\W_{g2} &= 1 \text{ W} \\R_{g1} &= 0,1 \text{ M}\Omega \text{ (1)} \\&0,25 \text{ M}\Omega \text{ (2)}\end{aligned}$$

- (1) Polarizzazione fissa.
Fixed bias.
- (2) Polarizzazione automatica.
Automatic bias.

$$\begin{aligned}C_{g1} &= 14 \\C_a &= 4,4 \\C_{g1-a} &= 0,15\end{aligned}$$

Amplificatore in classe A₁
Class A₁ Amplifier

$$\begin{aligned}V_a &= 300 \text{ V} \\V_{g2} &= 135 \text{ V} \\R_k &= 47 \text{ }\Omega \\I_a &= 31 \text{ mA} \\I_{g2} &= 4,8 \text{ mA} \\V_{g1} \text{ (per } I_a = 100 \text{ }\mu\text{A)} &= -4,5 \text{ V} \\S &= 32000 \text{ }\mu\text{A/V} \\R_i &= 60000 \text{ }\Omega\end{aligned}$$

Pentodo amplificatore finale video per TV colore.

Pentode for video output amplifier service in color TV receivers.

TIPO <i>Type</i>	Limiti massimi <i>Maximum ratings</i>	Capacità in pF <i>Capacitances</i>	Caratteristiche e funzionamento tipico <i>Typical operation</i>
12J5GT Accensione Heater supply 12,6 V — 0,15 A			Riferirsi al tipo: 6J5GT <i>See Type</i>
12J7GT Accensione Heater supply 12,6 V — 0,15 A			(Vedi dati condensati) <i>(See condensed data section)</i>
12K7GT Accensione Heater supply 12,6 V — 0,15 A			Riferirsi al tipo: 6K7G <i>See Type</i>

12Q7GT

Accensione
Heater supply
12,6 V — 0,15 A

Riferirsi al tipo: 6Q7G
See Type

12SA7GT

Accensione
Heater supply
12,6 V — 0,15 A

Riferirsi al tipo: 6SA7GT
See Type

12SJ7GT

Accensione
Heater supply
12,6 V — 0,15 A

Riferirsi al tipo: 6SJ7GT
See Type

TIPO <i>Type</i>	Limiti massimi <i>Maximum ratings</i>	Capacità in pF <i>Capacitances</i>	Caratteristiche e funzionamento tipico <i>Typical operation</i>
12SK7GT Accensione Heater supply 12,6 V — 0,15 A			Riferirsi al tipo: 6SK7GT <i>See Type</i>
12SL7GT Accensione Heater supply 12,6 V — 0,15 A			Riferirsi al tipo: 6SL7GT <i>See Type</i>
12SN7GT Accensione Heater supply 12,6 V — 0,3 A			Riferirsi al tipo: 6SN7GT <i>See Type</i>

12SN7GTA

Accensione
Heater supply
12,6 V — 0,3 A

Riferirsi al tipo: **6SN7GTA**
See Type

12SQ7GT

Accensione
Heater supply
12,6 V — 0,15 A

Riferirsi al tipo: **6SQ7GT**
See Type

12TE8GT

Accensione
Heater supply
12,6 V — 0,15 A

(Vedi dati condensati)
(*See condensed data section*)

TIPO <i>Type</i>	Limiti massimi <i>Maximum ratings</i>	Capacità in pF <i>Capacitances</i>	Caratteristiche e funzionamento tipico <i>Typical operation</i>																		
12X4 Accensione Heater supply 12,6 V — 0,3 A			Riferirsi al tipo: $\frac{6X4}{EZ90}$ See Type																		
13CL6 Accensione Heater supply 13,6 V — 0,3 A			Riferirsi al tipo: 6CL6 See Type																		
14GW8 PCL86 S  (segue) (follow)	Pentodo <i>Pentode Unit</i> $V_a = 300 \text{ V}$ $V_{g2} = 300 \text{ V}$ $W_a = 9 \text{ W}$ $W_{g2} = 1,8 \text{ W}$ $W_{g2} \text{ (picco/peak)} = 3,25 \text{ W}$ $I_k = 55 \text{ mA}$	Pentodo <i>Pentode Unit</i> $C_{g1} = 10$ $C_{g1-a} < 0,4$ Triodo <i>Triode Unit</i> $C_g = 2,3$ $C_a = 2,5$ $C_{g-a} = 1,4$	Amplificatore in classe A ₁ <i>Class A₁ Amplifier</i> <table border="0"> <thead> <tr> <th>Pentodo <i>Pentode Unit</i></th> <th>Triodo <i>Triode Unit</i></th> </tr> </thead> <tbody> <tr> <td>$V_a = 250$</td> <td>250 V</td> </tr> <tr> <td>$V_{g2} = 250$</td> <td>— V</td> </tr> <tr> <td>$V_{g1} = -7$</td> <td>-1,9 V</td> </tr> <tr> <td>$I_a = 36$</td> <td>1,2 mA</td> </tr> <tr> <td>$I_{g2} = 6$</td> <td>— mA</td> </tr> <tr> <td>$S = 10$</td> <td>1,6 mA/V</td> </tr> <tr> <td>$R_i = 48$</td> <td>— kΩ</td> </tr> <tr> <td>$\mu_{g1-g2} = 21$</td> <td>—</td> </tr> </tbody> </table>	Pentodo <i>Pentode Unit</i>	Triodo <i>Triode Unit</i>	$V_a = 250$	250 V	$V_{g2} = 250$	— V	$V_{g1} = -7$	-1,9 V	$I_a = 36$	1,2 mA	$I_{g2} = 6$	— mA	$S = 10$	1,6 mA/V	$R_i = 48$	— kΩ	$\mu_{g1-g2} = 21$	—
Pentodo <i>Pentode Unit</i>	Triodo <i>Triode Unit</i>																				
$V_a = 250$	250 V																				
$V_{g2} = 250$	— V																				
$V_{g1} = -7$	-1,9 V																				
$I_a = 36$	1,2 mA																				
$I_{g2} = 6$	— mA																				
$S = 10$	1,6 mA/V																				
$R_i = 48$	— kΩ																				
$\mu_{g1-g2} = 21$	—																				

14GW8
PCL86 S

(seguito)
(following)

Ingombro
Outline
Ø=22 h=71

Accensione
Heater supply
14,5 V — 0,3 A

TR=14,5 sec.

Triodo
Triode Unit

$V_a = 300 \text{ V}$
 $W_a = 0,5 \text{ W}$
 $I_k = 4 \text{ mA}$

senza schermo
without external shield

$\mu = \text{---} 100$

Triodo pentodo, preamplificatore BF audio e finale BF audio.

Triode-pentode.

The triode section is intended for use as audio amplifier.

The pentode section is intended for use as power amplifier.

15A6
PL83

Accensione
Heater supply
15 V — 0,3 A

Riferirsi al tipo: $\frac{6CK6}{EL83}$
See Type

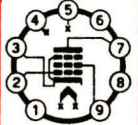
TIPO <i>Type</i>	Limiti massimi <i>Maximum ratings</i>	Capacità in pF <i>Capacitances</i>	Caratteristiche e funzionamento tipico <i>Typical operation</i>
<p>15CW5 S</p> <p>PL84</p>  <p>Ingombro Outline Ø=22 h=71</p> <p>Accensione Heater supply 15 V — 0,3 A</p> <p>TR=14,5 sec.</p>	<p>$V_a = 250 \text{ V}$</p> <p>$V_{g2} = 250 \text{ V}$</p> <p>$W_a = 12 \text{ W}$</p> <p>$W_{g2} = 1,75 \text{ W}$</p> <p>$I_k = 105 \text{ mA}$</p> <p>$R_{g1} = 1 \text{ M}\Omega$</p>	<p>$C_{g1} = 13$</p> <p>$C_a = 6,8$</p> <p>$C_{g1-a} < 0,6$</p> <p>senza schermo <i>without external shield</i></p>	<p>Amplificatore in classe A_1 <i>Class A_1 Amplifier</i></p> <p>$V_b = 200 \text{ V}$</p> <p>$R_{g2} = 470 \Omega$</p> <p>$R_k = 215 \Omega$</p> <p>$R_a = 2,5 \text{ k}\Omega$</p> <p>$V_i = 7 \text{ V}_{eff}$</p> <p>$I_a = 64 \text{ mA}$</p> <p>$I_{g2} = 11,4 \text{ mA}$</p> <p>$W_o = 5,3 \text{ W}$</p> <p>$d = 10 \%$</p> <p>Pentodo di potenza. <i>Beam Power Amplifier intended for use as Power Amplifier.</i></p>

15DQ8
PCL84 S

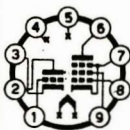

Ingombro

Outline
Ø=22 h=60

Accensione
Heater supply
15 V — 0,3 A

TR=14,5 sec.

Pentodo
Pentode Unit

V_a	=	250	V
V_{g^2}	=	250	V
W_a	=	4	W
W_{g^2}	=	1,7	W
I_k	=	40	mA
R_{g^1}	=	1	MΩ

Triodo
Triode Unit

V_a	=	250	V
W_a	=	1	W
I_k	=	12	mA
R_g	=	1	MΩ

Pentodo
Pentode Unit

C_{g^1}	=	8,7
C_a	=	4,2
C_{g^1-a}	<	0,1

Triodo
Triode Unit

C_g	=	3,8
C_a	=	2,3
C_{g-a}	=	2,7

senza schermo
without external
shield

Amplificatore in classe A₁
Class A₁ Amplifier

Pentodo
Pentode Unit

V_a	=	170
V_{g^2}	=	170
V_{g^1}	=	-2,1
I_a	=	18
I_{g^2}	=	3
S	=	11000
R_i	=	100
$\mu_{g^2-g^1}$	=	36
μ	=	—

Triodo
Triode Unit

	=	200	V
	=	—	V
	=	-1,7	V
	=	3	mA
	=	—	mA
	=	4000	μA/V
	=	—	kΩ
	=	—	
	=	65	.

Triodo-pentodo, amplificatore e separatore di sincronismo.

Triode-Pentode.

Triode section intended for use in circuits for keyed AGC, sync separation, sync amplification and noise suppression. Pentode section is intended for use as video output tube.

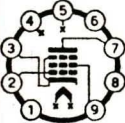
TIPO Type	Limiti massimi Maximum ratings	Capacità in pF Capacitances	Caratteristiche e funzionamento tipico Typical operation																																																								
<p>16A5</p> <p>PL82</p>  <p>Ingombro Outline Ø=22 h=71</p> <p>Accensione Heater supply 16,5 V — 0,3 A</p> <p>TR=14,5 sec.</p>	<p>V_a (picco/peak) = 2500 V (1)</p> <p>V_a (picco/peak) = -500 V</p> <p>V_{a_1} = 250 V</p> <p>V_{a_2} = 450 V (2)</p> <p>V_{g_2} = 250 V</p> <p>W_{a_1} = 9 W</p> <p>W_{g_2} = 2,5 W</p> <p>I_k = 75 mA</p> <p>R_{g_1} = 1 MΩ</p> <p>(1) Durata massima dell'impulso pari al 10% di un periodo con un massimo di 2 msec. <i>Valid for application in frame output circuits where the max. pulse duration is 10% of a cycle with a max. of 2 msec.</i></p> <p>(2) $W_a < 4,5$ W</p>	<p>C_{g_1} = 11</p> <p>C_a = 5,9</p> <p>$C_{g_1-a} < 1$</p>	<p>Amplificatore in classe A_1 <i>Class A_1 Amplifier</i></p> <table border="0"> <tr> <td>$V_a = V_b$</td> <td>= 170</td> <td>200</td> <td>V</td> </tr> <tr> <td>V_{g_2}</td> <td>= 170</td> <td>—</td> <td>V</td> </tr> <tr> <td>R_{g_2}</td> <td>= —</td> <td>680</td> <td>Ω</td> </tr> <tr> <td>V_{g_1}</td> <td>= -10,4</td> <td>-13,9</td> <td>V</td> </tr> <tr> <td>I_a</td> <td>= 53</td> <td>45</td> <td>mA</td> </tr> <tr> <td>I_{g_2}</td> <td>= 10</td> <td>8,5</td> <td>mA</td> </tr> <tr> <td>S</td> <td>= 10200</td> <td>8600</td> <td>μA/V</td> </tr> <tr> <td>R_i</td> <td>= 20</td> <td>24</td> <td>kΩ</td> </tr> <tr> <td>R_a</td> <td>= 3</td> <td>4</td> <td>kΩ</td> </tr> <tr> <td>W_a</td> <td>= 4</td> <td>4,2</td> <td>W</td> </tr> <tr> <td>d</td> <td>= 10</td> <td>10</td> <td>%</td> </tr> </table> <p>Amplificatore finale deflessione verticale <i>Vertical deflection output amplifier</i></p> <table border="0"> <tr> <td>V_a</td> <td>= 50</td> <td>60</td> <td>V</td> </tr> <tr> <td>V_{g_2}</td> <td>= 170</td> <td>220</td> <td>V</td> </tr> <tr> <td>I_a (picco/peak)</td> <td>= 90</td> <td>120</td> <td>mA</td> </tr> </table> <p>Pentodo finale amplificatore in BF o per deflessione verticale. <i>Pentode intended for use as frame output tube in television receivers and as audio power amplifier.</i></p>	$V_a = V_b$	= 170	200	V	V_{g_2}	= 170	—	V	R_{g_2}	= —	680	Ω	V_{g_1}	= -10,4	-13,9	V	I_a	= 53	45	mA	I_{g_2}	= 10	8,5	mA	S	= 10200	8600	μA/V	R_i	= 20	24	kΩ	R_a	= 3	4	kΩ	W_a	= 4	4,2	W	d	= 10	10	%	V_a	= 50	60	V	V_{g_2}	= 170	220	V	I_a (picco/peak)	= 90	120	mA
$V_a = V_b$	= 170	200	V																																																								
V_{g_2}	= 170	—	V																																																								
R_{g_2}	= —	680	Ω																																																								
V_{g_1}	= -10,4	-13,9	V																																																								
I_a	= 53	45	mA																																																								
I_{g_2}	= 10	8,5	mA																																																								
S	= 10200	8600	μA/V																																																								
R_i	= 20	24	kΩ																																																								
R_a	= 3	4	kΩ																																																								
W_a	= 4	4,2	W																																																								
d	= 10	10	%																																																								
V_a	= 50	60	V																																																								
V_{g_2}	= 170	220	V																																																								
I_a (picco/peak)	= 90	120	mA																																																								

16A8**PCL82**

Ingombro
Outline
 $\varnothing=22$ h=71

Accensione
Heater supply
16 V — 0,3 A

Pentodo
Pentode Unit

$$\begin{aligned} V_a &= 300 \text{ V} \\ W_a &= 5 \div 7 \text{ W} \\ V_{g^2} &= 300 \text{ V} \\ W_{g^2} &= 2 \text{ W} \\ I_k &= 50 \text{ mA} \end{aligned}$$

Triodo
Triode Unit

$$\begin{aligned} V_a &= 300 \text{ V} \\ W_a &= 1 \text{ W} \\ I_k &= 15 \text{ mA} \end{aligned}$$

Pentodo
Pentode Unit

$$\begin{aligned} C_{g^1} &= 9,3 \\ C_a &= 8,0 \\ C_{g^1-a} &< 0,3 \end{aligned}$$

Triodo
Triode Unit

$$\begin{aligned} C_{g^1} &= 2,7 \\ C_a &= 4,3 \\ C_{g-a} &= 4,4 \end{aligned}$$

senza schermo
without external shield

Amplificatore in classe A₁
Class A₁ Amplifier

Pentodo
Pentode Unit

V_a	= 100	170	200	200	100	V
V_{g^2}	= 100	170	170	200	—	V
V_{g^1}	= —	—	—	—	0	V
I_a	= 26	41	35	35	3,5	mA
I_{g^2}	= 5	8	6,5	7	—	mA
S	= 6800	7500	6800	6400	2200	$\mu\text{A/V}$
R_i	= 15	16	20,5	20	—	k Ω
$\mu_{g^2-g^1}$	= 10	9,5	9,5	9,5	—	
μ	= —	—	—	—	70	

Triodo
Triode Unit

Triodo pentodo. La sezione triodo può essere usata come oscillatore di deflessione e come amplificatore a BF. La sezione pentodo può essere usata come amplificatore di deflessione verticale o finale BF audio.

Triode-Pentode

The triode section is intended for use as frame oscillator and audio amplifier.

The pentode section is intended for use as frame output tube and audio power amplifier.

TIPO <i>Type</i>	Limiti massimi <i>Maxlimum ratings</i>	Capacità in pF <i>Capacitances</i>	Caratteristiche e funzionamento tipico <i>Typical operation</i>
16EB8S Accensione Heater supply 16 V — 0,3 A TR=14,5 sec.			Riferirsi al tipo: 6EB8 <i>See Type</i>
17EM5 Accensione Heater supply 17 V — 0,3 A			Riferirsi al tipo: 6EM5 <i>See Type</i>

17Z3**PY81****Ingombro**

Outline

Ø=22 h=75

Accensione

Heater supply

17 V — 0,3 A

TR=14,5 sec.

 $C_a = 6,4$ $C_{k-f} = 2,8$

Massima corrente continua di uscita = 150 mA

Maximum DC Output Current

Massima ampiezza della tensione inversa anodica

= 5000 V

Maximum Peak Inverse Plate Voltage

Picco massimo della corrente anodica

= 450 mA

Maximum Peak Plate Current W_a

= 3,5 W

Massima tensione di picco tra filamento e catodo

= 5000 V

*Maximum Peak Voltage Filament to Cathode***Diodo smorzatore per circuiti di deflessione orizzontale in TV.***Half-Wave Rectifier for television damper service.***18AQ8****HCC85****Accensione**

Heater supply

18 V — 0,15 A

Riferirsi al tipo:

*See Type***6AQ8****ECC85**

TIPO <i>Type</i>	Limiti massimi <i>Maximum ratings</i>	Capacità in pF <i>Capacitances</i>	Caratteristiche e funzionamento tipico <i>Typical operation</i>
18GV8 PCL85 S Accensione Heater supply 18 V — 0,3 A TR=14,5 sec.			Riferirsi al tipo: $\frac{6GV8}{ECL85}$ <i>See Type</i>
19AK8 HABC80 Accensione Heater supply 18,9 V — 0,15 A			Riferirsi al tipo: $\frac{6AK8}{EABC80}$ <i>See Type</i>
19BK7A Accensione Heater supply 18,9 V — 0,15 A			Riferirsi al tipo: 6BK7A <i>See Type</i>

19BY7

UF85

Accensione
Heater supply
19 V — 0,1 A

Riferirsi al tipo: $\frac{6BY7}{EF85}$
See Type

19DR7S

Accensione
Heater supply
18,9 V — 0,3 A

TR=14,5 sec.

Riferirsi al tipo: 6DR7
See Type

19T8

Accensione
Heater supply
18,9 V — 0,15 A

Riferirsi al tipo: 6T8
See Type

TIPO
Type

Limiti massimi
Maximum ratings

Capacità in pF
Capacitances

Caratteristiche e funzionamento tipico
Typical operation

19Y3
PY82 S



Ingombro
Outline
 $\varnothing=22$ h=71

Accensione
Heater supply
19 V — 0,3 A

TR=14,5 sec.

$V_{tr} = 250 V_{eff}$
 V_a (picco inverso)
(*peak negative*)
= 700 V
 $I_o = 180$ mA
 V_{k-f} (picco/peak)
= 550 V
C filtro = 60 μ F

Massima corrente continua di uscita = 180 mA
Maximum DC Output Current

Massima tensione raddrizzata = 195 V
Maximum DC Output Voltage

Capacità filtro = 60 μ F
Input capacitance of smoothing filter

V trasf.= 127 200 220 250 V

R trasf.= 0 30 65 125 Ω (1)

(1) Resistenza minima di protezione tra anodo e trasformatore.

Protecting resistance at transformer voltage.

Diode, raddrizzatore di una semionda.
Half-Wave Rectifier.

25AV5GT

Accensione
Heater supply
25 V — 0.3 A

Riferirsi al tipo: 6AV5GT
See Type

25AX4GT

Accensione
Heater supply
25 V — 0,3 A

Riferirsi al tipo: **6AX4GT**
See Type

25AX4GTBS

Accensione
Heater supply
25 V — 0,3 A

TR=14,5 sec.

Riferirsi al tipo: **6AX4GTB**
See Type

25BQ6GT

Accensione
Heater supply
25 V — 0,3 A

Riferirsi al tipo: **6BQ6GT**
See Type

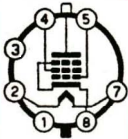
TIPO <i>Type</i>	Limiti massimi <i>Maximum ratings</i>	Capacità in pF <i>Capacitances</i>	Caratteristiche e funzionamento tipico <i>Typical operation</i>
25DQ6BS Accensione Heater supply 25 V — 0,3 A TR=14,5 sec.			Riferirsi al tipo: 6BQ6B <i>See Type</i>
25E5 S PL36  Ingombro Outline Ø=33 h=95 Accensione Heater supply 25 V — 0,3 A TR=14,5 sec.	$V_a = 250 \text{ V}$ V_a impulsiva (picco positivo) (peak Positive- Pulse Plate Voltage) $= 7000 \text{ V}$ $V_{g2} = 250 \text{ V}$ V_{g1} (picco negativo) (peak negative) $= 1000 \text{ V}$ $W_a = 10 \text{ W}$ $W_{g2} = 5 \text{ W}$ $I_k = 200 \text{ mA}$ $R_{g1} = 0,5 \text{ M}\Omega$	$C_{g1} = 17,5$ $C_a = 8$ $C_{g1-a} < 1,1$	Amplificatore in classe A_1 Class A_1 Amplifier $V_a = 100 \text{ V}$ $V_{g2} = 100 \text{ V}$ $V_{g1} = -8,2 \text{ V}$ $I_a = 100 \text{ mA}$ $I_{g2} = 7 \text{ mA}$ $S = 14 \text{ mA/V}$ $R_i = 5 \text{ k}\Omega$ $\mu_{g2-g1} = 5,6$ Pentodo finale di deflessione orizzontale in TV. <i>Beam Power Tube designed for service as</i> <i>horizontal amplifier in television receivers.</i>

25L6GT

Accensione
Heater supply
25 V — 0,3 A

Riferirsi al tipo: 50L6GT
See Type

25W4GT

Accensione
Heater supply
25 V — 0,3 A

Riferirsi al tipo: 6W4GT
See Type

25Z5

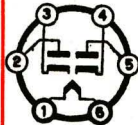

Ingombro
Outline
Ø=39 h=95

Riferirsi al tipo: 25Z6GT
See Type

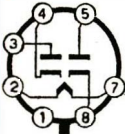
TIPO <i>Type</i>	Limiti massimi <i>Maximum ratings</i>	Capacità in pF <i>Capacitances</i>	Caratteristiche e funzionamento tipico <i>Typical operation</i>
<p>25Z6GT</p>  <p>Ingombro Outline Ø=39 h=95</p> <p>Accensione Heater supply 25 V — 0,3 A</p>			<p>Massima corrente continua di uscita = 75 mA <i>Maximum DC Output Current</i></p> <p>Massima ampiezza della tensione inversa anodica = 700 V <i>Maximum Peak Inverse Plate Voltage</i></p> <p>Massima tensione anodica alternata = 235 V_{eff} <i>Maximum AC Plate Supply Voltage</i></p> <p>Picco massimo della corrente anodica (per diodo) = 450 mA <i>Maximum Peak Plate Current (Each Plate)</i></p> <p>Caduta interna di tensione a 150 mA = 22 V <i>Plate Voltage Drop (for 150 mA)</i></p> <p>Doppio diodo raddrizzatore e duplicatore di tensione. <i>Full-Wave Rectifier.</i></p>

27GB5
PL500 S

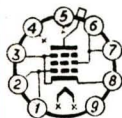

Ingombro
Outline
 $\varnothing=30$ h=96

Accensione
Heater supply
27 V — 0,3 A

TR=14,5 sec.

$V_a = 250$ V
 V_a (picco/peak) = 7000 V
 $V_{g2} = 250$ V
 $I_k = 250$ mA
 $W_a = 12$ W
 $W_{g2} = 5$ W

$C_{g1-f} < 0,2$
senza schermo
without external
shield

$V_a = 75$ V
 $V_{g2} = 200$ V
 $V_{g1} = -10$ V
 $I_{ap} = 440$ mA
 $I_{gap} = 30$ mA

Pentodo, finale di deflessione orizzontale in TV.

Beam Power Amplifier intended for use as line output tube in television receivers.

28AK8
UABC80

Accensione
Heater supply
28 V — 0,1 A

Riferirsi al tipo: $\frac{6AK8}{EABC80}$
See Type

TIPO Type	Limiti massimi Maximum ratings	Capacità in pF Capacitances	Caratteristiche e funzionamento tipico Typical operation
<p>30AE3 PY88 S</p>  <p>Ingombro Outline Ø=22 h=82</p> <p>Accensione Heater supply 30 V — 0,3 A</p> <p>TR=14,5 sec.</p>			<p>Massima corrente continua di uscita = 220 mA <i>Maximum DC Output Current</i></p> <p>Massima ampiezza della tensione inversa anodica = 6000 V <i>Maximum Peak Inverse Plate Voltage</i></p> <p>Massima tensione anodica alternata = 250 V_{eff} <i>Maximum AC Plate Supply Voltage</i></p> <p>Picco massimo della corrente anodica = 550 mA <i>Maximum Peak Plate Current</i></p> <p>Diode smorzatore per circuito di deflessione orizzontale in TV. <i>Half-Wave Rectifier for television damper service.</i></p>
<p>35D5</p> <p>Accensione Heater supply 35 V — 0,15 A</p>			<p>Riferirsi al tipo: 6QL6 <i>See Type</i></p>

35L6GT

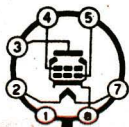

Ingombro
Outline

Ø=30 h=76

Accensione
Heater supply
35 V — 0,15 A

V_a	=	200	V
V_{g2}	=	125	V
W_a	=	8,5	W
W_{g2}	=	1	W

C_{g1} = 13
 C_a = 9,5
 C_{g1-a} = 08,
 senza schermo
*without external
 shield*

Amplificatore in classe A_1
 Class A_1 Amplifier

V_a	=	110	200	V
V_{g2}	=	110	110	V
V_{g1}	=	-7,5	-8	V
I_a	=	40	41	mA
I_{g2}	=	3	2	mA
R_a	~	14	40	kΩ
S	=	5800	5900	μA/V
R_a	=	2,5	4,5	kΩ
W_o	=	1,5	3,3	W
d	=	10	10	%

Tetrodo a fascio, amplificatore di potenza a BF.

Beam Power Amplifier designed for use as Power Amplifier.

35QL6

Accensione
Heater supply
35 V — 0,15 A

Riferirsi al tipo: 6QL6
 See Type

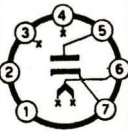
TIPO Type	Limiti massimi Maximum ratings	Capacità in pF Capacitances	Caratteristiche e funzionamento tipico Typical operation
<p>35W4</p>  <p>Ingombro Outline Ø=19 h=60</p> <p>Accensione Heater supply 35 V — 0,15 A</p> <p>(segue) (follow)</p>			<p>100 mA (1) Massima corrente continua di uscita = 60 mA (2) <i>Maximum DC Output Current</i> 90 mA (3)</p> <p>Massima ampiezza della tensione inversa anodica = 330 V <i>Maximum Peak Inverse Plate Voltage</i></p> <p>Massima tensione anodica alternata = 110 V_{eff} <i>Maximum AC Plate Supply Voltage</i></p> <p>Picco massimo della corrente anodica = 600 mA <i>Maximum Peak Plate Current</i></p> <p>Caduta interna di tensione a 200 mA = 18 V <i>Plate Voltage Drop (for 200 mA)</i></p> <p>Massima tensione tra filamento e catodo = 330 V <i>Maximum Voltage Filament to Cathode</i></p> <p>Note:</p> <p>(1) Senza lampada del pannello. <i>Without Panel Lamp.</i></p> <p>(2) Con lampada del pannello, senza resistenza in parallelo. <i>With Panel Lamp, no Shunting Resistor.</i></p>

35W4

(seguito)
(following)

(3) Con lampada del pannello, con resistenza
In parallelo (lampada tra i piedini 4 e 6).
With Panel Lamp, with Shunting Resistor
(Lamp connected to pins 4 and 6).

Diode raddrizzatore di una semionda.
Half-Wave Rectifier.

35X4

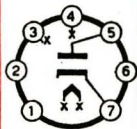

Ingombro
Outline
 $\varnothing=19$ h=F0

Accensione
Heater supply
35 V — 0,15 A

Massima corrente continua di uscita = 100 mA
Maximum DC Output Current

Massima ampiezza della tensione in-
versa anodica = 700 V
Maximum Peak Inverse Plate Voltage

Massima tensione anodica alternata = 220 V_{eff}
Maximum AC Plate Supply Voltage

Picco massimo della corrente ano-
dica = 600 mA
Maximum Peak Plate Current

Caduta interna di tensione a 200 mA = 18 V
Plate Voltage Drop (for 200 mA)

Massima tensione tra filamento e ca-
todo = 450 V
Maximum Voltage Filament to Cathode

Diode raddrizzatore di una semionda.
Half-Wave Rectifier.

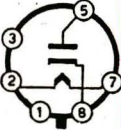
TIPO Type	Limiti massimi Maximum ratings	Capacità in pF Capacitances	Caratteristiche e funzionamento tipico Typical operation
<p>35Z4GT</p>  <p>Ingombro Outline Ø=30 h=78</p> <p>Accensione Heater supply 35 V — 0,15 A</p>			<p>Massima corrente continua di uscita = 100 mA <i>Maximum DC Output Current</i></p> <p>Massima ampiezza della tensione inversa anodica = 700 V <i>Maximum Peak Inverse Plate Voltage</i></p> <p>Massima tensione anodica alternata = 235 V_{eff} <i>Maximum AC Plate Supply Voltage</i></p> <p>Picco massimo della corrente anodica (per diodo) = 600 mA <i>Maximum Peak Plate Current (Each Plate)</i></p> <p>Caduta interna di tensione a 200 mA = 18 V <i>Plate Voltage Drop (for 200 mA)</i></p> <p>Massima tensione tra filamento e catodo = 350 V <i>Maximum Voltage Filament to Cathode</i></p> <p>Diodo raddrizzatore di una semionda. <i>Half-Wave Rectifier.</i></p>

35Z5GT



Ingombro
Outline
Ø=30 h=78

Accensione
Heater supply
35 V — 0,15 A

(segue)
(follow)

Massima corrente continua di uscita = 110 mA (1)
Maximum DC Output Current = 60 mA (2)
90 mA (3)

Massima ampiezza della tensione inversa anodica = 700 V
Maximum Peak Inverse Plate Voltage

Massima tensione anodica alternata = 235 V_{eff}
Maximum AC Plate Supply Voltage

Picco massimo della corrente anodica = 600 mA
Maximum Peak Plate Current

Caduta interna di tensione a 200 mA = 18 V
Plate Voltage Drop (for 200 mA)

Massima tensione tra filamento e catodo = 350 V
Maximum Voltage Filament to Cathode

Note:

- (1) Senza lampada del pannello.
Without Panel Lamp.
- (2) Con lampada del pannello, senza resistenza in parallelo.
With Panel Lamp, no Shunting Resistor.

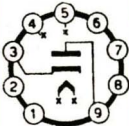
TIPO <i>Type</i>	Limiti massimi <i>Maximum ratings</i>	Capacità in pF <i>Capacitances</i>	Caratteristiche e funzionamento tipico <i>Typical operation</i>
35Z5GT (seguito) (following)			<p>(3) Con lampada del pannello, con resistenza in parallelo (lampada tra i piedini 2 e 3). <i>With Panel Lamp, with Shunting Resistor (Lamp connected to pins 4 and 6).</i></p> <p>Diodo raddrizzatore di una semionda. <i>Half-Wave Rectifier.</i></p>
38A3 UY85  Ingombro Outline $\varnothing=22$ h=61 Accensione Heater supply 38 V — 0,1 A			<p>Massima corrente continua di uscita = 110 mA <i>Maximum DC Output Current</i></p> <p>Massima ampiezza della tensione inversa anodica = 700 V <i>Maximum Peak Inverse Plate Voltage</i></p> <p>Picco massimo della corrente anodica = 660 mA <i>Maximum Peak Plate Current</i></p> <p>Diodo, raddrizzatore di una semionda. <i>Half-Wave Rectifier.</i></p>

41

Accensione
Heater supply
6,3 V — 0,3 A

(Vedi dati condensati)
(See condensed data section)

42



Ingombro
Outline
Ø=45 h=109

Riferirsi al tipo: 6F6GT
See Type

45B5

UL84

Accensione
Heater supply
45 V — 0,1 A

Riferirsi al tipo: $\frac{15CW5}{PL84}$ S
See Type

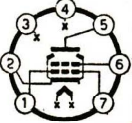
TIPO Type	Limiti massimi Maximum ratings	Capacità In pF Capacitances	Caratteristiche e funzionamento tipico Typical operation
<p>50B5</p>  <p>Ingombro Outline Ø=22 hQ60</p> <p>Accensione Heater supply 50 V — 0,15 A</p>	$V_a = 135 \text{ V}$ $V_{g2} = 117 \text{ V}$ $W_a = 5,5 \text{ W}$ $W_{g2} = 1,25 \text{ W}$	$C_{g1} = 13$ $C_a = 6,5$ $C_{g1-a} = 0,5$ senza schermo <i>without external shield</i>	<p>Amplificatore in classe A₁ <i>Class A₁ Amplifier</i></p> $V_a = 110 \text{ V}$ $V_{g2} = 110 \text{ V}$ $V_{g1} = -7,5 \text{ V}$ $I_a = 49 \text{ mA}$ $I_{g2} = 4 \text{ mA}$ $R_i \sim 10 \text{ k}\Omega$ $S = 7500 \mu\text{A/V}$ $R_a = 2,5 \text{ k}\Omega$ $W_o = 1,9 \text{ W}$ $d = 9 \%$ <p>Tetrodo a fascio, amplificatore di potenza a BF. <i>Beam Power Amplifier designed for use as Power Amplifier.</i></p>
<p>50BM8 UCL82</p> <p>Accensione Heater supply 50 V — 0,1 A</p>			<p>Riferirsi al tipo: $\frac{16A8}{PCL82}$ <i>See Type</i></p>

50C5



Accensione
Heater supply
50 V — 0,15 A

Riferirsi al tipo: 50B5
See Type

50L6GT

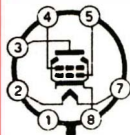

Ingombro
Outline
Ø=30 h=76

Accensione
Heater supply
50 V — 0,15 A

(segue)
(follow)

$V_a = 300 \text{ V}$
 $V_{g2} = 150 \text{ V}$
 $W_a = 10 \text{ W}$
 $W_{g2} = 1,25 \text{ W}$

Amplif. deflessione
verticale (colleg.
triode)
Vertical deflection
amplifier (Triode
operation)

$V_a = 300 \text{ V}$

$C_{g1} = 15$
 $C_a = 9$
 $C_{g1-a} = 0,8$

senza schermo
without external
shield

Amplificatore in classe A_1
Class A_1 Amplifier

V_a	= 110	200	V
V_{g2}	= 110	125	V
V_{g1}	= -7,5	—	V
R_k	= —	180	Ω
R_i	= 13	28	k Ω
S	= 8000	8000	$\mu\text{A/V}$
I_a	= 49	46	mA
I_{g2}	= 4	2,2	mA
R_a	= 2000	4000	Ω
W_o	= 2,1	3,8	W
d	= 10	10	%

TIPO <i>Type</i>	Limiti massimi <i>Maximum ratings</i>	Capacità in pF <i>Capacitances</i>	Caratteristiche e funzionamento tipico <i>Typical operation</i>
50L6GT (seguito) (following)	V_a (picco positivo) <i>(peak positive)</i> = 1200 V V_{g1} (picco negativo) <i>(peak negative)</i> = 250 V W_a = 7,5 W I_k = 60 mA I_k (picco/peak) = 180 mA		Collegamento a triodo - <i>Triode operation</i> V_a = 225 V V_g = -30 V I_a = 22 mA μ = 6,2 R_i = 1,6 k Ω S = 3800 μ A/V Tetrodo a fascio, amplificatore di potenza a BF o amplificatore finale di deflessione verticale in TV. <i>Beam Power Tube intended for service as general purpose audio amplifier or vertical deflection amplifier in television receivers sweep circuit.</i>
75 Accensione Heater supply 6,3 V — 0,3 A			(Vedi dati condensati) (See condensed data section)

77

Accensione
Heater supply
6,3 V — 0,3 A

(Vedi dati condensati)
(See condensed data section)

78

Accensione
Heater supply
6,3 V — 0,3 A

(Vedi dati condensati)
(See condensed data section)

80

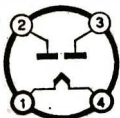

Accensione
Filament supply
5 V — 2 A

Riferirsi al tipo: 5Y3G/GT
See Type

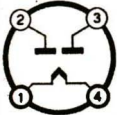
TIPO <i>Type</i>	Limiti massimi <i>Maximum ratings</i>	Capacità in pF <i>Capacitances</i>	Caratteristiche e funzionamento tipico <i>Typical operation</i>
<p data-bbox="113 170 158 202">83</p>  <p data-bbox="72 419 208 450">Ingombro Outline</p> <p data-bbox="57 461 213 492">Ø=51 h=123</p> <p data-bbox="57 512 213 585">Accensione Filament supply 5 V — 3 A</p>			<p data-bbox="798 191 1422 253">Massima corrente continua di uscita = 225 mA <i>Maximum DC Output Current</i></p> <p data-bbox="798 264 1422 326">Massima ampiezza della tensione inversa anodica = 1550 V <i>Maximum Peak Inverse Plate Voltage</i></p> <p data-bbox="798 336 1422 398">Massima tensione anodica alternata = 450 V_{eff} <i>Maximum AC Plate Supply Voltage</i></p> <p data-bbox="798 409 1422 471">Picco massimo della corrente anodica (per diodo) 1000 mA <i>Maximum Peak Plate Current (Each Plate)</i></p> <p data-bbox="798 481 1422 543">Caduta interna di tensione = 15 V <i>Plate Voltage Drop</i></p> <p data-bbox="798 554 1422 751">Doppio diodo a vapori di mercurio, raddrizzatore delle due semionde. <i>Full-Wave Mercury-Vapor Rectifier.</i></p>

807

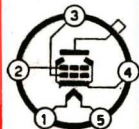

Accensione
Heater supply
6,3 V — 0,9 A

Riferirsi al tipo: 6L6G
See Type

1620GT



Accensione
Heater supply
6,3 V — 0,3 A

Riferirsi al tipo: 6J7GT
See Type

1629

Accensione
Heater supply
12,6 V — 0,15 A

(Vedi dati condensati)
(See condensed data section)

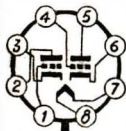
TIPO
*Type***Llimiti massimi**
*Maximum ratings***Capacità in pF**
*Capacitances***Caratteristiche e funzionamento tipico**
*Typical operation***6080****Ingombro**
Outline

Ø=40 h=89

Accensione
Heater supply
6,3 V — 2,5 APer ogni sezione
Each section

$V_a = 250 \text{ V}$

$V_a \text{ (picco inverso)}$
(peak inverse anode voltage)

$= 3000 \text{ V}$

$I_a = 125 \text{ mA}$

$V_g \text{ (picco/peak)}$

$= -2300 \text{ V}$

$W_a = 13 \text{ W}$

Per ogni sez.
Each section

$C_g = 6,0$

$C_a = 2,2$

$C_{g-a} = 8,0$

senza schermo
*without external shield*Valori per ogni sezione
Values are for each section

$V_{ba} = 135 \text{ V}$

$R_k = 250 \Omega$

$\mu = 2$

$R_i = 280 \Omega$

$S = 7000 \mu\text{A/V}$

$I_a = 125 \text{ mA}$

Doppio triodo a basso « μ », regolatore in serie per alimentatori di potenza in continua o triodo survoltore.*Double Power Triode.**This tube can be used in any application requiring high plate current at low plate voltages. It has found wide use in electronically regulated power supplies.*

**Valvole di tipo
Europeo**

*European types
receiving tubes*

**Valvole di tipo
U.S.A.**

*U.S.A. types
receiving tubes*

TIPO <i>Type</i>	Limiti massimi <i>Maximum ratings</i>	Capacità in pF <i>Capacitances</i>	Caratteristiche e funzionamento tipico <i>Typical operation</i>
DCC90 3A5 Accensione in serie Filament series supply 2,8 V — 0,11 A Accensione in parallelo Filament parallel supply 1,4 V — 0,22 A			(Vedi dati condensati) (See condensed data section)
DF92 1L4 Accensione Filament supply 1,4 V — 0,05 A			(Vedi dati condensati) (See condensed data section)

DF904

1U4

Accensione
Filament supply
1,4 V — 0,05 A

(Vedi dati condensati)
(See condensed data section)

DK91

1R5

Accensione
Filament supply
1,4 V — 0,05 A

(Vedi dati condensati)
(See condensed data section)

DL92

3S4

Accensione
in serie
Filament
series supply
2,8 V — 0,05 A

Accensione
in parallelo
Filament
parallel supply
1,4 V — 0,1 A

(Vedi dati condensati)
(See condensed data section)

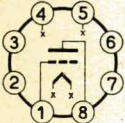
TIPO <i>Type</i>	Limiti massimi <i>Maximum ratings</i>	Capacità in pF <i>Capacitances</i>	Caratteristiche e funzionamento tipico <i>Typical operation</i>															
<p>DL94</p> <hr/> <p>3V4</p> <p>Accensione in serie Filament series supply 2,8 V — 0,05 A</p> <p>Accensione in parallelo Filament parallel supply 1,4 V — 0,1 A</p>			<p>(Vedi dati condensati) (See condensed data section)</p>															
<p>DM70</p> <hr/> <p>1M3</p>  <p>Ingombro Outline $\varnothing=10$ h=45</p> <p>Accensione Filament supply 1,4 V — 0,025 A</p>	<p>$V_b = 300$ V</p> <p>$V_a = 150$ V</p> <p>$V_a(\text{min.}) = 45$ V</p> <p>$W_a = 75$ mW</p> <p>$I_k = 0,6$ mA</p> <p>$R_g = 10$ MΩ</p>		<p>Alimentazione con batteria <i>Battery supply</i></p> <table data-bbox="817 621 1262 802"> <tr> <td>$V_b = 67,5$</td> <td>90</td> <td>V</td> </tr> <tr> <td>$V_a = 60$</td> <td>85</td> <td>V</td> </tr> <tr> <td>$V_g = 0$</td> <td>0</td> <td>V</td> </tr> <tr> <td>$I_a = 105$</td> <td>170</td> <td>μA</td> </tr> <tr> <td>pedino = 4</td> <td>5</td> <td>a massa grounded</td> </tr> </table> <p>Indicatore di sintonia <i>Tuning indicator</i></p>	$V_b = 67,5$	90	V	$V_a = 60$	85	V	$V_g = 0$	0	V	$I_a = 105$	170	μ A	pedino = 4	5	a massa grounded
$V_b = 67,5$	90	V																
$V_a = 60$	85	V																
$V_g = 0$	0	V																
$I_a = 105$	170	μ A																
pedino = 4	5	a massa grounded																

DY86

1S2

Accensione
Heater supply
1,4 V — 0,55 A

Senza trattamento speciale sulla superficie del vetro.

Without the envelope special treatment.

Riferirsi al tipo: $\frac{1S2A}{DY87}$
See Type

DY87

1S2A

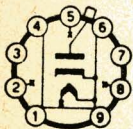

Ingombro
Outline
 $\varnothing=22$ h=67

Accensione
Heater supply
1,4 V — 0,55 A

$C_a = 1,55$
senza schermo
without external shield

Massima corrente continua di uscita = 0,5 mA
Maximum DC Output Current

Massima ampiezza della tensione
inversa anodica (componente con-
tinua) = 22000 V
Maximum Peak Inverse Plate Voltage

Picco massimo della corrente ano-
dica = 40 mA
Maximum Peak Plate Current

Diodo, rettificatore per alta tensione in TV.
*Half-Wave Rectifier designed for use as high
voltage rectifier in television receivers.*

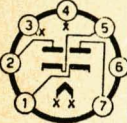
TIPO Type	Limiti massimi Maximum ratings	Capacità in pF Capacitances	Caratteristiche e funzionamento tipico Typical operation
<p>EAA91 6AL5</p>  <p>Ingombro Outline Ø=19 h=38</p> <p>Accensione Heater supply 6,3 V — 0,3 A</p>		<p>Per sezione Each Unit</p> <p>$C_k = 3,6$ $C_a = 3,2$ $C_{a1-a2} < 0,026$ con schermo with external shield</p>	<p>Massima corrente continua di uscita = 9 mA Maximum DC Output Current</p> <p>Massima ampiezza della tensione inversa anodica = 330 V Maximum Peak Inverse Plate Voltage</p> <p>Massima tensione anodica alternata = 117 V_{eff} Maximum AC Plate Supply Voltage</p> <p>Picco massimo della corrente anodica (per diodo) = 54 mA Maximum Peak Plate Current (Each Plate)</p> <p>Caduta interna di tensione a 60 mA = 10 V Plate Voltage Drop (for 60 mA)</p> <p>Doppio diodo, rivelatore o discriminatore per ricevitori MA e MF. Twin Diode with separate cathodes designed for high frequency operation.</p>

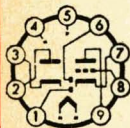
EABC80**6AK8**

Ingombro
Outline

$\varnothing = 22$ h = 60

Accensione
Heater supply
6,3 V — 0,45 A

Diodi
Diodes Unit

V_a inv. = 350 V
peak negative

I_{D_2} med. = 10 mA (1)
d.c. component

I_{D_1} med. = 1 mA (2)
d.c. component

I_{D_3} med. = 10 mA (3)
d.c. component

Triodo
Triode Unit

V_a = 300 V

W_a = 1 W

I_k = 5 mA

(1) piedino/pln n° 2

(2) piedino/pln n° 6

(3) piedino/pln n° 1

Diodi
Diodes Unit

C_{D_1} = 0,8

C_{D_2} = 4,8

C_{D_3} = 4,8

senza schermo
without external shield

Triodo
Triode Unit

C_g = 1,9

C_a = 1,4

C_{g-a} = 2,0

Amplificatori in classe A₁
Class A₁ Amplifier

V_a = 100 250 V

V_g = -1 -3 V

I_a = 0,8 1 mA

R_i = 48 50 k Ω

S = 1450 1400 μ A/V

μ = 70 70

Tripla diodo-triodo per uso in radiorecettori MF o MA-MF come discriminatore e rivelatore. In TV come rivelatore video e discriminatore audio.

Triple diode-triode intended for FM and AM signal detection, video-detection and audio-discriminator.

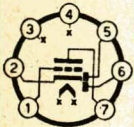
TIPO Type	Limiti massimi Maximum ratings	Capacità in pF Capacitances	Caratteristiche e funzionamento tipico Typical operation																														
<p>EBC90 6AT6</p>  <p>Ingombro Outline Ø=19 h=48</p> <p>Accensione Heater supply 6,3 V — 0,3 A</p>	<p>$V_a = 300 \text{ V}$ $V_{g1} = 0 \text{ V}$ $W_a = 0,5 \text{ W}$ $I_D = 1 \text{ mA}$</p>	<p>$C_{g} = 2,2$ $C_a = 1,2$ $C_{g-a} = 2,0$</p>	<p>Amplificatore in classe A_1 <i>Class A_1 Amplifier</i></p> <table border="0"> <tr> <td>V_a</td> <td>=</td> <td>100</td> <td>250</td> <td>V</td> </tr> <tr> <td>V_g</td> <td>=</td> <td>-1</td> <td>-3</td> <td>V</td> </tr> <tr> <td>μ</td> <td>=</td> <td>70</td> <td>70</td> <td></td> </tr> <tr> <td>R_i</td> <td>~</td> <td>54</td> <td>68</td> <td>kΩ</td> </tr> <tr> <td>S</td> <td>=</td> <td>1300</td> <td>1200</td> <td>$\mu\text{A/V}$</td> </tr> <tr> <td>I_a</td> <td>=</td> <td>0,8</td> <td>1</td> <td>mA</td> </tr> </table> <p>Doppio diodo-triodo, rivelatore e amplificatore a BF. <i>Twin diode-triode. Detector and audio amplifier.</i></p>	V_a	=	100	250	V	V_g	=	-1	-3	V	μ	=	70	70		R_i	~	54	68	k Ω	S	=	1300	1200	$\mu\text{A/V}$	I_a	=	0,8	1	mA
V_a	=	100	250	V																													
V_g	=	-1	-3	V																													
μ	=	70	70																														
R_i	~	54	68	k Ω																													
S	=	1300	1200	$\mu\text{A/V}$																													
I_a	=	0,8	1	mA																													

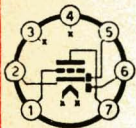
EBC91**6AV6****Ingombro**

Outline

 $\varnothing = 19 \text{ h} = 49$ **Accensione**

Heater supply

6,3 V — 0,3 A

$$\begin{aligned} V_a &= 300 \text{ V} \\ V_{g1} &= 0 \text{ V} \\ W_a &= 0,5 \text{ W} \\ I_D &= 1 \text{ mA} \end{aligned}$$

$$\begin{aligned} C_g &= 2,2 \\ C_a &= 1,2 \\ C_{g-a} &= 2 \\ C_{g-D2} &< 0,04 \end{aligned}$$

Amplificatore in classe A₁**Class A₁ Amplifier**

V_a	=	100	250	V
V_g	=	-1	-2	V
μ	=	100	100	
R_i	~	80	62,5	k Ω
S	=	1250	1600	$\mu\text{A/V}$
I_a	=	0,5	1,2	mA

Doppio diodo-triodo, rivelatore amplificatore a BF.*TwIn diode-triode designed for second detector-audio amplifier use in radio receivers.**Il triodo è elettricamente simile ad ogni regione della ECC83/12AX7*

TIPO
Type

Limiti massimi
Maximum ratings

Capacità in pF
Capacitances

Caratteristiche e funzionamento tipico
Typical operation

EBF89

6DC8

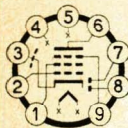

Ingombro
Outline
 $\varnothing=22$ h=60

Accensione
Heater supply
6,3 V — 0,3 A

Connessioni
Connections

Piedino
Pin
7=D₁

Piedino
Pin
8=D₂

Pentodo
Pentode Unit

V_a = 300 V
V_{g2} = 300 V
W_a = 2,25 W
W_{g2} = 0,45 W
I_k = 16,5 mA
R_g = 3 MΩ
V_{f-k} = 100 V

Diodi (ogni unità)
Diodes (each unit)

I_D = 0,8 mA
I picco/peak = 5 mA

Pentodo
Pentode Unit

C_{g1} = 5
C_a = 5,2
C_{g1-a} < 0,0025

Diodi
Diodes Unit

C_{D1} = 2,5
C_{D2} = 2,5
C_{D1-D2} < 0,25

Amplificatore in classe A₁
Class A₁ Amplifier

V_a = 250 200 V
R_{g2} = 62 30 kΩ
V_{g1} = -1 -1,5 V
V_{g2} = 0 0 V
I_a = 9 11 mA
I_{g2} = 2,7 3,3 mA
S = 4500 4500 μA/V
R_i = 0,9 0,6 MΩ

Amplificatore RF e FI a pendenza variabile, doppio diodo rivelatore.

Twin diode-pentode. Pentode intended for use as RF or IF amplifier. Diodes for detector.

EC86**6CM4**

Accensione
Heater supply
6,3 V — 0,175 A

Riferirsi al tipo: $\frac{4CM4}{PC86} S$
See Type

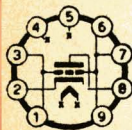
EC88**6DL4**

Ingombro
Outline
 $\varnothing=22$ h=44

Accensione
Heater supply
6,3 V — 0,165 A

$V_a = 175$ V
 $V_g = -50$ V
 $W_a = 2$ W
 $I_k = 13$ mA
 $R_g = 1$ M Ω

$C_{g-a} = 1,2$
senza schermo
without external shield

Amplificatore in classe A_1
Class A_1 Amplifier

$V_a = 160$ V
 $R_k = 100$ Ω
 $I_a = 12,5$ mA
 $S = 13,5$ mA/V
 $\mu = 65$

Triodo amplificatore UHF con griglia a massa per le bande IV e V.

Triode intended for use as grounded grid UHF amplifier for bands IV and V.

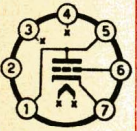
TIPO Type	Limiti massimi Maximum ratings	Capacità in pF Capacitances	Caratteristiche e funzionamento tipico Typical operation																																																								
<p>EC90 6C4</p>  <p>Ingombro Outline Ø=19 h=48</p> <p>Accensione Heater supply 6,3 V — 0,15 A</p>	<p>Amplific. Telegraf. <i>Telegraphy Amplifier</i></p> <p>Classe A Classe C <i>Class A Class C</i></p> <p>$V_a = 300$ 300 V $V_g = -$ -50 V $W_a = 3,5$ 5 W $I_a = -$ 25 mA $I_g = -$ 8 mA</p>	<p>$C_g = 1,8$ $C_a = 2,5$ $C_{g-a} = 1,4$</p> <p>con schermo <i>with external shield</i></p>	<table border="0"> <tr> <td></td> <td colspan="2">Amplificatore in classe A₁ <i>Class A₁ Amplifier</i></td> <td colspan="2">Telegrafia in classe C <i>Telegraphy - Class C</i></td> </tr> <tr> <td>V_a</td> <td>= 100</td> <td>250</td> <td>300</td> <td>V</td> </tr> <tr> <td>V_g</td> <td>= 0</td> <td>-8,5</td> <td>-27</td> <td>V</td> </tr> <tr> <td>I_a</td> <td>= 11,8</td> <td>10,5</td> <td>25</td> <td>mA</td> </tr> <tr> <td>I_g</td> <td>= -</td> <td>-</td> <td>~7</td> <td>mA</td> </tr> <tr> <td>R_i</td> <td>~ 6250</td> <td>7700</td> <td>-</td> <td>Ω</td> </tr> <tr> <td>S</td> <td>= 3100</td> <td>2200</td> <td>-</td> <td>μA/V</td> </tr> <tr> <td>μ</td> <td>= 19,5</td> <td>17</td> <td>-</td> <td></td> </tr> <tr> <td>W_i</td> <td>= -</td> <td>-</td> <td>~0,35</td> <td>W</td> </tr> <tr> <td>W_o</td> <td>= -</td> <td>-</td> <td>~5,5</td> <td>W</td> </tr> <tr> <td>f</td> <td>= -</td> <td>-</td> <td>50</td> <td>MHz</td> </tr> </table> <p>Triodo, amplificatore ed oscillatore. <i>Triode intended for service as an oscillator, a detector or amplifier.</i></p> <p><i>È elettricamente simile ad ogni sezione delle ECR82/12 AT7</i></p>			Amplificatore in classe A ₁ <i>Class A₁ Amplifier</i>		Telegrafia in classe C <i>Telegraphy - Class C</i>		V_a	= 100	250	300	V	V_g	= 0	-8,5	-27	V	I_a	= 11,8	10,5	25	mA	I_g	= -	-	~7	mA	R_i	~ 6250	7700	-	Ω	S	= 3100	2200	-	μA/V	μ	= 19,5	17	-		W_i	= -	-	~0,35	W	W_o	= -	-	~5,5	W	f	= -	-	50	MHz
	Amplificatore in classe A ₁ <i>Class A₁ Amplifier</i>		Telegrafia in classe C <i>Telegraphy - Class C</i>																																																								
V_a	= 100	250	300	V																																																							
V_g	= 0	-8,5	-27	V																																																							
I_a	= 11,8	10,5	25	mA																																																							
I_g	= -	-	~7	mA																																																							
R_i	~ 6250	7700	-	Ω																																																							
S	= 3100	2200	-	μA/V																																																							
μ	= 19,5	17	-																																																								
W_i	= -	-	~0,35	W																																																							
W_o	= -	-	~5,5	W																																																							
f	= -	-	50	MHz																																																							

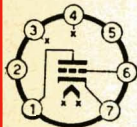
EC92**6AB4**

Ingombro
Outline

∅=19 h=48

Accensione
Heater supply
6,3 V — 0,15 A

$$\begin{aligned} V_a &= 300 \text{ V} \\ W_a &= 2,5 \text{ W} \\ V_g &= -50 \text{ V} \end{aligned}$$

$$\begin{aligned} C &= 2,2 \\ C_a &= 1,4 \\ C_{g-a} &= 1,5 \end{aligned}$$

con schermo
with external shield

Amplificatore in classe A₁

Class A₁ Amplifier

$$\begin{aligned} V_a &= 250 & 100 \text{ V} \\ R_k &= 200 & 270 \Omega \\ I_a &= 10 & 3,7 \text{ mA} \\ R_i &\sim 10,9 & 15 \text{ k}\Omega \\ S &= 5500 & 4000 \mu\text{A/V} \\ \mu &= 60 & 60 \end{aligned}$$

Triodo, amplificatore a RF.

Triode. RF Amplifier.

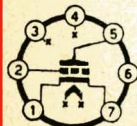
EC95**6ER5**

Ingombro
Outline

∅=19 h=48

Accensione
Heater supply
6,3 V — 0,18 A

$$\begin{aligned} V_a &= 250 \text{ V} \\ W_a &= 2,2 \text{ W} \\ I_k &= 20 \text{ mA} \\ V_g &= -50 \text{ V} \\ R_g &= 1 \text{ M}\Omega \end{aligned}$$

$$\begin{aligned} C_g &= 4,4 \\ C_a &= 3,0 \\ C_{a-g} &= 0,38 \end{aligned}$$

senza schermo
without external shield

Amplificatore in classe A₁

Class A₁ Amplifier

$$\begin{aligned} V_a &= 200 \text{ V} \\ V_g &= -1,2 \text{ V} \\ I_a &= 10 \text{ mA} \\ S &= 10500 \mu\text{A/V} \\ \mu &= 80 \\ R_i &= 8 \text{ k}\Omega \end{aligned}$$

Triodo, amplificatore a RF o TV-VHF.

Triode intended for use as RF amplifier in VHF television receivers.

$$\begin{aligned} C_g &= 4,4 \\ C_a &= 4,0 \\ C_{a-g} &= 0,36 \end{aligned}$$

con schermo
with external shield

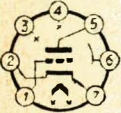
TIPO Type	Limiti massimi Maximum ratings	Capacità in pF Capacitances	Caratteristiche e funzionamento tipico Typical operation
EC97 6FY5 Accensione Heater supply 6,3 V — 0,215 A			Riferirsi al tipo: $\frac{5FY5}{PC97}$ See Type
EC900 6HA5  Ingombro Outline $\varnothing = 19$ h = 35 Accensione Heater supply 6,3 V — 0,18 A	$V_a = 200$ V $W_a = 2,2$ W $I_a = 20$ mA $V_g = -50$ V	$C_g = 4,3$ $C_a = 2,9$ $C_{g-a} = 0,36$ con schermo <i>with external shield</i>	Amplificatore in classe A_1 <i>Class A_1 Amplifier</i> $V_a = 135$ V $V_g = -1$ V $I_a = 11,5$ mA $S = 14,5$ mA/V $\mu = 72$ Triodo, amplificatore a RF per sintonizzatori TV-VHF. <i>Triode intended for use as RF amplifier in VHF television tuners.</i>

ECC81 12AT7

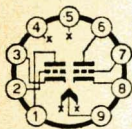

Ingombro
Outline

$$\varnothing = 22 \text{ h} = 49$$

Accensione
in serie
Heater

series supply
12,6 V — 0,15 A

Accensione
in parallelo
Heater

parallel supply
6,3 V — 0,3 A

$$\begin{aligned} V_a &= 300 \text{ V} \\ V_g &= -50 \text{ V} \\ W_a &= 2,5 \text{ W} \end{aligned}$$

Sezione 1 (1) Section No. 1

$$\begin{aligned} C_g &= 2,2 \\ C_a &= 1,2 \\ C_{g-a} &= 1,5 \end{aligned}$$

Sezione 2 (2) Section No. 2

$$\begin{aligned} C_g &= 2,2 \\ C_a &= 1,5 \\ C_{g-a} &= 1,5 \end{aligned}$$

con schermo
with external
shield

- (1) piedini 6, 7
e 8.
pins 6, 7 and
8.
- (2) piedini 1, 2
e 3.
pins 1, 2 and
3.

Amplificatore in classe A₁ Class A₁ Amplifier

$$\begin{aligned} V_a &= 100 & 250 & \text{V} \\ R_k &= 270 & 200 & \Omega \\ I_a &= 3,7 & 10 & \text{mA} \\ R_i &\sim 15 & 10,9 & \text{k}\Omega \\ S &= 4000 & 5500 & \mu\text{A/V} \\ \mu &= 60 & 60 & \end{aligned}$$

$$R_a = 27 \quad 25 \text{ k}\Omega$$

Doppio triodo, amplificatore a RF con griglia a massa e convertitore per frequenze fino a 300 MHz.

Twln triode designed for use as a grounded grid amplifier at frequencies up to 300 MHz.

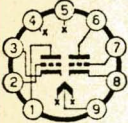
TIPO Type	Limiti massimi Maximum ratings	Capacità in pF Capacitances	Caratteristiche e funzionamento tipico Typical operation
<p>ECC82 12AU7</p>  <p>Ingombro Outline Ø=22 h=49</p> <p>Accensione in serie Heater series supply 12,6 V — 0,15 A</p> <p>Accensione in parallelo Heater parallel supply 6,3 V — 0,3 A</p>	<p>Amplif. classe A₁ Class A₁ Amplif.</p> <p>V_a = 300 V W_a = 2,75 W I_k = 20 mA</p> <p>Amplific. defless. verticale Vertical deflection amplifier</p> <p>V_a = 300 V V_a (impulsiva) (pulse) = 1200 V W_a = 2,75 W I_k = 20 mA I_k (picco/peak) = 60 mA</p>	<p>Per sezione Each section</p> <p>C_g = 1,8 C_a = 2,0 C_{g-a} = 1,5</p>	<p>Amplificatore in classe A₁ Class A₁ Amplifier</p> <p>(valori per sezione) (values are for Each Section)</p> <p>V_a = 100 250 V V_g = 0 —8,5 V I_a = 11,8 10,5 mA R_i = 6,5 7,7 kΩ S = 3100 2200 μA/V μ = 20 17</p> <p><i>R_e = 8,5 23,8 kΩ</i></p> <p>Doppio triodo, amplificatore a BF, amplificatore finale deflessione verticale, invertitore di fase, multivibratore ed oscillatore. Twin triode intended primarily for service as horizontal or deflection oscillator, vertical deflection amplifiers and Class A₁ resistance coupled amplifiers.</p> <p>(Each section of these types is electrically similar to the Type 6C4). <i>EC 90</i></p>

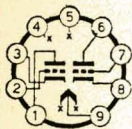
ECC83**12AX7**

Ingombro

Outline

Ø=22 h=49

Accensione

in serie

Heater

series supply

12,6 V — 0,15 A

Accensione

in parallelo

Heater

parallel supply

6,3 V — 0,3 A

Per sezione

Each section

$V_a = 300 \text{ V}$

$V_g = -50 \div 0 \text{ V}$

$W_a = 1 \text{ W}$

Per sezione

Each section

$C_g = 1,8$

$C_a = 1,9$

$C_{g-a} = 1,7$

Amplificatore in classe A₁Class A₁ Amplifier

(valori per ogni sezione)

(values are for each section)

$V_a = 100 \quad 250 \quad \text{V}$

$V_g = -1 \quad -2 \quad \text{V}$

$I_a = 0,5 \quad 1,2 \quad \text{mA}$

$R_i \sim 80 \quad 62,5 \quad \text{k}\Omega$

$S = 1250 \quad 1600 \quad \mu\text{A/V}$

$\mu = 100 \quad 100$

$R_a = 200 \quad 208 \quad \text{k}\Omega$

Doppio triodo, amplificatore a BF, invertitore di fase, separatore e multivibratore in circuiti TV (ogni sezione ha caratteristiche elettriche uguali al tipo 6AV6). / E(B)C 91

TwIn triode designed for service as an audio voltage amplifier or phase inverters in portable or compact equipment.

(Each section of these types has identical electrical characteristics to the Type 6AV6). / E(B)C 91

ECC84**6CW7**

Accensione

Heater supply

6,3 V — 0,33 A

(Vedi dati condensati)

(See condensed data section)

TIPO
Type

Limiti massimi
Maximum ratings

Capacità in pF
Capacitances

Caratteristiche e funzionamento tipico
Typical operation

ECC85

6AQ8

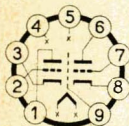

Per sezione
Each Unit

$V_a = 300 \text{ V}$
 $W_a = 2,5 \text{ W}$
 $I_k = 15 \text{ mA}$
 $V_g = -100 \text{ V}$
 $R_g = 1 \text{ M}\Omega$

Per sezione
Each Unit

$C_g = 3$
 $C_a = 1,2$
 $C_{g-a} = 1,5$
 $C_{a-k} = 0,18$

Amplificatore RF
RF Amplifier

$V_a = 250 \text{ V}$
 $V_g = -2 \text{ V}$
 $R_a = 1,8 \text{ k}\Omega$
 $R_k = 200 \text{ }\Omega$
 $I_a = 10 \text{ mA}$
 $S = 6 \text{ mA/V}$
 $R_i \sim 9,7 \text{ k}\Omega$

Mescolatore oscillatore
Oscillating mixer

$V_{ba} = 250 \text{ V}$
 $R_a = 12 \text{ k}\Omega$
 $R_g = 1 \text{ M}\Omega$
 $V_{osc} = 3 \text{ V}_{eff}$
 $I_a = 5,2 \text{ mA}$
 $S_c = 2,3 \text{ mA/V}$
 $R_i \sim 22 \text{ k}\Omega$

Doppio triodo, amplificatore a RF e mescolatore oscillatore in ricevitori MA-MF.
Twin triode intended for use as RF amplifier and self oscillating mixer.

Ingombro

Outline
 $\varnothing=22 \text{ h}=49$

Accensione

Heater supply
 $6,3 \text{ V} - 0,435 \text{ A}$

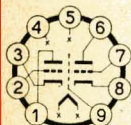
ECC88**6DJ8**

Ingombro
Outline

$\varnothing=22$ h=49

Accensione
Heater supply
6,3 V — 0,365 A

Per sezione
Each Unit

$V_a = 130$ V
 $W_a = 1,8$ W
 $I_k = 25$ mA
 $V_g = -50$ V
 $R_g = 1$ M Ω

Per sezione
Each Unit

$C_g = 3,3$
 $C_a = 2,5$
 $C_{g-a} = 1,4$
 con schermo
with external
shield

Amplificatore in classe A_1 (per sezione)
Class A_1 Amplifier (each unit)

$V_a = 90$ V
 $V_g = -1,3$ V
 $I_a = 15$ mA
 $S = 12,5$ mA/V
 $\mu = 33$
 $R_{eq} = 300$ Ω

Doppio triodo ad alta pendenza e basso fruscio per circuiti cascode in TV.

Twln triode intended for use as cascode amplifier in television tuners.

ECC91**6J6**

Accensione
Heater supply
6,3 B — 0,45 A

(Vedi dati condensati)
(See condensed data section)

ECC189**6ES8**

Accensione
Heater supply
6,3 V — 0,365 A

Riferirsi al tipo: $\frac{7ES8}{PCC189} S$
See Type

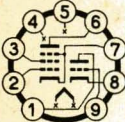
TIPO <i>Type</i>	Limiti massimi <i>Maximum ratings</i>	Capacità in pF <i>Capacitances</i>	Caratteristiche e funzionamento tipico <i>Typical operation</i>																														
<p>ECF80 6BL8</p>  <p>Ingombro Outline Ø=22 h=49</p> <p>Accensione Heater supply 6,3 V — 0,43 A</p>	<p>Pentodo <i>Pentode Unit</i></p> <p>$V_b = 550 \text{ V}$ $V_a = 250 \text{ V}$ $V_{g2} = 175 \text{ V}$ $(I_k = 14 \text{ mA})$ $W_a = 1,7 \text{ W}$ $W_{g2} = 0,5 \text{ W}$ $(W_a < 1,2 \text{ W})$ $R_{g1} = 0,5 \text{ M}\Omega (1)$ $R_{g1} = 1 \text{ M}\Omega (2)$</p> <p>Triodo/Triode Unit</p> <p>$V_b = 550 \text{ V}$ $V_a = 250 \text{ V}$ $I_k = 14 \text{ mA}$ $W_a = 1,5 \text{ W}$ $R_{g1} = 0,5 \text{ M}\Omega (3)$</p> <p>(1) Polarizz. fissa. <i>Fixed bias.</i> (2) Polarizz. autom. <i>Automatic bias.</i> (3) Polarizz. fissa o automatica. <i>Fixed/Automatic bias.</i></p>	<p>Pentodo <i>Pentode Unit</i></p> <p>$C_{g1} = 5,2$ $C_a = 3,4$ $C_{g1-a} < 0,025$</p> <p>Triodo <i>Triode Unit</i></p> <p>$C_g = 2,5$ $C_a = 1,8$ $C_{g-a} = 1,5$</p>	<p>Amplificatore in classe A₁ <i>Class A₁ Amplifier</i></p> <table border="0"> <thead> <tr> <th></th> <th>Pentodo <i>Pentode Unit</i></th> <th>Triodo <i>Triode Unit</i></th> </tr> </thead> <tbody> <tr> <td>$V_a = 170$</td> <td></td> <td>100 V</td> </tr> <tr> <td>$V_{g2} = 170$</td> <td></td> <td>— V</td> </tr> <tr> <td>$V_{g1} = -2$</td> <td></td> <td>-2 V</td> </tr> <tr> <td>$I_a = 10$</td> <td></td> <td>14 mA</td> </tr> <tr> <td>$I_{g2} = 2,8$</td> <td></td> <td>— mA</td> </tr> <tr> <td>$S = 6200$</td> <td></td> <td>5000 $\mu\text{A/V}$</td> </tr> <tr> <td>$\mu_{g2-g1} = 47$</td> <td></td> <td>—</td> </tr> <tr> <td>$\mu = —$</td> <td></td> <td>20</td> </tr> <tr> <td>$R_i = 0,4$</td> <td></td> <td>— MΩ</td> </tr> </tbody> </table> <p>Triodo-pentodo. Triodo a medio «μ». Pentodo ad interdizione rapida. Amplificatore FI, convertitore, ecc. <i>Triode-pentode.</i> <i>Medium-μ Triode.</i> <i>Sharp Cutoff Pentode.</i> <i>IF Amplifier, converter, ...</i></p>		Pentodo <i>Pentode Unit</i>	Triodo <i>Triode Unit</i>	$V_a = 170$		100 V	$V_{g2} = 170$		— V	$V_{g1} = -2$		-2 V	$I_a = 10$		14 mA	$I_{g2} = 2,8$		— mA	$S = 6200$		5000 $\mu\text{A/V}$	$\mu_{g2-g1} = 47$		—	$\mu = —$		20	$R_i = 0,4$		— M Ω
	Pentodo <i>Pentode Unit</i>	Triodo <i>Triode Unit</i>																															
$V_a = 170$		100 V																															
$V_{g2} = 170$		— V																															
$V_{g1} = -2$		-2 V																															
$I_a = 10$		14 mA																															
$I_{g2} = 2,8$		— mA																															
$S = 6200$		5000 $\mu\text{A/V}$																															
$\mu_{g2-g1} = 47$		—																															
$\mu = —$		20																															
$R_i = 0,4$		— M Ω																															

ECF82

6U8

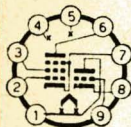

Ingombro
Outline
Ø=22 h=49

Accensione
Heater supply
6,3 V — 0,45 A

Pentodo
Pentode Unit

$$\begin{aligned} V_a &= 300 \text{ V} \\ V_{g1} &= 0 \text{ V} \\ W_a &= 2,8 \text{ W} \\ W_{ga} &= 0,5 \text{ W} \end{aligned}$$

Triodo
Triode Unit

$$\begin{aligned} V_a &= 300 \text{ V} \\ V_g &= 0 \text{ V} \\ W_a &= 2,7 \text{ W} \end{aligned}$$

Pentodo
Pentode Unit

$$\begin{aligned} C_{g1} &= 5 \\ C_a &= 3,5 \\ C_{g1-a} &= 0,006 \end{aligned}$$

Triodo
Triode Unit

$$\begin{aligned} C_g &= 2,5 \\ C_a &= 1 \\ C_{g-a} &= 1,8 \end{aligned}$$

con schermo
connesso al
catodo
with external
shield
connected to
the cathode

Amplificatore in classe A₁
Class A₁ Amplifier

Pentode
Pentode Unit

$$\begin{aligned} V_a &= 230 \\ V_{g2} &= 110 \\ R_k &= 68 \\ I_a &= 10 \\ I_{g2} &= 3,5 \\ R_i &= 400 \\ S &= 5200 \\ \mu &= - \end{aligned}$$

Triodo
Triode Unit

$$\begin{aligned} &150 \text{ V} \\ &- \text{ V} \\ &56 \Omega \\ &18 \text{ mA} \\ &- \text{ mA} \\ &5 \text{ k}\Omega \\ &8500 \mu\text{A/V} \\ &40 \end{aligned}$$

Triodo-pentodo, oscillatore e mescolatore in circuiti TV e MF.

Triode-pentode designed for use as local oscillator-pentode mixer and others combined functions in FM and TV receivers.

ECF801

6GJ7

Accensione
Heater supply
6,3 V — 0,41 A

Riferirsi al tipo: $\frac{8GJ7}{PCF801} S$
See Type

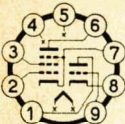
TIPO Type	Limiti massimi Maximum ratings	Capacità in pF Capacitances	Caratteristiche e funzionamento tipico Typical operation																					
<p>ECF802</p>  <p>Ingombro Outline Ø=22 h=49</p> <p>Accensione Heater supply 6,3 V — 0,43 A</p>	<p>Pentodo <i>Pentode Unit</i></p> <p>$V_a = 250 \text{ V}$ $V_{g2} = 250 \text{ V}$ $W_a = 1,2 \text{ W}$ $W_{g2} = 0,8 \text{ W}$ $R_{g1} = 0,56 \text{ M}\Omega$ (1) $R_{g1} = 1 \text{ M}\Omega$ (2)</p> <p>Triodo <i>Triode Unit</i></p> <p>$V_a = 250 \text{ V}$ $I_k = 10 \text{ mA}$ $W_a = 1,4 \text{ W}$ $R_g = 3 \text{ M}\Omega$ (1)</p> <p>(1) Polarizzaz. fissa. <i>Fixed bias.</i> (2) Polarizz. autom. <i>Automatic bias.</i></p>	<p>Pentodo <i>Pentode Unit</i></p> <p>$C_{g1} = 5,4$ $C_{a-g1} = 0,06$ $C_{g1-f} < 0,1$</p> <p>Triodo <i>Triode Unit</i></p> <p>$C_g = 2,4$ $C_{a-g} = 1,5$ $C_{g-f} < 0,1$</p>	<table border="0"> <tr> <td>Pentodo <i>Pentode Unit</i></td> <td>Triodo <i>Triode Unit</i></td> </tr> <tr> <td>$V_a = 100$</td> <td>200 V</td> </tr> <tr> <td>$V_{g2} = 100$</td> <td>— V</td> </tr> <tr> <td>$V_{g1} = -1$</td> <td>-2 V</td> </tr> <tr> <td>$I_a = 6$</td> <td>3,5 mA</td> </tr> <tr> <td>$I_{g2} = 1,7$</td> <td>— mA</td> </tr> <tr> <td>$S = 5500$</td> <td>3500 mA/V</td> </tr> <tr> <td>$\mu_{g2-g1} = 47$</td> <td>—</td> </tr> <tr> <td>$\mu = —$</td> <td>70</td> </tr> <tr> <td>$R_i = 400$</td> <td>20 kΩ</td> </tr> </table> <p>Triodo-Pentodo. Pentodo: oscillatore di riga. Triodo: tubo a reattanza. <i>Triode-Pentode.</i> <i>Pentode section intended for use as sine wave oscillator or pulse shaper.</i> <i>Triode section intended for use as reactance tube.</i></p>		Pentodo <i>Pentode Unit</i>	Triodo <i>Triode Unit</i>	$V_a = 100$	200 V	$V_{g2} = 100$	— V	$V_{g1} = -1$	-2 V	$I_a = 6$	3,5 mA	$I_{g2} = 1,7$	— mA	$S = 5500$	3500 mA/V	$\mu_{g2-g1} = 47$	—	$\mu = —$	70	$R_i = 400$	20 k Ω
Pentodo <i>Pentode Unit</i>	Triodo <i>Triode Unit</i>																							
$V_a = 100$	200 V																							
$V_{g2} = 100$	— V																							
$V_{g1} = -1$	-2 V																							
$I_a = 6$	3,5 mA																							
$I_{g2} = 1,7$	— mA																							
$S = 5500$	3500 mA/V																							
$\mu_{g2-g1} = 47$	—																							
$\mu = —$	70																							
$R_i = 400$	20 k Ω																							
<p>ECF805</p> <p>6GV7</p> <p>Accensione Heater supply 6,3 V — 0,35 A</p>			<p>Riferirsi al tipo: $\frac{7GV7}{PCF805} S$ See Type</p>																					

ECH81

6AJ8

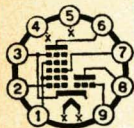

Ingombro
Outline
Ø=22 h=60

Accensione
Heater supply
6,3 V — 0,3 A

(segue)
(follow)

Eptodo Heptode Unit

V_a	=	300	V
$V_{g^{2-4}}$	=	125	V
W_a	=	1,7	W
$W_{g^{2-4}}$	=	1,0	W
I_k	=	12,5	mA

Triodo Triode Unit

V_a	=	250	V
W_a	=	0,8	W
I_k	=	6,5	mA

Eptodo Heptode Unit

C_{g^1}	=	4,8
C_a	=	7,9
$C_{g^{1-a}}$	<	0,006
C_{g^3}	=	6
$C_{g^{1-g^3}}$	<	0,3

Triodo Triode Unit

C_g	=	2,6
C_a	=	2,1
C_{g-a}	=	1

Amplificatore in classe A₁ Class A₁ Amplifier

Eptodo Heptode Unit	Triodo Heptode Unit
V_a	= 250 V
$V_{g^{2-4}}$	= 100 V
V_{g^1}	= -2 V
V_{g^3}	= 0 V
I_a	= 6,5 mA
$I_{g^{2-4}}$	= 3,8 mA
R_i	~ 700 Ω
S	= 2400 μA/V
μ	= 22

Convertitore di frequenza (1) Frequency Converter (1)

V_{aH}	=	250	V
$V_{g^{2-4}}$	=	100	V
V_{g^1}	=	-2	V
I_{aH}	=	3,25	mA
$I_{g^{2-4}}$	=	6,7	mA
S_{cH}	=	775	μA/V
R_{iH}	=	1	MΩ
V_{aT}	=	100	V
V_{g^1}	=	0	V
R_{g^1}	=	47	kΩ
I_g	=	200	μA

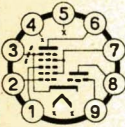
TIPO <i>Type</i>	Limiti massimi <i>Maximum ratings</i>	Capacità in pF <i>Capacitances</i>	Caratteristiche e funzionamento tipico <i>Typical operation</i>																		
ECH81 <hr/> 6AJ8 <i>(seguito)</i> <i>(following)</i>			$I_{aT} = 4,5 \text{ mA}$ (1) Griglia triodo collegato a g_3 eptodo. (1) <i>Grid triode connectet to grid No. 3 Heptode.</i> Triodo eptodo, amplificatore a RF e FI, convertitore per ricevitori MA-MF. <i>Triode-Heptode. RF or IF amplifier, frequency converter in AM/IFM receivers.</i>																		
ECH84 <hr/> 6JX7  Ingombro Outline $\varnothing=22 \text{ h}=60$ <i>(segue)</i> <i>(follow)</i>	Eptodo <i>Heptode Unit</i> $V_a = 250 \text{ V}$ $V_{g^{2-4}} = 250 \text{ V}$ $W_a = 1,7 \text{ W}$ $W_{g^{2-4}} = 0,8 \text{ W}$ $-V_{g^1} = 150 \text{ V}$ $-V_{g^3} = 150 \text{ V}$ $I_k = 12,5 \text{ mA}$	Eptodo <i>Heptode Unit</i> $C_{a-g} < 0,009$ Triodo <i>Triode Unit</i> $C_g = 3$ $C_a = 1,1$	Amplificatore in classe A_1 Class A_1 Amplifier <table border="0" style="width: 100%;"> <thead> <tr> <th style="text-align: left;">Eptodo <i>Eptode Unit</i></th> <th style="text-align: left;">Triodo <i>Triode Unit</i></th> </tr> </thead> <tbody> <tr> <td>$V_a = 135$</td> <td>50 V</td> </tr> <tr> <td>$V_{g^{2-4}} = 14$</td> <td>— V</td> </tr> <tr> <td>$V_{g^3} = -2 (1)$</td> <td>— V</td> </tr> <tr> <td>$V_{g^1} = -1,9 (2)$</td> <td>0 V</td> </tr> <tr> <td>$I_a = 1,7$</td> <td>3 mA</td> </tr> <tr> <td>$I_{g^{2-4}} = 0,9$</td> <td>— mA</td> </tr> <tr> <td>$S = 2200$</td> <td>3700 $\mu\text{A/V}$</td> </tr> <tr> <td>$\mu = —$</td> <td>50</td> </tr> </tbody> </table>	Eptodo <i>Eptode Unit</i>	Triodo <i>Triode Unit</i>	$V_a = 135$	50 V	$V_{g^{2-4}} = 14$	— V	$V_{g^3} = -2 (1)$	— V	$V_{g^1} = -1,9 (2)$	0 V	$I_a = 1,7$	3 mA	$I_{g^{2-4}} = 0,9$	— mA	$S = 2200$	3700 $\mu\text{A/V}$	$\mu = —$	50
Eptodo <i>Eptode Unit</i>	Triodo <i>Triode Unit</i>																				
$V_a = 135$	50 V																				
$V_{g^{2-4}} = 14$	— V																				
$V_{g^3} = -2 (1)$	— V																				
$V_{g^1} = -1,9 (2)$	0 V																				
$I_a = 1,7$	3 mA																				
$I_{g^{2-4}} = 0,9$	— mA																				
$S = 2200$	3700 $\mu\text{A/V}$																				
$\mu = —$	50																				

ECH84**6JX7**

(seguito)
(following)

Accensione
Heater supply
6,3 V — 0,3 A

TR=14,5 sec.

Triodo

Triode Unit

$$V_a = 250 \text{ V}$$

$$W_a = 1,3 \text{ W}$$

$$-V_g = 200 \text{ V}$$

$$I_k = 10 \text{ mA}$$

$$(1) V_{g1} = 0; I_a = 20 \mu\text{A}$$

$$(2) V_{g3} = 0; I_a = 20 \mu\text{A}$$

Triodo-Eptodo separatore di sincronismi e oscillatore.

Triode-Heptode intended for use as pulse separator, noise inverter and sync amplifier.

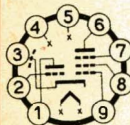
ECL80**6AB8**

Ingombro
Outline
 $\varnothing=22 \text{ h}=61$

Accensione
Heater supply
6,3 V — 0,43 A

(segue)
(follow)

Pentodo

Pentode Unit

$$V_a = 400 \text{ V}$$

$$V_a \text{ (picco/peak)} = 1200 \text{ V (1)}$$

$$= -500 \text{ V}$$

$$V_{g2} = 250 \text{ V}$$

$$W_a = 3,5 \text{ W}$$

$$W_{g2} = 1,2 \text{ W}$$

$$I_k = 25 \text{ mA}$$

$$I_k \text{ (picco/peak)} = 350 \text{ mA (1)}$$

$$R_{g1} = 2 \text{ M}\Omega$$

Pentodo

Pentode Unit

$$C_{g1} = 4,3$$

$$C_a = 4,8$$

$$C_{g1-a} < 0,2$$

Triodo

Triode Unit

$$C_g = 2,1$$

$$C_a = 0,8$$

$$C_{g-a} = 0,9$$

Amplificatore in classe A_1

Classe A_1 Amplifier

Pentodo

Pentode Unit

$$V_b = -$$

$$V_a = 170$$

$$R_a = 11$$

$$V_{g3} = 0$$

$$V_{g2} = 170$$

$$V_{g1} = -6,7$$

$$I_a = 15$$

$$I_{g2} = 2,8$$

$$R_{g1} = -$$

$$S = 3200$$

Triodo

Triode Unit

$$170 \text{ V}$$

$$- \text{ V}$$

$$100 \text{ k}\Omega$$

$$- \text{ V}$$

$$- \text{ V}$$

$$-3,5 \text{ V}$$

$$1 \text{ mA}$$

$$- \text{ mA}$$

$$330 \text{ k}\Omega$$

$$- \mu\text{A/V}$$

TIPO Type	Limiti massimi Maximum ratings	Capacità in pF Capacitances	Caratteristiche e funzionamento tipico Typical operation
ECL80 <hr/> 6AB8 (seguito) (following)	Triodo <i>Triode Unit</i> $V_a = 200 \text{ V}$ $W_a = 1 \text{ W}$ $I_k = 8 \text{ mA}$ $R_g = 3 \text{ M}\Omega \text{ (2)}$ $1 \text{ M}\Omega \text{ (3)}$ (1) Massima durata dell'Impulso pari al 10% di un periodo e non sup. a 2 msec. <i>Valid for application in frameout-put circuits where the max. pulse duration is 10% of a cycle with a max. of 2 ms.</i> (2) Polarizz. autom. <i>Automatic bias.</i> (3) Polarizz. fissa. <i>Fixed bias.</i>		$R_i = 150 \quad \text{---} \quad \text{k}\Omega$ $W_o = 1 \quad \text{---} \quad \text{W}$ $d = 10\% \quad \text{---} \quad \text{---}$ Triodo-pentodo, amplificatore di BF, oscillatore separatore, separatore di sincronismi, ecc. <i>Triode-pentode. Audio amplifier, Oscillator, Sync separator, ...</i>

ECL82

6BM8

Accensione
Heater supply
6,3 V — 0,78 A

Riferirsi al tipo: $\frac{16A8}{PCL82}$
See Type

ECL84

6DX8

Accensione
Heater supply
6,3 V — 0,72 A

Riferirsi al tipo: $\frac{15DQ8}{PCL84}$ S
See Type

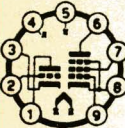
TIPO Type	Limiti massimi Maximum ratings	Capacità in pF Capacitances	Caratteristiche e funzionamento tipico Typical operation																					
<p>ECL85 6GV8</p>  <p>Ingombro Outline Ø=22 h=71</p> <p>Accensione Heater supply 6,3 V — 0,9 A</p>	<p>Pentodo <i>Pentode Unit</i></p> <p>$V_a = 250 \text{ V}$ $V_{g2} = 250 \text{ V}$ $W_a = 7 \text{ W}$ $W_{g2} = 1,5 \text{ W}$ $I_k = 75 \text{ mA}$</p> <p>Triodo <i>Triode Unit</i></p> <p>$V_a = 250 \text{ V}$ $W_a = 0,5 \text{ W}$ $I_a = 15 \text{ mA}$</p>	<p>$C_{g1-aP} < 0,6$ $C_{gT-aP} < 0,03$ $C_{gP-aT} < 0,08$ $C_{g-fT} < 0,15$ $C_{g1-f} < 0,2$</p>	<table border="0"> <tr> <td>Pentodo <i>Pentode Unit</i></td> <td>Triodo <i>Triode Unit</i></td> </tr> <tr> <td>$V_a = 50$</td> <td>100 V</td> </tr> <tr> <td>$V_{g2} = 170$</td> <td>— V</td> </tr> <tr> <td>$V_{g1} = -1$</td> <td>0 V</td> </tr> <tr> <td>$I_a = —$</td> <td>10 mA</td> </tr> <tr> <td>I_a (picco/peak) = 200</td> <td>10 mA</td> </tr> <tr> <td>I_{g2} (picco/peak) = 35</td> <td>— mA</td> </tr> <tr> <td>S = —</td> <td>5,5 mA/V</td> </tr> <tr> <td>$R_i = —$</td> <td>9 kΩ</td> </tr> <tr> <td>$\mu = —$</td> <td>50</td> </tr> </table> <p>Triodo-pentodo, finale deflessione verticale e oscillatore verticale o amplificatore d'impulsi in TV. <i>Triode-Pentode.</i> <i>Triode intended for use as frame oscillator or pulse amplifier. Pentode intended for use as frame output tube.</i></p>		Pentodo <i>Pentode Unit</i>	Triodo <i>Triode Unit</i>	$V_a = 50$	100 V	$V_{g2} = 170$	— V	$V_{g1} = -1$	0 V	$I_a = —$	10 mA	I_a (picco/peak) = 200	10 mA	I_{g2} (picco/peak) = 35	— mA	S = —	5,5 mA/V	$R_i = —$	9 kΩ	$\mu = —$	50
Pentodo <i>Pentode Unit</i>	Triodo <i>Triode Unit</i>																							
$V_a = 50$	100 V																							
$V_{g2} = 170$	— V																							
$V_{g1} = -1$	0 V																							
$I_a = —$	10 mA																							
I_a (picco/peak) = 200	10 mA																							
I_{g2} (picco/peak) = 35	— mA																							
S = —	5,5 mA/V																							
$R_i = —$	9 kΩ																							
$\mu = —$	50																							

ECL86**6GW8**

Accensione
Heater supply
6,3 V — 0,7 A

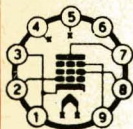
EF80**S****6BX6****Ingombro**

Outline

Ø=22 h=60

Accensione
Heater supply
6,3 V — 0,3 A

TR=14,5 sec.

stessa base
media f
EF 85
EF 183
EF 184

$V_a = 300 \text{ V}$
 $V_{g^2} = 300 \text{ V}$
 $W_a = 2,5 \text{ W}$
 $W_{g^2} = 0,7 \text{ W}$
 $I_k = 15 \text{ mA}$
 $R_{g^2} = 1 \text{ M}\Omega$

$C_{g^2} = 6,9$
 $C_a = 3,1$
 $C_{g^1-a} < 0,007$

Riferirsi al tipo: $\frac{14GW8}{PCL86} S$
 See Type

Amplificatore in classe A_1
 Class A_1 Amplifier

V_a	= 170	200	250	V
V_{g^2}	= 0	0	0	V
V_{g^2}	= 170	200	250	V
V_{g^1}	= -2	-2,55	-3,5	V
I_a	= 10	10	10	mA
I_{g^2}	= 2,5	2,6	2,8	mA
S	= 7400	7100	6800	$\mu A/V$
R_i	$\sim 0,5$	0,55	0,65	$M\Omega$
$\mu_{g^2-g^1}$	= 50	50	50	
R_{eq}	= 1	1,1	1,2	k Ω
r_{g^1}	= 10	12	15	k Ω (1)

(1) Resistenza d'ingresso a 50 MHz; piedini 1 e 3 connessi.

Grid No. 1 input resistance $f = 50 \text{ MHz}$, pin 1 connected to pin 3.

Pentodo, amplificatore a RF e FI; amplificatore video.

Pentode intended for use as RF, IF or video amplifier.

TIPO
Type

Limiti massimi
Maximum ratings

Capacità in pF
Capacitances

Caratteristiche e funzionamento tipico
Typical operation

EF85

6BY7

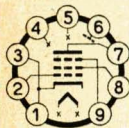

Ingombro

Outline

$\varnothing=22$ h=60

Accensione

Heater supply

6,3 V — 0,3 A

$V_a = 250$ V
 $V_{g2} = 250$ V
 $W_a = 2,5$ W
 $W_{g2} = 0,65$ W
 $I_k = 15$ mA
 $R_{g1} = 3$ M Ω

$C_{g1} = 6,9$
 $C_a = 3,2$
 $C_{a-g1} < 0,007$

Amplificatore in classe A₁.

Class A₁ Amplifier

$V_a = 250$ V
 $V_{g3} = 0$ V
 $V_{g2} = 100$ V
 $V_{g1} = -2$ V
 $I_a = 10$ mA
 $I_{g3} = 2,5$ mA
 $S = 6000$ μ A/V
 $R_i = 0,6$ M Ω
 $\mu_{g2-g1} = 26$

Pentodo a pendenza variabile, amplificatore RF o FI a larga banda.

RF pentode with variable transconductance intended for use as wide-band amplifier.

stessa
disposizione
pin. m. ↓
EF 183
EF 184
EF 80

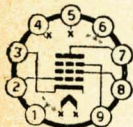
EF89**6DA6**

Ingombro

Outline

Ø=22 h=55

Accensione

Heater supply

6,3 V — 0,2 A

$$\begin{aligned} V_a &= 300 \text{ V} \\ V_{g^2} &= 300 \text{ V} \\ W_a &= 2,25 \text{ W} \\ W_{g^2} &= 0,45 \text{ W} \\ I_k &= 16,5 \text{ mA} \end{aligned}$$

$$\begin{aligned} C_{g^1} &= 5,5 \\ C_a &= 5,1 \\ C_{g^1-a} &< 0,002 \\ C_{g^1-f} &= 0,05 \end{aligned}$$

senza schermo
*without external
shield*

Amplificatore in classe A₁*Class A₁ Amplifier*

V_a	= 250	250	170	V
V_{g^2}	= 100	85	100	V
V_{g^3}	= 0	0	0	V
I_a	= 9	9	12	mA
V_{g^1}	= -1	-1,2	-1,2	V
I_{g^2}	= 3	3,2	4,4	mA
S	= 3600	4000	4400	μA/V
R_i	= 0,9	0,75	0,4	MΩ
$\mu_{g^2-g^1}$	= —	19	—	

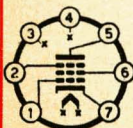
Pentodo, amplificatore a RF e FI.*Pentode intended for use as RF and IF amplifier.***EF93****6BA6**

(segue)

(follow)

$$\begin{aligned} V_a &= 300 \text{ V} \\ V_{g^2} &= 125 \text{ V} \\ V_1 &= -50 \div 0 \text{ V} \\ W_a &= 3 \text{ W} \\ W_{g^2} &= 0,6 \text{ W} \end{aligned}$$

$$\begin{aligned} C_{g^1} &= 5,5 \\ C_a &= 5,0 \\ C_{g^1-a} &< 0,0035 \end{aligned}$$

senza schermo
*without external
shield*

Amplificatore in classe A₁*Class A₁ Amplifier*

V_a	= 100	250	V
V_{g^2}	= 100	100	V
R_k	= 68	68	Ω
I_a	= 10,8	11	mA
I_{g^3}	= 4,4	4,2	mA
R_i	= 250	1000	kΩ
S	= 4300	4400	μA/V

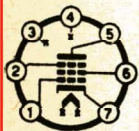
TIPO <i>Type</i>	Limiti massimi <i>Maximum ratings</i>	Capacità in pF <i>Capacitances</i>	Caratteristiche e funzionamento tipico <i>Typical operation</i>																																			
<p>EF93</p> <hr/> <p>6BA6</p> <p>(seguito) (following)</p> <p>Ingombro Outline Ø=19 h=48</p> <p>Accensione Heater supply 6,3 V — 0,3 A</p>			<p>Pentodo, amplificatore a RF e FI. <i>Pentode intended for use as RF and IF amplifier.</i></p>																																			
<p>EF94</p> <hr/> <p>6AU6 S</p>  <p>(segue) (follow)</p>	<p>$V_a = 300 \text{ V}$ $V_{g^2} = 150 \text{ V}$ $V_{g^1} = 0 \text{ V}$ $W_a = 3 \text{ W}$ $W_{g^2} = 0,65 \text{ W}$</p>	<p>$C_{g^1} = 5,5$ $C_a = 5,0$ $C_{g-a} < 0,0035$</p>	<p>Amplificatore in classe A₁ <i>Class A₁ Amplifier</i></p> <table border="0"> <thead> <tr> <th></th> <th colspan="2">Colleg. pentodo <i>Pentode operation</i></th> <th colspan="2">Colleg. triodo <i>Triode operation</i></th> </tr> </thead> <tbody> <tr> <td>V_a</td> <td>= 100</td> <td>250</td> <td>250</td> <td>V</td> </tr> <tr> <td>V_{g^1}</td> <td>= 100</td> <td>150</td> <td>—</td> <td>V</td> </tr> <tr> <td>R_k</td> <td>= 150</td> <td>68</td> <td>330</td> <td>Ω</td> </tr> <tr> <td>I_a</td> <td>= 5</td> <td>10,6</td> <td>12,2</td> <td>mA</td> </tr> <tr> <td>I_{g^2}</td> <td>= 2,1</td> <td>4,3</td> <td>—</td> <td>mA</td> </tr> <tr> <td>R_i</td> <td>~ 500</td> <td>1000</td> <td>—</td> <td>kΩ</td> </tr> </tbody> </table>		Colleg. pentodo <i>Pentode operation</i>		Colleg. triodo <i>Triode operation</i>		V_a	= 100	250	250	V	V_{g^1}	= 100	150	—	V	R_k	= 150	68	330	Ω	I_a	= 5	10,6	12,2	mA	I_{g^2}	= 2,1	4,3	—	mA	R_i	~ 500	1000	—	kΩ
	Colleg. pentodo <i>Pentode operation</i>		Colleg. triodo <i>Triode operation</i>																																			
V_a	= 100	250	250	V																																		
V_{g^1}	= 100	150	—	V																																		
R_k	= 150	68	330	Ω																																		
I_a	= 5	10,6	12,2	mA																																		
I_{g^2}	= 2,1	4,3	—	mA																																		
R_i	~ 500	1000	—	kΩ																																		

EF94
6AU6 S

(seguito)
(following)

Ingombro
Outline
Ø=19 h=48

Accensione
Heater supply
6,3 V — 0,3 A

TR=14,5 sec.

S	=	3900	5200	4800 μ A/V
μ	=	—	—	36

Pentodo, amplificatore a RF e FI.
Pentode intended for use as RF and IF amplifier.

EF95
6AK5

Accensione
Heater supply
6,3 V — 0,175 A

(Vedi dati condensati)
(See condensed data section)

TIPO
Type

Limiti massimi
Maximum ratings

Capacità in pF
Capacitances

Caratteristiche e funzionamento tipico
Typical operation

EF183
6EH7 S

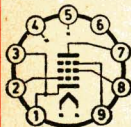

Ingombro
Outline
 $\varnothing=22$ h=55

Accensione
Heater supply
6,3 V — 0,3 A

TR=14,5 sec.

$V_a = 250$ V
 $V_{g2} = 250$ V
 $W_a = 2,5$ W
 $W_{g2} = 0,65$ W
 $I_k = 20$ mA

$C_{g1} = 9,5$
 $C_a = 3$
 $C_{g-a} < 0,0055$
senza schermo
without external shield

Amplificatore in classe A₁
Class A₁ Amplifier

$V_a = 200$ V
 $V_{g3} = 0$ V
 $V_{g2} = 90$ V
 $V_{g1} = -2$ V
 $I_a = 12$ mA
 $I_{g2} = 4,5$ mA
 $S = 12500$ μ A/V
 $R_i = 500$ k Ω

Pentodo, amplificatore a FI per TV.
Pentode intended for use as IF amplifier in television receivers.

Handwritten notes: EF183, 6EH7, EF85, EF80

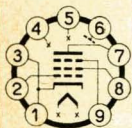
EF184**6EJ7**

Ingombro
Outline

Ø=22 h=55

Accensione
Heater supply
6,3 V — 0,3 A

TR=14,5 sec.

$V_a = 250 \text{ V}$
 $V_{g2} = 250 \text{ V}$
 $W_a = 2,5 \text{ W}$
 $W_{g2} = 0,9 \text{ W}$
 $I_k = 25 \text{ mA}$

$C_{g1} = 10$
 $C_a = 3$
 $C_{a-g1} < 0,0055$
 senza schermo
without external shield

Amplificatore in classe A₁
Class A₁ Amplifier

$V_a = 200 \text{ V}$
 $V_{g3} = 0 \text{ V}$
 $V_{g2} = 200 \text{ V}$
 $V_{g1} = -2,5 \text{ V}$
 $I_a = 10 \text{ mA}$
 $I_{g2} = 4,1 \text{ mA}$
 $S = 15 \text{ mA/V}$
 $R_i = 280 \text{ k}\Omega$
 $\mu_{g2-g1} = 60$

Pentodo, amplificatore a FI per TV.
Pentode intended for use as IF amplifier in television receivers.

Stessa
 disposizione
 pin. d.
 EF 183 &
 EF 85
 EF 80

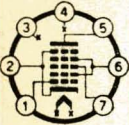
TIPO <i>Type</i>	Limiti massimi <i>Maximum ratings</i>	Capacità in pF <i>Capacitances</i>	Caratteristiche e funzionamento tipico <i>Typical operation</i>																																				
<p>EH90 S</p> <p>6CS6</p>  <p>Ingombro Outline Ø=19 h=48</p> <p>Accensione Heater supply 6,3 V — 0,3 A</p> <p>TR=14,5 sec.</p>	<p>$V_a = 300 \text{ V}$</p> <p>$V_{g^{2-4}} = 100 \text{ V}$</p> <p>$W_a = 1 \text{ W}$</p> <p>$W_{g^{2-4}} = 1 \text{ W}$</p> <p>$I_k = 14 \text{ mA}$</p>	<p>$C_{g^1} = 5,5$</p> <p>$C_{g^3} = 7,0$</p> <p>$C_a = 7,5$</p> <p>$C_{g^1-a} < 0,07$</p> <p>$C_{g^3-a} < 0,36$</p> <p>$C_{g^1-g^3} < 0,22$</p> <p>senza schermo <i>without external shield</i></p>	<p>Separatore sincronismi <i>Sync. separator</i></p> <table border="0"> <tr> <td>$V_a = 10$</td> <td>100</td> <td>100</td> <td>V</td> </tr> <tr> <td>$V_{g^{2-4}} = 30$</td> <td>30</td> <td>30</td> <td>V</td> </tr> <tr> <td>$V_{g^3} = 0$</td> <td>-1</td> <td>0</td> <td>V</td> </tr> <tr> <td>$V_{g^1} = 0$</td> <td>0</td> <td>-1</td> <td>V</td> </tr> <tr> <td>$R_i \sim$</td> <td>0,7</td> <td>1</td> <td>MΩ</td> </tr> <tr> <td>$S_{g^3} =$</td> <td>1500</td> <td>—</td> <td>μA/V</td> </tr> <tr> <td>$S_{g^1} =$</td> <td>—</td> <td>1100</td> <td>μA/V</td> </tr> <tr> <td>$I_a = 2$</td> <td>0,8</td> <td>1</td> <td>mA</td> </tr> <tr> <td>$I_{g^{2-4}} = 4,5$</td> <td>5,5</td> <td>1,3</td> <td>mA</td> </tr> </table> <p>Eptodo, separatore sincronismi antidisturbo in TV. <i>Heptode designed for television service as a combined sync separator and sync clipper.</i></p>	$V_a = 10$	100	100	V	$V_{g^{2-4}} = 30$	30	30	V	$V_{g^3} = 0$	-1	0	V	$V_{g^1} = 0$	0	-1	V	$R_i \sim$	0,7	1	MΩ	$S_{g^3} =$	1500	—	μA/V	$S_{g^1} =$	—	1100	μA/V	$I_a = 2$	0,8	1	mA	$I_{g^{2-4}} = 4,5$	5,5	1,3	mA
$V_a = 10$	100	100	V																																				
$V_{g^{2-4}} = 30$	30	30	V																																				
$V_{g^3} = 0$	-1	0	V																																				
$V_{g^1} = 0$	0	-1	V																																				
$R_i \sim$	0,7	1	MΩ																																				
$S_{g^3} =$	1500	—	μA/V																																				
$S_{g^1} =$	—	1100	μA/V																																				
$I_a = 2$	0,8	1	mA																																				
$I_{g^{2-4}} = 4,5$	5,5	1,3	mA																																				

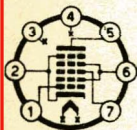
EK90**6BE6****Ingombro**

Outline

Ø=19 h=48

Accensione

Heater supply

6,3 V — 0,3 A

V_a	=	300 V
$V_{g^{2-4}}$	=	100 V
V_{g^3}	=	0 V
W_a	=	1 W
$W_{g^{2-4}}$	=	1 W
I_k	=	14 mA

$C_{g^{3-a}}$	<	0,3
$C_{g^{1-k}}$	=	3
$C_{g^{1-g^3}}$	<	0,15
$C_{g^{1-a}}$	=	0,1
C_2	=	7
C_{g^1}	=	5,5

senza schermo
without external
shield

Convertitore di frequenza
Frequency converter

V_a	=	100	250	V
$V_{g^{2-4}}$	=	900	100	V
V_{g^3}	=	-1,5	-1,5	V
R_{g^1}	=	20	20	kΩ
I_{g^1}	=	0,5	0,5	mA
I_a	=	2,6	2,9	mA
$I_{g^{2-4}}$	=	6,0	6,8	mA
R_i	=	0,4	1	MΩ
S_c	=	455	475	μA/V

Eptodo, convertitore per ricevitori MA-MF, separatore sincronismi antidisturbo in TV. Pentagrid Converter designed for AMIFM in radio receivers, sync separation, sync amplification and noise suppression.

TIPO
Type

Limiti massimi
Maximum ratings

Capacità in pF
Capacitances

Caratteristiche e funzionamento tipico
Typical operation

EL34

6CA7

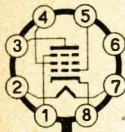

Ingombro
Outline
 $\varnothing=33$ h=98

Accensione
Heater supply
6,3 V — 1,5 A

(segue)
(following)

$V_a = 800$ V
 $V_{g^2} = 500$ V
 $W_a = 27,5$ W
 $W_{g^2} = 8$ W
 $I_k = 150$ mA
 $R_{g^1} = 0,7$ M Ω

$C_{g^1} = 15,2$
 $C_a = 8,4$
 $C_{g^1-a} < 1,1$

Amplificatore in classe A₁

Class A₁ Amplifier

V_a	=	265	300	V
V_{g^2}	=	250	300	V
V_{g^1}	=	-13,5	—	V
R_k	=	—	190	Ω
I_a	=	100	83	mA
I_{g^2}	=	15	13	mA
S	=	11000	—	μ A/V
R_i	=	15	—	k Ω
R_a	=	2	3,5	k Ω
W_o	=	11	11	W
d	=	10	10	%

Controfase in classe AB₁

Class AB₁ Push-pull Power Amplifier

V_a	=	375	450	400	V
V_{g^2}	=	375	450	400	V
R_{g^2}	=	470	1000	800	Ω
V_{g^1}	=	—	—	-36	V
R_k	=	130	232	—	Ω
I_a (1)	=	150	120	60	mA
I_a (2)	=	188	143	221	mA
I_{g^2} (1)	=	25	20	9	mA
I_{g^2} (2)	=	39	44	46	mA
R_a (3)	=	3,5	6,5	3,5	k Ω

EL34

6CA7

(seguito)
(following)

W_o	=	35	40	54	W
d	=	1,7	5,1	1,6	%

Controfase - Connessioni a Triodo
Push-pull Power Amplifier - Triode operation

V_a	=	400	V
I_a (1)	=	130	mA
I_a (2)	=	142	mA
R_k	=	220	Ω
R_a (3)	=	5	k Ω
W_o	=	16,5	W
d	=	3	%

- (1) In assenza di segnale.
Zero-Signal.
- (2) Con il massimo segnale.
Max-Signal.
- (3) Tra anodo e anodo.
Plate to plate.

Pentodo amplificatore di potenza in BF.
Power Pentode for BF Power Amplifier.

TIPO <i>Type</i>	Limiti massimi <i>Maximum ratings</i>	Capacità in pF <i>Capacitances</i>	Caratteristiche e funzionamento tipico <i>Typical operation</i>
<p>EL36</p> <hr/> <p>6CM5</p> <p>Accensione Heater supply 6,3 V — 1,25 A</p>			<p>Riferirsi al tipo: $\frac{25E5}{PL36}$ S See <i>Type</i></p>
<p>EL41</p> <hr/> <p>6CK5</p> <p>Accensione Heater supply 6,3 V — 0,71 A</p>			<p>(Vedi dati condensati) (See condensed data section)</p>

EL83 6CK6

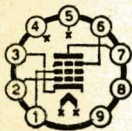

Ingombro
Outline
Ø=22 h=71

Accensione
Heater supply
6,3 V — 0,71 A

$$\begin{aligned} V_a &= 300 \text{ V} \\ V_{g^2} &= 300 \text{ V} \\ W_a &= 9 \text{ W} \sim \\ W_{g^2} &= 2 \text{ W} \\ I_k &= 70 \text{ mA} \\ R_{g^1} &= 1 \text{ M}\Omega \text{ (1)} \\ R_{g^1} &= 0,5 \text{ M}\Omega \text{ (2)} \end{aligned}$$

- (1) Polarizzazione automatica.
Automatic bias.
- (2) Polarizzazione fissa.
Fixed bias.

$$\begin{aligned} C_{g^1} &= 10,8 \\ C_a &= 6,6 \\ C_{g^1-a} &= 0,1 \end{aligned}$$

senza schermo
without external shield

Amplificatore in classe A₁ *Class A₁ Amplifier*

$$\begin{aligned} V_a &= 250 \text{ V} \\ V_{g^3} &= 0 \text{ V} \\ V_{g^2} &= 250 \text{ V} \\ V_{g^1} &= -5,5 \text{ V} \\ I_a &= 36 \text{ mA} \\ I_{g^2} &= 5 \text{ mA} \\ S &= 10000 \mu\text{A/V} \\ \mu_{g^1-g^2} &= 24 \\ R_i &= 0,13 \text{ M}\Omega \end{aligned}$$

Pentodo, finale video.

Pentode Power Tube intended for use as video output.

EL84 6BQ5

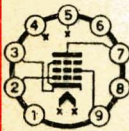

(segue)
(follow)

$$\begin{aligned} V_a &= 300 \text{ V} \\ V_{g^2} &= 300 \text{ V} \\ V_{g^1} &= -100 \text{ V} \\ W_a &= 12 \text{ W} \\ W_{g^2} &= 2 \text{ W} \\ I_k &= 65 \text{ mA} \end{aligned}$$

$$\begin{aligned} C_{g^3} &= 11 \\ C_a &= 6 \\ C_{g^1-a} &= 0,5 \end{aligned}$$

Connesso a Pentodo *Pentode Operation*

Classe/Class A ₁ (un tubo/one tube)	Classe/Class AB ₁ (in controfase/Push-pull)		
V _a = 250	250	300	V
V _{g²} = 250	250	300	V
V _{g¹} = -7,3	—	—	V
R _k = —	130	130	Ω
I _a = 48	62	72	mA
I _{g²} = 5,5	7	8	mA

TIPO <i>Type</i>	Limiti massimi <i>Maximum ratings</i>	Capacità in pF <i>Capacitances</i>	Caratteristiche e funzionamento tipico <i>Typical operation</i>																																													
EL84			S = 11,3 — — mA/V																																													
6BQ5			$\mu_{g_2-g_1}$ = 19 — — R_i ~ 38 — — kΩ R_a = 5,2 — — kΩ R_{a-a} = — 8 8 kΩ W_o = 5,7 11 17 W d = 10 3 4 %																																													
<i>(seguito)</i> <i>(following)</i>			Connesso a Triodo (1) <i>Triode connected</i>																																													
Ingombro <i>Outline</i> $\varnothing=22$ h=70			<table border="0"> <thead> <tr> <th>Classe/Class</th> <th>A₁</th> <th colspan="2">Classe/Class</th> <th>AB₁</th> </tr> </thead> <tbody> <tr> <td>V_a</td> <td>= 250</td> <td>250</td> <td>300</td> <td>V</td> </tr> <tr> <td>R_k</td> <td>= 270</td> <td>270</td> <td>270</td> <td>Ω</td> </tr> <tr> <td>V_i</td> <td>= 6,7</td> <td>8,3</td> <td>10</td> <td>V_{eff}</td> </tr> <tr> <td>I_a</td> <td>= 36</td> <td>43,4</td> <td>52</td> <td>mA</td> </tr> <tr> <td>R_a</td> <td>= 3,5</td> <td>—</td> <td>—</td> <td>kΩ</td> </tr> <tr> <td>R_{a-a}</td> <td>= —</td> <td>10</td> <td>10</td> <td>kΩ</td> </tr> <tr> <td>W_o</td> <td>= 1,95</td> <td>3,4</td> <td>5,2</td> <td>W</td> </tr> <tr> <td>d</td> <td>= 9</td> <td>2,5</td> <td>2,5</td> <td>%</td> </tr> </tbody> </table>	Classe/Class	A ₁	Classe/Class		AB ₁	V _a	= 250	250	300	V	R _k	= 270	270	270	Ω	V _i	= 6,7	8,3	10	V _{eff}	I _a	= 36	43,4	52	mA	R _a	= 3,5	—	—	kΩ	R _{a-a}	= —	10	10	kΩ	W _o	= 1,95	3,4	5,2	W	d	= 9	2,5	2,5	%
Classe/Class	A ₁	Classe/Class		AB ₁																																												
V _a	= 250	250	300	V																																												
R _k	= 270	270	270	Ω																																												
V _i	= 6,7	8,3	10	V _{eff}																																												
I _a	= 36	43,4	52	mA																																												
R _a	= 3,5	—	—	kΩ																																												
R _{a-a}	= —	10	10	kΩ																																												
W _o	= 1,95	3,4	5,2	W																																												
d	= 9	2,5	2,5	%																																												
Accensione <i>Heater supply</i> 6,3 V — 0,76 A			(1) g ₂ e anodo collegati insieme. <i>Grid No. 2 connected to plate.</i>																																													
			Pentodo, amplificatore di potenza a BF ed amplificatore di deflessione verticale in TV. <i>Pentode Power Tube intended for service as general purpose audio amplifier or vertical deflection am- plifier in television receivers sweep circuit.</i>																																													

EL86**6CW5**

Accensione
Heater supply
6,3 V — 0,76 A

Riferirsi al tipo: $\frac{15CW5}{PL84}$ S
See Type

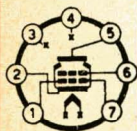
EL90**6AQ5**

Ingombro
Outline
Ø=19 h=60

(segue)
(follow)

Amplif. classe A₁
Class A₁ Amplifier

V_a = 250 V
V_{g₂} = 250 V
W_a = 12 W
W_{g₂} = 2 W

Amplif. defl. vert.
(coli. a triodo)
Vert. defl. amplif.
(Triode operation)

V_a = 250 V
V_a (picco/peak) = 1100 V
V_{g₁} = -250 V
W_a = 9 W
I_k (media/d.c. comp.) = 35 mA

C_{g₁} = 8
C_a = 8,5
C_{g_{1-a}} = 0,4
senza schermo
without external
shield

Amplificatore in classe A₁
Class A₁ Amplifier

Colleg. pentodo
Pentode operation

V_a = 180 250
V_{g₂} = 180 250
V_{g₁} = -8,5 -12,5
I_a = 29 45
I_{g₂} = 3 4,5
R_i ~ 58 52
S = 3700 4100
R_a = 5,5 5
W_o = 2 4,5
d = 8 8
μ = — —

Colleg. triodo
Triode operation

250 V
— V
-12,5 V
49,5 mA
— mA
1,97 kΩ
4800 μA/V
— kΩ
— W
— %
9,5

TIPO Type	Limiti massimi Maximum ratings	Capacità in pF Capacitances	Caratteristiche e funzionamento tipico Typical operation
EL90			
6AQ5			<p>Amplificatore in classe AB₁ (Valori per due valvole) <i>Class AB₁ Amplifier</i> (Values are for 2 tubes)</p>
(seguito) (following)			<p>$V_a = 250 \text{ V}$ $V_{g2} = 250 \text{ V}$ $V_{g1} = -15 \text{ V}$ $I_a = 70 \text{ mA}$ $I_{g2} = 5 \text{ mA}$ $R_a = 10 \text{ k}\Omega$ $W_o = 10 \text{ W}$ $d = 5 \%$</p>
<p>Accensione Heater supply 6,3 V — 0,45 A</p>			<p>Tetrodo a fascio, amplificatore di potenza a BF ed amplificatore finale di deflessione verticale. <i>Beam Power Tube intended for service as general purpose audio power amplifier or vertical deflection amplifier in television receiver sweep circuit.</i></p>

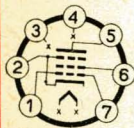
EL95**6DL5**

Ingombro
Outline

$\varnothing=19$ h=53

Accensione
Heater supply
6,3 V — 0,2 A

$V_a = 300$ V
 $V_{g2} = 300$ V
 $W_a = 6$ W
 $W_{g2} = 1,25$ W
 $I_k = 35$ mA
 $R_{g1} = 2$ M Ω (1)

(1) Polarizzazione automatica.
Automatic bias.

$C_{g1} = 5,3$
 $C_a = 3,5$
 $C_{g1-a} < 0,4$

Amplificatore in classe A₁
Class A₁ Amplifier

$V_a = 200$ 250 V
 $V_{g2} = 200$ 250 V
 $I_a = 23$ 24 mA
 $I_{g2} = 4,2$ 4,5 mA
 $R_k = 230$ 320 Ω
 $R_a = 8$ 10 k Ω
 $W_o = 2,3$ 3 W
 $V_i = 4,5$ 5 V_{eff}
 $d = 4,5$ 5 %

Controfase in classe AB
Class AB Push-pull Power Amplifier

$V_a = 200$ 250 V
 $V_{g2} = 200$ 250 V
 $I_a = 2 \times 20$ 2 \times 26 mA
 $I_{g2} = 2 \times 5,2$ 2 \times 7,5 mA
 $R_k = 180$ 180 Ω
 R_a (2) = 10 10 k Ω
 $W_o = 4,1$ 7 W
 $d = 4,5$ 5 %

(2) Tra anodo e anodo.
Plate to plate.

Pentodo amplificatore finale di potenza.
Power Pentode for Power Amplifier.

TIPO <i>Type</i>	Limiti massimi <i>Maximum ratings</i>	Capacità in pF <i>Capacitances</i>	Caratteristiche e funzionamento tipico <i>Typical operation</i>
EL500 <hr/> 6GB5 Accensione Heater supply 6,3 V — 1,38 A			Riferirsi al tipo: $\frac{27GB5}{PL500} S$ See <i>Type</i>
EM80 <hr/> 6BR5 Accensione Heater supply 6,3 V — 0,3 A			(Vedi dati condensati) (See <i>condensed data section</i>)
EM81 <hr/> 6DA5  Ingombro Outline $\varnothing = 22 \text{ h} = 60$ Accensione Heater supply 6,3 V — 0,3 A	$V_a = 300 \text{ V}$ $W_a = 0,2 \text{ V}$ $V_{al} = 300 \text{ V}$ $V_{al} = 165 \text{ V min.}$ $I_k = 3 \text{ mA}$ $R_g = 3 \text{ M}\Omega$		$V_b = 250 \text{ V}$ $V_{al} = 250 \text{ V}$ $R_a = 0,5 \text{ M}\Omega$ $R_g = 3 \text{ M}\Omega$ $V_g = \text{da } -1 \text{ a } -10,5 \text{ V}$ $\alpha = \text{da } 65^\circ \text{ a } 5^\circ$ $I_a = 0,37 \text{ mA}$ $I_{al} = 0,02 \text{ mA}$ $I_a = 2 \text{ mA}$ $I_{al} = 2,3 \text{ mA}$ Indicatore di sintonia. <i>Tuning indicator with triode unit.</i>

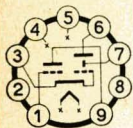
EM84**6FG6****Ingombro**

Outline

Ø=22 h=66

AccensioneHeater supply
6,3 V — 0,21 A

V_a	=	300	V
V_{defl}	=	300	V
V_{al}	=	300	V
V_{al}	=	170 V min.	
W_a	=	0,5	W
I_k	=	3	mA
R_g	=	3	MΩ

(piedini 7 e 9 collegati esternamente)
(Pins 7 and 9 external together connected)

V_b	=	250	V
V_{al}	=	250	V
R_a	=	470	kΩ
R_g	=	3	MΩ
V_g	=	0	-22 mA
I_a	=	0,45	0,06 mA
I_{al}	=	1	1,8 mA
L	=	~ 21	0 mm

Indicatore di sintonia*Tuning Indicator with triode unit.*

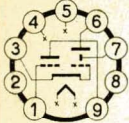
TIPO Type	Limiti massimi Maximum ratings	Capacità in pF Capacitances	Caratteristiche e funzionamento tipico Typical operation
<p>EM87 6HU6</p>  <p>Ingombro Outline Ø=22 h=66</p> <p>Accensione Heater supply 6,3 V — 0,3 A</p>	<p>$V_a = 300 \text{ V}$ $V_{\text{defl}} = 300 \text{ V}$ $V_{\text{al}} = 300 \text{ V}$ $V_{\text{al}} = 170 \text{ min.}$ $W_a = 0,6 \text{ W}$ $I_k = 5 \text{ mA}$ $R_g = 3 \text{ M}\Omega$</p>		<p>(piedini 7 e 9 collegati esternamente) (Pins 7 and 9 external together connected)</p> <p>$V_b = 250 \text{ V}$ $V_{\text{al}} = 250 \text{ V}$ $R_{\text{a Defl}} = 100 \text{ k}\Omega$ $R_g = 3 \text{ M}\Omega$ $V_g = 0 \quad -10 \quad -15 \text{ V}$ $I_{\text{a Defl}} = 2 \quad 0,5 \quad 0,2 \text{ mA}$ $I_{\text{al}} = 1 \quad 1,8 \quad 2 \text{ mA}$ $L = 21 \quad 0 \quad -1,5 \text{ mm (1)}$</p> <p>(1) I valori negativi indicano la sovrapposizione del tratto luminoso « L ». <i>Negative values of the shade length (« L ») mean overlapping.</i></p> <p>Indicatore di sintonia. <i>Tuning Indicator with triode unit.</i></p>

<p>EY86</p> <hr/> <p>6S2</p> <p>Accensione Heater supply 6,3 V — 0,09 A</p>			<p>Senza trattamento speciale sulla superficie del vetro. <i>Without the envelope special treatment.</i></p> <p>Riferirsi al tipo: $\frac{1S2A}{DY87}$ <i>See Type</i></p>
<p>EY87</p> <hr/> <p>6S2A</p> <p>Accensione Heater supply 6,3 V — 0,09 A</p>			<p>Riferirsi al tipo: $\frac{1S2A}{DY87}$ <i>See Type</i></p>
<p>EY88</p> <hr/> <p>6AL3</p> <p>Accensione Heater supply 6,3 V — 1,55 A</p>			<p>Riferirsi al tipo: $\frac{30AE3}{PY88} S$ <i>See Type</i></p>

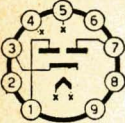
TIPO <i>Type</i>	Limiti massimi <i>Maximum ratings</i>	Capacità in pF <i>Capacitances</i>	Caratteristiche e funzionamento tipico <i>Typical operation</i>
<p>EZ80 6V4</p>  <p>Ingombro Outline Ø=22 h=61</p> <p>Accensione Heater supply 6,3 V — 0,6 A</p>			<p>Massima corrente continua di uscita = 90 mA <i>Maximum DC Output Current</i></p> <p>Massima tensione anodica alternata = $2 \times 350 V_{\text{eff}}$ <i>Maximum AC Plate Supply Voltage</i></p> <p>Tensione tra filamento e catodo (picco) = 500 V <i>Cathode to heater voltage (peak)</i></p> <p>Resistenza in serie agli anodi = $2 \times 300 \Omega$ (min.) <i>Protecting resistance</i></p> <p>Capacità d'ingresso del filtro = 50 μF <i>Input capacitor of smoothing filter</i></p> <p>Doppio diodo, rettificatore delle due semionde. <i>Full-Wave Rectifier.</i></p>

EZ81

6CA4

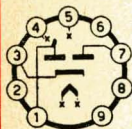

Ingombro

Outline

$\varnothing = 22$ h = 71

Accensione

Filament supply

6,3 V — 1 A

Massima corrente continua di uscita = 150 mA
Maximum DC Output Current

Massima ampiezza della tensione inversa anodica = 1000 V
Maximum Peak Inverse Plate Voltage

Massima tensione anodica alternata = 350 V_{eff}
Maximum AC Plate Supply Voltage

Picco massimo della corrente anodica (per diodo) = 450 mA
Maximum Peak Plate Current (Each Plate)

Caduta interna di tensione a 150 mA = 20 V
Plate Voltage Drop (for 150 mA)

Doppio diodo, rettificatore delle due semionde.

Full-Wave Rectifier.

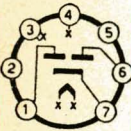
TIPO <i>Type</i>	Limiti massimi <i>Maximum ratings</i>	Capacità in pF <i>Capacitances</i>	Caratteristiche e funzionamento tipico <i>Typical operation</i>
<p>EZ90</p> <hr/> <p>6X4</p>  <p>Ingombro Outline $\varnothing = 19 \text{ h} = 60$</p> <p>Accensione Heater supply 6,3 V — 0,6 A</p>			<p>Massima corrente continua di uscita = 70 mA <i>Maximum DC Output Current</i></p> <p>Massima ampiezza della tensione inversa anodica = 1250 V <i>Maximum Peak Inverse Plate Voltage</i></p> <p>Massima tensione anodica alternata = 325 V_{eff} <i>Maximum AC Plate Supply Voltage</i></p> <p>Picco massimo della corrente anodica (per diodo) = 210 mA <i>Maximum Peak Plate Current (Each Plate)</i></p> <p>Caduta interna di tensione a 70 mA = 22 V <i>Plate Voltage Drop (for 70 mA)</i></p> <p>Doppio diodo, raddrizzatore delle due semionde. <i>Full-Wave Rectifier.</i></p>

HABC80**19AK8**

Accensione
Heater supply
18,9 — 0,15 A

Riferirsi al tipo: $\frac{6AK8}{EABC80}$
See Type

HBC90**12AT6**

Accensione
Heater supply
12,6 V — 0,19 A

Riferirsi al tipo: $\frac{6AT6}{EBC90}$
See Type

HBC91**12AV6**

Accensione
Heater supply
12,6 V — 0,15 A

Riferirsi al tipo: $\frac{6AV6}{EBC91}$
See Type

TIPO <i>Type</i>	Limiti massimi <i>Maximum ratings</i>	Capacità in pF <i>Capacitances</i>	Caratteristiche e funzionamento tipico <i>Typical operation</i>			
HCC85 <hr/> 18AQ8 Accensione Heater supply 18 V — 0,15 A			Riferirsi al tipo: <i>See Type</i> <table style="display: inline-table; vertical-align: middle;"> <tr> <td style="text-align: center; padding: 0 5px;">6AQ8</td> <td style="border-left: 1px solid black; padding: 0 5px;"></td> <td style="text-align: center; padding: 0 5px;">ECC85</td> </tr> </table>	6AQ8		ECC85
6AQ8		ECC85				
HCH81 <hr/> 12AJ8 Accensione Heater supply 12,6 V — 0,15 A			Riferirsi al tipo: <i>See Type</i> <table style="display: inline-table; vertical-align: middle;"> <tr> <td style="text-align: center; padding: 0 5px;">6AJ8</td> <td style="border-left: 1px solid black; padding: 0 5px;"></td> <td style="text-align: center; padding: 0 5px;">ECH81</td> </tr> </table>	6AJ8		ECH81
6AJ8		ECH81				
HF93 <hr/> 12BA6 Accensione Heater supply 12,6 V — 0,15 A			Riferirsi al tipo: <i>See Type</i> <table style="display: inline-table; vertical-align: middle;"> <tr> <td style="text-align: center; padding: 0 5px;">6BA6</td> <td style="border-left: 1px solid black; padding: 0 5px;"></td> <td style="text-align: center; padding: 0 5px;">EF93</td> </tr> </table>	6BA6		EF93
6BA6		EF93				

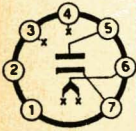
<p>HF94</p> <hr/> <p>12AU6</p> <p>Accensione Heater supply 12,6 V — 0,15 A</p>			<p>Riferirsi al tipo: $\frac{6AU6}{EF94}$ S See Type</p>
<p>HK90</p> <hr/> <p>12BE6</p> <p>Accensione Heater supply 12,6 V — 0,15 A</p>			<p>Riferirsi al tipo: $\frac{6BE6}{EK90}$ See Type</p>
<p>HY90</p> <hr/> <p>35W4</p>  <p>(segue) (following)</p>			<p>100 mA (1) Massima corrente continua di uscita = 60 mA (2) <i>Maximum DC Output Current</i> 90 mA (3) Massima ampiezza della tensione in- versa anodica = 330 V <i>Maximum Peak Inverse Plate Voltage</i> Massima tensione anodica alternata = 110 V_{eff} <i>Maximum AC Plate Supply Voltage</i> Picco massimo della corrente anodi- ca = 600 mA <i>Maximum Peak Plate Current</i></p>

TIPO Type	Limiti massimi Maximum ratings	Capacità in pF Capacitances	Caratteristiche e funzionamento tipico Typical operation
<p>HY90 35W4</p> <p>(seguito) (following)</p> <p>Ingombro Outline Ø = 19 h = 60</p> <p>Accensione Heater supply 35 V — 0,15 A</p>			<p>Caduta interna di tensione a 200 mA = 18 V <i>Plate Voltage Drop (for 200 mA)</i></p> <p>Massima tensione tra filamento e catodo = 300 V <i>Maximum Voltage Filament to Cathode</i></p> <p>Note:</p> <p>(1) Senza lampada del pannello. <i>Without Panel Lamp.</i></p> <p>(2) Con lampada del pannello, senza resistenza in parallelo. <i>With Panel Lamp, no Shuntig Resistor.</i></p> <p>(3) Con lampada del pannello, con resistenza in parallelo (lampada tra i piedini 4 e 6). <i>With Panel Lamp, with Shuntig Resistor (Lamp connected to pins 4 and 6).</i></p> <p>Diodo, raddrizzatore di una semionda. <i>Half-Wave Reetifier.</i></p>

PABC80 S
9AK8

Accensione
Heater supply
9,5 V — 0,3 A
TR=14,5 sec.

Riferirsi al tipo: **6AK8**
See Type **EABC80**

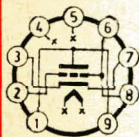
PC86 S
4CM4

Ingombro
Outline
Ø=22 h=49

Accensione
Heater supply
3,8 V — 0,3 A

TR=14,5 sec.

$V_a = 220 \text{ V}$
 $V_g = -50 \text{ V}$
 $W_a = 2,2 \text{ W}$
 $I_k = 20 \text{ mA}$
 $R_g = 1 \text{ M}\Omega$

$C_{a-g} = 2$
 $C_{a-k} = 0,2$
 $C_{g-k} = 3,6$
 $C_{g-f} = 0,3$

senza schermo
without external shield

Amplificatore con griglia a massa
As grounded grid amplifier

$V_a = 175 \text{ V}$
 $V_g = -1,5 \text{ V}$
 $I_a = 12 \text{ mA}$
 $S = 14 \text{ mA/V}$
 $\mu = 68$
 $R_k = 125 \Omega$

Oscillatore miscelatore
As self-oscillating mixer

$V_a = 220 \text{ V}$
 $R_a = 5,6 \text{ k}\Omega$
 $R_g = 47 \text{ k}\Omega$
 $I_a = 12 \text{ mA}$
 $I_g = 50 \mu\text{A}$

Triodo amplificatore UHF, oscillatore o miscelatore per le bande IV e V.

Triode intended for use as grounded grid UHF, amplifier, oscillator or mixer for bands IV and V.

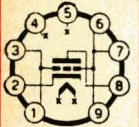
TIPO <i>Type</i>	Limiti massimi <i>Maximum ratings</i>	Capacità in pF <i>Capacitances</i>	Caratteristiche e funzionamento tipico <i>Typical operation</i>
<p>PC88 4DL4 S</p>  <p>Ingombro Outline Ø=22 h=44</p> <p>Accensione Heater supply 3,8 V — 0,3 A</p> <p>TR=14,5 sec.</p>	<p>$V_a = 174 \text{ V}$ $V_g = -50 \text{ V}$ $W_a = 2 \text{ W}$ $I_k = 13 \text{ mA}$ $R_g = 1 \text{ M}\Omega$</p>	<p>$C_{g-a} = 1,2$ senza schermo <i>without external shield</i></p>	<p>$V_a = 160 \text{ V}$ $R_k = 100 \Omega$ $I_a = 12,5 \text{ mA}$ $S = 13,5 \text{ mA/V}$ $\mu = 65$</p> <p>Triodo amplificatore UHF con griglia a massa, per le bande IV e V. <i>Triode intended for use as grounded grid UHF for bands IV and V.</i></p>

PC95**4ER5**

Accensione
Heater supply
3,7 V — 0,3 A

Riferirsi al tipo: $\frac{6ER5}{EC95}$
See Type

PC97 S
5FY5

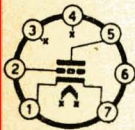

Ingombro
Outline
 $\varnothing=19$ h=48

Accensione
Heater supply
5 V — 0,3 A

TR=14,5 sec.

$V_a = 200$ V
 $V_g = -50$ V
 $W_a = 2,2$ W
 $I_k = 20$ mA
 $R_g = 1$ M Ω

$C_g = 5,0$
 $C_a = 4,3$
 $C_{a-g} = 0,48$
con schermo
with external
shield

Amplificatore in Classe A₁
Class A₁ Amplifier

$V_a = 135$ V
 $V = -1$ V
 $I_a = 11$ mA
 $S = 13$ mA/V
 $\mu = 65$
 $R_i = 5$ k Ω

Triodo, amplificatore a RF per TV-VHF.
Triode intended for use as RF amplifier in VHF television tuners.

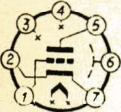
TIPO <i>Type</i>	Limiti massimi <i>Maximum ratings</i>	Capacità in pF <i>Capacitances</i>	Caratteristiche e funzionamento tipico <i>Typical operation</i>
<p>PC900 S 4HA5</p>  <p>Ingombro Outline Ø=19 h=35</p> <p>Accensione Heater supply 4 V — 0,3 A</p> <p>TR=14,5 sec.</p>	<p>$V_a = 200 \text{ V}$ $W_a = 2,2 \text{ W}$ $I_a = 20 \text{ mA}$ $V_g = -50 \text{ V}$</p>	<p>$C_g = 4,3$ $C_a = 2,9$ $C_{g-a} = 0,36$ con schermo <i>with external shield</i></p>	<p>Amplificatore in classe A_1 <i>Class A_1 Amplifier</i></p> <p>$V_a = 135 \text{ A}$ $V_g = -1 \text{ V}$ $I_a = 11,5 \text{ mA}$ $S = 14,5 \text{ mA/V}$ $\mu = 72$</p> <p>Triodo, amplificatore a RF per sintonizzatori TV-VHF. <i>Triode intended for use as RF amplifier in VHF television tuners.</i></p>
<p>PCC84 7AN7</p> <p>Accensione Heater supply 7 V — 0,3 A</p>			<p>(Vedi dati condensati) <i>(See condensed data section)</i></p>

PCC85
9AQ8

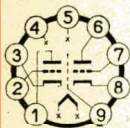

Ingombro
Outline
Ø=22 h=49

Accensione
Heater supply
9 V — 0,3 A

TR=14,5 sec.

Per sezione
Each Unit

$V_a = 300 \text{ V}$
 $W_a = 2,5 \text{ W}$
 $I_k = 15 \text{ mA}$
 $V_g = -100 \text{ V}$
 $R_g = 1 \text{ M}\Omega$

Per sezione
Each Unit

$C_{og} = 3$
 $C_a = 1,2$
 $C_{g-a} = 1,5$
 $C_{a-k} = 0,18$

Amplificatore RF
RF Amplifier

$V_a = 250 \text{ V}$
 $V_g = -2 \text{ V}$
 $R_a = 1,8 \text{ k}\Omega$
 $R_k = 200 \Omega$
 $I_a = 10 \text{ mA}$
 $S = 6 \text{ mA/V}$
 $R_i \sim 9,7 \text{ k}\Omega$

Mescolatore oscillatore
Oscillating mixer

$V_{ba} = 250 \text{ V}$
 $R_a = 12 \text{ k}\Omega$
 $R_g = 1 \text{ M}\Omega$
 $V_{osc} = 3 \text{ V}_{eff}$
 $I_a = 5,2 \text{ mA}$
 $S_c = 2,3 \text{ mA/V}$
 $R_i \sim 22 \text{ k}\Omega$

Doppio triodo, amplificatore a RF e mescolatore oscillatore in ricevitori MA-MF.

Twln triode intended for use RF amplifier and self oscillating mixer.

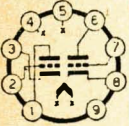
TIPO Type	Limiti massimi Maximum ratings	Capacità in pF Capacitances	Caratteristiche e funzionamento tipico Typical operation
PCC88 7DJ8 Accensione Heater supply 7 V — 0,3 A			Riferirsi al tipo: $\frac{6DJ8}{ECC88}$ <i>See Type</i>
PC189 7ES8 S  Ingombro Outline $\varnothing=22$ h=49 Accensione Heater supply 7,2 V — 0,3 A TR=14,5 sec.	$V_a = 130$ V $W_a = 1,8$ W $V_g = -50$ V $R_g = 1$ M Ω $I_k = 22$ mA	<i>Per sezione (each section)</i> $C_g = 3,5$ $C_a = 2,3$ $C_{a-g} = 1,9$ con schermo <i>with external shield</i> $C_g = 3,5$ $C_a = 1,7$ $C_{a-g} = 1,9$ senza schermo <i>without external shield</i>	Amplificatore in classe A_1 <i>Class A_1 Amplifier</i> (valori per ciascuna sezione) <i>(values for each section)</i> $V_a = 90$ 90 90 V $V_g = -1,4$ -5 -9 V $I_a = 15$ — — mA $S = 12500$ 625 125 μ A/V $R_i = 2,5$ — — k Ω Doppio triodo a «μ» variabile e basso fruscio, amplificatore per TT-VHF. <i>Twin triode with variable transconductance intended for use as VHF cascode amplifier in te- levision receivers.</i>

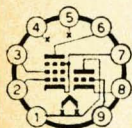
PCF80**9A8**

Ingombro
Outline

∅=22 h=49

Accensione
Heater supply
9 V — 0,3 A

TR=14,5 sec.

Pentodo*Pentode Unit*

$V_b = 550 \text{ V}$

$V_a = 250 \text{ V}$

$V_{g^2} = 175 \text{ V}$

$(I_k = 14 \text{ mA})$

$W_a = 1,7 \text{ W}$

$W_{g^2} = 0,5 \text{ W}$

$(W_a < 1,2 \text{ W})$

$R_{g^1} = 0,5 \text{ M}\Omega (1)$

$R_{g^1} = 1 \text{ M}\Omega (2)$

Triodo*Triode Unit*

$V_b = 550 \text{ V}$

$V_a = 250 \text{ V}$

$I_k = 14 \text{ mA}$

$W_a = 1,5 \text{ W}$

$R_{g^1} = 0,5 \text{ M}\Omega (3)$

(1) Polarizzaz. fissa.

Fixed bias.

(2) Polarizz. autom.

Automatic bias.

(3) Polarizz. fissa o

*automatica.**Fixed or automa-**tatic bias.***Pentodo***Pentode Unit*

$C_{g^1} = 5,2$

$C_a = 3,4$

$C_{g^1-a} < 0,025$

Triodo*Triode Unit*

$C_g = 2,5$

$C_g = 1,8$

$C_{g-a} = 1,5$

Amplificatore in classe A₁*Amplifier - Class A₁***Pentodo***Pentode Unit*

$V_a = 170$

$V_{g^2} = 170$

$V_{g^1} = -2$

$I_a = 10$

$I_{g^2} = 2,8$

$S = 6200$

$\mu_{g^2-g^1} = 47$

$\mu = -$

$R_i = 0,4$

Triodo*Triode Unit*

100 V

$- \text{ V}$

-2 V

14 mA

$- \text{ mA}$

$5000 \mu\text{A/V}$

$-$

20

$- \text{ M}\Omega$

Triodo-pentodo.**Triodo a medio « μ ».****Pentodo ad interdizione rapida.****Amplificatore FI, convertitore, ecc.***Triode-Pentode.**Medium « μ » triode.**Sharp Cutoff Pentode.**IF Amplifier, converter, ...*

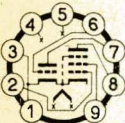
TIPO Type	Limiti massimi Maximum ratings	Capacità in pF Capacitances	Caratteristiche e funzionamento tipico Typical operation	
PCF82 9U8 Accensione Heater supply 9,45 V — 0,3 A			Riferirsi al tipo: $\frac{6U8}{ECF82}$ See Type	
PCF86 7HG8  Ingombro Outline $\varnothing=22$ h=49 Accensione Heater supply 8 V — 0,3 A TR=14,5 sec.	Pentodo <i>Pentode Unit</i> $V_a = 250$ V $V_{g2} = 150$ V $W_a = 2$ W $W_{g2} = 0,5$ W $I_k = 18$ mA $R_{g1} = 500$ k Ω (1) 250 k Ω (2) Triodo <i>Triode Unit</i> $V_a = 125$ V $W_a = 1,5$ W $I_k = 15$ mA $R_g = 500$ k Ω (1) Polarizz. autom. Automatic bias. (2) Polarizzaz. fissa. Fixed bias.	Pentodo <i>Pentode Unit</i> $C_{g1} = 6$ $C_a = 3,6$ $C_{g1-a} < 0,012$ Triodo <i>Triode Unit</i> $C_g = 2,4$ $C_a = 1,1$ $C_{g-a} = 2$	Pentodo <i>Pentode Unit</i> $V_a = 190$ $V_{bg2} = 190$ $R_a = -$ $R_{g2} = 18$ $R_{g1} = 100$ $I_a = 8,5$ $I_{g2} = 2,7$ $R_i = 0,6$ $S_{conv.} = 4500$ $V_{oscill.} = -$ $S = -$ Triodo <i>Triode Unit</i> 190 V $-$ V 8,2 k Ω $-$ k Ω 10 k Ω 12 mA $-$ mA $-$ M Ω $-$ μ A/V 4,5 V_{eff} 3500 μ S Triodo-pentodo oscillatore e miscelatore per TV-VHF. <i>Triode-pentode intended for use as frequency changer in VHF television tuners.</i>	

PCF200

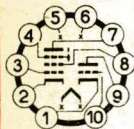

Ingombro
Outline
Ø=22 h=49

Accensione
Heater supply
8 V — 0,3 A

TR=14,5 sec.

Base decal

(segue)
(follow)

Pentodo Pentode Unit

V_{ao}	=	550 V
V_a	=	250 V
V_{g2o}	=	550 V
V_{g2}	=	250 V
W_a	=	2,1 W
W_{g2}	=	0,7 W
I_k	=	20 mA
R_{g1}	=	1 M Ω

Triodo Triode Unit

V_a	=	250 V
W_a	=	1,5 W
I_k	=	18 mA
R_{g1}	=	1 M Ω

Pentodo Pentode Unit

C_{g1}	=	6
C_a	=	3,5
C_{a-g1}	<	0,005

Triodo Triode Unit

C_g	=	2,1
C_a	=	3
C_{a-g}	=	2,2

Tra le 2 sez.
Between the
two sections

C_{g1-aT}	<	0,0012
C_{g1-gT}	<	0,0015
C_{aP-aT}	<	0,015

Pentodo - Pentode Unit

Amplific. classe A_1 Class A_1 Amplifier	Amplificatore FI IF Amplifier
---	----------------------------------

V_b	=	—	210 V
V_a	=	160	— V
V_{g2}	=	135	— V
V_{g1}	=	-1,7	— V
R_a	=	—	3,9 k Ω
R_{g2}	=	—	15 k Ω
R_k	=	—	91 Ω
I_a	=	13	13 mA
I_{g2}	=	5,3	5 mA
S	=	14000	14000 μ A/V
μ_{g2-g1}	=	53	—

Triodo Triode Unit

V_a	=	170 V
V_g	=	-1 V
I_a	=	8,5 mA
S	=	5200 μ A/V
μ	=	57

Triodo-Pentodo, amplificatore FI, separatore sincronismi, ...

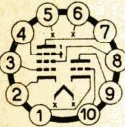
TIPO Type	Limiti massimi Maximum ratings	Capacità in pF Capacitances	Caratteristiche e funzionamento tipico Typical operation
PCF200 (seguito) (following)			<p><i>Triode-Pentode intended for use in television receivers.</i></p> <p><i>Triode section as limiter, AGC amplifier, sync separator, ...</i></p> <p><i>Pentode section as sound IF amplifier and video IF amplifier.</i></p>
PCF201  Ingombro Outline $\varnothing=22$ h=49 Accensione Heater supply 8 V — 0,3 A TR=14,5 sec. Base decal (segue) (follow)	<p>Pentodo <i>Pentode Unit</i></p> <p>$V_{ao} = 550$ V</p> <p>$V_a = 250$ V</p> <p>$V_{g2o} = 550$ V</p> <p>$V_{g2a} = 250$ V</p> <p>$W_a = 2,1$ W</p> <p>$W_{g2} = 0,7$ W</p> <p>$I_k = 20$ mA</p> <p>$R_{g1} = 1$ MΩ</p> <p>Triodo <i>Triode Unit</i></p> <p>$V_a = 250$ V</p> <p>$W_a = 1,5$ W</p> <p>$I_k = 18$ mA</p> <p>$R_{g1} = 1$ MΩ</p>	<p>Pentodo <i>Pentode Unit</i></p> <p>$C_{g1} = 6$</p> <p>$C_a = 3,3$</p> <p>$C_{a-g1} < 0,005$</p> <p>Triodo <i>Triode Unit</i></p> <p>$C_g = 2,1$</p> <p>$C_a = 3$</p> <p>$C_{a-g} = 2,2$</p> <p>Tra le 2 sez. <i>Between to the sections</i></p> <p>$C_{g1-aT} < 0,0012$</p> <p>$C_{g1-gT} < 0,0015$</p> <p>$C_{aP-aT} < 0,015$</p>	<p>Pentodo - Pentode Unit</p> <p>Amplific. in classe A₁ <i>Class A₁ Amplifiers</i></p> <p>$V_b = -$</p> <p>$V_a = 160$</p> <p>$V_{g2} = 110$</p> <p>$V_{g1} = -1,4$</p> <p>$R_a = -$</p> <p>$R_{g2} = -$</p> <p>$R_k = -$</p> <p>$I_a = 13$</p> <p>$I_{g2} = 5,3$</p> <p>$S = 12000$</p> <p>$\mu_{g2-g1} = 45$</p> <p>S (per/for $V_{g1} \sim -5,1$ V) = 1260 μA/V</p> <p>S (per/for $V_{g1} \sim -19$ V) = 126 μA/V</p> <p>Amplificatore FI <i>IF Amplifier</i></p> <p>210 V</p> <p>$V_a = -$</p> <p>$V_{g2} = -$</p> <p>$V_{g1} = -$</p> <p>3,9 kΩ</p> <p>18 kΩ</p> <p>79 Ω</p> <p>13,2 mA</p> <p>5,4 mA</p> <p>12600 μA/V</p> <p>$-$</p>

PCF201

(seguito)
(following)

Triodo - Triode Unit

Amplificatore classe A₁ Oscillatore bloccato
Class A₁ Amplifier Line-blocking oscillator

V _a	=	100	30	V
V _G	=	-2	-1,5	V
I _a	=	14	—	mA
I _k (picco/peak)	=		40	mA
I _a (picco/peak)	=		25	mA
I _G (picco/peak)	=		15	mA
S	=	4800	—	μA/V
μ	=	17,5		

Triodo-Pentodo, oscillatore bloccato, separatore sincronismi, ecc.

Pentodo amplificatore FI a pendenza variabile.

Triode-Pentode intended for use in TV receivers. Triode section as line-blocking oscillator, sync separator, pulse amplifier or AGC delay diode. Pentode section with remote cut-off as video IF amplifier.

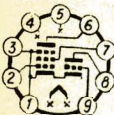
TIPO Type	Limiti massimi Maximum ratings	Capacità in pF Capacitances	Caratteristiche e funzionamento tipico Typical operation	
<p>PCF801 S</p> <p>8GJ7</p>  <p>Ingombro Outline Ø=22 h=44</p> <p>Accensione Heater supply 8,5 V — 0,3 A</p> <p>TR=14,5 sec.</p>	<p>Pentodo <i>Pentode Unit</i></p> <p>$V_a = 250$ V $V_{g^2} = 250$ V $V_{g^1} = -50$ V $W_a = 2$ W $W_{g^2} = 0,3 \div 0,45$ W $I_k = 18$ mA</p> <p>Triodo <i>Triode Unit</i></p> <p>$V_a = 125$ V $V_{g^1} = -50$ V $W_a = 1,5$ W $I_k = 20$ mA</p>	<p>Pentodo <i>Pentode Unit</i></p> <p>$C_{g^1} = 6,2$ $C_a = 3,5$ $C_{g^1-a} = 0,009$</p> <p>Triodo <i>Triode Unit</i></p> <p>$C_G = 3,3$ $C_a = 1,7$ $C_{g-a} = 1,8$</p> <p>con schermo <i>with external shield</i></p>	<p>Pentodo <i>Pentode Unit</i></p> <p>$V_a = 170$ $V_{g^2} = 120$ $V_{g^1} = -1,2$ $I_a = 10$ $I_{g^2} = 3$ $S = 11$ $R_i > 350$ $\mu_{g^2-g^1} = 55$ $R_{eq} = 1,5$</p> <p>Triodo <i>Triode Unit</i></p> <p>170 V — V —3 V 15 mA — mA 9 mA/V — kΩ — kΩ</p> <p>Triodo-pentodo, oscillatore e miscelatore per TV-VHF. <i>Triode-pentode.</i> High transconductance triode and RF pentode intended for use as frequency changer in VHF TV tuners.</p>	
<p>PCF802</p> <p>Accensione Heater supply 9 V — 0,3 A</p>			<p>Riferirsi al tipo: ECF802 See Type</p>	

PCF805
7GV7 S



Ingombro
Outline
Ø=22 h=49

Accensione
Heater supply
7,4 V — 0,3 A

TR=14,5 sec.

Pentodo
Pentode Unit

$V_a = 250$ V
 $V_{g2} = 230$ V
 $W_a = 2$ W
 $W_{g2} = 0,5$ W
 $I_k = 18$ mA

Triodo
Triode Unit

$V_a = 250$ V
 $W_a = 2$ W
 $I_k = 15$ mA

Pentodo
Pentode Unit

$C_{g1-tutti} = 6,7$
 C_{g1} to all
other electrodes
 $C_a-tutti = 2,7$
 C_a to all
other electrodes
 $C_{g1-a} = 0,007$

Triodo
Triode Unit

$C_{g-a} = 2$
con schermo
with external
shield

Amplificatore in classe A₁
Class A₁ Amplifier

Pentodo
Pentode Unit

$V_a = 125$
 $V_{g2} = 125$
 $V_{g1} = -1,5$
 $I_a = 10$
 $I_{g2} = 3,1$
 $S = 11$
 $\mu_{g2-g1} = 50$
 $\mu = -$

Triodo
Triode Unit

100 V
— V
—3 V
14 mA
— mA
5,5 mA/V
—
17

Triodo-pentodo, oscillatore e miscelatore per TV-VHF.

Triode-Pentode.

High transconductance triode and RF pentode intended for use as frequency changer in VHF-TV tuners.

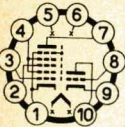
TIPO Type	Limiti massimi Maximum ratings	Capacità in pF Capacitances	Caratteristiche e funzionamento tipico Typical operation
<p>PCH200</p>  <p>Ingombro Outline Ø=22 h=49</p> <p>Accensione Heater supply 8,5 V — 0,3 A</p> <p>TR=14,5 sec.</p> <p>Base decal</p>	<p>Eptodo <i>Heptode Unit</i></p> <p>$V_{ao} = 550 \text{ V}$ $V_a = 100 \text{ V}$ $V_{g^{2+4}0} = 550 \text{ V}$ $V_{g^{2+4}} = 50 \text{ V}$ $W_a = 0,5 \text{ W}$ $W_{g^{2+4}} = 0,5 \text{ W}$ $I_k = 8 \text{ mA}$ V_{g_1} (picco/peak) = -100 V V_{g_3} (picco/peak) = -150 V $R_{g_1} = 3 \text{ M}\Omega$ $R_{g_3} = 3 \text{ M}\Omega$</p> <p>Triodo <i>Triode Unit</i></p> <p>$V_{ao} = 550 \text{ V}$ $V_a = 250 \text{ V}$ $W_a = 1,5 \text{ W}$ $I_k = 20 \text{ mA}$ V_g (picco/peak) = -200 V $R_g = 2 \text{ M}\Omega$</p>	<p>Eptodo <i>Heptode Unit</i></p> <p>$C_{g_1} = 4,4$ $C_a = 5,4$ $C_{g_1-a} < 0,1$ $C_{g_3-a} < 0,25$</p> <p>Triodo <i>Triode Unit</i></p> <p>$C_g = 3,3$ $C_a = 1,7$ $C_{g-a} = 1,8$</p> <p>Tra le 2 sez. <i>Between the two sections</i></p> <p>$C_{g_1H-gT} < 0,005$ $C_{g_1H-aT} < 0,01$ $C_{aH-aT} < 0,15$</p>	<p>Eptodo <i>Heptode Unit</i></p> <p>$V_a = 14 \quad 14 \quad 1 \text{ V}$ $V_{g^{2+4}} = 14 \quad 14 \quad 14 \text{ V}$ $I_a = 1500 \quad 750 > 300 \mu\text{A}$ $I_{g^{2+4}} = 1300 \quad - \quad - \mu\text{A}$ $I_{g_1} = 0,3 \text{ (1)} \quad 100 \quad 100 \mu\text{A}$ $I_{g_3} = 0,3 \text{ (1)} \quad 1 \quad 1 \mu\text{A}$</p> <p>Triodo - Triode Unit</p> <p>$V_a = 100 \quad 100 \quad 200 \text{ V}$ $V_{g_1} = -1 \quad 0 \quad -7 \text{ V}$ $I_a = 9 \quad 20 \quad 0,1 \text{ mA}$ $S = 8800 \quad - \quad - \mu\text{A/V}$ $\mu = 50 \quad - \quad -$</p> <p>(1) Per/for V_{g_1} e/and $V_{g_3} < -1,3 \text{ V}$</p> <p>Triodo-Eptodo, amplificatore e separatore di sincronismi. <i>Triode-Heptode intended for use as sync separator or IF amplifier.</i></p>

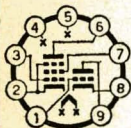
PCL82**16A8**

Ingombro
Outline
Ø=22 h=71

Accensione
Heater supply
16 V — 0,3 A

Pentodo
Pentode Unit

$$\begin{aligned} V_a &= 300 \text{ V} \\ W_a &= 5 \div 7 \text{ W} \\ W_{g^2} &= 2 \text{ W} \\ I_k &= 50 \text{ mA} \end{aligned}$$

Triodo
Triode Unit

$$\begin{aligned} V_a &= 300 \text{ V} \\ W_a &= 1 \text{ W} \\ I_k &= 15 \text{ mA} \end{aligned}$$

Pentodo
Pentode Unit

$$\begin{aligned} C_{g^1} &= 9,3 \\ C_a &= 8,0 \\ C_{g^1-a} &< 0,3 \end{aligned}$$

Triodo
Triode Unit

$$\begin{aligned} C_{g^1} &= 2,7 \\ C_a &= 4,3 \\ C_{g-a} &= 4,4 \end{aligned}$$

senza schermo
without external shield

Amplificatore in classe A₁
Class A₁ Amplifier

Pentodo
Pentode Unit

	100	170	200	200	100	V
V_a	= 100	170	200	200	100	V
V_{g^2}	= 100	170	170	200	—	V
V_{g^1}	= -6	-11,5	-12,5	-16	0	V
I_a	= 25	41	35	35	3,5	mA
I_{g^2}	= 5	8	6,5	7	—	mA
S	= 6800	7500	6800	6400	2200	μA/V
R_i	= 15	16	20,5	20	—	kΩ
$\mu_{g^2-g^1}$	= 10	9,5	9,5	9,5	—	
μ	= —	—	—	—	70	

Triodo
Triode Unit

Triodo pentodo. La sezione triodo può essere usata come oscillatore di deflessione e come amplificatore a BF. La sezione pentodo può essere usata come amplificatore di deflessione verticale o finale BF audio.

Triode-Pentode

The triode section is intended for use as frame oscillator and audio amplifier.

The pentode section is intended for use as frame output tube and audio power amplifier.

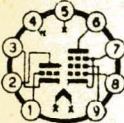
TIPO <i>Type</i>	Limiti massimi <i>Maximum ratings</i>	Capacità in pF <i>Capacitances</i>	Caratteristiche e funzionamento tipico <i>Typical operation</i>																				
<p>PCL84 S 15DQ8</p>  <p>Ingombro Outline Ø=22 h=60</p> <p>Accensione Heater supply 15 V — 0,3 A</p> <p>TR=14,5 sec.</p>	<p>Pentodo <i>Pentode Unit</i></p> <p>$V_a = 250 \text{ V}$ $V_{g2} = 250 \text{ V}$ $W_a = 4 \text{ W}$ $W_{g2} = 1,7 \text{ W}$ $I_k = 40 \text{ mA}$ $R_{g1} = 1 \text{ M}\Omega$</p> <p>Triodo <i>Triode Unit</i></p> <p>$V_a = 250 \text{ V}$ $W_a = 1 \text{ W}$ $I_k = 12 \text{ mA}$ $R_g = 1 \text{ M}\Omega$</p>	<p>Pentodo <i>Pentode Unit</i></p> <p>$C_{g1} = 8,7$ $C_a = 4,2$ $C_{g1-a} < 0,1$</p> <p>Triodo <i>Triode Unit</i></p> <p>$C_g = 3,8$ $C_a = 2,3$ $C_{g-a} = 2,7$</p> <p>senza schermo <i>without external shield</i></p>	<p>Amplificatore in classe A₁ <i>Class A₁ Amplifier</i></p> <table border="0"> <tr> <td>Pentodo <i>Pentode Unit</i></td> <td>Triodo <i>Triode Unit</i></td> </tr> <tr> <td>$V_a = 170$</td> <td>200 V</td> </tr> <tr> <td>$V_{g2} = 170$</td> <td>— V</td> </tr> <tr> <td>$V_{g1} = -2,1$</td> <td>-1,7 V</td> </tr> <tr> <td>$I_a = 18$</td> <td>3 mA</td> </tr> <tr> <td>$I_{g2} = 3$</td> <td>— mA</td> </tr> <tr> <td>S = 11000</td> <td>4000 $\mu\text{A/V}$</td> </tr> <tr> <td>$R_i = 100$</td> <td>— kΩ</td> </tr> <tr> <td>$\mu_{g2-g1} = 36$</td> <td>—</td> </tr> <tr> <td>$\mu = \text{—}$</td> <td>65</td> </tr> </table> <p>Triodo-pentodo, amplificatore e separatore di sincronismo. <i>Triode-Pentode.</i></p> <p><i>Triode section intended for use in circuits for keyed AGC, sync separation, sync amplification and noise suppression. Pentode section is intended for use as video output tube.</i></p>	Pentodo <i>Pentode Unit</i>	Triodo <i>Triode Unit</i>	$V_a = 170$	200 V	$V_{g2} = 170$	— V	$V_{g1} = -2,1$	-1,7 V	$I_a = 18$	3 mA	$I_{g2} = 3$	— mA	S = 11000	4000 $\mu\text{A/V}$	$R_i = 100$	— k Ω	$\mu_{g2-g1} = 36$	—	$\mu = \text{—}$	65
Pentodo <i>Pentode Unit</i>	Triodo <i>Triode Unit</i>																						
$V_a = 170$	200 V																						
$V_{g2} = 170$	— V																						
$V_{g1} = -2,1$	-1,7 V																						
$I_a = 18$	3 mA																						
$I_{g2} = 3$	— mA																						
S = 11000	4000 $\mu\text{A/V}$																						
$R_i = 100$	— k Ω																						
$\mu_{g2-g1} = 36$	—																						
$\mu = \text{—}$	65																						

PCL85
18VG8 S

Accensione
Heater supply
18 V — 0,3 A
TR=14,5 sec.

Riferirsi al tipo: $\frac{6GV8}{ECL85}$
See Type

PCL86
14GW8 S

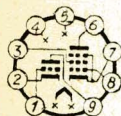

Ingombro
Outline
 $\varnothing=22$ h=71

Accensione
Heater supply
14,5 V — 0,3 A

TR=14,5 sec.

Pentodo
Pentode Unit

$V_a = 300$ V
 $V_{g^2} = 300$ V
 $W_a = 9$ W
 $W_{g^2} = 1,8$ W
 W_{g^2} (picco/peak)
= 3,25 W
 $I_k = 55$ mA

Triodo
Triode Unit

$V_a = 300$ V
 $W_a = 0,5$ W
 $I_k = 4$ mA

Pentodo
Pentode Unit

$C_{g^1} = 10$
 $C_{g^1-a} < 0,4$

Triodo
Triode Unit

$C_g = 2,3$
 $C_a = 2,5$
 $C_{g-a} = 1,4$

senza schermo
without external shield

Amplificatore in classe A₁
Class A₁ Amplifier

Pentodo/Pentode Unit	Triodo/Triode Unit
$V_a = 250$	250 V
$V_{g^2} = 250$	— V
$V_{g^1} = -7$	-1,9 V
$I_a = 36$	1,2 mA
$I_{g^2} = 6$	— mA
S = 10	1,6 mA/V
$R_i = 48$	— k Ω
$\mu_{g^1-g^2} = 21$	—
$\mu = —$	100

Triodo pentodo, preamplificatore BF audio e finale BF audio.

Triode-pentode.

The triode section is intended for use as audio amplifier.

The pentode section is intended for use as power amplifier.

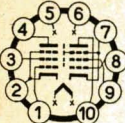
TIPO <i>Type</i>	Limiti massimi <i>Maximum ratings</i>	Capacità in pF <i>Capacitances</i>	Caratteristiche e funzionamento tipico <i>Typical operation</i>																		
<p>PFL200</p>  <p>Ingombro Outline Ø=22 h=72</p> <p>Accensione Filament supply 17 V — 0,2 A</p> <p>TR=14,5 sec.</p> <p>Base decal</p> <p>Connessioni Connections</p> <p>Pentodo fin. (F) Output pentode</p> <p>piedini/pins: n° 1-2-3-4</p> <p>(segue) (follow)</p>	<p>Pentodo finale (L) <i>Output pentode</i></p> <p>$V_{a0} = 550 \text{ V}$ $V_a = 250 \text{ V}$ $V_{g20} = 550 \text{ V}$ $V_{g1} = 250 \text{ V}$ $W_a = 5,1 \text{ W}$ $W_{g2} = 2,5 \text{ W}$ $I_k = 60 \text{ mA}$ $R_{g1} = 1 \text{ M}\Omega$</p> <p>Pent. amplific. (F) <i>Amplifier pentode</i></p> <p>$V_{a0} = 550 \text{ V}$ $V_a = 250 \text{ V}$ $V_{g20} = 550 \text{ V}$ $V_{g2} = 250 \text{ V}$ $W_a = 1,5 \text{ W}$ $W_{g2} = 0,5 \text{ W}$ $I_k = 15 \text{ mA}$ $R_{g1} = 1 \text{ M}\Omega$</p>	<p>Pent. finale (L) <i>Output pentode</i></p> <p>$C_{g1} = 12$ $C_a = 7$ $C_{g1-a} = 0,1$</p> <p>Pentodo am- plificat. (F) <i>Amplif. pentode</i></p> <p>$C_{g1} = 10$ $C_a = 11$ $C_{g1-a} = 0,14$</p> <p>Tra le 2 sez. <i>Between the two pentode sections</i></p> <p>$C_{g1L-g1F} < 0,01$ $C_{aL-aF} < 0,15$ $C_{aF-g1L} < 0,005$ $C_{aL-g1F} < 0,1$</p>	<p>Amplificatore in classe A_1 <i>Class A_1 Amplifier</i></p> <table border="0"> <tr> <td>Pentodo finale (L) <i>Output pentode</i></td> <td>Pentodo amplific. (F) <i>Amplifier pentode</i></td> </tr> <tr> <td>$V_a = 170$</td> <td>150 V</td> </tr> <tr> <td>$V_{g2} = 170$</td> <td>150 V</td> </tr> <tr> <td>$V_{g1} = -2,7$</td> <td>-2,1 V</td> </tr> <tr> <td>$I_a = 30$</td> <td>10 mA</td> </tr> <tr> <td>$I_{g2} = 7,2$</td> <td>3 mA</td> </tr> <tr> <td>$S = 22000$</td> <td>8500 $\mu\text{A/V}$</td> </tr> <tr> <td>$R_i = 32$</td> <td>160 kΩ</td> </tr> <tr> <td>$\mu_{g2-g1} = 38$</td> <td>38</td> </tr> </table> <p>Pentodo finale video (sezione L) <i>Output pentode as video output tube (L)</i></p> <p>$V_b = 220 \text{ V}$ R (serie/serie resistor) = 390 Ω V ingresso = 3,6 V picco-picco <i>Input Voltage = 3,6 V peak to peak</i> V uscita = 100 V picco-picco <i>Output Voltage = 100 V peak to peak</i></p>	Pentodo finale (L) <i>Output pentode</i>	Pentodo amplific. (F) <i>Amplifier pentode</i>	$V_a = 170$	150 V	$V_{g2} = 170$	150 V	$V_{g1} = -2,7$	-2,1 V	$I_a = 30$	10 mA	$I_{g2} = 7,2$	3 mA	$S = 22000$	8500 $\mu\text{A/V}$	$R_i = 32$	160 k Ω	$\mu_{g2-g1} = 38$	38
Pentodo finale (L) <i>Output pentode</i>	Pentodo amplific. (F) <i>Amplifier pentode</i>																				
$V_a = 170$	150 V																				
$V_{g2} = 170$	150 V																				
$V_{g1} = -2,7$	-2,1 V																				
$I_a = 30$	10 mA																				
$I_{g2} = 7,2$	3 mA																				
$S = 22000$	8500 $\mu\text{A/V}$																				
$R_i = 32$	160 k Ω																				
$\mu_{g2-g1} = 38$	38																				

PFL200

(seguito)
(following)

Filamento
Heater

piedini/pins:
n° 5-6

Pentodo
amplificat. (L)
Amplifier pentode

piedini/pins:
n° 7-8-9-10

Pentodo amplificatore (sezione F)
Amplifier pentode (section F)

	Separatore sincronismi <i>Sync separator</i>	Amplif. AGC	Amplif. FI	
V_b	= 220	—	—	V
V_a	= —	150	150	V
R_a	= 50	—	—	k Ω
V_{g^2}	= 75	60	150	V
V_{g^1}	= -2,7	-1,5	-2,1	V
R_{g^1}	= 1	—	—	M Ω
I_a	= 0,1	1	10	mA
S	= 400	2000	8500	μ A/V

Doppio pentodo impiegato come finale video, separatore sincronismi, amplificatore AGC, amplificatore FI.

Twin pentode intended for use as video output tube, sync separator, AGC amplifier or IF sound amplifier.

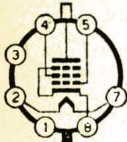
TIPO Type	Limiti massimi Maximum ratings	Capacità in pF Capacitances	Caratteristiche e funzionamento tipico Typical operation
<p>PL36 25E5 S</p>  <p>Ingombro Outline $\varnothing=33$ h=95</p> <p>Accensione Heater supply 25 V — 0,3 A</p> <p>TR=14,5 sec.</p>	<p>$V_a = 250$ V V_a impulsiva (picco positivo) (<i>peak Positive-Pulse Plate Voltage</i>) $= 7000$ V $V_{g2} = 250$ V V_{g1} (picco negativo) (<i>peak negative</i>) $= 1000$ V $W_a = 10$ W $W_{g2} = 5$ W $I_k = 200$ mA $R_{g1} = 0,5$ MΩ</p>	<p>$C_{g1} = 17,5$ $C_a = 8$ $C_{g1-a} < 1,1$</p>	<p>Amplificatore in classe A_1 <i>Class A_1 Amplifier</i></p> <p>$V_a = 100$ V $V_{g2} = 100$ V $V_{g1} = -8,2$ V $I_a = 100$ mA $I_{g2} = 7$ mA $S = 14$ mA/V $R_i = 5$ kΩ $\mu_{g2-g1} = 5,6$</p> <p>Pentodo finale di deflessione orizzontale in TV. <i>Beam Power Tube designed for service as horizontal amplifier in television receivers.</i></p>

PL81

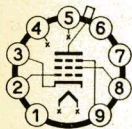

Ingombro
Outline

Ø=22 h=75

Accensione
Heater supply
21,5 V — 0,3 A

$V_a = 250$ V
 V_a (impulsivo -
picco positivo)
(*peak positive
Pulse-Plate Volt.*)

$V_{g2} = 7000$ V
 $W_a = 250$ V
 $W_{g2} = 8$ W
 $W_{g1} = 4,5$ W
 $I_k = 180$ mA
 $R_{g1} = 0,5$ MΩ

$C_{g1} = 14,7$
 $C_a = 6,4$
 $C_{a-g1} < 0,8$

Amplificatore in classe A_1
Class A_1 Amplifier

$V_a = 170$ V
 $V_{g2} = 170$ V
 $V_{g1} = -22$ V
 $I_a = 45$ mA
 $I_{g2} = 3$ mA
 $S = 6200$ μ A/V
 $R_i = 10$ kΩ
 $\mu_{g2-g1} = 5,3$

Pentodo amplificatore di deflessione orizzontale in TV.

Beam Power Tube designed for service as horizontal deflection amplifier.

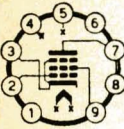
TIPO Type	Limiti massimi Maximum ratings	Capacità in pF Capacitances	Caratteristiche e funzionamento tipico Typical operation
<p>PL82</p> <p>16A5</p>  <p>Ingombro Outline Ø=22 h=71</p> <p>Accensione Heater supply 16,5 V — 0,3 A</p> <p>TR=14,5 sec.</p>	<p>V_a (picco/peak) = 2500 V (1)</p> <p>V_a (picco/peak) = -500 V</p> <p>V_a = 250 V</p> <p>V_a = 450 V (2)</p> <p>V_{g^2} = 250 V</p> <p>W_a = 9 W</p> <p>W_{g^2} = 2,5 W</p> <p>I_k = 75 mA</p> <p>R_{g^1} = 1 MΩ</p> <p>(1) Durata massima dell'impulso pari al 10% di un periodo con un massimo di 2 msec. <i>Valid for application in frame output circuits where the max. pulse duration is 10% of a cycle with a max. of 2 msec.</i></p> <p>(2) $W_a < 4,5$ W</p>	<p>C_{g^1} = 11</p> <p>C_a = 5,9</p> <p>$C_{g^1-a} < 1$</p>	<p>Amplificatore in classe A₁ <i>Class A₁ Amplifier</i></p> <p>$V_a = V_b$ = 170 200 V</p> <p>V_{g^2} = 170 V</p> <p>R_{g^2} = — 580 Ω</p> <p>V_{g^1} = -10,4 -13,9 V</p> <p>I_a = 53 45 mA</p> <p>I_{g^2} = 10 8,5 mA</p> <p>S = 10200 8600 μA/V</p> <p>R_i = 20 24 kΩ</p> <p>R_a = 3 4 kΩ</p> <p>W_a = 4 4,2 W</p> <p>d = 10 10 %</p> <p>Amplificatore finale deflessione verticale <i>Vertical deflection output amplifier</i></p> <p>V_a = 50 60 V</p> <p>V_{g^2} = 170 220 V</p> <p>I_a (picco/peak) = 90 120 mA</p> <p>Pentodo finale amplificatore in BF o per deflessione verticale. <i>Pentode intended for use as frame output tube in television receivers and as audio power amplifier.</i></p>

PL83**15A6**

Accensione
Heater supply
15 V — 0,3 A

Riferirsi al tipo: $\frac{6CK6}{EL83}$
See Type

PL84 S
15CW5

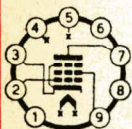

Ingombro
Outline
 $\varnothing=22$ h=71

Accensione
Heater supply
15 V — 0,3 A

TR=14,5 sec.

$V_a = 250$ V
 $V_{g2} = 250$ V
 $W_a = 12$ W
 $W_{g2} = 1,75$ W
 $I_k = 105$ mA
 $R_{g1} = 1$ M Ω

$C_{g1} = 13$
 $C_a = 6,8$
 $C_{g1-a} < 0,6$
senza schermo
without external shield

Amplificatore in classe A_1
Class A_1 Amplifier

$V_b = 200$ V
 $R_{g2} = 470$ Ω
 $R_k = 215$ Ω
 $R_a = 2,5$ k Ω
 $V_i = 7$ V_{eff}
 $I_a = 64$ mA
 $I_{g2} = 11,4$ mA
 $W_o = 5,3$ W
d = 10 %

Pentodo di potenza.

Beam Power Amplifier intended for use Power Amplifier.

TIPO
Type

Limiti massimi
Maximum ratings

Capacità in pF
Capacitances

Caratteristiche e funzionamento tipico
Typical operation

PL500
27GB5 S

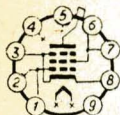

Ingombro
Outline
 $\varnothing=30$ h=96

Accensione
Heater supply
27 V — 0,3 A

TR=14,5 sec.

$V_a = 250$ V
 V_a (picco/peak) = 7000 V
 $V_{g^2} = 250$ V
 $I_k = 250$ mA
 $W_a = 12$ W
 $W_{g^2} = 5$ W

$C_{g^1-a} < 0,2$
senza schermo
without external
shield

$V_a = 75$ V
 $V_{g^2} = 200$ V
 $V_{g^1} = -10$ V
 $I_{ap} = 440$ mA
 $I_{g^2p} = 30$ mA

Pentodo, finale di deflessione orizzontale in TV.

Beam Power Amplifier intended for use as line output tube in television receivers.

PL504

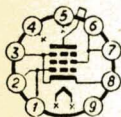

Ingombro

Outline

$\varnothing=30$ h=96

Accensione

Heater supply
27 V — 0,3 A

TR=14,5 sec.

$V_a = 250$ V

V_a (picco/peak)

= 7000 V

$V_{g2} = 250$ V

$I_k = 250$ mA

$W_a = 16$ W

$W_{g2} = 5,6$ W

$C_{g1-f} = 0,2$

$C_{a-g1} = 1,75$

Condizioni tipiche dinamiche

Typical dynamic operation

$V_a = 50$ V

$V_{g2} = 200$ V

$V_{g1} = -10$ V

I_a (picco/peak)

= 420 mA

I_{g2} (picco/peak)

= 37 mA

Pentodo finale di deflessione orizzontale in TV.

Beam Power Tube designed for service as horizontal deflection amplifier.

TIPO <i>Type</i>	Limiti massimi <i>Maximum ratings</i>	Capacità in pF <i>Capacitances</i>	Caratteristiche e funzionamento tipico <i>Typical operation</i>
<p>PY81 17Z3</p>  <p>Ingombro Outline $\varnothing=22$ h=75</p> <p>Accensione Heater supply 17 V — 0,3 A</p> <p>TR=14,5 sec.</p>		<p>$C_a = 6,4$ $C_{k-f} = 2,8$</p>	<p>Massima corrente continua di uscita = 150 mA <i>Maximum DC Output Current</i></p> <p>Massima ampiezza della tensione inversa anodica = 5000 V <i>Maximum Peak Inverse Plate Voltage</i></p> <p>Picco massimo della corrente anodica = 450 mA <i>Maximum Peak Plate Current</i></p> <p>$W_a = 3,5$ W</p> <p>Massima tensione di picco tra filamento e catodo = 5000 V <i>Maximum Peak Voltage Filament to Cathode</i></p> <p>Diodo smorzatore per circuiti di deflessione orizzontale in TV. <i>Half-Wave Rectifier for television damper service.</i></p>

PY82
19Y3 S

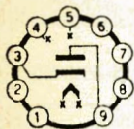

Ingombro

Outline
 $\varnothing=22$ h=71

Accensione
Heater supply
19 V — 0,3 A

TR=14,5 sec.

V = 250 V_{eff}
V_a (picco inverso)
(peak negative)
= 700 V
I_o = 180 mA
V_{k-f} (picco/peak)
= 550 V
C filtro = 60 μ F

Massima corrente continua di uscita = 180 mA
Maximum DC Output Current

Massima tensione raddrizzata = 195 V
Maximum DC Output Voltage

Capacità filtro = 70 μ F
Input capacitance of smoothing filter

V trasf.= 127 200 220 250 V

R trasf.= 0 30 65 125 Ω (1)

(1) Resistenza minima di protezione tra anodo e trasformatore.

Protecting resistance at transformer voltage.

Diodo, raddrizzatore di una semionda.
Half-Wave Rectifier.

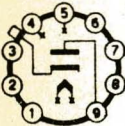
TIPO <i>Type</i>	Limiti massimi <i>Maximum ratings</i>	Capacità in pF <i>Capacitances</i>	Caratteristiche e funzionamento tipico <i>Typical operation</i>
<p>PY88 30AE3 S</p>  <p>Ingombro Outline Ø=22 h=82</p> <p>Accensione Heater supply 30 V — 0,3 A</p> <p>TR=14,5 sec.</p>			<p>Massima corrente continua d uscita = 220 mA <i>Maximum DC Output Current</i></p> <p>Massima ampiezza della tensione inversa anodica = 6000 V <i>Maximum Peak Inverse Plate Voltage</i></p> <p>Massima tensione anodica alternata = 250 V_{eff} <i>Maximum AC Plate Supply Voltage</i></p> <p>Picco massimo della corrente anodica = 550 mA <i>Maximum Peak Plate Current</i></p> <p>Diodo smorzatore per circuito di deflessione orizzontale in TV. <i>Half-Wave Rectifier for television damper service.</i></p>

UABC80

28AK8

Accensione
Heater supply
28 V — 0,1 A

Riferirsi al tipo: $\frac{6AK8}{EABC80}$
See Type

UCL82

50BM8

Accensione
Heater supply
50 V — 0,1 A

Riferirsi al tipo: $\frac{16A8}{PCL82}$
See Type

UF85

19BY7

Accensione
Heater supply
19 V — 0,1 A

Riferirsi al tipo: $\frac{6BY7}{EF85}$
See Type

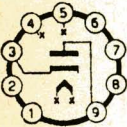
TIPO <i>Type</i>	Limiti massimi <i>Maximum ratings</i>	Capacità in pF <i>Capacitances</i>	Caratteristiche e funzionamento tipico <i>Typical operation</i>
UL84 45B5 Accensione Heater supply 45 V — 0,1 A			Riferirsi al tipo: $\frac{15CW5}{PL84} S$ <i>See Type</i>
UY85 38A3  Ingombro Outline $\varnothing=22$ h=61 Accensione Heater supply 38 V — 0,1 A			Massima corrente continua di uscita = 110 mA <i>Maximum DC Output Current</i> Massima ampiezza della tensione inversa anodica = 700 V <i>Maximum Peak Inverse Plate Voltage</i> Picco massimo della corrente anodica = 660 mA <i>Maximum Peak Plate Current</i> Diodo, raddrizzatore di una semionda. <i>Half-Wave Rectifier.</i>

CINESCOPI

Television picture tubes

DATI CONDENSATI - CINESCOPI
CONDENSED DATA - CRT

TIPO TYPE	Trappola ionica Ion trap	Zoccolo Socket	Dimens. schermo Screen dimens. mm.	Lunghezza totale Overall length/mm.	Angolo defless. Tipo di schermo Deflection angle Screen type	Accens. Heating V—mA	Tensione di focalizzaz. Focusing electrode Volt	Condizioni tipiche Typical operating conditions			Rivestim. conduttivo esterno External conductive coating μF	Tens. anod. mass. Max. anode voltage Volt
								Tens. anod. Anode voltage Volt	G2 Volt	Interdizione G1 Cutoff voltage Volt		
17AVP4A	SI	12-L	362 × 273	406	90° S-Al	6,3-600	-56 ÷ +308	14.000	300	-28 ÷ -72	750 ÷ 1500	16.000
17BP4A	SI	12-N	362 × 273	496	70° S	6,3-600	« M »	14.000	300	-28 ÷ -72	750 ÷ 1500	16.000
17BP4B	SI	12-N	362 × 273	496	70° S-Al	6,3-600	« M »	14.000	300	-28 ÷ -72	750 ÷ 1500	16.000
17BZP4	NO	8-HR	375 × 297	325	110° S-Al	6,3-600	0 ÷ 400	14.000	300	-35 ÷ -72	1000 ÷ 1500	17.600
17DKP4	NO	8-JR	375 × 300	278	110° S-Al	6,3-600	0 ÷ 400	14.000	500	-43 ÷ -72	900 ÷ 1400	17.600
17QP4	SI	12-N	362 × 273	496	70° C	6,3-600	« M »	14.000	300	-28 ÷ -72	750 ÷ 1500	16.000
17BP4/ 17HP4A	SI	12-L	362 × 273	496	70° S	6,3-600	-56 ÷ +308	14.000	300	-28 ÷ -72	750 ÷ 1500	16.000
17HP4B 17VP4/ 17LP4	SI	12-L	362 × 273	496	70° S-Al	6,3-600	-56 ÷ +308	14.000	300	-28 ÷ -72	750 ÷ 1500	16.000
17LP4	SI	12-L	362 × 273	496	70° C	6,3-600	-56 ÷ +308	14.000	300	-28 ÷ -72	750 ÷ 1500	16.000
19AFP4*	NO	8-HR	389 × 307	295	114° S-Al	6,3-600	0 ÷ 400	16.000	300	-35 ÷ -72	1000 ÷ 1500	20.000
19AQP4	NO	8-HR	390 × 308	289	114° S-Al	6,3-300	0 ÷ 400	16.000	300	-38 ÷ -72	1000 ÷ 1500	18.000
19AUP4**	NO	8-HR	389 × 307	295	114° S-Al	6,3-600	0 ÷ 400	16.000	300	-35 ÷ -72	1000 ÷ 1500	20.000
19BCP4**	NO	8-HR	389 × 307	295	114° S-Al	6,3-300	0 ÷ 400	16.000	300	-35 ÷ -72	1000 ÷ 1500	20.000
19BSP4	NO	8-HR	384 × 305	298	110° S-Al	6,3-600	0 ÷ 400	16.000	300	-35 ÷ -72	1000 ÷ 1500	20.000
19XP4	NO	8-HR	390 × 308	289	114° S-Al	6,3-600	0 ÷ 400	16.000	300	-35 ÷ -72	1000 ÷ 1500	18.000
19YP4	NO	8-JR	390 × 308	274	114° S-Al	6,3-600	0 ÷ 400	16.000	400	-34 ÷ -63	1000 ÷ 1500	18.000
21ALP4	SI	12-L	486 × 381	517	90° S	6,3-600	-64 ÷ +352	16.000	300	-28 ÷ -72	500 ÷ 750	18.000
21ALP4A	SI	12-L	486 × 381	517	90° S-Al	6,3-600	-64 ÷ +352	16.000	300	-28 ÷ -72	500 ÷ 750	18.000
21AUP4	SI	12-L	486 × 381	594	72° S-Al	6,3-600	-64 ÷ +352	16.000	300	-28 ÷ -72	500 ÷ 750	18.000
21CEP4	NO	8-HR	484 × 382	374	110° S-Al	6,3-600	0 ÷ 400	14.000	300	-28 ÷ -72	2000 ÷ 2500	20.000
21DAP4/ 21DEP4	NO	8-HR	484 × 382	381	110° S-Al	6,3-600	0 ÷ 500	17.000	300	-28 ÷ -72	2000 ÷ 2500	18.000
21DEP4A	NO	8-HR	484 × 382	381	110° S-Al	6,3-600	0 ÷ 500	17.000	300	-28 ÷ -72	2000 ÷ 2500	20.000

21EP4A	SI	12-N	486 × 352	594	70° C	6,3-600	« M »	16.000	300	-28 ÷ -72	500 ÷ 750	18.000
21EP4B	SI	12-N	486 × 352	594	70° C-AL	6,3-600	« M »	16.000	300	-28 ÷ -72	500 ÷ 750	18.000
21EQP4	NO	8-JR	484 × 382	327	110° S-AL	6,3-600	0 ÷ 400	16.000	500	-43 ÷ -72	1500 ÷ 2000	20.000
21FP4A	SI	12-L	486 × 352	594	70° C	6,3-600	-64 ÷ +352	16.000	300	-28 ÷ -72	500 ÷ 750	18.000
21FP4C	SI	12-L	486 × 352	594	70° C-AL	6,3-600	-64 ÷ +352	16.000	300	-28 ÷ -72	500 ÷ 750	18.000
21ZP4A	SI	12-N	486 × 360	594	70° S	6,3-600	« M »	16.000	300	-28 ÷ -72	500 ÷ 750	18.000
21ZP4B	SI	12-N	486 × 360	594	70° S-AL	6,3-600	« M »	16.000	300	-28 ÷ -72	500 ÷ 750	18.000
21YP4	SI	12-L	486 × 360	594	70° S-AL	6,3-600	-64 ÷ +352	16.000	300	-28 ÷ -72	500 ÷ 750	18.000
21YP4A	SI	12-L	486 × 360	594	70° S-AL	6,3-600	-64 ÷ +352	16.000	300	-28 ÷ -72	500 ÷ 750	18.000
23ARP4	NO	8-HR	490 × 386	378	110° S-AL	6,3-600	0 ÷ 400	16.000	300	-35 ÷ -72	1700 ÷ 2500	22.000
23AVP4**	NO	8-HR	490 × 386	384	110° S-AL	6,3-600	0 ÷ 400	16.000	300	-35 ÷ -72	2000 ÷ 2500	22.000
23AYP4**	NO	8-HR	490 × 386	384	110° S-AL	6,3-300	0 ÷ 400	16.000	300	-35 ÷ -72	2000 ÷ 2500	22.000
23BAP4**	NO	8-HR	490 × 386	362	110° S-AL	6,3-600	0 ÷ 400	16.000	300	-35 ÷ -72	2000 ÷ 2500	22.000
23BCP4	NO	8-HR	490 × 386	378	110° S-AL	6,3-300	0 ÷ 400	16.000	300	-35 ÷ -72	1700 ÷ 2500	22.000
23BP4*	NO	8-HR	490 × 386	362	110° S-AL	6,3-600	0 ÷ 400	16.000	300	-35 ÷ -72	2000 ÷ 2500	22.000
23CFP4	NO	8-HR	490 × 386	356	110° S-AL	6,3-600	0 ÷ 400	16.000	300	-35 ÷ -72	1700 ÷ 2500	22.000
23CP4*	NO	8-HR	490 × 386	384	110° S-AL	6,3-600	0 ÷ 400	16.000	300	-35 ÷ -72	2000 ÷ 2500	22.000
23DJP4**	NO	8-HR	490 × 386	362	110° S-AL	6,3-300	0 ÷ 400	16.000	300	-35 ÷ -72	2000 ÷ 2500	22.000
23DP4	NO	8-JR	490 × 386	344	110° S-AL	6,3-600	0 ÷ 400	16.000	500	-43 ÷ -78	2000 ÷ 2500	20.000
23MP4	NO	8-HR	490 × 386	365	114° S-AL	6,3-600	0 ÷ 400	18.000	400	-44 ÷ -94	1700 ÷ 2500	20.000
23SP4*	NO	8-HR	490 × 386	384	110° S-AL	6,3-300	0 ÷ 400	16.000	300	-35 ÷ -72	2000 ÷ 2500	22.000

Simboli: M = magnetica (*magnetic*); S = sferico (*sferic*); C = cilindrico (*cylindric*); AL = alluminato (*alluminized*);
 * Bonded; ** Bonded „VELVETONE”

CONNESSIONI ZOCCOLO SOCKET CONNECTIONS

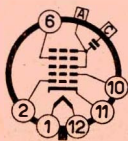

12-L

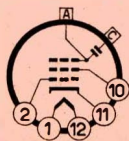

12-N

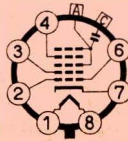

8-HR

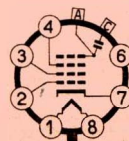

8-JR

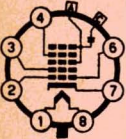
TIPO <i>Type</i>	Limiti massimi <i>Maximum ratings</i>	Capacità in pF <i>Capacitances</i>	Caratteristiche e funzionamento tipico <i>Typical operation</i>
<p>11TC1</p>  <p>$V_f = 6,3 \text{ V}$ $I_f = 0,3 \text{ A}$</p> <p>1 - f 2 - g_1 3 - g_2 4 - g_k 5 - n.c. 6 - g_i 7 - k 8 - f</p> <p>A - a, g_{2-5} C - m</p>	<p>$V_a = 14.000 \text{ V}$ $V_{g2} = 550 \text{ V}$ $V_{g1} = -155 \div 0 \text{ V}$ $V_{g4} \text{ (focusing elec.)}$ $= -550 \div 1100 \text{ V}$ $V_{f-k} = 200 \text{ V}$</p>	<p>$C_k = 5$ $C_{g1} = 6$ $C_{a-m} \approx 500$</p>	<p>$V_a = 12.000 \text{ V}$ $V_{g2} = 300 \text{ V}$ $V_{g1} \text{ (Voltage for cutoff)} = -35 \div -72 \text{ V}$ $V_{g4} = 0 \div 400 \text{ V}$</p> <p>Faccia rettangolare, rapporto 3×4 <i>Rectangular glass type, square line</i></p> <p>Tipo di protezione « Rimband » <i>Type of protection</i></p> <p>Angolo di deflessione 110 gradi <i>Deflection angle degrees</i></p> <p>Schermo sferico alluminato <i>Faceplate spherical alluminized</i></p> <p>Focalizzazione elettrostatica <i>Focusing method electrostatic</i></p> <p>Deflessione magnetica <i>Deflection method magnetic</i></p>

Fluorescenza	bianca
<i>Fluorescence</i>	<i>white</i>

Persistenza	corta ÷ media
<i>Persistence</i>	<i>medium short</i>

Dimensioni schermo (min.)	172 × 229 mm
<i>Screen dimensions</i>	

Lunghezza totale (max.)	224,5 mm
<i>Overall length</i>	

Tubo a raggi catodici per TV, 11" autoprotetto.

TV picture tube, 11" with integral protection

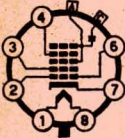
TIPO Type	Limiti massimi Maximum ratings	Capacità in pF Capacitances	Caratteristiche e funzionamento tipico Typical operation
<p>11TC3</p>  <p>V_f = 11 V I_f = 0,15 A</p> <p>1 - f 2 - g₁ 3 - g₂ 4 - g₄ 5 - n.c. 6 - g₁ 7 - k 8 - f</p> <p>A - a, g₂₋₃ C - m</p>	<p>V_a = 14.000 V V_{g₂} = 250 V V_{g₁} = -155 ÷ 0 V V_{g₄} (focusing elec.) = -550 ÷ 1100 V V_{f-k} = 200 V</p>	<p>C_k = 5 C_{g₁} = 6 C_{a-m} ≈ 500</p>	<p>V_a = 12.000 V V_{g₂} = 150 V V_{g₁} (Voltage for cutoff) = -35 ÷ -72 V V_{g₄} = -50 ÷ 250 V</p> <p>Faccia rettangolare, rapporto 3 × 4 Rectangular glass type, square line</p> <p>Tipo di protezione « Rimband » Type of protection</p> <p>Angolo di deflessione 110 gradi Deflection angle degrees</p> <p>Schermo sferico alluminato Faceplate spherical alluminized</p> <p>Focalizzazione elettrostatica Focusing method electrostatic</p> <p>Deflessione magnetica Deflection method magnetic</p>

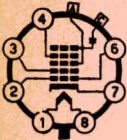
TIPO <i>Type</i>	Limiti massimi <i>Maximum ratings</i>	Capacità in pF <i>Capacitances</i>	Caratteristiche e funzionamento tipico <i>Typical operation</i>
<p>12TC1</p>  <p>V_f = 6,3 V I_f = 0,3 A</p> <p>1 - f 2 - g₁ 3 - g₂ 4 - g₃ 5 - n.c. 6 - g₄ 7 - k 8 - f</p> <p>A - a, g₂-s C - m</p>	<p>V_a = 14.000 V V_{g₂} = 550 V V_{g₁} = -155 ÷ 0 V V_{g₄} (focusing elec.) = -550 ÷ 1100 V V_{f-k} = 200 V</p>	<p>C_k = 5 C_{g₁} = 6 C_{a-m} ≈ 500</p>	<p>V_a = 12.000 V V_{g₂} = 300 V V_{g₁} (Voltage for cutoff) = -35 ÷ -72 V V_{g₄} = 0 ÷ 400 V</p> <p>Faccia rettangolare, rapporto 3 × 4 <i>Rectangular glass type, square line</i></p> <p>Tipo di protezione « Rimband » <i>Type of protection</i></p> <p>Angolo di deflessione 110 gradi <i>Deflection angle degrees</i></p> <p>Schermo sferico alluminato <i>Faceplate spherical aluminumized</i></p> <p>Focalizzazione elettrostatica <i>Focusing method electrostatic</i></p> <p>Deflessione magnetica <i>Deflection method magnetic</i></p>

Fluorescenza	bianca
<i>Fluorescence</i>	<i>white</i>

Persistenza	corta ÷ media
<i>Persistence</i>	<i>medium short</i>

Dimensioni schermo (mln.)	195 × 257 mm
<i>Screen dimensions</i>	

Lunghezza totale (max.)	244 mm
<i>Overal lenght</i>	

Tubo a raggi catodici per TV, 12" autoprotetto.

TV picture tube, 12" with integral protection

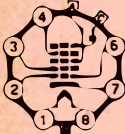
TIPO <i>Type</i>	Limiti massimi <i>Maximum ratings</i>	Capacità in pF <i>Capacitances</i>	Caratteristiche e funzionamento tipico <i>Typical operation</i>
<p>12TC3</p>  <p>$V_f = 11 \text{ V}$ $I_f = 0,15 \text{ A}$</p> <p>1 - f 2 - g₁ 3 - g₂ 4 - g₄ 5 - n.c. 6 - g₁ 7 - k 8 - f</p> <p>A - a, g₃₋₅ C - m</p>	<p>$V_a = 14.000 \text{ V}$ $V_{g^2} = 250 \text{ V}$ $V_{g^1} = -155 \div 0 \text{ V}$ $V_{g^4} \text{ (focusing elec.)} = -550 \div 1100 \text{ V}$ $V_{f-k} = 200 \text{ V}$</p>	<p>$C_k = 5$ $C_{g^1} = 6$ $C_{a-m} \approx 500$</p>	<p>$V_a = 12.000 \text{ V}$ $V_{g^2} = 150 \text{ V}$ $V_{g^1} \text{ (Voltage for cutoff)} = -35 \div -72 \text{ V}$ $V_{g^4} = -50 \div 250 \text{ V}$</p> <p>Faccia rettangolare, rapporto 3 × 4 <i>Rectangular glass type, square line</i></p> <p>Tipo di protezione « Rimband » <i>Type of protection</i></p> <p>Angolo di deflessione 110 gradi <i>Deflection angle degrees</i></p> <p>Schermo sferico alluminato <i>Faceplate spherical alluminized</i></p> <p>Focalizzazione elettrostatica <i>Focusing method electrostatic</i></p> <p>Deflessione magnetica <i>Deflection method magnetic</i></p>

Fluorescenza	bianca
<i>Fluorescence</i>	<i>white</i>

Persistenza	corta ÷ media
<i>Persistence</i>	<i>medium short</i>

Dimensioni schermo (min.)	195 x 257 mm
<i>Screen dimensions</i>	

Lunghezza totale (max.)	244 mm
<i>Overall length</i>	

Tubo a raggi catodici per TV, 12" autoprotetto.
TV picture tube, 12" with integral protection

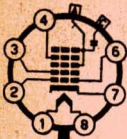
TIPO <i>Type</i>	Limiti massimi <i>Maximum ratings</i>	Capacità in pF <i>Capacitances</i>	Caratteristiche e funzionamento tipico <i>Typical operation</i>
<p>16BK1 (1) 16BK2 (2)</p>  <p>V_f = 6,3 V I_f = 0,3 A</p> <p>1 - f 2 - g₁ 3 - g₂ 4 - g₃ 5 - n.c. 6 - g₁ 7 - k 8 - f</p> <p>A - a, g₂₋₃ C - m</p>	<p>V_a = 18.000 V V_{g2} = 550 V V_{g1} = -155 ÷ 0 V V_{g4} (focusing elec.) = -550 ÷ 1100 V V_{f-k} = 200 V</p>	<p>C_k = 5 C_{g1} = 6 C_{a-m} = 1000 ÷ 1500</p>	<p>V_a = 16.000 V V_{g2} = 300 V V_{g1} (Voltage for cutoff) = -35 ÷ -72 V V_{g4} = 0 → 400 V</p> <p>Faccia rettangolare <i>Rectangular glass type</i></p> <p>Autoprotetto <i>With integral protection</i></p> <p>Angolo di deflessione 110 gradi <i>Deflection angle degrees</i></p> <p>Schermo sferico alluminato <i>Faceplate spherical alluminized</i></p> <p>Focalizzazione elettrostatica <i>Focusing method electrostatic</i></p> <p>Deflessione magnetica <i>Deflection method magnetic</i></p>

TIPO Type	Limiti massimi Maximum ratings	Capacità in pF Capacitances	Caratteristiche e funzionamento tipico Typical operation
<p>16BM1</p> <p>$V_f = 6,3 \text{ V}$ $I_f = 0,3 \text{ A}$</p> <p>1 - f 2 - g₁ 3 - g₂ 4 - g₄ 5 - n.c. 6 - g₁ 7 - k 8 - f</p> <p>A - a, g₃₋₅ C - m</p>	<p>$V_a = 18.000 \text{ V}$ $V_{g2} = 550 \text{ V}$ $V_{g1} = -155 \div 0 \text{ V}$ $V_{g4} \text{ (focusing elec.)} = -550 \div 1100 \text{ V}$ $V_{f-k} = 200 \text{ V}$</p>	<p>$C_k = 5$ $C_{g1} = 6$ $C_{a-n1} = 1000 \div 1500$</p>	<p>$V_a = 16.000 \text{ V}$ $V_{g2} = 300 \text{ V}$ $V_{g1} \text{ (Voltage for cutoff)} = -35 \div -72 \text{ V}$ $V_{g4} = 0 \div 400 \text{ V}$</p> <p>Faccia rettangolare <i>Rectangular glass type</i></p> <p>Tipo di protezione « Metalbonded » <i>Type of protection</i></p> <p>Angolo di deflessione 110 gradi <i>Deflection angle degrees</i></p> <p>Schermo sferico alluminato <i>Faceplate spherical alluminized</i></p> <p>Focalizzazione elettrostatica <i>Focusing method electrostatic</i></p> <p>Deflessione magnetica <i>Deflection method magnetic</i></p>

Intercambiabilità
Replacement type

A41 - 10 W

Fluorescenza

bianca

Fluorescence

white

Persistenza

corta ÷ media

Persistence

medium short

Dimensioni schermo (min.) 260,4 × 328,6 mm

Screen dimensions

Lunghezza totale (max.)

280 mm

Overall length

Tubo a raggi catodici per TV, 16" autoprotetto.

TV picture tube, 16" with integral protection

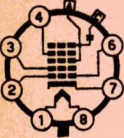
TIPO Type	Limiti massimi Maximum ratings	Capacità in pF Capacitances	Caratteristiche e funzionamento tipico Typical operation
<p>16BM3</p>  <p>$V_f = 11 \text{ V}$ $I_f = 0,15 \text{ A}$</p> <p>1 - f 2 - g_1 3 - g_2 4 - g_3 5 - n.c. 6 - g_4 7 - k 8 - f</p> <p>A - a, g_2, s C - m</p>	<p>$V_a = 18.000 \text{ V}$ $V_{g2} = 250 \text{ V}$ $V_{g1} = -155 \div 0 \text{ V}$ $V_{g4} \text{ (focusing elec.)} = -550 \div 1100 \text{ V}$ $V_{f-k} = 200 \text{ V}$</p>	<p>$C_k = 5$ $C_{g1} = 6$ $C_{a-m} = 1000 \div 1500$</p>	<p>$V_a = 16.000 \text{ V}$ $V_{g2} = 150 \text{ V}$ $V_{g1} \text{ (Voltage for cutoff)} = -35 \div -72 \text{ V}$ $V_{g4} = -50 \div 250 \text{ V}$</p> <p>Faccia rettangolare <i>Rectangular glass type</i></p> <p>Tipo di protezione « Metalbonded » <i>Type of protection</i></p> <p>Angolo di deflessione 110 gradi <i>Deflection angle degrees</i></p> <p>Schermo sferico alluminato <i>Faceplate spherical alluminized</i></p> <p>Focalizzazione elettrostatica <i>Focusing method electrostatic</i></p> <p>Deflessione magnetica <i>Deflection method magnetic</i></p>

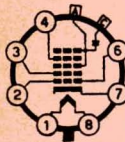
TIPO <i>Type</i>	Limiti massimi <i>Maximum ratings</i>	Capacità in pF <i>Capacitances</i>	Caratteristiche e funzionamento tipico <i>Typical operation</i>
<p>16NC1</p>  <p>V_f = 6,3 V I_f = 0,3 A</p> <p>1 - f 2 - g₁ 3 - g₂ 4 - g₄ 5 - n.c. 6 - g₁ 7 - k 8 - f</p> <p>A - a, g₂₋₄ C - m</p>	<p>V_a = 18.000 V V_{g₂} = 550 V V_{g₁} = -155 ÷ 0 V V_{g₄} (focusing elec.) = -550 ÷ 1100 V V_{f-k} = 200 V</p>	<p>C_k = 5 C_{g₁} = 6 C_{a-m} = 1000 ÷ 1500</p>	<p>V_a = 16.000 V V_{g₂} = 300 V V_{g₁} (Voltage for cutoff) = -32 ÷ -72 V V_{g₄} = 0 ÷ 400 V</p> <p>Faccia rettangolare <i>Rectangular glass type</i></p> <p>Angolo di deflessione <i>Deflection angle</i> 110 gradi degrees</p> <p>Schermo <i>Faceplate</i> sferico alluminato spherical alluminized</p> <p>Focalizzazione <i>Focusing method</i> elettrostatica electrostatic</p> <p>Deflessione <i>Deflection method</i> magnetica magnetic</p> <p>Fluorescenza <i>Fluorescence</i> bianca white</p>

TIPO <i>Type</i>	Limiti massimi <i>Maximum ratings</i>	Capacità in pF <i>Capacitances</i>	Caratteristiche e funzionamento tipico <i>Typical operation</i>
<p>17BM1</p>  <p>$V_f = 6,3 \text{ V}$ $I_f = 0,3 \text{ A}$</p> <p>1 - f 2 - g₁ 3 - g₂ 4 - g₄ 5 - n.c. 6 - g₁ 7 - k 8 - f</p> <p>A - a, g₂₋₃ C - m</p>	<p>$V_a = 18.000 \text{ V}$ $V_{g2} = 550 \text{ V}$ $V_{g1} = -155 \div 0 \text{ V}$ $V_{g4} \text{ (focusing elec.)} = -550 \div 1100 \text{ V}$ $V_{f-k} = 200 \text{ V}$</p>	<p>$C_k = 5$ $C_{g1} = 6$ $C_{a-m} = 1000 \div 1500$</p>	<p>$V_a = 16.000 \text{ V}$ $V_{g2} = 300 \text{ V}$ $V_{g1} \text{ (Voltage for cutoff)} = -35 \div -72 \text{ V}$ $V_{g4} = 0 \div 400 \text{ V}$</p> <p>Faccia rettangolare, rapporto 3 x 4 <i>Rectangular glass type, square line</i></p> <p>Tipo di protezione « Metalbonded » <i>Type of protection</i></p> <p>Angolo di deflessione 114 gradi <i>Deflection angle degrees</i></p> <p>Schermo sferico alluminato <i>Faceplate spherical alluminized</i></p> <p>Focalizzazione elettrostatica <i>Focusing method electrostatic</i></p> <p>Deflessione magnetica <i>Deflection method magnetic</i></p>

TIPO Type	Limiti massimi Maximum ratings	Capacità in pF Capacitances	Caratteristiche e funzionamento tipico Typical operation
<p>17BM3</p>  <p>V_f = 11 V I_f = 0,15 A</p> <p>1 - f 2 - g₁ 3 - g₂ 4 - g₄ 5 - n.c. 6 - g₁ 7 - k 8 - f</p> <p>A - a, g₂₋₄ C - m</p>	<p>V_a = 18.000 V V_{g₂} = 250 V V_{g₁} = -155 ÷ 0 V V_{g₄} (focusing elec.) = -550 ÷ 1100 V V_{f-k} = 200 V</p>	<p>C_k = 5 C_{g₁} = 6 C_{a-m} = 1000 ÷ 1500</p>	<p>V_a = 16.000 V V_{g₂} = 150 V V_{g₁} (Voltage for cutoff) = -35 ÷ -72 V V_{g₄} = -50 ÷ 250 V</p> <p>Faccia rettangolare, rapporto 3 × 4 <i>Rectangular glass type, square line</i></p> <p>Tipo di protezione « Metalbonded » <i>Type of protection</i></p> <p>Angolo di deflessione 114 gradi <i>Deflection angle degrees</i></p> <p>Schermo sferico alluminato <i>Faceplate spherical alluminized</i></p> <p>Focalizzazione elettrostatica <i>Focusing method electrostatic</i></p> <p>Deflessione magnetica <i>Deflection method magnetic</i></p>

Fluorescenza	bianca
<i>Fluorescence</i>	<i>white</i>
Persistenza	corta ÷ media
<i>Persistence</i>	<i>medium short</i>
Dimensioni schermo (min.)	270 × 346 mm
<i>Screen dimensions</i>	
Lunghezza totale (max.)	291 mm
<i>Overall length</i>	

Tubo a raggi catodici per TV, 17" autoprotetto.

TV picture tube, 17" with integral protection

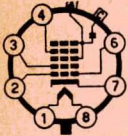
TIPO <i>Type</i>	Limiti massimi <i>Maximum ratings</i>	Capacità in pF <i>Capacitances</i>	Caratteristiche e funzionamento tipico <i>Typical operation</i>
<p>19BAP4</p>  <p>V_f = 6,3 V I_f = 0,3 A</p> <p>1 - f 2 - g₁ 3 - g₂ 4 - g₃ 5 - n.c. 6 - g₄ 7 - k 8 - f</p> <p>A - a, g₂₋₄ C - m</p>	<p>V_a = 20.000 V V_{g₂} = 550 V V_{g₁} = -155 ÷ 0 V V_{g₄} (focusing elec.) = -550 ÷ 1100 V V_{f-k} = 200 V</p>	<p>C_k = 5 C_{g₁} = 6 C_{a-m} = 1000 ÷ 1500</p>	<p>V_a = 16.000 V V_{g₂} = 300 V V_{g₁} (Voltage for cutoff) = -35 ÷ -72 V V_{g₄} = 0 ÷ 400 V</p> <p>Faccia rettangolare <i>Rectangular glass type</i></p> <p>Tipo di protezione « Bonded shield » <i>Type of protection</i></p> <p>Angolo di deflessione 114 gradi <i>Deflection angle degrees</i></p> <p>Schermo sferico alluminato <i>Faceplate spherical alluminized</i></p> <p>Focalizzazione elettrostatica <i>Focusing method electrostatic</i></p> <p>Deflessione magnetica <i>Deflection method magnetic</i></p>

Intercambiabilità
Replacemen ttype

19AMP4
19BCP4
19CWP4

Fluorescenza
Fluorescence

bianca
white

Persistenza
Persistence

corta ÷ media
medium short

Dimensioni schermo (min.)
Screen dimensions

307 × 389 mm

Lunghezza totale (max.)
Overal lenght

311 mm

Tubo a raggi catodici per TV, 19" bonded.
TV picture tube, 19" bonded shield

TIPO <i>Type</i>	Limiti massimi <i>Maximum ratings</i>	Capacità in pF <i>Capacitances</i>	Caratteristiche e funzionamento tipico <i>Typical operation</i>
<p>19BEP4</p>  <p>$V_f = 6,3 \text{ V}$ $I_f = 0,3 \text{ A}$</p> <p>1 - f 2 - g_1 3 - g_2 4 - g_4 5 - n.c. 6 - g_1 7 - k 8 - f</p> <p>A - a, g_3, s C - m</p>	<p>$V_a = 20.000 \text{ V}$ $V_{g^2} = 550 \text{ V}$ $V_{g^1} = -155 \div 0 \text{ V}$ V_{g^4} (focusing elec.) $= -550 \div 1100 \text{ V}$ $V_{f-k} = 200 \text{ V}$</p>	<p>$C_k = 5$ $C_{g^1} = 6$ $C_{a-m} = 1000 \div 1500$</p>	<p>$V_a = 16.000 \text{ V}$ $V_{g^2} = 300 \text{ V}$ V_{g^1} (Voltage for cutoff) = $-35 \div -72 \text{ V}$ $V_{g^4} = 0 \div 400 \text{ V}$</p> <p>Faccia rettangolare <i>Rectangular glass type</i></p> <p>Angolo di deflessione <i>Deflection angle</i> 110 gradi <i>degrees</i></p> <p>Schermo <i>Faceplate</i> sferico alluminato <i>spherical alluminized</i></p> <p>Focalizzazione <i>Focusing method</i> elettrostatica <i>electrostatic</i></p> <p>Deflessione <i>Deflection method</i> magnetica <i>magnetic</i></p> <p>Fluorescenza <i>Fluorescence</i> bianca <i>white</i></p>

Intercambiabilità
Replacement type

19BY3
19DJP4
AW47-91

Persistenza

corta ÷ media

Persistence

medium short

Dimensioni schermo (min.)

305 × 384 mm

Screen dimensions

Lunghezza totale (max.)

310 mm

Overall length

Tubo a raggi catodici per TV, 19".

TV picture tube, 19"

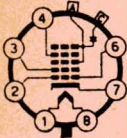
TIPO Type	Limiti massimi Maximum ratings	Capacità in pF Capacitances	Caratteristiche e funzionamento tipico Typical operation
<p>19BM1</p>  <p>V_f = 6,3 V I_f = 0,3 A</p> <p>1 - f 2 - g₁ 3 - g₂ 4 - g₃ 5 - n.c. 6 - g₄ 7 - k 8 - f</p> <p>A - a, g₂₋₅ C - m</p>	<p>V_a = 20.000 V V_{g₃} = 550 V V_{g₁} = -155 ÷ 0 V V_{g₄} (focusing elec.) = -550 ÷ 1100 V V_{f-k} = 200 V</p>	<p>C_k = 5 C_{g₁} = 6 C_{a-m} = 1000 ÷ 1500</p>	<p>V_a = 16.000 V V_{g₂} = 300 V V_{g₁} (Voltage for cutoff) = -35 ÷ -72 V V_{g₄} = 0 ÷ 400 V</p> <p>Faccia rettangolare Rectangular glass type</p> <p>Tipo di protezione « Metalbonded » Type of protection</p> <p>Angolo di deflessione 110 gradi Deflection angle degrees</p> <p>Schermo sferico alluminato Faceplate spherical alluminized</p> <p>Focalizzazione elettrostatica Focusing method electrostatic</p> <p>Deflessione magnetica Deflection method magnetic</p>

Intercambiabilità
Replacement type

RT47B4
A47-17W/S
A47 - 26 W

Fluorescenza
Fluorescence bianca
white

Persistenza
Persistence corta ÷ media
medium short

Dimensioni schermo (min.)
Screen dimensions 305 x 384 mm

Lunghezza totale (max.)
Overall length 310 mm

Tubo a raggi catodici per TV, 19" autoprotetto.

TV picture tube, 19" with integral protection

TIPO <i>Type</i>	Limiti massimi <i>Maximum ratings</i>	Capacità in pF <i>Capacitances</i>	Caratteristiche e funzionamento tipico <i>Typical operation</i>
<p>19BS1</p>  <p>V_f = 6,3 V I_f = 0,3 A</p> <p>1 - f 2 - g₁ 3 - g₂ 4 - g₄ 5 - n.c. 6 - g₁ 7 - k 8 - f</p> <p>A - a, g₃₋₅ C - m</p>	<p>V_a = 20.000 V V_{g₂} = 550 V V_{g₁} = -155 ÷ 0 V V_{g₄} (<i>focusing elec.</i>) = -550 ÷ 1100 V V_{f-k} = 200 V</p>	<p>C_k = 5 C_{g₁} = 6 C_{a-m} = 1000 ÷ 1500</p>	<p>V_a = 16.000 V V_{g₂} = 300 V V_{g₁} (<i>Voltage for cutoff</i>) = -35 ÷ -72 V V_{g₄} = 0 ÷ 400 V</p> <p>Faccia rettangolare <i>Rectangular glass type</i></p> <p>Tipo di protezione « Solidex » <i>Type of protection</i></p> <p>Angolo di deflessione 110 gradi <i>Deflection angle degrees</i></p> <p>Schermo sferico alluminato <i>Faceplate spherical alluminized</i></p> <p>Focalizzazione elettrostatica <i>Focusing method electrostatic</i></p> <p>Deflessione magnetica <i>Deflection method magnetic</i></p>

Intercambiabilità
Replacement type

RT47H6
19BY3CS
A47 - 11 W
A47 - 17 W

Fluorescenza

bianca

Fluorescence

white

Persistenza

corta ÷ media

Persistence

medium short

Dimensioni schermo (min.)

305 × 384 mm

Screen dimensions

Lunghezza totale (max.)

310 mm

Overall length

Tubo a raggi catodici per TV, 19" autoprotetto.

TV picture tube, 19" with integral protection

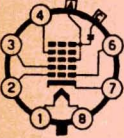
TIPO <i>Type</i>	Limiti massimi <i>Maximum ratings</i>	Capacità in pF <i>Capacitances</i>	Caratteristiche e funzionamento tipico <i>Typical operation</i>
<p>19CTP4S</p>  <p>V_f = 6,3 V I_f = 0,3 A</p> <p>1 - f 2 - g₁ 3 - g₂ 4 - g₄ 5 - n.c. 6 - g₁ 7 - k 8 - f</p> <p>A - a, g₂₋₄ C - m</p>	<p>V_a = 20.000 V V_{g₂} = 550 V V_{g₁} = -155 ÷ 0 V V_{g₄} (<i>focusing elec.</i>) = -550 ÷ 1100 V V_{f-k} = 200 V</p>	<p>C_k = 5 C_{g₁} = 6 C_{a-m} = 1000 ÷ 1500</p>	<p>V_a = 16.000 V V_{g₂} = 300 V V_{g₁} (<i>Voltage for cutoff</i>) = -35 ÷ -72 V V_{g₄} = 0 ÷ 400 V</p> <p>Faccia rettangolare <i>Rectangular glass type</i></p> <p>Angolo di deflessione <i>Deflection angle</i> 110 gradi <i>degrees</i></p> <p>Schermo <i>Faceplate</i> sferico alluminato <i>spherical alluminized</i></p> <p>Focalizzazione <i>Focusing method</i> elettrostatica <i>electrostatic</i></p> <p>Deflessione <i>Deflection method</i> magnetica <i>magnetic</i></p> <p>Fluorescenza <i>Fluorescence</i> bianca <i>white</i></p>

Intercambiabilità
Replacement type

A47 - 14 W

Persistenza

Persistence

corta ÷ media

medium short

Dimensioni schermo (min.)

Screen dimensions

305 × 384 mm

Lunghezza totale (max.)

Overall length

310 mm

Tubo a raggi catodici per TV, 19".

TV picture tube, 19"

TIPO <i>Type</i>	Limiti massimi <i>Maximum ratings</i>	Capacità in pF <i>Capacitances</i>	Caratteristiche e funzionamento tipico <i>Typical operation</i>
<p>20BM1</p>  <p>V_f = 6,3 V I_f = 0,3 A</p> <p>1 - f 2 - g₁ 3 - g₂ 4 - g₄ 5 - n.c. 6 - g₁ 7 - k 8 - f</p> <p>A - a, g₃₋₅ C - m</p>	<p>V_a = 20.000 V V_{g₂} = 550 V V_{g₁} = -155 ÷ 0 V V_{g₄} (<i>focusing elec.</i>) = -550 ÷ 1100 V V_{f-k} = 200 V</p>	<p>C_k = 5 C_{g₁} = 6 C_{a-m} = 1500 ÷ 2000</p>	<p>V_a = 16.000 V V_{g₂} = 300 V V_{g₁} (<i>Voltage for cutoff</i>) = -35 ÷ -72 V V_{g₄} = 0 ÷ 400 V</p> <p>Faccia rettangolare, rapporto 3 × 4 <i>Rectangular glass type, square line</i></p> <p>Tipo di protezione « Metaibonded » <i>Type of protection</i></p> <p>Angolo di deflessione 114 gradi <i>Deflection angle degrees</i></p> <p>Schermo sferico alluminato <i>Faceplate spherical alluminized</i></p> <p>Focalizzazione elettrostatica <i>Focusing method electrostatic</i></p> <p>Deflessione magnetica <i>Deflection method magnetic</i></p>

Fluorescenza	bianca
<i>Fluorescence</i>	<i>white</i>

Persistenza	corta ÷ media
<i>Persistence</i>	<i>medium short</i>

Dimensioni schermo (min.)	308 × 393,7 mm
<i>Screen dimensions</i>	

Lunghezza totale (max.)	320,5 mm
<i>Overall length</i>	

Tubo a raggi catodici per TV, 20" autoprotetto.

TV picture tube, 20" with integral protection

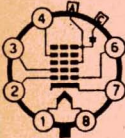
TIPO <i>Type</i>	Limiti massimi <i>Maximum ratings</i>	Capacità in pF <i>Capacitances</i>	Caratteristiche e funzionamento tipico <i>Typical operation</i>
<p>20BM5</p>  <p>V_f = 8,3 V I_f = 0,3 A</p> <p>1 - f 2 - g₂ 3 - g₃ 4 - g₄ 5 - n.c. 6 - g₁ 7 - k 8 - f</p> <p>A - a, g₂, ... C - m</p>	<p>V_a = 20.000 V V_{g2} = 550 V V_{g1} = -155 ÷ 0 V V_{g4} (focusing elec.) = -550 ÷ 1100 V V_{f-k} = 200 V</p>	<p>C_k = 5 C_{g1} = 6 C_{a-m} = 1500 ÷ 2000</p>	<p>V_a = 16.000 V V_{g2} = 300 V V_{g1} (Voltage for cutoff) = -35 ÷ -72 V V_{g4} = 0 ÷ 400 V</p> <p>Faccia rettangolare, rapporto 3 × 4 <i>Rectangular glass type, square line</i></p> <p>Tipo di protezione « Metalbonded » <i>Type of protection</i></p> <p>Angolo di deflessione 110 gradi <i>Deflection angle degrees</i></p> <p>Schermo sferico alluminato <i>Faceplate spherical alluminized</i></p> <p>Focalizzazione elettrostatica <i>Focusing method electrostatic</i></p> <p>Deflessione magnetica <i>Deflection method magnetic</i></p>

Intercambiabilità
Replacement type

A51 - 10 W

Fluorescenza
Fluorescence bianca
white

Persistenza
Persistence corta ÷ media
medium short

Dimensioni schermo (min.) 308 × 393,7 mm
Screen dimensions

Lunghezza totale (max.) 328 mm
Overall length

Tubo a raggi catodici per TV, 20'' autoprotetto.

TV picture tube, 20'' with integral protection

TIPO <i>Type</i>	Limiti massimi <i>Maximum ratings</i>	Capacità in pF <i>Capacitances</i>	Caratteristiche e funzionamento tipico <i>Typical operation</i>
<p>22BM1</p>  <p>V_f = 6,3 V I_f = 0,3 A</p> <p>1 - f 2 - g₁ 3 - g₂ 4 - g₄ 5 - n.c. 6 - g₃ 7 - k 8 - f</p> <p>A - a, g₃₋₄ C - m</p>	<p>V_a = 22.000 V V_{g₂} = 550 V V_{g₁} = -155 ÷ 0 V V_{g₄} (<i>focusing elec.</i>) = -550 ÷ 1100 V V_{f-k} = 200 V</p>	<p>C_k = 5 C_{g₁} = 6 C_{a-m} = 1700 ÷ 2500</p>	<p>V_a = 16.000 V V_{g₂} = 300 V V_{g₁} (<i>Voltage for cutoff</i>) = -35 ÷ -72 V V_{g₄} = 0 ÷ 400 V</p> <p>Faccia rettangolare, rapporto 3 × 4 <i>Rectangular glass type, square line</i></p> <p>Tipo di protezione « Metalbonded » <i>Type of protection</i></p> <p>Angolo di deflessione 114 gradi <i>Deflection angle degrees</i></p> <p>Schermo sferico alluminato <i>Faceplate spherical alluminized</i></p> <p>Focalizzazione elettrostatica <i>Focusing method electrostatic</i></p> <p>Deflessione magnetica <i>Deflection method magnetic</i></p>

Fluorescenza	bianca
<i>Fluorescence</i>	<i>white</i>

Persistenza	corta ÷ media
<i>Persistence</i>	<i>medium short</i>

Dimensioni schermo (min.)	344,5 × 439,7 mm
<i>Screen dimensions</i>	

Lunghezza totale (max.)	340,25 mm
<i>Overall length</i>	

Tubo a raggi catodici per TV, 22" autoprotetto.

TV picture tube, 22" with integral protection

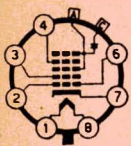
TIPO Type	Limiti massimi Maximum ratings	Capacità in pF Capacitances	Caratteristiche e funzionamento tipico Typical operation
<p>23AXP4</p>  <p>V_f = 6,3 V I_f = 0,3 A</p> <p>1 - f 2 - G₁ 3 - G₂ 4 - G₃ 5 - n.c. 6 - G₄ 7 - k 8 - f</p> <p>A - a, G_{3-s} C - m</p>	<p>V_a = 22.000 V V_{G₃} = 550 V V_{G₁} = -155 ÷ 0 V V_{G₄} (focusing elec.) = -550 ÷ 1100 V V_{f-k} = 200 V</p>	<p>C_k = 5 C_{G₁} = 6 C_{a-m} = 1700 ÷ 2500</p>	<p>V_a = 16.000 V V_{G₂} = 300 V V_{G₁} (Voltage for cutoff) = -35 ÷ -72 V V_{G₄} = 0 ÷ 400 V</p> <p>Faccia rettangolare Rectangular glass type</p> <p>Trasparenza 78% Light transmission</p> <p>Angolo di deflessione 110 gradi Deflection angle degrees</p> <p>Schermo sferico alluminato Faceplate spherical alluminized</p> <p>Focalizzazione elettrostatica Focusing method electrostatic</p> <p>Deflessione magnetica Deflection method magnetic</p>

Intercambiabilità
Replacement type

23BY3
23DFP4
23EYP4
AW59-91

Fluorescenza bianca
Fluorescence white

Persistenza corta ÷ media
Persistence medium short

Dimensioni schermo (min.) 385 × 489 mm
Screen dimensions

Lunghezza totale (max.) 368 mm
Overall length

Tubo a raggi catodici per TV, 23".
TV picture tube, 23"

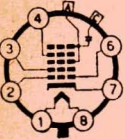
TIPO <i>Type</i>	Limiti massimi <i>Maximum ratings</i>	Capacità in pF <i>Capacitances</i>	Caratteristiche e funzionamento tipico <i>Typical operation</i>
<p>23BM2</p>  <p>V_f = 6,3 V I_f = 0,3 A</p> <p>1 - f 2 - g₁ 3 - g₂ 4 - g₄ 5 - n.c. 6 - g₁ 7 - k 8 - f</p> <p>A - a, g₂₋₄ C - m</p>	<p>V_a = 22.000 V V_{g₃} = 550 V V_{g₁} = -155 ÷ 0 V V_{g₄} (<i>focusing elec.</i>) = -550 ÷ 1100 V V_{f-k} = 200 V</p>	<p>C_k = 5 C_{g₁} = 6 C_{a-m} = 1700 ÷ 2500</p>	<p>V_a = 16.000 V V_{g₂} = 300 V V_{g₁} (<i>Voltage for cutoff</i>) = -35 ÷ -72 V V_{g₄} = 0 ÷ 400 V</p> <p>Faccia rettangolare <i>Rectangular glass type</i></p> <p>Tipo di protezione « Metalbonded » <i>Type of protection</i></p> <p>Angolo di deflessione 110 gradi <i>Deflection angle degrees</i></p> <p>Schermo sferico alluminato <i>Faceplate spherical alluminized</i></p> <p>Focalizzazione elettrostatica <i>Focusing method electrostatic</i></p> <p>Deflessione magnetica <i>Deflection method magnetic</i></p>

Intercambiabilità
Replacement type

RT59B4
23BY3CB
A59 - 12 W/S
A59 - 22 W
A59 - 23 W

Fluorescenza

bianca

Fluorescence

white

Persistenza

corta ÷ media

Persistence

medium short

Dimensioni schermo (min.)

385 × 489 mm

Screen dimensions

Lunghezza totale (max.)

368 mm

Overall length

Tubo a raggi catodici per TV, 23" autoprotetto.

TV picture tube, 23" with integral protection

TIPO Type	Limiti massimi Maximum ratings	Capacità in pF Capacitances	Caratteristiche e funzionamento tipico Typical operation
<p>23BS1</p>  <p>V_f = 6,3 V I_f = 0,3 A</p> <p>1 - f 2 - g₁ 3 - g₂ 4 - g₄ 5 - n.c. 6 - g₁ 7 - k 8 - f</p> <p>A - a, g₂ - s C - m</p>	<p>V_a = 22.000 V V_{g₃} = 550 V V_{g₁} = -155 ÷ 0 V V_{g₄} (focusing elec.) = -550 ÷ 1100 V V_{f-k} = 200 V</p>	<p>C_k = 5 C_{g₁} = 6 C_{a-n1} = 1700 ÷ 2500</p>	<p>V_a = 16.000 V V_{g₂} = 300 V V_{g₁} (Voltage for cutoff) = -35 ÷ -72 V V_{g₄} = 0 ÷ 400 V</p> <p>Faccia rettangolare <i>Rectangular glass type</i></p> <p>Tipo di protezione « Solidex » <i>Type of protection</i></p> <p>Angolo di deflessione 110 gradi <i>Deflection angle degrees</i></p> <p>Schermo sferico alluminato <i>Faceplate spherical alluminized</i></p> <p>Focalizzazione elettrostatica <i>Focusing method electrostatic</i></p> <p>Deflessione magnetica <i>Deflection method magnetic</i></p>

Intercambiabilità
Replacement type

RT59H4
23BY3CS
A59 - 11 W
A59 - 12 W

Fluorescenza
Fluorescence

bianca
white

Persistenza
Persistence

corta ÷ media
medium short

Dimensioni schermo (min.)
Screen dimensions

385 × 489 mm

Lunghezza totale (max.)
Overall length

368 mm

Tubo a raggi catodici per TV, 23'' autoprotetto.
TV picture tube, 23'' with integral protection

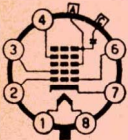
TIPO <i>Type</i>	Limiti massimi <i>Maximum ratings</i>	Capacità in pF <i>Capacitances</i>	Caratteristiche e funzionamento tipico <i>Typical operation</i>
<p>23DFP4S</p>  <p>V_f = 6,3 V I_f = 0,3 A</p> <p>1 - f 2 - g₁ 3 - g₂ 4 - g₄ 5 - n.c. 6 - g₃ 7 - k 8 - f</p> <p>A - a, g₂, s C - m</p>	<p>V_a = 22.000 V V_{g₂} = 550 V V_{g₁} = -155 ÷ 0 V V_{g₄} (<i>focusing elec.</i>) = -550 ÷ 1100 V V_{f-k} = 200 V</p>	<p>C_k = 5 C_{g₁} = 6 C_{a-m} = 1700 ÷ 2500</p>	<p>V_a = 16.000 V V_{g₂} = 300 V V_{g₁} (<i>Voltage for cutoff</i>) = -35 ÷ -72 V V_{g₄} = 0 ÷ 400 V</p> <p>Faccia rettangolare <i>Rectangular glass type</i></p> <p>Trasparenza 45% <i>Light transmission</i></p> <p>Angolo di deflessione 110 gradi <i>Deflection angle degrees</i></p> <p>Schermo sferico alluminato <i>Faceplate spherical alluminized</i></p> <p>Focalizzazione elettrostatica <i>Focusing method electrostatic</i></p> <p>Deflessione magnetica <i>Deflection method magnetic</i></p>

Intercambiabilità
Replacement type

A59 - 15 W

Fluorescenza
Fluorescence bianca
white

Persistenza
Persistence corta ÷ media
medium short

Dimensioni schermo (min.)
Screen dimensions 385 x 489 mm

Lunghezza totale (max.)
Overall length 368 mm

Tubo a raggi catodici per TV, 23".
TV picture tube, 23"

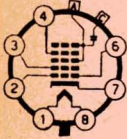
TIPO <i>Type</i>	Limiti massimi <i>Maximum ratings</i>	Capacità in pF <i>Capacitances</i>	Caratteristiche e funzionamento tipico <i>Typical operation</i>
<p>23DHP4</p>  <p>V_f = 6,3 V I_f = 0,3 A</p> <p>1 - f 2 - g₁ 3 - g_s 4 - g₄ 5 - n.c. 6 - g₁ 7 - k 8 - f</p> <p>A - a, g_s, s C - m</p>	<p>V_a = 22.000 V V_{g_s} = 550 V V_{g₁} = -155 ÷ 0 V V_{g₄} (<i>focusing elec.</i>) = -550 ÷ 1100 V V_{f-k} = 200 V</p>	<p>C_k = 5 C_{g₁} = 6 C_{a-m} = 1700 ÷ 2500</p>	<p>V_a = 16.000 V V_{g_s} = 300 V V_{g₁} (<i>Voltage for cutoff</i>) = -35 ÷ -72 V V_{g₄} = 0 ÷ 400 V</p> <p>Faccia rettangolare <i>Rectangular glass type</i></p> <p>Tipo di protezione « Bonded shield » <i>Type of protection</i></p> <p>Angolo di deflessione 110 gradi <i>Deflection angle degrees</i></p> <p>Schermo sferico alluminato <i>Faceplate spherical alluminized</i></p> <p>Focalizzazione elettrostatica <i>Focusing method electrostatic</i></p> <p>Deflessione magnetica <i>Deflection method magnetic</i></p>

Intercambiabilità
Replacement type

23BP4/03
23DGP4
A59 - 13 W
A59 - 16 W

Fluorescenza
Fluorescence bianca
white

Persistenza
Persistence corta ÷ media
medium short

Dimensioni schermo (min.)
Screen dimensions 386 × 490 mm

Lunghezza totale (max.)
Overall length 379 mm

Tubo a raggi catodici per TV, 23" bonded.
TV picture tube, 23" bonded shield

TIPO <i>Type</i>	Limiti massimi <i>Maximum ratings</i>	Capacità in pF <i>Capacitances</i>	Caratteristiche e funzionamento tipico <i>Typical operation</i>
<p>23HBP4</p>  <p>$V_f = 6,3 \text{ V}$ $I_f = 0,3 \text{ A}$</p> <p>1 - f 2 - g_1 3 - g_2 4 - g_3 5 - n.c. 6 - g_4 7 - k 8 - f</p> <p>A - a, g_{3-5} C - m</p>	<p>$V_a = 22.000 \text{ V}$ $V_{g2} = 550 \text{ V}$ $V_{g1} = -155 \div 0 \text{ V}$ V_{g4} (<i>focusing elec.</i>) $= -550 \div 1100 \text{ V}$ $V_{f-k} = 200 \text{ V}$</p>	<p>$C_k = 5$ $C_{g1} = 6$ $C_{a-m} = 1700 \div 2500$</p>	<p>$V_a = 16.000 \text{ V}$ $V_{g2} = 300 \text{ V}$ V_{g1} (<i>Voltage for cutoff</i>) = $-35 \div -72 \text{ V}$ $V_{g4} = 0 \div 400 \text{ V}$</p> <p>Faccia rettangolare <i>Rectangular glass type</i></p> <p>Tipo di protezione « Shelbond » <i>Type of protection</i></p> <p>Angolo di deflessione 110 gradi <i>Deflection angle degrees</i></p> <p>Schermo sferico alluminato <i>Faceplate spherical aluminized</i></p> <p>Focalizzazione elettrostatica <i>Focusing method electrostatic</i></p> <p>Deflessione magnetica <i>Deflection method magnetic</i></p>

Fluorescenza	bianca
<i>Fluorescence</i>	<i>white</i>

Persistenza	corta ÷ media
<i>Persistence</i>	<i>medium short</i>

Dimensioni schermo (min.)	385 x 489 mm
<i>Screen dimensions</i>	

Lunghezza totale (max.)	368 mm
<i>Overall length</i>	

Tubo a raggi catodici per TV, 23" autoprotetto.
TV picture tube, 23" with integral protection

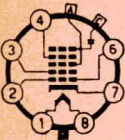
TIPO <i>Type</i>	Limiti massimi <i>Maximum ratings</i>	Capacità in pF <i>Capacitances</i>	Caratteristiche e funzionamento tipico <i>Typical operation</i>
<p>24BM1</p>  <p>V_f = 6,3 V I_f = 0,3 A</p> <p>1 - f 2 - g₁ 3 - g₂ 4 - g₄ 5 - n.c. 6 - g₁ 7 - k 8 - f</p> <p>A - a, g₂, s C - m</p>	<p>V_a = 22.000 V V_{g₂} = 550 V V_{g₁} = -155 ÷ 0 V V_{g₄} (focusing elec.) = -550 ÷ 1100 V V_{f-k} = 200 V</p>	<p>C_k = 5 C_{g₁} = 6 C_{a-m} = 1700 ÷ 2500</p>	<p>V_a = 16.000 V V_{g₂} = 300 V V_{g₁} (Voltage for cutoff) = -35 ÷ -72 V V_{g₄} = 0 ÷ 400 V</p> <p>Faccia rettangolare, rapporto 3 × 4 <i>Rectangular glass type, square line</i></p> <p>Tipo di protezione «Metalbonded» <i>Type of protection</i></p> <p>Angolo di deflessione 110 gradi <i>Deflection angle degrees</i></p> <p>Schermo sferico illuminato <i>Faceplate spherical alluminized</i></p> <p>Focalizzazione elettrostatica <i>Focusing method electrostatic</i></p> <p>Deflessione magnetica <i>Deflection method magnetic</i></p>

Intercambiabilità
Replacement type

A61 - 120 W

Fluorescenza

Fluorescence

bianca

white

Persistenza

Persistence

corta ÷ media

medium short

Dimensioni schermo (min.)

Screen dimensions

375 × 481 mm

Lunghezza totale (max.)

Overall length

370 mm

Tubo a raggi catodici per TV, 24" autoprotetto.

TV picture tube, 24" with integral protection

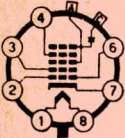
TIPO <i>Type</i>	Limiti massimi <i>Maximum ratings</i>	Capacità in pF <i>Capacitances</i>	Caratteristiche e funzionamento tipico <i>Typical operation</i>
<p>25BP1</p>  <p>V_f = 6,3 V I_f = 0,3 A</p> <p>1 - f 2 - g₁ 3 - g₂ 4 - g₄ 5 - n.c. 6 - g₁ 7 - k 8 - f</p> <p>A - a, g₃₋₅ C - m</p>	<p>V_a = 22.000 V V_{g₂} = 550 V V_{g₁} = -155 ÷ 0 V V_{g₄} (<i>focusing elec.</i>) = -550 ÷ 1100 V V_{f-k} = 200 V</p>	<p>C_k = 5 C_{g₁} = 6 C_{a-m} = 2000 ÷ 2500</p>	<p>V_a = 16.000 V V_{g₂} = 300 V V_{g₁} (<i>Voltage for cutoff</i>) = -35 ÷ -72 V V_{g₄} = 0 ÷ 400 V</p> <p>Faccia rettangolare <i>Rectangular glass type</i></p> <p>Tipo di protezione « Solidex » <i>Type of protection</i></p> <p>Angolo di deflessione 110 gradi <i>Deflection angle degrees</i></p> <p>Schermo sferico alluminato <i>Faceplate spherical alluminized</i></p> <p>Focalizzazione elettrostatica <i>Focusing method electrostatic</i></p> <p>Deflessione magnetica <i>Deflection method magnetic</i></p>

Intercambiabilità
Replacement type

RT65H4
25MP4
25BY3CS
A65 - 11W

Fluorescenza

bianca

Fluorescenze

white

Persistenza

corta ÷ media

Persistence

medium short

Dimensioni schermo (min.)

417 x 531 mm

Screen dimensions

Lunghezza totale (max.)

390,5 mm

Overall length

Tubo a raggi catodici per TV, 25" autoprotetto.

TV picture tube, 25" with integral protection

TIPO
Type

Limiti massimi
Maximum ratings

Capacità in pF
Capacitances

Caratteristiche e funzionamento tipico
Typical operation

25NC1



$V_f = 6,3 \text{ V}$
 $I_f = 0,3 \text{ A}$

- 1 - f
- 2 - g_1
- 3 - g_2
- 4 - g_4
- 5 - n.c.
- 6 - g_3
- 7 - k
- 8 - f

A - a, g_2 , s
C - m

$V_a = 22.000 \text{ V}$
 $V_{g^2} = 550 \text{ V}$
 $V_{g^1} = -155 \div 0 \text{ V}$
 V_{g^4} (focusing elec.)
 $= -550 \div 1100 \text{ V}$
 $V_{f-k} = 200 \text{ V}$

$C_k = 5$
 $C_{g^1} = 6$
 $C_{a-m} = 2000 \div 2500$

$V_a = 16.000 \text{ V}$
 $V_{g^2} = 300 \text{ V}$
 V_{g^1} (Voltage for cutoff) = $-35 \div -72 \text{ V}$
 $V_{g^4} = 0 \div 400 \text{ V}$

Faccia rettangolare
Rectangular glass type

Angolo di deflessione
Deflecting angle 110 gradi
degrees

Schermo
Faceplate sferico alluminato
spherical alluminized

Focalizzazione
Focusing method elettrostatica
electrostatic

Deflessione
Deflection method magnetica
magnetic

Fluorescenza
Fluorescence bianca
white

Persistenza	corta ÷ media
<i>Persistence</i>	<i>medium short</i>

Dimensioni schermo (min.)	417 × 531 mm
<i>Screen dimensions</i>	

Lunghezza totale (max.)	390,5 mm
<i>Overall length</i>	

Tubo a raggi catodici per TV, 25".
TV picture tube, 25"

NOTE

QUARZI

Quartz crystal units

INDICE QUARZI
Quartz crystal units index

Come ordinare un quarzo <i>How to order</i>	pag. 3
Tipi di custodie <i>Holders types</i>	» 4
Quarzi Elemento A (10.000 ÷ 125.000 kHz) <i>Quartz A Element</i> (10.000 ÷ 125.000 kHz)	» 12
Quarzi Elemento A (1.400 ÷ 20.000 kHz) <i>Quartz A Element</i> (1.400 ÷ 20.000 kHz)	» 13
Quarzi Elemento A speciale (500 ÷ 1.400 kHz) <i>Quartz Special A Element</i> (500 ÷ 1.400 kHz)	» 14
Quarzi Elemento RDT (100 ÷ 800 kHz) <i>Quartz RDT Element</i> (100 ÷ 800 kHz)	» 15
Quarzi Elemento C (200 ÷ 600 kHz) <i>Quartz C Element</i> (200 ÷ 600 kHz)	» 16
Quarzi Elemento D (150 ÷ 400 kHz) <i>Quartz D Element</i> (150 ÷ 400 kHz)	» 17
Quarzi Elemento E (50 ÷ 200 kHz) <i>Quartz E Element</i> (50 ÷ 200 kHz)	» 18
Quarzi Elemento H (8 ÷ 120 kHz) <i>Quartz H Element</i> (8 ÷ 120 kHz)	» 19
Quarzi Elemento N (8 ÷ 120 kHz) <i>Quartz N Element</i> (8 ÷ 120 kHz)	» 20
Quarzi Elemento XY (0,85 ÷ 20 kHz) <i>Quartz XY Element</i> (0,85 ÷ 20 kHz)	» 21
Quarzi a Norme MIL-C-3098/D <i>MIL-C-3098/D types</i>	» 22

INDICAZIONI DA FORNIRE ALL'ATTO DELLA RICHIESTA DI OFFERTA O ORDINAZIONE DI QUARZI

- Frequenza nominale e temperatura di riferimento.
- Modo di oscillazione (fondamentale, 3^a o 5^a armonica).
- Tipo di custodia richiesta.
- Campo della temperatura di lavoro.
- Tolleranza totale di frequenza (eventualmente suddivisa tra tolleranza di taratura e deriva di frequenza nel campo di temperatura richiesto).
- Tipo di funzionamento del cristallo (se in risonanza serie o antirisonanza).
- Se funziona in antirisonanza specificare il valore della capacità di carico (capacità totale vista dal quarzo).

Nota. - Se occorresse un quarzo che non figura nelle specifiche di cui alle pagine seguenti, la FIVRE è a disposizione degli utenti per consigliarli e per realizzare quarzi speciali di qualsiasi tipo. Per i tipi elencati nei Quarzi a Norme MIL-C-3098/D basterà che sia indicata la frequenza ed il numero « CR » del tipo desiderato.

HOW TO ORDER

When you ask for quotation or when ordering please state:

- *Nominal frequency and reference temperature.*
- *Mode of vibration (fundamental, third or fifth).*
- *Type of holder.*
- *Temperature range.*
- *Total frequency tolerance or with a specification of the accuracy of adjustment and the frequency drift separately.*
- *Operation (series or parallel resonance).*
- *Load capacity for parallel resonance operation.*

Note. - *For quartz with different specifications than specified, please submit to FIVRE your particular request.*
For MIL-C-3098/D types must be indicated only the « CR » number and the nominal frequency.

CUSTODIE METALLICHE NORMALI

Normal metal holders

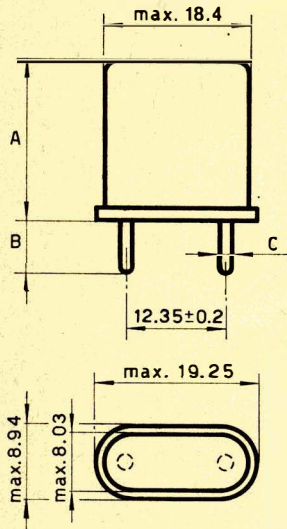

Sigla FIVRE <i>FIVRE</i> type	Sigla MIL <i>MIL</i> type	A max (mm)	B max (mm)	C max (mm)
F-6	HC-6/U	19,7	6,3	1,27
F-13	HC-13/U	38,8	6,3	1,27
F-14	HC-14/U	14,6	6,3	1,27
F-17	HC-17/U	19,7	11,4	2,40
F-131	—	25,4	6,3	1,27
F-132	—	64	6,3	1,27

CUSTODIE METALLICHE NORMALI

Normal metal holders

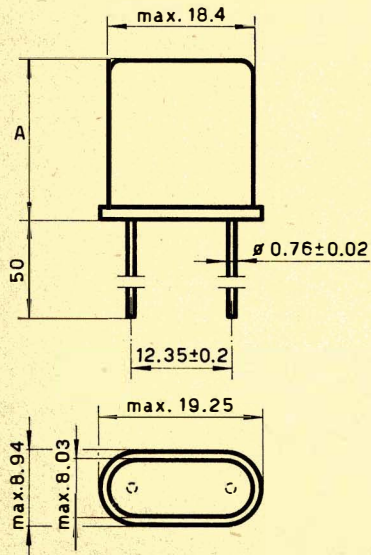

Sigla FIVRE FIVRE type	Sigla MIL MIL type	A max (mm)
F-6 L	—	19,7
F-13 L	—	38,8
F-14 L	—	14,6
F-131 L	—	25,4
F-132 L	—	64

CUSTODIE METALLICHE NORMALI

Normal metal holders

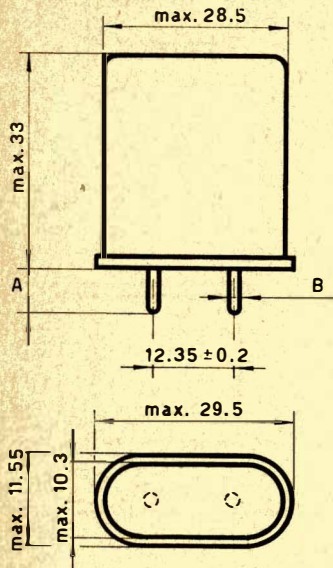

Sigla FIVRE <i>FIVRE</i> type	Sigla MIL <i>MIL</i> type	A max (mm)	B max (mm)
F-1	—	6,3	1,27
F-2	—	11.4	2,40
F-3	—	16.5	3.25

CUSTODIE METALLICHE NORMALI

Normal metal holders

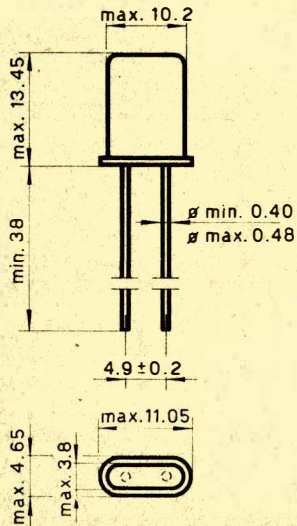

MIL HC-18/U
FIVRE F-18

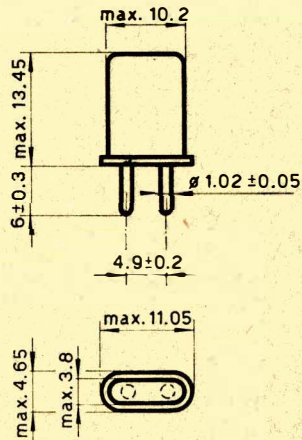

MIL HC-25/U
FIVRE F-25

CUSTODIE METALLICHE KOLDWELD

Koldweld metal holders

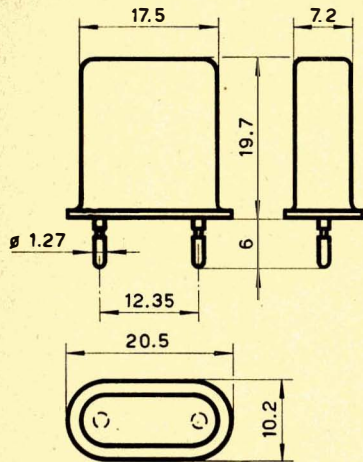

MIL HC-33/U
FIVRE F-33 CW

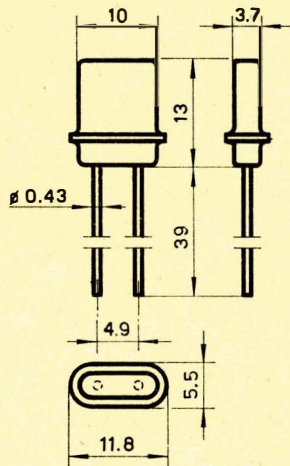

FIVRE F-18 CW

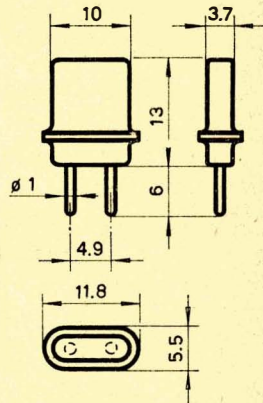

FIVRE F-25 CW

Con le custodie **Koldweld** è possibile ottenere le stesse caratteristiche dei quarzi in custodia « tutto vetro » ed anche migliori in quanto il processo di chiusura viene fatto a bassa temperatura al contrario di quanto avviene con le custodie « tutto vetro ».

Può essere controllato, in tal maniera, durante il processo produttivo, uno degli elementi più importanti che influenzano l'**Aging** e cioè la storia termica a cui il quarzo è stato assoggettato.

Nei normali contenitori metallici saldati a stagno e nei contenitori in vetro, durante la chiusura, si ha un degassamento dei materiali con conseguenti inevitabili contaminazioni che hanno come conseguenza variazioni di frequenza più ampie, valori di resistenza più elevati ed « **Aging** » peggiore. Ciò viene evitato col processo sopradetto.

*With the **Koldweld** sealing, characteristic identical to the all glass version are obtained but with the additional advantage that the sealing is effected at room temperature instead of requiring a glass melting temperature, i. d. 600°C.*

With the Koldweld sealing procedure, there are no thermal stresses on the quartz plate during the sealing operation.

In this way we have a low drift all through the quartz life.

Furthermore, the conventional system of sealing all-glass and tin soldered encapsulation frees some amount of gas which contaminates the quartz plate with the result of a wider frequency drift, higher resistance and less stability during the life.

As the Koldweld operation is made without heating the parts to be connected but only by pressure, no gas is left free and consequently no dangerous contamination takes place. With the Koldweld process aging rates from 3 to 5 ppm/year are obtained.

CUSTODIE IN BULBO DI VETRO
Glass holders

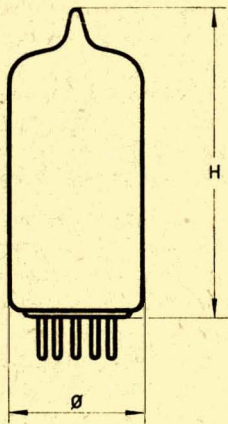

Fig. 1

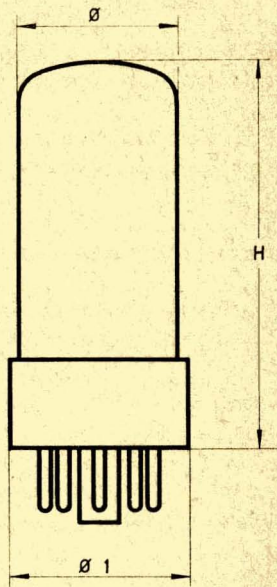

Fig. 2

CUSTODIE IN BULBO DI VETRO

Glass holders

Tipo <i>Type</i>	Figura <i>Figure</i>	H (mm)	Ø max (mm)	Ø ₁ max (mm)
T 5	1	40 ÷ 80	19	— (1)
T 6	1	40 ÷ 80	22,2	— (2)
T 9	2	57 ÷ 85	30,1	32,6
T 11	2	(3)	36,5	36,5
T 12	2	(3)	39,7	43,7
T 13	2	(3)	45	(3)

(1) Fondello a 7 piedini a 4 fili lunghi 30 mm.

Miniature bottom 7 pins or 4 leads of 30 mm

(2) Fondello a 9 piedini o 4 fili lunghi 30 mm

Miniature bottom 9 pins or 4 leads of 30 mm

(3) In funzione delle caratteristiche richieste

Depending on requested characteristics

CARATTERISTICHE QUARZI ELEMENTO A - GAMMA 10.000 ÷ 125.000 kHz

Element A Quartz Crystals - Frequency range 10.000 ÷ 125.000 kHz

Gamma di frequenza (kHz) <i>Frequency range (kHz)</i>	Custodia metallica (HC .../U) <i>Metal holder (HC.../U)</i>	Bulbo vetro (mm) <i>Glass holder (mm)</i>
10.000 ÷ 125.000	6-14-17-33	T 5 ($h_{\max} = 80$; $\varnothing_{\max} = 19$)
15.000 ÷ 125.000	6-14-17-18-25-33	T 5 ($h_{\max} = 80$; $\varnothing_{\max} = 19$)

Nota: le custodie HC-18/U e HC-25/U sono disponibili anche in edizione Koldweld.

Note: holders HC-18/U and HC-25/U also available in Koldweld types.

Campo temperatura (°C) <i>Temperature range (°C)</i>	Tolleranza totale di frequenza (Hz/MHz) <i>Total frequency tolerance (Hz/MHz)</i>	Potenza di eccitazione <i>Drive level</i>
0 ÷ + 50	± 20	2 mW
-20 ÷ + 70	± 30 (± 20 speciale - <i>special</i>)	
-55 ÷ + 105	± 40 (± 20 speciale - <i>special</i>)	
temp. fissa (<i>fixed temp.</i>) ± 5	± 15	

Funzionamento: risonanza serie o parallelo (con 32 pF o valori diversi a richiesta)

Operation: series or parallel resonance (with 32 pF or different values on request)

Massima resistenza effettiva (con 32 pF in serie):

Maximum effective resistance (with 32 pF in series)

da (from) 10.000 a (to) 60.000 kHz: 35 ohm (3^a armonica - 3^a overtone)

da (from) 60.000 a (to) 90.000 kHz: 50 ohm (5^a armonica - 5^a overtone)

da (from) 90.000 a (to) 125.000 kHz: 60 ohm (5^a armonica - 5^a overtone)

CARATTERISTICHE QUARZI ELEMENTO A - GAMMA 1.400 ÷ 20.000 kHz

Element A Quartz Crystals - Frequency range 1.400 ÷ 20.000 kHz

Gamma di frequenza (kHz) Custodia metallica (HC.../U)

Frequency range (kHz)

Metal holder (HC.../U)

1.400 ÷ 3.000

6-14-17-33

3.000 ÷ 5.000

6-14-17-33

5.000 ÷ 20.000

6-14-17-18-25-33

Nota: le custodie HC-18/U e HC-25/U sono disponibili anche in edizione

Note: holders HC-18/U and HC-25/U also available in Koldweld types.

Bulbo vetro (mm)

Glass holder (mm)

T 6 ($h_{\max} = 80$; $\varnothing_{\max} = 22,2$)

T 5 ($h_{\max} = 80$; $\varnothing_{\max} = 19$)

T 5 ($h_{\max} = 80$; $\varnothing_{\max} = 19$)

Koldweld.

Campo temperatura (°C)

Temperature range (°C)

0 ÷ + 50

- 20 ÷ + 70

- 55 ÷ + 105

temp. fissa (*fixed temp.*) ± 5

Tolleranza totale di frequenza (Hz/MHz)

Total frequency tolerance (Hz/MHz)

± 20

± 40

± 40

± 15

Potenza di eccitazione

Drive level

In termostato

Oven controlled

da 1.400 a 10.000 kHz: 5 mW

da 10.000 a 20.000 kHz: 2,5 mW

Senza termostato:

Non oven controlled:

da 1.400 a 10.000 kHz: 10 mW

da 10.000 a 20.000 kHz: 5 mW

Funzionamento: risonanza serie o parallelo (con 32 pF o valori diversi a richiesta)

Operation: series or parallel resonance (with 32 pF or different values on request)

Massima resistenza effettiva (con 32 pF in serie): a (to) 3.000 kHz: 150 ohm

Maximum effective resistance (with 32 pF in series): a (to) 10.000 kHz: 24 ohm

a (to) 20.000 kHz: 20 ohm

CARATTERISTICHE QUARZI ELEMENTO A SPECIALE - GAMMA 500 ÷ 1.400 kHz

Special Element A Quartz Crystals - Frequency range 500 ÷ 1.400 kHz

Gamma di frequenza (kHz) <i>Frequency range (kHz)</i>	Custodia metallica (HC.../U) <i>Metal holder (HC.../U)</i>	Bulbo vetro (mm) <i>Glass holder (mm)</i>
500 ÷ 1.400	6-14-17-33	T 6 ($h_{max} = 80$; $\varnothing_{max} = 22,2$)
Campo temperatura (°C) <i>Temperature range (°C)</i>	Tolleranza totale di frequenza (Hz-MHz) <i>Total frequency tolerance (Hz/MHz)</i>	Potenza di eccitazione <i>Drive level</i>
0 ÷ + 50	± 25	In termostato: 5 mW
- 20 ÷ + 70	± 30	<i>Oven controlled:</i>
- 55 ÷ + 90	± 50	Senza termostato: 10 mW
- 55 ÷ + 105	± 50	<i>Non-oven controlled:</i>
temp. fissa (<i>fixed temp.</i>) ± 5	± 15	

Funzionamento: risonanza serie o parallelo (con 32 pF o valori diversi a richiesta)

Operation: series or parallel resonance (with 32 pF or different values on request)

Massima resistenza effettiva (con 32 pF in serie): a (to) 500 kHz: 2.600 ohm

Maximum effective resistance (with 32 pF in series): a (to) 1.000 kHz: 410 ohm

a (to) 1.500 kHz: 290 ohm

CARATTERISTICHE QUARZI ELEMENTO RDT - GAMMA 100 ÷ 800 kHz

Element RDT Quartz Crystals - Frequency range 100 ÷ 800 kHz

Gamma di frequenza (kHz) <i>Frequency range (kHz)</i>	Custodia metallica (HC.../U) <i>Metal holder (HC.../U)</i>	Bulbo vetro (mm) <i>Glass holder (mm)</i>
100 ÷ 150	—	T 9 (h _{max} = 85; Ø _{max} = 30)
150 ÷ 200	—	T 6 (h _{max} = 80; Ø _{max} = 22,2)
200 ÷ 300	—	T 6 (h _{max} = 80; Ø _{max} = 22,2)
300 ÷ 500	6-17-33	T 6 (h _{max} = 80; Ø _{max} = 22,2)
500 ÷ 800	6-14-17-33	T 6 (h _{max} = 80; Ø _{max} = 22,2)

Campo temperatura (°C) <i>Temperature range (°C)</i>	Tolleranza totale di frequenza (Hz/MHz) <i>Total frequency tolerance (Hz/MHz)</i>	Potenza di eccitazione <i>Drive level</i>
0 ÷ + 50	± 30	1 ÷ 2 mW
- 20 ÷ + 70	± 50	
- 55 ÷ + 90	± 90	
- 55 ÷ + 105	± 100	
temp. fissa (<i>fixed temp.</i>) ± 5	± 20	

Funzionamento: risonanza serie o parallelo (con qualsiasi capacità di carico)

Operation: series or parallel resonance (with different values on request)

Massima resistenza effettiva:	a (fo) 200 kHz: 600 ohm
<i>Maximum effective resistance:</i>	a (fo) 500 kHz: 1.200 ohm
	a (fo) 800 kHz: 3.000 ohm

CARATTERISTICHE QUARZI ELEMENTO C - GAMMA 200 ÷ 600 kHz

Element C Quartz Crystals - Frequency range 200 ÷ 600 kHz

Gamma di frequenza (kHz) <i>Frequency range (kHz)</i>	Custodia metallica (HC.../U) <i>Metal holder (HC.../U)</i>	Bulbo vetro (mm) <i>Glass holder (mm)</i>
200 ÷ 600	6-14-17-33	T 5 ($h_{\max} = 80$; $\varnothing_{\max} = 19$)

Campo temperatura (°C) <i>Temperature range (°C)</i>	Tolleranza totale di frequenza (Hz/MHz) <i>Total frequency tolerance (Hz/MHz)</i>	Potenza di eccitazione <i>Drive level</i>
0 ÷ + 50	± 80	1 ÷ 2 mW
- 20 ÷ + 70	± 150	
- 55 ÷ + 90	± 180	
- 55 ÷ + 105	± 200	
temp. fissa (<i>fixed temp.</i>) ± 5	± 20	

Funzionamento: risonanza serie o parallelo (con 20 e 32 pF)

Operation: series or parallel resonance (with 20 or 32 pF)

Massima resistenza effettiva (con 32 pF in serie):	a (to) 225 kHz: 2.500 ohm
<i>Maximum effective resistance (with 32 pF in series):</i>	a (to) 325 kHz: 3.000 ohm
	a (to) 550 kHz: 5.000 ohm

CARATTERISTICHE QUARZI ELEMENTO D - GAMMA 150 ÷ 400 kHz

Element D Quartz Crystals - Frequency range 150 ÷ 400 kHz

Gamma di frequenza (kHz) <i>Frequency range (kHz)</i>	Custodia metallica (HC.../U) <i>Metal holder (HC.../U)</i>	Bulbo vetro (mm) <i>Glass holder (mm)</i>
150 ÷ 400	6-14-17-33	T 5 ($h_{\max} = 80$; $\varnothing_{\max} = 19$)
Campo temperatura (°C) <i>Temperature range (°C)</i>	Tolleranza totale di frequenza (Hz/MHz) <i>Total frequency tolerance (Hz/MHz)</i>	Potenza di eccitazione <i>Drive level</i>
0 ÷ + 50	± 30	1 ÷ 2 mW
- 20 ÷ + 70	± 80	
- 55 ÷ + 90	± 120	
- 55 ÷ + 105	± 150	
temp. fissa (<i>fixed temp.</i>) ± 5	± 20	

Funzionamento: risonanza serie o parallelo (con 20 o 32 pF)

Operation: series or parallel resonance (with 20 or 32 pF)

Massima resistenza effettiva (con 32 pF in serie): a (to) 175 kHz: 1.000 ohm

Maximum effective resistance (with 32 pF in series): a (to) 275 kHz: 2.000 ohm

a (to) 375 kHz: 4.000 ohm

CARATTERISTICHE QUARZI ELEMENTO E - GAMMA 50 ÷ 200 kHz

Element E Quartz Crystals - Frequency range 50 ÷ 200 kHz

Gamma di frequenza (kHz) <i>Frequency range (kHz)</i>	Custodia metallica (HC.../U) <i>Metal holder (HC.../U)</i>	Bulbo vetro (mm) <i>Glass holder (mm)</i>
50 ÷ 80	13 L (1)	T 5 ($h_{\max} = 80$; $\varnothing_{\max} = 19$)
80 ÷ 200	13	T 5 ($h_{\max} = 80$; $\varnothing_{\max} = 19$)

(1) custodia HC-13/U ma lunga 64 mm.
holder HC-13/U with a length of 64 mm.

Campo temperatura (°C) <i>Temperature range (°C)</i>	Tolleranza totale di frequenza (Hz/MHz) <i>Total frequency tolerance (Hz/MHz)</i>	Potenza di eccitazione <i>Drive level</i>
0 ÷ + 50	± 100	1 ÷ 2 mW
- 20 ÷ + 70	± 180	
- 55 ÷ + 90	± 250	
- 55 ÷ + 105	± 300	
temp. fissa (<i>fixed temp.</i>) ± 5	± 20	

Funzionamento: risonanza serie o parallelo (con 20 o 32 pF)

Operation: series or parallel resonance (with 20 or 32 pF)

Massima resistenza effettiva (con 32 pF in serie): a (to) 70 kHz: 3.000 ohm
Maximum effective resistance (with 32 pF in series): a (to) 130 kHz: 4.000 ohm
a (to) 200 kHz: 5.000 ohm

CARATTERISTICHE QUARZI ELEMENTO H - GAMMA 8 ÷ 120 kHz

Element H Quartz Crystals - Frequency range 8 ÷ 120 kHz

Gamma di frequenza (kHz) <i>Frequency range (kHz)</i>	Custodia metallica (HC.../U) <i>Metal holder (HC.../U)</i>	Bulbo vetro (mm) <i>Glass holder (mm)</i>
8 ÷ 16	13 L (1)	T 5 ($h_{\max} = 80$; $\varnothing_{\max} = 19$)
16.1 ÷ 75	13	T 5 ($h_{\max} = 80$; $\varnothing_{\max} = 19$)
75,1 ÷ 120	6-17	T 5 ($h_{\max} = 80$; $\varnothing_{\max} = 19$)

(1) custodia HC-13/U ma lunga 64 mm.
holder HC-13/U with a length of 64 mm.

Campo temperatura (°C) <i>Temperature range (°C)</i>	Tolleranza totale di frequenza (Hz/MHz) <i>Total frequency tolerance (Hz-MHz)</i>	Potenza di eccitazione <i>Drive level</i>
0 ÷ + 50	± 200	0,100 mW
- 20 ÷ + 70	± 350	
- 55 ÷ + 90	± 500	
temp. fissa (<i>fixed temp.</i>) ± 5	± 20	

Funzionamento: risonanza serie o parallelo (con 20 o 32 pF)

Operation: series or parallel resonance (with 20 or 32 pF)

Massima resistenza serie (tra 8 e 120 kHz): 25.000 ohm
Maximum series resistance (between 8 and 120 kHz):

Massima resistenza parallelo con 32 pF (tra 8 e 120 kHz): 35.000 ohm
Maximum parallel resistance with 32 pF (between 8 and 120 kHz):

CARATTERISTICHE QUARZI ELEMENTO N - GAMMA 8 ÷ 120 kHz

Element N Quartz Crystals - Frequency range 8 ÷ 120 kHz

Gamma di frequenza (kHz) <i>Frequency range (kHz)</i>	Custodia metallica (HC.../U) <i>Metal holder (HC.../U)</i>	Bulbo vetro (mm) <i>Glass holder (mm)</i>
8 ÷ 16	—	T 5 ($h_{\max} = 80$; $\varnothing_{\max} = 19$)
16,1 ÷ 75	13	T 5 ($h_{\max} = 80$; $\varnothing_{\max} = 19$)
75,1 ÷ 120	6-17	T 5 ($h_{\max} = 80$; $\varnothing_{\max} = 19$)

Campo temperatura (°C) <i>Temperature range (°C)</i>	Tolleranza totale di frequenza (Hz/MHz) <i>Total frequency tolerance (Hz/MHz)</i>	Potenza di eccitazione <i>Drive level</i>
0 ÷ + 50	± 50	0,100 mW
— 20 ÷ + 70	± 100	
— 55 ÷ + 90	± 150	
— 55 ÷ + 105	± 200	
temp. fissa (<i>fixed temp.</i>) ± 5	± 20	

Funzionamento: risonanza serie o parallelo (con 20 o 32 pF)

Operation: series or parallel resonance (with 20 or 32 pF)

Massima resistenza serie (tra 8 e 120 kHz): 70.000 ohm
Maximum series resistance (between 8 and 120 kHz):

Massima resistenza parallelo con 32 pF: 90.000 ohm
Maximum parallel resistance with 32 pF:

CARATTERISTICHE QUARZI ELEMENTO XY - GAMMA 0,25 ÷ 20 kHz

Element XY Quartz Crystals - Frequency range 0,25 ÷ 20 kHz

Gamma di frequenza (kHz) <i>Frequency range (kHz)</i>	Custodia metallica (HC.../U) <i>Metal holder (HC.../U)</i>	Bulbo vetro (mm) <i>Glass holder (mm)</i>
0,85 ÷ 3	—	T 5 ($h_{\max} = 80$; $\varnothing_{\max} = 19$)
3,1 ÷ 5	—	T 5 ($h_{\max} = 80$; $\varnothing_{\max} = 19$)
5,1 ÷ 9	13	T 5 ($h_{\max} = 80$; $\varnothing_{\max} = 19$)
9,1 ÷ 20	13	T 5 ($h_{\max} = 80$; $\varnothing_{\max} = 19$)

Campo temperatura (°C) <i>Temperature range (°C)</i>	Tolleranza totale di frequenza (Hz/MHz) <i>Total frequency tolerance (Hz/MHz)</i>	Potenza di eccitazione <i>Drive level</i>
— 40 ÷ + 70	± 150	10 μ W
— 55 ÷ + 90	± 200	
temp. fissa (<i>fixed temp.</i>) ± 5	± 20	

Funzionamento: risonanza serie o parallelo (con 20 o 32 pF)

Operation: series or parallel resonance (with 20 or 32 pF)

Massima resistenza effettiva (con 32 pF in serie) : 0,85 ÷ 2 kHz; 130.000 ohm
Maximum effective resistance (with 32 pF in series) : 2,1 ÷ 20 kHz: 70.000 ohm

QUARZI A NORME MIL-C-3098/D

Tipo	Custodia	Gamma di Frequenza (MHz)	Modo di Oscillazione	Tolleranza Frequenza (% ±)	Campo di Temperatura (°C)	Capacità di Carico (pF)
Type	Holder	Frequency Range (MHz)	Mode of Operation	Frequency Tolerance (% ±)	Temperature Range (°C)	Load Capacity (pF)
CR 18 A/U	HC-6/U	0,8 ÷ 20	Fondamentale	0,005	- 55 ÷ + 105	32 ± 0,5
CR 19 A/U	HC-6/U	0,8 ÷ 20	Fondamentale	0,005	- 55 ÷ + 105	
CR 24/U	HC-10/U	15 ÷ 25	3ª armonica	0,005	- 55 ÷ + 105	
CR 24/U	HC-10/U	25 ÷ 50	5ª armonica	0,005	- 55 ÷ + 105	
CR 25 A/U	HC-6/U	0,2 ÷ 0,5	Fondamentale	0,01	- 40 ÷ + 85	
CR 26 A/U	HC-6/U	0,2 ÷ 0,5	Fondamentale	0,002	+ 70 ÷ + 80	
CR 27 A/U	HC-6/U	0,8 ÷ 20	Fondamentale	0,002	+ 70 ÷ + 80	32 ± 0,5
CR 28 A/U	HC-6/U	0,8 ÷ 20	Fondamentale	0,002	+ 70 ÷ + 80	
CR 29 A/U	HC-21/U	0,08 ÷ 0,2	Fondamentale	0,002	+ 70 ÷ + 80	32 ± 0,5
CR 30 A/U	HC-21/U	0,08 ÷ 0,2	Fondamentale	0,002	+ 70 ÷ + 80	
CR 32 A/U	HC-6/U	10 ÷ 52	3ª armonica	0,002	+ 70 ÷ + 80	
CR 32 A/U	HC-6/U	52 ÷ 75	5ª armonica	0,002	+ 70 ÷ + 80	
CR 33 A/U	HC-6/U	10 ÷ 25	3ª armonica	0,005	- 55 ÷ + 105	32 ± 0,5
CR 35 A/U	HC-6/U	0,8 ÷ 20	Fondamentale	0,002	+ 80 ÷ + 90	
CR 38 A/U	HC-6/U	0,8 ÷ 20	Fondamentale	0,002	+ 80 ÷ + 90	32 ± 0,5

Tipo	Custodia	Gamma di Frequenza (MHz)	Modo di Oscillazione	Tolleranza Frequenza (% ±)	Campo di Temperatura (°C)	Capacità di Carico (pF)
Type	Holder	Frequency Range (MHz)	Mode of Operation	Frequency Tolerance (% ±)	Temperature Range (°C)	Load Capacity (pF)
CR 37 A/U	HC-13/U	0,09 ÷ 0,25	Fondamentale	0,02	-40 ÷ +70	20 ± 0,5
CR 38 A/U	HC-13/U	0,016 ÷ 0,1	Fondamentale	0,012	-40 ÷ +70	20 ± 0,5
CR 40/U	HC-15/U	0,16 ÷ 0,33	Fondamentale	0,003	+65 ÷ +75	
CR 42 A/U	HC-13/U	0,09 ÷ 0,25	Fondamentale	0,003	+70 ÷ +80	32 ± 0,5
CR 45/U	HC-6/U	0,455	Fondamentale	0,02	-40 ÷ +70	
CR 46 A/U	HC-6/U	0,2 ÷ 0,5	Fondamentale	0,01	-40 ÷ +85	20 ± 0,5
CR 47 A/U	HC-6/U	0,19 ÷ 0,5	Fondamentale	0,002	+70 ÷ +80	20 ± 0,5
CR 50 A/U	HC-13/U	0,016 ÷ 0,1	Fondamentale	0,012	-40 ÷ +70	
CR 51 A/U	HC-6/U	10 ÷ 61	3ª armonica	0,005	-55 ÷ +105	
CR 52 A/U	HC-6/U	10 ÷ 61	3ª armonica	0,005	-55 ÷ +105	
CR 53 A/U	HC-6/U	50 ÷ 87	5ª armonica	0,005	-55 ÷ +105	
CR 54 A/U	HC-6/U	50 ÷ 125	5ª armonica	0,005	-55 ÷ +105	
CR 55/U	HC-18/U	17 ÷ 61	3ª armonica	0,005	-55 ÷ +105	
CR 56 A/U	HC-18/U	50 ÷ 125	5ª armonica	0,005	-55 ÷ +105	
CR 57/U	HC-6/U	0,5	Fondamentale	0,001	+80 ÷ +90	32 ± 0,5
CR 58 A/U	HC-17/U	0,8 ÷ 20	Fondamentale	0,005	-55 ÷ +105	32 ± 0,5
CR 59 A/U	HC-18/U	50 ÷ 125	5ª armonica	0,002	+80 ÷ +90	

Tipo	Custodia	Gamma di Frequenza (MHz)	Modo di Oscillazione	Tolleranza Frequenza (% ±)	Campo di Temperatura (°C)	Capacità di Carico (pF)
Type	Holder	Frequency Range (MHz)	Mode of Operation	Frequency Tolerance (% ±)	Temperature Range (°C)	Load Capacity (pF)
CR 60 A/U	HC-18/U	5 ÷ 20	Fondamentale	0,005	- 55 ÷ + 105	
CR 61/U	HC-18/U	17 ÷ 61	3 ^a armonica	0,002	+ 80 ÷ + 90	
CR 62/U	HC-6/U	0,8 ÷ 20	Fondamentale	0,001	+ 70 ÷ + 80	32 ± 0,2
CR 63 A/U	HC-6/U	0,2 ÷ 0,5	Fondamentale	0,01	- 40 ÷ + 70	20 ± 0,5
CR 64/U	HC-18/U	2,9 ÷ 20	Fondamentale	0,005	- 55 ÷ + 105	30 ± 0,5
CR 65/U	HC-6/U	10 ÷ 61	3 ^a armonica	0,001	+ 70 ÷ + 80	
CR 66/U	HC-6/U	3 ÷ 20	Fondamentale	0,002	- 55 ÷ + 105	30 ± 0,5
CR 67/U	HC-18/U	17 ÷ 61	3 ^a armonica	0,0025	- 55 ÷ + 105	
CR 68/U	HC-6/U	3 ÷ 20	Fondamentale	0,002	+ 70 ÷ + 80	32 ± 0,5
CR 69/U	HC-18/U	2,9 ÷ 20	Fondamentale	0,002	- 55 ÷ + 105	
CR 71/U	HC-30/U	4,5 ÷ 5,5	5 ^a armonica	0,00008	+ 65 ÷ + 77	32 ± 0,5
CR 72/U	HC-18/U	17 ÷ 61	3 ^a armonica	0,005	- 55 ÷ + 105	
CR 73/U	HC-29/U	17 ÷ 61	3 ^a armonica	0,003	- 55 ÷ + 105	
CR 74/U	HC-26/U	45 ÷ 125	5 ^a armonica	0,001	+ 80 ÷ + 90	
CR 75/U	HC-6/U	50 ÷ 125	5 ^a armonica	0,001	+ 70 ÷ + 80	
CR 76/U	HC-18/U	17 ÷ 61	3 ^a armonica	0,0025	- 55 ÷ + 105	
CR 77/U	HC-25/U	17 ÷ 61	3 ^a armonica	0,002	- 55 ÷ + 105	

Tipo	Custodia	Gamma di Frequenza (MHz)	Modo di Oscillazione	Tolleranza Frequenza (% \pm)	Campo di Temperatura ($^{\circ}$ C)	Capacità di Carico (pF)
Type	Holder	Frequency Range (MHz)	Mode of Operation	Frequency Tolerance (% \pm)	Temperature Range ($^{\circ}$ C)	Load Capacity (pF)
CR 80/U	HC-18/U	50 \div 125	5 ^a armonica	0,002	- 40 \div + 90	
CR 80/U	HC-18/U	50 \div 125	5 ^a armonica	0,003	- 55 \div - 40/+ 90 \div + 105	
CR 81/U	HC-25/U	17 \div 61	3 ^a armonica	0,005	- 55 \div + 105	
CR 83/U	HC-25/U	50 \div 125	5 ^a armonica	0,002	- 40 \div + 90	
CR 83/U	HC-25/U	50 \div 125	5 ^a armonica	0,003	- 55 \div - 40/+ 90 \div + 105	
CR 84/U	HC-25/U	17 \div 61	3 ^a armonica	0,002	+ 85 \pm 1	
CR 84/U	HC-25/U	17 \div 61	3 ^a armonica	0,007	temp. amb.	
CR 84/U	HC-25/U	17 \div 61	3 ^a armonica	0,0005	+ 80 \div + 90	
CR 85/U	HC-6/U	0,8 \div 20	Fondamentale	0,002	- 40 \div + 90	
CR 85/U	HC-6/U	0,8 \div 20	Fondamentale	0,003	- 55 \div - 40/+ 90 \div + 105	
CR 86/U	HC-27/U	5 \div 15	Fondamentale	0,005	- 55 \div + 180	
CR 86/U	HC-27/U	5 \div 15	Fondamentale	0,02	+ 180 \div + 200	
CR 87/U	HC-27/U	15 \div 45	3 ^a armonica	0,005	- 55 \div + 180	
CR 87/U	HC-27/U	15 \div 45	3 ^a armonica	0,02	+ 180 \div + 200	
CR 88/U	HC-13/U	0,004 \div 0,016	Fondamentale	0,005	0 \div + 65	
CR 88/U	HC-13/U	0,004 \div 0,016	Fondamentale	0,01	- 40 \div + 70	
CR 89/U	HC-32/U	2,12 \div 6,2	Fondamentale	0,005	- 55 \div + 90	30 \pm 0,5

NOTE

- 1) Custodie tipo Koldweld sono disponibili anche con forma cilindrica - dati a richiesta.

HOLDERS IN KOLDWELD VERSION ARE ALSO AVAILABLE IN CYLINDRICAL SHAPE - INFORMATION ON REQUEST.

