

PENTODE

FOR TV VIDEO AMPLIFIER APPLICATIONS

DESCRIPTION AND RATING

The 12BY7-A is a miniature power pentode designed primarily for use as the video output amplifier in television receivers. Features of the tube include extremely high transconductance, low interelectrode capacitances, and high power sensitivity.

Electrically and mechanically, the 12BY7-A is a replacement for the 12BY7. In addition, however, the 12BY7-A exhibits a controlled heater warm-up characteristic which makes the tube particularly suited for use in television receivers which employ series-connected heaters. When the 12BY7-A is used in conjunction with other 600-milliampere types which exhibit essentially the same heater warm-up characteristic, heater voltage surges across the individual tubes are minimized during the warm-up period.

GENERAL

ELECTRICAL

Cathode—Coated Unipotential

	Series	Parallel
Heater Voltage, AC or DC	12.6	6.3 Volts
Heater Current	0.3	0.6 Amperes
Heater Warm-up Time*	..	11 Seconds

Direct Interelectrode Capacitances†

Grid-Number 1 to Plate, maximum	0.063 $\mu\mu\text{f}$
Input	10.2 $\mu\mu\text{f}$
Output	3.5 $\mu\mu\text{f}$

MECHANICAL

Mounting Position—Any

Envelope—T-6½, Glass

Base—E9-1, Small Button 9-Pin

MAXIMUM RATINGS

DESIGN-CENTER VALUES

Plate Voltage	300 Volts
Screen Voltage	180 Volts
Positive DC Grid-Number 1 Voltage	0 Volts
Negative DC Grid-Number 1 Voltage	50 Volts
Plate Dissipation	6.5 Watts
Screen Dissipation	1.1 Watts
Heater-Cathode Voltage	
Heater Positive with Respect to Cathode	200 Volts
Heater Negative with Respect to Cathode	200 Volts
Grid-Number 1 Circuit Resistance	
With Fixed Bias	0.25 Megohms
With Cathode Bias	1.0 Megohms

BASING DIAGRAM

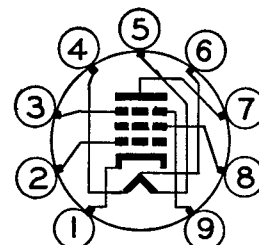

RETMA 9BF

TERMINAL CONNECTIONS

- Pin 1—Cathode
- Pin 2—Grid Number 1
- Pin 3—Internal Shield and Grid Number 3 (Suppressor)
- Pin 4—Heater
- Pin 5—Heater
- Pin 6—Heater Center-Tap
- Pin 7—Plate
- Pin 8—Grid Number 2 (Screen)
- Pin 9—Internal Shield and Grid Number 3 (Suppressor)

PHYSICAL DIMENSIONS

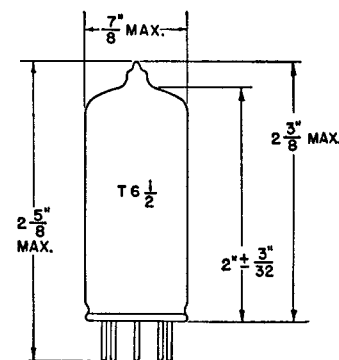

RETMA 6-3

CHARACTERISTICS AND TYPICAL OPERATION

CLASS A₁ AMPLIFIER

Plate Voltage	250	Volts
Suppressor, Connected to Cathode at Socket		
Screen Voltage	180	Volts
Cathode-Bias Resistor	100	Ohms
Plate Resistance, approximate	0.093	Megohms
Transconductance	11000	Micromhos
Plate Current	26	Milliamperes
Screen Current	5.75	Milliamperes
Grid-Number 1 Voltage, approximate		
IG = 20 Microamperes	-11.6	Volts
Triode Amplification Factor	28.5	

* Heater warm-up time is defined as the time required in the circuit shown at the right for the voltage across the heater terminals (V) to increase from zero to the heater test voltage (V₁). For this type, E=25 volts (RMS or DC), V₁=5.0 volts (RMS or DC), and R=31.5 ohms.

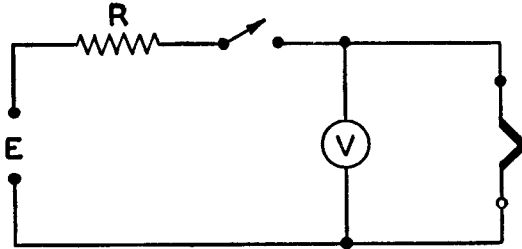

Heater of Tube under Test

† Without external shield.

AVERAGE PLATE CHARACTERISTICS

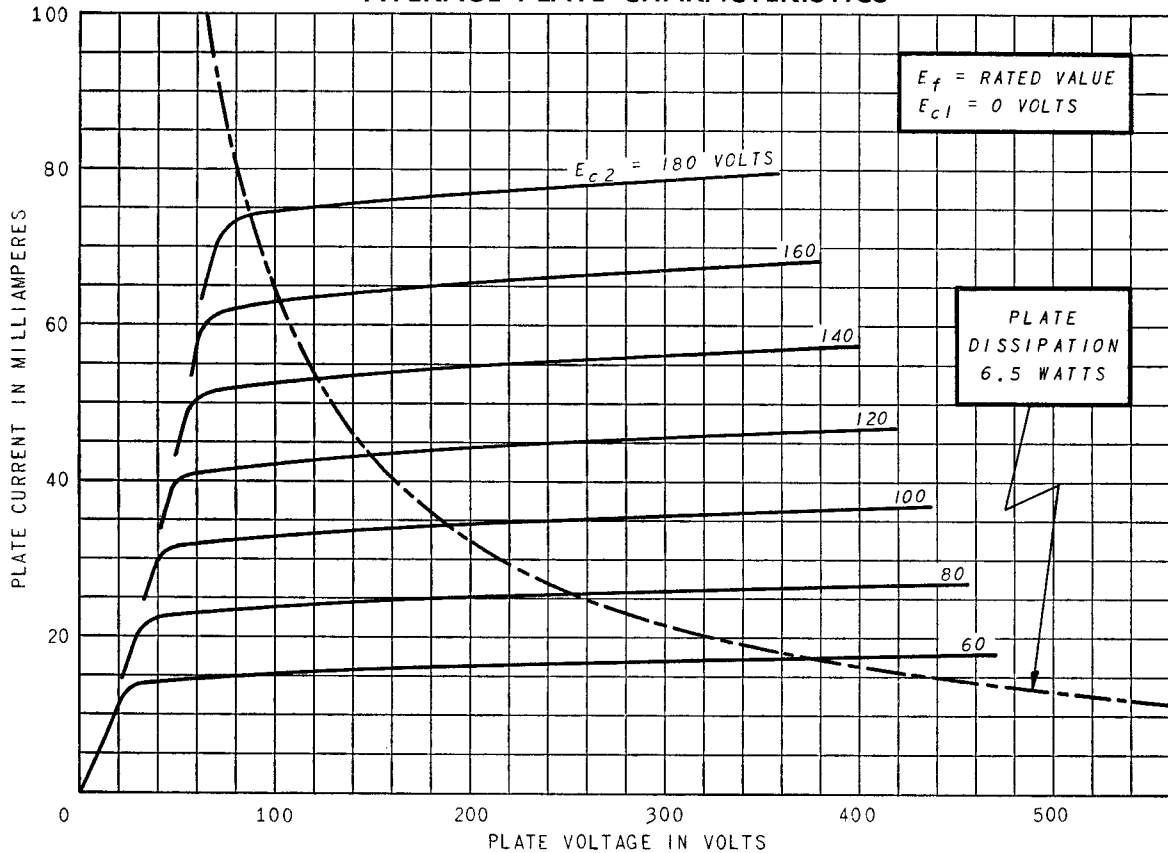

AVERAGE PLATE CHARACTERISTICS

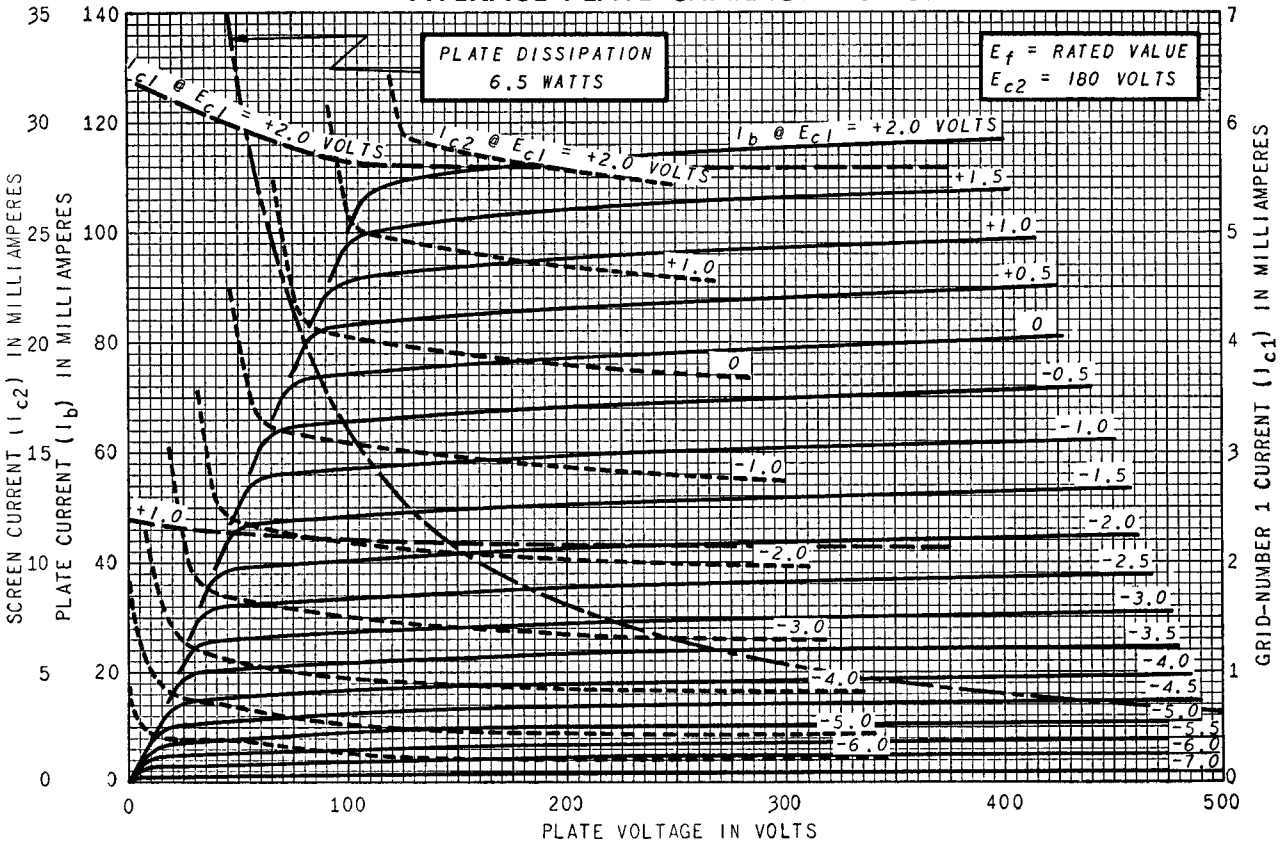

AVERAGE SCREEN CHARACTERISTICS

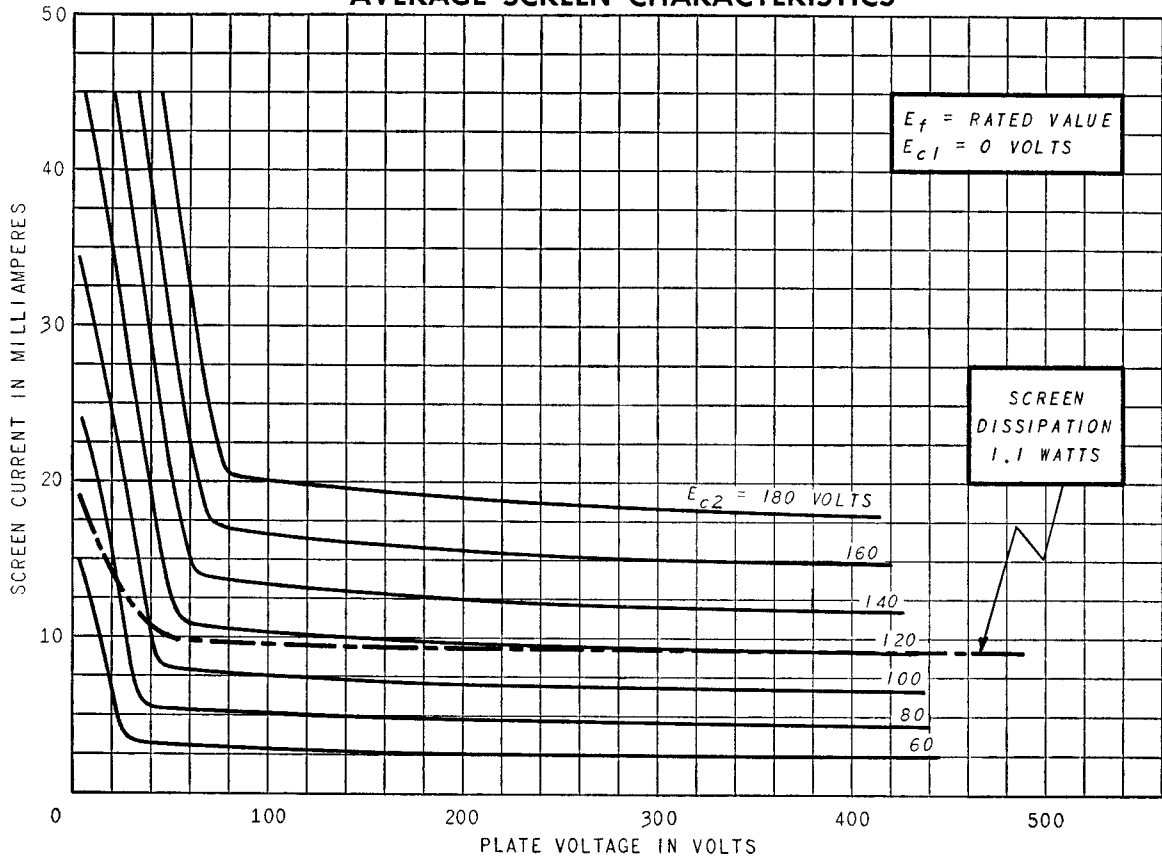

AVERAGE TRANSFER CHARACTERISTICS

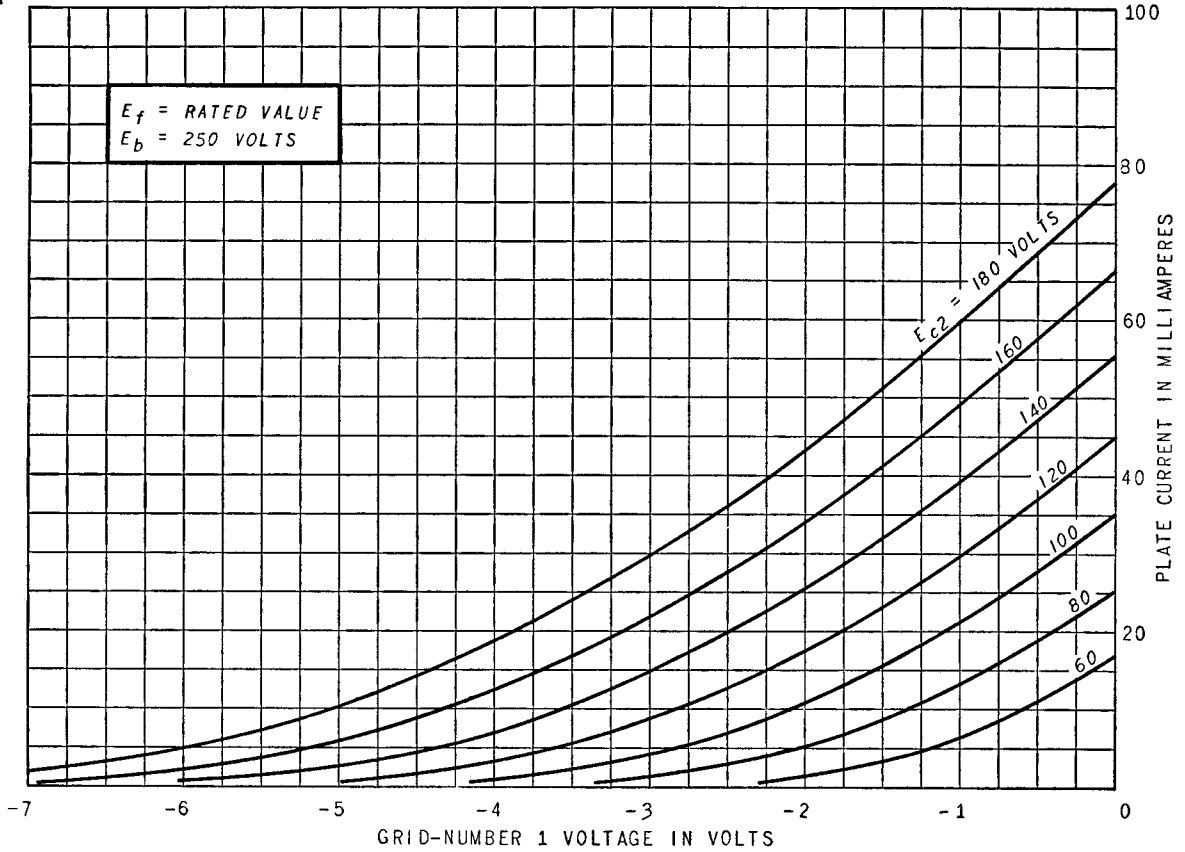

AVERAGE TRANSFER CHARACTERISTICS

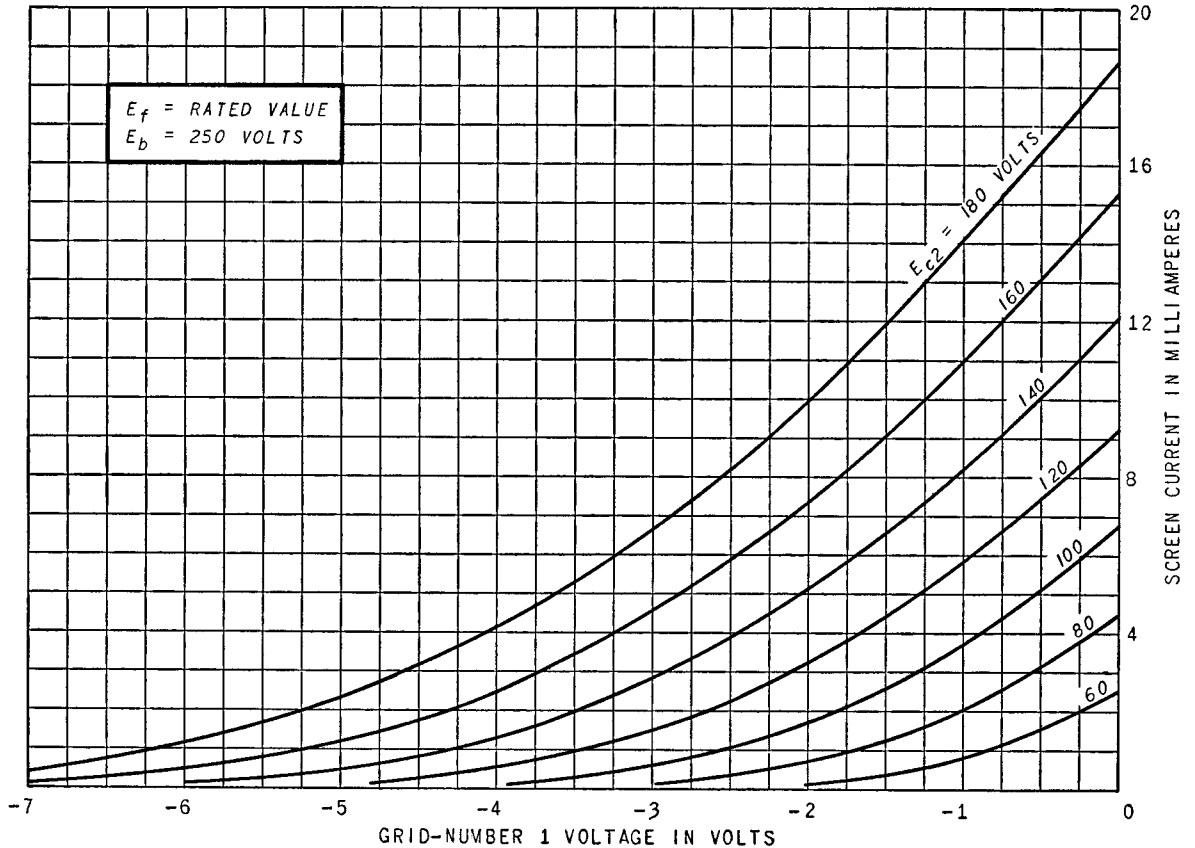

AVERAGE TRANSFER CHARACTERISTICS

