

**TRIODE
AUDIO-FREQUENCY AMPLIFIER**

Western Electric

DESCRIPTION

The 102L is a filamentary type triode. It is designed for use as an audio-frequency voltage amplifier or modulator.

CHARACTERISTICS

Filament Current	250 milliamperes
Maximum Plate Voltage	180 volts
Amplification Factor	30

GENERAL CHARACTERISTICS**ELECTRICAL DATA**

Filament Current	250 milliamperes
Filament Voltage, Nominal*	2.1 volts
Direct Interelectrode Capacitances	without external shield
Grid to Plate	5.0 uuf
Input	3.8 uuf
Output	2.4 uuf

MECHANICAL DATA

Cathode	Coated Filament
Base	Medium 4-pin type with bayonet pin
Mounting Position	Preferably vertical; if horizontal, pins #1 and #2 must lie in same vertical plane

Dimensions and pin connections shown in outline drawing on Page 5

MAXIMUM RATINGS, Design-Center Values

Plate Voltage	180 volts
Plate Dissipation	0.5 watt
Plate Current	7.5 milliamperes

TYPICAL OPERATING CONDITIONS AND CHARACTERISTICS—CLASS A₁ AMPLIFIER

Filament Current, D-C	250	250 milliamperes
Plate Voltage	130	160 volts
Grid Voltage	-1.5	-2.0 volts
Peak A-F Grid Voltage	1.5	2.0 volts
Plate Current	0.85	1.2 milliamperes
Transconductance	650	800 micromhos
Amplification Factor	30.2	30.2
Plate Resistance	46000	39000 ohms
Load Resistance	300000	300000 ohms
Maximum-Signal Voltage Output	34	44 peak volts
Total Harmonic Distortion Less Than	1.0	1.0 per cent

* The filament resistance of this tube increases slightly during the first year of operating life. The voltage given above is the nominal value after the filament resistance has stabilized.

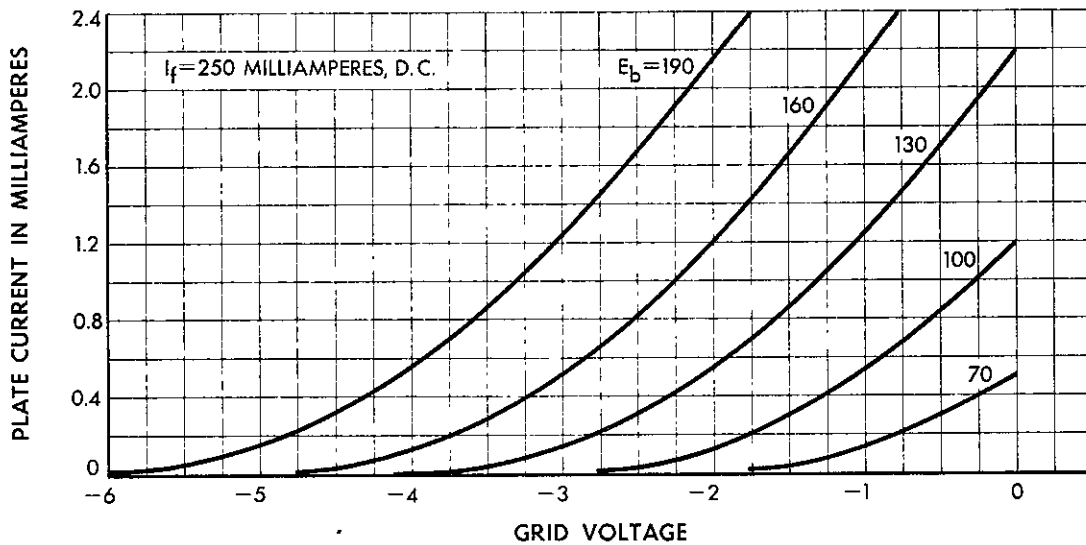
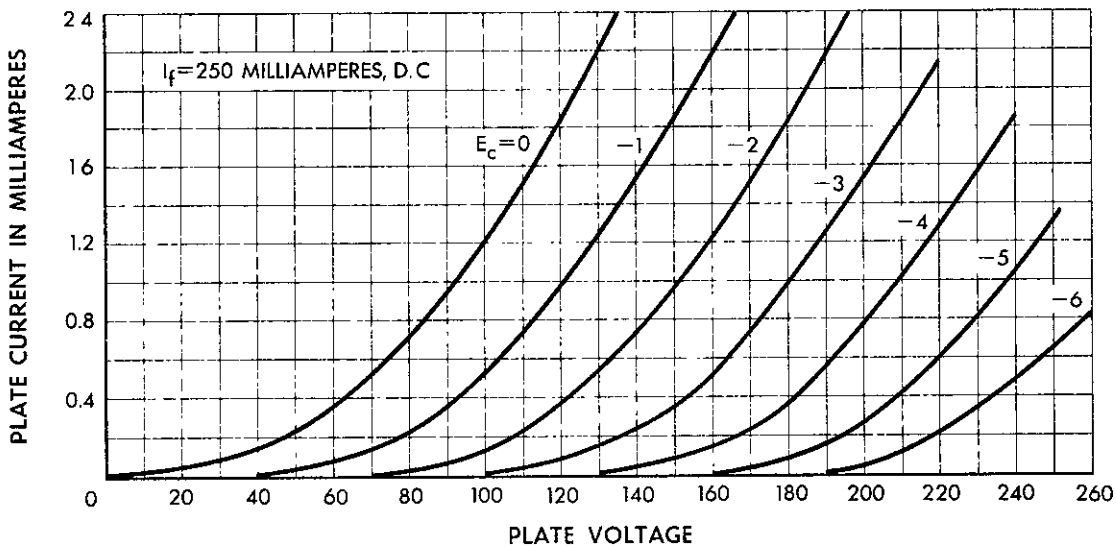

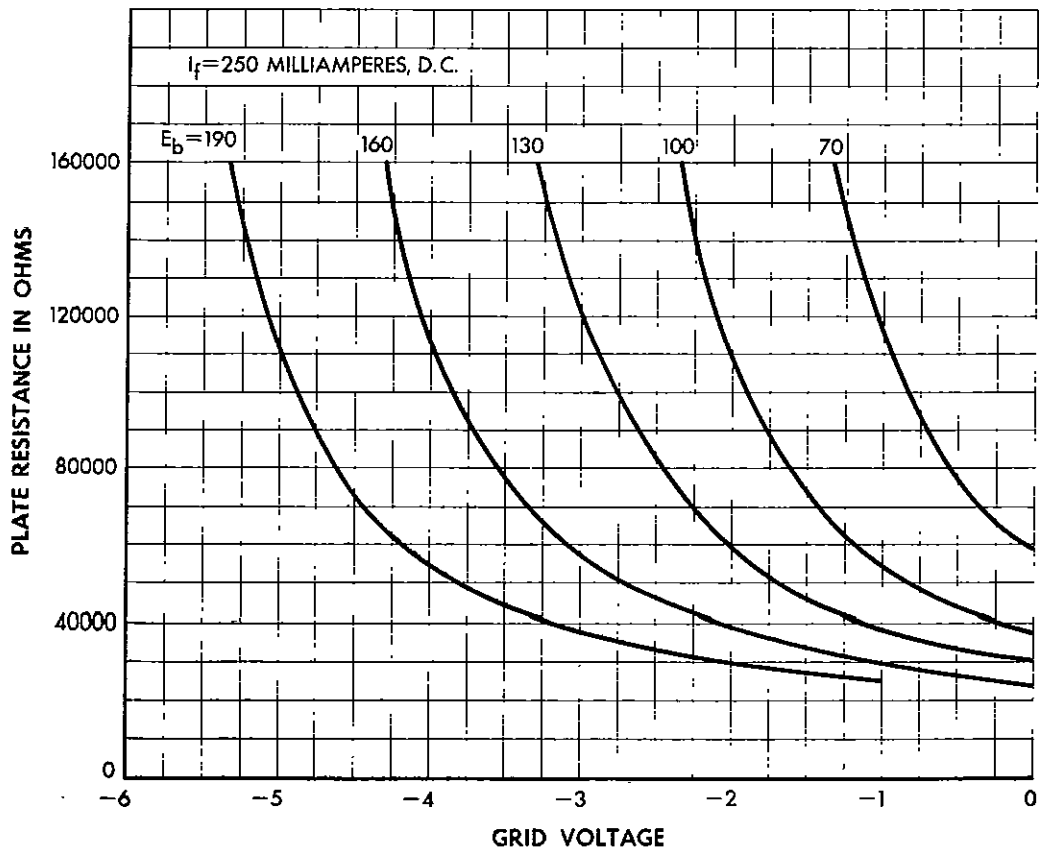
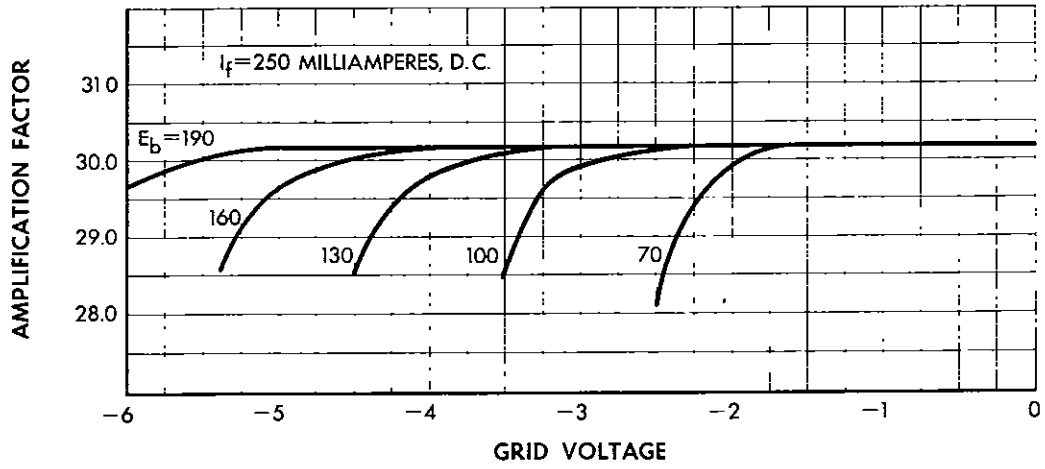

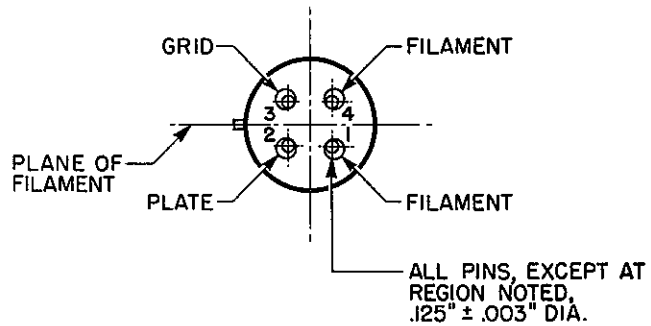
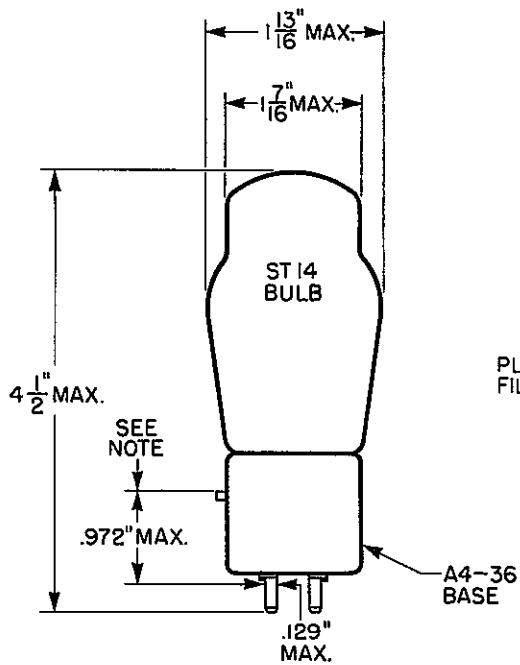
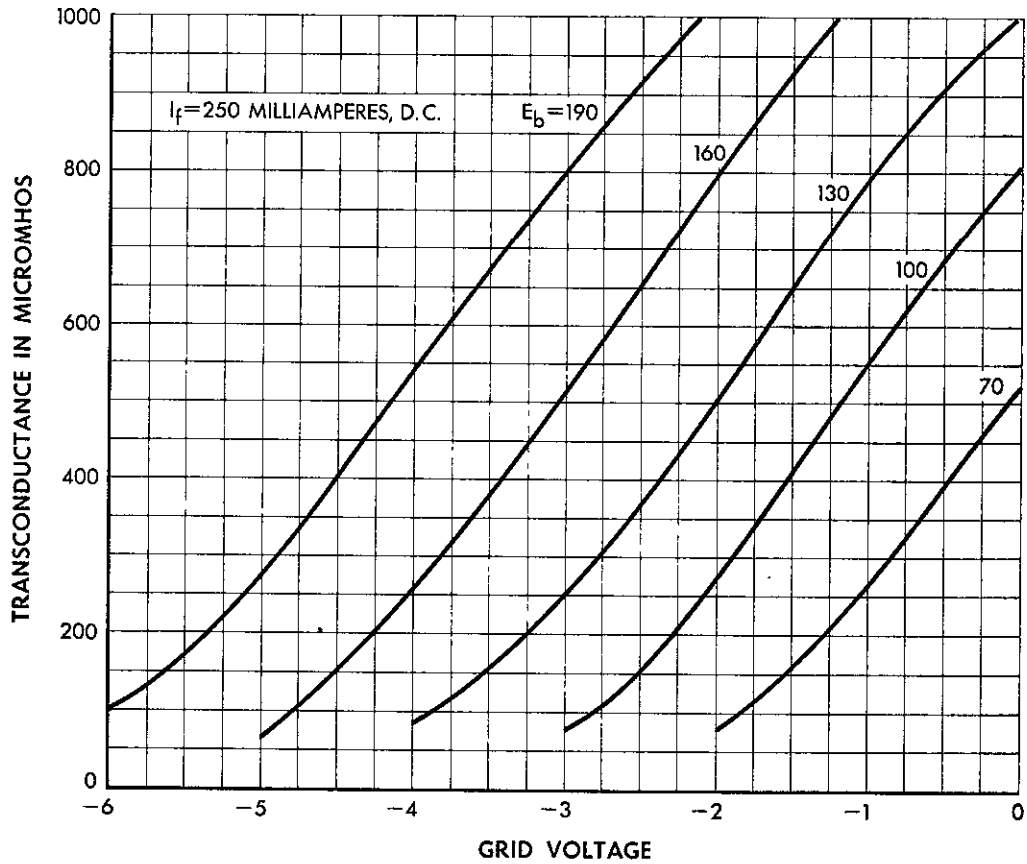

NOTE:
THIS DIMENSION APPLIES FROM THE TOP OF THE BAYONET PIN, TO A POINT ON THE STUD WHERE THE DIAMETER OF THE STUD PLUS SOLDER DOES NOT EXCEED $.129$ MAX.

Western Electric

A development of Bell Telephone Laboratories, the research laboratories of the American Telephone and Telegraph Company and the Western Electric Company.