

ELECTRON TUBE DATA SHEET
 WESTERN ELECTRIC 436A ELECTRON TUBE

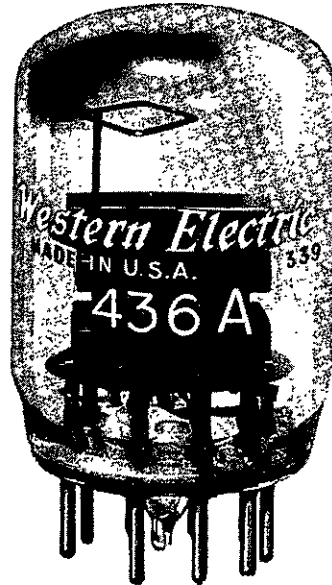

DESCRIPTION

The 436A electron tube is a high figure of merit tetrode with an indirectly heated cathode. It was designed primarily for use in the L-3 amplifier. ←

CHARACTERISTICS

Heater Voltage	· · · · ·	6.3	volts
Cathode Current	($E_b = 190$ volts; $E_{c2} = 160$ volts)	· · · · · 28.4	milliamperes ←
Transconductance	($E_{cc1} = +7.5$ volts; $R_k = 315$ ohms)	· · · · · 30000	micromhos

Note 1: In the "Absolute System" the maximum ratings specified are limiting values above which the serviceability of the device may be impaired from the viewpoint of life and satisfactory performance. Maximum ratings, as such, do not constitute a set of operating conditions and all values may not, therefore, be attained simultaneously.

Note 2: Reference point for Control Grid Voltage is the negative end of the cathode bias resistor.

File: General Purpose Section

Indicates a change ←

GENERAL CHARACTERISTICS

Electrical Data

Heater Voltage	6.3	volts
Heater Current	450	milliamperes
Direct Interelectrode Capacitances	Without External Shield	With External Shield (JEDEC #309)
Grid to Plate (maximum)07	.06 $\mu\mu\text{f}$
Input: g1 to (h+k+g2+i.s.)	14.0	14.2 $\mu\mu\text{f}$
Output: p to (h+k+g2+i.s.)	3.5	4.7 $\mu\mu\text{f}$

Mechanical Data

Cathode	Coated Unipotential
Bulb	T 9
Base	See outline drawing page 4
Mounting Position	Any

Dimensions and pin connections shown in outline drawing on page 4.

MAXIMUM RATINGS, Absolute System (Note 1, See Page 1)

Plate Voltage	210	volts
Screen Grid Voltage	175	volts
Plate Dissipation	5.0	watts
Screen Grid Dissipation	2.2	watts
Control Grid Dissipation	See footnote *	
Cathode Current	50	milliamperes
Heater-Cathode Voltage	55	volts
Bulb Temperature	130	centigrade
Maximum Grid Circuit Resistance for		
Fixed Bias	0.05	megohm
Cathode Bias	0.10	megohm

TYPICAL OPERATING CONDITIONS AND CHARACTERISTICS

Plate Voltage	130	160	190	volts
Screen Grid Voltage	130	160	160	volts
Control Grid Voltage	-1.0	-1.75	-	volts
Control Grid Supply Voltage (Note 2, See Page 1)	-	-	+7.5	volts
Cathode Bias Resistor (Note 2, See Page 1)	-	-	315	ohms
Plate Current	21.5	18.8	20.2	milliamperes
Screen Grid Current	12.5	10.8	8.2	milliamperes
Plate Resistance	5000	5000	36000	ohms
Transconductance	30000	28000	30000	micromhos
Control Grid Voltage (approximate) for				
Plate Current of 10 microamperes	-3.7	-4.7	-	volts
Modulation				
Second Order (2F)**	-	-	-32	db
Third Order (3F)***	-	-	-54	db
Load Resistance	-	-	270	ohms

* Operation with the control grid positive with respect to cathode is not recommended.

** Ratio of product to fundamental at output for 0.1 volt rms signal from grid to cathode.

*** Ratio of product to fundamental at output for a 0.2 volt rms signal from grid to cathode.

→ Indicates a change

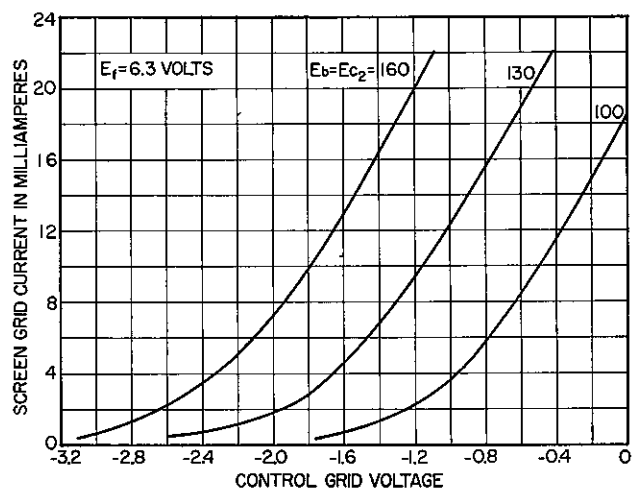
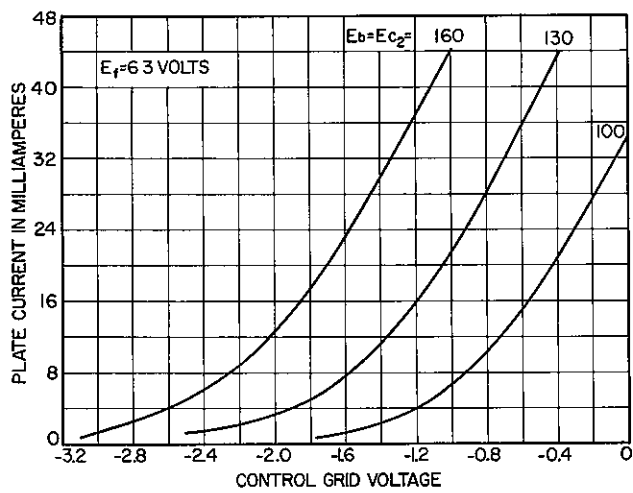
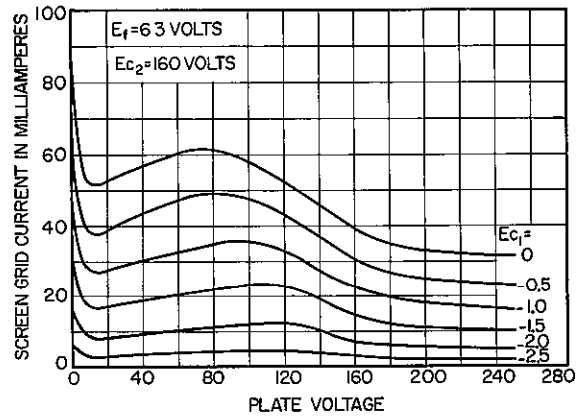
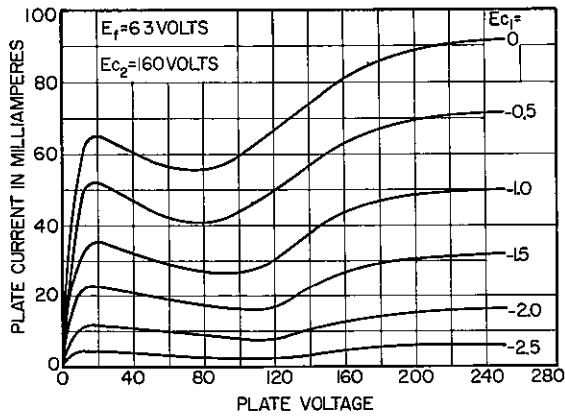
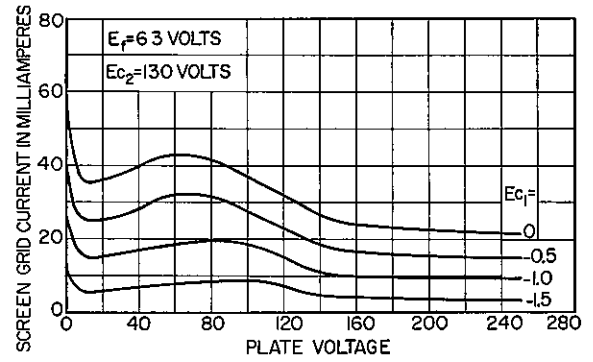
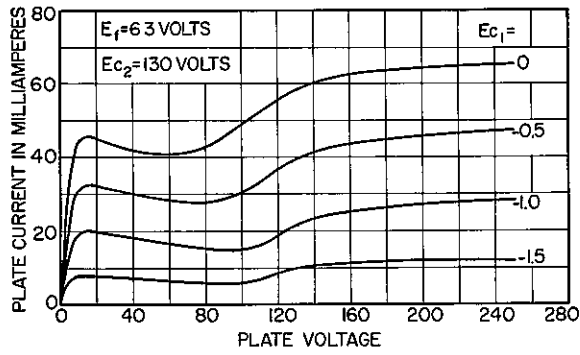

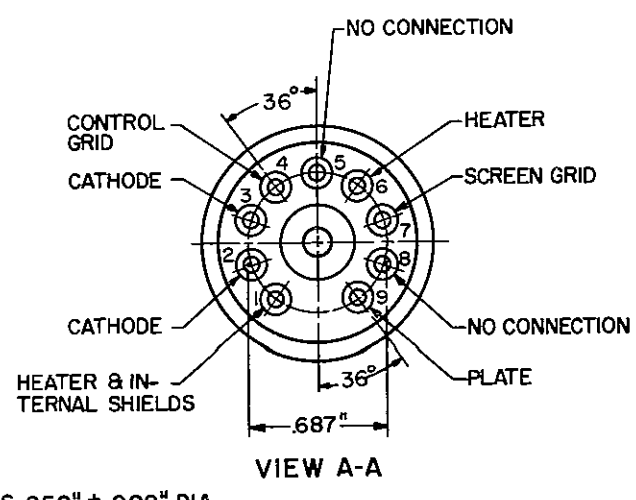
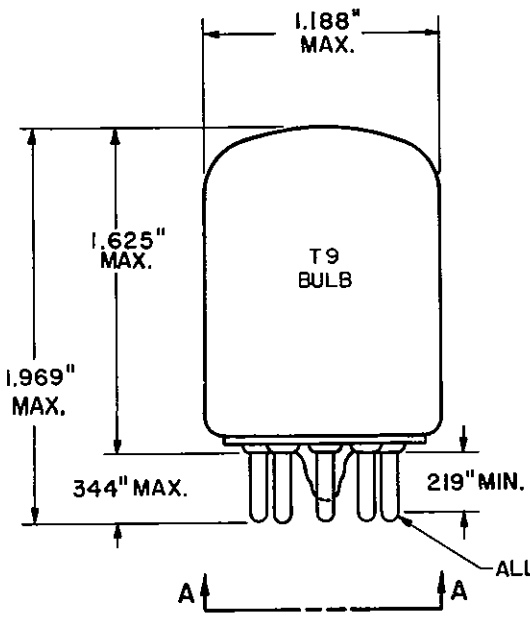
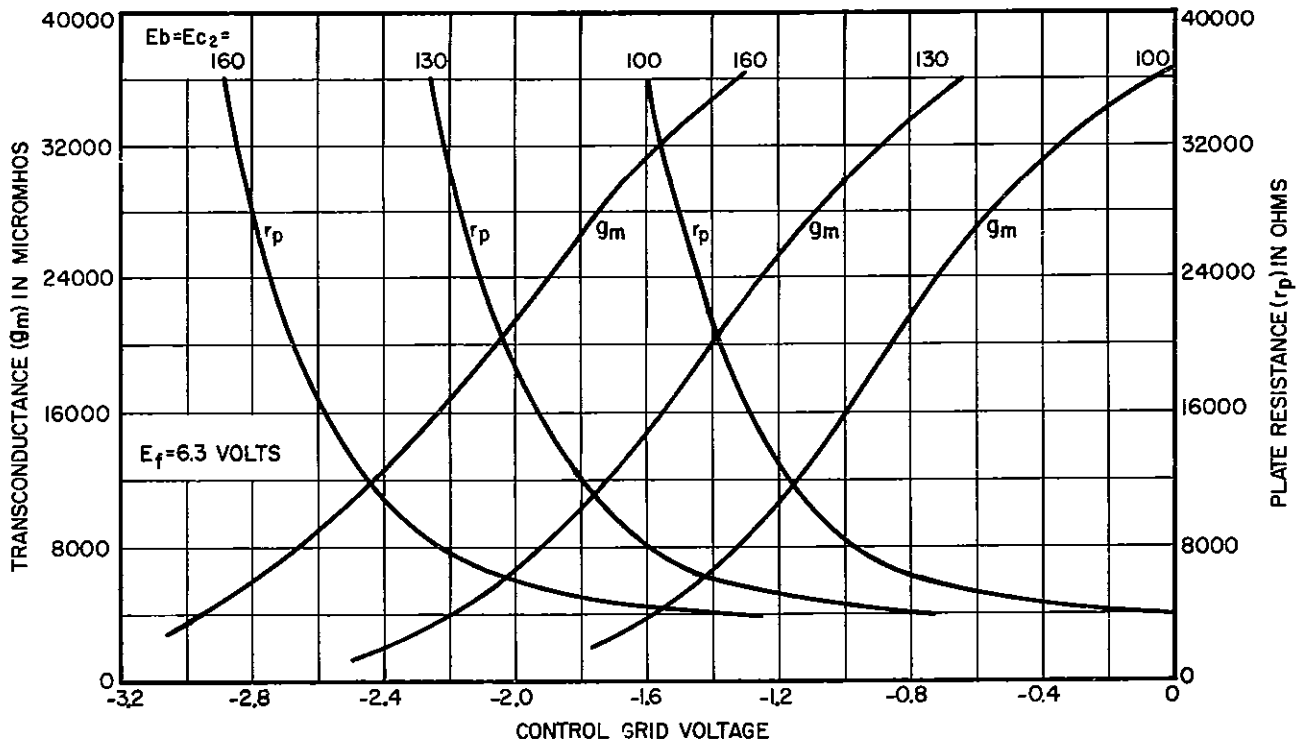

A development of Bell Telephone Laboratories, the research laboratories of the American Telephone and Telegraph Company and the Western Electric Company.