

ELECTRON TUBE DATA SHEET
WESTERN ELECTRIC 440A ELECTRON TUBE

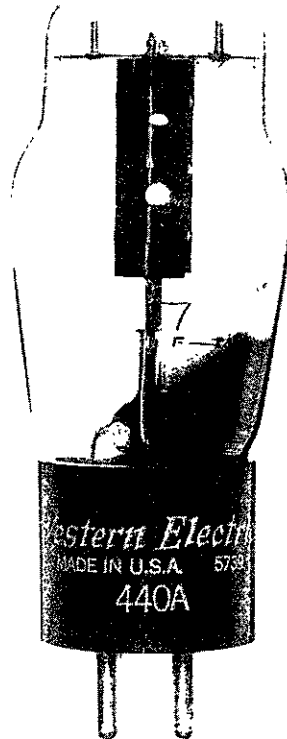

**TRIODE
 LOW-POWER AMPLIFIER**

DESCRIPTION

The 440A is a filamentary triode designed for use as a voice frequency and carrier frequency amplifier where low power output is required, also as an oscillator, a modulator, or a demodulator. The 440A is identical to the 101F electron tube except that it is fitted with a standard A4-9 medium 4-pin push type base.

CHARACTERISTICS

Filament Current (Note 1, Page 2)	0.50	ampere
Plate Current	$\left\{ \begin{array}{l} E_b = 130 \text{ volts} \\ E_c = -8 \text{ volts} \\ R_1 = 12000 \text{ ohms} \end{array} \right\}$	6.8 milliamperes
Power Output		53 milliwatts

ELECTRON TUBE DATA SHEET
 FILE: GENERAL PURPOSE SECTION

GENERAL CHARACTERISTICS

Electrical Data

Filament Voltage (D-C)	4.15	volts
Filament Current (D-C) (Note 1)	0.50	ampere
Direct Interelectrode Capacitance		
Grid To Plate	5.9	$\mu\mu\text{f}$
Grid To Filament.	4.2	$\mu\mu\text{f}$
Plate To Filament	2.7	$\mu\mu\text{f}$

Mechanical Data

Cathode	Coated Filament
Bulb	ST 14
Base	A4-9 medium 4-pin
Mounting Position.	Preferably vertical, if horizontal the position of the plane of the filament should be vertical

MAXIMUM RATINGS, Absolute System (Note 2)

Filament Voltage	4.30	volts
Plate Voltage	200	volts
Plate Power	2.0	watts

Dimensions and pin connections shown in outline drawing on page 6.

TYPICAL OPERATING CONDITIONS AND CHARACTERISTICS

Filament Current	0.50	0.50	0.50	0.50	ampere
Plate Voltage	130	160	190	190	volts
Grid Voltage	-8	-10	-14	-14	volts
Plate Current	6.8	10.0	10.9	10.9	milliamperes
Transconductance	1120	1300	1330	1330	micromhos
Plate Resistance	5800	5000	4900	4900	ohms
Amplification Factor	6.5	6.5	6.5	6.5	
Load Resistance	12000	5000	4900	12000	ohms
Power Output	53	100	205	180	milliwatts
Total Harmonic Distortion	1.4	3.2	4.5	1.4	per cent

Note 1: The filament of this tube is designed to operate on a current basis and should be operated at as near the rated current as practicable.

Note 2: In the "Absolute System" the maximum ratings specified are limiting values above which the serviceability of the device may be impaired from the viewpoint of life and satisfactory performance. Maximum ratings, as such, do not constitute a set of operating conditions and all values may not, therefore, be attained simultaneously.

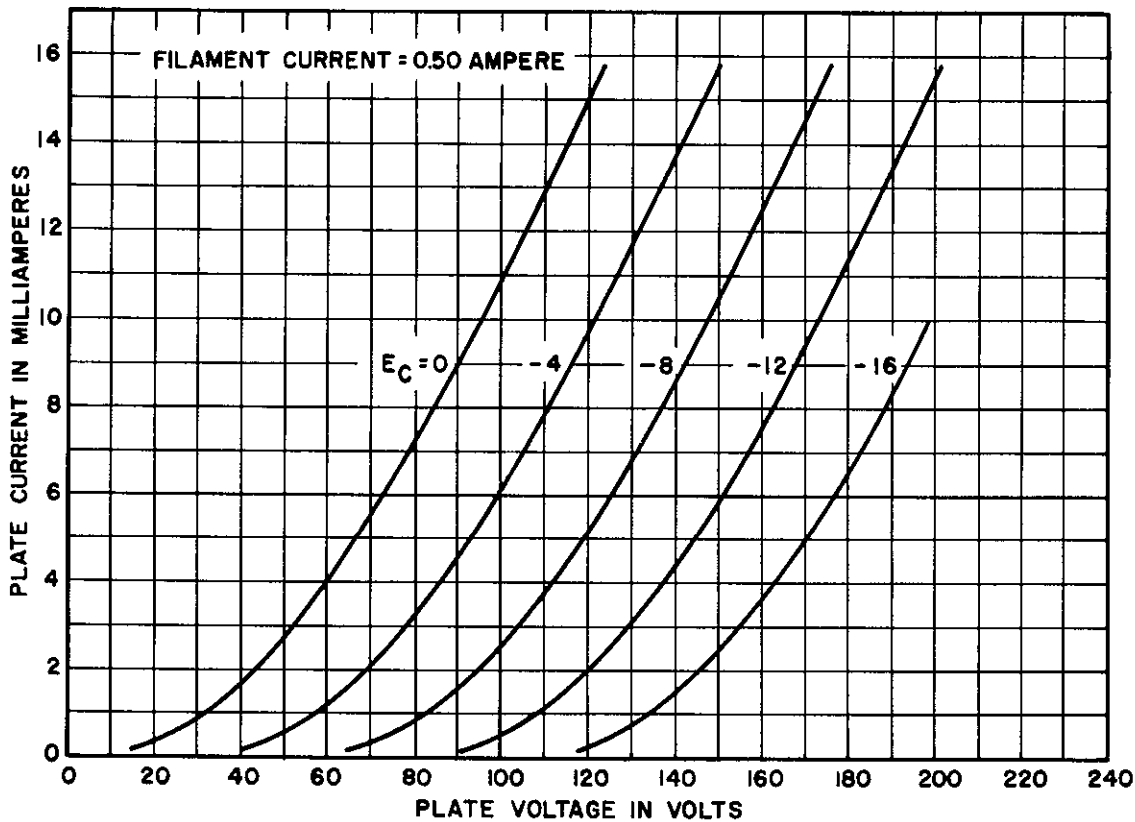

FIG.1

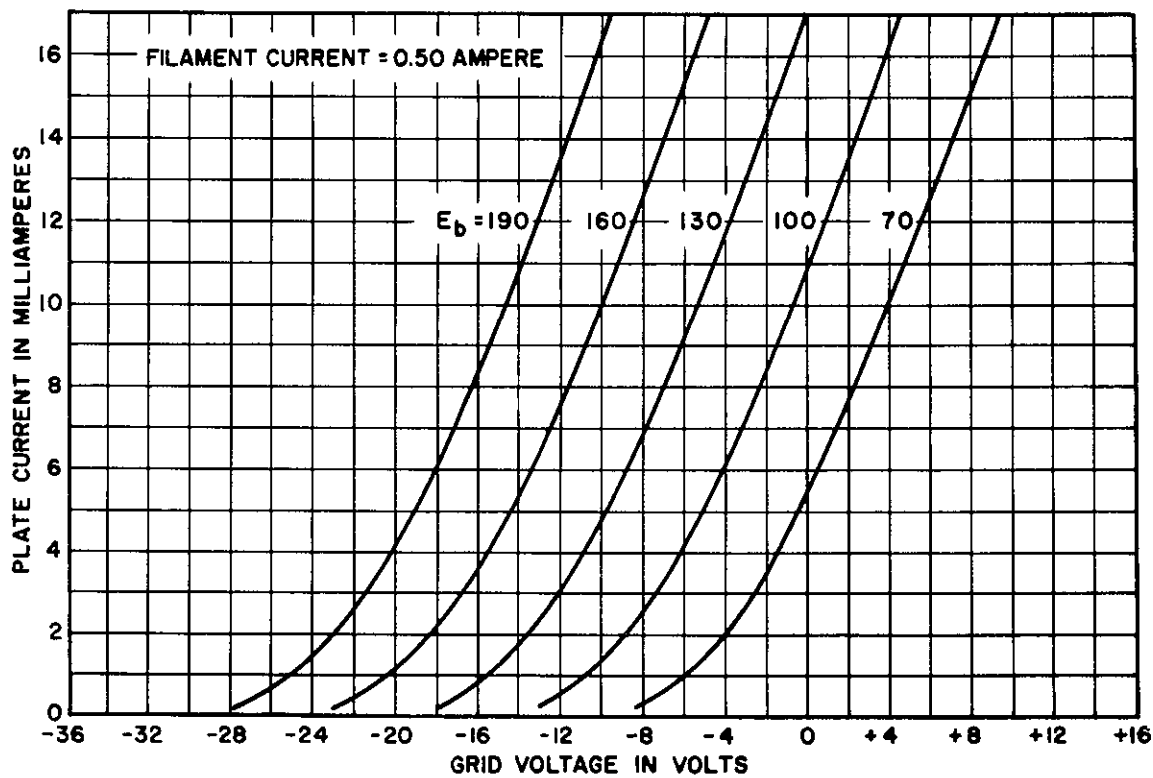
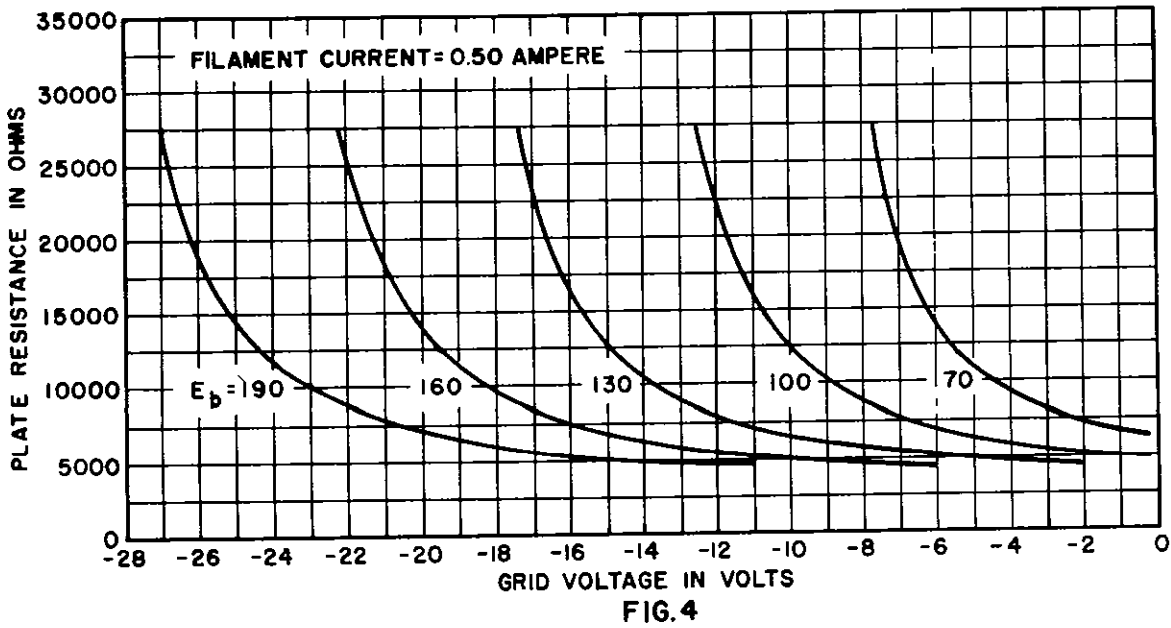
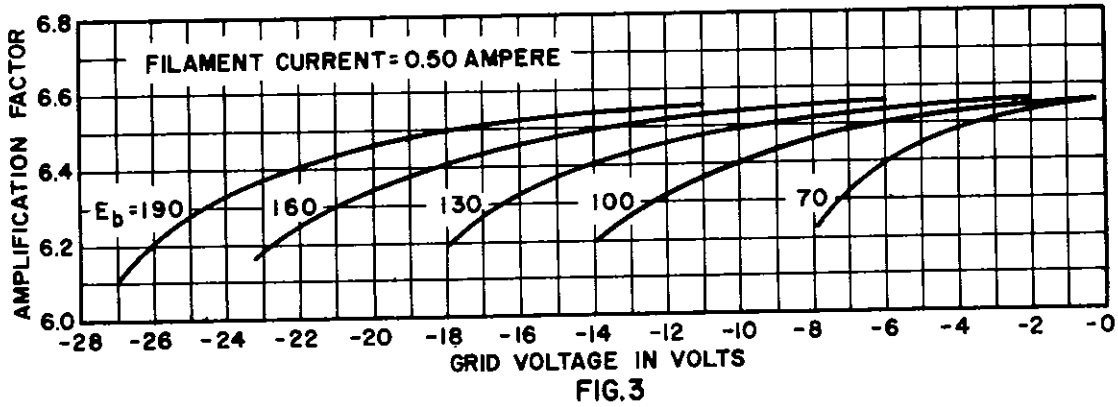

FIG.2



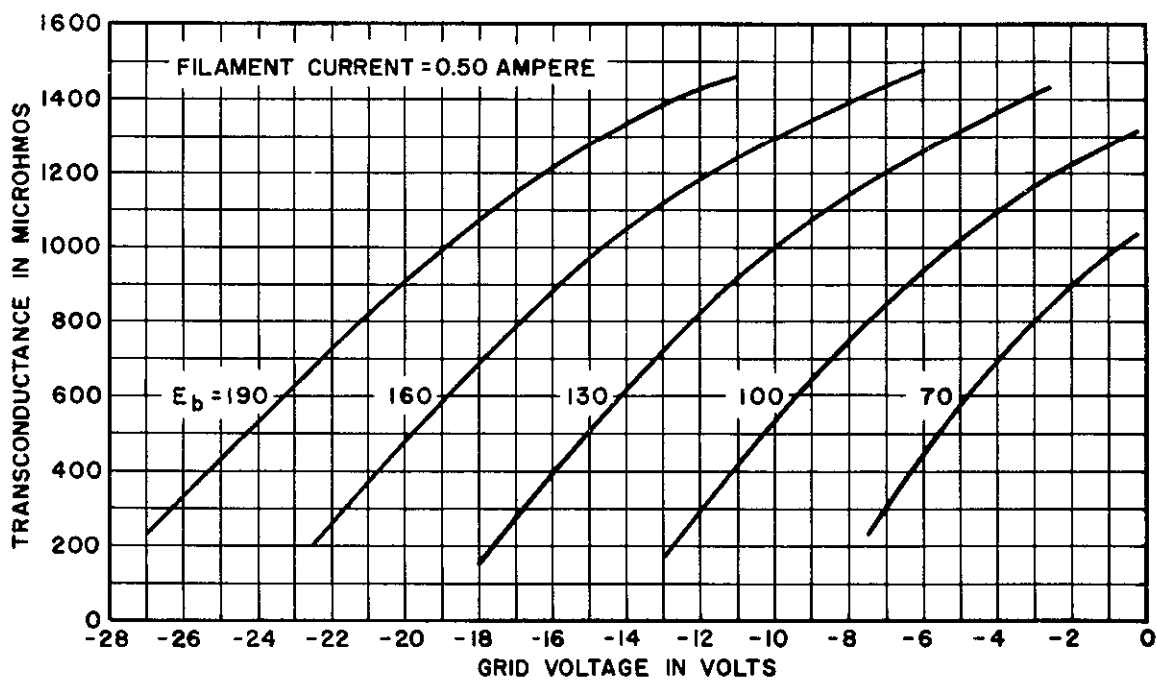
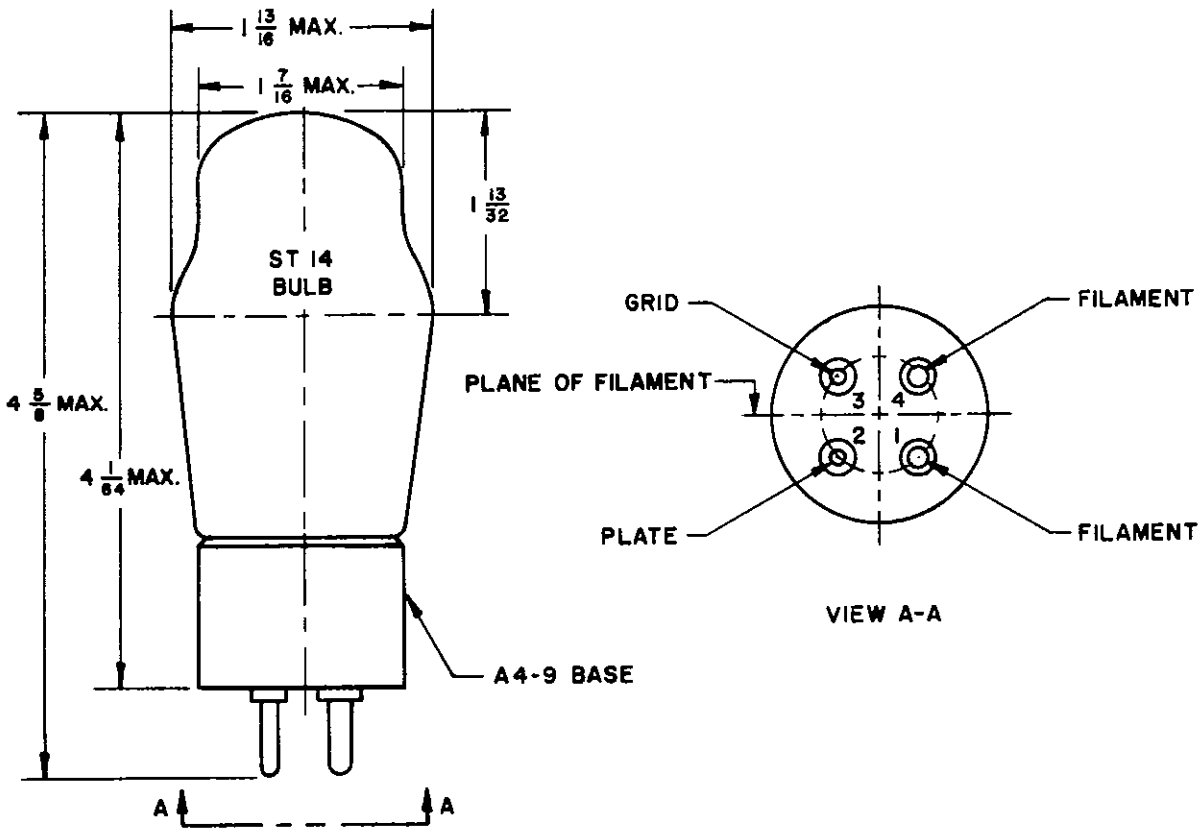

FIG.5



A development of Bell Telephone Laboratories, the research laboratories of the American Telephone and Telegraph Company and the Western Electric Company.

PRINTED IN U.S.A.