



813

BEAM POWER TUBE

Thoriated-Tungsten Filament
High Power Sensitivity

400 Watts Input on Phone (ICAS) up to 30 Mc
500 Watts Input on CW (ICAS) up to 30 Mc

7-1/2" Max. Length
2-9-16" Max. Diameter

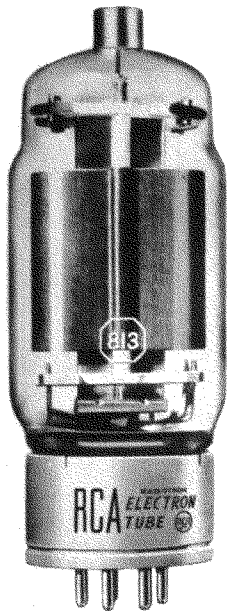

RCA-813 is a general-purpose transmitting beam power tube of the thoriated-tungsten filament type designed for use as an rf power amplifier and oscillator as well as an af power amplifier and modulator. The 813 has a maximum plate dissipation of 125 watts under ICAS conditions in modulator service and cw service. In the latter service it can be operated with full input to 30 Mc and with reduced input to 120 Mc.

Because of its high power sensitivity, the 813 requires very little driving power to give full power output. For example, in class C telegraph service under ICAS conditions, a single 813 is capable of giving a power output of approximately 375 watts with a driving power of only about 4 watts.

DATA

Electrical:

Filament, Thoriated Tungsten:		
Voltage (AC or DC)	10.0 ± 5%	volts
Current at 10.0 volts	5.0	amp
Transconductance (Approx.) for plate volts = 2000, grid-No.2 volts = 400, and plate current = 50 ma	3750	μmhos
Mu-Factor, grid No.2 to grid No.1 for plate volts = 2000, grid-No.2 volts = 400, and plate current = 50 ma	8.5	
Direct Interelectrode Capacitances: 0		
Grid No.1 to plate	0.25 max.	μμf
Grid No.1 to filament, grid No.2, and grid No.3	16.3	μμf
Plate to filament, grid No.2, and grid No.3	14	μμf

Mechanical:

Mounting Position	Vertical, Base up or down; Horizontal, with pins 2 & 6 in vertical plane
Maximum Overall Length	7-1/2"
Seated Length	6-5/8" ± 1/4"
Maximum Diameter	2-9/16"
Bulb	T-20
Cap	Medium (JETEC No.C1-5)

Base Medium-Metal-Shell Giant 7-Pin with Bayonet (JETEC No.A7-17)
Weight (Approx.) 8 oz.

AF POWER AMPLIFIER & MODULATOR - Class AB₁[#]

Maximum Ratings, Absolute Values:

	CCS ^o			ICAS ^{oo}	
DC PLATE VOLTAGE	2250 max.			2500 max.	volts
DC GRID-No.2 (SCREEN) VOLTAGE	1100 max.			1100 max.	volts
MAX.-SIGNAL DC PLATE CURRENT*	180 max.			225 max.	ma
MAX.-SIGNAL PLATE INPUT*	360 max.			450 max.	watts
MAX.-SIGNAL GRID-No.2 INPUT*	22 max.			22 max.	watts
PLATE DISSIPATION*	100 max.			125 max.	watts

Typical Operation:

	Values are for 2 tubes					
DC Plate Voltage	1500	2000	2250		2500	volts
DC Grid-No.3 (Suppressor) Voltage†	0	0	0		0	volts
DC Grid-No.2 Voltage**	750	750	750		750	volts
DC Grid-No.1 (Control-Grid) Voltage: 0						
From fixed-bias source	-85	-90	-95		-95	volts
Peak AF Grid-No.1-to-Grid-No.1 Voltage♦	160	160	170		180	volts
Zero-Signal DC Plate Current	50	50	50		50	ma
Max.-Signal DC Plate Current	305	265	255		290	ma
Zero-Signal DC Grid-No.2 Current	2	2	2		2	ma
Max.-Signal DC Grid-No.2 Current	45	43	53		54	ma
Effective Load Resistance (Plate to plate) 9300 16000 20000					19000	ohms
Max.-Signal Driving Power (Approx.)	0	0	0		0	watts
Max.-Signal Power Output (Approx.)	260	335	380		490	watts

Maximum Circuit Values (CCS or ICAS):

Grid-No.1-Circuit Resistance:##	
With fixed bias	30000 max. ohms
With cathode bias	Not recommended

RF POWER AMPLIFIER - Class B Telephony

Carrier conditions per tube for use with a max. modulation factor of 1.0

Maximum Ratings, Absolute Values:

	CCS ^o		ICAS ^{oo}	
DC PLATE VOLTAGE	2000 max.		2250 max.	volts
DC GRID-No.2 (SCREEN) VOLTAGE	400 max.		400 max.	volts
DC PLATE CURRENT	100 max.		125 max.	ma
PLATE INPUT	150 max.		200 max.	watts
GRID-No.2 INPUT	15 max.		20 max.	watts
PLATE DISSIPATION	100 max.		125 max.	watts

Typical Operation:

DC Plate Voltage	1500	2000	2250	volts
DC Grid-No.3 (Suppressor) Voltage†	0	0	0	volts
DC Grid-No.2 Voltage	400	400	400	volts



DC Grid-No.1 (Control-Grid) Voltage [⊕]	-60	-75	-60	volts
Peak RF Grid-No.1 Voltage	70	80	70	volts
DC Plate Current	100	75	85	ma
DC Grid-No.2 Current	4	3	3	ma
DC Grid-No.1 Current	★	★	★	ma
Driving Power [⊕]	▲	▲	▲	watts
Power Output (Approx.)	50	50	70	watts

Driving Power (Approx.) [⊕]	2.9	2.7	4.3	watts
Power Output (Approx.)	140	180	300	watts

Maximum Circuit Values (CCS or ICAS):

Grid-No.1-Circuit Resistance	30000 max.	ohms
--	------------	------

RF POWER AMPLIFIER & OSCILLATOR - Class C Telephony

Key-down conditions per tube without amplitude modulation[■]

Maximum Ratings, Absolute Values:

	CCS [●]	ICAS ^{●●}	
DC PLATE VOLTAGE	2000 max.	2250 max.	volts
DC GRID-No.2 (SCREEN) VOLTAGE	400 max.	400 max.	volts
DC GRID-No.1 (CONTROL-GRID) VOLTAGE	-300 max.	-300 max.	volts
DC PLATE CURRENT	180 max.	225 max.	ma
DC GRID-No.1 CURRENT	25 max.	30 max.	ma
PLATE INPUT	360 max.	500 max.	watts
GRID-No.2 INPUT	22 max.	22 max.	watts
PLATE DISSIPATION	100 max.	125 max.	watts

Typical Operation:

DC Plate Voltage	1250	1500	2000	2250	volts
DC Grid-No.3 (Suppressor) Voltage [†]	0	0	0	0	volts
DC Grid-No.2 Voltage [⊕]	300	300	400	400	volts
From a series resistor of	27000	40000	36000	46000	ohms
DC Grid-No.1 Voltage ^{⊕†}	-75	-90	-120	-155	volts
From a grid resistor of	6000	7500	12000	10000	ohms
From a cathode resistor of	330	400	520	565	ohms
Peak RF Grid-No.1 Voltage	160	175	205	275	volts
DC Plate Current	180	180	180	220	ma
DC Grid-No.2 Current	35	30	45	40	ma
DC Grid-No.1 Current (Approx.)	12	12	10	15	ma
Driving Power (Approx.) [⊕]	1.7	1.9	1.9	4.0	watts
Power Output (Approx.)	170	210	275	375	watts

Maximum Circuit Values (CCS or ICAS):

Grid-No.1-Circuit Resistance	30000 max.	ohms
--	------------	------

SELF-RECTIFYING OSCILLATOR or AMPLIFIER - Class C

Maximum CCS[●] Ratings, Absolute Values:

AC PLATE VOLTAGE (RMS)	2800 max.	volts
AC GRID-No.2 (SCREEN) VOLTAGE (RMS)	550 max.	volts
DC GRID-No.1 (CONTROL-GRID) VOLTAGE	-100 max.	volts
DC PLATE CURRENT	95 max.	ma
DC GRID-No.1 CURRENT	10 max.	ma
PLATE INPUT ^{★★}	295 max.	watts
GRID-No.2 INPUT ^{★★}	22 max.	watts
PLATE DISSIPATION	100 max.	watts

Typical Operation:

AC Plate Voltage (RMS)	2800	volts
DC Grid-No.3 (Suppressor) Voltage [†]	0	volts
AC Grid-No.2 Voltage (RMS) ^{○○}	530	volts
DC Grid-No.1 Voltage [◆]	-37	volts
From a grid resistor of	37000	ohms
DC Plate Current	95	ma
DC Grid-No.2 Current	12	ma
DC Grid-No.1 Current (Approx.)	1	ma
Driving Power (Approx.) [⊕]	1	watt
Output-Circuit Efficiency (Approx.)	75	per cent
Useful Power Output (Approx.)	170	watts

Maximum Circuit Values:

Grid-No.1-Circuit Resistance	30000 max.	ohms
--	------------	------

AMPLIFIER or OSCILLATOR - Class C

With Separate, Rectified, Unfiltered, Single-Phase, Full-Wave Plate and Grid-No.2 Supply

Maximum CCS[●] Ratings, Absolute Values:

DC PLATE VOLTAGE	1800 max.	volts
DC GRID-No.2 (SCREEN) VOLTAGE	360 max.	volts

Maximum Circuit Values (CCS or ICAS):

Grid-No.1 Circuit Resistance	30000 max.	ohms
--	------------	------

GRID-MODULATED RF POWER AMPLIFIER - Class C Telephony

Carrier conditions per tube for use with a max. modulation factor of 1.0

Maximum Ratings, Absolute Values:

	CCS [●]	ICAS ^{●●}	
DC PLATE VOLTAGE	2000 max.	2250 max.	volts
DC GRID-No.2 (SCREEN) VOLTAGE	400 max.	400 max.	volts
DC GRID-No.1 (CONTROL-GRID) VOLTAGE	-200 max.	-200 max.	volts
DC PLATE CURRENT	100 max.	125 max.	ma
PLATE INPUT	150 max.	200 max.	watts
GRID-No.2 INPUT	15 max.	20 max.	watts
PLATE DISSIPATION	100 max.	125 max.	watts

Typical Operation:

DC Plate Voltage	1500	2000	2250	volts
DC Grid-No.3 (Suppressor) Voltage [†]	0	0	0	volts
DC Grid-No.2 Voltage	400	400	400	volts
DC Grid-No.1 Voltage [⊕]	-140	-120	-110	volts
Peak RF Grid-No.1 Voltage	145	120	135	volts
Peak AF Grid-No.1 Voltage	60	60	55	volts
DC Plate Current	70	75	85	ma
DC Grid-No.2 Current	3	3	2.5	ma
DC Grid-No.1 Current	★	★	★	ma
Driving Power [⊕]	□□	□□	□□	watts
Power Output (Approx.)	40	50	75	watts

Maximum Circuit Values (CCS or ICAS):

Grid-No.1-Circuit Resistance:	
With fixed bias	30000 max. ohms
With cathode bias	Not recommended

PLATE-MODULATED RF POWER AMPLIFIER - Class C Telephony

Carrier conditions per tube for use with a max. modulation factor of 1.0

Maximum Ratings, Absolute Values:

	CCS [●]	ICAS ^{●●}	
DC PLATE VOLTAGE	1600 max.	2000 max.	volts
DC GRID-No.2 (SCREEN) VOLTAGE	400 max.	400 max.	volts
DC GRID-No.1 (CONTROL-GRID) VOLTAGE	-300 max.	-300 max.	volts
DC PLATE CURRENT	150 max.	200 max.	ma
DC GRID-No.1 CURRENT	25 max.	30 max.	ma
PLATE INPUT	240 max.	400 max.	watts
GRID-No.2 INPUT	15 max.	20 max.	watts
PLATE DISSIPATION	67 max.	100 max.	watts

Typical Operation:

DC Plate Voltage	1250	1600	2000	volts
DC Grid-No.3 (Suppressor) Voltage [†]	0	0	0	volts
DC Grid-No.2 Voltage [▲]	300	300	350	volts
From a series resistor of	27000	43000	41000	ohms
DC Grid-No.1 Voltage ^{††}	-160	-160	-175	volts
From a grid resistor of	12500	13500	11000	ohms
Peak RF Grid-No.1 Voltage	250	250	300	volts
DC Plate Current	150	150	200	ma
DC Grid-No.2 Current	35	30	40	ma
DC Grid-No.1 Current (Approx.)	13	12	16	ma



DC GRID-No.1 (CONTROL-GRID) VOLTAGE	-200 max.	volts
DC PLATE CURRENT	190 max.	ma
DC GRID-No.1 CURRENT	22 max.	ma
PLATE INPUT ††	360 max.	watts
GRID-No.2 INPUT ††	22 max.	watts
PLATE DISSIPATION	100 max.	watts

Typical Operation:

DC Plate Voltage	1800	volts
DC Grid-No.3 (Suppressor) Voltage †	0	volts
DC Grid-No.2 Voltage †	250	volts
DC Grid-No.1 Voltage †	-120	volts
From a grid resistor of	10000	ohms
DC Plate Current	160	ma
DC Grid-No.2 Current	37	ma
DC Grid-No.1 Current (Approx.)	12	ma
Driving Power (Approx.) ††††	2	watts
Output-Circuit Efficiency (Approx.)	75	per cent
Useful Power Output (Approx.)	210	watts

Maximum Circuit Values:

Grid-No.1-Circuit Resistance	30000 max.	ohms
--	------------	------

- Continuous Commercial Service.
- Intermittent Commercial and Amateur Service.
- * Averaged over any audio-frequency cycle of sine-wave form.
- † Grid No.3 should be connected to mid-tap on filament-transformer secondary winding or to negative end of filament operated on dc.
- ** Preferably obtained from a separate source or from the plate-voltage supply with a voltage divider.
- ⊗ For ac filament supply.
- ♦ The driver stage should be capable of supplying the No.1 grids of the class AB₁ stage with the specified driving voltage at low distortion.
- ## The type of input coupling network used should not introduce too much resistance in the grid-No.1 circuit. Transformer or impedance coupling devices are recommended. When the 813 is operated in class AB₁ service, only fixed bias should be used.
- ♣ Fixed supply or bypassed cathode-resistor bias is recommended.
- ★ Usually negligible.
- ▲ Never more than 2 watts.
- At crest of audio-frequency cycle with a modulation factor of 1.0.
- ⊗ Value shown for each operating condition is power required by grid No.1 and biasing device when the 813 is operated at frequency sufficiently low to avoid high-frequency losses. At moderate frequencies, the driver stage should be capable of providing about twice the tabulated value; at higher frequencies, the driver stage may have to supply 3 to 10 times the value shown.
- ♣♣ Obtained from fixed supply, or cathode resistor un-bypassed for audio frequencies.
- RF driving power is never more than 2 watts. AF power is usually not more than 1 watt.
- ▲▲ Obtained from a separate source modulated along with the plate supply, or from the modulated plate supply through a series resistor of the value shown for each operating condition.
- †† Obtained from a grid-No.1 resistor, from cathode resistor, or from a combination of grid-No.1 resistor with either fixed supply or cathode resistor.
- Modulation essentially negative may be used if the positive peak of the audio-frequency envelope does not exceed 115% of the carrier conditions.
- Obtained from a separate source, from the plate-voltage supply with a voltage divider, or through a series resistor of the value shown for each operating condition. A series grid-No.2 resistor should be used only when the 813 is used in a circuit which is not keyed. Grid-No.2 voltage must not exceed 800 volts under key-up conditions.
- ⊗ If preceding stage is keyed, the grid-No.1 bias must be obtained partially from a fixed supply in order to limit the plate current and, therefore, the plate dissipation to a safe value.
- ‡ From a self-rectified driver.
- ♠ This value of useful power is measured at load of output circuit having indicated efficiency.
- ††† Power input is 1.23 times the product of dc voltage and dc current.
- ⊗⊗ From a driver with a rectified, unfiltered, single-phase, full-wave plate supply.
- oo Obtained from a separate ac supply in phase with the plate supply or from a low-voltage tap on the plate transformer. Use of a grid-No.2 series voltage-dropping resistor is not recommended.
- ♦♦ Obtained from a grid-No.1 resistor of the value shown or from a combination of grid-No.1 resistor and cathode resistor. Fixed-bias operation is not recommended. The bias resistors should not be bypassed for the plate and grid-No.2 voltage supply frequency.
- ★★ Power input is 1.11 times the product of the ac voltage (rms) and the dc current.
- ♣♣ Obtained from a separate, rectified, unfiltered, single-phase, full-wave supply in phase with the plate supply, or from the rectified, unfiltered, single-phase, full-wave supply by means of taps on the plate transformer.

MAXIMUM RATINGS vs OPERATING FREQUENCY

FREQUENCY	30	45	60	120	Mc
MAX. PERMISSIBLE PERCENTAGE OF MAX. RATED PLATE VOLTAGE AND PLATE INPUT:					
Class B Telephony	100	93	88	76	%
Class C Telephony:					
Grid Modulated	100	93	88	76	%
Plate Modulated	100	87	75	50	%
Class C Telegraphy	100	87	75	50	%
Class C Self-Rectifying Oscillator, Amplifier	100	87	75	50	%
Class C Separately Rectified Oscillator, Amplifier	100	87	75	50	%

CHARACTERISTICS RANGE VALUES FOR EQUIPMENT DESIGN

	Note	Min.	Max.	
Filament Current	1	4.7	5.3	amp
Direct Interelectrode Capacitances:				
Grid No.1 to plate	2	-	0.25	μf
Grid No.1 to filament, grid No.2, and grid No.3	2	13	19.6	μf
Plate to filament, grid No.2, and grid No.3	2	10.5	17.5	μf
Plate Current (1)	1,3	35	65	ma
Plate Current (2)	1,4	-	2	ma
Grid-No.2 Current	1,3	-	4	ma
Useful Power Output	1,5	198	-	watts

- Note 1: With 10 volts dc on filament.
- Note 2: With no external shield and with base shell floating.
- Note 3: With dc plate voltage of 2000 volts, grid No.3 connected to negative filament terminal, dc grid-No.2 voltage of 400 volts, and dc grid-No.1 voltage of -35 volts.
- Note 4: With dc plate voltage of 2000 volts, grid No.3 connected to negative filament terminal, dc grid-No.2 voltage of 400 volts, and dc grid No.1 voltage of -80 volts.
- Note 5: In a self-excited oscillator with dc plate voltage of 2000 volts, grid No.3 connected to negative filament terminal, dc grid-No.2 voltage of 400 volts, dc grid-No.1 current of 9.6 to 14.4 ma, grid-No.1 resistor of 10000±10% ohms, dc plate current of 180 ma, and frequency of 15 Mc.

o With no external shield and with base shell floating.
 # Subscript 1 indicates that grid-No.1 current does not flow during any part of the input cycle.



OPERATING CONSIDERATIONS

The *maximum ratings* in the tabulated data for the 813 are limiting values above which the serviceability of the 813 may be impaired from the viewpoint of life and satisfactory performance. Therefore, in order not to exceed these absolute

user. Care should be taken during adjustment of circuits, especially when exposed circuit parts are at high dc potential.

Heavy leads and conductors together with suitable insulation should be used in all parts of the rf plate tank circuit so that losses due

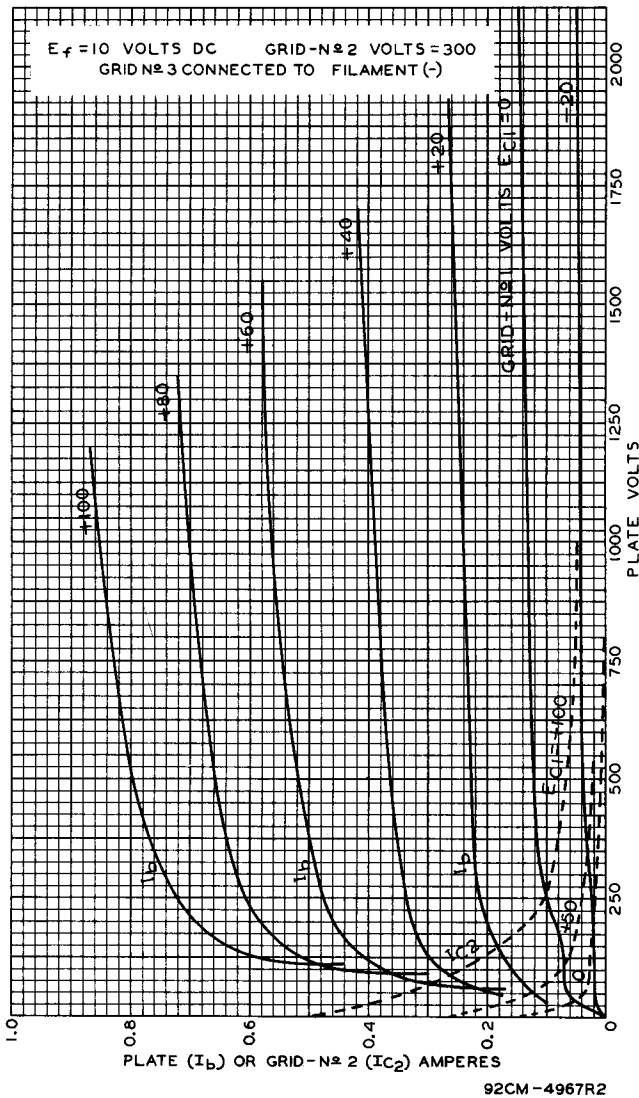

Fig. 1 - Average Plate Characteristics of Type 813.

ratings, the equipment designer has the responsibility of determining an average design value for each rating below the absolute value of that rating by an amount such that the absolute values will never be exceeded under any usual conditions of supply-voltage variation, load variation, or manufacturing variation in the equipment itself.

The rated plate voltage and grid-No. 2 voltage of this tube are high enough to be dangerous to the

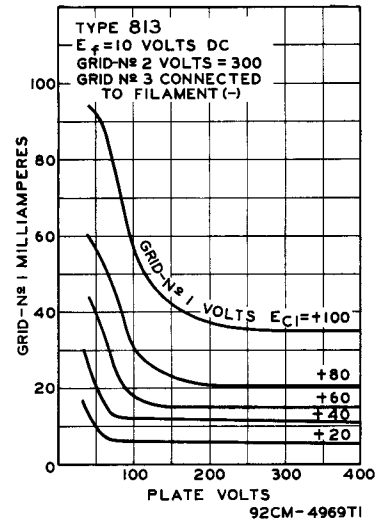

Fig. 2 - Average Characteristics of Type 813.

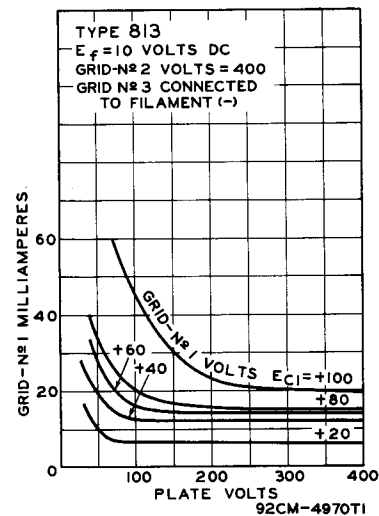

Fig. 3 - Average Characteristics of Type 813.

to rf voltages and currents may be kept at a minimum. At the higher frequencies, it is essential that short, heavy leads be used for circuit connections in order to minimize lead inductance and losses.

When a new circuit is tried or when adjustments are made, it is advisable to reduce the plate voltage and grid-No. 2 voltage. If the 813 is operated at maximum ratings and grid-No. 2 voltage is obtained through a series dropping



resistor, the use of a 5000-ohm protective resistor in the high-voltage supply lead is recommended. When a separate grid-No.2 voltage supply is used, a 4000-ohm protective resistor should be connected in the grid-No.2 supply lead.

A protective device, such as a fuse, should be used to protect not only the plate but also

rf amplifier, neutralization may be necessary to prevent feedback. It is not necessary, however, to provide an external shield for the 813.

The rf impedance between grid No.2 and the cathode must be kept low, usually by means of a suitable bypass capacitor. In telephony service when grid No.2 is modulated, a smaller bypass

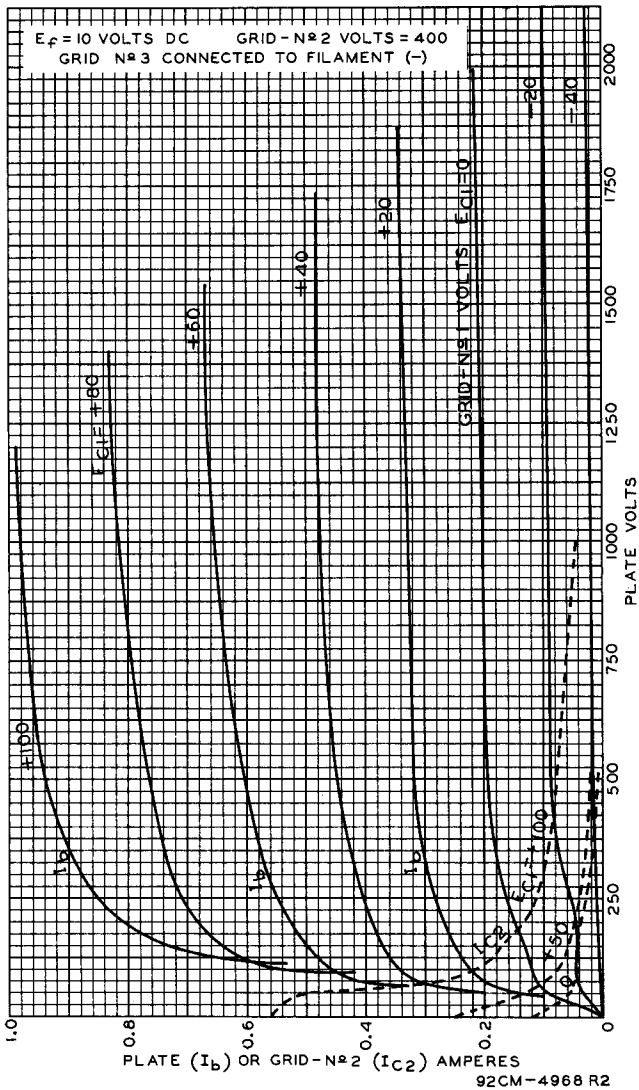

Fig. 4 - Average Plate Characteristics of Type 813.

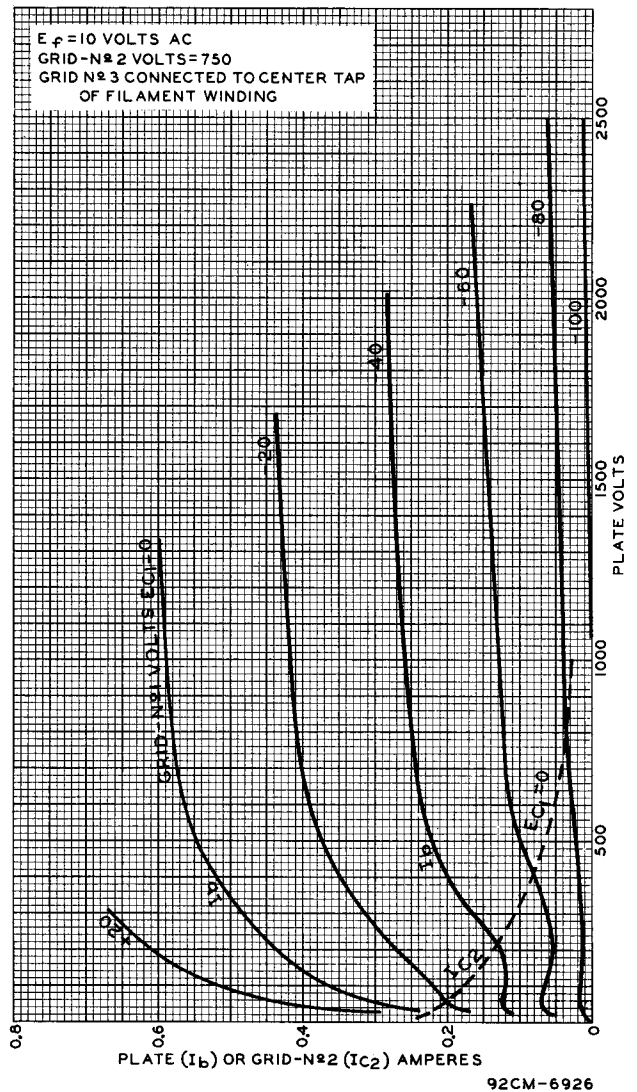

Fig. 5 - Average Plate Characteristics of Type 813.

grid No.2 against overload. In order to prevent excessive plate-current flow and resultant overheating of the tube, the plate circuit should be fused. Similarly, a fuse in the lead to grid-No.2 should remove the grid-No.2 voltage when the dc grid-No.2 current reaches a value slightly higher than normal.

Shielding and isolation of the input and output circuits are necessary for stable operation. In some cases where the 813 is used as an

capacitor than is used for telegraphy service may be required in order to avoid excessive af bypassing. However, if the capacitance value is too small, rf feedback may occur between plate and grid No.1, depending on the circuit layout, operating frequency, and power gain of the stage. AF bypassing difficulties can usually be eliminated if the grid-No.2 bypass capacitor is replaced by a series-resonant circuit which is tuned to resonate at the operating frequency.



This circuit presents a high impedance to audio frequencies but a very low impedance to its resonant frequency.

The *base pins* of the 813 fit the giant 7-contact socket which should be mounted to hold the tube in a vertical position with base up or down. If

Overheating of the 813 by severe overload may decrease the filament emission. Filament activity may sometimes be restored by operating the filament at rated voltage for ten minutes or more without voltages on the other electrodes. This process may be accelerated by raising the filament voltage to 12 volts (not higher) for a few minutes.

The *bulb* becomes very hot during operation. To insure adequate cooling, therefore, it is essential that free circulation of air be provided around the 813. The installation of all wires and connections should be made so they will not be close to or touch the bulb, in order to avoid puncture of the glass.

The *plate* shows no color when the 813 is operated at full ratings under either CCS or ICAS conditions in any class of service. Connections to the plate should be made with a flexible lead to prevent any strain on the seal at the cap.

Grid-No.2 voltage should be obtained from a source of good regulation. The plate voltage should be applied before or simultaneously with the grid-No.2 voltage; otherwise, with voltage on grid-No.2 only, its current may be large enough to cause excessive grid-No.2 dissipation. A dc milliammeter should be used in the grid-No.2 circuit so that its current may be measured and the dc power input determined.

The *grid-No.2* current is a very sensitive indication of plate-circuit loading and grid-No.2 current rises excessively (often to the point of damaging the tube) when the amplifier is operated without load. Therefore, care should be taken when tuning a circuit employing an 813 under no-load conditions in order to prevent exceeding the grid-No.2 input rating of the tube.

In *plate-modulated class C amplifier* service, the 813 can be modulated 100 per cent. The grid-No.2 voltage must be modulated simultaneously along with the plate voltage so that the ratio of grid-No.2 voltage to plate voltage remains constant. Modulation of the grid-No.2 voltage can be accomplished either by connecting grid-No.2 through a separate winding on the modulation transformer to the fixed grid-No.2 voltage supply, or by connecting grid No.2 through an audio-frequency choke of suitable impedance for low audio frequencies to the fixed grid-No.2 supply voltage. The supply end of the choke should be well-bypassed to ground.

When operated as a *self-rectifying class C amplifier*, or as a *class C amplifier with a separate, rectified, unfiltered, single-phase, full-wave plate and grid-No.2 supply*, the 813 can be biased by means of a grid-No.1 resistor, a cathode resistor, or a combination of the two methods. The use of grid-No.1 resistor bias is preferred, however, because the bias is automatically adjusted as the load on the circuit

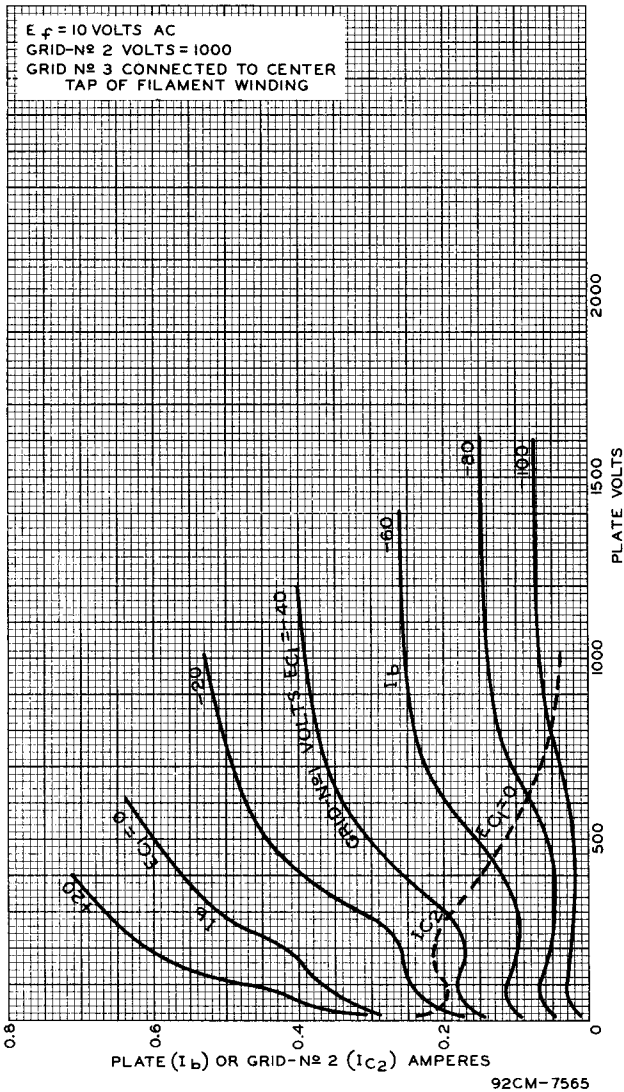

Fig. 6 - Average Plate Characteristics of Type 813.

it is necessary to operate the tube in a horizontal position, the base pins No.2 and No.6 should be positioned vertically one above the other.

The *filament* of the 813 is of the thoriated-tungsten type. It should be operated at the rated value of 10 volts \pm 5%. During standby periods in intermittent operation, it is recommended that the filament voltage be reduced to 80% of normal when the period is less than 15 minutes. For longer periods, the filament should be turned off.



varies. In those applications, such as are encountered in therapeutic equipment, where grid-No.1 current and grid-No.1 voltage may vary widely because of fluctuating loads, it is important to design equipment so that the maximum grid-No.1 current and grid-No.1 voltage ratings are never exceeded for any load.

Highest operating efficiency in high-frequency service, and therefore maximum power output, will be obtained when the 813 is operated under load conditions such that maximum rated plate current flows at the plate voltage which will give maximum rated input.

Push-pull or parallel circuit arrangements can be used when more radio-frequency power is required than can be obtained from a single 813. Two 813's in parallel or push-pull will give approximately twice the power output of one tube. The parallel connection requires no increase in exciting voltage from that required for a single tube. With either connection, the driving power required is approximately twice that for a single tube. The push-pull arrangement has the advantage of simplifying the balancing of high-frequency circuits.

DIMENSIONAL OUTLINE

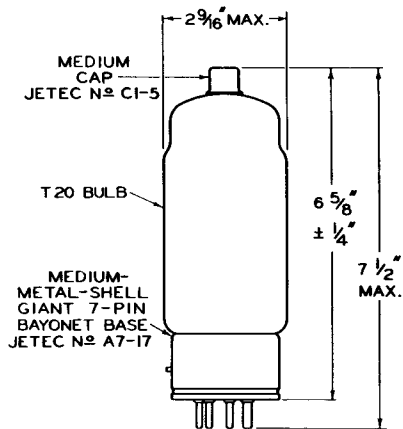

92CM-4963R3

SOCKET CONNECTIONS Bottom View

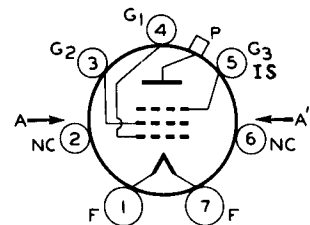

AA' = PLANE OF ELECTRODES
5BA

- PIN 1: FILAMENT
- PIN 2: NO CONNECTION
- PIN 3: GRID No. 2
- PIN 4: GRID No. 1
- PIN 5: GRID No. 3,
INTERNAL SHIELD
- PIN 6: NO CONNECTION
- PIN 7: FILAMENT
- CAP: PLATE

Devices and arrangements shown or described herein may use patents of RCA or others. Information contained herein is furnished without responsibility by RCA for its use and without prejudice to RCA's patent rights.