

"TRADER" SERVICE SHEET

1045

# ACE A.C./D.C. RECEIVERS

Covering Model U51 and Ace A.C./D.C.  
"Minigram" and "Mayfair" Autoradiograms

**B**ASED on the Ace U51 A.C./D.C. table receiver, with which is associated the 535 range of A.C./D.C. autoradiograms, this Service Sheet also covers a number of other models. The model numbers of the receivers and radiograms covered are listed below, and in this list are included all A.C./D.C. models styled "Minigram" and "Mayfair," which differ only in cabinet style. No attempt is made to link a particular arrangement with each model number, but the five different arrangements are explained under "Modifications" overleaf.

The basic table receiver is a 4-valve (plus rectifier) 3-band superhet designed to operate from A.C. or D.C. mains of 200-250 V. The mains frequency range (in radiograms) would be limited by the kind of motor employed. Where a radiogram is fitted with an A.C. motor, an electronic convertor unit supplies the motor with A.C. power. Waveband ranges are 16.5-50 m, 190-550 m and 800-2,100 m.

The models covered in this service sheet are, in numerical order:—

33U (table), 33UR, 33RG/DC, U51, MGU535, MGU535/C, MGUS535, MGUS535/C, RGU535, RGU535/C, RGUS535, RGUS535/C, RGU5351. MRGU635 and MRGUS635 are covered except for the omission of their C.R. tuning indicator. Export versions of all models are covered except for their waveband ranges.

Release dates and original prices: 33U (table), November 1950, £15 15s; 33UR, November 1950, £41 18s 6d; 33RG/DC, November 1950, £43 7s 10d; U51, March 1951, £19 0s 6d, increased later to £19 2s 6d; MGU535 or MGU535/C, November

1951, £60 6s 1d; MGUS535 or MGUS535/C, November 1951, £63 19s 7d; RGU535 or RGU535/C, November 1951, £47 16s 1d; RGUS535 or RGUS535/C, December 1951, £51 9s 7d; MRGU635, November 1951, £60 6s 1d; MRGUS635, November 1951, £63 19s 7d.

## CIRCUIT DESCRIPTION

Aerial input is inductively coupled on S.W. by L2 and capacitatively "bottom" coupled on M.W. and L.W. by C5 to single tuned circuits L3, C40 (S.W.), L4, C40 (M.W.) and L5, C40 (L.W.) which precede triode-hexode valve (V1, Brimar 6K8GT) operating as frequency changer with internal coupling. C1 and C4 isolate the aerial and earth sockets from the chassis while R1 provides a D.C. path between the sockets to prevent the build up of static charges on the aerial. R2 prevents modulation hum.

Oscillator anode coils L8 (S.W.), L9 (M.W.) and L10 (L.W.) are tuned by C44. Parallel trimming by C41 (S.W.), C42 (M.W.) and C11, C43 (L.W.); series tracking by C8 (S.W.), C9 (M.W.) and C10 (L.W.). Reaction coupling from grid circuit across the common impedance of the trackers with additional inductive coupling via L6 (S.W.) and L7 (M.W.). Stabilization by R5, R6 and R7.

Second valve (V2, Brimar 6K7GT) is a variable-mu R.F. pentode operating as intermediate frequency amplifier with tuned transformer couplings C6, L11, L12, C7 and C16, L13, L14, C17.

Intermediate frequency 472 kc/s. Diode signal detector is part of double diode triode valve (V3, Brimar 6Q7GT). Audio fre-

quency component in rectified output is developed across R12 and passed via C25 and volume control R14 to control grid of triode section, which operates as A.F. amplifier. I.F. filtering by C18, R11 and C19.

Second diode of V3 is fed from V2 anode via C21, and the resulting D.C. potential developed across its load resistor R18 is fed back as bias to V1 and V2 giving automatic gain control. Provision is made for the connection of a gramophone pick-up across R14 via S14 which closes in the gram position of the waveband switch. S6 closes and S13 opens on Gram to prevent radio break-through.

On the table model the P.U. sockets are isolated from chassis by C23 and C24, and shunted by C22. On the radiogram model a transformer isolates the P.U. sockets, one side of its primary being connected to the earth socket, and one side of its secondary to chassis.

Resistance-capacitance coupling via R17, C27 and R25 between V3 triode and beam tetrode output valve (V4, Brimar 25L6GT). Variable tone control by R26, R27 and C32 in V4 anode circuit. Fixed tone correction by negative feedback between the anodes of V4 and V3 via R28. Bias for V4 is obtained from the voltage drop across R22 and R23 in the H.T. negative lead to chassis. A proportion of this voltage, that dropped across R22, is fed via decoupling circuit R21, C29 to the A.G.C. line to act as delay voltage to the A.G.C. diode and to provide bias for V1 and V2. Provision is made for the connection of a low impedance external speaker across T1 secondary.

H.T. current is supplied by I.H.C. half-wave rectifying valve (V5, Brimar 25Z4GT). Smooth-

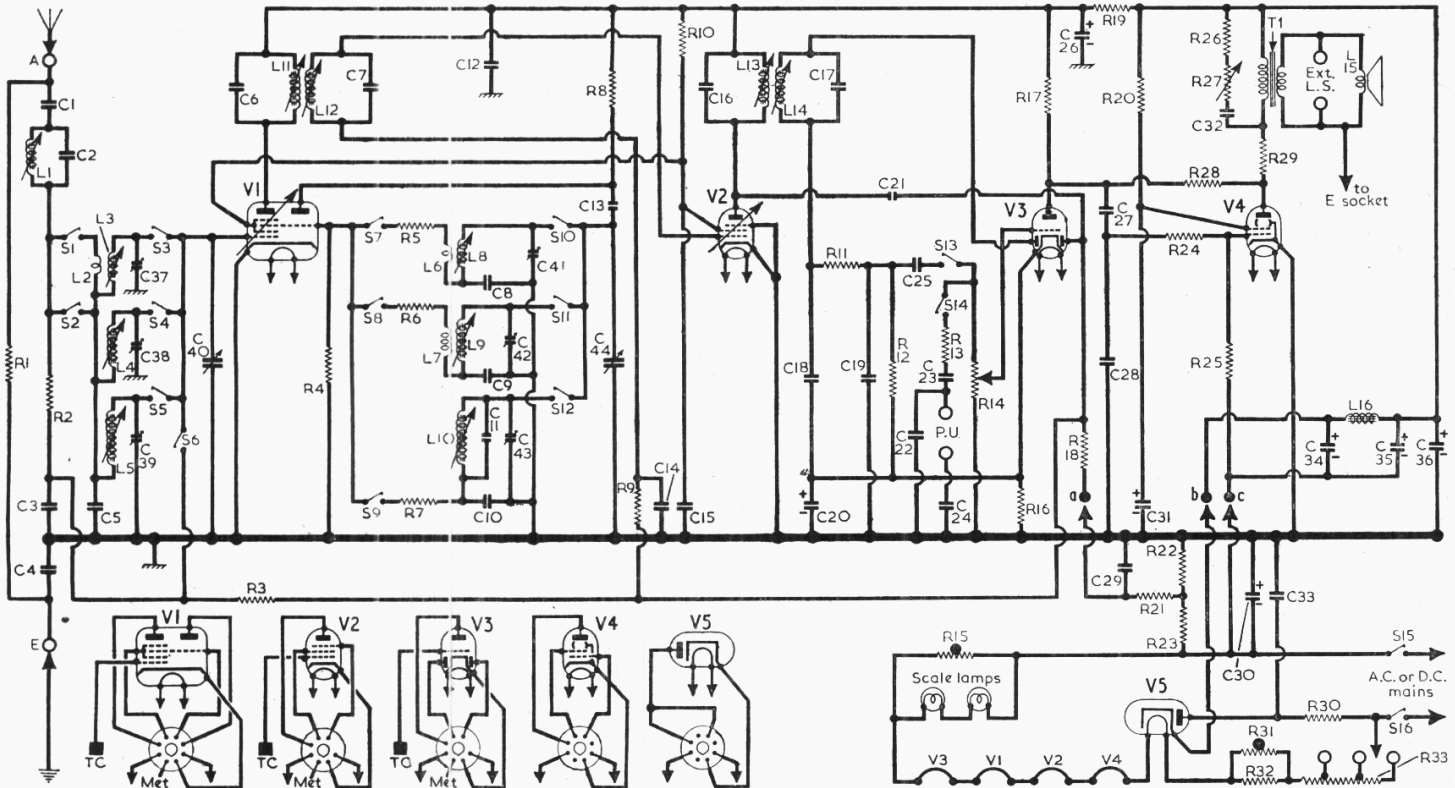

Circuit diagram of the Ace U51 A.C./D.C. superhet, which is the same as that in all A.C./D.C. "Minigram" and "Mayfair" autoradiograms with motors, an electronic convertor unit, whose diagram is shown on the right of the receiver diagram, is used to drive the motor with A.C. power from D.C.

ing by R19, choke L16 and electrolytic capacitors C26, C34, C35 and C36.

Valve heaters together with scale lamps, ballast and voltage adjustment resistors R32, R33 and thermistors R15, R31 are connected in series across the mains input. R15 shunts the scale lamps, and R31 protects the valve heaters from current surges.

In the radiogram models a D.C. to A.C. electronic converter is fitted to supply the gram motor with A.C. from D.C. mains. When the receiver is operated from A.C. mains the converter switch is set to A.C., opening S17, S18 and closing S19 which connects one side of the motor to the converter chassis. Starting the motor by closing motor switch S20 connects the mains input across the motor coils via ballast resistor R46.

When the receiver is operated from D.C. mains, the converter switch is set to D.C., opening S19 and closing S17, S18 which connect the motor coils directly across the output winding of T2. When the motor switch is now closed, the electronic converter is switched on by having its H.T. line connected via S17, motor switch S20 and ballast resistor R46 to the D.C. mains input.

The converter consists of a two valve 50c/s multivibrator (V6a, V6b, Brimar 12AU7) whose frequency is governed by the time-constant of C46, R35 and C47, R34. The output from V6a and b is developed across anode load circuit L17, C48, which is tuned to 50c/s, and passed via C49 and C50 to the control grids of the push-pull connected beam pentode output valves (V7, V8, Emitron or Cossor 185BT's). Output from V7, V8 is coupled via push-pull output transformer T2 and a four-way plug and socket 5, 6, 7, 8 to the gram motor (pin 7 is associated

with the heater ballast resistor R52 and associated components R50, R51, R53 are mounted on the converter chassis in the radiogram models, and are connected by a four-way plug and socket 1, 2, 3, 4. The heaters of V6 are connected in parallel for 0.3 amp operation and together with the heaters of V7, V8 are wired in series with the heaters in the radio chassis. Extra current is passed through V7, V8 heaters by ballast and voltage adjustment resistors R47, R48 and R49 to bring their total current, including the H.T. current from the receiver, up to 0.45 amp.

COMPONENTS AND VALUES

RESISTORS	Values	Locations
R1	Aerial shunts ...	2.2kΩ G4
R2		10kΩ F4
R3	A.G.C. decoupling	1MΩ F4
R4	V1 osc. C.G. ...	47kΩ G4
R5	Oscillator stabilizers ...	22kΩ F3
R6		2.2kΩ F3
R7	Osc. anode load ...	5.6kΩ F3
R8		22kΩ G4
R9	A.G.C. decoupling	1MΩ F4
R10	S.G. feed ...	10kΩ F4
R11	I.F. stopper ...	47kΩ F4
R12	Diode load ...	470kΩ F4
R13	Tone correction ...	22kΩ F4
R14	Volume control ...	1MΩ E3
R15	Thermistor CZ2 ...	— D3
R16	V3 G.B. ...	2.2kΩ F4
R17	V3 anode load ...	220kΩ F4
R18	A.G.C. diode load ...	1MΩ F4
R19	H.T. smoothing ...	1kΩ D3
R20	V4 S.G. feed ...	15kΩ E4
R21	A.G.C. decoupling	1MΩ D3
R22	G.B. resistors ...	68Ω D3
R23		22Ω D3
R24	V4 grid stopper ...	100kΩ E4
R25	V4 C.G. ...	470kΩ E4
R26	Part tone control ...	680Ω D3
R27	Tone control ...	50kΩ D3
R28	Neg. feed-back ...	1MΩ F4
R29	V4 anode stopper ...	47Ω E4
R30	Surge limiter ...	68Ω E4
R31	Thermistor CZ2 ...	— C2
R32	Heater ballast ...	140Ω C2
R33		*530Ω C2
R34	V6a, V6b, C.G. ...	47kΩ K6
R35	V6a, V6b, C.G. ...	47kΩ K7
R36		+20kΩ K6
R37	H.T. smoothing ...	100kΩ L6
R38	V7, V8 C.G. ...	100kΩ L7
R39	V7, V8 C.G. stoppers ...	1kΩ L6
R40		1kΩ L7

Continued next column

\* Tapped at 410Ω+60Ω+60Ω from R32.  
† Two 10kΩ resistors in series.

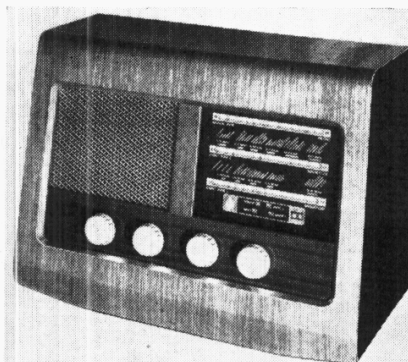

The appearance of the Ace U51 table receiver.

RESISTORS (continued)	Values	Locations
R41	V7, V8 G.B. ...	‡34Ω M6
R42	V7 anode stopper ...	68Ω H5
R43	V7, V8 S.G. stoppers ...	1.1kΩ L6
R44	pers ...	1.1kΩ L7
R45	V8 anode stopper ...	68Ω H5
R46	Motor voltage adj.	\$120Ω J5
R47	V7, V8 heater current boost ...	1.49kΩ J5
R48	V7, V8 heater current boost ...	500Ω L7
R49		500Ω L7
R50	Thermistor CZ2 ...	— J5
R51	Heater ballast resistors ...	410Ω J5
R52		\$120Ω J5
R53	550Ω J5	
R54	140Ω J5	

‡ Two 68Ω resistors in parallel.  
§ Tapped at 60Ω+60Ω.

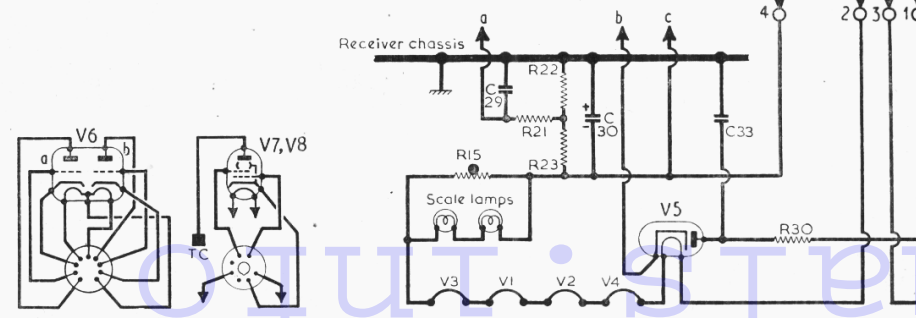
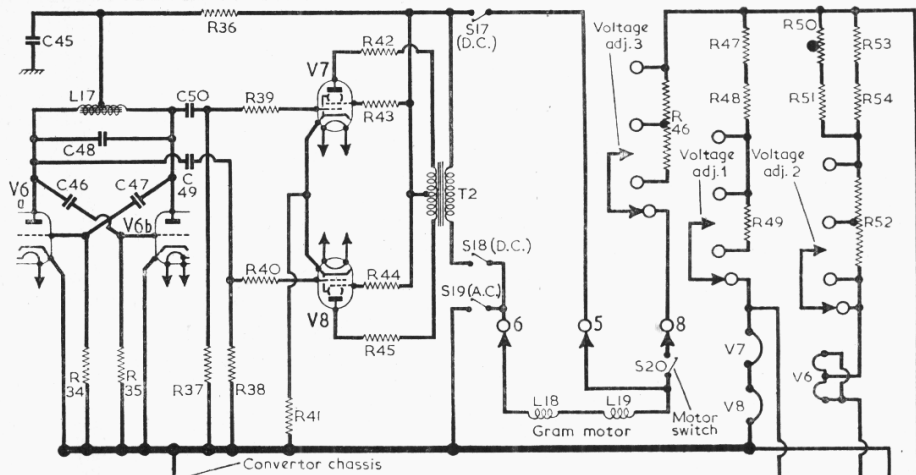

CAPACITORS	Values	Locations
C1	Aerial isolator ...	500pF G4
C2†	I.F. rejector tune ...	800pF G4
C3	A.G.C. decoupling	0.01μF F3
C4	Chassis isolator ...	0.05μF G4
C5	Aerial coupling ...	0.0032μF G3
C6	1st I.F. trans. tuning ...	100pF A2
C7		100pF A2
C8	S.W. osc. tracker ...	0.0022μF F3
C9	M.W. osc. tracker ...	380pF F3
C10	L.W. osc. tracker ...	150pF F3
C11	L.W. osc. trim. ...	25pF F3
C12	R.F. by-pass ...	0.1μF F4
C13	Osc. anode coup. ...	50pF G3
C14	A.G.C. decoupling	0.01μF G4
C15	S.G. decoupling ...	0.1μF F4
C16	2nd I.F. trans. tuning ...	100pF A2
C17		100pF A2
C18	I.F. by-passes ...	120pF F4
C19		120pF F3
C20*	V3 cath. by-pass ...	50μF E4
C21	A.G.C. coupling ...	23pF F4
C22	P.U. shunt ...	250pF F4

†Two capacitors, 300pF + 500pF, in parallel.  
||Two capacitors, 0.0014μF + 0.0018μF in parallel.  
\*Electrolytic.

If the component numbers given in the accompanying tables are used when ordering replacement parts, dealers are advised to mention the fact on the order, as these numbers may differ from those used in the manufacturer's diagram.

radiograms which are fitted with A.C./D.C. gramophone motors. When the A.C./D.C. autoradiograms are fitted with A.C. power from D.C. mains. Switching arrangements matters so that on A.C. mains the motor is connected directly across the mains.



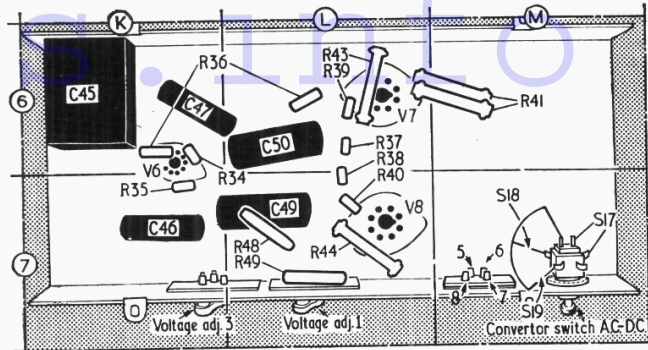
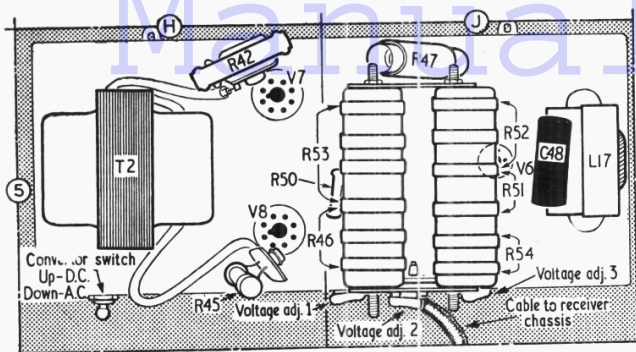

Plan view (left) and underside (right) illustrations of the electronic converter unit. The three voltage adjustment panels are grouped in a triangle at the rear. The A.C./D.C. change-over switch **S17-S19** is replaced by a plug-and-socket device in later models. The 4-pin socket numbered 5, 6, 7, 8 accepts the motor plug.

VALVE ANALYSIS

Valve voltages and currents given in the table below are those measured in our receivers. The figures for **V1-V5** were measured in a table model when it was operating from 230 V A.C. mains and tuned to the highest wavelength end of M.W. There was no signal input. The figures for **V6-V8** were measured in the converter unit of a radiogram model when it was switched to D.C., and operating from 230 V D.C. mains with the gram motor running. Voltage readings were measured with an Avo Electronic TestMeter, and as this instrument draws no appreciable current, allowance must be made for the current drawn by other types of meter. The A.C. voltage measured across the gram motor input with the converter operating from 230 V D.C. mains was 230 V. The receiver chassis was the negative connection for voltage readings from **V1-V5** and the converter chassis for readings from **V6-V8**.

Valve	Anode		Screen		Cath.
	V	mA	V	mA	
V1 6K8GT	192	2.6	110	5.4	—
	Oscillator { 105 4.0 }				
V2 6K7GT	195	4.7	110	2.4	—
V3 6Q7GT	95	0.4	—	—	1.2
V4 25L6GT	175	66.0	135	4.5	—
V5 25Z4GT	220†	—	—	—	230-0
V6 6A	68	3.0	—	—	—
V7 12AU7 1b	68	3.0	—	—	—
V7 185BT	175	115.0	165	16.0	9.5
V8 185BT	175	115.0	165	16.0	9.5

† A.C. reading.

GENERAL NOTES

**Switches.**—**S1-S12** are the waveband switches, and **S13, S14** are the radio-gram change-over switches, ganged in a single rotary unit beneath the chassis. The unit is indicated in our under-chassis illustration and shown in detail in the diagram in col. 4, where it is drawn as seen from the rear of an inverted chassis.

The table below it gives the switch positions for the four control settings, starting from the fully anti-clockwise position of the control knob. A dash indicates open, and **C**, closed.

**S15, S16** are the Q.M.B. mains switches, in a double-pole unit ganged with the volume control **R14**.

**Scale Lamps.**—These are two M.E.S. lamps, with small clear spherical bulbs rated at 6.5 V, 0.3 A. They are shunted by a Brimistor **C22, R15**.

**External Speaker.**—Two sockets are provided at the rear of the chassis for the connection of a low impedance (about 3-4 Ω) speaker.

**Drive Cord Replacement.**—About 50 inches of high-grade flax fishing line is required for a new drive cord, which should be run as shown in the sketch in col. 6 where it is drawn as seen from the rear of the chassis, neglecting obstructions, when the gang is at maximum capacitance.

**Capacitor C4.**—This is a 4μF paper type capacitor decoupling the H.T. feed to the converter oscillator. An electrolytic should not be used as a replacement because if the mains plug is inserted with reversed polarity, this will be applied to the capacitor as soon as the motor is switched on. The motor, of course, will not run under these conditions as the H.T. supply to the anodes of the converter is reversed.

**Resistors R30, R42, R45.**—These are 68 Ω resistors in the anode circuits of heavy-duty valves, and they are rated at 2 W dissipation.

MODIFICATIONS

**Export models.**—There are two versions of the U51 A.C./D.C. receiver for export, one with S.M.L. wavebands, as in the home version, and one with S.S.M. wavebands. The differences between the circuit of the home model and that of the export versions are that the latter are equipped with a cathode ray tuning indicator (Brimar 6U5G) and that the aerial circuit switcher is omitted.

DISMANTLING

**Removing Chassis.**—Remove control knobs (pull-off) and felt washers; unsolder leads from speech coil tags on speaker; remove four 2BA bolts with washers securing chassis to cabinet and withdraw chassis.

The foregoing applies to the table models only; the fixing is different in the radiograms.

Plan view of the receiver chassis as it is in the normal models. In those radiograms which use a converter, the heater ballast resistor **R32, R33** is in the converter unit.

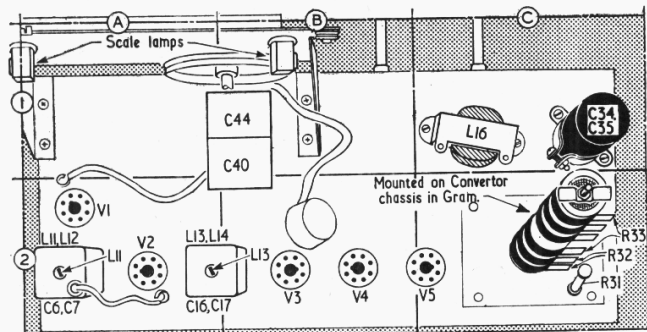

CAPACITORS (Continued)	Values	Locations
C23 } P.U. isolators ...	0.1μF	F4
C24 } ...	0.1μF	F4
C25 } A.F. coupling ...	0.1μF	F3
C26* } H.T. smoothing ...	8μF	E3
C27 } A.F. coupling ...	0.01μF	F4
C28 } I.F. by-pass ...	250pF	E4
C29 } A.G.C. decoupling ...	0.01μF	F4
C30* } G.B. by-pass ...	50μF	E3
C31* } V4 S.G. decoup. ...	8μF	E3
C32 } Part tone control ...	0.05μF	D3
C33 } Mains R.F. filter ...	0.05μF	E4
C34* } ...	16μF	C1
C35* } H.T. smoothing ...	16μF	C1
C36* } ...	12μF	D3
C37† } S.W. aerial trim. ...	—	G3
C38† } M.W. aerial trim. ...	—	G3
C39† } L.W. aerial trim. ...	—	G3
C40† } Aerial tuning ...	—	A1
C41† } S.W. osc. trim. ...	—	F3
C42† } M.W. osc. trim. ...	—	F3
C43† } L.W. osc. trim. ...	—	F3
C44† } Oscillator tuning ...	—	A1
C45† } H.T. decoupling ...	4μF	K6
C46† } Multi-vibrator re- action coup. ...	0.1μF	K7
C47 } Osc. anode tune ...	0.2μF	J5
C48 } ...	0.5μF	L7
C49 } ...	0.5μF	L6

\*Electrolytic. †Variable. ‡Pre-set.  
§Paper type, not electrolytic.

OTHER COMPONENTS	Approx. Values (ohms)	Locations
L1 } I.F. filter ...	1.8	G4
L2 } S.W. aerial coup. ...	—	G3
L3 } ...	—	G3
L4 } Aerial tuning coils ...	1.7	G3
L5 } ...	40.0	G3
L6 } Reaction coupling ...	0.4	F3
L7 } ...	1.0	F3
L8 } ...	—	F3
L9 } Oscillator tuning ...	5.5	F3
L10 } ...	17.5	F3
L11 } 1st I.F. trans. {Pri. ...	9.0	A2
L12 } ... {Sec. ...	9.0	A2
L13 } 2nd I.F. trans. {Pri. ...	6.0	A2
L14 } ... {Sec. ...	6.0	A2
L15 } Speech coil ...	2.5	—
L16 } Smoothing choke ...	140.0	C1
L17 } Converter osc. coil ...	650.0	J5
L18 } Gram. motor coils ...	230.0	—
L19 } ...	230.0	—
T1 } O.P. trans. {Pri. ...	500.0	E3
T2 } ... {Sec. ...	0.5	—
S1-S14 } Converter {Pri., total ...	50.0	H5
S15 } O.P. trans {Sec. ...	65.0	—
S16 } Waveband switches ...	—	G3
S17 } Mains sw., g'd R14 ...	—	E3
S19 } Converter switches ...	—	M7
S20 } Gram. motor sw. ...	—	—



Where we show **S1** in the home model, there is a short-circuit, and **S2** is omitted, as are **S6** and **S13** also. The switch unit is a simple rotary type with twelve contacts, the tags of two being nipped off, and it has four settings.

**Autoradiograms.**—There are several series of A.C./D.C. radiograms, with varying type numbers which need not be detailed here, but they divide up electrically into four kinds: (i) uses an unmodified U51 chassis with a single-speed A.C./D.C. record changer; (ii) is like (i) but has a 3-speed A.C./D.C. record changer; (iii) uses a modified U51 chassis with a single-speed A.C. record changer whose motor is run on D.C. mains from an electronic D.C. to A.C. converter; (iv) is like (iii) but has a 3-speed A.C. record changer whose motor is run from an electronic D.C. to A.C. converter. The model numbers covered are explained in the introduction and the title of this *Service Sheet*. Models designed for A.C. mains only are not covered at all.

**Universal Motors.**—Where the radiogram is fitted with an A.C./D.C. record-changer and the electronic converter is not needed, a standard U51 chassis is employed, as used in the table receiver, but in some models **R13**, **C22**, **C23** and **C24** are omitted and the pick-up is fed in via a matching transformer. One end of the primary goes to the **E** socket, and one end of the secondary goes to chassis.

**A.C. Motors.**—Where the radiogram is fitted with an A.C. record changer, an electronic converter is used on D.C. mains to supply A.C. to the motor, and the use of this involves physical changes in the chassis as compared with that in the U51 table model, although the circuit is not very different electrically. The same modification with regard to the pick-up input obtains as was described for universal motors.

**Converter Models.**—The physical differences involved in the models using the converter are associated with the power supply components, of which the heater ballast resistor is removed from the radio chassis and is included in the converter.

In order to make this quite clear, the affected part of the receiver circuit is redrawn, in our main diagram overlaid, beneath the converter circuit as it is in the converter models, although all the circuit shown below the chassis line of

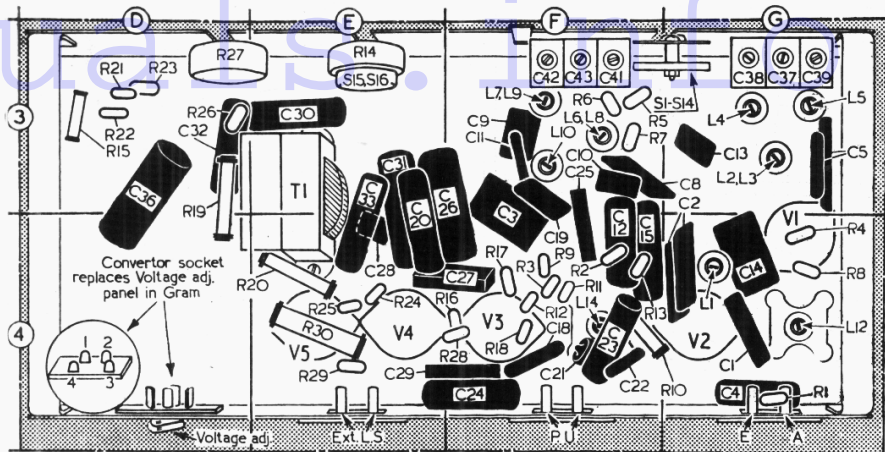

Underside drawing of the radio receiver chassis, with inset at the lower left-hand corner a diagram of the converter socket which takes the place of the voltage adjustment panel in the converter-type radiograms.

the heaters of the converter valves are included in the series heater chain. The two halves of the **V6** heater are connected in parallel to match the 0.3 A heater circuit, but the heaters of **V7** and **V8**, which are rated at 0.45 A, are at the "earthy" end of the chain and have a separate ballast resistor **R47**, **R48**, **R49** which passes 0.15 A, shunting the original heater circuit and bringing the total current for **V7**, **V8** up to the rated value.

**Converter Unit.**—The converter consists of a multi-vibrator type of 50 c/s oscillator driving a push-pull output stage of large-output valves whose output is transformer coupled to the A.C. motor of the gramophone, and it is required, of course, only when the A.C./D.C. receiver is operating from D.C. mains.

Change-over from A.C. to D.C. and vice versa is effected either by a double-pole 2-way switch or a plug-and-socket device. In either case the change-over is represented by switches **S17**, **S18**, **S19**, as explained in "Circuit Description." When a switch is used, its toggle is up for D.C., and down for A.C.; when a plug-and-socket arrangement is used, the plug goes to the upper sockets for D.C., and to the lower ones for A.C.

The gramophone motor is connected to the converter unit by means of plug and socket 5, 6, 7, 8, the socket being mounted on the rear member of the converter, and pin 7 being unused. The converter is connected to the receiver by a similar plug, whose socket is mounted on the rear member of the receiver chassis (it takes the place occupied in normal U51 receivers by the voltage adjustment panel). The mains input to the converter is via the receiver and then via pins 1 and 3 of the plug, and the heaters are connected in the series via pins 2 and 4. The chassis of the converter is at a different potential from that of the receiver.

For D.C. operation the gramophone motor is connected directly across the converter output transformer secondary, and the motor switch **S20** controls the H.T. supply to the converter valves. For A.C. mains **S20** controls the mains supply to the motor. If the converter model is connected to D.C. mains, therefore, while adjusted for A.C. the motor will burn out.

Voltage adjustment in the converter models requires attention at three points, all located on the converter unit. In our diagram they are numbered 1, 2 and 3. Unfortunately, in our sample at least, all the adjustment panels are not mounted at the same angle, so that although they have been grounded fairly close together it is not a simple matter to see that they are adjusted for the same settings, and the lettering on the panels must be read. In our specimen, adjustment No. 2 was mounted at right-angles to the other two.

H.T. current from the radio receiver, besides heater current from the receiver and the additional ballasting current from the voltage adjustment No. 1 ballast circuit, flows through the converter output valve heaters **V7** and **V8**, and the total current through them should be 0.45 A. The current through the oscillator valve heater **V6** is 0.3 A through the two halves connected in parallel. The rated current for each half is 0.15 A.

**CIRCUIT ALIGNMENT**

It is necessary before carrying out the following alignment procedure to remove the chassis from its cabinet in order to make all the core and trimmer adjustments accessible.

**I.F. Stages.**—Switch receiver to M.W. and turn gang to maximum capacitance. Connect output of signal generator, via 0.1 μF capacitor in each lead, to control grid (top cap) of **V1** and chassis. Feed in a 472 kc/s (635.6 m) signal and adjust the cores of **L14** (location reference **F4**), **L13** (**A2**), **L12** (**G4**) and **L11** (**A2**) for maximum output. Repeat those adjustments.

**R.F. and Oscillator Stages.**—Transfer signal generator leads, via a suitable dummy aerial, to **A** and **E** sockets.

**L.W.**—Switch receiver to L.W., tune to 2,000 m, feed in a 2,000 m (150 kc/s) signal and adjust the cores of **L10** (**F3**) and **L5** (**G3**) for maximum output. Tune receiver to 1,000 m, feed in a 1,000 m (300 kc/s) signal and adjust **C43** (**F3**) and **C39** (**G3**) for maximum output. Repeat these adjustments.

**M.W.**—Switch receiver to M.W., tune to 500 m, feed in a 500 m (600 kc/s) signal and adjust the cores of **L9** (**F3**) and **L4** (**G3**) for maximum output. Tune receiver to 200 m, feed in a 200 m (1,500 kc/s) signal and adjust **C42** (**F3**) and **C38** (**G3**) for maximum output. Repeat these adjustments.

**S.W.**—Switch receiver to S.W., tune to 50 m, feed in a 50 m (6 Mc/s) signal and adjust the cores of **L8** (**F3**) and **L3** (**G3**) for maximum output. Tune receiver to 20 m, feed in a 20 m (15 Mc/s) signal and adjust **C41** (**F3**) and **C37** (**G3**) for maximum output. Repeat these adjustments.

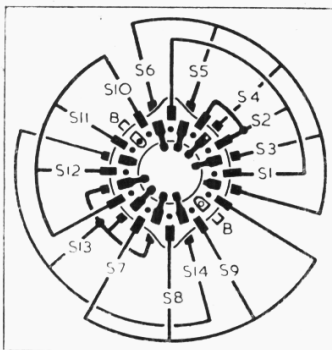
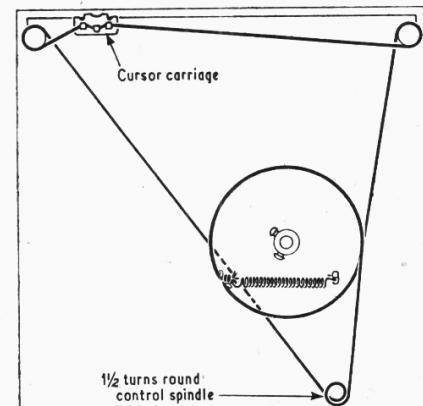

Diagram of the waveband switch unit, drawn as seen from the rear of an inverted chassis. Below is the associated switch table.

Switches	S.W.	M.W.	L.W.	Gram.
S1	C	—	—	—
S2	—	C	C	—
S3	C	—	—	—
S4	—	C	—	—
S5	—	—	C	—
S6	—	—	—	C
S7	C	—	—	—
S8	—	C	—	—
S9	—	—	C	—
S10	C	—	—	—
S11	—	C	—	—
S12	—	—	C	—
S13	C	C	C	—
S14	—	—	—	C

the converter unit is actually in the receiver chassis. Points **a**, **b** and **c** show where the affected part of the circuit joins the rest of the receiver.

It will be seen that the ballast circuit is a little different from that in the U51, and that



Sketch of the drive cord system, drawn as seen from the rear of the chassis, neglecting obstructions.