

**CITIZENS**

**RADIO  
CALLBOOK**

**50 Cents**

**FOREIGN 65 CENTS**



**A  
COMPLETE  
RADIO  
CYCLOPEDIA**

**THIS ISSUE**

World's  
Broadcasting Stations  
Maps  
Log Sheets  
Distance-Charts  
60 Kilocycle "Super"  
Reflexed-"Super"  
Five Tube "D" Coil  
Reflex  
Dresnadyne  
All  
Latest "Hook Ups"  
and  
Operating Data

**CIRCULATION THIS ISSUE  
OVER 200,000 COPIES**

*Printed in the  
United States of America*

**USED THE WORLD OVER**

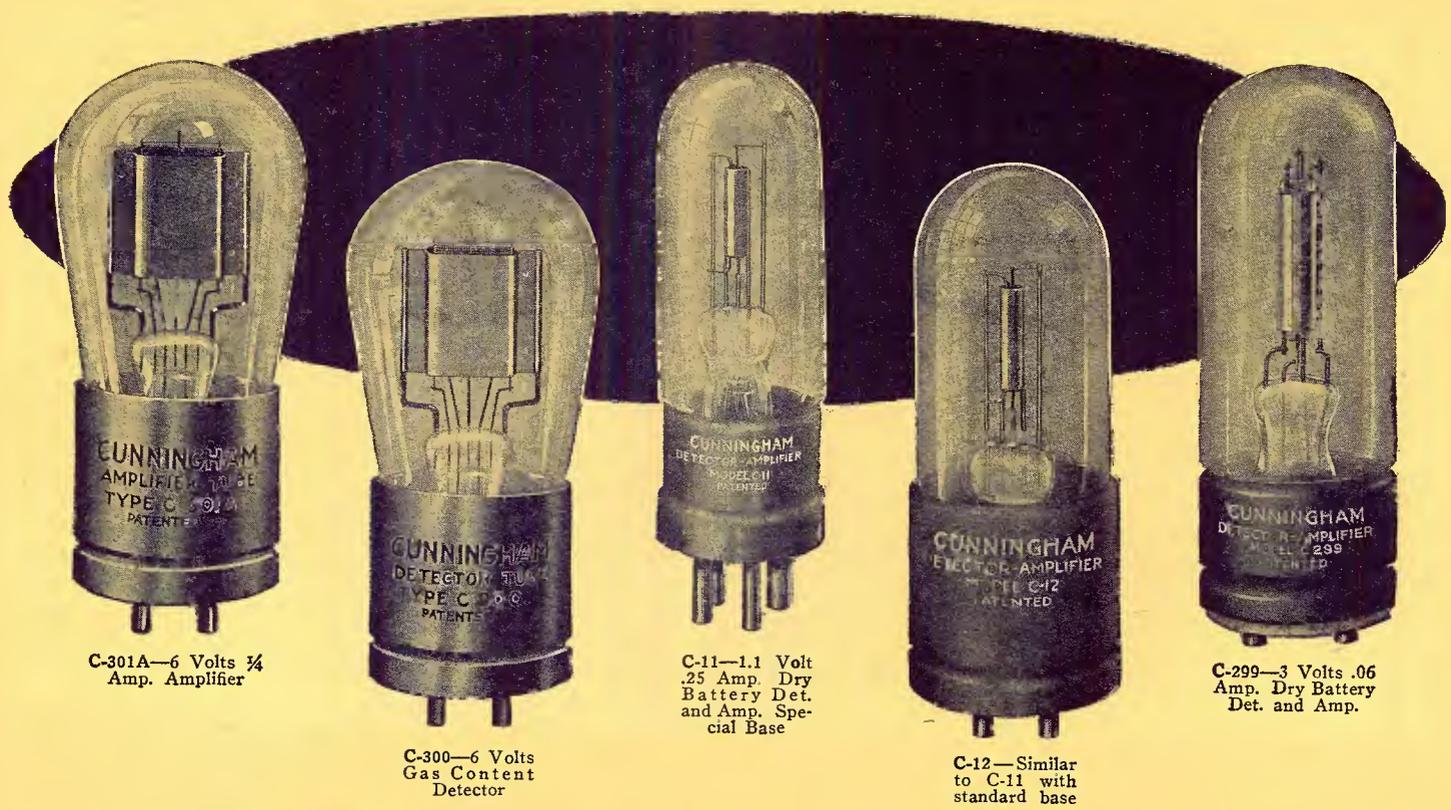

C-301A—6 Volts  $\frac{1}{4}$  Amp. Amplifier

C-300—6 Volts Gas Content Detector

C-11—1.1 Volt .25 Amp. Dry Battery Det. and Amp. Special Base

C-12—Similar to C-11 with standard base

C-299—3 Volts .06 Amp. Dry Battery Det. and Amp.

# Cunningham RADIO TUBES

SINCE 1915 STANDARD FOR ALL SETS

*In the Orange and Blue Carton*

*Type C-301A, C-300, C-299, C-11, C-12*

Three of these five tubes are designed to use dry batteries for filament lighting. C-299 is compact in design and highly efficient in operation as a radio frequency amplifier, a detector and as an audio-frequency amplifier. When used for the latter purpose, the output of two stages is sufficient for the operation of a small loud speaker.

The most remarkable feature of this tube is the new patented filament used which draws only .06 amperes at 3 volts.

C-11 is a dry battery tube with a special base for use in sets having special sockets. It is a good detector and audio-frequency amplifier. The filament is lighted from a single dry battery and draws .25 amperes.

C-12 is identical to C-11 in operating characteristics, but is mounted on a standard base to permit the use of a dry battery tube in sets equipped with standard sockets without the aid of special adaptors.

Whenever storage battery supply is available for filament lighting, the C-300 will be the best tube to use as a detector because it is the most sensitive for the reception of distant and weak signals.

Under the same condition, C-301A will be the best tube for amplification at either radio or audio frequency, because it gives greater gain per stage than any other tube on the amateur market. The new patented filament used, similar to that in C-299, draws only .25 amperes at 6 volts, reducing the necessity of frequent storage battery charging.

### Patent Notices

Cunningham tubes are covered by patents dated 2-18-08, 2-18-12, 12-30-13, 10-23-17, 10-23-17, and others issued and pending. Licensed for amateur, experimental and entertainment use in radio communication. Any other use will be an infringement.

*E. J. Cunningham Inc.*

Branch  
Chicago

Home Office: 182 Second St.  
San Francisco, Calif.

Branch  
New York

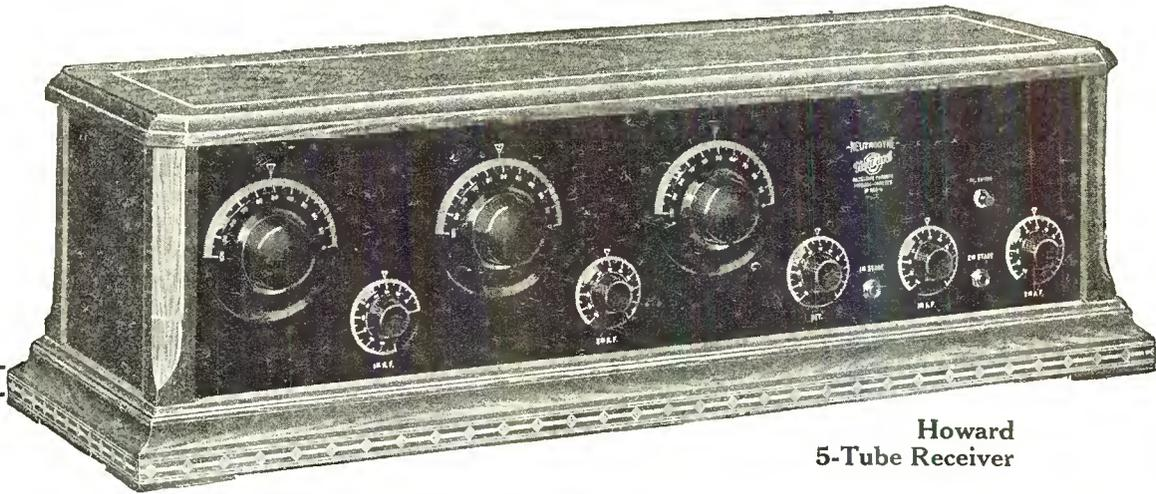

Howard  
5-Tube Receiver

**S**ELECTIVITY; distant reception range, volume and ease of operation are the most important things to consider when buying your radio receiver. To be sure that your selection will provide these essentials choose the Howard Five Tube Neutrodyne—it bears this label.



A Howard in your home will include practically all the United States and Canada as your neighborhood. To be content with less robs you of the satisfaction and realization of true radio reception.

*Any Howard dealer will be pleased to give you a demonstration.*

**Howard Manufacturing Company**  
Dept. C      451-469 E. Ohio Street      Chicago

Reg. U.S. Pat. Off.      Licensed by  
Independent Radio Manufacturers, Inc.      Reg. U.S. Pat. Off.  
**NEUTRODYNE**  
Pat. March 27, 1923 and April 1, 1924  
Hateline Pats. Nos. 1450,080 and 1469,229  
Other Patents Pending

# FROST-RADIO

*Ask Your Neighbor*

"TRUE REPRODUCTION

## Musette

OF VOICE AND MUSIC"

Popularly Priced

**\$12.50**

*in black finish*

**\$20**

*in silver or gold finishes*



## FROST-RADIO ACCESSORIES

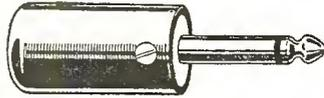

No. 137 **FROST-RADIO** Cord Tip Plug, \$1.25

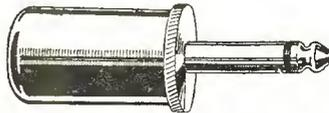

No. 139 **FROST-RADIO** Cord Tip Plug, 50c

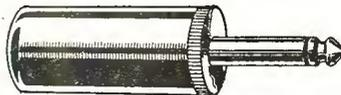

No. 140 **FROST-RADIO** 2-Fone Plug, 60c

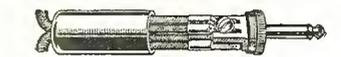

No. 141 **FROST-RADIO** Automatic 2-Fone Plug, 75c



**FROST-RADIO** Pan-Tab Jack Switches, \$1.00 to \$1.30

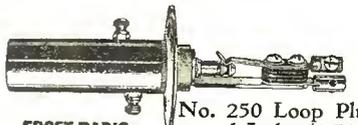

**FROST-RADIO** No. 250 Loop Plug and Jack, \$1.50

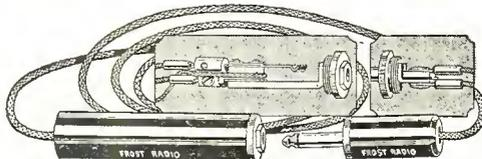

**FROST-RADIO** No. 332—30-foot Extension Cord, complete with plug and jack housing, twin conductor cord. . . . . \$2.50  
No. 336—Mounted Jack only, 75c



**\$4.00**  
**\$5.00**  
**\$6.00**

## FROST FONES

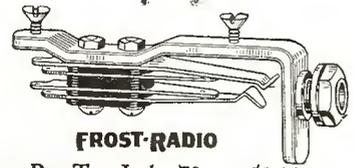

**FROST-RADIO** Pan-Tag Jacks 70c to \$1.00



No. 712 Musselman Selective Antenna, 75 feet, \$5.00

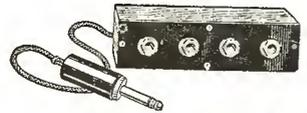

No. 501 **FROST-RADIO** Jac-Box, complete with cord and plug, \$2.50

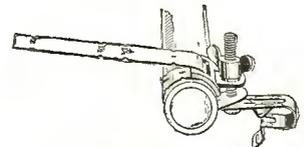

**FROST-RADIO** Ground Clamp 30c

# HERBERT H. FROST, Inc.

314-324 WEST SUPERIOR STREET, CHICAGO, ILLINOIS  
NEW YORK CITY CLEVELAND KANSAS CITY LOS ANGELES

# FROST-RADIO

*Ask Your Neighbor*

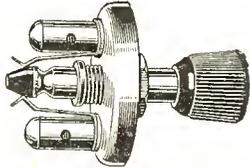

**FROST-RADIO**

No. 608 Push-Pull Battery Switch, single hole mounting, complete .....30c



**FROST-RADIO**

No. 622, BAKELITE Toggle Switch, Black, 50c  
No. 623, BAKELITE Toggle Switch, Maroon .....50c

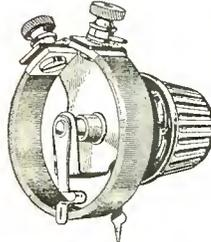

**FROST-RADIO**

No. 600 — Metal Frame Plain Rheostat, 6 ohm. .... 65c  
No. 602 — Metal Frame Plain Rheostat, 35 ohms ..... 65c  
No. 606 — Metal Frame Plain Rheostat, 25 ohms ..... 65c

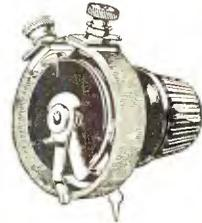

**FROST-RADIO**

No. 601—Metal Frame Vernier Rheostat, 6 ohms ..... 80c  
No. 604—Metal Frame Vernier Rheostat, 35 ohms ..... 80c  
No. 613—Metal Frame Vernier Rheostat, 25 ohms ..... 80c

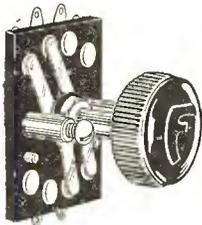

**FROST-RADIO**

No. 621, BAKELITE Series-Parallel Switch.....50c

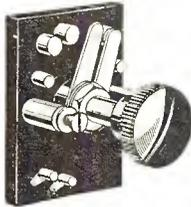

**FROST-RADIO**

No. 620, BAKELITE Potentiometer Cut - Out Switch .....50c

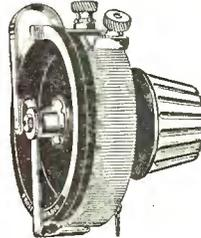

**FROST-RADIO**

No. 650, BAKELITE Plain Rheostat, 6 ohms .....\$1.10  
No. 652, BAKELITE Plain Rheostat, 35 ohms.....\$1.10  
No. 656, BAKELITE Plain Rheostat, 25 ohms .....\$1.10  
No. 651, BAKELITE Vernier Rheostat, 6 ohms.....\$1.25  
No. 653, BAKELITE Vernier Rheostat, 35 ohms .....\$1.25  
No. 657, BAKELITE Vernier Rheostat, 25 ohms .....\$1.25

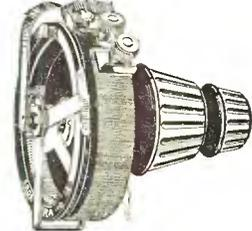

**FROST-RADIO**

No. 607, BAKELITE Tube Control Unit, combining 6 ohm Vernier Rheostat and 400 ohm Potentiometer, .....\$1.75  
No. 609, Same as No. 607, but with 25 ohm Rheostat and 400 ohm Potentiometer, .....\$1.75  
No. 610, Same as No. 607, but with 35 ohm Rheostat and 400 ohm Potentiometer, .....\$1.75

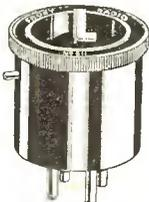

**FROST-RADIO**

No. 611, BAKELITE Adapter for UV-199 C-299 Tubes .....50c

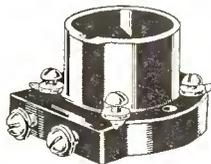

**FROST-RADIO**

No. 612, BAKELITE Socket for UV-199 C-299 Tubes, panel or table mounting .....60c



**FROST-RADIO**

No. 619 BAKELITE Shock-absorber Socket, 3 - Gang Standard Base Type.....\$3.25

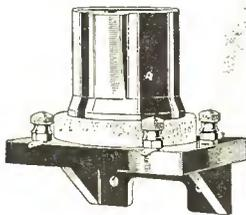

**FROST-RADIO**

No. 618, BAKELITE Shock - Absorber Socket, Standard base type, for panel or table mounting.. .....\$1.25



**FROST-RADIO**

No. 614 BAKELITE Heavy Duty Socket....65c

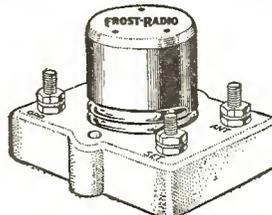

No. 700 **FROST-RADIO** Protector, complete, \$1.50

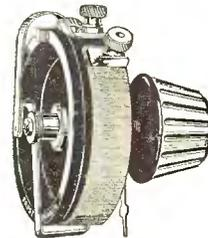

**FROST-RADIO**

No. 654, BAKELITE Potentiometer, 0-400 ohms....\$1.25  
No. 655, BAKELITE Potentiometer, 0-200 ohms....\$1.25

## HERBERT H. FROST, Inc.

314-324 WEST SUPERIOR STREET, CHICAGO, ILLINOIS  
NEW YORK CITY CLEVELAND KANSAS CITY LOS ANGELES

QUALITY RADIO EXCLUSIVELY — EST. 1918



**I**N the home of TELMACO—the home of quality radio products—there is a steadfast belief that quality is necessary for continued business success.

To you as a dealer, quality is a road to steady and profitable growth, and to us, as a manufacturer and jobber, there is great satisfaction in the fulfillment of this obligation to you.

Of equal importance to dealers, is our service. Radio service, as we understand it is something more than careful filling of orders

and prompt deliveries. TELMACO Service includes something better—a whole-hearted interest in development of more profitable merchandise by dealers together with constant effort to improve upon our own job as a manufacturer and distributor of radio products of quality.

We realize that the extent of our success is entirely contingent upon yours. Therefore we solicit a continuance of your valued patronage and we sincerely hope to merit it through consistent care and attention to every detail of all transactions.

**We Are Jobbers for These Well Known Quality Products**

- |               |              |            |            |              |            |          |            |
|---------------|--------------|------------|------------|--------------|------------|----------|------------|
| Accuratune    | Amsco        | Carter     | Filko      | Henninger    | Muter      | Remler   | Trimm      |
| Acme          | Branston     | Chelten    | Flewelling | Howard       | Na-Ald     | Saal     | Thordarson |
| All-American  | Bremer-Tully | Cunningham | Formica    | Jewell       | Pfanstiehl | Se-Ar-De | Vesta      |
| Allen-Bradley | Balkite      | Dubilier   | Freshman   | Karas        | Philco     | Signal   | Walnut     |
| Amer-Tran     | Burgess      | Electrad   | Frost      | King         | Premier    | Sodion   | Weston     |
| Amperite      | Cardwell     | Eby        | Harkness   | Music Master | Radiodyne  | Sterling | Willard    |
- and many others*

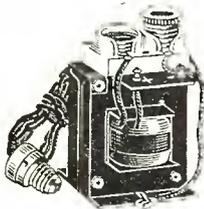

**T-100  
Charger**

The lowest priced battery charger on the market. No vibrating parts to get out of order. Noiseless in operation.



**Radiodyne WC-14**

This is a five-tube set of exceptional high quality. Two stages tuned R. F. Detector and two stages A. F. Priced remarkably low.

**Cunningham  
Tubes**

Cunningham Tubes have been the choice of Radio users for many years. Why take chances with unknown makes?



**Music  
Master**

This horn enhances all the full natural tones and makes your reception a hundred per cent perfect. 14" or 21" mahogany finish.



**—and Now! You Can Buy  
The Famous  
TELMACO P-1 RECEIVER  
in Kit Form**

In response to a mighty demand from the radio public, we now offer the TELMACO P-1 Receiver in kit form. The kit contains all parts, as built by us, including case, drilled and engraved panel, and complete illustrated instructions. The complete kit is now offered for only .....\$80.00

*Ask your dealer or write us direct.*



This is the famous Telmaco P-1 Receiver, the wonder portable radio set. Beautifully made for home use as well as outings. Four tubes do the work of seven. Coast to coast on self contained loud speaker. Complete with batteries and tubes.....\$143.50

**TELEPHONE MAINTENANCE CO.**

20 So. Wells St.

Chicago, Ill.

# GENERAL RADIO Condensers

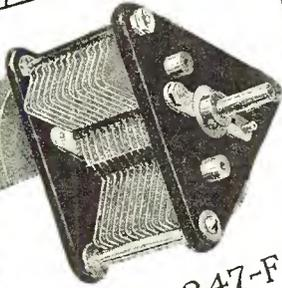

Type 247-F

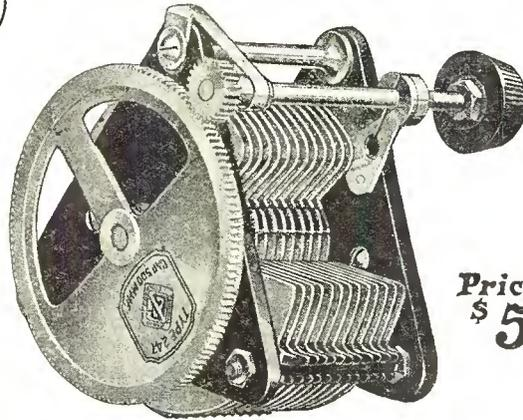

Type 247-H

Price  
\$5



Type 247-G

## The Standards of Excellence Since 1915

**T**HE original low loss condenser was introduced in 1915 by the General Radio Company.

This instrument heralded an era of rapid advancement in the science of radio.

Today the design and performance of the General Radio Type 247 Condensers merit their distinction as the standards of excellence:

Eight different models are now available for various radio requirements. All of these models incorporate the following features, which contribute to lower losses and greater efficiency:

Low resistance losses, because of soldered plates.

Straight line plates, which give a uniform wave-length variation.

Plates always in perfect alignment, being individually straightened before assembly in a jig, and firmly soldered while in position.

Rotor plates counterbalanced to permit greater precision of adjustment.

Mechanically rugged design, which insures faithful performance over long periods of use.

Tight and smooth running spring bearings, adjusted to compensate for wear.

Popular prices, made possible by large-scale production and efficient methods.

Ask your dealer or write for instructive folder "Quality Condensers," containing complete information on all 8 models of General Radio Condensers.

The red cartons with the General Radio label are your unflinching assurance of satisfaction.

# GENERAL RADIO Co

Cambridge, Mass.

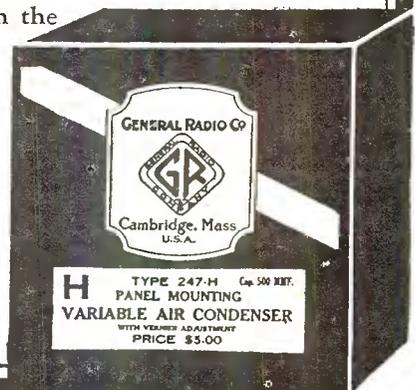

# CITIZENS RADIO CALLBOOK

A  
COMPLETE  
RADIO  
CYCLOPEDIA

Vol. 6

SPRING, 1925

No. 1

## Contents This Issue

American Broadcasting Stations.....	8
Log Sheets .....	22
Distance Chart .....	30
Blank Map .....	32
Map of the United States.....	34
Map of Canada.....	36
Canadian Broadcasting Stations .....	38
Blank Map of the World.....	40
Foreign Broadcasting Stations.....	42
The New Model L-2 Ultradyne.....	45
How to Build the New Three-Tube Ultra-Selective Reflex....	49
A Tuned Radio Frequency Receiver with Deresnated Plate Circuit .....	53
Construction of Reflexed Super-Heterodyne.....	58
A Knockout Receiver .....	63
Build the Greene Concert Selector.....	71
Construction Data on Super-Heterodyne Receivers.....	78
A Description of the New Five-Tube Reflex Using "D" Coil Transformers .....	83
Air Core Transformers.....	106
Glossary .....	120
Index to Advertisers.....	190

Published twice yearly by the

### CITIZENS RADIO SERVICE BUREAU

Executive Offices

508 South Dearborn Street Chicago, Ill., U. S. A.

Telephones—Wabash 8057-8067

CHAS. O. STIMPSON, President E. M. GIBSON, Advertising Manager  
J. R. MAC FARLAND, Vice-President F. C. SPERLING, Circulation Manager  
D. H. BELL, Secretary and Treasurer ARTHUR ELKINS, Technical Editor

#### CONTRIBUTING EDITORS

Kenneth Salisbury, Hogart S. Sweet, Cecil W. Preston, Lloyd C. Greene,  
G. E. M. Bertram

## With the Editor

AGAIN the CITIZENS RADIOCALLBOOK brings to the novice as well as the expert radio fan all the latest developments, illustrated and described in an easily understood manner.

It is the sincere hope of the publishers that the material in this issue will be directly responsible for many happy hours spent with your favorite circuit.

As in the last issue, the Amateur Section has been left out of the main book. A complete book containing an up-to-date list of all the calls in the world is now available for 75c.

While this issue of the Call Book is the most complete ever published, the plans we are laying for the Fall issue bid well to out-do all past efforts.

Again let us repeat what we have always said since the Call Book's inception in the field: "Our entire organization is united in one effort—to produce the most complete, valuable, and accurate Radio Cyclopeda that money can buy."

Copyright, 1925, by Citizens Radio Service Bureau, Incorporated

Requests for permission to reprint any articles or other matter contained in this publication must be made to the Executive Offices

New York City  
1674 Broadway  
Branch Office, Cor. 52nd St.  
Telephone, Circle 4887

Distributed to the Radio Trade by the Radio and Electrical Jobbers in all Principal Cities of the United States and Canada

Dealers supplied by The American News Company and Branches  
England and France: The International News Company, Brems Building,  
London, E. C., England; American News Co. (Havana Branch, Sucursal De  
Cuba, Sol 51, Havana, Cuba; Australia and New Zealand: Gordon & Groch,  
Melbourne, Australia

Boston, Mass.  
99 Chauncy Street  
E. H. Jaudon  
Telephone, Beach 5714

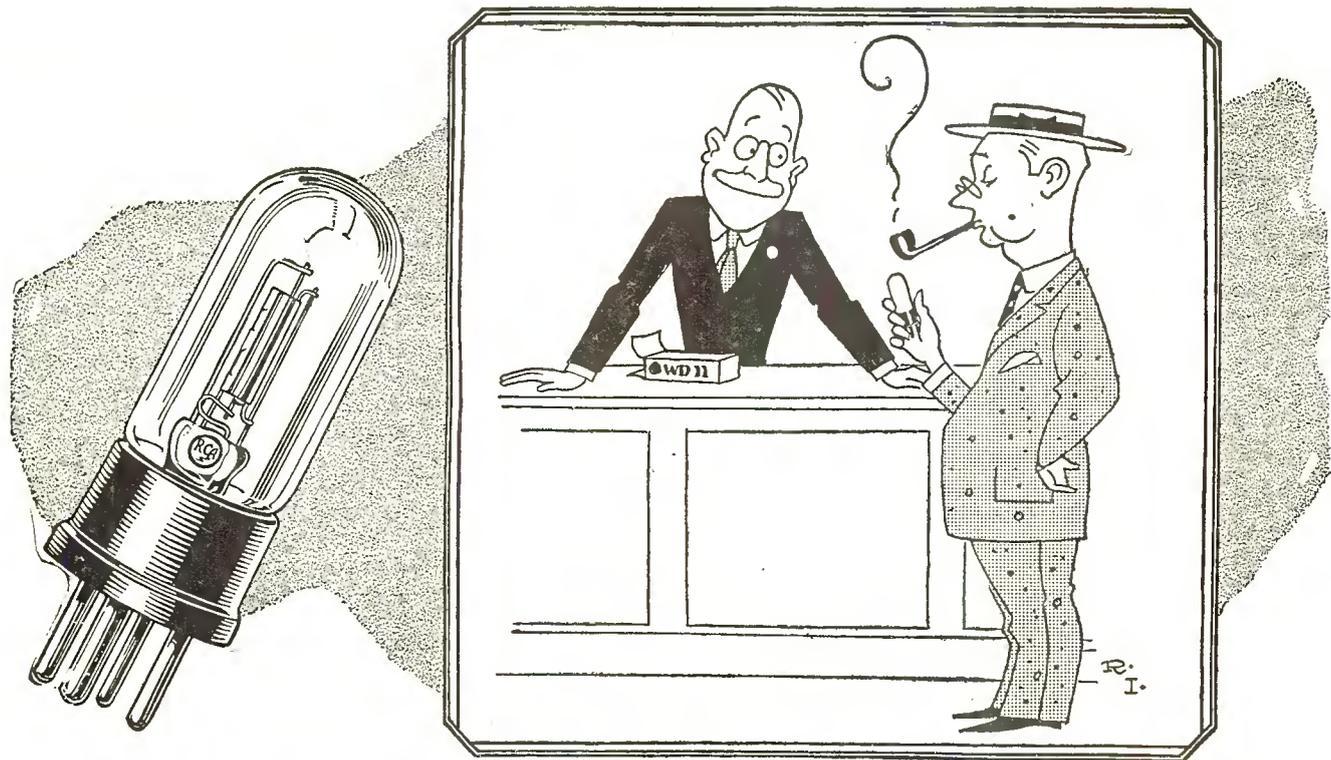

# Don't Buy Just Tubes!



This symbol of  
quality is your  
protection

It isn't a genuine WD-11  
unless it's a Radiotron.  
It isn't a genuine WD-12  
unless it's a Radiotron.  
It isn't a genuine UV-199  
unless it's a Radiotron.  
It isn't a genuine UV-200  
unless it's a Radiotron.  
It isn't a genuine UV-201-a  
unless it's a Radiotron.

If you go into a reliable store and ask for a vacuum tube, you will probably get a genuine Radiotron, because most reputable dealers carry nothing else. And most buyers mean "Radiotron" when they say "tube." But the wise man says "Radiotron." And he takes the precaution to look for the name, and the RCA mark. Those names have a history of invention, research and development back of them that has resulted in the production of the finest tubes possible today. And they have a history of *best performance* right within every fan's experience. That's why knowing fans buy by the name: Radiotron.

Radio Corporation of America

Sales Offices:

233 Broadway, New York

10 So. La Salle St., Chicago, Ill.

28 Geary St., San Francisco, Cal.

# Radiotron

REG. U.S. PAT. OFF.

# Telephone Broadcasting Stations

## For the United States

- KDKA**—Westinghouse Elec. & Mfg. Co., E. Pittsburgh, Pa. 309 meters, 970 kilocycles, class B. Daily ex Sun, 9:45 am, markets; 11:55 am, time signals; noon, weather; 3:30 pm, ex Sat, markets; 6:15 pm, concert; 7:15, stock reports; 7:30, children's hour. Mon, Wed & Fri, 8:15 pm, address; 8:30, concert; 9:55, time signals. Thurs, spec program, 8 pm. Tues & Thurs, 8:30 pm, concert; 9:55, time signals; 11 pm, concert. Tues, 10 pm, basket hall. Mon, Wed & Fri, 7-8 am, exercises. Sat, 1:30 & 6 pm, concert; 7:30 pm, children's hour; 8:30 pm, concert. Sun, 11 am, 2:30 pm & 4 pm, organ; 4:45 pm, vespers; 6:15 pm, concert; 7:45, church services. Slogan: "The Pioneer Broadcasting Station of the World." 1000 watts.
- KDLR**—Radio Elec. Co., Devils Lake, N. D. 231 meters, 1300 kilocycles, class A. 5 watts.
- KDPM**—Westinghouse Elec. & Mfg. Co., Cleveland, Ohio. 250 meters, 1200 kilocycles, class A. Schedule irregular, experimental station. 500 watts.
- KDYL**—Newhouse Hotel, Salt Lake City, Utah. 305 meters, 980 kilocycles, class B. Daily ex Sun 3-4 pm, & 9:30-8 pm. Standard Mountain time. 50 watts.
- KDYM**—The Savoy Theatre, San Diego, Calif. 280 meters, 1070 kilocycles, class A. 100 watts.
- KDZB**—Frank E. Siefert, 1402—20th St., Bakersfield, Calif. 240 meters, 1250 kilocycles, class A. 100 watts.
- KDZE**—Rhodes Dept. Store, Seattle, Wash. 270 meters, 1110 kilocycles, class A. 100 watts.
- KFAB**—Nebraska Buick Auto Co., Lincoln, Neb. 240 meters, 1250 kilocycles, class A. Mon, Wed & Fri, 7:30-9:30 pm. Sun, 4-5 pm, church services. Central standard time. 500 watts.
- KFAD**—McArthur Bros. Merc. Co., Phoenix, Ariz. 360 meters, 844 kilocycles. 100 watts.
- KFAE**—The State College of Washington, Pullman, Wash. 329 meters, 910 kilocycles, class B. Mon, Wed & Fri, 7:30-9 pm. Pacific standard time. 500 watts.
- KFAF**—Western Radio Corp., Denver, Colo. 278 meters, 1080 kilocycles, class A. 500 watts.
- KFAJ**—University of Colorado, Boulder, Colo. 261 meters, 1150 kilocycles, class A. 100 watts.
- KFAN**—University of Idaho, Moscow, Idaho. 231 meters, 1300 kilocycles, class A. 50 watts.
- KFAU**—High School, Boise, Idaho. 275 meters, 1090 kilocycles, class A. Daily ex Sat & Sun, 4-4:45 pm, market, weather, health, music, etc. Mon, Wed & Fri, 8-9:30 pm. Mountain time. 500 watts.
- KFAW**—The Radio Den, 115 No. Broadway, Santa Ana, Calif. 280 meters, 1070 kilocycles, class A. Daily ex Sun, 4-4:30 pm, news. Mon, Wed & Fri, 8-10 pm, concert. Second and fourth Wed, each month, 11-12 pm. Pacific standard time. Slogan: "Where There is Always a Friend from Your Own Home Town". 10 watts.
- KFBB**—F. A. Buttrey & Co., Havre, Montana. 275 meters, 1090 kilocycles, class A. 50 watts.
- KFBC**—W. K. Azbill, 5038 Cliff Place, San Diego, Calif. 278 meters, 1080 kilocycles, class A. Thurs, 7-9 pm. Pacific coast time. 20 watts.
- KFBG**—First Presbyterian Church, Tacoma, Wash. 240 meters, 1200 kilocycles, class A. Sun, 11 am to 1 pm, 7:30-9:30 pm. Pacific standard time. 50 watts.
- KFBK**—Kimball Upon Co., 610 California St., Sacramento, Calif. 283 meters, 1060 kilocycles, class A. 100 watts.
- KFBL**—Leese Brothers, 2814 Rucker Ave., Everett, Wash. 224 meters, 1340 kilocycles, class A. 15 watts.
- KFBU**—The Cathedral, Laramie, Wyo. 270 meters, 1110 kilocycles, class A. Wed, 5:45-6 pm, Cathedral Chimes. Sun, 5 pm, vesper service; 7:30 pm, church services. Mountain time. Slogan: "The Top of the World". 50 watts.
- KFCB**—Nielsen Radio Supply Co., 311 N. Central Ave., Phoenix, Ariz. 238 meters, 1250 kilocycles, class A. Wed, & Fri, 7:30-8:30 pm. Studio program Mountain time. Slogan: "The Pioneer Sportcasters". 50 watts.
- KFCC**—First Congregational Church, Helena, Mont. 247 meters, 1280 kilocycles, class A. Sun, 11 am and 7:30 pm. Mountain time. 10 watts.
- KFCF**—Frank A. Moore, 707 Baker Bldg., Walla Walla, Wash. 256 meters, 1190 kilocycles, class A. Mon, 8-10 pm, studio. Thurs & Fri, 10-12 pm, concert. Pacific standard time. Slogan: "The Valley They Liked So Well They Named It Twice". 100 watts.
- KFCL**—Leslie E. Rice, Los Angeles Union Stock Yards, Los Angeles, Calif. 236 meters, 1270 kilocycles, class A. 500 watts.
- KFCP**—Ralph W. Flygare, 2421 Jefferson Ave., Ogden, Utah. 208 meters, 1440 kilocycles, class A. 10 watts.
- KFCY**—Western Union College, Le Mars, Iowa. 252 meters, 1190 kilocycles, class A. Schedule irregular. Fri, 9-10:30 pm, musical and educational. Central standard time. 50 watts.
- KFCZ**—Omaha Central High School, Omaha, Neb. 258 meters, 1160 kilocycles, class A. 50 watts.
- KFDD**—St. Michaels Cathedral, Boise, Idaho. 275 meters, 1090 kilocycles, class A. 15 watts.
- KFDH**—University of Arizona, Tucson, Arizona. 258 meters, 1150 kilocycles, class A. Schedule irregular. 7:30-8:30 Mountain time. Slogan: "Copper, Cattle, Cotton, Climate". 50 watts.
- KFDJ**—Oregon Agricultural College, Corvallis, Ore. 254 meters, 1180 kilocycles, class A. 100 watts.
- KFDM**—Magnolia Petroleum Co., Beaumont, Texas. 315 meters, 950 kilocycles, class B. Tues & Fri, 7:7:30 pm, children's half hour; 8-10 pm, program. Sun, 9-10 pm, sacred concert. Central standard time. Slogan: "KFDM Call For Dependable Magnolene". 500 watts.
- KFDX**—First Baptist Church, Shreveport, La. 250 meters, 1200 kilocycles, class A. Sun, 11 am and 7:45 pm. Central standard time. 100 watts.
- KFDY**—South Dakota State College, Brookings, S. D. 273 meters, 1100 kilocycles, class A. Daily ex Sun, 12:15 pm, market and weather. Tues, 11 am, Thurs, 8-9 pm, music and lectures. 100 watts.
- KFDZ**—Harry O. Iverson, 2510 Thomas Ave. So., Minneapolis, Minn. 231 meters, 1300 kilocycles, class A. Sun, 6 pm, organ recital. Central Standard time. 100 watts.
- KFEC**—Meyer & Frank Co., Portland, Ore. 248 meters, 1210 kilocycles, class A. 50 watts.
- KFEL**—W. L. Winner Radio Shop, Denver, Colo. 254 meters, 1184 kilocycles, class A. Daily ex Sun, 11-11:45 am, 2-3 and 4-5 pm. Tues, Wed, Thurs & Fri, 10-11 pm. Sun, 3-4:30 pm. Mountain time. 50 watts.
- KFEO**—Scroggin & Co., (Bank) Oak, Neb. 268 meters, 1120 kilocycles, class A. 100 watts.
- KFER**—Auto Electric Service Co., Fort Dodge, Iowa. 231 meters, 1300 kilocycles, class A. Tues & Thurs, 9 pm, musical program. Sun, 9 pm, chapel services. Central standard time. 10 watts.
- KFEX**—Augsburg Seminary, Minneapolis, Minn. 261 meters, 1150 kilocycles, class A. 100 watts.
- KFEY**—Bunker Hill & Sullivan Mining & Concentrating Co., 834 McKinley Ave., Kellogg, Idaho. 234 meters, 1290 kilocycles, class A. Schedule irregular. Slogan: "The Voice of the Coeur d'Alenes". 10 watts.
- KFFP**—The First Baptist Church, Moberly, Mo. 266 meters, 1130 kilocycles, class A. Sun, 9:45 am and 11 am, 7:30 pm, services. Central standard time. Slogan: "The Gospel Messenger of the Air". 50 watts.
- KFFR**—Nevada State Journal, Sparks, Nevada. 226 meters, 1330 kilocycles, class A. 10 watts.
- KFFW**—Graceland College, Lamoni, Iowa. 250 meters, 1200 kilocycles, class A. Mon, 7:30-8:30 pm, musical program. Thurs, 7:30-8:30 pm, educational. First Sun each month, 7:45-9 pm. Second, third and fourth Sun each month, 11 am. Central standard time. Slogan: "The School With a Personal Touch". 100 watts.
- KFFY**—Louisiana College, Alexandria, La. 275 meters, 1090 kilocycles, class A. 50 watts.
- KFGC**—Louisiana State University, Baton Rouge, La. 268 meters, 1120 kilocycles, class A. Schedule irregular. 100 watts.
- KFGD**—Oklahoma College for Women, Chickasha, Okla. 252 meters, 1190 kilocycles, class A. Tues, Thurs & Sat, 8-9 pm. Wed, 10:05-10:45 am. Central standard time. 100 watts.
- KFGH**—Leland Stanford Junior University, Stanford University, Calif. 273 meters, 1100 kilocycles, class A. 500 watts.
- KFGQ**—The Crary Hardware Co., Boone, Ia. 226 meters, 1330 kilocycles, class A. Wed, 8-9 pm. Sun, 3-4 pm. Central standard time. Slogan: "The Daniel Boone Station". 10 watts.
- KFGK**—First Presbyterian Church, Orange, Texas. 250 meters, 1200 kilocycles, class A. 500 watts.
- KFHA**—Western State College of Colorado, Gunnison, Colorado. 252 meters, 1190 kilocycles, class A. Tues, 6:30 pm, bedtime stories; 7:30 pm, educational; 9 pm, conservatory music. Fri, 9 pm, Mountain standard time. Slogan: "Where the Sun Shines Every Day and the Fishing is Fine". 50 watts.
- KFHJ**—Fallon & Co., Santa Barbara, Calif. 360 meters, 833 kilocycles. 100 watts.
- KFHL**—Penn College, Oskaloosa, Iowa. 240 meters, 1250 kilocycles, class A. Tues, 8 pm. Sun, 4 pm. Central standard time. Slogan: "Keen for Higher Learning". 10 watts.
- KFHR**—Star Elec. & Radio Co., Seattle, Wash. 272 meters, 1070 kilocycles, class A. 100 watts.
- KFI**—Earle C. Anthony, Inc., Los Angeles, Calif. 469 meters, 642 kilocycles, class B. Daily ex Sun, 5-5:30 pm; News bulletins, 5:30-6 pm. Daily ex Mon, including Sun, 6:45-7 pm. Tues, Thurs & Sun, 7-8 pm. Wed, 7:30-8 pm, male quartet. Sat, 7-7:45, dance orchestra; 7:45-8 pm, the hook shelf. Daily incl. Sun, 8-9 pm, 9-10 pm, 10-11 pm, studio program and special features. Sun, 10-10:45 am; 11 am to 12:30 pm; 4-5 pm, church services. Pacific standard time. 1500 watts.
- KFIF**—Eenson Polytechnic Institute, Portland, Ore. 248 meters, 1210 kilocycles, class A. 100 watts.
- KFIO**—Radio Club of North Central High School, Spokane, Wash. 363 meters, 1130 kilocycles, class B. Fri, 8-10 pm. Sun, 7:30-9 pm, church services. Pacific standard time. 100 watts.
- KFIP**—First Methodist Church, 332 Miller Bldg., Yakima, Wash. 256 meters, 1170 kilocycles, class A. Wed, 6:30 pm, Organ recital. Sun, 11 am and 7:30 pm. Pacific standard time. 100 watts.
- KFIU**—Alaska Electric Light & Power Co., Juneau, Alaska. 226 meters, 1330 kilocycles, class A. Mon, Wed & Fri, 7-8 pm, Alaska time (6 pm Alaska time is 7 pm Pacific coast time). Slogan: "A Voice from the Far North". 10 watts.
- KFIZ**—The Daily Commonwealth and the Seyfert Radio Corp., Fond du Lac, Wis. 225 meters, 1320 kilocycles, class A. Daily ex Sun, 5 pm, markets, weather reports and news sports. Central standard time. 100 watts.
- KFJB**—Marshall Elec. Co., 1603 W. Main St., Marshalltown, Ia. 248 meters, 1210 kilocycles, class A. Daily, ex Sun, market and weather. Sun, 10 am. Tues & Fri, 8:30 pm, music and educational program. Central standard time. Slogan: "Marshalltown—the Heart of Iowa". 10 watts.
- KFJF**—National Radio Mfg. Co., 406 N. Hudson, Oklahoma City, Okla. 261 meters, 1149 kilocycles, class A. Daily ex Sun, 9-9:45 am, markets. 12-15 (Sat, 12:30). Daily ex Sat, 3:15 pm, weather, markets, news. Daily ex Sun, 7 pm. Tues & Fri, 8:30 pm, concert. Sun, 11 am and 7 pm, church services; 3 pm, concert. Central standard time. 225 watts.
- KFJG**—Liberator Theater and E. E. Marsh, Astoria, Oregon. 245 meters, 1220 kilocycles, class A. Wed & Fri, 10-11 pm. Sun, 10:30-11 pm. Pacific standard time. 10 watts.
- KFJM**—University of North Dakota, Grand Forks, N. D. 278 meters, 1080 kilocycles, class A. Daily ex Sat & Sun, 9 pm, grains and livestock markets, weather, Wed, 8:30 pm, story hour, news, music. Athletic events broadcast occasionally. Slogan: "Grand Forks the Educational Center of the World". 100 watts.
- KFJR**—Ashley Dixon & Son, Portland, Ore. 265 meters, 1140 kilocycles, class A. 100 watts.
- KFJX**—Iowa State Teachers College, Cedar Falls, Iowa. 258 meters, 1160 kilocycles, class A. Schedule irregular. 50 watts.
- KFJY**—Tunwall Radio Co., 13 No. 10th St., Fort Dodge, Iowa. 246 meters, 1220 kilocycles, class A. Tues, Wed, Thurs, Fri, 11:50 am Chimes. Daily ex Wed & Sun, 5:45 pm, markets, news, weather. Wed, 9 pm, concert. Sun, 11:50 am, church services. Central standard time. 50 watts.
- KFJZ**—Texas National Guard, 112th Cav. Fort Worth, Texas. 254 meters, 1180 kilocycles, class A. 20 watts.
- KKFA**—Colorado State Teachers College, Greeley, Colo. 278 meters, 1100 kilocycles, class A. Wed, 10 am, Lectures, Concerts, athletics, broadcast at irregular occasions. Mountain standard time. 50 watts.
- KKFB**—Brinkley Jones Hospital Ass'n., Milford, Kansas. 273 meters, 1100 kilocycles, class A. Daily ex Fri & Sun, 6-7 and 10-11 pm. Fri, 7-12 pm. Sun, 8-10 pm. Slogan: "Kansas First Kansas Best". Central standard time. 500 watts.
- KKFC**—Conway Radio Laboratories, Box No. 360, Conway, Ark. 250 meters, 1200 kilocycles, class A. Tues & Fri, 8-10 pm. Central standard time. Slogan: "Known for Knowledge Quest". 100 watts.
- KKFU**—University of Kansas, Lawrence, Kans. 275 meters, 1090 kilocycles, class A. Mon & Thurs, 6:50 pm, announcements; 7 pm, music; 7:15 pm, 7:30 pm, 7:45 pm, lectures, elementary Spanish, Chemistry, etc. Central standard time. 500 watts.
- KKFW**—Frank F. Gray, 3200 Richardson St., Butte, Mont. 283 meters, 1060 kilocycles, class A. 50 watts.
- KFKX**—Westinghouse Elec. & Mfg. Co., Hastings, Neb. 288 meters, 1040 kilocycles, class B. Mon & Thurs, 9:30-10:30 pm. Central standard time. Daily 6:15-7:15 pm (Eastern time), relay from KDKA Pittsburgh Tues & Thurs, 11:30 pm to 1 am, (Eastern time), relay from KDKA. 1500 watts.
- KFLA**—Abner R. Willson, Box 1366, Butte, Mont. 254 meters, 1160 kilocycles, class A. Schedule irregular. 5 watts.
- KFLB**—Signal Elec. Mfg. Co., Box 75, Menominee, Mich. 248 meters, 1210 kilocycles, class A. Tues & Fri, 8-10 pm. No broadcasting during summer months. Slogan: "The Wave From Green Bay". 50 watts.
- KFLE**—National Educational Service, Inc., 989 So. University, Denver, Colo. 266 meters, 1130 kilocycles, class A. Daily 6:30-7 pm. Mountain standard time. Slogan: "The Station With the Good Modulation". 100 watts.
- KFLP**—Everette M. Foster, 1242 S. 6th St., Cedar Rapids, Ia. 256 meters, 1170 kilocycles, class A. 20 watts.
- KFLR**—Korher Wireless Station, the State University of New Mexico, Albuquerque, New Mexico. 254 meters, 1180 kilocycles, class A. Sat, 8-9:30 pm. Mountain time. Special programs as required. Slogan: "The Sunshine Center of America". 100 watts.
- KFLU**—San Benito Radio Club, San Benito, Texas. 236 meters, 1270 kilocycles, class A. Mon & Thurs, 8:30-10:30 pm. Sat, 8-11 pm. Central standard time. 15 watts.
- KFLV**—Swedish Evang. Miss. Church, Rockford, Ill. 229 meters, 1310 kilocycles, class A. 100 watts.
- KFLX**—George R. Clough, 1214—40th St., Galveston, Texas. 240 meters, 1250 kilocycles, class A. Tues & Fri, 8 pm. Sun, 4 pm. Central standard time. 10 watts.
- KFLZ**—Atlantic Automobile Co., 3rd & Poplar St., Atlantic Ia. 273 meters, 1100 kilocycles, class A. Wed, 6:7:30 pm, 9-11 pm. Sat, 9-11 pm. Sun, 4 pm, vespers. Central standard time. Slogan: "Where East Meets West". 100 watts.
- KFMB**—Christian Churches of Little Rock, Little Rock, Ark. 254 meters, 1200 kilocycles, class A.
- KFMO**—University of Arkansas, Fayetteville, Ark. 299 meters, 1000 kilocycles, class B. Tues, 9 pm, music, Thurs, 7:30 pm, Radio extension courses. Special programs as announced. Central standard time. Slogan: "The Voice of the Ozarks". 500 watts.
- KFMR**—Morningside College, Sioux City, Ia. 261 meters, 1150 kilocycles, class A. Tues, Thurs & Sat, 8:55 am, 12:10 pm. Wed, 6-7 pm. Fri, 8:55 am. Central standard time. Slogan: "The College By the Sioux". 50 watts.
- KFMT**—Dr. Geo. W. Young, 2210 Bryant Ave. No., Minneapolis, Minn. 243 meters, 1140 kilocycles, class A. Mon, 7-8 pm. Thurs, 8-9 pm. Sun, 1:30-3:30 pm. Central standard time. Slogan: "See Young Again". 100 watts.
- KFMW**—M. G. Sateren, Houghton, Mich. 266 meters, 1130 kilocycles, class A. Sun, 3-4:30 pm. Central standard time. 50 watts.
- KFMX**—Carleton College, Northfield, Minn. 337 meters, 890 kilocycles, class B. Wed, concert with occasional lecture, 9 pm. Sun evening vesper service, 7 pm. Time signals daily ex Sun. Central standard time. 750 watts.
- KFNF**—Henry Field Seed Co., Shenandoah, Ia. 260 meters, 1130 kilocycles, class A. Daily ex Sun, 12:55 pm. Daily ex Tues & Sun, 6:30 pm. Sun, 10:45 am, 3 pm and 6:30 pm. Central standard time. Slogans: "Keep Friendly Never Frown" also "Known for Neighborly Folks". 500 watts.
- KFNG**—Wooten's Radio & Elec. Co., Coldwater, Miss. 254 meters, 1180 kilocycles, class A. Sat, 9:30-10:30 pm, dance program. Sun, 4-5 pm, concert. Central standard time. Slogan: "The Most Powerful Ten Watt Station in the World". 10 watts.
- KFNJ**—Central Missouri State Teachers College, Warrensburg, Mo. 234 meters, 1280 kilocycles, class A. Tues, 8:15-9:15 pm. Sun, 3-4 pm, Organ. Central standard time. Slogan: "Education for Service". 50 watts.
- KFNL**—Radio Broadcast Association, 1533 W. 10th St., Paso Robles, Calif. 240 meters, 1240 kilocycles, class A. Mon, 8-10 pm. Special programs as announced. Pacific standard time. 10 watts.
- KFNV**—L. A. Drake Battery & Radio Supply Shop, 505—3rd St., Santa Rosa, Calif. 234 meters, 1275 kilocycles, class A. Daily ex Sun, 7-8 pm, news, music, 8:30 pm, bedtime stories. Pacific coast time. Slogan: "The Home of Luther Burhank". 5 watts.
- KFNY**—V. Kemp Roberts, 40 Olive St., Helena, Mont. 248 meters, 1210 kilocycles, class A. 50 watts.



# THE GREBE

## SYNCHROPHASE

• TRADE MARK •

*It is written:*

"If there be no faith in our words,  
of what use are they?"

It is easy to prove the claims  
made for the Synchronphase.

*Doctor Mu*

No other receiver has  
these features:

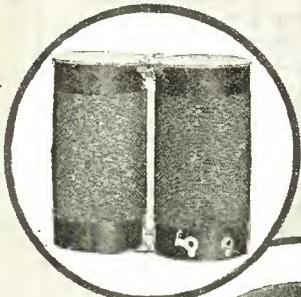

Binocular  
Coils

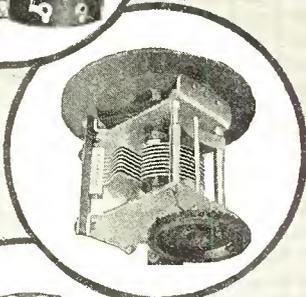

S-L-F  
Condensers

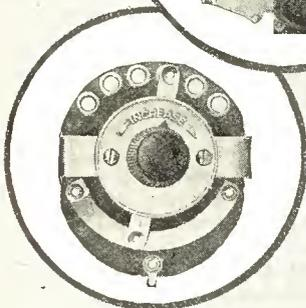

Volume  
Control

**I**F you have once operated a Synchronphase you will not be satisfied with any other type of receiver, because Grebe exclusive and fundamental features provide reception that is unsurpassed.

**Binocular Coils**, which keep the set balanced against local interference, provide greater selectivity and sensitivity.

**S-L-F (straight line frequency) Condensers** make tuning-in quick, easy and positive. All stations are spaced at equal intervals around the dials; short-wave stations are not crowded onto the lower numbers.

**Grebe Volume Control** gives six gradations of sound without detuning or reducing tube current; thus maintaining the true character and shading of every note.

In sets made up of assembled parts, the assembler has no control over their design and quality. Therefore, every detail of the Synchronphase is designed and built in the Grebe factory. Thus, all parts coordinate perfectly. This makes possible the perfect performance of the Synchronphase.

This perfection extends also to the Synchronphase cabinet. It is beautifully designed and built of solid mahogany, highly polished and with delicately embossed gold escutcheons.

Compare all sets before you buy, but be sure to have the Synchronphase demonstrated by your dealer.

*Ask your dealer or write us for full information*

**A. H. Grebe & Co., Inc.**

Van Wyck Blvd., Richmond Hill, N. Y.

Western Branch: 443 So. San Pedro St., Los Angeles, Cal.

*This company owns and operates station WAHG*



Synchronphase with  
battery base

All Grebe apparatus  
is covered by patents  
granted and pending.



**KFNZ**—Radio Sales Co., 1234 Burlingame Ave., Burlingame, Calif. 231 meters, 1304 kilocycles, class A. Daily ex Sun, 4-5 pm, news items. Mon, Wed, Fri & Sat, 7-8 pm, concert. Pacific standard time. 20 watts.

**KFOA**—Rhodes Dept. Store, 1321 Second Ave., Seattle, Wash. 450 meters, 660 kilocycles, class B. Tues, Wed & Fri, 12:30-1:30 pm. Daily ex Sun, 4-5:15 pm. Daily ex Thurs & Sun, 6:45-8:15 pm. Mon & Wed, 8-10 pm. Tues, Fri & Sat, 8-11 pm. Pacific standard time. Slogan: "Pacific Northwest Station". 500 watts.

**KFOC**—First Christian Church, Whittier, Calif. 236 meters, 1270 kilocycles, class A. 100 watts.

**KFOD**—The Radio Shop, Wallace, Ida. 224 meters, 1340 kilocycles, class A. 10 watts.

**KFOJ**—Moberly High School, Moberly, Mo., 246 meters, 1220 kilocycles, class A. Schedule irregular. 5 watts.

**KFOL**—Leslie M. Schafnuch, Marengo, Ia. 234 meters, 1280 kilocycles, class A. 10 watts.

**KFON**—Echophone Radio Shop, Long Beach, Calif. 234 meters, 1280 kilocycles, class A. Mon, 7:30-11 pm. Tues, Wed, Fri & Sat, 2:30-4 pm, 6:30-11 pm. Sun, 11-12 am, 6:30-11 pm. Pacific standard time. Slogan: "Where Your Ship Comes In." 100 watts.

**KFOO**—Latter Day Saints University, Salt Lake City, Utah. 261 meters, 1150 kilocycles, class A. 5 watts.

**KFOR**—David City Tire & Elec. Co., David City, Nebr. 226 meters, 1330 kilocycles, class A. Wed, 9:30 pm. Sun, 7:30 pm. Slogan: "The Voice of David City". 20 watts.

**KFOT**—College Hill Radio Club, 1st & Erie Sts., Wichita, Kans., 231 meters, 1300 kilocycles, class A. Daily ex Sun, 9-10:30 pm, concert. Sun, 11-12:30 pm, 7:30-9 pm, church services. Central standard time. Slogan: "Kansas Grows the Best Wheat in the World". 50 watts.

**KFOU**—Hommel Mfg. Co., Richmond, Calif. 254 meters, 1180 kilocycles, class A. 100 watts.

**KFOX**—Technical High School, Omaha, Nebr. 248 meters, 1210 kilocycles, class A. 100 watts.

**KFOY**—Beacon Radio Service, 375 Robert St., St. Paul, Minn. 252 meters, 1190 kilocycles, class A. 50 watts.

**KFPG**—Oliver S. Garretson, 5118 Maywood Ave., Los Angeles, Calif. 238 meters, 1260 kilocycles, class A. 10 watts.

**KFPH**—Harold C. Mailander, 992 Lake St., Salt Lake City, Utah. 242 meters, 1240 kilocycles, class A. 50 watts.

**KFPL**—C. C. Baxter, Dublin, Texas. 252 meters, 1190 kilocycles, class A. Mon & Thurs, 8 pm. Sat, 10 pm. Sun, 7 pm. Central standard time. 15 watts.

**KFPM**—New Furniture Co., Box 628, Greenville, Texas. 242 meters, 1240 kilocycles, class A. Tues, Wed & Fri, 7:45 pm, music. Thurs, 7:30 pm, latest Victor record releases. Sat, 10 pm, review. Sun, 11 am, church services; 7:15 pm, second and fourth Sundays each month. Central standard time. Slogan: "The Biggest Little Ten Watts in the Air". 10 watts.

**KFPR**—Los Angeles Co. Forestry, Los Angeles, Calif. 231 meters, 1300 kilocycles, class A. 500 watts.

**KFPT**—Radio Service Corp. of Utah, Salt Lake City, Utah. 261 meters, 1150 kilocycles, class A. 500 watts.

**KFPV**—Heintz & Kohlmoos, 219 Natoma St., San Francisco, Calif. 236 meters, 1270 kilocycles, class A. 50 watts.

**KFPW**—St. Johns M. E. Church, Box 424, St. Carterville, Mo. 268 meters, 1120 kilocycles, class A. Tues, 9-11 pm. Fri, 8-10 pm. Sun, 1-3 pm, chapel service. Central standard time. Slogan: "Keeping Pace with Christ Means Progress." 20 watts.

**KFPX**—First Presbyterian Church, Pine Bluff, Ark. 242 meters, 1240 kilocycles, class A. Sun, 11 am to noon, 7:30-8:30 pm. Central standard time. 100 watts.

**KFPY**—Synons Investment Co., Spokane, Wash. 266 meters, 1130 kilocycles, class A. 100 watts.

**KFOA**—The Principia, 5530 Page Ave., St. Louis, Mo. 261 meters, 1150 kilocycles, class A. 50 watts.

**KFOB**—Searchlight Publishing Co., Fort Worth, Texas. 254 meters, 1180 kilocycles, class A. Daily ex Sun, 6 pm. Mon, Tues & Fri, 8-30 pm. Sun, 11 am. Central standard time. 100 watts.

**KFOC**—Kidd Bros. Radio Shop, Taft, Calif. 231 meters, 1300 kilocycles, class A. 100 watts.

**KFOD**—Chovin Supply Co., Anchorage, Alaska. 280 meters, 1070 kilocycles, class A. 100 watts.

**KFOE**—Dickenson-Henry Radio Laboratories, Colorado Springs, Colo. 224 meters, 1340 kilocycles, class A. 10 watts.

**KFOG**—Southern California Assn., Exposition Park, Los Angeles, Calif. 229 meters, 1310 kilocycles, class A. Mon, Thurs & Sat, 7-8 pm. Pacific standard time. 50 watts.

**KFOH**—Radio Service Co., Burlingame, Calif. 231 meters, 1300 kilocycles, class A. Schedule irregular. 50 watts.

**KFQM**—Texas Highway Bulletin, Austin, Texas. 268 meters, 1120 kilocycles, class A. 100 watts.

**KFQN**—Third Baptist Church, Portland, Ore. 233 meters, 1060 kilocycles, class A. 10 watts.

**KFOO**—Meier Radio Shop, Russell, Kansas. 261 meters, 1150 kilocycles, class A. Mon & Wed, 8-10:30 pm, musical concert. Fri, 7:30-9 pm, concert and late oil news. Sun, 1-2 pm, special concert. Central standard time. Slogan: "The Oil City". 10 watts.

**KFQP**—George S. Carson, Jr., 906 College St., Iowa City, Ia. 224 meters, 1340 kilocycles, class A. Wed, 8-9 pm. Sun, 9-12 pm. Central standard time. 10 watts.

**KFOR**—Walter L. Ellis, 625 E. 6th St., Oklahoma City, Okla. 209 meters, 1140 kilocycles, class A. Daily 9:30 pm. Central standard time. 50 watts.

**KFOT**—Texas National Guard, 36th Signal Co., Denison, Texas. 229 meters, 1190 kilocycles, class A. Tues & Fri, 8-8:45 pm. Central standard time. 10 watts.

**KFOU**—Holy City Broadcasting Station, Holy City, (Alma, P.O.) Calif. 234 meters; 1280 kilocycles, class A. Daily ex Mon & Sun, 9-10 pm. Sun, 11-12 noon and 9-10 pm. Pacific coast time. 100 watts.

**KFOW**—Photo Radio & Electric Shop, North Bend, Wash. 215 meters, 1390 kilocycles, class A. Daily including Sun, 7:30-8:30 pm. Pacific standard time. Slogan: "At the Western Entrance of the Snoqualmie Pass". 50 watts.

**KFOX**—Alfred H. Hubbard, 310 Green Bldg., Seattle, Wash. 233 meters, 1290 kilocycles, class A. 500 watts.

**KFOY**—Farmers State Bank, Belden, Nebr. 273 meters, 1100 kilocycles, class A. Tues, 9 pm. Sun, 2 pm. 10 watts.

**KFOZ**—Taft Radio Co., Hollywood, Calif. 240 meters, 1250 kilocycles, class A. 250 watts.

**KFRB**—Hall Brothers (Rialto Theatre), Beville, Texas. 248 meters, 1210 kilocycles, class A. Fri, 10 pm to 12 midnight. Central standard time. Slogan: "Boost Better Beville". 250 watts.

**KFRD**—Radioart Corp., 347 Geary St., San Francisco, Calif. 270 meters, 1110 kilocycles, class A. Daily including Sun, 6:30-7:30. Tues, Wed & Thurs, 8-10 pm. Sun & Fri, 8-12 midnight. Wed, 11 pm to 1 am. Pacific standard time. Slogan: "Keep Forever Radiating Cheer." 50 watts.

**KFRF**—W. R. Brown, 222 Florence Ave., Alexandria, La. 242 meters, 1240 kilocycles, class A. 100 watts.

**KFRH**—The Radio Shop, 317 Hill Ave., Grafton, N. D. 268 meters, 1120 kilocycles, class A. 10 watts.

**KFRJ**—Guy Simmons, Jr., Conway, Ark. 250 meters, 1200 kilocycles, class A. 10 watts.

**KFRK**—First Presbyterian Church, Grand Forks, N. D. 240 meters, 1250 kilocycles, class A. Sun, 7:45 pm. Central standard time. 10 watts.

**KFRM**—Lieut. James P. Boland, Fort Sill, Okla. 263 meters, 1140 kilocycles, class A. Sun, 4:30 and 7:30 pm. Central standard time. Slogan: "Voice of the Prairie". 50 watts.

**KFRN**—M. Laurence Short, Hanford, Calif. 224 meters, 1340 kilocycles, class A. 5 watts.

**KFRP**—Curtis Printing Co., 1109 Eighth Ave., Ft. Worth, Tex. 246 meters, 1220 kilocycles, class A. Mon, 8-9 pm, lectures. Wed, 11-12 pm, concert. Thurs, 8:30-9:30 pm, lectures. Fri, 10:30-11:30 pm, concert. Sat, 9:30-7:30 pm, concert. Sun, 6-7 pm, Seventh Day Adventists Mass. Central standard time. Slogan: "Who Does Your Printing". 50 watts.

**KFRQ**—Trinity Episcopal Church, Redlands, Calif. 206 meters, 1450 kilocycles, class A. 50 watts.

**KFRQ**—Radio Market Service Co., Portland, Ore. 213 meters, 1410 kilocycles, class A. 10 watts.

**KFRU**—Ethical Studios, Bristow, Okla. 296 meters, 1010 kilocycles, class B. Daily 12 noon to 1:30 pm, 3-4:30 pm. Mon, Wed, Sun & Fri evenings. Central standard time. 500 watts.

**KFRW**—United Churches, Olympia, Wash. 220 meters, 1360 kilocycles, class A. Thurs, 9-9:30, Bible study. Sunday, 11 am and 7:30 pm, church services. Pacific standard time. Slogan: "Make the World a Brotherhood." 100 watts.

**KFRX**—J. C. Klemgard, Route No. 2, Pullman, Wash. 217 meters, 1370 kilocycles, class A. Schedule irregular. Daily, 9-12 pm. Pacific standard time. Slogan: "The Only Farmers' Radio Station in the World." 10 watts.

**KFRY**—New Mexico College of Agriculture, State College, N. Mex. 266 meters, 1130 kilocycles, class A. 50 watts.

**KFRZ**—The Electric Shop (P. M. Thies) Hartington, Neb. 222 meters, 1350 kilocycles, class A. Daily ex Sun, 11:45 am, 4:15-5:15 pm. Sun, 12 noon, 4:15 pm. Slogan: "Boosting for Light and Music." 15 watts.

**KFSG**—Echo Park Evangelistic Ass'n, 1100 Glendale Blvd., Los Angeles, Calif. 278 meters, 1080 kilocycles, class A. Tues, Thurs, Fri & Sat, 8:30-4:30 pm. Tues, 6:30-7:30 pm. Wed, 2:30-4:30, 6:30-7:30 pm. Thurs, Fri & Sat, 7:30-11 pm. Sun, 10:30 am to 12 noon, 2:30-4:30 and 7-9:30 pm. Pacific standard time. 500 watts.

**KFSY**—Van Blaricom Co., 20 So. Main, Helena, Mont. 248 meters, 1210 kilocycles, class A. Wed, 7:30 pm. Mountain time. 10 watts.

**KFUJ**—Hoppert Plumbing & Heating Co., Breckenridge, Minn. 242 meters, 1240 kilocycles, class A. Daily, 10:30 am, weather; 10:40 am, markets; 1:30 pm, markets; 5:40 pm, weather; 5:45 pm, markets. Mon & Wed, 8-9 pm, concert. Central standard time. Slogan: "Where the Red River of the North Finds Its Source." 50 watts.

**KFUL**—Thos. Goggan & Bro. Music Co., Galveston, Tex. 258 meters, 1160 kilocycles, class A. Schedule irregular. 10 watts.

**KFUM**—City of Colorado Springs, 226 Hagerman Bldg., Colorado Springs, Colo. 242 meters, 1240 kilocycles, class A. Tues & Sat, 8:30-10:30 pm, music. Sun, 7:45 pm, church services. Mountain time. Slogan: "City of Sunshine." 100 watts.

**KFUO**—Concordia Theological Seminary, St. Louis, Mo. 549 meters, 546 kilocycles, class B. Wed & Sun, 9:15 pm. 500 watts.

**KFUP**—Fitzsimons Gen'l Hospital, Denver, Colo. 234 meters, 1280 kilocycles, class A. 50 watts.

**KFUQ**—Julius Brunton & Sons Co., San Francisco, Calif. 234 meters, 1280 kilocycles, class A. 50 watts.

**KFUR**—H. E. Paery & Glenn Garner, 420 2nd St., Ogden, Utah. 224 meters, 1340 kilocycles, class A. Tues, Thurs & Sat, 9-12 midnight. Mountain time. 50 watts.

**KFUS**—Louis L. Sherman, Oakland, Calif. 233 meters, 1290 kilocycles, class A. 50 watts.

**KFUT**—University of Utah, Salt Lake City, Utah. 261 meters, 1150 kilocycles, class A. Tues & Thurs, 12 noon to 1 pm. Mountain time. 100 watts.

**KFUV**—Colburn Radio Laboratories, 448 Dowling Blvd., San Leandro, Calif. 224 meters, 1340 kilocycles, class A. Daily ex Sun, 10-11 am. Wed, 8-10 pm. Sun, 2-3 pm. Pacific Coast time. Slogan: "The Voice of the Cherry Valley." 100 watts.

**KFVU**—G. Pearson Ward, 236 W. State St., Springfield, Mo. 252 meters, 1190 kilocycles, class A. 10 watts.

**KFW**—Earl W. Lewis, 417 E. Carpenter St., Moberly, Mo. 233 meters, 1290 kilocycles, class A. Schedule indefinite. 10 watts.

**KFUY**—Irvine H. Bouchard, 5 S. Excelsior Ave., Butte, Mont. 254 meters, 1180 kilocycles, class A. 5 watts.

**KFVZ**—Y. M. C. A. 510 1/2 Chestnut St., Virginia, Minn. 248 meters, 1210 kilocycles, class A. 10 watts.

**KFWB**—Warner Bros. Pictures, Inc., 5842 Sunset Blvd., Hollywood, Calif. 252 meters, 1190 kilocycles, class A. 500 watts.

**KFWC**—L. E. Wall & C. S. Myers, Stoddard Canyon, Upland, Calif. 211 meters, 1420 kilocycles, class A. 10 watts.

**KGB**—Tacoma Ledger, Tacoma, Wash. 249 meters, 1195 kilocycles, class A. Mon, Wed & Fri, 7-9 pm. Pacific standard time. Slogan: "Tacoma, the Lumber Capital of America" and "The Gateway to Mt. Tacoma." 50 watts.

**KGO**—General Elec. Co., 5555 E. 14th St., Oakland, Calif. 300 meters, 1000 kilocycles, class B. Daily ex Sat & Sun, 11:30-1 pm, luncheon concert; 1:30 pm, stock market, weather (Sat 12:30 pm) and 6:45 pm. Mon, 9 am and 4:5-3:30 pm, orchestra; 5:30-6, children's half-hour. Mon & Thurs, 7-8 pm. Mon, Wed & Fri, 3 pm. Tues, Wed, Thurs, Fri & Sat, 4:5-3:30 pm, concert. Fri, 5:30-6 pm. Mon, Tues, Thurs & Sat, 8-10 pm; 10 pm to 1 am. Sun, 11 am, 3:30-5 pm, 7:45 pm. Pacific standard time. 1000 watts.

**KGU**—Marion A. Mulrony, 236 S. King St., Honolulu, Hawaii. 360 meters, 834 kilocycles. Daily, 7:30-9 pm. 2 1/2 hours later than Pacific standard time. 500 watts.

**KGW**—The Morning Oregonian, Portland, Ore. 492 meters, 610 kilocycles, class B. Mon, 11:30-11:35 am, 5-5:30, 7:15-8:45, 10-12 pm. Tues, Wed, Thurs & Fri, 11:30-1:35 am, 12:30-1:30 pm, 5-5:30, 7:15-8 pm. Tues, 8-8:30, 8:30-9:30, 10 pm to 12 midnight. Wed, 8-9 pm, 10-12 midnight. Fri, 8-8:30, 10:30-12 midnight. Sat, 11:30-11:35 am, 10-12 pm. Sun, 10:30-12 am, 3-5, 6-7, 7-8 pm. Pacific standard time. Slogan: "Keep Growing Wiser." 500 watts.

**KGY**—St. Martin's College, Lacey, Wash. 246 meters, 1220 kilocycles, class A. Tues, Fri & Sat, 8:30-9:30 pm. Pacific standard time. Slogan: "Out Where the Cedars Meet the Sea." 5 watts.

**KHJ**—Times-Mirror Co., Los Angeles, Calif. 442 meters, 742 kilocycles, class B. Daily ex Sun & Mon, 12:30-1:30 pm, 2:30-3:30 pm, 6-7:30 pm, 8-11:30 pm. Mon, 12:30-1:30 pm. Sun, 10 am to 12:30 pm, 6:30-7:30 and 8-10 pm. Pacific standard time. 500 watts.

**KHO**—Louis Wasmer, Excelsior Motor-cycle & Bicycle Co., Seattle, Wash. 273 meters, 1100 kilocycles, class A. 100 watts.

**KJO**—Gould, the Light Man, 615 E. Main St., Stockton, Calif. 255 meters, 1180 kilocycles, class A. Wed & Sat, 9-11 pm, dance music. Pacific standard time. 5 watts.

**KJR**—Northwest Radio Service Co., 1323 Sixth Ave., Seattle, Wash. 399 meters, 720 kilocycles, class B. Daily ex Sun, 4:30-6 pm, Post-Intelligencer. Mon, Wed & Fri, 8:30-10 pm. Thurs, 7:30-10 pm, School for Boys. Sun, 10:30 am, church services; 4:30-5 pm, organ recital; 5 pm, vesper services. Pacific standard time. 1000 watts.

**KJS**—Bible Institute of Los Angeles, 536 S. Hope St., Los Angeles, Calif. 293 meters, 1020 kilocycles, class B. Tues & Thurs, 8 pm. Sun, 10:45 am to 12:30 pm, 6-6:45 and 7-15-9:30 pm. Pacific standard time. 750 watts.

**KLDS**—Reorganized Church of Jesus Christ of Latter Day Saints, Box 253, Independence, Mo. 263 meters, 1120 kilocycles, class A. Tues & Thurs, 9 pm. Sun, 11 am and 7:30 pm. Central standard time. Slogan: "Dedicated to Knowledge, Liberty, Divinity, and Service." 250 watts.

**KLS**—Warner Bros., 2201 Telegraph, Oakland, Calif. 248 meters, 1190 kilocycles, class A. Sun, 10-11 am, Pacific standard time. Slogan: "City of Golden Opportunity." 250 watts.

**KLX**—The Tribune, Oakland, Calif. 509 meters, 588 kilocycles, class B. Mon, 6-7, 7-7:30 pm, 8-11 pm. Tues, Wed, Fri, 3-5, 6-7, 7-7:30 pm. Wed, 8-10:15 pm. Fri, 8-12 midnight. Thurs & Sat, 3-5, 7-7:30 pm. Pacific standard time. Slogan: "Where Rail and Water Meet." 500 watts.

**KLZ**—Reynolds Radio Co., 1534 Glenarm St., Denver, Colo. 267 meters, 1150 kilocycles, class A. Tues & Thurs, 8:15-9:30 pm. Sun, 9-10. Mountain time. Slogan: "Tis a Privilege to Live in Colorado" (with canary bird whistle). 250 watts.

**KMJ**—San Joaquin Light & Power Corp., Fresno, Calif. 234 meters, 1280 kilocycles, class A. Wed, 9-9:30 am, educational. Fri, 8-9 pm, community program. Schedule irregular. Pacific standard time. Slogan: "Home of the Raisin." 50 watts.

**KMO**—Association Station (Love Elec. Co.), Tacoma, Wash. 250 meters, 1200 kilocycles, class A. Mon, Wed & Fri, 6-7 and 9-10 pm. Pacific standard time. 10 watts.

**KNT**—Walter Hemrich, Kukak Bay, Alaska (P. O. Box 511, Aberdeen, Wash.). 263 meters, 1140 kilocycles, class A. 100 watts.

**KNX**—Los Angeles Evening Express, Hollywood, Calif. 336 meters, 890 kilocycles, class B. Daily ex Sun, each hour from 8 am to 6 pm, 6-12 midnight, concert. Mon, silent 6-8 pm. Sun, 5-6 and 7-11 pm. Pacific standard time. Slogan: "In the Heart of Hollywood." 500 watts.

**KOA**—General Electric Co., 1370 Kraemer St., Denver, Colo. 323 meters, 930 kilocycles, class B. Daily ex Sun, 12-12:30 pm, organ recital; 1-1:30 pm, stocks; 6-6:30 pm, stocks. Tues & Fri, 6:30-7 pm, stocks. Daily ex Sat & Sun, 8-10 pm, studio program. Sat, 9-12:30, dance music. Sun, 11 am and 7:30 pm, church services. Mountain time. Slogan: "Rocky Mountain Broadcasting Station." 1500 watts.

**KOB**—New Mexico College of Agriculture and Mechanic Arts, State College, New Mexico. 348 meters, 860 kilocycles, class B. Daily, 9:55-10 am, 11:55-12 noon, time signals; 10-10:02 pm, 12 noon to 12:02 pm, weather. Mon, Wed & Fri, 7:30-8:30 pm, concert, lectures etc. Mountain time. Slogan: "The Sunshine State of America." 500 watts.

**KOP**—Detroit Police Headquarters, 1300 Beaubien St., Detroit, Mich. 277 meters, 1090 kilocycles, class A. Daily ex Sun & Holidays, 1 pm and 6:30 pm, police reports. Emergencies broadcast any time. Eastern standard time. Slogan: "Safety First." 500 watts.

**KPO**—Hale Bros., Inc., Market and Fifth Sts., San Francisco, Calif. 429 meters, 700 kilocycles, class B. Daily ex Sun & Mon, 7 am. Daily ex Sun, 10:30-10:45 am. Daily ex Fri & Sun, 1-2 pm. Mon, Tues & Thurs, 4:30-6:30 pm, 7-7:30, 8-11 pm. Wed, 2:30-3:30, 4:30-6:30, 7-7:30, 8-12 midnight. Fri, 12:45-2 pm, 4:30-5:30, 8-10 pm. Sat, 2:30-5:30, 8-12 midnight. Sun & Mon, 11 am. Sun, 8:30-10 pm. Pacific Coast time. Slogan: "City by the Golden Gate." 500 watts.

**KPPC**—Pasadena Presbyterian Church, Pasadena, Calif. 229 meters, 1310 kilocycles, class A. Wed, 7:45-9 pm. Sun, 10:30 am to 1 pm, 7-9 pm, church services. One or two extra programs broadcast during the week. Pacific standard time. 50 watts.

**KOP**—Read's Radio Shop, Hood River, Ore. 270 meters, 1110 kilocycles, class A. Slogan: "Eat Hood River Apples." 10 watts.

**KOV**—Doubleday-Ifill Electric Co., 719 Liberty Ave., Pittsburgh, Pa. 276 meters, 1090 kilocycles, class A. Daily ex Sun, 10:30 am. Daily ex Sat & Sun, 8 pm. Mon, Wed & Fri, 9 pm, concert. Eastern standard time. 500 watts.

**KOW**—Charles D. Herrold, San Jose, Calif. 240 meters, 1250 kilocycles, class A. Daily ex Sun, 1-1:30 pm. Wed, 8-9 pm. Pacific standard time. 50 watts.

**KRE**—Berkeley Daily Gazette, Berkeley, Calif. 273 meters, 1090 kilocycles, class A. 50 watts. Sun, 10 am, 8-9:30 pm, church services. Tues, 8-10 pm. Wed & Sat, 8-12 midnight. Thurs, 8-9:30 pm, concert. Pacific standard time. 50 watts.



"Buy With Care—  
Build With Confidence"

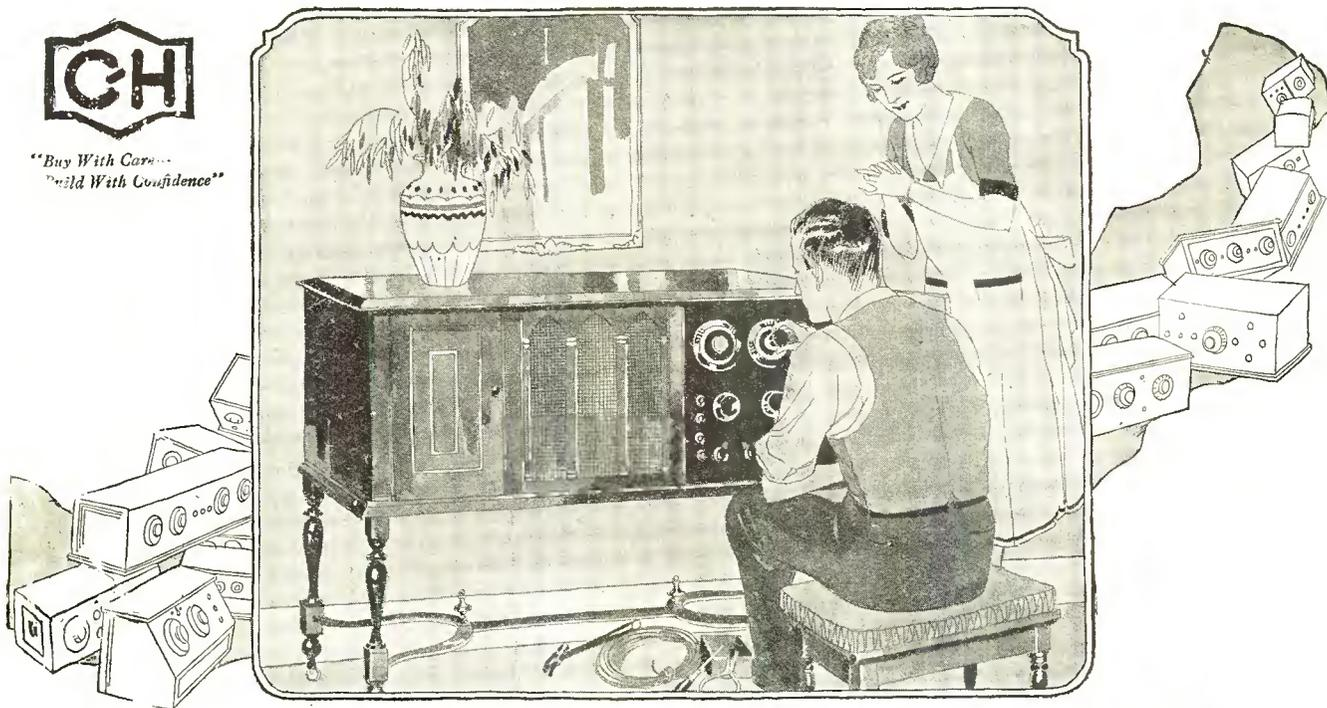

# The Better You Build—The More Carefully You Must Buy!



C-H Rheostats

For all tubes. Four Ohm, with or without vernier for detector and amplifier tubes, respectively. Thirty ohms for 1/4 ampere tubes. C-H Potentiometer of similar design.

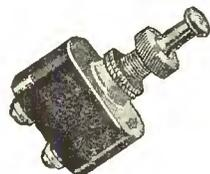

C-H Radio Switch

The original radio switch with the patented and exclusive C-H snap mechanism that assures long life and perfect operation.

The C-H trade mark has had an important mission in radio. In the early days when much apparatus was put on the market without sufficient engineering this mark of the world's leading electrical engineers served to guide non-technical and experienced enthusiasts alike to the construction of successful and efficient receiving sets.

Dealers were glad to recommend these parts to their customers knowing that Cutler-Hammer could only afford to stamp with their trade mark apparatus whose performance would more than justify their guarantee.

And today this quality takes on a new importance. Bigger sets—elaborate cabinets—mean a large investment, and care in the purchase of parts is doubly necessary. Demand the C-H trade mark and build with success.



Low Loss Socket

The departure in socket design that set fans talking everywhere. Silvered contacts—Bakelite and Thermoplas construction. Insist on the socket with the ORANGE shell.



C-H Radioloc

The new lock for your radio set. Protects tubes and batteries from meddling fingers and the children. Carry the key on your ring.

**THE CUTLER-HAMMER MFG. CO.**

Member Radio Section, Associated Manufacturers of Electrical Supplies

MILWAUKEE, WISCONSIN

# CUTLER HAMMER

Tell 'Em You Saw It in the Citizens Radio Call Book

**KSAC**—Kansas State Agricultural College, Manhattan, Kans. 341 meters, 88.2 kilocycles, class B. Daily ex Sat & Sun, 9:30-10 am, 10:10-10:30 am, housewives' program; 12:30-1 pm, farmers noonday program; 7:20-8 pm, "College of the Air." Thurs, 8-9 pm, music. Sun, 8-9 pm, Sunday service. Central standard time. Slogan: "Knowledge, Science, and Culture." 500 watts.

**KSD**—St. Louis Post-Dispatch, 12th and Olive Sts., St. Louis, Mo. 549 meters, 546 kilocycles, class B. Mon, 7 and 9 pm, Tues, 6 and 9 pm, Wed, 6:45 and 11 pm, Fri & Sat, 8 pm. Central standard time. 500 watts.

**KTMS**—New Arlington Hotel Co., Hot Springs, Ark. 374 meters, 500 kilocycles, class B. Daily ex Sun, 12:30-1:30 pm, markets, weather, orchestra; 8:30-10 pm, concert. Mon, Wed & Sat, 10-11 pm, dance music. Sun, 11 am, 8:30-10 and 10-11:30 pm. Central standard time. 500 watts.

**KTW**—First Presbyterian Church, Terminal St. Seattle, Wash. 455 meters, 658 kilocycles, class B. Sun, 11-12:30 pm, 3-4:30 and 7:15-9:30 pm. Pacific standard time. 1000 watts.

**KUO**—Examiner Printing Co., San Francisco, Calif. 246 meters, 1220 kilocycles, class A. 150 watts.

**KWG**—Portable Wireless Tel. Co., Stockton, Calif. 247 meters, 1210 kilocycles, class A. Daily ex Sun, 4-5 pm, news, markets. Tues & Fri, 8-9 pm. Sun, 2-3 pm, concert. Pacific standard time. 50 watts.

**KWH**—Los Angeles Examiner, Broadway at 11th St., Los Angeles, Calif. 360 meters, 833 kilocycles, class B. Schedule irregular. 250 watts.

**KYQ**—The Electric Shop, Fort and Beretania Sts., Honolulu, Hawaii. 270 meters, 1110 kilocycles, class A. 100 watts.

**KYV**—Westinghouse Elec. & Mfg. Co., 111 W. Washington St., Chicago, Ill. 536 meters, 560 kilocycles, class B. Daily ex Sun, latest news every half hour (ex from 7-12 pm). Tues & Thurs, 2:35-4 pm, 10 pm to 2:30 am. Fri & Sat, 9:30 pm to 2:30 am. Sun, 11 am, church service; 4-5 pm, concert; 7 pm, Sunday Evening Club service. Central standard time. 1500 watts.

**KZKZ**—Electrical Supply Co., 109 Plaza Moraga, Manila, P. I. 270 meters, 1110 kilocycles, class A. 100 watts.

**KZM**—Preston D. Allen, Hotel Oakland, Oakland, Calif. 241 meters, 1240 kilocycles, class A. Daily ex Sun, 6:30-7 pm, orchestra. Pacific standard time. 100 watts.

**KZKQ**—Far Eastern Radio, Inc., Manila Hotel, Manila, P. I. 222 meters, 1350 kilocycles, class A. 500 watts.

**KZUY**—F. Johnson Elser, Manila, P. I. 370 meters, 810 kilocycles, class B. 500 watts.

**WAAB**—Valdemar Jensen, 137 S. St. Patrick St., New Orleans, La. 268 meters, 1120 kilocycles, class A. 100 watts. Sun, 2-3 pm. Other programs as announced.

**WAAC**—Tulane University, New Orleans, La. 273 meters, 1090 kilocycles, class A. Fri, 7:30-9:30 pm, education and entertainment. Central standard time. 100 watts.

**WAAD**—Ohio Mechanics Institute, Cincinnati, Ohio. 258 meters, 1160 kilocycles, class A. Schedule irregular. Concerts and lectures as announced. 25 watts.

**WAFF**—Chicago Daily Drovers Journal, 836 Exchange Ave., Chicago, Ill. 278 meters, 1080 kilocycles, class A. Daily ex Sun & holidays, 8:40 am, markets; 10:30 am, weather; 10:45 am, markets; 12:30 pm, weather; 12:45 pm, markets; 3 pm, markets; 4:30 pm, Eastern meat trade conditions. Sat, final weather and markets, 12:30 pm. Central standard time. 200 watts.

**WAAM**—I. R. Nelson Co., Bond St., Newark, N. J. 294 meters, 1140 kilocycles, class A. Daily ex Sat & Sun, 11-12 noon, Mon, Fri & Sat, 6:15-11 pm. Tues & Wed, 7-11 pm. Eastern standard time. Slogan: "We Are American Manufacturers." 500 watts.

**WAAN**—University of Missouri, Columbia, Mo. 254 meters, 1180 kilocycles, class A. 50 watts.

**WAAW**—Omaha Grain Exchange, 19th and Harney St., Omaha, Neb. 278 meters, 1080 kilocycles, class A. Daily ex Sun, market reports, Thurs, 7:30-9 pm, educational night. Central standard time. Slogan: "Where Agriculture Accumulates Wealth." 500 watts.

**WABA**—Lake Forest College, Lake Forest, Ill. 227 meters, 1320 kilocycles, class A. Wed, 7 pm. Daily chapel at 10 am. Central standard time. 100 watts.

**WABB**—Harrisburg Sporting Goods Co., Harrisburg, Pa. 266 meters, 1130 kilocycles, class A. Tues & Fri, 8 pm. Sun, 9 pm, church services. Eastern standard time. 10 watts.

**WABH**—Lake Shore Tire Co., Sandusky, Ohio. 240 meters, 1250 kilocycles, class A. 10 watts.

**WABI**—Bangor Ry. & Elec. Co., Bangor, Maine. 240 meters, 1250 kilocycles, class A. Daily ex Sun, 5 pm, markets. Wed night, concert. Eastern standard time. 100 watts.

**WABL**—Connecticut Agricultural College, Storrs, Conn. 275 meters, 1090 kilocycles, class A. Mon, Wed & Fri, 7-9 pm, Eastern standard time. 100 watts.

**WABM**—F. E. Doherty Co., 901 E. Genesee St., Saginaw, Mich. 261 meters, 1150 kilocycles, class A. Daily ex Sun, 10:15 am, 2:30 and 6 pm. Mon, 8 pm, studio. Tues, Thurs & Fri, 6 pm, Hotel Bancroft. Wed, 9:15, dance program, 12:30 am, studio. Sat, 9:30, dance program; 12:30 am, midnight frolic. Sun, 12:30 pm, dinner program; 7:30 pm, church services. Central standard time. 300 watts.

**WABN**—Ben Ott, La Crosse, Wis. 244 meters, 1230 kilocycles, class A. Mon & Thurs, 9 pm to 12 midnight. Central standard time. Slogan: "The City Beautiful on the Banks of the Mississippi." 500 watts.

**WABO**—Lake Ave. Baptist Church, Rochester, N. Y. 277 meters, 1080 kilocycles, class A. Sun, 10:15 am to 12 noon, 7:15-9 pm. Eastern standard time. 100 watts.

**WABO**—Haverford College Radio Club, Haverford, Pa. 261 meters, 1150 kilocycles, class A. Tues, 8-9 pm, educational; Thurs, 9-11 pm, music. Eastern standard time. 50 watts.

**WABR**—Scott High School, Toledo, Ohio. 263 meters, 1140 kilocycles, class A. Fri, 8:15-9 pm. Eastern standard time. 50 watts.

**WABU**—Victor Talking Mach. Co., Camden, N. J. 226 meters, 1330 kilocycles, class A. 50 watts.

**WABW**—College of Wooster, Wooster, Ohio. 206 meters, 1450 kilocycles, class A. 20 watts.

**WABX**—Henry B. Joy, 1830 Penobscot Bldg., Detroit, Mich. 254 meters, 1180 kilocycles, class A. 250 watts.

**WABY**—John Magaldi, Jr., 815 Kimball St., Philadelphia, Pa. 242 meters, 1240 kilocycles, class A. Sun, 9 pm. Eastern standard time. Slogan: "Quaker City Sleep Dodgers." 50 watts.

**WABZ**—Coliseum Place Baptist Church, Camp and Teopichone Sts., New Orleans, La. 275 meters, 1090 kilocycles, class A. Wed, 9-10 pm. Sun, 11 am to 12 noon, 7:45-9 pm. Central standard time. Slogan: "The Station with a Message." 100 watts.

**WAHG**—H. Grebe & Co. Inc., Richmond Hill, L. I., New York. 315 meters, 950 kilocycles, class B. Mon, 7:30-11:45 and 12 midnight to 2 am. Wed & Fri, 12-1 pm, 7:30-12 midnight. Eastern standard time. Slogan: "Wait and Hear Grebe." 500 watts.

**WAIT**—A. H. Waite & Co., Inc., Taunton, Mass. 229 meters, 1326 kilocycles, class A. Fri 8-11 pm, music. Eastern standard time. 10 watts.

**WBAA**—Purdue University, Dept. of Electrical Engineering, W. Lafayette, Ind. 273 meters, 1170 kilocycles, class A. Daily ex Sun, 9:50 am, weather and Indianapolis markets. Mon & Fri, 7:15 pm, agricultural lecture. Central standard time. 250 watts.

**WBAK**—Pennsylvania State Police, Harrisburg, Pa. 400 meters, 749 kilocycles, class B. Daily ex Sun, 10:30 am, 1:30 pm, 5:45 pm, 12:30 am. Eastern standard time. 500 watts.

**WBAN**—Wireless Phone Corp., 193 Ellison St., Paterson, N. J. 244 meters, 1230 kilocycles, class A. Daily ex Sun, 9-11:30 am, 12:30-5:30 pm (ex Sat). Sun, 10 am to 12 noon, 2-5, and 7:30-10:30 pm. Eastern standard time. Slogan: "The Silk City of America." 100 watts.

**WBAO**—James Milliken University, Decatur, Ill. 275 meters, 1100 kilocycles, class A. Schedule irregular. 100 watts.

**WBAP**—The Star-Telegram, Fort Worth, Tex. 476 meters, 630 kilocycles, class B. Daily ex Sun, 10 am, 11 am, 12 noon, 1-2 and 3 pm; 5 pm, Missing Men and Texas Sheriffs. Daily ex Sat & Sun, 12:05-12:30 pm, 7:30-8:30 pm, 9:30-10:45 pm. Sat 7 pm, Sun 11 am, church services; 4 pm, organ; 11 pm, popular concert. Central standard time. 1000 watts.

**WBAP**—Ermer & Hopkins Co., 146 N. Third St., Columbus, Ohio. 293 meters, 1020 kilocycles, class A. Daily ex Sun, 12 noon to 1 pm. Mon & Fri, 8-10 pm. Eastern standard time. 500 watts.

**WBAX**—John H. Stenger, Jr., Box No. 104, Wilkes-Barre, Pa. 256 meters, 1170 kilocycles, class A. Tues, Wed, Thurs & Sat, 9:30 pm to 12 midnight. Sun, 6-9 pm, dance music, dinner concert, etc. Eastern standard time. Slogan: "In Wyoming Valley, Home of the Anthracite." 100 watts.

**WBAY**—A. T. & T. Co., New York, N. Y. 492 meters, 610 kilocycles, class B. 500 watts.

**WBBA**—Plymouth Congregational Church, Newark, Ohio. 225 meters, 1330 kilocycles, class A. Fri, 7:30 pm, music. Sun, 11 am, church services; 7:30 pm, church services. Eastern standard time. 20 watts.

**WBBD**—Barbey Battery Service, Fourth and Walnut Sts., Reading, Pa. 234 meters, 1230 kilocycles, class A. Wed & Sat, 10-11:30 pm. Eastern standard time. 50 watts.

**WBGG**—Irving Vermilya, Mattapoiset, Mass. 248 meters, 1210 kilocycles, class A. Mon, Wed & Fri, 8-10:30 pm, dance music, radio drama. Sat midnight, tests. Sun, 10:45 am, church services. Eastern standard time. Slogan: "The Voice from Cape Cod." 500 watts.

**WBHH**—J. Irving Bell, Port Huron, Mich. 205 meters, 1460 kilocycles, class A. 50 watts.

**WBBJ**—Neel Electric Co., West Palm Beach, Fla. 258 meters, 1170 kilocycles, class A. Tues, Thurs & Fri, 8-10 pm. Sun, 11 am to 12 noon, 7:30-9 pm. Eastern standard time. Slogan: "Where Summer Spends the Winter." 50 watts.

**WBBL**—Grace Covenant Church, Richmond, Va. 229 meters, 1310 kilocycles, class A. Tues, 8 pm, musical program. Sun, 11 am, church services; 7:45 pm, organ recital; 8 pm, service. Eastern standard time. Slogan: "The Gateway North and South." 50 watts.

**WBBS**—H. Leslie Atlas, 1554 Howard St., Chicago, Ill. 226 meters, 1330 kilocycles, class A. Tues, Thurs & Sat, 8 pm. Central standard time. Slogan: "We Broadcast Broadmore Music." 200 watts.

**WBBS**—Petoskey High School, Petoskey, Mich. 214 meters, 1400 kilocycles, class A. Wed, 8-9 pm. Central standard time. 100 watts.

**WBBS**—People's Pulpit Ass'n, 124 Columbus Heights, Brooklyn, N. Y. 273 meters, 1100 kilocycles, class A. Mon, Wed & Sat, 8-9 pm. Thurs & Sun, 9-10:30 pm. Eastern standard time. 500 watts.

**WBBS**—First Baptist Church, New Orleans, La. 252 meters, 1190 kilocycles, class A. Wed, 7:45-8:30 pm. Sun, 11 am to 12:30 pm. Central standard time. 50 watts.

**WBBS**—Jenks Motor Sales Co., Monmouth, Ill. 224 meters, 1340 kilocycles, class A. 10 watts.

**WBBS**—Johnstown Radio Co., Johnstown, Pa. 248 meters, 1210 kilocycles, class A. 5 watts.

**WBBS**—Ruffner Junior High School, Norfolk, Va. 222 meters, 1350 kilocycles, class A. Fri, 8 pm. Eastern standard time. Slogan: "The School You'd Like To Go To." 50 watts.

**WBBS**—Washington Light Infantry, Charleston, S. C. 268 meters, 1120 kilocycles, class A. 10 watts.

**WBBS**—Noble B. Watson, 233 Iowa St., Indianapolis, Ind. 227 meters, 1320 kilocycles, class A. Varied programs, 8:30-4 pm. Sun, special programs 3-4 pm. Central standard time. Slogan: "Near the Center of Population of the United States." 50 watts.

**WBBS**—Southtown Economist Station, 730 W. 56th St., Chicago, Ill. 266 meters, 1130 kilocycles, class A. Daily ex Sun, 6-7 pm, juvenile. Tues, Thurs & Sat, 7-8 pm, classical concert; 8-12, popular concert, talks and stories; 12-1 am, Pirate Ship Club. Wed & Fri, 7-10, classical and popular concerts. Sun, 10:30 am to 12:15, church; 4-5, organ and vocal; 7-8 pm, concert; 8-10 pm, popular concert. Central standard time. Slogan: "World's Best Community Newspaper." 500 watts.

**WBBS**—The Baxter Laundry Co., 747 Fountain St., E. Grand Rapids, Mich. 256 meters, 1170 kilocycles, class A. Daily ex Sun, 5:30-6 pm. Mon, 7-9:30 pm. Daily ex Mon & Sun, 7-8 pm. Sun, 10-11:30 am. Slogan: "World Wide Baxter Dry Cleaning." 50 watts.

**WBBS**—Bliss Electrical School, Takoma Park, Md. 222 meters, 1350 kilocycles, class A. 100 watts.

**WBBS**—Pennsylvania State Police, Troop P, Butler, Pa. 258 meters, 1160 kilocycles, class A. Daily ex Sun, 9:30, 10, 10:30 am, 1, 1:30, 2, 5:30, 5:45, 6:15 pm, midnight, 12:30-1 am. Eastern standard time. 250 watts.

**WBBS**—Baltimore Radio Exchange, Wilkes-Barre, Pa. 231 meters, 1300 kilocycles, class A. Mon, Wed & Fri, 1:30-4 pm. Tues & Sat, 9 pm to 12 midnight. Alternating Sundays, 2-5 pm. Eastern standard time. 10 watts.

**WBBS**—D. W. May Inc. 325 Central Ave., Newark, N. J. 252 meters, 1190 kilocycles, class A. Mon, Thurs & Sat, 8:30-7 pm and 8:30-12 midnight. Tues, Wed & Fri, 7:30-8:30 pm. Fri, 2 pm to 1:15 am. Sun, 12 noon to 5:30 pm, and 7-9 pm. Eastern standard time. 100 watts.

**WBBS**—Southern Radio Corp., Realty Bldg., Charlotte, N. C. 275 meters, 1090 kilocycles, class A. Daily ex Sun, 11 am, weather; 12:30-1:30 pm; 7 pm, concert; 7:15 pm, markets. Tues & Thurs, 9 pm, Mon, Wed & Sat, 10:45 pm. Sun, 11 am and 7:30 pm, church services. Eastern standard time. 250 watts. Slogan: "The Queen City of the South."

**WBBS**—Westinghouse Elec. & Mfg. Co., 82 Worthington St., Springfield, Mass. 333 meters, 900 kilocycles, class B. Daily ex Fri & Sun, 6-7 pm, dinner concert. Mon, Tues & Sat, 7:45-10:30 pm, children's period. Mon, 7:45-10:30 pm, music; 11:20-12 pm, dance program. Tues, Wed & Thurs, 7:30-8 pm, lecture; 8-10:30 pm, music's pet. Wed, Sat, 7:30-10:30 pm, music. Sun, 10:45 am, church services; 3:25, symphony program; 7:30-10:30 pm, lecture and music. Eastern standard time. Slogan: "WBBS—New England." 1500 watts.

**WBBS**—St. Lawrence University, Canton, N. Y. 263 meters, 1140 kilocycles, class A. Daily ex Sun, 11 am, weather reports and educational bulletins. Wed, 8:30 pm, concert. Eastern standard time. Slogan: "The Voice of the North Country." 250 watts.

**WCAE**—The Pittsburgh Press and the Kaufman & Baer Co., Pittsburgh, Pa. 462 meters, 650 kilocycles, class B. Daily ex Sun, 12:30 pm, news; 4:30 pm, closing stock reports (ex Sat); 6:30 pm, dinner concert; 7:30 pm, Uncle Kaybee; 7:45-8:30 pm, special features; 8:30 pm, concert. Sat, 2:30 pm, Tea-Dansant music; 4:30, orchestra. Mon & Tues, 10:30 pm, late concert. Sun, 10:45 am, services; 3 pm, chapel services; 4 pm, piano recital; 6:30 pm, dinner concert. Eastern standard time. Slogan: "Pittsburgh—Where Prosperity Begins." 500 watts.

**WCAE**—Clyde R. Randall, 2813 Calhoun St., New Orleans, La. 268 meters, 1120 kilocycles, class A. Daily, 7:30-8 pm. Mon & Thurs, 8-9 pm. Central standard time. 50 watts.

**WCAH**—Entrekin Elec. Co., 321 W. 10th Ave., Columbus, Ohio. 266 meters, 1130 kilocycles, class A. Daily, 11:30-12:30 pm, Tues, 8-10:30 pm. Sun, 10-12:30 pm; 4 pm, vesper; 7:30-9 pm. Slogan: "The Heart of Ohio." 200 watts.

**WCAJ**—Nebraska Wesleyan University, University Place, Neb. 275 meters, 1100 kilocycles, class A. Daily ex Sun, 10:30 am, weather. Tues, 7 pm, children's hour. Fri, 9 pm, music, lectures. Central standard time. 500 watts.

**WCAJ**—St. Olaf College, Northfield, Minn. 336 meters, 890 kilocycles, class B. Daily ex Sun & Wed, 9:45 am, chapel services. Thurs, 9 pm, music; Fri, 8:30 pm, book talk. Sat, 12, midnight, music. Sun, 8:30 pm, sacred. Central standard time. Slogan: "The College on the Hill." 500 watts.

**WCAO**—Sanders & Stayman Co., 319 N. Charles St., Baltimore, Md. 275 meters, 1090 kilocycles, class A. Daily ex Sun, 11:55 am, time signals; 12 noon, weather; 12:05 pm, studio program; 12:30 pm, dance music. Mon & Tues, 8 pm, studio concert. Wed, 9:30 pm, dance music; 11 pm, organ recital. Sun, 5 pm, vesper service. Eastern standard time. 500 watts.

**WCAO**—Chesapeake & Potomac Tel. Co., 725 13th St., N.W., Washington, D. C. 469 meters, 640 kilocycles, class B. Mon, Wed & Fri, 7:30-12 pm. Sun, 4 pm, 4 pm and 7:20-10:20 pm. Eastern standard time. 500 watts.

**WCAO**—Southern Radio Corp. of Texas, 824 N. Navarro St., San Antonio, Tex. 268 meters, 1140 kilocycles, class A. Mon, Thurs & Sun, 8:30-9:30 pm. Mon & Thurs, 11 pm to 12 midnight. Central standard time. 100 watts.

**WCAO**—South Dakota State School of Mines, Rapid City, S. D. 240 meters, 1250 kilocycles, class A. Daily ex Sun, 9:30 am, weather; 12:30 pm, weather. Thurs, 7:30 pm. Mountain time. Slogan: "The Wild Cat of the Hill." 500 watts.

**WCAO**—Durham & Co., 1936 Market St., Philadelphia, Pa. 273 meters, 1060 kilocycles, class A. Tues & Thurs, 7:30-10 pm. Wed & Fri, 6:30-10 pm. Sun, 5-8 pm. Eastern standard time. 500 watts.

**WCAV**—J. C. Dice Elec. Co., Little Rock, Ark. 263 meters, 1140 kilocycles, class A. Wed & Fri, 8:30 pm. Central standard time. 10 watts.

**WCAV**—University of Vermont, Burlington, Vt. 252 meters, 1190 kilocycles, class A. Schedule irregular. Fri, 7-8 pm. Eastern standard time. 100 watts.

**WCAV**—Milwaukee Civic Broadcasting Association, Inc., Hotel Antlers, Milwaukee, Wis. 266 meters, 1130 kilocycles, class A. Mon, Wed & Fri, 10:15 am, 12:15 pm, 3-4 pm. Tues & Thurs, 9:15 pm. Wed, 6:30 pm. Sun, 9 am and 9 pm. Central standard time. Slogan: "We Can Accommodate You." 250 watts.

**WCAV**—Carthage College, Carthage, Ill. 246 meters, 1220 kilocycles, class A. Wed, 9-10 pm. Central standard time. Slogan: "The College with an Ideal." 50 watts.

**WCAV**—Chas. W. Heimlich Camera Graph Repair Shop, Allentown, Pa. 234 meters, 1180 kilocycles, class A. Wed, 8:15-11 pm. Fri, 6:45-7:45 pm, bedtime stories. Sun, 5-7 pm, church services. Eastern standard time, 10 watts.

**WCBG**—University of Michigan, Ann Arbor, Mich. 229 meters, 1310 kilocycles, class A. 200 watts.

**WCBG**—Wilbur Glenn Voliva, Zion, Ill. 345 meters, 870 kilocycles, class B. Wed, 12:30-1 pm, organ concert. Thurs, 2:30-3:45 pm, service. Sun, 9-10:45 am, Bible school; 2:30-6 pm, service. Mon, Thurs & Sun, 8-10:30 pm. Central standard time. Slogan: "Where God Blesses Man Prospers." 1500 watts.

**WCBG**—Uhart Bros. Radio Co., New Orleans, La. 263 meters, 1140 kilocycles, class A. Mon & Thurs, 9-10 pm. Sun, 1-2 pm. Central standard time. 5 watts.

**WCBG**—Howard S. Williams (Portable), permanent address, Hattiesburg, Miss. 268 meters, 1120 kilocycles, class A. Daily ex Mon, 7:15-9:30 or 10 pm. Central standard time. Slogan: "Will Christ Be Glorified?" 10 watts.

**WCBH**—University of Mississippi (near) Oxford, Miss. 242 meters, 1240 kilocycles, class A. Mon & Fri, 8 pm. Central standard time. 10 watts.

**WCBH**—Nicoll, Duncan & Rush, Remis, Tenn. 240 meters, 1250 kilocycles, class A. Sat, 8-9:30 pm. Central standard time. 150 watts.

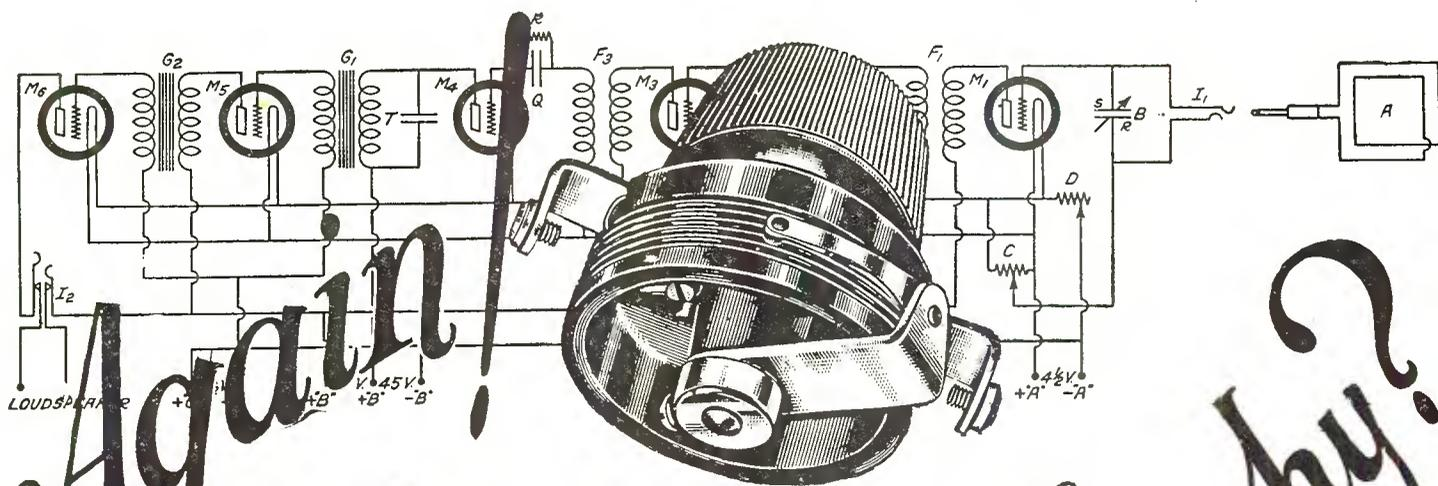

# Again! Why?

Mr. L. M. Cockaday specifies  
the Unity Vernier Rheostat  
(with switch)

**New!**

**UNITY  
Electric  
Soldering  
Iron**

**Set Manufacturers  
Use It—Because**

No UNITY Electric Soldering Iron ever burns out! It's built on the same principle as a flat-iron. Nichrome heating element is in the tip of the iron—not behind it. Pure mica insulation under pressure. Porcelain lining prevents heat from passing through handle. Light weight, well balanced. Specially designed for radio wiring. Unlimited guarantee.

And just look at the price

**\$ 1 50**

IN a recent issue of Popular Radio Mr. L. M. Cockaday I specified the Unity Vernier Rheostat for use in the Popular Radio Portable Set. Previously he used it for the detector tube of his famous 4-circuit tuner. Why? And why is the Unity used by such well-known set manufacturers as Garod, Bristol, Amrad, Moon, and many others? And why does Station WGN (formerly WDAP) offer them repeatedly as prizes, giving away hundreds of them during the year? Ask anyone who has used the Unity on his set—or better still try it yourself and the answer will soon be forthcoming!

**Use the UNITY—**  
because it is the only continuous wire vernier rheostat.  
because of its unique cut-out switch—tube can be turned on or off at any point without changing adjustment.

because it is the choice of both experimenters and set manufacturers.

Unity Vernier Rheostat (6 ohms, 25 ohms, or 40 ohms).....\$2.00

The Unity Cartridge Rheostat provides a convenient method of interchanging special resistances when different tubes are used.

Unity Cartridge Rheostat (Complete).....\$1.00

All Cartridges, \$0.40. Brackets only, \$0.60

See your dealer today. If he hasn't the Unity in stock, write us direct, mentioning his name.

**Write for FREE Copy of "Tube Control"—**

A helpful booklet for the set-builder prepared by J. E. Jenkins, engineer, station WGN. It shows what proper tube control means to the selectivity and quality of a receiving set.

Your copy is ready!

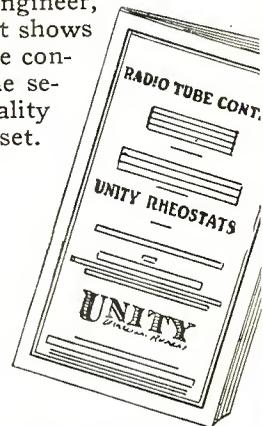

**UNITY MFG. CO., 224 N. Halsted St., CHICAGO**  
New York Office: C. M. Hunt, 50 Church St.

# UNITY Vernier Rheostat

**WCBJ**—J. C. Mans, Jennings, La. 244 meters, 1230 kilocycles, class A. Sun, 3-4 pm. Central standard time. 10 watts.

**WCBK**—E. Richard Hall, St. Petersburg, Fla. 266 meters, 1120 kilocycles, class A. Mon & Thurs, 7-8 pm. Tues, 8-8:15 pm. Sun, 8-10 pm. Eastern standard time. 500 watts.

**WCBL**—Northern Radio Mfg. Co., Houlton, Maine. 266 meters, 1130 kilocycles, class A. Wed, 7:30-10 pm. Sun, 10-30 am and 7:30 pm. Eastern standard time. 50 watts.

**WCBM**—Hotel Chateau, Baltimore, Md. 229 meters, 1310 kilocycles, class A. Tues & Thurs, 10 pm to 1 am, dance music. Sat, 9:30 pm to midnight, dance music. Sun, 9:45 to 11 pm, vocal concert. Eastern standard time. 50 watts.

**WCOB**—Radio Shop, Inc., Memphis, Tenn. 250 meters, 1200 kilocycles, class A. Sun & Wed, 8:30 pm. Central standard time. 20 watts.

**WCBO**—First Baptist Church, Nashville, Tenn. 236 meters, 1270 kilocycles, class A. 100 watts.

**WCBR**—Chas. H. Messer, 42 Boyle, Providence, R. I. (portable). 205 meters. 1460 kilocycles, class A. 30 watts.

**WCBT**—Clark University, Worcester, Mass. 238 meters, 1260 kilocycles, class A. 250 watts.

**WCBU**—Arnold Wireless Supply Co., Arnold, Pa. 220 meters, 1360 kilocycles, class A. Wed & Sun, 9-10 pm. Sat, 10-11 pm. Eastern standard time. 50 watts.

**WCBW**—Tallahoma Radio Club, Tallahoma, Tenn. 252 meters, 1190 kilocycles, class A. 10 watts.

**WCBX**—Geo. P. Rankin, Jr. & Maitland Solomon, 300 College St., Macon, Ga. 226 meters, 1330 kilocycles, class A.

**WCBY**—The Radio Shop, Newark, N. J. 233 meters, 1280 kilocycles, class A. Tues, Wed & Fri, 6-6:30 pm, 7:30-10:30 pm. Eastern standard time. 100 watts.

**WCCB**—Forks Electrical Shop, Buck Hill Falls, Pa. 230 meters, 1300 kilocycles, class A. 100 watts.

**WCCD**—Coppotelli Bros. Music House, 20 Illinois St., Chicago Heights, Ill. 248 meters, 1210 kilocycles, class A. Mon & Fri, 8:30 pm, musical program. Central standard time. Slogan: "Where the Lincoln and Dixie Highways Meet." 50 watts.

**WCCO**—Gold Medal Station, St. Paul, Minneapolis, Minn. 417 meters, 720 kilocycles, class B. Daily ex Sun, 9:40 am, 10 am, 10:30 am, 1:30 pm, 3 and 9 pm, market and weather reports. Daily ex Sun, 10:45 am, home service. Daily ex Sat & Sun, 2 pm, Woman's hour; 4 pm, magazine hour; 5:30 pm, Children's hour, Mon, Wed & Fri, 2:30 pm, music. Wed & Fri, 6 pm, sport hour. Tues, Wed, Thurs, Fri, 6:30 pm, Wed, 7 pm, resper. Fri, 7:30 pm, lecture. Mon & Sat, 8 pm, lecture; 8:30, music; 11 pm, dance program. Tues, 9 pm, weather. Wed, 9 pm, music; 11 pm, dance program. Fri, 8:30 pm, music. Thurs, 10 pm, concert. Sun, 10:20 am, 4:15 pm, 7:35, 9:15 pm. Central standard time. 500 watts.

**WCDH**—University of Mississippi, University, (P.O.) Miss. 242 meters, 1240 kilocycles, class A. Mon, Wed & Fri, 8 pm. Central standard time.

**WCEE**—Charles E. Erbstein, Elgin, Ill. 278 meters, 1100 kilocycles, class A. Daily ex Thurs & Sun, 7-8 pm. Mon, 10:30 pm to 12 midnight, Tues, Wed, Fri & Sat, 10 pm to 12 midnight. Central standard time. 500 watts.

**WCK**—Stix-Baer and Fuller, St. Louis, Mo. 273 meters, 1110 kilocycles, class A. Daily at noon and 3 pm. Mon, Tues, Wed, Fri & Sat, 8 pm. Mon & Fri, 11 pm. Wed, 11:30 pm. Sun, 7 pm. Central standard time. 100 watts.

**WCM**—University of Texas, Austin, Texas. 268 meters, 1120 kilocycles, class A. Daily ex Sun, 9:45 am, 11:45 am, 2:45 and 3:45 pm, markets. Central standard time. 250 watts.

**WCTS**—C. T. Sherer Co., Worcester, Mass. 268 meters, 1130 kilocycles, class A. 100 watts.

**WCX**—Detroit Free Press, Detroit, Mich. 516 meters, 580 kilocycles, class B. Daily ex Sun, 2 pm, news; 2:15 pm, markets; 2:50, weather; 4:15 and 6 pm, music. Daily ex Sat & Sun, 8:30-10:30 pm, alternate weeks. Tues, 10-12 midnight, "Red Apple Club." Sun, 10:30 am and 7:15 pm, church services. Eastern standard time. 500 watts.

**WDAE**—Tampa Times, Tampa, Florida. 273 meters, 1090 kilocycles, class A. Daily ex Sun, 5-5:30 pm, music. Daily ex Thurs & Sun, 7:30-7:45 pm, music, weather, news. Thurs, 8-10 pm, concert. Eastern standard time. 250 watts.

**WDAF**—The Kansas City Star, Kansas City, Mo. 365 meters, 824 kilocycles, class B. Daily ex Sun, 3:30-4:30 pm, 6-7 pm, 11:45 pm to 1 am. Mon & Tues, 5-5:30 pm. Mon, Wed & Fri, 8-9:30 pm. Sun, 4-5:45 pm. Central standard time. 500 watts.

**WDAG**—J. L. Martin, 605 E. 4th St., Amarillo, Texas. 263 meters, 1140 kilocycles, class A. Tues & Thurs, 8-9:30 pm. Central standard time. Slogan: "Where Dollars Always Grow." 100 watts.

**WDAH**—Trinity Methodist Church, El Paso, Texas. 268 meters, 1120 kilocycles, class A. Sun, 11 am. Wed & Sun, 7:30 pm, services. Mountain time. 50 watts.

**WDAY**—Radio Equip. Corp. Fargo, N. Dak. 244 meters, 1230 kilocycles, class A. Daily ex Sun, 10 am, markets and news; 11 am, markets; 12:30-2 pm, music; 7:30 and 8 pm. Tues, Thurs & Sat, 7:30 pm, music. Sun, 10:30 am, church services, 4 pm, concert. Central standard time. Slogan: "Biggest Little City in the World." 50 watts.

**WDCC**—Kirk, Johnson & Co., Lancaster, Pa. 253 meters, 1160 kilocycles, class A. 50 watts.

**WDD**—H. E. Burns, Martinsburg, W. Va. 254 meters, 1180 kilocycles, class A. Tues & Thurs, 8-10:30 pm. Eastern standard time. Slogan: "We Do Better Daily." 5 watts.

**WDBE**—Gillham-Schoen Elec. Co., 22 Luckie St., Atlanta, Ga. 278 meters, 1080 kilocycles, class A. Tues & Sat, 9-10 pm, music. Sun, 6-7 pm, music. Central standard time. Slogan: "We Distribute Better Equipment." 100 watts.

**WDBF**—Robert G. Phillips, Youngstown, Ohio. 222 meters, 1350 kilocycles, class A. 50 watts.

**WDBI**—Radio Specialty Co., St. Petersburg, Fla. 226 meters, 1330 kilocycles, class A. 20 watts.

**WDBJ**—Richardson-Wayland Elec. Corp., Roanoke, Va. 229 meters, 1310 kilocycles, class A. Daily ex Sun, 12-1 pm, 5:30-6:30 pm. Wed & Fri, 9-11 pm. Sun, 8-9 pm, church services. Eastern standard time. Slogan: "Roanoke Stand in Old Virginia." 50 watts.

**WDBO**—Rollins College, Winter Park, Fla. 240 meters, 1250 kilocycles, class A. 50 watts.

**WDBP**—Superior State Normal School, Superior, Wis. 261 meters, 1150 kilocycles, class A. 50 watts.

**WDBS**—The Morton Radio Supply Co., Salem, N. J. 234 meters, 1280 kilocycles, class A. Schedule irregular. Sun, 7:30 pm. Eastern standard time. 50 watts.

**WDBR**—Tremont Temple Baptist Church, Boston, Mass. 261 meters, 1150 kilocycles, class A. Fri, 7:30-9 pm. Sun, 10:30 am to 12 noon, 6:30-9 pm. Eastern standard time. 100 watts.

**WDBS**—The S. M. K. Radio Corp. 39 E. 3rd St., Dayton, Ohio. 275 meters, 1090 kilocycles, class A. Daily ex Sun, 12 noon to 1 pm, 6-8 pm, 8:05-11:30 pm. Sun, 10:45 am to noon, 12-1 pm, 7:30-9 pm. Central standard time. Slogan: "The Home of Aviation." 5 watts.

**WDBT**—Taylor's Book Store, Hattiesburg, Miss. 236 meters, 1270 kilocycles, class A. 10 watts.

**WDBW**—The Radio Den, 6th & Garden Sts., Columbia, Tenn. 268 meters, 1120 kilocycles, class A. Daily ex Sun, 12 noon, market and weather. Tues, Thurs & Sat, 8-9 pm. Sun, 11 am to 12:30 pm, music; 7:30-9 pm. Central standard time. Slogan: "The Dimple of the Universe." 125 watts.

**WDBX**—Otto Baur, 138 Dyckman St., New York N. Y. 233 meters, 1290 kilocycles, class A. 5 watts.

**WDBY**—North Shore Congregational Church, 1011 Wilson Ave., Chicago, Ill. 258 meters, 1160 kilocycles, class A. Wed, 7 pm, Bible class. Thurs, 7 pm, music. Sun, 11 am, church service. 3-4 studio; 7:45 pm, church service. Central standard time. 500 watts.

**WDBZ**—Ulster County Council Boy Scouts of America, Kingston, New York. 233 meters, 1290 kilocycles, class A. Thurs, 8-11 pm. Sun, 2:30 pm, services. Eastern standard time. Slogan: "Voice of the Catskills." 5 watts.

**WDM**—Church of the Covenant, Washington, D. C. 270 meters, 1110 kilocycles, class A. 10 watts.

**WDWF**—Dutee W. Flint, Cranston, R. I. 240 meters, 680 kilocycles, class B. 500 watts.

**WDZ**—James L. Bush, Tuscola, Ill. 278 meters, 1080 kilocycles, class A. Chgo. Board of Trade grain and live stock markets every 30 minutes from 9:30 am and 1:15 pm, each week day. Central standard time. 100 watts.

**WEAA**—Frank D. Fallain, 321-1st Ave., Flint, Mich. (Station Police Bldg.) 234 meters, 1280 kilocycles, class A. Daily ex Sun, 7 pm, police reports and music. Eastern standard time. Slogan: "The Vehicle City." 100 watts.

**WEAF**—American Telephone & Telegraph Co., 195 Broadway, New York City. 492 meters, 611 kilocycles, class B. Tues & Fri, 11-12 am. Mon & Sat, 4-5 pm. Mon & Tues, 6-11 pm. Wed, Thurs, Fri & Sat, 6-12 pm. Sun, 2-5:30 and 7:20-10:15 pm. Eastern standard time. 2000 watts.

**WEAH**—Wichita Board of Trade, Wichita, Kans. 268 meters, 1120 kilocycles, class A. Daily ex Sun, markets every hour until 2 pm; 5:30-7:30, Orchestra. Tues & Sat, program from Broadview Hotel. Central standard time. Slogan: "Kansas Grows the Best Wheat in the World." 50 watts.

**WEAI**—School of Electric Engineering, Cornell University, Ithaca, New York. 234 meters, 1180 kilocycles, class A. Schedules irregular. 500 watts.

**WEAJ**—University of South Dakota, Vermillion, S. Dak. 278 meters, 1080 kilocycles, class A. Wed, 8:30-9:30 pm and 10:15-11:30 pm. Central standard time. Athletic and sports, musical recitals, etc., also broadcast. Slogan: "South Dakota U. for South Dakotans." 100 watts.

**WEAM**—Borough of North Plainfield, North Plainfield, N. J. 261 meters, 1150 kilocycles, class A. 250 watts.

**WEAN**—Shepard Co., Providence, R. I. 270 meters, 1110 kilocycles, class A. 100 watts.

**WEAO**—Ohio State University, Columbus, Ohio. 293 meters, 1020 kilocycles, class B. Daily ex Sun, 9:45 am, markets, weather, agric. bulletins; 11 am, markets, weather; 11:15 am, markets, weather. Wed, 8 pm, concert. Lectures occasionally at 9 am, 1:30 pm, 5 pm. Slogan: "Where Education Advances Ohio." 500 watts.

**WEAP**—Mobile Radio Co., Mobile, Ala. 263 meters, 1140 kilocycles, class A. Daily ex Sun, 4-5 pm. Tues, Thurs & Sat, 7:45-8:45 pm. Sun, 11 am to 12 noon, 7:30-9 pm. Central standard time. 100 watts.

**WEAR**—The Goodyear Tire & Rubber Co., 2023 Union Trust Bldg., Cleveland, Ohio. 364 meters, 823 kilocycles, class B. Daily ex Sun, 11:30-12 noon, (ex Sat) 3:30-4 pm, market review. Tues, 7:30-11 pm, music. Wed, Fri & Sat, 7-8 pm, dinner concert. Thurs, 7-11 pm. First Saturday each month 12 midnight, Nite-Caps concert. Eastern standard time. 1000 watts.

**WEAU**—Davidson Bros. Co., Sioux City, Iowa. 275 meters, 1090 kilocycles, class A. Daily ex Sun, 9 am, (day-light saving time only) 10 am, 11 am, 12 noon, 1 pm, 1:30 and 5 pm. Tues, Thurs & Sat, 7:30-9:30 pm. Central standard time. Slogan: "The Heart of the Corn Belt." 100 watts.

**WEAY**—Iris Theater, Houston, Texas. 360 meters, 833 kilocycles, class C. Daily 11-12:20 am. Daily ex Sun, 12 noon to 1 pm, 2:30-3 pm, 6-7:15 pm. Tues, Wed & Fri, 8:30-9:30 pm. Sun, 11 am and 8 pm. Central standard time. Slogan: "We Entertain All Year." 500 watts.

**WEBA**—The Electric Shop, 131 Church St., New Brunswick, N. J. 233 meters, 1290 kilocycles, class A. Mon & Thurs, 8-10 pm. Eastern standard time. Slogan: "We Electrify by Appointment." 15 watts.

**WEBC**—Walter C. Bridges, 1225 Tower St., Superior, Wis. 242 meters, 1240 kilocycles, class A. 10 watts.

**WEBD**—Electrical Equip. & Service Co., 124 W. Ninth St., Anderson, Ind. 246 meters, 1220 kilocycles, class A. Schedule irregular. 100 watts.

**WEBE**—Roy W. Waller, 319 Wall St., Cambridge, Ohio. 234 meters, 1280 kilocycles, class A. Fri, 7:30-9 pm, music, talk, markets. Sun, 2-3:30 pm, music. Slogan: "Waller's Evening Broadcast Entertainers." 10 watts.

**WEBH**—Edgewater Beach Hotel-Chicago Evening Post, 5300 Sheridan Road, Chicago, Ill. 370 meters, 810 kilocycles, class B. Daily ex Mon & Sun, 7-8 pm, 9-10 pm, 11-12 midnight. Sun, 8-6 pm. Twilight Musicals, 7-9 pm. Central standard time. Slogan: "Voice of the Great Lakes." 1000 watts.

**WEBJ**—Third Avenue Railway System, 130th St. & Third Ave., New York City, N. Y. 273 meters, 1100 kilocycles, class A. Tues & Fri, 7-9 pm. Eastern standard time. Slogan: "The Red Trolley Station." 500 watts.

**WEBK**—Grand Rapids Radio Co., Hotel Howe, Grand Rapids, Mich. 242 meters, 1240 kilocycles, class A. Daily ex Sun, 7-8 pm. Wed, 8-9 pm. Sun, 7:15 pm, church services. Daily 10 am, weather; 20 minute piano program; household hints. Central standard time. 200 watts.

**WEBL**—Radio Corp of America, Woolworth Bldg., New York City, N. Y. (Portable). 226 meters, 1330 kilocycles, class A. 100 watts.

**WEBM**—Radio Corp of America, Woolworth Bldg., New York City, N. Y. (Portable). 226 meters, 1330 kilocycles, class A. 100 watts.

**WEBP**—E. Budd Peckdick, Spanish Fort, New Orleans, La. 280 meters, 1070 kilocycles, class A. 50 watts.

**WEBQ**—Tate Radio Co., Harrisburg, Ill. 226 meters, 1330 kilocycles, class A. Daily ex Sun, 7:15 pm, news, weather, etc. Tues & Fri, 8-10 pm, concert. Sun, 3-4 pm. Central standard time. Slogan: "The Voice from Egypt." 10 watts.

**WEBR**—Howell Elec. Co., 54 Niagara St., Buffalo, N. Y. 244 meters, 1230 kilocycles, class A. Tues, Thurs & Fri, 8:30-11:30 pm. Sun, 12 noon to 3 pm. Eastern standard time. 50 watts.

**WEBT**—The Dayton Cooperative Industrial High School, Dayton, Ohio. 256 meters, 1170 kilocycles, class A. Schedule irregular. Slogan: "Worthy Effort Brings Triumph." 5 watts.

**WEBW**—Bellevue College, Beloit, Wisc. 268 meters, 1119 kilocycles, class A. Tues, 8 pm, concert. Sun, 4:30 pm, vesper. Central standard time. 500 watts.

**WEBX**—John E. Cain Jr., Nashville, Tenn. 263 meters, 1140 kilocycles, class A. 50 watts.

**WEBY**—Hobart Radio Co., 570 Hyde Park Ave., Rosindale, Mass. 226 meters, 1330 kilocycles, class A. Daily schedule irregular. Sun, 2:15 pm. Eastern standard time. Slogan: "The First Station of Rosindale." 10 watts.

**WEBZ**—Savannah Radio Corp., Savannah, Ga. 234 meters, 1280 kilocycles, class A. 50 watts.

**WEEL**—Edison Electric Illuminating Co., Boston, Mass. 476 meters, 630 kilocycles, class B. Mon & Fri, 1:30-10 pm. Tues, 2-11 pm. Wed, 2-10 pm. Thurs, 1-11 pm. Sun, 3:45-5:30, 7:20-10:30 pm. Eastern standard time. Slogan: "The Friendly Voice." 500 watts.

**WEMC**—Emanuel Missionary College, Berrien Springs, Mich. 286 meters, 1050 kilocycles, class B. Mon & Wed 8:15 pm, music, educational lectures, etc. Fri, 9 pm, Old Time and Sacred Music. Sun, 11 am, Chapel service, 8:15 pm, same. Central standard time. Slogan: "The Radio Lighthouse." 500 watts.

**WEW**—St. Louis University, University Station St. Louis, Mo. 248 meters, 1210 kilocycles, class A. Daily ex Sun, 9 and 10 am, market and weather; 2 pm, closing market. Thurs, 7 pm, entertainment. Sun, 7 pm, lecture. Central standard time. 100 watts.

**WFAP**—Dallas News and Journal, Dallas, Texas. 475 meters, 630 kilocycles, class B. Daily 10:30-10:55 am, weather markets; 12:30-1 pm, lectures; 2:30-3 stock, news, sports; 3:30-4, 4:30-5, news and sports; 5:30-6, Children's stories; 6:30-7:30, dinner concert; 8:30-9:30, concert. weather. Tues, Thurs & Sat, 11-12 midnight, concert. Wed, silent after 1 pm. Sun, 6-7 pm, Bible class, 9:30-11 pm, weather, concert. Central standard time. 500 watts.

**WFAM**—Times Publ. Co., St. Cloud, Minn. 273 meters, 1100 kilocycles, class A. 10 watts.

**WFAY**—Dept. of Elec. Engineering, University of Nebraska-Lincoln, Nebr. 275 meters, 1090 kilocycles, class B. Daily ex Sun, 10 am and 12:15 pm, weather, road, health, agr. bulletins. Thurs, 7 pm, music and lectures. Sat, 11 pm, music. Central standard time. Slogan: "The Home of the Cornhuskers." 500 watts.

**WFBB**—Eureka College, Eureka, Ill. 240 meters, 1250 kilocycles, class A. Mon & Thurs, 8-9 pm. Central standard time. 100 watts.

**WFBC**—First Baptist Church, Knoxville, Tenn. 250 meters, 1300 kilocycles, class A. Daily schedule irregular. Sun, 10:30 am and 7:30 pm, church services. 4-5 pm, sacred concert. Central standard time. 50 watts.

**WFBD**—Getsemene Baptist Church, Philadelphia, Pa. 234 meters, 1280 kilocycles, class A. 5 watts.

**WFBE**—Van de Walle Music & Radio Co., 205 W. 2nd St., Seymour, Ind. 226 meters, 1330 kilocycles, class A. Mon, Wed & Fri, 9-10 pm. Central standard time. 200 watts.

**WFBG**—The Gable-Tribune Broadcast Station, Altoona, Pa. 277 meters, 1050 kilocycles, class A. Daily ex Sun, 11:45 am, 3:45 pm, 6:15 pm. Mon & Fri, 7:15 and 8:30 pm. Tues, Wed, Thurs, 8:30 pm. Tues, 10:30 pm. Fri, 11:15 pm. Sat, 9:15 pm. Sun, 10:30 am and 4 pm. Eastern standard time. Slogan: "Altoona, the Original Gateway to the West." 100 watts.

**WFBH**—Concourse Radio Corp., 72nd St. & Central Park W., New York City, N. Y. 272 meters, 1010 kilocycles, class A. Lectures, classical, popular, concerts. Eastern standard time. Slogan: "Voice of Central Park." 500 watts.

**WFBJ**—Calvin Radio Supply Co., 521 Market St., Camden, N. J. 236 meters, 1270 kilocycles, class A. Mon & Thurs, 9-12 midnight. Eastern standard time. Slogan: "The City Across the Bridge." 100 watts.

**WFBK**—St. John's University, Collegeville, Minn. 236 meters, 1270 kilocycles, class A. 50 watts.

**WFBK**—Dartmouth College, Hanover, N. H. 256 meters, 1170 kilocycles, class A. 100 watts.

**WFBM**—The Onondaga Hotel, Syracuse, New York. 252 meters, 1190 kilocycles, class A. 100 watts.

**WFBM**—Merchants Heat & Light Co., Indianapolis, Ind. 268 meters, 1120 kilocycles, class A. 250 watts.

**WFBN**—Bridgewater Radio Sales & Service Co., Broad St., Bridgewater, Mass. 226 meters, 1330 kilocycles, class A. Daily ex Sun, 5-6 pm, dinner concert. Fri, 8-10 pm. Sun, 1-3 pm. Eastern standard time. Slogan: "Bridgewater the Home of the K C Chocolates." 200 watts.

**WFBQ**—Wynne Radio Co., Raleigh, N. C. 232 meters, 1190 kilocycles, class A. 50 watts.

**WFBR**—Fifth Infantry, Maryland Nat'l Guard, Baltimore, Md. 254 meters, 1150 kilocycles, class A. 100 watts.

**WFBT**—Gloucester Co. Civic League, Pitman, N. J. 231 meters, 1300 kilocycles, class A. 50 watts.

**WFBY**—U. S. Army Signal Corps, Ft. Benj Harrison, Ind. 238 meters, 1160 kilocycles, class A. Mon, Wed & Fri, 8:30-11:30 pm. Central standard time. 100 watts.

**WFBZ**—Knox College, Galesburg, Ill. 254 meters, 1180 kilocycles, class A. 10 watts.

**WFI**—Strawbridge & Clothier, 8th & Market Sts., Philadelphia, Pa. 395 meters, 760 kilocycles, class B. Daily ex Sun, 10:15 am, market and live stock. 1 pm, Orchestra; 1:50 pm, (ex Sat) 3 pm, concert; 8:30 pm, Orchestra; 7 pm, Sunny Jim—Kiddies. Pal. Tues, 8-11:30 pm. Thurs, 8 pm, Boy Scouts; 8:30-10 pm. Sat, 10-11 pm. Sun, 10:30 am, church services; 4:30 pm, chapel services; 7:30 pm, church services. Eastern standard time. 500 watts.

# Prest-O-Lite RADIO CHART

Voltage of Tubes	No. of Tubes	Type of Tubes (see foot-note)	Total Rated Ampere Drain	Recommended Prest-O-Lite "A" Batteries		
				Order by following Types	Days between Charges	
5-Volt Tubes  C-300 and UV-200 are interchangeable C-301A, DV-2 and UV-201A are interchangeable	1	UV-200	1	69 WHR OR 67 WHR	22 14	
	2	UV-201A	1/2	67 WHR	33	
	2	1 UV-200 1 UV-201A	1 1/4	611 WHR OR 69 WHR	22 17	
	3	UV-201A	3/4	69 WHR OR 67 WHR	21 22	
	3	1 UV-200 2 UV-201A	1 1/2	611 RHR OR 69 WHR	21 14	
	4	UV-201A	1	69 WHR OR 67 WHR	22 14	
	4	1 UV-200 3 UV-201A	1 3/4	613 RHR OR 611 WHR	22 15	
	6	UV-201A	1 1/4	611 WHR OR 69 WHR	22 17	
	5	1 UV-200 4 UV-201A	2	613 RHR OR 611 WHR	19 13	
	6	UV-201A	1 1/2	611 RHR OR 69 WHR	21 14	
	2	UV-201A	1	69 KPR OR 67 KPR	21 15	
	For sets using current at a rate higher than 2 amperes.			2 1/4	69 KRL OR 67 KPR	22 13
				2 1/2	69 KRL OR 69 KPR	19 16

Copyright, 1915 The Prest-O-Lite Co., Inc.

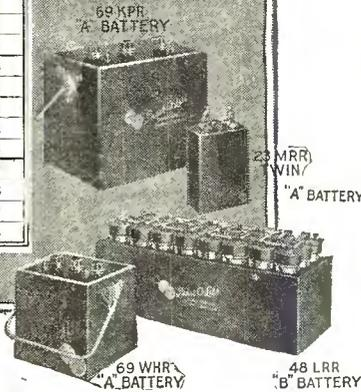

Write today for this free booklet

Whether you have a one-tube set or most advanced multi-tube outfit, you'll find a fund of interesting information in our booklet, "How to fit a storage battery to your set—and how to charge it."

This booklet gives you the complete Prest-O-Lite Radio Chart—technically accurate recommendations covering both "A" and "B" storage batteries for every type of set.

In addition, there is much vitally important data on battery care and upkeep—in information that any radio fan will find of real value. In keeping his set at its maximum efficiency. Write for your copy right now

## What size batteries will work best in your set?

SELECTING storage batteries of the right size and capacity is necessary, not only for the best reception, but also to arrange the time between chargings to suit your convenience.

The Prest-O-Lite Chart now makes this easy. Illustrated above is a section of the master chart showing Prest-O-Lite "A" Batteries for 5-volt tube sets. If your set has these tubes, you will find, in the fifth column, the Prest-O-Lite "A" Battery that fits it exactly. Two sizes are recommended, but the larger capacity battery will be found more desirable unless facilities for frequent and easy charging are provided. (The days between chargings are based on an average use of your set of three hours a day.)

Thousands of radio dealers have the complete chart, showing you also how to select Prest-O-Lite "B"

Batteries, as well as Prest-O-Lite "A" Batteries for peanut tube sets.

You'll prefer Prest-O-Lite Storage Batteries because of their special features designed for better radio reception. Improved separators and plates insure steady, unvarying current and years of life. They're easy to recharge. Handsomely finished to go well with the finest sets. Prest-O-Lite Batteries offer you truly remarkable savings. Though standard in every respect, they are priced as low as \$4.75 and up.

Let the Prest-O-Lite Chart guarantee you batteries scientifically correct for your set. It is endorsed by the world's largest electrochemical research laboratories. See it at your dealer's—or write for our interesting booklet, "How to fit a storage battery to your set—and how to charge it."

THE PREST-O-LITE CO., INC., INDIANAPOLIS, IND.

New York

San Francisco

In Canada: Prest-O-Lite Company of Canada, Ltd., Toronto

# Prest-O-Lite



**WGAL**—Lancaster Elec. Sup. & Const. Co., Lancaster, Pa. 248 meters, 1210 kilocycles, class A. 10 watts.

**WGAO**—W. G. Patterson, Shreveport, La. 263 meters, 1140 kilocycles, class A. Mon & Wed, 9:10-30 p.m. music. Sat, 9-12 midnight, dance music. Sun, 9:30-10:30 am, Bible class, music and lecture. Central standard time. 150 watts.

**WGAZ**—South Bend Tribune, South Bend, Ind. 275 meters, 1090 kilocycles, class A. Mon, Wed & Fri 7-9 pm. Central standard time. Slogan: "Broadcasting From the Hoosier State." 250 watts.

**WGBA**—Jones Elec. & Radio Mfg. Co., Baltimore, Md. 254 meters, 1180 kilocycles, class A. 50 watts.

**WGBB**—Harry H. Carman, 217 Bedell St., Shreveport, N. Y. 244 meters, 1240 kilocycles, class A. 100 watts.

**WGBO**—First Baptist Church, Memphis, Tenn. 266 meters, 1130 kilocycles, class A. 10 watts.

**WGBF**—The Finke Furniture Co., 307 So. 7th St., Evansville, Ind. 217 meters, 1380 kilocycles, class A. Daily ex Sun, 11-10 am, markets, weather, police reports. Tues & Fri, 8-10 pm, concert. Fri, 11 pm to 12:15 am, midnight frolic. Sun, 9:10 am, Bible class. Central standard time. Slogan: "We're Gon'a Be Friends." 50 watts.

**WGBG**—Breitenbach's Radio Shop, Thrifton, Va. 226 meters, 1330 kilocycles, class A. 100 watts.

**WGBH**—F. R. Herald Publ. Co., Fall River, Mass. (Portable), 210 meters, 1430 kilocycles, class A. 10 watts.

**WGBI**—Frank S. Megargee, Scranton, Pa. 240 meters, 1250 kilocycles, class A. 10 watts.

**WGBK**—Lawrence W. Campbell, Johnstown, Pa. 248 meters, 1210 kilocycles, class A. 5 watts.

**WGBM**—Theodore N. Saaty, 92 Dover St., Providence, R. I. 234 meters, 1280 kilocycles, class A. 5 watts.

**WGBN**—Hub Radio Shop, 728 First St., La Salle, Ill. 256 meters, 1170 kilocycles, class A. 10 watts.

**WGBO**—Dr. Rosas Artan, 197 Ponce de Leon Ave., San Juan, Porto Rico. 275 meters, 1090 kilocycles, class A. 10 watts.

**WGBP**—M. L. Price Music Co., Tampa, Fla. 250 meters, 1200 kilocycles, class A. 50 watts.

**WBGQ**—Stout Institute, Menomonic, Wis. 234 meters, 1280 kilocycles, class A. 20 watts.

**WGBR**—Marshfield Broadcasting Association, 114 Central Ave., Marshfield, Wis. 229 meters, 1310 kilocycles, class A. 10 watts.

**WGBS**—Gimbel Brothers, Inc., 33d St. & Broadway, New York, N. Y. 316 meters, 950 kilocycles, class B. Daily ex Sun, 10-11 am, 1:30-2:30 pm, 3-4 pm. Mon, Wed & Fri, 6:7-30 pm. Tues and Sat, 6 pm to midnight. Thurs, 6 pm to 1 am. Sun, 2:30-5:30 pm, 9:30-11:30 pm. Eastern standard time. 1000 watts.

**WGBT**—Furman University, Greenville, S. C. 236 meters, 1270 kilocycles, class A. 15 watts.

**WGBV**—Valley Theater, 102 Erie St., Spring Valley, Ill. 212 meters, 1410 kilocycles, class A. 20 watts.

**WGBX**—University of Maine, Orono, Maine. 252 meters, 1190 kilocycles, class A. 10 watts.

**WGBY**—The Progress Sales Co., R. R. No. 2, New Lebanon, Ohio. 218 meters, 1370 kilocycles, class A. 30 watts.

**WGI**—American Radio & Research Corp., Medford Hillside, Mass. 261 meters, 1150 kilocycles, class A. Tues, Wed, Thurs & Fri, 7:30 pm, reports; 8 pm, concert. Sun, 6-45 pm, church service; 8 pm, sacred concert. Eastern standard time. Slogan: "Amrad The Voice of the Air—Where Broadcasting Began." 100 watts.

**WGN**—The Chicago Tribune—Drake Hotel, Chicago, Ill. 370 meters, 810 kilocycles, class B. Daily ex Sun, 9:31 am, time signals; 9:35 am, 10 am, 10:30 am, 11 am, 1:30 am, markets; 11:55 am, time signals; 12 noon, (ex Sat), 12:30 pm, markets; 12:35 pm, and 1:05 pm, Tea room orchestra; 1 pm (ex Sat) 1:25 pm, markets; 1:35 pm, readings from Chicago Tribune; 1:45-2:30 pm, luncheon music; 2:30-3 pm (ex Sat) concert recital; 3-3:30 pm, fiction, humor, verse; 5 pm, stock exchange; 5:30-5:37 pm, Skeezix time for the Children; 5:57 pm, time signals. Daily ex Sun and Mon, 6-6:30 pm, Organ recital; 6:30-7 pm, dinner music; 8-9 pm, classic hour; 9-11 pm, the jazz scene. Sat, closing quotation and markets, 12:10 pm. Sun, 11-11:45 am, Uncle Walt; 11:45-12:45 pm, concert; 2-5 pm, recital; 9-10 pm, concert. Central standard time. 1000 watts.

**WGR**—Federal Telephone Mfg. Corp. Hotel Statler, Buffalo, N. Y. 319 meters, 940 kilocycles, class B. Daily ex Sun, 12-12:30 pm, Mon, Wed & Fri, 2:30-6:30 pm, Tues, Thurs & Sat, 2:30-6 pm. Daily ex Sat & Sun, 7:30-11 pm. Sun, 3-4 pm, 7:15-7:30 pm. Eastern standard time. Slogan: "Key City of Industry." 750 watts.

**WGST**—Georgia School of Technology, Atlanta, Ga. 270 meters, 1110 kilocycles, class A. Mon, 9-10 pm. Thurs, 7-8 pm. Central standard time. Slogan: "The Southern Technical School with a National Reputation." 500 watts.

**WGW**—General Electric Co., 1 River Road, Schenectady, New York, 380 meters, 790 kilocycles, class B. Daily ex Sun, 11:55 am, time signals; 12:30 pm, stock quotations; 12:50 pm, weather. Daily ex Sat & Sun, 12:40 pm, fruit and vegetable market; 6 pm, closing stock quotations; 6:10, produce market report; 6:15 pm, news bulletins, Mon, Tues, Thurs & Fri, 2 pm, music and talks to women, 7:45 pm. Mon, 6:30 pm, review of sports. Tues & Thurs, 6:30 pm, dinner music. Wed, 6:30 pm, adventure story. Fri, 6:30 Children's stories; 7 pm, Sunday school lesson; 7:45 pm, health talks; 10:30 pm, late program. Tues, 11:40 pm, Organ. Thurs, 7:45 pm, books; 11:20 pm, Organ. Sat, 9:30 pm, dance program. Second and last Mon each month, 7:15 pm, farm bureau talks. Sun, 10:30-11 am, Church; 3:35 and 5 pm, Organ; 7:30-8 pm, 9 pm, Orchestra. Eastern standard time, 1500 watts.

**WHA**—University of Wisconsin, Madison, Wis. 355 meters, 560 kilocycles, class B. 500 watts.

**WHAD**—Marquette University, Milwaukee, Wisc. 275 meters, 1090 kilocycles, class A. Daily 11 am, weather. Wed, 7:30-8:30 pm, concert, health reports. Occasional lecture broadcast in afternoon. Central standard time. 500 watts.

**WHAG**—University of Cincinnati, Cincinnati, Ohio. 233 meters, 1290 kilocycles, class A. 100 watts.

**WHAM**—Eastman School of Music, Rochester, N. Y. 278 meters, 1080 kilocycles, class A. Daily ex Sun, 3:30-4 pm, Orchestra; 4-6 pm, Organ recital; 6:50 pm, market, weather; 7-7:30 pm, Orchestra. Tues, 6:15-6:45 pm, Organ recital. Sun, 3-15 pm, chapel service. Eastern standard time. 100 watts.

**WHAR**—Seaside Hotel, Atlantic City, N. J. 275 meters, 1090 kilocycles, class A. 100 watts.

**WHAS**—Courier-Journal and Louisville Times, Louisville, Ky. 400 meters, 750 kilocycles, class B. Mon, 4-5 pm. Daily ex Mon & Sun, 4-5 pm, 7:30-9 pm. Sun, 9:57-10:45 am, 4-4 pm. Central standard time. 500 watts.

**WHAV**—Wilmington Electric Specialty Co., Wilmington, Dela. 266 meters, 1130 kilocycles, class A. 100 watts.

**WHAZ**—Rensselaer Polytechnic Institute, Troy, N. Y. 385 meters, 778 kilocycles, class B. Every Mon, 9-11 pm, second Mon each month, special trans-Atlantic and transcontinental test program 12 midnight to 1:30 am. Eastern standard time. 500 watts.

**WHB**—Sweeney Automotive & Electrical School, Kansas City, Mo. 411 meters, 730 kilocycles, class B. Daily ex Sun, 8:25 am, 9:25, 10:25, 11:25 am, 12:15 pm, 1:25 pm, live stock quotations, grain, weather, etc.; 2-3 pm, music; 3 pm, weather. Mon, Wed & Fri, 7-8 pm, music and educational program. Tues & Thurs, 8-10 pm, concert. Sun, 9:45-11 am, church; 12 midnight, concert. Central standard time. Slogan: "The Heart of America." 500 watts.

**WHBA**—Shaffer Music House, Oil City, Pa. 250 meters, 1200 kilocycles, class A. 20 watts.

**WHBB**—Hebal's Store, Stevens Point, Wisc. 240 meters, 1250 kilocycles, class A. 50 watts.

**WHDI**—Wm. Hood Dunwoody Industrial Institute, Minneapolis, Minn. 278 meters, 1080 kilocycles, class A. 100 watts.

**WHK**—The Radiovox Co., 1025 Boliver St., Cleveland, Ohio. 273 meters, 1100 kilocycles, class A. Daily ex Sun, 12:30-1:30 pm, 6-6:30 pm, 6:30-7:30, 7:30-8 pm. Thurs & Fri, 8:30-11:30 pm. Sat, 9 pm to 1 am. Sun, 10:30-12:30 pm, 4:30-5:30, 7:30-9, 9:15-11:30 pm. Eastern standard time. Slogan: "The Fifth Oldest Station in the U. S. Located in the Fifth City." 500 watts.

**WHN**—Geo. Schubel, 1540 Broadway, New York City, N. Y. 361 meters, 830 kilocycles, class B. Daily ex Sun, 12-1 pm, 2:15-3:15, 3:45-5:30 pm. Mon, Wed & Sat, 6-12 pm. Tues, Thurs & Fri, 6:7-30, 9:30-12 midnight. Sun 3-6 pm, 10-12 pm. Eastern standard time. Slogan: "The Voice of Great White Way." 500 watts.

**WHO**—Pankers Life Co., 1101 Liberty Bldg., Des Moines, Iowa. 522 meters, 974 kilocycles, class B. Daily ex Sun, 9:45 am, 10:15 am, 12 noon. Daily ex Sat & Sun, 2 pm. Mon, 7:30-9 pm, 11:15 pm to midnight. Wed, 6:30-9:45 pm, Fri, 7:30-9 pm. Every second week Thurs, 11 pm to midnight. Sun, 11 am, church and 4 pm, concert. Central standard time. Slogan: "We Help Others." 500 watts.

**WHT**—New high power 5 kw. station under construction in Chicago to be operated by Radio Broadcasting Corporation of which William H. Thompson (W.H.T.) is President. Will be under way with tests in about 60 days, wave length not yet assigned. Will be class "B" station.

**WIAD**—Howard R. Miller, 6318 No. Park Ave., Philadelphia, Pa. 250 meters, 1200 kilocycles, class A. Tues & Thurs, 9 pm. Eastern standard time. Slogan: "The Voice From the Birthplace of Liberty." 100 watts.

**WIAG**—Journal-Stockman Co., Stock Yards, Omaha, Nebr. 278 meters, 1080 kilocycles, class A. Daily ex Sun, 7:45 am, 9:10 am, 10:20 am, 12 noon. Daily ex Sat & Sun, 1:35 and 3:50 pm. Central standard time. 250 watts.

**WIAS**—Home Elec. Co., Burlington, Iowa. 254 meters, 1180 kilocycles, class A. Tues, 8 pm, studio concert. Thurs, 7 pm, Organ. Sat, 10:30 pm, Organ. Sun, 10:30 am, church services. Central standard time. Slogan: "Burlington On the Mississippi." 100 watts.

**WIK**—K. & L. Elec. Co., McKeesport, Pa. 234 meters, 1280 kilocycles, class A. 100 watts.

**WIL**—Benson Radio Co., St. Louis, Mo. 273 meters, 1099 kilocycles, class A. Mon & Wed, 10-12 pm. Fri, 9-11 pm. Sat, 11 pm to 1 am. Central standard time. Slogan: "A Wave Length Ahead." 100 watts.

**WIP**—Gimbel Bros., Philadelphia, Pa. 509 meters, 590 kilocycles, class B. Daily ex Sun, 1-1:30 pm, 1:30-3 pm, 3-4:30 pm, 6-7:30 pm. Tues, 8-10:30 pm. Thurs, 8-11 pm. Sat, 8-12 pm. Alternate Sundays, 10:30 am to noon, 4-5 pm, first Sunday. Second Sunday, 4-4:30 pm, 7:15-8, 9:30-10 pm. Eastern standard time. 500 watts.

**WIAB**—American Elec. Co., Lincoln, Nebr. 229 meters, 1310 kilocycles, class A. 100 watts.

**WIAD**—Jackson's Radio Eng. Laboratories, Waco, Texas. 352 meters, 850 kilocycles, class B. Mon & Fri, 9-10 pm. Sun, 11 am and 8 pm. Central standard time. 500 watts.

**WIAG**—The Norfolk Daily News, Norfolk, Nebr. 270 meters, 1110 kilocycles, class A. Daily ex Sun, 12:15 pm. Central standard time. 250 watts.

**WJAK**—Rev. Clifford L. White, Greentown, Ind. 254 meters, 1180 kilocycles, class A. Mon, Fri & Sat, 7:30-8:30 pm, music. Central standard time. Slogan: "The Radio Parson." 500 watts.

**WIAM**—D. M. Perham, 322-3rd Ave. West, Cedar Rapids, Iowa. 268 meters, 1120 kilocycles, class A. Daily ex Sun, 10 am, 11:30 am and 1:30 pm, market reports. Tues, Thurs & Sat, 6:10-30 musical program. Sun, 3:50 pm, vesper services. Central standard time. 100 watts.

**WIAN**—Peoria Star, Peoria, Ill. 273 meters, 1100 kilocycles, class A. 100 watts.

**WIAR**—The Outlet Company, Providence, R. I. 305 meters, 993 kilocycles, class B. Mon, Wed & Fri, 10 am. Daily ex Sun, 1:05 pm, studio. Fri, 11 am, Orchestra. Thurs, 7:30 pm, studio. Mon, Thurs & Fri, 8 pm. Tues, 8:30 pm, Gold Dust Twins. Mon, Tues, Wed & Thurs, 9 pm. Mon & Wed, 10 pm, Orchestra. Sat, 7:05 pm, studio. Sun, 7:20 pm, theater program; 9:15 pm, Organ. Eastern standard time. Slogan: "The Southern Gateway of New England." 500 watts.

**WIAS**—Pittsburgh Radio Supply House, 963 Liberty Ave., Pittsburgh, Pa. 275 meters, 1090 kilocycles, class A. 500 watts.

**WIJZ**—Zenith Radio Corp., 332 So. Michigan Ave., Chicago, Ill. (Portable) 268 meters, 1120 kilocycles, class A. Schedule variable. Central standard time. Slogan: "The Most Powerful Portable Broadcasting Station in the World." 100 watts.

**WJD**—Denison University, Dept. of Physics, Granville, Ohio. 217 meters, 1380 kilocycles, class A. Schedule irregular. Educational, entertainment, athletic events broadcast. Slogan: "The College on the Hill." 500 watts.

**WIJD**—Loyal Order of Moose, Mooseheart, Ill. 302 meters, 990 kilocycles, class B. Daily ex Thurs & Sun, 3:30-4:30 pm, 6:30-8 pm, 10:30 pm to 1:30 am. Sun, 7:45-8:45 am, 9:9-40 am, 9:40-10:30 am. Central standard time. Slogan: "The Call of the Moose." 500 watts.

**WIJY**—Radio Corporation of America, 33 West 42nd St., New York, N. Y. 405 meters, 740 kilocycles, class B. Tues, Thurs & Fri, 7:30-11:30 pm. Eastern standard time. 750 watts.

**WIJZ**—Radio Corporation of America, 33 West 42nd St., New York, N. Y. 455 meters, 660 kilocycles, class B. Daily ex Sun, 10-11 am, 1-2 pm, 4-6 pm, 7-11:30 pm. Sun, 9-10 am, 11-1 pm, 2:30-5 pm, 7-10:30 pm. Eastern standard time. 500 watts.

**WKAA**—H. F. Paar, 1444 Second Ave., Cedar Rapids, Iowa. 278 meters, 1080 kilocycles, class A. Mon, Wed & Fri, 3:45-4:30 pm. Mon and Wed, 7:15-8, 9:30-11 pm. Fri, 8:30-11:30 pm. Sun, 11 am, church services; 5 pm, same. Central standard time. 500 watts.

**WKAD**—Chas. Looff, Crescent Park, East Providence, R. I. 240 meters, 1250 kilocycles, class A. 20 watts.

**WKAN**—United Battery Service Co., Montgomery, Ala. 226 meters, 1330 kilocycles, class A. 15 watts.

**WKAP**—Dutee W. Flint, Cranston, R. I. 234 meters, 1280 kilocycles, class A. 50 watts.

**WKAO**—Radio Corp. of Porto Rico, San Juan, P. R. 340 meters, 880 kilocycles, class B. 500 watts.

**WKAR**—Michigan Agricultural College, East Lansing, Mich. 285 meters, 1050 kilocycles, class B. Daily ex Sun, 12 noon, weather and road bulletins. Mon & Fri, 7-8 pm, educational program. Wed, 8-9 pm. Sat, 12:30-1:30 am, dance program. Eastern standard time. 500 watts.

**WKAV**—Laconia Radio Club, Laconia, N. H. 254 meters, 1180 kilocycles, class A. 50 watts.

**WKY**—W K Y Radio Shop, Oklahoma City, Okla. 275 meters, 1090 kilocycles, class A. Daily 3-4 pm. Mon, Wed & Fri, 7-7:30 and 9-10:30 pm. Sun, 9:30 am to noon, 7:30-9 pm. Central standard time. 100 watts.

**WLAL**—First Christian Church, Tulsa, Okla. 250 meters, 1200 kilocycles, class A. Thurs, 8-9:30 pm, sacred concert. Fri, 8 pm, vocal and instrumental program. Sat, 8 pm, Bible school lesson. Sun, 11 am and 7-8 pm, sermon. Slogan: "The Voice of the Church." Central standard time. 500 watts.

**WLAP**—W. Y. Jordan, 306 W. Breckenridge St., Louisville, Ky. 275 meters, 1090 kilocycles, class A. 20 watts.

**WLAX**—Greencastle Community Broadcasting Station, Greencastle, Ind. 231 meters, 1300 kilocycles, class A. 20 watts.

**WLB**—University of Minnesota, Minneapolis, Minn. 278 meters, 1080 kilocycles, class A. 5 watts.

**WLBL**—Wisconsin Dept. of Markets, Stevens Point, Wisc. 278 meters, 1080 kilocycles, class A. Daily ex Sun, 8:45 am, markets, live stock; 9:45 am, weather, butler and egg markets; 10:45 am, weather; 11:45 am, weather, cheese market; 12:30 pm, weather, summary of markets, grain and feed quotations each Wed & Sat; 1:45 pm, weather, live poultry market. Tues, 8 pm, musical program. Sun, 12:01 am, "Enemies of Sleep." Central standard time. Slogan: "Wisconsin Land of Beautiful Lakes." 500 watts.

**WLIT**—Lit Bros., Philadelphia, Pa. 394 meters, 760 kilocycles, class B. Daily ex Sun, 11:45-12:55 pm, 2-3, 4:30-6, 7:30-8 pm. Mon & Wed, 8-10 pm, concert. Fri, 8-10:30 pm. Eastern standard time. 500 watts.

**WLS**—Sears, Roebuck and Co., 925 Ioman Ave., Chicago, Ill. 345 meters, 870 kilocycles, class B. Daily ex Sun, 9-11 am. Daily ex Sat & Sun, 12-1 pm, 1:30 pm, 3:5-4:45 pm. Mon, 6 pm, Tues, 6 pm to 1 am, Wed & Fri, 6-11 pm, Thurs, 6-8 pm. Sat, 1:30 and 4:30 pm to 12:30 midnight. Sun, 6:30-8 pm. Central standard time. Slogan: "World's Largest Store." 500 watts.

**WLW**—Crosley Radio Corp., Cincinnati Ohio. 422 meters, 710 kilocycles, class B. 1500 watts.

**WMAC**—Clive B. Meredith, Cazenovia, N. Y. 275 meters, 1090 kilocycles, class A. 100 watts.

**WMAF**—Round Hills Radio Corp., Dartmouth, Mass. 348 meters, 860 kilocycles, class B. 500 watts.

**WMAH**—General Supply Co., Lincoln, Nebr. 284 meters, 1180 kilocycles, class A. 100 watts.

**WMAK**—Norton Laboratories, Lockport, New York. 266 meters, 1130 kilocycles, class A. Daily ex Sun, 11 am, weather. Mon, 7:45-9 pm. Thurs, 12 midnight. Sun, 10:25 am, church services. Eastern standard time. 500 watts.

**WMAN**—First Baptist Church, Columbus, Ohio. 278 meters, 1080 kilocycles, class A. Sun, 10:30-11:45 am, 7:30-8:45 pm. Eastern standard time. 50 watts.

**WMAQ**—The Chicago Daily News, 15 N. Wells St., Chicago, Ill. 448 meters, 670 kilocycles, class B. Daily ex Sun, 1-3 pm, 4-5 pm, 6-7 pm, Tues, Wed, Thurs, Fri & Sat, 8-10 pm. Central standard time. 500 watts.

**WMAY**—Kingshighway Presbyterian Church, St. Louis, Mo. 247 meters, 1215 kilocycles, class A. Sun, 11 am, services; 7 pm, musical program, 8 pm, services. Central standard time. Slogan: "May Every Byway Hear Kingshighway." 100 watts.

**WMAZ**—Mercer University, Macon, Ga. 261 meters, 1150 kilocycles, class A. Tues, Wed, Thurs, 10:20-10:50 am, Chapel. Mon, Tues & Thurs, 8-10 pm, music, radio classes. Wed, 11-12 pm, Fri, 8-12 pm, concert. Sat, tentative program, music and college students, 8:30-9:30 pm. Eastern standard time. Slogan: "Mercer—The South's Most Progressive University." 1000 watts.

**WMBF**—Fleetwood Hotel, Miami Beach, Fla. 854 meters, 780 kilocycles, class B. 500 watts.

**WMC**—Commercial Appeal, Memphis, Tenn. 503 meters, 585 kilocycles, class B. Daily ex Sun, 9:45 am, weather and markets; 12 noon, music; 3 pm, closing market (ex Sat); 8 pm, bedtime story (ex Wed); 8:30 pm, music. Tues & Fri, 11 pm, Sun, 11 am, church services. Central standard time. Slogan: "Memphis, Down in Dixie." 500 watts.

**WMH**—The Ainsworth-Gates Radio Co., Cincinnati, Ohio. 326 and 424 meters, 920 and 690 kilocycles, class B. Mon & Thurs, 8-10 pm. Wed, 8-11 pm. Sat, 10-12 pm. Sun, 7-7:30 pm. Central standard time. Slogan: "The Station on the Hill." 750 watts.

**WMO**—Doubleday-Hill Elec. Co., 715-12th St. N. W., Washington, D. C. 261 meters, 1150 kilocycles, class A. 100 watts.



**Style R-20**

Solid Mahogany or Walnut

Panel size	Price
7x18 inches	\$11.00
7x21 "	12.00
7x24 "	13.00
7x26 "	14.00
7x28 "	15.00
7x30 "	16.00

## EXCELLO RADIO CABINETS

Represent the latest development in wall console cabinets. They combine years of experience in quality cabinet work with a thorough understanding of what radio fans are demanding in special cabinet features, conveniences and adaptability.

All Excello Cabinets have ample battery space. The filling pieces are adjustable to accommodate panels of varying sizes.

The sturdy construction and refinement of Excello Cabinets win them quick leadership with dealers and permanent satisfaction with users.



**Style R-9**

Price \$38.00

Mahogany or Walnut  
Size 38x18x30 inches High



**Style R-7**

Price \$57.00  
Mahogany or Walnut  
Panel Space—8x32 inches



**Style R-14**

Price \$60.00  
Mahogany or Walnut  
Panel Space—10x32 inches

### WRITE FOR CATALOG

Find out about the complete Excello line and see why these cabinets excel all others in quality and attractiveness.

Prices quoted on this page are for Cabinets with Tone Chambers only and do not include other equipment.



**Style R-8**

Price \$57.00

Mahogany or Walnut  
Panel Space—10x24 inches

## Excello Products Corporation

4820-28 West 16th Street  
Cicero, Ill.

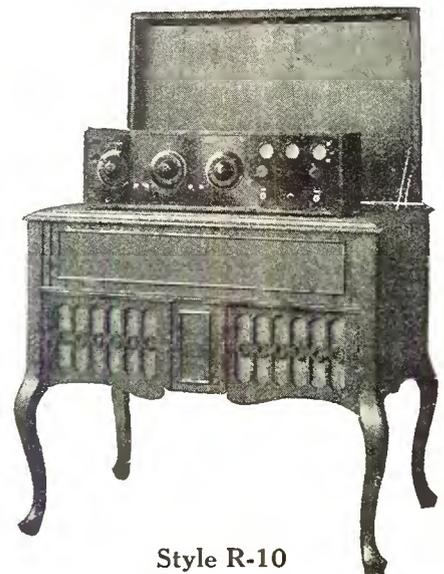

**Style R-10**

Price \$73.00  
Mahogany or Walnut  
Receiver Space—32x12x10½ inches High

**WNAC**—The Shepard Stores, Boston, Mass. 280 meters, 1070 kilocycles, class A. Daily ex Sat & Sun, 10:30 am to noon, 12:15-1 pm, Mon, 4:5-8:30 to 10 pm. Tues & Thurs, 3:3-8:30, 6:30-7:30 to 10 pm. Wed & Fri, 3:5-8:30, 8-10 pm. Sat, 10:30 am to noon, 1-3, 5:30-6:30, 8-11 pm. Sun, 10:45 am, 3:15-5:30, 6:45-8:30 pm. Eastern standard time. 500 watts.

**WNAD**—University of Oklahoma, Norman, Okla. 254 meters, 1180 kilocycles, class A. Daily including Sun, 9:15 pm, weather. Wed, 8:30-9:30 pm, concert. Central standard time. Slogan: "Oklahoma—The Voice of Sooner Land." 250 watts.

**WNAI**—Omaha Central High School, Omaha, Neb. 258 meters, 1160 kilocycles, class A. 500 watts.

**WNAJ**—Wittenberg College, Springfield, Ohio, 248 meters, 1210 kilocycles, class A. 100 watts.

**WNAK**—First Christian Church, Butler, Mo. 231 meters, 1300 kilocycles, class A. 20 watts.

**WNAT**—Lennig Bros. Co., Philadelphia, Pa. 250 meters, 1200 kilocycles, class A. 100 watts.

**WNAX**—Dakota Radio Apparatus Co., Yankton, S. Dak. 244 meters, 1230 kilocycles, class A. Daily ex Sun, 11:30 am, market reports; 5-6 pm, music. Central standard time. 100 watts.

**WNJ**—Radio Shop of Newark, 89 Lehigh Ave., Newark, N. J. 233 meters, 1290 kilocycles, class A. 150 watts.

**WNKY**—City of New York, New York City, N. Y. 526 meters, 570 kilocycles, class B. 1000 watts.

**WOAC**—Page Organ Co., Lima, Ohio. 266 meters, 1130 kilocycles, class A. 50 watts.

**WOAF**—Tyler Commercial College, Tyler, Texas. 360 meters, 833 kilocycles. 10 watts.

**WOAI**—Southern Equip. Co., San Antonio, Texas. 394 meters, 760 kilocycles, class B. Daily ex Sun, 10:30-10:50 am, 12:15-12:55 pm, 3-3:20, 6-6:20 and 7-7:20 pm. Tues & Thurs, 7:30-8:30, 9:30-10:30 pm. Sun, 11 am and 9:30-10:30 pm. Central standard time. 500 watts.

**WOAN**—James D. Vaughan, Lawrenceburg, Tenn. 282 meters, 1060 kilocycles, class B. Tues, Wed, Thurs, Fri, 11 am to 12 noon. Daily including Sun, 8:30-9:30 pm. Mon & Thurs, 11 pm to 12 midnight. Central standard time. Slogan: "Wake Up America." 500 watts.

**WOAV**—Penn. Nat'l Guard, 2nd Bat 112th Infantry, Erie, Pa. 242 meters, 1240 kilocycles, class A. 50 watts.

**WOAW**—Woodmen of the World Life Insurance Ass'n., Omaha, Neb. 522 meters, 576 kilocycles, class B. Mon, Fri, 6:7-8:30 pm, 9-11 pm. Tues & Thurs, 12:30-2 pm, 6-7:30 pm, 9-11 pm. Sat, 6-7:30, 9-10:30, 11 pm to 12 midnight. Sun, 10:45 am, 1:30-4 pm, 6:30-9:11 pm. Slogan: "Omaha The City Surrounded by the United States." 1000 watts.

**WOAX**—Franklin J. Wolf, The Monument Pottery Co., Trenton, N. J. 240 meters, 1250 kilocycles, class A. Daily ex Sun, 12:15 pm, weather. Tues & Fri, 9-11 pm, concert. Eastern standard time. Slogan: "The Voice From Trenton." 500 watts.

**WOC**—Palmer School of Chiropractic, Davenport, Iowa. 453 meters, 620 kilocycles, class B. Daily 9 am, market reports; 11:15 am (Sat only), closing markets; 12 noon, chimes; 12:15 pm, weather; 1 pm, closing markets, (ex Sat), 5:45 pm, (Thurs only), chimes; 6 pm (Thurs only), weather and sports; 7 pm, sports, weather, (ex Tues), 9 am, Wed & Fri, 8 pm, music. Thurs & Sat, 9 pm, Orchestra. Mon, 10 pm, music. Central standard time. Slogan: "In the State Where the Tall Corn Grows." 500 watts.

**WOGL**—Hotel Jamestown, Jamestown, New York. 275 meters, 1090 kilocycles, class A. Wed, 8-12 pm, popular program. Sun, 10:45-12:15 am, church; 2-5 pm, classical; 7:45-9 pm, church services. Eastern standard time. Slogan: "We're on Chautauqua Lake." 30 watts.

**WOI**—Elec. Engineering Dept., Iowa State College, Ames, Iowa. 270 meters, 1110 kilocycles, class A. Daily 9:30 am, weather reports; 12:30 pm, market and crop reports; 9:30 pm, weather. Mon, 10 pm, dance program. Thurs, 8:15 pm, classical program. Sun, 10:45 am, chimes program. Central standard time. 500 watts.

**WOO**—John Wanamaker, Philadelphia, Pa. 309 meters, 590 kilocycles, class B. Daily ex Sun, 11 am, Organ, 11:30 am, weather; 11:55, Time signals; 12 noon, luncheon music; 4:45 pm, Organ; 5 pm, sport and police reports; 9:55, time signal; 10:05, weather. Mon, Wed & Fri, 7:30-11 pm. Sun, 10:45 am or 7:45 pm. Eastern standard time. 500 watts.

**WOO**—Unity School of Christianity, Unity Bldg., Kansas City, Mo. 278 meters, 1080 kilocycles, class A. Tues & Sat, 8-9:30 pm. Thurs, 7:15-7:45 pm. Sat, 10-10:30 pm. Sun 11 am to 12:30 pm, 7-7:45 pm, 7:45-9:15 pm. Central standard time. 500 watts.

**WOR**—L. Bamberger & Co., Newark, N. J. 405 meters, 740 kilocycles, class B. 500 watts.

**WORD**—Peoples Pulpit Ass'n., Batavia, Ill. 273 meters, 1080 kilocycles, class A. 500 watts.

**WOS**—State Marketing Bureau, Board of Agriculture, Jefferson City, Mo. 440 meters, 680 kilocycles, class B. Daily ex Sun, 8:15-11 am, announcements; 9-9:15 am, hog market; 10-10:15 am, weather, hog and grain markets; 11-11:15 am, live stock, grain; 12:12-15 pm, live stock and grain; 1-1:15 pm, weather, poultry, butter, egg, markets; 2-2:15 pm, closing live stock, grain markets; 5:05-5:20 pm, music, address. Mon, Wed & Fri, 8-9:30 pm, concerts; lectures. Sun, 7:30-8:30 pm, religious services. Central standard time. Slogan: "Watch Our State." 500 watts.

**WPAJ**—Doollittle Radio Corp., 115 Crown St., New Haven, Conn. 268 meters, 1120 kilocycles, class A. 100 watts.

**WPAK**—North Dakota Agricultural College, Agricultural College, N. Dak. 275 meters, 1090 kilocycles, class A. 50 watts.

**WPAU**—Concordia College, Moorehead, Minn. 258 meters, 1160 kilocycles, class A. 100 watts.

**WPAZ**—Dr. John R. Koch, Charlestown, W. Va. 268 meters, 1120 kilocycles, class A. 100 watts.

**WPG**—Municipality of Atlantic City, Atlantic City, N. J. 299 meters, 1000 kilocycles, class B. 500 watts.

**WPSC**—Pennsylvania State College, State College, Pa. 261 meters, 1150 kilocycles, class A. Mon, 8-11 pm. Eastern standard time. 500 watts.

**WQAA**—Horace A. Beale, Jr., Parkersburg, Pa. 220 meters, 1360 kilocycles, class A. No schedule at present time. 500 watts.

**WQAC**—Gish Radio & Service, 108 E. 8th St., Amarillo, Texas. 234 meters, 1280 kilocycles, class A. No definite schedule. 100 watts.

**WQAE**—C. H. Moore Co. Inc., Litchfield St., Springfield, Vt. 246 meters, 1220 kilocycles, class A. Sat, 11 pm to 1 am. Sun, 8:30-9 pm. Eastern standard time. Slogan: "Among the Green Hills of Vermont." 50 watts.

**WQAF**—The Sandusky Register, Sandusky, Ohio. 240 meters, 1250 kilocycles, class A. Schedule irregular. 5 watts.

**WQAM**—Electrical Co., 42 N. W. 4th St., Miami, Fla. 268 meters, 1120 kilocycles, class A. Mon & Wed, 7:30-9 pm, Orchestra. Sun, 7:30-9 pm first Sunday each month. Sun 9-11 pm. Eastern standard time. Slogan: "Wonderful Qualities Advertise Miami." 100 watts.

**WQAN**—Scranton Times, 222 Spruce St., Scranton, Pa. 250 meters, 1200 kilocycles, class A. Daily ex Sun, 12:30-1 pm, 4:15-4:45 pm. Tues & Fri, 8-11 pm. Eastern standard time. Slogan: "The Voice of the Anthracite." 100 watts.

**WQAO**—Calvary Baptist Church, New York, N. Y. 360 meters, 833 kilocycles. 100 watts.

**WQAS**—Prince-Walter Co., Lowell, Mass. 252 meters, 1190 kilocycles, class A. Schedule irregular. Slogan: "The Voice of Merrimack Valley." 100 watts.

**WQJ**—Calumet Baking Powder and Rainbo Gardens Station, 4510 N. Clark St., Chicago, Ill. 448 meters, 670 kilocycles, class B. Daily ex Sun, 11-12 noon, 2-4 pm. Daily ex Sun, 8 & Mon, 7-8 pm and 10 pm to 2 am. Sun, 10:30 am and 8-10 pm. Central standard time. 500 watts.

**WRAA**—Rice Institute, Houston, Texas. 256 meters, 1170 kilocycles, class A. Sat, 3:30-5:30 pm, athletic events. Sun, 3:30-5:30 pm, lectures. Central standard time. 100 watts.

**WRAP**—The Radio Club, Inc., La Porte, Ind. 224 meters, 1340 kilocycles, class A. Mon, Thurs & Sat, 8:30 pm, music. Central standard time. Slogan: "The Voice of the Maple City." 15 watts.

**WRAL**—Northern States Power Co., St. Croix Falls, Wisc. 248 meters, 1210 kilocycles, class A. 100 watts.

**WRAM**—Lombard College, Galesburg, Ill. 244 meters, 1230 kilocycles, class A. Wed, 8 pm, music and educational talks. Central standard time. 100 watts.

**WRAN**—Blackhawk Elec. Co., Waterloo, Iowa. 236 meters, 1270 kilocycles, class A. 100 watts.

**WRAO**—St. Louis Radio Service Co., 1211 Hodiamont Ave., St. Louis, Mo. 227 meters, 1320 kilocycles, class A. 100 watts.

**WRAP**—Antioch College, Yellow Springs, Ohio. 263 meters, 1140 kilocycles, class A. Wed, 8-9 pm. Sun, 7-8 pm. 100 watts.

**WRAY**—Avenue Radio & Electric Shop, 450 Schuykill Ave., Reading, Pa. 238 meters, 1260 kilocycles, class A. Thurs, 10 pm, music. Daily schedule irregular, local news and topics. Eastern standard time. Slogan: "The Schuykill Valley Echo." 10 watts.

**WRAX**—Flexon's Garage, Gloucester City, N. J. 268 meters, 1120 kilocycles, class A. 100 watts.

**WRBC**—Immanuel Lutheran Church, Valparaiso, Ind. 278 meters, 1080 kilocycles, class A. Mon, musical and educational programs. Sun, 7:30 pm, church services. Central standard time. Slogan: "World Redeemed by Christ." 500 watts.

**WRC**—Radio Corporation of America, 3308-14th St. N. W., Washington, D. C. 469 meters, 640 kilocycles, class B. Mon, Wed & Fri, 4-6:30 pm. Tues, Thurs, 6:45-11:30 pm. Sat, 6:45 pm to 12 midnight. Eastern standard time. Slogan: "The Voice of the Capital." 500 watts.

**WREO**—Reo Motor Car Co., Lansing, Mich. 285 meters, 1050 kilocycles, class B. Daily ex Sun, 10 pm, weather. Tues & Thurs, 8:15-9:45 pm, concert. Sat, 9-12 midnight, Orchestra. Sun, 10 am, chimes; 10-30 am, services; 7 pm, services. Central standard time. 500 watts.

**WRHF**—Washington Radio Hospital Fund, 529-11th St. N. W., Washington, D. C. 256 meters, 1170 kilocycles, class A. Daily ex Sun, 12-1 pm. Eastern standard time. 50 watts.

**WRK**—Doron Bros. Elec. Co., Hamilton, Ohio. 207 meters, 1110 kilocycles, class A. 200 watts.

**WRL**—Union College, Schenectady, New York. 360 meters, 833 kilocycles, 500 watts.

**WRM**—University of Illinois, Urbana, Ill. 273 meters, 1100 kilocycles, class A. Football and basketball games. Relay carnivals and occasional experimental programs. Central standard time. 500 watts.

**WRR**—City of Dallas, Dallas, Texas. 261 meters, 1148 kilocycles, class A. Daily ex Sun, 12 noon, weather, 1:30 am-12:30 pm, 2-4:5-3:30 pm, 7 pm, police bulletin; 7:30-8:30 pm, Tues & Thurs, 8:30-9:30 pm. Sat, 12-2 am, the Dixie Nite Owls. Sun, 11 am, church services. Central standard time. Slogan: "Watch Radio Radiate." 350 watts.

**WRW**—Tarrytown Radio Research Laboratory, Tarrytown, N. Y. 273 meters, 1100 kilocycles, class A. Daily ex Thurs & Sun, 9-11:30 pm. Thurs & Sun, 8-9 and 10:30-11:30 pm. Eastern standard time. Slogan: "Everything in Radio." 500 watts.

**WSAB**—Southeast Mo. State Teachers College, Cape Girardeau, Mo. 273 meters, 1090 kilocycles, class A. 100 watts.

**WSAC**—Clemson Agricultural College, Clemson College, S. C. 336 meters, 890 kilocycles, class B. 500 watts.

**WSAD**—Foster-Jewelers, Dorrace & Weybosset Sts., Providence, R. I. 256 meters, 1170 kilocycles, class A. Daily ex Sun, 2:30-4 pm. Mon, Wed, Fri & Sat, 6-8 pm. Tues, 6-6:30 pm. Thurs, 8:30-11 pm. Eastern standard time. 100 watts.

**WSAG**—Gospel Tabernacle, St. Petersburg, Fla. 266 meters, 1130 kilocycles, class A. 500 watts.

**WSAI**—The United States Playing Card Co., Cincinnati, Ohio. 325 meters, 920 kilocycles, class B. Mon & Thurs, 10-12 pm. Tues, 7-10 pm. Sat, 8-10 pm, 12-2 am. Sun, 3-4 pm. Central standard time. 1500 watts.

**WSAJ**—Grove City College, Grove City, Pa. 229 meters, 1310 kilocycles, class A. Tues & Thurs, 9-10 pm, Orchestra, vocal and basketball games. Wed, 7:30-8:30 pm, vocal and piano. Fri & Sat, 8:15-9:30 pm, basketball game. Sun, 7:30-9:15 pm, church service. Eastern standard time. Slogan: "Grove City College—Wolf Pack." 250 watts.

**WSAN**—Allentown Call Publishing Co. Inc., Allentown, Pa. 229 meters, 1310 kilocycles, class A. Tues & Thurs, 8 pm. Special programs as announced. Eastern standard time. 50 watts.

**WSAP**—The City Temple, New York, N. Y. 263 meters, 1140 kilocycles, class A. 250 watts.

**WSAR**—Doughty & Welch Elec. Co., Fall River, Mass. 254 meters, 1180 kilocycles, class A. 100 watts.

**WSAU**—Camp Marienfeld, Chesham, N. H. 220 meters, 1310 kilocycles, class A. 100 watts.

**WSAV**—Clifford W. Vick Const. Co., Houston, Texas. 246 meters, 1220 kilocycles, class A. Mon, Wed & Fri, 8-9 pm. Sat, 10-12 midnight. Sun, 11 am to 12 noon. Central standard time. Slogan: "Top O' Texas." 100 watts.

**WSAX**—Zenith Radio Corp., 332 So. Michigan Ave., Chicago, Ill. 268 meters, 1120 kilocycles, class A. Schedule variable. Central standard time. 20 watts.

**WSAZ**—Chase Elec. Shop, Pomeroy, Ohio. 244 meters, 1230 kilocycles, class A. 50 watts.

**WSB**—Atlanta Journal, Atlanta, Ga. 429 meters, 700 kilocycles, class B. Daily ex Sun, 12-1 pm, entertainment; 2:30-2:45 pm, markets; 5-6 pm. Daily ex Wed & Sun, 8-9 pm, 10:45 pm to 12:15 pm, church services; 5-6 pm, studio program; 7:30-9:15 pm, church services. Central standard time. Slogan: "The Voice of the South." 750 watts.

**WSJ**—J. & M. Elec. Co., Utica, N. Y. 273 meters, 1100 kilocycles, class A. 100 watts.

**WSOE**—School of Engineering of Milwaukee, 415 Marshall St., Milwaukee, Wis. 246 meters, 1219 kilocycles, class A. Daily ex Sat & Sun, 9-10 am, lecture; 1-3 pm, lecture; 5:30-6:30 pm, twilight concert. Sat, 5:30 pm. Sun, 9:30-11:30 am, services; 12:30-1:30 pm, concert. Mon & Fri, 9-12 pm, popular program. Tues, Thurs, Sat & Sun, 7:30-9 pm. Central standard time. Slogan: "In the Land of Sky Blue Waters." 500 watts.

**WSRF**—Harden Sales & Service, Broadlands, Ill. 233 meters, 1290 kilocycles, class A. 100 watts.

**WSRO**—Radio Company, 409 High St., Hamilton, Ohio. 252 meters, 1190 kilocycles, class A. Tues & Fri, 8-10 pm, talks, orchestra. Sun, 2-4 pm, Maple Leaf orchestra. Slogan: "We Sell Radio Only." 5 watts.

**WSUI**—State University of Iowa, Iowa City, Iowa. 484 meters, 620 kilocycles, class B. Wed, 9-9:30 am, High School Assembly program. Daily ex Sun, 12:30-1 pm, music and address. Tues, 8-9:30 pm, music. Wed, 4:30-5 pm, radio course lectures. Thurs & Sat, 7:30-9 pm, occasionally. Sun, 7-7:30 pm, children's hour; 9-9:30, familiar hymns. Central standard time. 500 watts.

**WSY**—Alabama Polytechnic Institute, Auburn, Ala. 250 meters, 1200 kilocycles, class A. Schedule irregular. 500 watts.

**WTAB**—Fall River Herald, Fall River, Mass. 266 meters, 1130 kilocycles, class A. Mon & Fri, 3:30 pm, sunrise hour. Tues & Thurs, 8 pm, music. Wed & Sat, 5 pm, children's hour. Eastern standard time. 100 watts.

**WTAC**—Penn Traffic Co., Washington St., Johnstown, Pa. 209 meters, 1430 kilocycles, class A. Tues & Thurs, 7:30-9:30 pm. Eastern standard time. 100 watts.

**WTAF**—Louis J. Gallo, New Orleans, La. 268 meters, 1120 kilocycles, class A. 100 watts.

**WTAL**—Toledo Radio & Elec. Co., Toledo, Ohio. 252 meters, 1190 kilocycles, class A. 100 watts.

**WTAM**—Willard Storage Battery Co., 246 E. 131st St., Cleveland, Ohio. 390 meters, 768 kilocycles, class B. Daily ex Sun, 6-7 pm, dinner concert. Mon & Wed, 8-10:30 pm, studio concert. Wed, 10:30 pm to 1 am, dance program. Sat, 9 pm to 12 midnight, dance concert. Eastern standard time. Slogan: "The Voice from the Storage Battery." 1500 watts.

**WTAP**—Cambridge Radio & Elec. Co., Cambridge, Ill. 242 meters, 1240 kilocycles, class A. 50 watts.

**WTAS**—S. H. Van Gordon & Son, Osseo, Wis. 254 meters, 1180 kilocycles, class A. 100 watts.

**WTAR**—Reliance Elec. Co., Inc., 526 Huntington Ave., Norfolk, Va. 263 meters, 1150 kilocycles, class A. Daily ex Sun, 6 pm. Tues, 8-10 pm. Eastern standard time. Slogan: "Down in Old Virginia." 100 watts.

**WTAS**—Villa Olivia Broadcasting Station, Elgin, Ill. 302 meters, 990 kilocycles, class B. Mon, Tues, Wed & Sat, 8-10 pm. Thurs & Fri, 12:30-1:30 pm. Sun, 7-12 pm. Central standard time. Slogan: "Willie Tommy Annie Sammy." 1000 watts.

**WTAT**—Edison Elec. Illuminating Co., Boston, Mass. (notable). 244 meters, 1230 kilocycles, class A. No definite schedule. 100 watts.

**WTAU**—Ruegg Battery & Elec. Co., Tecumseh, Neb. 242 meters, 1240 kilocycles, class A. 100 watts.

**WTAW**—Agricultural & Mechanical College of Texas, College Station, Texas. 270 meters, 1110 kilocycles, class A. 250 watts.

**WTAX**—Williams Hardware Co., Strator, Ill. 231 meters, 1300 kilocycles, class A. Mon, 9-11 pm. Central standard time. Slogan: "Tappa Keg O' Nails." 50 watts.

**WTAY**—Oak Leaves Broadcasting Station, Inc., Oak Park Arms Hotel, Oak Park, Ill. 256 meters, 1060 kilocycles, class A. Daily ex Sun & Mon, 6:15-7:30 pm. Wed, Fri & Sat, 9-10 pm. Wed & Sat, 12 midnight to 1:30 am. Central standard time. Slogan: "Programs for Everybody." 500 watts.

**WTAZ**—Thomas J. McGuire, Lambertville, N. J. 261 meters, 1150 kilocycles, class A. 15 watts.

**WTG**—Kansas State Agricultural College, Manhattan, Kans. 273 meters, 1100 kilocycles, class A. 50 watts.

**WTIC**—Travelers Insurance Co., Hartford, Conn. 348 meters, 860 kilocycles, class B. Tues & Fri, 8-10:30 pm. Eastern standard time. 500 watts.

**WWAD**—Wright and Wright, Inc., 2215 N. Broad St., Philadelphia, Pa. 225 meters, 1199 kilocycles, class A. Mon & Thurs, 7:45 pm to 1 am. First and fourth Sun of each month. Eastern standard time. Slogan: "Penn City Station." 100 watts.

**WWAE**—Lawrence J. Crowley, Joliet, Ill. 242 meters, 1240 kilocycles, class A. 500 watts.

**WWAO**—Michigan College of Mines, Houghton, Mich. 244 meters, 1230 kilocycles, class A. Daily ex Sun, 12 noon to 12:35, music, market, weather. Tues & Thurs, 8-9:30 pm. Central standard time. Slogan: "Copper Country Station." 250 watts.

**WWI**—Ford Motor Co., Dearborn, Mich. 266 meters, 1130 kilocycles, class A. Wed, 8-9:30 pm. Eastern standard time. 500 watts.

**WWJ**—The Detroit News, Detroit, Mich. 352 meters, 850 kilocycles, class B. Daily ex Sun, 8-8:20 am, exercises; 9:30-9:45 am, dinner hints to housewives; 9:45-10:30 am, weather; 11:55-12, time signals and weather; 12:24:45 pm, concert; 3:30-5 pm, orchestra; 3:50-4 pm, weather and markets; 6-7 pm, dinner concert. Daily first and third weeks, including Sat, 7-8 pm, concert. Second and third weeks (ex Sat), 8:30-10 pm, concert. Sun, 11 am, church services; 2 pm, orchestra. Second and third Sundays, 5 pm, Orchestra; 7:30 pm, church services. Eastern standard time. 500 watts.

**WWL**—Loyola University, New Orleans, La. 275 meters, 1099 kilocycles, class A. Sat, 8-9 pm. Central standard time. 100 watts.



**\$25**

**TRIMM  
CONCERT**

## To Fit Every Need



**TRIMM  
Home Speaker  
\$10**

Trimm Home Speaker is the biggest value in radio. Surprising volume, with headset distinctness and minimum distortion are the results obtained by every Home Speaker user

Trimm Concert Speaker is the peer of all radio reproducers. The low pitched tones of cello, harp, organ and piano, so often lost in radio reception, are broadcast in all their original beauty through the Trimm Concert. Easily accessible adjustment provides control of volume. This speaker is recommended for high-powered, multi-stage amplifying sets.

There is a Trimm Reproducer to meet every requirement of the radio fan. Trimm Headsets are famed the world over for sensitivity and ability to get distant stations with great volume. Trimm Phonoadapters are designed to fit every well-known make of talking machine.

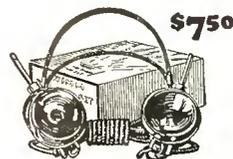

**Professional  
Headset**

**\$7.50**



**Dependable  
Headset**

**\$5**

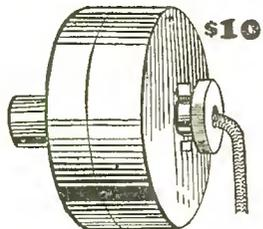

**"Giant"  
Phonadapter**

**\$10**

**TRIMM**  
RADIO MANUFACTURING  
COMPANY  
24 So. Clinton St.  
CHICAGO  
U.S.A.

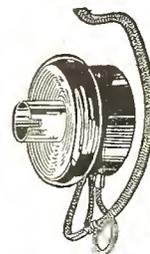

**"Little Wonder"  
Phonadapter**

**\$4.50**

# THE NEW CROSLEY 51-SPECIAL

**\$23<sup>50</sup>**

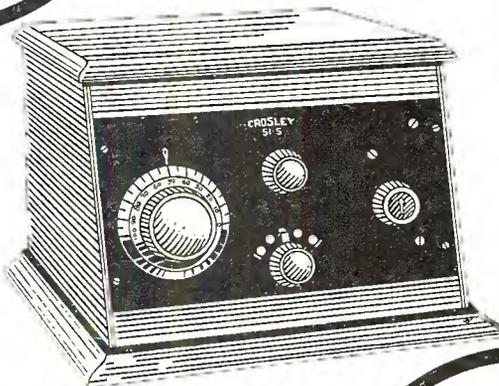

*Of Course  
the Famous  
Crosley 51 Regular at  
**\$185<sup>00</sup>**  
Will be Continued*

Here is the popular Crosley 51 dressed up in new clothes. It is known as the Crosley 51-Special. This two-tube, genuine Armstrong regenerative receiver is exactly the same as the nationally known Crosley 51, except it is installed in a larger cabinet in which there is room for dry cell batteries. Also there is the slanting panel, a feature that adds to the appearance of the set and makes operation more comfortable. This

radio is as artistic as it is efficient, appealing to the housewife who demands beautiful appearance and elimination of visible batteries. All Crosley radios are licensed under Armstrong Regenerative U. S. Pat. 1,113,149. Other models priced from one tube 50, at \$14.50, to the Trirdyn Special with sloping panel, at \$65. For sale by good dealers everywhere. Write for catalog.

*Prices West of Rockies—add 10%*

**THE CROSLEY RADIO CORPORATION**  
541 Sassafras Street - Cincinnati, Ohio  
*Crosley owns and operates Broadcasting Station WLW*

# CROSLLEY TRIRDYNS

*Special*  
**\$60**  
*Formerly \$75*

*Regular*  
**\$50**  
*Formerly \$65*

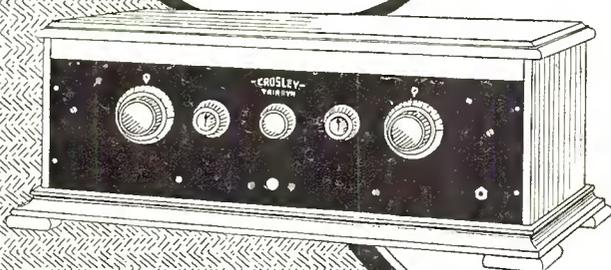

*Three Tubes  
 Do the work of  
 Five or Six  
 in the  
 Trirdyn*

The recognized outstanding achievement in radio is the Crosley Trirdyn. An overburdening amount of evidence proves that it is excelled by none and superior to most receivers costing many times more. It is a three tube radio combining one stage of tuned radio frequency, regenerative detector and reflex amplification. This combination enables three tubes to do the work of five or six. Brings in every large station in the country on the loud speaker. Is very selective,

easy to tune and economical to operate. The straight front Trirdyn Regular, formerly \$65; now \$50. The Trirdyn Special in large cabinet to house dry cell batteries formerly \$75; now \$60. To these have been added the new Trirdyn Regular with sloping panel at \$55 and the new Trirdyn Special in a beautiful cabinet with sloping panel at \$65. Demand a Crosley Trirdyn at any good dealer. All Crosley radios are licensed under Armstrong Regenerative U. S. Patent 1,113,149.

*Prices West of Rockies—add 10%*

*Write for catalog.*

**THE CROSLLEY RADIO CORPORATION**  
 541 Sassafras Street - Cincinnati, Ohio  
*Crosley owns and operates Broadcasting Station WLW*

# LOG SHEET

**K**

Call	1st Dial	2nd Dial	3rd Dial	Call	1st Dial	2nd Dial	3rd Dial	Call	1st Dial	2nd Dial	3rd Dial
KDKA	.....	.....	.....	KFFV	.....	.....	.....	KFNF	.....	.....	.....
KDPM	.....	.....	.....	KFFY	.....	.....	.....	KFNG	.....	.....	.....
KDPT	.....	.....	.....	KFGC	.....	.....	.....	KFNJ	.....	.....	.....
KDYL	.....	.....	.....	KFGD	.....	.....	.....	KFNL	.....	.....	.....
KDYM	.....	.....	.....	KFGH	.....	.....	.....	KFNV	.....	.....	.....
KDYQ	.....	.....	.....	KFGQ	.....	.....	.....	KFNY	.....	.....	.....
KDZB	.....	.....	.....	KFGX	.....	.....	.....	KFNZ	.....	.....	.....
KDZE	.....	.....	.....	KFHA	.....	.....	.....	KFOA	.....	.....	.....
KFAB	.....	.....	.....	KFHJ	.....	.....	.....	KFOC	.....	.....	.....
KFAD	.....	.....	.....	KFHL	.....	.....	.....	KFOD	.....	.....	.....
KFAE	.....	.....	.....	KFHR	.....	.....	.....	KFOJ	.....	.....	.....
KFAF	.....	.....	.....	KFI	.....	.....	.....	KFOL	.....	.....	.....
KFAJ	.....	.....	.....	KFIF	.....	.....	.....	KFON	.....	.....	.....
KFAN	.....	.....	.....	KFIO	.....	.....	.....	KFOO	.....	.....	.....
KFAR	.....	.....	.....	KFIQ	.....	.....	.....	KFOR	.....	.....	.....
KFAU	.....	.....	.....	KFIU	.....	.....	.....	KFOT	.....	.....	.....
KFAW	.....	.....	.....	KFIZ	.....	.....	.....	KFOU	.....	.....	.....
KFBB	.....	.....	.....	KFJB	.....	.....	.....	KFOX	.....	.....	.....
KFBC	.....	.....	.....	KFJF	.....	.....	.....	KFOY	.....	.....	.....
KFBG	.....	.....	.....	KFJI	.....	.....	.....	KFPG	.....	.....	.....
KFBK	.....	.....	.....	KFJM	.....	.....	.....	KFPH	.....	.....	.....
KFBL	.....	.....	.....	KFJR	.....	.....	.....	KFPL	.....	.....	.....
KFBU	.....	.....	.....	KFJX	.....	.....	.....	KFPM	.....	.....	.....
KFCB	.....	.....	.....	KFJY	.....	.....	.....	KFPP	.....	.....	.....
KFCC	.....	.....	.....	KFJZ	.....	.....	.....	KFPR	.....	.....	.....
KFCF	.....	.....	.....	KFKA	.....	.....	.....	KFPT	.....	.....	.....
KFCL	.....	.....	.....	KFKB	.....	.....	.....	KFPV	.....	.....	.....
KFCP	.....	.....	.....	KFKQ	.....	.....	.....	KFPW	.....	.....	.....
KFCY	.....	.....	.....	KFKU	.....	.....	.....	KFPX	.....	.....	.....
KFCZ	.....	.....	.....	KFKV	.....	.....	.....	KFPY	.....	.....	.....
KFDD	.....	.....	.....	KFKX	.....	.....	.....	KFQA	.....	.....	.....
KFDH	.....	.....	.....	KFLA	.....	.....	.....	KFQB	.....	.....	.....
KFDJ	.....	.....	.....	KFLB	.....	.....	.....	KFQC	.....	.....	.....
KFDL	.....	.....	.....	KFLE	.....	.....	.....	KFQD	.....	.....	.....
KFDM	.....	.....	.....	KFLR	.....	.....	.....	KFQE	.....	.....	.....
KFDX	.....	.....	.....	KFLU	.....	.....	.....	KFQG	.....	.....	.....
KFDY	.....	.....	.....	KFLV	.....	.....	.....	KFQH	.....	.....	.....
KFDZ	.....	.....	.....	KFLX	.....	.....	.....	KFQM	.....	.....	.....
KFEC	.....	.....	.....	KFLZ	.....	.....	.....	KFQN	.....	.....	.....
KFEL	.....	.....	.....	KFMB	.....	.....	.....	KFQP	.....	.....	.....
KFEQ	.....	.....	.....	KFMQ	.....	.....	.....	KFQR	.....	.....	.....
KFER	.....	.....	.....	KFMR	.....	.....	.....	KFQT	.....	.....	.....
KFEX	.....	.....	.....	KFMT	.....	.....	.....	KFQU	.....	.....	.....
KFFP	.....	.....	.....	KFMW	.....	.....	.....	KFQV	.....	.....	.....
KFFR	.....	.....	.....	KFMX	.....	.....	.....	KFQW	.....	.....	.....

**EVEREADY HOUR**  
**EVERY TUESDAY AT 9 P. M.**  
 For real radio enjoyment, tune in the  
 "Eveready Group." Broadcast through  
 stations

<b>WEAF</b> New York	<b>WFI</b> Philadelphia
<b>WJAR</b> Providence	<b>WCAE</b> Pittsburgh
<b>WEEI</b> Boston	<b>WGR</b> Buffalo

*Dry "B" Batteries  
 are an economical,  
 dependable and  
 convenient source  
 of plate  
 current!*

# There's more life in Eveready Batteries

Buy Eveready "B" Batteries and you get electricity in its surest, safest and most compact form. They reduce your operating expense. New developments in the Union Carbide and Carbon Research Laboratories, Inc., have been converted into new manufacturing processes in the Eveready factories. Good as they always have been, Eveready "B" Batteries are much better today.

The Eveready achievement of giving you more hours of "B" Battery service for less money has cut the cost of running receivers in half, and in some cases the new Evereadys make "B" Battery expense only a third of what it used to be.

There is an Eveready Radio Battery for every radio use.

*Manufactured and guaranteed by*  
**NATIONAL CARBON COMPANY, INC.**  
*Headquarters for Radio Battery Information*  
 New York San Francisco  
 Canadian National Carbon Co., Limited, Toronto, Ontario

## EVEREADY Radio Batteries —they last longer

**No. 7111.**  
 1½-volt  
 Dry Cell  
 "A"  
 Battery  
 for all  
 dry cell  
 tubes

**No. 772**  
 45-volt  
 Large  
 Vertical  
 Price  
 \$3.75

**No. 770.**  
 45-volt  
 Extra  
 Large  
 Vertical  
 for heavy  
 duty  
 Price  
 \$4.75

**No. 771.**  
 4½-volt  
 "C"  
 Battery  
 improves  
 quality,  
 saves "B"  
 Batteries  
 Price 60c

Tell 'Em You Saw It in the Citizens Radio Call Book

# LOG SHEET

Call	1st Dial	2nd Dial	3rd Dial	Call	1st Dial	2nd Dial	3rd Dial	Call	1st Dial	2nd Dial	3rd Dial
KFQX	.....	.....	.....	KLZ	.....	.....	.....	WABX	.....	.....	.....
KFQY	.....	.....	.....	KMJ	.....	.....	.....	WABY	.....	.....	.....
KFQZ	.....	.....	.....	KMO	.....	.....	.....	WABZ	.....	.....	.....
KFRB	.....	.....	.....	KNT	.....	.....	.....	WAHG	.....	.....	.....
KFRC	.....	.....	.....	KNX	.....	.....	.....	WBAA	.....	.....	.....
KFRF	.....	.....	.....	KOA	.....	.....	.....	WBAN	.....	.....	.....
KFRH	.....	.....	.....	KOB	.....	.....	.....	WBAO	.....	.....	.....
KFRJ	.....	.....	.....	KOP	.....	.....	.....	WBAP	.....	.....	.....
KFRL	.....	.....	.....	KPO	.....	.....	.....	WBAV	.....	.....	.....
KFRM	.....	.....	.....	KPPC	.....	.....	.....	WBAX	.....	.....	.....
KFRN	.....	.....	.....	KQV	.....	.....	.....	WBBA	.....	.....	.....
KFRO	.....	.....	.....	KQW	.....	.....	.....	WBBD	.....	.....	.....
KFRP	.....	.....	.....	KRE	.....	.....	.....	WBBG	.....	.....	.....
KFRQ	.....	.....	.....	KSAC	.....	.....	.....	WBBH	.....	.....	.....
KFRW	.....	.....	.....	KSD	.....	.....	.....	WBBL	.....	.....	.....
KFRX	.....	.....	.....	KTHS	.....	.....	.....	WBBM	.....	.....	.....
KFRY	.....	.....	.....	KTW	.....	.....	.....	WBBP	.....	.....	.....
KFRZ	.....	.....	.....	KUO	.....	.....	.....	WBBR	.....	.....	.....
KFSG	.....	.....	.....	KWG	.....	.....	.....	WBBS	.....	.....	.....
KFSY	.....	.....	.....	KWH	.....	.....	.....	WBBU	.....	.....	.....
KFUJ	.....	.....	.....	KYQ	.....	.....	.....	WBBV	.....	.....	.....
KFUL	.....	.....	.....	KYW	.....	.....	.....	WBBW	.....	.....	.....
KFUM	.....	.....	.....	KZKZ	.....	.....	.....	WBBY	.....	.....	.....
KFUO	.....	.....	.....	KZM	.....	.....	.....	WBBZ	.....	.....	.....
KFUP	.....	.....	.....	KZRQ	.....	.....	.....	WBCN	.....	.....	.....
KFUQ	.....	.....	.....					WBDC	.....	.....	.....
KFUR	.....	.....	.....					WBRE	.....	.....	.....
KFUS	.....	.....	.....	WAAB	.....	.....	.....	WBS	.....	.....	.....
KFUT	.....	.....	.....	WAAC	.....	.....	.....	WBT	.....	.....	.....
KFUU	.....	.....	.....	WAAD	.....	.....	.....	WBZ	.....	.....	.....
KFUV	.....	.....	.....	WAAF	.....	.....	.....	WCAD	.....	.....	.....
KFUW	.....	.....	.....	WAAM	.....	.....	.....	WCAE	.....	.....	.....
KGB	.....	.....	.....	WAAN	.....	.....	.....	WCAG	.....	.....	.....
KGO	.....	.....	.....	WAAW	.....	.....	.....	WCAH	.....	.....	.....
KGU	.....	.....	.....	WABA	.....	.....	.....	WCAJ	.....	.....	.....
KGW	.....	.....	.....	WABB	.....	.....	.....	WCAL	.....	.....	.....
KGY	.....	.....	.....	WABH	.....	.....	.....	WCAO	.....	.....	.....
KHJ	.....	.....	.....	WABI	.....	.....	.....	WCAP	.....	.....	.....
KHQ	.....	.....	.....	WABL	.....	.....	.....	WCAR	.....	.....	.....
KJQ	.....	.....	.....	WABM	.....	.....	.....	WCAS	.....	.....	.....
KJR	.....	.....	.....	WABN	.....	.....	.....	WCAT	.....	.....	.....
KJS	.....	.....	.....	WABO	.....	.....	.....	WCAU	.....	.....	.....
KLDS	.....	.....	.....	WABQ	.....	.....	.....	WCAV	.....	.....	.....
KLS	.....	.....	.....	WABR	.....	.....	.....	WCAX	.....	.....	.....
KLX	.....	.....	.....	WABU	.....	.....	.....	WCAY	.....	.....	.....
				WABW	.....	.....	.....				

# "Distance Coverers"



## The "EAGLE"

### Receivers

INDIFFERENT to mere miles, superior to difficulties that balk ordinary receivers, freed of the complications that have heretofore so limited the enjoyment of radio. Capacities precisely balanced.

#### EAGLET Receiver, \$75

3 Tube—Dry Cell Operated

A true EAGLE Receiver, with the EAGLE features and workmanship. Remarkable range for a receiver at so low a price. Inexpensive to install and to operate.

#### The EAGLE Receiver, \$175

Model B—5 Tubes

The receiver made famous by enthusiastic owners. Distance, selectivity, volume and easy operation. Not necessary to speculate: buy the Eagle Receiver for continuous satisfaction.

Write for Literature

### EAGLE RADIO COMPANY

28 Boyden Place - - - Newark, N. J.

**EAGLET**  
3 Tube \$75  
Dry Cell Operated

The GREATER  
Neutrodyne  
EAGLE  
Balanced Receiver  
\$175



# LOG SHEET

Call	1st Dial	2nd Dial	3rd Dial	Call	1st Dial	2nd Dial	3rd Dial	Call	1st Dial	2nd Dial	3rd Dial
WCAZ	.....	.....	.....	WDBW	.....	.....	.....	WFBE	.....	.....	.....
WCBA	.....	.....	.....	WDBX	.....	.....	.....	WFBG	.....	.....	.....
WCBC	.....	.....	.....	WDBY	.....	.....	.....	WFBH	.....	.....	.....
WCBD	.....	.....	.....	WDBZ	.....	.....	.....	WFBI	.....	.....	.....
WCBE	.....	.....	.....	WDM	.....	.....	.....	WFBJ	.....	.....	.....
WCBG	.....	.....	.....	WDZ	.....	.....	.....	WFBK	.....	.....	.....
WCBH	.....	.....	.....	WEAA	.....	.....	.....	WFBL	.....	.....	.....
WCBI	.....	.....	.....	WEAF	.....	.....	.....	WFBM	.....	.....	.....
WCBJ	.....	.....	.....	WEAH	.....	.....	.....	WFBN	.....	.....	.....
WCBL	.....	.....	.....	WEAI	.....	.....	.....	WFBQ	.....	.....	.....
WCBM	.....	.....	.....	WEAJ	.....	.....	.....	WFBR	.....	.....	.....
WCBO	.....	.....	.....	WEAM	.....	.....	.....	WFBT	.....	.....	.....
WCBQ	.....	.....	.....	WEAN	.....	.....	.....	WFBY	.....	.....	.....
WCBR	.....	.....	.....	WEAO	.....	.....	.....	WFBZ	.....	.....	.....
WCBT	.....	.....	.....	WEAP	.....	.....	.....	WFI	.....	.....	.....
WCBU	.....	.....	.....	WEAR	.....	.....	.....	WGAL	.....	.....	.....
WCBV	.....	.....	.....	WEAU	.....	.....	.....	WGAQ	.....	.....	.....
WCBW	.....	.....	.....	WEAY	.....	.....	.....	WGAZ	.....	.....	.....
WCBY	.....	.....	.....	WEB	.....	.....	.....	WGBA	.....	.....	.....
WCBZ	.....	.....	.....	WEBA	.....	.....	.....	WGBB	.....	.....	.....
WCCO	.....	.....	.....	WEBC	.....	.....	.....	WGBC	.....	.....	.....
WCEE	.....	.....	.....	WEBD	.....	.....	.....	WGBF	.....	.....	.....
WCK	.....	.....	.....	WEBE	.....	.....	.....	WGBG	.....	.....	.....
WCM	.....	.....	.....	WEBH	.....	.....	.....	WGBH	.....	.....	.....
WCX	.....	.....	.....	WEBJ	.....	.....	.....	WGBI	.....	.....	.....
WDAE	.....	.....	.....	WEBK	.....	.....	.....	WGBK	.....	.....	.....
WDAF	.....	.....	.....	WEBL	.....	.....	.....	WGBL	.....	.....	.....
WDAG	.....	.....	.....	WEBM	.....	.....	.....	WGBS	.....	.....	.....
WDAH	.....	.....	.....	WEBP	.....	.....	.....	WGBT	.....	.....	.....
WDAR	.....	.....	.....	WEBQ	.....	.....	.....	WGI	.....	.....	.....
WDAY	.....	.....	.....	WEBR	.....	.....	.....	WGN	.....	.....	.....
WDBB	.....	.....	.....	WEBT	.....	.....	.....	WGR	.....	.....	.....
WDBC	.....	.....	.....	WEBW	.....	.....	.....	WGST	.....	.....	.....
WDBD	.....	.....	.....	WEBX	.....	.....	.....	WGY	.....	.....	.....
WDBE	.....	.....	.....	WEBY	.....	.....	.....	WHA	.....	.....	.....
WDBF	.....	.....	.....	WEBZ	.....	.....	.....	WHAD	.....	.....	.....
WDBH	.....	.....	.....	WEEI	.....	.....	.....	WHAG	.....	.....	.....
WDBI	.....	.....	.....	WEMC	.....	.....	.....	WHAM	.....	.....	.....
WDBJ	.....	.....	.....	WEW	.....	.....	.....	WHAR	.....	.....	.....
WDBO	.....	.....	.....	WFAA	.....	.....	.....	WHAS	.....	.....	.....
WDBP	.....	.....	.....	WFAM	.....	.....	.....	WHAU	.....	.....	.....
WDBQ	.....	.....	.....	WFAV	.....	.....	.....	WHAZ	.....	.....	.....
WDBR	.....	.....	.....	WFBB	.....	.....	.....	WHB	.....	.....	.....
WDBS	.....	.....	.....	WFBC	.....	.....	.....	WHK	.....	.....	.....
WDBT	.....	.....	.....	WFBD	.....	.....	.....	WHN	.....	.....	.....

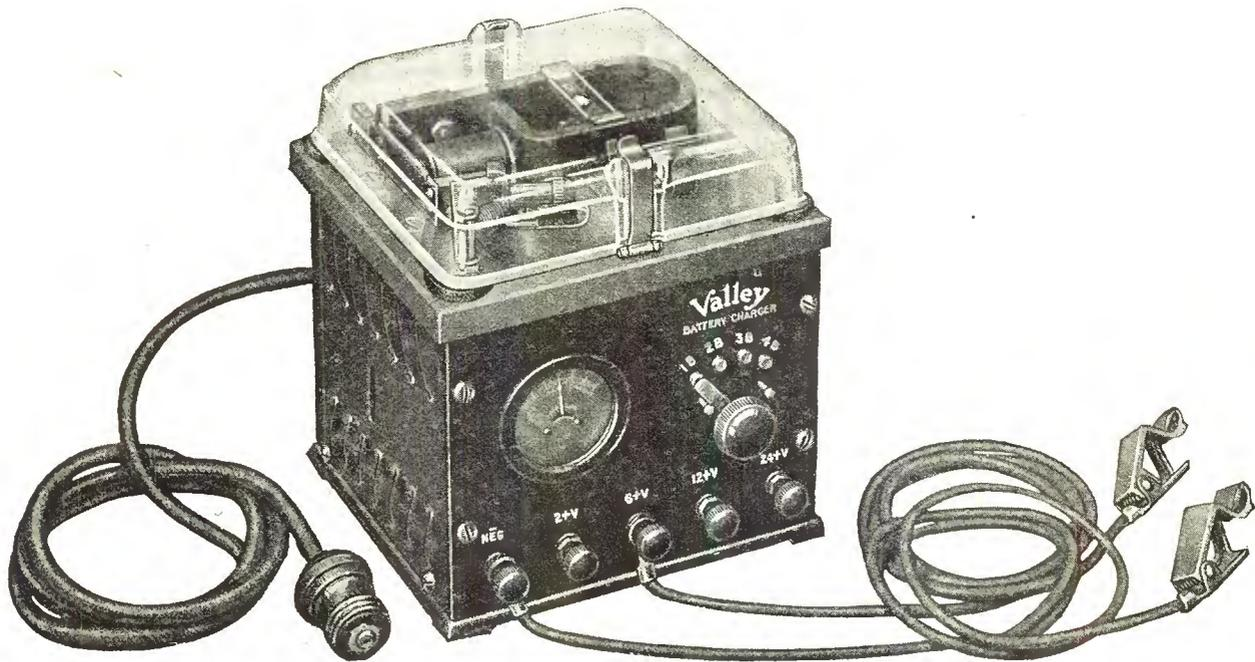

## Proven Principles Adapted to Radio

# in the **Valley Battery Chargers**

Long before radio became one of the pleasures of the home, Valley Battery Chargers were in successful operation in telegraph, telephone, railway, and other signal work.

When radio came, our engineers adapted the proven principles of the Valley Battery Charger to Radio Battery service. The result is the Valley Type ABC Battery Charger—the radio member of an aristocratic family of battery chargers.

The Valley Type ABC Battery Charger is the only charger needed for all batteries; for 6-volt "A" batteries, for one, two, three, or four 24-volt "B" batteries, and for 2-volt batteries. Also for 6- and 12-volt automobile batteries.

It embodies all the essential characteristics of a battery charger for radio—and more. Just look at the ten points of superiority of the Valley Battery Charger. You'll not find another charger with ten years of research and development behind it and with all these superior features.

When you buy a charger, be sure to get the Valley. You can't be satisfied with less.

Sold by radio dealers everywhere. If your dealer cannot supply you, write our nearest office.

VALLEY ELECTRIC COMPANY,

3157 S. Kingshighway . . . . . St. Louis, Mo.

NEW YORK      PHILADELPHIA      CHICAGO      INDIANAPOLIS  
MINNEAPOLIS      CLEVELAND      KANSAS CITY      SAN FRANCISCO

### Ten Points of Valley Superiority

1. Listed as standard by Underwriters' Laboratories.
2. No bulbs.
3. No liquids.
4. Quiet in operation.
5. Cannot harm your battery.
6. Efficient. Takes about a dime's worth of current for a full charge.
7. Correct 6-ampere charging rate enables you to recharge your battery overnight.
8. Ammeter mounted flush with panel shows if battery is receiving charge and if charging rate is correct.
9. Has only two wearing parts, the contacts, which can be replaced easily and cheaply. Average life of these contacts is about two years.
10. Built in handsome black case with grained and engraved Bakelite panel and clear glass top which shows simple, patented working parts. Harmonizes with the finest receiving set.

THE ONE CHARGER FOR ALL RADIO STORAGE BATTERIES

Tell 'Em You Saw It in the Citizens Radio Call Book

# LOG SHEET

Call	1st Dial	2nd Dial	3rd Dial	Call	1st Dial	2nd Dial	3rd Dial	Call	1st Dial	2nd Dial	3rd Dial
WHO	.....	.....	.....	WNAP	.....	.....	.....	WRHF	.....	.....	.....
WIAD	.....	.....	.....	WNAR	.....	.....	.....	WRK	.....	.....	.....
WIAK	.....	.....	.....	WNAT	.....	.....	.....	WRL	.....	.....	.....
WIAS	.....	.....	.....	WNAX	.....	.....	.....	WRM	.....	.....	.....
WIK	.....	.....	.....	WNJ	.....	.....	.....	WRR	.....	.....	.....
WIP	.....	.....	.....	WNYC	.....	.....	.....	WRW	.....	.....	.....
WJAB	.....	.....	.....	WOAC	.....	.....	.....	WSAB	.....	.....	.....
WJAD	.....	.....	.....	WOAF	.....	.....	.....	WSAC	.....	.....	.....
WJAG	.....	.....	.....	WOAI	.....	.....	.....	WSAD	.....	.....	.....
WJAK	.....	.....	.....	WOAN	.....	.....	.....	WSAG	.....	.....	.....
WJAM	.....	.....	.....	WOAR	.....	.....	.....	WSAI	.....	.....	.....
WJAN	.....	.....	.....	WOAV	.....	.....	.....	WSAJ	.....	.....	.....
WJAR	.....	.....	.....	WOAW	.....	.....	.....	WSAN	.....	.....	.....
WJAS	.....	.....	.....	WOAX	.....	.....	.....	WSAP	.....	.....	.....
WJAZ	.....	.....	.....	WOC	.....	.....	.....	WSAR	.....	.....	.....
WJD	.....	.....	.....	WOCL	.....	.....	.....	WSAU	.....	.....	.....
WJJD	.....	.....	.....	WOI	.....	.....	.....	WSAV	.....	.....	.....
WJY	.....	.....	.....	WOO	.....	.....	.....	WSAX	.....	.....	.....
WJZ	.....	.....	.....	WOQ	.....	.....	.....	WSAZ	.....	.....	.....
WCAA	.....	.....	.....	WOR	.....	.....	.....	WSB	.....	.....	.....
WKAD	.....	.....	.....	WORD	.....	.....	.....	WSL	.....	.....	.....
WKAN	.....	.....	.....	WOS	.....	.....	.....	WSOE	.....	.....	.....
WKAP	.....	.....	.....	WPAJ	.....	.....	.....	WSRF	.....	.....	.....
WKAQ	.....	.....	.....	WPAK	.....	.....	.....	WSRO	.....	.....	.....
WKAR	.....	.....	.....	WPAU	.....	.....	.....	WSY	.....	.....	.....
WKAU	.....	.....	.....	WPAZ	.....	.....	.....	WTAB	.....	.....	.....
WKBF	.....	.....	.....	WPG	.....	.....	.....	WTAC	.....	.....	.....
WKY	.....	.....	.....	WPSC	.....	.....	.....	WTAF	.....	.....	.....
WLAP	.....	.....	.....	WQAA	.....	.....	.....	WTAL	.....	.....	.....
WLAX	.....	.....	.....	WQAC	.....	.....	.....	WTAM	.....	.....	.....
WLB	.....	.....	.....	WQAE	.....	.....	.....	WTAP	.....	.....	.....
WLBL	.....	.....	.....	WQAM	.....	.....	.....	WTAQ	.....	.....	.....
WLS	.....	.....	.....	WQAN	.....	.....	.....	WTAR	.....	.....	.....
WLW	.....	.....	.....	WQAO	.....	.....	.....	WTAS	.....	.....	.....
WMAC	.....	.....	.....	WQAS	.....	.....	.....	WTAT	.....	.....	.....
WMAF	.....	.....	.....	WQJ	.....	.....	.....	WTAU	.....	.....	.....
WMAH	.....	.....	.....	WRAA	.....	.....	.....	WTAW	.....	.....	.....
WMAK	.....	.....	.....	WRAF	.....	.....	.....	WTAX	.....	.....	.....
WMAN	.....	.....	.....	WRAL	.....	.....	.....	WTAY	.....	.....	.....
WMAQ	.....	.....	.....	WRAM	.....	.....	.....	WTAZ	.....	.....	.....
WMAY	.....	.....	.....	WRAN	.....	.....	.....	WTG	.....	.....	.....
WMAZ	.....	.....	.....	WRAO	.....	.....	.....	WTIC	.....	.....	.....
WMC	.....	.....	.....	WRAV	.....	.....	.....	WWAD	.....	.....	.....
WMH	.....	.....	.....	WRAW	.....	.....	.....	WWAE	.....	.....	.....
WMU	.....	.....	.....	WRAX	.....	.....	.....	WWAO	.....	.....	.....
WNAC	.....	.....	.....	WRBC	.....	.....	.....	WWI	.....	.....	.....
WNAD	.....	.....	.....	WRC	.....	.....	.....	WWJ	.....	.....	.....
WNAL	.....	.....	.....	WREO	.....	.....	.....	WWL	.....	.....	.....

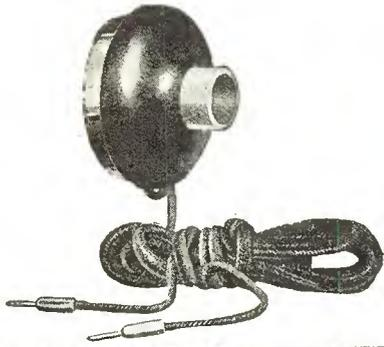

**N & K Imported Phonograph Unit**  
Rigid brass, heavily nicked. Generous length of cord. Fits Victrola and other standard phonographs without screws or special attachments. Price \$7.50.

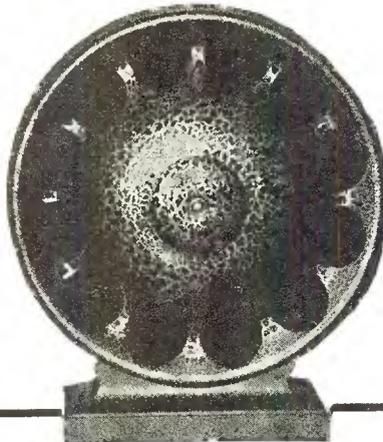

**N & K Imported Loudspeaker**  
14 inches high. Three period designs to choose from, also dull black stippled in gold. Price \$27.50. Descriptive folder free.



**N & K Imported Phones**  
Handsomely nicked casings of rigid metal, instead of flimsy aluminum. Generous six-foot cord. 4000 ohms capacity. Price \$8.50. Descriptive folder free.

**N&K TONE**  
TRADE MARK  
Reg. U. S. Pat. Off.

*So Clear!—So Rich!*

ALL the delicate high notes, all the soft low ones, as well as all the lovely harmonies in between—in short you hear the **entire music clearly and naturally**, when you listen through N & K Speaker, Phones or Phonograph Unit.

Each of these radio reproducers is a master achievement of a group of European master scientists. Each embodies marked improvements over the usual reproducers of its class. For example, the

**N & K Imported Loudspeaker**

is entirely new in principle and appearance. It is built to **reflect and filter the sound**, giving greater mellowness and a freedom from the exaggerated megaphone falsity of commonplace horn speaker tone. A new scientific material, burtex, is used instead of resounding metal or wood. This material eliminates counter-vibrations, which are the cause of rasping, twanging, rattling speaker sounds. And instead of a disfiguring "smokestack" shape, you see a simple bowl-like form with artistic decoration in color schemes to harmonize with any type of home decoration.

**N & K Imported Phones**

are larger in size than ordinary phones. This makes them fit more comfortably,

covering the ear completely and shutting out room sounds. The larger diaphragms and accurately designed sound chamber add to the beautiful clearness of their tone. And a sanitary covering of real leather on the head bands adds to beauty of appearance. Speaker owners can add many more stations to their logs by adding a set of N & K Phones to their radio equipment.

**N & K Imported Phonograph Unit**

makes your phonograph do double duty, and gives you the equivalent of a loud speaker of the highest type. Like N & K Phones the diaphragms and sound chamber are scientifically perfected for clear purity of tone. And the Unit slips onto Victrola or other standard phonograph instantly, without screws or attachment devices.

**Your Money Back**

Every N & K product is sold with the clear understanding that your money will be promptly refunded if you are not wholly **delighted** with N & K clearness of tone.

If your dealer is not yet carrying the N & K line we will gladly see that you are supplied. Just write us.



Reg. U. S. Pat. Off.

Th. Goldschmidt Corp., Dept. F3

15 William Street

New York

DISTANCE CHART

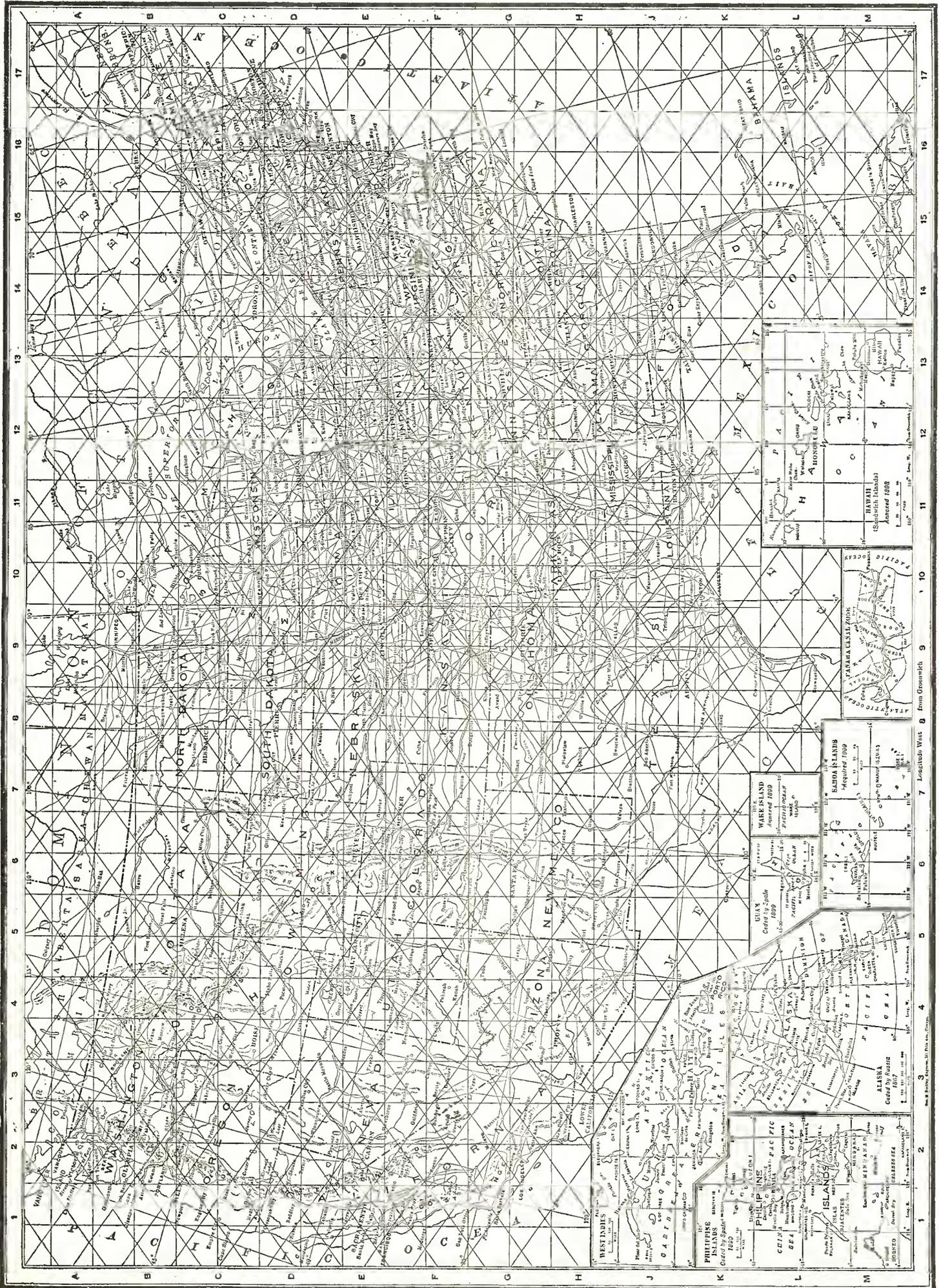

The lines on this map are drawn 100 miles apart

"The Voice of the Air"

# AMRAD NEUTRODYNE

only  
\$ **85**

## FIVE TUBES

*Wonderful Tone Quality—  
Positive Simplicity*

This LICENSED Neutrodyne—made by AMRAD, one of the radio pioneers, delivers the tremendous power of FIVE Tubes, but is controlled by only TWO Tuning Adjustments. Wonderful, clear, pure tone is the result.

Go to your dealer and see this set. Take plenty of time to make comparisons. Your choice will be this AMRAD Neutrodyne with its simplified controls, and its power, fine tone and selectivity, remarkably low-priced for a LICENSED Neutrodyne.

Send for Folder 520 explaining the features which distinguish the AMRAD Neutrodyne.

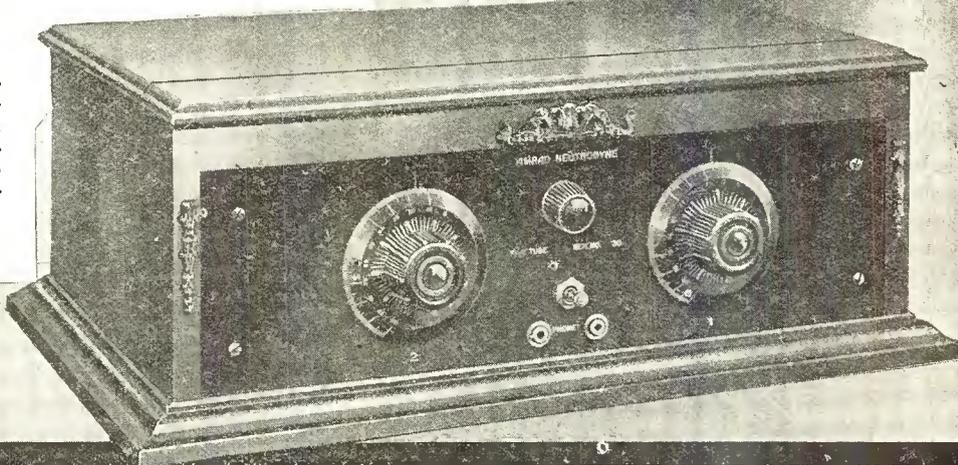

## AMERICAN RADIO AND RESEARCH CORPORATION

Dept. C. C.

Medford Hillside, Mass.

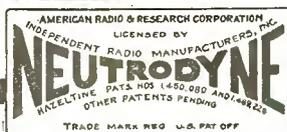





Dear Jim:

So you've been bothered with battery noises. When a battery leaks electricity between plates or across cell-tops it sure kicks up a row.

This unbalances the current in the set and you get the same spitting and cracking noises as with partly run down batteries.

Willard Radio Batteries enable me to cut out these noises, and I can work on a full charge all the time, for Willards are *rechargeable*.

Their Threaded Rubber Insulation guards against leakage inside the battery, and their widely-spaced cells of glass with hard rubber tops say, "Halt," to current that tries to stray outside.

Willards are the only radio batteries insulated with Threaded Rubber. You'll find that they will make a tremendous difference in your set.

Your radio friend,

Sam.

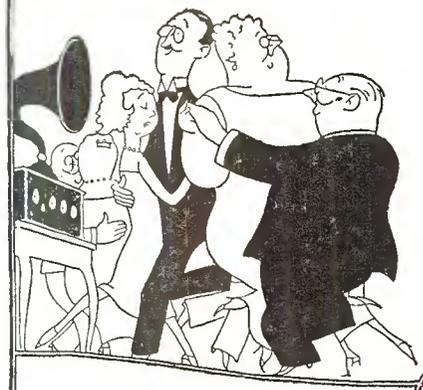

# WILLARD RADIO BATTERIES

Every radio fan should have WTAM's booklet, "Better Results from Radio." This booklet tells how to get better results, how to clear up battery noises, and gives many other interesting facts that you should know. Not a technical book. Written so everyone can understand.

Write to

# WTAM

(The Voice of the Storage Battery)

for this  
booklet

WTAM is the Radio Research Laboratory and Broadcasting Station of the Willard Storage Battery Company, Cleveland, Ohio.

Its function consists of research which is being done to improve the quality of radio reception and the broadcasting of radio programs for you entertainment.



Mail me to WTAM. I'll bring you "Better Results."

.....  
Name

.....  
City and State

.....  
Street Address

C.B.-May

# MAP OF THE

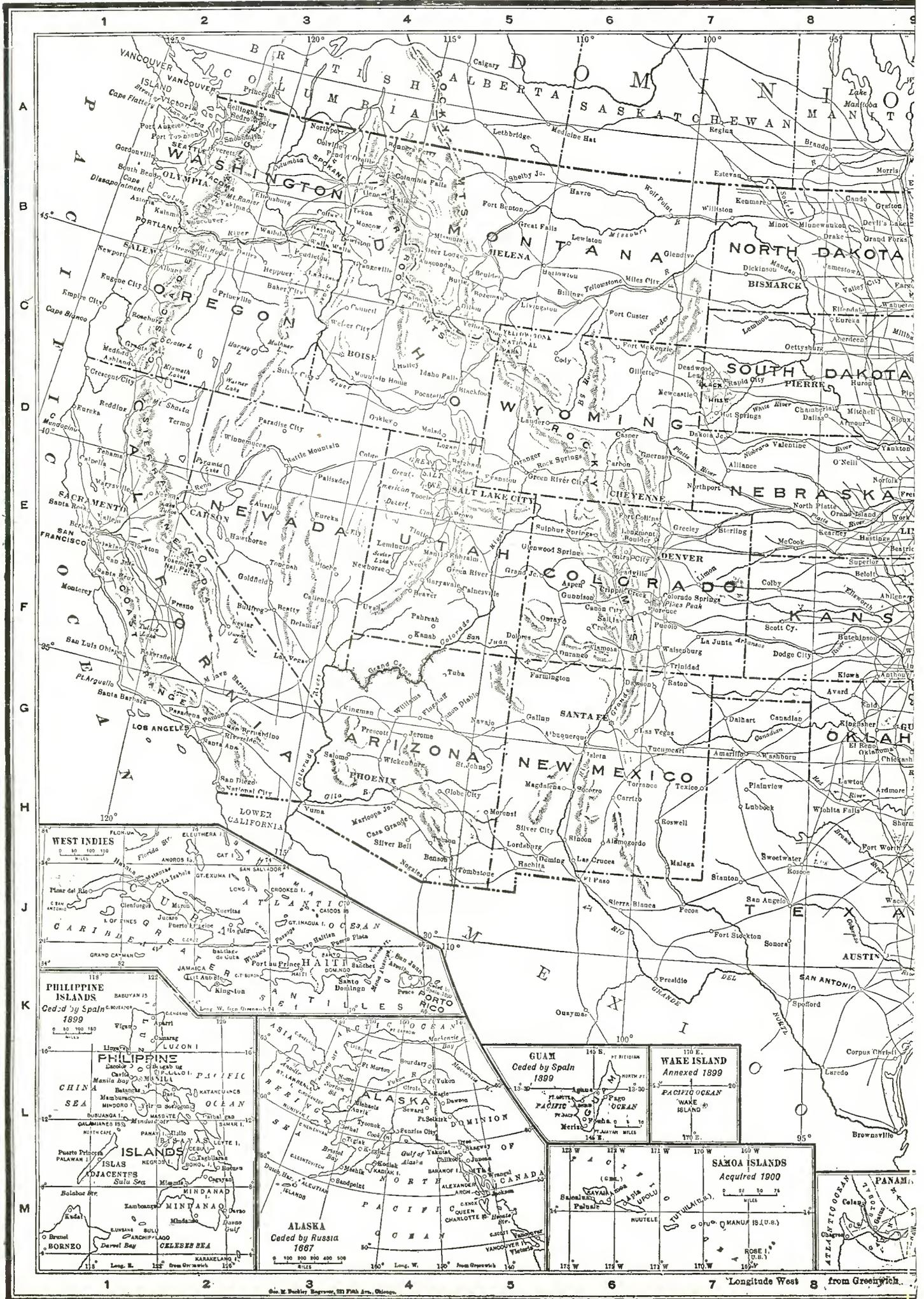

# UNITED STATES

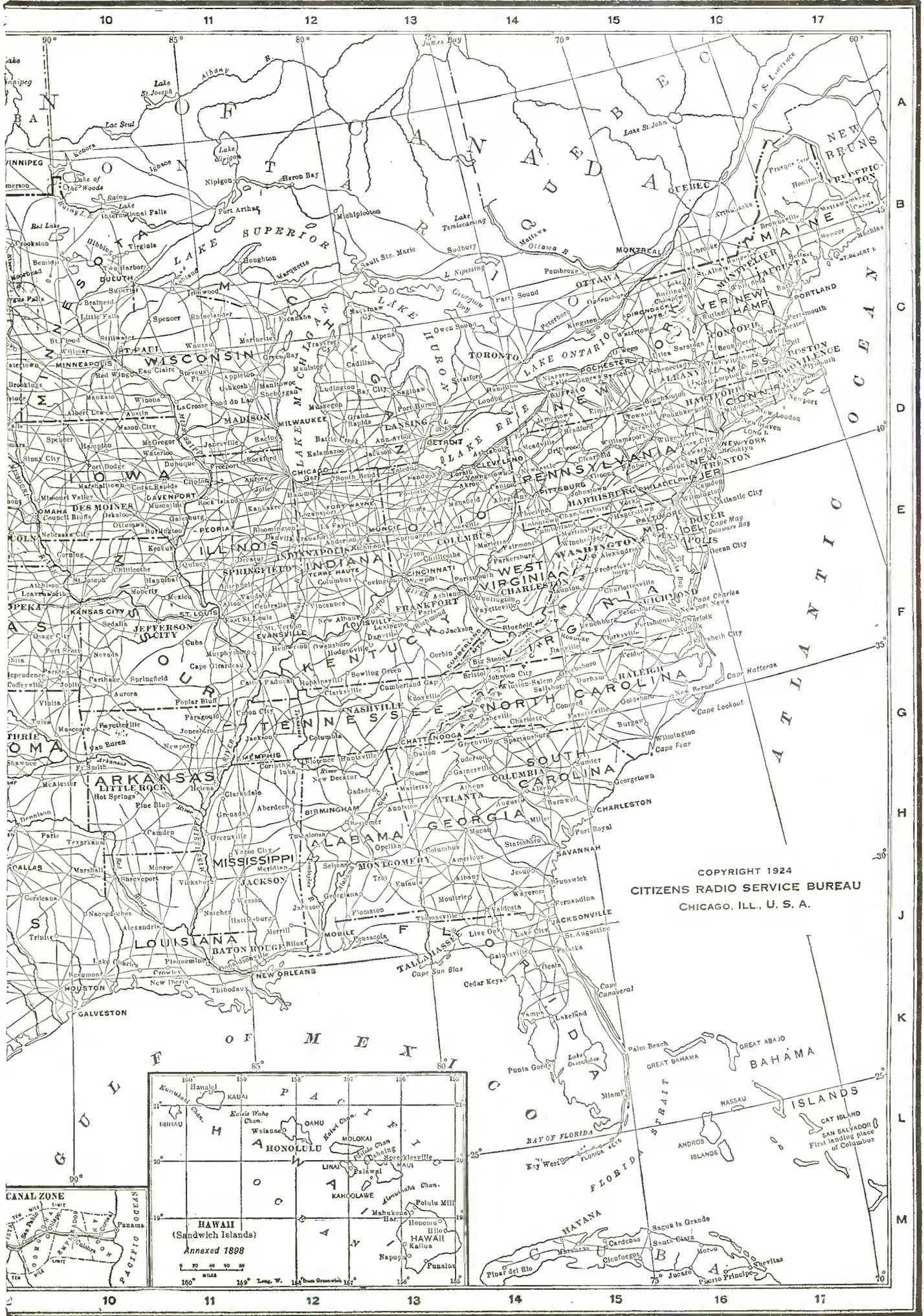

# Map Of

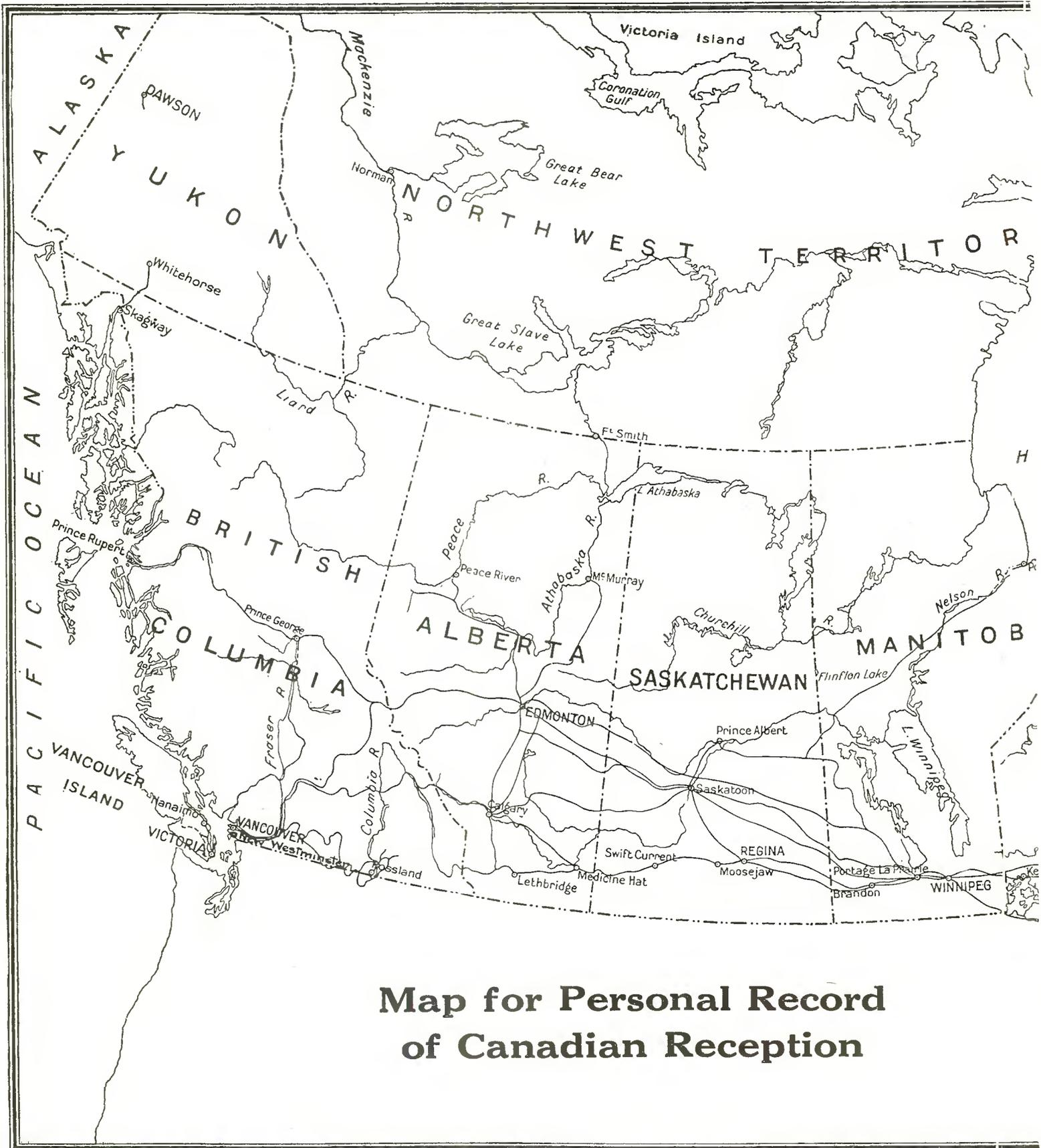

## Map for Personal Record of Canadian Reception

# Canada

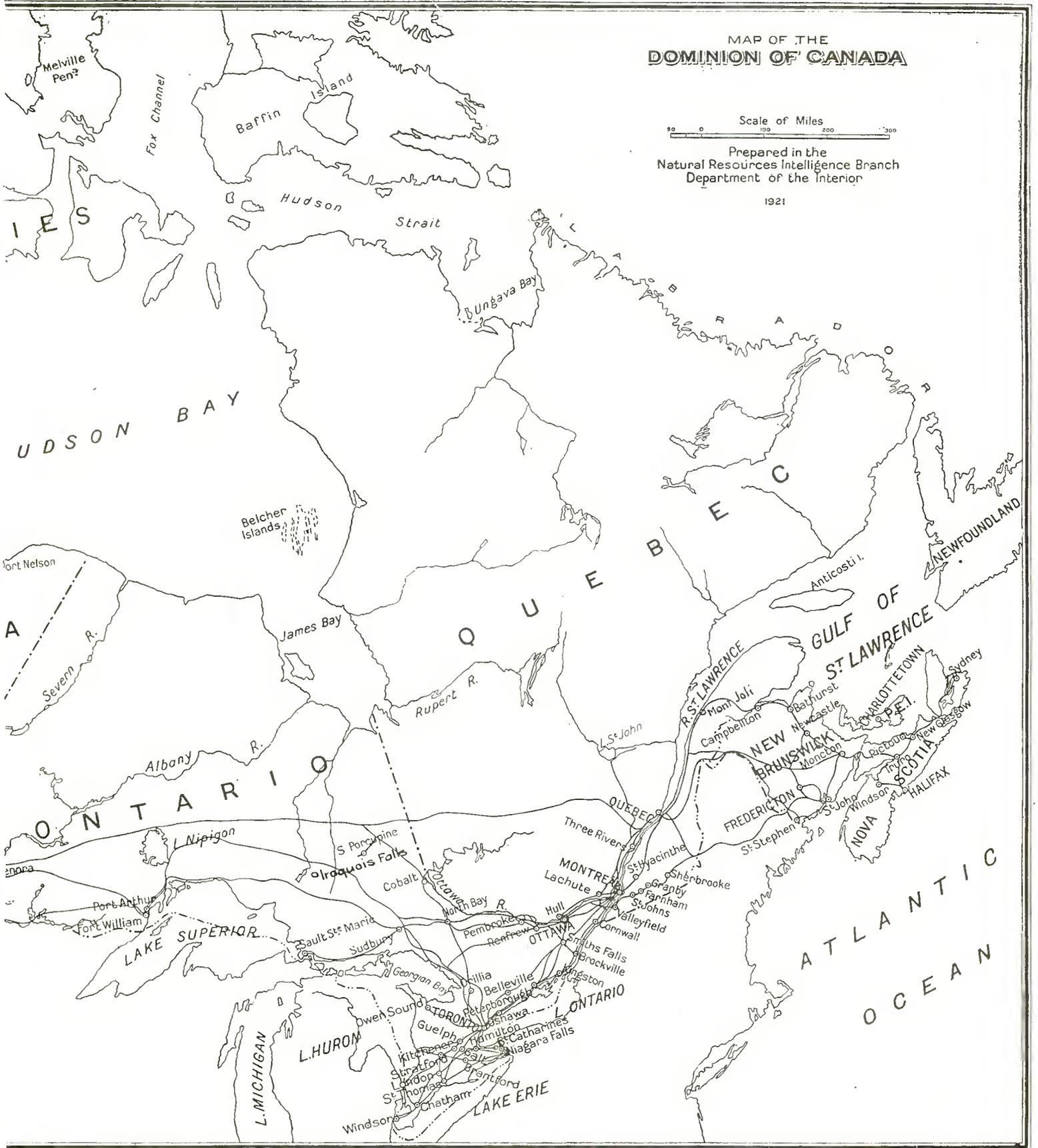

# Canadian Broadcasting Stations

- CFAC**—The Calgary Herald, Calgary, Alberta. 430 meters, 697 kilocycles, 1000 watts. Daily except Sun 1 pm. market, news, 3:30-4:30 pm, music. Mon 10-12 midnight, dance program. Tues 7:45-8:45 pm, concert. Wed 7:15 pm, bedtime story, 7:45-8:45 pm, vocal. Thurs 9-11 pm, concert. Fri 7-8 pm, organ. Sun 11 am or 7:30 pm, church services. Mountain time.
- CFCA**—Star Publ. & Printing Co., 18 King St. W., Toronto, Ontario. 400 meters, 749 kilocycles, 2000 watts.
- CFCF**—Marconi Wireless Telegraph Co. of Canada, Ltd., Canada Cement Bldg., Phillips Square, Montreal, Quebec. 440 meters, 681 kilocycles, 2000 watts.
- CFCH**—Abitibi Power & Paper Co., Ltd., Iroquois Falls, Ontario. 400 meters, 749 kilocycles, 500 watts. Mon, Wed, Sat & Sun 8-10 pm. Tues, Thurs & Fri, 8-8:30 pm. Eastern Standard time. Slogan, "The Home of the World's Largest Newsprint Mill."
- CFCK**—Radio Supply Co., Ltd., 10229 101st St., Edmonton, Alberta. 410 meters, 731 kilocycles, 250 watts.
- CFCL**—Centennial Methodist Church, Victoria, British Columbia. 400 meters, 749 kilocycles, 500 watts.
- CFCN**—Wm. W. Grant, 605 24th Ave. West, Calgary, Alberta. 439 meters, 681 kilocycles, 1000 watts. Fri 9:30-11 pm, Sat 10-12 midnight, dance program. Sun 11 am and 7:30 pm, church services, 5:30-6:30, salon program. Mountain time. Slogan, "The Voice of the Prairie."
- CFCQ**—Radio Specialties, Ltd., 791 Dunsmuir Ave., Vancouver, B. C. 450 meters, 666 kilocycles, 40 watts. For testing only.
- CFCR**—Laurentide Air Service, Ltd., Nickle Range Hotel, Sudbury, Ontario. 410 meters, 731 kilocycles, 200 watts.
- CFCT**—Victoria City Temple, Fletcher Bros. Music House, 1110 Douglas St., Victoria, British Columbia. 410 meters, 750 kilocycles, 500 watts. Tues & Thurs 7-8 pm, Wed & Fri 8 pm, concert program. Pacific time.
- CFCU**—Jack V. Elliot, Ltd., 123 King St. W., Hamilton, Ontario. 485 meters, 620 kilocycles, 20 watts. Daily including Sun 5:15-6 pm. musical program. Mon, Wed & Fri 8:30-10 pm. Thurs 8-11 pm. Sat 9-12 pm. Central Standard time.
- CFCW**—London Radio Co., 314 Dundas St., London, Ontario. 430 meters, 697 kilocycles, 600 watts.
- CFDC**—Sparks Company, Wallace & Fitzwilliam Sts., Nanaimo, British Columbia. 430 meters, 697 kilocycles, 50 watts. Mon, Wed & Fri 7:30-8:30 pm. Sun 4-5 pm. Pacific Standard time.
- CFHC**—Henry Birks & Sons, Ltd., 708 Crescent Road, N. W., Calgary, Alberta. 440 meters, 681 kilocycles, 1000 watts.
- CFKC**—D. J. Fendell, Patricia Theatre Bldg., Thorold, Ontario. 295 meters, 1015 kilocycles, 150 watts.
- CFLC**—Chas. Guy Hunter, 551 Adelaide St., London, Ontario. 430 meters, 697 kilocycles, 100 watts.
- CFQC**—The Electric Shop, Ltd., 144 2nd Ave. N., Saskatoon, Sask. 400 meters, 749 kilocycles, 250 watts. Daily ex Sun 1:15-2 pm. Thurs 7:45-9 pm. Fri 9-11:30 pm, dance programs. Sun 11 am, church services. Mountain time. Slogan, "Hub City of the West."
- CFRC**—Queen's University (Dept. of Electrical Engineering), Fleming Hall, Kingston, Ontario. 450 meters, 666 kilocycles, 1500 watts.
- CFXC**—Westminster Trust Co., Columbia & Begbie Sts., New Westminster, British Columbia. 440 meters, 681 kilocycles, 50 watts.
- CFYC**—Victor Wentworth Odum, Mercantile Bldg., 318 Homer St., Vancouver, British Columbia. 400 meters, 749 kilocycles, 20 watts.
- CHBC**—The Albertan Publishing Co., Ltd., 708 Crescent Road, N. W., Calgary, Alberta. 410 meters, 731 kilocycles, 1000 watts.
- CHCE**—Western Canada Radio Supply, Ltd., 919 Fort St., Victoria, British Columbia. 400 meters, 749 kilocycles, 20 watts.
- CHCM**—Riley & McCormick, Ltd., 133 8th Ave. East, Calgary, Alberta. 440 meters, 681 kilocycles, 1000 watts. Thurs 8-9. Special programs as announced. Mountain time. Slogan, "Western Canada's Leading Leather Goods Mail Order House."
- CHCS**—The Hamilton Spectator, Spectator Bldg., Hamilton, Ontario. 415 meters, 731 kilocycles, 2000 watts. Program irregular. Broadcast news, sport, speeches, lectures, etc., as announced.
- CHIC**—Northern Electric Co., Ltd., Toronto, Ontario. 350 meters, 857 kilocycles, 100 watts. Special programs as announced.
- CHNC**—Toronto Radio Research Society, 46 Laurier Ave., Toronto, Ontario. 350 meters, 857 kilocycles, 500 watts. Mon 8:30 pm, musical program. Sat 9-11 pm, dance music and specialties. Eastern Standard time.
- CHUC**—International Bible Students Association, Cor. Main & 2nd Sts., Saskatoon, Sask. 400 meters, 749 kilocycles, 200 watts.
- CHXC**—J. R. Booth, Jr., 28 Range Rd., Ottawa, Ontario. 435 meters, 689 kilocycles, 1200 watts.
- CHYC**—Northern Elec. Co., Ltd., 121 Shearer St., Montreal, Quebec. 341 meters, 880 kilocycles, 500 watts. Tues 8:45 pm. Wed 8:30 pm. Sun 7 pm. Eastern Standard time.
- CJBC**—Jarvis Street Baptist Church, Toronto, Ontario. 312 meters, 960 kilocycles, 4000 watts.
- CJCA**—The Edmonton Journal, Ltd., Journal Bldg., Edmonton, Alberta. 450 meters, 666 kilocycles, 500 watts. Daily ex Fri & Sunday 12:30 pm. Daily ex Fri 7:30 pm. Mon & Wed 8:30-9:30 pm. Thurs & Sat 9:15 pm to 12 midnight. Mountain time. Slogan, "The Sunniest Spot in Sunny Alberta."
- CJCD**—The T. Eaton Co., Ltd., Queen St. W., Toronto, Ontario. 410 meters, 731 kilocycles, 100 watts.
- CJCE**—Spratt Shaw Radio Co., Room 1604, Tower Bldg., Vancouver, British Columbia. 400 meters, 749 kilocycles, 150 watts.
- CJCF**—The News-Record. Limited, 39 S. Cameron St., Kitchener, Ontario. 295 meters, 1016 kilocycles, 300 watts. Daily concerts as announced. Sun 9-10 pm. Eastern Standard time.
- CJCK**—Radio Corp. of Calgary, Ltd., 223 2nd Ave., N. E., Calgary, Alberta. 316 meters, 955 kilocycles, 500 watts.
- CJCM**—Dr. J. L. P. Landry, Mont Joli, Quebec. 306 meters, 990 kilocycles, 250-500 watts. Daily 5-6 pm. Mon 8:30-10 pm, irregular. Sat 8:30-10 pm. Wed & Sun 8-10 pm. Tues 11 pm. Wed, Thurs, Fri, Sat & Sun 11 pm. Eastern Standard time.
- CJCN**—Simons, Agnew & Co., Toronto, Ontario. 410 meters, 731 kilocycles, 2000 watts.
- CJGC**—London Free Press Printing Co., 440 Richmond St., London, Ontario. 430 meters, 697 kilocycles, 200 watts.
- CJSC**—The Evening Telegram, 81 Bay St., Toronto, Ontario. 430 meters, 697 kilocycles, 2000 watts.
- CKAC**—La Presse, Montreal, Quebec. 425 meters, 710 kilocycles, 2000 watts. Mon, Wed & Fri 1:45 pm, 4 pm, 4:30 pm. Tues 4 pm, 7 pm, 7:30, 8:30 & 10:30 pm. First and third Wed each month, midnight frolic. Thurs 4 & 8:30 pm. Sat 7 pm, 7:30, 8:30 & 10:30 pm. Sun 4:30 pm. Eastern Standard time.
- CKCD**—The Daily Province, 142 Hastings St. W., Vancouver, British Columbia. 410 meters, 713 kilocycles, 2000 watts. Daily ex Sun 8:30-9:30 pm. Pacific Standard time.
- CKCE**—Canadian Independent Tel. Co., Wallace Ave. & Ward St., Toronto, Ontario. 450 meters, 666 kilocycles, 2000 watts.
- CKCI**—Le "Soleil," Limitee, C. W. Lindsay Bldg., Cor. St. John & St. Eustache St., Quebec, P. Quebec. 295 meters, 1025 kilocycles, 200 watts.
- CKCK**—Leader Publishing Co., Regina, Sask. 420 meters, 714 kilocycles, 2000 watts. Daily ex Sun 9:50-10:30 am, 12:30-1:15 pm, 7:30-8:10 pm. Sun 9-10 pm. Mountain time. Slogan, "Queen City of the West."
- CKCO**—Dr. G. M. Geldert for Ottawa Radio Association, 282 Somerset West, Ottawa, Ontario. 435 meters, 697 kilocycles, 100 watts. Tues 8-10 pm. Sun 7 pm, church service, 9 pm sacred concert. Eastern Standard time. Slogan, "The Community Voice of Canada's Capital" and "Ottawa's Radio Voice."
- CKCX**—P. Burns & Co., Limited, 708 Crescent Road, N. W., Calgary, Alberta. 440 meters, 681 kilocycles, 500 watts. Tues 9-10 pm, musical program and food talks. Mountain time.
- CKFC**—First Congregational Church, Vancouver, British Columbia. 385 meters, 788 kilocycles, 200 watts.
- CKLC**—Wilkinson Elec. Co., Ltd., 2119 7th Ave., N. W., Calgary, Alberta. 400 meters, 749 kilocycles, 100 watts. Mon 9-10 pm, concert. Fri 7:45-8:45 pm, concert. Sun 9:30-10:30 pm, sacred concert. Mountain time.
- CKOC**—Wentworth Radio Supply Co., 31 John St. N., Hamilton, Ontario. 410 meters, 731 kilocycles, 100 watts. Daily ex Sun 7:30-9:30 pm. Slogan, "In the Garden of Canada."
- CKY**—Manitoba Telephone System, Sherbrooke St., Winnipeg, Manitoba. 450 meters, 666 kilocycles, 2000 watts.
- CNRA**—Canadian National Railways, Moncton, New Brunswick. 313 meters, 960 kilocycles, 500 watts. Tues 8:30 pm. Fri 7:30 pm. Atlantic Standard time. Slogan, "Maritime Radio Station—Voice of the Maritimes."
- CNRC**—Canadian National Railways, Calgary, Alberta. 430 meters, 697 kilocycles, 1000 watts. Thurs 9 pm, bedtime stories & studio program. Mountain time.
- CNRE**—Canadian National Railways, Edmonton, Alberta. 450 meters, 666 kilocycles, 500 watts. Fri 6 pm orchestra, 7:30 pm children's bedtime stories, 8:30 pm orchestra. Mountain time.
- CNRM**—Canadian National Railways, Montreal, Quebec. 425 meters, 700 kilocycles, 2000 watts. Thurs 8:30 pm concert. Eastern Standard time.
- CNRO**—Canadian National Railways, Ottawa, Ontario. 435 meters, 688 kilocycles, 500 watts. Wed 7 pm market, 7:30 pm children's half hour, 8 pm studio program. Wed & Sat 7:30 pm, 8 pm dinner concert, 8:30 pm studio program, 10:45 pm dance program. Eastern Standard time.
- CNRR**—Canadian National Railways, Regina, Sask. 420 meters, 713 kilocycles, 2000 watts. Tues 8 pm, bedtime travel tales, orchestra. Mountain time.
- CNRS**—Canadian National Railways, Saskatoon, Sask. 400 meters, 749 kilocycles, 500 watts. Daily 2:30 pm, music and market reports. Mountain time.
- CNRT**—Canadian National Railways, Toronto, Ontario. 400 meters, 749 kilocycles, 2000 watts. Fri 6:30 pm concert, 8:30 pm studio program, 9 pm address, 10:30 pm orchestra. Eastern standard time. Slogan, "The Largest Railway System in the World."
- CNRW**—Canadian National Railways, Winnipeg, Manitoba. 450 meters, 666 kilocycles, 2000 watts. Thurs 8 pm market, 8:15 pm bedtime stories, 8:30 pm studio program. Central Standard time.



Tune in with  
*a Matched Tone*  
 Headset —  
 listen with  
 a Brandes  
*Table-Talker*

# Brandes

Superior  
 Matched Tone  
 Headset \$6  
 \$7 in Canada

Table-Talker  
 \$10.  
 50¢ extra west  
 of the Rockies  
 In Canada \$12.50

Navy Type  
 Matched Tone  
 Headset \$8  
 \$9 in Canada

*The name  
 to know in Radio*

# BLANK MAP

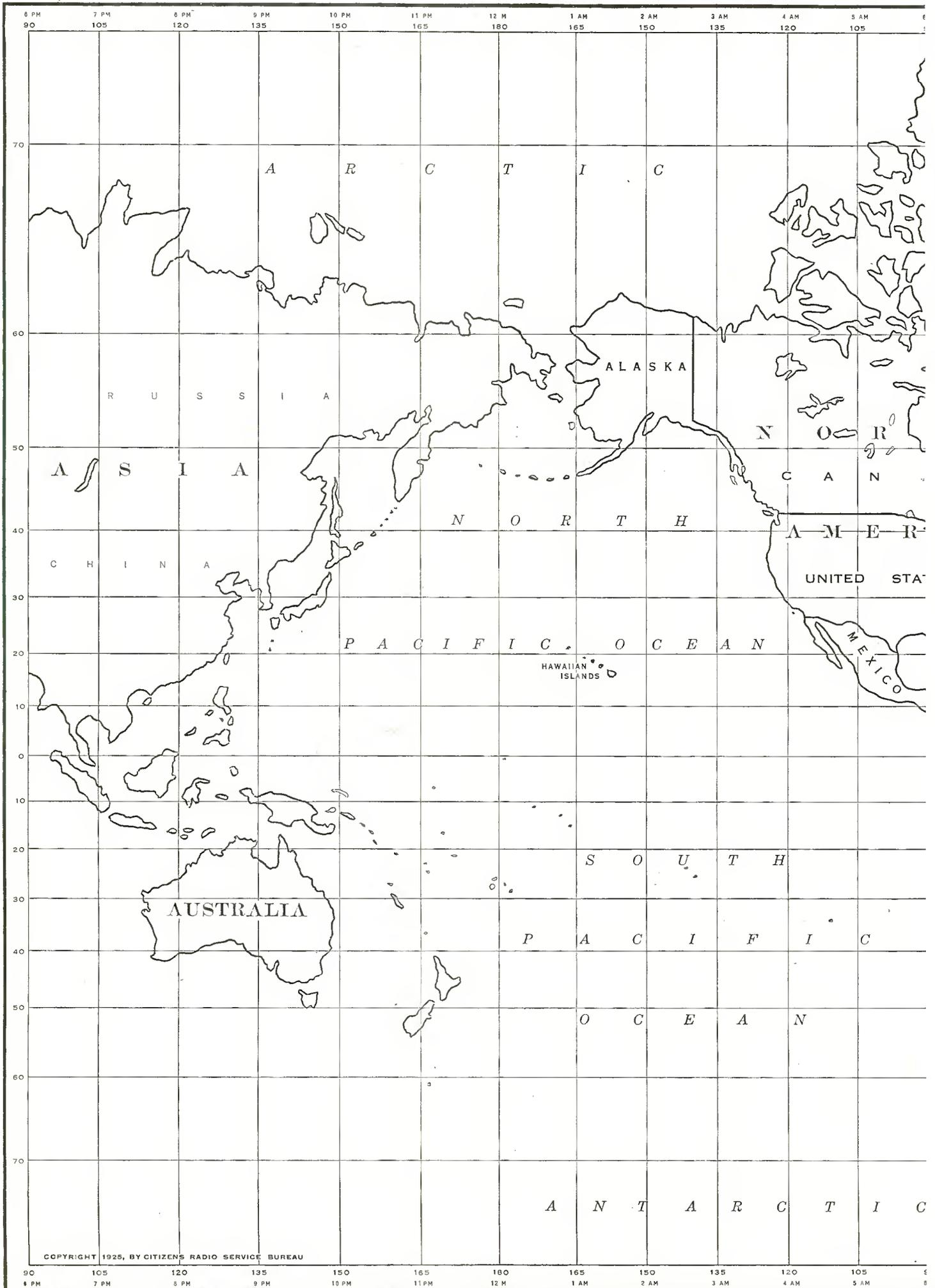

COPYRIGHT 1925, BY CITIZENS RADIO SERVICE BUREAU

90 105 120 135 150 165 180 165 150 135 120 105  
 8 PM 7 PM 6 PM 9 PM 10 PM 11 PM 12 M 1 AM 2 AM 3 AM 4 AM 5 AM

# OF THE WORLD

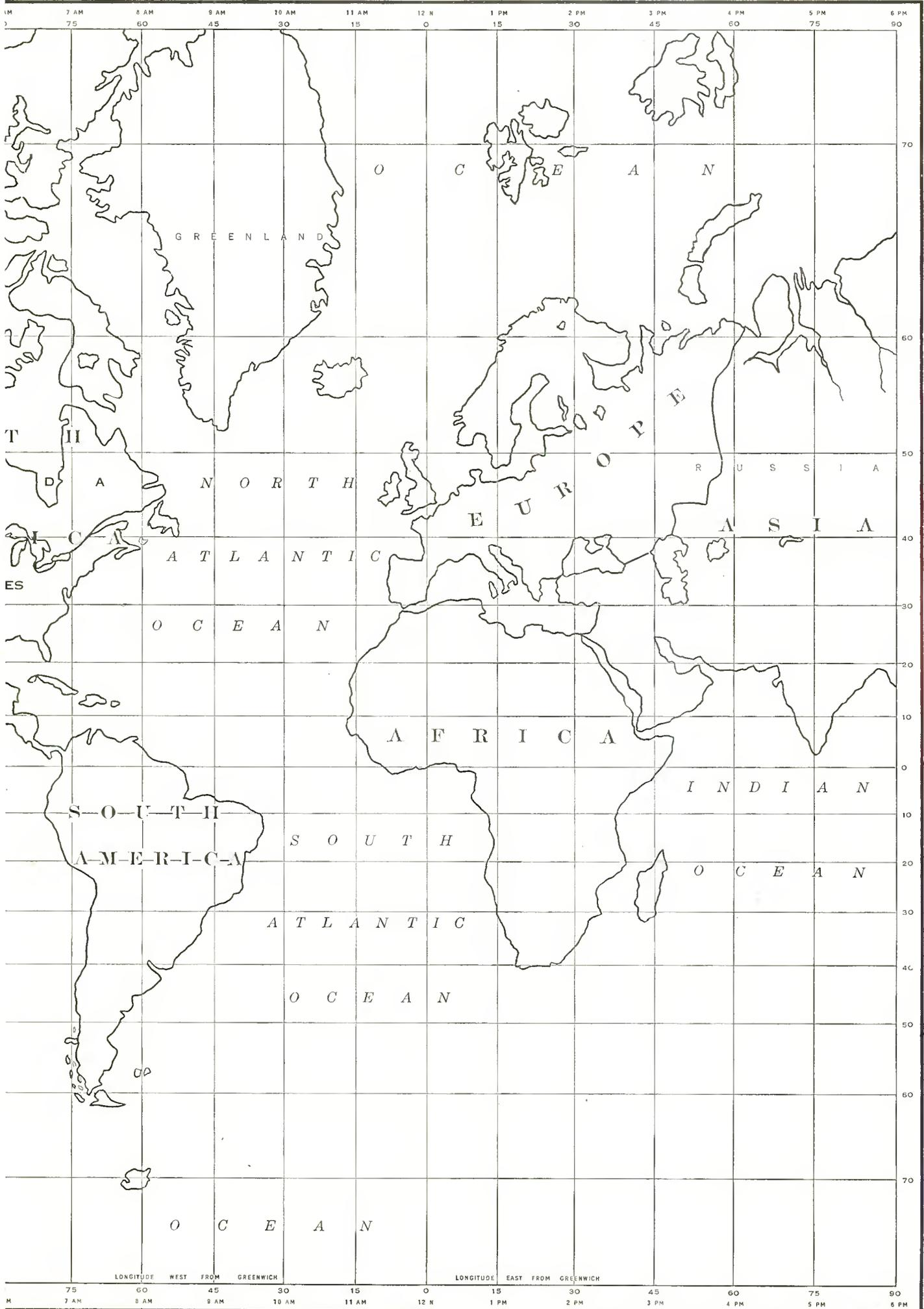

# Foreign Radio Broadcasting Stations

Location	Operated by	Call	Wave l'gth meters	Power watts	Location	Operated by	Call	Wave l'gth meters	Power watts	Location	Operated by	Call	Wave l'gth meters	Power watts
<b>ALASKA</b>														
Anchorage:	Chovin Sup. Co.	KFQD	280	100	Julio Power		2HS	180	20	Glasgow		5SSC	420	1100
Juneau:	Alaska Electric Light & Power Co.	KFIU	226	10	Oscar Collado		2OL	290	15	Leeds-Bradford		2LS	346	No data
Kukak Bay:	Walter Heinrich	KNT	263	100	Amadeo Saenz		2WW	210	20	Also			310	
<b>ARGENTINA</b>														
Buenos Aires:	Radio Sud				Colon: Leopoldo V. Figuerca		5EV	360	100	<b>HAWAII</b>				
America		LOZ	375	500	Tuinucu: Frank H. Jones		6KW	340	100	Honolulu: Marion A. Mulrony	KGU		360	500
Also			384		Frank H. Jones		6KJ	275	100	The Electric Shop		KYQ	270	100
Radio Cultura		LOX	375		<b>INDIA</b>					Calcutta: Radio Club (2BZ)				
Francisco J. Brusa		TCR	325	100*	Cienfuegos: Antonio T. Figuerca		6CX	170	20	operated by Marconi	5AFO		425	
Also			300		Eduardo Terry		6DW	225	10	<b>ITALY</b>				
Cia. Radio Argentina†		LOR	350	500	Jose Ganduxe		6BY	300	100	Rome: No data		ICD	3200	
Also			410		Valentin Ullivarri		6AZ	200	10	Ing. Ranieri		None	350	
Ciara†			400	500	Caibarien: Josefa Alvarez		6EV	225	20	Also		None	450	
Francisco J. Brusa		LOV			Camaguey: Pedro Nogueros		7AZ	225		Centocello: No data		None	2900	
Francisco J. Brusa		B-1			Salvador Rionda		7BY	350		<b>JUGOSLAVIA</b>				
Grand Splendid Theater		LOW			Santiago de Cuba: Alfredo Brooks		8AZ	240	20	Belgrade: No data			1625	
Radio Nacional		LOY			Alberto Ravelo		8BY	250	100	<b>MARTINIQUE, French West Indies</b>				
Tucuman			No data		Andres Vinnel		8FU	225	15	La p. des Carrieres: French				
Rosario			No data		Pedro C. Andus		8DW	275	50	Marine de Guerre		HYV	600	
*Now installing equipment for 1000 watts.														
†Radio Cultura and Sociedad Radio Argentina also named as operators of this station.														
‡Cia. Radio Argentina.														
<b>AUSTRALIA</b>														
Sydney: Farmer & Co. (Ltd.)		2CF	1120	1000	Eduardo Mateo		8EV	180	75	Also			2000	
Broadcastings Sydney (Ltd.)		2BL	380	500	Juan F. Chibas		8GT	260		<b>MEXICO</b>				
Melbourne: Associated Radio Co. (Ltd.)		2AB	480	250	<b>CZECHOSLOVAKIA</b>									
Adelaide: So. Australia Broadcastings (Ltd.)			480		Kbely: Radio Journal		None	1100	1000	Mexico City: El Buen Tono		CYB	360	500
Perth: West Australian Farmers (Ltd.)		6WF	1250	500	Prague: No data		PRG	*1800	10000	El Universal		CYL	360	500
<b>AUSTRIA</b>														
Vienna: Technologische Gewerbemuseum		"Radio Wien"	700	100	Brunn: No data		OKB	1800	1000	El Excelsior (not now operating)				
Radio Hekaphon		OHW	600		<b>DENMARK</b>									
<b>BELGIUM</b>														
Brussels: No data		SRB	405		Lyngby: Danish Government		ONE	2400	2500	<b>NETHERLANDS</b>				
No data		BAV	900		<b>FINLAND</b>									
Also			1100		Tammerfors: Amateur Radio Society		3NB	300	20	The Hague: Velthuyzen		PCKK	1050	
Radio Electrique			265		Skatuddcn: Nuoren Voiman Liiton Radioyhdistys			450	75	Nederlandsche Radio Industri		PCGG	1050	
<b>BRAZIL</b>														
Rio de Janeiro: Praia Vermelha		No data		500	<b>FRANCE</b>									
Marconi (Radio Soeiedade do Rio de Janeiro)		No data		6000	Paris: Eiffel Tower		FL	2600	4000	Laboratorium Heussen		PCUU	1050	
Sao Paulo: Radio Bondeirantes		No data		10000	Ecole Supericure des P. T. & T.		ESP	450	350	Ijmuiden: Middelraad		PCMM	1050	
Belle Horizantes: National Telegraph Service		No data		500	Levallois (Radiola)		SFR	1780	2000	Amsterdam: Smith and Hooghout		PA5	1050	
Bahia: Radio Sociedade do Bahia		(Projected station)			No data		SAJ	1780		Vas Diaz Press Office		PCFF	2000	
<b>CHILE</b>														
Valparaiso: Senor Placi do Munoz Rojas		No data			Tours: French Government		YG	2500	500	Hilversum: Dutch Radio Apparatus Factory		NSF	1050	
Santiago: Radio Corporation of Chile		CRC	400		LaDoua (Lyons): French Government		YN	480	500	<b>NEW ZEALAND</b>				
Also			460		Also			3100		Dunedin: Otago University		4XO	140	
Vina del Mar: Radio Corporation of Chile		ABC	400		Nice: French Government		None	460		British Electrical & Engineering Co.		4YA	310	500
<b>CHINA</b>														
Hongkong: Hongkong Hotel Co.					Issy-sur-Moulineaux: French Government		None	1600		Auckland: Auckland Radio Service		1YA	260	200
Radio Communication Co. (Orient), Ltd.					Bourges: French Government		None	900		C. H. Pearson for Newcombe (Ltd.)		1YL	260	500
Shanghai: The Evening News					Abbeville: French Governm't.		None	900		Wellington: Wellington Broadcasters (Ltd.)		2YB	275	15
Macao: (Portuguese)					<b>GERMANY</b>									
<b>CUBA</b>														
Habana: Cuban Telephone Co.		PWX	400	500	Berlin: Konigswusterhausen		LP	2800		Dominion Radio Co.		2YK	275	15
Pedro Zayas		2DW	300	100	Vox Haus		None	450	1500	Gisborne: Gisborne Radio Co.		2YM	335	500
Alberte S. Bustamante		2AB	240	20	Leipzig: Mitteldutsche Rundfunk AG		None	436	1000	<b>PERU</b>				
Mario Garcia Velcz		2OK	360	100	Also			1500		No data: Peruvian Broadcasting Co. (projected)				
Frederick W. Borton		2DY	260	100	Frankfurt: Sudwestdeutsche Rundfunkienst		None	460		<b>PORTO RICO</b>				
Frederick W. Borton		2CX	320	10	Hamburg: Nordischer Rundfunk AG		None	392		San Juan: Radio Corporation of Porto Rico		WKAQ	360	100
Westinghouse Electric Co.		2EV	220	50	Breslau: Schlesische Rundfunk AG		None	415		<b>PORTUGAL</b>				
Roberto E. Ramirez		2TW	230	20	Konigsburg: Ostmarken Rundfunk AG		None	460		Lisbon: Aero Lisboa		None	370	
Heraldo de Cuba		2HC	275	500	Stuttgart: Sudddeutsche Rundfunkdienst AG		None	437		Also		None	400	
Luis Casas		2LC	250	30	Munich: Deutsche Stunde in Bayern		None	485	1500	<b>SOUTH AFRICA</b>				
E. Sanchez Fuentes		2KD	350	100	Eberswalde: No data		None	2930		Johannesburg: Association of Scientific and Tech. Soc.		None	450	
Fausto Simon		2MN	270	300	<b>GREAT BRITAIN</b>									
Manuel G. Salas		2MG	280	20	The following stations are operated by the British Broadcasting Co., which holds an exclusive concession from the British Government:					Cape Town: No data				
Raul Perez Falcon		2JQ	150	10	Sheffield		None	303		<b>SPAIN</b>				
Alvaro Daza		2KP	200	10	Plymouth		None	330		Madrid: No data		EGC	2100	
<b>GREAT BRITAIN</b>														
The following stations are operated by the British Broadcasting Co., which holds an exclusive concession from the British Government:														
London		2LO	365	900	Cardiff		5WA	350	1100	No data		PTT	400	
Manchester			375	1000	London		2LO	365	900	Also		700		
Bournemouth		6BM	385	1100	London		2LO	365	900	Radio Iberica		392		
Newcastle		5NO	400	1100	London		2LO	365	900	Cartagena: No data		EBX	1200	
Glasgow		2SC	415		London		2LO	365	900	<b>SWEDEN</b>				
Belfast		None	435		London		2LO	365	900	Stockholm: Royal Telegraph Radio Office		None	440	500
Birmingham		5IT	475	500	London		2LO	365	900	Svenska Radioactiebolaget		None	470	300
Aberdeen		2BD	495	1100	London		2LO	365	900	Goteborg: Royal Telegraph Radio Office		SAB	700	200
Chelmsford		5XX	1600		Bournemouth		6BM	385	1100	Ingenior Eliassons		SMZX	460	50
Croydon		GED	900		Newcastle		5NO	400	1100	Boden: Royal Telegraph Radio Office		SAI	460	50
<b>SWITZERLAND</b>														
The following stations are operated by the British Broadcasting Co., which holds an exclusive concession from the British Government:														
Lausanne: Champ de l'Air		HB2	1060		Glasgow		2SC	415		Gothenburg: Nya Varvet			700	
Geneva: Station T. S. F.					Belfast		None	435		<b>NETHERLANDS</b>				
Cointrin		HB1	1100		Birmingham		5IT	475	500	The Hague: Velthuyzen		PCKK	1050	

# BARKELEW

## RADIO ACCESSORIES

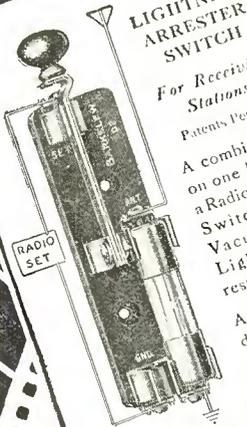

**LIGHTNING ARRESTER SWITCH**  
For Receiving Stations  
Patents Pending

A combination on one base of a Radio Ground Switch and a Vacuum Tube Lightning Arrester.

A distinctive device for those who know and demand the best lightning protection.

Approved by the Underwriters Laboratories.  
Catalog No. 602 Price \$3.00

**ANTENNA EQUIPMENT**

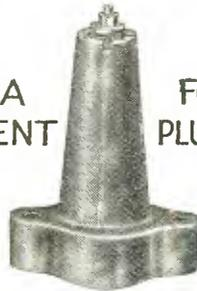

**PORCELAIN PEDESTAL**  
Brown Glaze

An insulator with a rigid clamp for the lead-in wire. A pedestal for spacing Ground Switches or other apparatus, 5" clear of the mounting surface.  
Catalog No. 611 Price \$0.40

**FOUR PHONE PLUGS AND POSTS**

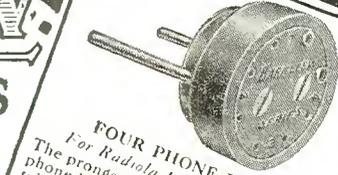

**FOUR PHONE POST**  
For Radiola III and III-A  
The prongs on this post fit through phone holes in the face of panel. It takes one to four head-sets in Series.  
Catalog No. 624 Price \$1.00



**FOUR PHONE PLUG**  
Connects one to four head-sets in Series to any Radio set using telephone jacks.  
Catalog No. 616 Price \$1.00

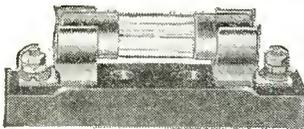

**VACUUM TUBE LIGHTNING ARRESTER**

Required on the antenna of every Receiving Station. Approved by the Underwriters Laboratories.  
Catalog No. 606 Price \$1.50

**BARKELEW PRODUCTS Have Merit and Reputation**

THE keen buyer of radio material knows that some items can be purchased on their own merit, while others the reputation of the manufacturer is of first importance.

He is happy when he finds a fast moving, well advertised line with real merit and with a factory reputation backing it up.

The articles shown here have several successful years behind them [they are old for radio] and our eighteen years in electrical manufacturing surely count for something.

For full description of each item, see our new Radio Catalog No. 32 at your dealer. If he hasn't his copy, we have one for him.

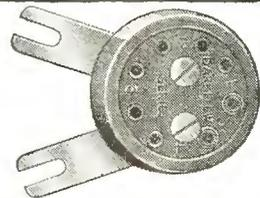

**FOUR PHONE POST**

For hinding post mounting. Connects one to four headsets in series to the more common types of brass phone posts.  
Catalog No. 628 Price \$1.00

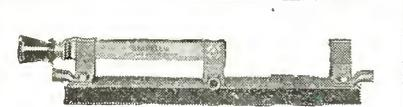

**GROUND SWITCH**

Required on all Transmitting Stations—Built of 60 Ampere Copper  
Catalog No. 600 Price \$2.50



**FOUR PHONE POST**

For Panel Mounting. Connects one to four head-sets in series.  
Catalog No. 618 Price \$0.75

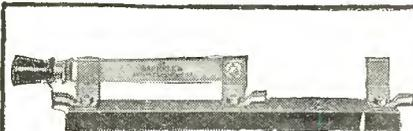

**GROUND SWITCH**

Required on all transmitting Stations. Built of 100 Ampere Copper.  
Catalog No. 601 Price \$3.15

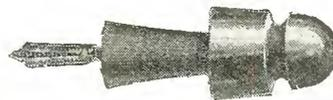

**"LEAD-IN" INSULATOR**  
For Receiving Stations

Spaces the "Lead In" Wire 5" out from the wall.  
Catalog No. 612 Price \$0.50

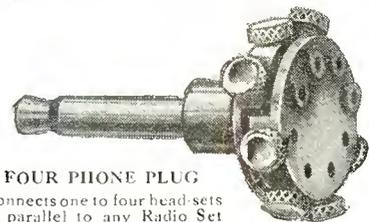

**FOUR PHONE PLUG**

Connects one to four head-sets in parallel to any Radio Set using telephone jacks.  
Catalog No. 614 Price \$1.50



**VACUUM ARRESTER TUBE**

Used in 602 Switch and 606 Arrester. Sold separately for replacement purposes.  
Catalog No. 622 Price \$1.00

**The Barkelew Electric Mfg. Co.**

Middletown, Ohio U.S.A.

- NEW YORK  
157 Chambers St.
- CHICAGO  
15 Clinton St.
- DETROIT  
McKerchey Bldg.
- WASHINGTON, D. C.  
Mills Building
- MINNEAPOLIS  
1017 Lumber Exchange
- SAN FRANCISCO  
75 Fremont St.
- LOS ANGELES  
443 S. San Pedro St.
- SEATTLE  
1041 Sixth Ave., S.
- DENVER  
Denham Bldg.

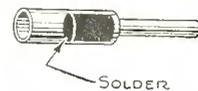

**STANDARD CORD TIPS**

If the wire is tinned they can be soldered on Phone Cord with a couple of matches.  
Cat. No. 623 Price \$0.05 ea.

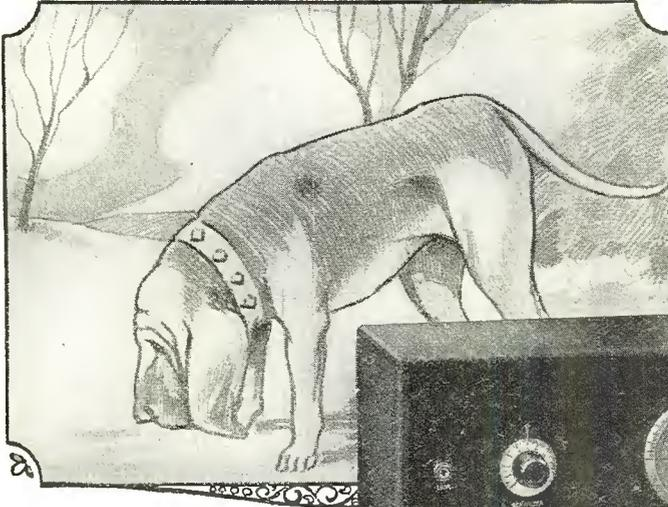

The bloodhound, remarkable for the acuteness of its smell, can pick up a scent and follow a trail when all else fails.

# Sensitivity

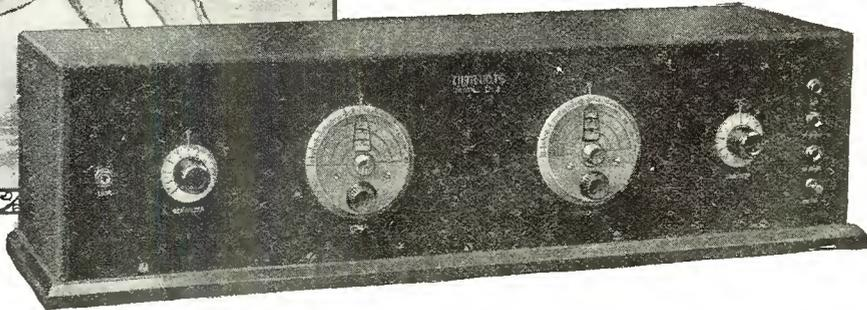

*-never before thought possible!*

With the extreme acuteness of the bloodhound's scent, the Model L-2 Ultradyne detects the faintest broadcast signals—signals that are "dead" to other receivers—regenerates and makes them audible on the loud speaker.

It's here, where the development of other super-radio receivers has halted; the Ultradyne forges ahead.

The unusual sensitivity of the Model L-2 Ultradyne is due to the successful application of regeneration, to the famous Modulation System of radio reception, recently perfected by R. E. Lacault, E.E., A.M.I.R.E., Chief Engineer of this Company and formerly Radio Research Engineer with the French Signal Corps Research Laboratories.

It's this development, an exclusive feature of the Model L-2 Ultradyne, that makes it possible to receive greater distance on the loud speaker.

In addition the Ultradyne is the most selective receiver known. Regardless of close similarity in wavelength, it selects any station within range—brings in broadcasting clearly, distinctly, faithfully.

Everything that the Model L-2 Ultradyne means in actual results and genuine satisfaction, you will appreciate the first evening you operate it.



**THE ULTRADYNE KIT**  
Consists of 1 Low Loss Tuning Coil, 1 Special Low Loss Coupler, 1 Type "A" Ultraformer, 3 Type "B" Ultraformers, 4 Matched Fixed Condensers.  
To protect the public, Mr. Lacault's personal monogram seal (R. E. L.) is placed on all genuine Ultraformers. All Ultraformers are guaranteed so long as this **\$30.00** seal remains unbroken.



**How to Build and Operate the ULTRADYNE**  
32 page illustrated book giving the latest authentic information on drilling, wiring, assembling and tuning the Model L-2 Ultradyne Receiver..... **50c**

Write for free descriptive folder.

## ULTRADYNE MODEL L-2

PHENIX RADIO CORPORATION

3-B Beekman Street,

New York

# The New Model L-2 Ultradyne

By HOGART S. SWEET

**R**EGENERATION plus modulation is the keystone of the new Ultradyne Receiver designed by Robert E. Lacault, formerly Radio Research Engineer with the French Signal Corps. This combination is going to prove as valuable to the level minded radio fan as four wheel brakes and balloon tires have to the level minded autoists. There is a strong comparison here, for both the autoist and radio fan seek the same things, namely, smooth operation and reliable and instant control.

As any radio technician will tell you, it is easy enough to

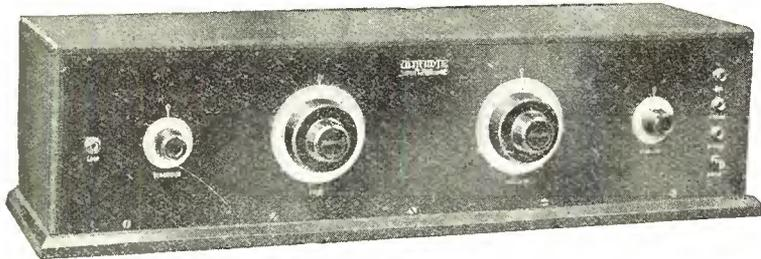

Front View of Receiver

think up any number of combinations and draw them into an intelligible circuit, but to get the combination to work and work satisfactorily is another story and one that is not without its note of despair. Mr. Lacault has met with numerous difficulties in his attempts to make the combination of regeneration and modulation work to his complete satisfaction, but he was successful in the end.

## Specifications

But listen to the specifications of Mr. Lacault's new design, Model L-2 Ultradyne, before we cover the constructional details. There are no rheostats! The filaments of all the vacuum tubes are controlled by automatic filament regulating devices. Filament control jacks are employed for the stages of audio frequency amplifications so that it is not necessary to play around with one or a couple of rheostats every time you shift. If you are using both stages of audio and wish to shift to the detector, out comes the plug with your own hands and out go the two audio frequency amplifier tubes without saying boo. Likewise, one or both go on when the plug is inserted in one or the other jack.

All binding posts have been moved to the rear, where they rightfully belong, for there should be no wires in front or on the side of the receiver, but behind, where they are out of sight and out of the way. The two variable condensers, of the low loss type, are both of the same capacity, whereas before, one was twice the capacity of the other. Making them both of a capacity of .0005 M.F. provides a more even adjustment than was possible with the original type of Ultradyne.

Naturally, the old type single layer cylindrical coils have been replaced by coils of the low loss type. These are the basket weave form and are more compact than the single layer type and decidedly more efficient.

It will be noted from the photo of Fig. 1 that there is a radical change in the position of the controls. Both the tuning dials are situated in the center of panel, really the most convenient positions for them—right where your hands normally rest. The re-

generation control and the potentiometer control are out to either side, being the less important adjusting mediums.

## The Layout

The layout is a work of art. Though the size of the panel is the same as in the former model, the instruments are not at all crowded and the leads from instrument to instrument are considerably shorter. It is a fact that it is much easier to wire this set than the old one or sets of similar design. A study of the accompanying photographs will assure you of this. The panel layout is shown in the photo of Fig. 1. The loop aerial jack is at the extreme left, followed by regeneration control knob, the tuner dial, the oscillator dial and the potentiometer control. The three phone jacks and the "A" battery switch are lined up on the extreme right of the panel.

A view of the layout from the rear of the panel is shown in Fig. 2, as well as that part of the wiring which is completed before the panel is attached to the baseboard. From left to right are: the phone jacks and "A" battery switch, the potentiometer, the 23 plate oscillator condenser, the 23 plate tuning condenser, the regeneration coupler and its copper shield and the loop aerial jack. Fig. 3 shows a view of the instruments mounted on the baseboard. The devices similar in appearance to grid leaks are the automatic filament regulators. The oscillator coupler is seen just to the right of the second rear tube socket. The tuning coil is situated to the extreme right of the baseboard. The Ultraformers are seen lined along the front portion of the baseboard, in the photo, though this is actually the rear. The "A," "B" and "C" battery binding posts are all mounted on a single strip of bakelite which is supported by two brass columns, and are at the extreme left of the baseboard, in the photo. The aerial and ground binding posts are mounted in the same manner and are seen to the extreme right.

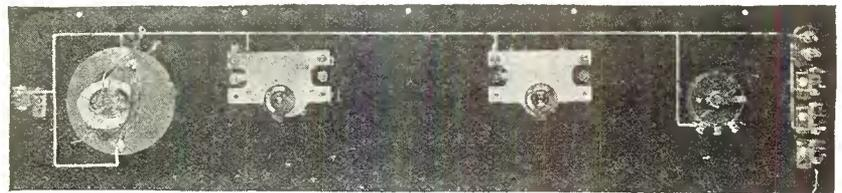

Rear View of Receiver

## The Parts Required

Below is given the complete list of parts required for the construction of the Model L-2:

- 1—7x30-inch cabinet with baseboard.
- 1—7x30-inch panel.
- 2—.0005 M.F. low loss variable condensers.
- 2—Vernier knobs and dials.
- 1—Low loss tuning coil.
- 1—Low loss oscillator coil.
- 1—Ultraformer, type A.
- 3—Ultraformer, type B.
- 1—Low loss 180 coupler with shield.
- 1—Dial for coupler.
- 8—Vacuum tube sockets.
- 1—Dial for potentiometer.
- 8—Amperites, type A.
- 2—Double circuit jacks.
- 1—Single circuit filament control jack.
- 1—Double circuit filament control jack.
- 1—"A" battery switch.
- 2—Audio frequency transformers.
- 1—Variable grid leak.
- 7—Binding posts.
- 2—Bakelite binding post mounting strips.

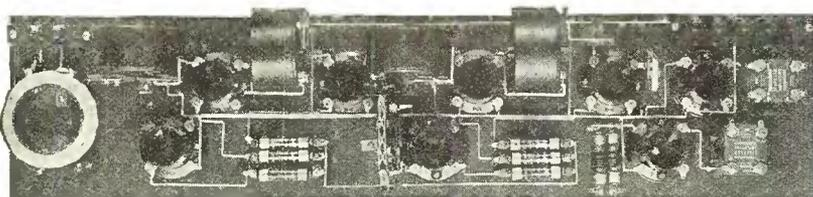

Looking Down on Receiver

- 1—.0005 M.F. condenser with grid leak mounting.
- 4—.00025 M.F. fixed condensers.
- 2—.001 M.F. fixed condensers.
- 1—.005 M.F. fixed condensers.
- No. 14 tinned copper bus bar wire.
- Assortment of screws and nuts.
- 1—400 ohm potentiometer.

Above all means purchase the best of materials. The L-2 Ultradyne is worthy of the best and if full service is to be expected, do not use any inferior parts.

### Assembling the Ultradyne

The first job to be done is the panel drilling and the mounting of the phone jacks, "A" battery switch, the two 23-plate variable condensers, the potentiometer and the coupler and shield. Lay-out the baseboard next, placing each instrument in its proper position as shown in the photo of Fig. 3. The complete circuit diagram is shown in Fig. 4. Wire the instruments mounted on the panel first, then the instruments on the baseboard. Be sure and solder all connections and take your time about it to insure a good job. Be sparing with the soldering flux and use a hot iron. After both the panel and baseboard instruments have been wired, attach the baseboard to the panel and complete the wiring between the instruments on each.

Be sure and check all the connections when you have completed the wiring and as a final check up, test each soldered joint with the battery and headphones to insure perfect electrical contact. As a precaution, before operating the set, connect your "A" battery to the "B" battery binding posts and with one tube test each and every socket to be positive that there is no short between the "B" and "A" battery connection. If the tube lights in any one or all of the sockets, it is proof that the set has either been incorrectly wired, or the "B" battery wires are touching the "A" battery wires at some point.

After all instruments and connections have been tested, insert the tubes in the socket, connect up the "A," "B" and "C" batteries to the proper binding posts, plug in the loop aerial or attach the aerial and ground and with the phones or loud speaker plugged in pull the filament switch.

### Tuning In

The following is the correct procedure for tuning the Model L-2 Ultradyne: Turn the oscillator dial one degree at a time and for each setting of this dial turn the tuning dial slowly through its whole range. If nothing is heard at any setting, move the oscillator dial one degree more and repeat the process with the tuning dial. At some point one should hear a station, and it will be noticed that a slight hissing noise is heard when the station is transmitting, but no speaking or singing into the microphone. This slight hissing noise indicates the presence of a carrier wave and will help materially in tuning in the various broadcast stations. All this tuning should be done with the potentiometer adjusted to a point where no whistles are heard. If whistling noises are present, the potentiometer should be turned towards the positive side until the whistling stops, at which

point the amplifier operates at its maximum sensitiveness. When tuning in distant stations, it may be necessary to readjust the potentiometer slightly. This should be done only after the station is heard faintly but clearly enough to increase the amplification. When tuning in very weak signals, the feed back or regenerative coupler should be turned slowly until a point is reached where a whistle is heard, then move back just below this point. A slight readjustment of the two condensers will then bring the signal to maximum audibility. When tuning in another station, turn the feed back coupler to zero (coils at right angle) and turn first with the two condensers, as explained above, then adjust the coupler once the station is tuned in.

### Calibrating the Ultradyne

If the same antenna or loop is used at all times, the Ultradyne may be calibrated and a curve made giving the proper settings of the two condensers for any station. A somewhat similar procedure which will also prove useful is to keep a record of the two dial settings for each station heard. This permits the operator to tune any station which has already been heard by tuning the two condensers to the proper settings.

### In Conclusion

It should be pointed out that the regeneration feature incorporated in the new Model L-2 Ultradyne is a form of radio frequency amplification and consequently plays its most important part when you are receiving a long distance station. Its use does not increase the volume of the signals received from the local stations to any appreciable extent, this not being the object. Greater volume can always be obtained by the addition of audio frequency amplification, but it does increase the volume of stations at a distance, for the reasons that the weak signals are boosted in amplitude before they pass through the long wave radio frequency amplifier. Since the object of the regeneration feature is to make the Ultradyne more sensitive to weak signals, it should be evident that it will not only increase the volume of signals from distant stations that could not be heard on an Ultradyne without regeneration.

As has been said, no great difference will be noticed in the volume of local stations, but it is surprising what the regenerative feature does in connection with the reception of long distant stations. Probably the most advantageous point is that it insures reliable and consistent reception from stations that heretofore faded or swung badly, and this is exactly what is desirable in a receiving set.

With the addition of regeneration, it will be found that the second stage of audio frequency amplification is of real use only when receiving from very distant stations. All the volume desired is had with one state of audio frequency amplification when receiving local or semi-local stations. The second stage of audio frequency amplification, however, is quite desirable for long distance work and may be likened to a high powered car when under normal conditions, the surplus power is not used, but is there for use in case of emergency. It is always nice to know that you have it to use when you wish.

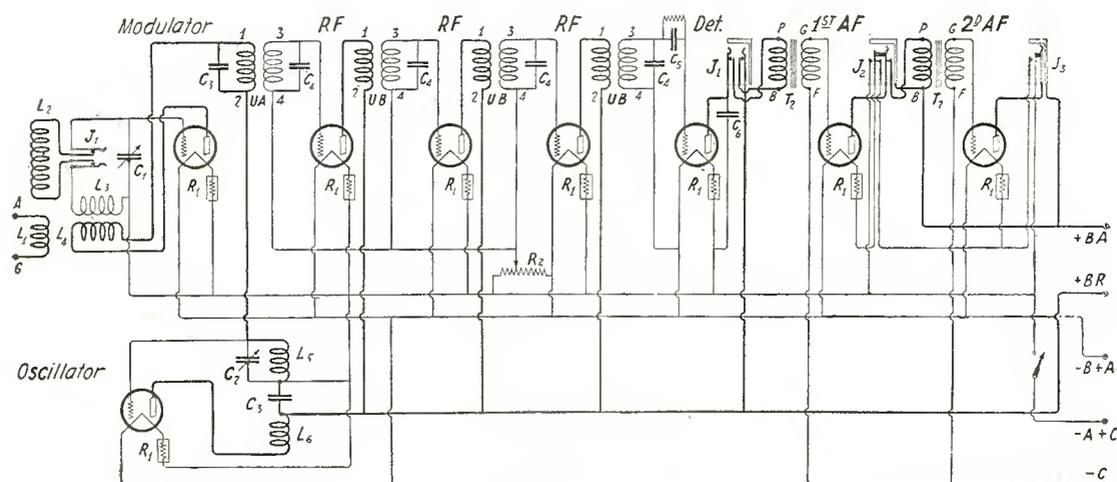

Pictorial Diagram of Receiver

# BEARCAT

THE WORLD'S GREATEST ONE TUBE RADIO SET

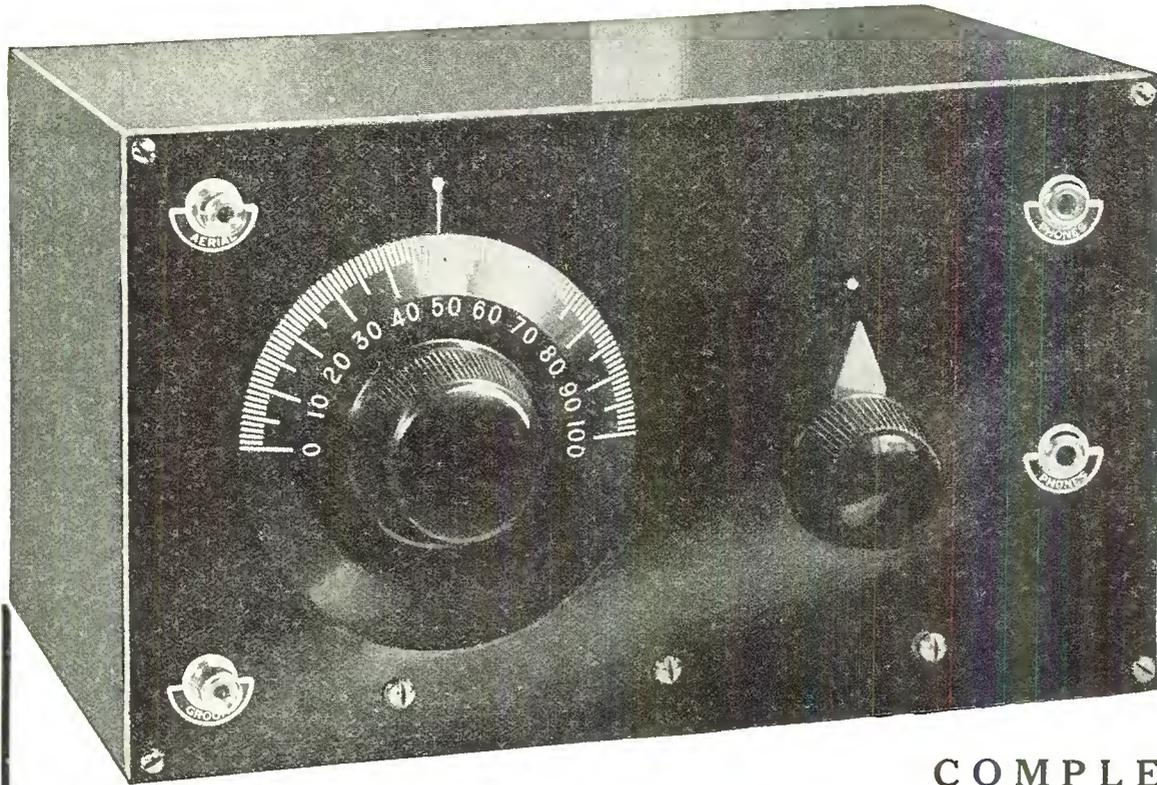

Long Distance

Super Selective

Pure Tone

Compact

Efficient

Bearcat Kit including cabinet, drilled panel, all parts, and clear, simple instructions for wiring and operating.

## Real Long Distance Reception

Sounds incredible but absolutely true as proven by many months of use by all kinds of critical people. Bearcat has given performance equal and superior to other sets costing two to ten times as much. It's a wonderful entertainer.

### Direct Sale from Factory to You Makes This Price Possible

If sold by usual methods Bearcat would cost you at least \$25.00. By selling direct we eliminate dealers' and distributors' profits and make only a very small production profit based on large volume. You get all these savings and furthermore we deliver Bearcat right to your door. Mail coupon.

#### BEARCAT Fans Received These Stations and Many More

- |      |                  |
|------|------------------|
| KDKA | Pittsburgh       |
| WHN  | New York         |
| KGO  | Oakland          |
| WGY  | Schenectady      |
| WHAZ | Troy, N. Y.      |
| WSB  | Atlanta, Ga.     |
| WLAG | Minneapolis      |
| WSAI | Cincinnati       |
| WHS  | Kansas City      |
| KFI  | Los Angeles      |
| KSD  | St. Louis        |
| WOWW | Omaha            |
| WMC  | Memphis          |
| WBAP | Ft. Worth        |
| WTAS | Elgin, Ill.      |
| WTAY | Oak Park, Ill.   |
| WCBD | Zion, Ill.       |
| WEBH | Post, Chicago    |
| WGN  | Tribune, Chicago |

#### World's Latest Most Amazing Discovery

"Truly Wonderful," say experts. BEARCAT gives distance and tone of expensive sets. Most selective set ever built, bar none. In Chicago, with five stations on BEARCAT brought in stations clearly 1,000 miles away. Outside of Chicago BEARCAT brings them in from all over. World's most efficient and lowest priced receiver.

#### All Batteries Fit Inside Cabinet

Complete—compact—convenient. The neatest, handiest little outfit you ever saw. Truly portable. Take BEARCAT with you anywhere. Operates on outside aerial or, for \$1.50, we furnish plug so you can use electric light circuit for aerial. Most economical set to operate.

#### Easiest Set to Use

One dial controls all tuning. Perfect reception on all wave lengths over great distances. Cuts out local stations and brings in DX. Non-regenerative. No squeals. The finest one-tube receiver ever designed—at the lowest price.

## COMPLETE KIT

**\$9<sup>98</sup>**

FROM FACTORY TO YOU

Bearcat Set completely assembled in cabinet, less accessories ..... \$12.98

Bearcat Set completely assembled with genuine 199 tube, all batteries, aerial, ground wire, insulators and fine set of head phones.... \$22.88

### SEND NO MONEY

Simply mark on coupon which set you want and mail it to us at once. Pay postman price, plus small postage, on delivery to you. Immediate shipment direct from factory. No waiting. No delay. Get this wonderful Radio now. Never before such value. Mark coupon now. Mail today.

#### COUPON

BEARCAT RADIO CO.

646 No. Michigan Ave., Dept. 33, Chicago, Ill.

( ) Send me Bearcat Set Kit, \$9.98.

( ) Send me Bearcat Kit assembled in Cabinet, \$12.98.

( ) Send me Bearcat Set complete with vacuum tube, phones, all batteries, aerial, ground wire insulators—all ready to operate, \$22.88.

I will pay postman correct amount plus small postage.

Name.....

Street.....

City.....

State.....

BEARCAT RADIO CO. 646 N. Michigan Ave. Dept. 33 Chicago, Ill.

# Wire Up in One Evening Your ALL-AMAX Set The ALL-AMERICAN Reflex



NO event of recent months has been as widely heralded as the appearance of the ALL-AMERICAN Reflex sets—embodying, as they do, two distinct advances in this type of reception; namely, *high selectivity* and *wide wave-length range*.

ALL-AMAX Senior approaches the 1925 *ideal* of radio reception, for it has, in addition, great sensitiveness with only two controls, and that faithfulness of tone reproduction which can always be relied upon where ALL-AMERICAN Audio Transformers are used.

You can buy ALL-AMAX Senior, completely mounted, ready to wire, as illustrated below, for \$42. Photographic wiring direction book, printed diagrams and a 48-page instruction book come with the set. Or you can build ALL-AMAX Senior yourself—but for perfect results be sure to have the genuine ALL-AMERICAN parts throughout.

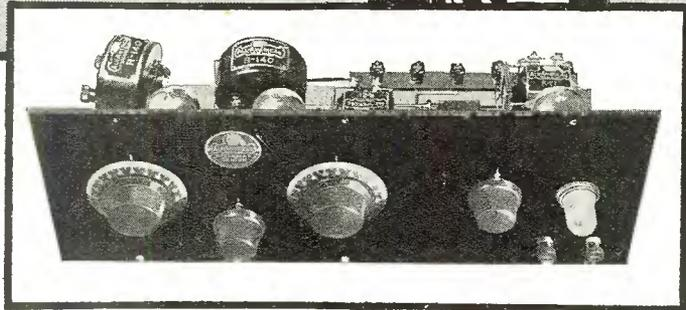

### Universal Coupler

Sharp tuning is here assured through the elimination of losses and accuracy of workmanship. Two are required in ALL-AMAX Senior.

Type R140 ..... \$4.00

### Self-Tuned Radio Frequency Transformer

For use with 201-A tubes only.  
Type R201-A ..... \$5.00  
(Or for 199 tubes use Type R199; the price is the same.)



### Audio Frequency Transformer

ALL-AMERICAN Standard Audios come in three ratios: 3:1, 5:1 and 10:1. Two 5:1 transformers are recommended in ALL-AMAX Senior. Type R21 ..... \$4.75

### Standard Base Tube Socket

Embodies at a moderate price all of the requirements for a trouble-proof socket. Contact is with the sides of the prongs. Short-circuiting is impossible. Fits UV-201-A, WD-12, UV-200 and similar tubes.

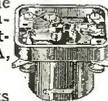

Type R25 ..... 75 cents

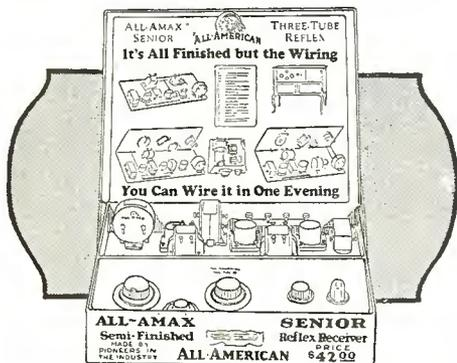

## ALL-AMAX JUNIOR



For those who prefer a single tube set requiring no storage battery, the same high quality and permanent dependability may be had in ALL-AMAX Junior. Fully mounted, with photographic wiring instructions, blue prints and 48-page instruction book, the price is \$22.

**SPECIAL OFFER:** For complete blueprint of either ALL-AMAX SENIOR or ALL-AMAX JUNIOR with 48-page instruction book, send 10 cents, coin or stamps, to All-American Radio Corporation, 2678 Coyne Street, Chicago, Ill.

# ALL-AMERICAN

## Largest Selling Transformers in the World

# How to Build the New Three-Tube Ultra-Selective Reflex

By A. ELKINS, Technical Editor

**T**HIS Receiver is the result of several years of study in our laboratory along the line of reflex hook-ups, which were undertaken in the belief that with proper development of suitable parts it would be possible to design a reflex set embodying to the fullest extent the theoretical advantages of the reflex principle, in such a way that these advantages would not be lost through various expedients frequently used for reducing the number of controls, stabilizing the tubes, etc.

That this expectation has been realized will be suggested by a mention of a few features of reception already accomplished with sets similar in every way to the one described here. No point in the United States is better adapted for a test of the selectivity of a radio receiver than Chicago. On a recent night, when one Chicago 500 watt station was broadcasting at 536 meters, another at 448 meters, another at 370 meters and another at 345 meters, a list of twenty stations outside the Chicago area were brought in on the loud speaker, including WBAP, Fort Worth, Texas; WBZ, Springfield, Mass.; WEAJ, New York City, and CNRW, Winnipeg, Canada. These distances are, of course, not remarkable for a set of this quality. The above example is quoted simply as a demonstration of the sharpness of tuning which can be attained. It has been found possible, when local interference was not so pronounced, to tune in at will all the well-known stations along both the Atlantic and Pacific coasts. Another experimenter in Chicago, using as antenna a short stretch of wire from a porch roof to a tree, brought in on the speaker, in rapid succession, KFI, Los Angeles; KGW, Seattle, and KGO, Oakland.

audio frequency amplifier. The chief advances in the reflex art have indeed been along the lines of refinements in the parts utilized.

In the set here described, the electrical impulses, set up in the antenna by a passing wave, flow through the primary winding of the coupler to ground. In so doing, however, a field is set up which links with a carefully designed secondary winding, and, if tuned to the frequency of the incoming waves, sets up a voltage across its terminals. A variable condenser forms the means of tuning the coupler, with a high selectivity due to the design of the coupler windings, in which losses have been reduced

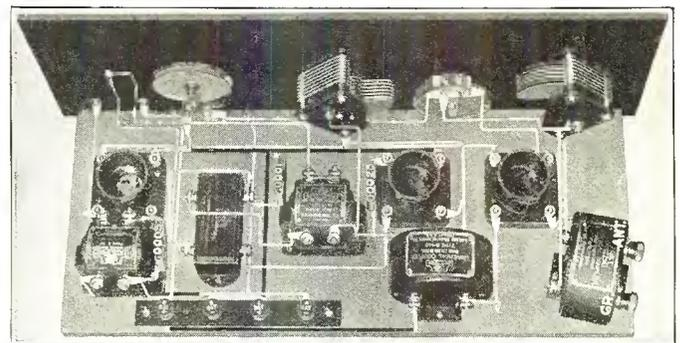

*This photograph of the completed set shows almost every wire clearly, and will give you a good idea of how the set should look. It is important in reflex work to have all wires correctly placed, as well as correctly connected*

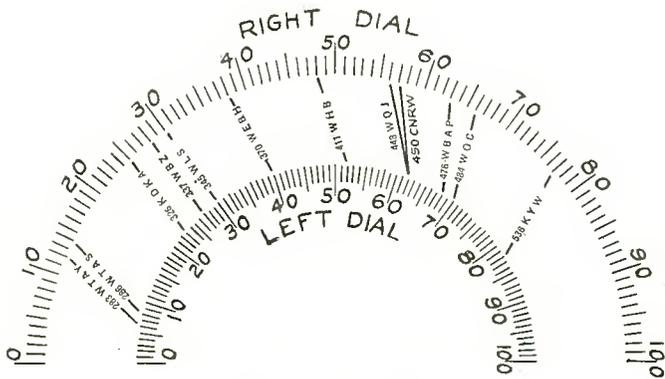

*Stations logged on one night, all on loud-speaker, by one Chicago listener. Note that, although several Chicago stations were operating, considerable distances were reached*

Results of this character are expected nowadays from a good eight-tube heterodyne and from certain of the more highly developed five and six-tube radio frequency outfits. For a three-tube set, which can be built at a cost of around \$40, we believe they set a new standard of efficiency.

In order to make this hook-up available to the largest possible number of persons, it has been set forth in the photographs here given, so that the wiring can be done by anyone, whether he has any knowledge of electricity or not. There are thirty-one wiring operations necessary, and each one is clearly shown on one of the three progressive wiring photographs.

Many readers will be interested in a short explanation of the reflex principle; those who are not may skip the explanation and proceed directly to the following section, headed "Choosing and Assembling the Parts."

## The Reflex Principle and How It Works

It has been known for many years that the same vacuum tube could be used simultaneously as a radio frequency and as an

to a minimum compatible with rugged construction, and to the unique arrangement of the windings, such that the coupling between them is almost entirely magnetic, with capacity effects a minimum.

The voltage thus set up is amplified by a "201-A" vacuum tube, at radio frequencies—that is, without being detected or rectified—and passed on to a tuned radio frequency transformer.

It is then further amplified in the second tube, coupled with a special self-tuned radio frequency transformer, which, being especially designed for a "201-A" tube, provides effective amplification over the entire range of broadcast wave lengths. The amplified radio frequency voltage at the secondary terminals of the self-tuned transformer must now be changed to an audible frequency or "detected" before it can be heard.

The rectification is performed by a crystal detector, producing an audio current. This is reflexed to the first audio frequency transformer, which in turn impresses an amplified audio voltage on the grid of the second tube. The output is then passed, through a second audio transformer, to the grid of the third tube.

Thus three vacuum tubes are made to function as a two-stage radio frequency amplifier and as a two-stage audio frequency amplifier, giving a powerful signal in the phones or loudspeaker.

The qualities of the set are due in general to the following features: the use of a high grade low-loss coupler in the antenna circuit and in the tuned stage is chiefly responsible for the sharp tuning. The necessity for a third main control in order to cover the broadcast range is avoided through the use of the self-tuned radio frequency transformer—a recent type of instrument which has an unusually broad and flat resonance curve. Clearness of tone and faithfulness of reproduction are secured through a crystal detector, and through the use of high grade audio transformers with the proper fixed condensers to bypass radio frequency currents.

## Choosing and Assembling the Parts

Parts required for building are as follows:

One panel 7x18 inches.  
 One base board 7x17 inches.  
 Two low-loss variable condensers .00025 mid.  
 One rheostat 30 Ohms (R1 in photos).  
 One rheostat 6 Ohms (R2 in photos).  
 One crystal detector.  
 Two universal radio frequency couplers (T1 and T2).  
 One self-tuned radio frequency transformer (T3).  
 Two audio frequency transformers, ratio 5-1.  
 Three standard base tube sockets.  
 One .0001 fixed condensers.  
 One .00025 fixed condenser.  
 One .0005 fixed condenser.  
 Four battery binding posts on a small panel strip.  
 Two phone binding posts, or one single-circuit jack, as preferred.  
 Bus wire, about 20 feet.

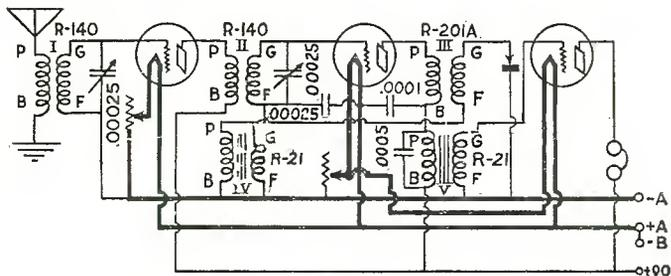

Schematic diagram of the Selective Reflex set. The five couplers and transformers are designated by Roman numerals corresponding to T numbers on photographs. There is a tuned r.f. stage, a reflex stage, and a straight audio stage

Accessories required with the set are as follows:

- 3 Vacuum Tubes—UV-201-A or C-301-A.
- 2 45-volt "B" Batteries.
- 1 6-volt "A" Battery (storage battery).
- Wire for antenna and ground connections and insulators.
- Headphones, 1 or more pairs. (Optional).
- Loudspeaker.

The parts above listed are all factory made. The set builder who has an aptitude for winding his own coils can, if he prefers, employ his own workmanship on the two radio frequency couplers. For each of these instruments he should have a short section of pasteboard tube  $2\frac{3}{4}$  inches diameter, and should wind upon it about 60 turns of No. 26 D.S.C. wire for the secondary winding. The primary of the coupler should be made by winding 18 turns of No. 32 D.S.C. wire on a smaller piece of tube to fit inside the secondary. The usual precautions in the way of avoiding shellac and other high loss insulating materials must be rigidly employed, if selectivity is to be preserved, and some experimenting will be necessary in every case to determine exactly the proper number of turns, since hand methods of winding involve so much variation in dimensions that no exact specification can be relied upon. It may be said in general that modern methods of coil winding in the better factories have progressed to such a point that even with simple radio frequency coils the amateur builder must not expect from his own coils results equal to those of the product of a reliable factory.

Rheostats, condensers and audio transformers must be of the very highest quality for the best results. Tube sockets should be of a simple non-metallic type; avoid the old-fashioned sockets which rely on the locating pin of the tube to hold all four contact springs against the prongs on the tube base.

The crystal detector should preferably be one designed to be reasonably permanent in its adjustment. With any crystal detector, however, we find it advisable for best results to test the contact at intervals.

#### How To Wire the Set

When the parts are all mounted, simply follow this wiring order:

Wires shown on photo A.

- 1 + on V3 to + on V2 to + on V1.

- 2 B + on T3 to P on T5.
- 3 B BAT — to A BAT + to Wire 1 (Insulate with tubing).
- 4 Attach .0001 condenser from B + on T3 to Wire 1.
- 5 B + on T4 to F — on T4 (Solder lugs—no wires used here).

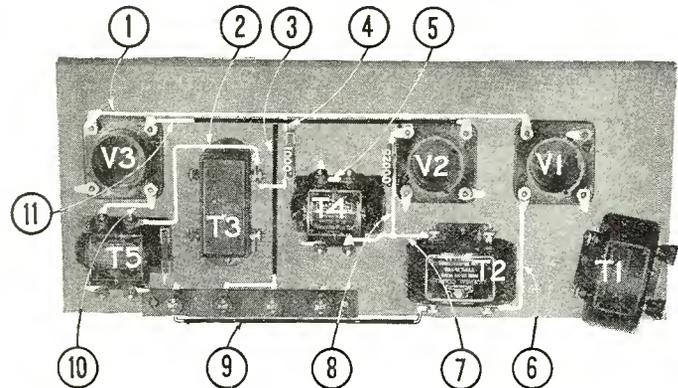

Photo A shows the wiring to be done on the baseboard before the panel is mounted. All wires are numbered right around the picture, in the best order for connecting them

- 6 P on V1 to P on T2.
- 7 F on T2 to G on T4.
- 8 Attach .00025 condenser from + on V2 to wire 7.
- 9 B + on T2 to B BAT + (Insulate with tubing).
- 10 G on T5 to G on V3.
- 11 on — V2 to — on V3 (Insulate with tubing except  $1\frac{1}{4}$  inches at left end).

Now attach panel to baseboard with three wood screws.  
 Wires shown, on photo B:

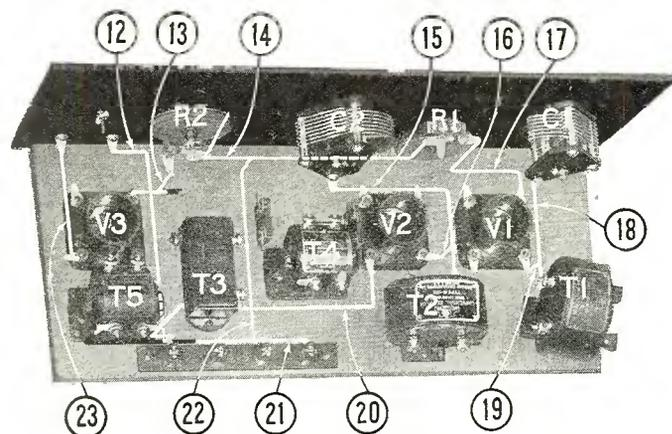

Photo B shows the next twelve wires to be put on; those already shown on Fig. A are not shown again, in order to simplify the picture

- 12 Right phone post to B BAT + to B + on T5, and leave 1 inch projecting end beyond B + on T5.
  - 13 Arm on R2 to Wire 11.
  - 14 Frame on R1 to frame on R2 and leave 2-inch end projecting upward at R2.
  - 15 G on T2 to stationary plates on C2.
  - 16 G on V2 to wire 15.
  - 17 Arm on R1 to — on V1.
  - 18 Stationary plates on C1 to G on T1, leaving a little slack for rotating adjustment of T1.
  - 19 G on V1 to Wire 18.
  - 20 P on V2 to P on T3.
  - 21 A BAT — to F — on T5 (Insulate left half with tubing).
  - 22 Wire 21 to Wire 14.
  - 23 P on V3 to left phone post.
- Wires shown on photo C:
- 24 B + on T4 to mineral mounting cup terminal of crystal detector.
  - 25 Attach projecting end of Wire 14 to Wire 24 and cut off any excess length.
  - 26 Rotating plates on C2 to Wire 7.

- 27 Rotating plates on C1 to frame on R1.
- 28 F on T1 to rotating plates on C1, leaving a little slack as on Wire 18.
- 29 F on T3 to P on T4.
- 30 "Catwhisker" terminal of crystal detector to G on T3.
- 31 Attach .0005 condenser from P on T5 to end of Wire 12 projecting at B + on T5.

It has been our experience that no form of solderless connection so far brought out is to be regarded as *permanent*, in the same sense as a well-soldered joint. Moreover, when right methods are used, soldering is not only the most perfect, but by far the *easiest*, method now known for connecting wires together electrically.

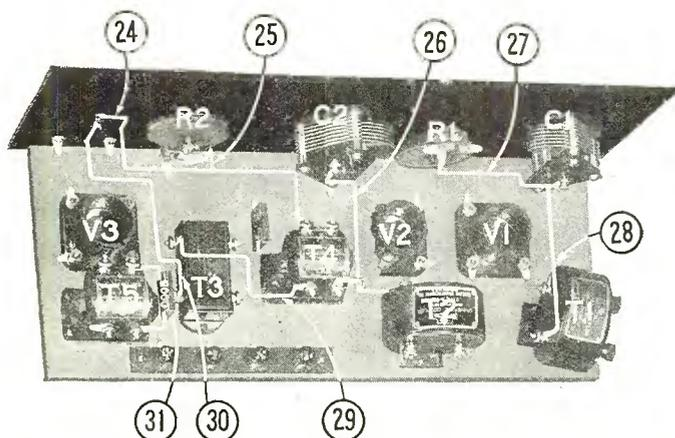

Photo C shows the eight wiring operations necessary to complete the set. Be sure that your fixed condensers are placed so that the capacity markings on them can be seen and checked for correctness

Wires should be soldered only to each other or to tinned terminals. Never solder a wire to the end of a binding post itself, and *never* rely upon a connection made by fastening stiff wire to a binding post without any terminal. We suggest that each wire be *penciled in with a colored lead* in the photograph after it has been put in place in the set.

**How to Install the Set**

An antenna about 50 ft. high and 50 to 75 ft. long is recommended. The lead-in wire from the antenna should be kept as far from the wall as possible; this will add to the sensitiveness of any radio set.

Where an outdoor aerial cannot be had, one can get splendid results with a length of insulated wire run around the room behind the picture moulding.

Before connecting the batteries permanently, the 6-volt storage battery should be connected across the posts marked B BAT, and both rheostats turned on. The tubes should be observed closely to see if they light. *If not*, then it is safe to connect the regular 90 volt "B" battery to these terminals, and the 6-volt battery to the posts marked "A Bat." Care should be taken in both cases that the + post is connected to the *positive* terminal of the battery.

**Operating the Set**

The first attempt to "tune in" should be made at a time when you are sure that some station is radiocasting within easy receiving range of the set.

The easiest and surest way to tune this receiver is to follow these directions exactly:

1. See that good contact is being made on the crystal detector.
2. Turn up both rheostats about half way.
3. Turn both dials slowly in unison—that is, turn both in the same direction and always keep them reading nearly alike. Listen carefully in the head phones and, when a signal is heard, turn each dial separately to exactly the point where the signal is loudest.
4. Adjust the two rheostats for loudest and clearest position for the signal being heard.
5. Adjust the contact on the crystal detector until you are sure it is on a point of maximum sensitiveness.

6. Turn the rheostats down, if necessary, to give the clearest possible tone.

When the set is thus gotten into good working order, other stations may be tuned in by again rotating the two condenser dials, approximately in unison.

A very great increase in selectivity can be obtained by rotating the antenna coupler T1 to exactly the proper angle to eliminate coupling with the tuned radio frequency transformer T2. A correct adjustment cannot be obtained with accuracy until the set is fully wired, when the following process should be carefully carried out:

First, tune in some near-by station to maximum signal strength. Then, listening in the head phones, turn off entirely the first rheostat R1. The signal will probably continue to be heard, owing to coupling between the two universal couplers. To eliminate this, rotate the first coupler slightly. When a position is finally found where no signal is heard, fasten the first coupler permanently in this position and do not again disturb it.

To get the most out of your set, learn to control properly the temperature of the tubes by adjusting both rheostats, with great care, for best volume, sensitiveness, and selectivity, and for perfect clearness of tone. Always try interchanging your tubes in all possible combinations, for there is great variation between the electrical constants of different tubes, even of the best makes.

The value of the fixed condenser which should be connected across the primary of the last audio transformer, T5, depends on the tube. The condenser specified above—.0005 mfd.—will give the best results with most average tubes. If you happen to have a better tube than the average you may do better with a .00025

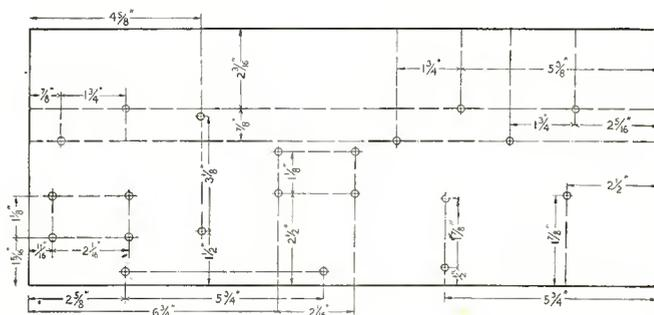
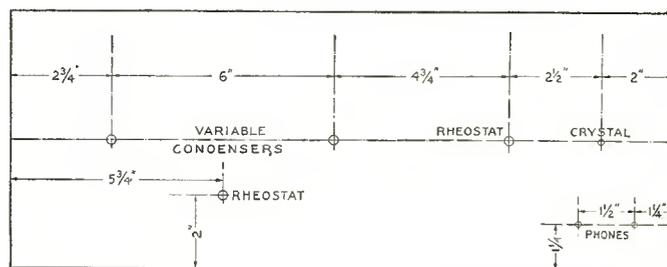

The panel and baseboard layouts are here seen, with the same edges at top and bottom, as in the photographs. Size of holes will vary, depending on instruments, etc.; be sure the instruments are in the same general position as in the photographs

here. If, on the other hand, you find that it is impossible after interchanging the three tubes in all possible positions, to adjust rheostat R2 so that beatnotes or "birdies" are heard when tuning, then the .0005 condenser is probably not of high enough capacity for the tubes and an .001 should be used.

The dial drawing shows approximately a log by one experimenter at Chicago. It must not of course be taken as applying to your own set since the values will vary somewhat with different antennas and different local conditions. However, if good parts have been used and wiring has been done as here described, this receiver will be found remarkably constant in its dial settings.

The author will be very glad to hear from builders, and will be especially glad to receive records of stations logged, and of any departure from the wiring diagrams which advance experimenters may find to give interesting results.

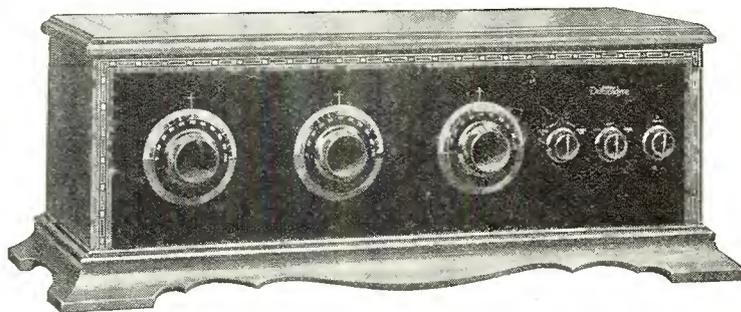

# Features of Deresnadyne Performance—

## *the Paddlewheel Inductance*

Patents Pending

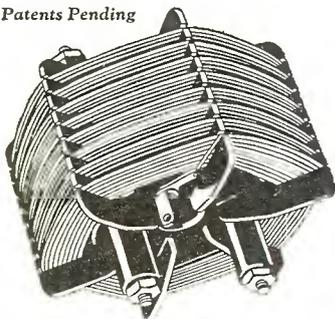

### *The Andrews Paddlewheel Inductance*

The Andrews Paddlewheel Inductance is a radically new type of coil. It has a remarkably high ratio of inductance to resistance—the measure of coil efficiency. The small amount and placing of the insulating material by the unique paddlewheel construction has reduced absorption losses to a minimum. The compact spiral winding makes possible the use of large wire, without increasing distributed capacity, thus lowering resistance. The wire is held in place by slots, and each group of turns is space insulated from the rest, eliminating inefficient lacquer and insuring a moist-proof coil. The Andrews Paddlewheel Inductance effects a marked increase in both signal strength and selectivity.

Deresnadyne performance in the hands of its users during the past season has been a revelation. The Deresnadyne is selective. In the largest cities, no matter how many local stations are going, the Deresnadyne tunes them all out to bring in outside stations with amazing clarity and strength. During International week Deresnadyne Owners did not merely “get” Europe. They heard full programs, including the call letters of European stations, clearly and distinctly over the loud speaker.

The reasons for Deresnadyne performance lie in the basic merit of the Deresnadyne principle, which marks a new stage in radio development, and in the design and quality of the apparatus. For example, there's the exclusive Paddlewheel Inductance.

Buy a Deresnadyne at your dealer's today. If he cannot supply you, write to us. *New De Luxe model, \$165, without accessories.*

*Andrews*  
**Deresnadyne**  
DĒ-RĒS-NĀ-DĪNE · PATENTS PENDING  
*Radio Receiving Set*

ANDREWS RADIO COMPANY, 327 S. LA SALLE STREET, CHICAGO

# A Tuned Radio Frequency Receiver With Deresonated Plate Circuit

## Part I—Theory and Paddlewheel Inductances

By ARTHUR ELKINS

**T**HE fundamental reason for self oscillation is just as much the amount of voltage across the plate circuit as it is the capacity between the plate and grid of the tube. The neutrodyne prevents it by counteracting the effect of the tube capacity. The Deresnadyne principle prevents it by allowing only the amount of energy to be generated in the plate circuit which can be used for undistorted amplification. Instead of building up more energy than can be used in the plate circuit and using the excess to stop oscillation, the Deresnadyne principle prevents this excess energy from ever being generated. Amplification is fully as great and oscillation is thus stopped at its source, in the simplest and most effective way. This result is accomplished by detuning, or deresonating, the plate circuit. The number of turns in the radio frequency transformers are reduced to such a point that maximum signal strength is obtained

without oscillation. In this condition, the plate circuit is not resonant to the signal being received and to which the grid circuit is tuned.

Due to the increased tendency to oscillate at lower wave lengths, it is necessary to provide some means to prevent the voltage across the plate circuit from increasing as the set is tuned to receive the lower wave length station. There are several ways by which this can be accomplished. One of these is the use of the plate balance control to lower the plate voltage of the radio frequency tubes as lower wave length stations are tuned in. This method will be described later on. Although these methods are the subject of several patent applications their free use by the home builder is encouraged.

The special resistance, variable from zero to 200,000 ohms, must be of the non-inductive type. A wire-wound type of this high value would not only be impractical but would have an inductance value that would affect tuning. The special switch not only acts as a battery switch, but also connects the loud speaker for one or two stages of audio frequency amplification as desired. If desired, the regular jack system and a battery switch can be substituted. No provision is made for plugging in headphones as they are unnecessary, all tuning in can be done with the loud speaker.

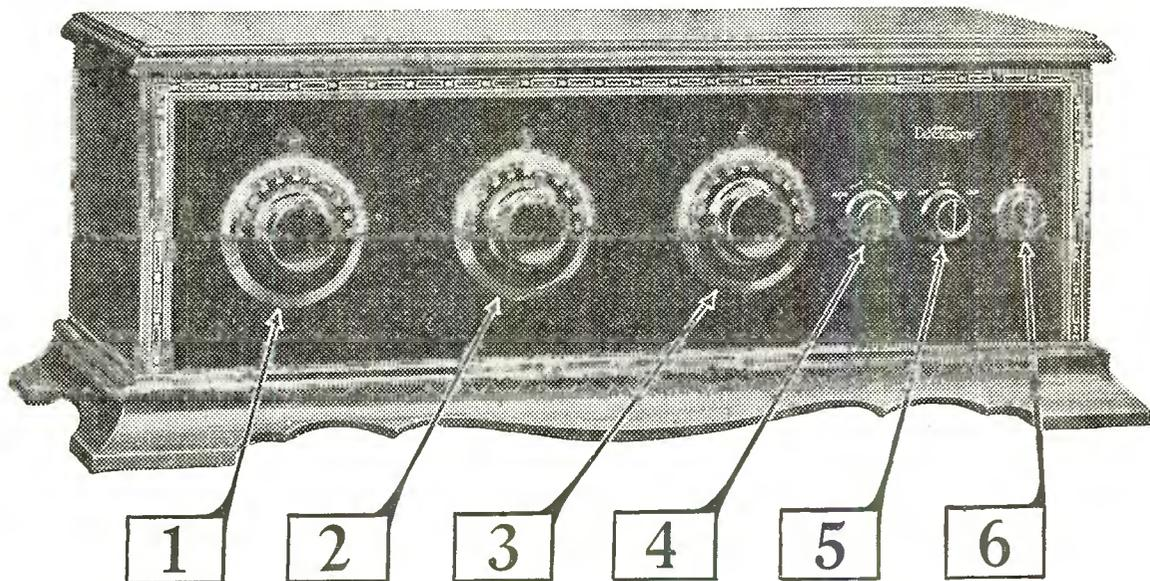

Fig. 8

The efficiency of the circuit as a whole depends to a very great extent upon the efficiency of the coupling coils used in the stages of tuned radio frequency amplification. Low loss condenser arguments are often absurd when the efficiency of inductance units are considered. This inductance is a radically new type of real low-loss inductance. In measuring coil efficiency, the highest possible ratio of inductance to resistance is essential. In a coil of this type the insulating material supporting the coil winding is so placed that absorption losses are almost eliminated. The high inductance value is proven by the fact that .00025 mfd variable condensers are used for tuning over the entire wavelength range. Figure 2 shows the Andrews Paddlewheel Inductance as used in the

### The Paddlewheel Inductances

get the kind where the springs make good positive contact with the prongs on the base of the tubes. Poor contact between spring and prong, especially in the two radio frequency stages, will make more trouble than can be imagined.

The special resistance, variable from zero to 200,000 ohms, must be of the non-inductive type. A wire-wound type of this high value would not only be impractical but would have an inductance value that would affect tuning. The special switch not only acts as a battery switch, but also connects the loud speaker for one or two stages of audio frequency amplification as desired. If desired, the regular jack system and a battery switch can be substituted. No provision is made for plugging in headphones as they are unnecessary, all tuning in can be done with the loud speaker.

The special switch not only acts as a battery switch, but also connects the loud speaker for one or two stages of audio frequency amplification as desired. If desired, the regular jack system and a battery switch can be substituted. No provision is made for plugging in headphones as they are unnecessary, all tuning in can be done with the loud speaker.

### List of Parts

- 1—Panel, 3/16 x 7 x 26.
  - 1—Battery Post Strip, 3/16 x 1 1/4 x 8.
  - 1—Ant & Gnd Post Strip, 3/16 x 1 1/4 x 2 1/2.
  - 1—Selector Jack Strip, 3/16 x 1 1/4 x 2 3/4.
  - 1—Baseboard, 1/2 x 9 x 25 3/4.
  - 3—pcs Metal Shielding, 1/32 x 3 1/4 x 5 3/4.
  - 12—Metal Spacer Tubes, 1/8 I. D. x 1/4 O. D. x 1 3/4.
  - 6—Midget Jacks.
  - 2—Midget Plugs.
  - 9—Binding Posts.
- J-1, 2, 3, 4  
P-1, 2

- L-1, 2, 3 1—Set 3 Paddlewheel Inductances.
- C-1, 2, 3 3—Variable Condensers, .00025 mfd.
- V-1, 2, 3, 4, 5 5—Standard Tube Sockets.
- C-4 1—Grid Condenser with clips .00025 mfd.
- C-5, 6 2—Fixed Condensers .5 mfd.
- C-7 1—Fixed Condenser .001 mfd.
- R-1 1—Rheostat, 6 ohm.
- R-2 1—Variable Resistance, 0 to 200,000 ohms.
- R-3 1—Fixed Grid Leak, 5 megohms.
- SP. SW. 1—Stage Control Switch.
- AT-1, 2 2—Audio Frequency Transformers, low ratio.
- 3—Dials, 4 inch.
- 1—Cabinet, to fit.
- Miscellaneous Wire, Terminals, Screws, etc.

**The Stage Control Switch**

The stage control switch presents some interesting features. The illustrations, figures 3, 4 and 5, show the OFF, SOFT and LOUD positions. In the OFF position, the A Battery connection is open. In turning the knob to the SOFT position, the A battery connection is closed and the loud speaker is connected to the plate of tube V-4. When the knob is turned to the LOUD position, the plate of tube V-4 is connected to the plate terminal of audio transformer AT-2 and the loud speaker is already in the plate circuit of tube V-5. In the SOFT position, one stage of audio amplification is used, while the LOUD covers both stages.

**The Panel Lay-out**

The use of a seven by twenty-six inch panel permits satisfactory spacing of the three variable condensers and the paddlewheel coils so as to avoid coupling in the radio frequency stages. Trying to save a few inches of panel stock and crowding the apparatus close together will soon convince the constructor of his foolishness when he starts operating the set. Compactness may be desirable but not at a sacrifice of quality and efficiency.

All told there are only six units that mount on the panel. The three variable condensers are kept to the left as shown in figure 6. The next knob is the variable resistance, then comes the stage control switch and last the rheostat, which controls the lighting of all five tubes.

**Plate Balance Control**

Little has been said about the variable resistance called the plate balance control. In order to secure maximum efficiency at high wavelengths, the Paddlewheel Inductances have their primary turns so proportioned as to give maximum amplification without oscillation. A variable resistance is connected in series between the plate coils and the B battery terminal to prevent oscillation at the lower wavelengths. Across this connection to the negative filament ter-

minial is a by-pass condenser. This condenser closes the plate circuit to the filament of the tube. The voltage of the B battery determines the energy in the plate circuit. This by-pass condenser prevents any radio frequency currents from flowing through the resistance—hence the resistance does not broaden the tuning.

This variable resistance provides a means of reducing this voltage

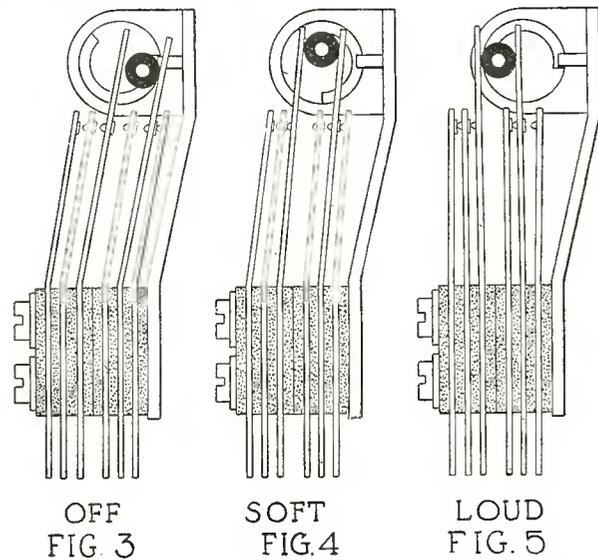

and thus the plate circuit energy. At high wavelength, with the knob turned to the right, the deresonance of the plate coil stabilizes the circuit. When turned to the right the resistance is zero. As the tuning approaches the lower wavelengths, and gets closer to the natural resonance point of the plate circuit, the set approaches the oscillation point. Now, by turning the knob to the left, resistance is inserted between the plate and the battery, thus lowering not only the voltage, but also the plate energy and thus preventing self oscillation. By keeping just below this oscillating point, the maximum radio frequency relay amplification is obtained with wonderful clarity of tone. It likewise acts as a volume control.

It seems to be a simple matter for the average fan to assemble the apparatus on the front panel, but for some reason or other the rear of a lot of sets looks like a cross-word puzzle. Perhaps the inside is not visible for guests' criticism, but don't overlook the fact that in nine cases out of ten it's the rear of the panel that is the cause of unsatisfactory operation. Figure 7 gives a clear illustration of the best arrangement of apparatus on the baseboard and at the same time indicates the logical arrangement of wiring to conform

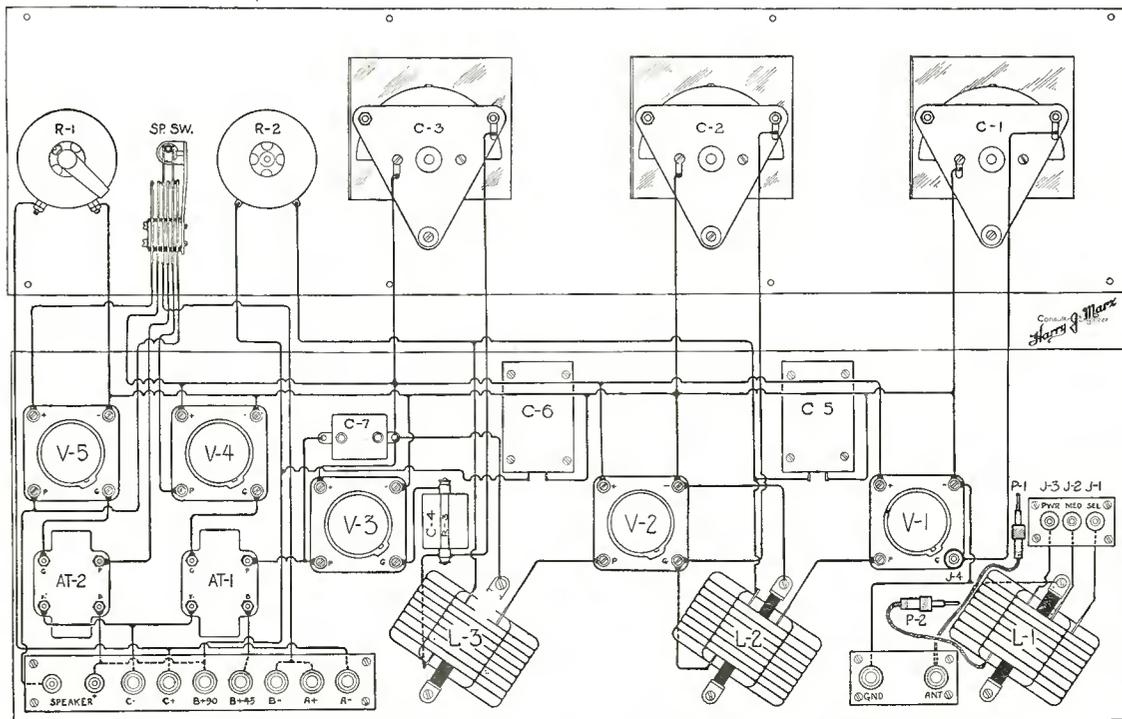

Fig. 7

to the hook-up diagram, figure 1. There is ample room on the baseboard, so no fears need be entertained regarding the accessibility of the various units for soldering the leads.

**The Selector Jack Strip**

This strip carries the three midget jacks J-1, 2 and 3. When the midget plug P-1, connected by a flexible lead to the antenna post, is plugged into J-1, maximum selectivity is obtained. This need only be done when interference is bad, such as may be encountered in very large cities. J-2 gives a little less selectivity for interference conditions but increases the volume, whereas when interference is negligible, then J-3 will give most volume.

**Battery Post Strip**

This strip not only carries the battery binding posts but also two more midget jacks, not marked, for loud speaker connections. This facilitates the connections and eliminates the necessity of jacks on the panel with plugs and wiring running all over the front of the set. Seven of the binding posts specified in the list of parts are used for these battery connections, while the other two are used on the antenna and ground post strip.

All three strips are mounted one and three-quarters inches above the baseboard by means of the twelve spacer tubes specified in the list of parts.

**Using a Loop Aerial**

The additional jack is mounted on the grid terminal of the tube socket V-1, making electrical connection with it. When using an outdoor aerial, the midget plug P-2, which is connected by a flexible lead to the grid terminal of the paddlewheel inductance L-1, is plugged into this midget grid jack J-4. When a loop is used, connections are made directly to the antenna and ground binding posts, but plug P-2 is taken from jack J-4 and left disconnected, while the plug P-1 is inserted in jack J-4 instead. This takes the coil L-1 from the grid circuit and directly connects the one side of the loop to the grid. The other end of the loop, on the ground post, connects to the negative filament but inside of the rheostat R-1.

**Accessories Required**

When the set is completed the following accessories will be required for operation of the set:

- Loud Speaker.
- Five Vacuum Tubes.

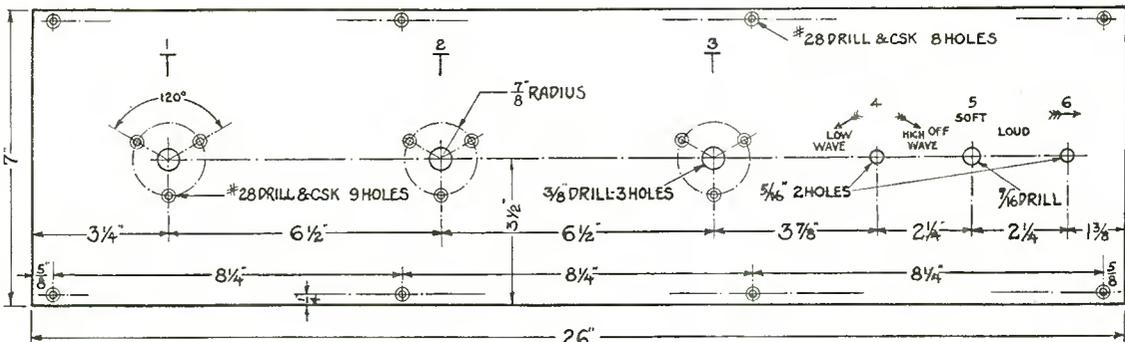

Fig. 6

- Six Volts Storage Battery.
- Ninety Volts "B" Battery.
- Antenna and Ground System.
- Necessary Wire for Connections.

The tubes should be all of the A type, but be sure you are using good ones. Poor tubes will ruin the best set. A detector tube of the UV-200 or C-300 type is not recommended.

The storage battery should be of a good reliable type with about 80 ampere-hour capacity, in order to avoid frequent recharging. It would be advisable to buy a good charger for this purpose. The use of dry cells is possible but will not be found economical.

The "B" battery can consist of four 22½ volt units or two 45 volt units. The heavy duty type are recommended for greater economy in the long run. Storage "B" batteries will also be found very satisfactory, but good ones must be purchased.

**Tuning the Set**

Before trying to operate the set, it will be well to carefully read over the following points on tuning the set.

1—Turn the stage control switch knob 5 to the LOUD position, if during the tuning the volume is too loud, it can be shifted to the SOFT position. When in the LOUD position the rheostat knob 6 will have to be advanced more as one more tube is connected in the filament circuit.

2—This rheostat knob should be turned to about a horizontal position pointing to the right. With knob 5 in the LOUD position all five tubes should light, but in the SOFT position only the first four will be lit. Don't turn knob 6 any further than necessary. Why use more battery current than is necessary to operate the set? In addition economical operation will also increase the life of the tubes.

3—The plate balance knob 4 should be retarded (turned to the left) for low wavelengths, near the zero end of the large dials and advanced to the right for high wavelengths near the 100 end of the large dials. This is indicated by the arrow arrangement shown in the panel layout figure 6. Advancing this knob 4 increases the strength of reception, and retarding it clears up reception and eliminates undesired noises.

4—To locate stations, turn dials 1, 2 and 3, slowly, keeping approximately the same number on each dial in line with the indicator line on the panel. This can be done by setting dials 2 and 3, say at 60, then turning dial 1 slowly from 55 to 65. If no station is heard set dials 2 and 3 at 57 and repeat the operation with dial 1, going

set dials 2 and 3 at 57 and repeat the operation with dial 1, going from five points below the setting to five points above. This is done because different antennas slightly affect the setting of dial 1. Proceed with this operation until a station is heard, but don't forget the relative position of knob 4 on different wavelengths.

5—After a station is heard, carefully adjust each of the three dials for best position.

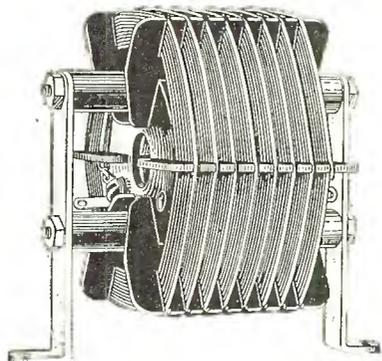

Fig. 2

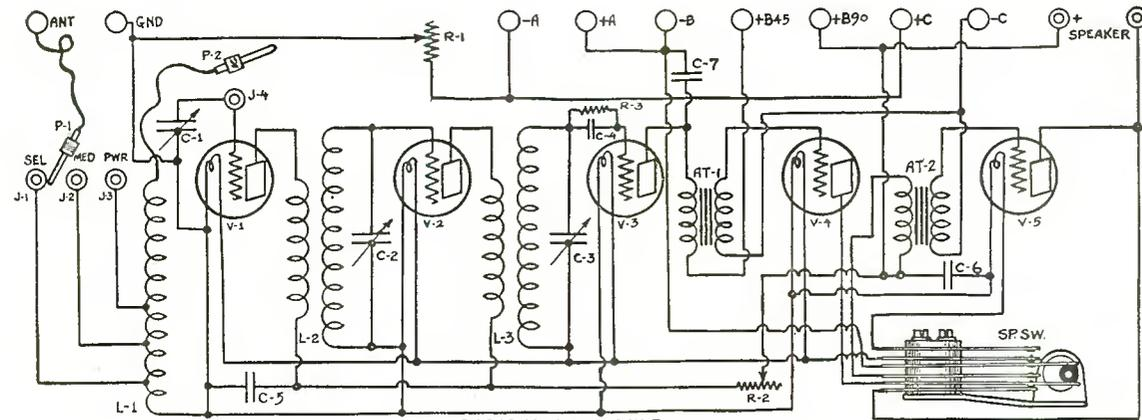

Fig. 1

# BRANSTON RADIO

Reg. U. S. Pat. Off.



Add Miles and Smiles with Branston Standard Radio Parts

## It's Surprisingly Easy to Build a Super Heterodyne Using Branston's Super Kit No. R-199

A reflexed Super Heterodyne in which seven tubes do the work of ten. Blue prints and directions are so thorough and easy to follow that any amateur can easily make a receiving set that is the equal of "manufactured sets" costing twice as much. Many sets have been made with these kits that have coast-to-coast range, micrometer selectivity, "local" volume on all stations, and unsurpassed tonal quality. You can do the same in just a few hours' pleasurable "work."

The Branston Transformers contained in Kit No. R-199 were designed through years of diligent research. They are remarkable instruments and function properly as those of each set are perfectly matched and each is given an operation test.

Blue prints and complete layouts covering Super Heterodyne, Radio Frequency and Honeycomb Coil circuits, also complete catalog of Branston Quality Radio Products sent for 25c in coin or stamps. Take this first step today.

Your dealer has Branston Kits or can get them for you (if not, write us)

### BRANSTON'S ACCESSORY KIT No. R-199-A

Contains Only Highest Grade Tested Parts  
Saves Time and Insures Success

**\$50.00**

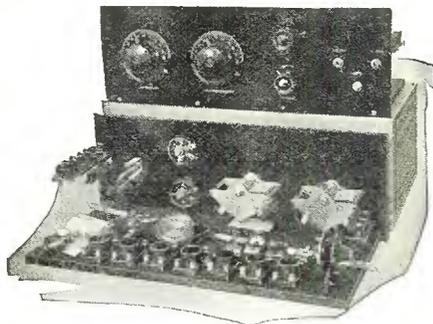

Partially Assembled, as Shown in Illustration  
Ready for Wiring

- |   |  |
|---|--|
| 1 7x21 Drilled and Engraved Panel             | 1 3 Plate Vernier Condenser and Mountings  |
| 2 23 Plate Straight Line Low Loss Condensers  | 2 .001 Tested Fixed Condensers   |
| 1 60 Ohm Rheostat                             | 2 .005 Tested Fixed Condensers   |
| 1 25 Ohm Rheostat                             | 1 .0001 Tested Fixed Condenser   |
| 1 Battery Switch                              | 1 .00025 Tested Fixed Condenser  |
| 1 Single Circuit Jack                         | 2 Grid Leak Mountings  |
| 1 Two Circuit Jack                            | 1 Variable Grid Leak   |
| 2 Branston Cam-Vernier Dials                  | 1 Fixed Grid Leak  |
| 2 Sub Panels and Ten Binding Posts, assembled | Sufficient square bus bar, spaghetti, nuts, screws, terminals and rosin core solder to complete wiring of set. |
| 1 Baseboard 20"x9 1/2"                        |  |
| 7 Sockets                                     |  |

Always state whether you intend using  
UV-199 or UV-201-A tubes

### BRANSTON'S TRANSFORMER KIT No. R-199

Eight  
Matched  
Trans-  
formers



**\$35.00**

Branston Super Transformers, Kit No. R-199 contains three-stage long wave R. F. Transformer No. R-200, Twin A. F. Transformers No. R-204, Long Wave Tuned R. F. Transformers No. R-201, Special Tuned Coupling Transformer No. R-203, Short Wave R. F. Transformer No. R-202.

Always state whether you intend using  
UV-199 or UV-201-A tubes

# BRANSTON RADIO

Reg. U. S. Pat. Off.

## Branston's Regenerative Loop No. R-210

An extremely efficient loop antenna especially designed to increase volume and selectivity. Regeneration is obtained by a double winding. It is especially efficient with Super Heterodyne Receivers.

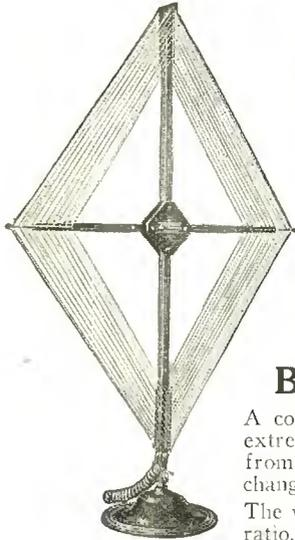

No. R-210

Branston Regenerative Loop.....\$13.50

### Specifications

**Size:** 38" high, 23" wide over all, including base.  
**Cross-Pieces:** Made of selected hard wood with bakelite winding supports.  
**Wire:** Special insulated stranded cordage made of 60 strands of No. 36 hard drawn copper wire and seven strands of phosphor bronze wire.  
**Base:** An extremely attractive base of sufficient size and weight, making it almost

impossible to upset the loop. Black crystal finish, diameter of base 8". Loop turns freely in base.

**Wave Length:** 200 to 600 meters.

**Terminals:** Three flexible leads 3 feet long are attached to the loop with terminal tips to connect to the loop posts on set.

**Packing:** Loop packed in substantial corrugated container.



Add Miles and Smiles with Branston Standard Radio Parts

## Branston Cam Vernier Dial No. R-55

A conventional 4" genuine bakelite dial capable of both coarse and extremely fine adjustment without the necessity of moving the hand from one knob to another, pushing in or pulling out on the knob or changing the mesh of gears.

The vernier movement covers any ten degrees on the dial at a 10 to 1 ratio. You can obtain vernier movement of the dial shaft instantly, at any point throughout the scale.

The highly polished nickel-plated pointer rides directly below the scale, leaving dial graduations visible at all times. Fits any condenser with 1/4" shaft. Diameter of knob, 2 1/4". Adds to the attractiveness of any set and insures extremely fine tuning and accurate logging of stations at all times.

No. R-55  
Branston Cam Vernier Dial

\$1.75



About One-Fourth Actual Size

No Gears No Lost Motion

## Branston Honeycomb Coils

The Universal all-wave inductance—accepted as standard in regard to superior construction and electrical units of measurement. Ask your "Old Timer" radio friend why sets using honeycomb coils are better; they give closer tuning, greater selectivity and range. No dead end losses, easy to operate. 16 sizes, mounted and unmounted. Interchangeable with all mountings. Be sure the set you buy or build has them.

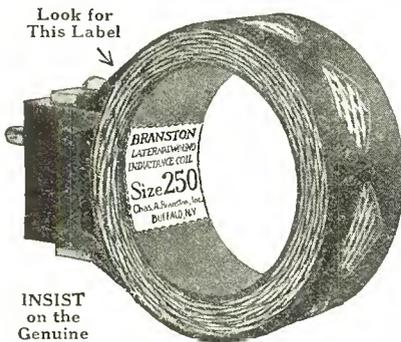

Look for This Label

INSIST on the Genuine

Licensed Under DeForest Patents

### PRICE LIST

No. Turns	Un- m't'd	Price Mounted	Milhenries Induc- tance, Appx.	Appx. Wave Length with .001 Mfd. Condenser
DL- 25	.50	\$1.25	.040	170- 375
DL- 35	.50	1.25	.075	200- 515
DL- 50	.55	1.30	.15	240- 730
DL- 75	.60	1.35	.3	330- 1030
DL- 100	.65	1.40	.6	450- 1460
DL- 150	.70	1.45	1.3	660- 2200
DL- 200	.80	1.55	2.3	860- 2850
DL- 250	.85	1.60	4.5	1120- 4000
DL- 300	.95	1.70	6.5	1340- 4800
DL- 400	1.15	1.90	11.	1860- 6300
DL- 500	1.30	2.10	20.	2340- 8500
DL- 600	1.45	2.25	40.	2940-12000
DL- 750	1.60	2.40	65.	3100-15000
DL-1000	1.90	2.80	100.	5700-19000
DL-1250	2.20	3.10	125.	5900-21000
DL-1500	2.50	3.40	175.	7200-25000

## Branston Two and Three Coil Mountings

Genuine Bakelite. Front and Back geared types.

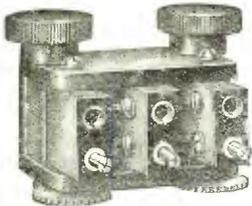

No. R-61. Three Coil Geared Type Front Panel Mounting. Substantial gears give vernier adjustment.....\$5.00  
 No. R-66. Two Coil Geared Type Front Panel Mounting, Same as No. R-61.....\$3.75

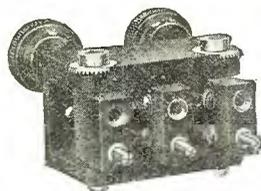

No. R-62. Three Coil Geared Type Back Panel Mounting. Bevel gears give smooth movement.....\$6.00  
 No. R-64. Two Coil Geared Type Back Panel Mounting, Same as No. R-62.....\$4.00



No. R-73. Regular Three Coil Mounting. Neatest and most efficient on the market..\$4.50  
 No. R-71. Regular Two Coil Mounting. Same as No. R-73.....\$3.25

No. R-79 Coil Rack complete with full set of sixteen Coils.....\$32.00

### WRITE FOR CATALOG

Complete catalog of Branston Quality Radio Apparatus sent free on request.  
 R. F. Transformers Branston Jacks and  
 A. F. Transformers Plugs  
 Branston Broadcast Branston Vacuum Gap  
 Coils Lightning Arrestor  
 Branston Series—Parallel Switches

# CHAS. A. BRANSTON, Inc.

837 Main Street

Buffalo, N. Y.

In Canada—Chas. A. Branston, Ltd., Toronto, Ont.

# Construction of Reflexed Super-Heterodyne

Incorporating Short Wave R. F., Regeneration, and Neutralization—  
Seven Tubes Give Results of Ten—An Inexpensive, Highly Efficient  
Super Circuit

By KENNETH SALISBURY,

**D**O you remember the early types of Super Heterodyne Receivers? Big cumbersome contraptions with control panels about four feet long covered with numerous dials, knobs and meters. What a contrast with the highly developed Super Heterodyne of today—neat, compact, efficient little receivers, mounted on extremely small panels, and with controls so simplified that a ten-year-old child can operate them successfully.

The Super Heterodyne described in this article is radically different from the conventional Super Heterodyne circuit. By incorporating the reflex principle in the radio frequency sides of the circuits, seven tubes are made to give results equal to the usual ten-tube circuit.

In a reflexed Super circuit, it is necessary to bypass the radio frequency across certain windings where its presence is not desired by means of fixed bypass condensers. When a condenser of this type is placed across the primary or secondary winding of a transformer, it immediately raises the wave length of the coil across which it is placed. As it is most important that the intermediate frequency transformers have the same peak of amplification they must be specially wound in order to compensate for the effect of the condenser used across them. In order to successfully obtain the proper windings and values, it is necessary that very accurate laboratory equipment be used, and that the transformers be manufactured and tested with great care.

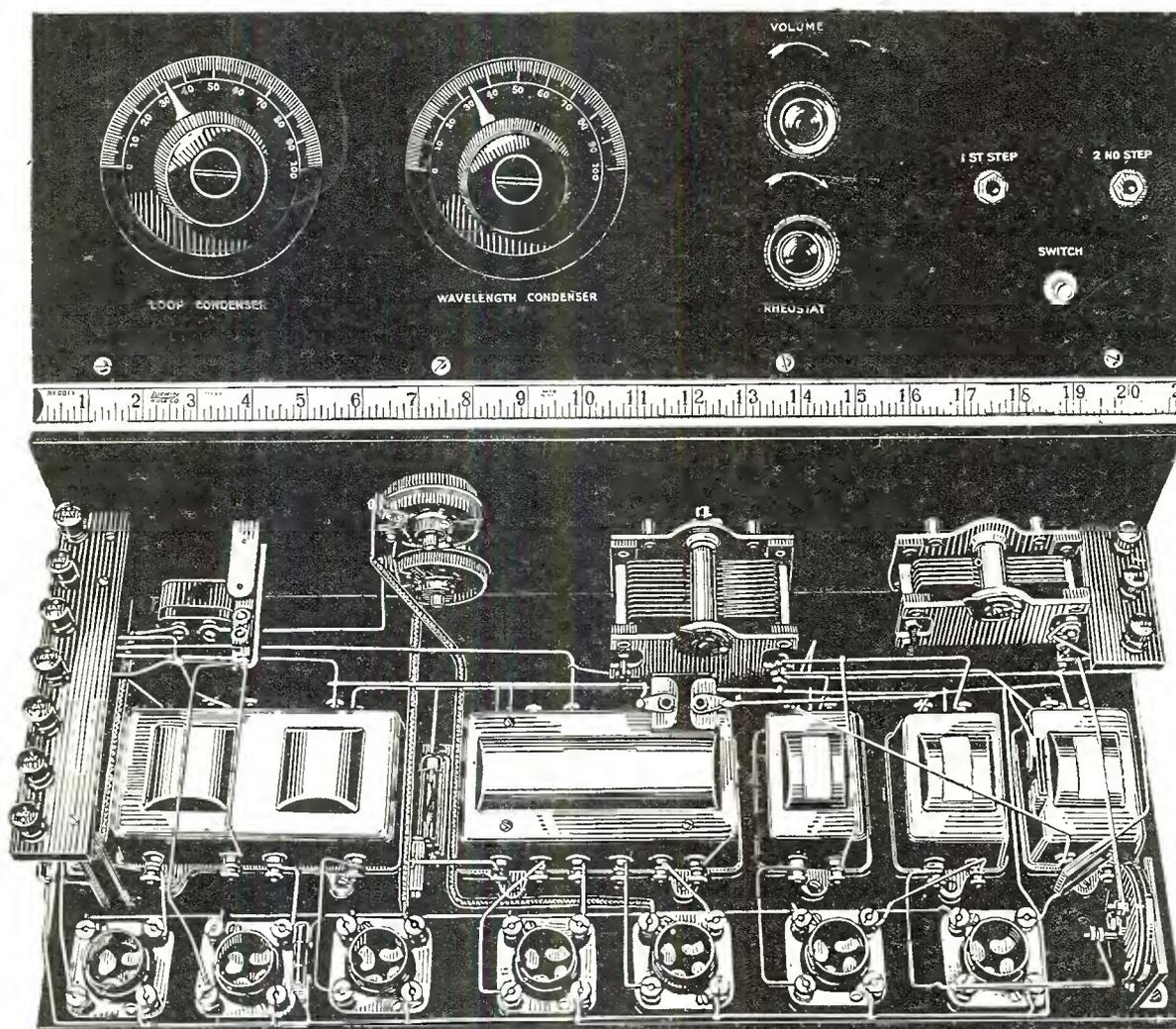

Fig. 1. Front Panel and Rear View of Complete Receiver

## Does Not Radiate

One of the greatest faults of the Super Heterodyne has been overcome in this circuit—radiation is prevented by a stage of short-wave radio frequency which prevents the oscillations from going “on the air” and spoiling reception for everyone within a radius of many blocks.

Up to this time the great advantages gained by reflexing have not been incorporated into a Super Heterodyne circuit intended for home construction because of the difficulty encountered in the design and winding of the intermediate radio frequency trans-

formers. The selectivity of this Super Heterodyne circuit has been increased to the most efficient point for average home use. It is possible to design a transformer that will tune so sharply as to make it possible to eliminate a powerful local station and obtain reception from a distant station with a difference of but two or three meters in wave length. But should such a transformer be used it would not tune broad enough to include the “side bands” or side frequencies of the broadcast wave which carry the modulation of the voice or music, and a true tone could not be received. Therefore, this Super Heterodyne is designed

with a peak of amplification sufficiently broad to well cover the side bands of a broadcast wave, and narrow enough to perfectly separate stations of from one to seven meters difference in wave length between a local and a distant station, depending upon the distance you are from the local station.

Investigating the new circuit to see just how it operates and what takes place, we find that the first tube serves as a short wave radio frequency amplifier. This is a feature not usually incorporated in Super Heterodyne construction, and makes for very efficient long-distance reception. The grid of the first tube accepts the signal picked up by the loop or antenna, passes it to the short wave radio frequency transformer, where it is amplified and passed to the grid of the second tube. This tube serves as a rectifier and frequency changer, thereby doing double duty. There is no loss of efficiency in this arrangement and a saving of one tube is effected here. The output of the frequency changing tube has two frequencies, one of short wave, or high frequency, and one of long wave, or low frequency. The short wave high frequency is bypassed and used no more. However, the long wave we wish to preserve, and it is passed on to the first long wave transformer, usually called intermediate frequency transformer. Here it is amplified and passed to the grid of the first tube, and now the first tube is doing its second duty, that of amplifying at intermediate frequency.

The first tube now passes the intermediate frequency on to the primary coil of the second intermediate frequency transformer, and it is here amplified again through the remaining two stages of the intermediate frequency amplifier. It is now readily seen that the first tube has done two duties, that of amplification at short wave, and also amplification at long wave or intermediate frequency. The second tube has done the service of amplification and rectification at short wave, and also has created a third frequency as the long wave radio frequency or heterodyne action.

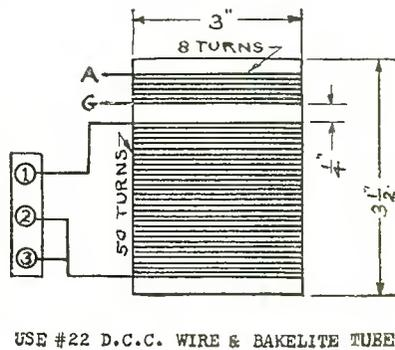

Fig. 4. Fixed Inductance Unit

From the last intermediate amplifier tube the signal is rectified in the detector tube and passed to the audio frequency tubes and transformers for amplification at audio frequencies.

**Low "B" Battery Consumption**

Heretofore it has been common super heterodyne practice to use a potentiometer to control oscillation, by returning the grid return lead of all radio frequency transformers to the center of the potentiometer. By adjusting the potentiometer toward the positive side of the A Battery, a positive potential is impressed upon the grids of the tubes, thus preventing oscillation. But in doing so, the B Battery current was raised far above the desired point, thus placing an unusually heavy drain on the B batteries and materially shortening their life. The remedy was to design a set of "neutralized" intermediate frequency transformers that would operate efficiently when the grid return leads of the tubes were brought to the negative side of the A battery instead of the positive side, or even carried further and run through a C battery. The use of the C battery in this manner greatly reduces the B battery current and greatly prolongs the life of the B batteries.

Whereas the usual Super Heterodyne set draws from 40 to 60 milliamperes, this Super operates with only a 10 milliamper B battery consumption. The use of the potentiometer control is completely eliminated, a special rheostat on the first immediate frequency amplifier tube acting as a volume control. The windings of the intermediate frequency transformers are so well neutralized that there is no tendency toward oscillation in the intermediate amplifier itself.

By the use of a regenerative loop, it is possible to greatly increase the strength of the received signal at the first tube. This is accomplished by a capacitive coupling between the grid and plate of the first tube. The feedback is obtained by a small variable condenser to the center tap of the specially wound loop. This regenerative loop has two windings running in the same direction and parallel to one another, tapped in the center and

brought out with flexible leads. The wire is composed of 60 strands of No. 36 hard drawn copper wire and 7 strands of phosphor bronze wire and is covered with two layers of insulation. The entire winding is supported on Bakelite strips, thoroughly insulating the winding from the frame of the loop.

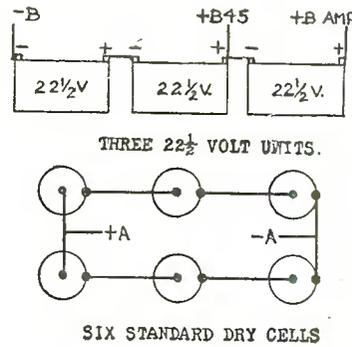

Fig. 2 Showing A and B Battery Connections

Another unusual feature of the set is the design of the transformer cases. All transformers are enclosed in drawn brass cases which completely shield the winding from outside disturbing noises, and prevent internal oscillation taking place. The entire winding are impregnated with a high grade insulating compound which prevents moisture absorption, and the possibility of damage through rough handling.

The first transformer used in the set is a specially designed long wave radio frequency transformer with a peak of amplification sufficiently sharp to permit close and accurate tuning without the diminution of the "side band" frequencies so necessary to true tonal reproduction. This transformer is peaked by the use of two condensers, a .0001 and a .001. It is not only adaptable for the heterodyne circuit but can be used for any long wave radio frequency amplifier.

The second transformer is a short wave radio frequency transformer and in it the convention design of short wave radio frequency transformers has been widely departed from. It has high amplification as low as 200 meters, and likewise amplifies efficiently as high as 600 meters. It is not only suitable for the circuit herein shown but can be used in many reflex circuits as well as for straight radio frequency amplification.

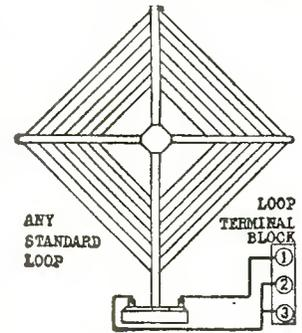

Fig. 3. Showing Loop Connections

The special unit contains three long wave untuned radio frequency transformers, whose curve covers a wide band of frequencies. Not only is it very adaptable for super heterodyne circuits, but when used in conjunction with the first transformer would make an excellent long wave radio frequency amplifier.

The third is a two stage audio frequency unit, completely shielded and of as high amplification ratio as is consistent with good tone quality.

**LIST OF APPARATUS**

- Following is a list of necessary material:
- One Special Kit of reflexed Super Heterodyne Transformers.
- One panel 7x21 inches.
- One baseboard 9 inches to 10x20 inches.
- Two straight line variable condensers .0005 M.F. each. These should be the best possible quality, without vernier attachments.
- Two 4-inch dials, preferably of the Cam-Vernier type.
- One 25 or 30 Ohm Rheostat, wire resistance type preferred.
- One 60 Ohm Rheostat, wire resistance type preferred.
- Ten binding posts.
- One Single Circuit Jack with bracket for holding terminal binding post strip.
- One Double Circuit Jack.
- One Midget Condenser, maximum capacity of approx. .0001 M.F.
- One Filament Switch.
- One battery terminal strip, size, 1 3/4 inches wide by 5 to 7 inches long.
- One loop terminal binding post strip, 1 3/4x3 inches.
- Seven Sockets, best quality obtainable.
- One Grid Leak (No. 1 in diagram) 2 to 7 Megohms.
- One Leak (No. 2 in diagram) variable type, range 50,000 to 150,000 ohms.

**Value of Fixed Condensers as shown in diagram**

- Fixed Condenser A—.001 M.F.
- Fixed Condenser B—.001 M.F.
- Fixed Condenser C—.0001 M.F. This condenser must be placed 2 inches from all other wires or transformers. If it is too close, coupling is liable to take place between plate and grid of first tube.
- Fixed Condenser D—.00025 M.F.

Fixed Condenser E—.005 M.F.  
 Fixed Condenser F—.005 M.F.  
 Wire, Spaghetti, Screws, etc.

**ASSEMBLY PRECAUTIONS**

In constructing this Receiver, owing to the fact that there are very few instruments on the panel (two each of the jacks, rheostats and variable condensers, and a battery switch) it is advisable to mount and wire all the baseboard instruments before connecting the panel to the baseboard.

The photograph and wiring diagram show the transformers, sockets, and midget condenser in their proper positions. In order to eliminate unnecessary detail in construction and to simplify wiring the three intermediate frequency transformers have been embodied in one compact, shielded unit, and the two audio-transformers are also combined in a separate unit.

This arrangement, together with the layout of instruments shown in the illustration, permits the use of very short connecting leads and increases the efficiency of the completed set.

Looking at the baseboard from the front of the panel, the tube sockets are placed in a row along the back edge of the baseboard. It is extremely important that the transformers be placed in their correct positions.

The Midget Variable Condenser, which is used to control regeneration in the loop, is mounted to the left of the long-wave transformer. Space is provided between the intermediate and audio frequency transformers for the grid leak mounting.

**FURTHER ASSEMBLY HINTS**

The binding posts for the loop are mounted in the same manner and placed at the edge of the baseboard below the variable condenser.

Begin wiring, using the square tinned bus-bar by connecting the filament leads. The sockets are mounted in such a position that the filament terminals will be toward the rear edge of the baseboard. One terminal of each tube socket is connected to a single length of bus-wire which is connected to the correct binding post after panel and baseboard are assembled.

The remaining filament terminal of each socket (excepting the third from the antenna coupler) is connected to another piece of bus wire. This line is completed after the panel has been attached by connecting from the proper binding post to the "A" battery switch and then through the rheostat to the line connecting the six filament terminals.

The metal cases of the transformers are "grounded" by connecting them to the positive side of the "A" battery.

Work slowly and carefully and do not try to see how quickly you can wire the set. Check each connection on the diagram with a colored pencil, that is, when each connection has been made, mark off the proper line on the diagram with red or blue crayon. This will enable you to check the wiring against the diagram as the work progresses.

When the baseboard instruments have been completely wired fasten the panel to the baseboard and complete the wiring.

**FINAL TESTING AND TUNING**

After completing the wiring and checking connect only the "A" battery and insert tubes and test to see that all filaments light. Next remove all tubes and disconnect "A" battery. Then attach the leads of "B" battery to proper terminals. Also connect the "C" battery correctly. Secure a small piece of wire and short the filament terminals to see that there is no spark from "B" battery. Do this with all sockets at one time. If no spark is seen you are reasonably sure the wiring of the filament circuit is correct. The tubes can now be placed in their sockets and the loop connected, and you are ready to tune the set. Set the midget variable condenser at its lowest capacity and carefully turn the wave length condenser a few degrees at a time, moving the loop condenser slowly over the entire scale. After receiving signals and adjusting both condensers to maximum volume further adjust the midget condenser and again readjust the loop condenser. After the best results have been obtained, it is not necessary to make further adjustment of midget condenser.

If set appears inoperative place finger on plate terminal of first tube. If by doing so the set operates, this indicates that your midget condenser is too small, and a larger one should be substituted.

**BATTERIES REQUIRED**

Three standard dry cells should be used for A Batteries. Six can be used by connecting series parallel as shown in cut.

"B" Batteries—45 volts on the detector and 60 to 90 volts on the Radio Frequency Amplifier and Audio Frequency Amplifier. These voltages may be varied to obtain maximum results according to the tubes used.

"C" Battery—1½ to 4½ volts.

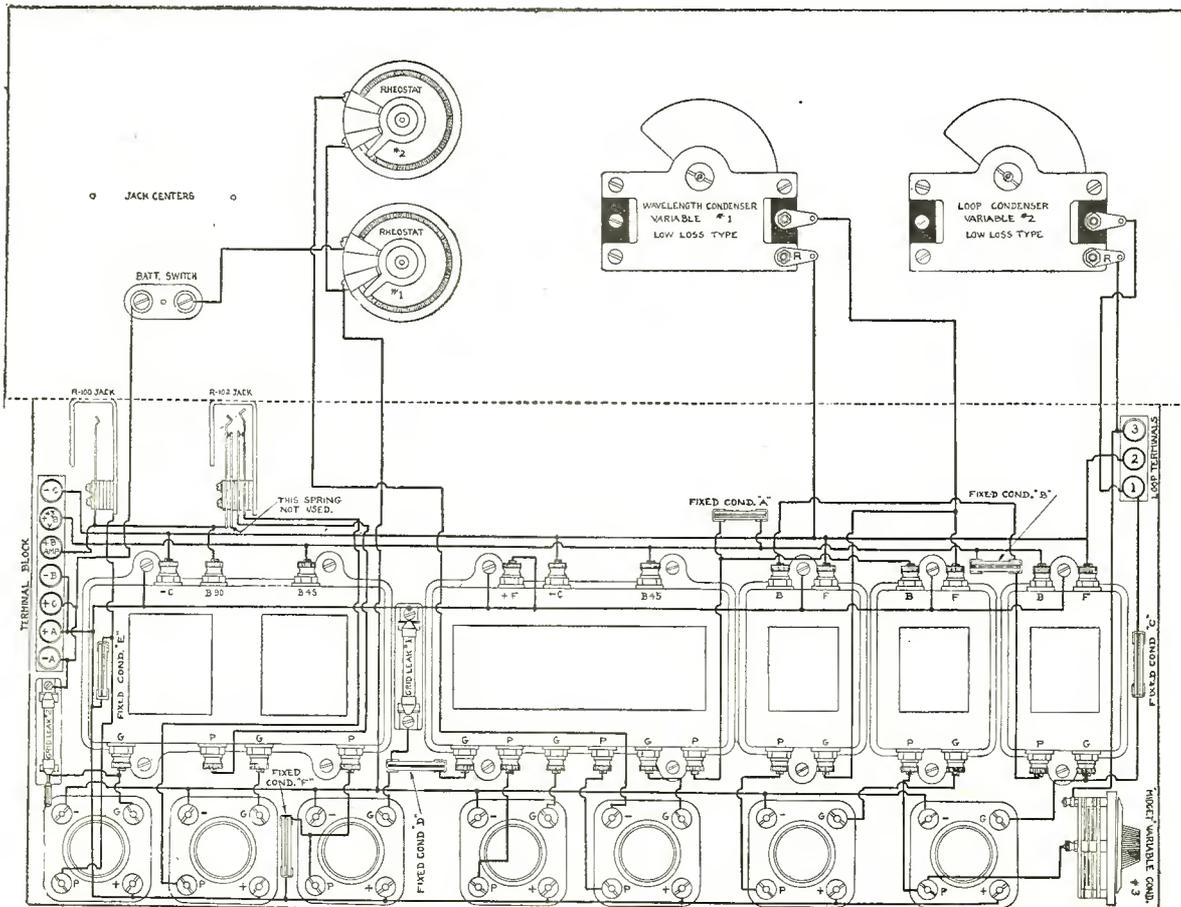

Fig. 5. Pictorial Diagram Showing Connections

# The Secret of MUSIC MASTER Supremacy

**M**USIC MASTER is built to insure faultless radio reception. By proper use of the proved principles of sound reproduction, long since thoroughly established, theories and guesses are eliminated.

The Unit in the base is made with watch-like precision, so delicately attuned that even the faintest radio impulses are reproduced distinctly. The Tone Chamber of heavy cast aluminum allows the sound waves to develop naturally, undistorted by over-vibrations. The amplifying horn is wood, because only wood has the resonance to completely recreate the original tone of voice or instrument.

The quality of these elements makes Music Master supremacy possible; their assembly into a well balanced musical instrument makes it a reality.

Music Master will improve your reception. Try one with your set and see.

*Dealers Everywhere*

**Music Master Corporation**

10th and Cherry Streets  
PHILADELPHIA

Chicago

Pittsburgh



*Resonant  
Wood  
Insures  
Tone  
Quality*



- MODEL V, Metal Cabinet, Mahogany Finish .....\$18
- MODEL VI, 14 inch Wood Bell.....\$30
- MODEL VII, 21 inch Wood Bell .....\$35
- MODEL VIII, Mahogany Cabinet with "Full Floating" Wood Horn \$35
- MODEL IX, 14 inch Horn, hand painted...\$40
- MODEL X, Pedestal Type .....\$100

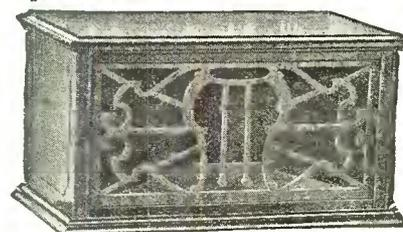

*Connect Music Master in place of Head Phones. No batteries necessary. No adjustments.*

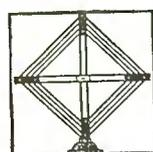

**Loop Aerial**  
Music Master Loop Aerial ..... \$10  
Has calibrated dial, and covers entire band of broadcasting wavelengths. Mahogany frame. Art metal stand and leads.



**Head Phones**  
Music Master Head-set.....\$10  
Supersensitive. Greater distance with clearness. Covers entire range of audible frequencies.

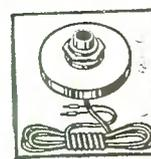

**Phonograph Attachment**  
Music Master Phonograph Attachment, \$8  
Fits tone arms of leading phonographs, converting them into good loudspeakers.

# The Four-Tube Knockout

Designed by *McMurdo Silver, Assoc. I. R. E.*

*Does Everything on a Seventy Foot Antenna A Super Will do on a Loop*

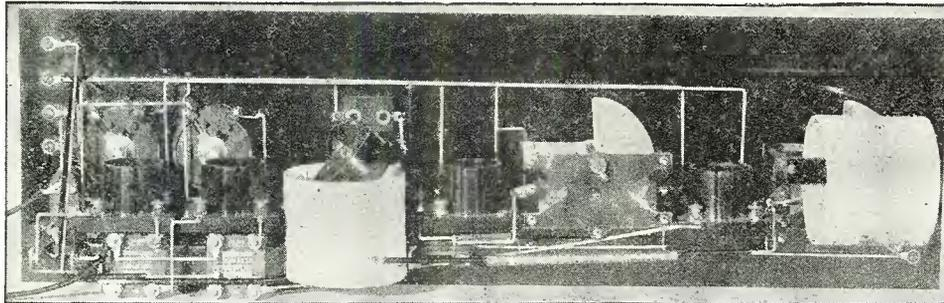

Rear view of set showing simplified wiring arrangement.

*Can be Built By Anyone at Home with Three Tools in a Few Hours*

## Parts for the Knockout

These are the parts specified by Mr. Silver for use in the FOUR-TUBE KNOCKOUT, including the Low-Loss Inductances specially designed by him for use in this set. They give to the KNOCKOUT Set its remarkable power—they make it possible for SILVER-MARSHALL to stand behind every claim made for it with a guarantee of complete satisfaction. Every item is guaranteed electrically and mechanically perfect.



**Type 105 Low-Loss Coupler**

The coils are self-supporting, with minimum of dielectric material in their fields. Wave length range from 200 to 550 meters with .0005 Mfd. condenser.

Price each.....\$5.00



**Type 205 Low-Loss Antenna Coil**

Windings are self-supporting, with air dielectric for minimum losses. Wave length range, from 200 to 550 meters with a .0005 Mfd. condenser.

Price each.....\$2.50

	Price, each		Price, each
2—Silver .0005 Low Loss Condensers No. 301	\$ 4.50	2—Thordarson 3 1/2-1 Audio Transformers	4.00
3—4-in. Moulded Dials—Tapered Knobs	1.00	1—On-off Switch	.60
Howard 6 1/2 Ohm Rheostat	1.10	1—.00025 Mica Condenser with Leak Chips	.45
6—Insulated Top Binding Posts	.05	1—.002 Mica Condenser	.40
1—Carter 102A Jack	.80	1—.0075 Mica Condenser	.75
1—Carter 101 Jack	.70	1—2 Meg Grid Leak	.50
1—Silver Low Loss Coupler No. 105	5.00	1—7 x 2 1/2 x 3/16 Bakelite Panel, Drilled, Grained and Engraved	7.00
1—Silver Low Loss Antenna Coil No. 205	2.50	Bus-Bar, Spaghetti, Screws, Nuts, Solder, Lugs, Etc.	1.00
4—Hoozok Falls Panel Mounting Sockets	.60		

Circulars on these parts will be sent upon request

### S-M INDUCTANCES

Although the Silver-Marshall Low-Loss Inductances were designed originally for the Four-tube Knockout, they will increase the efficiency of any set 100%, whether tuned R.F., three-circuit, or any other demanding inductances of this type. They are fully described in "The Knockout Book."

### THE KNOCKOUT BOOK

McMurdo Silver's new book on the FOUR-TUBE KNOCKOUT contains a complete account of this remarkable set, together with a valuable discussion of low-loss inductances. It will be indispensable to the man who builds the Knockout set. Price.....25c

Complete Parts for the FOUR-TUBE KNOCKOUT with Drilled and Engraved Panel. Price.....\$43.50

# THE SILVER SUPER

## The "Why of Silver Supers"

It remained for SILVER-MARSHALL to produce long-wave Transformers so uniform that individual amplification curves could be supplied with each instrument. As the intermediate amplifier is the most important element in any super, it is of the utmost importance that your transformers be matched—and for your protection and guidance, it is imperative that you have positive assurance of their uniformity. Such uniformity and such assurance have never before been obtainable. But now, Silver-Marshall makes such laboratory measurements accessible.

The amplification curve of each TWO-TEN (inter-stage) and TWO-ELEVEN (filter) transformer is plotted in the S-M laboratory and recorded directly upon a tag tied to the instrument. It shows the peak of that particular transformer—side-bands passed—amplification to be expected in any circuit. It permits you to build your super, as an engineer builds a bridge—after a definite plan—with complete assurance of success.

Send for the "Why of Silver Supers"

## The Seven-Tube Wonder Set

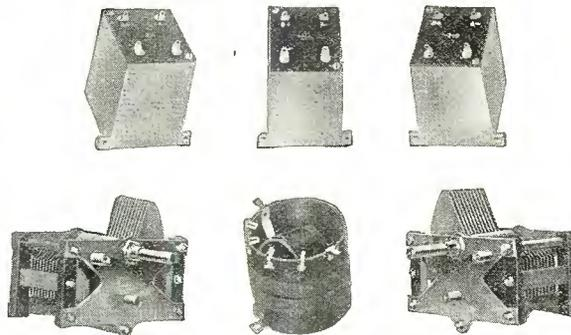

Essential Parts for the Silver Super

Write for Circulars on these parts and other S-M Radio Equipment

## Parts for the Silver Super

The fact has been repeatedly brought out by engineers and technical editors who have built the SILVER SUPER that its high efficiency depends upon the use of those parts designed and specified by Mr. Silver. Every item is guaranteed to be electrically and mechanically perfect by SILVER MARSHALL, and all orders are subject to replacement or refund if you are dissatisfied. In addition, the S-M free technical information service is ever at your command to aid you with your troubles.

Interesting circulars have been prepared on all essential parts, including Type 101a Coupling Unit (oscillator)—Type 301a and 302a Low-Loss Silver Condensers—Type 601 Collapsible Loop with center tap—and the new TWO-TEN and TWO-ELEVEN Long-wave Transformers. Any of these circulars will be mailed upon request.

Mr. Silver's book on the Super-heterodyne has been enlarged and reprinted, owing to thousands of requests received for it. It will be promptly mailed on receipt of fifty cents.

# Silver-Marshall, Inc.

RADIO EQUIPMENT

110 South Wabash Ave.

Dept. C

CHICAGO

# A Knockout Receiver

By CECIL W. PRESTON, Assoc. I. R. E.

**I**N this day of receivers boasting super-heterodyne results on one and two tubes, the man who wishes to build his own receiver, either for the pleasure to be derived from the work, or because of the financial saving that will result, is confused, and justly so—by the veritable legion of circuits, old and new, with which he is confronted. If this man is not swept away by extravagant claims, he will choose a circuit of known merit embodied in a receiver in which strict attention has been paid to each detail. He will not be influenced by phenomenal reports on but one receiver, but will rather consider the performance of many outfits under different and varied conditions—he will, if he is of an analytical turn

tion by an insulating compound, the composition of which is such that these inductances present substantially as low resistance as coils wound on air, which would have absolutely no mechanical means of holding them together. The impossibility of realizing this latter condition is apparent.

According to Dr. Pickard, probably the foremost inductance authority in this country, the single-layer winding used is the most efficient form that can be devised for broadcast reception, and the wire size, No. 20, is one of the sizes approved by Dr. Pickard, as well as the foremost testing laboratories of this country for broadcast work. The coils themselves are so placed in the set that adjacent

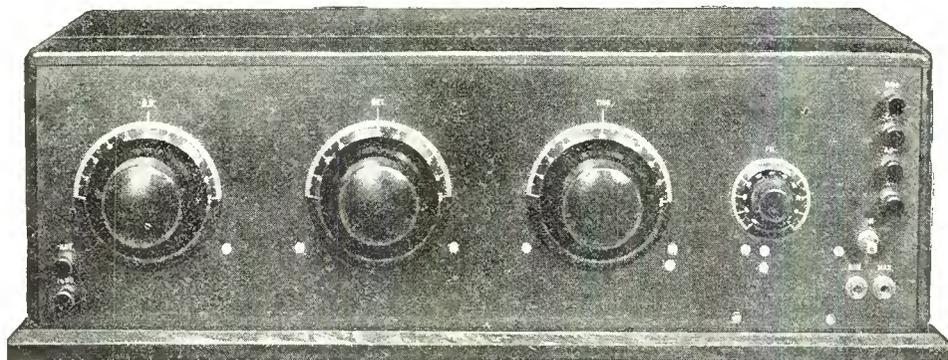

Fig. 1. Front View of the Four-Tube Receiver

of mind, select a receiver which has been proven to embody to a high degree the five prime receiver requisites: selectivity, sensitivity, ease of control, quality of reproduction and simplicity of assembly.

Such a receiver, designed by McMurdo Silver, Assoc. I. R. E., is described in this paper. It presents no radical features, being only a careful application of sound engineering principles to the problem of producing a receiver possessing the requisites previously mentioned—an outfit low in cost, simple to assemble, and capable of giving super-heterodyne results on a small outdoor antenna.

Anyone at all familiar with circuit diagrams will realize upon an

metal parts affect them to a negligible extent. They are fitting companions for the variable condensers used, whose losses are so low as to be immeasurable.

The radio frequency amplifying tube is so arranged with its circuits that maximum selectivity and sensitivity will be obtained with practically any antenna system. It is rendered stable and free from undesirable oscillation by the use of a neutralizing condenser, which in addition to its other functions, so balances the radio frequency amplifier circuits that the detector tube, when oscillating, cannot feed energy back into the antenna system.

This is an extremely important point, for it permits the use of

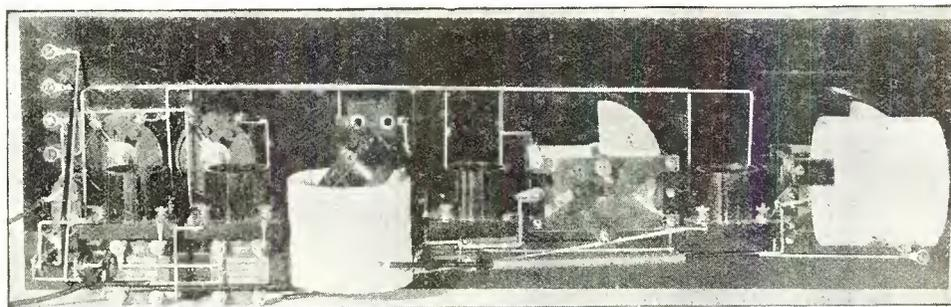

Fig. 2. Rear View of the Set, Showing Details of the Extremely Simple Wiring Arrangement.

examination of Figure 4 that this set consists essentially of one stage of tuned radio frequency amplification of the neutralized type, a regenerative detector circuit, and two stages of audio frequency amplification, a total of four tubes being used. These tubes may be of either dry-cell or storage battery type, UV199 or UV201A tubes being recommended throughout. If we examine the design carefully, the following points will be evident, with respect to its efficiency.

Air-core inductances, tuned by low-loss variable condensers, are used and provide tuning circuits of as high efficiency as it is possible to build. Although low-loss condensers have been in use for some time, very little attention has been paid by the broadcast experimenter to low-loss coil design, yet a good condenser is of no value if used with a high-loss coil. These air-core coils are wound with no supporting tube whatsoever, their turns being held in posi-

a regenerative detector, with all its resultant sensitivity to weak signals, yet without any tendency whatsoever to radiate. This non-radiating feature is of immense value, for it means that a person tuning this outfit would cause no interference with his neighbor's reception, no matter how he might operate his own receiver. In this respect this circuit conforms with the Golden Rule, for it will not disturb other nearby receivers.

The method of coupling the R. F. amplifier to the detector circuit, by means of a very small coil inside the lower end of the vario-coupled stator (outside) winding is in accord with the latest developments along this line, for it gives the greatest possible energy transfer with the minimum amount of capacity coupling, which means that the control of the R. F. amplifier and detector circuits will be independent of each other.

The tickler or rotor coil of the variocoupler is wound with as few turns as possible consistent with good regeneration control, and renders the tuning of the detector condenser almost entirely independent of the setting of the tickler coil. This, and the low capacity coupling between the R. F. stage and the detector, permit the two condenser dials to be logged accurately for any stations heard. (Stations may be tuned in whenever they are operating at exactly the same settings of the two condensers as were used the first time they were heard.)

The audio frequency amplifier employs two low-ratio amplifying transformers, selected for their exceptionally distortionless reproduction, and gives a surprising amount of amplification. Jacks are arranged so that one or two stages of audio amplification may be used at will.

The set itself is a very simple assembly proposition, for all parts are attached directly to the panel, or to the wiring, no sub base being used. The two left hand dials of Figure 1 are respectively the RF tuning condenser, and the detector condenser. The large right hand dial is the tickler, or regeneration control, while the small dial to its right controls the single rheostat, all that is necessary for the proper operation of the four tubes. The battery binding posts, jacks and on-off switch are on the right hand edge of the panel, and the antenna and ground posts at the left end. The panel itself is 7 in. x 24 in. x 3/16 in., of bakelite or formica.

**Results**

During the summer and fall quite a number of these receivers were built and operated in and around Chicago. In practically every case the extreme limit that had been set for them to come up to was achieved. This was reception on the four-tube set with a seventy-foot single wire outdoor antenna equal to that experienced with a seven-tube super-heterodyne operating on a twenty-inch loop. This in itself was a very stiff requirement, for few receivers, even on an outdoor antenna, will equal a really good super.

In one test, the super was used to log stations throughout the entire broadcasting wavelength range. Then the four-tube set went after the same stations. In nearly every case the volume was equal to the super, as well as the selectivity. In another test, a super and a four-tube set were put down between WQJ on 448 meters and WEBH on 360 meters, these stations being about three-quarters of a mile apart. The selectivity was in favor of the super, for neither station had but a single wave—anywhere from four to eight points being found between 550 and 200 meters for each station. KGO, in Oakland, California; WOR, in New York, and numerous other stations were brought through the locals, however, on both sets with equal volume—the four-tube set using an antenna and the super a loop.

Another test was run between a four-tube set and a standard five-tube neutrodyne, in Wilmette, a suburb of Chicago. Between the hours of 4 P. M. and 8 P. M., twenty-six stations were heard with

loud-speaker volume on the four-tube set, more than could be gotten on the factory-built neutrodyne. Among these were stations in New York, Toronto, San Antonio, Texas, and many in other parts of the country, heard before darkness.

Similar tests could be quoted forever, but suffice it to say that in all cases the four-tube set out-performed standard five-tube neutrodyne sets on the counts of selectivity, ease of control, quality of reproduction, and volume. Yet the knockouts were in many cases built without instructions, except circuit diagrams, by inexperienced fans. They indicate that coast to coast reception may be expected with fair regularity under good conditions.

**Construction**

The material required to build the Knockout is given in the list below, with an accessory list further along. It is strongly recommended that the builder adhere strictly to this list, using parts made by reputable, nationally-known manufacturers. If, however, the experimenter desires to deviate, he should only do so where his knowledge is sufficient to effect the necessary design changes attendant upon the use of material other than that specified.

- 2 Low Loss Condensers, .0005 mfd.
- 3 4-in. Molded Dials—Tapered Knobs
- 1 6½ Ohm Rheostat
- 6 Insulated Top Binding Posts
- 1 Jack, 3 Spring
- 1 Jack, 1 Spring
- 1 Low Loss Coupler
- 1 Low Loss Antenna Coil
- 4 Panel Mounting Sockets, Standard Base
- 2 3½:1 Audio Transformers
- 1 On-Off Switch
- 1 .00025 Mica Condenser with Leak Clips
- 1 .002 Mica Condenser
- 1 .0075 Mica Condenser
- 1 2 Meg Grid Leak
- 1 7 in. x 24 in. x 3/16 in. Bakelite Panel.
- Bus-Bar, Spaghetti, Screws, Nuts, Solder, Lugs, Etc.

**TOOLS REQUIRED:** Screw driver, pliers, soldering iron, hand-drill with drills, and counter-sunk.

If a plain, undrilled panel is procured, it should be laid out in accordance with Figure 1. Holes should be drilled with the drill sizes indicated, and double-circled holes countersunk for a No. 6 flat-head screw. The panel may then be grained by rubbing in one direction only with fine sandpaper and oil until all traces of the original bright finish have been removed. Only the front of the panel should be grained, however. Indicating marks for the dials may be scratched with a scribe and square above the shaft holes for all dials, and filled with chinese white, or some other white compound.

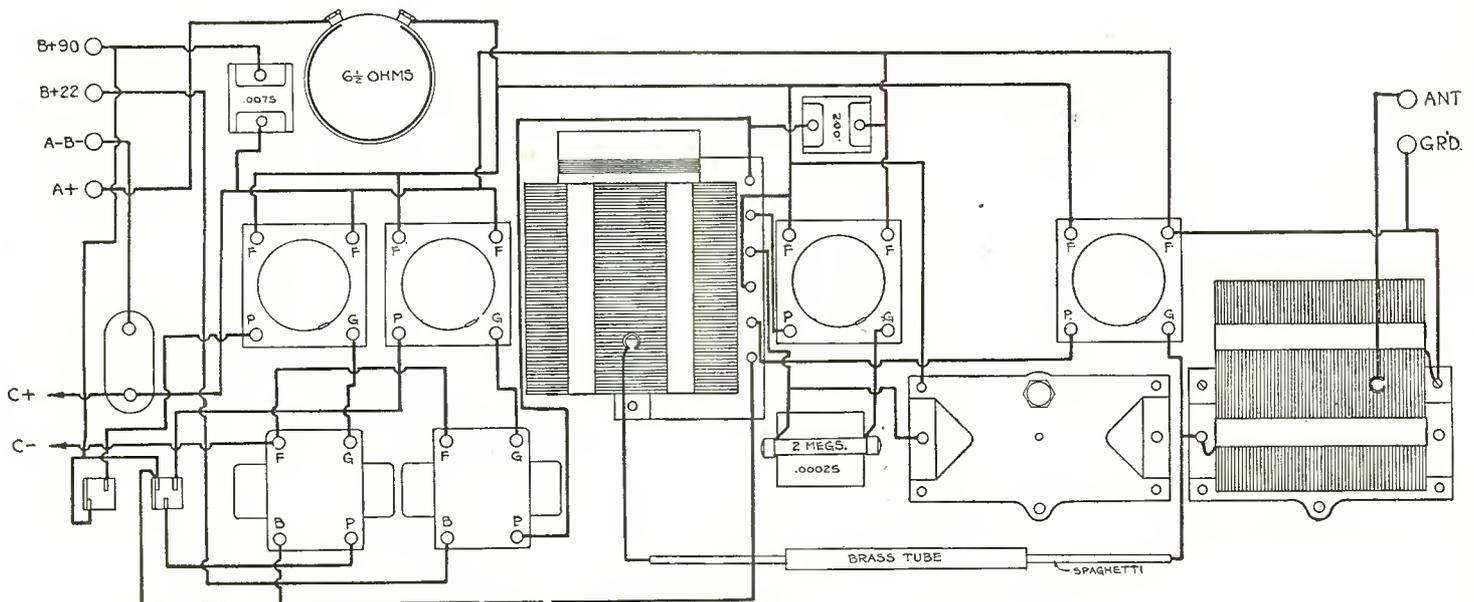

Fig. 3. Pictorial Circuit Diagram, Looking at Panel from Rear. This, and Fig. 2 Should Be Carefully Studied Before the Wiring Is Started.

The antenna coil should now be attached to one of the variable condensers. The first step is to remove the two mounting screws on the rear end-plate of the condenser that are in a line with the bearing adjustment screw. Two round-head 1/4" No. 6/32 machine screws should be put through the holes in the bakelite mounting strip of the antenna coil, and two nuts screwed loosely on each screw. These screws should be screwed into the condenser holes from which the two original screws have been previously removed. They should be turned in as far as they will conveniently go. Care should be taken to see that the loop, or tap, on the coil comes near the right-hand end of the condenser, when viewed from the rear, and with the stator or fixed plate section of the condenser turned down, as in Figures 2 or 3. One nut on each screw should be tightened up against the condenser frame with a pair of pliers, and the other nut tightened against the bakelite coil-support strip. This will provide a firm mounting for the antenna coil on the back of the condenser.

All screws and nuts on condensers, transformers, sockets, etc., should be tightened up, and jacks and sockets carefully checked for proper contact and spring tension. Jack springs should make good contact with the phone plug, and socket springs should be

solder. To get a smooth coating it will be necessary to rub the iron on the lug slightly to transfer the heat. Above all things, the iron must be kept clean, and its tip tinned, or covered with solder. A good joint will not look rough—if properly made the solder will flow in around the lug and wire smoothly.

The rear view of the wired set, and the pictorial diagram should be carefully studied, and the wiring put in place progressively, starting with the filament circuit. The wiring for the audio amplifier is then done. The variocoupler is put on the panel next and wired in circuit, followed by the two condensers, the one holding the antenna coil going at the right end of the panel, seen from the rear. The fixed condensers are soldered directly to the wiring, and require no other support than this. The neutralizing condenser will be wired in later, it also being supported by the wiring. Care should be taken in scraping and soldering to the antenna coil tap and variocoupler neutralizing tap not to damage the coils themselves.

The 4" dials should be attached to the condenser and coupler shafts by means of the set screws provided. The dials should read 100 degrees on a line running down from the top of the panel to the shaft holes when the condenser plates are entirely

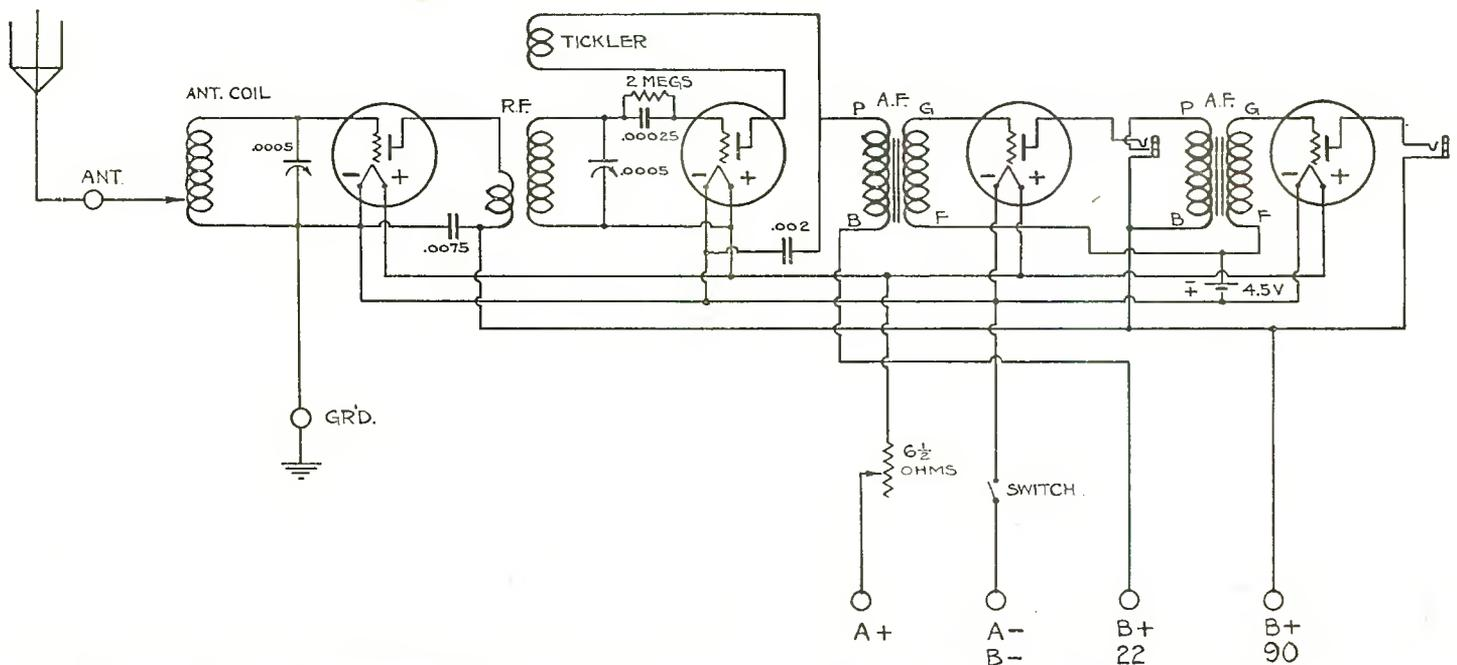

Fig. 4. Schematic Circuit. This Should Be Followed if Possible, as Doing so Will Insure a More Accurate Job than Following the Pictorial Diagram.

bent up to make good contact with the tube-base pins. Soldering lugs should be put on the tube sockets, the filament lugs pointing toward the panel except in the case of two audio frequency sockets. The two lugs, one on either of these sockets, that will be adjacent when the sockets are on the panel, should be turned toward each other so that the wires to them can be put in without touching the rheostat.

Binding posts should be put on the panel, with lugs pointing straight in, under the screw head of each post. The nicked collars, as well as the insulated tops, are tightened up on the front of the panel.

The binding posts now being on the panel, the four sockets, rheostat, jacks, on-off switch and audio transformers should be fastened on with screws and nuts. The audio transformers should be so arranged that their grid terminals come under the grid terminals of the audio frequency, or two left hand, tube sockets. The jacks should be turned so that two lines drawn along the panel from top to bottom would run through their frames horizontally. If it is found that the screws for fastening the sockets to the panel are too long, they should be filed down, as this trouble is sometimes encountered with Panel Mounting sockets.

Before starting the wiring, a well-tinned soldering iron should be heated, or an electric one used, and a quantity of rosin-core solder and a can of non-corrosive soldering paste produced. Each lug should be tinned by depositing a very small amount of paste on its end, followed by an application of the soldering iron and

interleaved and the coupler rotor is closest to the stator winding.

All wiring is now completed except the neutralizing condenser, and the set is ready for test. The following accessories will be required:

- 1—90 volt B battery (4 22½ volt or 2 45 volt batteries).
- 1—6 volt storage battery, if storage battery tubes are used, or three dry cells if UV199 tubes are used.
- 1—4½ volt C battery.
- 4—tubes (UV201A for storage battery recommended) or UV199 with adapters if dry cell. (The use of 199 sockets was not considered as there are no satisfactory panel-mounting 199 sockets, and adapters with standard sockets make a satisfactory electrical arrangement, and an excellent mechanical one).
- 1—pair of phones with phone plug, or loud-speaker with plug, or preferably both (any standard make).

A suitable antenna would consist of a 70 to 100 foot single wire run between two trees, or two buildings. The lead-in wire should not be over fifty feet long if possible. A good ground can be had by fastening a wire to a previously scraped water pipe with a ground-clamp.

The set should now be connected to the antenna and ground and to the A battery, but not to the B or C batteries. The tubes, upon insertion in their sockets, should light up if the on-off switch is pulled out and the rheostat turned on. If they do, disconnect the A+ battery lead and connect it first to the B 22 and then to the B 90 binding post. If the tubes then light, the

wiring is incorrect and should be checked. Assuming they do not, the A battery should be reconnected properly, and the B and C batteries connected. The C+ post connects to the flexible lead soldered to the on-off switch, and the C- post connects to the flexible lead attached to the F terminals of the audio transformers. The B batteries should be connected in series so that 22 volts will come between the AB- and the 22+ posts, and 67 volts between the 22+ and 90+ posts, or 90 volts between the AB- and 90+ posts.

#### Operation

The tickler dial should be turned to zero, and the tubes lighted up by turning the rheostat about three-quarters on for UV201A tubes or one-quarter on for UV199 tubes, and once set, it need not be varied, but should always be operated as low as is consistent with good signal strength. The first two condenser dials should be rotated, holding about the same settings, over their entire scales, with the phones in the three-contact, or first stage, jack. These two condenser dials will operate as the first two dials on a neutrodyne, keeping about the same relative separation in degrees over the entire wavelength range of the receiver. If there is any tendency for the RF amplifier to oscillate, it will be evidenced by clicking in the phones at certain dial settings on the lower, and possibly on the higher, waves. If stations are heard as a whistle, it means the amplifier is oscillating, and must be neutralized. Up to now the tickler has been left set at zero.

The neutralizing condenser should be connected in between the grid of the RF tube and the loop, or tap, on the variocoupled stator widening. It may best be hung on its own connecting wires, or one of its lugs may be soldered directly to the grid lug of the first tube, which will provide a substantial mounting. The condensers shown in the photos are nothing more than five-inch lengths of brass tube slipped over a length of spaghetti, which in turn is slipped over two pieces of bus bar of equal length soldered to the first grid lug and the coupler tap. The ends of these wires come within  $\frac{1}{4}$ " of touching in their spaghetti sleeve, but do not quite touch.

A station should now be turned in on other lower waves, or with little of either condenser in use. When the clicking or squealing is no-

ticed, the neutralizing condenser should be adjusted in small steps until this clicking or whistling disappears. The set is then neutralized. This method is both simple and effective, although there are others that might be employed. If the set cannot be neutralized on an outdoor antenna, the two lower lugs on the vario-coupler should be reversed, and if this does not help, one or two turns may be pulled off the small winding connected to these lugs and fastened inside the vario-coupled stator coil.

The set now operating, the tickler coil should be turned toward 100 on its dial until a plunk is heard, and stations come in again as a whistle. This is entirely correct, as the whistle can be cut out by reducing the tickler coupling. If the plunk cannot be heard, even using 45 volts on the detector instead of 22, the two top lugs on the variocoupler should be reversed. If the plunk is heard at different points as the tickler is turned up, and then down, stripping a few turns off the tickler coil will cause this point to be about the same whether going up or down on the scale.

In tuning the set either of two methods may be used. The first one is to tune in a station with the two condensers, leaving the tickler at zero, and then strengthening the signal with the tickler when heard. The second, and preferable, is to turn the tickler up until stations come in as a squeal, rotate the detector condenser until a squeal is heard, then vary the first condenser for maximum intensity, following this by turning the tickler back until the squeal disappears and the station modulation is heard. In either case final adjustments will have to be made on all dials when receiving weak signals.

If the receiver is broad in tuning, a small fixed condenser connected in series with the antenna lead-in will remedy matters. It should be either .0001, .00025 or .0005 MFD capacity, arranged so it can be short-circuited by a single-pole, single-throw knife switch when desired.

If an indoor antenna is to be used, it may be put up in an attic, and should consist of several wires run parallel to each other and connected together at both ends, or it may be as long a wire as is convenient run around a picture moulding. Some difficulty may be experienced in neutralizing the set on such indoor antennas, however. A loop could be used in place of the antenna coil, leaving off the antenna and ground connections, but the range of the set would be very materially reduced and this is not recommended.

## Co-operative Dealers' Policy with Guarantee of Service

Western Pennsylvania  
Headquarters for

# RADIO SETS and PARTS

U. S. Pioneer Radio Distributors

Distributors for—

Radio Corporation of America  
Magnavox Mfg. Co.  
A. H. Grebe Co.  
Gould Storage Battery Co.  
Stromberg-Carlson Tel. Mfg. Co.  
Freed-Eiseman Co.  
National Carbon Co.  
Valley Electric Co.

and OTHER HIGH GRADE MANUFACTURERS  
Aggressive Dealers See Us First

## DOUBLEDAY-HILL ELECTRIC CO.

SOUTHERN WAREHOUSE  
715 12th Street, N. W.,  
Washington, D. C.

"Everything Electrical"  
Radiophone Station—**KQV**—

719-21 Liberty Ave.  
Pittsburgh, Pa.

**BALKITE BATTERY CHARGER.** For charging 6 volt radio "A" storage batteries. Operates from 110-120 AC 60 cycle current. Special model for 50 cycles. Price \$19.50. \$20 West of Rockies. \$27.50 in Canada.



**BALKITE "B" PLATE CURRENT SUPPLY.** Replaces either storage "B" batteries or dry "B" cells. Fits any radio set without additions or changes. Gives unlimited constant current supply to the "B" circuit. Operates from 110-120 AC 60 cycle current. Special model for 50 cycles. Price \$55. In Canada, \$75.

# Balkite Radio Power Units

*solve the power problem  
for both "A" and "B" circuits*

Balkite Radio Power Units—the Balkite Battery Charger and Balkite "B"—bring a convenient and unfailing power supply to both the "A" and "B" circuits. They bring to your set a constant uniform voltage, clearer tone, greater distance and greater volume. The Balkite Battery Charger keeps your "A" storage battery charged and working at maximum efficiency. Balkite "B"—one of the most important recent developments in radio—replaces "B" batteries entirely and supplies unlimited plate current from the electric lighting circuit.

Both the Balkite Battery Charger and Balkite "B" are entirely noiseless in operation. They do not create disturbances in either your set or your neighbor's. They have no moving parts, vibrators or bulbs, and nothing to adjust, break or get out of order. They cannot deteriorate through use or disuse. They require no attention other than the infrequent addition of distilled water. They are simple and unfailing in operation. Both can be put to use at any time by merely connecting to a light socket. Their current consumption is remarkably low. Both are guaranteed to give you satisfaction.

*Both are sold by leading radio dealers everywhere*

**FANSTEEL**  
**Balkite** *Radio Power Units*

**BALKITE BATTERY CHARGER — BALKITE "B" PLATE CURRENT SUPPLY**

*Manufactured by FANSTEEL PRODUCTS COMPANY, Inc., North Chicago, Ill.*



## Each Instrument in PERFECT TUNE

It makes all the difference in the world with the enjoyment you get out of radio whether the high notes of voice and orchestra are in tune or just a little "off."

A big point of the Bristol Audiophone is that each instrument, and each vocal note, comes in in the proper pitch. You will love your Audiophone for its pure harmony of reception.

There are four Bristol Audiophones, priced from \$12.50 to \$25.00, and a cabinet model at \$30.00. If not at your dealer's, write for Bulletin.

MODEL S, \$25.00  
Rubber horn 14½" in diameter. Cast metal throat. Velvet mat finish or mottled bronze and gold.



CABINET MODEL, \$30.00  
Size 17x10x10¼. Beautifully finished mahogany. Full floating wooden horn, cast metal throat.



Model J  
\$20.00



Baby Grand  
\$15.00



Baby, \$12.50

# BRISTOL TRADE MARK AUDIOPHONE REG. U.S. PAT. OFFICE Loud Speaker

The Bristol Company Waterbury, Connecticut  
FOR 36 YEARS ASIANRY MAKERS OF  
TECHNICAL ENGINEER  
 BRISTOL'S RECORDING INSTRUMENTS

# LANGBEIN + KAUFMAN

## High Grade "Low Loss" Tuning Devices

**L+K**

 A Guide to  
 TECHNICAL  
 ACCURACY

## VARIABLE CLARIFYING SELECTOR

### Big Improvement For Any Standard Circuit

This unusual tuning device is a real investment. Whether your set is a reflex, a straight R. F., one of the "dynes" or the old reliable Regenerator, you will find the Variable Clarifying Selector a very noticeable improvement.

In combination with a .0005 variable condenser, it will take the place of your fixed coupler, variocoupler, tapped coil, variometer, or other aerial tuner, with remarkable results.

Patent Applied for



It will separate and tune out conflicting stations like a born peace maker. Its selectivity is indescribably minute. And, signals which can't be coaxed beyond the muffled stage in most receivers can be cleared up to full brilliancy of tone.

The price is \$7.00, the best seven dollar investment you've ever made in radio. If not at your dealer's, we'll ship to you.

### This Instrument Makes Possible the Remarkable

## L+K-PENETRATOR

### Do You Have Trouble Getting Thru Local B. C.?



If so, and if you want to increase the selectivity of your present receiver without tearing it apart, use or build this little Penetrator. The way it enables you to cut through local stations will be a joy to your heart. When hooked on to the antenna or loop side of your set, no matter what it is, it lets in one station at a time. Type A will change your present regenerative set to a combination R. F. and regenerative receiver and will increase its selectivity to a surprising degree. Type L is especially arranged for loop sets and will greatly increase both selectivity and range.

However, don't confuse this instrument with the hundred and one so-called wave traps, which are usually no more than a coil and condenser and merely add losses to your set.

The L + K Penetrator is a tube unit taking one tube of the 201-A type. Price without tube for either type is \$25.00; kit of parts, \$17.50.

It will pay for itself in increased enjoyment each night you use your set.

## READY NOW—THE NEW ELKAY SUPER-SELECTOR

(An L + K Product)

Here is the Super-Selector, the latest addition to the L + K line. It contains our standard tuning devices, the Variable Clarifying Selector and the VT-25, Vario-transformer, and, as a result, give you "needlepoint" penetration, and extremely sweet tone quality and volume in any degree that pleases your ear. When you lift the cover and see that it contains but four tubes, you will wonder how it is done—and it becomes all the more wonderful when you discover that it is done entirely without reflexing. The price without tubes or accessories is \$70.00. In kit form, \$50.00.

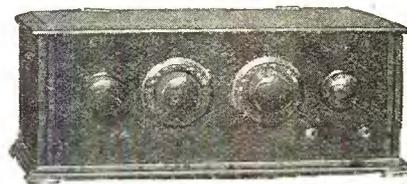

### Set Builders, Attention!

Are you handy at making sets? Do you want to make some extra money out of hours, supplying your friends and the local trade? If so, write us and we will start you in the set-building business. You can start on a very small capital. This is a fine opportunity to develop a profitable radio business. Special terms to manufacturers using large quantities of our parts.

Send for free diagram spread of L + K penetrator and Elkay Super-Selector set. We maintain a technical department which is ready, without charge, to discuss your problems at any time. Write us freely. Address

### THE LANGBEIN-KAUFMAN RADIO CO.

511 Chapel St., Dept. C., New Haven, Conn.

# LANGBEIN + KAUFMAN

## High Grade "Low Loss" Tuning Devices

**L+K**  
A Guide to  
TECHNICAL  
ACCURACY



VT-25 Variotransformer

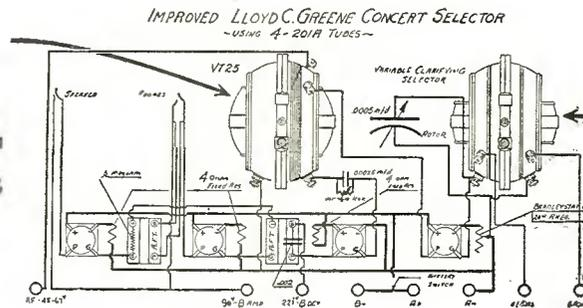

Patent Applied for



Variable Clarifying Selector

## The Heart and Soul of the IMPROVED GREENE CONCERT SELECTOR

The new Lloyd C. Greene Concert Selector, which has just been perfected to use the large storage battery type of tube (VV-201A and C-301"), employs the two L + K low loss tuning devices illustrated above. These tuners are quite different from any others so far brought out and have the following remarkable characteristics:

### "Needlepoint" Selectivity

*The Variable Clarifying Selector.*

- tunes out local B. C.
- clears up muffled signals to full brilliance
- gives complete control of the antenna coupling
- eliminates tapped coils with their high losses
- displaces fixed couplers with their limited range
- works in any standard circuit with all tubes
- \$7.00 at your dealer's.

### Double Amplification

*The Vt-25, Variotransformer*

- an improved R. F. Transformer
- gives amplification of two ordinary R. F. Transformers over the entire B. C. range, 180 to 550 meters
- gives two-tube efficiency on one tube of any type
- supplants the ordinary tuned R. F. Transformer and works without variable condenser
- a satisfying addition to any tube set. Price, \$8.50

### Scientifically Correct Materials and Methods

These tuners are wound on highly polished, pure black hard rubber forms. Hard rubber has a dielectric constant of less than 2, as against 4 to 8 in the most widely known other materials.

The windings are of double silk-covered copper wire secured with a coating of pure Para rubber. No varnish or shellac is used. Every step of the work is done with the same care that is exercised by the makers of fine scientific instruments.

## SEND FOR FREE DIAGRAM CHART

*showing and explaining the new Greene Concert Selector circuit and other effective hook-ups. (Jobbers and Dealers, write for our proposition.)*

**THE LANGBEIN-KAUFMAN RADIO CO.**

511 Chapel St., Dept. C., New Haven, Conn.

# Build the Greene Concert Selector\*

A Most Remarkable Radio Frequency Receiver Which Uses Any Type of Vacuum Tube, Has No Rheostats, and Gives Five-Tube Performance with Four-Tube Economy

By LLOYD C. GREENE, Radio Editor of the Boston Globe

\*Reg. U. S. Pat. Off.

**B**EFORE beginning the description of my Concert Selector I wish to take this opportunity to express sincere appreciation to the hundreds of radio experimenters and enthusiasts of those readers of the Citizens' Radio Call Book who have written from every state in the union and foreign countries to tell me of the gratifying success they have had with the radio receiver which I described in last issue.

Last fall I came to you, through this valued publication, a stranger. Yet, as time has since proven, there was a conviction borne to many of you in this first presentation which induced you to place confidence in my suggestion that you construct a Concert Selector. Now we are a little better acquainted with each other.

In New England, where my radio receivers are better known, more than 75,000 have been constructed by home experimenters in the last three years. During this time I have designed and described but two different sets. Radio receivers of good design cannot be "served out" with the speed of "hot dogs" at a quick lunch, at least this has been my observation.

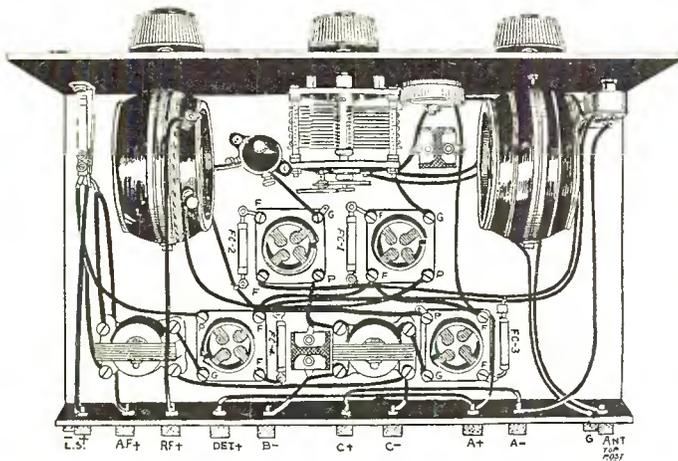

Pictorial Diagram of Receiver

The Concert Selector already has gained great popularity. There has been sufficient demand for it to attract manufacturing interests which have recently placed on the market a factory-built model as well as a complete set of parts in kit form. This information is offered only as further evidence of the genuine merit of the receiver and as assurance to the prospective builder that, when properly constructed, the Concert Selector is an instrument well worthy of its costs in time and money.

As some of you will remember, the Concert Selector model which I previously described was designed especially for those fans who wanted an efficient and economical radio set in which small dry-cell vacuum tubes could be used. This receiver, with four UV-199 or C-299 tubes, is capable of receiving local and semi-distant broadcasts on a non-power type of loud speaker, is reasonably selective and could be operated satisfactorily from a few dry cells. Hundreds of letters which have come to me bear testimony to the fact that this receiver fulfilled a long-felt want on the part of many fans.

Following the success of this model, demand arose for a receiver of similar design in which larger tubes, such as UV-201-A, might be used. After some experimentation it was found that

if a few changes were made in the original circuit and controls of the Concert Selector nearly any type of vacuum tube could be used. The tubes best to use when great volume, extreme distance and high selectivity are paramount demands of the new Selector are given in the order of merit, as follows: UV-201-A or C-301-A, DV-2 or DV-3, and C-299 and UV-199. With the first three types mentioned it is absolutely necessary to use a 6-volt storage battery of not less than 60-ampere-hour capacity for filament lighting. Dry cells in series-multiple connection which give a 6-volt source for the filament current of the last three types of tubes may be used for convenience, but dry cells will not prove as economical as would a storage battery.

Although any of the vacuum tubes named may be advantageously used in the new Concert Selector, the receiver has no rheostats. At first thought this condition of affairs may strike you as "impossible." But it is not, as I will explain. A special filament current control cartridge has been developed in two different forms to take care of filament current from a 6-volt source to any of the types of tubes above mentioned. One form of filament control cartridge is marked "UV-201-A" and this cartridge will properly regulate the filament current to tubes of the following types: UV-201-A, C-301-A and DV-2. The other form of filament control cartridge, marked "UV-199," will correctly govern the flow of filament current to tubes of the DV-3, C-299 and UV-199 types. So it becomes evident that the seemingly impossible can be accomplished with but two sets of cartridges. And these cartridges cost less than a good rheostat.

The advantages of the filament control system employed in the Concert Selector are many. Most important of these is the protection which they offer against burning the filaments of tubes too brightly. Any person who has had only a little experience in using UV-199 and similar low-temperature filament tubes will readily appreciate the value of a device which insures correct filament current. The old bugaboo question of "How brightly should the tubes be burned?" has been forever banished by this simple system of filament current control. Seventy-five per cent of the vacuum tubes which "go dead" prematurely do so because they have been subjected to excessive filament current. This cannot happen to tubes used in the new Selector.

After three or four years' experimenting with different types of radio sets many fans find they have a collection of miscellaneous vacuum tubes, perhaps one UV-199, a C-301-A, a DV-2 and a DV-3, for example. These four tubes, of but little or no value in any other type of multi-tube receiver, can be used not only to advantage in the Concert Selector but without the least difficulty with respect to filament lighting. This is due to the fact that none of these tubes require a voltage source greater than six volts, for which the special control cartridges have been designed.

If you desire to experiment with different types of vacuum tubes as radio frequency or audio frequency amplifiers, or detectors, it is only necessary to insert the proper form of filament cartridge in its receptacle beside the vacuum tube it is to control and forget about the filament adjustment. The cartridge will take care of it. So you see the system is extremely flexible and versatile.

Another advantage accruing to this system of filament current control is one which is a valuable protection to your storage battery. The storage battery should not, for best interests of the battery, be discharged to the point of exhaustion. Such practice rapidly shortens the useful life of the battery and always results in unsatisfactory operation of the radio set during the



He Looks Happy. He IS Happy. And You'll Be Happy, too, with a genuine

# Lloyd C. Greene Concert Selector\*



There's something fascinating about building a good radio receiver. It's real fun to watch it grow, bit by bit, as a part is added here and another there until the instrument is finally completed. And then comes the greatest thrill of all when the product of your own skill and handiwork is finished and ready for the test. **Let us hope that you have chosen wisely and built a CONCERT SELECTOR.** If you have, the surprise of a lifetime will be yours at this moment. You'll tune in on a station of tremendous volume and probably conclude that "It's only a local," and you'll be tempted to pass

it up and reach out for a station "outside." But don't be hasty; wait for your "local" to sign. For it's barely possible that your "local" is 1,000 to 2,000 miles away! And now you will want to test its selectivity: Turn the dials carefully a degree or two and again the loudspeaker booms with volume. After the first experience you decide not to venture a guess this time on the identity of your station. You'll wait until "he" announces. And great is your surprise to find when the selection is finished that THIS IS a local station going full blast within a "wink" on the dials of your distant friend of the moment before.

You'll take pride in operating a CONCERT SELECTOR and in demonstrating its capabilities to your radio friends and you won't be ashamed to say: "I built it." For the completed instrument is as beautiful in appearance as it is dependable in performance. Nor is its beauty "only skin deep," as you can readily see by glancing at the vitals of the receiver as shown in the accompanying photographs. No more straggling wires, no more unsightly, haphazard assembly of parts, and no more useless rheostats. All wiring is neatly concealed beneath the base panel, which is of bakelite, handsomely engraved.

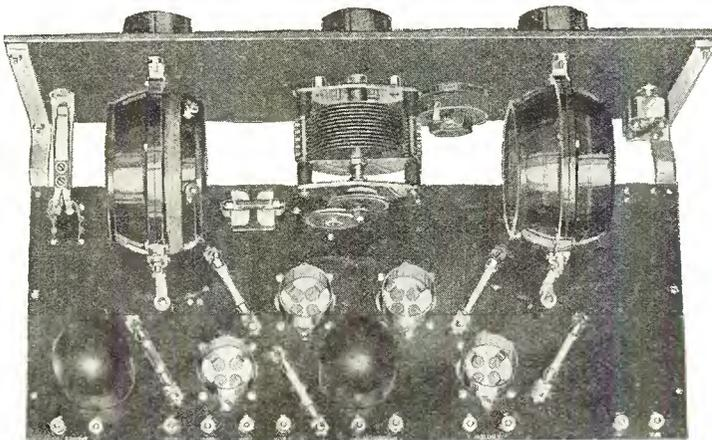

Filament current control is effected by specially designed Resistor Cartridges which insure correct brilliancy of vacuum tube filaments for maximum results. Both front and base panels are accurately drilled to make construction simple and easy for you. All of the parts necessary to build the CONCERT SELECTOR, even to the last nut and screw, will be found in this kit set, and with the aid of

pliers, screwdriver and a soldering iron, in an hour's time the completed receiver will stand before you just as shown in the illustrations.

For your information and protection the CONCERT SELECTOR was designed by Lloyd C. Greene, whose signature appears engraved on the front panel of every genuine Kit Set and every genuine factory-built instrument. More than 75,000 Radio Receivers of Mr. Greene's design have been constructed in New England alone by radio fans who have successfully followed his directions.

If you wish to construct a good broadcast receiver you can do no better than to set your choice upon the LLOYD C. GREENE CONCERT SELECTOR. Price of Kit with complete instructions, \$65.

\*Reg. U. S. Patent Office.

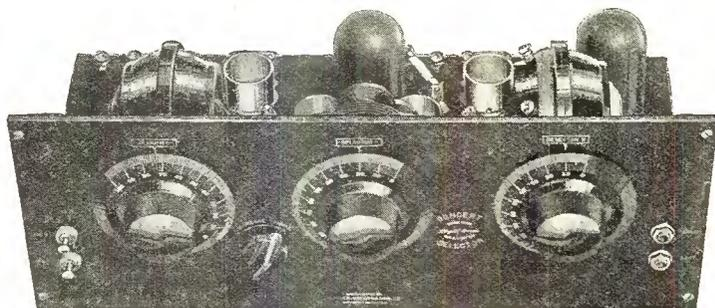

Manufactured by

CULVER-STEARN'S MFG. CO., Worcester, Mass., U. S. A.

## Lloyd C. Greene Concert Selector\*



*The Receiver with  
Five Tube Performance  
and Four Tube  
Economy*

*"Beautiful in Appearance—Dependable in Performance"*

# WHICH SHALL IT BE?

When you have become convinced, as thousands upon thousands already have, of the truly wonderful things which Radio Broadcasting offers, you also will want to be numbered in that vast Radio Audience which nightly listens in on the world. And when you join the Radio Audience you will want a seat of vantage just as you now do when attending the theatre to witness a play on the legitimate stage.

In choosing a ticket for the theatre one would not think of asking simply for "a seat," for obvious reasons. And while not quite so obviously unwise, yet, in selecting "a seat" in the Radio Audience, that is about all one can expect to get when he buys just "a radio." It is your privilege to ask, and our pleasure to suggest, what your guide should be in choosing "a seat of vantage" when you enter the great Auditorium of Radio Broadcasting.

For most enduring satisfaction choose a broadcast receiver which embodies PURITY OF TONE, SELECTIVE TUNING and ABUNDANT VOLUME.

## The LLOYD C. GREENE CONCERT SELECTOR

Offers you all of these desirable features and more. It is adaptable to either indoor or outdoor antenna; it operates economically from dry cells or storage battery; it performs dependably with different types of vacuum tubes. It has aptly been acclaimed the most versatile receiver in Radio.

Sensibly  
Priced at **\$100**

*Which Shall It Be, "Just a Radio," or a*

## LLOYD C. GREENE CONCERT SELECTOR?

*\*The Concert Selector was designed by Lloyd C. Greene, long recognized as an authority on radio receiver design. In New England alone more than \$1,000,000 has been spent by radio fans for Greene Receivers.*

Manufactured by

**CULVER-STEARN'S MFG. CO., Worcester, Mass., U. S. A.**

*For 15 Years Manufacturers of High Grade Electrical Apparatus.*

**ZENITH**  
**KENNEDY**  
 Radiodyne  
 THERMODYNE  
 ULTRADYNE  
 MURDOCK  
 AZARKA  
 Pfanstiehl  
 MICHIGAN  
 Deresnadyne  
 MALONE LEMON  
 MASTER RADIO  
**ROYAL**  
 Howard  
**Pathé**  
 HARMONY  
 AUDIOLA  
 GLOBE  
 EAGLE AND  
 MANY OTHERS

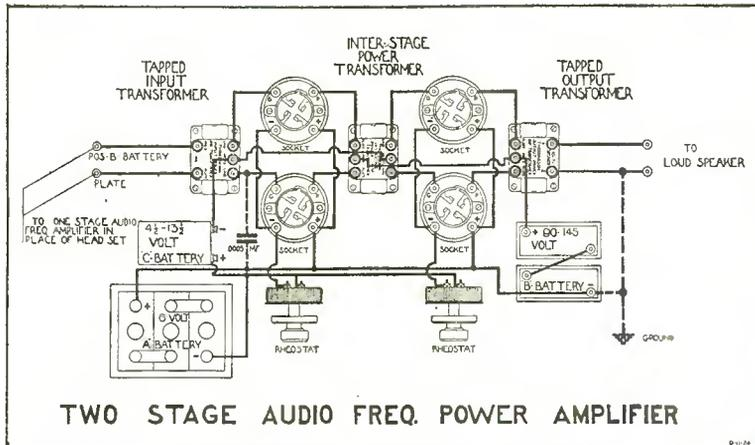

## When Better Transformers Can Be Bought- They Will Be Thordarsons!

Tone quality! Clear, natural reception! Even volume over the entire musical range! That is what the public demands today. And is getting in the finer sets—equipped with Thordarsons for musical amplification. Leading set makers continually test and compare transformers. They use more Thordarsons than all competitive makes combined—which answers the transformer question. If you want the best amplification, simply follow their lead; build or replace with Thordarsons! Unconditionally guaranteed.

They Use

# THORDARSON

Super TRANSFORMERS  
 Standard on majority of quality sets

They say—

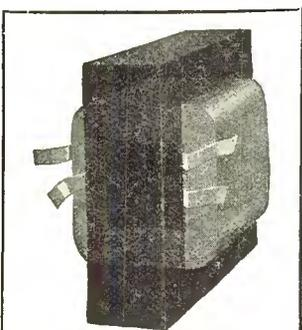

### THE EXCLUSIVE THORDARSON SQUARE COIL Leak-Proof Construction

The Thordarson-made layer-wound SQUARE coil fits snugly around the square core. Coil can't turn—no open circuits due to layers slipping. No air spaces between coil and core (exclusive Thordarson feature)—no lost energy, no lost volume (especially on low notes), no leaks from primary to cause howls in set. (Thordarsons are quiet, even on the third stage.) Over-size core (3/4 in. cross section) provides 50% larger magnetic circuit—minimizes core losses, prevents over-saturation. Broad ribbon leads locked in the coil give short, direct and more durable connections to the patented inner-locked terminal posts—no tangled or broken wires inside case (exclusive). Each Thordarson transformer comes completely protected, shielded and tightly clamped in a stout case. No rivets or screws through the special silicon steel core to cause short circuits or eddy current losses between the laminations (exclusive). Do you wonder that Thordarson leads the field in output and produces more transformers for more makers of quality sets than all competitors combined?

**They Say of the New Super-Zenith:**  
 "Greater clarity and volume. Amplification is always at a maximum in each stage for any wave-length. Three stages audio frequency amplification."  
 Zenith amplifies with Thordarsons!

**They Say of the Kennedy:**  
 "The Kennedy tone quality is superb; full-rounded, musically pure reproduction of any program within a good long range. No hollow tones or distortion. For the Kennedy is a musical instrument. A musician will enjoy its purity of tone."  
 Kennedy amplifies with Thordarsons!

**They Say of the Murdock Neutrodyne:**  
 "To hear the real voice of the nation full and clear—your room. . . . Volume that floods your room. . . . Distant stations can be tuned in with remarkable clearness and volume."  
 Murdock amplifies with Thordarsons!

**They Say of the Andrews Deresnadyne:**  
 "It secures the finest tone and high selectivity with increased volume and distance. It

brings to the home—a reproduction of music really comparable to the original. In volume the Deresnadyne will give anything from a mute tone to a volume that fills a large hall."  
 Deresnadyne amplifies with Thordarsons!

**They Say of the Ultradyne L-2:**  
 "Selectivity is so high and amplification so strong that distant stations can be tuned in through local stations and put on the loud speaker."  
 Ultradyne amplifies with Thordarsons!

**They Say of the Pfanstiehl Model 7:**  
 "People now want trouble-proof service and purity of tone. The new Pfanstiehl . . . gives a clear, natural tone at any distance. . . . There is no distortion, however great the amplification. . . . It comes in like velvet. . . . Two stages of audio amplification—low ratio, of course, to give perfect quality, with all the volume desired."  
 Pfanstiehl amplifies with Thordarsons!

**They Say of the Howard Neutrodyne:**  
 "It brings in distant stations distinctly. It has natural tone qualities. It has remarkable volume."  
 Howard amplifies with Thordarsons!

**They Say of the Radiodyne:**  
 "When you own a Radiodyne you can hear singers' voices and orchestral harmonies faithfully reproduced thru the loud speaker . . . so clear and distinct that you lose nothing."  
 Radiodyne amplifies with Thordarsons!

All stores can now supply Thordarsons. Accept no substitutes. If your dealer is sold out, you may order from us by mentioning his name. Interesting bulletins on amplification mailed free. Write



Six floors, 100,000 square feet, devoted to making transformers.

**THORDARSON ELECTRIC MANUFACTURING CO.**  
 Transformer specialists since 1895  
**WORLD'S OLDEST AND LARGEST EXCLUSIVE TRANSFORMER MAKERS**  
 Chicago, U.S.A.

## New!

The Thordarson INTERSTAGE Power Amplifying Transformer. Provides two stages of POWER amplification when inserted in circuit between input and output Power Amplifying transformers as per diagram at left. Four tubes are required, but the quality of the reception more than repays you. Only Thordarson builds a transformer of this type.



Thordarson INTER-STAGE Power Amplifying Transformer. Unconditionally guaranteed. . . . \$8

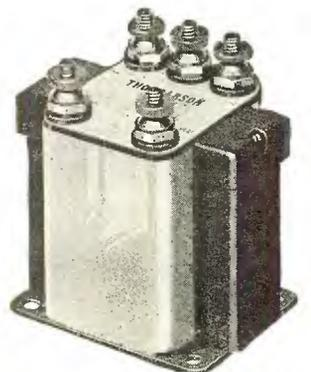

Thordarson Power Amplifying Transformers. Give best results when preceded by two stages using 3 1/2:1 Thordarson A.F. Transformers. May also be used as 4 1/2:1 audio frequency transformers by disregarding center taps, or as a coupling transformer for loud speakers. Unconditionally guaranteed. Per pair. . . . \$13



Thordarson "Super" Audio Frequency Transformers are the best at any price. Unconditionally guaranteed. Three ratios: 2-1, \$5; 3 1/2-1, \$4; 6-1, \$4.50.

### Super-Het Builders!

For the "Best" 45,000 Cycle Super-Heterodyne "RADIO" and other leading authorities recommend in highest terms the Thordarson 2:1 ratio transformers. Take no others!

# Samson Helical



## Showing SAMSON Helical Winding

found only in SAMSON Transformers, which insures much clearer reception from far greater distances due to its very much lower distributed capacity, resistance and leakage effect.

These lower losses are obtained by eliminating paper or other insulation between layers. Since adjacent parts of the winding are never more than 80 turns apart instead of the usual 800 to 1200, the voltage between them is correspondingly reduced. This makes layer insulation unnecessary, reduces the length of wire per turn, cutting down resistance, and also lowers the leakage between turns.

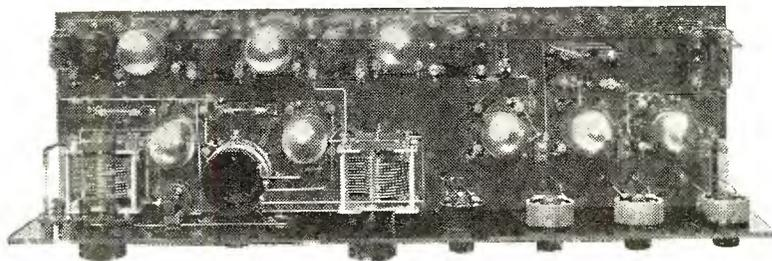

## Make This Wonder Radio Set Yourself

Build the set described on page — of this issue of the Citizen's Radio Call Book.

Thousands have been built. The owners report remarkable results—distance, selectivity, volume and tone quality surpassing any set they ever heard or operated.

You cannot buy as good a set as this; you must build it yourself. And when you have it finished you can get "Entertainment from Everywhere."

People who have built this set say that it goes through powerful local stations and brings in what they go after if it is on the air.

During Trans-Atlantic Test Week, a set like this was operated at an official Government Listening Post on Long Island, N. Y. In one evening it got Edinburgh and Glasgow, Scotland, and Birmingham, England, on the loud speaker using only **one** stage of audio amplification.

All along the Atlantic coast, owners of these sets say that they have no difficulty in getting Pacific coast stations.

SAMSON Helical Wound L. W. Transformers and the SAMSON Oscillator Coupler make this set possible. Price \$4.50 each.

For your convenience, three matched SAMSON L. W. Transformers, one matched Filter Transformer and a SAMSON Oscillator Coupler are assembled in one package.

Your dealer has or can get SAMSON Helical Wound L. W. Transformers for you. If you have difficulty, write us.



## SAMSON Radio Frequency Transformers Type HW-RI

give higher amplification without detectable distortion, greater sensitivity and unusual compactness.

The amplification in intermediate frequency amplifiers the SAMSON Helical Winding makes possible is truly remarkable and, when SAMSON Audio Transformers are used in the same set, assures reception right down to the static level. No set can do more.

Even the first detector tube can be operated at its maximum efficiency in sets having two detectors if the SAMSON Filter Transformer is used.

## RADIO DIVISION SAMSON ELECTRIC COMPANY

Manufacturers Since 1882

Canton, Mass.

Direct factory representatives in 19 American cities and in foreign countries in all parts of the world.

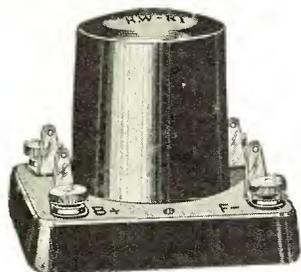

# Wound Transformers

## SAMSON Transformers Help Spell Success

Every day more and more experienced set builders are using SAMSON Helical Wound Transformers exclusively.

Radio engineers in all parts of the country have tested SAMSON H. W. Transformers on all kinds of circuits and hook-ups. Now, having proved that SAMSONS better any set, these engineers are recommending SAMSON Transformers to others as well as using them on their own sets. Manufacturers of the better type of receiving sets realize that the quality of the transformer affects the operation of their sets. Many are forgetting price and using SAMSONS although SAMSON Transformers cost them from one-third more to twice as much as the transformers they had been using.

You, too, will notice the difference the minute you use SAMSON Transformers. Musical notes come through clearly and distinctly—full, rounded, resonant—with a tonal quality which can be had only with SAMSON Helical Wound Transformers.

For forty-three years the Samson Electric Company has been manufacturing apparatus which had to meet the highly critical and scientific tests of engineers, architects and scientific investigators.

SAMSON Helical Wound Transformers are made for those in radio who are satisfied only with the finest apparatus and parts. Yet, at \$5, SAMSONS cost no more than inferior transformers.

Your radio dealer has or can get SAMSON Transformers for you. Insist on SAMSONS if he tries to sell you some other kind. If he will not get SAMSON Transformers for you write us and we'll see that you are supplied.

### SAMSON Audio Frequency Transformers

HW-A2 in two ratios—6:1 and 3:1

bring in distant stations on loud speakers with the quality demanded by the most exacting music lovers.

You will be delighted with the absence of distortion—for the singer's tones come to you as though you sat in the distant concert hall. The speaker's voice is clear and vibrant. You get the ringing tone of the band instruments; the delicate notes of muted violin strings.

You will be astonished with the far greater amplification obtained which places the offerings of a nation at one's fingertips.

RADIO DIVISION  
**SAMSON ELECTRIC COMPANY**

Manufacturers Since 1882

Canton, Mass.

Direct factory representatives in 19 American cities and in foreign countries in all parts of the world.

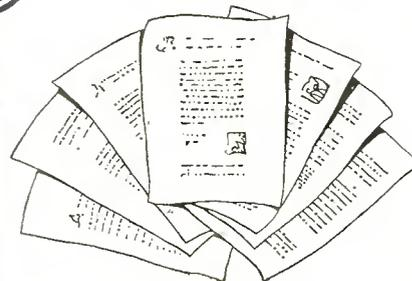

#### Comments from Experts

"The Samson audio transformers were found superior to a number of various makes tested for this kind of work. An uncontrollable howl was always present when some of the other transformers were used."

—Chicago Daily News.

"The Samson transformer also has the advantage of the helical winding in which the distributed capacity effect is very materially reduced."

—R. W. Cotton.

Recommended by R. W. Bradley for the "DX Go-Getter" in December *Wireless Age*.

"The Samsons are practically free from distortion on any of the frequencies. \* \* \* The amplification is far beyond that of the ordinary type transformer proving that volume does not have to suffer in the effort to obtain distortionless reception. \* \* \* The Samson transformer does just about everything its manufacturers claim for it, as we have proven by actual tests in Everybody's Radio Weekly Experimental Laboratory."

—Everybody's Radio Weekly.

"The transformers (Samson) seem to be well made and certainly function beautifully as audio amplifiers."

—J. C. Keogh, Chicago American.

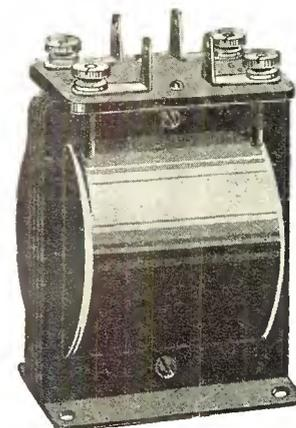

# Construction Data on Super-Heterodyne Receivers

## 1. Position in Field

**A**MONG all the means which have been provided by the mind of man and the ingenuity of the skillful craftsmen for the reception of wireless signals, the Super-Heterodyne stands out clearly as the most sensitive, selective and satisfactory equipment for the reception of Radio Telephony.

This universal acknowledgment of the supremacy of the Super-Heterodyne, on the other hand, does not depreciate the usefulness of the smaller sets any more than the ranking of the Eagle as the King of Birds lessens the beauty or usefulness of bird life in general. But for those who want, in a single instrument, the ultimate in sensitivity, in selectivity, in volume, in tone quality—in short, the most satisfactory Radio reception—nothing in the field today will equal the Super-Heterodyne.

## II. Principle of Operation

The fundamental principle of the Super-Heterodyne is the efficient amplification of Radio frequency currents before they are rectified and become audible.

The amplification of low wave length Radio Frequency currents at their very high signal frequencies is an exceedingly diffi-

plified long wave into audible frequency so that it can be heard by the human ear and deliver it to the detector jack or to the

### Audio Amplification Section

This consists of two Audio amplifying transformers, two vacuum tubes with associated jacks and phone bypass condenser. This is used to further amplify the signal at audio frequency and deliver the increased volume to the loud speaker.

### III. Data on Construction

Three photographs and the wiring diagram of an 8-tube 60 kilocycle Super-Heterodyne are shown in the illustrations accompanying this article. The parts necessary to construct this receiver are not so many nor as expensive as is generally believed, as they list at about \$75, including the panels, and amateurs and experimenters will find their efforts will be amply repaid by its construction. One thing, however, should be kept uppermost in mind by the constructor—use only the best parts, for “the best is the cheapest in the long run.”

#### Loop

The specifications of the loop which is suited to this receiver are as follows:



Front View of Receiver

cult thing to control. High frequency currents will jump from one wire to another at the slightest opportunity, and the extremely weak currents received are often dissipated before they can be used. This tendency increases with the frequency, and the lower the wave length, the higher the frequency.

In order to avoid this difficulty and to avoid these losses, instead of attempting to amplify the low wave length at their high frequencies, the Super-Heterodyne converts the incoming waves to a higher wave, which means lower frequencies, and amplifies them at this intermediate frequency before passing the signal along to be rectified by the detector and amplified at audio frequencies as in other receivers.

In order to understand the operation of a Super-Heterodyne, it is necessary to understand its component parts. They are briefly as follows:

#### The Oscillator Circuit

This comprises the third section of the set, and is composed of an oscillator coupler, vacuum tube with its grid leak and condenser, rheostat and tuning condenser. This circuit sets up the independent high wave length signal at low wave length and delivers it to the frequency changing equipment as noted above.

#### The Intermediate Frequency Amplifying Units

These consist of a filter and three long wave Radio transformers with three vacuum tubes and rheostat. Their sole duty is that of amplification of the new long wave signal (at low frequencies) received from the Frequency Changing Equipment, which is delivered enormously amplified to the rectifying or

#### Detector Unit

This consists of a vacuum tube, grid leak and grid condenser and its rheostat. The purpose of this unit is to convert the am-

plified long wave into audible frequency so that it can be heard by the human ear and deliver it to the detector jack or to the

Length of long sides, 25 inches; length of short sides, 12½ inches; distance across the top of the loop, 18 inches; total height of the loop, 33 inches. The wire on the loop is wound on 5/16-inch centers and is composed of 12 turns of No. 18 insulated braid with a tap taken off at the exact center of the wire. The pieces of wood which support the wire are 4x¼-inch thickness by 1½-inches wide and notches are cut in one side of these, which are ⅛-inch deep and 5/16-inch on centers to accommodate the wire. The loop frame should be made of any good dry 1-inch square wood.

There is a great deal of question on the average experimenter's mind as to the relative merits of Litz wire as against that of ordinary stranded wire. If the constructor is building his own loop, the advantages of having Litz wire is probably not worth the extra amount of money which the use of Litz would involve.

There are a great many people who desire to use an antenna and ground with any receiver they may use. If it is desired to use an antenna with this set, all that is necessary is to connect the antenna wire to the ground wire by means of approximately 4 or 5 feet of stranded insulated wire. This wire may be turned once around the outside of the loop.

#### Panels

In selecting panels both for the front and base of this set, the constructor is given considerable latitude in that he may use hard rubber, bakelite or many of the composition panel materials available on the market. If hard rubber is used, the panel should be ¼-inch in thickness; otherwise, 3/16-inch will be satisfactory.

The front panel is 28x7 inches and the base panel 27x8 inches. It is recommended that the base panel be of this material or similar, rather than of wood—whereas good dry wood or wood impregnated with paraffin is an exceptionally good insulating

material; in a good many cases it has been found that wood which has not been seasoned has caused a great deal of trouble when used for baseboards—particularly if bare wires are led through the board and come in contact with the wood.

#### Variable Condensers

In choosing variable condensers for this set, it is well to purchase one of the so-called "low loss" type, with a grounded rotor. There are many of these on the market which are very good.

Be sure in buying this that the minimum capacity is low—at least not more than .00002 mfd., this reading to be taken when the rotor plates are entirely removed from those of the stator.

There are two variable condensers of .0005 mfd. maximum capacity required for this set and one small variable feed back condenser of approximately .000045 mfd. maximum capacity to control regeneration used in the first detector.

#### Oscillator Coupler

The oscillator coupler is rather a departure in design from the ordinary coupler. On account of this fact the following data are set down to explain the reason for its design:

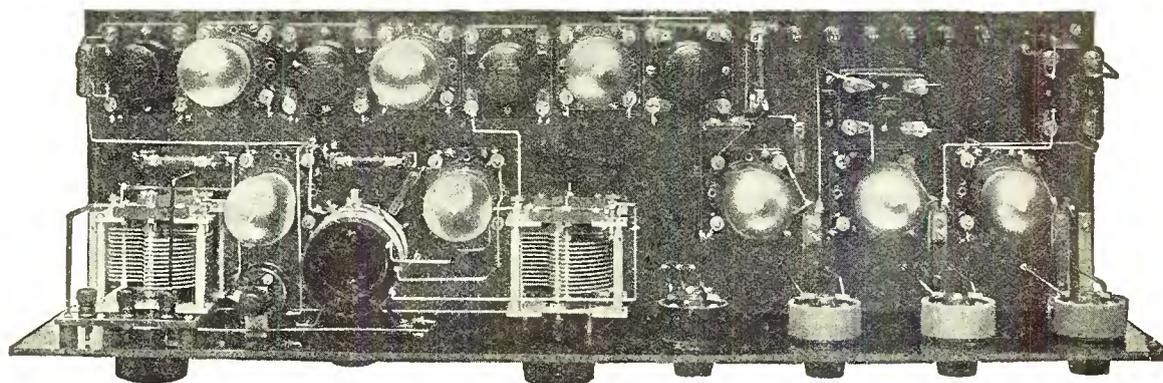

Looking Down on Receiver

This coupler has been designed to give the necessary variation in frequency over the range of the 5,000 meter intermediate frequency transformers. This means that it will not be found that part of the time the heterodyning will be done by the harmonics and part of the time by the fundamental. For the proper operation of the 5,000 meter transformers, the oscillator must range in wave-length from about 215 meters to about 600 meters. This variation can be obtained within the scale of the ordinary .0005 mfd. condenser dial.

In order to accomplish this wide variation in wave-length, it is necessary that the winding of the plate coil on the coupler shall not be of wire of too small a cross section, for as the cross section becomes smaller, the winding is more compact with the attendant increase in self capacitance, which tends to make the lowest frequency obtainable with the coil in the oscillator circuit higher than it would be were this capacitance not present, and this apparent capacitance adds to that of the variable condenser.

Another fact which cannot be overlooked is that in order for the oscillator coil and condenser to "oscillate," the energy necessary must come from the tube, or more properly, from the "B" battery through the relay action of the tube. In order for this to happen, the coupling between the oscillator coil and the grid coil must be right. In an oscillator designed for use for the Super-Heterodyne, frequency variation from one extreme to the other must be obtained by a single uniform adjustment for convenience. This means that there can be but one coil and but one condenser.

For any given frequency, there is one best relationship for the oscillator coil, the grid coil and the condenser. In the oscillator of the Super-Heterodyne, a compromise must be made. Above all else, the compromise must not effect the ability of the oscillator.

In the coupler which is used here, an extra tap is taken off the oscillator coil for the plate lead, which increases the stability at the high frequency end, and allows at the same time sufficient coupling between the plate and grid coils to insure operation with the entire scale of the condenser.

#### Intermediate Frequency Amplifying Transformers and the Intermediate Frequency Filter

The Intermediate Frequency Amplifying Transformers have been said to be the heart of the Super-Heterodyne circuit, and this statement is without question true, as the difference between a good Super-Heterodyne and an average Super-Heterodyne lies in the material used in this particular part of the set.

There has been a great deal of discussion as to which wave length is best, and each wave length from 2,000 to 10,000 meters will find its particular supporter, but the 5,000 meter band seems to offer the advantages of both the higher and lower without some of their disadvantages.

There has also been a large amount of discussion as to the relative advantages of iron core transformers versus air core transformers. In the design of the transformers used in this set, it is believed that a happy medium has been struck, as the transformers are primarily of the air core type with a very small amount of iron in them.

This iron is introduced only in a quantity sufficient to broaden the peak of the transformer. These transformers are sufficiently

sharp so that great amplification is obtained, and yet they are not so sharp that they will not work properly together or so that the side bands are cut.

The Input or Filter Transformer is of the air core type, and brought to a sharp peak by the use of a .001 mfd. fixed condenser across its primary winding. This Input Transformer is sufficiently sharp to eliminate interference and cause sharp tuning, but its peak is broad enough so that none of the side bands are prohibited from passing through it—thus insuring good quality of reception. By its use the first detector tube acts as a by-pass for the frequency of the incoming wave.

#### Rheostats and Potentiometers

There are three rheostats required in this Super-Heterodyne—one controlling the first and second detector tubes of 15 ohms resistance; the second one controlling the oscillator, and the three intermediate frequency tubes of 5 ohms resistance, and one controlling the two audio tubes of 15 ohms resistance.

A Potentiometer of 200 ohms resistance is used.

#### Sockets

There are eight sockets required for this set. A high grade socket should be used, preferably of the non-metallic type, such as those made of Pyrex, Porcelain or all Bakelite. In fact, any good socket may be used, but it is highly desirable that a socket, either spring-cushioned or with an under mounting of sponge rubber, be chosen to avoid the microphonic action of the tubes from becoming audible.

#### Grid Leaks and Fixed Condensers

It will be noted that the grid condensers of the first and second detectors are in the usual position, and that the grid leaks are connected from the grids to the positive ends of the filament.

With the grid leaks connected in this manner, it makes no difference to which side of the filament the grid return is connected, since there is no direct current in the grid return, owing to the presence of the grid condenser.

In the oscillator circuit, there are also a grid leak and grid oscillator. This is essential for satisfactory operation of the



oscillator over the entire range. With the grid leak and condenser, a large amount of energy is lost and the grid circuit when the oscillator is in operation, since for a part of the time during each cycle the grid is quite positive.

A UV201A tube will operate best as an oscillator with a grid leak of about 30,000 ohms, although this value is not critical. A grid leak of 50,000 ohms or .05 meg-ohms will work very satisfactorily.

The grid oscillator condenser only acts as a by-pass for the alternating current and need only be large enough to serve this purpose. For the oscillator in question, a value of about .005 mfd. will be good, although a .004 mfd. or a .006 mfd. will do as well.

It is important, particularly in the filter transformer, that fixed condensers which are of the capacity marked on them be used. These condensers should be of the mica type with the exception of the large by-pass condensers, which may be of waxed paper and tin foil construction. All condensers must be sufficiently well constructed to withstand a high plate voltage.

On the Filter Transformer it is suggested that the purchaser ask to have a .001 mfd. condenser tested on a capacity meter to insure its being the correct capacity. The capacities used are as follows:

1 Oscillator tube grid condenser.....	.005	mfd.
1 First detector tube grid condenser.....	.0005	"
1 Filter tuning condenser.....	.001	"
1 Second detector tube grid condenser.....	.0005	"
1 Phone by-pass condenser.....	.001	"
2 "A" and "B" battery by-pass condensers.....	1.	"

**Audio Transformers**

Any good Audio Transformers may be used. It will be found that one having as low a distributed capacity as possible will give the clearest tone, and at the same time largest volume per stage. A six to one ratio is recommended for the first stage, provided one having a low capacity effect is used. A three to one ratio should be used on the second stage.

**Jacks and Switches**

It is recommended that high grade jacks be used, as it is not advisable to use a jack which would show leakage across its terminals. A switch to break the "A" battery circuit should be used. The potentiometer is directly across the "A" battery, and although the consumption of current is small, it is there nevertheless, unless the "A" battery circuit is broken.

**Batteries**

Any good "B" batteries may be used on this set. There are 90 volts used in all—45 on the radio frequency and detector tubes and 90 on the audio amplifier tubes.

Although the first cost is greater, storage "B" Batteries are recommended for any set of this character, as in the long run they are by far the cheaper, as the life of dry "B" Batteries on a set of this character is not high, due to the current consumption, which is normally from 25 to 30 miliamps.

Any good 6-volt 100 amp. hour storage battery or larger is recommended for the filament current, using C301A or similar tubes.

**Dials**

To obtain the best results with the Super-Heterodyne, Vernier Dials are a necessity.

**Wire and Solder**

Small tinned copper wire or insulated wire is the very best material to use in the construction of this set. Wire smaller than No. 14 is not recommended for use in the filament circuit, but smaller wire may be used elsewhere in the set.

Rosin core solder should be used, or plain solder with a mixture of rosin and alcohol as a flux. Never use paste or acid core solder, as this has a tendency to create trouble later on.

**Wiring**

It is rather needless to go into a long description as to how to wire this set.

A few general ideas, however, may be helpful.

The first thing to do is to fasten the instruments to the base panel and to the front panel. Do not, however, put these panels together. Wire all that can be done on the front panel, and then wire all that can be accomplished on the base panel.

When these are finished, attach the front panel to that of the base panel by brackets and finish the wiring from panel to base. Make all the joints rigid enough so that it is possible to slide the set on your table by the joint which has just been made. This will save you the trouble of broken connections at some later date.

The best way to proceed is to do all of the filament wiring first. Then follow with the wiring of the "B" battery connections; this, in turn, may be followed with wiring of the loop tuning circuit and the oscillator circuit.

**Testing and Preparing for Operation**

The first thing to do is to be sure that the wiring is correct so that the tubes will not be burned out; connect your "A" battery to the "A" battery binding posts, taking one tube and inserting it in each successive socket with the filament switch on and rheostat controlling the particular tube socket which you have the tube in, about half way on. If the tube lights in each place controlled by the rheostat corresponding to the socket in which the tube is inserted, you may be reasonably certain that the filament wiring is correct.

Then connect the "A" battery to the detector "B" battery terminals, taking one tube and inserting it in each socket as before. If the tube does not light, this wiring is correct. Do the same thing with the "A" battery connected to the amplifying "B" terminals.

Next connect the "B" battery to the "B" battery binding posts and insert the telephone plug in the detector jack. This should give you a click, showing that the "B" battery circuit is correct. Now insert one tube in each socket successively with the filament current on, and if nothing happens, the "B" battery connections are not shorted with that of the "A" battery. Now put all tubes in their respective sockets and connect the three tap loop to the

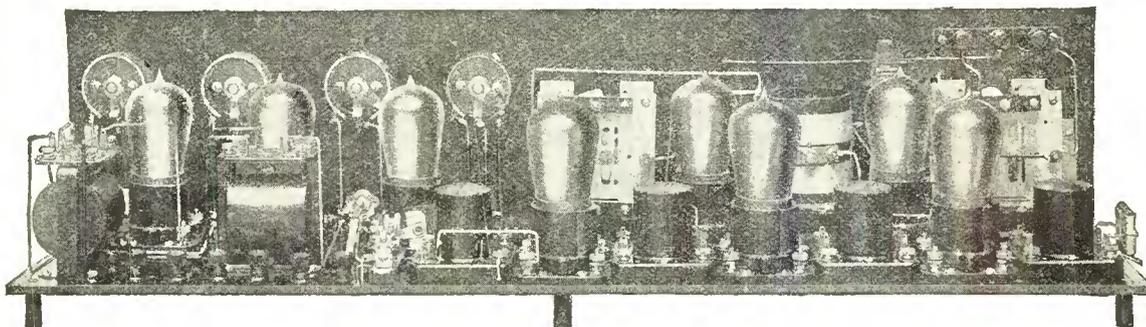

Rear View

three binding posts. The center tap of the loop must by all means be connected to the center binding post.

Turn on the detector tubes to approximately normal brilliancy, which will be about three-quarters of the rheostat. Follow this by turning on the intermediate frequency amplifiers and the oscillator by means of the rheostat, which controls them, to their normal brilliancy. Be sure that the small variable condenser is at its minimum capacity. When listening to a low wave-length station, 1,000 or more miles away, move this condenser up to the point where the greatest signal strength is obtained without distortion. In some cases it may be possible to throw the first detector tube into oscillation by means of this small condenser, and, of course, it would be set just beneath this point. Now that this condenser is set, it will not have to be varied.

On a station of at least 1,000 miles away, make the adjustment of the oscillator rotor to the minimum coupling position that it is possible to attain without decreasing signal strength. This may be accompanied by a small change in the oscillator condenser dial. Now that this adjustment is fixed, it need not be changed, except when a new oscillator tube may be inserted in the oscillator tube.

# You can save about \$60.00 on your radio if you will put a Model "S" Acmeflex Kitset together

*Like earning \$60.00 cash for a few hours' fun*

The wonderful new Model "S" Acmeflex Kitset would cost you if assembled complete in our factory, \$150.00. But it costs you only \$80.00 (plus a small cost for a cabinet) if you put it together yourself. You can easily do it. We give complete directions. You save about \$60.00.

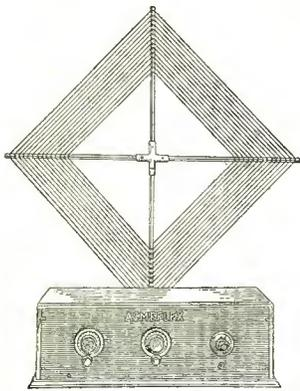

**A set anyone can put together**

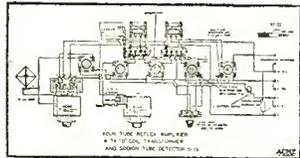

**Wiring diagram new Model "S" Acmeflex Kitset**

The radio fan will especially notice the use in the new Model "S" of the D-Coil radio frequency tuning unit and the vacuum tube detector, which together wonderfully improve distance, reception, and selectivity.

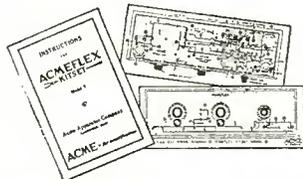

**Directions given so simply that anyone can follow them**

Above are illustrated the circular of printed instructions and the life-size diagrams of the wiring, which are packed with each Model "S" Kitset. Step by step the making of the set is described in clear, simple language—just simple operations which anyone can easily follow.

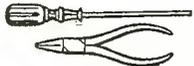

Only two tools required—a screwdriver and pliers—and they are included in the Kit.

### Enthusiastic praise from Model "S" users

From New York City:

"Well, I believe we had every jerk-water station in the U. S. Stations I never heard of before. At 11:45 P. M. I pulled in KFI (Los Angeles, Calif.) on the loudspeaker. At 12:15 A. M. KGO (Oakland, Calif.) I went back and picked up KFI three times. My home is located in what is considered one of the worst sections for radio. The skyline of New York is directly opposite me. I am on the harbor, a mile from the Navy Yard, and have three bridges with electric trains to bother me, but with it all I got the coast."

THE perfection by Acme engineers of the new model "S" Acmeflex Kitset not only makes it possible for you to get a \$150 worth of radio for only \$80 (plus a cabinet), but it also places in your home the famous Acme 4-tube Reflex (trade mark) now wonderfully improved through the combined use of a D-Coil radio frequency tuning unit and a Sodian S-13 Detector Tube. You get greater distance, greater selectivity and better reception. We could make it for less than \$80, but it would not give results.

### Contents of Kitset is complete

ALL the parts necessary for making the complete set are included in the Kitset. Even the loop is included. There is no antenna to erect. Each part is packed carefully in its own carton and not thrown in a jumbled heap. Each part is fresh, bright, new and well made. Screws, nuts and bolts are in a box of their own. Everything is included; nothing forgotten. The only accessories to get are the tubes, batteries, loud speaker and cabinet. We have put everything in the kit but the fun.

### No technical knowledge or workshop necessary

You do not have to be a radio engineer in order to put this set together. Anybody can do it. Many have done it easily in three hours—had the set complete and working all in one evening. Only two tools are needed, a screwdriver and a pair of special Acme pliers and they are included in the kit. Good tools which you can use afterwards for other things. The panel is all drilled for you, and no soldering is necessary. If you do not want to assemble the set yourself, there are plenty of amateurs and dealers glad to do it for you at a nominal charge, still saving you a lot of money.

### Complete printed directions and diagrams

WITH each Kitset are included complete printed directions, telling you just how to put the set together, step by step; just simple operations that anyone can easily follow and have a good time doing it. In addition to these printed directions are two life-size printed diagrams, one giving the wiring diagram for the set both from the baseboard view and the panel view, and the other showing, in actual size, exactly how every wire in the set is bent and connected.

### More, tube for tube than any other set

THE finished Model "S" Acmeflex Kitset, a Reflex (trade mark) set, gives two stages of radio frequency amplification, two stages of audio frequency amplification plus a D-Coil radio frequency tuning unit and detector, with only five tubes.

The new Model "S" Acmeflex Kitset will pull in more stations, louder and clearer, on a loop and loud speaker, than any other set using the same number of tubes (five), and more than many sets using from six to eight tubes. It is easy to tune. There is only one tuning dial.

### Everything on loud-speaker

The selectivity, range and volume of this set make it remarkable for loud, clear reception of stations near and far. The pleasure and the joy of it can be yours at a price only a little more than half what it would cost you to buy the set complete. Anyone can now sit down and put together a set that will perform on a plane with the highest-priced factory-made receivers.

### Note these features of Model "S" Acmeflex Kitset

- Complete directions given for putting set together.
- No antenna to erect.
- No technical knowledge of workshop required.
- Only two tools and they are in the Kit.
- No soldering to do.
- Only one tuning dial.
- Excellent reproduction.
- Greater distance, sensitivity and selectivity.
- Non-radiating—won't bother your neighbor.
- Saves you about \$60.00.

Send coupon now and start putting this wonderful set together

Just tear out the coupon below; write your name and address on it plainly, mail it to us, and we will send you by return mail a special circular completely describing this set in every detail. Send coupon today.

### Send this coupon

ACME APPARATUS CO.,  
Dept. O1, Cambridge, Mass.

Send complete information about the new Model "S" Acmeflex Kitset to:

Name.....

Street.....

City..... State.....

### ACME APPARATUS COMPANY

Transformer and Radio  
Engineers and Manufacturers

Dept. O1 Cambridge, Mass.

# ACME ~for amplification

# A Description of the New Five Tube "Reflex" Set Using the "D" Coil Transformer and Sodian Tube Detector

By G. E. M. BERTRAM

**W**HEN anyone contemplates getting a radio set there are two questions which always present themselves; first, how much can I afford to invest, and, second, how can I get the best set that my money will buy?

If he turns for information to the advertisements in newspapers and some magazines he will immediately see that nothing is impossible. That almost every set will give "coast to coast" reception at any time and do twice as much as every other set, and if he looks at circuit diagrams he will meet a maze of supers and dynes which may or may not mean anything to him.

But in spite of the thousands of circuits which have been printed and exploited, there are only six basic radio reception systems of which all the circuits are merely adaptations. These systems are as follows:

1. Crystal Detector.
2. Vacuum Tube Detector.
3. Regeneration.
4. Heterodyne.
5. Radio Frequency Amplification.
6. Audio Frequency Amplification.

The radio frequency amplification may be attained by means of tuned R. F. or fixed transformer R. F. Until recently, however, tuned R. F. amplification has been objectionable on account of multiplicity of adjustments and the necessity of using some means of stabilizing or preventing oscillation, most of which are not efficient over the whole broadcast range and accomplish the results with considerable loss of energy.

Every radio receiving set uses either one of these systems or a combination of two or more and until some new fundamentals are discovered the only improvement will be in styles and efficiency of the apparatus and circuits.

The most efficient circuit in use at present and one which is rapidly gaining popularity among set builders, because of the excellent results it produces, is "Reflex" (trade mark) and particularly Reflex (trade mark) with tuned radio frequency amplification.

## What Reflex Is and How It Works

A Reflex circuit is essentially one in which one or more of the vacuum tubes are used for both radio and audio frequency am-

plification, the advantage being in reducing the amount of apparatus used and at the same time getting better results than if more apparatus were used. Better because with the same amount of amplification the smaller amount of apparatus causes lower losses and less distortion, also lower initial and operating costs and fewer controls, some of the tubes doing double duty.

The fact that a loop can be used with this "Reflex" circuit is a measure of its sensitivity. The loop is sufficient to pick up stations a long distance away directly on a loud speaker without the bother of using head phones for tuning in. Only a really sensitive set can use a loop effectively, but those that do have a big advantage, as interference is reduced to a minimum and selectivity is obtained by the low losses in the loop and the ability to turn it in the direction of the station for best results.

The Reflex set shown in the accompanying pictures is designed especially to work with an indoor loop antenna, although in locations where interference from radiating receivers, etc., is not a factor an outdoor aerial may be coupled to the loop in order to increase the volume on very distant stations.

The loop connects at the left of the set as shown, and with the condenser at that side forms the complete tuning circuit. By turning this condenser knob this circuit is brought to resonance for the particular wavelength desired.

Mounted on the same shaft with this condenser and directly in back of it is a variable radio frequency transformer. This is a piece of apparatus quite new in design and very efficient in operation. It consists of a flat plate rotor and stator, each of which carry two low loss coils shaped like the letter "D." These four coils are connected in parallel so that when the windings of the rotor and stator coils, which are opposite each other, are in the same direction, the inductance of the circuit is maximum, and when the shaft is turned through 180 degrees the windings of the rotor and stator coils opposite each other are in opposite directions the inductance of the circuit is minimum. The constants of the coils being properly arranged, the variation of inductance from minimum to maximum corresponds to a difference in wavelength of 200 to 560 meters, which more than covers the broadcast range. By mounting the rotor of this transformer on the shaft of the tuning condenser all of the tuning for the set is easily

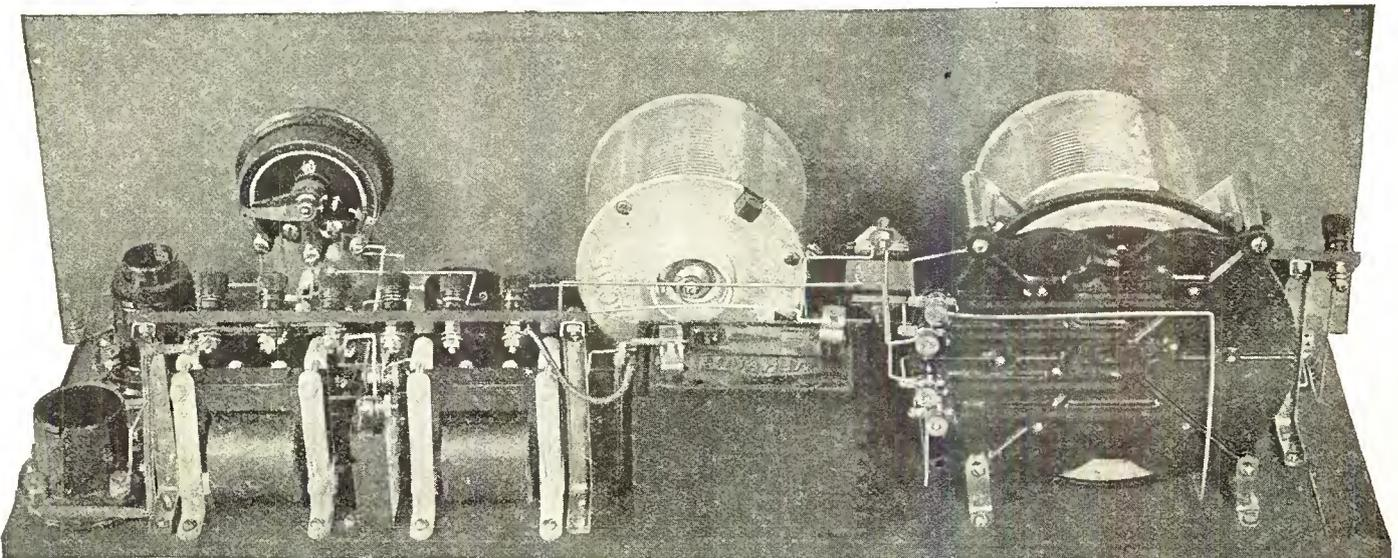

Rear View of Receiver



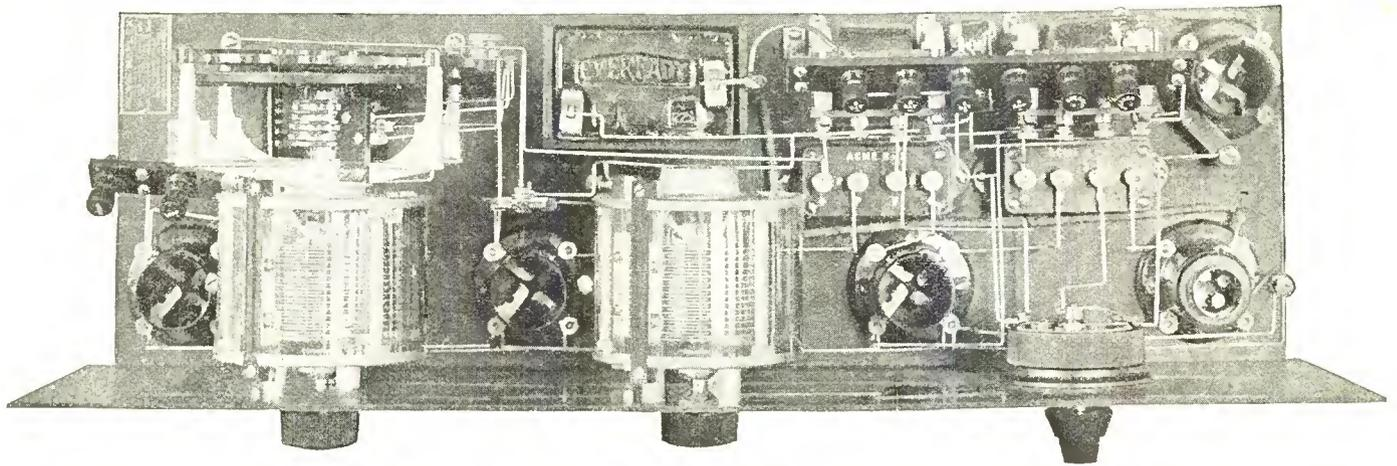

Looking Down on Receiver

accomplished with one dial. With this tuning circuit equal amplification is obtained over the whole broadcast range, which is not found in the usual tuned R. F. circuit.

The right hand condenser is connected across the secondary of the tuned R. F. transformer and acts as the stabilizer to prevent oscillation and at the same time balances the phase shifting effect of the inductance of the "D" coils.

The current generated in the loop circuit by the broadcast wave is very small, but nevertheless is of sufficient strength to impress a potential on the grid of the first tube, causing its plate current to vary in the same form but increased in amplitude. This plate current, which is many times stronger than the initial signal, passes through the primary of the tuned R. F. transformer. The coupling of this transformer remains fixed, but varying the mutual inductance until the circuit is in resonance, for the frequency in question lowers the impedance of this circuit to a minimum and allows a still larger but similarly shaped potential to be set up in the secondary of this transformer, which is impressed on the grid of the second tube, where it in turn causes a variation in the plate current of this tube. This plate current passes through the primary of the first fixed R. F. transformer (R-3), which is built to give equal amplification over as wide a band of frequencies as possible. The secondary potential is then impressed on the grid of the third vacuum tube, where it, as before, causes a variation of the much stronger current in the plate circuit. The third tube is used for amplification at both radio and audio frequencies, and this time acts as a radio frequency amplifier. The plate current from the third tube passes through the primary of the second fixed R. F. transformer (R-4), which is designed to work with the R13 to give practically equal amplification over the entire broadcast range. The secondary potential of the R-4 is then impressed on the sodion tube detector (type S-13).

This is an extremely sensitive, non-oscillating detector whose filament and sensitivity are best controlled by a combination rheostat and potentiometer. This tube is more sensitive to weak signals than strong ones, consequently acting as a valve which greatly reduces troublesome fading and causes distant stations

to come in practically as loud as locals under average reception conditions.

From the detector on, the current is at audio frequency, and from the plate of the detector tube it passes through the first audio frequency transformer, impressing a potential on the grid of the third tube, thereby making it function at audio as well as radio frequency. It will be noticed that only the secondary of the first audio transformer is used. This is because it is used as an impedance coil to enable the sodion tube to operate at maximum efficiency. The current in the plate circuit of the third tube passes through the primary of the second audio transformer, where it causes a stronger audio frequency potential to be generated in the secondary, which is impressed on the grid of the last tube. The current in the plate circuit of this tube passes through the loud speaker, creating audible sounds.

#### Special Features of This Reflex Receiver

There are eleven features which a prospective owner should always look for in a radio set and it is seldom that all are found within the same set. They are:

1. Quality of reception.
2. High degree of selectivity.
3. Ability to reach distant stations.
4. Simplicity of control.
5. Ease and simplicity of construction.
6. Low cost per tube.
7. Low operating cost.
8. Ability to give good reception all the year around.
9. Power to successfully operate a loud speaker.
10. Ability to be used with either an indoor loop or an outside aerial.
11. Non radiation.

Any received signal which is not understandable is not worth receiving. Reflex receivers have always been noted for their good quality of reception. If the proper transformers and condensers are used, there will be practically no distortion, and as

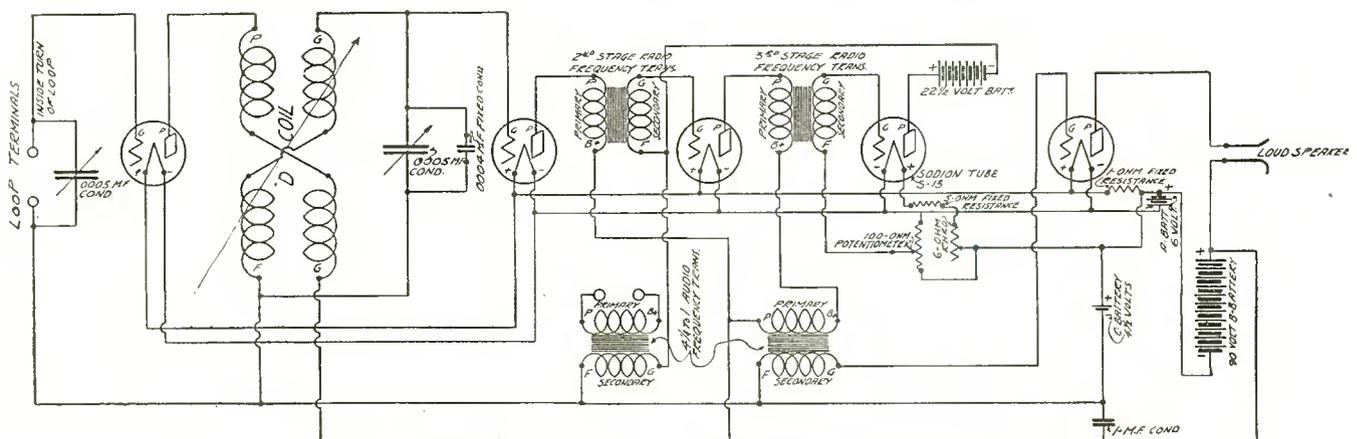

Schematic Diagram

there are no oscillators or noisy detector tubes, only clear music or speech will be heard in the speaker.

Selectivity, which is the ability to cut out one station and bring in another, is accomplished to a very high degree by the use of a directional loop antenna, and by tuning at radio frequency.

The tuned radio frequency amplification and the controllable sensitivity of the sodion tube are also chiefly responsible for the remarkable distance getting qualities of this set, and reliable reception over a range of 1,000 to 2,000 miles under average conditions is not at all uncommon.

#### Easy to Construct

It is all very well to read about or have someone tell you how simple it is to build a real good radio set, but did you ever try it? If you have, you know that it is usually the little construction details that cause so much trouble. Placing the parts correctly, getting neat holes drilled in the right places, using the proper screws, nuts and bolts and above all running wires so as to eliminate coupling between leads in the set.

In the set described in this article all of the engineering has been done in the most satisfactory manner. Every little detail is taken care of. It is marketed in the form of a kit, which is 100 per cent complete. The parts included in the kit are as follows and may be purchased separately if so desired:

#### List of Parts

- 2 Audio frequency transformers, 4 $\frac{1}{4}$  to 1 ratio.
- 1 Radio frequency transformer for second stage.
- 1 Radio frequency transformer for third stage.
- 1 .0005 mf. Var. condenser with screws.
- 1 Pot-rheo, 6 ohm rheo, 100 ohm potentiometer.
- 5 Sockets (with screws).
- 1 "D" coil unit complete with screws.
- 1 .0004 mf. fixed condenser.
- 1 By-pass condenser, 1 mf.
- 8 Engraved binding posts.
- 2 Three-inch condenser knobs and dials.
- 1 Drilled front panel.
- 1 Drilled baseboard.
- 1 Pair pliers.
- 1 Screw driver.
- 1 Set of prints.
- 1 Instruction book.
- 1 Fifteen-inch rule.
- 20 Pieces No. 14 tinned wire 24-inch long.
- 1 Box with all necessary screws containing:
  - 4 No. 6-32 binding post tops.
  - 4 No. 6-32 binding post bottoms.
  - 4 6-32 R.H. Mach. screws, 9/16-inch long.
  - 1 ohm fixed resistance on red fibre.
  - 1 5 ohm fixed resistance on black fibre.
  - 1 Package soldering lugs.
  - 1 Filament switch.
  - 1 Insulating bushing for pot-rheo.
  - 1 Pair storage battery clips.

- 30 No. 6 R. H. wood screws,  $\frac{1}{2}$ -inch long.
- 6 6-32 R. H. machine screws,  $\frac{1}{2}$ -inch long.
- 30 6-32 Hex. nuts.
- 30  $\frac{3}{8}$ -inch brass washers.
- 6 6-32 H. R. machine screws,  $\frac{3}{8}$ -inch long.
- 2  $\frac{5}{8}$ -inch F. H. No. 6 wood screws.
- 1 Forked connector.
- 3 Terminal panel brackets.
- 2 Terminal panels.
- 1 D battery box.
- 2 Shielded leads.
- 1 Sodion tube adapter.

#### For Loop

- 4 Arms.
- 1 Center metal piece.
- 1 Base metal piece.
- 2 Base wood legs.
- 2 Plain binding posts.
- 2  $\frac{3}{8}$ -inch brass washers for 6-32 machine screws.
- 1 10-32 round head machine screws,  $\frac{1}{2}$ -inch long.
- 1  $\frac{3}{4}$ -inch brass washer for 10-32 machine screws.
- 100 Ft. Litzendraht loop wire.

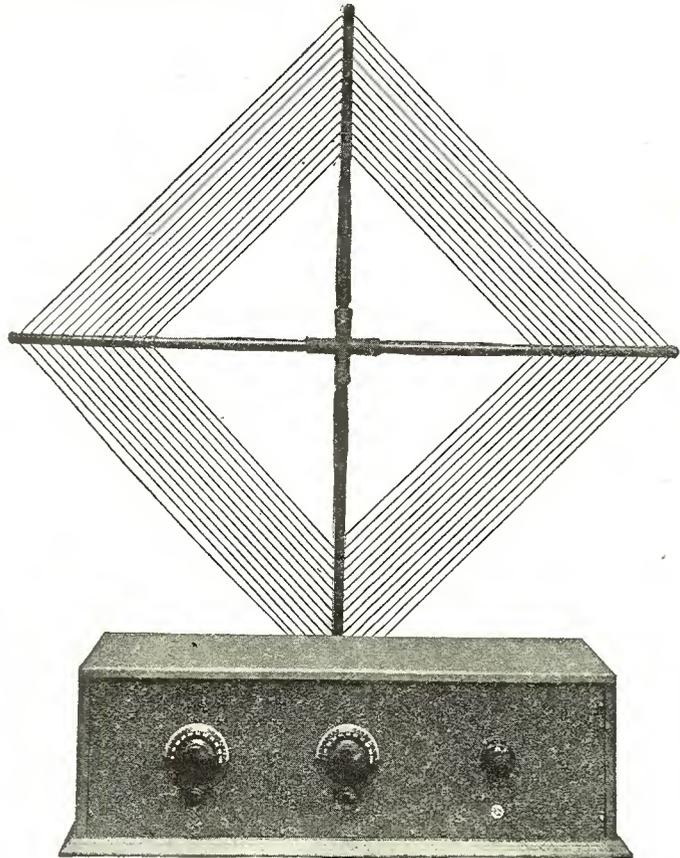

Front View of Receiver

In describing receivers for Radio fans to buy or build, the editorial staff of the Citizens Radio Call Book has been untiring in their efforts to give you a complete description of the best that money can buy, consistent with results.

We know that you will find the circuit section an accurate guide in building your favorite hookup. Send your inquiries direct to the manufacturer.

# You can give your set this big advantage —

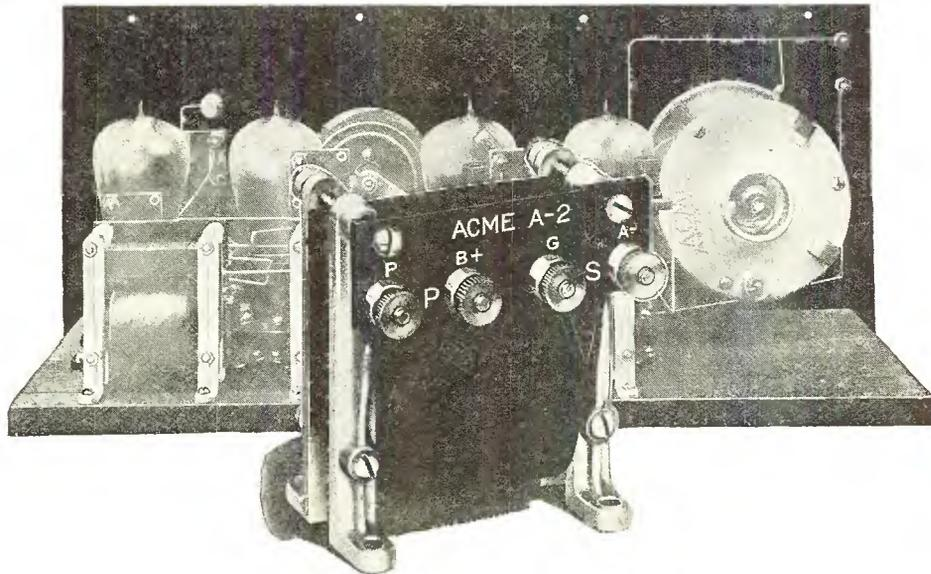

## Amplification without Distortion

*How to make sure of getting everything loud and clear*

**Y**OU can make your set so that it will reproduce clearly and distinctly without distortion. The real pleasure in radio comes when you can understand and enjoy what you hear—voices that are natural—music that is clear in tone. In order to hear clearly and distinctly you want to be sure that you are using amplifying transformers that amplify the sound without distorting it.

Give your set this big advantage—Amplification without Distortion. Whether you have a neutrodyne, superheterodyne, regenerative or reflex the addition of the Acme A-2 Audio Amplifying Transformer will make it better.

The Acme A-2 has become famous among radio owners for increasing the volume of sound without distorting. It has improved thousands of radio sets. If you are bothered by distortion, try an Acme A-2 and note the difference.

Each transformer is tested and carries a guarantee tag. If you want Amplification without Distortion use Acme Transformers in the set you build and insist on them in the set you buy. (That's one of the big reasons why the Acmeflex Kit-set gives such good results—it uses Acme Transformers.) Send for our 40-page booklet which explains how to get the best results by proper amplification and also contains a number of valuable wiring diagrams. It will help you build a set. Mail the coupon with 10 cents.

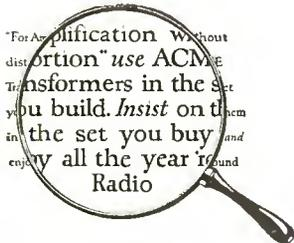

*The Amplifying Transformer is the Magnifying Glass of Radio*

**ACME APPARATUS COMPANY, Dept. O2, Cambridge, Mass.**

*Transformer and Radio Engineers and Manufacturers*

*Have the fun of making your own radio set*

# ACME

*~ for amplification*

ACME APPARATUS COMPANY,  
Dept. O2, Cambridge, Mass.

Gentlemen:

I am enclosing 10 cents (U. S. stamps or coin) for a copy of your book, "Amplification without Distortion."

Name .....

Street .....

City ..... State.....

# ERLA SUPEREFLEX CIR-KITS

## *More Power, Tube for Tube—The Economical Way to Finest Radio*

Circuits of matchless efficiency, plus apparatus equally advanced, plus ingenious facilities that make child's play of assembly—these stamp Erla CIR-KIT knock-down receivers the most far reaching contribution yet made to radio reception.

Founded upon the exclusive principle of Supereflex amplification that enables tubes to do triple duty as simultaneous amplifiers of received radio, reflexed radio and reflexed audio currents, each of these receivers provides, tube for tube, materially greater range and volume than any other types.

Tone quality, likewise, is notably superior, with a richness and exquisite purity of reproduction that has earned the acclaim of foremost musical authorities.

Ease of control and selectivity are similarly outstanding. But two major dials are used for tuning in even the five-tube types, with ability to separate cleanly stations only ten meters apart, and to bring them in always with the same dial setting.

Ranging from one to five tubes, in loop and antenna models, a type and size is provided to meet every requirement, from metropolitan apartment to isolated ranch. And each model is guaranteed to deliver highest attainable efficiency per number of tubes employed.

The one-tube circuit, for example, incorporating three stages, one radio, detector and one audio, operates a loud speaker at full volume on local stations, with headphone range from coast to coast, while the five-tube antenna model provides volume sufficient for the largest concert auditorium, when operated at full capacity.

For portable use, small apartments, or remote regions where charging facilities are not readily available, a special 199-tube loop circuit has been developed that in range and volume compares most favorably with conventional loop circuits employing amplifying tubes of larger size. In fact, through special transformers, the efficiency of the larger tubes is approached within 10% to 25%.

The relative ability of the various types, together with their salient characteristics, are catalogued as

follows, enabling intelligent choice between them, according to the requirements of the user.

**One-Tube Antenna**—Three stages, one radio, detector and one audio. Operates loud speaker on local stations at full volume. Headphone range coast to coast.

**Two-Tube Antenna**—Two stages of radio amplification, detector and one audio. Loud speaker range under favorable conditions, 1,000 miles.

**Three-Tube Antenna**—Two stages radio, detector, and two audio. Coast to coast loud speaker range.

**Four-Tube Antenna**—Three-tube circuit with one stage of audio added. Volume on long distance stations exceeding five and six-tube conventional designs.

**Five-Tube Antenna**—Three-tube circuit with stage of push-pull amplification added. Tremendous volume, ample for concerts or outdoor gatherings.

**Five-Tube Loop 199**—Three stages radio, detector and three audio, providing range and volume equal to three-tube antenna design using large tubes.

Construction of each of these CIR-KIT models is surrounded with every safeguard for success. Every needed part, to the last screw, nut and wire, is provided. Synchronizing radio and audio transformers, balanced crystals, tested capacity condensers—these and other units manufactured to Erla standards of highest efficiency insure maximum performance, while correct construction is made certain through a drilled and lettered panel, stenciled baseboard and full-size blue-prints giving the exact location of every unit and connection.

Even soldering, bugaboo of the beginner, is eliminated through Erla solderless connectors. The most inexperienced individual, therefore, can easily build Erla CIR-KIT receivers to professional standards with no tools other than a screwdriver and a pair of pliers, and in a few hours' time.

Erla Supereflex CIR-KIT is the quickest, easiest, surest way to most efficient radio reception, at minimum effort and cost.

## **ELECTRICAL RESEARCH LABORATORIES, Chicago**

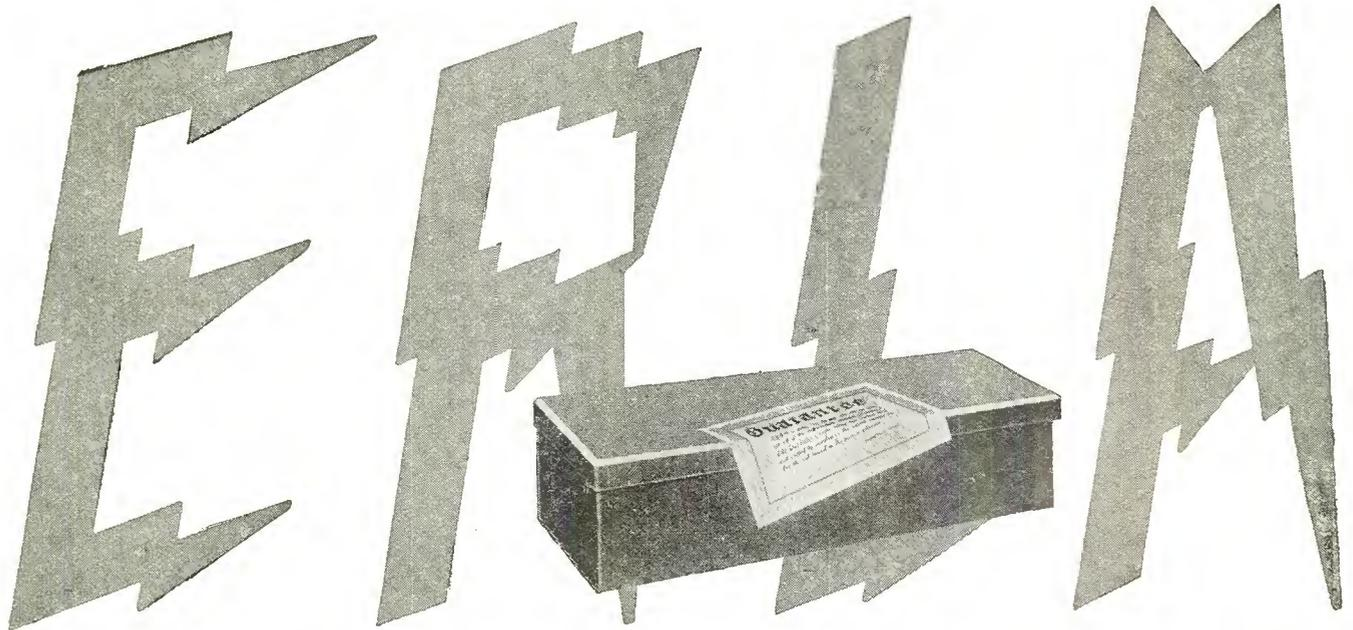

**SUPEREFLEX** means **MORE POWER** per tube



Erla Floor Console



Erla Table Console

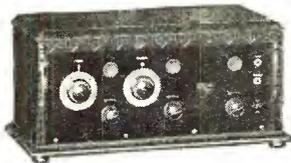

Erla Table Cabinet

Erla Radio Instruments, in a complete series of styles, embody improvements which qualify radio as true musical art.

Erla Supereflex makes tubes do triple duty. One tube actually does the work of three that would be needed otherwise. Three tubes do the work of five, unquestionably! That is why simple, compact, inexpensive Erla Supereflex receivers equal or surpass the performance of costliest, temperamental multi-stage radio sets.

More power, tube for tube, is basic in Erla Supereflex. Nothing else can "make up for it." Greatest power in Erla Supereflex just simply means finest radio. And you can now afford it.

For you yourself can confidently build these matchless Erla circuits with Erla Supereflex *CIR-KIT*.

*CIR-KIT* is a complete assortment of Erla Scientific Precision Apparatus, especially created to make Supereflex possible. *CIR-KIT* provides clear, simple instructions for perfect assembly. Blueprints are full size. The panel is pre-drilled for you. The baseboard is marked to locate every unit accurately. The famous Erla Solderless Connectors do away with soldering entirely.

With screwdriver, pliers and *CIR-KIT* you are sure of a set that will make you proud, both for appearance and performance. The cost is very moderate. Yet the range, volume, selectivity AND TONE PURITY are rarely equaled at any price, because Supereflex does give you most power, tube for tube.

**Electrical Research Laboratories**  
 Department L, 2500 Cottage Grove Avenue, Chicago

**CIR-KIT**

Tell 'Em You Saw It in the Citizens Radio Call Book



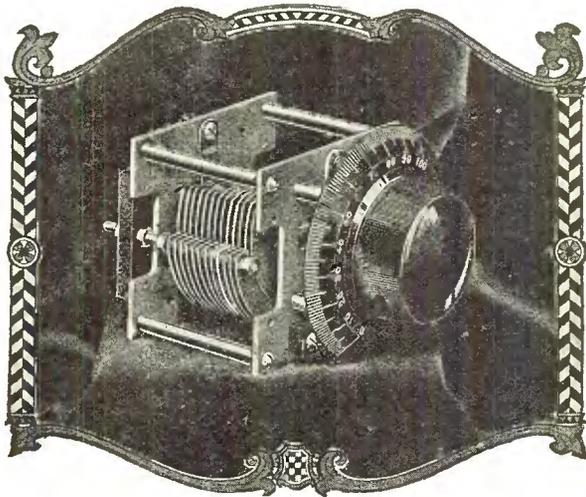

# National Condensers

Make a wonderful difference in the home built set.

Tested and approved by all prominent Radio authorities.

Capacity, Max., MF.....	.001	.0005	.00035	.00025
Price without dial .....	\$6.00	\$5.00	\$4.75	\$4.50
Complete with Velvet				
Vernier, 3 3/8" .....	7.25	6.25	6.00	5.75
Bakelite Dial, 4".....	7.50	6.50	6.25	6.00

*“—results are simply amazing”*

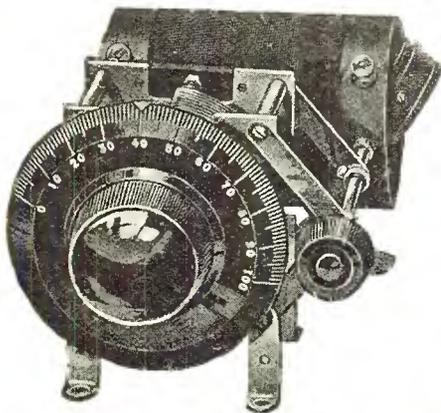

National Velvet Vernier Dials driving National Condensers upon which are mounted the newest National Radio Products.

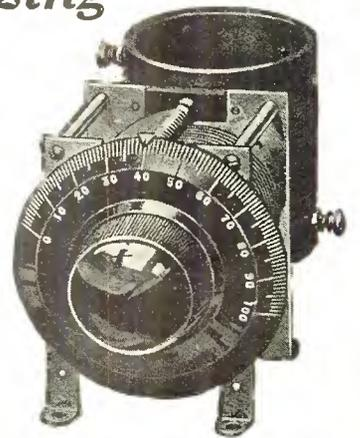

*Write for Bulletin 105RC*

## The National Rageniformer and Antenna Inductance

The National Rageniformer is a tuned radio frequency transformer of highest efficiency. When used with a Browning-Drake receiver, the results are amazing. We should like to tell you about this highly efficient radio device. It has won the enthusiastic approval of the radio editors of five Boston newspapers.

### The NATIONAL VELVET VERNIER DIAL

A touch of velvet smoothness, no back lash and no lost motion after a test covering 1,000,000 revolutions.

4" Bakelite.....	\$2.50
3 3/8" Bakelite.....	2.25



## NATIONAL COMPANY, Inc.

110 Brookline Street, Cambridge, Mass.

Engineers and Manufacturers. Established 1914

# Flewelling Single Circuit Receiver Wiring Diagram

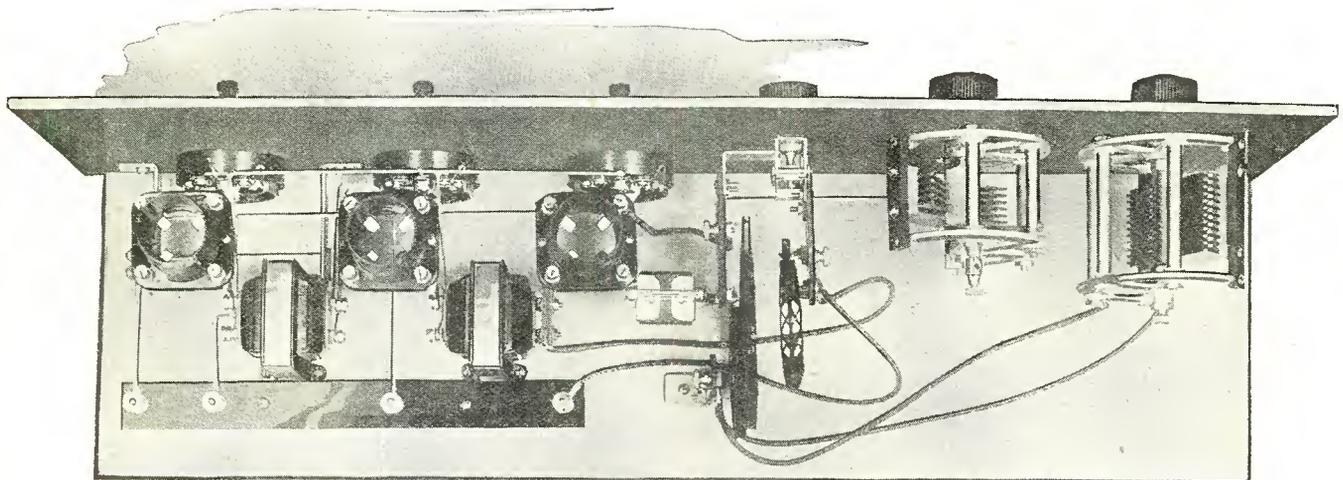
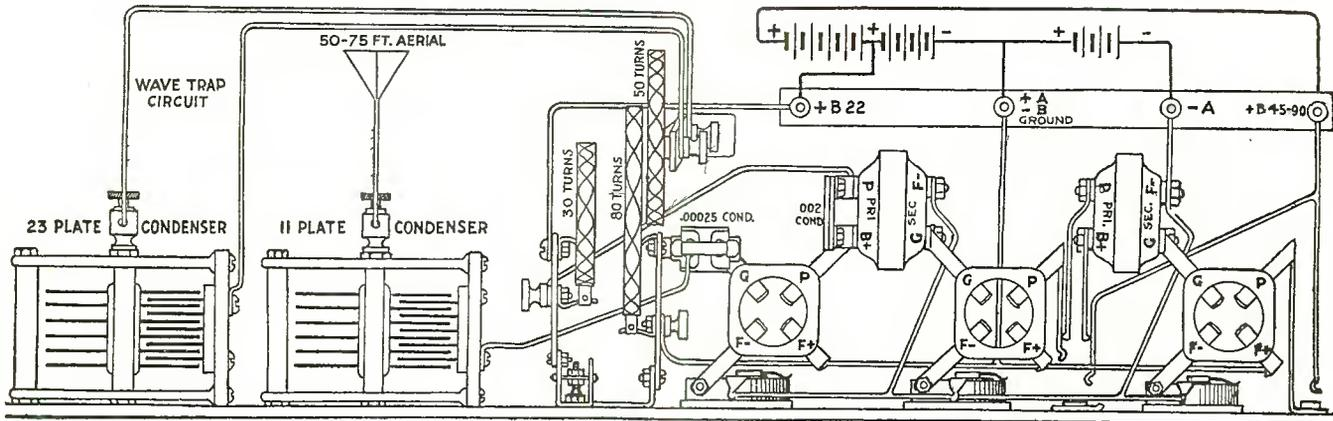

Top View of Receiver

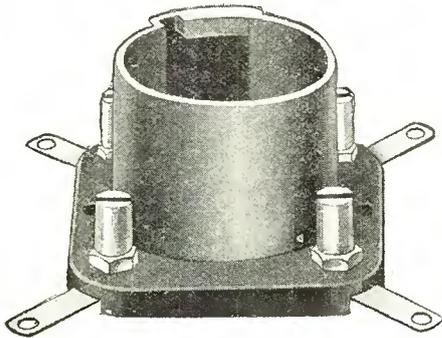

Standard Socket . . . . . **75c**  
 No. 199 Socket . . . . . **75c**

# BUELL *E. J. Flewelling*

## RADIO APPARATUS DE LUXE

**The Flewelling Socket** by a departure from the usual method of making contact, secures an extra firm contact on the brass of the tube terminals instead of the lead end. It locks tight with a sure contact grip and requires no downward pressure on tube.

Extra wide spacing of contacts make it a true "Low-Loss" socket. Extension terminals for direct connection insure greatest efficiency. It costs no more to have the best. Insist on Flewelling Sockets at your dealer's.

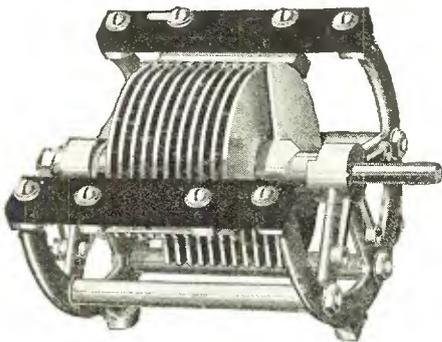

.0005 mfd. Condenser . . . **\$7.00**  
 .00025 mfd. Condenser . . . **6.00**  
 (Vernier Included)

**Flewelling Condenser** is of mechanical superiority that can be appreciated at a glance. Its rugged construction assures long life. Its extra heavy 1-16 inch plates will not warp out of alignment. They are die cast using S. A. E. specification bearing metal. Extra large ball bearings insure free action of rotor plates. Bearing plates and "drag" on rotor are all adjustable independent of each other.

The condenser is the most important element in your set. In its selection you may save a few cents, but never without the sacrifice of the important features you desire. Buy a Flewelling Condenser and you know you have the best.

**Flewelling Uniformers** are designed to eliminate all unnecessary and detrimental wiring in set construction such as tuned radio-frequency, untuned radio-frequency loop sets—in fact any type of set from the simple one-tube to the various types of Super-Heterodyne. The advantage of wiring elimination is readily and most aptly appreciated in the latter type.

The Uniformer case is of polished hard rubber—a material of the lowest loss as a dielectric. It is recessed and terminals are so spaced that the Flewelling Socket assembles readily in unit construction with a true "factory made" appearance. A six-tube assembly measures but 19 inches in length and 3 1-2 inches in width. This enables you to construct a neat compact set in a phonograph cabinet or any small cabinet. Ask your dealer for Flewelling Uniformers.



Audio or Radio Uniformer . **\$5.00**

**The Flewelling Type S Tuner** is of basket weave design having exceptionally low distributed capacity. With 80 and 30 turn coils, as it is regularly supplied, when connected in series with a .0005 mfd Flewelling Condenser in a single circuit "hook-up" will cover a range of 220 to 550 meters with very sharp tuning. [This is without the use of taps and providing the aerial is of correct capacity.]

The Flewelling Type S Tuner with two stages of audio will bring distant stations up to loud speaker volume. Coils are interchangeable, however a wide range can be covered without change. This tuner must be seen to be appreciated to the utmost. Ask your dealer to show it to you.

## **BUELL MANUFACTURING COMPANY**

**2975-77 Cottage Grove Avenue  
 CHICAGO**

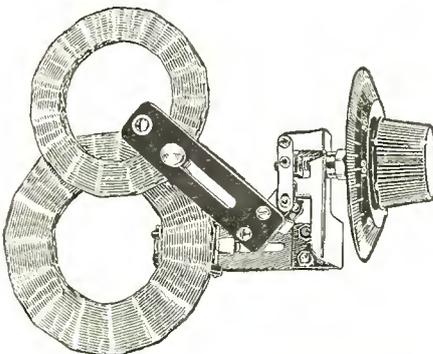

Tuner Complete . . . . . **\$7.25**  
 Coils Less Than 50 Turns . . **1.00**  
 Coils 50 to 100 Turns . . . . **1.25**  
 Single Coil Mounts . . . . . **.75**

**The Flewelling Vernier** is of our own "heavy duty" type design. Gives a ratio of 20 to 1 when used on a 4 inch dial. It is highly recommended to those desiring fine, sharp tuning. The friction disc is of especially prepared gum rubber. The knob is of correct size to have a real "feel." Rugged construction throughout. See it at your dealer's.



Friction Vernier . **50c**

## Tuned Plate Receiver

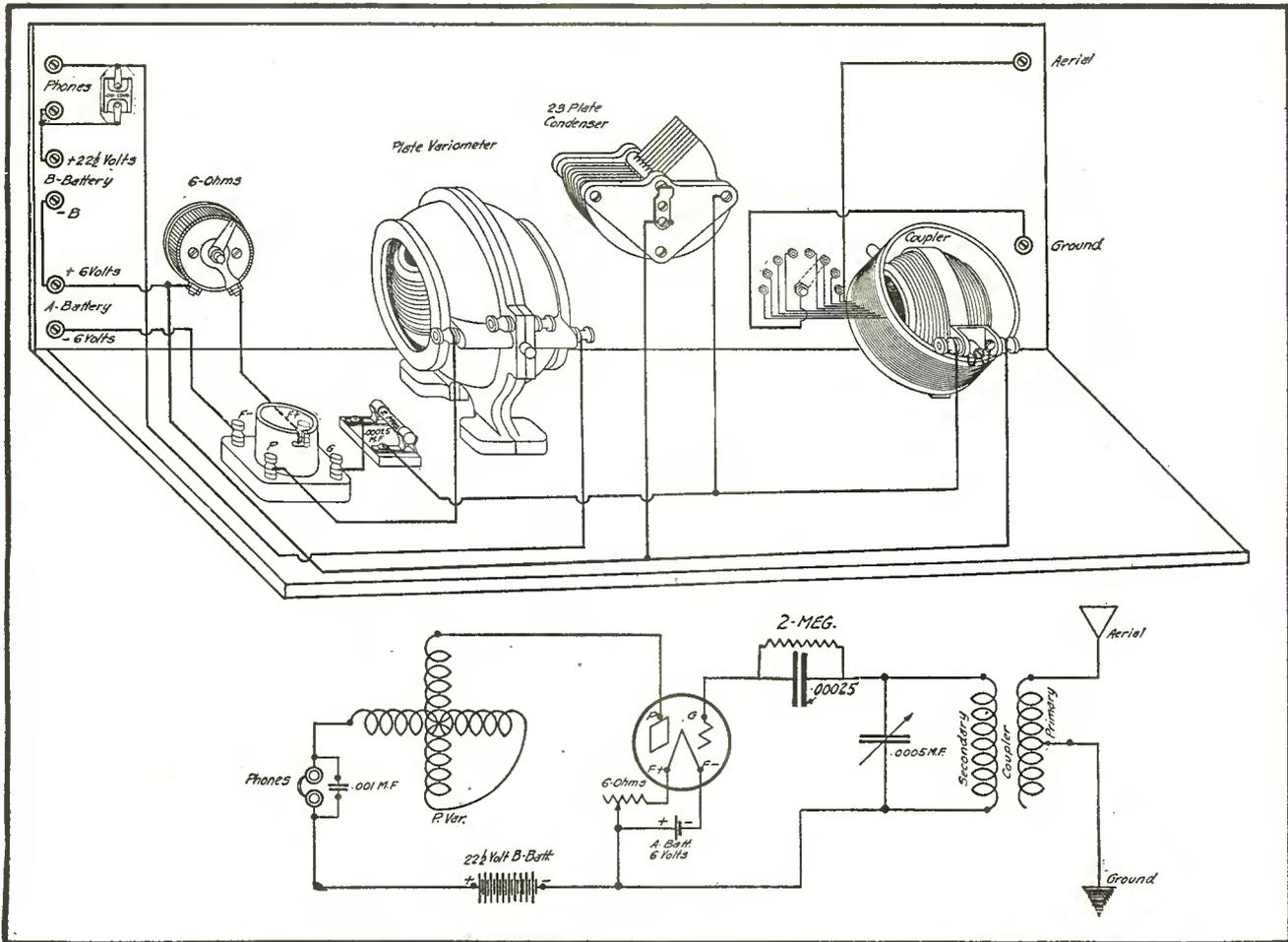

## Two Step Audio Frequency Amplifier

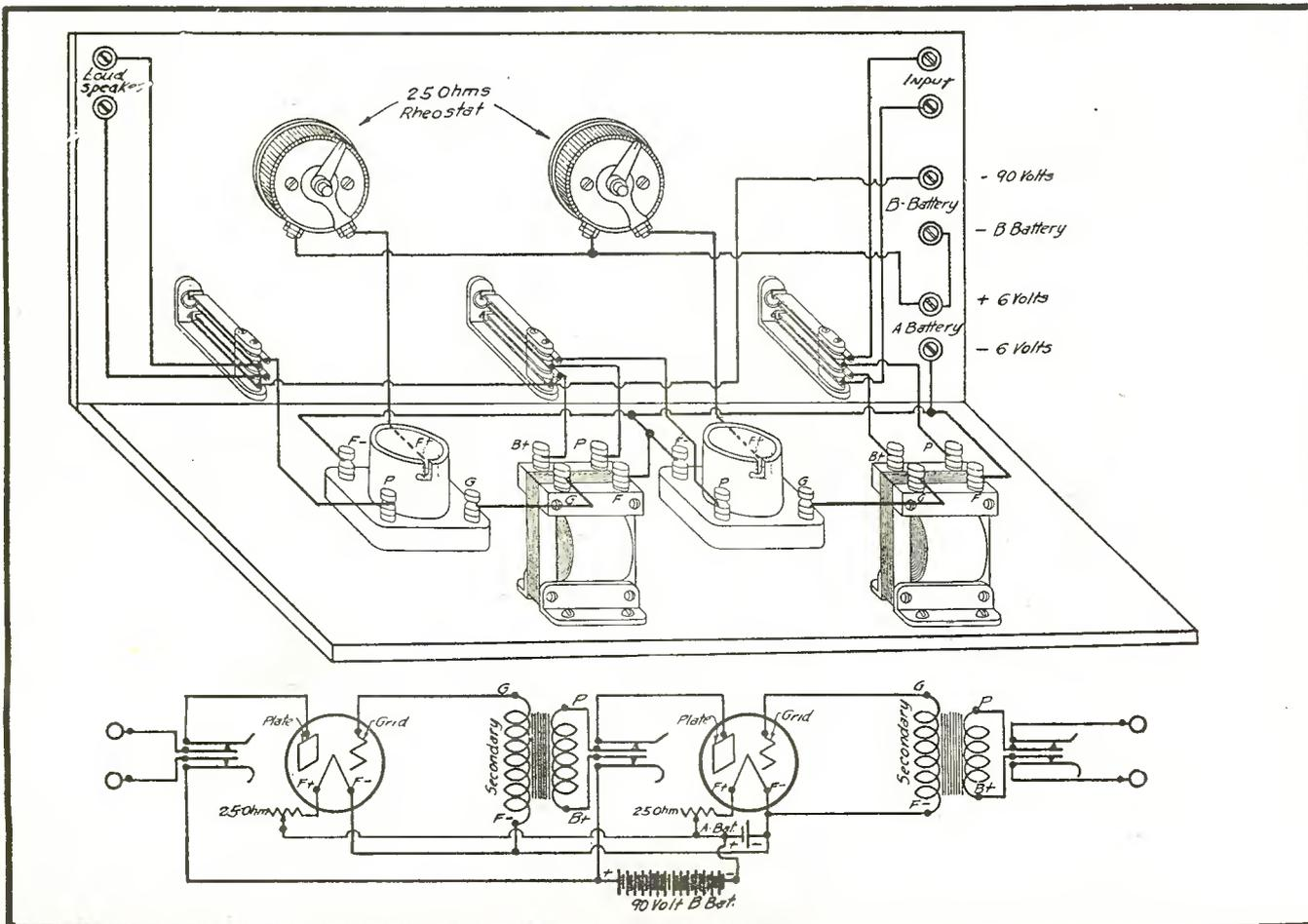

**SUPERIOR**



Cle-Ra-Tone Socket

**RADIO**



Battery Switch

**PARTS**

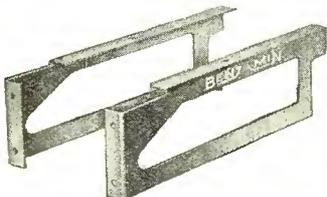

Radio Brackets

**FOR**



Grid Leak Panel

**BETTER**



Cle-Ra-Tone Gang Socket and Mounting Shelf

**RADIO SETS**



# Cle-Ra-Tone Sockets

*Shock Absorbing—Spring Suspended*

Tube holding element "floats" on perfectly balanced springs. Spring supports are not affected by stiff bus wiring. Molded parts of genuine Bakelite. Keeps your tubes sensitive only to the radio waves. Keeps microphonic disturbances, due to jars and vibration, out of the receiving set. The Cle-Ra-Tone Socket marked so great an advance in the mechanics of radio reception that it is the choice of the leading manufacturers of high-class sets, and is recommended by the foremost engineers for their most popular hook-ups.

8645 For Standard Base Vacuum Tubes, \$1  
8646 For UV-199, etc., Tubes..... 1

## Radio Battery Switch

Lightest and neatest switch made. Mounts in single 1/4 inch panel hole. No spacer washers required. Push-pull single contact features give positive contact. When it's in its off, avoiding accidental cutting in of battery.

No. 8640, \$0.30

## Radio Bracket

Gets the wiring out of sight. Adaptable for standard cabinet mounting.

No. 8629, per pair, \$0.70

## Grid Leak Panel

With the bracket, provides a safe, secure mounting for this important element.

No. 8632, each, \$0.15

## Cle-Ra-Tone Gang Socket and Mounting Shelf

Simplifies construction of the larger receiving sets, and may be used with most of the latest hook-ups. Consists of Cle-Ra-Tone Shock-Absorbing Sockets attached to Bakelite mounting shelf with set of binding posts and markers. There is adequate space for mounting of accessory equipment.

Standard VT Sockets	or UV-199, etc Sockets	Dimensions of Shelf	No. of Sockets	
8613	8603	7 7/8" x 4 1/8" x 1/4"	3	\$ 5.50
8615	8605	17 1/4" x 4 1/8" x 1/4"	5	10.50
8626	8606	17 1/4" x 4 1/8" x 1/4"	6	11.25
8627	8607	17 1/4" x 4 1/8" x 1/4"	7	12.00

*Ask for Benjamin Radio Products at your dealer's or write us*

# Benjamin Electric Mfg. Co.

120-128 S. Sangamon St., Chicago

247 W. 17th Street  
New York

448 Bryant Street  
San Francisco

# Self Neutralized Tuned Radio Frequency Receiver

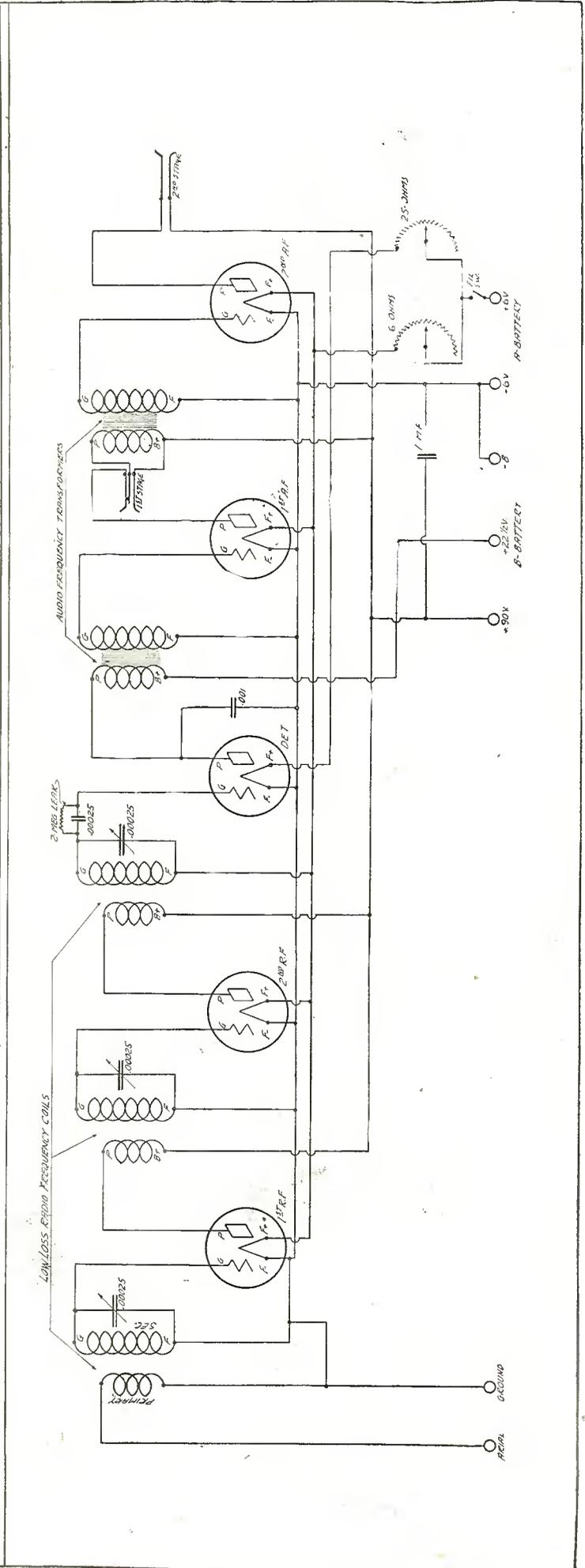
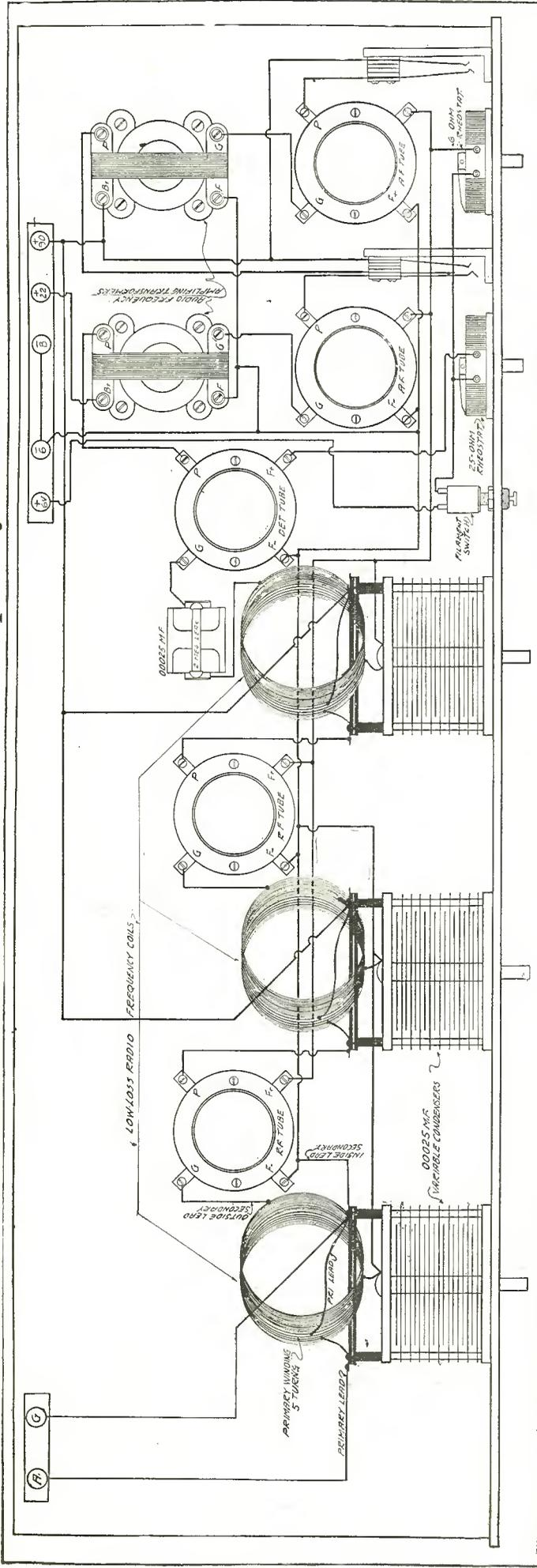

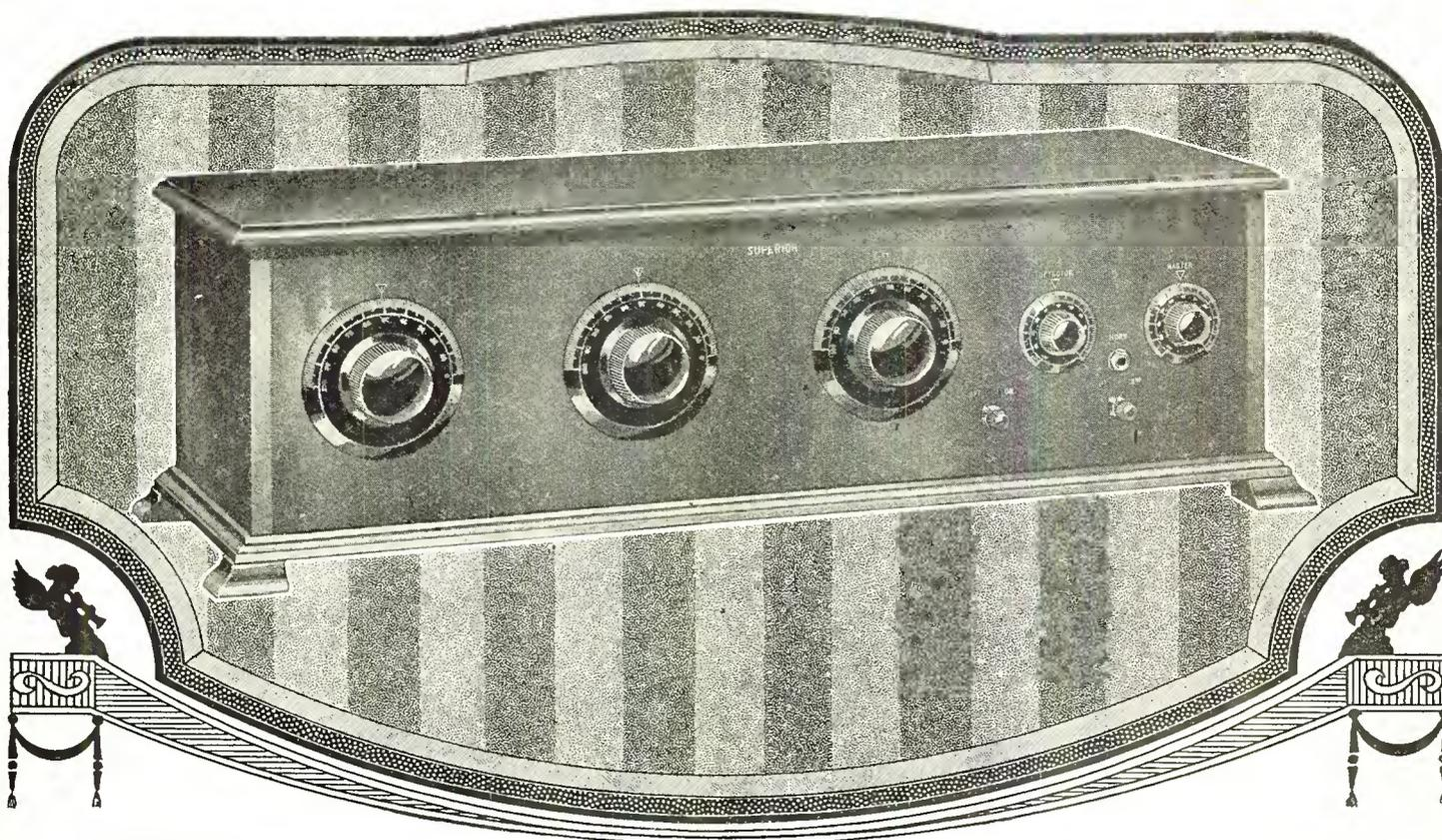

SELECTIVITY  
DISTANCE  
CLARITY  
VOLUME

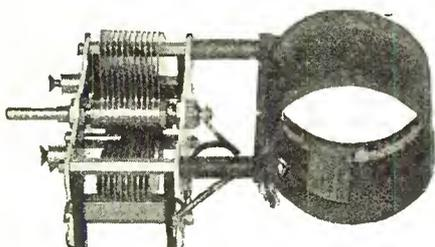

**The Secret of Superior's Success**

*Here is the exceptionally designed and constructed Low Loss Coil found only in the SUPERIOR. It has a very low degree of distributive capacity with a consequent high degree of inductance, obtained through the self-supporting method of mounting.*

**Your Assurance of Perfect Reception**

In the "Superior" Receiver you will find only materials of the finest quality together with absolute precision of construction. It is an exceptional receiving set designed and built to give the utmost in radio entertainment.

As you get better acquainted with the "Superior," you will find in it finer tone qualities, more faithful reproduction, greater range and more selectivity than you ever dreamed was possible on any five-tube set. It is the result of years of careful study and experiment and comes to you, a product of unusually fine quality. Unusually attractive in design, easy to tune, simple to operate.

*Have your dealer demonstrate the SUPERIOR to you today. You will readily appreciate the fine qualities of this set. If your dealer does not handle the SUPERIOR, write us direct for complete data.*

**UNITED ELECTRIC CO. of CHICAGO**

9030 Commercial Avenue

CHICAGO

*Tell 'Em You Saw It in the Citizens Radio Call Book*



# THE AMPLIFEX LOOP

*A Revelation and a Revolution in Loop Construction*

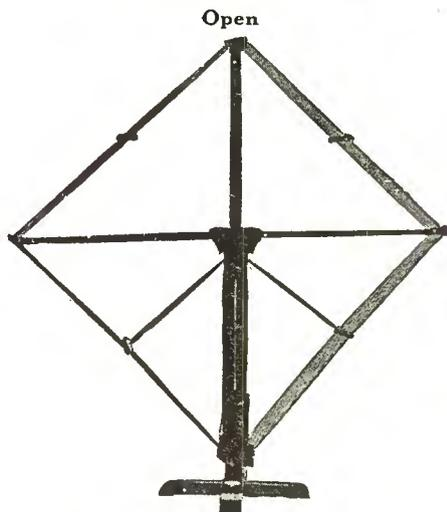

Open



Partly Closed

THE AMPLIFEX LOOP collapses by simply turning a thumb nut in the center. WOUND with 40 strands No. 38 double silk-covered Litzendraht wire. Has a COMPASS in the base for directional adjustment.

THE AMPLIFEX LOOP by a series of six numbered binding posts can be tapped for seven combinations giving 3, 4, 6, 7, 9, 10 and 13 turns with a wave length range of 88 meters to 1,000 meters WITHOUT ANY DEAD-END LOSSES. THE MOST IMPORTANT AND REVOLUTIONARY FACTOR IN LOOP CONSTRUCTION.

When extended the Loop is 43" high and 39" wide. Beautifully finished in mahogany with all metal parts nickel-plated. Packed in individual cartons.

### The Amplifex Loop Is Center Tapped—Portable—Directional—Efficient

Approved by COCKADAY, RADIO NEWS, POPULAR RADIO, RADIO IN THE HOME and many leading Radio Publications all over the country.

MR. HENRY M. NEELY, Publisher of RADIO IN THE HOME, says: "VERY FINE WORKMANSHIP . . . EXTREMELY CLEVER . . . ITS EFFICIENCY HAS SURPRISED ME."

IF YOU WANT A LOOP THAT WILL SOLVE YOUR NOISE TROUBLES AND GIVE YOU REAL VOLUME AND SELECTIVITY, WRITE US TO DEPT. RC FOR CIRCULAR AND CHART.

ESPECIALLY RECOMMENDED FOR THE RADIOLA SUPERHETRODYNE, FOUR AND FIVE TUBE REFLEXES, GRIMES INVERSE DUPLEX, ETC.

**DEALERS:** *Our Jobbers listed below are working in close co-operation with us in the proper distribution of our products. Dealers who are interested in selling the finest product of its kind on the market, should write us for details.*

#### DISTRIBUTED BY

- |   |   |   |
|---|---|---|
| E. B. Latham & Company, New York City.    | Atlantic Radio Co., Boston.             | Superior Supply Co., Bluefield, W. Va.      |
| Elec. Supply & Equip. Co., Albany, N. Y.  | Jos. M. Zamoiski Co., Baltimore, Md.    | Stern & Co., Hartford, Conn.                |
| Central Elec. Co., Chicago, Ill.          | F. D. Pitts Co., Boston, Mass.          | Union Elec. Supply Co., Providence.         |
| Carter Elec. Co., Atlanta, Ga.            | Wetmore Savage Co., Boston, Mass.       | Trilling & Montague, Philadelphia.          |
| National Elec. & Supply Co., Wash., D. C. | Erner Hopkins Co., Columbus, Ohio.      | Sweeney Radio & Elec. Co., Kansas City, Mo. |
| Doubleday-Hill Elec. Co., Pittsburgh.     | Northeastern Radio, Inc., Boston, Mass. |   |

Representatives: D. A. Schnebel, Ninety West Broadway, N. Y. C. B. J. Fitzner Co., 159 E. Elizabeth St., Detroit. Keeler White Company, Los Angeles, San Francisco and Seattle.

#### For Dealers Only

Amplifex Radio Corp.,  
Arlington, Mass.

Enclosed find Check—Money Order for \$7.50 (Regular list \$15.00). Send me one Amplifex Loop.

Name.....  
Street.....  
City.....State.....

#### WE CONTRACT TO MANUFACTURE LOOPS TO ANY SPECIFICATIONS

Write to DEPT. RC for descriptive circular and chart.

Formerly \$18.50—Now \$15.00

MANUFACTURED BY

**Amplifex Radio Corporation**  
Arlington, Massachusetts

#### For Citizens Radio Call Book Readers

Amplifex Radio Corp.,  
Arlington, Mass.

Enclosed find Check—Money Order for \$10.00 (Regular list price \$15.00). Send me one Amplifex Loop.

Name.....  
Street.....  
City.....State.....



**8** improvements  
at **ONE** stroke

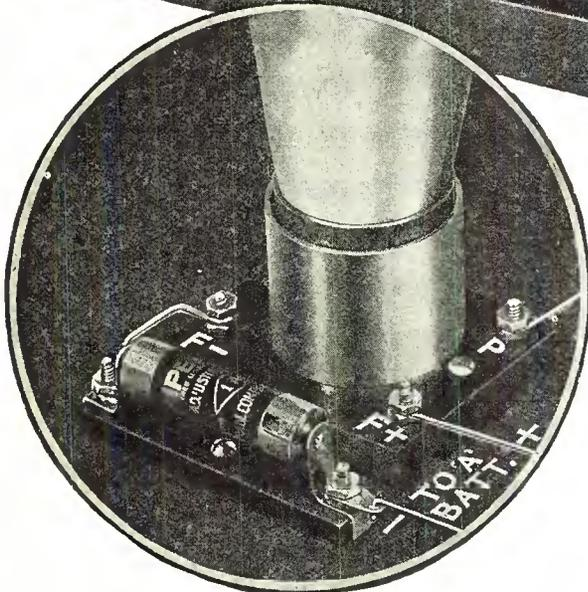
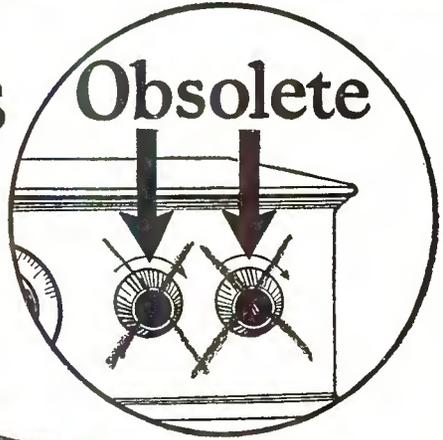

PRICE \$1.10 EVERYWHERE

Write for  
**FREE**  
Hook-Ups

### The Self-Adjusting Rheostat

1. Eliminates hand rheostats—thereby simplifying control and giving compactness.
2. Greatly simplifies set wiring, therefore makes for greater efficiency.
3. Prolongs life of tubes from 2 to 3 times.
4. No moving parts—therefore no grinding noises.
5. Permits use of any type of tubes or any combination of tubes.
6. No filament meters necessary.
7. Brings the most out of each individual tube—automatically—no guessing.
8. Makes perfect tube operation absolutely fool-proof.

**AMPERITE** operates on the thermoelectric principle. Contains a specially treated filament hermetically sealed in a glass tube and surrounded by an inert gas. This filament has the unique property of automatically changing in resistance as the "A" battery voltage changes—so that a practically constant current is maintained in the tube filament. Consequently the tubes are constantly operated at maximum efficiency. No knob to turn. Nothing to get out of order. **AMPERITE** mounts conveniently inside the set. Really takes the place of a good hand rheostat, a delicate meter and an expert operator. Thoroughly approved by every prominent laboratory. Used as standard equipment in such sets as **Somerset, Ultradyne, Marshall, Pfanstiehl, Kilbourne & Clark, Ambassador, Cockaday** and numerous others. Perfect for every circuit. Fully guaranteed.

**RADIALL COMPANY**  
Dept. C.B.-1, 50 Franklin St., New York

**AMPERITE**  
REG. U.S. PAT. OFF.  
*"means right amperes"*

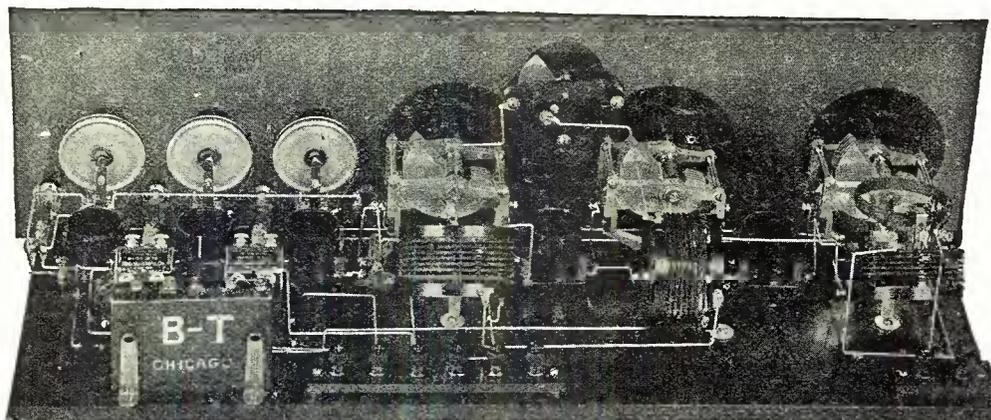

# The B-T Low Loss Nameless

Ever since the fall of 1923, when the official organ of the American Radio Relay League, QST, published an article dealing with the reduction of losses in radio receivers we have been hearing almost continually of "low loss" coils and condensers. Despite anything that may have been said to the contrary, this trend is certainly in the right direction, and has been instrumental in greatly improving the standard of design of radio parts, with a resultant increase in sensitivity, selectivity and volume of receivers.

It is logical therefore that the tremendous success of the Nameless should be still further increased by the introduction of essential parts possessing the good qualities properly attributed to real "low loss" parts.

The Nameless circuit comprises two stages of tuned radio frequency amplification, a tuned rectifier and two audio amplifiers. The system of oscillation control

is entirely peculiar to this circuit.

Those who understand regenerative sets know that the greatest volume and selectivity are obtained by keeping the set at all times just below the point of oscillation. The same condition is true of an R.F. amplifier—just below oscillation is the best point of operation. As this cannot be a permanent adjustment, as no means have as yet been discovered to keep regeneration constant over the entire broadcast range, the tremendous advantage of the panel control system used in the Nameless is immediately apparent. As you will note in the schematic wiring diagram, the small control condenser links circuits No. 1 and No. 2, thereby causing or preventing oscillation at will, as compared with other R. F. circuits where so-called neutralization is used at one particular frequency. Or where large losses are introduced to prevent any approach to oscillation at any wave length.

Another valuable improvement in this circuit is the adjustable antenna coupling on the first stage of radio. This adjustment in Transformer No. 3 permits you to adapt your set to long or short aerial and corrects for extreme local interference conditions.

Other important and recently developed features are incorporated in the set. For instance, a "C" battery on both radio and audio frequency stages allows greater selectivity and keeps "B" battery consumption down to a minimum. Due to this, a set of batteries will last two or three times as long as usual.

As for results; under any reasonable conditions the Nameless will step all over the country, getting plenty of volume on even lower power stations. Its ability to tune out locals is a most decided pleasure to those located near any of the larger stations.

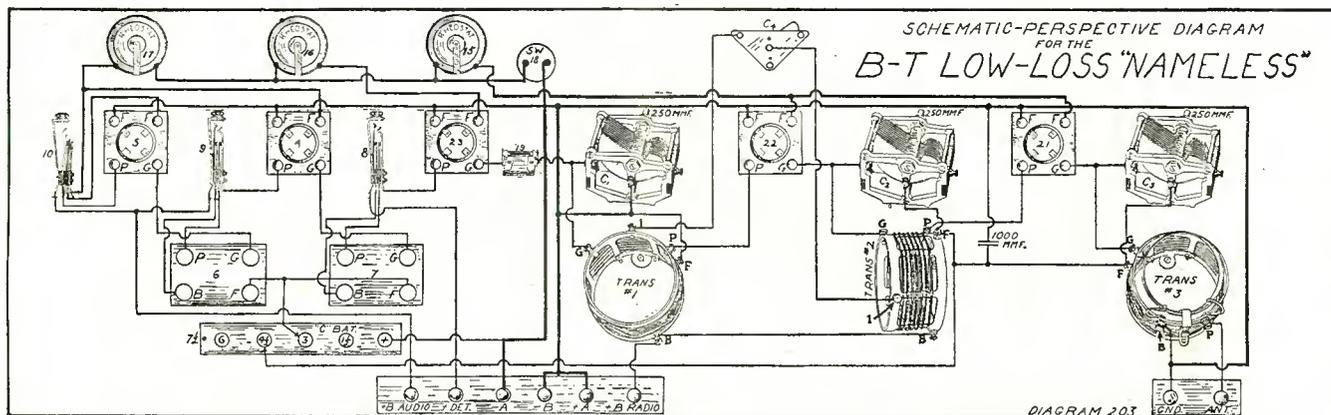

# BREMER-TULLY

*"Pioneers of Better Tuning"*

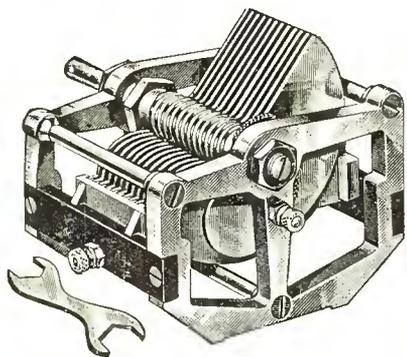

**B-T Laboratory Type  
Low Loss Condenser**

One glance at the rigid die cast construction of the new B-T Low Loss Condenser will convince you that it is the finest made. Special plate shape spaces the stations uniformly over the dials, eliminating crowding on the lower waves. Lifetime Bearing can be adjusted for wear or friction without changing capacity. Soldered, pigtail connection. Grounded rotor. Made in the following sizes:

Type	Capacity	Price
L-7	125 M.M.F.	\$4.25
L-11	250 M.M.F.	4.50
L-23	500 M.M.F.	5.00
L-35	750 M.M.F.	6.50



**B-T Air Core Transformers**

The most efficient transformer for use in tuned radio frequency circuits. Skeleton coil form reduces the amount of insulation in the field of the coil to a minimum. Special series banks windings give additional selectivity and sensitivity. Type AC-3, as illustrated, has adjustable untuned primary. Type AC-1 has fixed primary. Ranges given below covered with an L-11, Laboratory Condenser.

Type AC-3.....(200 to 565 meters).....	\$3.50
Type AC-1.....(200 to 565 meters).....	2.50

**M**ERIT of design and workmanship established B-T parts in a position of commanding superiority three years ago. Since that time B-T has kept up, and in some instances led, in the development of radio practice. It is worthy of note, that notwithstanding the radical changes that the past two years have brought, that every B-T part that we have ever put out is still successfully fulfilling the purpose for which it was designed. Proof of the pudding is in the eating! As proof of the worth of B-T parts we offer the following unsolicited testimonials. We receive hundreds of letters, like the ones reprinted, in every mail. They are the rule—not the exception.

Clifford, N. D., Dec. 26, 1924

Old or new all B-T sets work splendidly. It's impossible for me to keep one for my own use, as some one wants it as soon as I get it hooked up.  
B-T only for Radio.

(Rev.) K. K.

New York, N. Y., Dec. 30, 1924.

One isn't likely to praise a good article with the same enthusiasm he displays in condemning a poor one—but too much can not be said in favor of the B-T Tuner. Upon the earnest recommendation of R. A. Bradley, Technical Editor of Wireless Age, I purchased a B-T Tuner, and it surpassed all expectations, logging 33 stations the first night from Montreal to Jacksonville and New York to Texas. The Tuner is satisfactory in every way and I am only too glad to pass the good word along.  
(R. C. A. Operator S. S.) C. L. J.

Pittsburgh, Pa., Dec. 12, 1924.

I meant to write you that I tuned in KFI and KHJ (California) twice recently with your B-T No. 2, using your new Tuner and Condenser. You should be proud of that. Have received Montreal, Winnipeg, Ottawa, Dallas, Fort Worth, Atlanta and so on all season.

Mrs. E. L. N.

P. S.—Last evening I tuned in PWX, Havana, through two local stations, for forty-five minutes.

Chicago, Dec. 10, 1924

I purchased one of your Low Loss Condensers recently and it is the finest piece of work I ever saw outside of my 23-jewel watch.

F. J. N.

Chicago, Nov. 26, 1924

Just a note to tell you that last night using B-T No. 1, at 10:35 I tuned in 5NO, Newcastle, England on 400 meters and listened to two numbers, a piano solo and a mandolin. At 10:50 I tuned in 2BD, Aberdeen, Scotland on 495 meters for two numbers. Both stations came in clear.

### Get a Copy of This Book

Don't start on another set until you read "Better Tuning." 48 pages of diagrams, hook-ups, construction and tuning information. From your dealer or sent post-paid for 10c.

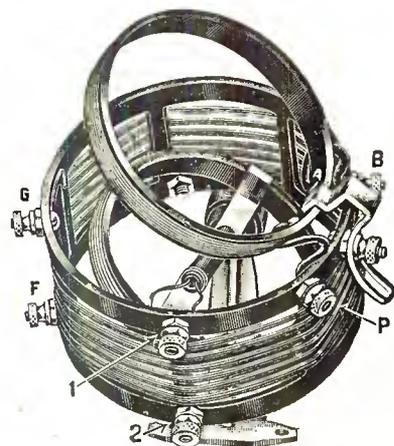

**B-T Broadcast Type  
Low Loss Tuner**

"Without question the finest regenerative type tuner that the radio industry has ever seen", is the comment of many experts. Employs the famous B-T skeleton coil form and "series-banks" windings. The adjustable untuned primary may be locked in the best position to meet any requirements of circuit or location. Broadcast listeners in congested districts will find this instrument a great aid in bringing in distance through local stuff. Ranges covered with an L-11, Laboratory Type Condenser.

Type B.....200 to 565 Meters.....\$5.00

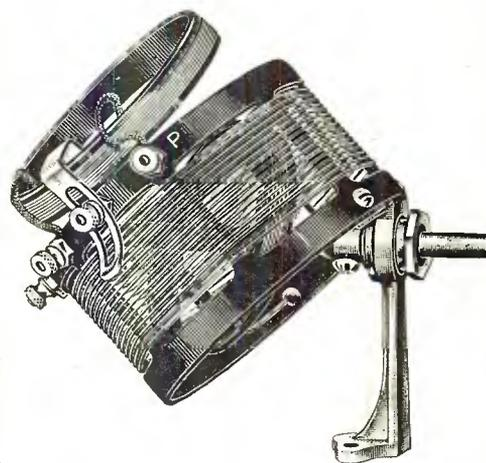

**B-T Short Wave Type  
Low Loss Tuner**

Similar in construction to the Broadcast Type except that it is designed for low wave lengths, either amateur or broadcast. Praised by A.R.R.L. members everywhere. Covers 50 to 150 meters with type L-11, Laboratory Condenser and 49 to 110 with type L-7, Laboratory Condenser. Type SW.....\$5.00

**BREMER-TULLY MFG. CO., 532 S. CANAL STREET CHICAGO, ILLINOIS**

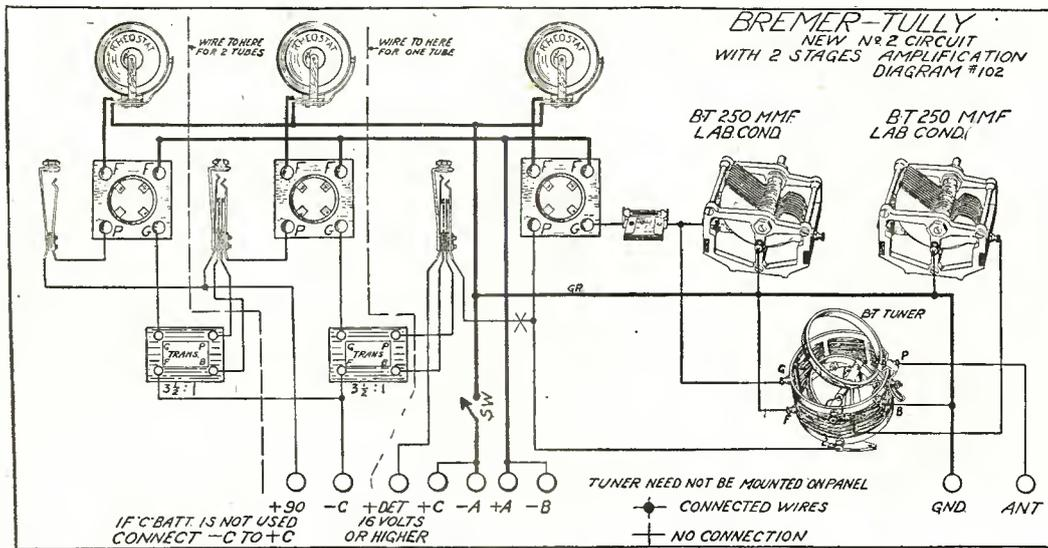

## Two Dependable Circuits for Low Loss Parts

A rather general survey of the radio field, including discussions with dealers and perusal of various magazines and newspaper sections would seem to indicate that for one, two, three or four tube sets some form of feed-back type of circuit is the most popular.

Just as the highest standard of automobile today consists of a refinement of the first sound principles developed in that industry, so it is that the fundamental efficiency of the feed-back circuit furnishes the mainstay on which to fall back when in search of dependability.

Due to the ease with which variations may be effected, this type of circuit has appeared, and still appears under countless modifications and if not too widely divergent from original principles most of them give satisfactory results, provided efficient parts are used in their construction. In other words, the proper choice of well-designed parts is a most important factor and the safest procedure is to follow the experience

and judgment of a manufacturer whose products have been known for their merit. Unless one is looking for experience only he will do better to allow the laboratory expert to weed out the impractical and inefficient from the mass of suggestions continually in evidence.

The circuits shown herewith are chosen because of their record of consistent dependability under the most difficult conditions.

The three tube hook-up is a modified shunt feed-back that is not surpassed by any set of an equal number of tubes. Regeneration is controlled by variation of capacities, in a smoother and less critical way than other methods used in feed-back circuits, and the feed-back does not affect tuning appreciably, which simplifies operation without sacrificing essentials.

Progressive construction may readily be followed without waste of parts by anyone wishing to begin with one tube, and he is assured that with each stage added he has

all possible with an equal amount of equipment.

The 4-tube hook-up includes a stage of radio frequency, making a very practical set that will cut through heavy local interference—which is most necessary in or near all broadcasting centers, and is becoming more important as super-power stations increase in number. The adjustable primary of the tuner, and of the transformer also, if desired, furnishes the greatest possible assistance in this respect. This set may be made so selective that close vernier tuning is necessary even on local stations, and it is of the type where attention to proper tuning will bring amazing results.

The inductances as shown require condensers of only 250 M.M.F. to cover 200 to 565 meters, this being an important consideration not only from a standpoint of tuning but also of being prepared to receive all stations as new allotments are made on the lower lengths.

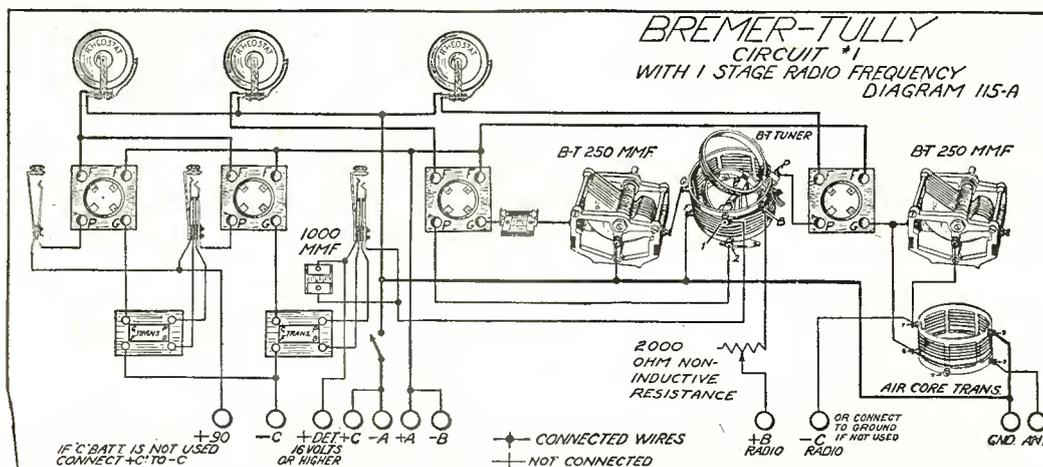

# BREMER-TULLY

## "Pioneers of Better Tuning"

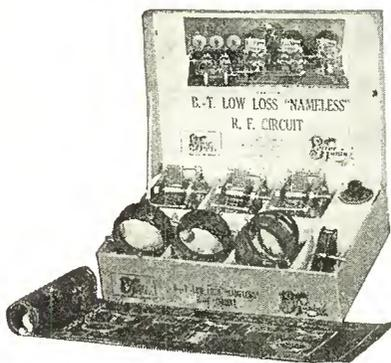

### B-T Nameless Kit No. 3

Contains three 3-Circuit Transformers, three 250 M.M.F., L-11, Laboratory Condensers, one 40 M.M.F. Control Condenser with 2-in. Dial, and a complete, full size set of Blue Prints and Instructions.....\$26.50

### B-T Nameless Kit No. 1

Contains three 3-Circuit Transformers only. Blue Prints for building the Nameless must be purchased separately.....\$10.50

### B-T Nameless Blue Prints

Full size Panel Template, Baseboard Template, Straight Schematic and Pictorial Schematic Blue Prints. Also complete Instructions for building and testing with list of all parts needed.....\$1.00

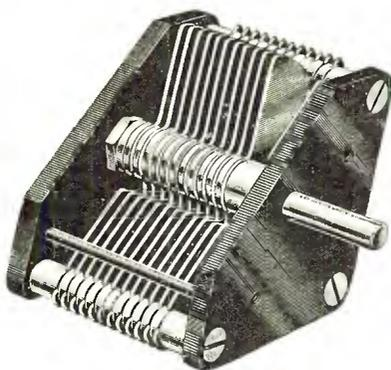

### B-T Plain Condensers

For every day use where micrometer adjustments are not required B-T Plain Condensers fill the bill admirably at an extremely fair price. Made in a wide variety of capacities to meet every need.

Type	Price
P-3.....	\$1.50
P-5.....	1.90
P-11.....	2.40
P-23.....	3.00
P-43.....	3.50

FOR real satisfaction there is not a set on the market that equals the B-T Low Loss Nameless. Since this circuit was brought out in 1924 a year of constant research has brought a distinct improvement in the circuit as well as in the parts employed. We consider the 1925 Low Loss Nameless the climax of our achievements.

Read the letters below. They will give you some idea of what you may expect if you build a Nameless.

San Antonio, Texas, Dec. 29, 1924  
In each instance where I did not use B-T parts I regretted it. I think they are the best obtainable. My reception with the Nameless is nation wide at all times, and twice as loud as any other five tube set. As for selectivity I bring in Toronto through our local stations without any interference at all.

J. B. Y.  
Tito Schipa, the world's greatest lyric tenor, praises the Nameless set installed in his apartment in the Congress Hotel, Chicago. Part of his letter follows:

"After having used several other well known makes of receivers and discarding same, to say that I am pleased with your set is putting it mildly. The volume, selectivity, quality of tone and ease with which distant stations were tuned in whilst other Chicago stations were radiocasting, is simply marvelous and almost beyond understanding. I suppose that you will hardly believe me when I tell you that I tuned in 42 stations my first night."

Atlanta, Ga., Dec. 2, 1924  
Pleased to report verified reception of PTT, Madrid, Spain, evening of 27th, by W. D. Alexander Jr., using the Five-Tube Nameless.

Alexander Seewald Company  
Chicago, Ill., Dec. 16, 1924  
As I believe in credit where credit is due I am submitting a list of 30 stations, received last night on the Nameless, and covering coast to coast. This is not my record, but what I get regularly on Monday nights, and am quite successful in getting DX during the week. Thank you for your efforts in putting on the market A-No. 1 radio equipment.

E. G. S.  
Chicago, Dec. 15, 1924  
I have been testing my new Nameless for two weeks using your new Low Loss Condensers and Coils, and it is without question the best radio set it has ever been my pleasure to tune. On Monday night, December 1st, I logged 40 stations, listening to one to four numbers from each station. I live about four miles from WEBH and succeed in bringing in WGY, with WEBH operating—this is a difference of ten meters. I can now get many distant stations each night regardless of who is operating in and around Chicago.

L. S. W.

**Get Your Copy of This Folder**  
Our circular "RF-32" contains more details of the B-T Low Loss Nameless. A postcard will bring it to you.

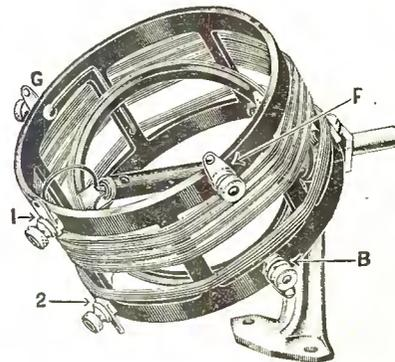

### B-T Oscillator Coupler

Built with B-T "series-banks" windings on B-T skeleton coil form, suitable for use in any circuit that requires an Oscillator Coupler. The low capacity winding requires only a 500 M.M.F., L-11, Laboratory Condenser to tune a band of 205 to 725 meters. The high ratio of inductance to capacity insure stability and uniformity of power. Pickup rotor coil may be locked in position .....\$4.00

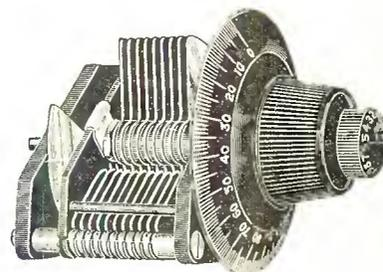

### B-T Vernier Condensers

The B-T was the first and is still the most perfect vernier condenser on the market. Users delight in its positive vernier action. Losses and minimum capacity are lower than most of the so-called "low loss" condensers. For anyone desiring highly sensitive vernier control no better product can be found than the B-T Vernier Condensers. Vernier Condensers are furnished with a 3-inch Dial.

Type	Price
V-16.....	\$4.50
V-23.....	5.00
V-43.....	6.00

# BREMER-TULLY MFG. CO.,

532 S. CANAL STREET  
CHICAGO, ILLINOIS

# Air Core Radio Frequency Transformers

ORIGINALLY radio frequency transformers were of air core construction. These air core transformers amplified very efficiently, but only over a rather narrow band of wavelengths; for instance, a transformer designed to work at 200 meters might amplify excellently from 150 to 250 meters, and fairly well from 100 to 300 meters, but outside this range they would be practically worthless. With the growth of broadcasting stations, therefore, and the spreading out of the necessary wavelength range, it became evident that in order to cover this band, it would be necessary to design an iron core with as little loss as possible, as the loss would be partly compensated for by the increased efficiency over a wider range.

Short wave radio frequency sets now use either tuned air core transformers, giving maximum amplification and sharp tuning, or untuned iron core transformers, which permit the discarding of one or two tuning dials, but which tend to be rather broad in tuning.

In the super-heterodyne circuit the amplification system is designed to work at one certain wavelength, all signals being what might be termed "transposed" by the oscillating system, and introduced into the amplifying tubes at this predetermined frequency. In a set of this type, then, we can use air core transformers confident that, providing they are carefully matched, we will obtain the utmost in quality and volume and a degree of sharpness. If a condenser is connected across a transformer secondary, a very sharp peak is produced which will distort the music or speech, and the usual practice in a system of iron core intermediate frequency amplification is to tune the secondary of the filter coil by means of a small fixed condenser. This sharp peak is necessary because the intermediate transformers cannot be depended upon to eliminate hardly any of the undesired frequencies.

As each air core transformer acts as a fairly broad filter, the true filter transformer does not require a sharply tuned secondary, and the difference in quality is quite noticeable. The main advantage, or the reason for the use of iron core transformers, lies in the ease with which they may be manufactured. If the wavelength of each transformer is slightly different, the addition of an iron core smooths out the amplification curve and eliminates the necessity of testing each one to determine its true wavelength. Manufacturers of air core intermediates must find the exact wavelength of each transformer and sell them in complete sets in order to insure satisfaction to the builder.

Very often, due to a flaw in the insulation, twenty-five or thirty turns may be shorted in a coil: On a test board used in some factories to determine the wavelength of the transformer, a shorted coil can be detected instantly, although the wavelength may be exactly the same as that of a transformer having fewer turns than the average, and a careful manufacturer desiring to maintain his reputation, will reject these faulty ones because the shorted turns form a very undesirable absorption coil, affecting the operation of the set considerably, whereas a transformer with a few turns less than normal can be matched with others in the same condition, and will work exactly the same as transformers of slightly higher wavelength. If no wavelength test is made, as is the case with iron core transformers, such a condition would never be disclosed and the result would be unsatisfactory reception, especially in the case of weak signals, where every bit of energy is necessary.

The proper frequency to select for the operation of the amplifying system of a super-heterodyne is still largely a matter of opinion; but a wavelength of twenty-two hundred meters is very satisfactory. A lower wavelength, about fifteen hundred meters, will give slightly greater selectivity with a loss in amplification, and vice-versa, three thousand meters will give some additional amplification, but the loss in selectivity seems to overbalance this gain. Twenty-two hundred meters, or approximately one hundred thirty kilocycles, will be found to be a very good balance of these two desirable features.

The coils used in the construction of intermediate frequency transformers may be either random wound, usually on wood or bakelite spools, or they may be of self-supporting construction. In the case of random wound coils, a wood spool is usually used, the wire being wound haphazardly in order to separate the turns as much as possible, and so cut down the distributed capacity between turns. Any insulating material in close proximity to coils adds a certain amount of resistance to the circuit, resulting in a slight loss and broader tuning, so, although the loss may be very little and largely theoretical, it would seem that if it can be dispensed with it would be wise to do so. Then, too, the distributed capacity will always be greater in coils of this type than in stagger wound or honeycomb inductances.

The advantage of random wound coils seems to be entirely with the manufacturer. They can be wound much faster and on less expensive machines. The only disadvantage is that the wavelength varies considerably with each transformer, as the tension of wire and the number of turns, as well as the way the wire happens to be wound, are all factors governing the wavelength of the completed coil, and are likely to vary with each one. Even if the number of turns is kept constant, twelve hundred turns on one spool will give a different wavelength than twelve hundred on another, because the position of the wire in the coils will be different, this difference resulting in a variation of both inductance and distributed capacity. Consequently, if the manufacturer is really careful to match up his transformers, he will find a wider variation than would be the case if self-supporting coils were used.

It is considered poor practice to impregnate coils, as the distributed capacity is increased enormously in this manner. Silk covered wire is less likely to absorb moisture from the air than is cotton covered wire, so unless the transformer is absolutely air tight, which is seldom the case, silk covered wire, although somewhat more expensive to use, is undoubtedly more desirable. Silk covered wire makes a smaller, more compact and a neater looking coil than cotton covered wire, and allows a smaller transformer shell to be used if the wavelength is kept up to the desired standard.

Transformers, whether of the random or "stagger" wound type, may or may not use a split secondary. Some transformers on the market use a wood spool with two grooves each five-sixteenths of an inch wide and separated about a sixteenth of an inch. The diameter is about three-eighths of an inch. On one side is wound at random approximately twelve hundred turns of wire. This is the secondary, the outside turn being the grid terminal and the inside going to the filament circuit. The primary coil consists of about nine hundred fifty turns in the other half of the spool, the outside turn going to the plate and the inside lead to the B battery supply.

Some random wound transformers use a spool about three or four inches in diameter, with three grooves for wire, the center one being used as a primary and the two outside coils joined together in series to act as a secondary. Such a practice seems to produce a more satisfactory transfer of energy from the primary to the secondary circuit and is to be preferred to the first type mentioned. The size of this transformer renders it cumbersome and obsolete, however, the newer ones taking up no more room than a tube socket. One of these late ones may be described, as it seems to incorporate most, if not all, of the desirable features. In this three coils, twelve hundred turns each of the "stagger" wound construction, and of single silk covered wire, are wound on a quarter-inch diameter. The coils are separated about one-quarter of an inch, the inside coil being the primary and the two outside coils connected together to form the secondary. A central stem of bakelite is used to support the three coils, so the resistance due to insulation in the vicinity of the coils is cut down to a minimum. The complete transformer is small and neat and gives excellent amplification.



Cut Shows Transformer Full Size. Notice Short Connection to Socket

## A Super-Heterodyne for Quality, Amplification, Distance

The efficiency of your "Super" depends on the quality of the intermediate frequency transformers. Klentz air core transformers are designed to give maximum efficiency.

### Salient Features

Quality of tone—Selectivity—Perfect matching—Stagger windings—Non-impregnated — Bakelite construction throughout — Easily assembled on account of Bottom Connection—Moderately priced. One filter and three intermediate frequency matched transformers for only \$20.00. Universal Oscillator for above, \$3.50.

### BLUE PRINTS

No. 1. This sheet shows full size panel layout giving dimensions and can be used as a template. Very handy when laying out apparatus that is mounted on front panel.

No. 2. Shows full base-board layout so that you can lay out evenly apparatus to be mounted on base-board. Gives exact dimensions of distance between each instrument.

No. 3. This shows a complete schematic diagram with all electrical connections plainly marked so that receiver will work when it is hooked up.



This "cut-away" view of the Klentz Transformer shows the Stagger windings which assure its perfect performance at all times.

Complete set of three prints 50c postpaid

**Klentz Radio Co., Not Inc.**  
2324 No. Sawyer Ave., Chicago



W O R K R I T E R A D I O S E T S W O R K R I G H T

The WorkRite  
CHUM  
\$65



REG. U.S. PAT. OFF.  
Licensed by  
Independent Radio Manufacturers, Inc.  
**NEUTRODYNE**  
Pat. Nos. 27,192,3 and April, 1924  
Machine Pat. Nos. 1,450,080 and 1,488,278  
Other Patents Pending.

A 3-Tube Neutrodyne That  
Out-performs Most 4-Tube Sets

HERE'S a brand new 3-tube reflexed Neutrodyne—one that sells for a remarkably low price. You have never seen a 4-tube set—even one that costs many dollars more—that could beat it.

The WorkRite Chum has a remarkable range. Distant stations—fully a thousand miles away—come in clearly and distinctly on the loud speaker. Under favorable conditions the Chum will cover a much larger area—and without whistles, howls or distortion to spoil your fun.

It has selectivity, too. Tunes out local stations and brings in others clearly and sweetly as can be.

This beautifully built set is self-contained. There is space in the handsome dark mahogany cabinet for both A and B dry batteries. It works with any kind of an aerial—outdoor or indoor—and is always ready for instant use—any time or any place.

You must hear the Chum or any of the other famous WorkRite sets to appreciate real radio reception. Sit at the dials yourself. Get the real thrill of radio from WorkRite. Any WorkRite dealer will gladly let you demonstrate any of these famous sets to your own satisfaction. If the dealer you visit hasn't WorkRite in stock, send us the coupon today for complete information.

THE WORKRITE MANUFACTURING COMPANY  
1812 EAST 30<sup>TH</sup> STREET CLEVELAND, OHIO  
Chicago, 536 Lake Shore Drive

WORKRITE ARISTOCRAT

A 5-tube Neutrodyne Set  
In this beautiful mahogany console, the loud speaker is placed on one side and compartment for A and B batteries on other side. All connections made inside with cable and plug. A set unsurpassed in any respect.  
Price, without accessories . . . . \$350

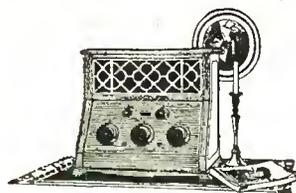

WORKRITE RADIO KING  
A 5-tube Neutrodyne Set

Encased in genuine brown mahogany cabinet with graceful sloping panel. Distortionless loud speaker built into cabinet behind handsome grille. WorkRite Air Master is almost identical with Radio King except it has no loud speaker.

Prices:  
Radio King, without accessories . . \$170  
Air Master, without accessories . . \$120

Send Coupon for FREE  
Rotogravure Booklet

The WorkRite Manufacturing Co.  
1812 East 30th Street Cleveland, Ohio  
Please send me FREE a copy of the Roto-gravure booklet which describes WorkRite.  
Name .....  
Address .....  
City.....State.....

WORKRITE  
SUPER NEUTRODYNE RADIO SETS

Tell 'Em You Saw It in the Citizens Radio Call Book

# Now You Can Learn The Code In One Night!



## Thousands Have Done This—So Can You

With this short cut designed by a Naval officer you can learn the wireless code in one evening.

A large percentage of Radio messages are sent in code and a wonderful field is opened to you if you learn it.

This short cut was designed for emergency purposes during the war to qualify operators in the minimum amount of time.

Used by thousands of students in hundreds of schools all over the country.

No phonograph records or other mechanical devices required. Simply take the short cut we send and you will be able to master the code enough to receive messages in one evening.

### FAILURE IMPOSSIBLE

*Sent postpaid upon receipt of fifty cents  
in stamps or coin*

The Best Fifty Cents You Will Ever Spend In Radio

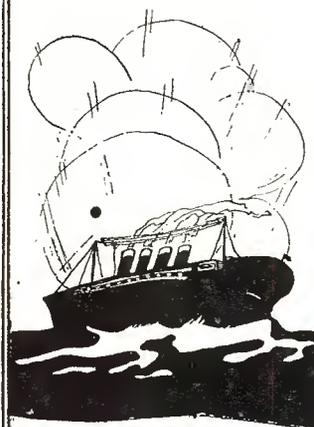
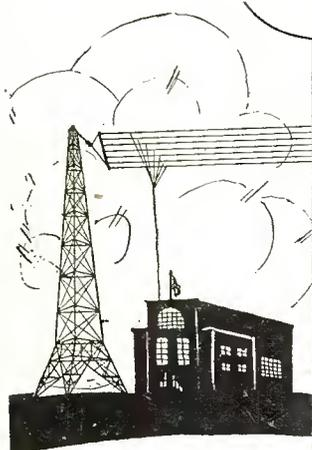

# Roberts Radio 785 Service

Caxton Bldg.  
Chicago.

# World Batteries

*"To Purchase a World is to Purchase Economy"*



## RADIO Storage "B" Battery

**\$350**  
C.O.D.

4 Batteries in Series  
(96 Volts)  
\$13.00

### World Storage "B" Battery

12 Cells—24 Volts—Solid Rubber Case

To ten million homes with Radio Sets—and to countless millions of prospective buyers—this WORLD Storage "B" Battery brings a new conception of battery economy and performance. Here is a battery that pays for itself in a few weeks—will last for years, and can be recharged at a negligible cost.

Approved and listed as Standard by leading Radio Authorities, including Pop. Radio Laboratories, Pop. Sci. Inst. Standards, Radio News Lab., Lefax, Inc., and other important institutions.

A *Superior* Battery Equipped With Solid Rubber Case.

Has heavy duty 2 1/8" by 1" by 1/4" plates and plenty of acid circulation. Extra heavy glass jars allow ready observation of charge and prevent leakage and seepage of current. It holds its charge while idle, at constant voltage. You will find this battery a boon to long distance reception. It does away with a great many noises so often blamed on "static."

### World Storage "A" Batteries

Two-Year Written Guarantee

*Famous for Guaranteed Quality and Service. Backed by Years of Successful Manufacture and Thousands of Satisfied Users.*



6 Volt, 100 Amps.....	\$12.25
6 Volt, 120 Amps.....	14.25
6 Volt, 140 Amps.....	15.00



## Send No Money

Just state number and kind of batteries wanted, and we will ship order the day it is received. When shipment arrives, examine the battery or batteries before you pay one penny. Then pay C.O.D. charges. 5% discount for cash in full with order. Remember, *"to purchase a World is to purchase economy."* Send your order TODAY.

## WORLD BATTERY COMPANY

1219 So. Wabash Ave.

Dept. 26

Chicago, Ill.

# Save You 50%



# For low loss and clear reception your socket must have these three features

Here's the *only* socket  
that has all three



De Luxe No. 400  
Socket  
Price 75c  
For 200 Series  
Tubes



Na-Ald Adapter  
No. 429  
For 199 Tubes  
Price 75c



Na-Ald Special  
Socket No. 499  
For U. V. 199 Tubes  
and C-299  
Price 50c



Na-Ald Panel Mount  
No. 460  
For All Na-Ald  
Sockets  
Price 35c

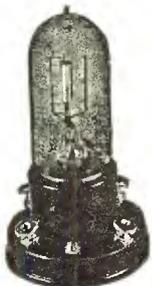

Na-Ald W. D. 11  
No. 411  
Price 75c

**T**O determine scientifically which make of socket is most efficient in cutting down losses, a test was recently conducted in the laboratory of a leading Engineering University. It proved that:

1. Of 13 best-known makes, Na-Ald Sockets were the only ones having a loss as low as a good low loss condenser. Without Na-Ald Sockets your set is NOT lowest loss.
2. Na-Ald has the lowest capacity of any socket—a very essential feature for short wave-length reception.
3. Na-Ald is the only socket with positive side-scraping contact (not just side pressure) that cleans corrosion from sides of tube terminals.

No other socket has all these essential advantages. For best results make sure you have Na-Ald Sockets in the set you build. No matter what the circuit, these sockets will add to its efficiency. Na-Ald De Luxe Sockets are 75c at all radio stores. Other Na-Ald Sockets, 35c and 50c. Use them with sets you buy or build.

### Na-Ald Super De Luxe Dials

These dials are made of genuine Bakelite, Alden-processed. The numbers and lengths, spacing and width of lines are so scientifically arranged that there is no eye-strain even if you tune in station after station for hours at a stretch. And the big generous-sized knob fits your fingers naturally. Super De Luxe Dial, 75c; other sizes, 35c and 50c.



Na-Ald Super  
De Luxe Dial  
Price 75c  
No. 3043—3/16 inch  
Shaft  
No. 3044—1/4 inch  
Shaft



No. 3783—3/16 inch  
Insert  
No. 3784—3/4 inch  
Insert  
3 3/8 inch Dial  
Price 50c



Small Space Socket  
No. 401  
35c—3 for \$1.00

**Alden Manufacturing Company**  
Dept. F1, Springfield, Mass.

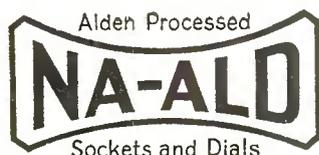

Write for free  
booklet of select-  
ed, tested circuits  
and details of  
laboratory test.

Mail This Coupon Today

Alden Manufacturing Co.,  
Dept. F-1, Springfield, Mass.

Please send your book of tested, selected circuits, "What to Build"—also full information about laboratory tests.

Name.....

Address.....



# Sickles Diamond Weave Coils

Specified in the New Hoyt Augmenter Circuit

# ?

BECAUSE  
THEY ARE THE BEST

Complete Set of Coils Designed Under the Personal Supervision of Francis R. Hoyt.  
No. 21 Coil Set, Price \$10.00

ALSO

For the Craig 4-Tube Reflex Circuit With Sodian Tube, No. 20 Coil Set, Price \$4.50.  
For the Roberts Reflex Circuit, No. 18 Coil Set, Price \$8.00.

For Tuned Radio Frequency Receivers, No. 14 Tuned Transformer Coil, Price, \$2.00 Each.

Send for Catalog

## THE F. W. SICKLES CO.

337 Worthington Street  
Springfield, Mass.

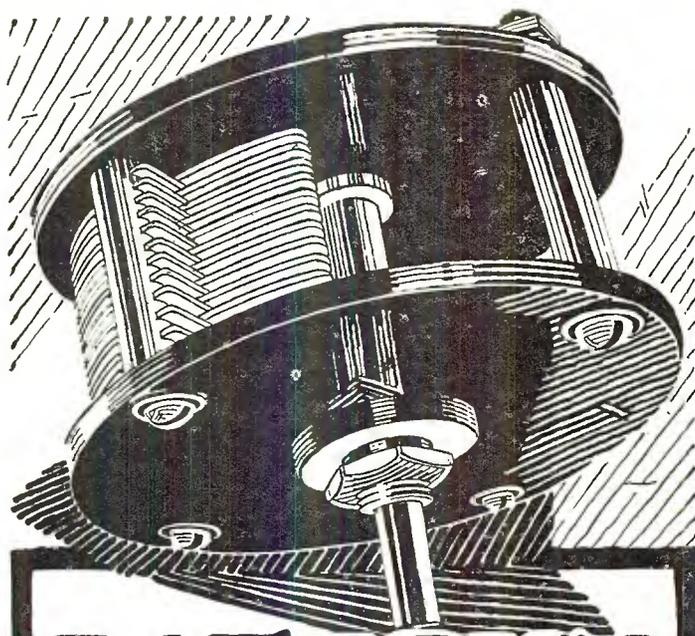

# RATHBUN HONEST CONDENSERS

Don't be fooled by "Low-Loss" Bunk!

RATHBUN Condensers—with genuine Bakelite moulded end plates—will give results fully equal to any variable condenser on the market. None are more honestly made or more reasonably priced.

We are proud of our condenser—proud of the materials, the workmanship and the care put into it. It would be easy for us to make metal end plate condensers of the so-called "low-loss" type, but we are firmly convinced that our present methods of construction are right and that the radio public has been grossly misled as to the supposed advantages of the "low-loss" metal end plate types.

In order to prove our sincerity, and to justify our product—honestly made—in the face of much exaggeration and misleading propaganda, every Rathbun Condenser is sold with the following guarantee:

Rathbun Condensers are guaranteed satisfactory in electrical and mechanical construction—any proving otherwise will be replaced free of charge, or the purchase price refunded. If you can get longer distance, sharper tuning, better quality, or more volume with any other condenser on the market today—return ours and your money will be immediately refunded.

*That's An Honest Guarantee For An Honest Product—and We Mean Every Word of It!*

We have prepared a little booklet giving in detail the story of so-called "low-loss" condensers, including a tabulation of the losses, accurately measured, in over fifty standard condensers. You will find it interesting and instructive and it's free for the asking.

**An Entirely New System of Radio Reception**

Rathbun Single Hole Mounting Superior Condensers have been specified for use in the Hoyt System of Signal Augmentation by the inventor, Francis R. Hoyt. We have a limited number of Blue Printed copies of Mr. Hoyt's original laboratory notes on this new system of radio reception, together with nine circuit sketches, which will be sent free to you upon receipt of this coupon and 4 cents for postage.

Name.....

Address.....

.....

**Rathbun Manufacturing Co., Inc.**  
JAMESTOWN Dept. CRCB NEW YORK

*"What a Difference the Hammarlund makes!"*

U. S. and Foreign Patents

Have You Tried the New Model "C"?

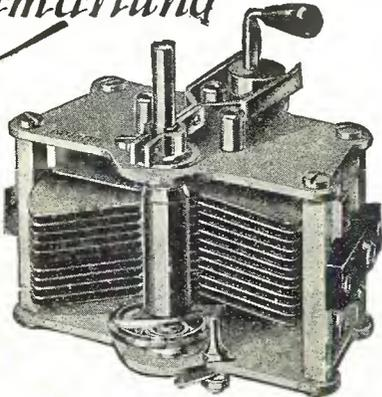

Ever since the early days of radio, Hammarlund Condensers have enjoyed the praise of experts.

Each of the two preceding models represented the best of their time. The New Model "C" is a worthy successor of these, embodying as it does every known principle of modern electrical and mechanical efficiency.

You make no mistake when you choose Hammarlund condensers for your radio construction work.

Made in all capacities; plain and vernier. Sold by the better radio dealers.

Write for folder

HAMMARLUND MANUFACTURING CO.

424-438 West 33rd Street, New York

Pacific Coast Representatives:  
Atlantic-Pacific Agencies Corp.,  
204-212 Rialto Bldg., San Francisco  
Canadian Distributors, Radio, Ltd., Montreal

### 9 points of Superiority

1. Soldered brass plates; chemically treated against corrosion; perfect alignment.
2. Stator plates specially shaped for easy tuning on low waves.
3. Adjustable ball-bearing rotor shaft, grounded through metal end-plates.
4. Soldered clock-spring pig-tail, with automatic stop.
5. Minimum dielectric; loses too small to measure.
6. Rugged, compact construction; cannot warp.
7. Micrometer vernier; moves all plates; no backlash.
8. Takes any size dial.
9. The product of 14 years' experience, making precision instruments.

For Better Radio  
**Hammarlund**  
PRECISION  
CONDENSER

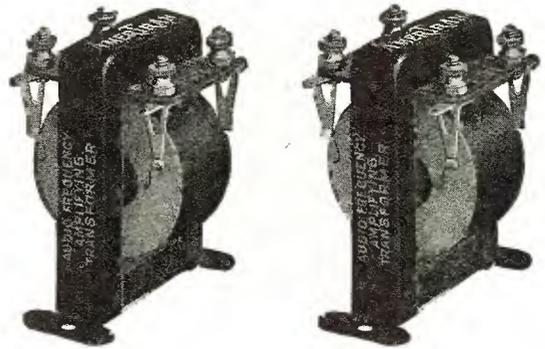

## Improve Your Set

The sure way to do it is to rebuild the audio side and use a pair of AmerTran. Do this, and the utmost in volume, clarity and tone quality will result.

AmerTran is the product of over twenty-four years' specialized experience in transformer building. Increasing appreciation of its quality comes with continued use.

AmerTran is made in two types, one quality.

Type A F 6 (ratio 5:1) for use in the first stage.

Type A F 7 (ratio 3½:1) for use in successive stages.

Price, either type, \$7.00  
Use them by the pair.

THE  
AMERICAN TRANSFORMER  
COMPANY

180 Emmet Street, Newark, N. J.

"Transformer builders for over twenty-four years."

**AMERTRAN**  
TRADE MARK REG. U.S. PAT. OFF.

# BE A RADIO EXPERT!

*The Opportunity of a Lifetime*

**Amazing money-making possibilities — Big Salaries — yes, even fortunes and independence await wide-awake ambitious men entering the Radio field.**

**Earn \$3,000 to \$10,000 a year**



Everyone knows that the men who got in on the ground floor opportunities of the locomotive, the telephone, electricity, the automobile, moving pictures, etc., have been handsomely rewarded—many of them made millions. Now science contributes the greatest opportunity of the age—a discovery so marvelous and so easily within the means of all that even the humblest home seeks its possession and benefits.

From a business and money-making standpoint Radio fairly staggers the mind of anyone who gives it a moment's thought. Even men with little or no knowledge of its principles are making \$3,000 to \$10,000 a year. Radio is the fastest growing industry in the world. Everywhere people are crying for radios. Manufacturers are swamped with orders that cannot be filled. And yet anyone of average intelligence can learn at home in spare time how to construct, install, repair and sell dependable sets.

## Train at Home in Three Months

If you are in a routine job with poor pay and no future, here is truly *the chance of a lifetime*. Don't miss it. In a few short months at home by mail we can make you an expert representative of our Association. Become the radio expert of your town or neighborhood. Find out how the Radio Association of America throws the doors of opportunity wide open for you. We will show you the way to swing big salary jobs or to get into business for yourself and be your own boss.

### No Previous Experience Necessary

Get your share of the big money to be made in the most rapidly growing business of all time. Mail the coupon below for our big free book, which tells how in your spare time at home, without giving up your present position or losing a dollar of pay, you can become a thoroughly

trained radio expert in a few short months.

No previous experience is necessary. For the man who prefers a salary, big pay jobs are waiting with the U. S. Government, Steamships, Railroads, and thousands of corporations and business houses. For the man who wants to start in business on a full or spare time basis, with little or no capital, grow and become independent, Radio offers an easy way to unlimited money-making opportunities. In no other line can ambitious men find an easier road to success.

You can train under one of America's leading Radio authorities. Read Mr. A. G. Mohaupt's offer to train you personally in everything about constructing, installing, repairing and selling Radio Sets and Accessories. By enrolling with us now, you get the benefit of the direct personal guidance of this well-known Radio expert.



**A. G. MOHAUPT, B. A., M. S.**  
Head of the Radio Association of America, Graduate Electrical Engineer, University of Wisconsin. Former Radio Instructor for U. S. Government. Author of "Practice and Theory of Modern Radio."  
"I give my personal attention to every student taking my course. Your individual problems and questions are answered by myself. I work with you at every stage of the course, guiding you, directing you to your goal to be a Radio Engineer in the big-pay class. My course prepares you to successfully pass Gov't examination for Operator's License."

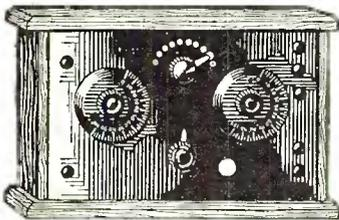

## FREE—1000 Mile Radio Outfit

This set when completed has a range of over 1000 miles. Right now we give it free to each member taking our course of training. Mr. Mohaupt's clear, simple instructions will show you how to build

similar sets to sell at a big profit. When you have finished the course, you can sell this free set at a price that will practically pay the cost of your training.

### Get the Facts—Mail Coupon

Our training is not only easy and interesting, and supplies knowledge you can always use in operating your own set, but is the most cashable knowledge a man can possess. Let us prove to you that there is nothing difficult about Radio—that any intelligent person can easily learn it right at home by mail under our simplified and approved methods. Mail the coupon now for our big, free Radio Book, which gives all the facts. Let us prove that Radio is easier to learn and offers bigger money than any other business or profession you can get into. Don't wait—act while our Free Offer of a 1000 mile radio outfit is still in effect.

**A. G. MOHAUPT, Radio Engineer**  
**RADIO ASSOCIATION OF AMERICA**  
4513 Ravenswood Avenue Chicago, Ill.

**Radio Association of America,**  
4513 Ravenswood Avenue,  
Dept. RBC,  
Chicago, Ill.

Please send me your free book telling all about Radio opportunities and your Expert Home Training Plan and offer to representatives, also your offer of a 1000 mile Radio Set FREE.

Name.....

Address.....

City.....State.....

# FIL-KO-LEAK \$2.00

SCIENTIFICALLY CORRECT  
VARIABLE GRID LEAK

\$2.90  
In Canada



*its calibrated*

YOU can "log" your FIL-KO-LEAK just as you do your other tuning units. You will get stations you never heard before. You will clear up distortion on nearby broadcasters and increase volume of weak, distant stations and get them with crystal clarity. You read FIL-KO-LEAK resistance in exact terms of the megohm through a peep-hole in the panel. (It's also equipped for baseboard mounting.) Resistance element is constant and accurate, and is not affected by atmospheric conditions, wear or jarring. Every FIL-KO-LEAK is guaranteed to be perfect electrically and mechanically, and to be accurately calibrated over the operating range for all tubes ( $\frac{1}{4}$  to 5 megohms). This calibration is doubly checked.

Fits  
Standard  
Condensers

FIL-KO-LEAKS are specified for the Hoyt SYSTEM OF SIGNAL AUGMENTATION by the inventor, FRANCIS R. HOYT. We have a limited number of blue printed copies of Mr. Hoyt's original laboratory notes on this new system together with nine circuit sketches, which will be sent free on receipt of four cents postage.



# FIL-KO-ARRESTER \$1.50

LIGHTNING  
SCIENTIFICALLY CORRECT  
RADIO LIGHTNING ARRESTER

\$2.10  
In  
Canada

*with the \$100.00 Guarantee*

Absolutely warranted to protect your set from lightning, with a guarantee to pay you \$100 or to repair your set, should it be damaged through faulty operation of the arrester.

The "umbrella" shield keeps dust, moisture, etc., from the Bakelite insulation, preventing leakage losses from aerial to ground. This makes certain that all radio impulses reaching the antenna pass through your set, which assures maximum reception.

Listed as standard under re-examination service of Underwriters' Laboratories.

*New and Improved*

# FIL-KO-STAT \$2.00

SCIENTIFICALLY CORRECT RADIO RHEOSTAT

\$2.90  
In Canada

*with Battery Switch Attached*



Tune your tube filament with Fil-KO-Stat and receive stations you never heard before. Get greater distance, louder signals, sharper tuning, freedom from tube noises. Fil-KO-Stat is the only rheostat that permits adjustment over the entire operating range of all tubes and enables you to get maximum audibility in phones or loud speaker. And now the improved model is fitted with battery switch that attaches to the regular mounting screws. Distinctly signals "on" and "off" and enables you to break circuit without changing Fil-KO-Stat adjustment. Fil-KO-Stat fits any type tube in any hookup. Unconditionally guaranteed.

Send 2c stamp to Dept. CB125 for interesting literature on improved reception.

**DX INSTRUMENT CO.** HARRISBURG, PA.

# MODERN RADIO RECEPTION

*A New Book*

BY

**CHARLES R. LEUTZ**

**325 PAGES  
200 ILLUSTRATIONS  
FULLY BOUND**

*Partial List of Contents:*

- Radiola Super-Heterodyne Diagram
- Western Electric 4B Receiver
- Model C Super-Heterodyne
- Model C7 Super-Heterodyne
- Long Distance Reception
- Short Wave Reception
- Long Wave Receivers
- Pliodynes and Super-Pliodynes
- Laboratory Equipment
- Broadcast Transmitters
- High Efficiency Amateur Transmitters
- Model L Super-Heterodyne

and

Everything of importance relating to  
Broadcast Reception

This supersedes Mr. Leut's earlier book  
entitled "Super-Heterodyne Receivers"

Price **\$3.00** Postpaid

**RADIO PUBLISHING Co.**

508 South Dearborn Street,  
Chicago, Illinois

# Radio Dealers receiving my "Salespeaker" are making money—

If you want to make more money this year, you can. You positively can. My "Salespeaker" will show you how. And I won't charge you a penny for it, now or later. I send it free to the ambitious. Just mail the coupon below. Read my offer.

NOT many years ago I was a manufacturer's agent with an income from \$2500 to \$4500 a year. Today I am President of Hudson-Ross, Inc., the largest wholesaler radio jobbers. The same principles that have made Hudson-Ross the leading jobber in our

**DOUBLES SALES**



"My sales this month are double those of a year ago. Your attractive discounts help very much. Yes, I read the 'Salespeaker' every month—and wouldn't miss it."

H. Dimberg, Chicago  
**BUILDS SETS**



"I was particularly interested in the super-het pages. At these prices I can build and sell two sets a week."

C. Field,  
Milwaukee

field, can make you the leading dealer in yours. There is no secret about the way we made this success. We followed the path of least resistance.

**This policy will double your sales, too**

Now, I will show you

what I mean by following the path of least resistance. How I apply this old law in a new way.

You, better than many, fully appreciate the great fundamental wrong in the radio field today. Too many folks are trying to get rich overnight. What is the result? The market is flooded. Just as it was in the old days when talking machines first appeared. But what happened to this industry will happen to radio also. Without question, many products now clamoring for favorable attention will entirely disappear. And out of the multitude of names a certain definite few will stand aloft and secure.

The reason for this is plain. Some radio products today are inherently sound. They are made of the best

that money can buy. They are the result of the greatest scientific and engineering ability in the country. These two factors alone insure the success of such products. But there is still another—the greatest factor of all: *National advertising.*

**Hudson-Ross distribute only nationally advertised goods**

I anticipated the development of nationally advertised radio products several years ago. So I tied up only with national leaders. That is why I am enjoying such a large business today. That is what I mean by following the path of least resistance. In other words, give people the products they know about and ask for. Give them products identified with the greatest manufacturers in the business. Give them nationally advertised merchandise.

Glance at the list of products we distribute. You know them all. So does the radio public—your customers. They are all leaders in their line. They are nationally adver-

- A FEW OF OUR WELL KNOWN LINES**

  - Accuratone
  - Acme
  - All-American
  - Allen-Bradley
  - American Brand
  - Amperite
  - Ansco
  - Apco
  - Baldwin
  - Balkite
  - Belden
  - Benjamin
  - Bowman
  - Carter
  - Celeron
  - Connecticut
  - Coto-Coll
  - Cunningham
  - Daven
  - DeWaldyne
  - Dubilier
  - Eby
  - Echophone
  - Ekko
  - Electrahof
  - Erla
  - Eveready
  - Freshman
  - Frost
  - General Instrument
  - Haynes-Griffin
  - Hilco
  - Howard
  - International
  - Jewell
  - Karas
  - King
  - Martin-Copeland
  - Melco
  - Music Master
  - Muter
  - Na-Aid
  - Philco
  - Precision
  - Pyrex
  - Rathbun
  - Remler
  - Signal
  - Thompson
  - Thordanson
  - Thorla
  - Tungar
  - Ultradyne
  - Univernier
  - Western Electric
  - Weston
  - Willard



**R. Himmel,  
Pres. Hudson-Ross, Inc.**

*"Ambition is a mighty thing, but ambition without patience is only fireworks."  
"Churches with high steeples do not always save the most souls."  
"A man without character is like a cipher with the rim off."  
"Common sense harnessed to initiative makes the world go 'round."  
"Delay puts out the fire of purpose in men. Big men do things—little men delay things."*

ROBERT HIMMEL.

tised. They are here to stay. They are bringing in big profits for our dealers every week. For we can let them go at very liberal discounts.

## FREE

Write at once for your personal copy of my "Salespeaker." It is the liveliest dealer radio bulletin published today. It contains actual photographs of the leading nationally advertised sets, speakers, parts, hook-ups, etc. One entire page is devoted to the latest radio news from all parts of the country. New ideas for your window. Successful selling stunts used by other dealers.

In each issue, along with the merchandise, I list the retail price and cost to you. My generous discounts will appeal to your sense of business. You will enjoy the neat tabulation which shows how large your profits are.

All this is entirely free. Yet I do even more. I will turn over to you all inquiries from your neighborhood sent to us in response to our advertising. I will send you one of our full-color seals for your window which will identify you as the Hudson-Ross neighborhood dealer. But

I can do nothing for you unless you act right away. Unless you write your name and address on the handy coupon below. We are receiving so many requests for the "Salespeaker" that we urge you to write at once. Fill in and mail the coupon now while it's in your mind.

Hudson-Ross, Inc., 123 W. Madison St., Chicago

**HUDSON-ROSS, INC.,** 101

**123 W. Madison St., Chicago, Ill.**

Gentlemen:

Please mail me free and prepaid your "Salespeaker" and one of your full-color seals for my store window.

Name-----

Address-----

City-----State-----



# HUDSON-ROSS

B U I L T T O A S T A N D A R D — N O T P R I C E



\$50.00

# The Outstanding Radio Value of 1925

THE DON-MAC PREMIER 3 offers to radio fans the best of everything in radio. Constructed throughout with standard parts furnished by reputable manufacturers such as Premier Electric Company, Bremer-Tully, and others whose products are made under the stamp of QUALITY.

Strict adherence to quality, many years experience and study and a desire to produce only a genuinely valuable product, have made the DON-MAC PREMIER 3 the outstanding value of 1925.

Have your dealer demonstrate the DON-MAC PREMIER 3 to you. You will

immediately appreciate its fine tone quality and simplicity of operation.

The PREMIER 3 is a three tube 100% low loss, triple feed back set. Range and selectivity are remarkable with it. Coast to coast stations are easily brought in even through powerful local stations. Operates on loop aerial and reproduces clearly on loud speaker.

We have some interesting and valuable information for dealers who want a quality product at a popular price. Let us send you our proposition today.

Consumer—if your dealer does not handle the PREMIER 3 write us direct, giving his name.

## SPECIFICATIONS

- |   |   |
|---|---|
| Premier Crowfoot Condenser<br>Premier Duo-Stat<br>Premier Microstat<br>Premier Hegehog Transformers<br>Bremer-Tully Tuner | Premier Lo-Loss Sockets<br>Bakelite Panel<br>Bakelite Baseboard (Specially built)<br>Birch Mahogany Cabinet, 20"x8"x8". |
|---|---|

Every minute detail of the parts entering into THE DON-MAC PREMIER 3 was selected on quality and performance alone.

**DON-MAC CO., Inc.** 29 SO. DESPLAINES ST. CHICAGO - - ILLINOIS  
 A QUALITY SET—UNCONDITIONALLY GUARANTEED

Tell 'Em You Saw It in the Citizens Radio Call Book

# Glossary of Circuits

## The "How" and "Why" of Push-Pull Amplification (See Page 94 for Diagram)

THE principal advantages of "Push-pull" amplification are as follows:

1—The signal current from the amplifier to which the "Push-pull" unit is attached is divided between two tubes. Thus, the tubes are not overloaded by strong signals from local stations.

2—In ordinary transformers there is a magnetic flux at all times in one direction, due to the "steady plate current" from the tube. In the push-pull circuit the steady component is "balanced out," leaving no flux except that due to audio-frequency variations in plate current. This gives a very nearly ideal condition in the transformer core.

3—The fact that we have two tubes in parallel in "Push-pull" amplification enables us to use a specially designed transformer in the output circuit, having very low resistance. This results in a maximum of current delivered to the loud speaker.

4—The *characteristics of any amplifying tubes*, particularly at audio frequencies, always produce a certain amount of undesirable harmonics ("kinks") which may, or may not be, noticeable to the ear. In "Push-pull" amplification, these harmonics are balanced out, resulting in a decided improvement in tone quality.

There are other advantages of using "Push-pull" amplification in the last stage, but these additional points are somewhat too technical to discuss in a brief article of this kind. Having gained some knowledge of the principal advantages of "Push-pull" amplification, we shall now consider the operation of this unit.

For a "Push-pull" circuit, the output of an ordinary one or two stage audio frequency amplifier is connected directly to the primary winding of a special input transformer, which has two windings on the *secondary*.

It will be observed that both of the secondary windings are connected to a common terminal. It is evident that if one of the "G" terminals is at any instant positive with respect to the center terminal the other will at that instant be negative. Since the two "G" terminals of the double secondary windings are connected to the grid terminals of two tubes a positive potential is impressed on the grid of one tube, while simultaneously a negative potential is impressed on the grid of the other tube. This means that we have *divided the secondary voltage* of the input transformer equally between the two tubes of our "Push-pull" unit. The result is a corresponding increase and decrease in the plate currents of these two tubes, since this plate current is governed by the potential of the grid.

Having followed the circuit from the input terminals of the power unit, through the input transformer and thence to the grids of the two tubes, we will now consider the plate circuits of these two tubes and their relation to the output transformer.

In actual operation there is, at a moment of silence, a steady plate current flowing in both primary windings, but in opposite directions from the common terminal. Since these currents oppose each other—one "pushing" and the other "pulling"—their magnetizing effect on the iron core of the transformer is neutralized as stated above, and *there is no flux present*. But when a voltage appears on the grids, its effect is to *increase* one of these opposing plate currents and *decrease* the other, so that while one "increases its push," the other "relaxes its pull." Consequently, both windings *combine their effect* to produce a powerful sound current in the secondary. As a matter of fact, one stage of "Push-pull" amplification gives more volume than one stage of ordinary audio amplification, but somewhat less than two stages.

The principal value of "Push-pull" power amplification is its action in dividing the voltage delivered by the previous stage equally between the grids of the two tubes. From your studies of vacuum tubes you may remember that the output, that is to say the variations of plate current, is seldom, if ever, exactly in proportion to the signal impressed on the grid. This gives rise to "harmonics" which are balanced out in the "Push-pull" style of amplification, this being a further reason why we recommend a stage of "Push-pull" instead of a third stage of ordinary audio amplification. All radio engineers recognize the fact that even though it were possible to produce a transformer ideally perfect in every detail, yet with plate currents

as high as those in an ordinary third stage, the *tube characteristics* alone would result in introduction of undesirable harmonics, and consequently would impair tone quality. This is exactly what the "Push-pull" circuit avoids.

In the following paragraph we list a number of suggestions which the builder will be wise in following when constructing his "Push-pull" power unit. We want to emphasize particularly the point regarding use of tubes of the same type in the power stage. That is, the tubes in parallel between the input and output transformers should be of exactly the same type; for instance, *both* tubes should be UV-201A or similar type tubes such as C-301A, or else both should be of any other type which you find gives good results.

We wish also to mention the advisability of constructing your stage of "Push-pull" amplification as a separate unit electrically. It can, of course, be incorporated mechanically as a fixed part of your set, but when wired as a separate unit, with its own plug and jack, it can be plugged in on either the first or second stage of audio frequency amplification.

### Suggestions

1. Follow layout of apparatus as shown in the diagram. Make connections from transformers to circuit exactly as indicated on transformer plate. Grid and plate leads or wiring should be as *short as possible* to eliminate local feedback effects. These important leads may be shortened by raising the sockets an inch or two from the base board.

2. We recommend the use of UV-201-A or C-301-A tubes throughout the amplifier. *Be sure that you use tubes of like characteristics* in the power stage. *This is essential* to obtain the balancing effect; it is not so important in the other stages.

3. Ordinarily 90 volts will be found sufficient for the plate potential; however, when using power tubes, such as UV-202, greater voltages will be required, depending upon their specifications.

4. It is *essential* that the "C" or biasing battery be used. When using the 201-A type tubes, six volts will be sufficient; however, we suggest that you experiment with voltages ranging from three to nine and choose the value that gives the best tone. Ordinary flashlight cells will be found satisfactory, if cell-to-cell connections are well soldered.

5. We suggest the grounding of the transformer casing to the negative "A" battery or ground.

6. *Do not use soldering paste*—even so-called non-corrosive—even making joints in your wiring. Use only rosin-core solder.

7. Remember that a Push-pull amplifier depends absolutely, as does no other type, on perfect *balancing* of the two transformers; unless both are designed and made in a factory accustomed to *precision workmanship*, the neutralizing of distortion described above can by no means be depended on.

### Non-Reradiating Superheterodyne

(See Page 98 for diagram)

This circuit has many desirable features, namely: Non-reradiation, strong signals on a loop, selectivity, quality of tone, simplicity, and compactness.

It will operate satisfactorily using 6 volt "A" tubes which draw only  $\frac{1}{4}$  of an ampere apiece.

WD-12 tubes are used with a 6-volt "A" battery as the filaments are connected in series. The last two tubes are "A" tubes and are operated in parallel, using a 6-ohm rheostat.

This receiver will "get" all stations in the band of wavelengths used by radiocast stations and is equipped with a switching device for reception on the higher wavelengths.

In selecting parts use the best. Vernier condensers are essential when tuning this circuit.

### The Browning-Drake Receiver

(See Page 90 for Diagram)

To Glen H. Browning and Frederick H. Drake, of Harvard University, belongs the honor of designing this remarkable receiver which has proved so efficient that over 90% of the value of amplification calculated by mathematics was actually produced when subjected to laboratory tests. The Browning-Drake Circuit has essentially two tubes—a radio frequency amplifier and detector to which two stages

of audio amplification may be added making a four-tube set for loud-speaker reception.

Mr. L. D. Yont, of Brighton, Mass., received 35 stations in one evening on this set, among which were: KGO, Oakland, California; KSD, St. Louis, Missouri, and PWX, Cuba. Dr. D. B. Cheetham, located in Worcester, Mass., says: "This set is a wonder—had Dallas, Atlanta and Kansas City the first night, before 9 P. M. on the loud speaker. Marvelous clarity and wonderful volume. Can't use push-pull on stations under 1500 miles; has too much volume."

#### List of Parts

The necessary apparatus for construction is given below:

- 1—panel, 7-24 inches.
- 1—baseboard, 8½x23½ inches.
- 1—Regenaformer kit, which consists of 1 .0005 mf. condenser, 1 .00035 mf. condenser, 1 antenna coil and 1 regenaformer.
- 1—balancing condenser.
- 4—standard tube sockets or one UV-199 tube socket with three standard sockets.
- 2—audio transformers.
- 2—rheostats (1 of 10 ohms and 1 of 30 ohms resistance).
- 1—25-ohm fixed resistance.
- 1—volt-meter.
- 1—.0001 mf. fixed condenser.
- 1—.001 mf. or .002 mf. fixed condenser.
- 1—.00025 mf. fixed grid condenser.
- 1—variable grid leak.
- 1—double circuit jack.
- 1—single open circuit filament control jack.
- 1—filament switch.
- 1—1. mf. by-pass condenser (this is optional).
- 9—binding posts.
- 20—feet of wire for connecting parts.
- 4—tubes.
- 1—"A" battery.

#### Cockaday Four Circuit Tuner

(See Page 124 for Diagram)

Going a little beyond the three circuit tuner, Laurence M. Cockaday has designed a receiver in which four circuits are employed, insuring absolute elimination of interference, unlimited range and ease of tuning.

The primary circuit consists of a single turn of tinned copper bus wire 1/16 inch square, the secondary winding consisting of 65 turns of No. 18 DCC wire, stabilizer 34 turns of No. 18 DCC wire and the antenna tuning coil 40 turns of No. 18 DCC wire double bank wound.

No variations of coupling are necessary in a set of this type, therefore eliminating coupler, variometer and feed back coil, thus allowing a fixed regeneration feature that will stay put over the entire wave length's range.

It will be noted from the diagram that the primary inductance consists of only a single turn of wire, this being inductively coupled to the secondary. The wave length of the primary current is controlled by the bank wound inductive coil. As the inductive effect of this coil is used for adjusting the wave length, care should be taken in locating it in the set so that it will not have any inductive effect on the other coils.

The other three coils are all in inductive relation to each other. The antenna tuning is done by varying the primary coil by use of the switch lever. Regeneration and all secondary units are controlled by the use of the two (11 plate) variable condensers.

When tuning the receiver, one will at first find difficulties; but after a little practice and when more familiar with the set, it will seem very easy.

#### Tuned Plate Receiver

(See Page 94 for Diagram)

The tuned plate receiver is similar to the three circuit regenerative set, except that in place of a grid variometer for tuning the secondary and grid circuit, a 23 plate condenser is shunted across the secondary of the coupler. This makes the set tune sharper.

#### Superdyne Receiver

(See Page 112 for Diagram)

This is one of the very recent circuits which have appeared to be most successful in the many attempts to combine regeneration and radio frequency amplification.

The circuit differs from the usual radio frequency circuit in the

use of the tickler coil. It is found in all tuned radio frequency circuits, that when all the circuits are tuned alike oscillations begin. Various methods have been tried to neutralize this tendency. In the superdyne, it is accomplished by use of the tickler coil, which may be adjusted so as to bring enough energy from the plate circuit to the grid circuit in the reverse direction.

When all connections are properly made, there should be no popping or squealing. If this occurs, try reversing the leads to the rotor of the coupler.

#### Choosing Your Receiver

In choosing a receiver that will give you the most satisfaction take into consideration the quality of tone consistent with volume. The set must bring in stations you want to hear and keep out the stations that you do not want to hear. Efficient performance day after day is an important item and this is more easily obtained from a receiver whose construction is simple.

First of all your receiver is no better than the parts used. Each part has a distinct duty to perform and pains should be taken to see that each section of your receiver is operating at its maximum efficiency. You should request parts that have been thoroughly tested.

Each tube should be controlled by separate rheostats although the average set controls more than one tube with one rheostat. Such practice is at the expense of good reception, because tubes in use are known to develop peculiarities.

If you buy a receiver completely assembled, pick out one that is the simplest constructed. Do not pay for frills or complicated, mysterious equipment.

A well designed receiver will be so arranged that a minimum amount of wire will be used, and the connections must be perfect.

We understand that manufacturers of parts for this circuit have prepared a complete book describing the circuit, and it is suggested that you write to them for full particulars. You will find these parts advertised in another part of this book.

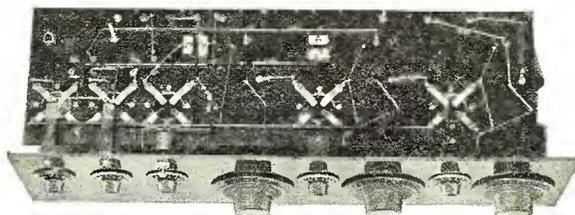

*Here is an example of neat assembling and exceptionally careful wiring. Power losses are slight in this set because the interior wiring has been cut down to only 14 feet of wire where the average five-tube set uses 50 feet*

#### The Hoyt Augmentor

(See Page 114 for Diagram)

To enable the builder to properly construct this circuit the dimensions of the coils are shown in another part of this book. The coils have a combination winding including an aperiodic primary.

It is important that the aperiodic primary be NOT used directly on the antenna when the receiver is in the city. This is to be used only with the stage of tuned radio frequency as shown in the diagram. With high powered stations operating only ten kilocycles apart, the day of the aperiodic primary is past where extreme selectivity is desired.

The antenna tuning coil should be very loosely coupled to the secondary; this is from two and a half to three inches, or it can even be at right angles. This position can be fixed, once it is determined. Tune out the most persistent interference and leave the coil in that position.

In constructing this receiver the best parts throughout should be used. Only the best grade of fixed mica condensers and low loss variable condensers should be employed. Standard 3½ to 1 audio frequency transformers give the best results.

Regarding tubes, it is recommended that 201-A or 301-A types be used, although the detector tube may be a 200 type if desired. But, as the rheostat setting is not at all critical in this circuit, the hard tubes may be used to advantage, and one rheostat for all of the tubes will then be sufficient. This of course is optional.

Be very careful when you construct the augmentor coil. The illustration gives the number of turns and size of wire to be used. The augmentor coupler has been designed around standard dimension

tubing, and there are on the market one or two makes of variocouplers which can be purchased and rewound for this circuit.

#### Non-Reradiating Regenerative Receiver

(See Page 100 for Diagram)

With the constantly increasing number of radio listeners, the problem of radiation from the regenerative sets has become acute and any circuit that reduces or eliminates this feature will be welcomed by all radio fans.

In the first place due to the untuned antenna, the set tunes independent of antenna length, which is a decided advantage. The tuning is exceptionally sharp and for that reason micrometer dials must be used on condensers.

Under certain conditions of wiring the feed backs between some of the wires may render it advisable to run the lead from the fixed coupler to a potentiometer instead of directly to negative "A" but this is not ordinarily necessary. A variable grid leak is strongly recommended because of the variation of operating characteristics of the tubes available on the market.

This set has given remarkable results, as it will tune out local stations on less than one-half degree on the dial and for distant stations requires exceptionally careful tuning even with a micrometer dial control.

The circuit operates very well with hard tubes but a soft detector tube may be used in which case the proper "B" battery voltage must of course be used. Audio amplification can be added in the usual way.

For the advanced amateur who is interested in rather startling results, some very remarkable effects will be secured by placing an 11 plate condenser across the tickler coil, but it is not recommended to any one that is not possessed of a great deal of patience.

Care should be used in connecting the condenser with the rotary plates to the lowest possible potential in all cases and as the set is somewhat sensitive to body capacity, shielding is advisable, although when operating properly the body capacity effect is hardly noticeable.

The selectivity and success of this circuit depends upon the use of the best parts obtainable and inefficient parts will ruin operation of circuit both as to distance and selectivity.

#### 45 Kilocycle "Super" Using UV 199 Tubes

(See Page 126 for Diagram)

Forty-five kilocycles is a very good frequency to use when the person constructing the set wishes to employ UV-199 tubes.

Efficient results depend a great deal on the intermediate frequency amplification employed. At relatively long wavelengths this is simple, but at the short broadcast wavelengths there is a tendency toward oscillation due to internal capacity and circuit coupling. This is overcome in this circuit by eliminating the "stabilizer" or potentiometer.

Another advantage of this set is that it employs dry battery tubes. The filament current is less than  $\frac{1}{2}$  ampere for the entire eight tubes. By using three "C" batteries the plate current drain on the "B" batteries is only 10 to 12 milliamperes.

A loop having three taps is used which gives a regenerative effect on the loop itself.

#### Maintaining Your Neutrodyne

(See Page 108 for Diagram)

##### The Antenna System

The best antenna for a Neutrodyne set is one consisting of a single wire of about 100 to 125 feet long, strung between supports that are as high as possible from the ground. The antenna must be insulated at each end by insulators of the highest quality. Whereas the antenna itself may be either of bare or insulated wire, it is extremely important that in no case it touch any structures such as chimneys, trees, neighboring buildings, etc., and that it should be at least several feet from any obstructions.

The antenna lead-in should in all cases be part of the antenna itself. By this is meant that the antenna wire stretched between the two supporting points is continued directly down from one end to connect to the receiving set. It is not necessary to cut the wire and then connect the lead-in to the antenna. This latter practice requires careful scraping of the antenna wires and secure soldering to insure good electrical contact and maximum efficiency. Making the antenna and lead-in all in one obviates the necessity of soldering. It is also important that the lead-in should be kept away from buildings, trees, and other obstructions.

The antenna lead-in, as it comes to the set, should be kept away from the set. It is poor policy to bring the antenna back along the length of the receiver, so that the electric field around it affects the receiver. This usually results in trouble and makes the receiver inoperative. It may be necessary at times to insert the antenna lead-in within a shield. This shield can best be of flexible copper braid or a copper tube, which should be connected to ground.

It is a very great advantage in installing an outdoor antenna or an indoor antenna, for that matter, to have the antenna directional. By directional it is meant that the antenna system will receive signals with greater efficiency from one direction than from another. The simplest method of erecting a directional antenna is: always connect the lead-in to the end of the antenna pointing toward the station from which it is desired to receive the signals.

An indoor antenna differs from an outdoor antenna only in that it is placed entirely indoors and therefore must be shorter and lower than the outdoor antenna. As a result the reception and intensity of the received signals must be considerably weaker than the corresponding signals as obtained from an outdoor antenna.

An indoor antenna may be made of ordinary insulated wire such as an annunciator or bell wire and concealed about the room by placing it behind picture moulding, etc.

#### The Ground Connection

The ground connection is one of the most important factors for the proper operation of any receiving set. In the city, especially in congested districts, the ground is extremely important. The cold water pipe system of the house is usually the best ground connection. The pipe or connection to which the ground is made must be very carefully scraped and cleaned so that the metal shows bright. A ground clamp will be of great aid in making a good connection, and can be installed in a few moments. The ground wire from the receiving set to the clamp must be securely attached to the clamp, and preferably soldered. It has been proven time and time again that reception has been increased from very poor to astounding results merely by removing the ground clamp, cleaning the insulating paint, dirt, etc., between the clamp and ground proper, and cleaning and soldering all connections.

#### Vacuum Tubes

The low filament battery consumption of filament tubes, namely, the types UV-201-A and C-301-A, or "hard" tubes, as they are called, has made their use almost universal, supplanting almost entirely the earlier UV-201 and C-301 types. However, the types UV-199, C-299 and WD-11, which are dry battery tubes, are fairly popular. The "UV" type tubes are known as Radiotrons and the "C" type tubes are known as Cunninghams. These tubes are made from identical specifications, and can be used interchangeably in any receiver.

UV-201-A or C-301-A tubes are recommended because of their greater amplification. However, when these tubes, or others, are used in a Neutrodyne receiver, there are times when the receiver does not seem to function properly. Among the various causes that may render the receiver inoperative is the fact that the tubes themselves are defective. By interchanging the tubes among themselves one may arrive at a combination which gives best results. Some tubes act better as radio frequency amplifiers and some better as audio frequency amplifying tubes. There is no way of telling beforehand; trial alone will tell.

One of the chief causes for tubes becoming inoperative after being used for some time is the excessive filament current to which they are sometimes subjected. Rheostats are put into the receiver to regulate the filament current of the vacuum tubes and should be adjusted so that the maximum signals are obtained with a minimum amount of filament current. It is a well established fact that when the filament such as the "UV" and "C" type tube is adjusted to a certain filament current, the maximum signal strength is obtained. Any further increase in the filament current *will not* and *should not* increase the signal strength.

The 2 ohm power rheostat previously furnished with some Neutrodyne receivers to control the amplifier tubes is so designed that when using UV-201-A or C-301-A tubes, one need but turn the rheostat knob until the contact lever just makes contact with the resistance strip. This will give the proper signal strength. Further decreasing the resistance by turning the rheostat knob further to the right will not increase the intensity of the signals. It will only diminish the life of the tubes and render them inoperative in a short period of

time. If it is necessary to cut out all the resistance to obtain the loudest signals, either the filament battery is discharged or one or more of the tubes are defective.

"Bootleg" tubes are very inferior to the genuine product and therefore must be scrupulously avoided.

**Detector Tubes:** The choice of a detector tube is dependent upon the type of service the broadcast listener desires. If he is content with consistent results from broadcasting stations at medium distances, no better tube can be used as a detector than either the UV-201-A or the C-301A. Should he desire to listen to broadcasting stations at great distances, in other words to try for "DX" reception, the "soft" tube type UV-200 or C-300 should be used.

The "hard" tube requires no adjustment of its filament current beyond the initial adjustment to obtain signals. Thereafter the filament rheostat need not be adjusted every time the receiver is used. Local powerful broadcasting signals will not swamp or overload "hard" detector tube but on the contrary such signals will be more efficiently rectified. Signals obtained when using a "hard" tube as a detector in this case will be several times as loud as those obtained with a "soft" detector tube. The relative lack of sensitivity of a "hard" tube for weak signals renders the receiver in which it is used, seemingly more highly selective than when a "soft" detector tube is used. The "soft" tube of the UV-200 or C-300 type is very sensitive to weak signals. It is therefore an excellent tube to be used for the reception of long distance signals. A "soft" tube contains a slight amount of gas, and due to partial ionization, or the breaking down because of electronic bombardment of the gas, it becomes extremely sensitive. It therefore requires very careful adjustment of its filament current and its plate potential, in order that the most sensitive point be obtained. This makes the tube a rather critical device, and requires some experience to obtain the maximum results. Due to the gaseous ionization, a "soft" tube is somewhat noisy in operation, and therefore a compromise must be made between the tube noise and the strength of the signal desired.

Signals of various intensity will require different adjustments of the filament current of a "soft" tube. For fairly strong signals from nearby stations it is not necessary to adjust the filament current of the tube to the maximum sensitive point. For weak signals, it is absolutely necessary to obtain the most critical point of operation. Thus, the filament current required for strong signals is less than that required for weak signals. In tuning in for any particular station, it is best to reduce the filament current of the detector tube until the signals obtained are fairly weak. Then turn the dials of the receiver until maximum signals are obtained. The signal then obtained should not be very strong. Now the filament current of the detector tube is increased until maximum response is obtained. If this procedure is followed the receiver will be tuned exactly to the incoming wave length of the broadcast signals. Following this method the operator will not be confused by the seemingly broad tuning obtained when listening to strong signals and with his detector tube adjusted for extreme sensitivity.

The plate voltage required for a "soft" detector tube is usually between 16 and 25 volts. This voltage is best determined by listening to the "hiss" which is very characteristic of the "soft" detector tube when it is adjusted to its critical point of operation. The best plate voltage is that voltage at which a reasonable adjustment of the filament is necessary to obtain this "hiss" point. If the plate potential is low, more filament current will be required to obtain the hiss point, than if the plate potential is higher. If, after adjusting the plate voltage throughout the entire possible range, this point is not obtained, either the filament battery is low and insufficient filament current is obtained, or the particular detector tube is defective, and should be replaced.

#### New Radio Chart

The Radio Chart Bureau of Fresno, Calif., has perfected a new radio chart that is so designed that the operator can find the desired station in the minimum amount of time.

If the directions printed on this Radio Chart and the Call-Letters Tabulator are followed closely, the operator of any kind of receiving set can keep constantly up-to-date, regardless of the continuous wavelength changes and new stations coming on the air.

In re-locating, for instance, a station previously indexed for which either the Call-Letters or Wavelength is known, the operator can

conveniently eliminate all unwanted Call-Letters or Meters by looking only in the particular column for the desired information.

When a new station is received which has not yet been logged on the chart and for which the Call-Letters cannot be distinctly understood, the approximate wavelength can be quickly determined by following the directions printed on the Call-Letters Tabulator. Here again the operator can conveniently eliminate the many hundreds of unwanted Call-Letters until the correct Call-Letters for the new station are definitely determined beyond doubt. There are sufficient blank spaces provided on the Call-Letters Tabulator so that the operator can constantly insert any meter changes or new stations coming on the air as announced in radio publications, an advantage which has not been provided for in the many publications giving printed information of Call-Letters, Wavelengths, etc.

#### Audio Frequency Amplification

During the past few years vacuum tubes have practically displaced all other forms of audio-frequency amplifiers, because of the great volume and fidelity of reproduction obtainable with the tubes. Their use always requires some sort of coupling device, and the most effective is the transformer. An amplifier tube, together with the transformer which supplies the input current to its grid, make up what is called one *stage* of amplification.

We shall not attempt to describe in detail the amplifying action of the vacuum; we shall simply say that a vacuum tube of any of the common types, used without the grid condenser and leak, has primarily a "valve" action, by which we mean that an alternating voltage delivered to the grid of the tube "stops off" and "releases" the flow of plate current so as to mould it very closely to the wave form of the grid voltage itself. Hence the voltage we get from the detector tube need only be high enough to "work the valve" on the grid of the amplifier tube. However, we cannot connect the detector output directly to the amplifier grid, since we must have there only the *variations* of the plate voltage, and not the full continuous "plus" voltage necessary on the detector plate. So we use, as by far the best means of getting these variations of voltage delivered to the amplifier grid, an "audio-frequency transformer."

To the radio-wise, we could define a transformer as simply a very close inductive coupler—but for such readers no definition would be necessary at all. So instead, we have on this page a picture which symbolizes the parts of a transformer so that their functions can be better understood. Any iron-core transformer is, in its operation, simply a chain of three "links": two coils of wire, each interlinking with the iron core or "magnetic link." According to the principle of electromagnetic induction, when an alternating electric current is sent through one of the coils, it causes magnetism to appear in the iron core, and all changes and reversals of the current are accompanied by corresponding changes and reversals of magnetism. All the changes of magnetism are at the same time causing voltages in the other or secondary coil, proportional to the rapidity with which the magnetism is changing, and therefore proportional to the rapidity with which the primary coil current is changing.

The kind of current which flows from the detector to the audio frequency amplifier is a "direct current," since it flows always in one direction, but it is a "pulsating direct current," because its strength is not uniform, but varies according to the form of the sound wave it is transmitting. This is the current which we send through the primary coil of our transformer, and variations in it cause continual variations in the magnetism of the core. Imagine one of these "peaks" of current coming from the detector; as the current grows, it causes a voltage to appear in the secondary. Then, as the primary current stops growing and reaches its maximum, the secondary voltage vanishes; as the primary voltage now begins to decrease, voltage appears again in the secondary, but in the reverse direction.

All these changes of secondary voltage are transmitted to the grid of the amplifying tube, reflecting each little "kink" in the primary (detector) current. The *voltage* of this secondary current depends on the number of turns in the secondary coil as compared with the primary; thus, by winding five times as many turns on the secondary as on the primary, we have a "5 to 1 ratio" transformer, and can send out to the amplifier grid a voltage almost five times as high as we get from the detector plate. This "stepping up" of voltage increases the amplifying action.

# Now—more than ever the Right Set to Buy

*The self-contained set is the radio receiver of the future—and the only satisfactory type for summer use*

There are a host of people who will get fully as much pleasure out of radio this summer as they have all winter. They are the thousands of owners of the 1925 Operadio. Whether they stay at home or travel, splendid radio reception is always available. For with this complete, self-contained set they may listen in anywhere. Its extra large battery supply, six tubes, large loop in the removable cover, and efficient loud speaker—all enclosed in the compact carrying case—assure powerful distance performance. Think of it! No outside wires or connections, no accessories, nothing but a smart-looking case, opened and easily tuned in less than a minute. The 1925 Operadio is not to be confused with the ordinary so-called "portable" set. It has far longer battery life because three years of concentrated effort by nationally known radio engineers has resulted in extreme compactness, allowing space for six "A" batteries and four of the largest "B's." It has greater range and selectivity, greater ease of tuning, and much finer tonal qualities than any set of this type ever designed, and its performance is comparable with that of any set on the market. Before you buy any set, judge it by the standard established by the Operadio. Get the convenience and added enjoyment of a set that can be enjoyed anywhere. If your dealer is not yet handling Operadio, write us and mention his name.

THE OPERADIO CORPORATION  
8 South Dearborn Street CHICAGO, ILL.

# OPERADIO

The Original Self-Contained Radio Set

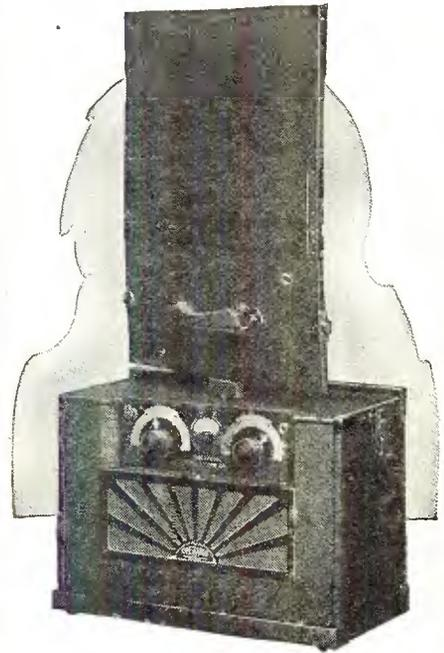

The Operadio is entirely complete in its smart leatherette carrying case. An attractive De Luxe Walnut Cabinet has also been designed for those desiring a furniture model in which the case may be placed.

Price Complete  
With Tubes and Batteries  
(Portable Type Only)  
**\$189<sup>00</sup>**



Close it up  
Take it with you  
Use it anywhere



# BROADCASTING

the SilverVoice Story to Your Customers and Prospects in 1925

The LOUD SPEAKER de Luxe  
With the Natural Tone

## SilverVoice

MADE on a new and proved, but revolutionary principle of sound reproduction giving all the natural tone quality of the original voice or instrument broadcast. Its amazing sensitiveness gives far greater distance than has ever been known before. SilverVoice is the supreme achievement in loudspeakers — acknowledged by all who have heard and seen it as a masterpiece of both tone reproduction and decorative beauty.

There's a SilverVoice Dealer Near You

With SilverVoice magnet this 19 times the strength of the ordinary loud speaker magnets.

Instead of metal, the SilverVoice diaphragm is made of specially treated, corrugated silk.

Manufactured by  
**RADIOTIVE CORPORATION**  
Brooklyn New York



This smashing full page in Collier's, The National Weekly, will bring business to every dealer

Write Now for the SilverVoice  
"S-A-L-E-S Broadcast"

Both together we can do volume selling, and you will sell more loud speakers than any other dealer in your locality. Your profits start when you "tune in". Do it now! Every dealer should write at once.

Distributors: A few Jobbing Territories still open. Write or Wire.

**RADIOTIVE CORPORATION**  
21st AVENUE & 53rd STREET BROOKLYN, N. Y.

Write Now!  
For the Silvervoice S-A-L-E-S Broadcast

### Advertising

WE will run a series of nine advertisements in Collier's, The National Weekly, beginning with a striking full-page in the February 7th issue.

Collier's million families are just the type of people who are now coming into your store. Collier's has a special Radio Department which interests radio fans, and it is read by the kind of men and women who can afford good radio speakers.

We also are running newspaper advertising in large cities. This advertising has wide influence beyond the cities themselves; being read in outlying small towns and suburbs. Moreover, large cities read one another's papers. You can buy New York papers in Boston and Boston papers in New York. Thus, by merely concentrating on the richest markets — where you are — we can further make the SilverVoice name nationally known.

### Dealer Cooperation

Half the power in this drive is the individual effort of our dealers. Through you we will apply pressure on your town-folks where the sales are actually made. You will find that our advertising makes sales easy if you tie up to it.

By advertising and by local display at your store we send them in and you bring them in — to your profit.



# Buy Where WESTON Radio Instruments are sold—You'll find a Quality Stock



**Radio Plug**

The smooth and instantaneous action of this Radio Plug, the positive grip, the beauty of design and finish, mark it as a typical Weston product. The large popular demand has made this plug one of radio's outstanding sale successes.



**Radio Table Voltmeter**

This model 489 Double Range Radio Table Voltmeter with ranges of 150-75 volts was especially designed by the Weston Corporation for the radio enthusiast. It is a high resistance instrument, beautifully made with a strong Bakelite case. Its portable form, accuracy, dependability and range combination make it an ideal all purpose voltmeter around the radio set, for checking filament and grid voltages, locating troubles such as loose or broken connections, testing new hook-ups, for improving reception and for materially increasing the useful life of the tubes through close regulation of filament voltage.

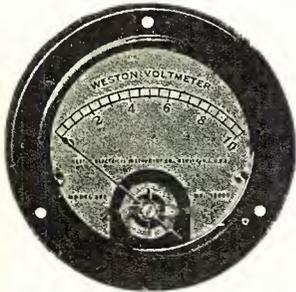

**Filament Voltmeter**

A Filament Voltmeter is no longer a luxury. It is now recognized as an essential of every good radio set, because close regulation of filament voltage improves reception and materially lengthens the life of the tubes.

As the ammeter on the dash of the automobile is the telltale of the battery, so is the filament voltmeter the tell tale of the radio set.

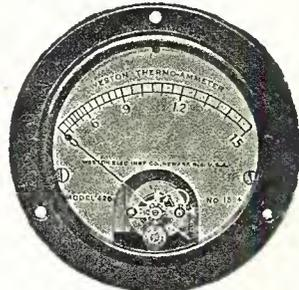

**Antennae Ammeter**

This Weston thermo-couple type Ammeter solves perfectly the problem of measuring high frequency currents, such as are imparted to the antennae. It also measures accurately and with equal facility, alternating currents of low frequency. It is also accurate on direct current service and is a remarkable contribution to the art of electrical measurement.

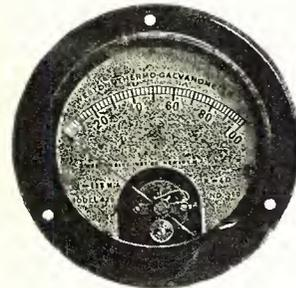

**Thermo Galvanometer**

A sensitive Thermo-milliammeter of low resistance, designed especially for use in a wave meter circuit for the measurement of wave length and decrement; and for the measurement of high frequency resistances by the resistance and reactance variation methods. It has a large overload capacity, a resistance of 4.5 ohms and requires only 115 milliamperes for full scale deflection.

FOR over 36 years Weston Electrical Indicating Instruments for Power Switchboards, Commercial Testing, Standardizing Laboratories, Research Work, etc., have been recognized as the world standards.

Weston Radio products embody the same forethought and preciseness of design and workmanship to be found in the larger instruments so long used in the electrical measuring field. These instruments have won for Weston its well-known international reputation.

These radio instruments are accurate, dependable, and will render a lifetime of service if used with reasonable care. Furthermore, the interest of the Weston Corporation does not cease at the time of the making of a sale. It wants to be assured that every purchaser of a Weston Instrument actually receives the service he has a right to expect. Any information regarding individual experiences with these instruments will always be welcomed.

## WESTON ELECTRICAL INSTRUMENT CORPORATION

1 Weston Avenue - Newark, N. J.

OFFICES IN ALL PRINCIPAL CITIES

STANDARD THE WORLD OVER

# WESTON

Pioneers since 1888

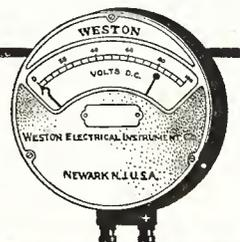

Tell 'Em You Saw It in the Citizens Radio Call Book

# Simple or Complex Tuning - Which do you Want ?

Simple tuning, to be sure! Then why not use the only single plate vernier condenser that can be tuned and definitely logged on neutrodyne or radio frequency circuits without a preliminary operation of setting the vernier. Why not use the condenser with a single plate vernier that will give you the complete wave range of your coil without an extra operation. The Proudfoot Low Loss One Knob Vernier Condenser is built for modern hook-ups.

### Assemblage

Two rods, instead of three, completely and efficiently support stator plates.

### Tuning Plates

Stator and rotor plates are made of No. 18-B. & S. Gauge (.040-in.) aluminum with .026-in. clearance.

### Vernier Plate

Vernier plate lining up and operating as one of the rotor plates in making rough adjustment, insures quick tuning and extreme range of capacity. In making vernier adjustment, it turns a complete 360 degrees.

### End Plates

Made of 1/8-in. aluminum. Front end plate is at the same potential as the rotor plates, thus eliminating body capacity when grounded.

### Bearings

Bronze bearings with dissimilar metals at wearing points.

### Contacts

Three positive contacts eliminate the pigtail and provide perfect electrical connection of the vernier.

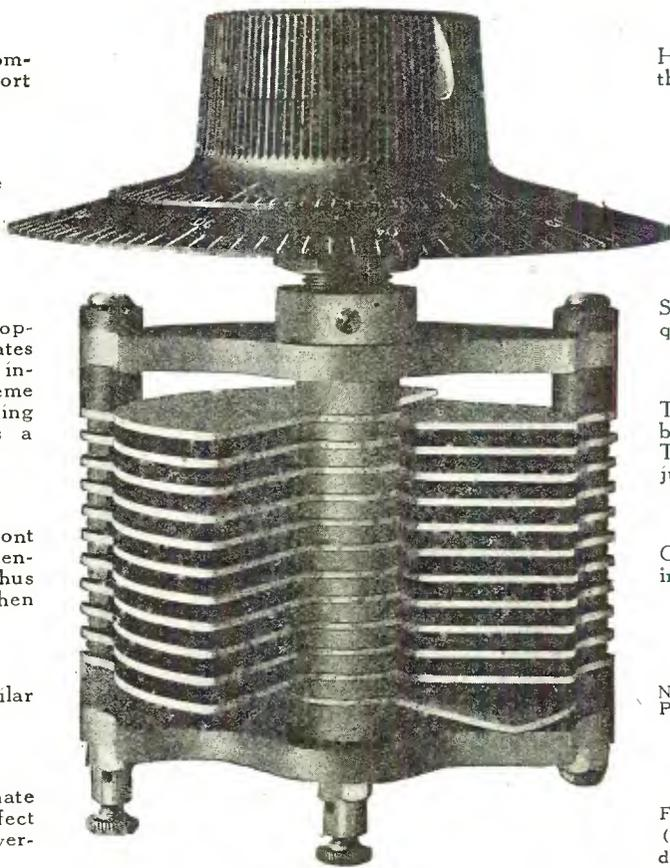

### Insulation

High grade hard rubber is used throughout for insulation.

### Mounting

Single hole in panel and single nut firmly lock the condenser at the most efficient working angle.

### Connections

Sturdy binding posts permit quick, positive wiring.

### Adjustment

Turning complete knob adjusts both group and vernier plate. Turning outer half of knob adjusts only the vernier plate.

### Logging

Outer scale logs group plates and inner scale logs vernier plate.

### Prices

No. of Plates	M.F.C.	With Vernier Dial and Knob	Without Vernier Dial and Knob
13	.00025	\$3.75	\$3.25
17	.00035	4.40	3.90
25	.0005	4.50	4.00
43	.001	5.75	5.25

Four-inch polished bakelite two piece (for group and vernier readings) dial .....\$1.00

See the Proudfoot at your dealer's. Note the sturdy construction—that explains why it is such a serviceable unit. It is used as standard equipment in many popular nationally-used sets. And it's priced right, too! Get one today. If your dealer cannot supply you, write us sending us his name and we will see that you are promptly supplied.

## Cruver Manufacturing Company

2456 Jackson Boulevard, Chicago, Ill.

# PROUDFOOT Low Loss One Knob Vernier Condenser

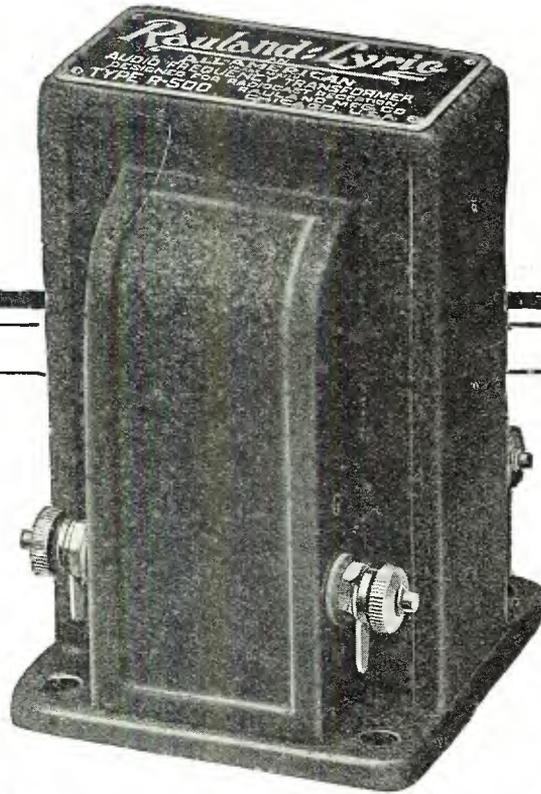

## Tonal Beauty Lies Deeper than the Varnish

**D**EEPER even than the circuit diagram—chiefly, indeed, in the *audio transformer*.

All-American engineers, builders for years of the *largest selling transformers in the world*, have achieved another triumph, in the *world's finest transformer* at any price. *Rauland-Lyric amplification*, with an ordinary tuner and loudspeaker, has received the plaudits of musical authorities hitherto skeptical of all radio reproduction.

Perfect amplification makes of a radio a joy unending. Who shall say that such a benefit is not worth the slight additional cost?

There is romance in the story of Rauland-Lyric. A request will bring it to you complete—from the laboratory studies to the auditions with world-famous music critics. All-American Radio Corporation, 2678 Coyne Street, Chicago.

*The price is nine dollars*

**Rauland-Lyric**  
AN  
**ALL-AMERICAN**  
TRADE MARK  
**TRANSFORMER**

*The Choice of Noted Music Critics*



# What Reliable Radio Means to You

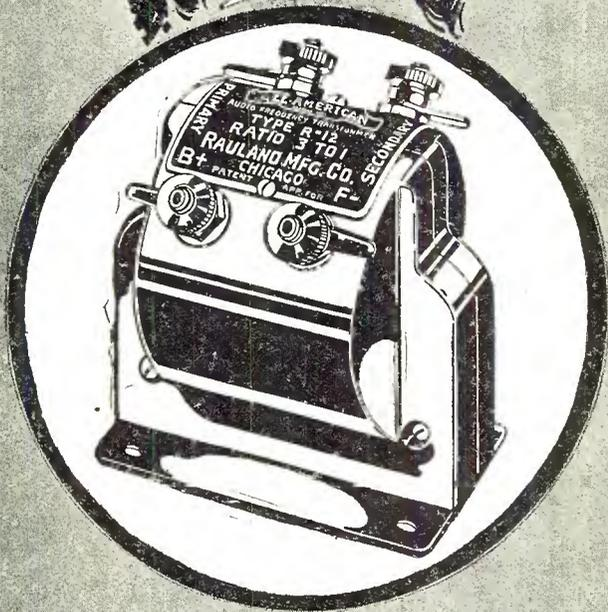

☞ An assurance that, when you try out a hook-up, you can rely on your instruments to give you a *fair* test. ☞ A knowledge that each part has been put to such searching tests that its proper performance, *under any conditions*, is assured. ☞ In short, a conviction that each individual part *will continue* to do its work *year after year*.

Two pleasant hours spent with the RADIO KEY BOOK will acquaint you with the essential facts of modern reception, and how to enjoy it at its best. Ten cents—coin or stamps—brings the KEY BOOK.

ALL-AMERICAN RADIO CORPORATION  
PIONEERS IN THE INDUSTRY  
2678 Coyne Street Chicago

## ALL-AMERICAN Guaranteed Radio Products

Standard Audio Transformers  
3 to 1 Ratio, type R-12... \$4.50  
5 to 1 Ratio, type R-21... 4.75  
10 to 1 Ratio, type R-13... 4.75

Power Amplifying Transformers  
(Push-Pull)  
Input type R-30... \$6.00  
Output type R-31... 6.00

Rauland-Lyric  
A laboratory grade audio transformer for music lovers. R-500... \$9.00

Universal Coupler  
Antenna coupler or tuned r. f. transformer. R-140... \$4.00

Self-Tuned  
R. F. Transformer  
Wound to suit the tube. R-199 \$5.00. R-201A \$5.00

Long Wave Transformer  
(Intermediate Frequency)  
(15-75 kc.) R-110... \$6.00

10,000 Meter (30kc.)  
Transformer  
Tuned type (filter or input). R-120... \$6.00

Radio Frequency Coupler  
(Oscillator Coupler). R-130 \$5.00

Super-Fine Parts  
Consisting of  
three R-110's,  
one R-120 and  
one R-130, \$26.00

All-American  
Reflex  
Receivers  
Complete receiving sets with extraordinary range, volume and selectivity. All parts mounted on panel and baseboard, with full instructions for wiring. All-Amaz Junior (one-tube)... \$22.00  
All-Amaz Senior (three-tube) \$42.00

# ALL-AMERICAN

## Largest Selling Transformers in the World

For further details on All-American Reflex Sets, see pages 48-51

Tell 'Em You Saw It in the Citizens Radio Call Book

# Your Set is Only as Good as You Make It!

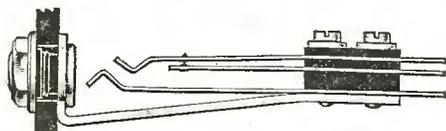

## Radio Jacks

The following features, many of them exclusively Yaxley, recommend these Jacks: One nut mounting. Brass Frames. Springs genuine phosphor bronze. Pure silver self-cleaning contact rivets. Firm contact pressure; low resistance. Pressure assembly, assuring permanent alignment. Spring terminals tinned for soldering. Mount in 7-16" panel hole without adjusting collars.

## Rheostat

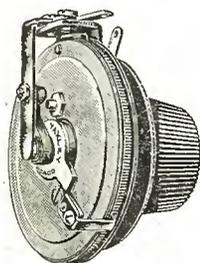

Resistance coil is stationary and the contact spring, carried on a heavy rotor arm, rides noiselessly on the flat side of the winding without producing microphonic disturbances in the tubes. A large number of turns of high resistance wire assures sharp tuning without the use of Vernier attachments. One nut mounting, can be turned to any position to suit wiring layout.

Resistance coil is stationary and the contact spring, carried on a heavy rotor arm, rides noiselessly on the flat side of the winding without producing microphonic disturbances in the tubes. A large number of turns of high resistance wire assures sharp tuning without the use of Vernier attachments. One nut mounting, can be turned to any position to suit wiring layout.



## Midget Battery Switch

**YAXLEY No.10**

Very compact. One nut mounting in single panel hole. Hard rolled phosphor bronze springs. Pure silver contacts. Insulated from metal frame.

Very compact. One nut mounting in single panel hole. Hard rolled phosphor bronze springs. Pure silver contacts. Insulated from metal frame.

Yaxley Approved Radio Products are fully protected and guaranteed by the manufacturer.

There is no magic in Radio. Results are governed by absolute laws of cause and effect. You cannot get out of your set any more than you put into it.



have always stood for correct design, precise workmanship and right materials. Leading makers of high-class radio equipment have adopted Yaxley made radio parts as standard for excellence. The radio public has accepted and looks to Yaxley-made jacks, plugs, rheostats and other radio parts as the best that can be obtained regardless of price.

Yaxley Approved Radio Products are designed with a fine technical understanding of the part they play in radio receiving and they are made with a keen sense of responsibility to the radio public which underlies their guarantee of satisfaction in service.

*When you want what is best for your set, ask your dealer for Yaxley Products*

## YAXLEY MFG. CO.

Manufacturers of Jacks, Jack Switches, Rheostats, Potentiometers, Inductance Switches, Dials and Knobs, Plugs, Battery Switches and Other Radio Parts.

Dept. C, 217 No. Desplaines St.,  
Chicago, Ill.

# Another Famous TOWER

# Tower's Scientific LOUD-SPEAKER \$8.50



It had to be the **BEST**

We could have manufactured a loud speaker two years ago, but we wouldn't! We have waited—studying, planning, continually striving for perfection and now at last! WE HAVE IT—In the new TOWER'S LOUD SPEAKER. Surely a Wonderful TOWER Triumph.

The many features include, magnets that lift 2 lbs. 10 oz. diaphragm of specially constructed material, perfect non-vibrating horn, 10" bell.

TOWER'S phones are tested by Government Licensed Radio Operators. Weight only 8½ oz. On sale at all good dealers from coast to coast.



**THE TOWER MFG. CORPORATION**

98 BROOKLINE AVE. Dept. F BOSTON, MASS.

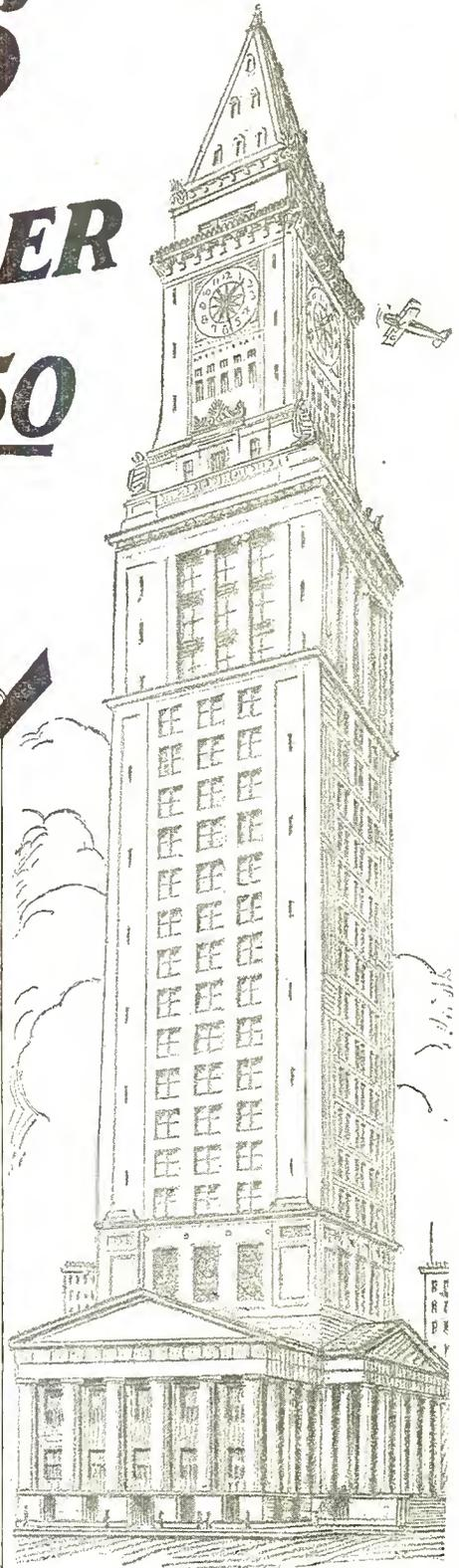

The U. S. Custom House Tower at Boston is 500 feet high and is situated in the business district overlooking Boston Harbor. It is the tallest Government building in America.

## Worlds Greatest Loud Speaker Value

Tell 'Em You Saw It in the Citizens Radio Call Book

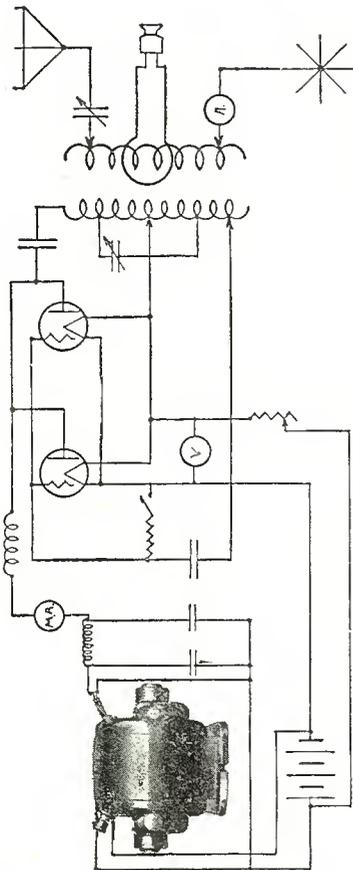

A SMALL PORTABLE SET FOR THE AUTO, BOAT OR HUNTING LODGE. KEEP IN TOUCH WITH BUSINESS AND THE FOLKS AT HOME.

Item No. 68 6-12 volt primary, 500 volts, 40 watt secondary. This little ten watt set can easily be constructed for less than \$100. Requires a minimum of technical knowledge to effectively operate.

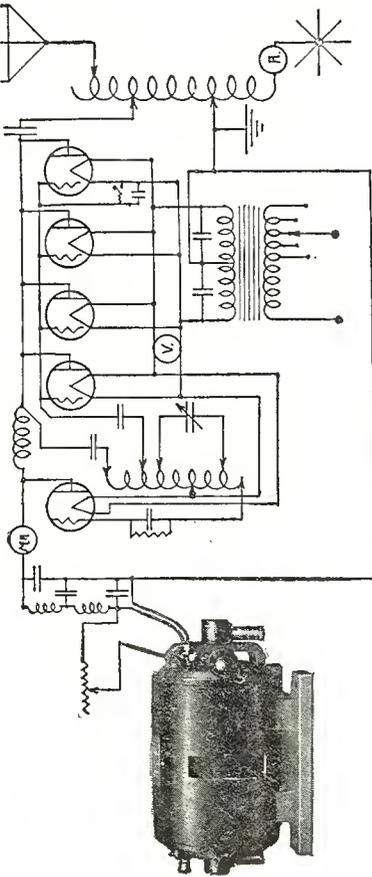

Item No. 8 Type M. G. 113 500 volts 150 watts when used with one five wattter as a master oscillator and four as amplifiers, will make a set of which the owner may be justly proud. A real DX getter.

This is but two of the many combinations built by "ESCO" and designed to give a "pure wave," and the maximum miles per watt.

Don't forget—the maximum miles per watt equals the maximum miles per dollar.

TRADE MARK  
"ESCO"

MOTORS - DYNAMOTORS - GENERATORS - MOTOR-GENERATORS

Used by more than 150 Universities—Colleges—Research Labs., etc. Many Federal—State—County and Municipal Depts.  
Write for Bulletins 237B and 242A Listing over 200 combinations

Send us your problems—we'll help you solve them

# ELECTRIC SPECIALTY COMPANY

267 South Street, Stamford, Conn., U. S. A.

*Pioneers in Developing and Perfecting High Voltage Wireless Apparatus*

# STORAD

## RADIO BATTERIES

### STORAD

#### Leads the Way

**STORAD** Storage "B" Batteries are designed and manufactured by Storage Battery Engineers who know radio and its battery requirements.

**STORAD** is a pioneer in the Storage "B" Battery field. The following points emphasize its superiority:

**STORAD** has especially designed combination perforated rubber and treated wood separators.

**STORAD** has a special patented top combining the advantages of the soft and hard rubber tops.

**STORAD** gives the right kind of power because it is not connected with any outside power lines.

With static, local interference due to power lines, street cars, other receiving sets, etc., it is necessary to reduce radio power interference to a minimum if satisfactory reception is to be accomplished.

**STORAD** is noiseless in operation and will aid in obtaining satisfactory reception. The U. S. Bureau of Standards tests show that "B" Batteries are



**STORAD** has heavy glass jars made up according to exact specifications especially for this purpose.

**STORAD** has heavy plates 5/16" thick. These are necessary for high capacity, long life and constant voltage.

**STORAD** has a capacity of 4½ amp. hrs. It's a heavy duty battery.

**STORAD** has welded on cable terminals which eliminate the use of expensive, troublesome and corrosive clips which more often than realized are the cause of noisy and poor reception.

**STORAD** is compact.

absolutely quiet and noiseless during the entire life of the battery.

**STORAD** supplies power of a steady, even voltage in pure direct current. This assures an even volume of sound because it is not subject to fluctuation of voltage like the ordinary house lighting circuit.

That's why we say that for "B" circuit power **STORAD** "B" Batteries will give ideal results.

The **STORAD** Storage "B" Battery is built in two sizes—24 and 48 volt units.  
Capacity for both sizes, 4½ ampere hr. (4500 M. A. H.)

Get **STORAD** from your dealer. Ask for them by numbers.

**STORAD** No. 4548—48 volt.  
**STORAD** No. 4524—24 volt.

#### **STORAD** "B" Battery Charger

A chemical rectifier that will charge 48 volts of "B" Batteries at a time. Inexpensive to operate. Complete instructions with each charger. Ask for part No. 4R.

*Insist That Your Dealer Supply You with Storad Battery Products*



#### **STORAD** "A" Battery

A heavy duty Storage Battery for radio work. Has full 100 amp. hr. capacity. Handy carrying handle. Ask for **STORAD** "A" Battery No. R. A. 100.

#### **STORAD** "C" Battery

Every radio set needs a "C" Battery for best reception. **STORAD** "C" Batteries are rechargeable. Made in 4 volt units. May be used as additional "B" Battery if needed. No. 2-C.

**THE CLEVELAND ENGINEERING LABORATORIES CO.**  
2427 Superior Viaduct, N. W. Cleveland, Ohio

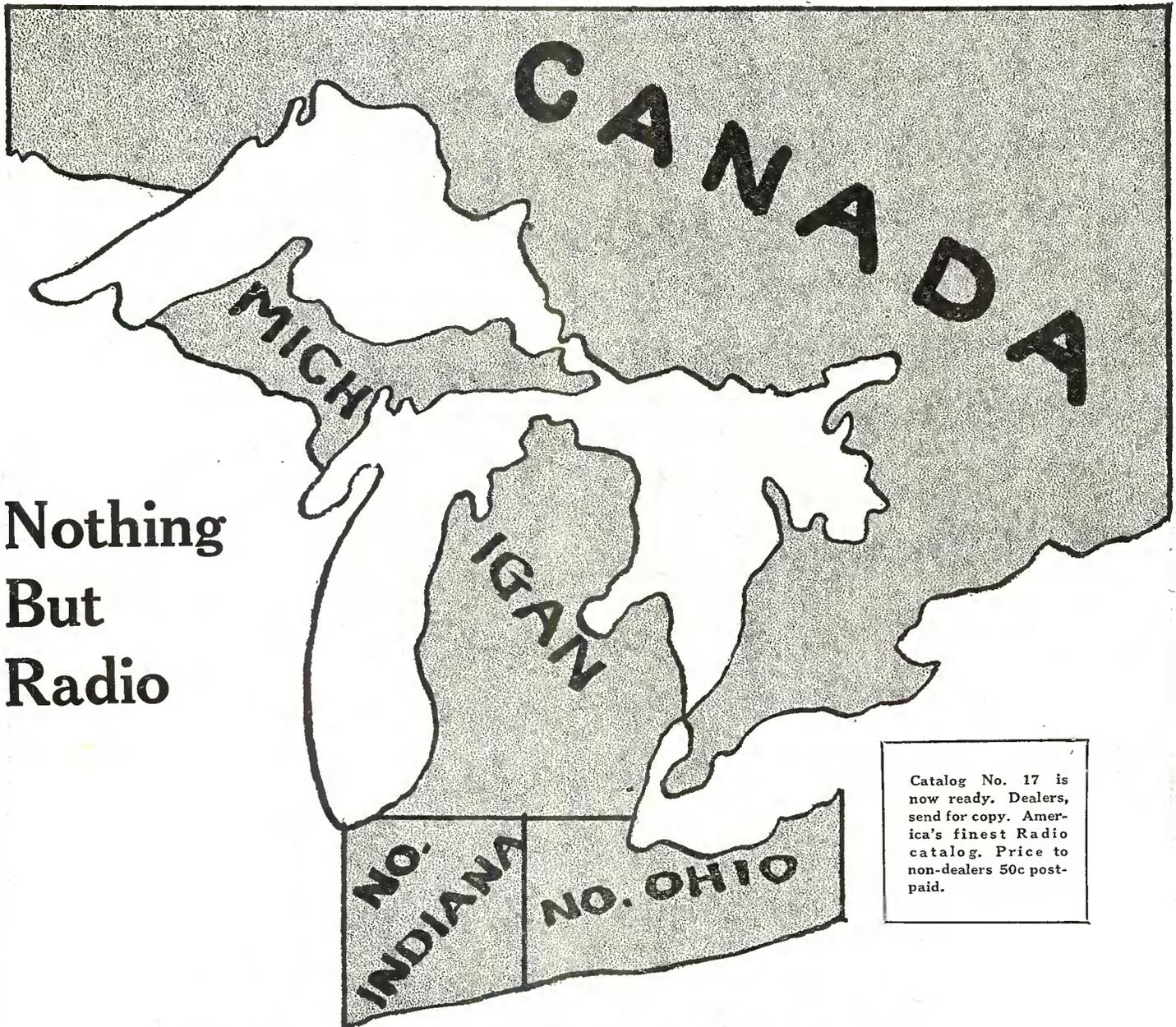

Nothing  
But  
Radio

Catalog No. 17 is now ready. Dealers, send for copy. America's finest Radio catalog. Price to non-dealers 50c post-paid.

## —the only all radio house in this territory

There are five men operating from this house who call on the trade in Michigan, Northern Ohio, Northern Indiana and Canada—and they sell *nothing but radio parts and complete outfits*.

We have on hand *always* thousands upon thousands of dollars worth of radio essentials—everything the best—ready to ship on a moment's notice. What are your needs?

**DETROIT ELECTRIC CO., Est. 1883**

111-113 E. Jefferson Ave., Detroit, Mich.  
234 Ottawa Ave., N. W., Grand Rapids

A branch at Fort Wayne, Ind.  
will open March 15th.

Distributor for Grebe, Freed Eisemann, Crosley, Cardwell, Hammarlund, General Radio, Burgess, Cunningham, Haynes-Griffin, Frost, Brandes, Jewett, Operadio, Willard, Balkite, Dubilier, Eby and 40 other leading lines.

# KESTER *Radio* SOLDER

(Rosin Core)



# Oh boy!

## It Sure is Safe and Simple

"Requires Only Heat"



Approved by  
*Radio Engineers*

**IF YOUR DEALER CANNOT SUPPLY YOU**

Chicago Solder Company  
4226 Wrightwood Ave., Chicago, Ill.  
Gentlemen: Send me one can Kester Radio Solder, for which I enclose 25c in stamps.  
(Postpaid anywhere in U. S. A.)

Name.....  
Address.....  
City..... State.....  
Dealer.....

# MAGNAVOX Radio

*The Utmost  
in Quality and Value*



*As world pioneers in the art of sound reproduction and amplification, Magnavox has brought radio to its highest point of MUSICAL expression.*

**Y**EARS AGO, when the Radio meant little more than listening through a set of headphones to a phonograph record played a few miles away, Magnavox developed the now famous electro-dynamic Reproducer.

This instantly opened the door to that astonishingly vast fund of free musical entertainment, lectures, and feature programs which Radio offers the world today.

The name Magnavox now stands for a great organization pledged to the highest manufacturing standards, initiative in research, and policies insuring unequalled value to the purchaser of any Magnavox instrument.

Especially important to the new radio user (and also those who desire to replace their old equipment with the latest and best apparatus obtainable) are the remark-

able cabinet receivers and storage battery tubes now exhibited by Magnavox dealers everywhere.

## Magnavox Radio Products

- Broadcast Receivers**—A 5-tube tuned radio frequency circuit with Unit Tuner and Volume Control, in handsomely carved cabinets with built-in or external Magnavox Reproducer . . . \$125.00, \$150.00
- Vacuum Tubes**—Amplifier and Detector Tubes designed on new principles making them far superior to ordinary storage battery tubes for all standard sets . . . \$5.00
- Reproducers**—Instruments of the electro-dynamic type with Volume Control, and of the semi-dynamic type requiring no external battery, for all vacuum tube receiving sets . . . \$25.00 to \$50.00
- Phonograph Attachment**—The semi-dynamic Magnavox Reproducer mechanism in a unit readily attached to any standard phonograph . . . \$15.00

*Registered Magnavox Dealers in every community are prepared to demonstrate Magnavox Radio equipment. Catalog on request.*

## THE MAGNAVOX COMPANY

OAKLAND, CALIFORNIA

NEW YORK: 350 W. 31st St. CHICAGO: 162 N. State St.

Canadian Distributors:  
Perkins Electric Limited, Toronto, Montreal, Winnipeg

# Earn \$50 to \$200 a Week in RADIO

You can! Hundreds of ambitious men are already earning thousands of dollars in this wonderful new industry—you, too, can get your share. Mail coupon below for Free Book which describes fully the amazing money-making opportunities in Radio and tells how YOU can earn from \$5,000 to over \$10,000 a year.

The astounding growth of Radio has created thousands of big money opportunities. Millions of dollars were spent during the past year on Radio, and thousands of young men are needed right now to meet the ever-increasing demand of work.

Men are needed to build, sell and install Radio sets—to design, test, repair—as Radio engineers and executives—as operators at land stations and on ships traveling the world over—as operators at the hundreds of broadcasting stations. And these are just a few of the wonderful opportunities.

Scores of young men who have taken our course are already earning from \$75 to \$200 a week. Merle Wetzel of Chicago Heights, Ill., advanced from lineman to Radio Engineer, increasing his salary 100% *even while taking our course!* Emmett Welch, right after finishing his training, started earning \$300 a month and expenses. Another graduate is now an operator of a broadcasting station—PWX of Havana, Cuba, and earns \$250 a month. Still another graduate, only 16 years, is averaging \$70 a week in a radio store.

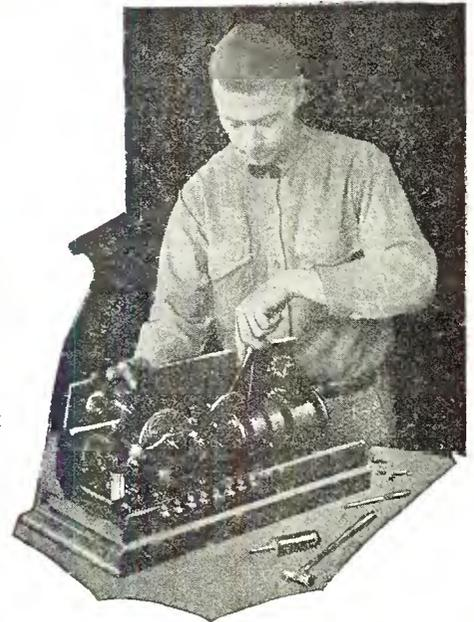

## Send for FREE RADIO BOOK

Learn more about this tremendous new field and its remarkable opportunities. Learn how you can quickly become a radio expert and make big money in radio.

We have just prepared a new 32-page booklet which gives a thorough outline of the field of Radio—and describes our amazing practical training in detail. This Free Book, "Rich Rewards in Radio," will be sent to you without the slightest obligation. Mail coupon for it *now!*

For a short time we are offering a reduced rate to those who enroll at once. Act promptly and save money.

## Easy to Learn Radio at Home in Spare Time

No matter if you know *nothing* about Radio now, you can quickly become a Radio expert, by our marvelous new method of practical instruction—instruction which includes all the material for building the latest up-to-date radio apparatus.

## Wonderful Opportunities

Hardly a week goes by without our receiving urgent calls for our graduates. "We need the services of a competent Radio Engineer." "We want men with executive ability in addition to radio knowledge to become our local managers." "We require the services of several resident demonstrators"—These are just a few small indications of the great variety of opportunities open to our graduates.

Take advantage of our practical training and the unusual conditions in Radio to step into a big paying position in this wonderful new field. Radio offers you more money than you probably ever dreamed possible—fascinating easy work—a chance to travel and see the world if you care to or to take any one of the many radio positions all around you at home. And Radio offers you a glorious future!

The National Radio Institute is America's Pioneer Radio School—established in 1914. Our course is the absolutely complete one now being offered which qualifies for a government first-class commercial license. It gets you the *bigger* paying jobs in Radio.

## National Radio Institute

Dept. 85EB  
Washington,  
D. C.

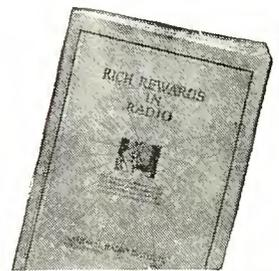

NATIONAL RADIO INSTITUTE  
Dept. 85EB, Washington, D. C.

Please send me without the slightest obligation your Free Book, "Rich Rewards in Radio," and full details of your special offer of Free Employment Service. Please write plainly.

Name..... Age.....  
Address.....  
City..... State.....

**PAY INCREASES OVER  
\$100 A MONTH**



I am averaging anywhere from \$75 to \$150 a month more than I was making before enrolling with you. I would not consider \$10,000 too much for the course.  
(Signed) A. N. Long,  
Greensburg, Pa.



I can very easily make double the amount of money now than before I enrolled with you. Your course has benefited me approximately \$3000 over and above what I would have earned had I not taken it.  
T. Winder,  
Grand Junction, Colo.

**DOUBLES SALARY**

**FROM \$15 to \$80 A WEEK**



Before I enrolled with you I was making \$15 a week on a farm. Now I earn from \$20.50 to \$14.20 a year, and the work is a hundred times easier than before. Since graduating a little over a year ago, I have earned almost \$4000 and I believe the course will be worth at least \$100,000 to me.  
(Signed) Geo. A. Adams,  
Tamaqua, Pa.

# HOWARD RADIO COMPANY—CHICAGO

**HOWARD STANDARD RHEOSTAT WITH DIAL CONTROL.** Note the simplicity of this rheostat and the convenience of drilling only one hole in the panel for mounting.

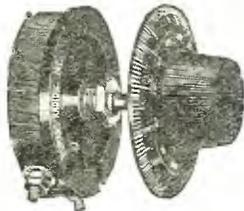

HOWARD

HOWARD Rheostats are guaranteed to give uniform service, perfect filament control and maintain constant resistance under continuous duty. HOWARD Rheostats meet every radio requirement. Workmanship and materials are of the highest quality. The bases are of special heat resisting materials, preserving shape and finish under all operating conditions. Slide contacts are phosphor bronze, insuring perfect electrical connections and resistance elements constructed of special non-corrosive resistance wire, accurately spaced by precision machines and wound under tension on a seasoned fibre strip so that the turns cannot come loose. Carrying capacity 1.5 amperes. Its operation is controlled by a beautiful 2 1/2-inch dial with 100 point marking covering full sweep of contact arm. Diameter of base 2 5/32 inches. Made in resistance of 6 1/2, 25, 40 and 60 Ohms.

Each .....\$1.10

**HOWARD MICROMETER RHEOSTAT WITH DIAL. ONE CONTROL.** The HOWARD Micrometer Rheostat gives instantly that extremely fine and hair line adjustment so necessary for the successful operation of all gas content tubes, known as soft tubes. The micrometer adjustment does not have a separate control but is automatically carried along with the main contact arm and brought into play instantly when desired. Made in resistances of 6 1/2, 25 and 40 Ohms. The micrometer attachment can be purchased separately and will fit any standard HOWARD Rheostat.

Dial Rheostat with Micrometer Attachment. Each.....\$1.50  
Micrometer Attachment separate. Each..... .50

**POTENTIOMETERS WITH DIAL. HOWARD** Potentiometers are noted for that extremely close control of the potential in the plate and grid circuits so necessary to increase selectivity and obtain satisfactory results. The potential is kept under positive control at all times. The HOWARD Potentiometer is the same size and matches the HOWARD Standard Rheostats. Furnished in resistance of 200 and 400 Ohms.

200 Ohms. Each.....\$1.50  
400 Ohms. Each..... 2.00

**MIDGET RHEOSTATS.** The HOWARD MIDGET RHEOSTAT was designed to meet the long-felt want for a high grade rheostat small enough to be used in portable sets where space is limited and a smaller instrument is desired. The same materials and workmanship will be found in this Rheostat as in the standard HOWARD Rheostats, the only difference being in the size, the base being 1 1/8 inches as compared with 2 5/32 inches on the standard Rheostat. This Rheostat is not furnished with micrometer attachment. Made in resistances of 6 1/2, 25, 40 and 60 Ohms.

Each .....\$1.10

(Cut is 2/3 actual size)

Front view of HOWARD Dial. These dials are sold separately and may be placed on any HOWARD Rheostat or Potentiometer. Size, 2 1/2 inches in diameter.  
Each .....\$0.25

Rear view of HOWARD Dial showing 3/16-inch shaft permanently anchored in dial. The length of this shaft is 1 1/8 inches.  
Each .....\$0.25



451-469 E. Ohio St.

The superiority of the HOWARD Socket lies in the "Sure Contact" which is made to the side of the tube pins and not to the ends. The contact arms have more than twice the spring value found in the average socket, as well as a full 1/4-inch contact surface applied to the side of the pins. These contact arms cannot lose their spring tension and can be relied upon to make a permanent, perfect contact. The base of the Howard Socket is moulded from the highest grade bakelite.

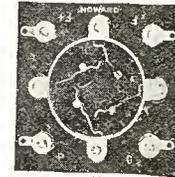

Each .....\$1.25  
Upper Cut shows the Howard Socket and Lower Cut shows the construction of the "Sure Contact" springs.

**THE HOWARD MULTI-TERMINAL PHONE PLUG** is the most simple and efficient on the market. The patented feature provides instantly a positive connection for phones or loud speaker and will accommodate from one to six pairs of phones, all connected in at the same time, with maximum electrical efficiency. Slip in another pair of phones instantly without interfering with connections previously made. Merely insert the tips in the holes provided in the plug for that purpose.

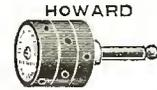

Each .....\$2.00

**FIXED CONDENSERS.** Nearly every radio set in existence makes use of small fixed condensers. They perform a very important part in the successful operation of the set. Defective or inaccurate condensers cause no end of trouble. When a circuit calls for a condenser of a "fixed" rated capacity, install a "HOWARD" for accuracy and permanency. Only the best grade of Indian Ruby Mica is used to separate the copper and brass conductors. No paraffin or similar substances form any part of the dielectric. They are all hand made, each tested on a capacity bridge and guaranteed to be noiseless and accurate. Made in capacities of .00025, .0005, .001 and .002.



Each .....\$0.60

**HOWARD INDUCTANCE SWITCH LEVER.** This switch lever is made in two sizes, with small and large knob and having a blade radius of 1 inch and 1 9/32 inches respectively. The highly nickel-plated phosphor bronze contact blade is securely keyed to the knob and will not turn or come loose under any condition.



Each .....\$0.50

**HOWARD BINDING POST.** The special feature of this binding post is the holding device which positively prevents the binding post from turning after it has been mounted. The top is made of the same high-grade insulating material as used in the manufacture of other Howard products.

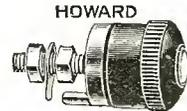

Each .....\$0.20

21-22 — Large and small indicating pointers. .020 inch thick, 8-32 thread, 1 1/16 inch radius and 13/16 inch radius respectively. Highly nickel plated.  
Each .....\$0.08



23-24-25—Soldering Lugs with standard 6-32 hole, nickel plated.  
Per dozen .....\$0.10



26-27—Switch points and switch stops, highly nickel plated, 6-32 thread and equipped with nut.  
Each .....\$0.03

All Howard Products are sold with a Guarantee of "Satisfactory Performance or Money Back"  
Ask your dealer to show you the Howard line of parts. If he cannot supply your wants, send his name to us with your order.

# SUPERADIO

REG. U.S. PAT. OFF.

## A New Combination of exclusive features

### Something Different

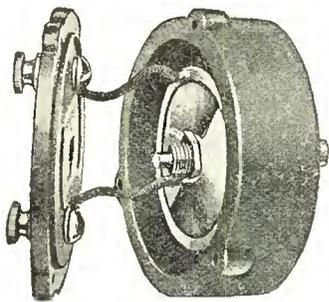

Open

A low loss straight capacity curve condenser made of mica-mercury built on a new principle. Extremely compact, requiring only two and one-fourth inches on the panel. Made in two capacities—.00025 M. F. D. and .0005 M. F. D. List Price, \$3.00.



Closed

The new Superadio Type 103, 5-tube, non-oscillating Tuned Radio Frequency Receiver, in which are incorporated the new Type X Transformer and the new Superadio compact variable Condenser; List Price, \$90.

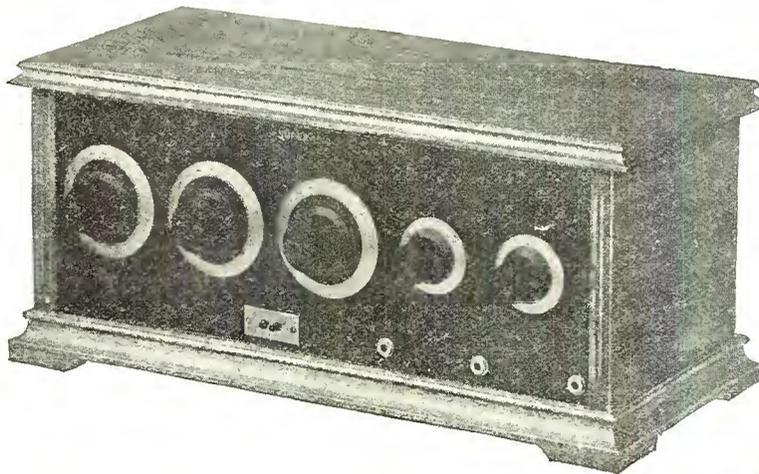

This set can be supplied in Kit form which consists of three Radio Frequency Amplifier Units and two Audio Amplifier Units, drilled panel; Dials, three jacks, Switch Terminal board, and Wires all numbered and bent to shape, with complete layout of wiring and can be set up by anyone in one hour. This complete Knock-down 5 tube set, excepting Cabinet, \$50.00.

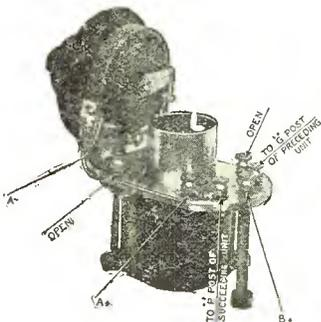

R. F. Unit

One complete stage of tuned Radio Frequency Amplification in one unit. Supplied in groups of three units. 2 Type, 1, \$8.50 each. 1 Type, 2, \$9.00.

One complete stage of Audio Amplification in one unit.

List Price, \$7.00.

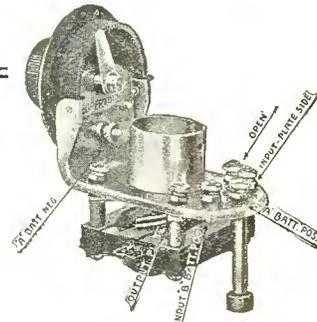

A. F. Unit

# De WITT~LaFRANCE Company, Inc.

54 Washburn Avenue~Cambridge, Mass.

# CHI-RAD

OLDEST EXCLUSIVE RADIO JOBBER IN THE MIDDLE WEST

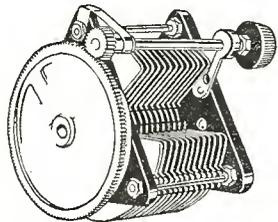

**Type 247 Condensers**

The type 247 General Radio condenser is a universal favorite because of its high electrical efficiency. Plates of Rotor and Stator Groups soldered together thus insuring perfect electrical contact. Vernier adjustment is by balanced metal gear operated by fibrol pinion. End plates of hard rubber.

Price .....\$3.25 to \$7.25



**Type 231-A Amplifying Transformer**

The core is of closed, shell type construction and of a carefully selected grade of steel.

The windings of the coil are of proper ratio to insure maximum results with respect to quality volume of singles.

Binding posts and mounting brackets are easily accessible. The 231-A has an unusually high and flat amplification curve which indicates that it is best for all stages. Price..\$5.00



**Type 271 Medium Frequency Transformer**

The type 271 transformer has been specially designed for use in long wave reception (10,000 meters-30 kilocycles) and in the superheterodyne circuit. The core, and coil windings are completely enclosed in a metal shell. Shielded both electrostatically and electromagnetically. Very compact and rugged.

Price .....\$5.00

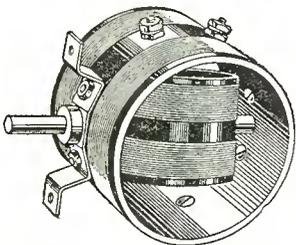

**Type 268 Vario Coupler**

Very compact and rugged—ideal for the portable set. Stator coil has but a single tap which simplifies installation, operation, and reduces losses. Bearings very smooth running. Forms of genuine moulded bakelite wound with green silk covered wire. Price.....\$3.50

**I**f you want quality radio merchandise—  
If you want radio apparatus that will make friends out of customers—  
If you want prompt, intelligent attention to all your orders—big or small—  
If you want courteous, friendly cooperation—

**Make Chi-Rad your jobbing headquarters for Radio in 1925 and every year thereafter!**  
**Jobbers for the following:**

- |  |   |
|--|---|
| General Radio Co.<br><i>Complete Line</i>                            | Kurz-Kasch Co.<br><i>Dials</i>  |
| Adams-Morgan Co.<br><i>Paragon Receivers</i>                         | Lopez Low-Loss Tuners   |
| Benjamin Electric Mfg. Co.<br><i>Sockets</i>                         | Mica Insulate Co.<br><i>Tubing</i>                                      |
| Allen D. Cardwell Mfg. Co.<br><i>Condensers</i>                      | Mu-Rad Laboratories<br><i>Receivers</i>                                 |
| Corning Glass Works<br><i>Pyrex Insulators</i>                       | National Co.<br><i>Condensers, Coils, Dials, Regenformer Kits</i>       |
| E. T. Cunningham, Inc.<br><i>Cunningham Tubes</i>                    | Fansteel Products Co.<br><i>Balkite Chargers and "B" Current Supply</i> |
| Dubilier Condenser & Radio Corp.<br><i>Dubilier Condensers</i>       | Radio Units Co.<br><i>Radiu Loops</i>                                   |
| H. H. Eby Mfg. Co.<br><i>Eby Binding Posts</i>                       | Remler Mfg. Co.<br><i>Condensers, Transformers</i>                      |
| Fiat Loops   | Reichmann Co.<br><i>Thorola Talkers</i>                                 |
| Fleron Insulators  | Thordarson Transformers   |
| Formica Insulation Co.<br><i>Sheets, Tubing</i>                      | Vesta Storage Batteries   |
| French Battery & Carbon Co.<br><i>Ray-O-Vac Batteries</i>            | Western Electric Co.<br><i>Loud Talkers, Tubes</i>                      |
| Jewell Instrument Co.<br><i>Jewell Meters</i>                        | Weston Electric Inst. Corp.<br><i>Meters, Plugs</i>                     |
| Jones Multiplug  |   |
| Kellogg Switchboard & Supply Co.<br><i>Sockets, Fixed Condensers</i> |   |

**DEALERS Write for New Catalog**

Every radio dealer should have a copy of our handy loose-leaf catalog—a perpetually up-to-date Radio Catalog. Free to dealers only.

Write for **FREE BULLETIN** on new General Radio Company Type 285 Audio Transformer

**Chicago Radio Apparatus Co.**

*Radio Jobbers Exclusively*

415 South Dearborn Street, Chicago, U. S. A.



**Type 247-W Wavemeter and Filter**

The type 247-W wavemeter and filter increases the selectivity of a receiver by tuning out interference from various sources. Composed of a special type condenser with filter coil attached. Filter coil with range of 150 to 500 meters is of moulded bakelite wound with silk cover wire. Price.....\$10.00  
Extra interchangeable filter coils for shorter or longer wavelengths furnished for.....\$3.00

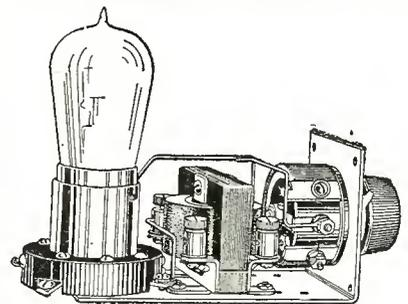

**Type 300 Amplifier Unit**

Self contained except for tubes and batteries. It is ready for use with either crystal or vacuum tube detector. The parts used are standard General Radio instruments described in these pages. The complete unit is particularly convenient for persons building their own sets, since the bother of assembling and wiring the parts is eliminated. Panel or table mounting.

Type 300-D for Standard tubes .....  
(UV-201) .....\$8.00  
Type 300-C for dry cell tubes .....  
(UV-199) ..... 7.75

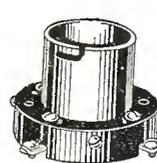

**Type 156 Standard Tube Socket**

The type 156 socket holds the tube securely so as to prevent vibration and to make firm electrical contact. The contact springs are of bronze, nickel finished. The tube is of heavy brass with highly polished nickel-finish. For mounting standard tubes such as UV-200, UV-201A, and other similar tubes having the standard base. Price .....\$1.00

**Type 301 Rheostat and Potentiometer**

The type 301 rheostat maintains positive contact at all times. There is no momentary opening of the circuit to cause a bothersome click in the ear-phones.

The resistance units are tightly wound on specially treated fibre strips.

The base and tapered knob are of genuine moulded bakelite. Pointer on knob indicates the position of the contact arm. Furnished with resistance units of 10, or 30 ohms.

Price .....\$1.25  
Potentiometer similar in construction but with 200 ohm resistance unit. Price .....\$1.25

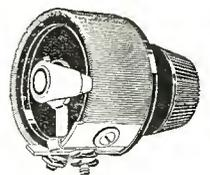

**A COMPLETE LINE OF GENERAL RADIO CO. PARTS**

# A Wonderful Radio Achievement!

## The First All-Glass Socket

Countless tests have proven glass to be the most effective insulation available to radio. After exhaustive research, our engineers have developed a new-idea Socket made entirely of **VIRALON** — a special glass processed for 100% electrical efficiency.

**VIRALON** Glass is heat resisting and moisture proof, and unaffected by those influences that commonly make rubber, rubber derivatives, porcelain and vitreous products so inefficient.

Duray All-Glass Sockets eliminate most of the so-called "tube noises" — cut down power losses — prevent short circuits — and eliminate radio frequency leakage.

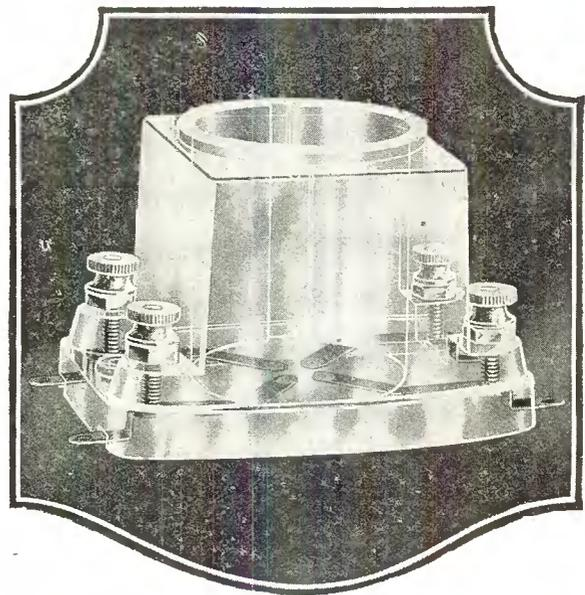

### **VIRALON GLASS** The 100% Insulation

You'll like all the exclusive Duray features — the all-glass construction — the one-piece contact springs — the knurled contact spots (corrosion-proof) — the handy soldering terminals.

**Price \$1.25 (Standard Size)**  
Packed in attractive carton

Until all dealers have been stocked, you can be supplied direct from the factory at the retail price, plus 10c each for packing and postage.

**Jobbers and Dealers—Write for Particulars**

**Duray Radio Corporation**  
Dept. 20, 263 Washington Ave., Newark, N. J.

**DURAY**  
ALL-GLASS  
VIRALON  
SOCKET

# Federal Batteries Reduce Your "B" Battery Expense

The best dry cell battery can last only for a few months at the best, with the result that the Radio public is constantly throwing away discharged dry batteries and buying new ones. The FEDERAL Rechargeable "B" Battery does away with the endless expense as it can be recharged at a negligible cost and it will last for years.

FEDERAL Batteries insure clearer reception and greater volume than is possible with dry cell batteries in which the voltage is decreasing constantly. With FEDERAL Batteries it is possible to maintain the full voltage at all times.

The battery plates are extra heavy—made of the best materials obtainable—hand pasted, and properly insulated. These plates insure a long life and a constant voltage. The cells are connected by heavy connectors, specially burned on, making the post and connector practically one piece. For greater voltage add additional units.



**DEALERS!**  
Write  
for Our  
Proposition

Patent  
Pending

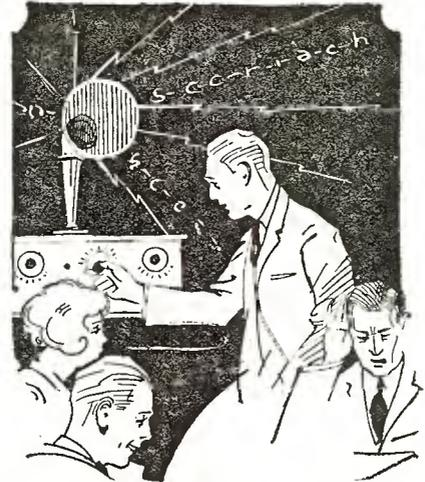

Federal Batteries eliminate noises frequently attributed to "Static"

## Suitable for Any House

The FEDERAL "B" Batteries are manufactured in two sizes, 24 and 48 volts. The Battery is contained in a very fine walnut finish cabinet 12½ in. long, 5 in. wide and 6¾ in. high in the 24 volts, and 12½ in. long, 9¾ in. wide and 6¾ in. high in 48 volts, making it compact and very easy to handle. The cover drops down so that no part of battery is exposed. The Positive and Negative terminals are on the outside of the case and are plainly marked, so that it is a simple matter to hook up to any Radio set.

Sold by Most Reliable Dealers

If your dealer cannot supply you, write to us

Manufactured by

**FEDERAL BATTERY & MFG. CORP.**

1509 S. Michigan Ave.

Chicago, Ill.

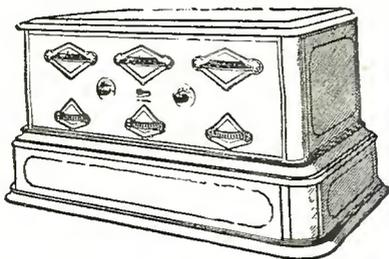

Grebe Synchronphase

**ALWAYS**—A Large Stock of  
Standard Radio Receivers  
and Accessories

**GREBE**—The New Grebe "Synchro-  
phase" Receiver is a "Knock-  
out" for Either "A" or Dry  
Cell Tubes.....\$155.00



"Perfect Satisfaction"

### — DISTRIBUTORS —

A. H. Grebe Company  
Herbert H. Frost, Inc.  
Nathaniel Baldwin, Inc.  
Erla Products  
Eveready Batteries  
E. T. Cunningham, Inc.  
Charles Freshman Co.  
Dubilier Radio Corp.  
Alden Mfg. Co.  
Atlas Speakers

Crosley Radio Corp.  
Bristol Company  
Gilfillan Bros.  
Remler Mfg. Co.  
R. E. Thompson Mfg. Co.  
Dictograph Products  
Acme Apparatus Co.  
Howard Radio Corp.  
Paragon Receivers  
Etc., Etc., Etc., Etc.

Wholesale—only—Dealers send for Free Catalog

CUNNINGHAM RADIO TUBES	
C-301 A—5 Volts 1.4 Ampere filament .....	\$3.00
C-299—3 Volts .06 Amp. Dry Battery Det. and Amp. ....	3.00
C-300—5 Volts Gas Content Detector .....	3.00
C-11—1.1 Volts .25 Amp. Dry Bat. Det. and Amp. Special Base .....	3.00
C-12—Similar to C-11 with stand- ard base .....	3.00

# ROCKY MOUNTAIN RADIO CORPORATION

Export Department  
549 West Washington Street  
Chicago, Ill., U. S. A.

"Largest Exclusive Radio Wholesalers in the Rocky Mountain Region"

1512-1516 Broadway

Denver, Colorado

**Volume Without Distortion**

"HEGEHOG" is the smallest audio transformer made—just half the size of others—which makes its great volume and pure, natural tone all the more remarkable. 100% self-shielded. Mounts anywhere. Just the thing for portables. Ideal for neat and compact wiring.



Ratios 1 to 3, 1 to 4, and 1 to 5, \$3.50  
Ratio 1 to 10, \$4.50

**"CROFOOT" Condenser**  
1 to 74 Tuning Ratio

"CROFOOT" has the lowest minimum capacity yet attained—and the greatest tuning ratio. Made entirely of brass and hard rubber, giving remarkably low skin resistance and low insulation leakage. Semi-straight line plate construction. All plates soldered, look for the "red stripe." Mounts with one hole.

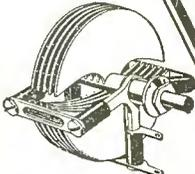

Capacity	List Price	Capacity	List Price
.0001 M.F.	\$2.75	.00035 M.F.	\$3.50
.00025 M.F.	3.25	.0005 M.F.	3.75

Vernier type with "E Z TON" dial, 75 cents extra

**"MICROSTAT"**

**Noiseless Vernier Rheostat**

Premier "MICROSTAT" stands alone in its fineness of adjustment and minute control. New principle provides two resistor units—one six ohms and one forty ohms—connected in parallel. Vernier adjustment on high resistor. Noiseless in operation. Insures perfect freedom from sputtering and scratching. Capacity 3 amperes. Bakelite moulded. Silver etched dial. Price \$2.50.

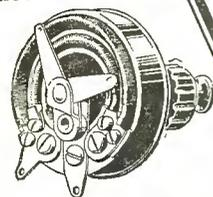

**Prevent Battery Waste**

and tube blowout danger with the Premier "Double Disconnect Potentiometer." The last word in plate current control. Its special feature, a double break switch, automatically disconnects "A" and "B" batteries when lever is off. Stays put. Contact circuits are riveted. One hole mounting. Similar in appearance to "Microstat." Price \$2.50.



**Fits Any Plug—Any Panel**

Premier "UNIVERSAL" Radio Jacks have been designed to make a quick and flexible method of connection. Have several exclusive advantages such as spring mounting adjustable for all lengths of plugs. Spring combinations are interchangeable on frame and may be purchased separately, if desired. Adjustable Thimble or Bushing permits mounting on any thickness of panel from 1/8" to 7/16" jacks. Phosphor bronze springs. All metal parts brass, nickel-plated. Prices range from 65c to \$1.10.



**A Quality R. F. Transformer**

Premier "RADIOTRAN" is an "AIR CORE," non-interfering (non-metallic case) radio frequency transformer, correctly designed to satisfy the experienced radio engineer and the super-critical amateur. In volume, non-distortion and long range it is unsurpassed. Efficient in all circuits. Mounts anywhere. Small in size—only 1 1/2 inches high. Price \$1.50.

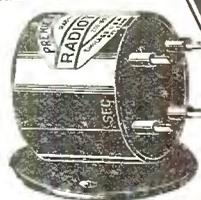

**"LO LOSS" Tube Socket**

For Greatest Speaker Volume Use Premier "LO LOSS" Tube Sockets throughout. This radically different tube socket has lowest insulation leakage, lowest capacity. Contacts always visible. Contact springs automatically clean tube prongs. New cam-action tube lock makes insertion of tubes easy and contact certain. Maximum spring deflection without set. Both sizes 90c.



**The QUALITY LINE**

Do not be misled. There is only one thing to consider first in selecting the parts for a radio receiving set—that is *quality*. You can have quality without paying an exorbitant price. Premier Radio Parts are first of all a quality line. But Premier prices are most reasonable. They offer the extreme in value for every dollar invested.

Every part in the line shown here has demonstrated its quality. Each has passed the test of the experimental laboratory and the far more exacting test of use in thousands of home-built receiving sets. Each is advanced in design, presenting radically different features contributing to its efficiency.

It will pay you to read carefully the description of the parts shown on this page. It will be even better to get the bulletin offered elsewhere on this page and read the complete descriptions. It will pay you most of all, when building your set, to make it a quality set throughout and specify

**PREMIER Quality Radio Parts**

Send for FREE Bulletin 94

Whether you plan to build or to buy a receiving set, you should know something about the "insides" of radio. This booklet gives you the "inside dope" on some of the recent inventions embodying the latest ideas of radio engineers. In this bulletin is full information about all the Premier Parts shown on this page and others included in the full line.

**FREE "HOOKUPS"**

For those desiring to make their own receiving sets, we have ready for distribution individual diagrams of each of the most popular "Hookups," including Harkness Reflex, Neutrodyne, Super-Heterodyne, Tuned Radio Frequency, Regenerative, etc. THEY ARE FREE FOR THE ASKING.

Ask your dealer to supply you with a set of these diagrams. If he does not have them on hand write to us and you will receive complete assortment by return mail.

**Premier Electric Company**  
3805 Ravenswood Avenue, Chicago

# HEATH RADIANT

Non-Dielectric Condensers  
Used in the

**AC DAYTON**  
XL5

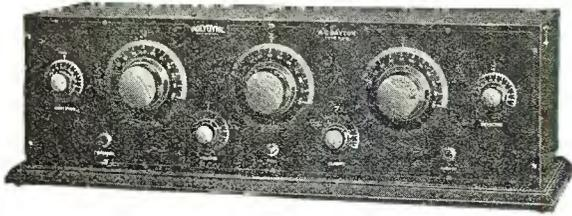

THE A. C. Electrical Co., in designing their Polydyne Receiver, looked for the make of condenser which could stand up under all sorts of usage without lessening its efficiency one particle. That their choice was the HEATH RADIANT Condenser, bears out the HEATH claim of permanent efficiency.

The adjoining panel explains the principal reason for this extraordinary durability. You yourself, can see the other reasons, once you've set eyes on a HEATH RADIANT Condenser. Everything about it impresses you with its scrupulous workmanship.

You want to make your new set the best yet—then learn about these "better condensers."

### PRICES FOR VERNIER CONDENSERS

	With Dial	Without Dial
No. 12AV 12 Plate..	\$5.00	\$4.35
No. 24AV 24 Plate..	5.50	4.85
No. 44AV 44 Plate..	6.50	5.85

Non-Vernier types in all capacities

Heath Sockets with the Exclusive Shock Absorber Feature. Price 75c. Heath Genuine Bakelite Dials in 2, 3 and 4 inch sizes. See the Heath Condenser at your dealer's.

Write for Literature



**HEATH RADIO & Electric Mfg. Co.**

202 First Street  
Newark, N. J.

Canadian Distributors: Marconi Wireless Telegraph Co. of Canada, Ltd., Montreal, St. Johns, Vancouver, Winnipeg, Halifax and Toronto

### Grounded Metal End Plates

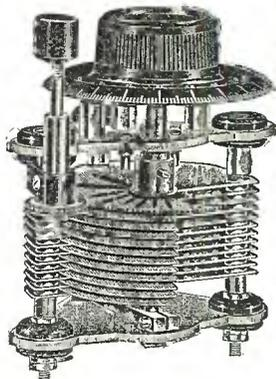

### Permanently Flat Plates

Stamped under huge presses to absolute flatness, tempered to prevent warping.

### Micrometer Geared Vernier

Ordinary adjustments reduced by separate geared adjustment to hairbreadth distinction. We guarantee the Heath Vernier Condenser to be more highly selective than any condenser employing a vernier which actuates ALL of the plates.

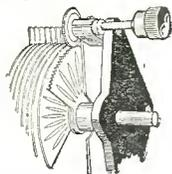

## SAVE \$2.25 ON COST OF NEW TUBES

By Having Your Old Tubes Rebuilt at **\$1.75 Each**

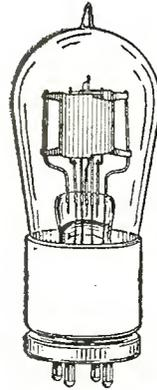

\$1.75

Guaranteed equal to new. Send us your tubes by parcel post (not necessary to insure package or guard against breakage). We return rebuilt tubes by parcel post, C.O.D. and try to maintain 24 hour service.

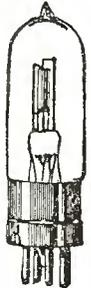

□□

## HARVARD RADIO LABORATORIES

300 Old Colony Ave., So. Boston, Mass.



Tops Don't Come Off

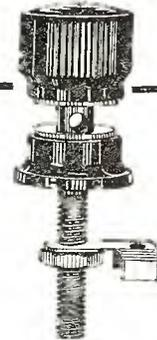

25 Different Markings

## Eby Binding Posts

Standard Equipment on over one hundred Manufacturer's Sets

This fact alone indicates what we mean when we say that EBYS are binding posts PLUS.

Superiority is built into them.

They can be furnished either plain or engraved in twenty-five different markings. And the Tops Don't Come Off.

If your dealer doesn't stock them—write us.

**H. H. EBY MFG. COMPANY**  
Philadelphia, Pa.



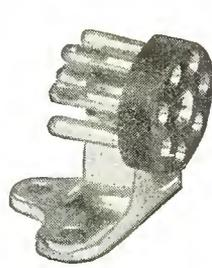

Type BM—For \$4.50  
Base Mounting,

## Jones MULTI-PLUG

THE STANDARD SET CONNECTOR

Used by  
**HOWARD**  
**WORKRITE**  
**ZENITH**  
**MURAD**  
**PFANSTIEHL**  
And Others

INSTALL a Jones Multi-Plug and Cable on your set. A plug and cable is to the radio what the socket and cord is to the electric iron—a connector which is efficient, convenient, safe, and indispensable. EFFICIENT because battery, antenna, and ground wires can be connected and disconnected by a single operation. Seven confusing operations reduced to a simple one. It assures perfect contact and is simple to connect. CONVENIENT because it permits the moving of set anywhere without disconnecting wires. The eight foot cable allows batteries to be placed in basement or other suitable place. SAFE because no live ends are exposed and center pin is keyed so that wrong connections are impossible. INDISPENSABLE. You will know why only after testing out this plug designed to meet the demand for an inexpensive yet practical and simple method of connecting batteries, antenna, and ground.

For Sale at Retail by All Leading Dealers

Manufactured and guaranteed by

**Howard B. Jones, 620 So. Canal St., Chicago**

DEALERS, SEE YOUR JOBBER

Write for folder of B. P. Type adaptable to any set

# Effarsee Brings the Stations In

Effarsee Portable Antennae is easier to put up than any other aerial and gives unequalled results on all sets from crystals to superheterodynes. It is a godsend to the man who finds it difficult to erect an outdoor aerial.

Effarsee Portable Antennae brings in distant stations with wonderful volume. It reduces static, improves selectivity. It is much better than a loop. Dealers are using Effarsee to demonstrate sets. Connected in the circuit with an outdoor antennae it improves volume and stabilizes the signals. Everyone should have an Effarsee for nights when static is bad.



Hang it  
anywhere!  
Greater  
Selectivity!  
Better Tone!  
Less Static!  
Use Indoors  
or Outdoors!

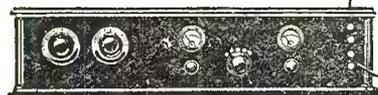

William L. Powell, 87 Midland Avenue, Highland Park, Michigan, reports the following log built up in two evenings using the \$2.50 Effarsee on a five tube Cockaday circuit, for which two outside wires each 100 feet long were recommended.

Stations logged in daylight: WSAI, KDKA, WBZ, WDAR, WGN, WGY.  
Stations logged after dark: WTAM, WOC, WFAA, WCBN, WJAS, WFAF, WJZ, WQJ, WOS, KFNF, WTAS, WLR, WEBB, KYW, KFKX, KFKB, WJY, WHN, WAHG, WEEL, WSB, KHJ, WCK, WJJD, WDAF, WOA W, WHB, WLW, WMH, WCAE, WCBY, WTAY, WHAS, WFI, WLS, WHN, WCAL, WCCO, KSD, WJAX, WOR, WMAQ, WRC, CNRO, WJZ, KOA, KGO, KFSG, WREO, WPC, WWAD, WRR.

The antennae was hung in an attic and 45 feet of wire run to the set. This is more stations than Mr. Powell has been able to get with any other type of antennae.

## Effarsee

PORTABLE  
ANTENNAE

Three Sizes  
\$1.00, \$1.50 and \$2.50

If your dealer can't supply you write direct. Money back if not satisfied.

**Fishwick Radio Company**  
Edwards Bldg. - Cincinnati, Ohio

Tear Off This Coupon

Fishwick Radio Company: Please ship by return mail one Effarsee Antennae of the.....size. I am a set user....., Dealer....., Jobber..... (Check one).

Enclosed please find money order for.....

Name.....

Street, or R. F. D.....

City.....

State.....

# Buy transformers that fit your wants

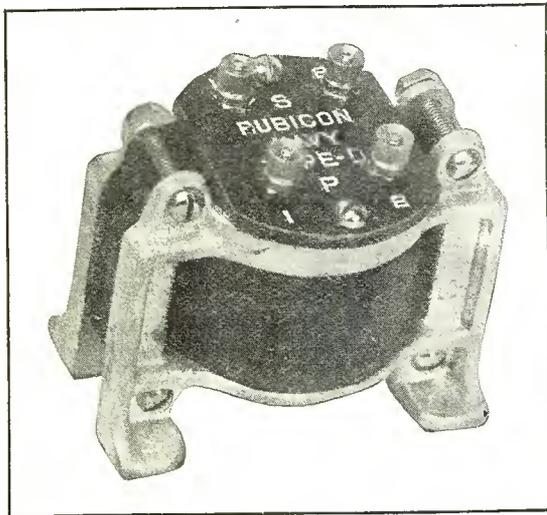

Send for your free copy of "The Inside Story." It tells how to select just the right type for any particular use. Maximum all around results follow when complete data guides.

## Save with Rubicon Super Kits

Build an 8 or 9 tube Super, using the parts you have—plus the special coils and transformers of a RUBICON Super Kit. Free folder gives list of needfuls. Savings average 60%.

A post card in the next mail will bring the above folders quickly

# RUBICON COMPANY

409 Victory Building, Philadelphia

## "CARCO" HAM SPECIAL Short-Wave Low Loss Coupler

A compact unit in a space of only 3 in. x 5 1/2 in. Antenna Rotor and secondary Stator designed for "Low Loss" and "Low Resistance." Our special single layer, multiple wound inductance does the trick. A "Low Loss" Condenser for secondary is the only addition required for a complete tuning unit. DX work requires a "Low Loss" tuner. Rebuild your set with a "CARCO" Ham Special. An increase in efficiency will result.

40 to 125 Meters \$5.00      70 to 205 Meters \$6.00

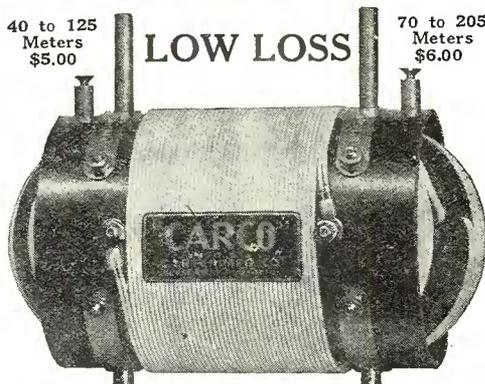

The Carter Mfg. Co.,  
1728 Coit Ave.  
E. Cleveland, Ohio.

Gentlemen:

I have been using one of your "CARCO" HAM SPECIAL COUPLERS and during the past month have heard the following stations:

- New Zealand—4AA (without ground), Z-4AK twice, Z-2AC four times.
- Australian—3BQ.
- English—5NN, 5LE, 2OD, 2NM often.
- French—8FO, 8SM often.
- Cuban—8BY.
- Bermudan—BER.
- Mexican—BX, 1B and 1K (worked).

The HAM SPECIAL is one of the best investments I have ever made, and I can truthfully say I have never seen a better one.

Best 73's,  
JOHN E. PHILLIPS, 8BVR.

## "CARCO" No. 3 P. S. T. LOW LOSS COUPLER

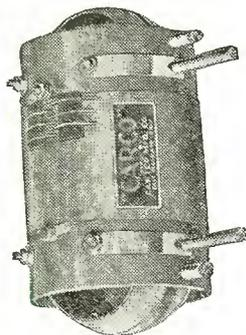

180 to 550 Meters  
"CARCO" No. 3  
\$6.75

This is the original P. S. T. with two rotors mounted on either end of a single tube. Not an awkward, ungainly, unsightly unit, with wobbly coils, but neat, compact and easy to mount on panel.

This coupler consists of a single unit in which is contained a "Low Loss" Stator or secondary winding and two rotors, one of which is the antenna inductance and wound with "Low Loss" coarse wire. The entire unit occupies a space of only 3 in. by 5 1/2 in. yet has the performance of a 3-circuit variometer regenerative set with even greater efficiency. By turning the antenna rotor a very high degree of selectivity is possible, due to the fact that the coupling at minimum is very close to zero. The coupler is strongly recommended for use in congested districts where interference is bad. The operation of the coupler is very simple, one major control only. The general construction of the coupler lends itself to flexibility and a variety of different hook-ups. The best materials are used in its construction. "Low Loss" Bakelite tubing, Hard Rubber Rotors, DC Cotton covered wire No. 18.

Using our specially designed wave trap with the P. S. T. coupler unusual selectivity is obtained. At a distance of one mile from a 1000 watt station we tune to within 10 meters of it and at a distance of 6 miles to within 5 meters. This feat requires a Super-Het to duplicate.

THE CARTER MANUFACTURING CO.

1728 Coit Ave., East Cleveland, O., U. S. A.

Dealers: Your Jobber carries "CARCO" Products

Send for "CARCO" Catalog

# DEALERS—Big Values and Prompt Service for You

Our big complete stock of standard highest quality radio merchandise enables us to offer you not only the lowest wholesale prices but also assures you of quick dependable delivery.

You should have our big catalog containing the greatest values in radio. Write for it today. Use your letterhead.

## LIBERAL DISCOUNTS

Be sure to see our prices before you buy. Lowest prices on all standard parts, kits or sets. Our liberal discounts allow you bigger profits.

## FREE

Send for our Free Catalog showing our complete stock of well advertised, fast selling radio items.

# WESTERN RADIO Mfg. Co.

138 WEST LAKE ST.

Jobbers and Distributors

CHICAGO, ILL.

Single hole mount

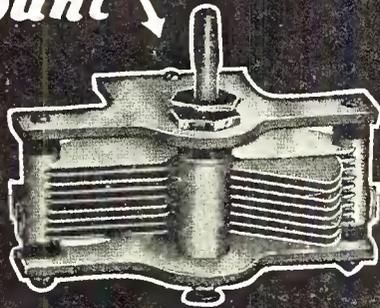

# “NOL-LOS”

Variable Condenser

Capacity .0005 M.F.

\$4.00

## A Masterpiece of Efficient Radio Equipment

Adapted for Any Circuit

Your Radio Hookup is not complete without a “Nol-Los” Condenser. The discriminating Fan demands it

- Because of its sharp tuning
- Because of distance and full volume
- Because it has no body capacity
- Because losses are negligible

Built almost entirely of aluminum, it is light yet rigid, and will withstand the most severe tests. The single post makes it easy to mount in any position on panel. It is a peerless product of most intensive study and experimentation of

Radio Experts. Tests made in the most important Radio Laboratories of the world have proven it equal in resistance to the standard Condensers used in these Laboratories.

Made in three capacities

	Prices
.0005 .....	\$4.00
.00035 .....	3.75
.00025 .....	3.50

When buying a Condenser, insist upon a Grosser “Nol-Los”. If he cannot supply you send direct to

**B. GROSSER SONS CO., Inc., 55 S. Sudbury Street, Boston, Mass.**

Jobbers and Dealers write for terms.



New General Radio Audio Transformer  
Price \$7.00

Wonderful Tone and Amplification never before attained

Use General Radio Condensers, Sockets, Rheostats and Transformers.

We carry complete stock. Write for General Radio Catalog.

## Chicago Jobbers

General Radio Parts  
Fada Neutrodyne Sets

Music Master  
Speakers

Acme Transformers

and 10 other equally good radio lines.

WHOLESALE  
EXCLUSIVELY

Dealers:—Get our new discount sheet

Phone HARRISON 7293

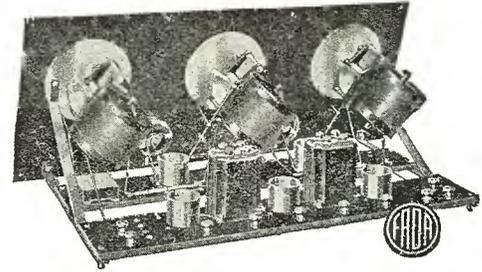

Rear View New Fada  
5 Tube Assembly  
Price \$125.00

Complete in Cabinet, \$160.00

FADA NEUTRODYNE  
PARTS

Always in Stock

New 5 tube Knocked-Down Set with Drilled Panel, \$72.00.

Kit of Essential Parts, \$25.00

New Revised Handbook, \$0.75

# LEONARD LYNN RADIO CO., Inc.

(FORMERLY LYNN RADIO CO.)

220 South State Street

Chicago, Illinois



## DE JUR

One Hole

Rheostats  
Potentiometers

Genuine Bakelite

The DeJur is the only rheostat that does not have to be taken apart in order to mount. It is a one hole mount rheostat, making it the most practical of them all. It absolutely eliminates all back panel fussing, because there are no screws to get loose, and when the DeJur is mounted it is permanent, fixed and rigid.

Sold at all dealers!

### DeJur Jr. Commercial Rheostats

Made especially for manufacturers requiring the most efficient parts at the lowest prices. Samples sent upon request to reputable manufacturers.

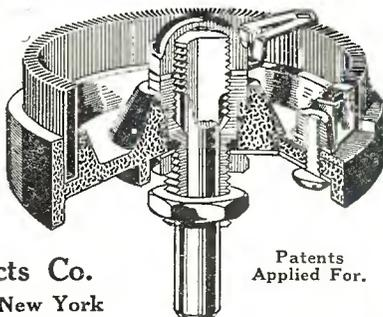

DeJur Products Co.  
199 Lafayette St., New York

Patents Applied For.

The LARGEST RADIO STORES in AMERICA



## Hookups!

All the latest and best Kits in our new

RADIO CATALOG



No other Radio Catalog includes such a complete assortment of the best and latest Knock-Down Kits, Parts and Accessories. You need this book—Write for your FREE copy today.

### We Save You Money!

Our business is to buy up manufacturers' and government surplus stocks, jobber and dealer bankrupt stocks—but only brand new, fully guaranteed, nationally advertised apparatus. Our enormous buying power permits us to pay spot cash and get rock-bottom prices—even way below manufacturer's costs. That's why our catalog is crammed with thousands of wonderful Radio Bargains.



509 So. State St., CHICAGO, ILL., Dept. C.R.6

# Handsome - Safe - Fast

## GOLD SEAL HOMCHARGER

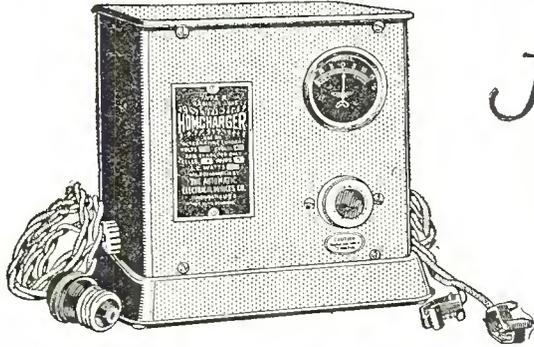

*fast!*

—charges in one-third the time required by 2 or 3 ampere chargers.

# Radio's most popular Battery! Charger!

OVER 250,000 Radio fans have found the big capacity 5 ampere GOLD SEAL HOMCHARGER ideal for keeping their Radio batteries fully charged and operating at top efficiency. Connects to any lamp socket and charges all Radio "A" and "B" and Auto Storage Batteries over night for a nickel.

Simple, reliable, fool-proof. Can be operated by any one. Contains no bulbs, acids or fast wearing carbon contacts. Only one moving part, replaceable for \$1.00 after thousands of hours' use.

Absolutely safe — no danger of shock or fire. Approved by Insurance Underwriters everywhere. Beautifully finished in mahogany and gold. May be used right in the finest living room. Price, \$18.50 complete for all currents.

Sold by all good Radio dealers, or shipped charges prepaid upon receipt of purchase price.

THE AUTOMATIC  
ELECTRICAL DEVICES CO.  
179 W. Third St., Cincinnati, Ohio

*Largest Manufacturers' vibrating rectifiers in the world*

*Free*

Write for booklet, "The Secret of Distance and Volume in Radio," containing information on this subject and fully describing the GOLD SEAL HOMCHARGER.

*Free*

## The "LITTLE JOE" Lightning Arrester

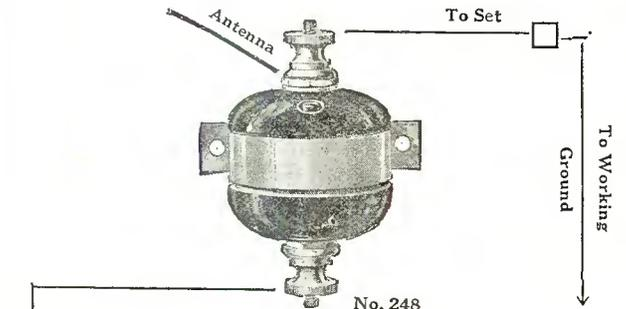

No. 248

Card No. E-5841

Jan. 5, 1923, Underwriters Approval

### Especially Designed for Radio Work

Made of Porcelain, small, neat, rugged and serviceable. Can be suspended on antenna or fastened to wall.

Ask your dealer or write for further information

CIRCLE F MFG. CO.  
TRENTON, NEW JERSEY

## Radio Dealers HEADQUARTERS

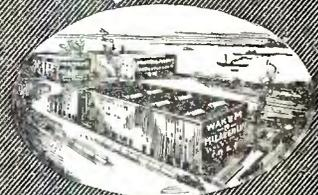

EIGHT BIG WAREHOUSES  
TO SERVE YOU



BIG  
CATALOG  
FOR  
DEALERS  
ONLY

### DEALERS

We ship fast. Use your letterhead to get our big catalog. Ask for F1003.

WAKEM & McLAUGHLIN  
225 E. ILLINOIS ST. - CHICAGO

# The New CHELSEA

FIVE TUBE RECEIVER

Enjoyable selectivity, plus a remarkable volume, makes the new CHELSEA the greatest Radio value today!

PRICE  
\$50.00

West of Rocky Mountains, \$55.00

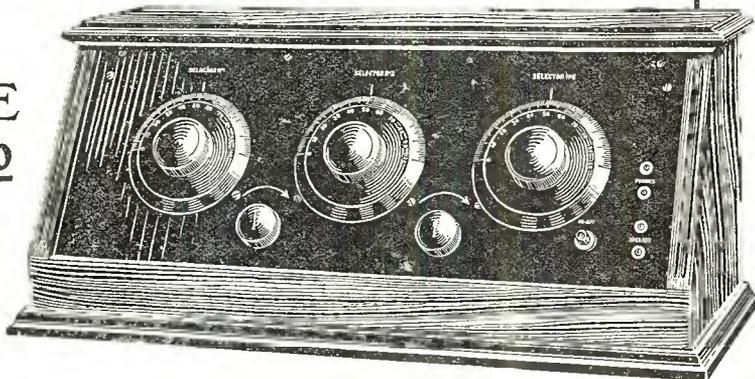

On sale at all good dealers—  
Catalog sent on request

**CHELSEA RADIO COMPANY**  
179 SPRUCE STREET ~ CHELSEA, MASS.

Chicago  
St. Louis  
Seattle

San Francisco

Denver  
Los Angeles  
Cleveland

## SUPER FIVE

The New Super-Five, manufactured by one of the oldest houses in radio, embodies all the best receiving principles of the finest non-regenerative sets. Encased in its beautiful mahogany finished cabinet with bakelite panel, the New CHELSEA Super-Five is a fitting addition to the most pretentious home.

The demand for the new CHELSEA Super-Five has taxed manufacturing facilities. If you have any difficulty securing a set write us direct and we will assist you.

# BROWNLIE VERNIER DETECTOR

PATENT PENDING

FOR REFLEX OR CRYSTAL SETS

Best  
Reflex  
Crystal  
Detector

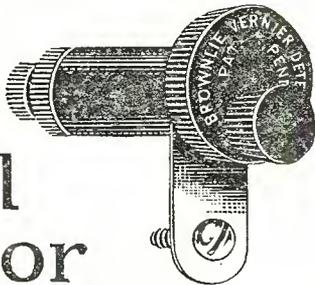

Says the Acme Apparatus Co.

No longer does the whisker scratch the crystal, or is the sensitiveness killed by heavy spring pressure—the Vernier Regulator takes care of that. It will surprise you to know how sensitive Crystal Detectors are when correctly made.

For Panel or Base Mounting including Crystal. Guaranteed **\$2.00**

At your dealers, otherwise send purchase price and you will be supplied postpaid.

**ROLAND BROWNLIE & COMPANY**  
20 Saunders Street Medford, Mass.

# Burns

LOUD  
SPEAKER  
of Distinctive  
Beauty



No. 205

Great Volume with Remarkable Clarity

14 Inch Pyralin Bell  
Aluminum Sound  
Column

Of generous proportion, gracefully shaped and designed along scientific lines. Tone quality is of a surprising clearness and naturalness that instantly attracts attention.

No. 100 Burns Speaker is designed for attaching to phonograph—fits all makes. Excellent model for built-in speakers.

No. 205B, all black bell.....\$22.50  
No. 205D, shell pyralin bell..... 25.00  
No. 100, Unit for phonograph..... 10.00

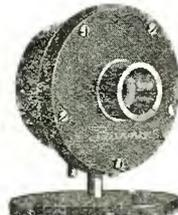

No. 100

*American Electric Company*

State and 64th Streets

Chicago, U. S. A.

### A Color For Every Circuit

Here is a colored bus bar for wiring radio sets. It is No. 14 tinned copper wire covered with flexible, varnished insulation, in red, yellow, green, brown and black—called

## CELATSITE

(Spaghetti Wire)

Looks like "spaghetti" but is smaller and goes in through narrower places. Highly dielectric, thoroughly moisture-proof. Makes the neatest looking job you ever saw. Your dealer should have it in 30-inch lengths at 10c per length. If not, send us his name and \$1.00 for ten lengths (enough for a 5-tube set) in one or assorted colors—say which.

Acme Wire Co., Dept. C, New Haven Conn.

# ACME WIRE

Makes Better Sets

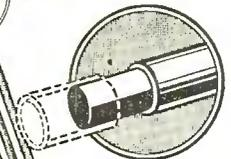

Cut Insulation and slide it off

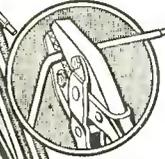

Bends without cracking

# The Kurz-Kasch Aristocrat Line of DIALS and KNOBS



### The Aristocrat 4" Clockwise Dial

A massive dial with a 2 3/8-in. tapered knob which adds beauty and a businesslike air to any set. Moulded from genuine Bakelite, graduated with easy-to-read lines and numbers—no dial made today is such a dependable asset to a fine receiver.

All dials are matched—all are supremely simple to operate and all stay accurate for easy, quick tuning. There is nothing to go wrong on Kurz-Kasch Aristocrat Dials.



### No. 702 Pointer Knob

The pointer knob is a handsome unit with a true, accurate balance.

The Patented Split Bushing permits dials to be used successfully on various size shafts.

The Kurz-Kasch method of assembly absolutely prevents dials from running out of true.



### No. 504 2" CW Rheostat Dial

The clockwise Rheostat Dial with tapered knob is superior in all respects to a knob and pointer for Rheostat control.



### Rheostat Bases

Rheostat Bases are especially adapted to Rheostats and will be furnished manufacturers.

*All Kurz-Kasch Aristocrat Dials and Knobs are identified by a trademark stamped on the back of each part. It is your guarantee of quality. Accept no substitutes.*

## THE KURZ-KASCH CO.

Dayton - Ohio

## Around the clock with

# DURHAM Grid Leaks

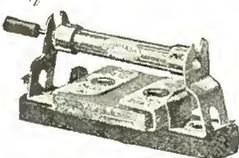

**DURHAM'S Standard in These Sets**  
Eagle, Eismann, Howard, Thompson Zenith—and fits all others.

### Prices

Fixed Leaks in 28 sizes

Over 1/4 meg—50c  
Under 1/4 meg—75c

### Variables

No. 100—1,000 ohms to 100,000 ohms  
No. 101—0.1 megs to 5 megs  
No. 201A—2 megs to 10 megs  
75c each

### Mounts

Single - - - - 30c  
Cond. & Leak - 35c  
Double - - - - 40c

At dealers or postpaid

THIS book gives the time different stations are on the air. DURHAM Grid Leaks make getting them surer—thru perfect detector adjustment and making the audio smoother. Slip a DURHAM into your set



A known and trusted product of several seasons standing is the DURHAM Variable. In the DURHAM Metallized Fixed type you get the nearest to theoretical ideal—metal fused to glass. Accurate, noiseless, permanent.

### Build a Resistance Amplifier

Parts cost less than one good transformer. Complete details make building easy. Booklet for 25c.

**DURHAM & CO., Inc.**  
1936 Market St., Philadelphia.

Canadian Distributors:  
De Forest Radio Corp., Ltd., Toronto

# THE SILENT FRANCE MULTI-DUTY SUPER-CHARGER

Charges Up To  
**120 Volts**  
of "B" Battery In Series

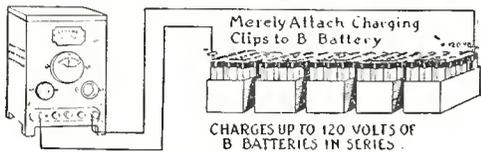

Simple - No Trouble - Quick - Convenient

No fuss or trouble—just connect charger clips to battery terminals and turn on the current. The France Super-Charger charges up to 120 volts of "B" battery IN SERIES, economically and quickly. It also charges 2, 4, 6 or 8 volt "A" or Auto batteries at a 5 to 7 ampere rate, tapering as the battery is charged.

The France Super-Charger is noiseless, and non-critical in adjustment. Sparking and sticking contacts have been eliminated by the use of special alloy contacts and a new application of the push-pull principle. No bulbs to burn out, no acids to replenish—an ideal charger for home use.

Price of Super-Charger, \$22.00  
West of the Rockies, \$23.00  
Canadian Prices furnished on request

Dealers and Jobbers: Write us today for prices and full information on our sales and advertising plans.

**THE FRANCE MFG. CO.**  
10328 BEREA ROAD  
CLEVELAND, OHIO  
U. S. A.

Stocks carried at convenient points throughout the United States and Canada

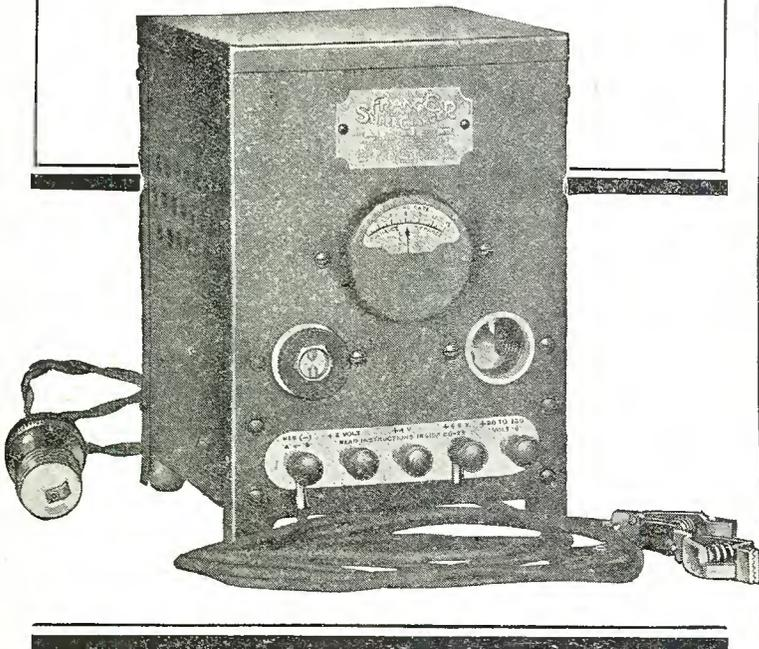

## Harry Alter & Co.

Ogden at Carroll Avenue Chicago

Wholesale Distributors for the following  
Radio Apparatus and Supplies

- |                |          |
|----------------|----------|
| Freed-Eisemann | Brandes  |
| Freshman       | Mohawk   |
| Remler         | Premier  |
| Radion         | Balkite  |
| Dubilier       | Howard   |
| Carter         | Erla     |
| Benjamin       | Pacent   |
| Flewelling     | Acme     |
| Baldwin        | Apco     |
| Frost          | Timmons  |
| Burgess        | Signal   |
| Allen Bradley  | Electrad |
| Raven          | Shamrock |

And many others of equal importance

Dealers who make Harry Alter & Co. their source of supply have at all times access to ample stocks of nationally known merchandise, and prompt delivery from these stocks

## QUALITY

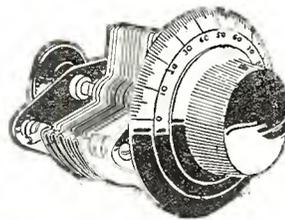

Backed by  
Originality  
of Design  
in

## U. S. Tool Condensers

A CONDENSER is no more efficient than its weakest feature—a thought borne constantly in mind in designing and making U. S. Tool Condensers. As a result, the gradual perfecting of each part has lead to the nearest point approaching condenser perfection. Inquire about Type 6 with the micrometer dial. Good dealers carry this newest model.

**FACTORY GUARANTEE**

Write for Literature

**U. S. TOOL COMPANY, Inc.**

119 Mechanic St., Newark, N. J.

Mfrs. of special tools, dies, jigs, automatic machinery and sub presses

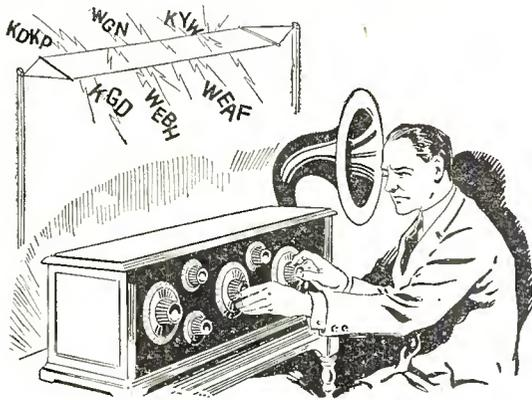

## Unlock the Scrambled Wave Lengths

with  
**E-Z-TOON**  
 (EASY TUNE)  
 RADIO DIALS

*The Key to Simplified Tuning*

E-Z-TOON Radio Dials are the key which will unlock the scramble of wavelengths that has been bothering you for so long. They are two dials in one, the smaller dial having a ratio of 80 to 1 to the larger dial. E-Z-TOON dials give a fine smooth vernier adjustment. Place a set of them on your set and you will marvel at its selectivity.

No cogs, gears, backlash or lost motion.

3" Dials, Black, \$2.00; Mahogany, \$2.20

4" Dials, Black, \$2.25; Mahogany, \$2.45

2" Non-Vernier Dials, Black, 40c; Mahogany, 45c each

All Vernier Dials are made with Zero mark on either right or left side.

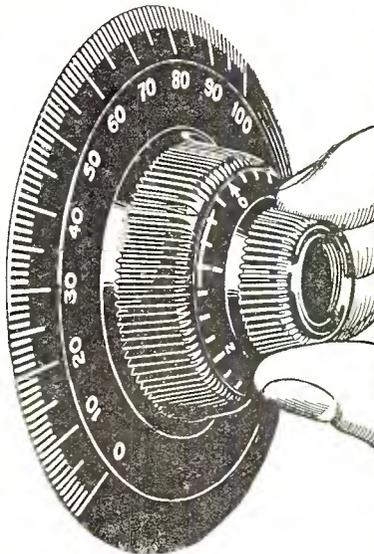

**Mr. Barry, White Plains, N. Y., Says:**

"Tuesday night, November 25th I heard station 2LO London, England with a 3 tube single circuit type receiving set, built by myself and equipped with an E-Z-TOON 4" dial on aerial tuning condenser."

"My whole success I contribute to the exceptional close tuning of the variable condenser, with vernier type dial, this condenser was not in itself a vernier type, but became one and better with the addition of your dial."

JOHN F. BARRY,  
 103 Main St., White Plains, N. Y.

**Easy to Install**

Only a small screw driver is required to install. There are no changes necessary in the shaft—no redrilling of panel. E-Z-TOON Dials are arranged to accommodate so-called single hole mounting condensers. Simply take off old dials slip on E-Z-TOON and tighten set screw.

If your dealer cannot supply, write us.

**E-Z-Toon Radio Company**  
 3236 W. Washington St. Indianapolis, Ind.

## THE FIAT WOUND LOOP

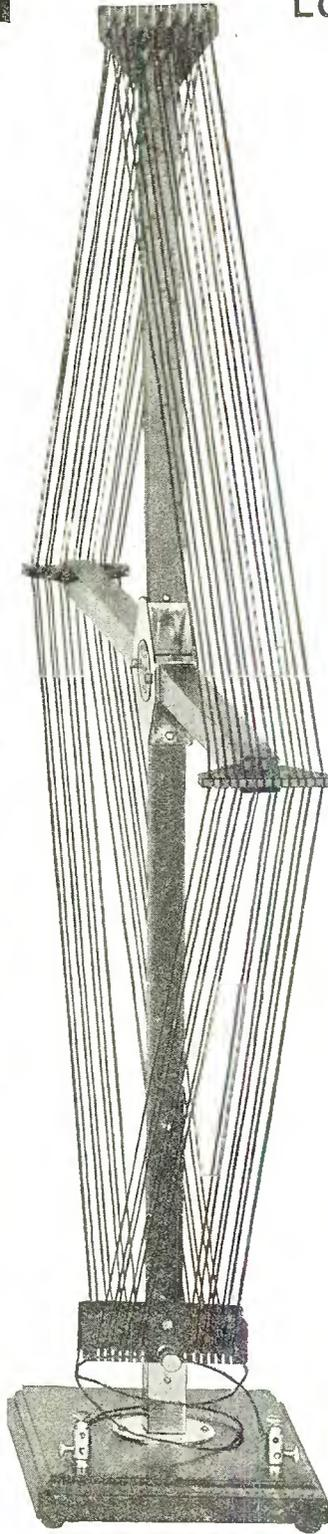

A Novel, Collapsible, Directional Loop Embodying Numerous New Features resulting in relatively small size, (18" on a side although more efficient than loops twice as large) unusual sensitivity, low dielectric losses, low radio frequency resistance, convenient size when folded and pleasing symmetry in the arrangement of the turns.

The Fiat Loop is a quality product throughout, painstakingly constructed to insure accurate, well fitting parts. It is attractive in appearance and will harmonize with other furnishings in the home. Woodwork is of either solid walnut or mahogany, hand rubbed, with metal parts of brass, heavily nicked.

Folded, The Fiat occupies very little space and may be readily carried in a hand bag or a small compartment in a portable set. The unique manner in which it folds prevents tangled wires and does not require the removal of any parts. It is easily opened without the use of tools. The construction is such that the wires are always taut and repeated opening and folding will not spring the parts out of alignment or cause the turns to sag.

In The Fiat Loop you have a device which is the equal of the best radio receivers or parts available. When you invest in the FIAT, there is the assurance of utmost performance and complete, lasting satisfaction.

**Laboratory Test**

Self inductance...0.00021 Henries  
 Distributed capacity...33 M.M.F.  
 Natural wave length...156 Meters  
 Resistance at 1,000,000 cycles...12 Ohms  
 Wave band covered when shunted by .0005 M.F. condenser...156-630 Meters

**PRICE \$15.00**  
 Solid Mahogany or Walnut

Designed and Manufactured by  
**RADIO APPLIANCE LABORATORY**  
 4884-90 North Clark Street, Chicago, U. S. A.

# Needlephone



**\$10.00**  
complete  
with  
cord

## MAGNIFIED Reproduction

Music as clear and melodious as the tinkle of silvered temple bells of Mandalay—that's what you'll get on your radio when you use the Needlephone with your phonograph. Nothing else will give the same mellow notes—the same wonderful discrimination of tone values—the same perfect reproduction, because no other loudspeaker takes advantage of the principles of "magnified reproduction" and the correct principles of acoustics (the laws of sound) as embodied in the phonograph reproducer.

Rhamstine\*

### NEEDLEPHONE

The Needlephone picks up the delicate impulses of high pitched notes—often lost on other types of loudspeakers—and through the vibrations of the flexible reed *enlarges them and transmits them* through the needle of the phonograph to the mica diaphragm, where they are transformed into sound.

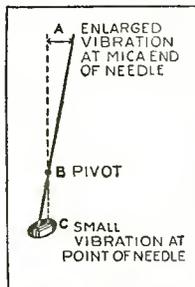

**"Magnified Reproduction" Principle**  
The delicate vibrations of the reed at "C" are transmitted through the pivoted needle and magnified at "A," where it is attached to the mica diaphragm.

This "magnified reproduction" principle also brings in distant stations more clearly than is possible with the ordinary loudspeaker that has a stiff metal diaphragm.

#### Send No Money. Take No Risk

Send the coupon today, pay on delivery, and try the Needlephone with your own set and your own phonograph. Try it with a soft needle for local broadcasting—or a loud needle for distant stations—and see what wonderful results await you. Then if you are not more than satisfied—if you cannot say you get far greater volume—if you do not get fuller, sweeter music and better reproduction, Rhamstine\* does not want you to keep it. Return it and we will gladly refund your money in full.

## J. Thos. Rhamstine\*

J. THOS. RHAMSTINE\*

510 E. Woodbridge, Detroit, Mich.

Send me the Needlephone. I'll pay the postman \$10 upon its arrival. It is distinctly understood I may return it if I desire, within 5 days, and receive a refund in full.

Name .....

Address .....

## Western New York Representatives

for Leading Makes

of

## Radio Sets and Parts

"Wireless Since 1910"

Also

— Thos. E. Wilson Line —

### SPORTING GOODS

## Rudolph Schmidt & Co.

New Location

43 South Ave. - - Rochester, N. Y.

Est. 1882

Model N. Cap.  
1.8 to 20 MMF.  
Price  
\$1.00



For positive balance in  
Neutrodyne and all  
other tuned radio fre-  
quency sets.

FRANK D. PEARNE

Technical Radio Editor of the Chicago  
Herald and Examiner, says:

"After testing two of your condensers in a five-tube-neutrodyne set, I am very glad to be able to report to you that they are all you claim for them and then some. I wish to congratulate you upon having produced a first-class article which should prove to be of great value to the vast army of neutrodyne users."

For Greater Distance Volume and Clarity Use

## X-L VARIO DENSERS

X-L Radio Laboratories

2424-26 Lincoln Ave., Chicago

If your dealer cannot supply you write direct.  
Dealers solicited

For correct grid condenser values, Super-  
heterodyne filter and intermediate fre-  
quency and reflex balance.

G. M. WILCOX

Prof. of Physics, Armour Institute  
of Technology, says:

"The range of adjustment of these condensers is sufficient to allow the value of grid capacity best suited for a particular tube or circuit to be obtained easily. These condensers are compact and well made and are a desirable accessory for high grade radio equipment."

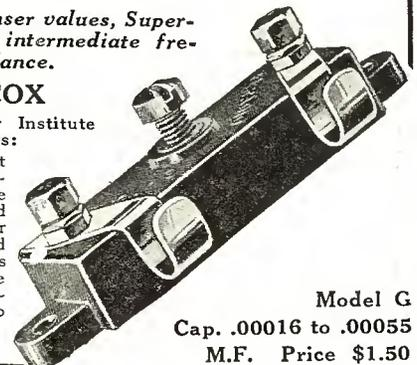

Model G  
Cap. .00016 to .00055  
M.F. Price \$1.50

# MUTER

## Dependable Radio Products

Used as Standard Equipment by the Better Class Set Builders



**Fixed Condensers**—assure noiseless operation—accurately calibrated—14 capacities.



**GUARDIAN "Approved" Lightning Arrester**—The greatest value for the money—4½" husky built—rain-proof—removable brushes—\$1.00



**Fixed Grid Leaks**—individually calibrated—guaranteed accurate—10 capacities.



**"Approved" Universal Lightning Arrester**—positive protection—50c



**Fixed Grid Leak Mounting**—Bakelite base—nickel plated brass clips, 20c



**Double Resistance Mounting**—Bakelite base—nickel plated brass clips, 40c

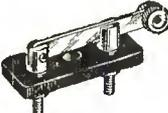

**Single Pole, Single Throw Switch**—for base or panel mounting—Bakelite base, nickel-plated brass posts, insulated handle—20c

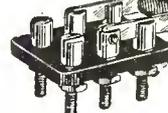

**Double Pole, Double Throw Switch**—for base or panel mounting—Bakelite base, nickel-plated posts, insulated handle—50c

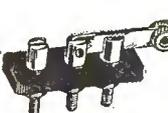

**Single Pole, Double Throw Switch**—for base or panel mounting—Bakelite base, nickel-plated posts, insulated handle—30c

Sold by all leading dealers  
**LESLIE F. MUTER COMPANY, MFGRS.**  
 76th and Greenwood Ave. Chicago, Illinois

# QUICK!

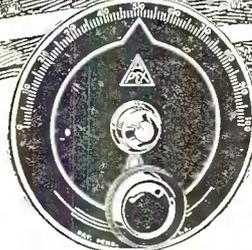

## Apex Vernier Dials Mean Finer Selectivity

You now have a radio receiver. Add to its selectivity by placing Apex Vernier Dials on the shafts. When you remove your hand from the ordinary dial you may turn it a hair's breadth—and the distant station is gone! Apex Vernier Dials get the stations and hold them. Ratio 12 to 1. Quickly applied to any shaft. At your dealer, or send \$2 for Royal Brass Finish; \$2.50 for Satin Silver Finish or \$3.50 for De Luxe Gold Plated (24k).

Dealers, Write for Literature  
**APEX ELECTRIC MFG. CO.**  
 1410 W. 59th St., Chicago

# SAVE MONEY AND GET RESULTS BY BUILDING

## A-C DAYTON XL-5 RADIO RECEIVER



**Knock Down Set—Type XL-5 (KD)**

Price—less standard cabinet 24 in. x 7 in. x 7 in...\$72.50  
 Price—Denver and West..... 76.50

Designed for use with either storage battery or dry cells.

Two stages radio, detector and two stages audio frequency  
*Engineered by R. S. Copp*

Write us for complete information and diagram of circuit

**The A-C Electrical Mfg. Co.**  
 Factory and Main Offices, Dayton, O.

The A-C Dayton XL-5 in knock-down form represents an opportunity to construct a super five tube radio receiver without the trouble and uncertainty usually attached to home-made radio equipment.

The XL-5 knock-down kit, at the price of \$72.50, includes drilled panel; base board; all parts and units except the standard size cabinet 7 in. x 24 in. x 7 in. (carried in stock by many dealers or furnished by us on special order). Each kit contains simple and complete instructions for building and operating this famous receiver. This receiver is easy to build and needs no balancing. The parts in this kit are exactly the same as used in our completed XL-5 Receiver which lists at \$115.00. The XL-5 is the last word in a fine radio receiver. It has no superior in any phase of radio performance, regardless of price.

The XL-5 knock-down kit is guaranteed against defects in workmanship and material. Any part found defective will be replaced without charge.

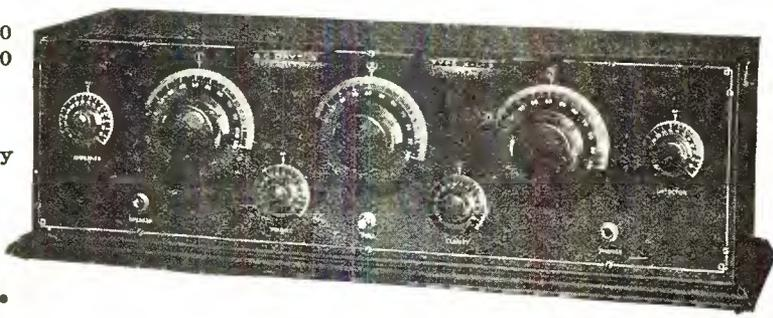

View of XL-5 completed

Reg. U.S. Pat. Office  
**Lincoln**  
 RADIO PRODUCTS

Laboratory tested  
 and fully guaranteed

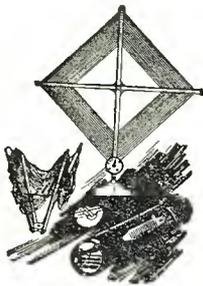

**Lincoln collapsible Loop Aerials . . . .**  
 the standard loop of the radio industry.

4-point tapped loop. List price..\$8.00  
 Center-tapped loop. List price..\$6.50

Great selectivity—quality reception—super-efficiency—beauty and grace have won leadership for Lincoln Loops. Built by radio engineers for superior performance. Built of the finest materials—beautifully finished—31½ inches high—28 inches wide. Both the 4-point Tapped Loop and the Center-Tapped Loop are correctly designed from an electrical

and mechanical standpoint. The Center-Tapped Loop can be used on any sets employing radio frequency amplification and is particularly adapted for use with certain superheterodynes requiring a center-tap. The 4-point Tapped Loop is built for the requirements of any circuit where it is desired to vary the inductance of the loop. This applies to Radiola Superheterodynes and many other types of superheterodyne sets, and also to neutrodyne types of receivers where an outside aerial is impractical.

**Lincoln Low-Loss Grounded Rotor Condenser**

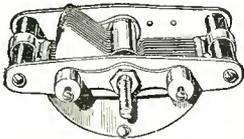

Most efficient electrically—strongest mechanically. Increases range of reception—selectivity and volume. Used by manufacturers of the finest radio sets. Several radical improvements. Minimum capacity extremely low. Two well-known laboratories

found this condenser to have a lower high frequency resistance than any other condenser of this type. A complete die-cast job—rugged in construction—fully guaranteed. 28-plate. List price.....\$4.50

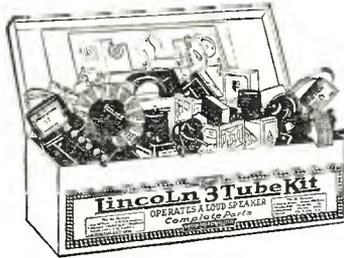

**Lincoln Kits**

Coast-to-coast on the Lincoln 1-tube Kit—or loud speaker performance on the Lincoln 3-tube Kit. Each Lincoln Kit contains all the parts necessary for a high quality set—every part laboratory tested and fully guaranteed. Easy to assemble—easy to operate. Full instructions with each Kit.

Lincoln 1-tube Kit—  
 List price .....\$21.50  
 Lincoln 3-tube Kit—  
 List price .....\$40.00

**Write for the Lincoln Catalog**

Send your name and your dealer's name for the Lincoln Catalog. Fully describes all Lincoln apparatus and shows 6 interesting hook-ups.

**To the Trade!**

We are always glad to receive orders or letters of inquiry from legitimate jobbers. And dealers who write us are informed at once of the name of the Lincoln jobber in their specific territory. Lincoln Radio Products are nationally advertised—and all fully guaranteed.

If you are not already handling the popular Lincoln Line—write us for prices.

**Lincoln Radio Corporation**  
 224 North Wells Street Chicago, Ill.

**New Radio Tubes**



REGULAR \$4.00 LIST PRICE  
 DIRECT TO CONSUMER

FOR **\$2.50** EACH

In the Following Types:  
 12, 199, 200 and 201A.

Every tube individually tested by our engineers in a specially designed meter for characteristics, in a set for actual reception, matched perfectly, and GUARANTEED.

We are still repairing all types of tubes for \$2.00 each—Guaranteed work.

**WE ARE RADIO TUBE EXPERTS**

Dealers—Write for our Proposition

**OHIO RADIO SALES**

RADIO TUBES EXCLUSIVELY  
 723-B Rose Building Cleveland, Ohio

**TUBES REPAIRED**

**In Our Own Laboratory**

In making this announcement, we wish to impress upon you the fact that we are not agents but that we repair all standard types of vacuum tubes in our own laboratory with our own equipment. Your satisfaction is, therefore, positively guaranteed.

**GUARANTEED LIKE NEW**

Burned out filament or broken bulb—send the tube in to us. We will return it to you good as new—and guaranteed against defective workmanship same as new tube. We put on new glass bulb in every instance. This makes sure of proper vacuum and proper "hardness" for all types of tubes. Tubes returned parcel post C.O.D. Send yours in TODAY.

**EXPERIMENTERS! INVENTORS!**

If you desire any particular high vacuum for any experimental purpose, outline your needs to us and we will quote you. We have complete equipment for filling any need you may have.

**CHICAGO ELECTRIC DEVICES COMPANY**  
 Established 1920 70 E. 22nd St., Dept. 17, Chicago, U. S. A.

**\$2.00**

**RADIO DEALERS!**

There certainly is a difference among Radio Jobbers, isn't there? Responsible Dealers everywhere tell us that we are a REAL Radio Jobbing House—one with a policy, a fine catalog, attractive discounts and a knack of making prompt and complete shipments.

— Some of Our Leading Lines —

- |                |                |                |
|----------------|----------------|----------------|
| Freed-Eisemann | Music Master   | Ultradryne     |
| Freshman       | Brandes        | Bremer-Tully   |
| Crosley        | Frost          | Remler         |
| Magnavox       | Cunningham     | Benjamin       |
| Baldwin        | Haynes-Griffin | and 100 others |

Send for Our Catalog TODAY and Give Us a Trial on Your Next Order!

**OHIO RUBBER**  
 228 W. 7th St, Cincinnati

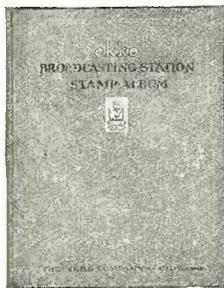

# The ekko Broadcasting Station Stamp Album

*Begin collecting  
ekko stamps today!*

Here's just what you have wanted for a long time—a convenient, permanent and authentic means of recording all the stations you have heard over your set.

### Verified Reception

The Ekko Broadcasting Station Stamp Album contains spaces for the beautifully engraved stamp of each of all the recognized stations in the United States and Canada—more than 550 in all. With the album are furnished PROOF OF RECEPTION CARDS. You send these cards to the station, together with facts that prove you have heard their broadcasting and 10 cents to cover the cost of verification and mailing. The station then sends you its Ekko Stamp as verified proof of reception. You then paste the stamp in your album. From the Ekko Album and the stamps pasted in it you can tell at a glance what stations you have heard.

### Beautiful Stamps and Album

The stamps are beautifully engraved in different colors. Each station has its own stamp showing call letters. The album is 9½ x 11 inches, handsomely bound in a two color cover. It contains 96 pages with

spaces for stamps of all recognized stations in the United States and Canada, arranged alphabetically by states and call letters. Contains also a convenient log and an alphabetical list of official names and other interesting features of call stations.

### A Fascinating Hobby

Think of how much fun you can have showing your friends your album and proving to them at once how many stations you have heard. And think of how much more fun you'll have collecting the stamps themselves. Most of the important broadcasting stations in America are already furnishing Ekko Stamps to their hearers. Although the game is still new, radio fans throughout the country are already enjoying this fascinating hobby. Many Ekko Album Owners already have more than 100 stamps pasted in their books.

### Begin Today!

You too can join this new radio game that is sweeping the country. Buy your copy of the Ekko Album and begin collecting Ekko Stamps today.

*For sale by radio dealers and bookstores everywhere. If your dealer cannot supply you, sent direct, post-paid, on receipt of price. Money back if not satisfied.*

**Price \$1.75**

\$2.50 in Canada

**THE EKKO COMPANY**

111 West Monroe Street

Chicago, Illinois

## For a Limited Time Only

You can purchase for \$3.50 a 12 cell 24 volt RABAT SENIOR battery. Saving \$6.10 through direct buying. The Jobber and Dealers profit now is yours. 24 cell 48 volt size \$7.00.

### Rabat Senior Storage "B" Batteries

are neat, powerful, noiseless and will harmonize with any Radio Set. Separate cells and patented rubber cork prevent current leakage and clear glass tubes give vision of the condition of battery. Heavy duty plates 3-16" x 1" x 2½" with staggered ribbed grid form the backbone of this sturdy battery. Shipped completely charged ready for instant use. And you can save \$6.10 by ordering now.

### Rabat Super-Charger \$3.00 c. o. d.

Is specially designed to satisfactorily recharge any make of storage "B" battery. Shipped complete ready to use, including lamp socket, attachment plug and cord. You save \$1.80 by ordering direct.

### SEND NO MONEY

But write us today, advising quantity and type wanted. After examining and approving these wonderful batteries then pay the Expressman the small C.O.D. charges.

The Rabat guarantee is back of all our products. DON'T WAIT, ORDER TODAY and save the middleman's profit.

### The Radio Rabat Company

1763 St. Clair Avenue.

Cleveland, Ohio

Mail this Coupon, today!

THE RADIO RABAT COMPANY,  
1763 St. Clair Ave., Cleveland, O.

Send me at once C.O.D. subject to examination and approval:  
..... 12 cell 24 volt Rabat Seniors at \$3.50 each .....  
..... 24 cell 48 volt Rabat Seniors at \$7.00 each .....  
..... Rabat Super-Chargers ..... at \$3.00 each .....

Total.....

Name .....

Street .....

City..... State.....

# FREE Radio Parts

**S**END only \$2.50 for a full year subscription to "RADIO" (San Francisco) and we will send you, free of all cost, one of the following useful radio premiums: *Genie Induction Filter* for eliminating induction noises in your receiving set; *Marathon Radio Frequency Transformer*; or one of the following well known radio books—"The Radiobuster," by *Mathison*, a great radio book of twelve complete live radio novels; "*Elements of Radio Communication*," by Lieut. E. W. Stone. Take your choice of one of these premiums, send \$2.50 to us today, get "RADIO" for one full year and one of these premiums free of cost.

## For A Two Year Subscription You Get One of These!—

For a two year subscription to "RADIO," full price \$5.00, you can have either a pair of 2000 ohm *Pennsylvania* headphones or a pair of the new *Dymac* headphones. This is a wonderful premium offer. We guarantee immediate delivery of premium.

### Use This Coupon!

Use the coupon for quick action! Pin a money order or check to it and mail today. If you are not interested in getting one of the premiums listed above, you can have a special trial subscription to "RADIO" for six months at the unusually low price of only one dollar. But get "RADIO" right now, it is the magazine you need to help you with your radio problems.

# RADIO

The World's Best Practical  
Radio Magazine. Published  
Monthly in San Francisco, Cal.

"RADIO," Pacific Building, San Francisco, Cal.

HERE IS \$.....for which you will send  
"RADIO" for.....years and mail me at once,  
absolutely free, the following premium.....

Name .....

Address .....

City.....

State.....

# APCO-RADIO

*“A Charged Battery Requires No Apology!”*



You can charge them over-night—without disconnecting a wire, with

## APCO BATTERY CHARGERS



APCO "A" CHARGER is extremely quiet in operation. Has high charging rate of  $7\frac{1}{2}$  amperes and taper charge for safety. It is neat, compact, sturdy—an ornament to your living room table. Fully charges radio "A" batteries over-night at a few cents' cost.....Price \$18.50

APCO "B" CHARGER is the first thoroughly dependable charger for 24 or 48 volt "B" storage batteries (or 90 volts in multiple). Rate varies from  $\frac{1}{4}$  to  $\frac{1}{2}$  ampere according to size of the cell. Does its work in ten hours for less than a dime.

Price \$10.00

## APCO Radio Switch

The toggle arm type. Positive in action. No springs to wear. Only one panel hole to drill. Will last a lifetime. The terminal connections are very accessible, making installations quick and easy. Heavily nicked on brass.

Price, 50c



## APCO Resistance Units

Permanent in their values, of constant, specific resistance for all practical changes in temperature, and rigid in construction. Current uniformly distributed throughout the whole cross section, giving maximum carrying capacity with minimum size.

Price, 50c

## APCO Radio Transformer

Permanent Installation Type

Any Ratio from 2 to 1 to 10 to 1

Price \$5.00

Has all the characteristics of the interchangeable tube base type in quality and construction, but is made to sell at a lower price to meet the demand for a high-grade popular priced transformer for permanent installation. APCO Transformers are built for the discriminating radio owner who realizes the advantages in reception from transformers of highest possible quality.



At Your Dealer's—or Write Us

**APCO Manufacturing Co. - Providence, R. I.**

## Low Loss Tuned Radio Frequency Receiver

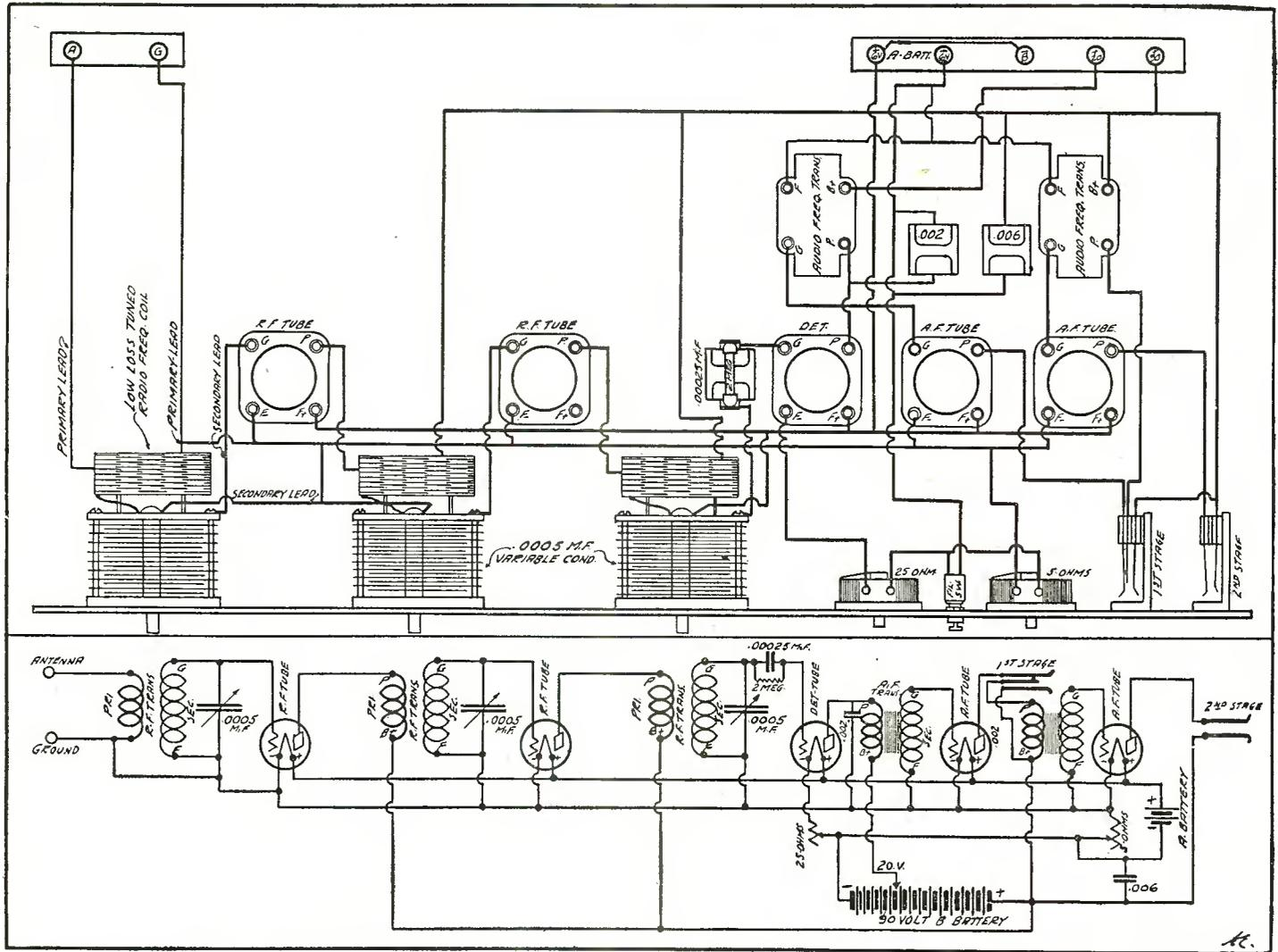

PAT. APPLIED FOR

(TRADE MARK)

# FILTERSPEAKER

MADE IN THE U. S. A.

*Ideal for Home Use*

**Unrivalled Perfection in Tonal Quality.  
Clear and Distinct. Improves With Use.**



CROSS-SECTION

### Type 3 CW

Height, 8 in. Dia., 10 in.  
Complete with special unit and  
polarity indicating cord.

**\$25**

*Circulars on Request*

Non-directional. Compact. Beautiful mellow tone. Renders a faithful reproduction of the original radiocast. Made of minute wood fibres compressed in steel moulds under hydraulic pressure of 25,000 pounds per square inch and baked at a temperature of 800 degrees Fahr.

**Order from your dealer. If he does not carry this item write us giving his name and address.**

*Dealers: Write for Attractive Proposition*



Black or Brown Crystal Finish

## FILTERSPEAKER SALES

1454 Monadnock Bldg.

Chicago, Ill.



# An Outstanding Radio Value of Unusual Merit

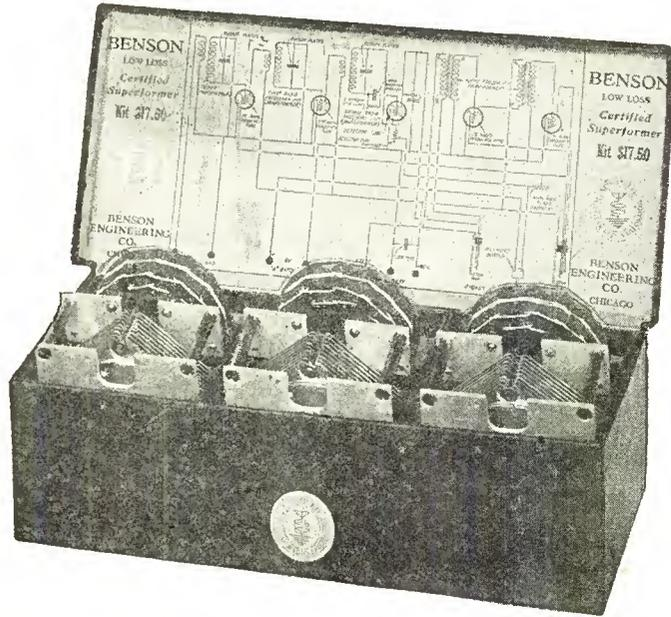

## Build the Benson Certified Superformer Receiver

The Benson Superformer Kit shown here is indeed an outstanding value. It assures perfect reception. Has lowest dialectic loss. (Actual tests prove this). It is simple to hook up from the diagram furnished on each box.

During International Radio Week foreign stations were picked up by the Benson Superformer Receiver. This is proof enough of its wonderful performance.

Have your dealer show you the kit today. If he does not handle them write us direct, giving his name.

**Benson Engineering Company**  
 2125-27 No. Halsted St. Chicago, Ill.

Insuline Frieze Finish

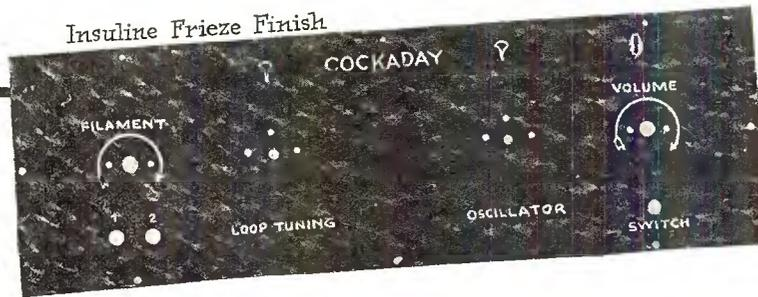

**Insuline Ear Phone Cushions.**  
 Soft rubber. Prevents outside noises, eliminates pressure of head phone. 75 cts. per pair.



**Insuline Binding Post Panels.** Drilled and Engraved, 1 1/2" x 7" black or mahogany, 20 cents.



**Insuline Tubing.** We cut tubing to order any length desired. Wall thickness 1/8". Polished Tan or Black Colors.



**Insuline Sure Grip Dial.** Beautiful design, 1/4-inch shaft, brass bushing and screws. 0° to 100° graduations 4 inch. In individual boxes. Black, 75 cents; mahogany, \$1.00.



**Insuline Aerial Insulators.** Heat resisting. Strain resistance 1,000 pounds. 10 cents.



**Insuline Low Loss Tube Sockets.** Skeleton barrel, direct connection, table mounting. 75 cts.

## INSULINE PANELS AND PARTS

Insuline fills the demand for a perfect insulating material specially made for radio purposes, beautiful in appearance, tough enough to stand the hardest usage, yet workable with ordinary tools. Being the largest panel house in the world equipped with cutting, engraving and drilling machinery, we are fully prepared to take care of your panel requirements for any circuit shown in this magazine or any other special circuit.

PRICES ON PANELS FOR 9 POPULAR CIRCUITS

	Fada 5 Tube 3 Tube Neutro- dyne, 7"x26" x3/16"	Fada 3 Tube Neutro- dyne, 7"x24" x3/16"	Ambas- sador 3 Tube, 7"x18" x3/16"	Journal 3 Tube Filter Tuner, 7"x21" x3/16"	Journal 1 Tube Filter Tuner, 7"x12" x3/16"	Fresh- man Master- piece, 5 Tube 7"x18" x3/16"	Rasla Reflex 3 Tube, 7"x18" x3/16"	Gennwin Low Loss 3 Tube, 7"x18" x3/16"	Trans- conti- nental Low Loss 3 Tube, 7"x18" x3/16"	Roberts Knock- out 4 Tube, 7"x21" x3/16"
Black.....	\$5.00	\$4.80	\$3.50	\$4.00	\$2.50	\$3.50	\$3.50	\$3.50	\$3.50	\$4.50
Mahogany.....	6.00	5.70	4.00	4.50	2.90	4.00	4.00	4.00	4.00	5.50
Frieze Finish	6.00	5.70	4.00	4.50	2.90	4.00	4.00	4.00	4.00	5.50

Send your specifications. Write for descriptive literature.

## RADIO PANEL & PARTS CORP.

(Insulating Co. of America)

Insuline Building—59 Warren St., New York, N. Y.

Western Division:

Insulating Co. of America, Madison, Wis.  
 538 So. Dearborn St., Chicago, Ill.

Michigan and Ohio Representative:

F. A. Krue, Jr.,  
 333 State St., Detroit, Mich.



### King Quality Radio Five Tube Neutrodyne Kit

Manufactured by  
**NEUTRODYNE**  
Patented in U.S.A. and other countries  
Other Patents Pending

THIS kit contains all the parts necessary for building a Five-Tube Neutrodyne Receiver of highest quality.

By means of telephone switchboard type of cable, all wiring goes into the set as a unit. Listening jacks are soldered in place. All bus wires are cut to length and bent to shape. Tube sockets are supported by metal brackets. The coils, of liberal proportions and wound with heavy wire, are attached to Cardwell Low Loss Condensers. Neutrodon is operated by a micrometer screw so receiver can be perfectly neutralized. The Bakelite Panel is properly drilled and engraved. Templates and full instructions for assembling furnished with kit.

- R-1400—Storage Battery Type
- R-1500—Dry Cell Type

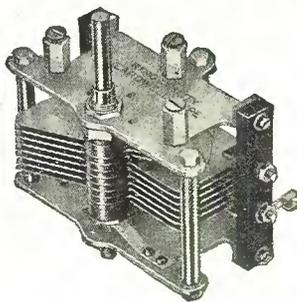

#### King Quality Cardwell Condensers

Type No.	Plates	Max. Cap. MF.	Min. Cap. MMF.
R-190	11	.00025	10.0
R-191	15	.00032	12.0
R-192	17	.00035	9.0
R-193	21	.0005	18.0
R-194	41	.001	20.0



#### King Quality All-Bakelite Dials

- R-300—4" dial
- R-301—3" dial
- R-303—2 3/4" Rheostat dial
- R-410—Rheostat knob

A one-piece, all-Bakelite dial with a specially designed knob which gives a perfect grip. Supplied in either black or mahogany Bakelite.

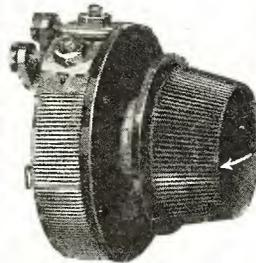

#### King Quality Rheostats with tapered fine knurl arrow knobs

- R-640, 6.5 ohms
- R-641, 6.5 ohms, Vernier
- R-642, 15 ohms
- R-643, 25 ohms
- R-644, 40 ohms

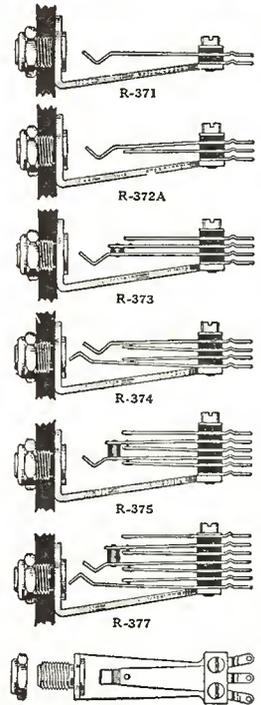

#### Diagrammatic Top View King Quality Jacks

A new and greatly improved type of jack. Terminals staggered to insure easy soldering, overall length much shorter than old style straight frame. Soldering flux cannot run into space insulators.

#### King Quality Vacuum Tube Sockets



- Standard Tube Sockets
- R-730, Black Bakelite.
- R-731, Mahogany Bakelite.
- UV-199 or C-299 Sockets
- R-732, Black or Mahogany Bakelite.

Write for copy of 1925 Radio Parts Catalog

**KING QUALITY PRODUCTS, INC.**  
Buffalo, N. Y.

Branches: Bridgeburg, Ont.

Chicago, Ill.

Kansas City, Mo.

# KING QUALITY RADIO

# RADIO WITHOUT THE HORN!

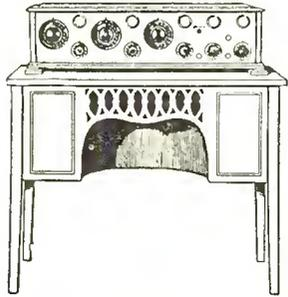

Goodbye to the Old-Fashioned Horn Speaker!

A Vastly Better Reproduction With This New Radio Console!



"Our old horn speaker never gave tones like this! An artistic addition to the living room—everything in its place—it's a joy!"

New Console Has Its Own Perfect Loudspeaker!

Ample Space for All the Rest of Your Outfit!

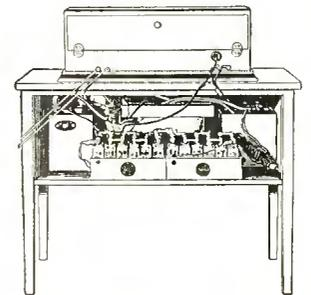

HERE is something that enables you to enjoy radio in the home without the clutter of unsightly apparatus that plays havoc in the decorative scheme of your living room! The horn speaker is out of date and out of place in radio for the home. This console, with its in-built loudspeaker, is scientific and sightly.

## A Truly Wonderful Tone

It does a good job of reproducing, for it has a good unit and its sound-box is of resonant wood instead of metal, fibre, or composition.

The appearance of a Windsor loudspeaker console is a delight. Its convenience is a joy. A piece of real living room furniture of pleasing lines and finish—and it accommodates all the miscellany of equipment which hitherto had no place except on table tops, shelves or floor. Ample space on top for any set, with plenty of elbow room in front. Nothing in sight but the console and receiving set. Everything else goes inside—from behind—in spaces cleverly designed to hold the largest batteries and outfit for home use—besides the self-contained loudspeaker—all unseen and protected from dust or disturbance.



Pat. Nov. 18, 1924

\$40

Loudspeaker Included  
West of the Rockies,  
\$42.50

*Windsor Loudspeaker Console*

## You Need This Console Whatever Your Present Outfit Is

It makes no difference what kind of radio outfit you have—this console was designed for your use. The graceful exterior of this console gives no hint of its inner utility, for it is a simple and effective piece of furniture in every line. But a glance at the interior reveals a most ingenious arrangement of the in-built loudspeaker with space either side and in back. These spaces are ample for the largest A battery, and the largest wet B batteries and the largest charging outfit for home use. It is 38 in. long, 18 in. deep, and 29 in. high. Notice the artistic grill that conceals sound-box, and the provision for the "knee-room" beneath. Made in mahogany or walnut finish, and the price is only \$40.00! (West of the Rockies, \$42.50.)

## INVESTIGATE!

Dealers everywhere are now showing the Windsor loudspeaker console, and have them for immediate delivery to your home. If you haven't already seen this remarkable contribution to radio enjoyment and convenience, write us now for the name of a nearby store where you may view it. We will also send you complete

information. Remember, this console gives you not alone a reproducing unit and a sound-box, but an altogether new beauty and utility in the provision for your entire radio outfit. Mail coupon or postal.

If you wish to use your own favorite unit, a deduction will be made for omission of unit.

### Dealers!

The sale of these consoles has already reached extraordinary figures. They are selling in surprising quantities in even smallest stores where there is one in the window or on the floor. It is a convenience and a value not to be duplicated.

Write us for discounts and particulars.

WINDSOR FURNITURE COMPANY

C.R.C.B.

1422 Carroll Ave., Chicago.

Please furnish pictures and full details, also name of nearest dealer who has the new Windsor loudspeaker console.

Name.....

Address.....

# Freed- Eisemann

## RADIO

### The Difference Is—*Finesse*

**T**HE easy way to build a radio receiver is to assemble it. The right way is to *create* it, unit for unit, testing each step.

That is why Freed-Eisemann Condensers are Freed-Eisemann-designed for Freed-Eisemann Receivers. That is why our specially wound radio frequency coils are individually matched with the condensers to achieve the greatest possible co-relation of dial readings.

Not an inch of bus wire, not a single screw is in its place without scientific consideration of its capacity and inductive effect in relation to the super-sensitive Freed-Eisemann Neutrodyne circuit.

Thus, it is in *finesse* that the Freed-Eisemann is great . . . in the trifles that make Perfection—which is no trifle.

The man who has progressively owned all types of radio receivers comes to the Freed-Eisemann at last with a new enthusiasm for radio . . . a new appreciation of what listening-in can mean. A demonstration is a revelation.

*Four-tube and five-tube models. Price, \$100 up . . . slightly higher in Canada and west of the Rockies. Booklet, "Buying a Radio" free on request.*

FREED-EISEMANN RADIO CORPORATION  
MANHATTAN BRIDGE PLAZA, BROOKLYN, N. Y.





*Distance Lends Enchantment*

**W**ITH THE FREED-EISEMANN RADIO RECEIVER—each day is a new anticipation—each night—a new surprise!

In the American home it is constantly cheering the silence, refreshing the hopes, and lifting the spirits of millions.

Ask any radio dealer to demonstrate the FREED-EISEMANN—the finest Receiver in the world... Learn with what perfect realism, clarity and ease it performs... Each set is individually built by



men who are masters of their craft, and each is subjected to seventeen tests before leaving the great plant. When you buy yours, you take with it our guarantee of complete dependability and lasting satisfaction.

\* \* \*

We have prepared a booklet to help you. It is called "Buying a Radio"... It is interesting, enlightening and non-technical. Free—address Dept. A

FREED-EISEMANN RADIO CORPORATION  
MANHATTAN BRIDGE PLAZA, BROOKLYN, N. Y.

Reliable dealers sell the genuine Freed-Eisemann Receivers at listed prices. Beware of imitations offered at cut rates.

# FREED-EISEMANN

## RADIO RECEIVERS





LITERALLY thousands of people have come to know the joys of perfect radio reception through the Ferbend Wave Trap. Testimonials from all parts of the world continue to pour in, unsolicited, from those who have equipped their set with this marvelous instrument.

You, too, will find it the shortest, easiest, and—best of all—the least expensive route to clear, undistorted reception—without interference. Never reduces, but nearly always increases volume. You can make your set selective to the point of perfection by simply adding a Ferbend Wave Trap. It will absolutely cut out any interfering station, no matter how loud, how close by or how troublesome. So why pay \$50.00 to \$200.00 extra for increased selectivity when you can buy it for \$8.50?

**Guaranteed** to tune out any interfering station. The Ferbend Wave Trap is designed and manufactured complete by us after years of careful experimenting. It is not to be confused with imitations, hastily assembled from ordinary parts. The price is \$8.50. Shipment is made Parcel Post C. O. D., plus a few cents postage. If you prefer, you can send cash in full with order, and we will ship postage prepaid. Clip and mail the COUPON today!

**FERBEND ELECTRIC CO.**

26 E. South Water Street

CHICAGO, ILL.



**FERBEND**  
*Wave Trap*  
REG. U.S. PAT. OFF.

Always look for this Trade Mark. It is your protection against misleading imitations and those who infringe on the registered name "Wave Trap" and its reputation. "If it isn't a FERBEND, it isn't a WAVE TRAP."

*Read the evidence*

Dunbar, West Va.  
Ferbend Electric Co.

Gentlemen: I bought your Wave Trap to see if I could not cut out the awful noise of telegraph stations which ruined most of our programs. Since we installed it in our five-tube Fada Neutrodyne set we have not heard any more telegraphers—we let 'em in sometimes to show our friends how easy it is to kick 'em out with the Wave Trap. I would not have a set without a Ferbend Wave Trap.

(Signed) H. E. Atherton.

Farragut, Iowa.  
Ferbend Electric Co.

Dear Sirs: I set my radio where Havana, Cuba, should come in but received only a jumble of K. F. N. F., W. O. R. and W. L. A. G. I then tuned in with the Trap and had Havana for two hours. I have several times taken a jumble like this and separated five and six stations. I find it a great help in cleaning up stations that can not be brought in distinct. I am using a Crosley X.J.

(Signed) W. T. Cox.

Towson, Md.  
Ferbend Electric Co.

Gentlemen: Well to say I am pleased with the Trap is putting it mildly. It is simply a wonderful instrument. I have had more or less trouble in getting K.D.K.A., W.B.Z., W.D.R. and W.L.W. with my Freed-Eisemann Set as they are only a few degrees apart on my dials. Your Trap lets me through with the clearest possible reception. In my candid opinion there is no Radio Receiving Set complete without the addition of the Ferbend Wave Trap.

(Signed) E. W. Stevenson.

FERBEND ELECTRIC CO.  
26 E. South Water St., Chicago, Ill.

Gentlemen: Please send me:

- WAVE TRAP. Send postpaid. I am enclosing (check, M. O., etc.) for \$8.50.
- WAVE TRAP. Send C. O. D. I will pay Postman \$8.50, plus few cents postage when it arrives.
- FREE BOOKLET on Interference.

Name .....

Address .....

City.....State.....

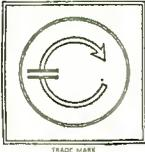

# CARDWELL CONDENSERS

## VARIABLE AIR TYPE

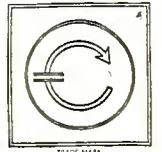

Bulletin No. 43

Published by The Allen D. Cardwell Mfg. Corporation  
Brooklyn, N. Y.

March, 1925

THE Allen D. Cardwell Manufacturing Corporation was the first to adopt the now standard method of condenser construction:—the use of metal end-plates and grounded rotors, and the supporting of the stator by means of small insulation strips instead of bushings. The Cardwell company produced the first "low loss" condenser over a year-and-a-half before the efficiencies which the Cardwell design afforded were sufficiently understood by others to suggest their following the same general design.

By this original construction, which was characterized by engineers as "low loss" to distinguish the Cardwell from ordinary varieties, the Cardwell Company was able to offer the public a laboratory type condenser at a low price.

The general ideals of good condenser design are now fairly well understood by the advanced radio experimenters, but a brief review may not be amiss in pointing out the more refined details of construction.

A condenser is a piece of machinery. It must be able to withstand rough usage, retain its rating under varied temperature conditions, give a permanent alignment of plates, have a proper bearing which will afford smooth, firm action, etc. Any condenser which can be set out of shape by pressure of panel screws so that the plates touch or which will become loosened or jammed by casual blows will never prove satisfactory.

In examining a condenser, therefore, see that it cannot be pressed at the opposite corners so that the shaft or plates will yield perceptibly. It should be possible to press the shaft in or pull outward on it without the condenser changing its calibration or "log."

The Cardwell condenser is so strong mechanically that it will not suffer from rough usage. The bearings are accurately set and adjusted so that they will remain serviceable after years of constant use. The frame is so built that it takes a severe blow to make the slightest change in the alignment of the plates. The spacing of the plates is so arranged that they cannot become wide or narrow on one side due to the heat of the vacuum tubes inside the cabinet.

From an electrical point of view the Cardwell condenser has many unusual points which have revolutionized the standards of good condenser design.

The low losses in the Cardwell are due to the arrangement of the insulation material as a support for the stator. The plates of the stator, it will be noted, are

swedged into brass blocks used as a spacing device and support. These brass blocks are held by screws which run through the rubber strips and are attached to the upper and lower end plates.

By this arrangement the electrostatic field is reduced to a minimum between the end plates (which are part of the rotor) and the screws which hold the stator. The distance from the end plate screw to the stator screw is ample to maintain a high resistance to any stray current in the regions across these points. The area of

of the end plates so that there is a relatively weak field between the end plates and the stator plates at the points where the rubber is supported and an even weaker field where the stator strip is held directly to the hard rubber. Thus the insulation is held almost entirely outside of the electro-static field where induced capacity effects will not cause losses in the rubber.

The arrangement of the insulation in the weakest part of the electro-static field and the restriction of the surface area used in

features of the Cardwell condenser which are not appreciated by many builders but which have no small importance in the satisfactory operation of a receiver.

The end bearing consists of a steel ball bearing which is set in a cup at the end of the rotor shaft and also set in a cup on the end adjusting-screw, which fixes the center of the shaft in perfect alignment and affords a smooth turning action. The shaft is of case-hardened steel and the end adjustment-screw is also of case-hardened steel. The bearing is practically immune from wear, as the case-hardened ball bearing revolves in a thin film of oil and is constantly keeping a constant distance and a fixed center.

The shaft is tightened at the other end by a broad hexagonal brass nut locked to the end plate. A steel washer rests against the hexagonal nut and thus two dissimilar metals afford a fine bearing which is not subject to wear or play.

The end plate lock nut has a projecting split collar which gives firm, even pressure against the shaft, thereby insuring a good contact from rotor to shaft, but also avoiding any tendency of the rotor to turn due to its weight.

The condenser employs a special type of friction contact at the end bearing which fits snug against the under end of the lock washer and presents a broad surface for positive contact. This special friction contact is not entirely needed but doubly assures absolutely noiseless operation and is only added as a special precaution. It also avoids the necessity of using end stops where a "pig-tail" is used.

The stator plates are swedged into grooves by a permanent jaming process which insures unvarying pressure and avoids any risk of conductivity losses. The brass grooves are of sufficient depth to afford a rigid alignment to the stator plates.

The rotor plates are spaced by machined brass washers which are very accurately finished. The surfaces are broad and afford ample area to maintain the rotor plates flat and in perfect parallel with the stator plates. The pressure on the rotor plates and washers is very great, one end being locked against the steel collar washer which rides on the shaft and the other end being washer locked by a thread on the shaft and a hexagon lock washer which is tightened by a heavy wrench. As the diameter across the washers is a half inch it is practically impossible to get any of the rotor plates to turn on the shaft,

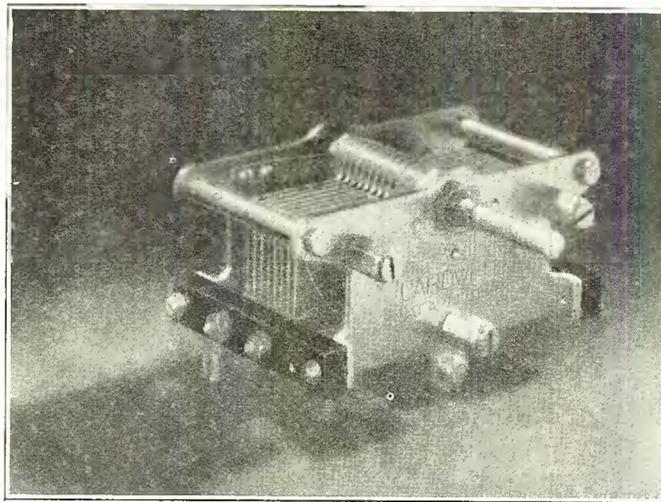

SOME STANDARD SIZES AND TYPES

Type Number	List Price	Number Plates	Minimum Capacity Micro-Micro-Parads	Maximum Capacity	Price with Vernier	Vernier* Type No.
159-B	\$ 4.00	5	2	50	\$ 5.50	159-BV
154-B	4.00	7	3	100	5.50	154-BV
141-B	4.25	11	12	250	5.75	141-BV
153-B	4.50	15	18	300	6.00	153-BV
152-B	4.75	17	20	350	6.25	152-BV
123-B	5.00	21	22	500	6.50	123-BV
137-B	6.00	41	25	1000	7.50	137-BV
155-B†	4.00	7	3	43		
147-B‡	15.00	43	27	450	16.50	147-BV‡
157-B‡	16.50	21	15	200	18.00	157-BV‡
164-B‡	10.00	21	18	250	11.50	164-BV‡
200-B°	7.25	11	7	250	8.75	200-BV°
201-B°	7.50	15	8	300	9.00	201-BV°
202-B°	8.00	17	9	350	9.50	202-BV°
203-B°	8.50	21	15	500	10.00	203-BV°

\*With either right or left hand verniers. †Double stator for balancing circuits. ‡Transmitting condensers. °Double stator, "over-all" end plates, with separate insulator strips, for balancing circuits.

contact at each supporting point is also small. Contrary to the general idea, the screw posts from the stator do not fit against the hard rubber except where the ends are locked. At each end there is a small circular seat. The area of this on one side and the washer on the other end, when added together, give only .05 square inches of surface contact with the rubber. This means that very little of the insulation is in the condenser circuit and the hysteresis losses are accordingly low.

It will be noted also that the rubber is placed out at the edge

contact between the insulation and the stator screws are the most important elements of the Cardwell design. The blocks supporting the stator, being continuous and extending beyond the points of support, shield the insulation from all stray field. In this respect no type of construction has been found since which can secure lower losses or better engineering than in the Cardwell.

Thus far we have dealt only with the broader considerations of good condenser design. In the succeeding paragraphs, we would point out a number of specific



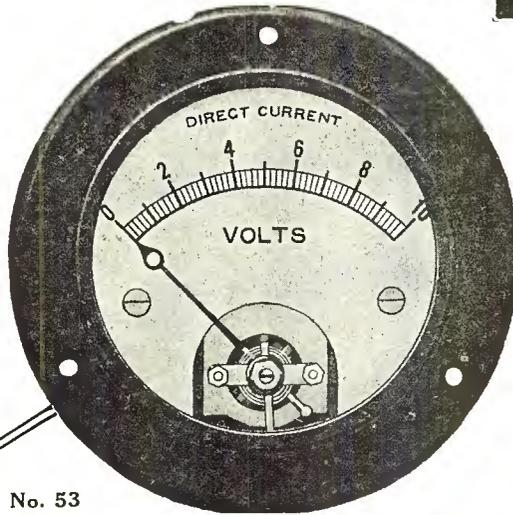

No. 53

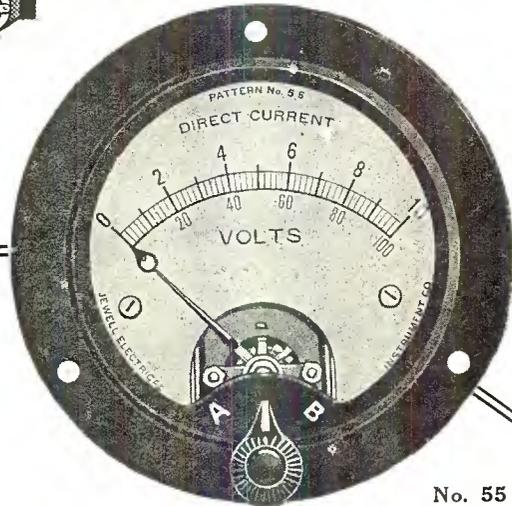

No. 55

# CONTROL FILAMENT *and* BATTERIES

During the past five years we have designed more new types of instruments for radio work than all other manufacturers combined. Not only have we studied the instrument needs of radio men, but we have built accuracy and quality into every instrument that leaves our plant. (Every radio enthusiast should have a copy of our 15-A radio catalog.)

Don't paralyze your tubes—Control their filaments by using a Jewell No. 53 voltmeter. This is very important with owners of Neutrodyne, Superheterodyne and multiple tube sets.

Your batteries—they must be watched if you would have good reception. Use a Jewell No. 55 on panel of your set, and you will always know the condition of your batteries.

Send for Jewell  
15A Radio Catalog

ORDER FROM YOUR DEALER OR JOBBER

**JEWELL ELECTRICAL INSTRUMENT CO.**  
1650 Walnut Street Chicago

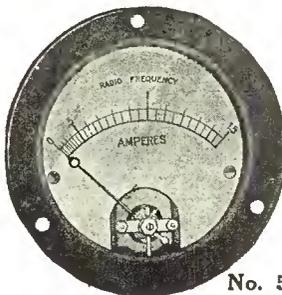

No. 54

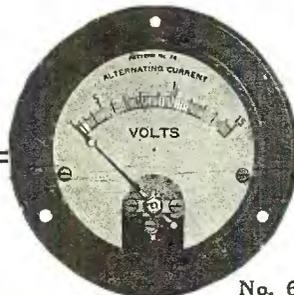

No. 64

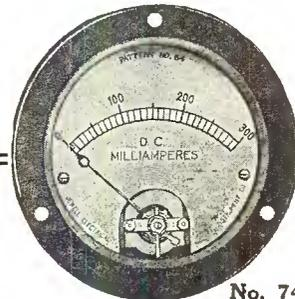

No. 74

## THE JEWELL TRIO

*"Famous Among Amateurs"*

*Tell 'Em You Saw It in the Citizens Radio Call Book*



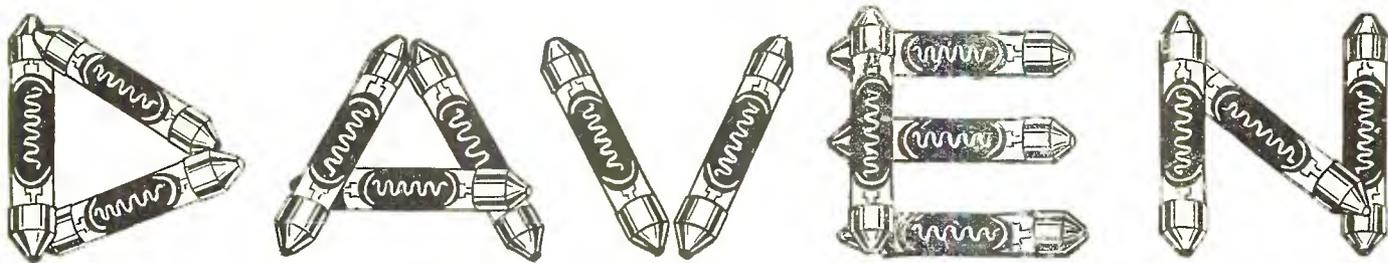

**D**AVEN is the real word for dependability when connected with Resistance Coupled Amplification. Daven engineers designed and built the first Resistance Coupled Amplifier offered the Broadcast fan—they were the pioneers and their devices have blazed the way for others to follow.



The Daven Resistance Coupled Amplifier Kits are highly perfected—their assembly is very simple—their output perfect. By adding this amplifier to your favorite tuner, you will have a worthy combination, hard to beat, and amplification that is perfect.

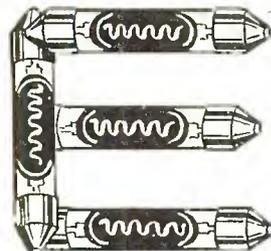

The Daven Super Amplifier Unit is laboratory tested and comes ready to install. The base is of molded Bakelite and small enough to fit within any cabinet. All wiring is hidden beneath the base.



The Daven Kits are supplied for either three or four stages—sockets and mica fixed condensers are not included, but instructions are furnished giving complete information and diagrams.



You can buy the Daven Products at any good Radio Store.

TRADE MARK  
**DAVEN RADIO**  
*"The Sine of Merit"*  
**CORPORATION**  
*Resistor Specialists*

Newark,

New Jersey

Obtain from your dealer the **RESISTOR MANUAL**, our complete handbook on Resistance Coupled Amplification, 25c. If your dealer cannot supply you, we will send you one direct, postpaid, for 35c.

Tell 'Em You Saw It in the Citizens Radio Call Book



# Guaranteed Service



Type E Headset, \$3.00



Type G Headset, \$5.00

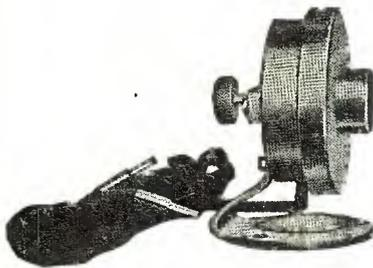

Loud Speaker Unit, \$5.00



Crystal Set, Complete with Phones, \$7.50

Every DYMAC radio accessory and radio part has behind it our guarantee that it must **prove its value to you.**

Long years of successful experience in the manufacture of intricate electrical and radio devices just naturally permits us to say "We guarantee DYMAC products," to your advantage and without trouble or loss to ourselves.

But ask your radio dealer to show you DYMAC radio equipment and judge for yourself. If your dealer can't supply you, send your order direct to us.

## ELECTRICAL PRODUCTS MFG. CO.

Manufacturers of DYMAC Guaranteed Radio Equipment  
69 Sprague St., Providence, R. I.

This is it—  
the  
**DYMAC**  
Loud  
Speaker

The 1925 radio sensation.

Wide range of volume with crystal-clarity and perfect modulation. Note convenient outside thumbscrew control on base.

Compare it with Speakers that sell for several times the DYMAC price—

**\$10**



High lustre black deckled enameled horn

**\$10.**

External thumbscrew control



Type G Audio Frequency Transformer, \$4.00



Type H Audio Frequency Transformer, \$4.00



Standard Rheostat and Potentiometer, \$1.00 and \$1.25



Soldering Iron Kit, \$2.50

# Dymac

Guaranteed  
Radio Equipment



DR. WM. D. REYNOLDS  
President

— KLZ —

# The Reynolds Radio Co., Inc.

ESTABLISHED 1914

The

# Radio Pioneers of Colorado

We are the largest wholesalers in radio sets and equipment, exclusively, covering Colorado, Wyoming, Montana, Utah, So. Dakota, Nebraska, Kansas, New Mexico, Texas, etc.

We are exclusive jobbers in this territory for the new Freed-Eisemann Neutrodyne and Kennedy receiving sets.

## Wholesalers and Retailers

*for these quality lines*

- |                |                    |            |               |                  |
|----------------|--------------------|------------|---------------|------------------|
| Kennedy        | Kilbourne & Clark  | Cardwell   | Burgess       | Westinghouse     |
| Freed-Eisemann | Signal             | Fleron     | Cunningham    | Weston           |
| Crosley        | Conrad             | Kellogg    | Bodine        | Shamrock         |
| Chas. Freshman | Trimm              | Rhamstine  | Howe          | Testrite         |
| Acme           | Precise            | Erla       | Federal       | Western-Electric |
| Kurz-Kasch     | Daven              | Rauland    | Howard        | Caswell-Runyan   |
| Amperite       | Kodel              | Thordarson | Frost         | Hoyt             |
| Benjamin       | Shermatram         | Branston   | Bradley       | Nazeley          |
| Little Tattler | Bremer-Tully       | Walnat     | Belden        | Receptrad        |
| Uncle Sam      | Nathaniel Baldwin  | Electrahot | Jewell        | Dymac            |
| Electrad       | General Instrument | Brach      | Willard       | Balkite          |
| Dubilier       | Remler             | Na-Ald     | Cutler-Hammer | Precision        |
|                |                    |            |               | E-Z-Toon         |

*Write for Catalogue*

**WE PROTECT OUR DEALERS**

No wholesale or courtesy discounts given to other than authorized radio dealers.

**PATRONIZE THE JOBBER WHO PROTECTS YOU**

## The REYNOLDS RADIO COMPANY, Inc.

Wholesale :: 1534 Glenarm Street :: Retail

DENVER —KLZ— COLORADO

*"When You Think Radio—Think Reynolds Radio"*

**INCREASES  
DISTANCE**



**STOPS  
HOWLING**

## Multi-Contact!

The **Crystalstat** solves one of the hardest problems in Radio in the production of a **Satisfactory Crystal for Reflex Sets**. Many makers of radio sets have told us that they would have discontinued making reflex sets had we not brought out the **Crystalstat**, as they had failed to find another crystal detector that enabled them to guarantee their sets.

## For Reflex Sets

Many inquiries come to us asking if the **Crystalstat** can be used on Shamrock, Harkness, Acme and DeForest reflex sets, including the DeForest D-10 and D-12 sets, to which we have replied that many hundreds of **Crystalstats** are giving new life to each of these makes of reflex sets and many others.

We do not claim that the **Crystalstat** is a cure-all for all the ills of radio sets, but will work wonders on any well balanced circuit that is in other words fundamentally correct; so before you set any reflex set aside try a **Crystalstat** in place of the present detector or crystal, and save many times its cost.

The method of mounting is simply to make a 5/16" hole in the panel and clamp the **Crystalstat** to the panel by means of the two nuts next to the knob.

## For DX Crystal Set Reception

Almost any good crystal set equipped with a **Crystalstat**, by the addition of a low loss 43 plate condenser in the antenna circuit, will get many distance stations if a 100-foot antenna and a good ground connection are provided. We have many records of 500 miles or more, and on October 1st we will give a \$100.00 Reflex Set to the **Crystalstat** user who sends a sworn and verified report showing the greatest distance with a tubeless crystal set.

All conditions of contest sent with **Crystalstat**.

**Price \$2.50**

*Order from any dealer, jobber  
or from the manufacturer*

**STAR—"B"-METAL CRYSTAL COMPANY**  
5th Floor—523 Woodward Ave.  
Detroit, Mich.

# LATEST AND MOST POPULAR Radio Books

EVERY RADIO FAN SHOULD HAVE A COPY OF THESE BOOKS

## Henley's Workable Radio Receivers



An authoritative book on practical receiving sets of modern design with complete and explicit directions for building them. It gives in greatest detail circuit and wiring diagrams, panel and baseboard layouts and drilling templates, so that any amateur may build a successful receiver from the directions given. In order to help the Workable Radio Set builder, who may not be familiar with the conventional symbols used in looking up a set, most of the receiving sets are illustrated by complete full page diagrammatic drawings, showing just where to attach the wires, location of condensers, rheostats, transformers, vacuum tubes, plugs, jacks, etc. 256 pages, 105 diagrams and illustrations. Specially made for this book.

PRICE \$1.00

## Construction of a MODERN SUPER-HETERODYNE TYPE RECEIVER

Including Testing and Operation

THE Super-Heterodyne Type Receiver is the most sensitive receiver it is possible to build. This booklet together with the working drawings give the most detailed information on the complete construction of a modern type of Super-Heterodyne which is extremely sensitive, selective and non-radiating and at the same time insures excellent quality of reproduction when used with a high quality loud speaker. Very complete information on the testing of all parts of the circuit as well as the complete receiver are given. The directions for operating the set are also very complete. Directions are included for slightly altering the wiring of the receiver to accommodate dry cell tubes, instead of the standard types which require storage batteries. The design may be altered for the use of a loop instead of an open antenna in accordance with the instructions given. This receiving set has actually been built and operated by a novice from directions given.

PRICE \$1.00

## Henley's 222 Radio Circuit Designs



An entirely new and thoroughly practical book on radio circuit designs which will meet the needs of every radio enthusiast, whether novice or expert, amateur or professional. It is replete with correct and trustworthy radio information from which any one can successfully build and operate any of the circuits given. Contains the largest collection of radio circuits and hook-ups ever published, including all the latest and standard circuits, such as ARMSTRONG, DE FOREST, REINARTZ, COCKADAY, HAZELTINE, COLPITTS, GRIMES, FLEWELLING, NEUTRODYNE, REFLEX, HEISING, PUSH-PULL, SUPER-HETERODYNE.

PRICE \$1.00

## THE A B C OF RADIO VACUUM TUBES USED IN RADIO RECEPTION

By E. H. Lewis

Assoc. I. R. E., and Radio Instructor

Written particularly for the person who "knows nothing about radio," but who would like to gain an understanding of the elementary principles of operation of vacuum tubes and various circuits in which they are used for the reception of radio telegraph signals and radio-telephone music and speech. Illustrated.

PRICE \$1.00

## EXPERIMENTAL WIRELESS STATIONS

By P. E. Edelman

Tells how to make apparatus to not only hear all telephoned and telegraphed radio messages, but also how to make simple equipment that works for transmission over reasonable long distances. Then there is a host of new information included. The first and only book to give you all the recent important radio improvements, some of which have never before been published. 392 pages, 167 illustrations.

PRICE \$3.00

## OTHER GOOD ELECTRICAL BOOKS

### STANDARD ELECTRICAL DICTIONARY

By Prof. T. O'Connor Sloane. Just issued an entirely new edition brought up-to-date and greatly enlarged—as a reference book this work is beyond comparison, as it contains over 700 pages, nearly 500 illustrations, and definitions of about 6,000 distinct words, terms and phrases. The definitions are terse and concise and include every term used in electrical science. New enlarged edition. Including a dictionary of radio terms. 767 pages. 477 illustrations.

PRICE \$5.00

### ELECTRICIANS' HANDY BOOK

By Prof. T. O'Connor Sloane. This work has just been revised and much enlarged. It is intended for the practical electrician who has to make things go. The entire field of electricity is covered within its pages. It is a work of the most modern practice, written in a clear, comprehensive manner, and covers the subject thoroughly, beginning at the A B C of the subject, and gradually takes you to the more advanced branches of the science. It teaches you just what you should know about electricity. A practical work for the practical man. Contains forty-eight chapters. 600 engravings, 824 pages, handsomely bound. New Revised Edition.

PRICE \$4.00

## Henley's Twentieth Century Book of Recipes, Formulas and Processes

Edited by Gardiner D. Hiscox. This book of 800 pages is the most complete book of recipes ever published, giving thousands of recipes for the manufacture of valuable articles for everyday use. Hints, helps, practical ideas and secret processes are revealed within its pages. It covers every branch of the useful arts and tells thousands of ways of making money and is just the book everyone should have at his command. A book to which you may turn with confidence that you will find what you are looking for. A mine of information up-to-date in every respect. Contains an immense number of formulas that everyone ought to have that are not found in any other work. New edition. 807 octavo pages. Cloth binding.

PRICE \$4.00

**Radio Publishing Co.**  
508 So. Dearborn St.,  
Chicago, Illinois

Enclosed herewith is \$..... for which please send me copies of the books checked.

- Henley's Workable Receivers
- Construction of a Modern Super-Heterodyne Receiver
- Henley's 222 Radio Circuit Designs
- The ABC of Vacuum Tubes Used in Radio Reception
- Experimental Wireless Stations
- Standard Electrical Dictionary
- Electricians Handy Book
- Henley's Twentieth Century Book of Recipes, Formulas and Processes

POST-PAID ONLY

NO C. O. D.



**THE BARRETT & PADEN**  
MICROMETER TYPE  
Variable Condenser

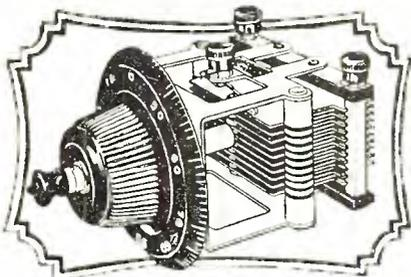

**Works Like a Mechanic's Micrometer**

In the shop, if it is necessary to make readable measurements as small or smaller than 1/1000 of an inch, a Micrometer is used.

By applying the micrometer principle to a variable condenser, we have enabled you to make 1000 readable capacity variations.

You will be agreeably surprised at the great difference a B & P Micrometer type Variable Condenser makes in tuning distant stations. Get one or a set of three at your dealer. Capacities accurate.

**LOW** Losses  
Minimum  
Capacity

.0005  
.00035  
.00025 **\$6.00**

**BARRETT & PADEN**

1314 Sedgwick St.

Chicago, Ill.

**Madera Clearspeakers**

"Wood Horns Are Good Horns"

**There Is a Real Reason for Their Superior Tone**

The better quality of music reproduction from the Madera Clear-speaker is not a myth. It is an established fact. You will recognize it the minute you hear one of these reproducers and compare its voice with that of others.

**HERE IS THE REASON**

Naturalness in voice or music reproduction requires that the instrument reproduce every tone variation audible to the human ear. They cannot do that unless the horn is made of such material as will detect and amplify all these tone variations. Wood alone will do this, and the denser the wood, the more variations it is sensitive to. Madera Clearspeakers are made of Compressed wood, which is many times denser than natural wood. Hence there are no holes in the music as it is delivered to you by a Madera speaker. The tone is full and complete. All the notes are there. Madera Clearspeakers are reasonably priced. There is no need to pay more. Go to your dealer and ask for a demonstration. A few words from a Madera will convince you.



No. 807  
Complete with  
powerful super-  
sensitive Unit.  
Crystal Black.  
**\$20.00**

Natural  
Wood finish.  
Mahogany  
or Walnut.  
**\$25.00**



No. 806  
Complete  
with  
powerful  
super-  
sensitive  
Unit.  
Crystal  
Black.  
**\$17.50**

Natural Wood finish.  
Mahogany or Walnut.  
**\$22.50**



No. 804. Complete  
with powerful super-  
sensitive Unit. Cryst-  
tal Black. **\$15.00**

**Compressed Wood Corporation**

Formerly American Art Mache Co.  
349 W. Austin Ave.,

Chicago

**THEY SELL THE  
YEAR AROUND**

Because They're Nationally Known  
"CROSLEY" "FRESHMAN"  
"AC-DAYTON"  
"BURGESS" "BALDWIN"  
"FROST"  
"MARWOL" "BREMER-TULLY"  
"CARTER" "TRIMM" "PREMIER"  
AND FIFTY OTHER LINES  
OF  
NATIONALLY ADVERTISED RADIO

**DEALERS:** Let us serve you with immediate shipments from our large Radio Stocks and 100% co-operation. WRITE FOR BULLETIN RD-5 and our CATALOG RD-4 "THE RADIO RED BOOK." Use your letter-head in writing for catalog.

Authorized Wholesale Radio Distributors

**WILLIAMS HARDWARE COMPANY**

Since 1884

RADIO DIVISION

100-140  
Vermillion Street

Streator, Illinois

(Owning and Operating "WTAX")

**Radio Broadcast Listeners  
GET THIS!**

Don't Let Wave-Length Changes Worry You!!

**"Find-Me-Quick" Radio Chart**

FOR ANY KIND OF RECEIVING SET  
ALWAYS UP-TO-DATE

Complete, self-indexed information  
CONSTANTLY IN FULL VIEW OF OPERATOR

When equipped with this practical time-saving Chart for rapidly logging Broadcasting Stations, your Radio at once brings Joy and Education to the whole family.

**Price 50c, Postpaid, Invaluable When Completed**

Size of chart, 23x11 inches; capacity for logging, 100 stations. Printed on heavy white ledger linen paper.

Elimination Wave-Length Tabulator, with over 600 Broadcasting Stations classified, GIVEN WITH EACH CHART.

One dollar bill brings you 2 charts and you can make a most appreciated gift to your best radio friend.

**Editor Radio News** Writes: ".....should prove of value to fans who wish to keep an accurate record....."

Published by

**Radio Chart Bureau, Fresno, Calif.**

2nd Floor, Patterson Bldg.

Member: Chamber of Commerce, Merchants Association,  
Better Business Bureau.

Liberal Discount to Dealers (1 doz. c. o. d.).  
Copyrights 1925. Patents Pending. Wholesale to Jobbers.

Radio Chart Bureau, Patterson Bldg., Fresno, Calif.

Send at once....."Find-Me-Quick" Radio Charts with  
Tabulators given with Chart for which I inclose \$.....  
in money order, coin or bill. (C.C.B.)

Name.....

Address.....

City.....State.....



## THE RAYDELUXE RECEIVER

*Brings Pleasure To The Home*

In placing this five-tube Receiver on the market, we have acted on the conviction that the Radio Fan wants results and have produced a set that stands pre-eminent—in a class by itself—for *selectivity, volume, distance, workmanship and general appearance.*

Five European stations were heard with the RAYDELUXE RECEIVER during International Week.

THE RAYDELUXE RECEIVER is furnished in a cabinet of two tone walnut and is an ornament in any home. The set can also be furnished in console type with folding door similar to a desk with space for batteries below.

THE RAYDELUXE RECEIVER, in standard Two-Tone Walnut Cabinet, without tubes.....\$130.00

THE RAYDELUXE RECEIVER, in Console Cabinet or Two-Tone Walnut or Mahogany, without tubes.....\$180.00

Write today for descriptive folder.

R. C. SCHOONHOVEN, Major Q. M. R. C., 312 Seneca St., ELGIN, ILL.

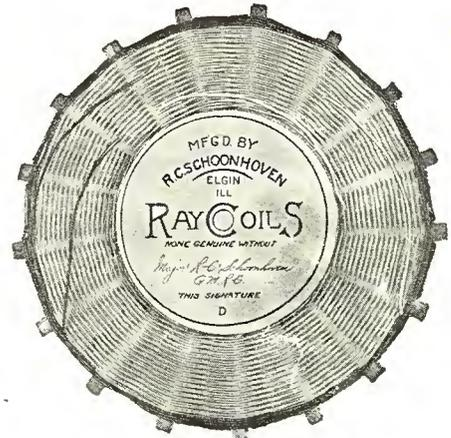

Low loss RAYCOILS have been designed to give results to the Radio Fan. They are made from the best grade of materials and constructed with unflinching precision. They assure perfect reception.

Price, each.....\$2.00

**!**  
**Live**  
**Radio**  
**Dealers**  
**Wanted!**

Our rapid growth has necessitated our recent removal to larger quarters. We grow because we give the kind of service the dealer wants. Let us serve you and help you to  
*"Grow With Us"*

## TRILLING & MONTAGUE



*Wholesale Only*

We Carry in Stock the Products of All  
**Leading Manufacturers and**  
**Guarantee Prompt**  
**Deliveries**

## TRILLING & MONTAGUE

*Wholesale Radio Merchandisers*

49 North Seventh Street

Philadelphia, Pa.



## High Grade Radio Sets and Devices

Our Radio policy is the same one we have used for nine years in the Victrola business. Our aim is "An Investment In Satisfaction" to you.

R. C. A. Westinghouse sets. Complete line of Atwater-Kent and Erla Parts.

Only merchandise of the highest grade carried. Guaranteed to provide the best entertainment free from any disappointment.

## MACAULEY & NEVERS

155 West Madison Street  
CHICAGO, ILL.  
Opposite Hotel La Salle

Retail Only

**HEADQUARTERS**  
*For*  
**RADIO**  
*and*  
**EQUIPMENT**

## The Andrews Paddlewheel-Coil



Patents Pending

A new low-loss coil of ideal characteristics for use with many different types of circuits. Embodying, as it does, an exceptionally high ratio of inductance to resistance it constitutes a marked advance in radio design. It can be used wherever a high-grade R. F. transformer-inductance is required.

The small amount and placing of the insulating material reduces absorption losses to a minimum. The compact, spiral winding makes possible the use of larger wire, thus lowering resistance, without increasing distributed capacity. No adhesives are used on the windings, insuring a coil with negligible internal losses and one which is highly resistant to moisture and atmospheric changes. Your results will be greatly improved by this superior inductance. Its exclusive construction assures *maximum amplification, minimum distortion* and much *greater selectivity*. Price \$3.00.

This coil, which is the type employed in the ANDREWS DERESNA-DYNE RECEIVER, is manufactured under license from the Andrews Radio Company.

Write for full information regarding this wonderful new coil, its characteristics and uses.

## Tiny-Turn Vernier Control

Makes perfect tuning easy. Has a gear ratio of 30 to 1. Friction drive eliminates lost motion. Rotates in same direction as dials. Can be disengaged, leaving dials free for coarse adjustment.

TINY-TURN will enable you to get more out of your set through perfect tuning. It will help you bring in the distant stations. Handsome nickel and ebony black finish. Easy to install on any set.

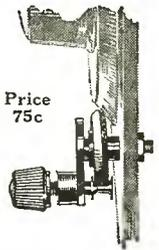

Price 75c

Price \$8.50

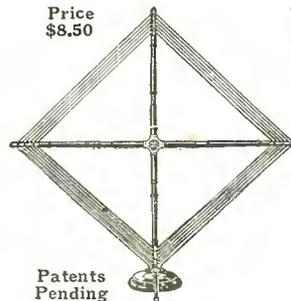

Patents Pending

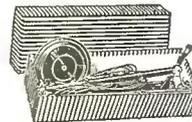

## Duo-Spiral Folding Loop

Enables you to enjoy the pleasures of radio during the summer months, for it reduces interference from static to a minimum. Its directional properties will make your set much more selective. *There is a model for every circuit.*

Handsomely finished in silver and mahogany to harmonize with the finest home furnishings. Provided with handle and silvered dial graduated for calibration. The folding feature makes it easily portable.

Write direct, if your dealer is unable to supply these standard products.

**Radio Units Inc.**  
*Maywood, Illinois*

1302 First Avenue, Maywood, Illinois

## Keep your Radio set Clean !

You must have a NODUST to keep your set working its best! Each stroke of a NODUST forces a blast of compressed air into all the hard-to-get-at places and cleans out every speck of dust and dirt in a jiffy.

If your dealer has not received his NODUST yet, we will send you one on receipt of one dollar. Satisfaction guaranteed.



**PEIFFER & CO.**  
88 Liberty St.  
Newark, N. J.

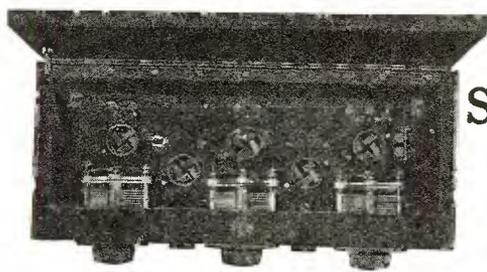

## Simplex SR 5 \$57

If they're on the air Simplex will get them. Five tube, tuned radio frequency—non-oscillating. Every piece of apparatus of guaranteed Simplex Standard. Low loss. Genuine mahogany, hand-rubbed cabinet.

Write for details  
**SIMPLEX RADIO CO., Manufacturers**  
1015 Ridge Avenue Philadelphia



## MAIN Rechargeable Storage B Batteries

are renewed overnight at a cost of about a nickel (5c) instead of all new dry batteries. They save their cost in a short time. The charge indicators tell you at a glance whether charged or discharged, without the use of a hydrometer.

They give full voltage, without hum or buzz, and for clear reception are essential. Shipped dry, so their life starts only when electrolyte is added. Write for circular.

DEALERS: Our proposition is free of prohibitive measures; it's easy to buy from us. Wire or write.

**MAIN RADIO BATTERIES, Inc.**  
7016 Euclid Avenue Cleveland, Ohio

# BEARDSLEY'S

219 18th Street Rock Island, Ill.  
"EVERYTHING IN RADIO"

DISTRIBUTORS OF

Akradyne	Dubiller	Fred-Elsemann	Jiffy	Radiall
All American	Dictograph	Franco	Kellogg	Remier
Ayanbee	Dymac	Flewelling	Keystone	Ray-O-Vac
Bremer Tully	Erla	Grewol	Kennedy	Reinartz
Baldwin	Electrad	Holtzer-Cabot	Mohawk	Starr
Belden	Eby	Hipwell	Million Points	Signal
Balkite	Ekko	Hamco	Michigan	Stevens
Bell	Electrahat	Hoyt	Mueller	Trimm
Carter	Estru	Hilco	Mazda	Turnit
Calumet	Echophone	Howard	Naald	Timmons
Conrad	E. I. Co.	Hartman	Premier	United
Columbia	French	Hegehog	Pudlin	Workrite
C. R. L.	Frost	Homecharger	Pal	Walbert
Citizens Call Book	Formica	Hot Spots	Posters	Walwart
Crowfoot	Freshman	Howe	Rauland	Yale

PROMPT ATTENTION TO MAIL ORDERS  
"WRITE FOR CATALOG"

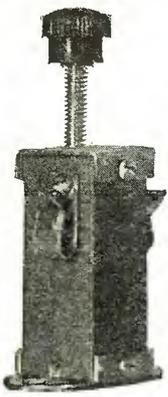

## The COLYTT Adjustable Grid-Leak Non-Microphonic

An easily adjusted leak, of high grade construction, at a reasonable price. (Patent applied for.) ONE HOLE, only, to be drilled in the panel. VERNIER TYPE, giving very minute adjustments. Made of bakelite and metal, and unaffected by moisture or heat.

EASILY COUPLED with its condenser, which may be of any type desired. Condenser furnished with leak, or omitted, as ordered. Be sure that your grid circuit is operating properly, by using the Colytt Adjustable Grid-Leak. The best tube made cannot give the right action if your grid leak is not adjusted to its right value.

**R. C. Colytt Laboratories**  
565 W. Washington St. Chicago, Ill.

(3057)

## RADIO DEALERS WANTED

BIG DISCOUNTS ON  
STANDARD PRODUCTS

# W. C. BRAUN CO.

32-40 S. Clinton St., Chicago

ASK DEPT. 118 FOR DEALERS CATALOG

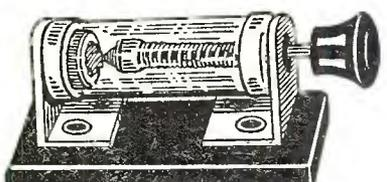

## BLARNEY STONE

An adjustable fixed detector suitable for high-class reflex or straight detector. No cat whisker.

Sent Prepaid for \$1.00. Satisfaction Guaranteed or Money Refunded

Hillebrand, Saratoga Springs, N. Y.

## HERCULES AERIAL MAST

20 Ft. Mast \$10  
40 Ft. Mast \$25  
60 Ft. Mast \$45

All steel construction, complete with guy wires and masthead pulley. We pay freight.

S. W. HULL & CO., Dept. O  
2048 E. 79th St., Cleveland, O.

Write for literature and FREE Blueprint



TESTRITE  
BATTERY HYDROMETERS

50¢ TO \$1.00

ASK YOUR JOBBER

TESTRITE INSTRUMENT CO NEW YORK

## Everything in Radio Sets or Parts—Small or Large

Attractive Prices. Everything new. Mail order only. Orders shipped same day.

### ALL RADIO

417 North Clark Street Chicago, Ill.

## Ask for DUPLEX

folders, "What Every Set Needs" and "How to Judge Condensers." Contain a variety of useful information. Both sent free on request.

Duplex Condenser and Radio Corporation  
28 Flatbush Ave. Ext., Brooklyn, N. Y.

# MODERN

MODERN TRANSFORMERS are the last word in quality amplification. Approved by radio authorities and used by the better set manufacturers, they provide clarity, volume and selectivity while reducing distortion.

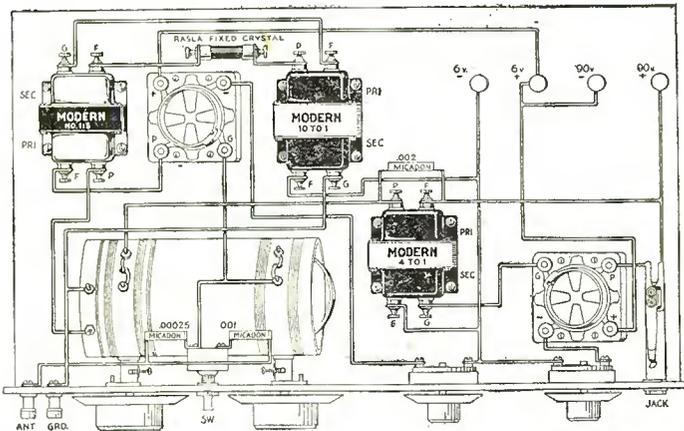

## MODERN TWO-TUBE "REFLEX"

Uses one Modern Radio Frequency Transformer No. 115, one Standard Audio 10 to 1 ratio and one Standard Audio 4 to 1. An effective and economical hook-up. Highly selective and unusually free from interference. Provides plenty of volume with remarkable clarity of tone. Hook-up bulletin sent on receipt of 4c in stamps.

*Amplify the*

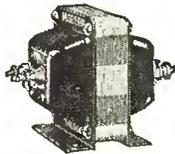

*MODERN way!*

"Push-Pull"

Standard Audio

The perfect balance of Modern "Push-Pull" Transformers, plus their ability to provide the greatest possible amplification with clarity and volume and a minimum of distortion, has made them the last word in "push-pull" amplification. Price, per matched pair, \$12.50.

This Transformer provides the utmost amplification with practically imperceptible distortion at all audio frequencies. Like other MODERN Transformers it has the endorsement of radio authorities and is used by numerous manufacturers of receiving sets. Price, each, \$5.00.

Reflex

Radio Frequency

This is the transformer that makes one tube do the work of three in the Rasla Reflex. Distance, selectivity and volume sufficient for a loud speaker. All these features are yours on one tube. Price, each, \$5.50.

Made in three types, Nos. 115, 116, 117, for use in first, second and third stages respectively of Radio Frequency amplifiers. These Transformers give exceptional results in loop sets. Price, each, \$5.00.

*Sold by Dealers Everywhere*

Most good dealers sell Modern Transformers. If yours hasn't them, write for catalog, giving dealer's name.

The Modern Electric Mfg. Co.

Builders of Transformers Exclusively  
Toledo, Ohio

# TRANSFORMERS

The "Just as good as"  
—or "Just the same as"  
are not genuine

Carter products. The leading set manufacturers of the country have adopted Carter products as standard equipment. Only the finest can stand their grilling tests—Every part made by Carter is an original design and covered by patents or patents pending. The cheaper "just as good as" cost more in the end in poor service.

*You will not be disappointed if you buy*

GENUINE

# CARTER

## RADIO PRODUCTS

- Potentiometer 200 & 400 ohms...\$2.00
- New Vernier Control Rheostats 3-6-10-20 25-30 ohms \$1.75
- "TU-WAY" Plug, \$1.00
- Carter Loop Aerial \$15
- New Loop Self-Supporting Aerial \$15.00
- Jack Switches, 4-spring Combinations \$1.00 to \$1.60
- Portable Jack, 75c
- "ONE-WAY" Plug, 50c
- "IMP" Plug, 15c
- "IMP" Jack 35c
- "IMP" Battery Switch 65c
- Inductance Switch 15 Contact Single Arm...\$2.00 15 Contact Double Arm.. 2.10 9 Contact Single Arm.. 1.90
- Jack Name Plates 5c Seven Styles
- "HOLD-TITE" Jacks, 70c to \$1.30 10 different spring combinations completely covering all circuit requirements.

In Canada—Carter Radio Co., Limited—Toronto



OFFICES IN PRINCIPAL CITIES

**Death Valley Crystal**



30c Everywhere

1. Natural mineral.
2. Entire surface sensitive.
3. Volume has not been equaled.
4. Sold only in sealed package.

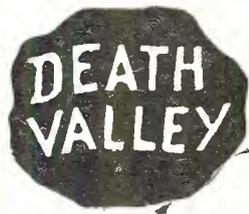

**ABSOLUTE  
GUARANTEE**

**Death Valley Permatect**

Improved  
**\$1.25**



1. Especially designed for reflex.
2. Will stand high plate voltage.
3. Recommended by radio engineers.
4. Easily mounted in any hook-up.

Unless You Use a "Death Valley" You Have Not Developed the Maximum Efficiency of Your Set  
Pacific Radio Specialty Company, 17 South Orianna Street, Philadelphia, Pa.

# DEALERS!

For  
Quality Apparatus  
And  
Real Service

Write  
**Prairie State Radio**

39 West Adams Street  
Chicago, Ill.



## RADIO TUBES

All Types **\$2.00** Each

FULLY GUARANTEED

All tubes tested on laboratory Radio tube testing machine.

Mail Orders Promptly Filled

We Ship C. O. D.

- Style 0199 .06 Amp. 3-4 Volts, Amplifier, Detector
- Style 0201A 1/4 Amp. 5-6 Volts, Amplifier, Detector
- Style 012 25 Amp. 1 1/2 Volts, Amplifier, Detector
- Style 0200A 1/4 Amp. 5-6 Volts, Detector

Dealers—Write for Our Quantity Prices

**RADIO TUBE MFG. COMPANY**

154 Nassau St. Dept. A - - New York City

# RADIO Catalog and Hook-ups FREE

Our great new catalog, fresh from the press, contains the very newest in complete sets, parts and accessories—hundreds of amazing bargains. 250,000 customers testify to our wonderful values and reliability. Complete instructions with diagrams for making most practical popular sets FREE. SEND QUICK for your copy. (Please include name of friend who is interested in Radio.)

**THE BARAWIK CO.**

Dept. 132 32-40 So. Clinton Street Chicago

Radiophans will all appreciate

## BEACH'S "COMMON SENSE" RADIO RECORD.

because it contains the necessary space for records that they all like to keep, and still costs so little—only TEN CENTS.

For 35 years we have made Beach's "Common Sense" Travelers' Expense Books, and through experience we know that most people like a little book to jot down records in.

Write for sample and quantity price to

**BEACH PUBLISHING CO.**  
545 Book Bldg. Detroit, Mich.

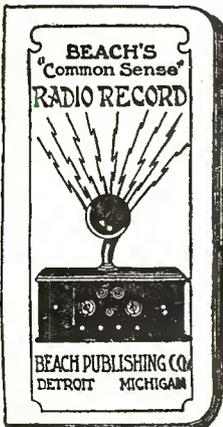

H. Lesser & Company, Ohio's largest Exclusive Radio Distributors. If Cleveland is a convenient shipping point, send us your orders for anything in Radio.

**H. Lesser & Company**

706 Prospect Avenue  
Cleveland, Ohio

## The St. James Intermediate Frequency Vacuum Transformer

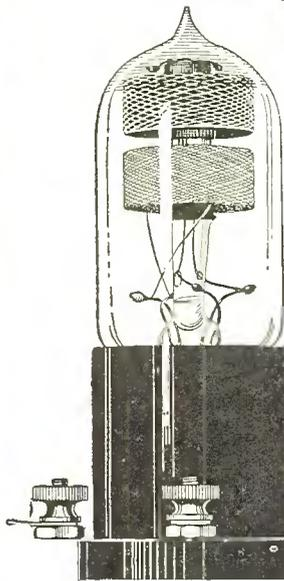

It has all the requirements for a perfect Transformer. Air core windings, complete de-hydration permanently maintained and **PERFECT MATCHING**. All internal connections are silver soldered and the degree of vacuum is .001 m.m.

Each transformer, matched to 1 K.C. variation, furnished with individual resonance curve.

**St. James Laboratories**

Incorporated  
845 Washington Blvd. Chicago, Illinois

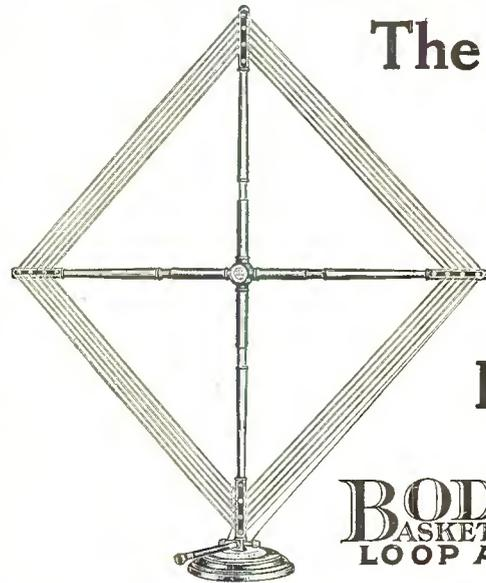

The Loop That Has No Equal

**BODINE**  
BASKET-WEAVE  
LOOP AERIAL

The Bodine Folding Loop gives unequalled reception on distant stations because of its exclusive basket weave winding similar to that used in the latest improved coils.

Its mahogany finish, calibrated silver dial and silk covered wire make it strikingly handsome and the choice of set owners who demand the utmost in performance and appearance.

Standard and Super-het Special with center tap, \$8.50. Tapped Loop with 8-point tap switch, \$10.00. The Bodine Special Loops for Grebe Synchronphase, \$10.00, and Radiola Super-heterodyne, \$8.50, are preferred by owners of these sets.

**BODINE ELECTRIC CO.,** 2250 West Ohio St., CHICAGO, ILLINOIS

Discovered at Last!  
The Real Variable Grid Leak

## NONOISE

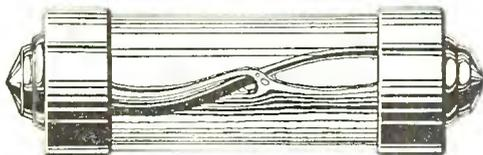

The real variable grid leak is now ready. Its name, NONOISE, is its best description. Can be added to any set—and will clear up that annoying noise.

Type L variable grid leak— $\frac{1}{2}$  to 7 megohms.  
Type A variable resistance—40,000 to 150,000 ohms.

**Retail Price, 85c**

Dealers and Jobbers write in for open territory

**Radio Foundation, Inc.**

150 East 53rd Street New York City

## LANE ELIMINATOR

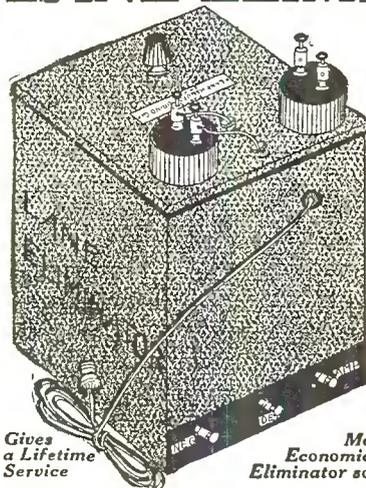

**COSTS 2c**

**A WEEK TO OPERATE**

Just Plug in Electric Light Socket

TAKES THE PLACE OF

“B”

**Batteries**

Gives a Lifetime Service

Most Economical Eliminator sold

No tubes—no recharging—Lasts a Lifetime. Gives unlimited current supply from house lighting circuit and operates on A. C. or D. C. Current.

### Lane Eliminator

Gives tone improvement and micrometer adjustment by a correct amount of plate voltage. Does not start discharging as soon as attached, but on the contrary,

**Keeps Up 100% Voltage Constantly**

Reduces operating cost of your radio—annual upkeep approximately \$1. Works on any set up to 8 tubes without hum in operation, and lasts as long as your set. Every eliminator tested and sent out with full guarantee.

Comes in handsome indestructible case, **\$25** At your dealer's or direct

Attractive Proposition to Dealers and Jobbers

**LANE MFG. CO., Dept. 18, 2941 W. Lake St., Chicago**

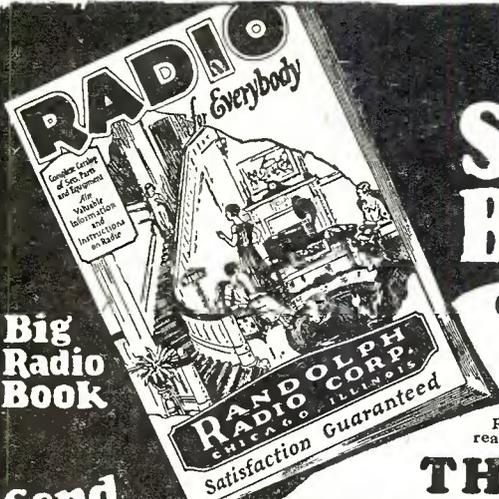

**Big Radio Book**

**Send For it At Once**

# Send For This Sensational Radio Bargain Book-FREE

**Order Direct From This Page! Save About One-half!**

Compare our prices with others. Only highest grade nationally known GUARANTEED parts. OUR GUARANTEE PROTECTS YOU. Money cheerfully refunded if you are not satisfied. Be sure to write your order and state prices plainly. Send post office or express money order or bank draft for total amount to insure prompt shipment. ALL PRICES ON THIS PAGE INCLUDE SHIPPING CHARGES RIGHT TO YOUR DOOR if you are east of the Rocky Mountains. Refer to any bank or commercial agency regarding our reliability. If your favorite circuit is shown here, order direct from this ad. No skill required to build your own radio with Randolph parts. Panels are all drilled. Instructions are simple and complete. Everything comes ready to assemble. Order direct! All shipping charges prepaid.

## THIS 5-TUBE SET \$39.50

FULLY BUILT AND WIRED COMPLETE IN DARK HEAVY MAHOGANY CABINET OF BEAUTIFUL DESIGN

The Biggest 5-Tube Value on the Market

which will bring in all distant stations on the loud speaker in clear loud tones. A value of three times the price. Shipped on a guarantee of satisfaction that requires no neutralizers and is self-balanced. Special features are low-loss coils, engraved bakelite panel, distortionless transformers and pure bakelite sockets. Wiring of the latest loose safety type. Perfect logging of stations. The set alone, shipped prepaid, is..... **\$39.50**

**This Set with All Accessories, Including American Bell Loud Speaker, with adjustable unit, 5 R.C.A. UV201-A Tubes, 2 45-volt "B" batteries, 1 6-volt 90 amp. hour storage battery, complete antenna equipment, including approved lightning arrester, shipped prepaid, east of the Rocky Mountains..... **\$81.30****

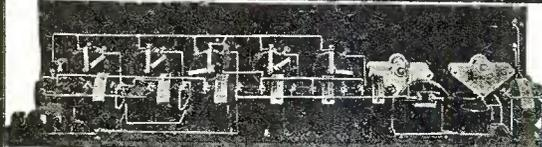
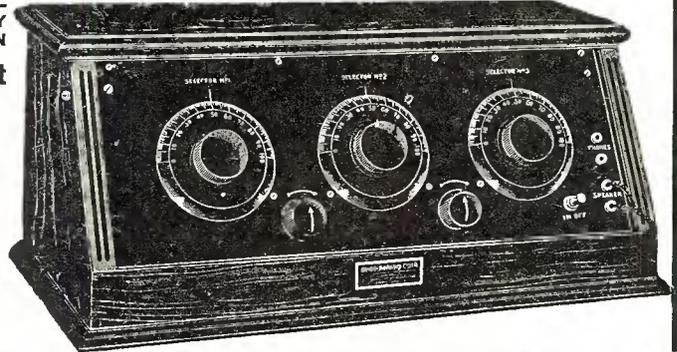

### COMPLETE PARTS FOR 8-TUBE SUPER-HETERODYNE

- 2 23-Plate Duplex or Laboratory Type Low Loss Condensers
  - 3 Remler or Columbia Intermediate Frequency Transformers
  - 1 Remler or Columbia Tuned Circuit Transformer
  - 1 Special Oscillator Coupler
  - 1 Midset Condenser
  - 8 Bakelite Sockets
  - 2 Thordarson or Columbia A. F. Transformers
  - 1 Connecticut Filament Switch
  - 2 Bakelite 6-ohm Rheostats
  - 2 Bakelite 30-ohm Rheostats
  - 1 Bakelite Potentiometer, 400 ohms
  - 1 Carter Double Circuit Jack
  - 1 Dubilier 1 mfd. Condenser
  - 1 .006 Mica Condenser
  - 1 .0005 Mica Condenser and 2 megohm Grid Leak
  - 3 .0025 Mica Condensers
  - 10 Binding Posts
  - 1 .00025 Mica Condenser
  - 1 Bakelite Terminal Strip for Binding Posts
  - 1 Multicord Cable for connecting batteries
  - 1 7x30 3/4" Drilled Bakelite Panel
  - 1 Baseboard
  - 35 ft. Hook-up Wire
  - 2 4-in. Bakelite Dials
  - 2 4 1/2-volt C Batteries
- Complete wiring diagrams, base board layout, blue-prints and instructions. **\$52.75**

- COMPLETE PARTS FOR**
- ACME 1-Tube REFLEX..... **\$17.45**
  - ACME 4-Tube REFLEX..... **\$39.85**

with Genuine Acme parts as specified, drilled bakelite panel and full wiring diagram.

- COMPLETE PARTS FOR 2-TUBE HARKNESS SET**
- including Licensed Harkness Coils, Drilled Panel and wiring diagram. Easy to build. Wonderful results..... **\$16.95**

- COMPLETE PARTS FOR REINARTZ**
- 1-Tube Rein-artz Set..... **\$10.45**
  - 3-Tube Rein-artz Set..... **\$17.55**

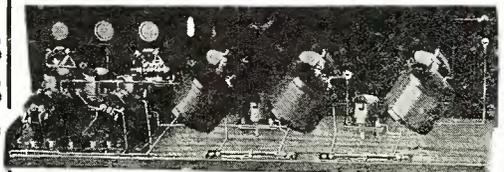

### COMPLETE PARTS FOR 5-TUBE NEUTRODYNE RECEIVING SET

Genuine Hazeltine Licensed Fada, or other Genuine Licensed Parts

- 1 7x24x 1/4" Drilled Panel
  - 2 Thordarson or Columbia Audio Transformers
  - 3 4-in. Bakelite Dials
  - 2 Precision Jacks
  - 1 Bakelite Rheostat, 30-ohm
  - 1 Bakelite Rheostat, 6-ohm
  - 1 Bakelite Binding Post Strip
  - 7 Marked Binding Posts
  - 1 Grid Leak and Condenser
  - 5 Bakelite Sockets
  - 1 .001 Condenser
  - 1 .006 Mica Condenser
  - 35 feet Hook-up Wire
  - 1 Kit consisting of 3 Hazeltine Licensed Neutrodyne transformers and 2 Neutrodons
  - 1 Baseboard
  - 3 Bezels
  - Complete blue-prints and working diagrams.
- \$33.45**

### COMPLETE PARTS FOR 5-TUBE IMPROVED COCKADAY RECEIVING SET WITH RESISTANCE COUPLED AMPLIFICATION

As designed by L. M. Cockaday. Including drilled panel and wiring diagram, complete, ready to wire.

**\$39.65**

### Easy to Build Your Own Radio Set

All complete parts for sets on this page consist of standard advertised guaranteed parts and include drilled bakelite panels and wiring diagrams for easy set construction. Everything guaranteed on money-back basis. All transportation charges paid. Don't forget! Only genuine guaranteed parts used. Lack of space does not permit us to itemize individual parts, but you are fully protected by our money-back guarantee. Our Service Division is behind you.

### FREE BIG MONEY SAVING RADIO CATALOG

containing a thousand bargains of everything on radio—parts, supplies, complete parts for sets, complete sets, etc., also a mine of very latest information on all different circuits, complete list of broadcasting stations, and other valuable, up-to-the-minute radio data. Send your name and address on a card or letter. Also the names of a few friends. We will send catalog free.

### Free Service Department

Our radio engineers will help you solve all your radio problems, and furnish up-to-date information on set construction, operation and improvement. This service is free to our customers.

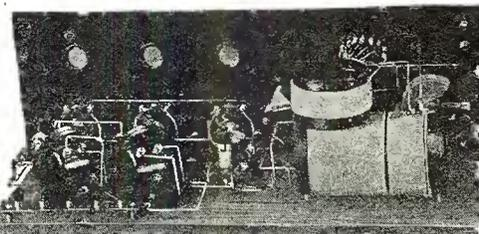

### COMPLETE PARTS FOR 3-TUBE COCKADAY RECEIVING SET

- 1 Cockaday Coil
- 2 23-Plate Hy-Grade Cond.
- 1 Bakelite Rheostat, 6-ohm
- 1 Bakelite Rheostat, 30-ohm
- 3 Bakelite Sockets
- 1 high ratio Columbia or Thordarson Transformer
- 1 Single Circuit Jack
- 1 low ratio Columbia or Thordarson Transformer
- 2 Double Circuit Jacks
- 2 3-in. Bakelite Dials
- 1 Grid Leak and Mica Cond.
- 7 Switch Points. 2 Stops.
- 1 Bakelite Binding Post Strip
- 7 Binding Posts
- 1 7x21x 1/4" in. Drilled Bakelite Panel
- 3 Bezels
- 1 Baseboard
- 1 Switch Lever
- 24-ft. Hoop-up Wire
- Complete blue-prints and wiring diagrams. **\$10.10**
- 1-Tube Set

### Our Money Saving Radio Catalogue

will be sent you immediately upon your request with a full line of radio parts, radio sets, and radio kits at such extraordinary savings that it will surprise all radio builders.

### One Hundred Thousand

satisfied radio set owners are buying constantly from Randolph Radio Corp, and making hundreds of dollars by reselling to their friends. These wonderful sets they are in a position to build and sell at a tremendous profit because of the money we can save them. We sell retail at wholesale prices.

Complete one tube, three tube, five tube, and eight tube sets listed in our big colored and illustrated catalogue. Thousands of quality radio bargains at real prices.

Just send your name and address.

**RANDOLPH RADIO CORPORATION**  
159 North Union Ave. Dept. 438 Chicago, Illinois

# *A Whirlwind Success!*

## AMERICAN BRAND CONDENSERS

These Condensers are now ready for you. Jobbers and dealers everywhere should have them to fill the public demand.

American Brand Condensers are made with the highest ratio geared adjustment ever developed on variable condensers. They are without question the **Lowest Loss** condensers available today. Their price is **no** higher than the price of ordinary condensers.

Please ask your dealer to show you this condenser—if he can't do so, write us for a descriptive folder and send us your dealer's name.

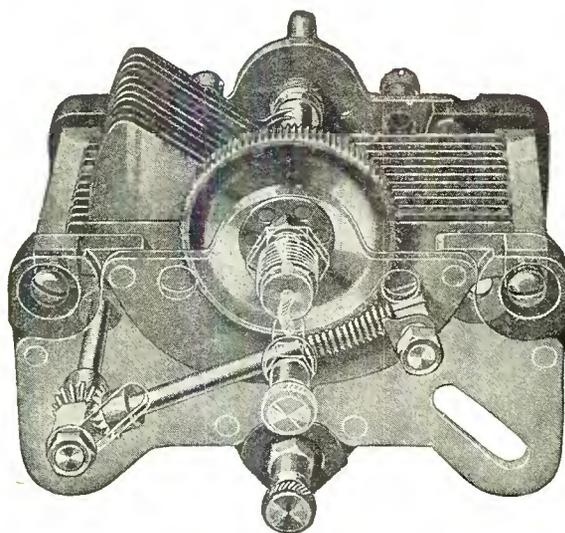

with  
the **100 to 1**  
*Worm Drive*  
23 Plate, only \$5.00

Note to dealer: If your jobber can't supply you, write us.

### AMERICAN BRAND CORPORATION

8 West Park Street, Newark, N. J.

Factory—Philadelphia

## The Little Service Station In Your Home

**Model 17**  
Model 17 (for 6-volt radio "A" and auto batteries)  
\$18.50 (50 or 60 cycle)  
\$21.00 (25 cycle)

NO CONFUSING ARRAY OF BINDING POSTS TO CONNECT

NO NEED TO INSERT RESISTANCE LAMPS

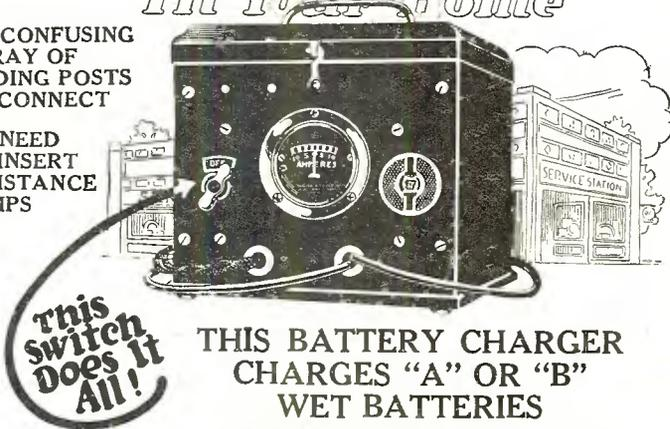

**Model 19**  
Model 19 (for "A" and "B" Batteries)  
\$22.50 (50 or 60 cycle)  
\$25.00 (25 cycle)

**THIS BATTERY CHARGER CHARGES "A" OR "B" WET BATTERIES FROM A SINGLE UNIT!**

**No Separate Attachment**

EACH quarter turn of the selector switch automatically adjusts this rectifier for charging 6-volt "A," 24, 48 or 72-volt "B," or two sections of 48-volt "B" Batteries.

No expensive bulbs to replace—no special care or wear—no chemicals or liquids to replenish—no metal contacts to fuse or burn out. IT IS JUST AS EASY TO USE AS AN ELECTRIC IRON.

Adequate charging rate. Battery fully charged over night. Charging rate not assumed but actually shown by accurate ammeter on face of charger.

The Sterling Battery Charger charges "A" Batteries at 5 amperes. Start the charger in the morning and the battery is ready when you come home at night. It is very quiet in operation, the only sound produced being a faint drowsy hum. But it is not merely quiet, it recharges "A" batteries within a reasonable length of time.

Not a new product or experiment, but a real tried and true charger with a five year reputation behind it. With proper use it will give excellent service for years.

PORTABLE

# Sterling

RECTIFIER



**No. 34-C Voltmeter**—This voltmeter is especially designed for voltage measurement of 22½ and 45 volt blocks of "B" battery, either of the dry cell or storage type. The well-known Sterling "right resistance" "B" battery tester. 0-50 volt scale, 1 volt divisions. List price, \$2.50.

## STERLING POCKET VOLTMETERS

*Tell the Truth*

Not Too Little Resistance to Overdrain the Battery  
Not Too Much Resistance to Give Meaningless High Readings

The 34 C Sterling Pocket Voltmeter tells you whether your new dry "B" Battery is full of energy or shelf-worn; whether your dry or storage "B" Batteries have the voltage required for your set. Thus you often locate your trouble instantly and save exasperating searches for the trouble where it is not. It tells you when to recharge Wet "B" Batteries and when to discard the Dry. Tells at times that the "static" is right in your set. It has just the "right resistance." It does not overdrain the battery because of having too little resistance nor yet give a meaningless high reading due to too much resistance. It tells the actual ability of the battery to function under working conditions.

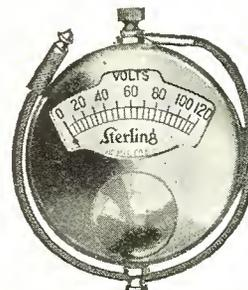

**No. 35 Voltmeter**—A new Pocket Voltmeter for "B" battery voltage measurement. Will show voltage of 5 units of "B" battery, 22½ volt dry, or 24 volt wet. Cord tip insulated for finger grip. 0-120 volt scale, 5 volt divisions. List price, \$3.50.

## THE STERLING MANUFACTURING COMPANY

2831-53 Prospect Avenue, Dept. O, Cleveland, Ohio

Largest Producers of Small Electrical Instruments in the World

Pocket Meters and Panel Meters



Audio and Radio Frequency Transformers



Rectifier



Rheostats



Microcondensers



# Sterling Radio Equipment



\$25

*“Certainly A Wonderful Reproducer”*

That's What Every Fan Says About the

## New Echo-Tone

*“The Loud Speaker With a Nose”*

You get perfect, even tones from this graceful loud speaker because the nasal, metallic annoyances in reception were properly considered when it was designed.

The New Echo-Tone creates stationary sound waves which in turn quench those annoying radio noises.

You can get proper modulation of reception every time.

If your dealer cannot supply you send us his name or mail your order direct to the factory.

**Williams Radio Company**  
1436 Washington Blvd. - Detroit, Mich.

# Biggest dollar's worth in RADIO

100,000 SOLD

Compiled by  
**HARRY F. DART, E.E.**  
Formerly with the Western Electric Co., and U. S. Army Instructor of Radio  
Technically edited by  
**F. H. DOANE**

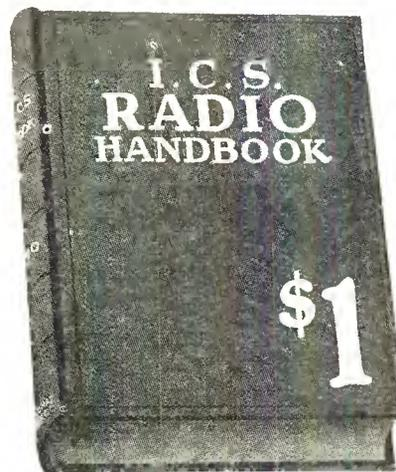

**T**HE greatest book on Radio ever written. Price only \$1. Filled with sound, practical, tested information for every radio fan, from beginner to hard-boiled owl. Written, compiled and edited by radio experts of national reputation.

You may dip into this I. C. S. Radio Handbook at random, or hunt up special information you want, or read it right through. Starts with simple explanations of Radio phenomena and leads you along gently until you can understand the most technical diagram. Hundreds of suggestions for getting more pleasure out of Radio. Will save you from wasting money on things that won't work.

**New—Authoritative—Complete**  
**514 PAGES—150 ILLUSTRATIONS**

Every page tells you something useful. And there are 514 pages! More than 150 illustrations and diagrams! Note this partial list of contents:

Electrical terms and circuits, antennas, batteries, generators and motors, electron (vacuum) tubes, every receiving hook-up, radio and audio frequency amplification, broadcast and commercial transmitters and receivers, wave meters, super-regeneration, codes, license rules. Many other features.

**Send \$1 today and get this 514-page I. C. S. Radio Handbook before you spend another cent on parts. Money back if not satisfied.**

**MAIL THE COUPON TODAY!**

**INTERNATIONAL CORRESPONDENCE SCHOOLS**  
Box 8319, Scranton, Penna.

I enclose One Dollar. Please send me—post-paid—the 514-page I. C. S. Radio Handbook. It is understood that if I am not entirely satisfied I may return this book within five days and you will refund my money.

Name.....

Address.....

Check here  and enclose \$1.50 if you wish the de luxe edition, bound in Leatheroid.

# Index to Advertisers

- A**
- Acme Apparatus Co.....82-87  
 Acme Wire Co.....153  
 A C Elec. Mfg. Co.....157  
 Alden Mfg. Co.....113  
 All Radio.....182  
 Allen-Bradley Co.....3d cover  
 Alter, Harry & Co.....154  
 American Brand Corp. Inc.....187  
 American Elec. Co.....152  
 American Radio & Research Corp.. 31  
 American Transformer Co.....116  
 Amplifex Radio Corp.....99  
 Andrews Radio Co.....52  
 Apex El. Mfg. Co.....157  
 Apco Mfg. Co.....161  
 Automatic Electrical Devices Co..151
- B**
- Barawik Co., The.....184  
 Barkeley Elec. Mfg. Co.....43  
 Barrett & Paden.....179  
 Beach Pub. Co.....184  
 Bearcat Radio Co.....47  
 Beardsley Specialty Co.....182  
 Benjamin Elec. Mfg. Co.....95  
 Benson Engineering Co.....163  
 Bodine Elec. Co.....185  
 Brandes, C. Inc.....39  
 Branston, Chas. A., Inc.....56-57  
 Braun, W. C. Co.....182  
 Bremer-Tully Mfg. Co.....103-105  
 Bristol Co., The.....68  
 Buell Mfg. Co.....93  
 Burgess Battery Co.....4th cover
- C**
- Cardwell Mfg. Allen D.....169  
 Carter Mfg. Co.....148  
 Carter Radio Co.....183  
 Chelsea Radio Co.....152  
 Chicago Electrical Devices Co.....158  
 Chicago Radio Apparatus Co.....142  
 Chicago Salvage Stock Co.....150  
 Chicago Solder Co.....137  
 Circle F Mfg. Co.....151  
 Cleveland Eng. Laboratories.....135  
 Compressed Wood Corp.....179  
 Colytt Laboratories, R. C.....182  
 Crosley Mfg. Co.....20-21  
 Cruver Mfg. Co.....129  
 Culver-Stearns Co.....73-74  
 Cunningham, E. T., Inc.....2nd cover  
 Cutler-Hammer Mfg. Co.....11
- D**
- Daven Radio Corp.....173  
 De Jur Products Co.....150  
 Detroit Electric Co.....136  
 De Witt LaFrance Co.....141  
 Don Mac, Inc.....120  
 Doubleday-Hill Elec. Co.....66  
 Duray Radio Corp.....143  
 Durham & Co., Inc.....153  
 Duplex Condenser & Radio Corp.....182  
 D X Instrument Co.....118
- E**
- Eagle Radio Co.....25  
 Eby, H. H. Mfg. Co.....146  
 Ekko Co.....159  
 Electric Products Mfg. Co.....174  
 Electrical Research Laboratory...88-89  
 Electrical Specialty Co.....134
- Excello Products Corp.....17  
 E-Z Toon Radio Co.....155
- F**
- Fansteel Products Co., Inc.....67  
 Federal Battery Co.....144  
 Ferbend Electric Co.....168  
 Filterspeaker Sales Co.....162  
 Fishwick Radio Co.....147  
 France Mfg. Co.....154  
 Freed-Eisemann Radio Corp.....166-167  
 Frost, Herbert H., Inc.....2-3
- G**
- General Radio Co.....5  
 Goldschmidt Corp., The.....29  
 Grebe, A. H. & Co., Inc.....9  
 Grosser, B. & Sons Co.....149
- H**
- Hammerlund Mfg. Co.....116  
 Harvard Radio Laboratories.....146  
 Heath Radio & El. Mfg. Co.....146  
 Hillebrand Co.....182  
 Howard Radio Co.....1-140  
 Hudson-Ross Co.....119  
 Hull, S. W. & Co.....182
- I**
- International Correspondence  
 Schools.....189
- J**
- Jewell Elec. Inst. Co.....171  
 Jones, Howard B.....147
- K**
- King Mfg. Co.....164  
 Klentz Radio Co.....107  
 Kurz-Kasch Co.....153
- L**
- Lane Mfg. Co., The.....185  
 Langbein & Kaufman.....69-70  
 Leonard Lynn Radio Co.....150  
 Liberty Transformer Co., Inc.....191  
 Lincoln Mfg. Co.....158  
 Lesser & Co., H.....184
- M**
- Macauley & Nevers.....181  
 Magnavox Co., The.....138  
 Main Radio Batteries, Inc.....182  
 Modern Elec. Mfg. Co.....183  
 Murdock, Wm. J. Co.....192  
 Music Master Corp., The.....61  
 Muter Co., Leslie F.....157
- N**
- National Co.....91  
 National Carbon Co.....23  
 National Radio Institute.....139
- O**
- Ohio Radio Sales Co.....158  
 Ohio Rubber & Textile Co.....158  
 Operadio Corp.....125
- P**
- Pacific Radio Specialty Co.....184  
 Peiffer & Co.....182
- Phenix Radio Corp.....44  
 Prairie State Radio Co.....184  
 Premier Elec. Co.....145  
 Prest-O-Lite Co.....15
- R**
- Radiall Co.....101  
 "Radio".....160  
 Radio Appliance Lab.....155  
 Radio Association of America.....117  
 Radio Chart Bureau.....179  
 Radio Corp. of America.....7  
 Radio Foundation, Inc.....185  
 Radio Panel & Parts Corp.....163  
 Radio Publishing Co.....118-177  
 Radio Rabat Co.....159  
 Radio Tube Co.....184  
 Radio Units, Inc.....181  
 Radiotive Corp.....127  
 Randolph Radio Co.....186  
 Rathbun Mfg. Co.....115  
 Rauland Mfg. Co.....48-130-131  
 Reynolds Radio Co.....175  
 Rhamstine, J. Thos.....156  
 Roberts Radio Service.....110  
 Roland Brownlie Co.....152  
 Rocky Mountain Radio Corp.....144  
 Rubicon Co., The.....148
- S**
- Samson Elec. Co.....76-77  
 Schoonhoven, R. C.....180  
 Schmidt, Rudolph.....156  
 Sickles Co., F. W.....115  
 Silver-Marshall, Inc.....62  
 Simplex Radio Co.....182  
 Star-B-Metal Refining Co.....176  
 St. James Laboratories.....185  
 Sterling Mfg. Co.....188
- T**
- Telephone Maintenance Co.....4  
 Testrite Instrument Co.....182  
 Thordarson Elec. Mfg. Co.....75  
 Tower Mfg. Co., The.....133  
 Trilling & Montague.....180  
 Trimm Radio Mfg. Co.....19
- U**
- United Electric Co.....97  
 United States Tool Co.....154  
 Unity Mfg. Co.....13
- V**
- Valley Electric Co.....27
- W**
- Wakem & McLaughlin.....151  
 Western Radio Mfg. Co.....149  
 Weston Electrical Instrument Co.....128  
 Willard Storage Battery Co.....33  
 Williams Hardware Co.....179  
 Williams Radio Co.....189  
 Windsor Furniture Co.....165  
 Workrite Mfg. Co.....109  
 World Battery Co.....111
- X**
- X L Radio Laboratory.....156
- Y**
- Yaxley Mfg. Co., The.....132

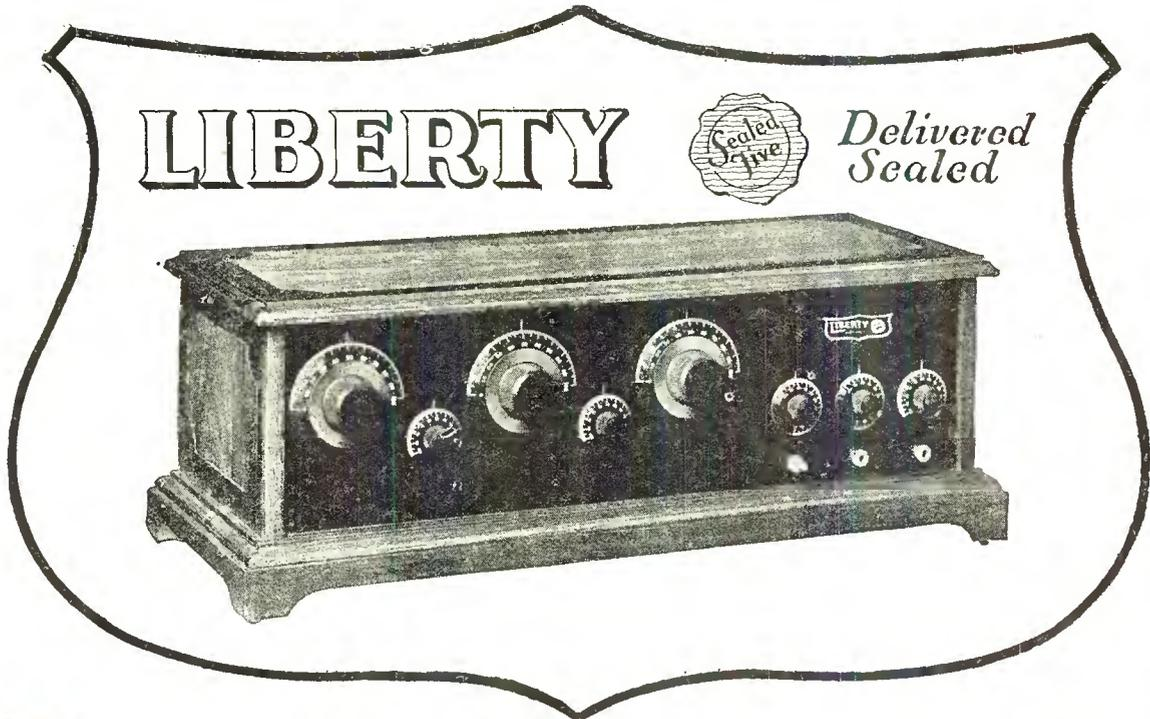

"My wife said all radio sets sounded 'mechanical' until she heard the LIBERTY. That's why we bought one."



All five tubes are kept "matched" because each tube is controlled by a separate rheostat. That gives pure tone.

Owners of the LIBERTY Sealed Five are never without excellent entertainment.



"A strong local station near us monopolized the air until we bought a LIBERTY Sealed Five."

LIBERTY is extremely selective. You need no verniers on these large dials.



**LIBERTY**  
is  
built for the  
Future

"I installed one of your Liberty Five radios in my home last week and the first three nights I operated this machine I pulled in the following stations:

- |                         |                         |                      |
|-------------------------|-------------------------|----------------------|
| KFI, Los Angeles        | WCAP, Washington        | WHN, New York        |
| PWX, Havana             | WCAE, Pittsburgh        | WCB, Zion            |
| KHJ, Los Angeles        | WJZ, New York City      | KDKA, E. Pittsburgh  |
| WBZ, Springfield, Mass. | WMAQ, Chicago           | WLW, Cincinnati      |
| WKAQ, San Juan, P. R.   | WOS, Jefferson City     | WSAI, Cincinnati     |
| WFAA, Dallas            | WSB, Atlanta            | WMH, Cincinnati      |
| KYW, Chicago            | WJB, Kansas City        | WTAS, Elgin, Ill.    |
| WVJ, Detroit            | WDAF, Kansas City       | WTAY, Oak Park, Ill. |
| WCX, Detroit            | WOR, Newark, N. J.      | WEBH, Chicago        |
| WOO, Philadelphia       | WHAS, Louisville        | WQJ, Chicago         |
| WIP, Philadelphia       | WTAM, Cleveland         | WLS, Chicago         |
| WEAF, New York City     | WJAX, Cleveland         | 2XBJ, New York City  |
| WOC, Davenport          | WGY, Schenectady        | WREO, Lansing, Mich. |
| WHAA, Iowa City         | WGN, Chicago            | WLBL, Stevens Point  |
| WBAP, Ft. Worth         | WCAL, Northfield, Minn. | 8XC, Willard Test    |
| WRC, Washington         |                         |                      |

"I think the above test is remarkable inasmuch as I was not familiar with the operation of the set. Might also state that my residence is not located in a very desirable spot for reception, but nevertheless the above stations were received in a very clear tone and with plenty of volume on the Loud Speaker.

"I wish you all the success you deserve with this wonderful set."

"Yours very truly,

(Signed) M. E. Mogg, President,

Linton Consolidated Collieries Company, Indianapolis.

**INVEST IN A LIBERTY SEALED FIVE**

**\$100.00**  
less accessories for this  
5-tube tuned Radio Fre-  
quency Receiver in  
beautiful two-tone solid  
walnut cabinet.

Manufactured by

**LIBERTY TRANSFORMER CO., Inc.**

555 North Parkside Ave., Chicago

# MURDOCK NEUTRODYNE

**\$100**  
with  
built-in  
**Loudspeaker**



Same set with adjustable  
loud speaker unit

**\$110**

Without loud speaker

**\$92.50**



THE Murdock Five Tube Neutrodyne is the outstanding 1925 model receiving set. You will be impressed by the beautiful tone quality and the rich cabinet design. There is space in the cabinet for "B" batteries and the only accessories necessary are batteries and tubes. A "Murdock" set is backed by our 20 years of successful experience in making radio apparatus.

WM. J. MURDOCK COMPANY

Dept. D1, Washington Ave.,

Chelsea, Mass.

Branch Offices: New York Washington Chicago Los Angeles San Francisco Seattle



# MURDOCK RADIO PRODUCTS

Standard since 1904

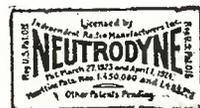

## Use Any Tube

### UV-200 or C-300



Volts—5  
Amps.—1  
Grid Leak  
0.5—2  
Megohms  
Condenser  
.00025  
-.0005 M-f.

### UV-201A or C-301A

Volts—5  
Amps.—.25  
Grid Leak  
2—9  
Megohms  
Condenser  
.00025 M-f.



### WD-12 or C-12



Volts—1.1  
Amps.—.25  
Grid Leak  
2—3  
Megohms  
Condenser  
.00025 M-f.

### WD-11 or C-11

Volts—1.1  
Amps.—.25  
Grid Leak  
2—3  
Megohms  
Condenser  
.00025 M-f.



### UV-199 or C-299



Volts—3  
Amps.—.06  
Grid Leak  
2—9  
Megohms  
Condenser  
.00025 M-f.

**AB**

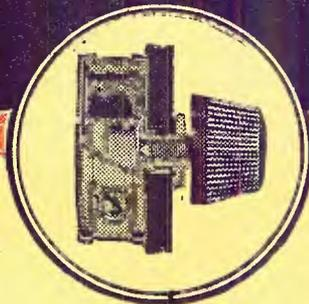

**Bradleystat**  
PERFECT FILAMENT CONTROL

**Bradleyleak**  
THE PERFECT GRID LEAK

## Do You Know—

*that any tube can be used in your set  
without changing rheostats or grid leaks?*

**I**T SOUNDS unbelievable, but it's true. The perplexing problem of selecting the correct rheostat or grid leak is solved by using the Bradleystat and the Bradleyleak. They offer the most marvelous range without steps or noise, and such smooth precision of control that no other rheostat or grid leak can approach them in performance.

The Bradleystat has a resistance range from approximately  $\frac{1}{4}$  to 100 ohms, by merely turning the adjusting knob that varies the pressure on the graphite discs. It will handle *all tubes* without change of connections, and provide ample control in every case.

The Bradleyleak, with a range from  $\frac{1}{4}$  to 10 megohms, can be adjusted instantly for any tube, indicated in the adjoining table of tube ratings, by turning the adjusting knob.

Be ready to use any tube in your radio set. Install Allen-Bradley Radio Devices, throughout.

*Have you  
used the  
Bradleyswitch?  
It saves  
batteries and  
tubes.*

## Allen-Bradley Co.

**ELECTRIC CONTROLLING APPARATUS**

Sales Offices:  
Baltimore  
Birmingham  
Boston  
Buffalo  
Chicago  
Cincinnati  
Cleveland  
Denver  
Detroit



Sales Offices:  
Knoxville  
Los Angeles  
New York  
Philadelphia  
Pittsburgh  
Saint Louis  
Saint Paul  
San Francisco  
Seattle

General Offices and Factory: 488 Clinton Street Milwaukee, Wis.

Manufacturers of Graphite Disc Rheostats for Over Twenty Years

# BURGESS

## RADIO BATTERIES



Burgess 'C' Batteries improve reception economically.



One of several sizes of Vertical 'B' Batteries.



Standard Burgess Radio No. 6 'A' Battery "Over Twice the Life."

### Quality at *Every* Price

Cabinet or table space many times determine the size and type of radio batteries selected by the user.

Burgess manufactures a battery for every radio circuit and tube. Your choice of any one of many types involves no sacrifice of economy or service hours. The value and quality of Burgess Radio Batteries are constant—your satisfaction assured.

#### Ask Any Radio Engineer

Write to 323 Burgess Engineering Building, Madison, Wisconsin, for the Burgess Radio Compass. It is amusing, unusual and useful.

#### BURGESS BATTERY COMPANY

Engineers DRY BATTERIES Manufacturers  
Flashlight - Radio - Ignition - Telephone

General Sales Office: Harris Trust Bldg., Chicago  
Laboratories and Works: Madison, Wisconsin

In Canada: Niagara Falls and Winnipeg



Burgess block shape 'B' Batteries are made in numerous types and voltages.