

C tizens

# RADIO CALL BOOK MAGAZINE

50¢

WINTER  
EDITION



A COMPLETE RADIO CYCLOPEDIA



# Now! AC TUBES 226-227



Two New Favorites in  
"The World's Largest  
Tube Line"

33 Distinct Types

Of course you want an A C set! Sonatron places at your service the two newest developments—226 A C and 227 A C. Every advantage of A C tube operation is enhanced by the superlative quality built into these two new Sonatrons. For best results in tone, volume and distance—see that you have a Sonatron in every socket! Every tube in the famous Sonatron line is carefully adapted to do its particular work—and do it better! Standard quality—in every way. Sold everywhere—under a remarkable guarantee! For the latest tube information, write us for our Circular CB-1.

## THE NEWEST! SONATRON 225 A

A Sensational New Tube Designed to  
Replace the 225 AC!

Here is the inevitable step forward in AC tubes! Has the cathode connections right on the base, replacing the prongs on top of the tube in the old style. This 3-volt transformer, AC Heater element tube can be used in all sets wired for the 225 AC.

This label identifies the genuine to hundreds of thousands of Sonatron enthusiasts!

# SONATRON

SONATRON TUBE COMPANY

NEWARK, N. J.

108 West Lake St., CHICAGO

320 Lafayette Building, DETROIT

16 Hudson St., NEW YORK CITY

WINDSOR, ONT., CAN.



# 97¢

# WHILE THEY LAST

Now—thousands of fans who never felt they could afford a real audio amplifier can have one for far less than factory cost.

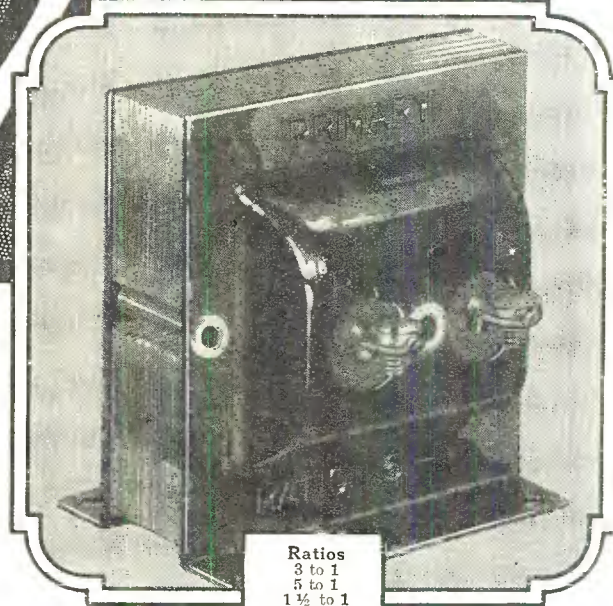

Ratios  
3 to 1  
5 to 1  
1 1/2 to 1  
(For 3 stage Audio)

## The FAMOUS ILLINOIS "All-Frequency" AUDIO

This truly marvelous transformer, made in a slightly different manner with respect to mounting, is being used today in high priced, fine toned manufactured radio sets.

The lot which we are offering at 97c is a batch made up to the specification of a set manufacturer who proved financially unable to take them. Hence, we are making them available to fans, music lovers and professional set builders at a price which we know positively will clear the entire stock quickly. The Illinois "All-Frequency" Audio Transformer is, in every sense of the word, a \$4.00 value. You get it for only 97c.

## Superb Music—Real Volume

These are not old-fashioned "tin-pan" sounding transformers, but fresh, new, up-to-date units built to the highest standards of electrical excellence. The laminated core is oversize and of the finest grade of silicon steel. The windings are also oversize, and the primary winding is of a very low resistance so as to consume the smallest amount of "B" battery current. Windings are completely shielded and the binding posts are conveniently located. You will be amazed when you hear the reproduction the Illinois "All-Frequency" transformer gives you. Clear, strong, true-to-life music—from the low to the highest notes.

## Beautifully Finished

The Illinois "All-Frequency" Transformer is attractively finished. It looks like the \$4.00 transformer that it is. The shielding case is enameled black and highly polished. The binding posts are polished nickel. When built into a set, this transformer looks as good as it performs. Take advantage of our 97c price offer now. Mail the Guarantee Coupon from this page today.

**ILLINOIS TRANSFORMER CO.**  
223 West Elm St. Chicago, Ill.

Fans! Here is your opportunity to save a lot of money. Music Lovers! Here is your chance to enjoy the kind of radio reproduction you have always dreamed about. Professional Set Builders! This great factory clearance sale gives you the chance of a lifetime to greatly increase your profits. For here is a high grade, heavy duty, genuine all-frequency transformer of exceptional musical qualities—offered to you at only a fraction of actual cost. Never before has such a value been offered. And when this stock is gone, gone too will be the biggest, best, money-saving bargain opportunity the radio industry has ever known.

## ORDER a PAIR AT OUR RISK

If you are a lover of music, order a pair of these famous Illinois "All-Frequency" Audio Transformers NOW, while this offer lasts. If you are a professional set-builder, order as many of these transformers as you can. Don't wait! Don't hesitate! Don't let the greatest of all bargain opportunities get by you. You take no risk. Order at once. We back every transformer and agree to refund your money promptly if you are not satisfied. Use the coupon from this page for your order blank. Pin your money order to it and mail it now—TODAY.

### GUARANTEE COUPON

ILLINOIS TRANSFORMER CO.  
223 West Elm St., Chicago, Ill.

I enclose \$.....for which send me..... Illinois "All-Frequency" Audio Transformers.

3:1 Ratio  5:1 Ratio  1 1/2:1 Ratio (for 3 stage audio)  
(Write in squares above, quantity of each ratio wanted)

I understand I can have my money back if not satisfied within 10 days after receipt of transformers.

Name.....

Street.....

Town.....



# FIRST WITH THE LATEST

## A Service That Means More Profit for Dealers

THIS year has been a difficult one for the dealer because of the many changes that have taken place in radio. But Braun dealers have been able to keep pace with every new move. When the newest A-C sets came out, we had them. And everything connected with A-C operation, the new grid tube, the newest A-C circuits and accessories, were immediately available to our dealers and customers. Braun dealers make more money by being able to keep up to date always.

Here the retail dealer may draw upon the largest, most complete stock of radio receivers, parts, accessories and supplies. In our books will be found the latest circuits, as specified in the various radio publications. Our force of experts renders aid in selling and advertising, and more than a hundred trained specialists assemble and dispatch your orders—12 hours (or less) service on mail orders, 2-hour service on telegraph, telephone and air mail orders. Inspectors, dealers' representatives are here—the most highly organized staff ever brought together to assure quick, intelligent service and fair treatment for our dealers.

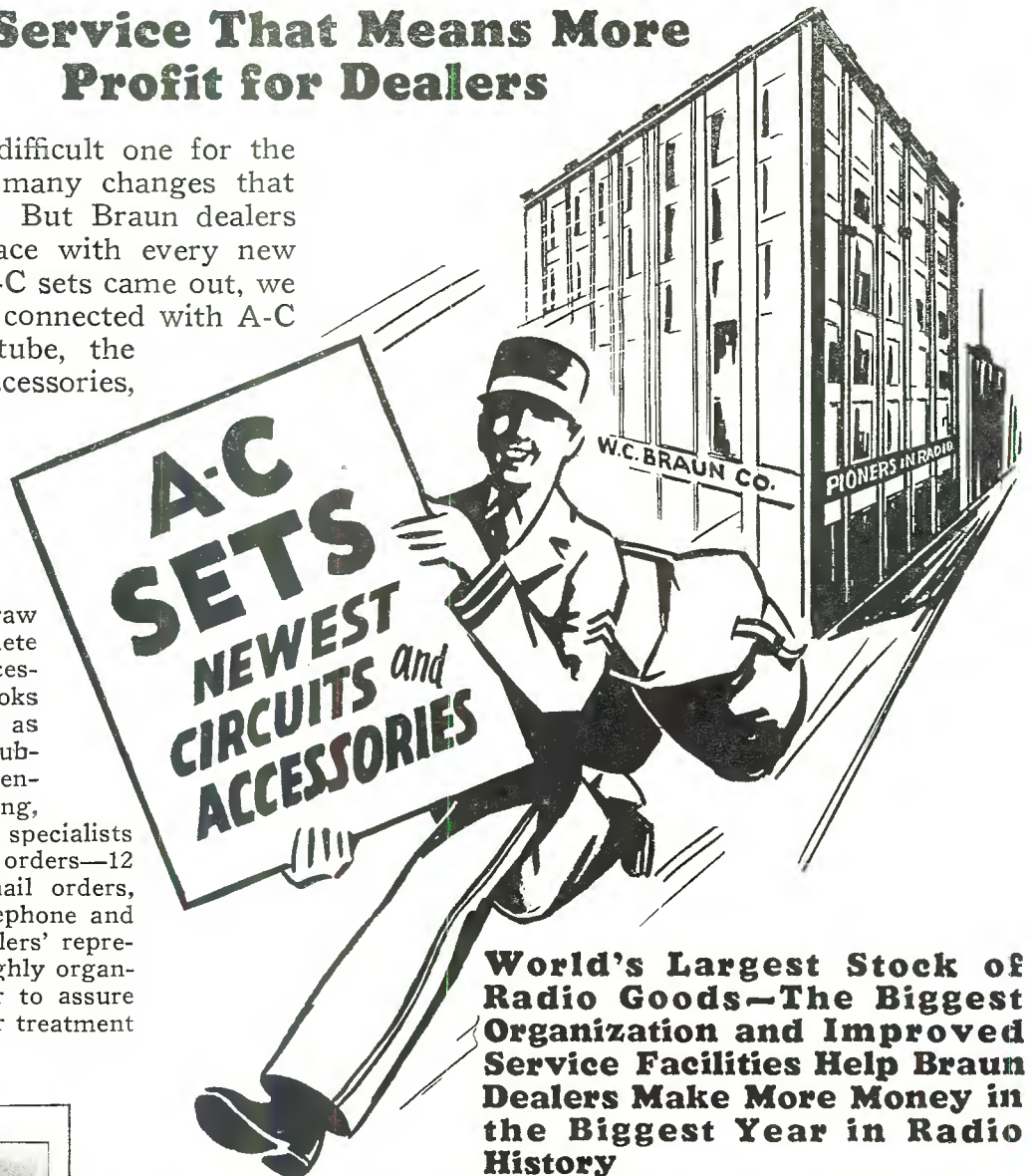

**World's Largest Stock of Radio Goods—The Biggest Organization and Improved Service Facilities Help Braun Dealers Make More Money in the Biggest Year in Radio History**

This has been one of the greatest years of activity in radio since its inception. With broadcast conditions vastly improved and reception apparatus largely perfected, there is a new wave of public confidence and a renewed interest in the purchase of radio apparatus. Thousands of backward fans are equipping their homes with radio this year. We are backing our dealers up in this rush of business and we are doing it daily. Nowhere else may they find such wide selections and obtain such quick service. This places the Braun dealer in a position where he easily overcomes all competition.

### Every Radio Dealer Should Have Braun's Latest Confidential Wholesale Price Guide

Thousands of dealers everywhere use the Braun Book as their guide in selling and expanding their business. If you are not now on our list, write us on your letterhead. If not rated, kindly note names of two wholesale establishments from whom you now purchase. We want every established radio dealer in the country and abroad to have this guide.

**W.C. BRAUN COMPANY**  
*Pioneers in Radio*  
**577 Randolph St.**  
**CHICAGO**  
 ILLINOIS

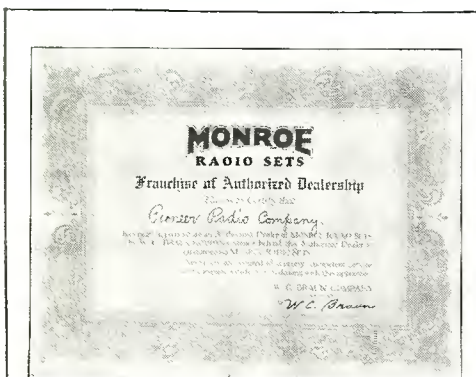

#### New Line of Monroe Radio Receivers Prove Instantly Popular

Last season our line of Monroe sets enjoyed a phenomenal popularity in every section of the country. Into their construction we placed the very finest materials obtainable, and only the most highly skilled workmanship. As a result, these sets became very popular with our dealers, because of the lack of servicing and the trouble-free service which they gave in the hands of the users. This year these old dealers will push these sets to the very limit, and although our appointments have been very widespread there are many good districts yet open for the Monroe franchise.



# Al -Electric **AERO-SEVEN** RECEIVER A-C

*A Custom-Built, Modern, Up-to-date Receiver  
That Any Radio Fan Can Easily Build*



**T**HOUSANDS of radio fans the country over welcomed the Aero-Seven circuit with open arms. It was one of the really new and different circuits that the set builder could depend upon for building up business. For here was the one circuit that could be bought at a really reasonable price and that could be sold at a good profit by the set builder. And with everything to back it up—real performance, the reputation of radio's leading parts manufacturers, new ideas, good looks and a most reasonable price, it is no wonder that the fans by the thousands have flocked to the Aero-Seven.

The Aero-Seven is as up to date now as when it first came out, for it incorporated advanced ideas that are still advanced. The transformation from a battery-operated set to an A-C, all-electric set has been simple indeed.

To those fans who have not built the Aero-Seven before, and who desire the very latest in an A-C operated, socket-power, all-electric set, we recommend the Aero-Seven AC, with the assurance that it will give you every radio thrill on the books and plenty more besides.

This circuit has been developed in the laboratories of the Call Book, under expert engineering supervision. It is really marvelous in its simple, easy, smooth and quiet operation and in its power to deliver the purest, sweetest tones you ever heard, reaching out, as it does, from coast to coast and with a 10-kilocycle selectivity that is a real fact.

If you want full value for your money and still keep the cost down to rock-bottom, get the parts listed here and build the Aero-Seven, the Wonder of the Air.

*Mail the handy coupon below and get complete information and facts before you at once*

## **AERO PRODUCTS, Inc.**

1768 Wilson Ave., Dept. 1011

Chicago, U. S. A.

*Associated Manufacturers*

*Amsco, Aero, Carter, Westinghouse-Micarta, Silver-Marshall, X-L*

### Official List of Parts Aero A. C. Seven

1—Aero-Seven Foundation Unit.....	\$12.00
1—U-12 Aero R. F. Transformer Kit.....	12.00
1—60 Aero R. F. Choke Coil.....	1.50
1—Amsco .0005 mfd. 3 Gang Variable Condenser .....	11.25
1—AA-17 Aero Antenna Adaptor.....	1.75
1—669 Yaxley Cable Connector with Phone Jacks .....	3.25
1—Carter .0005 mfd. Fixed Condenser.....	.40
1—Benjamin 5 Prong Socket.....	1.20
6—Amsco Sockets @ 50c .....	3.00
1—Amsco 2 megohm Grid Gate and Mounting .....	.80
1—Amsco .5 megohm Grid Gate .....	.50
1—Amsco .25 megohm Grid Gate .....	.50
3—Amsco .1 megohm Grid Gates @ 75c .....	2.25
1—Amsco 1 megohm Grid Gate .....	.50
3—RC-1 Amsco Resistor Couplers @ 1.25 .....	3.75
1—Carter 2 ohm Rheostat.....	.75
1—Silver-Marshall Drum Dial.....	3.00
1—Carter 110 volt Switch.....	.75
2—Carter 1 mfd. By-Pass Condensers @ \$1.25 .....	2.50
1—Carter .001 mfd. Fixed Condenser.....	.50
1—Carter .00025 mfd. Fixed Condenser.....	.40
1—Carter 6 ohm Sub-Panel Mounting Potentiometer .....	1.00
1—Carter 300,000 ohm Variable Resist- ance .....	2.00
1—Yaxley 500 ohm Fixed Resistance.....	.25
2—Yaxley 3 ohm Fixed Resistances @ 15c .....	.30
1—Silver-Marshall .00025 mfd. Midget Condenser .....	1.50
2—Yaxley 10 ohm Fixed Resistance @ 15c .....	.30
9—XL Binding Posts.....	1.35
Total List Price.....	\$69.25

AERO PRODUCTS, INC.  
1768 Wilson Ave., Dept. 1011  
Chicago, Ill.

Dear Sirs: I am taking advantage of your free offer to send me complete details and information on the Aero-Seven A-C operated radio receiver.

Your name.....  
Address.....  
City..... State.....



# Citizens Radio Call Book Magazine

Established 1921

C. O. STIMPSON, President  
 E. H. JAUDON, Vice-President  
 D. H. BELL, Secretary-Treasurer  
 H. ANHEISER, Assistant Treasurer

Executive Offices:  
 508 So. Dearborn St., Chicago, Ill.

F. A. HILL, Managing Editor  
 RICHARD K. PEW, Technical Editor  
 E. M. GIBSON, Advertising Manager  
 M. R. HARRIS, Circulation Manager

Member Audit Bureau of Circulations

JANUARY, 1928

Vol. 9, No. 1

## CONTENTS THIS ISSUE

American Broadcasting Stations.....	16
Broadcasting Stations by States.....	52
Simplified Log Sheet.....	54
Foreign Broadcasting Stations.....	56
World's Record Super Ten with Power Amplifier.....	60
Radio Celebrities (Rotogravure Section).....	64
Ampere Andy's Assistors (Rotogravure Section).....	64
Infradyne Operation Article.....	66
Thordarson Power Amplifier—Later Developments.....	68
Truvolt B Supply.....	69
Harkness Counterfonic Six.....	72
Lynch-Hammarlund Five.....	76
Bremer-Tully Power Six Electric.....	78
Phasatrol DeLuxe Seven.....	82
Aerodyne Six A. C.....	85
Tyrman Shield Grid Amplimax.....	87
Citizens Unitune Symphonic.....	91
S-M Universal Phono-Radio Combination.....	95
Hammarlund-Roberts Hi-Q Six.....	99
Karas A. C. Equamatic.....	103
Vitrohm D. C. Eliminator.....	107
Bodine A. C. Phono-Radio Combination.....	110
Browning-Drake & Acme Power Amplifier.....	114
St. James Twin Four Super.....	118
Lynch-Precision Five.....	122
Aero A. C. Seven.....	124
Madison-Moore Operating Article.....	128
Everyman Four.....	130
Silver-Marshall Shield Grid Six.....	134
Citizens Shielded Five.....	138
Remler A. C. Super.....	142
Nine-in-Line Electrified.....	146
Samson Power Supply.....	150
Abox ABC Eliminator.....	153
With the Accessory and Parts Manufacturers.....	155

## With the Editor

THREE things are squarely in the set building public's eye as we go to press. First, the shield grid tube, which was announced to the experimenters and set builders by this publication in its November issue; second, alternating current tubes of the heater type for complete electrification of radio sets; and third, means of adapting the storage battery receiver to light socket operation through suitable A power devices.

However, it is indicated that despite the A. C. craze, we may expect for many years a continuation of storage battery operation. This statement is based on the large area of this country which is not wired for alternating current and whose residents must depend on the storage battery tubes.

As stated in our November issue, the shield grid tube continues to give the greatest promise along experimental lines for two reasons, the chief one being tremendous amplification and the second one being absence of oscillation. Of course, to gain these two points, complete shielding is imperative.

In presenting our January issue the editors believe a wide range of subjects has been covered in our construction articles. We are always glad to have the benefit of suggestions from our readers as to the manner of presentation of these articles.

—EDITOR.

Copyright, 1928, by Citizens Radio Service Bureau, Incorporated, Publishers. Requests for permission to reprint any articles or other matter contained herein must be made in writing to the executive offices.

Citizens Radio Call Book Magazine is published four times a year and is on sale approximately the first of January, March, September and November. Subscription price \$1.75 per year in U. S. A. Canada and Foreign \$2.00 per year, payable in advance. Single copies 50 cents. Remit by check, draft or P. O. order. No foreign stamps or coins accepted. Mail subscriptions to 508 So. Dearborn Street, Chicago. We will not be responsible for cash sent for subscriptions unless registered.

Citizens Radio Call Book Magazine is for sale on all newsstands in the United States and Canada; also Department Stores and Book Stores; also can be purchased in most radio stores. Paris, France, Brentanos, Ave de L'Opera. England, R. A. Rothermel, Ltd., 24-26 Maddox St., Regent St., London. and W. H. Smith & Sons, London. Australia, McGills Agency, 179 Elizabeth St., Melbourne.

We also publish Citizens Radio Amateur Call Book, tri-annual, \$1.00 per copy, foreign \$1.10, listing all amateur transmitting stations in the world. Subscription price, \$2.50 yearly, foreign \$2.75. Published September, December and March.

### Advertising Representatives:

Chicago—A. B. Mills, E. E. Hayes, 508 So. Dearborn St. Wabash 1901.  
 New York—(Branch Office) 1674 Broadway, Columbus 4693. Cor. 52nd St.

Entered as second class matter March 17, 1927, at the Postoffice at Chicago, Illinois, under the act of March 3, 1879



# New Bremer-Tully Products Command Attention

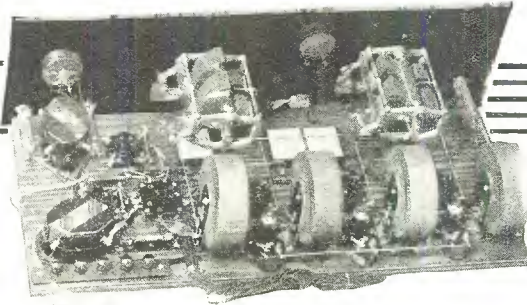

## Power Six "Electric"

## Uses New AC Tubes

The B-T Power Six, unsurpassed for three years, is now **wonderfully improved**. It was the **first circuit** to use **three stages** of tuned R. F. successfully. It has proved the best.

The new "Power-Six-Electric" uses the new AC tubes. The improved "Power-Six '28" operates on DC with regular tubes.

Complete diagrams for changing present Power-Six to AC, or building either set new (specify P-6-Electric or P-6-'28).....\$1.00

Price of AC Kit.....\$42.00  
Price of DC Kit..... 41.50

The new B-T Audio Coupler explodes an old theory—it proves a B-T claim that "amplification curves," as a basis for comparison were never anything more than a minor factor.

"Harmonic Distortion," the real cause of poor tone, is entirely eliminated in this new Audio Coupler.

**It is more than a transformer—and better!**

A "constant-impedance" core—an air gap—tertiary loading coil—and finest laminations, combine to produce **QUALITY UNEQUALLED** anywhere, regardless of size or price.

Read more in "Better Tuning"—see coupon.

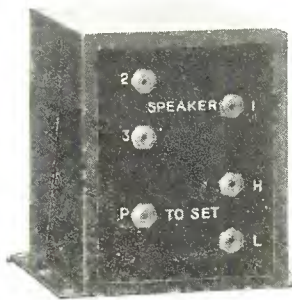

### Speaker Coupler

The new B-T speaker coupler protects your speaker and prolongs its life. Connects between power tube, and speaker without tools.

A necessity with 171 or larger tubes. Gives wonderful improvement in tone quality. This is the same as used in Bremer-Tully's finest Counterphase receivers.

Price .....\$7.50

### B-T Audio Couplers

Two types; 3-31 for first stage; 2-22 for second stage, or for all stages when three stages are used, as in replacing resistance or impedance coupling.

Price.....\$6.00 each

*If your local dealer cannot supply B-T parts, send your order direct to us*

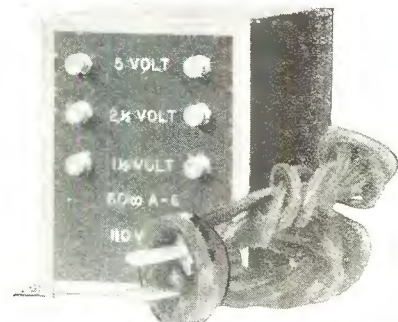

### "A" Transformer

For AC Power-Six "Electric." Eliminates battery and charger. Plugs into light socket. Everything, including phonograph, controlled from panel switch.

Price .....\$7.50

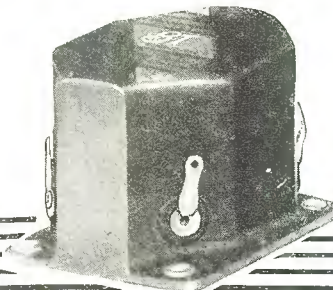

### "Better Tuning"

A booklet of 80 pages, answering the latest questions on radio, free upon request.

**SEND THE COUPON!**

**Bremer-Tully Mfg. Company**  
520 South Canal St. Chicago, Ill.

*Please send 80-page booklet.*

Name.....  
Address.....  
I am a Dealer..... User.....  
CR Interested in Kit..... Parts..... Sets.....





Samson Power Block No. 210. The only block which will supply 500 volts at 80 miles to two 210 tubes

## Powerize with Samson Units for Best Results

For new SAMSON Power Units insure the best there is in radio current supply by

1. Doing away with hum, motor boating and poor voltage regulation.
2. Remaining so cool after 24 hours continuous operation under full load that they will be well within the 20° rise of temperature specified by the A. I. E. E.
3. Being designed to more than meet the specifications adopted by the National Board of Fire Underwriters.
4. Insuring safety against shock because of protected input and output terminals.
5. Insuring for all tubes the correct filament voltages specified by their manufacturers.
6. Compensating for lighting circuit voltage variation by the use of a special input plug and terminal block to which is attached a 6 ft. flexible rubber-covered connecting cord and plug.
7. Being more economical in operation than other units of similar power rating.
8. Living up to the name plate rating.

*Limited space prevents us from listing the fourteen types that we make. Our Power Units bulletin, descriptive of these, is free for the asking. In addition, our construction bulletin on many different "B" Eliminators and Power Amplifiers will be sent upon receipt of 10c in stamps to cover the mailing cost.*

**Samson Electric Co.**

MANUFACTURERS SINCE 1882  
Canton, Mass.

*Tell 'Em You Saw It in the Citizens Radio Call Book Magazine*



# Now You Can Build

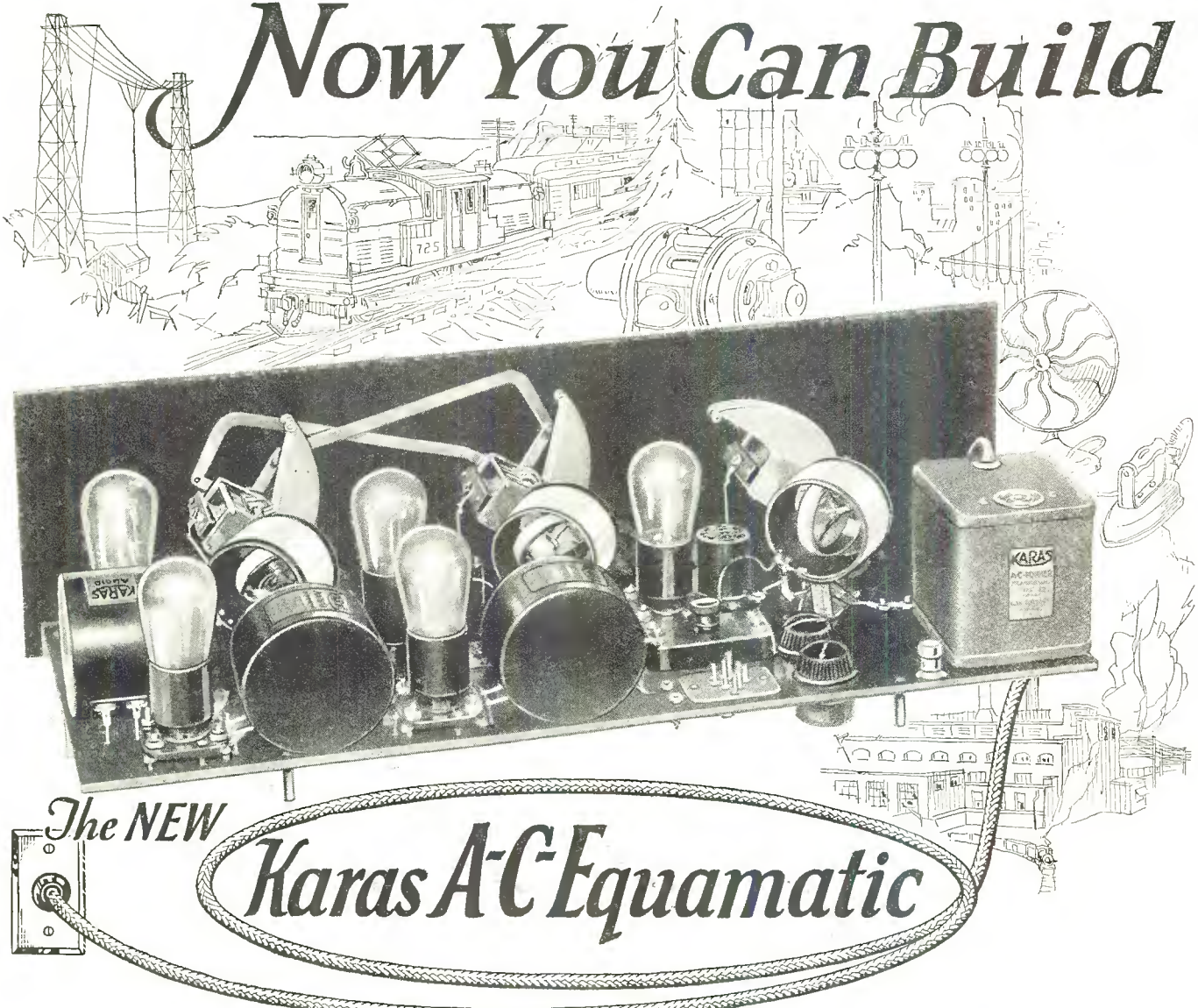

The NEW

## Karas A-C-Equamatic

It operates from any 110-volt A. C. light socket

Associated  
Manufacturers



**T**HE new Karas A-C-Equamatic is the only completely balanced and perfectly neutralized 5-Tube A. C. Kit using standard Cunningham, RCA or CeCo 1½ volt, 2½ volt and 5 volt A. C. tubes. All of the "A" filament supply for this marvelous new set is furnished by the new Karas A-C-Former Filament Supply, Type 12. Those who build this great receiver will have a set that is two years ahead of them all!

The Karas A-C-Equamatic does away with all need for "A" batteries and chargers, the Karas A-C-Former providing a constant, noiseless and unvarying filament supply of correct potential for each of the A-C Tubes used in the set. And this is accomplished without the sacrifice of a particle of the matchless tone, remarkable selectivity, splendid distance-getting qualities and tremendous volume for which the Karas 2-Dial Equamatic has become famous.

The Karas A-C-Equamatic is the perfected product of the Karas Engineering laboratories, utilizing Karas parts in association with other standard parts of the Affiliated Manufacturers who have cooperated with Karas to make this great receiver what it is—the A-C-E of A-C operated sets. Because of this fact you will find this receiver extremely easy to build. It utilizes a Type 227 or 327 2½ volt A. C. detector tube, three Type 226 or 326 A-C 1½ volt amplifier tubes and a Type 171 or 371 5-volt output amplifier tube, all receiving their current supply from the house lighting circuit through the Karas A-C-Former Filament Supply.

Build this great receiver! Enjoy its freedom from "A" Battery and charger troubles! Enjoy its tone, its volume, its selectivity and simplified control. Write us TODAY for full size wiring diagrams and complete instructions, which we mail FREE on request. Begin to build this matchless A-C-Equamatic right away.

Send for Testimonial Letters Supplying Convincing Proof of the Results Achieved by This Receiver

**Karas Electric Company**  
PRECISION ELECTRICAL APPARATUS  
4026-A North Rockwell Street · Chicago



# Easy to Build.... A Marvelous Unit!

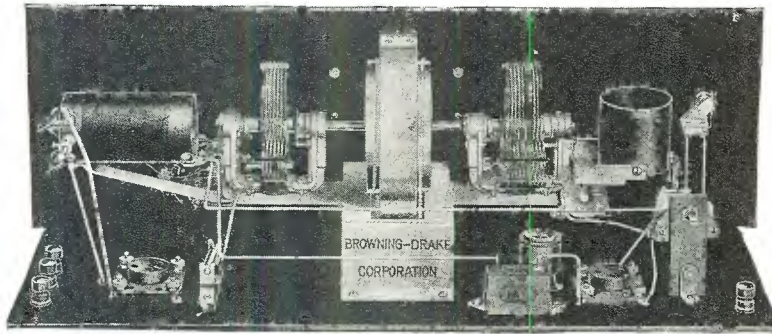

## The New Official Browning-Drake Two Tube Tuner AC or Battery Operated—Single Control With Illuminated Drum Dial Completely Shielded

**B**ROWNING-DRAKE fans throughout the world are welcoming the new Official Drum Dial BROWNING-DRAKE Kit now ready for distribution. Our engineering staff has developed in this new kit the foundation for building one of the most dependable sets ever assembled. Single dial illuminated drum control is used, which is operated by a knob below the dial and functions without the slightest trace of backlash. Other up-to-the-minute refinements in set engineering are incorporated in this new assembly. It presents a pleasing appearance, and its performance is, in every way, worthy of the name—BROWNING-DRAKE.

A new five-tube assembly has been designed

by Prof. Browning to be used with this new unit. The two-tube assembly (pictured above), when used with the Acme Power Amplifier or other dependable power apparatus, makes an excellent combination.

New construction booklets covering the assembly of these new units are now available either from your dealer, or direct, for 25c.

### NEW BROWNING-DRAKE PARTS

Official Single Dial Drum Kit.....	\$26.00
Foundation Unit for 5-tube assembly.....	16.50
Foundation Unit for 2-tube assembly.....	13.00
Complete shielding assembly.....	8.00

Browning-Drake Corporation  
CAMBRIDGE      --      MASS.

**BROWNING**  
TRADE MARK  
**DRAKE**

CABINETS PARTS      RECEIVERS KITS

Tell 'Em You Saw It in the Citizens Radio Call Book Magazine



# After Combing the Entire Field Browning-Drake Decided on ACME

**B**ROWNING-DRAKE have completed a new A.C. operated tuner which incorporates many important advancements. Naturally, they wanted the best A.C. amplifier that could be obtained to go with their tuner. Therefore, they chose the new Acme amplifiers on which we have just finished research and which give volume and quality such as never before believed possible in Radio.

These new amplifiers, which can be added to any set, are described elsewhere in this magazine as used with the new Browning-Drake A.C. tuner. You may choose the circuit best adapted to your requirements and after adding it to the new Browning-Drake A.C. tuner or after your present tuner you will have an amplifier which will enable you to get more amplification without distortion than ever before and radio will take a more important part in your entertainment than ever before.

The tapped transformers and impedance output devices are new Acme products which are the result of Acme's constant efforts toward Amplification Without Distortion.

All Acme apparatus is guaranteed free from defects in material and workmanship and is manufactured in a modern plant by experts long in the employ of the company.

Send the coupon below and ten cents in stamps or coin for your copy of our new booklet combining "Amplification Without Distortion" and "Power Supply for Radio Sets" which contains new and valuable information.

# Iron and Wire Plus

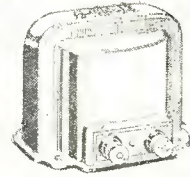

All Transformers have iron and wire. But Acme Transformers have iron and wire "Plus"

The Acme "Plus" makes Acme Transformers stand up in oil burners and neon signs as well as radio sets.

*Insist on  
Acme Transformers*

*Insist on  
Acme Transformers*

It's the "Plus" that distinguishes the Acme Transformers—engineering research, brains, years of experience.

Skilled workmen, superior factory equipment, and scientific experiment have made it worth your while to—

*Insist on  
Acme Transformers*

*Insist on  
Acme Transformers*

# ACME TRANSFORMERS

## LIST OF PARTS FOR A. C. AMPLIFIERS

- Parts Required. Circuit No. 1**
- 1 Acme AC-2 transformer.
  - 1 Acme MA-2 transformer.
  - 1 Acme Z-3 unit.
  - 3 Sockets.
  - 1 Daven No. 42 Resisto-coupler.
  - 1 Tobe .00025 M.F. condenser.
  - 2 Grid leak mountings.
  - 2 50,000 ohm Bradley units.
  - 1 200,000 ohm Bradley unit.
  - 1 500,000 ohm Bradley unit.
  - 2 Tobe 1 M.F. Condensers.
  - 2 30 ohm rheostats (to be connected as potentiometers).
  - 2 2,000 ohm rheostats.
  - 8 Binding posts.
  - 1 Baseboard 9"x8"x 1/2".

- Sheet iron for shielding .020" thick.  
2 UX-226 tubes.  
1 UX-171 tube.

- List of Parts. Circuit No. 2**
- 1 Acme AC-2 transformer.
  - 2 Acme Z-3 units.
  - 1 Acme PT 1 audio transformer.
  - 1 Acme PT 2 audio impedance.
  - 4 Sockets.
  - 2 30 ohm rheostats (to be connected as potentiometers).
  - 2 2000 ohm rheostats.
  - 2 Tobe 1 M.F. condensers.
  - 2 50,000 Bradley units.
  - 2 Grid leak mountings.
  - 1 Tobe .00025 M.F. fixed condenser.
  - 8 Binding posts.

- 2 UX-226 tubes.
- 2 UX-171 tubes.
- 1 Baseboard 14"x8"x 1/2".
- Sheet iron .020" thick, for shielding.

- \*Parts Required. Circuit No. 3**
- 2 Acme Z-3 units.
  - 1 Acme PT 1 audio transformer.
  - 1 Acme PT 2 audio impedance.
  - 4 Sockets.
  - 3 Grid leak mountings.
  - 3 50,000 ohm Bradley units.
  - 8 Binding posts.
  - 1 .00025 M.F. condenser.
  - 2 Tobe 1.0 M.F. condensers.
  - 1 30 ohm rheostat (to be connected as potentiometer).
  - 1 300 ohm potentiometer.

- 2 2000 ohm rheostats.
- 1 Baseboard 14"x8"x 1/2".
- Sheet iron for shielding, .020" thick.
- 2 UX-226 tubes.
- 2 UX-210 tubes.

- \*Parts Required. Circuit No. 4**  
(Power supply for circuit No. 3.)
- 1 Acme AC-2 transformer for heating filaments of UX-226 tubes.
  - 1 Acme BI-1 transformer.
  - 2 Acme B-2 20 henry choke coils.
  - 2 UX-281 rectifier tubes.
  - 2 Sockets.
  - 6 Tobe 2 M.F. 1000 volts filter condensers.
  - 1 Baseboard 24"x11"x 1/2".

\*As used with the new Browning-Drake tuner.

# ACME for amp ification

Acme Apparatus Corp., Dept. P.A., Cambridge, Mass.

Gentlemen: Please find enclosed ten cents in (stamps) (coin) for which please send me my copy of the new Acme booklet, "Amplification Without Distortion and Power Supply for Radio Sets."

Name.....

Address.....

City.....State.....



Look for the  
ACME Head



# Abox

## "A" BATTERY ELIMINATOR

Licensed by The  
Andrews-Hammond  
Corporation, under Pat-  
ent No. 1,637,  
795 and appli-  
cations

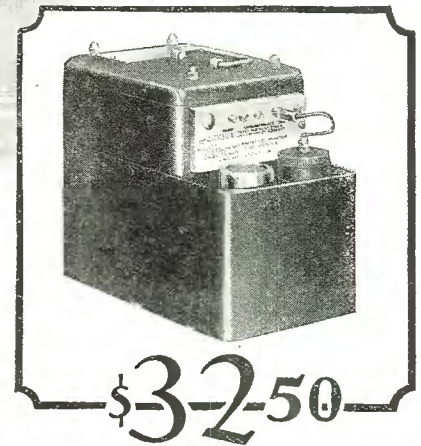

**\$3-2-50**

Input—110 volts, 50-60 cycles A. C.  
Output—6-volts D. C., 2 amperes.  
This model will operate any set using eight  
or less standard 6-volt tubes. Not necessary  
to change wiring set.

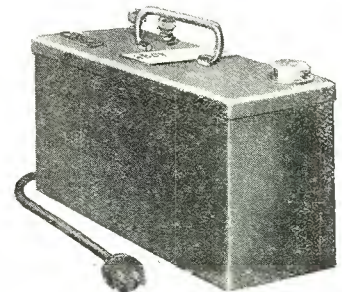

Four-volt model for sets using 4-volt  
tubes. Fits Radiola battery com-  
partment. Size, 8 $\frac{3}{4}$  inches long, 4  
inches wide, 6 $\frac{1}{2}$  inches high. Out-  
put—6 amperes, 4 volts D. C. Price

**\$27<sup>50</sup>**

All prices slightly higher on West Coast

It is significant that Abox is highly regarded and widely used among set-builders and experimenters. They are quick to recognize a good thing, quick to make use of it and glad to pass the good word along.

Abox is a true "A" Eliminator. It contains no battery. It consists of a rectifier and a filter which uses two electrolytic condensers. Abox uses electrolytic condensers because experience has shown that it is the best and most satisfactory method.

Liquid is absolutely necessary to secure the regulating characteristics and dependability so necessary in a satisfactory "A" Eliminator.

Let the experience of over 100,000 users guide you in the selection of an "A" Eliminator to electrify your own receiver.

Send for free reprints of construction article on  
A BC Eliminator and power amplifier using Abox

## The Abox Company

215 North Michigan Avenue

Chicago, Illinois

Tell 'Em You Saw It in the Citizens Radio Call Book Magazine



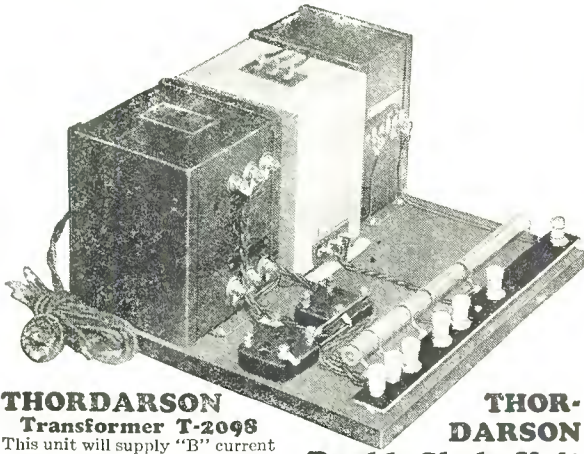

**THORDARSON Transformer T-2098**

This unit will supply "B" current to any receiver, and at the same time provide A, B, & C current for either a single transformer coupled stage of 210 power audio, or a stage of Push-Pull Audio using two 210 power tubes. The T-2098 makes up into a full wave rectifying system employing two UX-216B or two UX281 rectifying tubes and has a total output of 130 milliamperes at 450 volts.

**THORDARSON Double Choke Unit T-2099**

Consists of two individual 30 Henry chokes, each of 130 milliamperes current capacity, permanently mounted together in an hermetically sealed steel case. Makes the ideal filter system for heavy current requirements.



**Filter Condensers**

Condensers of exceptional quality and electrical durability are required to withstand the load imposed upon them by this "B" supply. TOBE Condensers suit the requirements perfectly, and are therefore recommended.

**Carter Resistances**

Entirely overcome the difficulty of inconsistency with which builders have had to deal in the past when working with high voltage, heavy current "B" supply devices. Carter No. S20 Vitreous Enamel Resistance is calibrated to give the exact required voltages for each tap to the Scott World's Record Super 10.

# The Magnificent TONE

and Superb Volume of this amazing receiver made possible by

- SCOTT -

# THORDARSON

## POWER SUPPLY EQUIPMENT

As explained on the next page, a 210 power tube is necessary for the proper handling of the large out-put of the Scott World's Record Super 10.

The incorporation of a 210 power tube in this or in any other receiver immediately demands that the very finest type of "B" supply equipment be used.

Exhaustive tests made with various types of transformers, chokes, and filter condensers put THORDARSON

and TOBE units in the position of unquestionable superiority.

The "B" supply illustrated above provides an abundance of current for the operation of the Scott World's Record Super 10, including the high voltage, heavy current drain of the 210 Power Tube. Mail the coupon at once for full particulars of this better, advanced type "B" supply, including construction details.

# The Scott World's Record Super 10

~and put your Phonograph Music thru the World's Record Super 10 with a

## UNITED ELECTRIC PICK-UP

The United Electric Pick-Up, sets a new standard in the electrical reproduction of recorded sound. Compare it in operation with any that you will. As you listen, you will find yourself saying, "Here is something more, something finer and better than the industry has seen before." You will appreciate the fact that United Engineers have gone beyond the beaten path and opened for you even greater wonders in

the field of electrically-reproduced sounds. You will marvel at the small compact design of the United Pick-Up—its beauty of form and finish—its light weight which means long life for your records—its dust-proof, trouble-proof construction, which insures many years of unflinching service. Richly finished in gold, silver or bronze, it matches in appearance any set on which it may be used.

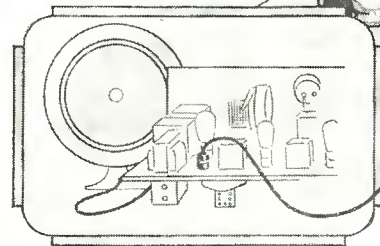

The United Electric Pick-Up electrically transmits the sound vibrations from the phonograph record to the power audio system in the World's Record Super 10 (or any other set) by simply plugging the connecting cord into the detector socket in the set. Phonograph music is reproduced by this unit with new brilliance, naturalness, color and volume through your speaker. Mail coupon at once for full particulars.

All about the World's Record Super 10 on the next three pages



**SCOTT TRANSFORMER CO., 7620-26 Eastlake Terrace, Chicago**

**MAIL THIS COUPON NOW**

Send me full particulars of

THORDARSON HEAVY DUTY "B" SUPPLY

UNITED ELECTRIC PICK-UP

NAME \_\_\_\_\_

ADDRESS \_\_\_\_\_

CITY \_\_\_\_\_

STATE \_\_\_\_\_

Tell 'Em You Saw It in the Citizens Radio Call Book Magazine



9400 MILES

AUSTRALIA  
PERTH

CHICAGO  
U.S.A.

# Build the 94000

You cannot possibly have any conception of the power of the Scott World's Record Super 10 until you spend a few minutes at its dials. Stations which you have heard in whispers on other sets, this receiver brings in with full, lifelike volume.



MR. E. H. SCOTT

## Read What Builders of This Set Say

"I can tune in nearly any station in Canada or any place in the United States consistently and at will, without interference from other stations."—Adrien Goulet, Montreal.

"The tone is beautiful and for DX reception no other Super I have built or heard can compare with it."—Dr. Louis Schulze, Chicago.

"Received 6. W. F. of Perth, Australia, June 25th with plenty of volume. Also have received J. O. C. K., Japan."—Virgil C. Zeis, Chicago.

"Tone is wonderful; volume enough to rattle the windows on DX like K. F. I., K. G. W., etc. The whole city is talking about it."—Albert K. Saylor, Monessen, Pa.

"I can tune in station K. F. I. every evening after 9:30 p. m. having no interference from local stations and with volume equal to local stations."—W. H. Hollister, Chicago.

### VERIFIED RECORDS

- 8,375 Miles**  
1. On March 17th World's Record for loop aerial reception—8,375 miles with Loud Speaker Volume.
- 9,400 Miles**  
2. On June 25th Scott World's Record Super, located in Chicago received 6 W.F., PERTH, Australia, 9,400 miles away.
- 6,000 Miles**  
3. On March 29th established new World's Record with reception of six foreign stations distant 6,000 miles or more.
- 6,000 Miles**  
4. Established new World's Record for greatest number of broadcasting stations heard, located 6,000 or more miles away.
- 6,000 Miles**  
5. Established new World's Record for most consistent reception of stations 6,000 miles or more distant—117 programmes from 19 different Foreign Stations between December 27th and April 10th.

## I GUARANTEE That the Set You Build Will Be Every Bit as Good as My Laboratory Model

The Scott World's Record Super 10—the set which eclipsed all previous radio performance standards was not a freak. Evidence of this—and proof that the set you build will do every bit as much as my laboratory model, is the fact that builders in all parts of the country report new and greater distance records every day. Every Scott World's Record Super 10 *should* be as good as my laboratory model, because the vital parts of each kit are all matched to the laboratory standard, and the plans I furnish are so complete, precise and so easily understood that error is practically impossible.

Build the Scott World's Record Super 10 and you will have a receiver which is years ahead of the present day com-

mercial conception of radio. Build this set and be the proud owner of the very finest receiver in your community. Real Distance—real Selectivity—and the tonal advantages of high voltage power tube amplification will all be yours in a combination that no other receiver can even approximately approach. Mail the coupon right now for the whole story of the Scott World's Record Super 10.

# The SCOTT WORLD'S

MADE AVAILABLE TO YOU THRU THE COOPERATION

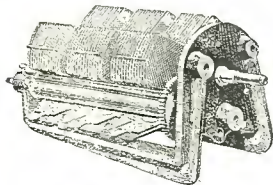

**REMLER 3-IN-LINE**

Mechanically, and from the standpoint of efficiency in the handling of radio frequency currents, the REMLER 3-IN-LINE is the last word in gang condenser construction. Staggered connection of plates shields each stator section, one from the other. Balancing condensers are integral with the main unit and are easily and quickly adjusted.

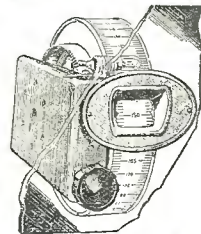

**REMLER DRUM DIAL**

A precision product in every sense, reflecting in each detail of construction, the best in engineering and manufacturing practice. So designed that it is easily and quickly attached to any standard condenser, providing very smooth condenser control. Calibrated from 0 to 200 over the whole of its 360 degree surface. Handsome bronze panel face plate furnished with each unit.

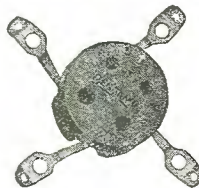

**BENJAMIN SOCKET**

Spring cushioned, and hence completely shock-absorbing. Eliminates much tube noise and micropbonic howl. Also greatly increases tube life by preventing jarring and consequent cracking of hot filaments. Made of genuine bakelite, and so fashioned that tube contacts are positive at all times.

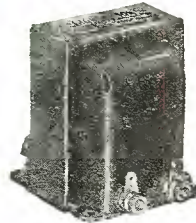

**Thordarson R-200 Audio**

Every test reveals the undisputed supremacy of Thordarson amplifying transformers. The pair of R-200 Thordarson's which are called for in the specifications of the Scott World's Record Super 10, will correctly amplify throughout the whole musical range, every audible frequency which the broadcasting station itself is able to register. To the "tweet" of the highest flute note and the "zoom" of the cello, the Thordarson R-200 instantly responds. A Thordarson R-76 out-put transformer is also specified.

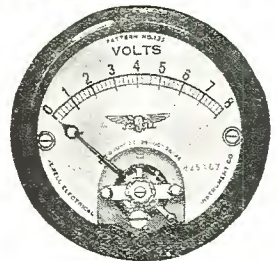

**Jewell Voltmeter**

In the careful selection of parts and accessories for the New World's Record Super 10, it is quite natural that a Jewell Pattern No. 135 Radio Voltmeter should be chosen. The black enameled case encloses a fine, D'Arsonval, moving coil type movement, having silvered parts and equipped with a zero adjuster. The scale is silver etched with black characters.

Tell 'Em You Saw It in the Citizens Radio Call Book Magazine



# Mile Receiver!

**The First Set to really Combine Extreme Distance ~ actual 10 Kilocycle Selectivity and absolute realism in Reproduction**

The Scott World's Record Super 10 exceeds all present day standards of receiver performance. Positively nothing else is like it. Distance? The whole world seems to be on its dials! Volume? More than enough to fill a concert hall! Tone? Absolute realism—full, round, natural!

Beyond all doubt, this receiver has been the subject of more enthusiastic interest than any other ever built. It made its first bid for fame by establishing the world's long distance record for loop aerial reception—8357 miles. Since then it has piled up a host of records which would be unbelievable were it not for the authentic verifications at hand.

up to terrific volume by the amplification system of the Scott World's Record Super 10. And for much the same reason, this amazing receiver provides actual 10 Kilocycle selectivity no matter where it is located. The intermediate amplifier is peaked to pass only a 10 Kilocycle band, and the two tuned stages which feed it, pre-sharpen the signal to a point well within the 10 Kilocycle limit irrespective of the signal's strength at the time of input. Indeed, there has never before been such a receiver as the Scott World's Record Super 10—never before such power—never before such selectivity. No wonder it is the favorite in districts where broadcasting is congested. No wonder it is the favorite with those who feel that nowhere in the world is there a station too far away to get!

## Easy to Build in a Few Hours

The completeness of the Scott World's Record Super 10 is the main reason for its extreme efficiency. There is a great deal to this receiver. It embodies every known facility for conserving and using the bits of energy that other receivers waste. Complete though it is—complicated as it may appear, it nevertheless is so simple to build that the most inexperienced novice can put it together quickly—and with assurance of results beyond his fondest expectations.

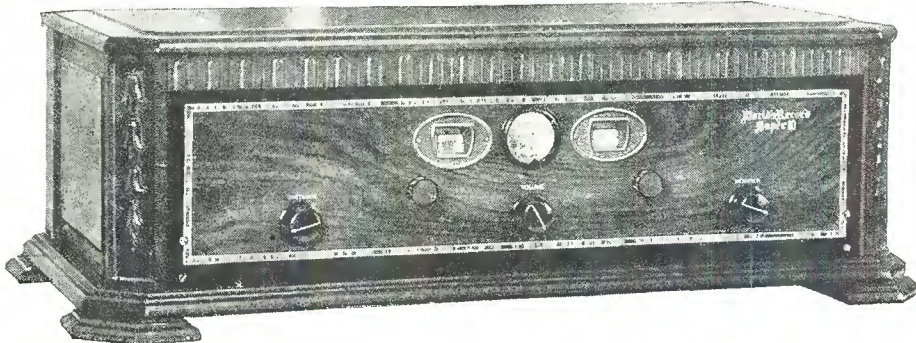

## Super Power Audio

Most naturally nothing less capable than power audio amplification could handle the second detector output of the Scott World's Record Super 10. This was a foregone conclusion at the time this receiver was designed, and it was found, that not only was a power tube necessary, but that a 210 power tube—and only a 210 would handle all that this receiver could feed to it. Result! Clear, pure undistorted volume limited only by the size and capability of the speaker used.

## Two Stages of Tuned R. F. for Correctly Amplified Input and Additional Selectivity—and Three Stages of Long Wave R. F. for Power and Extreme Sensitivity

Most superheterodyne receivers depend solely upon the intermediate amplifier for radio frequency amplification. The Scott World's Record Super 10 has two stages of high-gain tuned radio frequency amplification preceding its intermediate amplifier. Hence, the signal fed into its intermediate amplifier, instead of being merely the weak impulse picked up by the loop, is as strong as the output signal of a highly efficient 5 tube tuned radio frequency set. The signal is then tremendously amplified in the long wave amplifier, the output of which, therefore, is most naturally many, many times greater than usually obtained from other types of superheterodyne receivers. Power? Signals barely audible are built

## FREE CIRCUIT DIAGRAM and Full Particulars

The far superior performance of the Scott World Record Super 10 is not happenstance. It is the direct result of coordinating many new and advanced engineering features in circuit and vital-part construction. Hence, the whole detailed story of the Scott World's Record Super 10 is one of the most enlightening radio stories ever written—and of vital, intense interest to you, whether you have a radio or not. Mail the coupon and we will send you absolutely FREE, complete circuit diagram and full constructional information. Mail the coupon Now. No Obligation.

# RECORD SUPER 10

## OF THESE LEADING PARTS MANUFACTURERS—



**Tobe Condensers**  
The quality of by-pass condensers is of far more importance than the average set builder thinks. Too often, troubles which the builder cannot locate are to be found in the by-pass condensers. Hence, to insure year after year of quiet, efficient condenser performance in the Scott World's Record Super 10, TOBE Condensers were specified. These condensers, being better designed and better made of better materials, are certain in their action.

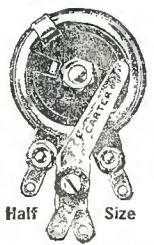

**Carter Rheostats**  
Chosen for their unmistakable quality, smooth operation and compactness. The Carter Rheostat is an engineering masterpiece. It fits snugly up against the panel. Its sliding arm moves smoothly and its contact is so positive that filament temperature variation is accomplished without even the slightest suggestion of attendant noise. Air cooled.

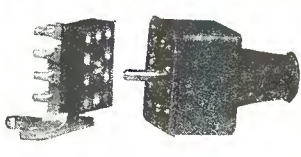

**Jones Multi-Plug and Cord**  
The Jones 10 Contact Multi-Plug and Cord is, beyond all doubt, the finest way to connect batteries to a set, that has ever been devised. Easier and quicker than binding posts to install, all the lead wires are in one compact, neat looking braid covered cable; contacts are always tight and all the batteries can be instantly disconnected from the set by merely pulling the plug. The cable and the unit which mounts onto the set are color coded to prevent mistakes, and the plug is keyed so it can go in the right way only.



**Selectone Transformers**  
SCOTT Selectone Long Wave Transformers are, as laboratory tests reveal, the most efficient units of their type ever produced. They afford maximum selectivity and amplification and at the same time pass the full musical band, thereby assuring perfect tonal reproduction. Laboratory matched into kits and guaranteed to hold their ideal characteristics against time.

### MAIL COUPON NOW

SCOTT TRANSFORMER CO.  
7620-26 Eastlake Terrace  
Chicago, Ill.

Send me FREE Circuit Diagram and full particulars of the Scott World's Record Super 10.

Name.....

Street.....

City.....

State.....

Tell 'Em You Saw It in the Citizens Radio Call Book Magazine



# These JOBBERS CARRY COMPLETE KITS FOR

## The Scott World's Record Super 10

### CALIFORNIA

Radio Supply Co., 920 Broadway, Los Angeles, Calif.  
Offenbach Electric Co., 1452 Market St., San Francisco, Calif.  
J. C. Rendler, 625 S. Main St., Los Angeles, Calif.

### DISTRICT OF COLUMBIA

Star Radio Co., 409 11th St. N.W., Washington, D. C.  
J. C. Rau, 524 12th St. N.W., Washington, D. C.  
Radio Auto Supply, 1305 S St. S.E., Anacostia, D. C.

### CONNECTICUT

Post & Lester, 33 Allyn St., Hartford.

### ILLINOIS

Harry Alter Co., 18th & Michigan, Chicago, Ill.  
W. C. Braun Co., 563 W. Randolph, Chicago, Ill.  
Chicago Salvage Stock Store, 509 S. State St., Chicago, Ill.  
Columbia Radio, 711 W. Lake, Chicago. Electric & Radio Supply, 165 N. Wells St., Chicago, Ill.  
Hudson Ross, 116 S. Wells, Chicago, Ill.  
Miller Welles, 20 W. Kinzie St., Chicago.  
Inland Electric Co., 20 S. Wells, Chicago.  
Harco Company, 1255 S. Wabash, Chicago, Ill.  
New England Mills, 849 W. Washington, Chicago, Ill.  
Nelson Electric, 508 S. Dearborn, Chicago.  
Newark Electric, 226 W. Madison, Chicago, Ill.  
National Radio, 227 W. Madison, Chicago.  
Telephone Mtc. Co., 123 S. Wells, Chicago, Ill.  
Western Radio, 128 W. Lake St., Chicago.  
Walter Rowan, 229 S. Peoria St., Chicago, Ill.  
Shure Radio Co., 19 S. Wells, Chicago, Ill.

### INDIANA

Kruse Connell Radio, 33 W. Ohio, Indianapolis, Ind.  
Cummins Bros., 34 W. Ohio, Indianapolis,

### IOWA

The Sieg Company, Davenport, Iowa.

### MICHIGAN

Detroit Electric Co., 111 E. Jefferson, Detroit, Mich.  
Koploy & Ross, 1306 Randolph St., Detroit, Mich.  
Serlin & Company, 1419 Broadway, Detroit, Mich.

### MASSACHUSETTS

Electrical Sales Co., 271 Franklin St., Boston, Mass.  
Sager Electrical Supply Co., 201 Congress St., Boston, Mass.

## Set Builders!

The World-Wide Popularity of this receiver offers you an exceptional opportunity

The Scott World's Record Super 10, as many set builders know, is without a precedent in popularity—in its class.

The results that this receiver never fails to deliver make the Scott World's Record Super 10 Kit the best proposition you could possibly tie up with. Obtain it from any of the jobbers listed on this page—or direct your inquiry to us, signifying your favorite jobber. Pin the coupon below to your letterhead and MAIL NOW.

Sager Electrical Supply Co., 349 Worthington, Boston, Mass.  
F. D. Pitts Co., 219 Columbus Ave., Springfield, Mass.  
U. S. Radio Corp., 320 Dwight St., Springfield, Mass.  
Sager Electrical Supply Co., Worcester.

### MARYLAND

Star Radio Co., 106 N. Howard, Baltimore, Md.  
Jos. M. Zamviski, 111 W. Redwood, Baltimore, Md.

### MINNESOTA

Minnesota Roycroft Co., 21 N. 3rd St., Minneapolis, Minn.

### MISSOURI

American Auto & Radio Mfg. Co., 1416 McGee St., Kansas City, Mo.  
Kansas City Radio Co., 1314 McGee St., Kansas City, Mo.  
Walter Ashe Radio Co., 211 N. 10th St., St. Louis, Mo.  
Van Ashe Radio Co., 10th and Pine, St. Louis, Mo.  
James C. Gordon, Inc., 1213 Pine St., St. Louis, Mo.

### NEBRASKA

Radio Apparatus Co., 1109 Farnam St., Omaha, Neb.

### NEW YORK

Wholesale Radio Service Co., 6 Church St., New York City.  
Allen Rogers Madison, 35 W. 31st St., New York City.  
S. Hammer Radio Co., 303 Atkins Ave., Brooklyn, N. Y.

Barclay's, Inc., Main and Goodell Sts., Buffalo, N. Y.

### OHIO

Aitken Radio Co., Superior at Jackson, Toledo, Ohio.  
I. J. Cooper Rubber Co., 142 E. Gay St., Columbus, Ohio.  
Hughes Petcrs Rubber Co., 104 E. Long St., Columbus, Ohio.  
Cingel Radio, 217 W. 5th St., Cincinnati.  
I. J. Cooper Rubber Co., Cincinnati, Ohio.

### OKLAHOMA

Southern Sales Company, 320 Third St., Oklahoma City, Okla.

### OREGON

Stubbs Electric Co., 75 Sixth Ave., Portland, Ore.

### PENNSYLVANIA

Anchor Lite Appliance Co., 330 Blvd. of Allies, Pittsburgh, Pa.  
Keystone Radio Co., 640 Grant St., Pittsburgh, Pa.  
Keystone Radio Co., 111 N. 4th St., Philadelphia, Pa.  
Lewis Radio Jobbers, 45 N. 7th St., Philadelphia, Pa.  
M & H Sporting Goods Store, 512 Market St., Philadelphia, Pa.  
U. S. Radio Corp., 134 9th St., Pittsburgh.  
Eugene G. Wile, 7 N. 10th, Philadelphia.

### RHODE ISLAND

Reliable Supply Co., 19 Broad St., Providence, R. I.

### WASHINGTON

Oxo Radio Mfg. Co., 1023 Third Ave., Seattle, Wash.

### WISCONSIN

Radio Parts Co., 309 State St., Milwaukee, Wis.  
Samson's, 219 W. Water St., Milwaukee.

### CANADA

Aikenhead Hardware, Ltd., 17-21 Temperance St., Toronto, Canada.  
Radio Sales Service, 171 Cordova St. W., Vancouver, B. C.

### ENGLAND

R. A. Rothermel, Ltd., 22 Maddox St., London, England.

**SET BUILDERS! MAIL THIS**  
SCOTT TRANSFORMER CO., 7620-26 Eastlake Terrace, Chicago, Illinois  
Send Set Builders' proposition on Scott World's Record Super 10

NAME \_\_\_\_\_  
STREET \_\_\_\_\_  
CITY \_\_\_\_\_  
STATE \_\_\_\_\_

Write favorite jobber's name and city in the margin

**SCOTT TRANSFORMER COMPANY**  
7620-26 Eastlake Terrace • Chicago, Ill.





J. L. Karas—A. C. Equamatic and Knickerbocker 4

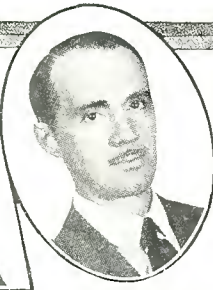

Robert St. James St. James Twin Four



Citizens Radio Call Book



Arthur Lynch All Models



E. H. Scott—World's Record Supers. Eight, Nine, and Ten



Herman Bernard—Man's Editor "Radio World"



Merwyn Heald Hot-Spot 14

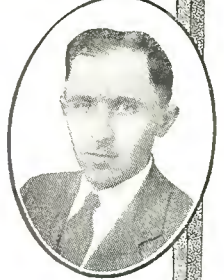

Ernst Tyrman Tyrman 10 and 70



T. H. H. Naken Ultra-5



Harry Madison Madison-Moore International

These—and a host of other world famous radio engineers and designers recommend and

# Specify LIGNOLE RADIO PANELS

"The Professional Builder's Choice" for Custom Built Sets

LIGNOLE panels are made of genuine woods, 5 ply laminated construction and finished either plain or in two-tone. The two-tone panels have a darker border separated from the body of the panel by a small vein or by a beautiful inlaid Marqueterie. This finish produces a panel that will blend and harmonize with any style or make of cabinet in which it is placed. As a di-electric, there is no better panel material obtainable. It is extremely rigid and will not warp.

## Lignole Two-Tone Kit Panels

Drilled and Lettered

These panels are the same as the inlaid panels except that they have a narrow vein or line substituted in place of the Marqueterie. Panels are furnished either Walnut or Mahogany.

(All Panels 3/16-in. thick)

	List		List
St. James Twin 4	7x21 \$5.00	Magnaformer	7x26 \$6.00
Victoreen Universal	7x26 6.00	Karas A. C.	7x24 5.50
Madison Moore One Spot	7x26 6.00	Melo Heald II	7x28 6.50
Madison Moore International	7x28 6.50	Hot Spot 14	7x30 7.00
Tyrman Ten (drilled only)	7x26 5.50	Hammarlund Roberts Hi-Q 6	7x21 5.00
Tyrman "70"	7x24 5.50	Camfield Duoformer	7x26 6.00
World's Record 8	7x24 5.50	Eight in Line	7x24 5.50
World's Record 9	7x26 6.00	Citizen's Super 8	7x26 6.00
World's Record 10	7x26 6.00	Citizen's Super 9	7x26 6.00
Nine in Line "1928"	7x26 6.00	Browning Drake	7x21 5.00
Nine in Line "1928"	7x26 6.00	St. James	7x24 6.00
		Knickerbocker Four	7x18 4.50
		R. G. S. Octomonic	7x21 5.00

INLAID Kit Panels About \$3.00 List Extra

FOR SALE BY JOBBERS EVERYWHERE

Write for Complete Price List

## THE LIGNOLE CORPORATION

508 So. Dearborn Street

Chicago, Illinois

The High Frequency Laboratories for "1928 Berlin Special A. C. Nine-in-Line"

Geo. W. Walker Co. for "1928 Victoreen Universal"

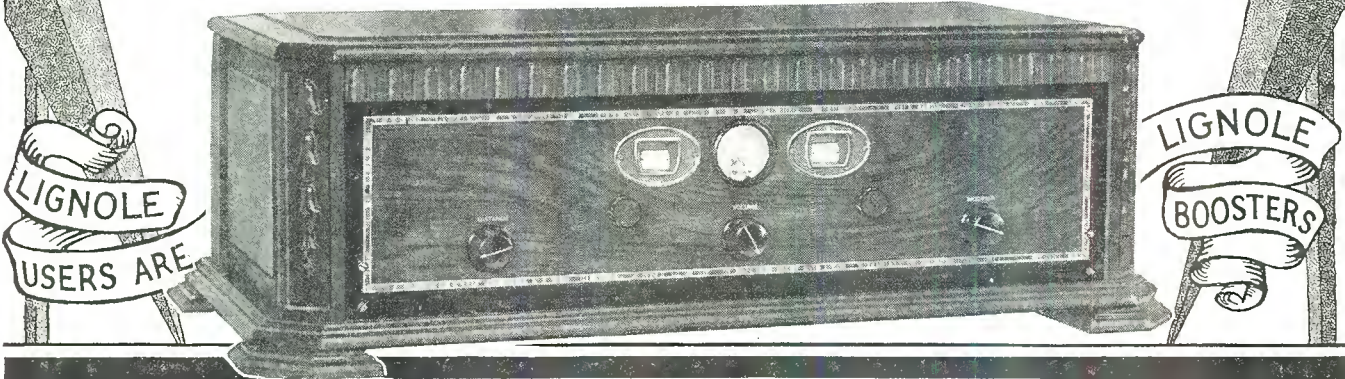

Tell 'Em You Saw It in the Citizens Radio Call Book Magazine



# American Broadcasting Stations

Corrected up to the moment of going to press, this list, to the best of our knowledge, is identical with that of the Federal Radio Commission's bulletins. If mistakes occur in the list, we will be glad to have notice from our readers to that effect. Address communications to the CITIZENS RADIO CALL BOOK MAGAZINE, 508 So. Dearborn Street, Chicago, Illinois

**KDKA** Westinghouse Elec. & Mfg. Co., East Pittsburgh, Pa. 315.6 meters, 950 kilocycles, 50,000 watts. Week days, market and weather reports, 10 am, 12 noon, 4 & 5 pm. Time signals, 11:55 am; 6 pm, dinner concert. Evening program, 8 pm, Tues 7 pm. Wed, Fri, 7 & 7:15 pm, studio talks. Fri, 11:30 pm, concert. Sun, 10:45 am, church; 4 pm, organ; 4:45 pm, vesper; 6 pm, orchestra; 7 pm, church; 8:15, concert. Blue Chain Programs, Mon, 7:30-10 pm; Tues, Wed, Fri, 8-10 pm; Thurs, 8-11 pm; Sat, 8-10 pm; Sun, 8:15-10:45 pm. Eastern standard time.

**KDLR** Radio Elec. Co., Devils Lake, N. Dak. 230.6 meters, 1300 kilocycles, 15 watts. Daily ex Sun, 12:10 pm, weather; 6:15 pm, markets, sports, news, etc. Mon, 9:30-11 pm, studio program. Sun, 11 am, church; 4:30-6 pm, studio program. Central standard time.

**KDYL** Intermountain Broadcasting Corp., 1009-10-11 Ezra Thompson Building, Salt Lake City, Utah. 258.5 meters, 1160 kilocycles, 100 watts. Sun, 3-5 pm, 8-10 pm. Daily ex Sun, 10:30-11:30 am, 2-5 pm, 6-8 pm, studio programs. Mon & Wed, 8-10:30 pm. Tues, Thurs & Sat, 8-10 pm, 10 pm-12, midnight dance music. Sat, midnight-2 am. Mountain time. Slogan: "On the Air—Goes Everywhere."

**KELW** Earl L. White, Broadcasting Station, Magnolia Park, Burbank, Calif. 228.9 meters, 1310 kilocycles, 250 watts. Daily ex Sun, 11:00 am, 2 pm, Press hour; 6-10 pm. Studio program. Pacific standard time. Divides time with KPCC. Slogan: "The White Spot of the San Fernando Valley."

**KEX** Western Broadcasting Co., Terminal Sales Bldg., Portland, Ore. 239.9 meters, 1250 kilocycles, 2500 watts. Sun, 8-10 pm, sacred music & organ concert. Daily ex Sun, 9 am-12 noon, home economics; 12 noon-2 pm, music; 6 pm-12 midnight, varied programs. Pacific standard time. Slogan: "A Public Service Necessity."

**KFAB** Nebraska Buick Auto Co., 13th and Que St., Lincoln, Nebr. 319.0 meters, 940 kilocycles, 5000 watts daytime. Mon, Tues, Wed, Fri, Sat, 9:30-9:45 am, 10-10:30 am, 11:45 am-12:30 pm, 3:30-4 pm, 5:30-6:30 pm, 8-10:30 pm. Thurs, 9:30-9:45 am, 10-10:30 am, 11:45 am-12:30 pm, 3:30-4 pm. Sun, 9-10 pm. Central standard time. Divides time with KOIL. Slogan: "Home, Sweet Home."

**KFAD** Electrical Equipment Co., 312-16 N. Central av., Phoenix, Ariz. 272.6 meters, 1100 kilocycles, 500 watts. Daily ex Mon & Sun, 3-4 pm, 6-7 pm. Daily ex Mon, Thurs & Sat, 8-9 pm. Mon, Sat & Sun, 2-3 pm. Tues, Wed, Fri, Sat, 9-10 pm. Mountain standard time. Slogan: "Phoenix, Where Winter Never Comes."

**KFAU** High School, Boise, Idaho. 285.5 meters, 1050 kilocycles, 2000 watts night, 4000 watts daytime. Sun, 3-5 pm, musical program; 7:30-8:30 or 9 pm, church services. Mon, Tues, Wed, Thurs, Fri, 12:30-1:15 pm, weather, market reports, U. S. Dept. of Agriculture features. Tues, 7:30-8 pm, Children's Half Hour; 8-9:30 or 10 pm, entertainment, news. Thurs, 7:30-8 pm; 8-9:30 or 10 pm, news, entertainment. Mountain standard time.

**KFBB** F. A. Buttrey Co., Havre, Mont. 275.1 meters, 1090 kilocycles, 50 watts. Daily ex Sun, 12:30-1:45 pm, noonday program. Sun, 1-3 pm. Wed, 7:30-9 pm. Slogan: "Voice of the Treasure State."

**KFBC** Arthur W. Yale, M. D., and Union League Club of San Diego County, on roof of Balboa Theater Bldg., San Diego, Calif. 247.8 meters, 1210 kilocycles, 100 watts. Sun, 10-12 am. Daily ex Sun, 9:30-10:30 am, 12:45-1:45 pm, 5-10 pm. Pacific standard time.

**KFBK** Kimball Upson Co., 607 K st., Sacramento, Calif. 535.4 meters, 560 kilocycles, 100 watts. Mon, 7:30-9 pm, artist program & orchestra; 9-10 pm, dance program. Thur, 8-9 pm, artist program; 9-10:30 pm, dance program. Sat, 7:30-8 pm, dinner music; 8-9 pm, artist program; 9-10 pm, dance music. Pacific standard time. Slogan: "In the Heart of California."

**KFBL** Puget Sound Station, Leese Bros., 2814 Rucker ave., Everett, Wash. 223.7 meters, 1340 kilocycles, 50 watts. Daily, 7:30-8:30 pm. Sun, 11 am-12 noon. Mon, Wed, Fri, 6:30-8 pm. Tues, Thur, 7-8 pm, 9-10 pm. Sat, 9-11 pm. Pacific time. Slogan: "The Voice of Puget Sound."

**KFBU** St. Matthews Cathedral (Bishop N. S. Thomas), Laramie, Wyo. 483.6 meters, 620 kilocycles, 500 watts. Sun, 11 am, church. Daily ex Sun, 12 noon. Wed & Fri, 7:30 pm, studio programs. Mountain standard time. Slogan: "The Top of the World."

**KFCB** Nielsen Radio Supply Co., 311 N. Central av., Phoenix, Ariz. 243.8 meters, 1230 kilocycles, 125 watts. Sun, 9:30 to 10:30 am, Radio Community Bible Class. Mon, 7:30 to 8:30 pm, children's hour. Wed, 8 to 9 pm, musical. Thurs, 8 to 9 pm, educational program. Fri, 9 to 10 pm, dance music. Sat, 9 to 10 pm, dance music. Sun, 9:30-10:30 am, community Bible class. Mountain standard time. Slogan: "Kind Friends Come Back."

**KFCR** Santa Barbara Broadcasting Co., Daily News Bldg., Santa Barbara, Calif. 211.1 meters, 1420 kilocycles, 50 watts.

**KFDM** Magnolia Petroleum Co., Box 798, Beaumont, Tex. 483.6 meters, 620 kilocycles, 500 watts. Sun, 8-9 pm, church services. Tues & Fri, 12:35 pm, band concert. Tues, 8-10 pm, orchestra. Fri, 8-10:30 pm, band concert. Central standard time. Divides time with WTAW. Slogan: "Kall for Dependable Magnolene."

**KFDX** First Baptist Church, Shreveport, La. 236.1 meters, 1270 kilocycles, 250 watts. Sun, 10:45 am, 7:45 pm, church services. Central standard time.

**KFDY** South Dakota State College Agriculture and Mechanical Arts, Brookings, So. Dak. 545.1 meters, 550 kilocycles, 500 watts. Sun, 3:15 pm, vesper service. Daily ex Sat & Sun, 12:30-12:45 pm, markets, weather, farm talks, news, music. Tues & Thurs, 7:30 pm, music and talks. Central standard time. Divides times with WDAY.

**KFDZ** Harry O. Iverson, 2510 Thomas av., South Minneapolis, Minn. 215.7 meters, 1390 kilocycles, 10 watts. Central standard time.

**KFEC** Meier & Frank Co., Portland, Ore. 214.2 meters, 1400 kilocycles, 500 watts. Daily ex Sun, 12 n, weather reports; 4-5 pm, music; 6-7 pm, weather, crop, market reports and music. Pacific time. Slogan: "Known for Every Courtesy." Divides time with KFIF.

**KFEL** Eugene P. O'Fallon (Inc.), Argonaut Hotel, Denver, Colo. 247.8 meters, 1210 kilocycles, 250 watts. Sun, 8:30 am, 9-10 am, church services. Daily ex Sun, 7:15 am, setting-up exercises; 10 am-12 noon, 2-6:45 pm, station programs. Mon & Sat, 11 pm, dance program. Tues, 8-10 pm, special program. Thurs, 8 pm-12 midnight, Sleepwreckers' program. Mountain standard time. Divides time with KOW. Slogan: "The Argonaut Station."

**KFEQ** Scroggin & Co. Bank, Robidoux Hotel, St. Joseph, Mo. 230.6 meters, 1300 kilocycles, 1000 watts. Sun, 10:45 am, church; 11 am-12 noon, organ. Daily 5-6 pm, 6:30-7:30 pm, 8:30-10 pm, music. Mon, 11 am-12 noon, orchestra. Central standard time.

**KFEY** Bunker Hill & Sullivan Mining & Concentrating Co., Y. M. C. A. & Union High School, Kellogg, Idaho. 232.4 meters, 1290 kilocycles, 10 watts. Sun, 11 am-7:30 pm, church services. Wed, 7:30-8:30 pm, musical. Thurs, 7:30, health talks. Sat, 9-10 pm, dance music. Pacific standard time. Slogan: "The Voice of the Coeur d'Alenes."

**KFGL** N. L. Cotter, 219 W. Main St., Trinidad, Colo. 222.1 meters, 1350 kilocycles, 50 watts.

**KFGQ** Boone Biblical College, Boone, Iowa. 209.7 meters, 1430 kilocycles, 10 watts. Sun, 2:30 pm. Western standard time.

**KFH** Hotel Lassen (Rigby-Gray Hotel Co.), Wichita, Kan. 245.8 meters, 1220 kilocycles, 500 watts. Sun, 9:30-10:30 am, 7:30-9 pm, church services. Daily ex Sun, 8:30-9 am, 10-11 am, 1-2 pm, markets; 7:30-9 pm, studio program. Central standard time. Slogan: "Kansas' Finest Hotel—In the Very Heart of God's Country."

**KFHA** Western States College of Colorado, Gunnison, Colo. 254.1 meters, 1180 kilocycles, 50 watts. Tues, Fri, 7 pm, kiddies' hour; 7:30 pm, musical. Mountain time. Slogan: "Where the Sun Shines Every Day."



# Two Remarkable Circuits

*equipped with*

## Bodine Twin-Eight Coils

Improve the Clarity  
of Your T. R. F. Set

Use Bodine  
Twin-Eight Coils

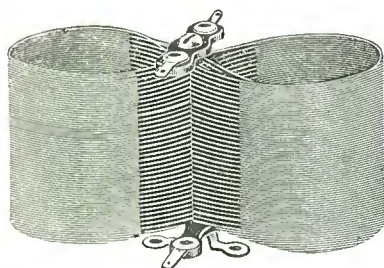

Radio fans everywhere are enthusiastic over the big improvement in their T.R.F. sets when ordinary coils are replaced by Bodine Twin-Eights.

The surprising results in clarity, volume, and selectivity are due to the unique design of these coils. The field is practically concentrated within the coil itself, eliminating interference with other coils; and the tight magnetic coupling between circuits gives tremendous amplification.

Equip your T.R.F. set with Bodine Twin-Eight Coils and be sure of best results. Write for specifications and diagrams of sets using these coils. Twin-Eight Coils, price each, \$2.00.

### The Bodine Twin-Eight A. C. Radio-Phonograph Combination *Described in This Issue*

This set represents the last word in quality reproduction. Nothing can surpass it at any price. Four Twin-Eight Coils in the radio frequency unit give great selectivity and distance-getting ability. The audio amplification is built as part of the power unit, using UX-112 power tube in the first stage and push-pull amplification for the last stage with two UX-210 power tubes. This extraordinary amplification gives tremendous volume if desired, even on distant stations. The built-in phonograph turntable with electrical pick-up reproduces through the power amplifier. A revelation in phonograph reproduction. Designed and built by Bodine engineers. Complete construction blue prints are ready at the Citizens Radio Service Bureau. Write for them. Complete set full size prints, \$1.50.

### The New Bodine Twin-Eight Truphonic Six

For home set builders, the Bodine Electric Company has designed a new six tube T.R.F. set embodying the latest developments of radio, including

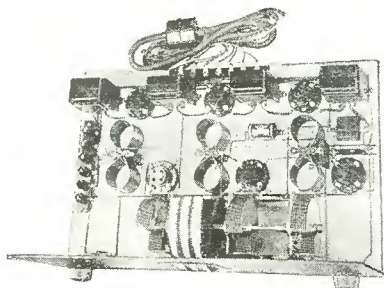

a power tube in the last stage of audio amplification. You will be amazed at the quality of its reproduction and selectivity. It is easy to build and the cost is comparatively low. Write today for free wiring diagrams. Full size blue print, \$0.50.

### The Beautiful and Efficient BODINE DE LUXE LOOP

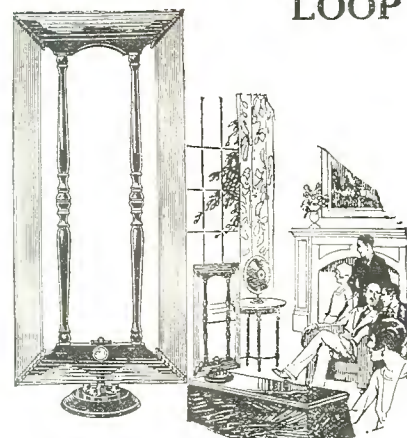

The Bodine Loop, with its beautiful solid walnut frame, adds an artistic touch to your radio set. It harmonizes with any room and its compactness makes it unusually attractive.

Its remarkable efficiency and directional characteristics add greatly to the selectivity of your set. All entangling wires are eliminated, and it can be mounted in the top of the set with no connecting wires visible. Send in the coupon for a complete description of this exceptional loop.

Mail the Coupon for Literature and Diagrams

#### BODINE ELECTRIC COMPANY

2256 W. Ohio St., Chicago, Ill.

I am interested in the items checked below. Send me complete information at once.

- Bodine Twin-Eight Coils
- Bodine DeLuxe Loop
- Wiring Diagrams for sets using Twin-Eight Coils

Name..... Address..... City.....



**KFHL** Penn. College, Oskaloosa, Ia. 212.6 meters, 1410 kilocycles, 10 watts. Central standard time.

**KFI** Earle C. Anthony, Inc., 1000 S. Hope st., Los Angeles, Calif. 468.5 meters, 640 kilocycles, 5000 watts. Sun. 10 am, 11 am-12:30 pm, church; 5:30-10 pm, musical program. Wed, 5:30-10:30 pm. Wed, Fri, 10:45-11:05 am, household talk. Daily ex Wed, Sat, Sun, 5:30-10 pm. Sat, 5:30-11 pm. Pacific standard time. Slogan: "National Institution."

**KFIF** Benson Polytechnic School, Portland, Ore. 214.2 meters, 1400 kilocycles, 50 watts. Pacific standard time. Divides time with KFEC.

**KFIO** North Central High School, Spokane, Wash. 245.8 meters, 1220 kilocycles, 100 watts. Fri, 8-9:30 pm. Pacific standard time. Divides time with KFPY.

**KFIU** Alaska Electric Light & Power Co., Juneau, Alaska. 225.4 meters, 1330 kilocycles, 10 watts. Mon. Wed & Fri, 6-7 pm, daily news items, steamer sailings, music, vocal and instrumental. Alaska time. (Note: 6-7 pm Alaska time is equivalent of 7-8 pm, Pacific standard time.) Slogan: "A Voice from the Far North."

**KFIZ** Fond du Lac Commonwealth Reporter, Fond du Lac, Wis. 267.7 meters, 1120 kilocycles, 100 watts. Daily, 5 to 5:30 pm, markets, weather and news. Occasional evening programs of music. Sun, 6-7 pm, dinner hour concert. Central standard time.

**KFJB** Marshall Electric Co., 1603 W. Main st., Marshalltown, Iowa. 247.8 meters, 1210 kilocycles, 100 watts. Daily ex Sun, 10 am, market reports; 6-7 pm, musical. Tues & Fri, 8:30-11 pm, musical programs. Sun, 10 am-12 n; 7:30-9 pm. Central standard time. Slogan: "Marshalltown, the Heart of Iowa."

**KFJF** National Radio Mfg. Co., 406 N. Hudson st., Oklahoma City, Okla. 272.6 meters, 1100 kilocycles, 1000 watts daytime, 750 watts night time. Daily ex Sun, 9 am, 10 am, 12:30 pm, 4:30 pm, market service; 9:15 am, music; 6-7, orchestra; 7 pm, dinner musical; 9 pm, musical program. Sun, 9 am, 10 am, 11 am, 7:30 pm, 9:30 pm, church. Central standard time. Slogan: "Radio Headquarters of Oklahoma, the Tired Hand Announcing."

**KFJI** E. E. Marsh, Astoria, Ore. 249.9 meters, 1200 kilocycles, 15 watts. Wed, 9-10 pm, organ music. Sun, 12:30-1:30 pm. Sat, 10:30-11 pm. Pacific standard time. Divides time with KMED.

**KFJM** University of North Dakota, Grand Forks, N. Dak. 333.1 meters, 900 kilocycles, 100 watts. Limited coml. Sun, 10:45-12, church service. Daily, 12 n-1 pm, music records; 6-7 pm, orchestra. Central standard time.

**KFJR** Ashley Dixon & Son, 1350 E. 36th st., Portland, Ore. 282.8 meters, 1060 kilocycles, 100 watts. Daily ex Sun, 5-6 pm, 7-8 pm. Fri. & Sat, 4-5 pm. Mon, Tues & Sat, 9-10 pm. Mon, 10-11 pm. Tues, 10-10:30 pm, studio program. Fri, 12 midnight-1 am. Pacific standard time. Divides time with KTBR.

**KFJY** Tunwall Radio Co., 1004 Central av., Ft. Dodge, Iowa. 232.4 meters, 1290 kilocycles, 100 watts. Sun, 11 am, church services. Daily ex Sun, daily, 5:45 pm, market and weather reports. Mon, Wed, Fri, 10-11 am, musical. Mon, 11-12 pm, musical. Thurs, 8:30 pm, musical program. Central standard time. Divides time with KFMR.

**KFJZ** W. E. Branch, 3219 Avenue L, Fort Worth, Tex. 249.9 meters, 1200 kilocycles, 50 watts. Sun, 7-10 pm, 11-12:30 mornings. Daily ex Sun & Wed, 8:30-9:30 pm, 9 am to 6 pm. Central standard time.

**KFKA** Colorado State Teachers' College, Greeley, Colo. 249.9 meters, 1200 kilocycles, 200 watts. Tues, 10-11 am. Thurs, 8-10 pm. Mountain standard time.

**KFKB** Dr. Brinkley's Hospital, Milford, Kan. 241.8 meters, 1240 kilocycles, 2500 watts daytime, 1500 watts night. Sun, 8 am, 10 am, Bible lecture; 6 pm, 6:30 pm-12 midnight, concert. Daily ex Sat, 10:15 am, 12 noon, 6 pm, 10 pm, markets and weather reports; 1 pm, 6:30 pm, 10 pm, lectures; 3-4 pm, matinee program; 5:30-6:30 pm, 8-10 pm, variety program. Daily, 12 noon-1 pm, Tiffin hour program. Tues & Thurs, 11 pm-1 am. Central standard time. Slogan: "The Sunshine Station in the Heart of the Nation."

**KFKU** University of Kansas, Lawrence, Kan. 254.1 meters, 1180 kilocycles, 500 watts. Mon & Thurs, 7-8 pm. (Also special broadcasting.) Central standard time. Divides time with WREN. Slogan: "Up at Lawrence on the Kaw."

**KFKX** Agricultural Station, Westinghouse Elec. & Mfg. Co., 509 S. Wabash Ave., Chicago, Ill. 526 meters, 570 kilocycles, 2500 watts. Daily ex Sat & Sun, 9:30 am-3 pm. Sat, 9:30 am-12:30 pm, stock, grain, weather, government reports. Central standard time. Divides times with KYW.

**KFKZ** State Teachers College, 107 E. Harrison st., Kirksville, Mo. 225.4 meters, 1330 kilocycles, 15 watts. Sun, 3:30 to 4:30 pm. Mon, 8-9 pm, dance music; 9 pm, radio plays. Central standard time. Slogan: "Kirksville, the Home of Osteopathy."

**KFLV** Swedish Evang. Miss. Church, Rockford, Ill. 267.7 meters, 1120 kilocycles, 100 watts. Sun, 10:40 am. Mon, 8:15 pm. Central standard time.

**KFLX** George R. Clough, 3327 Avenue P, Galveston, Tex. 270.1 meters, 1110 kilocycles, 100 watts. Central standard time.

**KFMR** Morningside College, Sioux City, Iowa. 232.4 meters, 1290 kilocycles, 100 watts. Commercial. Daily ex Sat & Sun, 11:40 am-12:30 noon. Tues, Wed, Thur, Fri, 7:30-8:30 pm. Central standard time. Divides time with KFPY.

**KFMX** Carleton College, Northfield, Minn. 236.1 meters, 1270 kilocycles, 500 watts. Fri, 8:15-8:45 pm, lecture; 8:45-9:45 pm, musical program; 10-11 pm, organ. Central standard time. Divides time with WCAL.

**KFNF** Henry Field Seed Co., Shenandoah, Iowa. 461.3 meters, 650 kilocycles, 1000 watts night, 2000 watts daytime. Sun, 8:30-9:30 am, 10:45-12:15 pm, 2-4 pm, 6:7 pm, 7:45-8:15 pm, church services, etc. Daily ex Sun, 6:8-8:30 am, 10-11 am, 12 noon-2 pm, 3-3:30 pm, 3:30-4 pm, 4:30-5 pm, 5-7 pm, varied programs. Central standard time. Slogan: "Known for Neighborly Folks."

**KFOA** Rhodes Dept. Store, 1321 2nd av., Seattle, Wash. 447.5 meters, 670 kilocycles, 1000 watts. Mon & Fri, 10 am-12 midnight. Tues, 12:30-11 pm. Wed, 10 am-10 pm. Thurs, 12:30 pm-10 pm. Sat, 4:30 pm-9 pm. Sun, 5:30-6:30 pm. Pacific standard time.

**KFON** Nichols & Warinner (Inc.), 212 Jergins Trust Bldg, Long Beach, Calif. 241.8 meters, 1240 kilocycles, 500 watts. Daily including Sun, 9:30 am-12 midnight. Varied programs. Pacific standard time. Slogan: "Where Your Ships Come In."

**KFOR** Howard A. Shuman, Lincoln, Nebr. 217.3 meters, 1380 kilocycles, 100 watts. Daily ex Sun, 12:05-1:05 pm, 2-2:35 pm, 6-7 pm, 8-10 pm. Fri, 11 pm-1 am, midnight frolic. Central standard time.

**KFOX** Technical High School, Omaha, Nebr. 258.5 meters, 1160 kilocycles, 100 watts. Daily ex Sat & Sun, 12:30-2 pm. Tues, 7:30-9 pm. Central standard time. Divides time with WNAL & KOCH.

**KFOY** Maurice Gordon Goldberg, St. Paul, Minn. 222.1 meters, 1350 kilocycles, 250 watts. Sun, silent. Mon, 7 pm, popular hour. Mon, Tues, Fri, 9 pm, reports. Wed, Thurs, Sat, 9 pm, reports; 9:05 pm, dance music. Central standard time. Divides times with WAMD.

**KFPL** C. C. Baxter, 205 Grafton st., Dublin, Tex. 275.1 meters, 1090 kilocycles, 15 watts. Sun, 7:30 am, 1:30 pm. Mon & Thurs, 8-9 pm. Central standard time. Slogan: "Baxter's Place."

**KFPM** The New Furniture Co., Box 628, Greenville, Tex. 230.6 meters, 1300 kilocycles, 15 watts, Sun, 11 am, services. Mon. & Fri, 8 pm, music; Wed, 8 pm, music; 7:15, sports in season; 1 pm daily ex Sun, musical program. Central standard time. Slogan: "Biggest Little Ten Watts on the Air."

**KFPR** Los Angeles County Forestry, Los Angeles, Calif. 232.4 meters, 1290 kilocycles, 250 watts. Irregular schedule. Pacific standard time. Divides time with KFQZ.

**KFPW** Lannie W. Stewart, Cartersville, Mo. 263 meters, 1140 kilocycles, 50 watts. Sun, 1-2 pm, chapel service. Daily, 5:45-6:30 am, 2:30-3 pm. Central standard time. Slogan: "Keeping Pace with Christ Means Progress."

**KFPY** Symons Investment Co., Symons Block, Spokane, Wash. 245.8 meters, 1220 kilocycles, 250 watts. Sun, 7:45 pm-12 midnight. Mon, Tues, Wed, Thurs, Fri, 9:45-11 am, 3-5 pm, 6:15-10:30 pm. Pacific standard time. Divides time with KFIO.

**KFQA** The Principia, 5539 Page av., St. Louis, Mo. 234.2 meters, 1280 kilocycles, 50 watts. Sun, 11 am, church services. Fourth Church of Christ, Scientist. Central standard times. Divides time with WMAY and KWK.

**KFQB** Lone Star Broadcast Co., Ft. Worth, Tex. 331.1 meters, 900 kilocycles, 1000 watts. Daily ex Sun & Wed, 8-12 midnight, musical. Sun, 10 am-12 pm, 3-10 pm, church services. Central standard time. Divides time with WJAD. Slogan: "Keep Folks Quoting the Bible - KFQB."

**KFQD** Anchorage Radio Club, Anchorage, Alaska. 344.6 meters, 870 kilocycles, 100 watts.

**KFQU** W. E. Riker, Holy City, Calif. 249.9 meters, 1200 kilocycles, 100 watts. Daily ex Sun, 6:30-7:30 pm, miscellaneous. Tues, 9:30-11:45 pm, musical. Wed, Thurs, Sat, 9-10 am, lecture. Fri, 9-11:30 pm, musical. Sun, 11 am-12 noon, 9-10 pm, lectures. Pacific standard time.

**KFQW** KFQW, Inc., Continental Hotel, Seattle, Wash. 217.3 meters, 1380 kilocycles, 100 watts. Sun, 10 pm-12 midnight, popular program. Daily ex Sun, 10-11 am, University District hour; 12 noon-1 pm, luncheon musicale; 4:30-5:30 pm, tea hour program; 5:30-6 pm, amusements; 6-11 pm, musical program. Pacific time. Slogan: "Gateway to Alaska and the Orient."

**KFQZ** L. E. Taft, 5653 De Longpre ave., Hollywood, Calif. 232.4 meters, 1290 kilocycles, 100 watts. Tues, Fri, 9-11 pm, musical program. Pacific standard time. Divides time with KFPR.

**KFRC** Don Lee (Inc.), San Francisco, Calif. 454.3 meters, 660 kilocycles, 1000 watts. Daily ex Sun, 7-9 am, musical program; 10-1 pm, studio program; 5:30-6:30 pm, children's program. Mon & Thurs, 6:30-10 pm. Tues & Fri, 6:30-11 pm, concert. Wed, 6:30-12 pm. Sat, 6:30 pm-1 am, dance music. Sun, 12-1 pm, church services; 5-6 pm, organ recital. Pacific standard time.





**TRY IT 30 DAYS FREE BEFORE YOU BUY**

**ALL METAL SHIELDED CHASSIS**

**FACTORY PRICES~SAVE 50%**  
Choice of beautiful cabinets offered

3 Year Guarantee

**8 tube~one dial**

**MIRACO**  
TRADE MARK REGISTERED

Only **\$69<sup>75</sup>**  
Retail List Completely Assembled

**MAGNIFICENT TONE~SUPER SELECTIVE~POWERFUL DISTANCE GETTER**

**All Electric or Battery Set!** **Big Discounts to User-Agents**

**MIRACO Users Say:**

Reports from users everywhere leave little for us to add. These are only a few of the many in our files and which we receive daily. Send coupon for plenty of additional proof and testimony of nearby users.

**TRIED MANY SETS—MIRACO BEST**  
Miraco is best set I've ever heard. It's just the set I've always wanted and I've had so many sets I got just a little hard-boiled about believing there were any sets perfect. I sure got my wish. I've had just 104 stations. There's about a station to each number on dial. I get KFI (Cal.) every night. Had PWX last night and got 6KW tonight good and loud.—FRANCIS ARMBURUSTER, Cleveland, Ohio.  
P.S. You pack your sets wonderful.

**HE KNOWS SETS—READ THIS**  
I have built radios since they first made their appearance and it has been my pleasure to build, repair and sell them. For quality, selectivity and sensitivity it is my firm belief that the Miraco cannot be excelled. I have proven beyond any shadow of doubt that it will outperform any other radios. I bring in the farthest distance with little or no effort. The Miraco also gives me tone quality.—URBAIN BARIL, Jr., Fall River, Mass.

**MIRACO EXCELS EXPENSIVE RADIOS**  
The Miraco set and loud speaker beat anything around here, regardless of price. Have tried them out against a \$200 outfit. Have logged 140 stations, coast to coast.—E. J. CARRIÈRE, Bathgate, N. D.

**HEARS CUBA, CANADA, MEXICO**  
A friend visited here that has close to \$300 in a radio—but no better tone and no plainer than the Miraco. Have gotten 118 stations. We get Mexico City, Winnipeg, Canada and Havana, Cuba—all of these so plain.—MRS. CLEM CORRELL, Morristown, Ind.

**CUTS THRU NEW YORK LOCALS**  
I can get distant ones in the evening when they are all on early in the evening.—J. F. LOGAN, Rockaway Beach, New York.

America's big, old, reliable Radio Corporation\* (8th successful year) guarantees in its big, powerful, latest 6, 7 and 8 tube Miraco sets "the finest, most enjoyable performance obtainable in high grade radios." Unless 30 days' use in your home fully satisfies you a Miraco is unbeatable at any price for beautiful, clear cathedral tone, razor-edge selectivity, powerful distance reception, easy operation, etc.—**don't buy it! Your verdict final.** Save or make lots of money on sets and equipment—write for testimony of nearby users and **Amazing Special Factory Offer.**

**Miraco's work equally fine on "AC" electric house current or with batteries.** Take your choice. Many thousands of Miraco users—who bought after thorough comparisons—enjoy programs Coast

to Coast, Canada to Mexico, loud and clear—with the magnificent cathedral tone quality of costliest sets. Don't confuse Miraco's with cheap, "squawky" radios. Miraco's have finest parts, latest approved shielding, metal chassis, etc.—as used in many \$200 sets.

**Deal Direct with Big Factory**  
Your Miraco reaches you completely assembled, rigidly tested, fully guaranteed. Easy to connect and operate. **30 days' trial free.** 3 year guarantee if you buy. You take no risk, you insure satisfaction, you enjoy **rock-bottom money-saving prices** by dealing direct with one of radio's oldest, most successful builders of fine sets. 8th successful year in the radio manufacturing business.



**7 tube one dial METAL SHIELDED CHASSIS**

**\$49<sup>75</sup> RETAIL LIST**

MIRACO "Powerplus" sets—both in 8 and 7 tube models—have magnificently beautiful, clear cathedral tone quality. Turn on dial for stations everywhere. Ultra-selective. Miraco multi-staged distance amplification gives "power-plus" on far-off stations. Latest all-metal shielded chassis. Illuminated dial. Fully guaranteed. **Try one free for 30 days!** Choice of beautiful cabinets.

**Dealers Write!**

**MIRACO Radio gets 'em Coast to Coast!**

**Free!**

**BEAUTIFULLY ILLUSTRATED CATALOG AND AMAZING SPECIAL OFFER**

**SEND NO MONEY—30 DAYS' TRIAL, Special Wholesale Price Offer to User-Agents, Bank References, testimony of nearby Miraco users—all the proof you want—sent with catalog.**

**mail coupon right now!**

**Electrify Any Radio with MIDWEST NO-BATTERY "AC" Light Socket Power Units**

**BIG DISCOUNT TO User-Agent**

"A", "B" and "C" power, direct from light socket, without batteries! Write for Midwest prices and discounts. Midwest Units are highest grade—lastingly dependable, quiet in operation. Fully guaranteed.



**6 tube Super \$36<sup>75</sup> RETAIL LIST**

**Another Big Bargain!** Famous powerful big Miraco Super 6, 1928 model—ultra selective! Thousands find it outperforms sets of much higher price. **30 Days' Trial Free. Fully Guaranteed.**

**MIDWEST RADIO CORPORATION**  
Pioneer Builders of Sets  
531-K Miraco Building, Cincinnati, Ohio.

Without obligation, send free catalog, **AMAZING SPECIAL OFFER**, testimony of nearby Miraco users.  User  Agent  Dealer

NAME \_\_\_\_\_

ADDRESS \_\_\_\_\_

**THIS COUPON IS NOT AN ORDER**



**KFRU** Stephen's College, a Junior College for Women, Columbia, Mo., "The Athens of the West." 249.9 meters, 1200 kilocycles, 500 watts. Sun, 7:30 am, sunrise service; 9:20 am, Burrall class; 7:30 pm, church services. Daily ex Sun & Sat, 8:30 am, public school convocation; 4:30 pm, popular program; 6 pm, dinner hour. Wed, 9 pm, musical program. Thurs, 10 pm, musical program. Sat, 4:30 pm, popular program; 6:15 pm, weather news. Central standard time. Slogan: "Where Friendliness is Broadcast Daily."

**KFSD** Airfan Radio Corporation, U. S. Grant Hotel, San Diego, Calif. 440.9 meters, 680 kilocycles, 500 watts. Sun, 3-4 pm, musical program; 6:15-10 pm, musical program. Daily ex Sun, 6:15-11 pm, musical program. Pacific time.

**KFSG** Angelus Temple, 1100 Glendale Blvd., Los Angeles, Calif. 275.1 meters, 1090 kilocycles, 500 watts. Sun, 10:30 am-12:30 pm, 2:30-4:30 pm, 6:30-11 pm. Tues & Wed, 10:30 am-12:30 pm, 2:30-4:30 pm, 6:30-9:30. Thurs & Fri, 10:30 am-12:30 pm, 2:30-4:30 pm, 6:30-11 pm. Sat, 10:30 am-12:30 pm, 2:30-4:30 pm, 6:30-9:30 pm. Church services, organ recitals, band concerts, sacred and classical music. Slogan: "The Church of the Air."

**KFUL** Thos. Goggan & Bro. Music Co., 2126 Market, Galveston, Tex. 258.5 meters, 1160 kilocycles, 500 watts. Daily, 1-2 pm. Mon & Fri, 8 pm. Central standard time. Slogan: "The City of Perpetual Sunshine."

**KFUM** W. D. Corley, Mining Exchange Bldg., Colorado Springs, Colo. 282.8 meters, 1060 kilocycles, 1000 watts. Sun, 11 am. Mon & Fri, 5-7 pm. Tues & Sat, 8-10 pm. Thurs, 8 pm-12 midnight. Mountain standard time. Divides time with KFXX. Slogan: "Known For Unsurpassed Mountain Scenery."

**KFUO** Concordia Seminary (Lutheran), St. Louis, Mo. 545.1 meters, 550 kilocycles, 1500 watts daytime, 1000 watts night. Sun, 3:30 pm, 4 pm. Shut-in Hour, 9:15 pm. Mon, 9 pm, young people's hour. Fri, 6:30 pm, children's hour; 9 pm, Bible class. Central standard time. Divides time with Station KSD. Slogan: "The Gospel Voice."

**KFUP** Fitzsimmons General Hospital, Educational & Recreational Dept., U. S. Army, Denver, Colo. 227.1 meters, 1320 kilocycles, 100 watts. Mountain time.

**KFUR** Perry Building Co., 420 Twenty-fifth st. (H. W. Peery, Mgr.), Ogden, Utah. 225.4 meters, 1330 kilocycles, 500 watts. Tues, Thurs, Sat, 9:50-11:50 pm, dance music. Mountain time.

**KFUS** Louis L. Sherman, 1444 Havenscourt Blvd., Oakland, Calif. 256.3 meters, 1170 kilocycles, 50 watts. Tues, 2:30-3:30 pm, educational; 8-9 pm, 6:30-7:30 pm, sacred studio program. Wed & Fri, 8-9 pm, sacred program. Thurs, 4:30-5 pm, educational; 5-5:30 pm, children's program. Sun, 9-9:30 am, S.S. lesson; 3:30-4:30 pm, sacred program. Pacific standard time. Divides time with KRE.

**KFUT** University of Utah, Salt Lake City, Utah. 249.9 meters, 1200 kilocycles, 50 watts. Tues, Wed, Thur, Fri, 7-8 pm. Mountain time.

**KFVD** W. J. & C. I. McWhinnie, Venice Ballroom, Venice, Calif. 208.2 meters, 1440 kilocycles, 250 watts. Sun, 6-12 pm, dance program. Daily ex Sun, 9:30 am-12 noon, 4:30-6 pm, 9 pm-12 midnight. Pacific time. Slogan: "The Voice of the Sea." Divides time with Station KGFJ.

**KFVG** First Methodist Episcopal Church, 204 S. Penn. ave., Independence, Kan. 225.4 meters, 1330 kilocycles, 50 watts. Sun, 10:55 am-12:30 pm & 7:30-9:15 pm, church services. Central standard time. Slogan: "Kansas Folks Very Good."

**KFVI** Headquarters Troop, 56th Cavalry Brigade, 305 Sabine st., Houston, Tex. 238 meters, 1260 kilocycles, 50 watts. Central standard time.

**KFVS** Hirsch Battery & Radio Co., 312 S. Frederick st., Cape Girardeau, Mo. 223.7 meters, 1340 kilocycles, 50 watts. Daily ex Sun, 12:15 noon, news and markets; 6:45 pm, musical. Central standard time. Slogan: "The City of Opportunity."

**KFWB** Warner Bros. Motion Picture Studios, Inc., 5842 Sunset Blvd., Hollywood, Calif. 361.2 meters, 830 kilocycles, 500 watts. Sun, 7:30-10 pm. Daily ex Sun, 10:10-40 am. Mon, Tues, Thurs, Fri, 11:45 am-2:30 pm. Mon, Tues, 4:45 pm-12 midnight. Sat & Wed, 11:45 am-12 midnight. Thurs & Fri, 4:15 pm-12 midnight. Pacific time.

**KFWC** L. E. Wall, San Bernardino, Calif. 222.1 meters, 1350 kilocycles, 100 watts. Sun, 7 pm-12 midnight. Daily ex Sun, 9 am-1 pm, 2:5-3:30 pm. Mon & Wed, 7 pm-12 midnight. Tues, 7-8 pm, 10 pm, 12 midnight. Thurs, 10 pm-12 midnight. Fri, 8 pm-12 midnight. Sat, 9 pm-12 midnight. Pacific standard time. Divides time with KWTC. Slogan: "The Voice of the Orange Empire."

**KFWF** St. Louis Truth Center, 4030 Lindell st., St. Louis, Mo. 214.2 meters, 1400 kilocycles, 250 watts, non-commercial. Sun, 10:45 am, 7:45 pm, 9 pm, organ & chimes. Thurs, 10:45 am, sunrise hour; 7:45 pm, sermon; 9 pm, music. Central standard time. Slogan: "The Voice of Truth."

**KFWI** Radio Entertainments, Inc., 1182 Market St., San Francisco, Calif. 267.7 meters, 1120 kilocycles, 500 watts. Sun, 7:50-11 pm. Daily ex Sat & Sun, 1-1:30 pm, 5-7:30 pm, 8-11 pm (Wed. 5-7:15 pm). Sat, 5-7 pm, 8 pm-12 midnight. Pacific standard time.

**KFWM** Oakland Educational Society, 1520 8th Ave., Oakland, Calif. 236.1 meters, 1270 kilocycles, 500 watts night, 1000 watts daytime. Sun, 9:30-11 am, 12:30-2:30 pm, 7:30-9:30 pm. Daily ex Sun & Wed, 8-10 pm. Tues, Wed, Fri, 2-3 pm. Tues, 12:30-1:30 pm. Thurs, 12:30-4:30 pm. Pacific standard time. Slogan: "The Most Good to the Most People."

**KFWO** Major Lawrence Mott, 346 Claressa av., Avalon, Catalina Island, Calif. 299.8 meters, 1090 kilocycles, 250 watts. Daily including Sun, 12:30-1:30 pm, 5-6 pm, 6-7:30 pm. Tues, 8 pm-midnight. Pacific standard time. Slogan: "Catalina for Wonderful Outings."

**KFXD** Service Radio Co., East Main St., Jerome, Utah. 204 meters, 1470 kilocycles, 15 watts. Daily at noon with news, markets, etc. Mountain time.

**KFXF** Colorado Radio Corporation, Republic Bldg., Denver, Colo. 282.8 meters, 1060 kilocycles, 500 watts. Mon, Wed, Fri, Sun, 6-12 pm. Mountain standard time. Divides time with KFUM. Slogan: "The Voice of Denver."

**KFXJ** R. G. Howell, Olinger Gardens, Edgewater, Colo. 215.7 meters, 1390 kilocycles, 50 watts input. Daily, 2:30-4:30 pm, 6-8 pm, dinner concert; 8-10 pm, studio. Sun, 7 pm, sacred hour. Mountain standard time. Slogan: "America Scenic Center."

**KFXR** Exchange Avenue Baptist Church, 1818 Linden St., Oklahoma City, Okla. 223.7 meters, 1340 kilocycles, 50 watts. Central standard time.

**KFXY** Mary M. Costigan, Flagstaff, Ariz. 205.4 meters, 1460 kilocycles, 25 watts. Tues, Thurs, Sat, 10-11 pm. Mountain time.

**KFYO** Kirskey Bros., Breckenridge, Tex. 211.1 meters, 1420 kilocycles, 15 watts. Sun, 10:30-11:30 am, 12 noon-1 pm, 3-9 pm. Silent Wed night. Daily ex Sun, 8-9 pm. Central standard time. Slogan: "Breckenridge, the Dynamo of West Texas."

**KFYR** Hoskins-Meyer, Inc., 200 4th st., Bismarck, N. Dak. 249.9 meters, 1200 kilocycles, 250 watts night time, 500 watts daytime. Sun, 10:30-12 noon, church; 3-5 pm, music. Daily ex Sun, 12:30-1:30 pm, music, weather forecast, etc. Central standard time.

**KGA** Northwest Radio Service Co., Spokane, Wash. 260.7 meters, 1150 kilocycles, 2000 watts. Sun, 11 am-12:30 pm, 7:30-9 pm, church. Daily ex Sun, 9-11 am, music; 11 am-12 noon; 12 noon-12:20 pm, stocks, weather, news, etc.; 12:20-5:30 pm, music; 5:30-6 pm, kiddies program; 6 pm, time signals, weather reports, etc.; 6:15-7:15 pm, organ; 7:15-10 pm. Pacific standard time.

**KGAR** The Tucson Citizen, 80 S. Stone av., Tucson, Ariz. 234.2 meters, 1280 kilocycles, 100 watts. Sun, 11 am-12:30 pm, 7:30-9 pm, church services. Daily ex Sat & Sun, 6-9 pm, musical program. Sat midnight frolic every 2nd week from 12 midnight-3 am. Slogan: "Way Out on the Desert."

**KGBU** Alaska Radio & Service Co., Ketchikan, Alaska. 228.9 meters, 1310 kilocycles, 500 watts.

**KGBX** Foster-Hall Tire Co., 1221 Fred av., St. Joseph, Mo. 288.3 meters, 1040 kilocycles, 100 watts. Central standard time.

**KGBY** Dunning & Taddiken, Columbus, Nebr. 222.1 meters, 1350 kilocycles, 50 watts. Sun, 3-5 pm, religious program. Tues, 8-10:30 pm, popular program. Fri, 6-7 pm, dinner program; 8-10:30 pm, popular program. Central standard time. Slogan: "The Voice of Shelby, in the Heart of the Corn Belt."

**KGBZ** Dr. George R. Miller, York, Nebr. 212.6 meters, 1410 kilocycles, 100 watts. Sun, 9 am, church services, 5 pm, alternately. Daily ex Sun, Tues, 12:30 pm, market, livestock; 2:30 pm, musical. Thurs, Sat, 9 pm, dance music. Central standard time. Slogan: "The Swine and Poultry Station."

**KGCA** Chas. W. Greeley, Decorah, Iowa. 247.8 meters, 1210 kilocycles, 10 watts. Sun, 2-4 pm. Daily ex Sun, 12:30-1:30 pm. Wed, 7:30-8:30 pm. Central standard time. Divides time with KWLC.

**KGCB** Wallace Radio Institute, 105 W. 13th st., Oklahoma City, Okla. 215.7 meters, 1390 kilocycles, 50 watts. On air daily, programs irregular. Divides time with Station KGFJ.

**KGCH** Wayne Hospital, Wayne, Nebr. 293.9 meters, 1020 kilocycles, 250 watts. Sun, 2:30-4 pm, 6 pm, sacred service. Tues, Wed, Thurs, Fri, 6:30-8 pm, featuring college educational and entertaining programs. Central standard time. Divides time with KGDW. Slogan: "Remember Us When U R Ill."

**KGCI** Liberto Radio Sales, San Antonio, Tex. 204.6 meters, 1360 kilocycles, 15 watts. Sun, 1:30-2:30 pm. Daily ex Sun, 9:30-10:30 am, 11:30 am-12:15 pm, 3-4 pm, 5:30-6:30 pm. Mon & Thurs, 9:30-10:30 pm. Tues, 7:30-8:30 pm. Central standard time. Divides time with Station KGRC, the Gene Roth Co., San Antonio, Tex. Slogan: "Radio Sam at San Antonio."

**KGCL** Piper & Taft, Inc., Sporting Goods Store, 1107 2nd Ave., Seattle, Wash. 230.6 meters, 1300 kilocycles, 50 watts. Mon, Wed, Thurs, 9 am-11 pm. Tues, Fri, Sat, 9 am-7:30 pm. Sun, 12 noon-8 pm. Pacific standard time. Slogan: "Splitdorf Radio Center." Divides time with station KPCB, the Pacific Coast Biscuit Co.

**KGCN** Concordia Broadcasting Co., Concordia, Kan. 208.2 meters, 1440 kilocycles, 50 watts. Sun, 11 am-12 noon. Daily ex Sun, 12:30-1:30 pm, 7:30-9 pm. Central standard time. Slogan: "KGCN—The Shamrock Station."

**KGCR** Cutlers Radio Broadcasting Service, 415 Main st., Brookings, S. Dak. 208.2 meters, 1440 kilocycles, 15 watts. Central standard time.

**KGCU** Mandan Radio Association (H. L. Dahners), Mandan, N. Dak. 239.9 meters, 1250 kilocycles, 100 watts. Sun, 11 am-12 noon, 4:30-6:30 pm. Daily ex Sun, 7-8 am, 12 noon-2 pm, 6:30-7:30 pm. Mountain standard time. Slogan: "The Voice of the West."



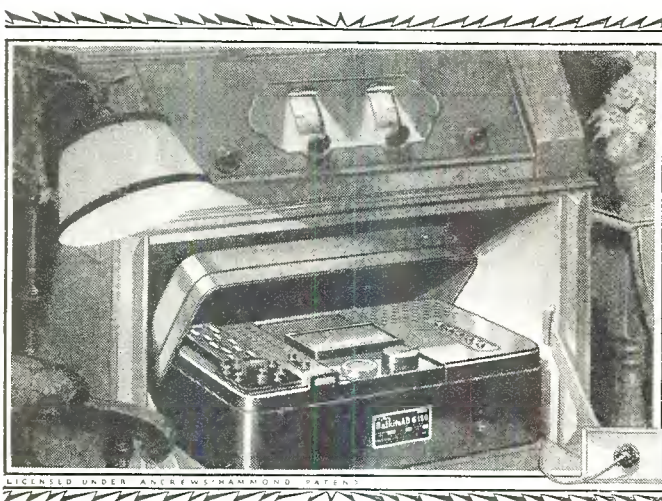

# Now AC Electric Radio

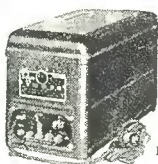

Licensed under Andrew-Hammond patent

To owners of a "B" eliminator:

Balkite "A" is like Balkite "AB" but for the "A" circuit only. It enables you to make an electric installation at very low cost. \$35.



Balkite "B"

The accepted, tried and proved light socket "B" supply. One of the longest lived devices in radio. Three models, \$22.50, \$35, \$42.50.



Balkite Chargers

Standard for "A" batteries. Noiseless. Can be used during reception. High rate or trickle. Three models, \$17.50, \$9.50, \$7.50.

There are special models for 25-40 cycle current at slightly higher prices. Prices are higher West of the Rockies and in Canada.

**Without  
the uncertainty of  
untried apparatus  
And without any  
sacrifice in quality  
of reception**

Of course you want an AC electric receiver. For its convenience. Now you can have it, without the uncertainty of untried apparatus and without sacrificing quality of reception.

Simply by adding Balkite *Electric* "AB" to your present radio set. Balkite *Electric* "AB" replaces both "A" and "B" batteries and supplies radio power from the light socket. It contains no battery in any form. It operates only during reception. It makes any receiver an electric set.

This method makes possible the use in electric reception of standard sets and standard type tubes. Both are tried and proved, and give by far

the clearest and truest reproduction. With this method there is no waiting for tubes to warm up. No difficulty in controlling volume. No noise. No AC hum. No crackling or fading of power. Instead the same high standard of reception to which you are accustomed.

In this method there is nothing experimental, nothing untried. It consists of two of the most dependable products in radio—a standard set and Balkite. And if you should already own a radio set, the cost of equipping it with Balkite is only a fraction of the cost of a new receiver.

By all means go to AC reception. Its convenience is the greatest improvement in radio. But be as critical of an AC receiver as you would of any other. That your AC receiver be a standard set equipped with Balkite *Electric* "AB." Then it will be as clear and faithful in reproduction as any receiver you can buy.

Two models, \$64.50 and \$74.50. Ask your dealer. Fansteel Products Co., Inc., North Chicago, Illinois.

**Chicago Civic Opera**  
on the air Thursday Evenings, 10 o'clock Eastern time. Over stations WJZ, WBZA, WBZ, KDKA, KYW, WGN, WMAQ, WBAL, WHAM, WJR, WLW, WENR. 10:30 Eastern time: WEBH, KSD, WOC, WOW, WCCO, WHO, WDAF.  
**BALKITE HOUR**

# Balkite ELECTRIC AB

⌈contains no battery⌋

Tell 'Em You Saw It in the Citizens Radio Call Book Magazine



**KGCC** First State Bank of Vida, Vida, Mont. 243.8 meters, 1230 kilocycles, 10 watts.

**KGDA** Home Auto Co., Dell Rapids, S. D. 254.1 meters, 1180 kilocycles, 15 watts daytime.

**KGDE** Jaren Drug Co., Barrett, Minn. 205.4 meters, 1460 kilocycles, 50 watts. Daily ex Sun, 12:30 pm, 4 pm, 7 pm. Sun, 10:30 am, 3 pm, 6 pm, 8 pm. Central standard time.

**KGDM** Peffer Music Co., 42 S. California st., Stockton, Calif. 217.3 meters, 1380 kilocycles, 10 watts.

**KGDP** Boy Scouts of America, Pueblo Council, Pueblo, Colo. (John D. Price), 261.7 meters, 1340 kilocycles, 10 watts.

**KGDR** Joe B. McShane, 206 Laurel Hgts. Place, San Antonio, Tex. 206.8 meters, 1450 kilocycles, 15 watts. Sun, 9-10 am, classical. Daily ex Sun, 4-5:30 pm, tea dancing program. Wed, 9:30-11:30 pm, frolic. Thur, 7:30-8:30 pm. Central standard time. Slogan: "The Little Station with the Big Programs."

**KGDW** Frank J. Rist, Humboldt, Nebr. 293.9 meters, 1020 kilocycles, 100 watts. Central standard time. Divides time with KGCH.

**KGDX** William E. Antony, 1513 Laurel st., Shreveport, La. 212.6 meters, 1410 kilocycles, 250 watts. Divides time with KGCH.

**KGDY** J. Albert Loesch, Oldham, S. Dak. 206.8 meters, 1450 kilocycles, 15 watts. Thur, 7:45 pm, 11:45 pm. Central standard time. Slogan: "The Little Brick Town on the Prairie."

**KGDF** Trinity Methodist Church, Los Angeles, Calif. 263 meters, 1140 kilocycles, 500 watts.

**KGEG** Eugene Broadcast Station, W. E. Miner Bldg., Eugene, Ore., 201.6 meters, 1+90 kilocycles, 50 watts.

**KGEL** Beehler Electric Equipment Co., Yuma, Colo. 263 meters, 1140 kilocycles, 10 watts daytime only. Daily. 12 noon-1 pm, stock markets, lectures, etc.

**KGEM** E. R., Irey & F. M. Bowles, El Centro, Calif. 225.4 meters, 1330 kilocycles, 15 watts.

**KGEO** Hotel Yancey, Grand Island, Nebr. 205.4 meters, 1460 kilocycles, 100 watts.

**KGEP** Glenwood Radio Station, 920 5th av., No. Minneapolis, Minn. 204 meters, 1470 kilocycles, 50 watts. Mon, 7-8 pm, miscellaneous. Tues, Thur, 8:30-11 pm, miscellaneous. Wed, 6:30-8:30 pm, 10-11 pm. Fri, 6:15-9 pm, music, entertainment. Sat, 4:30 pm. Children's Story Hour. Central standard time. Slogan: "In the Land and Lakes and Rivers."

**KGES** C. Merwin Bobyns, Long Beach, Calif. 215.7 meters, 1390 kilocycles, 100 watts. Pacific standard time. Divides time with KRLO. Slogan: "Service Club of the Air." **KGES** Central Radio Electric Co., Central City, Nebr. 204 meters, 1470 kilocycles, 10 watts.

**KGEU** L. W. Clement, Lower Lake, Calif. 227.1 meters, 1320 kilocycles, 50 watts.

**KGFW** City of Fort Morgan, Fort Morgan, Colo. 218.8 meters, 1370 kilocycles, 200 watts daytime, 100 watts night. Sun, 11 am-12 noon, church; 2-4 pm, classical program. Daily ex Sat & Sun, 5:15-6 pm, markets & news. Tues, Thurs, Sat, 8-10 pm, varied programs. Sat, 12 noon-1 pm, talks. Mountain standard time. Slogan: "Fort Morgan, the City of Lights."

**KGFX** J. W. Dietz, Denver, Colo. 201.6 meters, 1490 kilocycles, 250 watts. Sun, 1-2 pm. Daily ex Sun, Thur, 7-8 pm. Western standard time.

**KGFY** Flathead Broadcasting Association, Kalispell, Mont. 293.9 meters, 1020 kilocycles, 100 watts. Daily ex Sun, 12:30 pm-1:30 pm; 6:30-7:30 pm. Thurs, 9-10:30 pm. Sun, 11 am, church services. Mountain standard time. Slogan: "Located in the Switzerland of America—The Beautiful Flathead Valley."

**KGFB** Iowa City, Ia. 223.7 meters, 1340 kilocycles, 10 watts.

**KGFC** Earl E. Hampshire, 718 5th st., Alva, Okla. 205.4 meters, 1460 kilocycles, 25 watts. Programs irregular. Central standard time.

**KGFD** Full Gospel Church, "Old Glory" Station, Oklahoma City, Okla. 215.7 meters, 1390 kilocycles, 50 watts. Slogan: "The Whole Gospel to the Whole World."

**KGFE** La Crescenta, Calif. 223.7 meters, 1340 kilocycles, 250 watts. Divides time with KMIC.

**KGFF** San Angelo, Tex. 220.4 meters, 1360 kilocycles, 15 watt. Sun, 11 am-8 pm. Daily ex Sun, 10 am-12 noon, 3:30 pm, markets & weather; 8-10 pm, music. Central standard time. Slogan: "The Voice of West Texas."

**KGFG** Ben S. McGlashan, Washington Blvd. & Oak St., Los Angeles, Calif. 208.2 meters, 1440 kilocycles, 100 watts. Sun, 9 am-2:30 pm. Daily. 6:30-9:30 am, 12 noon-4:30 pm, 6-9 pm, 12 midnight-6:30 am, ex Thurs when on the air 2-6:30 am. Pacific standard time. Divides time with KFVD. Slogan: "Keep Good Folks Joyful."

**KGFH** Hallock, Minn. 223.7 meters, 1340 kilocycles, 50 watts.

**KGFI** Raton, N. M. 222.1 meters, 1350 kilocycles, 50 watts.

**KGFK** Geo. W. Johnson, Yuba City, Calif. 211.1 meters, 1420 kilocycles, 15 watts. Daily ex Sun, 9:30-10:30 am, advertising; 2-2:30 pm, musical. Mon, Wed, Fri, 8-10 pm, entertainment. Pacific standard time.

**KGFL** Aneta, N. Dak. 199.9 meters, 1500 kilocycles, 15 watts.

**KGFM** Terre Haute, Ind. 204 meters, 1470 kilocycles, 100 watts.

**KGFN** Mitchell, S. Dak. 212.6 meters, 1410 kilocycles, 10 watts.

**KGFO** Cedar Grove, La. 212.6 meters, 1410 kilocycles, 250 watts. Central standard time. Divides time with KGDX.

**KGFP** General Electric Co., Oakland, Calif. 384.4 meters, 780 kilocycles, 5000 watts. Sun, 11 am, 7:30 pm, church; 4 pm, 5:30-6:30 pm, concert; 9-10 pm. Daily ex Sun, 11:30 am; 4-5 pm, concert; 5:30 pm, Kiddies Klub; 6-6:55 pm, dinner concert; 9 pm, Book Review. Tues, Wed, Thurs, Fri, Sat, 9-10 pm, varied programs. Tues, Fri, Sat, 10-11 pm; Wed, 10 pm-12 midnight, dance music. Fri, 11 pm-12 midnight. Pacific standard time.

**KGRC** Gene Roth & Co., San Antonio, Tex. 220.4 meters, 1360 kilocycles, 50 watts. Divides time with KGCI.

**KGSD** Gish Radio Service, 108 E. 8th st., Amarillo, Tex. 243.8 meters, 1230 kilocycles, 150 watts. Daily ex Sun, 6:30 am-6:30 pm; 10 am, weather & markets. Mon, Wed, Fri, 9 pm. Sun, 11:30 am, 4:30 pm, 7:30 pm. Central standard time.

**KGTE** Glad Tidings Temple—Bible Institute, 1471 Ellis st., San Francisco, Calif. 206.8 meters, 1450 kilocycles, 50 watts. Sun, 2:30-5 pm, 8-10 pm. Mon, Tues, Thurs & Sat, 12:10-12:30, sacred. Wed, 12:10-12:30 pm, 2:30-3:33 pm, sacred. Fri, 12:10-12:30 pm, 3-4 pm, 8-10 pm, sacred. Pacific standard time. Slogan: "Knights of Glad Tidings."

**KGTF** The Advertiser Publishing Co., 217 King st., Honolulu, Hawaii. 270.1 meters, 1110 kilocycles, 600 watts. 2½ hours later than Pacific time. Sun, 6-9:30 pm, music, lectures, church, news. Daily, 12 noon-1:15 pm, 5-6 pm, stock, weather reports, music. Daily ex Sat & Sun, 7:30-9:30 pm. Hawaiian program, news, sports, music, etc. Slogan: "In the Land of Sunshine, the Future Playground of America."

**KGU** Oregonian Publishing Co., Portland, Ore. 491.5 meters, 610 kilocycles, 1000 watts. Sun, 8:30-9:15 am. Auntie Blossom and Winnie Winkle; 10 am-12 noon, church; 3-11 pm, concerts. Daily ex Sun, 10-11:30 am, Town Crier: 6-7 pm, concert. Mon, 7-11 pm, musical entertainment. Tues, 6 pm-12 midnight, music & educational program. Wed, 7:30 pm-12 midnight, diversified program. Thurs, 6 pm-12 midnight, concert. Fri, 7-9 pm, utility & musical entertainment; 9-10:30 pm, concert; 10:30-12 midnight, Hoot Ow! Frolic. Sat, 7-11 pm, concert; 11 pm-12 midnight, dance music. Pacific standard time. Slogan: "Keep Growing Wiser."

**KGW** St. Martins College, Lacey, Wash. 243.8 meters, 1230 kilocycles, 50 watts. Tues, Thurs, Sun, 8:30-9:30, PST concert. Pacific standard time. Slogan: "Out Where the Cedars Meet the Sea."

**KGX** Times-Mirror Co., Los Angeles, Calif. 416.4 meters, 720 kilocycles, 500 watts. Sun, 10-12 am, 7-10 pm. Daily ex Sun, Mon, 6-10 pm. Pacific time. Slogan: "Kindness, Happiness, Joy."

**KGY** Louis Wasmer, Inc., Peyton Building, Spokane, Wash. 370.2 meters, 810 kilocycles, 1000 watts. Sun, 11-12:30, 6-7:30, 7:30-10 pm, church services. Mon, Tues, Thurs, Fri, Sat, 2:30-4:30 pm, matinee; 5-6 pm, service hour. Thurs, Fri, Sat, 6-7 pm, concert. Mon, Tues, 7:30-12 pm, varied. Wed, 9-10 pm, dance music. Thurs, Fri, 8-10 pm, popular; 10:30-12 pm, KGW. Pacific time. Slogan: "In the Friendly City."

**KHZ** Atlantic Automobile Co., Atlantic, Iowa. 322.4 meters, 930 kilocycles, 100 watts daytime. Divides time with WIAS.

**KIA** Julius Brunton & Sons Co., 1380 Bush st., San Francisco, Calif. 220.4 meters, 1360 kilocycles, 50 watts. Sun, 1:30-5 pm. Daily ex Sat & Sun, 9 am-12 noon, 1:30-7:30 pm. 8-11 pm. Sat, 9 am-12 noon, 1:30-7:30 pm. Pacific standard time. Slogan: "The Voice of the Storage Battery."

**KIB** Northwest Radio Service Co., 604 Home Savings Bldg., Seattle, Wash. 348.6 meters, 860 kilocycles, 2500 watts. Sun, 9:30-11 am, 11-12:30 pm, church; 2:30-4 pm, 7-10:30 pm, music & church. Daily ex Sun, 9 am-12 noon, 12 noon-5 pm, 5 pm-12 midnight, news, talks, music, weather reports, etc., broadcast. Pacific standard time. Divides time with KXA.

**KIC** City of Seattle, Harbor Department, Seattle, Wash. 265.3 meters, 1130 kilocycles, 15 watts.

**KID** Reorganized Church of Jesus Christ of Latter Day Saints, Independence, Mo. 270.1 meters, 1110 kilocycles, 1500 watts. Sun, 8:30-11 am, 3-6:30 pm, 9 pm. Mon, silent. Tues, 6:30 am, 2:30 pm, 7 pm, 8 pm. Wed, silent. Thurs, 2:30 pm, 7 pm, 8 pm. Fri, 6:30 pm. Sat, 7 pm, 8 pm. Morning devotional, Tues & Fri, 6:30 am. Slogan: "The Station Dedicated to Knowledge, Liberty, Divinity and Service."





# The Right Instrument — ALWAYS

When a new development in radio indicates the need for a new instrument—Jewell always can be depended upon to provide it.

The new alternating current operated radio sets have created an urgent need for a new service instrument with which the service man can completely service both A. C. and D. C. operated sets. The answer to the requirement is the Jewell Pattern 137 A. C. and D. C. Radio Set Analyzer. It is an added assurance to the owners of A. C. operated sets, or of sets using the new A. C. tubes, that any trouble developing will be quickly corrected by the service man who carries this instrument.

Dealers will find the new Jewell product to be the most useful of all service instruments and the easiest to operate. It maintains the usual high quality of Jewell instruments. Special circular No. 1141, which is available on request, describes it in detail.

Jewell developments in other phases of radio have always been attentive to the demand. Manufacturers, set builders, amateurs—all use Jewell instruments because there are so many different styles to choose from and they have always found them to be entirely satisfactory.



**Pattern No. 137**  
A. C. and D. C. Radio Set Analyzer—the latest and most popular development in radio service equipment

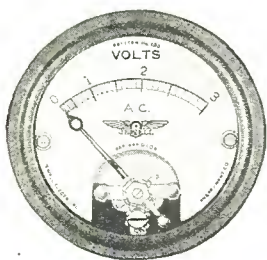

**Radio Set Builder**  
Pattern 190

A flush type, 2-inch, alternating current instrument of the same size and appearance as our Pattern 135. It will be found very valuable for filament control of the new alternating current tubes for it is frequently found that a particular setting of the filament voltage is required to eliminate objectionable hum. It is furnished in ranges of 0-1.5, 0-3, 0-5, 0-8, 0-10, 0-15 and 0-150 volts. The movement of Pattern 190 is of the moving vane type with special modifications for the small size case. The instrument is accurate and is designed for continuous service with a very small energy consumption.

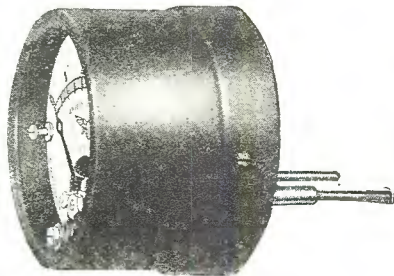

**Radio Set Owners**  
Pattern 135-A

The Jewell tip-jack voltmeter is 2 inches in diameter and has two prods that can be perfectly adjusted to fit varying spacings of the two phone jacks now found on the panels of several makes of radio sets. The movement is a high resistance type with a zero adjuster and a silver etched scale having black characters and is enclosed in a black enameled case. This instrument is particularly useful for adjusting filament voltage and is furnished in three ranges—0-5, 0-7, or 0-50 volts. The 0-50 volt range is for adjusting filament voltage on sets having the tube filaments in series.

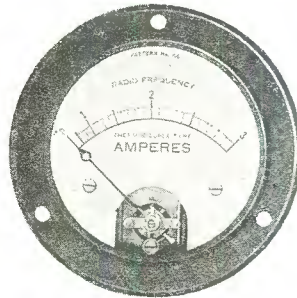

**Radio Amateurs**  
Pattern 64

This instrument is a member of the famous Jewell Trio of transmitting instruments for amateurs. It is a thermocouple type and is guaranteed to stand an overload of 30%. The loss in the instrument is less than one-half of the minimum required by the Navy. The thermocouples are made from special furnace alloys of non-oxidizing nature and are worked at a low temperature to give a high overload capacity. The case is three inches in diameter with a 3/4-inch flange. Scales are silver etched and all visible parts are silver plated.



**Radio Dealers**  
Pattern 117

Radio Service Set for general servicing of radio apparatus. It tests tubes, batteries, "B" eliminators, transformers, condensers, resistance, circuits, charging rates, etc. Has a drawer for tools and a detachable battery compartment in which a complete set of test batteries may be carried. It is the ideal instrument for doing a complete service job. The two contained instruments are the highest grade obtainable, the voltmeter having a high resistance of 800 ohms per volt. It is described in detail in our special circular No. 1117.

Write for a copy of our 15c Radio Instrument Catalog

**Jewell Electrical Instrument Company**  
1650 Walnut St. - - Chicago, Ill.

"27 Years Making Good Instruments"

Tell 'Em You Saw It in the Citizens Radio Call Book Magazine



**KLIT** Portland, Ore. 206.8 meters, 1450 kilocycles, 10 watts.

**KLS** Warner Bros. Radio Supplies Co., 2201 Telegraph av., Oakland, Calif. 245.8 meters, 1220 kilocycles, 250 watts. Sun, 10-11 am, church services. Pacific standard time. Divides time with KZM. Slogan: "The City of Golden Opportunity."

**KLX** The Oakland Tribune, Oakland, Calif. 508.2 meters, 590 kilocycles, 500 watts. Daily ex Sun, 10-11:30 am, 11:30 am-1 pm, 1-1:30 pm, 6:30-7:30 pm, 8-10 pm. Wed & Thurs, 4:30-5:30 pm. Daily ex Sat & Sun, 5:30-6:30 pm. Pacific standard time. Slogan "Where Rail and Water Meet."

**KLZ** Pioneer Station of the West, Shirley Savoy Hotel, Denver, Colo. 296.9 meters, 1010 kilocycles, 1000 watts daytime, 500 watts night. Sun, 9:30-10:30 am, 11 am-12:30 pm, 3-4 pm, 7 pm-12 midnight. Daily ex Sun, 9-11 am, 3-4:30 pm, 6-10 pm. Sun, Tues, Fri & Sat, 10 pm-12 midnight, dance music. Mountain time. Slogan: "The Pioneer Station of the West."

**KMA** Earl E. May Seed & Nursery Co., Shenandoah, Ia. 394.5 meters, 760 kilocycles, 1000 watts. Sun, 8-9 am, sacred; 11 am, church service; 12:15-2:30 pm, music; 4-6 pm, sacred. Daily ex Sun, 6-7 am, 9-10 am, 11 am-1 pm, 2-3 pm. Daily ex Sun & Mon, 5-10:30 pm. Daily, 12:20 & 6:30 pm, markets. Central standard time. Divides time with KWAH. Slogan: "Keeps Millions Advised."

**KMED** W. J. Virgin, Sparta Bldg., Medford, Ore. 249.9 meters, 1200 kilocycles, 50 watts. Sun, 11 am-12:15 pm, 3:30-4:30 pm, 8-9:15 pm. Daily ex Sat & Sun, 12:15-1:15 pm, 5:45-10 pm. Wed, 10-11 pm. Sat, 6:15-6:30 pm, 10-11:30 pm. Pacific standard time. Divides time with KFJI. Slogan: "See Crater Lake."

**KMIC** J. R. Fouch, Inglewood, Calif. 223.7 meters, 1340 kilocycles, 250 watts. Pacific standard time. Divides time with KGFH.

**KMJ** Fresno Bee, Fresno, Calif. 365.6 meters, 820 kilocycles, 50 watts. Mon, Wed, Fri, 7:15-9 pm. Pacific time.

**KMMJ** M. M. Johnson Co., Clay Center, Nebr. 285.5 meters, 1050 kilocycles, 500 watts daytime, 250 watts night. Sun, 9 pm. Daily ex Sun, 7:30-9:45 am, 11 am-12:15 pm, 1:45-3:30 pm, 6-6:30 pm, 8-10 pm. Central standard time. Divides time with WJAG. Slogan: "The Old Trusty Station."

**KMO** Hotel Winthrop, Tacoma, Wash. 254.1 meters, 1180 kilocycles, 250 watts. Sun, 11-12 am, 6:15-7 pm, 8-9 pm. Mon, 10-11 am, 2-4 pm, 7-8 pm. Tues, 10-11 am, 2-4 pm, 7:30-11 pm. Wed, 10-11 am, 2-4 pm, 8-9 pm. Thurs, 10-11 am, 2-4 pm, 8-10 pm. Fri, 10-11 am, 2-4 pm, 7-8 pm, 10-11 pm. Sat, 10-11 am, 2-4 pm, 6:15-7 pm, 10-11 pm. Pacific time.

**KMOX** "The Voice of St. Louis, Inc." St. Louis, Mo. 299.8 meters, 1000 kilocycles, 5000 watts. Daily ex Sun, 9:40 am-12 noon, 12 noon-6 pm, educational, musical, women's & farmers' programs. Daily ex Sat, 6 pm-2 am, varied & Columbia Chain programs. Sun, 2-10 pm, featuring Columbia Chain & dance orchestras. Central standard time.

**KMTR** KMTR Radio Corp., 1025 N. Highland av., Hollywood, Calif. 526.0 meters, 570 kilocycles, 500 watts. Sun, 5:30-10 pm. Daily ex Sun, 7 am-11 pm. Programs vary. Pacific time. Slogan: "Your Friend in Hollywood."

**KNRC** Clarence B. Juneau, Municipal Auditorium Bldg., Santa Monica, Calif. 374.8 meters, 800 kilocycles, 500 watts. Sun, 10:45-11 pm. Daily ex Sat & Sun, 2-11 pm. Sat, 2 pm-2 am. Pacific standard time. Slogan: "The Station With a Smile."

**KNX** The Los Angeles Evening Express 6116 Hollywood Blvd., Hollywood, Calif. 336.9 meters, 890 kilocycles, 500 watts. Sun, 10 am-5:15 pm, 6:30 pm, 7 pm, church; 2-4 pm, 8 pm, 9 pm, music. Daily ex Sun, 6:45-8 am, 8 am-6 pm, 6:30 pm, dinner hour concert; 7 pm, 8 pm, 10 pm, 11 pm, Mon, Tues, Wed, Thurs 11 pm. Tues, 11:15 am, 12:45 pm. Fri, 2 pm. Sat, 2:15 pm, 7:45 pm & 12 midnight. Mon, 2:30 pm, 4:30 pm, 9:30 pm. Mon & Fri, 6:45 pm. Mon, Tues, Wed, Sat, 7:30 pm. Tues, Wed, Thurs, Fri, 9 pm. Pacific standard time. Slogan: "The Voice of Hollywood."

**KOA** Rocky Mountain Broadcasting Station, General Electric Co., 1370 Krameria st., Denver, Colo. 325.9 meters, 920 kilocycles, 5000 watts night, 2500 watts daytime. Sun, 10:30 am; 6:30 pm, dinner concert; 7:30 pm, church. Daily ex Sun, 11:45 am, weather, news; 12 noon, time signals; 12:05 pm, organ. Daily ex Sat & Sun, stocks, markets, etc.; 6:30 pm, dinner concert; 8:15 pm, studio program. Tues, Thurs, Fri, 3:30 pm, matinee. Tues & Fri, 4 pm, culinary hints; 4:15 pm, fashion review. Mon, Tues, Wed, Fri, 7:30 pm, varied programs. Thurs, 4 pm. Mountain standard time.

**KOAC** Oregon Agricultural College, Corvallis, Ore. 270.1 meters, 1110 kilocycles, 500 watts. Mon, Tues, Wed, Thurs, Fri, 7-9 pm. Pacific standard time. Slogan: "Science for Service."

**KOB** New Mexico College of Agriculture & Mechanical Arts, State College, N. M. 394.5 meters, 760 kilocycles, 5000 watts night, 7500 watts daytime. Daily ex Sun, 11:55 am & 9:55 pm, time signals; 12 noon & 10 pm, weather reports; 12:02 pm & 10:02 pm, road reports; 12:08 pm, financial reports; 12:08-12:30 pm, concert. Mon, Wed, Fri, 7:30-8:30 pm. Mountain standard time. Divides time with KWSC & KTW. Slogan: "The Sunshine State of America."

**KOCH** Central Radio School, Omaha, Neb. 258.5 meters, 1160 kilocycles, 250 watts. Sun, 3-5 pm, classical. Mon, Tues, Thurs, & Sat, 9:10-30 pm, musical. Central standard time. Divides time with WNAL-KFOX.

**KOCW** Oklahoma College for Women, Chickasha, Okla. 252 meters, 1190 kilocycles, 250 watts. Mon, Tues, Thur & Fri, 12-1 pm, educational talk and music. Tues, Fri & Sat, 8-9 pm, musical program. Wed, 10-10:40 am, chapel services; 12-1 pm, musical. Sun, 11 am-12 n, church services; 2:30-3:30 pm, musical. Central standard time.

**KOIL** Mona Motor Oil Co., Council Bluffs, Iowa. 319 meters, 940 kilocycles, 5000 watts. Sun, 11 am-12 noon, church services; 1-2:30 pm, 6-9 pm, 11 pm-12 midnight. Daily ex Sun & Sat, 11:45 am-2:30 pm, 6-9 pm, 11 pm-12 midnight. Mon, 6-12 midnight. Central standard time. Slogan: "The Hilltop Studio."

**KOIN** KOIN (Inc.), Portland, Ore. 319 meters, 940 kilocycles, 1000 watts. Daily ex Sun, 10 am-12 noon, housewife's hour; 12 noon-1 pm, organ concert; 1-1:15 pm, 3-4 pm, news; 5:15-6 pm; 6-7 pm, dinner organ concert; 7-7:15 pm, 7:15-8 pm, orchestra. Mon, Wed, Fri, 10-11:30 pm. Tues, 10-11 pm. Sat, 11 pm-1 am. Nightly ex Sat & Sun, 8-10 pm, diversified studio program. Sun, 3-4:30 pm, 6-7 pm, organ; 7-8 pm, orchestra; 8-9 pm, church services; 9-10 pm, orchestra. Pacific standard time. Slogan: "The Station of the Hour."

**KOMO** Fisher's Blend Station (Inc.), Seattle, Wash. 305.9 meters, 980 kilocycles, 1000 watts. Mon, Tues, Wed, Thurs, Fri & Sat, 10 am-12:30 midnight. Tues, 7-8 pm, 8-9 pm, 10 am-9:30 pm, church service. Pacific time.

**KOW** The Associated Industries, Inc., Albany Hotel, Denver, Colo. 247.8 meters, 1210 kilocycles, 250 watts. Sun, 11 am-12 noon, church programs; 6-7 pm, 7:30-9 pm. Daily ex Sun & Thurs, 7-9 pm. Mountain standard time. Divides time with KFEL. Slogan: "The KOW Station Away Out West."

**KPCB** Snowflake Station, Central Bldg., Seattle, Wash. 230.6 meters, 1300 kilocycles, 50 watts. Sun, 8-9 pm. Daily ex Sun, 9:30-10:30 am, household talks. Mon & Wed, 5:30-6 pm, children's program; 6-6:30 pm, sport news. Mon, Wed, Thurs, 7:30-8:30 pm. Mon, Wed, Fri, 7:30 & 9:45 am. Tues, Fri, Sat, 7:30-11 pm. Evening programs, musical. Pacific standard time. Divides time with KGCL.

**KPLA** Pacific Development Co., Los Angeles, Calif. 252.0 meters, 1190 kilocycles, 500 watts. Daily ex Sun, 11 am-11 pm, music, educational, news, etc. Sun, 7-10 pm. Pacific standard time.

**KPNP** Muscatine, Iowa. 211.1 meters, 1420 kilocycles, 100 watts.

**KPO** Hale Brothers & The Chronicle, San Francisco, Calif. 422.3 meters, 710 kilocycles, 1000 watts. Sun, 9:45 am, church services; 5 pm, chamber music; 6-10 pm, concert, orchestra. Daily ex Sun, 6:45-7:45 am, health exercise; 8-9 am, happy hour; 10:30 am-1 pm, time signals, market reports, etc.; 1-5:30 pm, features, organ music, 6-11 pm, concerts, orchestra, studio programs. Pacific standard time. Slogan: "The City by the Golden Gate."

**KPPC** Pasadena Presbyterian Church, Colorado & Madison sts., Pasadena, Calif. 228.9 meters, 1310 kilocycles, 50 watts. Wed, 6:45-9 pm, mid-week service. Pacific standard time. Divides with KELW.

**KPRC** Houston Post-Dispatch, Houston, Texas. 293.9 meters, 1020 kilocycles, 500 watts. Sun, 7:30 pm, church services. Daily ex Fri & Sun, 7:30 pm & 9:30 pm. Mon & Tues, 8:30 pm. Wed & Sat, 8:15 pm. Thurs, 8 pm. Mon, 9:15 pm. Tues & Thurs, 9 pm. Talks, music, weather reports broadcast. Central standard time. Slogan: "Kotton Port Rail Center."

**KPSN** The Pasadena Star-News, 525 E. Colorado st., Pasadena, Calif. 315.6 meters, 950 kilocycles, 1000 watts. Tues, Thurs, Sat, 8-9 pm, studio concert. Sun, 10:30 am, church services. Daily ex Sun, 12:15 pm & 6-6:15 pm, news. Slogan: "Pasadena, California, Station KPSN."

**KQV** Doubleday Hill Elec. Co., 719 Liberty av., Pittsburgh, Pa. 270.1 meters 1110 kilocycles, 500 watts. Mon, Wed, Fri, 4-9 pm. Tues, Thurs, 4-7 pm. Sun, 1 pm, sacred music. Eastern standard time. Slogan: "The Smoky City Station." Divides time with Station WJAS.

**KQW** California Farm Bureau Station, San Jose, Calif. 296.9 meters, 1010 kilocycles, 500 watts. Daily ex Sun, 1-2:30 pm, music, news, etc.; 5-5:30 pm, Children's Hour; 5:30-6 pm, studio program; 6-7 pm, 7-8 pm, 8-9 pm, studio program. Sun, 10:15 am-12:30 pm, church; 7:30-9:30 pm, church. Pacific standard time. Slogan: "For God and Country."

**KRAC** Caddo Radio Club, State Fair Grounds, Shreveport, La. 220.4 meters, 1360 kilocycles, 50 watts.

**KRE** First Congregational Church and Pacific School of Religion, Berkeley, Calif. 256.3 meters, 1170 kilocycles, 100 watts. Sun, 7:30-9 pm. Mon, Tues, Wed, Thurs, 12:30 noon-1 pm. Tues, 8-9 pm. Pacific standard time. Divides time with KFUS.

**KRLD** The Daily Times Herald & The Adolphus Hotel, Dallas, Tex. 461.3 meters, 650 kilocycles, 500 watts. Sun, 9:30-10:30 am, 11 am-12 noon, 3-4 pm, 5:30-6:30 pm, 6:30-6:45 pm, church; 6:45-7:30 pm, 7:30-9:30 pm, 10:30-11:30 pm. Daily ex Sun, 11-11:30 am, 12:30-2 pm, 3-3:30 pm, 5-6 pm, 7-8 pm, 9:10 am, 11:30 pm-12:30 am, varied programs. Central standard time. Divides time with WRR. Slogan: "Down Where the Blue Bonnets Grow."

**KRLO** Los Angeles, California, 215.7 meters, 1390 kilocycles, 250 watts. Divides time with KGER.

**KRSC** Radio Sales Corp., 1202 Fifth av., Seattle Wash. 211.1 meters 1420 kilocycles, 50 watts.

**KSAC** Kansas State Agricultural College, Manhattan, Kan. 333.1 meters, 900 kilocycles, 500 watts. Daily ex Sat & Sun, 9-10:25 pm, 12:20-1:20 pm, 4-4:30 pm, 6:30-7 pm, 7-8 pm, varied programs. Sat, 12:35 pm, 7:30-8:30 pm. Central standard time.





Total Price Only  
**\$14<sup>95</sup>** *On Easy Payments*

**Radio Cabinet and Bench**

**\$1<sup>00</sup> down**

Only \$1.00 with coupon below brings this handsome, massive, pure Period design console radio cabinet, with bench to match, to your home on 30 days

**Free Trial!**

Just the thing you need to give your radio the appearance of a costly set and to beautify the room with a

touch of elegance. Ample space inside of cabinet for all batteries, chargers and eliminators. Keep all unsightly accessories out of sight in this splendid piece of furniture. Made of well seasoned, selected hardwood in **Handsome Walnut Finish.** Two large, French style swinging doors at front with ornamental brass knobs. Front panels of doors in carved panel effects and legs of both cabinet and bench are neatly turned. Edge of top neatly bevelled. Cabinet has lower cross brace to insure rigidity. Top is 33<sup>1</sup>/<sub>4</sub> x 18 inches, height inside 11<sup>1</sup>/<sub>2</sub> inches. Full height 33 inches. Bench is 18 inches high.

**\$1<sup>50</sup> a Month**

After 30 days trial if not satisfied, send Cabinet and bench back at our expense and we'll refund your \$1.00 plus all transportation charges you paid. Or keep them and pay only \$1.50 a month till you've paid our smashed cut price for this sale—only **\$14.95.** Our credit price beats cash prices anywhere. Order by No. B182A. Shpg. wgt. about 70 lbs.

**Send Coupon NOW!**

**Straus & Schram** Dept. R1511 **Chicago**

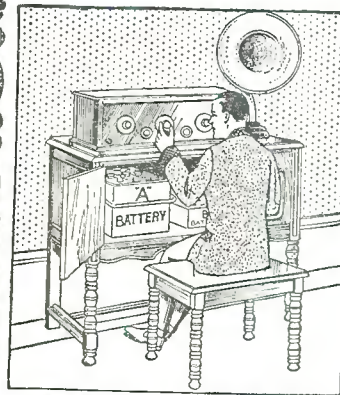

**FREE Catalog** of home furnishings sent with or without order. See coupon.

**Straus & Schram, Dept. R1511 Chicago**  
 Enclosed find \$1. Ship Walnut Finish Radio Cabinet and Bench. I am to have 30 days free trial. If I keep the cabinet and bench I will pay you \$1.50 monthly. If not satisfied, I am to return them at your expense and you are to refund my money and any freight or express charges I paid.  
 Radio Cabinet and Bench No. B182A, \$14.95

Name.....  
 Street, R.F.D. or Box No.....  
 Shipping Point.....  
 Post Office..... State.....  
 Married or Single..... Nationality or Color.....  
 If you want only our free catalog of home furnishings, mark X here



**KSBA** Shreveport Broadcasting Association, Shreveport, La. 267.7 meters, 1120 kilocycles, 1000 watts. Sun, 11 am-12 noon, church services; 5-6 pm, musical; 7:30-9 pm, church services. Mon, Wed, Thurs, Fri, 8-9, musical. Tues & Sat, 9-11 pm. Hotel Youreer dance music. Mon, 11 pm-12 midnight, organ. Daily, 9:15 am, 12:15 pm and 2:15 pm, market and weather reports. Central standard time. Slogan: "Keep Shreveport Before America."

**KSCJ** The Sioux City Journal, Sioux City, Iowa. 243.8 meters, 1230 kilocycles, 500 watts night, 1000 watts daytime. Sun, 11-12 am, 2-4 pm, 7-9 pm. Daily ex Sun, 9:45-10:45 am, markets; 11:30 am-12:30 pm, noon program; 6-7 pm, dinner program; 8:30-midnight, studio program. Central standard time. Divides time with Station KWUC.

**KSD** St. Louis Post-Dispatch, 12th & Olive sts., St. Louis, Mo. 545.1 meters, 350 kilocycles, 500 watts. Sun, 3:15 & 4:45 pm, orchestra; 5:30 pm, religious program; 6:15 pm, Capitol family; 7:15 pm, Collier's hour; 8:15 pm, Atwater-Kent hour. Mon, 6:30-11 pm, Daily ex Sun & Mon, 7-10:30 pm. Central standard time.

**KSEI** KSEI Broadcasting Association, Pocatello, Idaho. 333.1 meters, 900 kilocycles, 250 watts. Sun, 9-11 pm. Daily ex Sun, 3-4 pm, 6:30-7:30 pm, 9-11 pm. Mountain time. Slogan: "Kumunity Southeast Idaho."

**KSL** Utah Radio Service Corp., South Temple St., Salt Lake City, Utah. 302.8 meters, 990 kilocycles, 1000 watts. Sun, 10 am, 12 noon, 1:55 pm, 4-5 pm, 7:30-8:30 pm, 9-10 pm. Daily ex Sun, 10 am-12 noon, 4-5 pm, 6:30-8 pm, 9-10 pm, 11 pm, 12 midnight. Slogan: "The Voice of the Inter-Mountain Empire."

**KSMR** Santa Maria Valley R. R., Santa Maria, Calif. 272.6 meters, 1100 kilocycles, 100 watts. Daily ex Sun, 6:30-10 pm, music, children's hour, home & farm, music. Sat, 7:30-8:15 pm, markets, reports, etc. Pacific time. Slogan: "Santa Maria, Calif., The Valley of Gardens."

**KSO** Berry Seed Co., Clarinda, Iowa. 227.1 meters, 1320 kilocycles, 500 watts. Sun, 11 am, church services; 5 pm. Mon, Tues, Wed, Thurs, Fri, 6 am, 12 noon, 6:30-8:30 pm, musical. Sat, 6 am, 12 noon. Sunday school, 7-8:30 pm. Central standard time. Slogan: "Keep Serving Others."

**KSOO** Sioux Falls Broadcast Association, 609 Minnehaha Bldg., Sioux Falls, S. D. 209.7 meters, 1430 kilocycles, 250 watts.

**KTAB** The Associated Broadcasters (Inc.), 1410 10th av., Oakland, Calif. 280.2 meters, 1070 kilocycles, 500 watts. Sun, 9:45-12:30 pm, 1:30-2:30 pm, 7-9:15 pm, varied program. Daily ex Sun, 6:45 am, 1:30 pm, 4-7:30 pm, 8-11 pm. Pacific standard time. Slogan: "Knowledge, Truth and Beauty."

**KTAP** Radio Service Shop, 822 W. Mulberry St., San Antonio, Tex. 228.9 meters, 1310 kilocycles, 20 watts. Sun, 4-6 pm, varied musical program; 9:30-10:30 pm. Daily ex Sun, 6:30-8:30 am, 10:30-11:30 am, 12:30-2 pm. Mon, Wed & Sat, 6:30-8:30 pm. Daily ex Mon, 9:30-10:30 pm. Varied programs. Central standard time. Slogan: "The World's Biggest Little Station."

**KTBI** Bible Institute of Los Angeles, 536 S. Hope st., Los Angeles, Calif. 288.3 meters, 1040 kilocycles, 500 watts. Mon, Tues, Wed, Thurs, 8 pm, musical studio program. Fri, 7 pm, Sunday school lessons. Sun, 10:45 am, 7:15 pm, church services; 6 pm, vespers. Pacific standard time.

**KTBR** M. E. Brown, Commodore Hotel, 16th & Morrison Sts., Portland, Ore. 282.8 meters, 1060 kilocycles, 50 watts. Sun, 10:30 am-12 noon, church; 1-7:30 pm, 7:30-9 pm. Daily ex Sun, 9-11 am, 1-3 pm, 6-7 pm. Mon, Tues, Sat, 8-9 pm. Wed, Thurs, Fri, 8 pm-12 midnight. Pacific standard time. Divides time with KFJR.

**KTHS** The Arlington Hotel, Hot Springs National Park, Ark. 384.4 meters, 780 kilocycles, 1000 watts. Sun, 11 am-12:30 pm, 8-11:30 pm. Mon, Tues, Fri, Sat, 12 noon-1 pm. Mon & Wed, 7:30-10:30. Tues, 6-10:30 pm. Fri & Sat, 8-11 pm. Central standard time. Slogan: "Kum to Hot Springs."

**KTNT** Norman Baker, Muscatine, Iowa. 256.3 meters, 1170 kilocycles, 2000 watts. Sun, 12 noon, sacred program; 2:30-4 pm, varied program. Mon, 6 am, 9 am, 11 am, 12 noon, 2-5 pm, 6:30-10 pm. Daily ex Sun. Mon & Sat, 6:30-10 pm, 6 am-5 pm, 6:30-9 pm. Sat, 6 am-5 pm. Central standard time. Slogan: "The Voice of the Iowa Farmers' Union."

**KTSA** San Antonio, Tex. 265.3 meters, 1130 kilocycles, 2000 watts.

**KTUE** Uhalt Electric Co., 614 Fannin St., Houston, Tex. 212.6 meters, 1410 kilocycles, 5 watts. Daily, 5:30-6:30 pm. Tues & Sat, 8-9:30 pm. Central standard time.

**KTW** First Presbyterian Church 7th av. and Spring st., Seattle, Wash. 394.5 meters, 760 kilocycles, 1000 watts. Sun, 11 am to 1 pm, 3-4 pm, 7:30-9:30 pm. Pacific time. Divides time with KWSC & KOB.

**KUOA** University of Arkansas, Fayetteville, Ark. 296.9 meters, 1010 kilocycles, 500 watts. Sun, 7:30 pm. Mon & Thurs, 7 pm, radio school; 8 pm, musical program. Central standard time.

**KUOM** State University of Montana, Missoula, Mont. 461.3 meters, 650 kilocycles, 500 watts. Mon & Thurs, 8 pm, music & popular educational talks. Sun, 9:15 pm, sacred concert & sermon. Mountain standard time.

**KUSD** University of South Dakota, Vermillion, S. D. 483.6 meters, 620 kilocycles, 250 watts. Mon and Fri, 6:30-7:30 pm. College events broadcast as they occur. Central standard time.

**KUT** University of Texas, Austin, Tex. 232.4 meters, 1290 kilocycles, 500 watts. Sun, 11 am, St. David's Episcopal Church. Mon, Wed & Fri, 8 pm. Studio program. Slogan: "Come to University of Texas."

**KVI** Puget Sound Radio Broadcasting Co., 15 S. Tacoma av., Tacoma, Wash. 234.2 meters, 1280 kilocycles, 50 watts. Sun, 11:30-12:45 pm, 1:30-5:30 pm, 7:30-9:30 pm. Daily ex Sun, 8-10 am, 6:15-10 pm. Pacific standard time. Slogan: "Puget Sound Station."

**KVOO** South Western Sales Corp., Bristow, Okla. 348.6 meters, 860 kilocycles, 1000 watts. Sun, 8 am-12 noon, church; 5:10 pm, musical entertainment. Daily ex Sun, 11 am, markets; 12 noon-1 pm, farmer's hour; 2:45 pm, markets; 3-4 pm, music; 6-10:30 pm, varied musical, Red & Blue network programs. Central standard time. Slogan: "The Voice of Oklahoma."

**KVOS** L. L. Jackson & L. Kessler, 1208 10th av., Bellingham, Wash. 209.7 meters, 1430 kilocycles, 50 watts.

**KWBS** Schaeffer Radio Co., 226 E. 41st st., Portland, Ore. 199.9 meters, 1500 kilocycles, 15 watts.

**KWCR** H. F. Parr, 1444 2nd av. E., Cedar Rapids, Ia. 239.9 meters, 1250 kilocycles, 250 watts. Daily, 6:30 am, chapel services; 11:30 am, music hour; 4 pm, music; 5:30 pm, 6-7 pm, dinner hour. Mon, Wed, Fri, 9 pm. Central standard time. Divides time with WJAM. Slogan: "Voice of Cedar Rapids."

**KWGW** Portable Wireless Telephone Co., 530 E. Market st., Port Stockton, Calif. 344.6 meters, 870 kilocycles, 50 watts. Sun, 4:30-5:30 pm concert; 7:30-9:30 pm. Daily ex Sun, 5:30 pm, news; 5-5:30 pm, 5:30-6 pm, children's hour; 6-7:30 pm, dinner concert; 8-9 pm, studio; 9-10 pm, studio; 10-11 pm, studio. Pacific time.

**KWJJ** Wilbur Jerman Station, Route No. 1, Box 481, Portland, Ore. 228.9 meters, 1310 kilocycles, 50 watts. Studio at Broadway Theater, 220 Broadway st. Daily ex Sun, 10 am-12 noon, 3-4 pm. Mon & Wed, 5:30 pm-1 am. Tues & Thurs, 5:30 pm-12 midnight. Fri, 5:30 pm-12:30 am. Sat, 5:30-8 pm, 10 pm-12 midnight, dance music. Pacific standard time. Slogan: "The Voice from Broadway."

**KWK** St. Louis, Mo. 234.2 meters, 1280 kilocycles, 1000 watts night, 2000 watts daytime. Central standard time. Divides time with KFQA & WMAY.

**KWKC** Wilson Duncan Studios, 39th & Main sts., Kansas City, Mo. 222.1 meters, 1350 kilocycles, 100 watts. Tues, Wed, Thurs, Fri, 7-9:15 pm. Central standard time. Slogan: "Keep Watching Kansas City."

**KWKH** W. K. Henderson Iron Works & Supply Co., Spring & Fanning sts., Shreveport, La. 394.5 meters, 760 kilocycles, 1000 watts. Divides time with KMA.

**KWLC** Luther College, Decorah, Iowa. 247.8 meters, 1210 kilocycles, 50 watts. Central standard time. Divides time with KGCA.

**KWSC** The State College of Washington, Pullman, Wash. 394.5 meters, 760 kilocycles, 500 watts. Mon, Wed, Fri, 7:30-9 pm. Pacific standard time. Slogan: "The Voice of the Cougars." Divides time with Stations KTW, KOB.

**KWTC** Dr. John Wesley Hancock, 1101 N. Ross St., Santa Ana, Calif. 222.1 meters, 1350 kilocycles, 100 watts. Daily ex Sun, 6:30-7:30 pm, dinner hour; Tues & Thurs, 7:30-10 pm, studio program; Fri, 7:30-8 pm, Farm Bureau talk; Sat, 7:30-9 pm, program. Pacific standard time. Divides time with KFVC. Slogan: "The Garden of Eden Station."

**KWUC** Western Union College, Le Mars, Iowa. Commercial Studio, Wright Bldg., Sioux City, Iowa. 243.8 meters, 1230 kilocycles, 1500 watts. Sun, 4-5 pm, vesper service. Daily ex Sun, 9:30-11:15 am; 12:30-4 pm; 5-7 pm, musical, organ. Sat, 10 pm, college frolic. Central standard time. Divides time with Station KSCJ. Slogan: "The Station Surrounded by North America."

**KWWG** City of Brownsville, Board of City Development, Brownsville, Texas. 277.6 meters, 1080 kilocycles, 500 watts. Sun, church services at 11 am. Mon, weather and river reports, music 12-12:30; music, 6-6:30, 8:30-9:45, 12 midnight-1 am. Tues, weather & river reports, 12-12:30 pm; music, 6-6:30. Wed, Thurs, Fri, Sat, same as Tues. Slogan: "Kum to the World's Winter Garden."

**KXA** American Radio Telephone Co., Home Savings Bldg., Seattle, Wash. 348.6 meters, 860 kilocycles, 500 watts. Sun, 7:15-8:15 pm. Mon, Wed, Fri, 5:45-11 pm. Tues, Thurs, 6-8:30 pm. Pacific standard time. Divides time with KJR. Slogan: "Know the Charmed Land."

**KXL** KXL Broadcasters, Inc., 7th floor Bedell Bldg., Portland, Ore. 220.4 meters, 1360 kilocycles, 50 watts. Slogan: "The Voice of Portland."

**KXRO** Brott Laboratories, 609 Washington Blvd., Seattle, Wash. 227.1 meters, 1320 kilocycles, 50 watts.

**KYA** Pacific Broadcasting Corp., West Coast Theaters Studio, 988 Market St., San Francisco, Calif. 309.1 meters, 970 kilocycles, 500 watts. Sun, 11 am-12:30 pm, 7:30-6 pm, church. Daily ex Sun, 11 am-12 noon, 5-7:30 pm, 8-10 pm. Pacific standard time. Slogan: "At the Golden Gate."



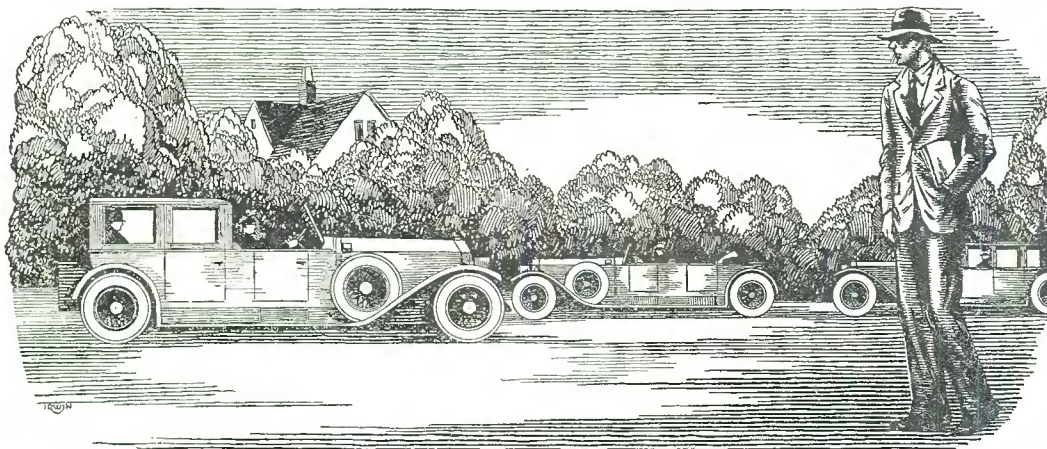

Many times in the old days, while I trudged home after work to save carfare, I used to gaze enviously at the shining cars gliding by me, the prosperous men and women within. Little did I think that inside of a year, I, too, should have my own car, a decent bank account, the good things of life that make it worth living.

# I Thought Success Was For Others

*Believe It Or Not, Just Twelve Months Ago I Was Next Thing To "Down-and-Out"*

**T**ODAY I'm sole owner of the fastest-growing Radio store in town. And I'm on good terms with my banker, too—not like the old days only a year ago, when often I didn't have one dollar to knock against another in my pocket. My wife and I live in the snuggest little home you ever saw, right in one of the best neighborhoods. And to think that a year ago I used to dodge the landlady when she came to collect the rent for the little bedroom I called "home"!

It all seems like a dream now, as I look back over the past twelve short months, and think how discouraged I was then, at the "end of a blind alley." I thought I never had had a good chance in my life, and I thought I never would have one. But it was waking up that I needed, and here's the story of how I got it.

**I** WAS a clerk, working at the usual miserable salary such jobs pay. Somehow I'd never found any way to get into a line where I could make good money.

Other fellows seemed to find opportunities. But—much as I wanted the good things that go with success and a decent income—all the really well-paid vacancies I ever heard of seemed to be out of my line, to call for some kind of knowledge I didn't have.

And I wanted to get married. A fine situation, wasn't it? Mary would have agreed to try it—but it wouldn't have been fair to her.

Mary had told me, "You can't get ahead where you are. Why don't you get into another line of work, somewhere that you can advance?"

"That's fine, Mary," I replied, "but *what* line? I've always got my eyes open for a better job, but I never seem to hear of a really good job that I can handle." Mary didn't seem to be satisfied with the answer but I didn't know what else to tell her.

*It was on the way home that night that I stopped off in the neighborhood drug store, where I overheard a scrap of conversation about myself. A few burning words that were the cause of the turning point in my life!*

With a hot flush of shame I turned and left the store, and walked rapidly home. So that was what my neighbors—the people who knew we best—really thought of me!

"Bargain counter sheik—look how that suit

fits." one fellow had said in a low voice. "Bet he hasn't got a dollar in those pockets." "Oh, it's just 'Useless' Anderson," said another. "He's got a wish-bone where his backbone ought to be."

As I thought over the words in deep humiliation, a sudden thought made me catch my breath. Why had Mary been so dissatisfied with my answer that "I hadn't a chance"? *Did Mary secretly think that too?* And after all, wasn't it true that I had a "wish-bone" where my backbone ought to be? Wasn't that why I never had a "chance" to get ahead? It was true, only too true—and it had taken this cruel blow to my self-esteem to make me see it.

With a new determination I thumbed the pages of a magazine on the table, searching for an advertisement that I'd seen many times but passed up without thinking, an advertisement telling of big opportunities for trained men to succeed in the great new Radio field. With the advertisement was a coupon offering a big free book full of information. I sent the coupon in, and in a few days received a handsome 64-page book, printed in two colors, telling all about the opportunities in the Radio field and how a man can prepare quickly and easily at home to take advantage of these opportunities. I read the book carefully, and when I finished it I made my decision.

**W**HAT'S happened in the twelve months since that day, as I've already told you, seems almost like a dream to me now. For ten of those twelve months, *I've had a Radio business of my own!* At first, of course, I started it as a little proposition on the side, under the guidance of the National Radio Institute, the outfit that gave me my Radio training. It wasn't long before I was getting so much to do in the Radio line that I quit my measly little clerical job, and devoted my full time to my Radio business.

Since that time I've gone right on up, always under the watchful guidance of my friends at the National Radio Institute. They would have given me just as much help, too, if I had wanted to follow some other line of Radio besides building my own retail business—such as broadcasting, manufacturing, experimenting, sea operating, or any one of the score of lines they prepare you for. And to think that until that day I sent for their

eye-opening book, I'd been wailing "I never had a chance!"

**N**OW I'm making real money. I drive a good-looking car of my own. Mary and I don't own the house in full yet, but I've made a substantial down payment, and I'm not straining myself any to meet the installments.

Here's a real tip. You may not be as bad off as I was. But, think it over—are you satisfied? Are you making enough money, at work that you like? Would you sign a contract to stay where you are now for the next ten years, making the same money? If not, you'd better be *doing* something about it instead of drifting.

This new Radio game is a live-wire field of golden rewards. The work, in any of the 20 different lines of Radio, is fascinating, absorbing, well-paid. The National Radio Institute—oldest and largest Radio home-study school in the world—will train you inexpensively in your own home to know Radio from A to Z and to increase your earnings in the Radio field.

Take another tip—No matter what your plans are, no matter how much or how little you know about Radio—clip the coupon below and look their free book over. It is filled with interesting facts, figures and photos, and the information it will give you is worth a few minutes of anybody's time. You will place yourself under no obligation—the book is free, and is gladly sent to anyone who wants to know about Radio. Just address J. E. Smith, President, National Radio Institute, Dept. 1-D, Washington, D. C.

J. E. Smith, President,  
National Radio Institute,  
Dept. 1-D, Washington, D. C.

Dear Mr. Smith:  
Please send me your 64-page free book, printed in two colors, giving all information about the opportunities in Radio and how I can learn quickly and easily at home to take advantage of them. I understand this request places me under no obligation, and that no salesman will call on me.

Name.....  
Address.....  
Town..... State.....



**KYW** Westinghouse Elec. & Mfg. Co., roof of Congress Hotel, Chicago, Ill. 526.0 meters, 570 kilocycles, 5000 watts, after 10 pm 2500 watts. Sun, 11 am-12:15 pm, church; 1-2, 7:15-8:15 pm, 10:55-11 pm, time signals & weather reports. Daily ex Sun, 10:55 am, time signals; 5:45 pm, markets; 6 pm, Uncle Bob's Bedtime Story; 6:30 pm, weather report. Daily ex Mon, 10:55-11:05, time signals. Mon & Thurs, 12 noon-1 pm, studio program. Tues & Fri, 4 pm, Women's Hour; 7-9 pm, program from New York; 9-10:55 pm, music. Wed, Thurs, Fri, 6:32-7 pm, dinner concert. Mon, 6:30-7 pm, Roxy and His Gang from WJZ, N.Y. Wed, 7-7:30 pm, program from WJZ, N.Y.; 7:30-8 pm, studio program; 8-9 pm, program from New York; 9-10:55, musical program, etc. Thurs, 7-8 pm, studio program; 8-9:30 pm, program from New York; 9:30-10:55 pm, musical program. Sat, 7-10:55 pm, music, etc. Central standard time. Divides time with KFKX.

**KZM** Preston D. Allen, 13th & Harrison sts., Hotel Oakland, Oakland, Calif. 245.8 meters, 1220 kilocycles, 100 watts. Daily ex Sun, 6:30-8 pm, Hotel Oakland dinner orchestra. Sun, 8-10 pm, orchestra. Pacific standard time. Divides time with KLS.

**NAA** United States Navy, Washington, D. C. 434.5 meters, 690 kilocycles, 1000 watts. Daily weather broadcast 10:05 am, 3:45 pm, 10:05 pm. Regular program Tues, 7:30 pm. Daily time signals, noon & 10 pm. This station is located at Navy Yard, Washington, D. C. Slogan: "Where the Time Signals Originate."

**NAA** United States Navy, Radio Station, Arlington, Va. Broadcast time signals daily at noon and 10 pm on the following meters or frequencies: Meters, 25.0, 12045; 37.3, 8030; 74.7, 4015; 2678.0, 112.

**WAAD** Ohio Mechanics Institute, Cincinnati, Ohio. 230.6 meters, 1300 kilocycles, 25 watts. Central standard time.

**WAAF** Chicago Daily Drovers Journal, 836 Exchange av., Chicago, Ill. 389.4 meters, 770 kilocycles, 500 watts. Daily ex Sun, & holidays, 8:45 am, markets; 10:30 am, weather; 10:50 am, markets; 11 am, estimated receipts of following day; 12:30 pm, weather; 12:50 pm, markets; 3 pm, markets; 4:30 pm, eastern meat trade conditions. Sat, 12:30 pm, final weather & market reports. Central standard time. Divides time with WJBT and WBBN.

**WAAM** I. R. Nelson Co., 1 Bond st., Newark, N. J. 267.7 meters, 1120 kilocycles, 250 watts. Sun, 11 am-5:30 pm. Daily ex Sun, 7-8 am. Daily ex Sat & Sun, 11 am-1:30 pm, 4-6 pm. Mon, Wed, Fri, 7 pm-12:12 am. Tues, Thurs & Sat, 6:30-7:30 pm. Eastern standard time. Divides time with WNJ & WBCP. Slogan: "Sunshine Station."

**WAAT** Bremer Broadcasting Corp., Hotel Plaza, Jersey City, N. J. 245.8 meters, 1220 kilocycles, 300 watts. Sun, 9 am, 5:30-11 pm, mixed program. Daily ex Sun, 10:30-11 am, 6-6:45 pm. Tues, Wed, Fri, 11 am. Tues & Sat, 12 noon. Mon, 8-11 pm. Tues, 7-8:45 pm. Wed & Fri, 7 pm. Thurs & Sat, 7-9 pm. Eastern standard time. Divides time with Stations WEVD & WGBB. Slogan: "The Voice at the Gate of the Garden State."

**WAAW** Omaha Grain Exchange, Grain Exchange bldg., Omaha, Nebr. 440.9 meters, 680 kilocycles, 500 watts daytime only. Daily ex Sun, 6 am, Oma-Tan Program Harness Bill; 9:30 am-1:40 pm, market reports; 1:30-2:30 pm, program; 5-7 pm, Oma-Tan program. Central standard time. Slogan: "Pioneer Market Station of the West."

**WABC** Atlantic Broadcasting Corp., Richmond Hill, N. Y. Studios, 113 W. 57th St., New York. 309.1 meters, 970 kilocycles, 2500 watts night, 5000 watts daytime. Sun, 10:30 am-1 pm, 7-9 pm. Daily ex Sun, 11:50 am-12:05 pm, weather reports & time signals. 1-2 pm. Daily ex Tues & Sun, 7:15 pm-12 midnight. Eastern standard time. Divides time with WBOQ.

**WABF** Markle Broadcasting Corp., 292 Wyoming av., Kingston, Pa. 205.4 meters, 1460 kilocycles, 250 watts. Sun, 9:30-10:30 am, 10:30 am-12 noon, church; 7:30-9 pm. Daily ex Sun, 12 noon-1 pm, luncheon program. Mon, 7-9 pm, music. Wed & Fri, 7:30-9 pm, music. Eastern standard time. Slogan: "The Voice of Wyoming Valley."

**WABI** First Universalist Church, Park st., Bangor, Me. 389.4 meters, 770 kilocycles, 100 watts. Sun, 10:30 am-12 pm, morning services; 7:30-9 pm, evening services. Eastern standard time. Slogan: "The Pinetree Wave."

**WABW** College of Wooster, Wooster, Ohio. 247.8 meters, 1210 kilocycles, 50 watts. No regular schedule. Eastern standard time.

**WABY** John Magaldi, Jr., 930 S. 8th st., Philadelphia, Pa. 247.8 meters, 1210 kilocycles, 50 watts. Eastern standard time. Divides time with WFKD.

**WABZ** Coliseum Pl. Baptist Church, 1376 Camp St., New Orleans, La. 238.0 meters, 1260 kilocycles, 50 watts. Sun, 10:55 am to 12:30-7:25 to 9:15 pm. Central standard time. Divides time with WSBW. Slogan: "The Station with a Message."

**WADC** Allen Theatre Broadcasting Station, Towell Cadillac Bldg., Akron, Ohio. 238 meters, 1260 kilocycles, 1000 watts. Sun, 10:30-11:45 am, 12:30-1:30 pm, 3-5 pm, 8-11 pm. Daily ex Sun, 11 am-12 noon, 5:30-6 pm. Daily ex Sat, 8-11 pm. Eastern standard time. Slogan: "Watch Akron Develop Commercially."

**WAFD** WAFD Broadcasting Co., Addison Hotel, Charlotte & Woodward Aves., Detroit, Mich. 230.6 meters, 1300 kilocycles, 100 watts. Menu service, 2 pm daily. Dinner music, 6:45 pm. Daily studio program, 7:30 pm daily ex Sat. Eastern standard time.

**WAGM** R. L. Miller, Royal Oak, Mich. 225.4 meters, 1330 kilocycles, 50 watts. Sun, Mon, Wed & Fri, 8-10:30 pm. Slogan: "The Little Station With the Big Reputation."

**WAIT** A. H. Waite & Co. (Inc.), 32 Weir st., Taunton, Mass. 214.2 meters, 1400 kilocycles, 10 watts. No regular schedule. Eastern standard time.

**WAUI** American Insurance Union, Columbus, Ohio. 282.8 meters, 1060 kilocycles, 5000 watts. Daily ex Sun, 10:30 through 12 noon. Daily ex Sat & Sun, 3 pm. Mon & Wed, 6-10 pm. Tues & Thurs, 6-6:30 pm. Fri, 6-10:30 pm. Talks, music, weather reports & chain programs. Sun, 3 through 4 pm, 7:15 through 10:30 pm. Eastern standard time. Divides time with WEOA. Slogan: "The Radio Voice of the American Insurance Union."

**WALK** Bethayres, Pa. 201.6 meters, 1490 kilocycles, 50 watts.

**WAMD** Radisson Radio Corp. & Stanley E. Hubbard, Minneapolis, Minn. 222.1 meters, 1350 kilocycles, 500 watts. Sun, 10:30 am, church; 12:30, unnieys; 3 pm, popular program; 5:30 pm, concert; 9:30 pm, popular. Daily ex Sun, 10:30 am, musical; 11 am, Aunt Sammy; 12 noon & 5:30 pm, organ; 6:05 pm, farm feature; 7 pm, classical hour; 8-9 pm, popular program; 10 pm, dance music; 11:15 pm, organ. Central standard time. Divides time with KFOY. Slogan: "The Call of the North."

**WAPI** Alabama Polytechnic Institute, Auburn, Ala. 340.7 meters, 880 kilocycles, 1000 watts. Daily ex Sun, 12-1 pm, 9-10 pm Tues, Thurs, Fri. All programs include musical numbers, educational lectures and news. Central standard time. Divides time with WJAX.

**WARS & WSDA** Amateur Radio Specialty Co., Hotel Shelburne, Brooklyn, N. Y. 227.1 meters, 1320 kilocycles, 500 watts. Sun, 7-9 am, 12:30-3 pm. Mon, Wed, Thurs, Fri, 7-8 am, 9-10 am. Mon & Fri, 8-10 pm. Wed & Fri, 3-6 pm. Tues & Thurs, 12 noon-2 pm. Mon, 3-7 pm. Wed, 7-10 pm. Thurs, 6-7 pm, 10 pm-12 midnight. Sat, 7-9 am, 1-3:30 pm, 9 pm-12 midnight. Eastern standard time. Divides time with WBBC. Slogan: "The Voice of the Atlantic."

**WASH** Baxter Launderers & Cleaners, 747 Fountain st., N. E., Grand Rapids, Mich. 256.3 meters, 1170 kilocycles, 250 watts. Sun, 11 am-12:15 pm. Daily ex Sun, 12:30-1:30, 5:30-6, 7-8 pm. Sat, 2:15 pm (football season only). Central standard time.

**WATT** Edison Elec. Illuminating Co., 39 Boylston, Boston, Mass. (portable). 201.6 meters, 1490 kilocycles, 100 watts.

**WBAA** Purdue University, West Lafayette, Ind. 272.6 meters, 1100 kilocycles, 500 watts. Daily, 11:15 am, markets, etc. Mon & Fri, 7 pm, music and talks. Athletic contests and special features as announced. Central standard time. Divides time with WRM.

**WBAK** Pennsylvania State Police, 18th & Herr sts., Harrisburg, Pa. 299.8 meters, 1000 kilocycles, 500 watts. Daily ex Sun, 10:30 am, police reports; 1:30 pm, 4 pm. Mon & Thurs, 7 pm. Eastern standard time. Divides time with WPSC. Slogan: "The Voice of Pennsylvania."

**WBAL** Baltimore, Md. 285.5 meters, 1050 kilocycles, 5000 watts. Sun, 6:30-7:30 pm, concert orchestra; 7:30-8:15 pm, musical programs. Daily ex Sat, 3:30-5 pm, 6-11 pm. Sat, 6:30-11 pm. Eastern standard time. Slogan: "The Station of Good Music."

**WBAO** James Millikin University, Decatur, Ill. 267.7 meters, 1120 kilocycles, 100 watts. Mon, Wed, 7-8 pm, music & lectures. Thur, Fri, Sat, basketball & football games whenever scheduled. Central standard time. Slogan: "Millikin at Decatur."

**WBAP** Carter Publications (Inc.), 400 W. 7th st., Fort Worth, Tex. 499.7 meters, 600 kilocycles, 5000 watts. Sun, 11 am, church; 12:30 pm, kiddies' hour; 5 pm, sacred music, 9:30 pm, orchestra. Daily ex Sun, 6-7 pm. Daily ex Sun & Wed, 8-9 pm. Mon, Thurs, Fri, 10 pm-12 midnight. Central standard time. Divides time with Station WOAI.

**WBAW** Waldrum Drug Co. & Braid Electric Co., 7th av., South & Broad sts., Nashville, Tenn. 239.9 meters, 1250 kilocycles, 500 watts. Divides time with WOAN.

**WBAX** John H. Stenger, Jr., 66 Gildersleeve, Box 104, Wilkes-Barre, Pa. 249.9 meters, 1200 kilocycles, 100 watts. 6:30 pm, studio. Mon, 7-8 dance music. Tues, 7-9 pm, main studio; 10:30 pm, classical. Thurs, 9-10:30 pm, recital; 3:15-5 pm, lectures; 11:15-2 am, witching hour. Sat, 10-12 pm, dance. Eastern standard time. Divides time with WBRE. Slogan: "In Wyoming Valley, Home of the Anthracite."

**WBBC** Peter J. Testan, 2123 Troy av., New York, N. Y. 227.1 meters, 1320 kilocycles, 500 watts. Tues, Thurs, Sat, 8-12 pm, musical. Eastern time. Divides time with WARS-WSDA.

**WBBL** Grace Covenant Presbyterian Church, Richmond, Va. 234.2 meters, 1280 kilocycles, 100 watts. Sun, 11 am-7:45 pm. Tues, 8 pm. Eastern standard time. Slogan: "Richmond, the Gateway North and South."

**WBBM** WBBM Air Theatre, 306 S. Wabash av., Chicago, Ill. 389.4 meters, 770 kilocycles, 5000 watts. Daily ex Sun & Mon, 12:45-2 pm, 7-11 pm. Mon, 12:30-2 pm, 6-7 pm. Sat, 12 midnight-2 am. Silent Sun. Central standard time. Divides time with Stations WJBT and WAAF.

**WBBP** Petoskey High School, Petoskey, Mich. 239.9 meters, 1250 kilocycles, 100 watts. Program irregular. Central standard time. Slogan: "There's Only One Petoskey."

**WBBR** People's Pulpit Association, 117 Adams St., Brooklyn, N. Y. 256.3 meters, 1170 kilocycles, 1000 watts. Sun, 10-12 am, orchestra, lectures, lessons; 2-4:30 pm, concert; 7-9 pm, Bible questions, music. Daily ex Sun & Sat, 2-4 pm. Mon, Tues, Thurs, Fri, 7-9 pm. Wed, 6-7 pm. Eastern standard time. Slogan: "Watchtower."



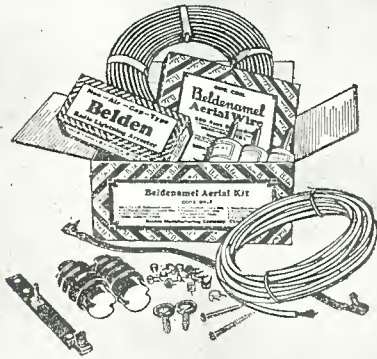

**Beldenamel Aerial Kit**

Includes Beldenamel Aerial Wire, Lightning Arrester, Colorubber Hookup Wire, Belden Ground Wire, as well as Lead-in Strip, Ground Clamp, Screws, Staples, Insulators, and everything needed for an aerial of enduring efficiency.

**Beldenamel Aerial Wire**

An aerial wire that is just as efficient after years of service as when first installed. Does not deteriorate in service because the copper is protected by the Beldenamel coating. Solves the aerial problem definitely.

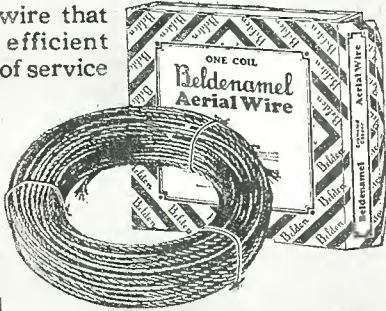

**Belden Colorubber Hookup Wire**

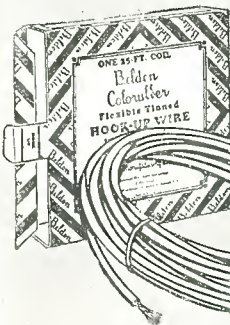

This is the ideal wire for connecting up radio sets, internal wiring of the set, or in fact any place where a high grade wire is needed. Made with light insulation for general use and heavy insulation for A B C use.

**Belden Loud Speaker Extension Cord**

Multiplies the usefulness of the radio receiver. By using this cord, the loud speaker can be moved to any point desired without disturbing the set. Colorubber insulation on both conductors assures faithful delivery of signals with minimum waste.

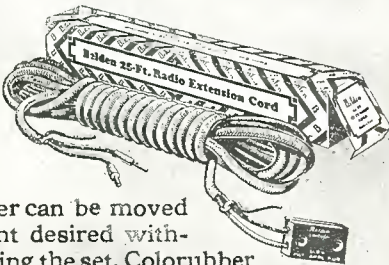

*An*  
**Extension Cord**  
*That Lies Flat Under the Rug*

The Belden Flat Floor Cord passes under the rug and permits the radio set or radio power unit to be operated from an outlet on the opposite side of the room.

This remarkable cord lies so flat that it is hardly noticeable under the rug. The soft rubber insulation does not cause the rug to wear. Anybody can install the Belden Flat Floor Cord without tools. A four-foot lamp cord on one end is fitted with standard plug. A receptacle on the other end receives standard plugs. Ask your dealer about the Belden Flat Floor Cord today.

**Belden Manufacturing Company**

2322-A So. Western Ave.  
Chicago, Illinois



**Belden Lightning Arrester**

The Belden Resistor Type Lightning Arrester has no air gap. The design is of the latest type and has been thoroughly tested and approved by underwriters. Can be installed either inside or out of doors.



**Belden Indoor Aerial and Loop Wire**

A neat indoor aerial wire that is very efficient. The neutral-colored braid is easily concealed around a window or over the picture molding. An indoor aerial of this excellent wire is very selective.



**Belden Lead-in and Ground Wire**

A high grade insulated wire for the ground connection. Assures a ground of permanent efficiency.



**WBBW** Ruffner Junior High School, Norfolk, Va. 236.1 meters, 1270 kilocycles, 100 watts. Programs vary. Eastern standard time. Divides time with WTAR, WSUF.

**WBBY** Washington Light Infantry, 240 King st., Charleston, S. C. 249.9 meters, 1200 kilocycles, 75 watts. Irregular through week. Sat, 7-12 pm, orchestra, vocal, instrumental and talks. Eastern time. Slogan: "The Seaport of the Southeast."

**WBBZ** C. L. Carrell, 36 S. State st., Chicago, Ill. (Portable). 204.0 meters, 1470 kilocycles, 100 watts. Central standard time.

**WBCN** Great Lakes Broadcasting Co., 306 S. Michigan Ave., Chicago, Ill. 288.3 meters, 1040 kilocycles, 250 watts. Sun, 10:30 am-12:15 pm, 4-6 pm, 7:30-9:30 pm, classical and religious. Daily ex Sun & Mon, 1-2 pm, 5-6 pm, classical; 7-8 pm, popular program. Central standard time. Divides time with WENR. Slogan: "Voice of Service."

**WBES** Bliss Electrical School, Takoma Park, Md. 265.3 meters, 1130 kilocycles, 100 watts. Eastern standard time.

**WBET** Boston Transcript Co., 324 Washington St., Boston, Mass. 288.3 meters, 1040 kilocycles, 500 watts. Divides time with WSSH.

**WBIS & WNAC** The Shepard Stores, Winter St., Boston, Mass. 461.3 meters, 650 kilocycles, 500 watts. Daily ex Sun, 7:45-9:30 am, 2-4 pm. Eastern standard time.

**WBKN** Municipal Bank Bldg., 350 Stone av., Brooklyn, N. Y. 199.9 meters, 1500 kilocycles, 100 watts. Daily ex Sun, 12 noon-1 pm, 3-5 pm. Mon, Fri, 8-10 pm. Tues, 10 pm-12 midnight. Wed, 12 midnight-2 am. Thur, 6-8 pm. Sat, 6-8 pm. Eastern standard time. Slogan: "The Voice of Community Service." Divides time with Stations, WWRL & WGOP.

**WBMH** Braun's Music House, Detroit, Mich. 211.1 meters, 1420 kilocycles, 100 watts.

**WBMS** The Union City Municipal Broadcasting Station, State-Capital Theater Bldg., Union City, N. J. 199.9 meters, 1500 kilocycles, 100 watts. Sun, 10 am-1 pm. Popular program. Daily ex Sun, 10-11 am, dance program; 5-6 pm, dinner music. Mon & Fri, 12 midnight-2 am, nut club. Tues, Thur, 8-10 pm, popular program. Wed, 6-8 pm, popular program. Sat, 10 pm-12 midnight, popular program. Eastern standard time. Slogan: "The Voice of Union City, New Jersey."

**WBNY** Baruch Corp., 400 E. 139th St., New York, N. Y. 236.1 meters, 1270 kilocycles, 500 watts. Daily ex Sun, 7-11 pm. Sun, 2:30-6 pm. Eastern standard time. Divides time with WHAP-WPUB. Slogan: "The Voice of the Heart of New York."

**WBOQ** New York Cty, N. Y. 309.1 meters, 970 kilocycles, 500 watts. Eastern standard time. Divides time with WABC.

**WBRC** Birmingham Broadcasting Corp., 1913 5th av. N., Birmingham, Ala. 241.8 meters, 1240 kilocycles, 250 watts. Sun, 10:45 am-12:30 pm, church; 6:30-7:30 pm, organ; 7:30-9:30 pm, church. Mon, Tues, Wed, Fri, 8-9 pm. Daily ex Sat & Sun, 1-2 pm. Central standard time. Slogan: "The Biggest Little Station in the World."

**WBRE** 16 N. Main St., Liberty State Bank & Trust Bldg., Wilkes-Barre, Pa. 249.9 meters, 1200 kilocycles, 100 watts. Sun, 9 pm-12 midnight. Mon & Fri, 6-11 pm. Wed, 6 pm-12 midnight. Eastern standard time. Divides time with WBAX.

**WBR5** North American Broadcasting Corp., 1062 Broadway, Brooklyn, N. Y. 211.1 meters, 1420 kilocycles, 100 watts. Eastern standard time. Divides time with WCDA-WRST.

**WBSO** Babson's Statistical Organization, Wellesley Hills, Mass. 384.4 meters, 780 kilocycles, 100 watts. Sun, 12 midnight, good cheer service. Daily ex Sat, Sun 4 pm. Daily, 12 midnight. Eastern standard time.

**WBT** C. C. Coddington, 500 W. Trade st., Charlotte, N. C. 258.5 meters, 1160 kilocycles, 750 watts night, 1000 watts daytime. Sun, 10:55 am, 7:30 pm, church; 8:30 pm, Capitol theater program; 9:15 pm. Daily ex Sun & Tues, 12:30 pm, weather reports; 7 pm. Mon, Wed & Thurs, 7:30 pm. Mon, 7:10 pm. 7:20 pm. 9:30 pm. Wed & Thurs, 8 pm. Sat, 7:45 pm, 8:45 pm. Mon, Thurs, Sat, 9 pm. Fri, 10 pm. Varied studio & chain programs. Eastern standard time. Slogan: "The Queen City of the South."

**WBZ** Westinghouse Electric & Mfg. Co., Hotel Kimball, East Springfield, Mass. 333.1 meters, 900 kilocycles, 15,000 watts. Broadcasts in synchronism with WBZA, Boston, Mass. Slogan: "The Broadcasting Station of New England."

**WBZA** Westinghouse Electric & Mfg. Co., Hotel Statler, Boston, Mass. 333.1 meters, 900 kilocycles, 500 watts. Broadcasts on a 24-hour schedule daily. Eastern standard time.

**WCAC** Connecticut Agricultural College, Mansfield, Conn. 535.4 meters, 560 kilocycles, 500 watts. Mon, 1-2 pm. Mon & Sat, 7-8 pm. Eastern standard time. Divides time with WTIC. Slogan: "Voice from the Nutmeg State."

**WCAD** St. Lawrence University, Canton, N. Y. 243.8 meters, 1230 kilocycles, 500 watts pm, 1000 watts am. Sun, 4-5 pm, organ recital. Daily ex Sun, 12:30 pm-1 pm. Wed, 8-10 pm. Eastern standard time. Slogan: "The Voice of the North Country."

**WCAE** The Pittsburgh Press and Kaufman & Baer Co., Pittsburgh, Pa. 461.3 meters, 650 kilocycles, 500 watts. Sun, 9:30 am-10 pm. Daily ex Sun, 6:45 am-11 pm, inclusive. Programs include exercises, educational talks, musical programs, children's periods, news & recitals. Eastern standard time. Slogan: "Where Prosperity Begins."

**WCAH** C. A. Entekin, 1304 Fort Hayes Hotel Columbus, O. 234.2 meters, 1280 kilocycles, 250 watts. Sun, 11:45 am-12:45 pm, church; 12:45-1:30 pm, 6-7:15 pm, 8:45-9:45 pm, church. Daily ex Sun, Mon & Wed, 12 noon-1 pm, 6-10:30 pm. Mon & Wed, 6-7:30 pm. Sat, 6 pm-12 midnight. Eastern standard time. Divides time with WMAN.

**WCAJ** Nebraska Wesleyan University, University Place, Nebr. 379.5 meters, 790 kilocycles, 500 watts. Sun, 11 am, church services; 4 pm, vespers. Daily ex Sat & Sun, 10 am, convocation program; 4:30 pm, weather, news, features. Tues & Fri, 12 noon, musical half hour. Tues, 7:30 pm. Bible study; 8 pm, teachers' training course. Wed, 9 pm, musical program. Central standard time.

**WCAL** St. Olaf College, Northfield, Minn. 285.5 meters, 1050 kilocycles, 500 watts. Daily ex Sun & Thurs, 9:45 am, chapel service. Sunday, 8:30 am, Norwegian Church service. Central standard time. Divides time with WDGX. Slogan: "The College on the Hill."

**WCAM** City of Camden, Camden, N. J. 223.7 meters, 1340 kilocycles, 500 watts. Mon, Wed, Fri, 7:30-12 pm, mixed program. Eastern time. Divides time with WFAN.

**WCAO** Monumental Radio, Incorporated, 842 N. Howard st., Baltimore, Md. 243.8 meters, 1230 kilocycles, 250 watts. Mon, Wed, Fri, 8-11 pm. Sun, 11 am-12 noon, church services; 3-4 & 4-5 pm, Columbia Chain Program; 8-9:30 pm, church services; 9:30 & 10 pm, Columbia Chain Program. Eastern standard time. Divides time with WFBR. Slogan: "The Gateway of the South."

**WCAT** South Dakota State School of Mines, Rapid City, S. Dak. 247.8 meters, 1210 kilocycles, 100 watts. Daily ex Sun, 9:30-9:45 am, weather; 12:30-1 pm, weather & agrigrams. Mountain time. Slogan: "WCAT, Station of the South Dakota State School of Mines at Rapid City."

**WCAU** Universal Broadcasting Co., Hotel Pennsylvania, 39th & Chestnut sts., Philadelphia, Pa. 260.7 meters, 1150 kilocycles, 500 watts. Mon & Fri, 5:15 pm-12 midnight. Tues, Thurs, Sat, 5:30 pm-12 midnight. Wed, 5:15 pm-1 am. Sun, 2 pm-12 midnight. Eastern standard time. Slogan: "Where Cheer Awaits U."

**WCAX** University of Vermont, Burlington, Vt. 254.1 meters, 1180 kilocycles, 100 watts. Fri, 7:30-8:30 pm, education & entertainment. Eastern standard time. Slogan: "The Voice of the Green Mountains."

**WCAZ** Carthage College, Carthage, Ill. 249.9 meters, 1200 kilocycles, 500 watts. Daily ex Sat & Sun, 11:40 am, church services. Mon, 7-8 pm, musical program. Athletic contests at various times. Central standard time.

**WCBA** Charles W. Heimbach (Queen City Radiophone Station WCBA), 1350 Allen St., Allentown, Pa. 222.1 meters, 1350 kilocycles, 100 watts. Wed & Fri, 8:15-11 pm, musical programs. Sat, 9:30-11 pm, dance program. Sun, 10 am, 5:30 pm, 7 pm, church services. Eastern standard time. Divides time with WSAJ.

**WCBD** Wilbur Glenn Voliva, Temple Site, Zion, Ill. 344.6 meters, 870 kilocycles, 5000 watts. Sun, 9-10:45 am, 2:30-6 pm, 8-10:30 pm. Tues, 8-10:30 pm. Wed, 12:30-1 pm. Thurs, 2:30-3:45 pm, 9-10 pm. Divides time with WLS, Sears-Roebuck Station, Chicago.

**WCBE** Uhalt Bros. Radio Co., 1219 N. Rampart st., New Orleans, La. 227.1 meters, 1320 kilocycles, 5 watts. Daily ex Sun, 11:30-12:30 pm. Sun, 12:30-2:30 pm, 7:30-8:30 pm. Central standard time. Slogan: "Second Post, U. S. A."

**WCBM** Hotel Chateau, Baltimore, Md. 225.4 meters, 1330 kilocycles, 100 watts. Sun, 6-8 pm, vocal & instrumental. Tues & Wed, 11 pm. Sat, 9:30-12 midnight. Eastern standard time. Slogan: "At Dixie's Door." Divides time with Station WCAO.

**WCBR** C. H. Messter (Portable), 42 Doyle av., Providence, R. I. 201.6 meters, 1490 kilocycles, 100 watts. Daily ex Sun, 6:30 pm, 7:30 pm, 9-10 pm. Eastern time.

**WCBS** St. Nicholas Hotel, Springfield, Ill. 209.7 meters, 1430 kilocycles, 250 watts. Sun, 10:45 am-12 noon, church services; 12:30-2 pm, 6-7 pm. Mon, Tues, Fri, 8:30-10:30 pm, 11-12 pm. Wed, Thur, 8-11 pm. Central standard time.

**WCCO** Gold Medal Flour Station, Nicollet Hotel, Minneapolis, and Hotel Lowry, St. Paul, Minn. 405.2 meters, 740 kilocycles, 5000 watts night, 7500 watts daytime. Daily ex Sun, 9:30 am, 9:35 am, 9:45 am, 10:30 am, 11:30 am, 12 noon, 1:30 pm, news, markets, weather, noon concert. Mon & Tues, 6-10 pm. Wed, 6-11:30 pm. Thurs, 6-10:05 pm. Fri & Sat, 6:15-10:05 pm. Sun, 9:45 am, 4:10-11 pm. Central standard time. Slogan: "Service to the Northwest."

**WCDA** New York City, N. Y. 211.1 meters, 1420 kilocycles, 250 watts. Eastern standard time. Divides time with WBR5-WRST.

**WCFL** Chicago Federation of Labor, 633 So. Wabash av., Chicago, Ill. 483.6 meters, 620 kilocycles, 1500 watts. Sun, 11-12:30 noon, church; 2-6:30 pm, popular program; 7:45-9:15 am, Baptist Church; 9:15, Utah Hour. Mon, 10 am-2 pm, 4-6 pm, musical. Daily ex Sun & Mon, 10 am-2 pm, 4 pm-12 midnight, music and speakers. Central standard time. Divides time with WLTS & WEMC. Slogan: "The Voice of Labor."



# There are many fluxes for soldering but only one—is safe for Radio!

**F**LUX for soldering is a general term; it embraces, as a class, all types of soldering fluxes. To designate a flux as safe for radio construction is specific; it means rosin. Chloride pastes, acids and fluid solutions are soldering fluxes, and are well adapted for certain work, but *conductive and corrosive properties forbade their use for radio assembly*. Their active elements, zinc and ammonium chlorides, display spreading, creeping tendencies that promote leakage and will eventually cause increased resistance in the wiring.

Rosin, an organic mixture, is a *non-conductor and non-corrosive*. The glass-like surface of this material does not readily lend itself to the collection of dust (carbon particles) as will the sticky organic greases of paste. Nor will rosin attract moisture from the atmosphere; the chlorides of pastes and fluids will. *Moisture plus carbon particles defeat the best insulations produced.*

*Moisture plus chlorides direct a slow but determined corrosive attack upon supporting metals.* Such slow corrosion in wiring causes a steadily increasing resistance to the flow of electrical energy.

Kester Rosin-Core Radio Solder scientifically combines radio's premier flux, Rosin, with a solder alloy of unvarying quality. The use of Kester Radio Solder furnishes the user with a means of accomplishing *Safer, Faster, and Cleaner* set wiring. Constructors who solder-protect wiring with Kester Radio Solder enjoy increased receptive range, improved tonal quality and the satisfying assurance that their receivers will never be forced into the discard through the corrosive and conductive action of a chloride flux.

**A Kester Soldered Receiver Is a Better Set**

*Manufacturers of Radio Sets and Equipment:* Tests conducted with the various types of commercial fluxes are under constant observation in our laboratory. Can we assist you in your soldering problems?



## KESTER Radio SOLDER

CHICAGO SOLDER COMPANY  
4226 Wrightwood Ave. Chicago, U.S.A.

*Originators and World's Largest Manufacturers of Self-fluxing Solder—  
Convince Yourself Without Expense*

Use This Coupon Now! →

CHICAGO SOLDER CO. C.R.—1-28  
 4226 Wrightwood Ave., Chicago, U. S. A.  
 Gentlemen: Please send me a test sample of Kester Radio Solder, together with descriptive literature without any obligation whatsoever.

Name.....  
 Address.....  
 City..... State.....  
 Dealer.....

Tell 'Em You Saw It in the Citizens Radio Call Book Magazine



**WCGU** Chas. G. Unger, New Perl House, Coney Island, New York. 218.8 meters. 1370 kilocycles, 500 watts. Eastern standard time. Divides time with WKBQ-WKBO.

**WCLO** C. E. Whitmore, Camp Lake, Wis. 227.1 meters, 1320 kilocycles, 100 watts. Sun. 2-5 pm, popular. Mon. Wed, Fri, Sat. 7 pm-midnight, popular program. Central standard time. Slogan: "The Playground of the Lake Region." Divides with WWAE and WJBC.

**WCLS** WCLS, Inc., 301 E. Jefferson st., Joliet, Ill. 215.7 meters, 1390 kilocycles, 150 watts. Sun. 9:30 am, services, 11 am, services; 8-11 pm, studio program. Tues, 8-11 pm, studio features. Wed, 7-8 pm, organ concert. Fri. 7-8 pm, organ & vocal; 8-11 pm, studio program. Sat. 8-11 pm, studio features, orchestra. Central standard time. Divides time with WKBB. Slogan: "Will County's Largest Store."

**WCMA** Culver Military Academy, Culver, Ind. 260.7 meters, 1150 kilocycles, 500 watts. Daily ex Sat & Sun. 3-4 pm, public service hour, highway reports, etc. Sun, 11 am, chapel service. Mon, 8 pm, band concert & studio. Wed, 8 pm, dance music & studio. Central standard time. Slogan: "The Voice of Culver." Divides with WOOD.

**WCOA** Municipal Broadcasting Station, City Hall, Pensacola, Fla. 249.9 meters, 1200 kilocycles, 500 watts. Sun, 12:30-7:30 pm. Mon. Wed, Fri, 10:30 am, 12:30-11 pm. Tues, Thurs. Sat. 10:30 am-12:30 pm. Central standard time. Slogan: "Wonderful City of Advantages."

**WCOC** Crystal Oil Co., Columbus, Miss. 230.6 meters, 1300 kilocycles, 250 watts. Daily ex Sun. 5-6 pm, music. Tues, 8-10 pm, vocal & instrumental studio program. Fri, 8-10 pm, dance music. Central standard time.

**WCOT** Jacob Conn, Olympia Theatre, Olneyville sq., Providence, R. I. 225.4 meters, 1330 kilocycles, 100 watts. Daily including Sun. 2:30-4 pm. Daily ex Sun. 7:30-9 pm. Programs varied. Eastern standard time.

**WCRW** Clinton R. White, Embassy Hotel, Diversey parkway, at Pine Grove, Chicago, Ill. 223.7 meters, 1340 kilocycles, 500 watts. Daily ex Sun, 11:30 am-1 pm. Daily ex Mon, 6:30-7:30 pm. 9:30-10:30 pm. Sun. 6:30-7:30 pm. 10-11 pm. Central standard time. Divides time with WKFB, WPCC. Slogan: "For Your Entertainment."

**WCSH** Henry P. Rines, Congress Square Hotel, Portland, Maine. 365.6 meters, 820 kilocycles, 500 watts. Sun, 10:30-12 noon, 1:30-2:30 pm. 4-5:30 pm, 7:30-10 pm. Mon, 10-12 am. 12-1:30 pm, 3-4 pm, 6-11 pm. Daily ex Sun, same as Mon. Slogan: "The Voice from Sunrise Land."

**WCSO** Wittenberg College, Springfield, O. 256.3 meters, 1170 kilocycles, 500 watts. Mon, Wed, Fri, 7-9 pm. Tues, 6:30-7:30 pm. Sat, 2-4:30 pm. Eastern standard time.

**WCWK** Chester W. Keen, Fort Wayne, Ind. 214.2 meters, 1400 kilocycles, 250 watts. Sun, 10:30 am, 6:30-7:30 pm, church services. Mon, Tues, Wed, Thurs, Fri, Sat, 11 am-12 noon, musical program. Mon, 4-5:30 pm, children's hour. Tues, Fri, 8-11 pm, musical program. Central standard time. Slogan: "The Hoosier Station."

**WCWS** The Connecticut Portable Broadcasting Station, Danbury, Conn. 265.3 meters, 1130 kilocycles, 100 watts. Divides with WICC.

**WCX & WJR** Richards-Oakland Co. & Detroit Free Press, 2914 Book-Cadillac Hotel, Detroit, Mich. 440.9 meters, 680 kilocycles, 5000 watts. Sun, 10 am, church; 12:30 pm, 2 pm, 3 pm, 4:15-4:30 pm, 6-10:30 pm. Daily ex Sun, 12:30 pm, 12:45-2 pm, 4-4:30 pm, 5-5:45 pm-12 midnight. Mon, Wed, Fri, 10-11 pm. Mon, Tues, Wed, 12:15 pm. Music, talks, weather reports & chain programs broadcast. Eastern standard time. Slogan: "The Good Will Station."

**WDAD** Dad's Auto Accessories, Inc., 171-173 8th av., North Nashville, Tenn. 225.4 meters, 1330 kilocycles, 1000 watts. Sun, 3-4 pm, 6:30-7:30 pm. Mon, Wed, Sat, 11:45 am-1 pm. 3-4 pm, 9 pm-12 midnight. Tues & Thurs, 11:45 am-1 pm, 3-4 pm, 7-9 pm. Central standard time. Divides time with WLAC. Slogan: "Where Dollars Are Doubled."

**WDAE** Tampa Daily Times, Tampa, Fla. 267.7 meters, 1120 kilocycles, 500 watts. On air every afternoon and evening. Eastern standard time. Slogan: "WDAE, the Voice of the Times at Tampa."

**WDAF** The Kansas City Star, Kansas City, Mo. 370.2 meters, 810 kilocycles, 1000 watts. Sun. 3-4:45 pm, church concert and services; 7:13-9:15 pm. Daily ex Sun. 8-8:15 am, Bible lesson; 12 noon-1 pm, 3-4 pm, 5:30-10 pm; 11:45 pm-1 am, musical. Central standard time. Slogan: "Enemies of Sleep."

**WDAG** J. L. Martin, 605 E. 4th st., Amarillo, Texas. 263 meters, 1140 kilocycles, 250 watts. Week days, 12:45 pm, chats, markets & weather; 9-10 pm, entertainment. Fri, 8-10 pm, entertainment. Sun, 9:45 am, Bible class; 7:30-9:30 pm, church services. Central standard time. Slogan: "Where Dollars Always Grow."

**WDAH** Trinity Methodist Church, El Paso, Tex. 234.2 meters, 1280 kilocycles, 100 watts. Sun, 9:30 am-12 noon; 7:30-9 pm. Wed, 7:30-8:30 pm. Mountain standard time.

**WDAY** Radio Equipment Corp., 119 Broadway, Fargo, N. Dak. 545.1 meters, 550 kilocycles, 250 watts night, 500 watts daytime. Sun, 10:30 am, church; 2 pm, lecture; 4-6, entertainment. Daily ex Sun, 7-9 am, music, news; 10:15 am, Concordia Chapel; 12 noon-1 pm, farmers' musical hour; 1:05 pm, farm flash; 3-4 pm, women's hour, music; 3:15 pm, Aunt Sammy talk; 5:45 pm, news; 6-7:30 pm, entertainment. Daily ex Sun, 10 am, 11 am, 12 noon, 1 pm, 2 pm & 5:45 pm, markets. Mon, Wed, Thurs, 7:30-8:15 pm, college program. Central standard time. Divides with KFDY.

**WDBJ** Richardson Wayland Electric Corp., 106 Church st., S.W., Roanoke, Va. 230.6 meters, 1300 kilocycles, 250 watts. Sun, 7:30-8:30 pm, church services. Daily ex Sun, 12 noon-1 pm, 5:30-6 pm, 8-9 pm, musical. Wed, 9-11 pm. Fri, Sat, 9-10 pm, dance, sports, music. Eastern standard time. Slogan: "The Magic City."

**WDBO** Orlando Broadcasting Co., for Rollins College, Inc., Fort Gatlin Hotel, Orlando, Fla. 288.3 meters, 1040 kilocycles, 1000 watts daytime, 500 watts evening. Sun, 10:45 am, church; 4 pm, musicale; 7:30 pm, church. Mon & Tues, 8:40-10 pm. Thurs, 9:15-10:30 pm, studio program. Fri, 8:50-10:30 pm, studio program. Eastern standard time. Slogan: "The Voice of Central Florida."

**WDEL** Wilmington Electric Specialty Co., 405 Delaware av., Wilmington, Del. 296.9 meters, 1010 kilocycles, 100 watts. Sun, 8-10 pm. Tues, Thur, 7:30-9:30 pm. Sat, 9:30-12 midnight. Eastern standard time. Slogan: "First City of the First State."

**WDGY** Dr. Geo. Young's Jewelry & Optical Station, Minneapolis, Minn. 285.5 meters, 1050 kilocycles, 500 watts. Mon, Wed, Fri, 7-8 pm, 10-12 pm. Tues, 7-12 pm. Thurs, 7-10 pm. Sat, 7-8 pm. Sun, 2-6 pm. Central standard time. Divides with WCAL.

**WDOD** Chattanooga Radio Co., Inc., 615 Market st., Chattanooga, Tenn. 243.8 meters, 1230 kilocycles, 500 watts. Sun, 11 am, church; 5 pm, 6:30 pm, ensemble; 7:30 pm, church. Daily ex Sun, 12 noon, WDOD Trio. Mon & Fri, 6 pm, dinner hour. Tues, Wed, Sat, 6:45 pm, dinner hour & studio program. Sat, 9 pm, dance program. Central standard time.

**WDRC** Doolittle Radio Corp., 70 College st., New Haven, Conn. 282.8 meters, 1060 kilocycles, 500 watts. Daily ex Sat, 11 am-12 noon. Daily ex Sat & Sun, 5-10 pm. Classical and popular program. Eastern standard time.

**WDFW** Dutee Wilcox Flint, Inc., Cranston, R. I. 260.7 meters, 1150 kilocycles, 250 watts. Eastern standard time. Divides time with WLSI.

**WDZ** James L. Bush, Star Store Bldg., Tuscola, Ill. 277.6 meters, 1080 kilocycles, 100 watts daytime. Daily ex Sat & Sun, grain markets, 9 am-2:15 pm, each half hour. Sat, 9 am-1:15 pm, each half hour. Central standard time. "The Buckle of the Corn Belt."

**WEAF** National Broadcasting Company, Inc. 711 5th Ave., New York City. 491.5 meters, 610 kilocycles, 50,000 watts. Sun, 2-11 pm. Daily ex Sun, 6:45-8:30 am, 4-6 pm, 6 pm-12 midnight. Daily ex Sun, Sat, 11 am-1:15 pm. Sat, 12:45-1:45 pm. Eastern time.

**WEAM** Borough of North Plainfield, North Plainfield, N. J. 263.0 meters, 1140 kilocycles, 250 watts. Eastern standard time. Divides time with WJBL.

**WEAN** The Shepard Co., Westminster st., Providence, R. I. 275.1 meters, 1090 kilocycles, 500 watts. Sun, 10:45 am, 7-8:30 pm. Daily ex Sun, 11:55 am-1 pm, 4-5 pm, 6:30-10:30 pm. Eastern standard time. Slogan: "We Entertain a Nation."

**WEAO** Ohio State University, Columbus, Ohio. 282.8 meters, 1060 kilocycles, 750 watts. Daily ex Sun & holidays, 9:45 am, weather, market reports, agricultural bulletin; 11 am, market reports, music; 12:30 pm, market reports, music; 4 pm, markets. Mon, Wed, Fri, 10 am, Homemakers Half Hour. Tues, 7-11 pm, lectures, music (4 pm, Book Review). Wed, 7-9 pm, Farm Night program (4 pm, Story Hour). Thurs, 7-11 pm, lectures, music. Football and basketball games broadcast as per Ohio State schedule. Eastern standard time. Divides time with Station WAU.

**WEAR** The Willard Storage Battery Co., Union Trust Bldg., Cleveland, Ohio. 399.8 meters, 750 kilocycles, 1000 watts. Daily ex Sun, 11:30 am-12:05 pm, weather, markets. Daily ex Sat & Sun, 3:30-4:10 pm, weather, markets. Eastern standard time. Divides time with WTAM and WSET.

**WEBC** Head of the Lakes, Walter C. Bridges, 1225 Tower st., Superior, Wis. 241.8 meters, 1240 kilocycles, 250 watts. Sun, 10:40 am, 7:45 pm, church services. Mon, 12:15 noon, musical; 5:30 pm, organ; 6 pm, musical; 6:45 pm, news & baseball, weather; 7:15 pm, childrens hour; 8 pm, feature music. Tues, Thur, Fri, Sat, 12:15 noon, musical; 6 pm, music; 6:45 pm, news; 7 pm, childrens hour; 7 pm, weather. Fri, Sat, 9 pm, organ, dance music. Wed, 10:30 am, cookery corner; 12:15 pm, music; 1:15 pm, weather; 6 pm, music; 6:45 pm, news; 8 pm, music. Slogan: "Where Sail Meets Rail."

**WEBE** Cambridge, Ohio, 247.8 meters, 1210 kilocycles, 10 watts.

**WEBH** Edgewater Beach Hotel, Chicago Herald & Examiner, 5349 Sheridan Rd., Chicago, Ill. 365.6 meters, 820 kilocycles, 500 watts. Daily ex Sun, Mon, 7-8 pm, 9-10 pm. 11 pm-1 am (Sat, 11 pm-2 am). Sun, 10:40 am-12 noon, church service; 5-6 pm, 7-9 pm, musical program. Central standard time. Divides time with WJJD. Slogan: "Where Everybody's Happy."

**WEBJ** Third Avenue Railway, 2396 Third St., New York, N. Y. 256.3 meters, 1170 kilocycles, 500 watts. Wed, 7-11 pm. & Fri, 9-11 pm, popular and educational. Eastern standard time. Divides time with WBBR & WLTH.

**WEBQ** Tate Radio Co., 1 N. Main St., Harrisburg, Ill. 223.7 meters 1340 kilocycles, 15 watts. Daily ex Sun, 7:15-7:40 pm, local news, markets. Mon & Thurs, 7:30-10 pm, 10:45-12 midnight, musical programs. Sun, 7:8-30 pm, church services. Central standard time. Slogan: "The Voice from Egypt."



# Pierson Cabinets All Have True Pedigrees!

You possibly have heard people say “*Pierson makes wonderful Cabinets*, but they are high-priced.” This is true, they are high-priced—and they are *highly prized*.

A street mongrel can be had for nothing—but a full-blooded Boston Bull is worth much money. A cross-bred dray-horse brings but little in a sale, but try to buy a winner like “Man-O-War.”

*Pierson Cabinets* may appear high-priced, but stop—study them for a minute and you will see that you get more for your money in a *Pierson Cabinet* than in a dozen cheap imitations.

## Here is Why the *Pierson Cabinets* Are Valuable:

☐ *Pierson Cabinets* follow definite periods in their design, and like Classical Music, do not pass out of style—they are Heirloom furniture from their conception.

☐ *Pierson Cabinets* are produced from the best, and only select materials, proper as to strength, grain, color and period adaptation. All in Piano Finish.

☐ Every *Pierson Cabinet* is originated, designed and built in its entirety in our own plant. (Mark This.)

☐ *Pierson Craftsmen* and designers have a National reputation for their honest workmanship, ability, and painstaking care.

☐ *Pierson Radio Cabinets* were the First Exclusive Radio Cabinets on the Market—Richest in Experience.

☐ *Pierson Cabinets* bear an Indeterminate Guarantee as to Stability. They are Recommended to all who take pride in their homes and are the Greatest Contribution as to beauty to the Entire Radio Industry.

You Will Find *Pierson Cabinets* in All the Better Homes Where Radio Is Enjoyed

Ask for Pedigrees of These

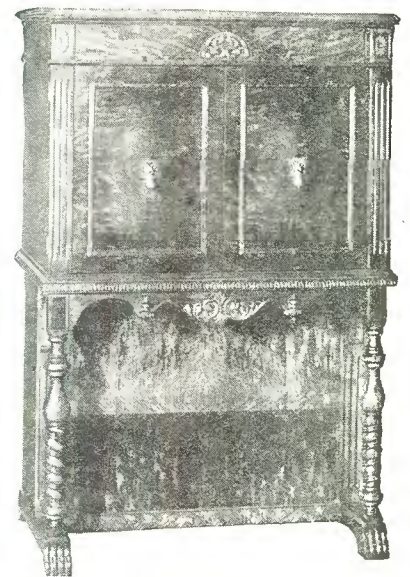

*The Canterbury*

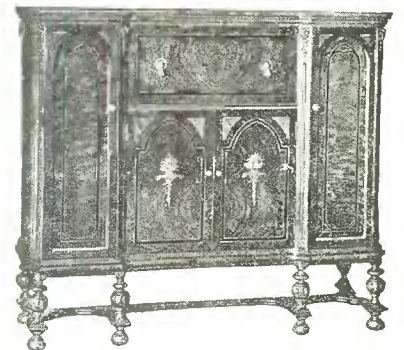

*The Arlington*



*The Aragon*

**SURE!** We issue a complete CATALOG — JUST ASK FOR ONE

**THE PIERSON COMPANY**  
ROCKFORD, ILL.

“The RICHELIEU” a model bearing the Finest Motives of the French Louis’, is a New 1928 Model.

Tell 'Em You Saw It in the Citizens Radio Call Book Magazine



**WEBR** H. H. Howell, 54 Niagara st., Buffalo, N. Y. 241.8 meters, 1240 kilocycles, 200 watts. Mon. Wed. Fri. 8:30-11 pm. Sun. church services. Thur. 10:15 pm-12:15 am. Slogan: "We extend Buffalo's Regards."

**WEBW** Beloit College, Beloit, Wis. 258.5 meters, 1160 kilocycles, 500 watts. Sun. 4:25-5:40 pm, vesper services. Central standard time.

**WEDC** Emil Deunemark Broadcasting Station, 3860 Ogden av., Chicago, Ill. 241.8 meters, 1240 kilocycles, 500 watts. Central standard time. Divides time with WGES.

**WEEL** The Edison Electric Illuminating Co. of Boston, 39 Boylston st., Boston, Mass. 508.2 meters, 590 kilocycles, 500 watts. Sun. 10:50 am-12 noon. Daily ex Sat & Sun, 6:45 am, 9:30 am-12 noon, 2-5 pm, 5:45-11 pm. Sat, 2-5 pm, 6:10-30 pm. Eastern standard time. Slogan: "The Friendly Voice."

**WEHS** Victor C. Carlson, 636 Church St., Evanston, Ill. 215.7 meters, 1390 kilocycles, 100 watts.

**WEMC** Emmanuel Missionary College, Berrien Springs, Mich. 483.6 meters, 620 kilocycles, 1000 watts. Daily ex Sat & Sun, 7:30-9 am. Sun. 9-10 am. Mon. 7-11 pm. Tues & Thurs, 3-4 pm. Central standard time. Divides time with WLTS-WCFL. Slogan: "The Radio Lighthouse."

**WENR** Great Lakes Radio Broadcasting Co., 306 S. Michigan Ave., Chicago, Ill. 288.3 meters, 1040 kilocycles, 500 watts. Sun. 2-4 pm, 6-7 pm, 9:30-11 pm, classical music. Daily ex Sun & Mon. 11:30 am-12 noon. Home service feature; 12 noon-1 pm, classical program; 2-5 pm, popular request program; 6-7 pm, dinner concert; 8-9:30 pm, classical; 9:30 pm-12 midnight, popular program. Central standard time. Divides time with WBCN. Slogan: "Voice of Service."

**WEPS** Matheson Radio Co., Inc., Gloucester, Mass. 296.9 meters, 1010 kilocycles, 100 watts.

**WEVD** Union Course Laboratories, 9024 78th st., Woodhaven, N. Y. 245.8 meters, 1220 kilocycles, 500 watts. Sun. 12:30-4 pm. Mon. Wed. Fri. 1-6 pm, 11-12 pm. Tues, 1-6 pm, 9-12 pm. Thur. 1-6 pm. Eastern standard time. Divides time with WAAT & WGBB.

**WEW** St. Louis University, College Station, St. Louis, Mo. 352.7 meters, 850 kilocycles, 1000 watts. Daily ex Sun, 9-10 am, 2 pm, government reports. Tues, 7 pm, literary reading. Thurs, 7 pm, music, lectures. Sun, 9:35-11 am, religious services; 2 pm, difficulties in religion answered; 7:15 pm, lecture. Central standard time.

**WFAA** Dallas News & Journal, Dallas, Tex. 545.1 meters, 550 kilocycles, 500 watts. Sun, 1:45-6 pm, 6-7 pm, 11 pm-12 midnight. Daily ex Sun, each half hour from 6:30 am-6 pm, 7-8 pm, 9-10 pm. Tues & Sat, 11 pm-12 midnight. Central standard time. Divides time with WBAP. Slogan: "Working for All Alike."

**WFAM** St. Cloud Daily Times, St. Cloud, Minn. 252.0 meters, 1190 kilocycles, 10 watts.

**WFAN** Philadelphia, Pa. 223.7 meters, 1340 kilocycles, 500 watts. Eastern standard time. Divides time with WCAM.

**WFBC** First Baptist Church, Knoxville, Tenn. 234.2 meters, 1280 kilocycles, 50 watts. Sun, 10:30 am, 7:30 pm, church services; 4 pm, concert sacred music. Central standard time.

**WFBE** The Garfield Place Hotel Co., Cincinnati, Ohio. 245.8 meters, 1220 kilocycles, 250 watts. Eastern standard time. Divides time with WKRC.

**WFBJ** St. Johns University, Collegeville, Minn. 272.6 meters, 1100 kilocycles, 100 watts. Wed. 8:9:30 pm. Fri. 4-5 pm. Central standard time. Slogan: "In the Heart of the Landscape Paradise."

**WFBL** The Onandaga Hotel, Syracuse, N. Y. 258.5 meters, 1160 kilocycles, 750 watts. Daily ex Sun, 3:30-30 pm, 6:30 pm-12 midnight. Sun, 2 pm-12 midnight. Eastern standard time. Slogan: "When Feeling Blue, Listen."

**WFBM** Indianapolis Power & Light Co., 48 Monument Circle, Indianapolis, Ind. 275.1 meters, 1090 kilocycles, 250 watts. Sun, 9:30-10:45 am, 2 pm, 4:45 pm, 7:30 pm, church services. Daily ex Sat & Sun, 5:30 pm, sports, stock market reports; 10 pm, orchestra. Fri, 11 pm, request organ program. Central standard time. Slogan: "The Crossroads of America."

**WFBR** Fifth Infantry Maryland National Guards, Fifth Regiment Armory, Baltimore, Md. 243.8 meters, 1230 kilocycles, 100 watts. Daily ex Sun. 12 noon, dance music; 7-10 pm, sporting results and news. Tues, Thurs & Sat, 12 noon, 7 pm, 10 pm, general programs. Sun, 11 am. Central standard time. Slogan: "Home of the Star-Spangled Banner." Divides time with WCAO.

**WFBZ** Knox College, Galesburg, Ill. 247.8 meters, 1210 kilocycles, 50 watts. Eastern standard time. Divides time with WRAM.

**WFCL** Frank Crook, Inc., 103 Exchange st., Pawtucket, R. I. 241.8 meters, 1240 kilocycles, 50 watts. Mon. Wed. Fri. 8-10 pm, entertainment. Eastern standard time. Divides time with WNBX. Slogan: "The City of Diversified Industries."

**WFDF** Frank D. Fallain, 513 S. Saginaw St., Flint, Mich. 272.6 meters, 1100 kilocycles, 100 watts. Divides time with WSKC.

**WFI** Strawbridge & Clothier, Market, 8th & Filbert sts., Philadelphia, Pa. 405.2 meters, 740 kilocycles, 500 watts. Daily ex Sun, 10:15 am, markets; 1-2 pm, orchestra; 3-4 pm, concert; 6:30-7:15 pm, dinner music. Tues, Thurs, Sat, 8-11:30 pm, musical program. Sun morning and evening, alternating, church services; 9-15 pm, Atwater-Kent Hour. Eastern standard time. Divides time with WLIT.

**WFIW** Hopkinsville, Ky. 260.7 meters, 1150 kilocycles, 750 watts night and 1000 watts daytime. Central standard time.

**WFJC** Akron, Ohio. 227.1 meters, 1320 kilocycles, 250 watts. Eastern standard time. Divides time with WJAY.

**WFKB** Francis K. Bridgman, 4536 Woodlawn av., Chicago, Ill. 223.7 meters, 1340 kilocycles, 500 watts. Daily ex Sun, 2:30-4 pm, 7-8 pm, classical; 9-11 pm, popular. Central standard time. Divides time with WCRW, WPCC.

**WFKD** Foulkrod Radio Engineering Co., 1510 Oxford av., Philadelphia, Pa. 247.8 meters, 1210 kilocycles, 50 watts. Eastern standard time. Divides time with WABY.

**WFLA** The Clearwater Chamber of Commerce, Clearwater, Fla. 516.9 meters, 580 kilocycles, 750 watts. Daily ex Sun, 8:30 pm-12 midnight, studio programs, music, weather, markets, talks, etc. Eastern standard time. Slogan: "Inviting the World to the Springtime All the Time City."

**WFPG** Wm. F. Gable Co., Altoona, Pa. 267.7 meters, 1120 kilocycles, 100 watts. Sun, 10:45 am, 3:30 pm, 7:30 pm, church. Daily ex Sun & Mon, 3 pm, 6:30 pm, 8:30 pm. Tues, Wed, Thurs, 12:15 pm. Fri & Sat, 9:30 pm. Thurs & Sat, 7:30 pm. Wed, 6 pm. Thurs, 4 pm, 10 pm. Fri, 12 noon, 11:15 pm. Eastern standard time. Slogan: "The Original Gateway to the West and we wish you all the very best."

**WGAL** Lancaster Elec. Sup. & Const. Co., 23 E. Orange st., Lancaster, Pa. 252.0 meters, 1190 kilocycles, 15 watts. Sun, 10:30 am-12 noon, church. Daily ex Sun, 9-9:15 am, talks; 12-12:05 noon, markets; 5:20-5:45 pm. Wed. Fri. 5:45-6:15 pm, dinner concert. Wed, 11:15-1 am, organ concert. Eastern standard time. Divides time with WKJC. Slogan: "World's Gardens at Lancaster."

**WGBB** Harry H. Carman, 217 Bedell st., Freeport, N. Y. 245.8 meters, 1220 kilocycles, 400 watts. Sun, 10:40 am-12:30 pm, 4:50-30 pm. Mon, 7-8 pm. Wed, Fri, 7-11 pm. Slogan: "The Voice of the Sunrise Trail." Divides time with Station WAAT-WEVD.

**WGBC** First Baptist Church, Memphis, Tenn. 228.9 meters, 1310 kilocycles, 15 watts. Sun, 9:55-10:55 am, 7:30-9 pm. Central standard time. Divides time with WMBR.

**WGBF** The Finke Furniture Co., 307 Upper Seventh st., Evansville, Ind. 236.1 meters, 1270 kilocycles, 250 watts. Daily ex Sun, 7:15 am, morning worship service; 12:10 pm, news, markets, weather, etc. Mon, 7-12 pm, musical program. Tues, 8-11 pm, music. Fri, 7-11 pm, musical program. Sun, 9 am, Bible class. Central standard time. Slogan: "Gateway to the South."

**WGBI** Scranton Broadcasters, Inc., 318 Adams Ave., Scranton, Pa. 230.6 meters, 1300 kilocycles, 250 watts. Eastern standard time. Divides time with WQAN.

**WGBS** Gimbel Bros., Inc., 33rd st. & Broadway, New York City, N. Y. 348.6 meters, 860 kilocycles, 500 watts. Sun, 8:30-10 pm, vocal & instrumental music. Daily ex Sun, 1:30-7 pm. Tues, Thurs, Sat, 1:30-6:30 pm, 7:30 pm-12:30 am. Programs consist of talks, vocal and instrumental selections. Divides time with Stations WIP and WOO—Mon, Wed, Fri. Eastern standard time.

**WGCP** Paramount Broadcasting & Artist Service, Inc., 519 Broad St., Newark, N. J. 267.7 meters, 1120 kilocycles, 500 watts. Mon. Wed, Fri. 12 noon-3 pm, 6-9 pm. Tues, Thurs, Sat, 9 am-12 noon, 3-6 pm, 9 pm-12 midnight. Sun, 12 noon-6 pm. Eastern standard time. Divides time with WNJ and WAAM.

**WGES** Oak Leaves Broadcasting Corp., 128 N. Crawford av., Chicago, Ill. 241.8 meters, 1240 kilocycles, 500 watts. Sun, 10:30 am-12 noon, church; 3-6 pm, 7:30-9:30 pm, 11:30 pm-1:30 am. Daily ex Sat & Sun, 4-6 pm, popular. Tues, 8:30-9:30, 10-11:30 pm. Wed, Thurs, Fri & Sat, 7:30-9:30 pm. Wed & Sat, 11:30-1:30 pm. Fri, 11:30 pm-3 am, Ozone Club. Sat, 2:30-6 pm. Central standard time. Divides time with WEDC. Slogan: "World's Greatest Entertainment Service."

**WGHP** George Harrison Phelps, Inc., Radio Division, Maccabee Bldg., Woodward and Putnam av., Detroit, Mich. 277.6 meters, 1080 kilocycles, 750 watts. Sun, 10:45 am-12:15 pm, 2:30-6, 9-11 pm. Daily ex Sat & Sun, 1:15-3 pm, 6-11 pm. Eastern standard time.

**WGL** "Public Service Station," International Broadcasting Corp., 16 E. 42nd St., New York, N. Y. 293.9 meters, 1020 kilocycles, 500 watts. Eastern standard time. Divides time with WODA.

**WGM** Verne & Elton Spencer, 501 Cowan av., Jeannette, Pa. 208.2 meters, 1440 kilocycles, 50 watts. Sun, 1:30-3 pm, music. Daily ex Sun, Wed, Sat, 7:30-9 pm, dance music. Popular program. Eastern time. Slogan: "Voice from the Glass City, Voice from the Hilltop."





# EARN \$75<sup>00</sup> a week — in Your Spare Time

**J**OINING the Radio Association enables you to cash in on Radio *now!* Follow its success-proven plans and you can earn \$3 an hour, in your spare time, from the very first. Over \$600,000,000 is being spent yearly for sets, supplies, service. You can get your share of this business and, at the same time, fit yourself for the big-pay opportunities in Radio.

### Founded on a New Idea

Members of the Association do not wait for months before they make money out of Radio. Without quitting their jobs, our members are earning \$25 to \$75 a week spare time by building "tailored" radio sets, serving as "radio doctors," selling ready built sets and accessories, or following one of the many profit-making plans of the Association.

### Earned \$500 in Spare Hours

Hundreds earn \$3 an hour as "radio doctors." Lyle Follick, Lansing, Mich., has already made \$500 in spare time. Werner Eichler, Rochester, N. Y., is earning \$50 a week for spare time. F. J. Buckley, Sedalia, Mo., is earning as much in spare time as he receives from his employer.

*We will start you in business.* Our cooperative plan gives the ambitious man his opportunity to establish himself. Many have followed this plan and established radio stores. Membership in the Association has increased the salaries of many. Scores are now connected with big radio organizations. Others have prosperous stores.

A year ago Claude De Grave knew nothing about Radio. Today he is on the staff of a famous radio manufacturer and an associate member of the Institute of Radio Engineers. He attributes his success to joining the Association. His income now is 350% more than when he joined.

### Doubled Income in Six Months

"I attribute my success entirely to the Radio Association," writes W. E. Thon, Chicago, who was clerk in a hardware store before joining. We helped him secure the managership of a large store at a 220% increased salary.

"In 1922 I was a clerk," writes K. O. Benzing, McGregor, Ia., "when I enrolled. Since then I have built hundreds of sets—from 1-tube Regenerative to Superheterodynes. I am now operating my own store and my income is 200% greater than when I joined the Association. My entire success is due to the splendid help it gave."

### Easiest Way Into Radio

If ambitious to become a Radio Engineer, to fit yourself for the \$3,000 to \$10,000 opportunities in Radio, join the Association. It gives you a comprehensive practical and theoretical training and the benefit of our Employment Service. You earn while you learn. You have the privilege of buying radio supplies at wholesale. You have the Association behind you in carrying out your ambitions.

### ACT NOW—if You Wish Special Membership Plan

To a limited number of ambitious men, we will give Special Memberships that may not—need not—cost you a cent. To secure one, write today. We will send you details and also our book, "Your Opportunity in the Radio Industry." It will open your eyes to the money-making possibilities of Radio. Write today.

### What a Membership Can Do for You

- 1—Enable you to earn \$3 an hour upwards in your spare time.
- 2—Train you to install, repair and build all kinds of sets.
- 3—Start you in business without capital, or finance an invention.
- 4—Train you for the \$3,000 to \$10,000 big-pay radio positions.
- 5—Help secure a better position at bigger pay for you.
- 6—Give you the backing of the Radio Association.

**A MEMBERSHIP NEED NOT COST YOU A SINGLE CENT**

RADIO ASSOCIATION OF AMERICA  
4513 Ravenswood Ave.  
Chicago, Ill.

Dept. RCB-1

Gentlemen:

Please send me by return mail full details of your Special Membership Plan and also copy of your book, "Your Opportunity in the Radio Industry."

Name.....

Address.....

City.....State.....



**WGMU** Atlantic Broadcasting Corp., New York City, 201.6 meters, 1490 kilocycles, 100 watts. Unlimited schedule. Eastern standard time. Divides time with WRMU.

**WGN** The Chicago Tribune Station on the Drake Hotel, Chicago, Ill. 416.4 meters, 720 kilocycles, 15,000 watts. Sun, 12 noon-5 pm, 6:10-11 pm. Daily ex Sun, 9:10-30 am, 11-11:30 am, 12:40-7 pm. Daily ex Sun & Mon, 8-11 pm. Central standard time. Divides time with Station WLBB.

**WGOP** Flushing, N. Y. 199.9 meters, 1500 kilocycles, 100 watts. Eastern standard time. Divides with WWRL and WBKN.

**WGR** Federal Radio Corp., Hotel Statler, Buffalo, N. Y. 302.8 meters, 990 kilocycles, 750 watts. Sun, 10:45 am, church; 7:45 pm, church; 9:15 pm, concert; 10:15-11:15, concert. Mon, 12 noon, reports; 1-1:30 pm, ensemble; 2:30 pm, program; 6:30, music; 7:30, reports; 1-1:30, ensemble; 2:30 pm, program; 6:30, music; 7:30, reports; 8-11 pm, program. Wed, 12 noon, reports; 1-1:30, ensemble; 2:30 pm, concert; 6:30 pm, music; 7:30, reports; 8-11 pm, program. Thurs, 12 noon, reports; 1-1:30, ensemble; 2:30 pm, program; 6:30 pm, music; 7:30 pm reports; 8-11 pm, program. Fri, 12 noon, reports; 1-1:30, ensemble; 2:30, concert; 6:30, music; 8 pm-1 am, program. Eastern standard time. Slogan: "Key City of Industry."

**WGST** Georgia School of Technology, Atlanta, Ga. 270.1 meters, 1110 kilocycles, 500 watts. Mon, 9:30-10:30 pm, "Tech Nite" program. Thurs, 7-8 pm, "Artist Series" program. Central standard time. Divides time with WMAZ. Slogan: "The Southern School with the National Reputation."

**WGWB** Radiocast Corp. of Wisconsin, 144 Broadway, Milwaukee, Wis. 218.8 meters, 1370 kilocycles, 500 watts. Daily ex Sun, 10:30 am-12:30 pm. Sun, 10-11 am, 6-7 pm. Silent Saturdays. Central standard time.

**WGY** General Electric Co., 1 River Road, Schenectady, N. Y. 379.5 meters, 790 kilocycles, 50,000 watts. Daily ex Sun, 11:55 pm, 12:30 pm, 12:45 pm, 6 pm, 6:10 pm. Daily ex Sat & Sun, 6-11 pm. Mon, Tues, Thurs, Fri, 2-3 pm. Sat, 6:30 pm-12 midnight. Sun, 10:30 am-12 noon, 3-10:45 pm. Eastern standard time.

**WHA** University of Wisconsin, Madison, Wis. 333.1 meters, 900 kilocycles, 750 watts. Mon, Wed & Fri, 7-9:30 pm. Programs on these evenings consist of educational talks, music, athletic events, etc. Central standard time. Divides time with WLBB.

**WHAD** Marquette University, Milwaukee, Wis. 270.1 meters, 1110 kilocycles, 500 watts. Sun, 4:30-5 pm, organ recital. Daily ex Sat & Sun, 3:30-4 pm, 7:30-8 pm. Fri, 8-9:30 pm, musical program. Central standard time. Divides time with WSOE. Slogan: "The Voice of Wisconsin."

**WHAM** Stromberg Carlson Telephone Mfg. Co., Rochester, N. Y. 280.2 meters, 1070 kilocycles, 5000 watts. Sun, 10:30 am, church; 3:30-10:15 pm. Mon & Fri, 6:30-10 pm. Tues, 2:30 pm. 3 pm. Tues, Wed, Thurs, Sat, 6:30-11:05 pm. Varied studio & Blue network programs. Eastern standard time.

**WHAP** WHAP, Carlstadt, N. J. 236.1 meters, 1270 kilocycles, 1000 watts. Sun, 7:30-9:30 pm. Mon, Thurs, 6-9 pm. Wed, 9-12 pm. Sat, 7-11:30 pm. Eastern standard time. Divides time with stations WBNY, WPUB.

**WHAR** Pioneer Broadcasting Station of Atlantic City, the Hotel Seaside, Atlantic City, N. J. 272.6 meters, 1100 kilocycles, 1000 watts. Sun, 10:45-1 pm, 2:15-3:10 pm, 7:30-9 pm. Daily ex Sun & Wed, 2:15-3:15 pm, 7:45-9 pm. Eastern standard time. Divides time with WPG. Slogan: "Pioneer Broadcasting Station of Atlantic City."

**WHAS** The Courier-Journal Co. and The Louisville Times Co., Louisville, Ky. 322.4 meters, 930 kilocycles, 500 watts. Sun, 9:57-10:45 am, church services; 2-3 pm, 4:30-9:15 pm. Daily ex Sun, 2:15-2:30 pm, 3:30-5 pm, 7-9 pm. Central standard time. Slogan: "Old Kentucky Home."

**WHAZ** Rensselaer Polytechnic Institute, Troy, N. Y. 305.9 meters, 980 kilocycles, 500 watts. Mon, 8 pm. Eastern standard time. Slogan: "Transcontinental and International Radiophone Broadcasting from the Oldest College of Engineering and Science in America, Rensselaer Polytechnic Institute, Troy, N. Y." Divides with WHT and WIBO.

**WHB** Sweeney Automotive and Electrical School, Kansas City, Mo. 340.7 meters, 880 kilocycles, 500 watts. Sun, 9:40-10:45 am, church services; 6:30-7:15 pm, church; 11:15 pm-12:15 am, organ. Daily ex Sun, 8:25-9:25 am, 10:25-11:20 am, 12 noon-1:25 pm, 2-3 pm, Ladies' Hour; 3 pm, markets. Mon, Tues, Thurs, Sat, 7-10 pm. Wed, Fri, 7-8 pm. Central standard time. Divides time with WOO. Slogan "Kansas City, Missouri, the Heart of America."

**WHBA** Shaffer Music House, Oil City, Pa. 260.7 meters, 1150 kilocycles, 10 watts. Limited commercial broadcast. Mon, 8 pm until 11 pm, musical. Fri, 9 pm until 12 pm, musical. Eastern standard time.

**WHBC** Rev. E. P. Graham, 627 McKinley av., Canton, Ohio. 236.1 meters, 1270 kilocycles, 10 watts. Mon, 8-8:30 pm, lecture, sermon. Eastern time. Slogan: "Dispel Ignorance."

**WHBD** Chamber of Commerce, 118½ N. Main st., Bellefontaine, Ohio. 222.1 meters, 1350 kilocycles, 100 watts. Sun, 10:45 am, 7:30 pm. Daily ex Sun & Sat, 7:30-9 pm. Eastern standard time. Slogan: "Ohio's Highest Point."

**WHBF** Beardsley Spec. Co., Inc., 217 18th st., Rock Island, Ill. 222.1 meters, 1350 kilocycles, 100 watts. Mon, Wed, 9-11 pm. Sat, 2-4, 7-9 pm. Central standard time. Slogan: "Where Historic Blackhawk Fought."

**WHBL** C. L. Carrell, 36 S. State st., Chicago, Ill. 204.0 meters, 1470 kilocycles, 100 watts. Central standard time.

**WHBM** C. L. Carrell (portable), 1506 No. American Bldg., 36 S. State st., Chicago, Ill. 201.6 meters, 1490 kilocycles, 100 watts, class A. Central standard time.

**WHBP** The Johnstown Automobile Co., 101 Main st., Johnstown, Pa. 228.9 meters, 1310 kilocycles, 250 watts. Daily ex Sun, 1:15 pm. Tues & Sat, 10 pm. Eastern standard time. Slogan: "The Voice of the Friendly City."

**WHBQ** Broadcasting Station WHBQ, Inc., Dermon Bldg., Memphis, Tenn. 232.4 meters, 1290 kilocycles, 100 watts. Sun, church services. Daily ex Sun, 7-8 pm, orchestra. Central standard time.

**WHBU** Riviera Theater & Bing's Clothing, 1002 Meridian st., Anderson, Ind. 220.4 meters, 1360 kilocycles, 15 watts. Daily ex Sun, 9-9:30 am, 12-12:30 pm. Wed, Fri, Sun, 7-9 pm. Central standard time. Slogan: "The Home of Chief Anderson."

**WHBW** D. R. Kienzle, 4916 Chestnut st., Philadelphia, Pa. 220.4 meters, 1360 kilocycles, 100 watts. Tues., Thurs, Sun, pm. Eastern standard time.

**WHBY** St. Norbert's College, West De Pere, Wis. Green Bay-De Pere Broadcasting Station. 249.9 meters, 1200 kilocycles, 50 watts. Sun, 10-11 am. Daily ex Sun; 6:30 pm, weather & markets. Mon, 8-10 pm, musical entertainment. Wed & Fri, 5-6 pm, dinner hour. Central standard time. Slogan: "Prepared for All Good Works."

**WHDI** Dunwoody Industrial Institute, 818 Superior Blvd., Minneapolis, Minn. 245.8 meters, 1220 kilocycles, 500 watts. Daily ex Sun, 6:57-9:30 am. Mon, 8-9 pm. Wed, 8:30-10 pm. Fri, 9-10 pm. Central standard time. Divides time with Station WLBB.

**WHEC-WABO** Hickson Electric Co., Inc., 36 South av., Rochester, N. Y. 254.1 meters, 1180 kilocycles, 250 watts. Sun, 10:30-12 noon, 8-10 pm. Daily ex Sun, 12 noon-3 pm. 6:30-9 pm. Fri, 10-11 pm. Eastern standard time.

**WHFC** The Goodson & Wilson Station, 4145 Broadway, Chicago, Ill. 215.7 meters, 1390 kilocycles, 200 watts. Sun, Tues, Wed, Thurs, Fri, Sat, Sat, 8-12 pm. Slogan: "Where Happiness First Commences." Divides with WKBI.

**WHK** The Radio Air Service Corporation, Inc., 1220 Huron road, Cleveland, Ohio. 265.3 meters, 1130 kilocycles, 1000 watts daytime, 500 watts night. Sun, 10 am, 5:15-9:30 pm. Daily ex Sun, 12 noon-1 pm. Mon, Tues, Thurs, Sat, 6 pm-12 midnight. Tues, Wed, Fri, 3:30-4:15 pm. Wed & Fri, 5:30-12 midnight. Eastern standard time. Slogan: "Cleveland's Pioneer Station."

**WHN** Marcus Loew Booking Agency, 1540 Broadway, New York, N. Y. 394.5 meters, 760 kilocycles, 500 watts. Sun, 9-11 am, 12:30-3 pm. 5-7:30 pm, 9:45 pm-12 midnight. Daily ex Sun, 1-2 pm, 6 pm-12 midnight. Eastern standard time. Divides time with WQAO and WPAP. Slogan: "Voice of the Great White Way."

**WHO** Banker's Life Company, Des Moines, Iowa. 535.4 meters, 560 kilocycles, 5000 watts. Sun, 10 am, 11 am, 1 pm, 6:20 pm, 8:15 pm, 9:15 pm. Tues, Wed, Thurs, Fri, 8 am through 3 pm. Mon, 8 am through 3:30 pm. 6:30-11 pm. Sat, 8 am-1 pm, 6:30-10 pm. Tues & Wed, 4-10:30 pm. Thurs & Fri, 10 pm. Music, talks, weather reports & chain programs broadcast. Central standard time. Slogan: "W-H-O, Who? Banker's Life, Des Moines."

**WHPP** Bronx, New York. 206.8 meters, 1450 kilocycles, 10 watts. Eastern standard time. Divides time with WMRJ-WTRL.

**WHT** Radiophone Broadcasting Corp., Wrigley Bldg., 410 N. Michigan Blvd., Chicago, Ill. 305.9 meters, 980 kilocycles, 5000 watts. Sun, 10 am-2:30 pm, 7-10 pm. Daily ex Sun, 10 am-2:30 pm, 7-10 pm. Tues, Thurs, 11 pm-1 am. Central standard time. Divides time with WIBO-WHAZ. Slogan: "Write Home Tonight."

**WIAD** Howard R. Miller, 1301-5 Filbert St., Philadelphia, Pa. 288.3 meters, 1040 kilocycles, 100 watts. Tues, Thurs, Fri, 2 pm-12 pm. Eastern standard time. Divides time with WNAT.

**WIAS** Poling Elec. Co., 218 E. Main St., Ottumwa, Ia. 322.4 meters, 930 kilocycles, 100 watts. Daily ex Sun & Tues, 12 noon-1 pm. Mon & Thurs, 8-9 pm. Wed, Fri & Sat, 8-10:30 pm. Sun, 10 am-12:30 pm, church. Central standard time. Slogan: "Burlington on the Mississippi." Divides with KICK.

**WIBA** The Capital Times, Strand Theater, Madison, Wis. 239.9 meters, 1250 kilocycles, 100 watts. Mon, 7-11 pm. Wed, 8-10 pm. Fri, 6-7 pm. Sat, 7-8 pm. Sun, 12-1 pm. Central standard time. Slogan: "The Four Lakes City."

**WIBG** St. Paul's Protestant Episcopal Church, Elkins Park, Philadelphia, Pa. 440.9 meters, 680 kilocycles, 50 watts. Sun, 10:45 am, 3:45 pm. Eastern standard time.

**WIBJ** C. L. Carrell, 36 S. State st., Chicago, Ill. (portable). 201.6 meters, 1490 kilocycles, 100 watts. Central standard time.



# Quality Units for Quality Reproduction

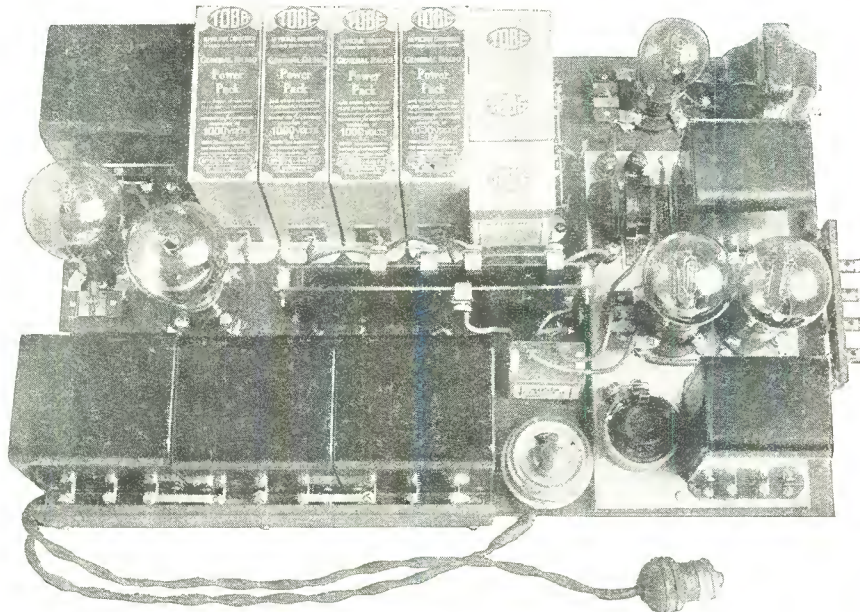

**A Complete A. C. Operated Amplifier Constructed with General Radio Parts**

FOR those people who demand the most perfect reproduction obtainable, a power amplifier is a necessity. A power amplifier is not intended primarily to increase the volume of a set, but rather to make use of tubes capable of delivering to the speaker considerable energy. To a certain extent the greater the power output the better the quality. The Amplifier illustrated above is a complete two stage A. C. operated device constructed of General Radio units, and is capable of remarkable reproduction together with great volume. Write for folder describing this amplifier.



The primary of the Type 365 Transformer is designed for a 110 volt, 60 cycle circuit. The high voltage secondary consists of two sections of 275 volts each. There is also a 7.5 volt secondary.

Type 365 Rectifier Transformer .....\$8.00



The Type 366 Choke is actually two chokes assembled in one case and is mounted in the same type and size of case as the Type 365 Transformer. The direct current resistance is low, reducing the voltage lost in the Chokes to a minimum.

Type 366 Filter Choke .....\$8.00

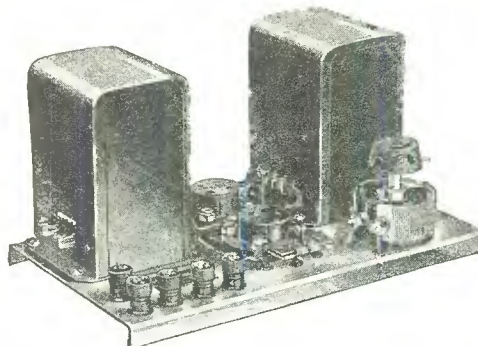

In a search for an amplifier which would give the maximum in quality and volume the push-pull method has proved particularly satisfactory. The Type 441 unit is licensed by the Radio Corporation of America for radio amateur experimental and broadcast reception only, and under the terms of the R. C. A. license the unit may be sold only with tube.

Type 441 Push-Pull Amplifier.....\$20.00



The General Radio Type 285 Transformers are designed to have a high inductance value with a low distributed capacity. This combination sustains both the upper and lower ends of the amplification curve. The transformer are available in two ratios as follows:

Type 285-II—1 to 6.  
Type 285-D—1 to 3.  
Price, each.....\$6.00



The Type 439 center tap resistance is adaptable to any socket in which the new A. C. tubes may be used.

Type 439 Center Tap Resistance .....\$0.60

GENERAL RADIO CO., CAMBRIDGE, MASS.

# GENERAL RADIO

LABORATORY EQUIPMENT  
PARTS AND ACCESSORIES



**WIBM** C. L. Carrell, 36 S. State st., Chicago, Ill. 201.6 meters, 1490 kilocycles, 100 watts. Daily ex Sun, 8:45-9:45 pm. Central standard time. Slogan: "The Gypsy Station."

**WIBO** WIBO Broadcasters, Inc., 6312 Broadway, Chicago, Ill. 305.9 meters, 980 kilocycles, 500 watts. Sun, 8:45-10 am. Daily ex Sun, 2:30-5 pm. Daily ex Sun & Mon, 7:10-8:30 pm. 10 pm-12:30 am. Central standard time. Divides time with WIIT & WHAZ.

**WIBR** Tri-State Service Co. (Thurman A. Owings, Mgr.), Steubenville, Ohio. 249.9 meters, 1200 kilocycles, 50 watts. Daily, 6:30-7:30 pm. Mon & Fri, 8:30-9:30 pm. Wed, 11:15 pm-12:45 am. Eastern standard time. Slogan: "Where Investments Bring Results."

**WIBS** Lieut. Thomas F. Hunter (portable), 921 Edgewood road, Elizabeth, N. J. 204.0 meters, 1470 kilocycles, 250 watts, class A. Eastern standard time. Divides with WLBX & WMBQ.

**WIBU** The Wisconsin State Journal, Electric Farm Station, Poyntette, Wis. 217.3 meters, 1380 kilocycles, 20 watts. Sun, 2-3 pm, concert; 4-5:30 pm, vesper service. Mon, 9-12 pm., community program. Central standard time.

**WIBW** Topeka's Own Broadcasting Station, 901-2 National Reserve Life Bldg., Topeka, Kan. 204.0 meters, 1470 kilocycles, 100 watts. Sun, 12:15-1:45 pm, dinner music; 1:45-3 pm, studio program; 6:15-7:45 pm, string ensemble. Daily ex Sun, 12:15-1:15 pm, organ music; studio program, 5-7:30 pm, organ, weather, news, bed-time story, dinner music; 8:30-10 pm, studio program. Mon, 11 pm-12 midnight. Central standard time. Slogan: "Topeka—Where Investment Brings Wealth."

**WIBX** WIBX, Inc., Hotel Utica, Utica New York. 238.0 meters, 1260 kilocycles, 150 watts. Daily, 9:30-10:30, 10:30-11 am, 12-1 pm, music, news, etc.; 6-11 pm ex Wed night. Sun morning, church services, 6-11 pm. Eastern standard time.

**WIBZ** A. D. Trum, 217 Catoma st., Montgomery, Ala. 230.6 meters, 1300 kilocycles, 15 watts. Fri, 9-10 pm. Sun, 12-1 pm. Central standard time. Slogan: "We Interest Business Zeal."

**WICC** The Bridgeport Broadcast Station, Inc., 1044 Main St., Bridgeport, Conn. 265.3 meters, 1130 kilocycles, 500 watts. Sun, 10:50 am, church services; 2 pm. Daily ex Sun, 9 am, 12 noon, music; 1 pm. Mon, 6-11 pm. Tues, Wed, Thurs, Fri, 6-10 pm. Sat, 6-7 pm. Eastern standard time. Slogan: "The Industrial Capital of Connecticut." Divides with WCWS.

**WIL** Benson Broadcasting Corp., Missouri Hotel, 11th & Locust st., St. Louis, Mo. 258.5 meters, 1160 kilocycles, 250 watts. Sun, 5-7 pm. Daily ex Sun, 9:30-11:30 am, 2:45-5 pm, 8-11 pm. Central standard time. Divides time with WSBF. Slogan: "A Wave Length Ahead."

**WIOD** Carl G. Fisher, Miami Beach, Fla. 247.8 meters, 1210 kilocycles, 1000 watts. Slogan: "Wonderful Isle of Dreams."

**WIP** Gimbel Bros., Philadelphia, Pa. 348.6 meters, 860 kilocycles, 500 watts. Daily ex Sun, Mon & Fri, 6:45-7:30 am, 10-11 am, 1-2 pm, 3-4 pm, 6-7:30 pm. Tues, Thurs & Sat, 8 pm-12 midnight. Mon, Wed & Fri, 6:45-8 am, 10-11 am, 1-2 pm, 3-4:30 pm, 6-7:30 pm. Sun, 10:30 am-12:30 pm, 4-6 pm, 7-9:15 pm, 9:15 pm-12 midnight. Eastern standard time. Divides time with WOO & WGBS. Slogan: "Watch Its Progress."

**WJAD** Frank P. Jackson, 801 Austin av., Waco, Tex. 333.1 meters, 900 kilocycles, 500 watts. Mon, Tues, Thur, Fri, 8:30-10:30 pm, musical. Wed, 8:30-9:30 pm, musical. Central standard time. Divides time with KFQB. Slogan: "Waco, Texas, All Around It."

**WJAG** Norfolk Daily News, Norfolk, Neb. 285.5 meters, 1050 kilocycles, 500 watts daytime, 250 watts night. Daily ex Sun, 12:15 pm, features, sports, word pictures, etc. Wed & Sat, 6:30 pm, dinner hour orchestra. Sun, 3 pm, musical program. Central standard time. Divides time with KMMJ. Slogan: "Home of the Printers' Devil."

**WJAK** The Kokomo Tribune, Kokomo, Ind. 234.2 meters, 1280 kilocycles, 50 watts. Daily ex Sun, 11:45 am, radio chapel. Mon, 7:30 pm, musical program. Wed, Thurs, 6 pm, musical program. During basketball season, Fri & Sat, 7:30 pm. Central standard time.

**WJAM** D. M. Perham, 322 3rd av. W., Cedar Rapids, Iowa. 239.9 meters, 1250 kilocycles, 250 watts. Daily, 9:15 am, 1:15 pm, Chicago grain & livestock markets. Daily ex Sun, 8:30 am-12:30 pm, music & talks. Mon, Wed, Fri, 7-9 pm, music. Tues, Thurs, 9-11 pm, music. Divides time with KWCR.

**WJAR** The Outlet Company, 174 Weybosset st., Providence, R. I. 483.6 meters, 620 kilocycles, 500 watts. Daily ex Sun, 1:05 pm, musical; 1:30, weather reports. Mon, 8 pm, 9 pm & 10 pm, musical programs & grand opera. Tues, 7 pm, 8 pm, 9 pm, musical; 10 pm, bridge. Wed, 7:30 pm, music. Thurs, 8, 9 & 10 pm, music & entertainment. Fri, 8:20, 8:30, 9 & 11 pm, music & entertainment. Sun, 7:20 pm & 9:15 pm. Eastern standard time. Slogan: "The Southern Gateway of New England."

**WJAS** Pickering's, 10th St. & Penn Ave., Pittsburgh, Pa. 270.1 meters, 1110 kilocycles, 500 watts. Daily ex Sun, 10:30, music; 11:15 am, 11:30, music; 12 noon, church; 12:45 pm, 1:30 pm, news, etc.; 8 pm, code lesson, music, etc. Mon, Wed, Fri, 9-11 pm, Columbia chain. Sun, 11 am, 2 pm, church; 3-5 & 9-11 pm, Columbia chain. Eastern standard time. Divides time with KQV.

**WJAX** Jacksonville Municipal Radio Broadcasting Station, Waterworks Park, Jacksonville, Florida. 340.7 meters, 880 kilocycles, 1000 watts. Sun, 11 am, church; 6:30 pm, dinner hour concert; 7:30 pm, church, 10-11 pm. Daily, 11:55 am, time signals; 12 noon, weather. Mon, 7:45 pm-12 midnight, musical. Tues & Sat, 8-10 pm, musical. Wed, 7-8 pm. Thurs, 7:15-11 pm, musical. Fri, 7-10 pm, musical. Eastern standard time. Slogan: "WJAX—W for Wonderful, JAX for Jacksonville." Divides with WAPI.

**WJAY** Cleveland, Ohio. 227.1 meters, 1320 kilocycles, 500 watts. Eastern standard time. Divides time with WFJC.

**WJAZ** Zenith Radio Corp., 3620 Iron st., Chicago, Ill. Studio, Chez Pierre. 263.0 meters, 1140 kilocycles, 5000 watts. Sun, 7-9 pm. Tues, Wed, Fri, Sat, 7-8 pm, 9-11 pm. Thurs, 9-12 pm, Chez Pierre program. Divides time with Station WMBI, 8-9 pm, except Thurs, 7-9 pm. Sun, 3:30-7 pm. Central standard time.

**WJBA** D. H. Lentz, Jr., 301 Whitley av., Joliet, Ill. 247.8 meters, 1210 kilocycles, 50 watts. Tues, 8-11 pm. Central standard time.

**WJBB** The Financial Journal, Inc., Sarasota, Fla. 238.0 meters, 1260 kilocycles, 250 watts. Eastern standard time. Slogan: "The Pioneer Semi-Tropical Business Journal." Divides with WQBA.

**WJBC** Hummer Furniture Co., Second and Joliet, La Salle, Ill. 227.1 meters, 1320 kilocycles, 100 watts. Sun, 10-11 am, Catholic church services; 7:30-9:30 pm, Baptist church services. Mon, 8-10 pm, studio program. Tues, Thurs, Sat, 12:30-1 pm, organ concert. Sat, 1-2 pm, children's program. Central standard time. Divides time with WVAE & WCLO. Slogan: "Better Homes Station."

**WJBI** Robert S. Johnson, 63 Broad st., Red Bank, N. J. 263 meters, 1140 kilocycles, 250 watts. Mon, 9-12 pm. Wed, 10-11 am, 4-6 pm. 10-12 pm. Fri, 9-10:30 am, 9-12 pm. Eastern standard time. Divides time with WEAM.

**WJBK** Ernest F. Goodwin, 803 Congress st., Ypsilanti, Mich. 220.4 meters, 1360 kilocycles, 15 watts. Central standard time.

**WJBL** Wm. Gushard Dry Goods Co., 301 N. Water st., Decatur, Ill. 212.6 meters, 1410 kilocycles, 250 watts. Mon, Wed & Sat, 9 pm. Sun, 3 pm. Central standard time.

**WJBO** Valdemar Jensen, 119 South st., New Orleans, La. 263.0 meters, 1140 kilocycles, 100 watts. Tues & Fri, 8 pm & 11 pm, dance programs. Sun, 3-4:30 pm, classical; 5-5:45 pm, church. Central standard time.

**WJBT** J. S. Boyd, Inc., 306 S. Wabash Ave., Chicago, Ill. 389.4 meters, 770 kilocycles, 500 watts. Sun, 10:30 am, 2:30 pm-12 midnight. Daily ex Sun, 11 am, 3 pm, 7 pm. Mon, 9-10 pm. Tues, 11 pm-1 am. Thurs, 12 midnight-2 am. Wed, Fri & Sat, 11 pm-12 midnight. Central standard time. Divides time with WBBM & WAAT.

**WJBU** Bucknell University, Lewisburg, Pa. 214.2 meters, 1400 kilocycles, 100 watts. Eastern standard time. Slogan: "In the Heart of the Keystone State."

**WJBW** Serve-U-Radio Co., 2743 Dumaine st., New Orleans, La. 238.0 meters, 1260 kilocycles, 30 watts. Tues, Fri, 7-8 pm. Central standard time. Divides time with WABZ. Slogan: "The Serve You Broadcasting Station at New Orleans."

**WJBY** Electric Construction Co., 517 Broad st., Gadsden, Ala. 234.2 meters, 1280 kilocycles, 50 watts.

**WJBZ** Roland G. Palmer and A. Coppotelli, 144 East 16th st., Chicago Heights, Ill. 208.2 meters, 1440 kilocycles, 100 watts. Mon & Tues, 7-10 pm. Central standard time. Slogan: "Crossroads of the Nation."

**WJJD** Loyal Order of Moose, Mooseheart, Ill. 365.6 meters, 820 kilocycles, 1000 watts. Children's programs from Mooseheart. Chicago programs from the Palmer House in cooperation with the Chicago Herald and Examiner. Sun, 3 hrs; Mon, 7 hrs; Tues, Wed, Thurs, 7 hrs 30 min; Fri, 5 hrs 30 min; Sat, 6 hrs 30 min. Central standard time. Divides time with WEBH. Slogan: "Every Child Is Entitled to a High School Education and a Trade."

**WJKS** Gary, Ind. 232.4 meters, 1290 kilocycles, 500 watts. Central standard time. Divides with WSBC.

**WJPW** J. P. Wilson, Ashtabula, Ohio. 208.2 meters, 1440 kilocycles, 30 watts.

**WJR & WCX** Richards-Oakland Co. & Detroit Free Press, 2914 Book-Cadillac, Detroit, Mich. 440.9 meters, 680 kilocycles, 5000 watts. Daily ex Sun, 12:45-2 pm, 4-4:50 pm, 5:45 pm, 12 midnight. Sun, 10 am, 12:30 pm, 2 pm, 3 pm, 4:15-4:30 pm, 6-10:30 pm. Mon, Wed, Fri, 10-11 pm. Mon, Tues, Wed, 12-15 pm. Music, talks, weather reports & chain programs broadcast. Eastern standard time. Slogan: "The Good Will Station."

**WJZ** Radio Corporation of America, managed by National Broadcasting Co., 711 5th Ave., New York City, N. Y. 454.3 meters, 660 kilocycles, 30,000 watts. Sun, 9-10 am, 1-10:45 pm. Daily ex Sat & Sun, 1-2:40 pm, 4:30-6 pm. Sat, 1-2:05 pm, 4:30-5:30 pm, 6 pm-12 midnight. Eastern standard time.

**WKAQ** Radio Corp. of Porto Rico, Telephone Bldg., San Juan, Porto Rico. 322.4 meters, 930 kilocycles, 500 watts. Wed, 7-9 pm. Municipal Band of San Juan. Fri, 7-10 pm, Studio Program. Slogan: "Porto Rico, The Island of Enchantment in the Caribbean Sea." Eastern standard time.



# EXCELLO RADIO CONSOLES

*in many models to  
suit every taste*



Style R-31

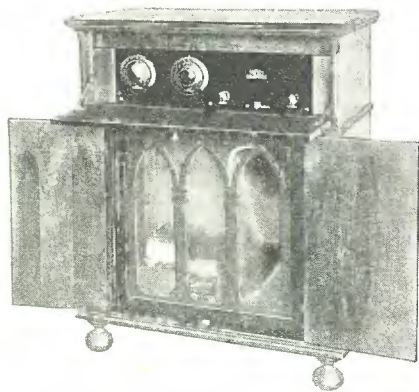

*Style R-31. Phantom view to show location of long air travel type horn and accessories*

See the new Excello Consoles at your dealer, or write us for descriptive catalog.

Dealers and distributors, write for interesting proposition on open territory

In the Excello Line you will find every modern type of Radio Console all incorporating latest features of convenience and utility.

The creation of these smart designs so closely in keeping with the present trend is an achievement to delight all radio fans and to add a beautiful piece of furniture to the home.

The cabinet work is of true Excello quality. Doors of 5-ply butt walnut; rich piano finish.

The sound chambers are above or below the set compartment. In the latter type all confusing vibrations arising when a cone is enclosed are entirely eliminated. Consoles of this type come with or without horn speaker of long air travel type and will accommodate a 22-inch cone type speaker as well as batteries, charger or eliminator.

Excello Cabinets with sound chamber above as in Styles R-23 or R-32 are so designed that they develop the full tonal range from lowest base to highest treble.

Special filler panels are furnished without extra charge so that any Excello Console will accommodate Atwater-Kent, Fada, Freed-Eisemann, Kellogg, Stromberg-Carlson and all other standard receivers.



Style R-32

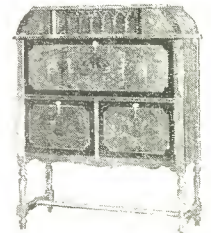

Style R-23

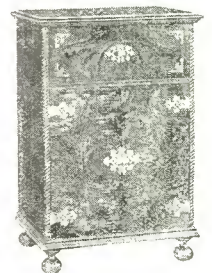

Style R-29

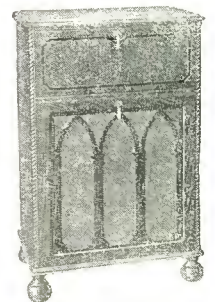

Style R-28

## EXCELLO Radio Consoles

### Excello Products Corporation

4820-28 West 16th Street, Cicero, Illinois  
(Suburb of Chicago)

Electric, 250 watts, You Save It in the Citizens Radio Call Book Magazine



**WKAR** The Michigan State College, East Lansing, Mich. 277.6 meters, 1630 kilocycles, 1000 watts daytime, 500 watts night. Daily ex Sun, 12-12:30, markets, weather, educational program.

**WKAV** Laconia Radio Club, Auditorium of Public Service Co., Laconia, N. H. 223.7 meters, 1340 kilocycles, 50 watts. Sun, 5 pm. Fri, 7:30 pm. Eastern standard time. Slogan: "The Voice of the Winnepesaukee Lake Region."

**WKBB** Sanders Bros., 607 Jefferson st., Joliet, Ill. 215.7 meters, 1390 kilocycles, 150 watts. Wed, 6:30-8 pm, dinner program. Thurs, 8:30-12 pm, good time program. Sun, 3-5 pm, classical; 8:30-12 pm, frolics. Central standard time. Divides time with WCLS.

**WKBC** H. L. Ausley, 1428 N. 12th av., Birmingham, Ala. 218.8 meters, 1370 kilocycles, 10 watts. Tues, Thurs, Sat, 7:30-8 pm, music. Sat, Sunday school talks on lessons for Sunday. Central standard time.

**WKBE** K. & B. Electric Co., 59 Emerald av., Webster, Mass. 228.9 meters, 1310 kilocycles, 100 watts. Mon, 8-11:30 pm. Thurs & Sat, 8-11 pm. Eastern standard time.

**WKBF** Noble Butler Watson, 902 N. Meridian St., Indianapolis, Ind. 252 meters, 1190 kilocycles, 250 watts. Slogan: "We Keep Building Friendships."

**WKBG** C. L. Carrell, 36 S. State st., Chicago, Ill. (Portable). 201.6 meters, 1490 kilocycles, 100 watts.

**WKBH** Callaway Music Co., 221 Main st., LaCrosse, Wis. 220.4 meters, 1360 kilocycles, 500 watts. Daily ex Sun, 10 am, weather report, talk & music; 12 noon, weather report, farm service, music. Sun, 10:30 am, church service; 6:30 pm, classical & vesper service. Mon, Wed, Fri & Sat, 8:30 pm, studio program. Wed, 9:30 pm, dance music. Fri, 7:30 pm. Central standard time.

**WKBI** Fred L. Schoenwolf, Lincoln Trust & Savings Bank Bldg., Chicago, Ill. 215.7 meters, 1390 kilocycles, 50 watts. Central standard time. Divides with WIIP.

**WKBL** Monrona Radio Mfg. Co., 16 S. Monroe, Monroe, Mich. 205.4 meters, 1460 kilocycles, 15 watts. Mon, 8-9 pm. Wed, 9-10:30 pm. Thurs, 8-10 pm. Fri, 8-11 pm. Sat, 9-12 pm. Slogan: "The Most Powerful 15-Watt Station in the World."

**WKBN** Radio Electric Service, 17-21 N. Champion st., Youngstown, Ohio. 214.2 meters, 1400 kilocycles, 50 watts. Eastern standard time. Divides time with WMBW.

**WKBO** Camith Corp., Jersey Observer Bldg., Jersey City, N. J. 218.8 meters, 1370 kilocycles, 500 watts. Eastern standard time. Divides time with WKBQ & WCGU.

**WKBP** Battle Creek Enquirer & News, Battle Creek, Mich. 212.6 meters, 1410 kilocycles, 50 watts.

**WKBQ** Starlight Amusement Park, 1100 E. 177th st., New York City, N. Y. 218.8 meters, 1370 kilocycles, 500 watts. Mon & Tues, 10 am-12 noon. Tues, 1-5 pm. Tues & Wed, 9 pm-12 midnight. Thurs, 1-3 pm. Thurs & Sun, 8 pm-12 midnight. Fri, 3-6 pm. Sat, 3-8 pm. Eastern standard time. Divides time with WKBO & WCGU.

**WKDR** Kenosha, Wis. 247.8 meters, 1210 kilocycles, 15 watts output. Sun, 2-3 pm, religious services. Sat, 11-12:30 pm.

**WKBS** Galesburg, Ill. 217.3 meters, 1380 kilocycles, 100 watts. Daily ex Sat & Sun, 10-11 am, 12:30-1 pm, 2:30-3:30 pm. Sun, 1:30-3 pm, church. Mon, Wed, Fri, 7-11 pm. Tues, Thurs, Sat, 7-9 pm, 10-11 pm. Sat, 12:30-1 pm, 11 pm-12 midnight. Central standard time. Divides time with WLBO. Slogan: "The Mayflower Station in the Renowned City of Colleges."

**WKBT** First Baptist Church, 3436 St. Charles av., New Orleans, La. 252 meters, 1190 kilocycles, 50 watts. Sun, 11 am & 7:30 pm, church services & special music.

**WKBV** Knox Battery & Electric Co., 658 Main st., Brookville, Ind. 217.3 meters, 1380 kilocycles, 100 watts.

**WKBW** Churchill Tabernacle, 1420-28 Main, Buffalo, N. Y. 217.3 meters, 1380 kilocycles, 500 watts night, 750 watts daytime. Sun, 9:30 am, 10:30 am, 3 pm, 7 pm, 10:15 pm-12 midnight. Daily, 7:30 pm. Mon, 7:45 pm. Wed, 9 pm, civil service exams; 9:15 pm, prayer service. Fri, 7 pm. Sunday School lesson. Eastern standard time. Slogan: "Well Known Bible Witness."

**WKBZ** Karl L. Ashbacher, First National Bank Bldg., Ludington, Mich. 199.9 meters, 1500 kilocycles, 15 watts.

**WKEN** Kenmore, Buffalo, N. Y. 204 meters, 1470 kilocycles, 250 watts. Sun, 11 am-12 noon, 7:30-8:30 pm. Daily ex Sun, 6-6:45 pm. Mon, Tues, Thurs, 8-11 pm. Eastern standard time. Divides time with Station WSVS, Wed, Fri evenings, 7:30-9:30 pm.

**WKJC** Kirk Johnson & Co., 16-18 W. King st., Lancaster, Pa. 252.0 meters, 50 watts, 1190 kilocycles. Sun, 9:30-12 noon, 7:30-9:30 pm. Mon, Wed, Fri, 7:30-9:30 pm. Sat, 2:30-4:30 pm. Eastern standard time. Divides time with WGAL.

**WKRC** The Kodel Radio Corp., 507 E. Pearl st., Cincinnati, Ohio. 245.8 meters, 1220 kilocycles, 500 watts. Sun, 11 am, church; 10 pm, classical; 11:15 pm, popular. Mon, Wed, 6 pm, dinner music; 8 pm, instrumental. Mon, 12 midnight, dance music. Wed, 8:30 pm, classical. Tues, 10 pm, vocal, instrumental; 11 pm, popular. Sat, 10 pm, dance program. Eastern standard time. Divides time with WFBE. Slogan: "WKRC—K. Kodel—R. Radio—C. Corporation."

**WKY** WKY Radiophone Co., Huckins Hotel, Oklahoma City, Okla. 288.3 meters, 1040 kilocycles, 150 watts. Daily ex Sun, 9:45 am, Sunshine Hour; 12 noon-1 pm, organ; 6:30-7:30 pm, dinner hour; 7:30-8 pm, organ; 8 pm-12 midnight, Huckins Hotel Studio. Sun, 11 am, 7:30 pm, church; 3-4 pm, concert. Central standard time.

**WLAC** Life and Casualty Insurance Co., Nashville, Tenn. 225.4 meters, 1330 kilocycles, 1000 watts. Sun, 6:30-7:30 pm, church; 9:15-10:15 pm. Daily ex Fri & Sun, 6:45-8:30 am, 11:45 am-12:35 pm. Mon, Wed, Sat, 6-9 pm. Tues & Thurs, 6-7 pm, 9-12 midnight. Central standard time. Divides time with WDAD. Slogan "The Thrift Station."

**WLAP** Virginia Av. Baptist Church, 2600 Virginia av., Louisville, Ky. 267.7 meters, 1120 kilocycles, 30 watts night, 100 watts daytime. Sun, 11 am-12 noon, 7:30-8:45 pm. Central standard time.

**WLB** University of Minnesota, Minneapolis, Minn. 245.8 meters, 1220 kilocycles, 500 watts. Mon, 7:30-8 pm. Tues, 6-7 pm, 8-9 pm. Wed, 6:15-7 pm, 7:30-8:30 pm. Fri, 4-5 pm, 7:30-8 pm. Central standard time. Divides time with WHDI.

**WLBC** D. A. Burton, 2224 S. Jefferson st., Muncie, Ind. 209.7 meters, 1430 kilocycles, 50 watts.

**WLBK** Everett L. Dillard, 300-A E. 33rd st., Kansas City, Mo. 209.7 meters, 1430 kilocycles, 50 watts. Daily ex Sun, 10 am-11 pm, popular & classical; 7:30-10:30 pm, popular & classical. Central standard time. Slogan: "Where Listeners Become Friends."

**WLBG** R. A. Gamble, 126 N. Sycamore st., Petersburg, Va. 214.2 meters, 1400 kilocycles, 100 watts. Irregular programs daily.

**WLBH** Joseph J. Lombardi, Farmingdale, N. Y. 232.4 meters, 1290 kilocycles, 30 watts.

**WLBK** Wenona Legion Broadcasters, 107 Chestnut st., Wenona, Ill. 238.0 meters, 1260 kilocycles, 250 watts. Sun, 11 am, church. Mon, 7-11 pm, music. Wed, 7-8 pm, lecture, music, etc. Thurs, 2-3 pm, markets, etc. Fri, 7-9 pm, music. Sat, 2-3 pm, 7-9 pm. Central standard time. Slogan: "In the Heart of the Corn Belt."

**WLBL** Wisconsin Department of Markets, Stevens Point, Wis. 333.1 meters, 900 kilocycles, 1000 watts. Daily ex Sun, 8, 9, 10 & 11 am, 12 noon, 1 pm, markets. Thurs & Sat, 8 pm, musical program. Central standard time. Divides time with Station WHA. Slogan: "Wisconsin, Land of Beautiful Lakes."

**WLBK** Boston, Mass. 230.6 meters, 1300 kilocycles, 50 watts.

**WLBK** William E. Hiler, 339 S. Homan av., Chicago, Ill. (Portable). 204.0 meters, 1470 kilocycles, 100 watts.

**WLBO** Frederick A. Trebbe, Jr., 526 Monmouth blvd., Galesburg, Ill. 217.3 meters, 1380 kilocycles, 100 watts. Central standard time. Divides time with WKBS.

**WLBQ** E. Dale Trout, Atwood, Ill. 218.8 meters, 1370 kilocycles, 25 watts. Central standard time.

**WLBK** Alford Radio Co., Belvidere, Ill. 247.8 meters, 1210 kilocycles, 15 watts.

**WLBK** Harold Wendell, 317 E. North st., Crown Point, Ind. 247.8 meters, 1210 kilocycles, 50 watts. Central standard time.

**WLBK** Mansfield Broadcasting Association, Chamber of Commerce Bldg., Mansfield, Ohio. 206.8 meters, 1450 kilocycles, 50 watts. Sun, 10:30-12 noon. Mon, Wed, 9 am-10 pm. Mon, 6-7 pm, dinner hour. Sat, 9:30-12 pm. Eastern standard time.

**WLBK** Northwestern Pennsylvania Broadcast Station, P. O. Box No. 163, Oil City, Pa. 293.9 meters, 1020 kilocycles, 500 watts. Sun, 3:30 pm, sacred. Daily ex Sun, 12:15-1:15 pm, 12 midnight. Mon, 9:30 pm, miscellaneous program. Thurs, 10 pm, miscellaneous program. Eastern standard time.

**WLBK** John N. Brahy, 283 Cr... Long Island... meters, 1470 kilocycles... ard time. Divides

**WLBK** Aimon... Iron M... 1430 kilocycles, 50 w...



# How's Your Old Audio Amplifier

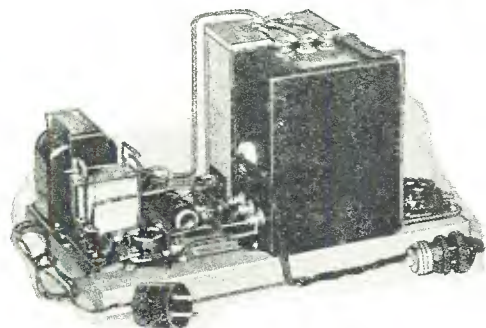
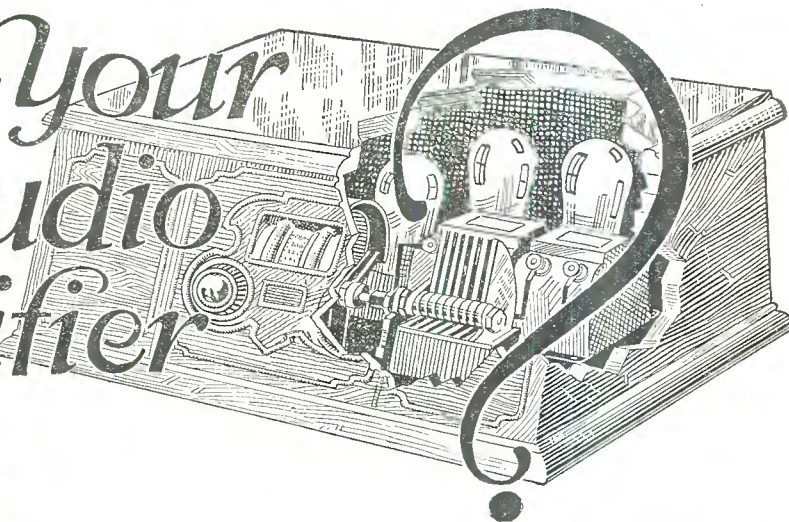

**THORDARSON 171 TYPE POWER AMPLIFIER**

Built around the Thordarson Power Compact R-171, this power amplifier supplies "A," "B," and "C" current for one UX-171 power tube and B-voltage for the receiver. Employs Raytheon B. H. rectifier.

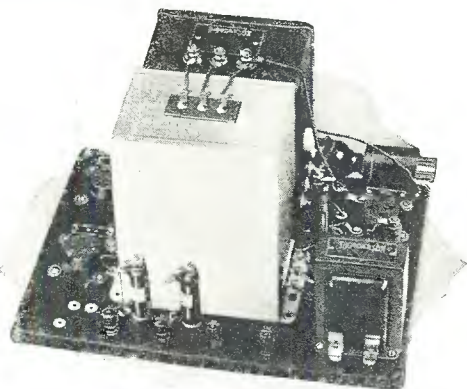

**THORDARSON 210 TYPE POWER AMPLIFIER**

This amplifier, mounted on a special metal chassis, uses the Thordarson Power Compact R-210. Provides "A," "B," and "C" current for one UX-210 power tube and "B" voltage for the receiver. Employs one 216-B or 281 rectifier.

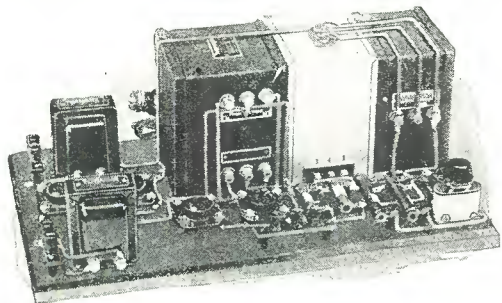

**THORDARSON 210 PUSH-PULL POWER AMPLIFIER**

Every duty power amplifier operates two 210 power tubes in push-pull and has an ample reserve of power for the heaviest drain receivers. Built with Thordarson Power Transformer T-2098, and Double Rectifier T-2099.

## A Home Assembled Thordarson Power Amplifier Will Make Your Receiver A Real Musical Instrument

IMPROVEMENTS in the newer model receiving sets are all centered around the audio amplifier. There is no reason, however, why you cannot bring your present receiver up to 1928 standards of tone quality by building your own Thordarson Power Amplifier.

With a screw driver, a pair of pliers and a soldering iron you can build any Thordarson Power Amplifier in an evening's time in your own home. Complete, simple pictorial diagrams are furnished with every power transformer.

{ The fact that Thordarson power transformers are used by such leading manufacturers as Victor, Brunswick, Federal, Philco and Willard insures you of unquestionable quality and performance. }

Give your radio set a chance to reproduce real music. Build a Thordarson Power Amplifier.

Write today for complete constructional booklets sent free on request.

# THORDARSON

**THORDARSON ELECTRIC MANUFACTURING CO.**  
*Transformer Specialists Since 1895*  
**WORLD'S OLDEST AND LARGEST EXCLUSIVE TRANSFORMER MAKERS**  
*Huron and Kingsbury Streets — Chicago, Ill. U.S.A.*

3572



**WLBZ** Thompson L. Guernsey, Dover-Foxcroft, Me. 208.2 meters, 1440 kilocycles, 250 watts.

**WLCI** Lutheran Association of Ithaca, Ithaca, N. Y. 247.8 meters, 1210 kilocycles, 50 watts.

**WLEX** Lexington, Mass. 215.7 meters, 1390 kilocycles, 5 watts. Eastern standard time.

**WLIB** Liberty Magazine, Chicago, Ill. 416.4 meters, 720 kilocycles, 15,000 watts. Daily ex Sun & Mon, 10:30-11 am, 11:30 am-12:40 pm, 7-8 pm, 11-12:30 am, Sun, 5-6 pm, 11 pm-12:30 am. Central standard time. Divides time with WGN. Slogan: "Liberty, a Weekly for Everybody."

**WLIT** Lit Bros., Philadelphia, Pa. 405.2 meters, 740 kilocycles, 500 watts, class B. Daily ex Sun, 12-1 pm, 2-3 pm, 4:30-5 pm, Mon, 12 noon to 11 pm, Tues, 11 am to 8 pm, Wed, 12 noon to 11 pm, Thurs & Sat, 12 noon to 8 pm, Fri, 12 noon to 12 midnight. Eastern standard time. Divides time with WFL. Slogan: "The Quaker City Siren."

**WLOE** Chelsea, Mass. 211.1 meters, 1420 kilocycles, 100 watts. Eastern standard time. Divides with WMES.

**WLS** Sears, Roebuck & Co., Chicago, Ill. 344.6 meters, 870 kilocycles, 5000 watts. Sun, 10:45-12:20, U. of C. church; 12:20-1, organ; 1-1:30, trio concert; 6-8, Little Brown church. Mon, markets; 9-9:10-10:30-11-11:30-11:45, markets every day ex Sun; R. F. D. program & markets, 12-1 pm; closing markets every day, 1-25-1:35; home makers' hour, Mon, Tues, Wed, Fri, 2:30-3:30 pm; organ every day ex Sat & Sun, 5:30. Birthday time, ex Sat & Sun, 5:45 pm. Supper bell program ex Sun, 6 pm. Sports time ex Sun, 6:30 pm. Mon, 7-10:30 pm, Tues, 5:30-8, 10:30-12:30 pm, Wed, 5:30-12 pm, Thurs, 5:30-8, 10:30-12:30 pm, Fri, 5:30-12 pm, Sat, 6-1 am. Central standard time. Divides time with WCBD. Slogans: "World's Largest Store," "Work Better, Live Better, Sell Better."

**WLSI** Lincoln Studios (Ind.), 335 Westminster St., Providence, R. I. 260.7 meters, 1150 kilocycles, 250 watts. Eastern standard time. Divides time with WDVF.

**WLTH** "The Voice of Brooklyn." Inc., Leverick Towers Hotel, Brooklyn, N. Y. 256.3 meters, 1170 kilocycles, 250 watts. Sun, 11 am-2 pm, 5-6 pm, 9-11 pm, Mon, 10 am-1 pm, 5-6 pm, 9-11 pm, Tues, Wed, Thurs, 4-7 pm, Tues, Wed & Sat, 9 pm-12 midnight, Thurs, 9 pm-2 am, Fri 5-7 pm, Sat, 4-6 pm. Eastern standard time. Divides time with WBBR & WEBJ.

**WLTS** Lane Technical High School, 1223 Sedgwick st., Chicago, Ill. 483.6 meters, 620 kilocycles, 100 watts. Daily ex Sat & Sun, 2-4 pm, musical & educational. Mon, 6-7 pm, musical. Central standard time. Slogan: "World's Largest Technical School." Divides time with WCFL & WEMC.

**WLW** The Crosley Radio Corp., Harrison, Ohio. 428.3 meters, 700 kilocycles, 52.02 meters, 5764 kilocycles, 5000 watts. Daily ex Sun, 8 am through 12 noon, Sat, 10 am through 12 noon, 12:45-11 pm, Mon, Tues, Wed, Thurs, 1:30-11 pm, Fri, 1:30-9 pm. Music, news, talks, chat programs, etc. Sun, 9:30, 11 am, church services; 3 pm, 4 pm, 7:10 through 10:15 pm. Eastern standard time.

**WLWL** Kearney, N. J. 370.2 meters, 810 kilocycles, 1000 watts. Eastern standard time. Divides time with WMCA.

**WMAC** Clive B. Meredith, Cazenovia, N. Y. 225.4 meters, 1330 kilocycles, 500 watts. Sun, 3:30 pm, choral singing; 9:30 pm, popular program. Mon, 8:30, semi-classical program; 7:30, Weekly Letter to Dad. Daily ex Sun & Mon, 7:30 pm, Tues, Autobiography of Infamous Bugs. Wed, Chats with Weatherman; 8:30, popular program. Thurs, Primer for Town Farmers. Fri, 7:30 pm, Agricultural Interview; 8:30 pm, classical program. Sat, Farm News Digest. Eastern time. Divides time with WSYR. Slogan: "Voice of Central New York."

**WMAF** Round Hills Radio Corp., South Dartmouth, Mass. 428.3 meters, 700 kilocycles, 500 watts. Eastern standard time.

**WMAK** WMAK Studios, Inc., Liberty Bank Bldg., Buffalo, N. Y. 545.1 meters, 550 kilocycles, 750 watts. Sun, 10 am-12 noon, 2-5 pm, 7-11 pm. Daily ex Sun, 11 am-12 noon, 1:30-6 pm, 6 pm-12 midnight. Eastern standard time.

**WMAL** Washington Radio Forum, owned & operated by the M. A. Leese Radio Co., 720 11th st., N. W., Washington, D. C. 241.8 meters, 1240 kilocycles, 500 watts. Daily, 6:45-11 pm, varied programs. Eastern standard time.

**WMAN** W. E. Heskett Radio Station, First Baptist Church, Columbus, Ohio. 234.2 meters, 1280 kilocycles, 50 watts. Sun, 10:30 am-12 noon; 7:30-9 pm, church services. Eastern standard time. Divides time with WCAH.

**WMAQ** The Chicago Daily News, 15 N. Wells st., Hotel La Salle, Chicago, Ill. 447.5 meters, 670 kilocycles, 1000 watts. Daily ex Sun & Mon, 6:30-11 am, 12 noon-3 pm, 4-6 pm, 7-10 pm, Sun, 4-6 pm, 7-10 pm, Mon, 3-11 am, 12 noon, 3 pm, 4-6 pm. Central standard time. Divides time with WQJ.

**WMAY** Kingshighway Presbyterian Church, St. Louis, Mo. 234.2 meters, 1280 kilocycles, 100 watts. Sun, 11 am-12 pm, 8-9 pm, church services. Central standard time. Divides time with KWK & KFQA.

**WMAZ** Mercer University, Macon, Ga. 270.1 meters, 1110 kilocycles, 500 watts. Tues, Wed & Thurs, 8-9:15 pm, Fri, 11 pm-12:15 pm. Eastern standard time. Divides time with WGST. Slogan: "Watch Mercer Attain Zenith."

**WMBA** Leroy J. Beebe, 13 Robinson st., Newport, R. I. (Portable). 204.0 meters, 1470 kilocycles, 100 watts.

**WMBB** American Bond & Mortgage Co., 6201 Cottage Grove av., Chicago, Ill. 252.0 meters, 1190 kilocycles, 5000 watts. Sun, 3-6 pm, popular concert program; 7:40-9 pm, Christian Science services; 9-11 pm, popular program. Daily ex Sun, Mon, 7-8:30 pm, semi-classical program; 9-10 pm, popular program. Tues & Fri, 7-10 pm, quartet. Central standard time. Slogan: "World's Most Beautiful Ballroom."

**WMBC** Michigan Broadcasting Co. (F. G. Siegel), Hotel Savoy, Detroit, Mich. 243.8 meters, 1230 kilocycles, 100 watts. Sun, 6:30-10 pm, dinner hour, studio program. Daily ex Sun & Sat, 6-6:30 pm, Children's Hour; 6:30-10 pm, dinner hour, studio program. Sat, 6-6:30 pm, Children's Hour, 6:30-8 pm, dinner hour. Eastern standard time.

**WMBD** Peoria Heights Radio Laboratory, Peoria Heights, Ill. 205.4 meters, 1460 kilocycles, 250 watts. Sun, 11 am-12 noon, church. Daily ex Sun, 6:55-7:30 pm, markets; 8-10 pm, studio program. Central standard time. Slogan: "World's Most Beautiful Drive."

**WMBE** Dr. C. S. Stevens, St. Paul, Minn. 208.2 meters, 1440 kilocycles, 10 watts. Central standard time. Slogan: "The Winter Garden Station."

**WMBF** Fleetwood Hotel Corp., Miami Beach, Fla. 384.4 meters, 780 kilocycles, 500 watts. Daily, 7-8 pm, concert orchestra; 8-9 pm, popular program; 10-11 am, dance music. Eastern time. Divides time with WQAM. Slogan: "Wonderful Miami Beach Fleetwood."

**WMBG** Havens & Martin, 914 W. Broad St., Richmond, Va. 220.4 meters, 1360 kilocycles, 15 watts. Daily ex Sun, 2-3 pm, 6-8 pm. Eastern standard time. Divides time with WTAZ. Slogan: "The Daytime Station."

**WMBH** Joplin, Mo. 204.0 meters, 1470 kilocycles, 100 watts. Central standard time.

**WMBI** The Moody Bible Institute of Chicago, 153 Institute pl., Chicago, Ill. 263.0 meters, 1140 kilocycles, 5000 watts. Sun, 3:30-5 pm, 5-7 pm, Bible Exposition and sacred music. Daily ex Sun, 7-7:40 am, morning worship; 10:30-11:30 am, missionary hour, Bible study; 12:30-1:30 pm, organ program; 3:30-4:30 pm, reading & music; 8-9 pm, Bible study or sacred program. Central standard time. Divides time with WJAZ. Slogan: "The West Point of Christian Service."

**WMBJ** Wm. Roy McShaffrey, Monessen, Pa. 232.4 meters, 1290 kilocycles, 50 watts.

**WMBK** John C. Slade, Hamilton, Ohio, 205.4 meters, 1460 kilocycles, 100 watts. Sat & Sun, 2:30-4 pm, 10 pm-12 midnight. Daily ex Sun, 1-2 pm, 6:45-10:30 pm. Eastern standard time.

**WMBL** Benford Radio Studios, Lakeland, Fla. 228.9 meters, 1310 kilocycles, 100 watts. Sun, church services, morning & evening. Daily ex Sun, 10:30 am-1:30 pm, varied program; 2:30-3:30 pm, varied; 8-9:30 pm, classical; 9:30-10:30 pm, popular; 10:30-11:30 pm, dance program. Eastern standard time. Slogan: "Lakeland—The City of Heart's Desire."

**WMBM** Memphis, Tenn. 209.7 meters, 1430 kilocycles, 10 watts.

**WMBO** Auburn, N. Y. 220.4 meters, 1360 kilocycles, 100 watts.

**WMBQ** 95 Leonard St., Brooklyn, N. Y. 204 meters, 1470 kilocycles, 100 watts. Eastern standard time. Divides time with WBS, WLBN. Slogan: "The Home, Sweet Home Station of Williamsburgh."

**WMBR** F. J. Reynolds, 109 Franklin st., Tampa, Fla. 252.0 meters, 1190 kilocycles, 100 watts. Daily ex Sun, 1-2 pm, weather reports, organ; 7-8 pm, baseball returns, orchestra. Tues, 7-8 pm, orchestra. Wed, 9-10 pm, musical. Fri, 10 pm, fight returns. Sat, 8-10 pm, musical. Eastern standard time. Slogan: "WMBR, Everything for Radio at Tampa, Florida."

**WMB S** Macks Battery Service, 210 Locust st., Harrisburg, Pa. 234.2 meters, 1280 kilocycles, 250 watts. Sun, 9 am-9 pm. Daily ex Sat & Sun, 6-11:30 pm, Sat, 6 pm-2 am. Eastern standard time.

**WMBW** Youngstown, Ohio. 214.2 meters, 1400 kilocycles, 50 watts. Eastern standard time. Divides time with WKBN.



# VITROHM RESISTORS and RHEOSTATS

## Vitrohm Radio Resistors

**WARD LEONARD** Resistors and Rheostats are now available to the experimenter and home constructor in 93 types and styles covering the resistance demands of *every* current supply circuit.

A few of these products are listed on this page. A full description is contained in Radio Bulletin 507 which will be sent you without charge.

"Vitrohm News," a monthly Bulletin covering circuits and items of interest to the radio fan, was first published in September. This copy and subsequent issues will be sent you upon request.

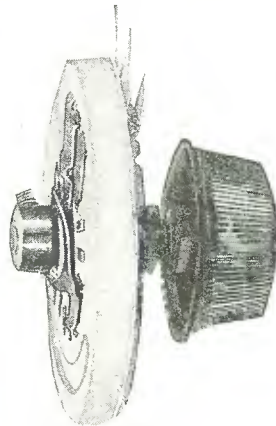

THE ADJUSTAT

### The Adjustat

The Vitrohm Adjustat is a 15-step potentiometer connected rheostat adopted for use in all current supply circuits. Like all Vitrohm Products, the resistive element, wire, is embedded in and protected by fused-on vitreous enamel.

The Adjustat is priced at \$3.00.

#### Types

507-79	1 ohm	4000 m. a.	507-81	600 ohms	180 m. a.
507-71	2 ohms	3000 m. a.	507-75	1000 ohms	125 m. a.
507-72	6 ohms	1500 m. a.	507-76	2250 ohms	90 m. a.
507-73	20 ohms	1000 m. a.	507-84	7500 ohms	50 m. a.
507-74	30 ohms	800 m. a.	507-77	10,000 ohms	40 m. a.
507-80	50 ohms	650 m. a.	507-78	25,000 ohms	20 m. a.

### Resistor 507-66

Vitrohm Resistor 507-66 is a transmitting grid leak for circuits up to and including 1000 watts input. It is particularly recommended for circuits employing the R. C. A. UX852 Tube.

Total Resistance 15,000 ohms, tapped at 5000 and 10,000 ohms. \$6.00.



RESISTOR 507-66

### Resistor 507-9

This resistor is for use in B & C Supply Circuits having an output under load of 180 volts. At this voltage, intermediate voltages of 22, 45, 67, 90 and 135 are available. Priced at \$6.75.



RESISTOR 507-9

### Vitrohm HEAVY DUTY Rheostat

The Vitrohm heavy duty Rheostat has 11 steps of adjustable resistance. It is particularly adaptable to use in series with transformer primaries to compensate for line voltage changes. These Rheostats are 4 inches in diameter and are arranged for either base or panel mounting. \$5.50.

#### Types

507-83	12.5 ohms	2200 m. a.
507-59	20 ohms	2000 m. a.
507-63	50 ohms	100 m. a.

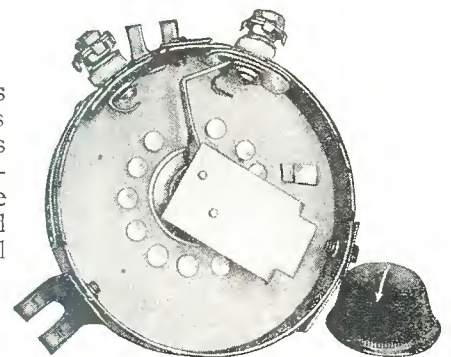

VITROHM HEAVY DUTY RHEOSTAT

# Ward Leonard Electric Company

31-41 South Street

Mount Vernon, N. Y.

resistor specialists for more than 35 years



**WMC** Commercial Publishing Co., The Commercial Appeal, 30 N. 2nd st., Memphis, Tenn. 516.9 meters, 580 kilocycles, 500 watts. Sun, 11 am, church services. Daily ex Sun, 9:45 am, markets. Mon, Wed, Fri, 12 noon, music. Tues, Thurs, 12 noon, markets. Mon, 8 pm, farm talks. Tues, 7:45 pm, bridge game. Thurs, 8 pm, music. Mon, Tues, Fri, Sat, 8:30-11 pm, music, frolic. Central standard time. Slogan: "WMC, Memphis, Down in Dixie."

**WMCA** Hotel McAlpin (Greeley Square Hotel Co.), New York City. 370.2 meters, 810 kilocycles, 500 watts. Sun, 11 am-1 am. Daily ex Sun, 10:30 am-1 am. Eastern standard time. Divides time with WLWL. Slogan: "Where the White Way Begins."

**WMES** Boston, Mass. 211.1 meters, 1420 kilocycles, 500 watts. Eastern standard time. Divides with WLOE.

**WMPC** First Methodist Protestant Church, Lapeer, Mich. 234.2 meters, 1230 kilocycles, 30 watts. Sun, 10:30 am-1 pm, 4:5-3:30 pm, 7:30-10:00 pm. Daily ex Sat & Sun, 12 noon-1 pm. Mon, Tues, Wed, Fri, 7:30-10 pm. Programs include sermons, vocal, instrumental music, missionary, church & educational services. Eastern standard time. Slogan: "Where Many Preach Christ."

**WMRJ** Peter J. Prinz, 10-12 New York av., Jamaica, N. Y. 206.8 meters, 1450 kilocycles, 10 watts. Sun, 11:30 am-2:30 pm, 8:30-11:30 pm. Tues & Thurs, 8-11:30 pm. Eastern time. Slogan: "The Gateway of the Sunrise Trail." Divides with WTRL & WHPP.

**WNAC** The Shepard Store, Winter St., Boston, Mass. 461.3 meters, 650 kilocycles, 500 watts. Sun, 10:45 am, church services; 12:15-5 pm, concert; 7:30-9 pm, church services; 9-11 pm, Columbia chain. Daily ex Sun, 9:30-10:30 am, 10:30-11:30 am. Women's Club; 11:30 am-12:15 pm, 12:15-1 pm, church; 1-2 pm, luncheon concert; 4-5 pm, Theatre Hour, music; 6-6:30 pm, children's club; 6:30-7:30 pm, dinner dance; 7:30-8 pm, news & talks; 8-11 pm, concert; 11 pm-12 midnight, dance program. Eastern standard time.

**WNAD** University of Oklahoma, Norman, Okla. 239.9 meters, 1250 kilocycles, 500 watts. Mon & Thurs, 7:15-9:30 pm. Tues, 12:15-1 pm. Wed, 7:15-8:45 pm. Fri, 12:15-1 pm. Sat, broadcast of athletic events & special features. Central standard time. Slogan: "The Voice of Soonerland."

**WNAL** R. J. Rockwell, 5019 Capitol av., Omaha, Neb. 258.5 meters, 1160 kilocycles, 250 watts. Tues, Fri, 7:30-9 pm. Central standard time. Divides time with KOCH, KFOX. Slogan: "Pioneer Station of Omaha."

**WNAT** Lennig Bros. Co., Spring Garden & 9th st., Philadelphia, Pa. 288.3 meters, 1040 kilocycles, 100 watts. Tues, Wed, Sat, 8:11 pm. Eastern standard time. Divides time with WIAD. Slogan: "We Never Are Tired."

**WNAX** Gurney Seed & Nursery Co., Yankton, So. Dak. 277.6 meters, 1080 kilocycles, 1000 watts daytime, 250 watts nighttime. Daily ex Sun & Tues, 11 am-1:30 pm, 2:30-10 pm. Sun, 11 am-12 noon, 2-7 pm. Tues, 11 am-1:30 pm, 2:30-7 pm. Central standard time.

**WNBA** Forest Park, Ill. 208.2 meters, 1440 kilocycles, 200 watts.

**WNBK** Howitt-Wood Radio Co., Inc., Endicott, N. Y. 208.6 meters, 1450 kilocycles, 50 watts. Sun, 12:30-2 pm, 7:30-9:30 pm. Thurs, 7:30-10 pm. Eastern standard time. Slogan: "The Voice of the Triple Cities."

**WNBH** New Bedford Hotel, Pleasant st., New Bedford, Mass. 247.8 meters, 1210 kilocycles, 250 watts. Mon, Wed, Fri, 6:10-30 pm, musical program. Tues, Thurs, Sat, 7:7-30 pm, news reports, sports. Eastern standard time. Slogan: "The Gateway to Cape Cod."

**WNBK** Knoxville, Tenn. 206.8 meters, 1450 kilocycles, 50 watts. Central standard time.

**WNBL** Bloomington, Ill. 199.9 meters, 1500 kilocycles, 15 watts.

**WNBO** Symplex Electrical & Radio Research Laboratories, George Washington Hotel, Washington, Pa. 211.1 meters, 1420 kilocycles, 15 watts. Sun, 11-12 noon, 10-11 pm, church services. Mon, Tues, Thurs, Fri, 3:30-4:30 pm, 9-11:30 pm, orchestra, baseball, weather. Sat, 3:30-4:30 pm, 9:30-12 pm, orchestra, studio programs. Eastern standard time. Slogan: "The Voice of Washington, Pa."

**WNBQ** Rochester, N. Y. 205.4 meters, 1460 kilocycles, 15 watts.

**WNBK** Memphis, Tenn. 228.9 meters, 1310 kilocycles, 100 watts. Sun, 2:30 pm, musical program of sacred numbers. Mon, Thurs, Fri, Sat, 6:30 pm, musical program. Tues, 6:30 pm, Old Time Melody Makers. Wed, 6:30 pm, Bible talk. Central standard time. Divides time with WGBC.

**WNBW** Carbondale, Pa. 199.9 meters, 1500 kilocycles, 5 watts. Eastern standard time.

**WNBX** Springfield, Vt. 241.8 meters, 1240 kilocycles, 10 watts. Eastern standard time. Divides time with WFCL.

**WNBZ** Saranac Lake, N. Y. 232.4 meters, 1290 kilocycles, 10 watts. Eastern standard time.

**WNJ** Herman Lubinsky, 89 Lehigh av., Newark, N. J. 267.7 meters, 1120 kilocycles, 250 watts. Daily ex Mon & Thurs, 6-6:30 pm, 8:30-12 pm, dance music. Eastern standard time. Divides time with WGCP, WAAM. Slogan: "The Voice of Newark."

**WNOX** Peoples Tel. & Tel. Co., 313 Commerce st., Knoxville, Tenn. 265.3 meters, 1130 kilocycles, 1000 watts. Mon, Wed, Fri, 12 noon-9 pm. Central standard time. Slogan: "Smoky Mountain Station."

**WNRC** Wayne M. Nelson, Greensboro, N. C. 223.7 meters, 1340 kilocycles, 250 watts. Sun, 11:15 am & 7:30 pm, church. Mon & Wed, 6:45-9 pm. Tues, 7-9 pm. Thurs, 7-10 pm. Fri, 6:45-8:30 pm. Eastern standard time.

**WNYC** City of New York, New York City, N. Y. 526 meters, 570 kilocycles, 500 watts, class B. Daily ex Sun, 6-11 pm. Mon, Wed, Fri, 11 am-12:30 pm. Sun, irregular. Eastern standard time. Slogan: "Municipal Broadcasting Station of the City of New York."

**WOAI** Southern Equip. Co., San Antonio, Tex. 499.7 meters, 600 kilocycles, 5000 watts. Sun, 11 am-7:30 pm, church services. Daily ex Sat, Sun, Mon, 8:30-9:30 pm. Varied program. Central standard time. Divides time with WBAP. Slogan: "The Winter Playground of America."

**WOAN** The Vaughan School of Music, Lawrenceburg, Tenn. 239.9 meters, 1250 kilocycles, 500 watts. Daily ex Sun, 9-10 pm, musical. Central standard time. Divides time with WBAP. Slogan: "Watch Our Annual Normal."

**WOAX** Franklin J. Wolff, the Monument Pottery Co., Trenton, N. J. 239.9 meters, 1250 kilocycles, 500 watts. Daily ex Sun, 12:15-1 pm, music, weather forecast, etc. Wed, 7:30-9:30 pm, popular program. Fri, 7:30-9:30 pm, popular program. Fri, 7:30-8:30 pm. Sun, 7:30-8:30 pm, classical and dance orchestra. Eastern standard time. Divides time with WCAP. Slogan: "Trenton Makes, the World Takes."

**WOBR** Shelby, Ohio. 204.0 meters, 1470 kilocycles, 10 watts. Eastern standard time.

**WOBT** Union City, Tenn. 205.4 meters, 1460 kilocycles, 15 watts. Central standard time.

**WOBU** Charleston, W. Va. 267.7 meters, 1120 kilocycles, 50 watts. Eastern standard time.

**WOC** The Palmer School of Chiropractic, 1002 Brady st., Davenport, Iowa. 374.8 meters, 800 kilocycles, 5000 watts. Sun, 11 am-12:15 pm, church; 12:15 pm-3 pm, WJZ & WEAF programs; 4:30-5:30 pm, WEAF program; 7-8 pm, church; 8:15-9:15 pm, Atwater-Kent hour; 9:15-10:15 pm. Daily ex Sun, 7-8 am, 9:45-10 am, 5:45-6 pm. Wed, Thurs, Fri, 10:10-15 am, 10:15 am-12 noon. Mon & Tues, 11 am-12 noon. Sat, 11-11:15 am, 12:57-1 pm, 7-9 pm. Wed, 4-5 pm. Mon & Wed, 7-10:30 pm. Tues, 7-9:30 pm. Thurs & Fri, 7-10 pm. Daily ex Sat & Sun, 1:57-3:30 pm. Music, weather reports, talks, chain programs broadcast. Central standard time.

**WOCL** A. E. Newton, Jamestown, N. Y. 223.7 meters, 1340 kilocycles, 25 watts. Sun, 10:30 am & 7:30 pm, church service. Mon, 9-9:15 pm, 9:15-12 midnight, educational feature popular program. Eastern standard time.

**WODA** The O'Dea Temple of Music, 115 Ellison st., Paterson, N. J. 293.9 meters, 1020 kilocycles, 1000 watts. Sun, 10:30 am, 7:30 am, church services. Daily ex Sun, 12-1 noon; 5-7 pm, studio; 8-11 pm, studio. Tues, 11:30-12:30 am, Nite Club. Thurs, 11-12 midnight, Nite Club. Fri, 10:30-11:30 pm, dance; 11:30-12:30 am, Nite Club. Eastern standard time. Divides time with WGL. Slogan: "The Voice of the Silk City."

**WOI** Iowa State College, Ames, Iowa. 265.3 meters, 1130 kilocycles, 2500 watts night time, 5000 daytime. Daily ex Sun, 7 am, 7:30 am, 8:45 am, 9:30 am, 10 am, 10:30 am, 12:10-12:45 pm, 1 pm, music; 1:30 pm, 9:30 pm, market reports, weather, varied programs. Mon, 7-9 pm. Mon & Thurs, 7:30 pm, 7:45 pm, 8 pm. Sat, 4:15 pm. Talks, music, etc. Sun, 10:45 am, chimes; 11 am, church; 3:15 pm. Central standard time.

**WOK & WMBB** Neutrowound Radio Mfg. Co., Homewood, Ill. 252.0 meters, 1190 kilocycles, 5000 watts. Daily ex Sun, 6-7 pm, 8-9 pm, 11 pm-12:30 am. Sun, 6 pm-12 am, orchestra & popular program. Central standard time.

**WOKO** Harold E. Smith, Peekskill, N. Y. 215.7 meters, 1390 kilocycles, 250 watts. Mon, Thurs, Sat, 7-12 pm. Tues & Fri, 7-12 pm, non-regular. Eastern standard time.

**WOKT** Titus-Ets Corp., 608 Terminal Bldg., Rochester, N. Y. 209.7 meters, 1430 kilocycles, 500 watts. Sun, 11 am-12:30 pm, religious. Daily ex Sun, 11:30 am-12 midnight, musical and educational programs. Eastern standard time. Slogan: "Where the Better Programs Are Broadcast From."

**WOMT** The Mikadow Theater, Manitowoc, Wis. 222.1 meters, 1350 kilocycles, 100 watts.



# Announcing New and Improved

## AERO COIL SUPER-SENSITIVE INDUCTANCE UNITS

### New AERO Circuits For Either Battery or A. C. Operation

Once more improved! These two popular Aero kits, for the improved Aero-Dyne 6 and the Aero Seven, are now adaptable to either battery or A. C. operation. Proper constants have been satisfactorily studied out and A. C. blue prints packed with each foundation unit. These blue prints may also be obtained separately by sending 25c for each direct to the factory.



Code No. U-16

### The AERO Universal Tuned Radio Frequency Kit Kit of 4 Coils (For Improved Aero-Dyne 6)

Kit consists of 4 twice matched units—adaptable to 201-A, 199, 112 and the new 240 and A. C. tubes. Tuning range below 200 to above 550 meters. This kit will make any set better in selectivity, tone and range. Will eliminate losses and give the greatest receiving efficiency. Each kit is carefully matched at both ends of the broadcast range.

For .0005 Condenser, Code No. U-16..... Price \$15.00  
For .00035 Condenser, Code No. U-163..... Price 15.00

### The AERO Universal Tuned Radio Frequency Kit Kit of 3 Coils (For Aero-Seven)

Kit consists of 3 twice matched units—adaptable to 201-A, 199, 112 and the new 240 and A. C. tubes. Coils are wound on Bakelite skeleton forms, assuring a 95% air dielectric. Range from 200 to above 550 meters. Each kit carefully matched at both ends of the broadcast range.

For .0005 Condenser, Code No. U-12..... Price \$12.00  
For .00035 Condenser, Code No. U-123..... Price 12.00



Code No. U-12

#### AERO Universal 3-Circuit Tuner



In the form of a 3 circuit tuner with a fixed tickler, this Aero Coil will improve any circuit. Adaptable only to 201-A, 199, 112, or the new A. C. Tubes. Has variable primary for governing selectivity.

Code U-55 (for .0005 Condenser) or Code U-553 (for .00035 Condenser)..Price \$4.00

#### AERO Radio Frequency Regenerative Kit

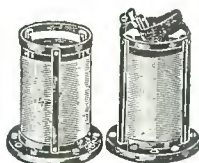

The supersensitive kit used in the new Aero 4 and The Chicago Daily News Receiver will improve the efficiency of any circuit for use with 201-A, 112, 199, and the new A. C. Tubes. Used as .0005 variable condenser to tune fixed tickler. Code U-95 (for .0005 Condenser) or Code U-953 (for .00035 Condenser).....Price \$8.00

#### AERO Universal Antenna Coupler



A highly efficient low-loss and antenna coupler with variable primary, adaptable to 201-A, 199, 112, 240 and the new A. C. Tubes.

Code No. U-96 (for .0005 Condenser) or Code No. U-963 (for .00035 Condenser). Price .....\$4.00

#### AERO Universal Wave Trap Unit

Makes an excellent wave trap due to low distributive capacity and low high frequency resistance. Helps greatly in eliminating interference. Can also be used to improve efficiency of Crystal Sets.

Code No. U-4 (for .0005 Condensers) or Code No. U-43 (for .00035 Condenser).....Price \$4.00

#### AERO "No-Skip" Choke 60

Has uniform choking action over a wide range of wave lengths. Eliminates customary "holes" in the tuning range—so common with ordinary chokes. You will find the Aero "No-Skip" Choke 60 perfect in every respect.

Price each.....\$1.50



#### AERO Short Wave Kit

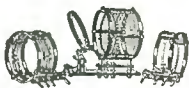

The most efficient and satisfactory short wave kit ever offered. Completely interchangeable, and covers U. S. Bands range 15 to 130 meters.

Kit consists of 3 coils and base mountings. Code No. L. W. T. 125.....Price \$12.50

#### AERO Transmitter Kits



An interchangeable Transmitter Kit at last. Kit 2040-K has range of 16.5 to 52 meters. Kit 4080-K has range of 36 to 90 meters. Kit includes two mounting bases and two choke coils that are interchangeable.

Price (each kit).....\$12.00

#### AERO "No-Skip" Choke 248

Designed for use with Aero Transmitter Kits and other circuits. Prevents a high impedance over usual amateur wave lengths.

Price each.....\$1.50



#### IMPORTANT NOTICE

We furnish foundation units, drilled and engraved by Westinghouse Micarta for the Aero Short Wave, Aero 6, Aero 7, Aero 4, and The Chicago Daily News 4 tube circuits. This is a special service for the home set builder. Full working blue prints with each unit. Dealers may secure samples of blue prints to show their trade for 25c each.

Any of these Aero Kits, Coils and Chokes should be available at your dealer's. If he cannot supply you, order direct from the factory. Be sure to specify code or key numbers when ordering.

**AERO PRODUCTS, Inc., Dept. 113**  
1772 Wilson Avenue  
Chicago, Ill.



**WOO** John Wanamaker, Philadelphia, Pa. 348.6 meters, 860 kilocycles, 500 watts. Daily ex Sun, 11 am, music; 11:30, weather; 11:55 am, time signals; 12 noon, music; 4:40 pm, news reports; 4:45 pm, musical; 9:55 pm, time signals; 10:02 pm, weather report. Mon, Wed, Fri, 7:30-11 pm, concerts. Sun, 10:45 am or 7:45 pm, 2:15 pm, Sunday school musical program; 6 pm, organ recital. Eastern standard time. Divides time with WIP & WGBS.

**WOOD** Walter B. Stiles, Inc., Hotel Rowe, Grand Rapids, Mich. 260.7 meters, 1150 kilocycles, 500 watts. Sun, 9-10 pm. Daily ex Sun, 9-11 pm, popular request programs, vocal and dance programs. Central standard time. Divides time with W.C.M.A. Slogan: "The Voice of the Whispering Pines."

**WOQ** Unity School of Christianity, 917 Tracy av., Kansas City, Mo. 340.7 meters, 880 kilocycles, 500 watts. Sun, 11 am-12:30 pm, 2:30-3 pm, 7:45-9 pm, church. Daily ex Sun & Thurs, 6-7 pm, concert; 11 pm, prayer service. Mon, 9-10 pm. Wed & Fri, 8-10 pm, concert. Sat, 10-11 pm, healing service. Central standard time. Divides with WHB.

**WOR** L. Bamberger & Co., 46 Bank st., Newark, N. J. New York Studio, 1440 Broadway, New York City. 422.3 meters, 710 kilocycles, 3500 watts. Mon, 3:45 pm, 5:15-12 pm. Tues & Thurs, 5:15-7:30 pm. Wed, 5:15-11 pm. Fri, 5:15-6:30 pm. Sat, 3 pm, 6:30-12 pm. Eastern standard time.

**WORD** International Bible Students Association, 2150 Lincoln Park West, Chicago, Ill. 252.0 meters, 1190 kilocycles, 5000 watts. Sun, 6:7-10 pm. Daily ex Sun, Mon, 6-7:10 pm. Mon, 6-7 pm. Central standard time. Slogan: "The Watch Tower, Radio WORD."

**WOS** Missouri State Marketing Bureau, Board of Agriculture, Jefferson City, Mo. 422.3 meters, 710 kilocycles, 500 watts. Daily ex Sun, 9 am, 10 am, 11 am, 12 noon, 1 pm, 2 pm, 7 pm, 7:15 pm. Markets, weather reports, bonds, stocks, news, etc. Central standard time. Slogan: "Watch Our State."

**WOW** The Voice of the Woodmen of the World Life Insurance Association, Headquarters Bldg., Omaha, Neb. 508.2 meters, 590 kilocycles, 1000 watts. Sun, 9-11 am, 2-3 pm, 4:5-30 pm, 6-11 pm. Daily ex Sun, 8-9 am & 10-11:30 am, stock reports and commercial instructions; 12:30-2 pm, 3-5 pm, stock reports, news period & musical program; 6-7 pm, dinner concert; 7-11 pm, chain & other concert programs. Central standard time. Slogan: "The Omaha Station."

**WOWO** The Main Auto Supply Co., 215 W. Main st., Fort Wayne, Ind. 228.9 meters, 1310 kilocycles, 2500 watts night, 5000 watts daytime. Sun, 4-5 pm, church; 8-10 pm, Columbia chain. Daily ex Sat & Sun, 10:30 am-12 noon, news, reports, music, etc. Daily ex Sun, 12 noon-1:30 pm, musical program. Mon, 6:15-8 pm, 10-11:30 pm. Wed, Thurs, Fri, 7-8 pm. Mon, Wed & Fri, 8-10 pm, Columbia chain. Wed, 10-11 pm. Thurs, 8-9 pm, 9-11 pm. Sat, 6-6:45 pm, news, etc. Central standard time.

**WPAP & WQAO** Palisade Amusement Park, Cliffside, N. J. 394.5 meters, 760 kilocycles, 500 watts. Eastern standard time. Divides time with WHN.

**WPCC** North Shore Congregational Church, Chicago, Ill. 223.7 meters, 1340 kilocycles, 500 watts. Central standard time. Divides time with WFKB & WCRW.

**WPCH** Eastern Broadcasters, Inc., Park Central Hotel, New York City, N. Y. 325.9 meters, 920 kilocycles, 500 watts. Mon, 7-9 pm, 10 pm-midnight. Tues, 4-7 pm. Wed, 6-10 pm. Thurs, 4-12 pm. Sat, 4-7 pm, 11 pm-2 am. Sun, 6:30 pm-midnight. Eastern standard time. Slogan: "Voice of Central Park." Divides with WRNY.

**WPPE** Waukegan Pep Station, 140 Hazel Court, Waukegan, Ill. 215.7 meters, 1390 kilocycles, 250 watts. Sun, 3-5 pm, 7:30-9:30 pm, 10-12 pm. Daily ex Sun, Mon, 7:30-9:30 pm, 10-12 pm. All programs popular and semi-popular. Central standard time. Slogan: "Where Pep Entertains Public."

**WPG** Municipality of Atlantic City, Atlantic City, N. J. 272.6 meters, 1100 kilocycles, 5000 watts. Sun, 3:15 pm until 12 midnight. Mon, Tues, Thurs, Sat, 1:30 pm midnight. Eastern standard time. Divides time with WHAR.

**WPRC** Wilson Printing & Radio Co., 1740 5th st., Harrisburg, Pa. 209.7 meters, 1430 kilocycles, 100 watts. Sun, 9-11 pm. Eastern standard time.

**WPSC** Pennsylvania State College Dept. of Elec. Engineering, State College, Pa. 299.8 meters, 1000 kilocycles, 500 watts. Mon, Wed & Fri, 7-11 pm. Eastern standard time. Divides time with WBAK. Slogan: "The Voice of the Titany Lion."

**WPSW** Philadelphia School of Wireless Telegraphy, 1533 Pine St., Philadelphia, Pa. 206.8 meters, 1450 kilocycles, 50 watts. Wed, 7 pm, radio questions & answers. Fri, 7 pm, talks on radio, care & operation. Eastern standard time. Slogan: "First Wireless School in America."

**WPTF** Raleigh, N. C. 545.1 meters, 550 kilocycles, 500 watts. Eastern standard time.

**WPUB** Madison Square Garden, 319 W. 49th st., New York, N. Y. 236.1 meters, 1270 kilocycles, 500 watts. Eastern standard time. Divides time with WHAP, WBNY.

**WQAA** Horace A. Beale, Jr., Parkersburg, Pa. 215.7 meters, 1390 kilocycles, 500 watts. Eastern standard time.

**WQAM** Electrical Equipment Co., 42 N. W. 4th st., Miami, Fla. 384.4 meters, 780 kilocycles, 750 watts. Sun, 10:45 am-12 noon. 8-9:15 pm, church. Daily ex Sun, 11:45 am-12:15 pm, organ, time signals, weather, stock reports; 7-8:15 pm, organ, dance, orchestra, weather, baseball results & studio programs. Divides with WMBF.

**WQAN** Scranton Times, 222 Spruce st., Scranton, Pa. 230.6 meters, 1300 kilocycles, 250 watts. Daily ex Sun, 12:30-1 pm, 4:30-5 pm. Tues & Fri, 8-10:30 pm. Sat, 10:30-12 pm. Eastern standard time. Slogan: "The Voice of the Anthracite." Divides time with WGBI. Monday, Wed, Thurs nights & Tues, Fri, 6:45-7:55 pm.

**WQAO & WPAP** Calvary Baptist Church, Cliffside, N. J. 394.5 meters, 760 kilocycles, 500 watts. Wed, 8-9 pm, mid-week evening services. Sun, 11 am-12:30 pm, church services; 3-4:30 pm, Bible study class; 7:45-9:30 pm, evening services. Eastern standard time. Divides time with WHN. Slogan: "The Bible, the Whole Bible and Nothing but the Bible."

**WQBA** Tampa, Fla. 238.0 meters, 1260 kilocycles, 250 watts. Eastern standard time. Divides time with WJBB.

**WQJ** Calumet Broadcasting Co., operated by Chicago Daily News, Hotel La Salle, Chicago, Ill. 447.5 meters, 670 kilocycles, 500 watts. Sun, 10:45 am-12:30 pm, 2-4 pm, 6-7 pm, 10-11 pm. Daily ex Sun, 11 am-12 noon, 3-4 pm, 6-7 pm, 10 pm-1 am. Central standard time. Divides time with WMAQ.

**WRAF** The Radio Club (Inc.), 719 Michigan av., LaPorte, Ind. 208.2 meters, 1440 kilocycles, 100 watts. Sun, 10:45 am-12:15 pm, church services. Daily ex Sun, 12:15-7 pm. Central standard time. Slogan: "The Voice of the Maple City."

**WRAH** Stanley N. Read, 191 Alabama av., Providence, R. I. 199.9 meters, 1500 kilocycles, 250 watts.

**WRAK** Economy Light Co., 1105 Ludington st., Escanaba, Mich. 282.8 meters, 1060 kilocycles, 50 watts. Sun, 6:30-8 pm, classical. Mon and Fri, 10:30-11 am, household hints and weather forecast; 6:30-7:00 pm, late news and weather forecast followed by musical program. Tues & Thurs, same as Mon & Fri. Wed, 10:30-11:30 am, household hints & weather forecast. Sat, 10:30-11 am, household hints & weather forecast; 6-6:30 pm, late news & weather forecast, followed with dance program. Eastern standard time. Slogan: "The Gateway to Cloverland."

**WRAM** Lombard College, Galesburg, Ill. 247.8 meters, 1210 kilocycles, 50 watts. Mon, 7 pm, bedtime stories; 8 pm, educational; 9-11 pm, musical. Central standard time. Divides time with WFBZ.

**WRAW** Avenue Radio & Electric Shop, 460 Schuylkill av., Reading, Pa. 238 meters, 1260 kilocycles, 100 watts. Sun, 11 am, 1:30-3 pm. Tues, 8 pm. Thur, 8-10 pm. Eastern standard time. Slogan: "The Schuylkill Valley Echo."

**WRAX** Berachan Church (Inc.), 1608 Alleghany Ave., Philadelphia, Pa. 212.6 meters, 1410 kilocycles, 250 watts. Eastern standard time.

**WRBC** Immanuel Lutheran Church, Valparaiso, Ind. 238.0 meters, 1260 kilocycles, 250 watts. Sun, 7:30-9 pm, church service. Mon, 7:30-9 pm, diversified program. Central standard time. Slogan: "World Redeemed by Christ."

**WRC** Radio Corporation of America, 3308 14th st., N. W., Washington, D. C. 468.5 meters, 640 kilocycles, 500 watts. Sun, 11 am-12:30 pm, church services; 4:5-30 pm, church; 6:20-10:15, musical. Mon, Tues, Wed, Thur, Fri & Sat, 6:45 am to 11 pm, varied. Eastern standard time. Slogan: "The Voice of the Capital."

**WRCV** Radio Corp. of Virginia, Norfolk, Va. 209.7 meters, 1430 kilocycles, 100 watts. Wed, Fri, Sat, 2-5 pm, 7:30-9 pm. Sun, 10:30 am-12:15 pm, 7:15-8:45 pm. Eastern standard time. Slogan: "The Voice of the Business District."

**WREC** Wooten's Radio & Elec. Co., Whitehaven, Tenn. 249.9 meters, 1200 kilocycles, 100 watts. Daily, 7-8. Sun, 4:5-30 pm. Central standard time. Divides time with WSIX.

**WREN** Jenny Wren Co., Lawrence, Kan. 254.1 meters, 1180 kilocycles, 750 watts. Central standard time. Divides time with WFKU.

**WRES** Harry Leonard Sawyer, Quincy, Mass. 217.3 meters, 1380 kilocycles, 50 watts. Mon & Thurs, 8 pm, entertainment. Eastern standard time.

**WRHF** American Broadcasting Co., Colorado Bldg., Washington, D. C. 322.4 meters, 930 kilocycles, 150 watts. Daily ex Sun, 10-11:30 am, 6-7 pm. Eastern standard time.

**WRHM** Rosedale Hospital (Inc.), Nicolet & 4th st., Minneapolis, Minn. 260.7 meters, 1150 kilocycles, 1000 watts. Sun, 9:15 am, 10 am, Children's Bible stories; 11 am, church; 6:30 pm, dramatic hour; 7:45 pm, church; 9:30 pm, lecture. Mon, Wed, Fri, 9 am, Housewife's Hour. Daily ex Sun, 12 noon-2 pm, concert; 3-6 pm, Commercial Hour; 6 pm, dinner concert; 8 pm, popular; 9 pm, dance program. Central standard time. Slogan: "Welcome Rosedale Hospital, Minneapolis."



# Sterling

## 6 volt "A" and "B" Power Team

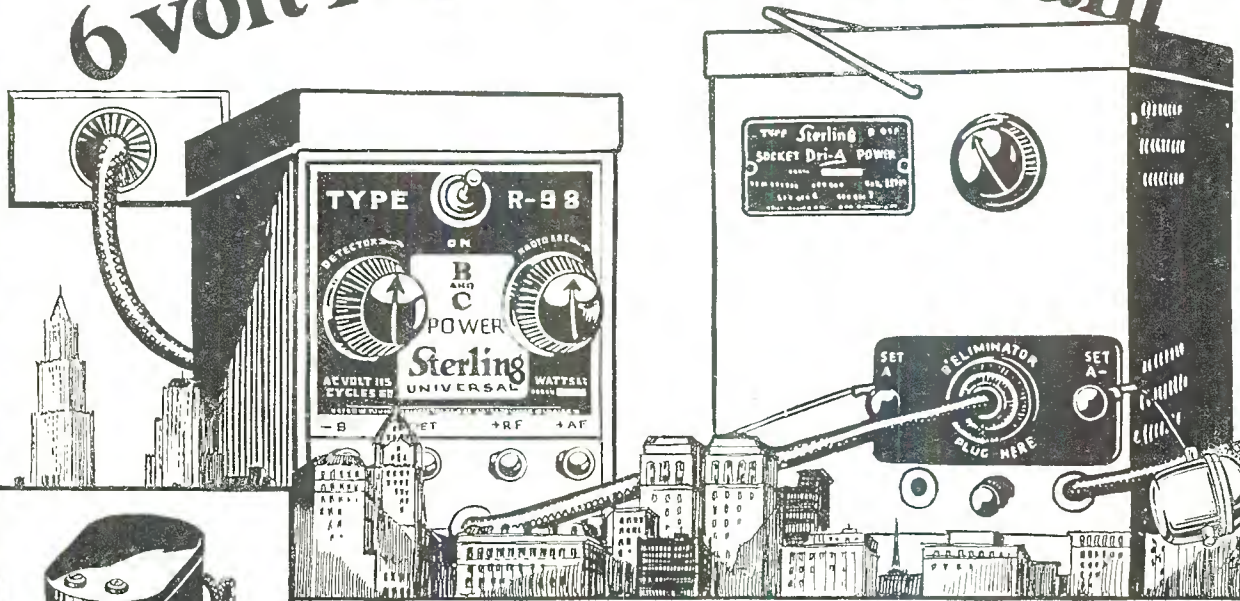

**Output Transformer**  
Protects speaker from overload. Eliminates noise, improves tone quality.  
R-360 . . . . \$5.00

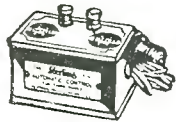

**Automatic Switch**  
Controls all "A" and "B" Power filament switch.  
R-106—  
Single pole . . . \$3.00  
R-107—  
Double pole . . . \$4.50



**"B" Power Tester**  
A high resistance meter for Power Units and all D. C. circuits up to 300 volts.  
R-415 D. C. . . . \$8.50  
R-417 A. C. . . . \$7.50

## Have an A. C. Set but don't experiment!

If you have a good radio set you can have A. C. without buying new tubes, without rewiring. Simply add a Sterling A. C. Power Team and you have a light socket set, an electric set, an A. C. receiver.

The 6 volt Sterling A. C. Power Team is absolutely dry. It contains no battery or charger in any form. Reception and power are controlled entirely from a single

switch. It operates only during reception.

Nothing untried or experimental about a set made A. C. with Sterling. You are sure of clear tone quality, distance and above all, *dependability*.

If you are about to buy a set, select a good standard receiver and power it with Sterling A. C. Power Team.

There is no better combination in radio—play safe.

Any set  
**Sterling**  
Powered is an A. C. Set

THE STERLING MFG. COMPANY  
2831 Prospect Avenue . . . . Cleveland, Ohio

For 3 to 8 tube sets: R-81  
"B" Power . . . \$28.50  
For 5 to 10 tube sets:  
R-98 B-C Power \$38.00  
For all 6 volt sets: R-93  
"Dri-A" Power \$39.50  
For Radiolas, Victor or  
Brunswick combinations,  
Best supers and all  
4 volt sets:—  
RT-41 "B" Power \$27.00  
R-94 "A" Power \$2.00  
Above prices include tubes  
Prices slightly higher  
West of Rockies and Canada



**WRK** John C. Slade, Hamilton Ohio. 205.4 meters. 1460 kilocycles. 100 watts. Sun. 2-3:15 pm, church; 7-9 pm. Daily ex Sat & Sun, 1-2 pm. Mon. Wed. Fri. 6:45 pm-12 midnight. Sat. 1-5 pm. Tues & Sat, 6:45-10:30 pm. Thurs, 6:45 pm-2 am. Eastern standard time. Slogan: "The Voice of the Miami Valley."

**WRM** University of Illinois, Urbana, Ill. 272.6 meters. 1100 kilocycles. 500 watts. Sun. 3:45-4 pm, chimes; 4-5 pm, organ. Mon, Tues. Wed. Thurs. Fri, 5-6 pm, music & lectures. Tues, 7-8 pm, recital. Athletic events broadcast. Central standard time. Divides time with WBAA.

**WRMU** Atlantic Broadcasting Corp., New York City, N. Y. (Portable). 201.6 meters. 1490 kilocycles. 100 watts. Unlimited schedule. Eastern standard time. Divides time with WGMU.

**WRNY** Radio News, Hotel Roosevelt, 45th st. & Madison av., New York City, N. Y. 325.9 meters. 920 kilocycles. 500 watts. Sun, 10:30-1 pm, 1-7 pm. Mon, Wed, 10:30 am-7 pm. Wed, 9-12 midnight. Tues, 10:30-12. Thurs, 10:30-1. Sat, 11 am-1, 7-9 pm. Eastern standard time. Divides time with Station WPCH.

**WRPI** Rose Polytechnic Institute, Hotel Deming, Terre Haute, Indiana. 208.2 meters. 1440 kilocycles. 100 watts. Sun, 9:30 am-12 noon, church. Daily ex Sun, 7 pm, markets. Mon, Wed, Fri, 8 pm, Popular programs. Central standard time. Slogan: "On the Banks of the Wabash."

**WRR** Municipal Station, Jefferson Hotel, Dallas, Tex. 352.7 meters. 850 kilocycles. 500 watts. Daily ex Sun & Wed, 11:30 am-12:30 pm, 6-7 pm, 8-9 pm. Mon & Thurs, 10-11 pm. Fri, 8:10 pm. Alternate Sun, 11 am-12:15 pm. 7:30-9 pm, every Sun. 9:30-10:30 pm. Central standard time. Divides time with KRLD. Slogan: "City of Achievements."

**WRRS** Racine Broadcasting Corp., Hotel Racine, Racine, Wis. 247.8 meters. 1210 kilocycles. 50 watts.

**WRST** Radiotel Mig. Co., Inc., 76 Main st., Bay Shore, N. Y. 211.1 meters. 1420 kilocycles. 250 watts. Daily ex Sun, 12 noon-1 pm. Mon, Wed & Fri, 7-11:30 pm, concerts. Tues & Thurs, 8-11:30 pm. Sat, 7-11:30 pm. Sun, 11 am-12:45 pm, church services; 7-11 pm, musical concert. Eastern standard time. Divides time with WCDA-WBRS. Slogan: "Bay Shore, Garden Spot of Long Island."

**WRVA** Edgeworth Tobacco Station, Richmond, Va. 254.1 meters. 1180 kilocycles. 1000 watts. Mon, Wed, Fri, 12 noon-2 pm. 8 pm-12 midnight. Tues, Thurs, 12 noon-1 pm. Thurs, 8 pm-12 midnight. Sun, 11 am-1 pm. 8-10 pm. Eastern standard time. Slogan: "Carry Me Back to Old Virginny."

**WSAI** United States Playing Card Co., Cincinnati, Ohio. 361.2 meters. 830 kilocycles. 5000 watts. Sun, 10:45 am, church; 12 noon, concert; 4 pm, 6-15 through 10:15 pm. Daily ex Sun & Sat, 10:35 am-1:10 pm. Mon, Tues, Thurs, 3:45 through 7 pm. Wed & Fri, 3:45-4 pm. Mon, Tues, 7:30 through 11 pm. Wed & Thurs, 7 through 11:30 pm. Fri, 7 through 11 pm. Sat, 6:45 through 11 pm. Talks, music, news, chain programs, etc. Eastern standard time. Slogan: "The Gateway to Dixie."

**WSAJ** Grove City College, Grove City, Pa. 223.7 meters. 1340 kilocycles. 250 watts. Irregular schedule. Eastern standard time.

**WSAN** Allentown Call Publishing Co., Inc., Allentown, Pa. 222.1 meters. 1350 kilocycles. 100 watts. Tues, Thurs & Sats, 8:15 pm, musical. Eastern standard time. Divides time with WCBA. Slogan: "We Serve Allentown Nationality."

**WSAR** Doughty & Welch, Elec. Co., 46 N. Main st., Fall River, Mass. 252.0 meters. 1190 kilocycles. 100 watts. Daily ex Sun, 12-1 pm. Sun, 10:30-12 m. Eastern standard time.

**WSAX** Zenith Radio Corp., 3620 Iron st., Chicago, Ill. 204.0 meters. 1470 kilocycles. 100 watts. (Portable.) Central standard time.

**WSAZ** McKellar Electric Co., 1143 4th av., Huntington, W. Va. 249.9 meters. 1200 kilocycles. 100 watts. Sun, 9 am-1 pm. 3-4 pm, 7:30-9 pm, 10-11 pm. Daily ex Sun, 12 noon-1 pm, 5:30-6:30 pm, 9:30-12: midnight. Eastern standard time.

**WSB** The Atlanta Journal, care Biltmore Hotel, Atlanta, Ga. 475.9 meters. 630 kilocycles. 1000 watts. Sun, 9:30 am-5 pm, church services. 6:20 pm & 8:15 pm, chain programs. Daily ex Sun, 10 am, 1-2:30 pm, 10:45 pm. Mon, Tues, Wed, Fri, 10:30 am, public school program. Wed & Fri, 11 am. Wed & Thurs, 5 pm. Thurs, 5:30 pm. Mon, 6:30 pm. Wed, 6:15-7 pm. Sat, 6-6:30 pm & 7 pm. Thurs & Fri, 7:30 pm. Mon, Wed & Fri, 8:30 pm. Tues & Thurs, 9 pm. Tues & Wed, 9:30 pm. Daily ex Fri & Sun, 8 pm. Music, talks, news, chain programs, broadcast. Central standard time. Slogan: "The Voice of the South."

**WSBC** The World Battery Company Station, 1219 S. Wabash av., broadcasting from New Southern Hotel, Chicago, Ill. 232.4 meters. 1290 kilocycles. 500 watts. Sun, 5-7 pm, classical; 9:30 pm-1 am, popular. Mon, 5-7 pm, popular program. Tues, Wed, Thur, Sat, 5-7

pm, 9:30 pm-1 am, popular program. Fri, 6-8 pm, 9 pm-1 am, popular program. Central standard time. Divides time with WJKS. Slogan: "World Storage Battery Company."

**WSBF** Mississippi Valley Broadcasting Co., 6th & Washington Ave., St. Louis, Mo. 258.5 meters. 1160 kilocycles. 250 watts. Sun, 9-10 pm, theater. Mon, 1 pm. 3-4 pm. Tues, 1 pm, 3-4 pm, popular. Wed & Fri, 12 noon-1 pm, 3-4 pm, music. Thurs, 12 noon-1 pm, 3-4 pm, popular. Sat, 12 noon-1 pm, 3-4 pm. Daily ex Sun, 7:30-11 pm, studio program. Central standard time. Divides with NIL.

**WSBT** South Bend Tribune, South Bend, Ind. 399.8 meters. 750 kilocycles. 500 watts. Sun, 11 am-12 noon, church. Mon, 7:30-10:30 pm, 12 midnight-1:30 am, popular program. Wed, 8-10 pm, 12 midnight-1 am. Fri, 7:15-10 pm, classical, 12 midnight-1 am. Central standard time. Divides time with WEAR-WTAM.

**WSDA & WARS** Amateur Radio Specialty Co., Hotel Shelburne, Brooklyn, N. Y. 227.1 meters. 1320 kilocycles. 500 watts. Sun, 7-9 am. 12:30-3 pm. Mon, Wed, Thurs, Fri, 7-8 am, 9-10 am. Mon & Fri, 8-10 pm. Wed & Fri, 3-6 pm. Tues & Thurs, 12 noon-2 pm. Mon, 3-7 pm. Wed, 7-10 pm. Thurs, 6-7 pm, 10 pm-12 midnight. Sat, 7-9 am, 1-3:30 pm, 9 pm-12 midnight. Eastern standard time. Divides time with WBBC. Slogan: "The Voice of the Atlantic."

**WSEA** The Virginia Beach Broadcasting Co., Norfolk, Va. 263 meters. 1140 kilocycles. 500 watts. Daily ex Sun, 11 am-2 pm, music; 5 pm, stocks, talks, police & weather forecast; 6 pm, news flashes; 6:45 pm, dinner music; 7 pm-10 pm, studio; 10-11 pm, organ; 11 pm-12 midnight, dance music. Sun, 3-5 pm & 7-9 pm, concerts. Eastern standard time. Slogan: "The Voice of Tidewater Virginia."

**WSIX** Springfield, Tenn. 249.9 meters, 1200 kilocycles, 150 watts. Divides time with WREC.

**WSKC** World's Star Knitting Co., Bay City, Mich. 272.6 meters. 1100 kilocycles. 250 watts. Daily ex Sun, 12 noon-1 pm, music. Tues, Thurs, Sat, 9-11 pm. Sat, 9-11 pm. 12 midnight-2 am. Sun, 11 am. Eastern standard time. Divides time with WFDF. Slogan: "Where the Summer Trails Begin."

**WSM** The National Life and Accident Ins. Co., Inc., Seventh av. N. & Union st., Nashville, Tenn. 336.9 meters, 890 kilocycles. 5000 watts. Sun, 6:20-9:15 pm. Daily ex Sat, Sun, 11:45-12:30 noon, 1 pm, concert. Mon, 6:15-11 pm. Tues, 7-10:30 pm. Wed, 7-11 pm. Thurs, 6:30-10:30 pm. Fri, 9 pm. Sat, 6-11:30 pm. Central standard time. Slogan: "We Shield Millions."

**WSMB** Saenger Theatres, Inc., & Maison Blanche Dept. Stores, 1401 Tulane Ave., New Orleans, La. 296.9 meters, 1010 kilocycles, 750 watts. Daily ex Sun, 12:30-1:30 pm, 6-7 pm. Mon, Wed, Thurs & Sat, 8:30-10:30 pm, entertainment. Central standard time. Slogan: "America's Most Interesting City."

**WSMK** S. M. Krohn, Jr., 20th fl. U. B. Bldg., Dayton, Ohio. 296.9 meters, 1010 kilocycles, 200 watts. Daily ex Thurs & Sun. 9-11 am, shippers guide; 12-1 noon, dinner bell program, 6-10 pm, studio program. Sat, 11 pm-3 am Sun. Central standard time. Slogan: "The Home of Aviation."

**WSOE** School of Engineering of Milwaukee, Oneida & Jackson sts., Milwaukee, Wis. 270.1 meters, 1110 kilocycles, 250 watts. Sun, 3:30-4:30 pm, 7:30-8:30 pm, religious program. Daily ex Sun, 1:30 pm, 2:15 pm, 2:30 pm, 5 pm, 5:50 pm, 6:15 pm, 8 pm. Thurs, 9 pm. Varied program. Central standard time. Divides time with WHAD.

**WSRO** Radio Company (Harry W. Fahrlander), Central & Canal sts., Middletown, Ohio. 236.1 meters, 1270 kilocycles, 100 watts. Tues & Fri, 8-10 pm. Sun, 2-4 pm. Central standard time. Slogan: "We Sell Radio Only."

**WSSH** Tremont Temple Baptist Church, Boston, Mass. 288.3 meters, 1040 kilocycles. 100 watts. Sun, 10:15 am-12 noon, 6:30-9 pm. Fri, 7:30-9 pm. Eastern standard time. Divides time with WBFT. Slogan: "Stranger's Sunday Home."

**WSUF & WTAR** Reliance Elec. Co., Inc., 519 W. 21st Ave., Norfolk, Va. 236.1 meters. 1270 kilocycles. 500 watts. Daily ex Sun, 6 pm, weather, markets & news. Eastern standard time. Divides time with WBBW. Slogan: "Down in Old Virginia."

**WSUI** State University of Iowa, Capitol & Washington sts., Iowa City, Iowa. 475.9 meters, 630 kilocycles. 500 watts. Sun, 9 pm, hymns. Daily ex Sun, 9 am, markets, weather forecast; 10:30 am & 12:25 pm, news, music; 5:30 pm, radio review. Wed, 9:10 am, high school program. Athletic contests broadcast. Central standard time. Slogan: "The Old Gold Studio."

**WSUN** Chamber of Commerce, St. Petersburg, Fla. 516.9 meters, 580 kilocycles. 750 watts. Tues, Thurs & Sat, 7:30-11:30 pm. Eastern standard time. Slogan: "Sunshine City."

**WSVS** Seneca Vocational School, 666 East Delavan Ave., Buffalo, N. Y. 204.0 meters. 1470 kilocycles. 50 watts. Wed & Fri, 8-9:30 pm, musical program. Eastern standard time. Divides time with KFEW. Slogan: "Watch Seneca Vocational School."

**WSYR** Voice of Central New York, Hotel Syracuse, N. Y. 225.4 meters. 1330 kilocycles. 500 watts. Sun, 7:30 am, church services; 6:30-7:30 pm, dinner concert. Daily ex Sun, 6:20 pm-10:30 pm, Varied programs. Eastern standard time. Divides time with WMAC.

**WTAD** Illinois Stock Medicine Broadcasting Corp., Quincy, Ill. 236.1 meters, 1270 kilocycles. 250 watts night, 500 watts daytime. Sun, 11-12 am, 2:30-3:30 pm, 10-12 pm. Daily ex Sun, 11:30 am-12:45 pm, 6-7 pm, 9-10 pm. Central standard time.

**WTAG** Worcester Telegram-Gazette Broadcasting Station, 18 Franklin st., Worcester, Mass. 516.9 meters, 580 kilocycles, 250 watts. Sun, 4-10:25 pm. Daily ex Sat & Sun, 10:30-11 am, 12:30-1:05 pm, 7:30-10:10 pm. Sat, 12:30-1:05 pm, 8-11:10 pm. Eastern standard time. Slogan: "The Voice from the Heart of the Commonwealth."

**WTAL** Toledo Broadcasting Co., Waldorf Hotel, Toledo, Ohio. 239.9 meters, 1250 kilocycles, 250 watts. Sun, 10:45 am-9:30 pm. Daily ex Sat & Sun, 6-11 pm. Sat, 8-12 pm. Eastern standard time. Slogan: "The Gateway of the Sea."



# Karas A.C. Equamatic; B.T. Power Six Electric and Flewelling's New Kit

These new panels have been added to the line of handsomely decorated and drilled Formica kit panels which are sold by leading jobbers and dealers, all ready to assemble.

You can get World's Record Super Ten front and sub panels; Tyrman front and sub; Magnaformer front and sub; Madison-Moore "One Spot" and "A.C." One Spot; Victoreen, H. F. L. front and sub, and many others.

Formica finish and decoration are superior—all the work on these panels is done in the Formica Plant under Formica control.

## THE FORMICA INSULATION COMPANY

4666 Spring Grove Avenue  
Cincinnati, Ohio

*Formica Panels Are Sold by  
Leading Jobbers*

*Formica Has a Complete Service on  
Insulation for Manufacturers*

**FORMICA**  
Made from Anhydrous Bakelite Resins  
**SHEETS TUBES RODS**



**WTAM** Willard Storage Battery Co., 1100 Chester av., Cleveland, Ohio. 399.8 meters, 750 kilocycles, 3500 watts night, 5000 watts daytime. Sun, 11 am-2 pm, 3-5 pm, 5:30-6 pm-12 midnight. Daily ex Sun, 12:30-1:30 pm, 6 pm-12 midnight. Wed, Thurs, Fri, 11-11:15 am. Eastern standard time. Divides time with WEAR & WSBT. Slogan: "The Voice from the Storage Battery."

**WTAQ** Gillette Rubber Co., Eau Claire, Wis. 254.1 meters, 1180 kilocycles, 500 watts. Sun, 11 am, church service. Mon, Wed, Thurs, Sat, 12:15 pm, weather, news, etc. Daily ex Sun & Sat, 6 pm, markets, news, etc. Mon, Wed & Thurs, 6:30 pm, dinner hour. Tues & Fri, 12 noon, luncheon program. Mon, 7:30 pm, theater hour. Mon & Thurs, 10 pm. Tues, 9 pm, concert. Fri, 8 pm, studio program. Central standard time.

**WTAR & WSUF** Reliance Elec. Co., Inc., 519 W. 21st Ave., Norfolk, Va. 236.1 meters, 1270 kilocycles, 500 watts. Daily ex Sun, 6 pm, weather, markets & news. Eastern standard time. Divides time with WBBW. Slogan: "Down in old Virginia."

**WTAS** Illinois Broadcasting Corp., R.F.D., Elgin, Ill. 275.1 meters, 1090 kilocycles, 500 watts. Sun, 10 am-1 pm. Daily ex Sun, 12 noon-2:30 pm, 6-7 pm, 10 pm-1 am. Central standard time. Slogan: "Willie, Tommy, Annie, and Sammy."

**WTAW** Agricultural & Mechanical College of Texas, College Station, Texas. 483.3 meters, 620 kilocycles, 500 watts. Sun, 11 am. Mon, Tues, Wed, Thurs & Fri, 12:10 pm. Wed & Fri, 7 pm. Central standard time.

**WTAX** Williams Hardware Co., 115 S. Vermillion St., Streator, Ill. 247.8 meters, 1210 kilocycles, 50 watts. Mon, 8-10 pm. Studio program. Wed, Fri, 8-10:30 pm. studio program. Thur, 9-11 pm, dance program. Central standard time. Slogan: "Tappa Kugga Nails."

**WTAZ** Thomas J. McGuire, 48 N. Main st., Lambertville, N. J. 220.4 meters, 1360 kilocycles, 15 watts. Mon, 8-10 pm, musical. Eastern standard time. Divides time with WMBG.

**WTFF** Mt. Vernon Hills, Va. 202.6 meters, 1480 kilocycles, 10,000 watts. Eastern standard time. Divides time with WHBN.

**WTFI** Toccoa, Ga. 209.7 meters, 1430 kilocycles, 750 watts.

**WTHS** Atlanta, Ga. 227.1 meters, 1320 kilocycles, 200 watts. Central standard time.

**WTIC** The Travelers Insurance Co., 700 Main st., Hartford, Conn. 535.4 meters, 560 kilocycles, 500 watts. Daily ex Sat & Sun, 11:55 am-1 pm. Tues, 10:45-11:15 am. Wed & Fri, 10:45-11 am. Thurs, 11-11:15 am. Mon, 6:25-12 midnight. Tues & Fri, 6:25-11:30 pm. Wed & Thurs, 6:25-11 pm. Sat, 8-9 pm. Sun, 4:30-7:30 pm. Eastern standard time. Divides time with WCAC. Slogan: "The Insurance City."

**WTMJ** The Milwaukee Journal Station, Milwaukee, Wis. 293.9 meters, 1020 kilocycles, 1000 watts. Sun, 11 am-12 noon, organ; 12 noon-1 pm, comics; 12:30-1 pm, 2:30-3:15 pm, music; 3:15-5 pm, Little Symphony; 6 pm, organ; 6-7 pm, dinner concert; 7-9:15 pm, music; 9:15-9:45 pm, chain program. Daily ex Sun, 10-11 am, 11-11:30 am, news, talks; 11:30 am-12:30 pm, organ; 12:30-1 pm, 2-5:15 pm, 6:15-7:30 pm, music; 8:15-9:45 pm, concert; 10:30-11:30 pm, dance music. Central standard time. Divides time with WHAD.

**WTRL** Technical Radio Laboratory, 28 Si-comac av., Midland Park, N. J. 206.8 meters, 1450 kilocycles, 15 watts. Sun, 2-4 pm, religious program. Tues, Fri, 7-9 pm, Sports & dance music. Eastern standard time. Divides time with WHPP, WMRJ.

**WWAE** C. F. Courier, 2024 S. Wabash av., Chicago, Ill. 227.1 meters, 1320 kilocycles, 500 watts, class A. Daily ex Sun & Mon, 7-9 pm. Central standard time.

**WWJ** Detroit News, Detroit, Mich. 352.7 meters, 850 kilocycles, 1000 watts. Sun, 7:20 pm, WEAJ program. Daily ex Sat & Sun, 6 pm, dinner concert; 8 pm, program from WEAJ. Eastern standard time.

**WWL** Loyola University, New Orleans, La. 245.8 meters, 1220 kilocycles, 500 watts. Sat, 7:30-8:30 pm. Central standard time.

**WWNC** Chamber of Commerce, Asheville, N. C. 296.9 meters, 1010 kilocycles, 1000 watts. Sun, 11 am & 8 pm, church; 4-5 pm, musical program; 9-10 pm, organ. Daily, 1-2 pm, 7-8, Mon, 8-10:45 pm. Thurs, 8 pm-12 midnight. Eastern standard time.

**WWRL** Long Island Broadcast Laboratories. W. H. Reuman, Director, 4130 58th St., Woodside, L. I., N. Y. 199.9 meters, 1500 kilocycles, 100 watts. Sun, 1-10:30 pm, popular program. Daily ex Sun, 11 am. Mon, Tues, Thurs, Sat, 1 pm. Mon & Fri, 10 pm-12 midnight. Sat, 12 midnight-4 am. Tues, 12 midnight-2 am. Wed, Thurs, 8-10 pm. Eastern standard time. Divides time with Stations WGOP, WBKN.

**WWVA** John C. Strobel, Jr., National Road, Wheeling, W. Va. 516.9 meters, 580 kilocycles, 250 watts. Daily ex Sun, 6:45 am, 7:45 am, 2 pm, 6 pm, exercises. Sun, 3:30 pm, Y.M.C.A. Mon, 7-11 pm. Sat, 11 pm-1:30 am. Mountaineer Club. Eastern standard time.



IN THIS ISSUE we are printing on page 54 a condensed and simplified log sheet, by means of which our readers may readily mark down their favorite stations for quick reference. This log has been prepared in the form shown on page 54, because the Federal Radio Commission has decreed that there shall be 96 channels, each separated by 10 kilocycles lying between 1500 kilocycles, which is the lowest wave allocation, and 550 kilocycles, which is the highest wave allocation. Some of these 96 channels are allotted to Canadian broadcasters, while others are occupied a portion of the time by Canadian broadcasters and the remainder of the time by American stations.

In addition to serving as a ready guide for the logging of your favorite broadcast stations, this table will serve also as a kilocycle conversion chart within the broadcast band. Knowing the frequency of a given broadcast station, the meters may be readily found by looking in the meter column. Conversely, if the wavelength of a station is known, its frequency equivalent may be seen by looking in the kilocycle column.

Space has only been allowed for two dials in the belief that this is ample for the present day sets, whereas in the case of the three dial sets, the second and third dials usually track and their settings may be put down in column two.

We shall be glad to hear from our readers as to their comments on this form of a log sheet. If our readers like this particular method of logging and signify this fact to us, we shall be glad to continue it.

Address communications to the

## CITIZENS RADIO CALL BOOK MAGAZINE

508 South Dearborn Street

Chicago, Illinois



# Foreign Radio Broadcasting Stations

Country	Call	Wave	Power	Country	Call	Wave	Power
<b>ALASKA</b>				<b>New Brunswick</b>			
Anchorage: Chovin Supply Co.	KFQD	227.1	100	Fredericton	CFNB	247.8	25
Juneau: Alaska Electric Light & Power Co.	KFIU	225.4	10	Moncton: Canadian National Railways	CNRA	322.4	500
<b>ALGERIA</b>				<b>Quebec</b>			
Algiers: Colin & Fils	SDB	310	100	Montreal: Northern Electric Co., Ltd.	CHYC	410.7	750
<b>ARGENTINA</b>				E. Fontaines	CHRC	347	5
Buenos Aires: No data. Received at Pernambuco and Valparaiso	LOO	252	1000	La Presse Publishing Co.	CKAC	410.7	1200
No data	LB2	275	100	Canadian Marconi Co.	CFCP	410.7	1650
No data	LOL	236	2000	Canadian National Railways. Uses equipment of other local stations	CNRM	.....	.....
No data	LON	210	5000	Quebec	CHRC	340.7	5
Argentine Association of Broadcasters	LOR	314.8	1000	Le Soleil	CKCI	347	22 1/2
No data	LOT	400	1000	St. Hyacinthe	CKCV	340.7	50
Francisco J. Brusa	LOV	261.5	1000	CKSH	312.3	50	
Graud Splendid Theatre	LOW	303	1000	<b>Ontario</b>			
Radio Cultura Magazine	LOX	380	500	Bowenville	CKCW	312.5	5000
Radio Nacional	LOY	315.8	1000	Hamilton	CHCS	340.7	10
University of La Plata	LOP	425	1000	Jack V. Elliott, Ltd.	CFU	340.7	500
<b>AUSTRALIA</b>				Wentworth Radio Supply Co.	CKOC	340.7	50
<b>New South Wales</b>				Burketon Junction	CKCW	329.5	5000
Bathurst: Mockler Bros.	2MK	275	250	Cobalt	CKMC	247.8	5
New Castle: H. A. Douglas	2HD	288	20	Huntsville: A. Staples	CKCO	247.8	5
Sydney: Bargain Electric Co.	2BE	326	20	Iroquois Falls: Abitibi Power & Paper Co.	CKCI	499.7	250
Broadcasters, Ltd.	2BL	353	1000	King: York Co.	CJQC	291.1	1000
Farmers Broadcasting Co., Ltd.	2FC	442	2000	Kingston: Monarch Battery Co.	CFMC	267.7	20
Otto Sandel	2FW	263	100	Queens University	CFRC	267.7	500
Theosophical Broadcasting Service	2GB	326	1500	Kitchener: O. Rumpel	CJCF	247.8	25
Trades Hall Broadcasting Station	2KY	280	300	London: London Free Press Printing Co., Ltd.	CJGC	329.5	500
Electrical Utilities Supply Co.	2UE	297	50	Midland: E. O. Swan	CKFR	267.7	50
Sydney	2VA	462	100	Ottawa: J. R. Booth, Jr.	CHOC	434.5	250
Wagga: Otto Sandel	2UX	200	500	Canadian National Railways	CNRO	434.5	500
<b>Victoria</b>				Dr. G. M. Geldert. (For Ottawa Radio Assn.)	CKCO	434.5	100
Brighton: Projected. No data	3BP	.....	.....	Prescott: Radio Association of Prescott	CFLC	296.9	50
Melbourne: Associated Radio Co. of A. Pty. Ltd.	3AR	484	320	Preston: Wallace Russ	CKPC	247.8	7 1/2
Broadcasting Co. of Australia Pty. Ltd.	3LO	371	1000	Scarboro Station	CHYC	291.1	500
Druleigh Business & Tech. College	3DB	255	500	Toronto: Star Publishing & Printing Co.	CFCA	356.9	500
O. J. Nilson & Co.	3IZ	319	20	Toronto Radio Research Society	CHNG	356.9	500
L. J. Heilner, Wangaratta Sports Depot	3WR	303	20	.....	.....	356.9	50
Mildura: R. J. Egge	3EO	286	20	.....	.....	356.9	500
<b>Queensland</b>				.....	.....	356.9	500
Brisbane: Dr. V. McDowell	4CM	278	50	.....	.....	356.9	500
Radio Manufacturers Ltd.	4MB	337	250	.....	.....	356.9	500
Queensland Government	4QG	385	1000	.....	.....	356.9	5000
Rockhampton: Ditto	4RN	323	100	.....	.....	356.9	500
Toowoomba: Gold Radio Elec. Service	4GR	294	20	.....	.....	356.9	500
<b>South Australia</b>				.....	.....	356.9	500
Adelaide: Central Broadcasting Co.	5CL	395	1000	.....	.....	356.9	500
E. J. Hume. Operated by 5DN Pty. Ltd.	5DN	313	100	.....	.....	356.9	500
Milwood Auto & Radio Co.	5MA	.....	.....	.....	.....	356.9	500
Marshall & Co.	5MC	273	500	.....	.....	356.9	500
Sport Radio Broadcasting Station	5KA	250	1000	.....	.....	356.9	500
<b>Western Australia</b>				.....	.....	356.9	500
Perth: Westralian Farmers, Ltd.	6WF	1250	1000	.....	.....	356.9	500
<b>Tasmania</b>				.....	.....	356.9	500
Hobart: Tasmanian Broadcasters, Ltd.	7ZL	525	3000	.....	.....	356.9	500
<b>AUSTRIA</b>				.....	.....	356.9	500
Vienna: Oesterreichischer Radioverkehr A. G. broadcasts three 2-hour programs daily, including music (opera and popular), weather and market reports and news. Reception reported at Antwerp, Tcheran, Smyrna, Tunis.	ORV	577	1500	.....	.....	356.9	500
Oesterreichischer Radioverkehr A. G. Testing: to replace above station in the near future	ORV	517.2	7000	.....	.....	356.9	500
Graz: Oesterreichischer Radioverkehr A. G.	.....	365.8	500	.....	.....	356.9	500
Innsbruck	.....	294.1	500	.....	.....	356.9	500
Klagenfurt: Relays Vienna	.....	272.7	500	.....	.....	356.9	500
Linz: (Projected)	.....	254.2	5000	.....	.....	356.9	500
Rosenhugel	.....	517.2	5000	.....	.....	356.9	500
<b>BELGIUM</b>				.....	.....	356.9	500
Antwerp: (General, 2 hours daily)	.....	265.5	100	.....	.....	356.9	500
Brussels: Radio Belgique	BAV	508.5	1500	.....	.....	356.9	500
Liege: Radio Wallonie Station	.....	205	100	.....	.....	356.9	500
Radio Central Station	.....	294.1	100	.....	.....	356.9	500
<b>BOLIVIA</b>				.....	.....	356.9	500
La Paz: (Irregular)	.....	175, 300	50	.....	.....	356.9	500
<b>BRAZIL</b>				.....	.....	356.9	500
Bahia: Radio Sociedade do Bahia	.....	465	50	.....	.....	356.9	500
Bello Horizonte: National Telegraph Service	.....	400	500	.....	.....	356.9	500
Fortaleza: Radio Club	.....	30	30	.....	.....	356.9	500
Para	.....	.....	50	.....	.....	356.9	500
Pernambuco: Radio Club. One hour daily and two hours three days each week	.....	310	300	.....	.....	356.9	500
Porto Alegre: Radio Society. Broadcasts one hour daily. To be replaced by 50-watt station	.....	380	80	.....	.....	356.9	500
Rio de Janeiro: Radio Society. Daily programs by local artists	.....	400	1000	.....	.....	356.9	500
National Telegraph Service, Praia Vermelha Station. Operated by Radio Club. Daily news and concerts	.....	312	500	.....	.....	356.9	500
Rio de Janeiro: No data. Phonograph records broadcast 2 to 4 pm daily, concerts from 7 to 9 pm three or four days each week	.....	.....	10	.....	.....	356.9	500
Santos: No data	.....	.....	10	.....	.....	356.9	500
Sao Paulo: Dias Carneiro & Co., operated by the Radio Club of Sao Paulo	.....	380, 420	100	.....	.....	356.9	500
Radio Club of Sao Paulo Broadcasts Hotel Terminus orchestra and phonograph records daily	.....	350	10	.....	.....	356.9	500
<b>CANADA</b>				.....	.....	356.9	500
<b>Nova Scotia</b>				.....	.....	356.9	500
Halifax: (Carlton Hotel station, Northern Electric Co., Ltd.)	CHNS	322.4	100	.....	.....	356.9	500
<b>Prince Edward Island</b>				.....	.....	356.9	500
Charlottetown: General during winter	CFCY	312.3	100	.....	.....	356.9	500
Summerside: R. T. Holman, Ltd.	CHGS	267.7	25	.....	.....	356.9	500
<b>Manitoba</b>				.....	.....	356.9	500
Winnipeg: Manitoba Telephone System	CKY	384.4	500	.....	.....	356.9	500
Canadian National Railways. Uses equipment of CKY	CNRW	.....	.....	.....	.....	356.9	500
<b>Saskatchewan</b>				.....	.....	356.9	500
Moose Jaw	CJRM	296.9	500	.....	.....	356.9	500
Regina: R. H. Williams & Sons, Ltd.	CHWC	312.3	15	.....	.....	356.9	500
Leader Publishing Co., Ltd.	CKCK	312.3	500	.....	.....	356.9	500
Canadian National Railways. Uses Station CKCK equipment	CNRR	312.3	500	.....	.....	356.9	500
Sask. Co-op. Wheat Prod., Ltd.	CJBR	312.3	500	.....	.....	356.9	500
Saskatoon: The Electric Shop	CEQC	329.5	500	.....	.....	356.9	500
International Bible Students' Association	CHUC	329.5	500	.....	.....	356.9	500
Wheaton Electric Co.	CJWC	329.5	250	.....	.....	356.9	500
Canadian National Railways. Uses equipment of other local stations	CNRS	.....	.....	.....	.....	356.9	500
Unity: Horace N. Stovin	CFQC	329.5	500	.....	.....	356.9	500
Yorkton: Winnipeg Grain Exchange	CHSC	267.7	50	.....	.....	356.9	500
.....	CJGC	475.9	500	.....	.....	356.9	500
<b>Alberta</b>				.....	.....	356.9	500
Calgary: W. W. Grant Radio, Ltd.	CFCN	434.5	1800	.....	.....	356.9	500
The Alberta Pacific Grain Co., Ltd.	CKLC	356.9	2000	.....	.....	356.9	500
Calgary Herald	CFAC	434.5	500	.....	.....	356.9	500
Canadian National Railways. Uses equipment of other local stations	CNRC	434.5	500	.....	.....	356.9	500
Radio Service & Repair Shop	CJCF	434.5	250	.....	.....	356.9	500
<b>Edmonton</b>				.....	.....	356.9	500
Edmonton: International Bible Students' Assn.	CHCY	516.9	250	.....	.....	356.9	500
Alberta Pacific Grain Co., Ltd.	CKLC	356.9	1000	.....	.....	356.9	500
Christian & Miss. Alliance	CHMA	516.9	250	.....	.....	356.9	500
University of Alberta	CKFA	516.9	500	.....	.....	356.9	500
Radio Supply Co., Ltd.	CFCK	516.9	50	.....	.....	356.9	500
Edmonton Journal	CJCA	516.9	500	.....	.....	356.9	500
Canadian National Railways. Uses equipment of other local stations	CNRE	516.9	500	.....	.....	356.9	500
Lethbridge: J. E. Palmer	CJOC	267.7	50	.....	.....	356.9	500
<b>British Columbia</b>				.....	.....	356.9	500
Burnaby: International Bible Students' Assn.	CFVC	410.7	500	.....	.....	356.9	500
Kamloops: N. S. Dagleish & Sons and Weller & Weller	CFIC	267.7	15	.....	.....	356.9	500
Mission City: E. R. Streeter	CJCU	247.5	5	.....	.....	356.9	500
New Westminster: Westminster Trust Co.	CFXC	291.1	20	.....	.....	356.9	500
Sea Island	CFOR	291.1	50	.....	.....	356.9	500
Vancouver: A. Holmstead & William Hanlon	CFDC	410.7	15	.....	.....	356.9	500
G. W. Deauville	CFCT	329.5	500	.....	.....	356.9	500
A. Halstead & Wm. Hanlon	CKWX	410.7	10	.....	.....	356.9	500
Central Presbyterian Church	CHPC	410.7	1000	.....	.....	356.9	500
Radio Corporation of Vancouver	CFYC	410.7	500	.....	.....	356.9	500
Daily Province of Canada	CKCD	410.7	1000	.....	.....	356.9	500
United Church of Canada	CKFC	410.7	50	.....	.....	356.9	500
Canadian National Railways	CNRY	291.1	500	.....	.....	356.9	500
Sprott-Shaw Radio Co.	CFQC	410.7	10	.....	.....	356.9	500
Pyramid Temple Society. Uses equipment of other local stations	CUKC	.....	.....	.....	.....	356.9	500
<b>CANARY ISLANDS</b>				.....	.....	356.9	500
La Laguna: Servando Ortoll Delmotte	EAF5	280	50	.....	.....	356.9	500
Las Palmas: Canary Islands Radio Club	.....	300	6	.....	.....	356.9	500
Club Radio Canarias	.....	300	6	.....	.....	356.9	500
Teneriffe: Servando Ortoll Delmotte	EAR5	250, 350	200	.....	.....	356.9	500
<b>CEYLON</b>				.....	.....	356.9	500
Colombo	.....	800	1500	.....	.....	356.9	500



**\$50<sup>00</sup>**

# FOR YOUR OLD RADIO

REGARDLESS OF SIZE, TYPE  
AGE OR CONDITION (NO CRYSTAL SETS ACCEPTED)

## Think of it

For only \$49.50—and your old radio set, whether it be a 1, 2, 3, 4, 5, 6, 7, 8, 9 or 10 tube outfit. Whether it works or not, and regardless of value, you can get one of the new modern Radex Shielded Sixes in a beautiful console cabinet as illustrated.

## Act Now

This offer may be withdrawn at any time, and we urge you to send in your order immediately if you want to get in on the most sensational offer ever made by any radio concern in the history of radio. You take no chances. See our money back guarantee.

*Cabinet alone is worth the price*

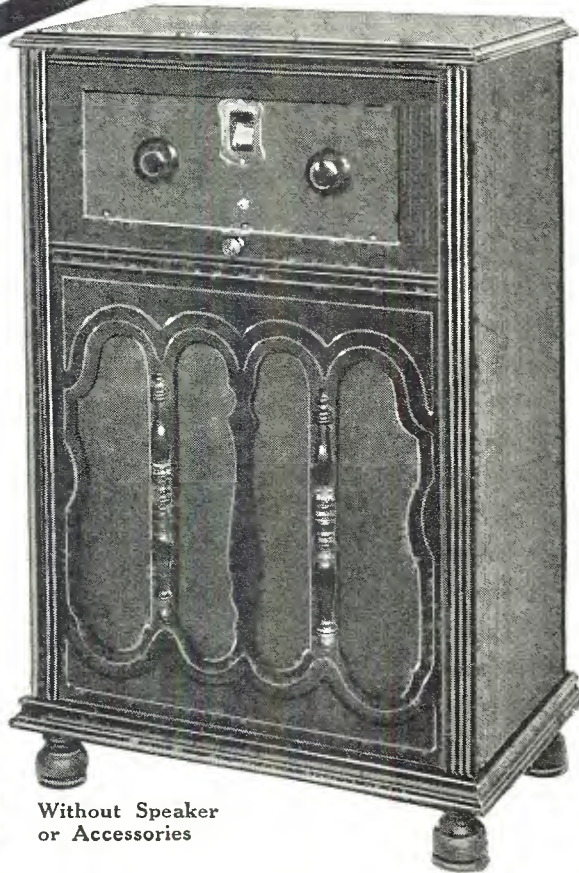

**MONEY BACK GUARANTEE**

This receiver is fully guaranteed against all mechanical and electrical defects. Try it out for 10 days, and then if you are not satisfied with your bargain, ship it back in the original container and your money will be refunded.

*Price*

**\$99.50**

Without Speaker or Accessories

## THE NEW RADEX SHIELDED SIX CONSOLE

### SPECIFICATIONS

Six tubes—3 R.F., Det., 2 A.F.; single dial control, illuminated; all metal construction throughout, including front and sub-panel. Tuned R.F. stages individually shielded. See photo below. Volume control and switch in one. Selectivity switch. Power tube operation as well as all electric operation.

Great volume; superior tone quality; extreme selectivity; distance getting ability. Simple and rugged construction throughout. Beautiful walnut finished cabinet with ample space for batteries, power units and any type of speaker desired. Outside dimensions 25 in. wide, 15¾ in. deep, 43 in. high.

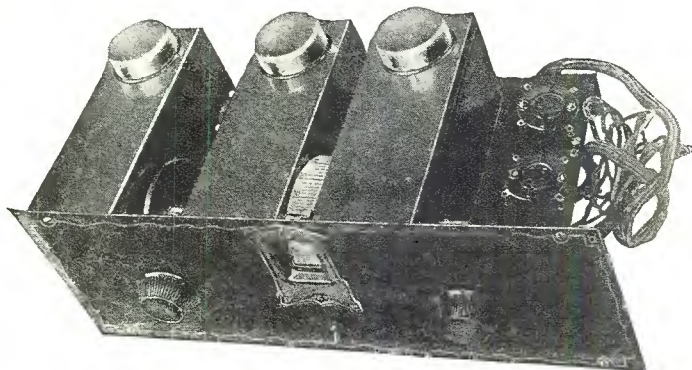

View Showing Interior of Radex Chassis

**RADEX MFG. CO., SIOUX CITY, IOWA**

### USE THIS COUPON AT ONCE

RADEX MFG. CO., Dept. C, Plymouth Bldg.,  
Sioux City, Iowa.

Enclosed find money order for \$49.50, for which please ship one of your new Radex Shielded Six Console Radio Sets. I will keep it ten days and if satisfactory will ship you my old radio, prepaid, but if I am not satisfied, I will return your set and you are to refund my money.

Name.....

Address.....

Town & State.....

Shipment is usually by express—if desired by freight advise

*Keep Your Batteries, Tubes, Speaker or Other Accessories —Just Ship Your Bare Set, PREPAID*

Tell 'Em You Saw It in the Citizens Radio Call Book Magazine



KC	Meters	STATIONS	DIALS		KC	Meters	STATIONS	DIALS	
			1	2				1	2
1500	199.9				1020	293.9			
1490	201.2				1010	296.9			
1480	202.6				1000	299.8			
1470	204.0				990	302.8			
1460	205.4				980	305.9			
1450	206.8				970	309.1			
1440	208.2				960	312.3			
1430	209.7				950	315.6			
1420	211.1				940	319.0			
1410	212.6				930	322.4			
1400	214.2				920	325.9			
1390	215.7				910	329.5			
1380	217.3				900	333.1			
1370	218.8				890	336.9			
1360	220.4				880	340.7			
1350	222.1				870	344.6			
1340	223.7				860	348.6			
1330	225.4				850	352.7			
1320	227.1				840	356.9			
1310	228.9				830	361.2			
1300	230.6				820	365.6			
1290	232.4				810	370.2			
1280	234.2				800	374.8			
1270	236.1				790	379.5			
1260	238.0				780	384.4			
1250	239.9				770	389.4			
1240	241.8				760	394.5			
1230	243.8				750	399.8			
1220	245.8				740	405.2			
1210	247.8				730	410.7			
1200	249.9				720	416.4			
1190	252.0				710	422.3			
1180	254.1				700	428.3			
1170	256.3				690	434.5			
1160	258.5				680	440.9			
1150	260.7				670	447.5			
1140	263.0				660	454.3			
1130	265.3				650	461.3			
1120	267.7				640	468.5			
1110	270.1				630	475.9			
1100	272.6				620	483.6			
1090	275.1				610	491.5			
1080	277.6				600	499.7			
1070	280.2				590	508.2			
1060	282.8				580	516.9			
1050	285.5				570	526.0			
1040	288.3				560	535.4			
1030	291.1				550	545.1			



# Better . . . than it looks

Some radio sets are all Queen Ann in front and plain Mary Ann when you lift the lid. A beautiful finish—to please the wife—is more important than quality in the actual working parts. And some circuits are sweet performers when it comes to radio reception but they certainly look like a junk-shop product when you have a party of critical friends in for the evening. But here is a set . . . well, just look at it. And then remember that its performance is even better than its appearance. Yes, of course, it's the

## 1928 Infradyne

This is a circuit which is never sold as a factory product. It can't be. But that does not mean that you have to work for weeks in building it up from small unmatched parts. Just buy four Remler units, a few extra parts, and in a few hours your Infradyne will give you the finest reception you—or anyone else—ever enjoyed.

Use the coupon below.

**REMLER**  
Division of

Gray & Danielson Mfg. Co.

260 First Street, SAN FRANCISCO

CHICAGO

NEW YORK

Eastern Warehouse, Elkhart, Indiana



Dept. A

REMLER DIVISION, GRAY & DANIELSON MANUFACTURING CO.  
260 First Street, San Francisco, Calif.

Please send me complete information about the Infradyne and folder describing all Remler Parts.

Name.....Street.....City.....

Do you build and sell sets? .....







# Resistors that Manufacturers Use for B-Eliminator Hookups

## BRADLEYSTAT *Perfect Filament Control*

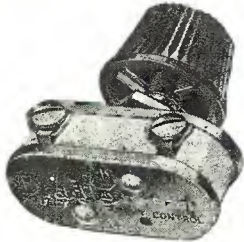

Provides the correct control for all tubes, thus making it possible to interchange tubes without difficulty. Provides accurate, stepless, noiseless control which makes it a great favorite and a very profitable, fast-selling item.

## BRADLEYLEAK *Perfect Variable Grid Leak*



A fast-selling item that provides the ideal grid leak resistance value for every tube. With this remarkable unit best results can be had with any tube. Push the Bradleyleak to provide perfect grid leak control for your customers and secure good profits for yourself.

THE extensive use of Bradleyunits and Bradleyohms for B-Eliminator manufacturers demonstrates conclusively their superiority for this service. Profit by the experience of B-Eliminator manufacturers. Use Allen-Bradley resistance units to insure successful results with B-Eliminators.

## BRADLEYOHM-E

This remarkable unit is used for plate-voltage control in a large percentage of the leading B-Eliminators on the market today. It is popular because of its exceptionally wide control, which is stepless, noiseless and completely dependable. Is not affected by moisture or atmospheric changes. Furnished in extremely wide range of resistance values.

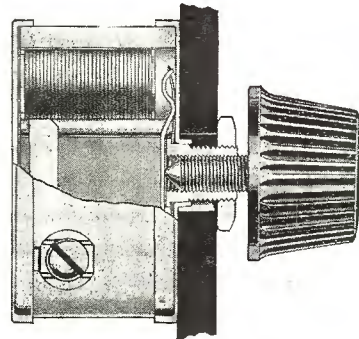

## BRADLEYUNIT-A

This molded fixed resistor does not deteriorate in service. It is impervious to atmospheric conditions and is not affected by moisture, temperature or

age. The end caps are tinned for easy soldering and the unit is readily installed. Ideal for use in B-Eliminator hookups where a fixed resistor is required.

**ALLEN-BRADLEY COMPANY**

488 Clifton Street • Milwaukee, Wisconsin

# Allen-Bradley

## PERFECT RADIO RESISTORS

Tell 'Em You Saw It in the Citizens Radio Call Book Magazine



Call	Wave	Power	Call	Wave	Power
<b>CHILE</b>					
Autofagasta: Senor J. Pedreny.....	CHAO	.....	St. Etienne: Radio Club Forezien.....	.....	.....
Concepcion.....	CMAL	345 1500	Strasbourg: Military station.....	.....	200 15,000
Santiago: El Mercurio, newspaper.....	CMAC	360 1200	Radio Club.....	8GF	222.2 1500
Fratelli Castagneto.....	CMAD	320 100	Toulouse: Radio du Midi.....	.....	389.6 2000
Chilean Broadcasting Society.....	CMAE	280 100	Ministry of Posts, Telegraphs and Telephones, Aero-drome station.....	MRD	260 1000
Commercial Radio Co.....	CRC	385 350	Radio Vitus.....	.....	308 250
Tacna: Chilean Government.....	CRCT	350 30	Reziars.....	.....	178 500
Valparaiso: Antonio Cornish.....	.....	550 200	<b>GERMANY</b>		
.....	.....	400 50	Berlin: Postal Authorities, Konigswusterhausen Station, Relays Vox Hans programs. Reception reported at Rome, Constantinople, Bergen, Algiers.....	LP	1300 12,000
<b>CHINA</b>					
Shanghai: Kellogg Switchboard & Supply Co. Operates four hours daily between 9:45 am and 11 pm.....	.....	365 20	Postal Authorities, Vox Haus station.....	.....	507 2250
(Note: Stations have been reported in other Chinese cities, but the present operation is very doubtful. The above station is the only one mentioned in more recent reports.)	.....	.....	Magdeburger Platz.....	.....	566 400
<b>CHOSEN</b>					
Seoul: Under construction.....	JODK	345 1000	Konigswusterhausen Station.....	AFT	1250 4000
<b>COSTA RICA</b>					
San Jose: Government. Under construction.....	.....	.....	Witzelben.....	.....	483.9 4000
<b>CUBA</b>					
Central Eila: Eila Sugar Co.....	.....	300 500	Wolffs Bureau.....	.....	252.5 5000
Salvador Rionda.....	7SR	350 500	Freiburg.....	.....	577 1000
Cienfuegos: Jose Gaudix.....	GBY	260 200	Bremen: Nordische Rundfunk A. G. Relays Hamburg programs.....	.....	400 140
Habana: Cuban Telephone Co.....	PWX	400 500	Breslau: Schlesische Funkstunde. Received at Rome.....	.....	315.8 750
Bernardo Barrie.....	2BR	250 15	Darmund: Mitteldentscher Rundfunk A. G. Relays Leipzig programs.....	.....	272.7 750
Frederick W. Borton.....	2BY	260 100	Dresden: Mitteldentscher Rundfunk A. G. Relays Leipzig programs.....	.....	283 300
El Pais.....	2EP	355 400	Elberfeld.....	.....	294.1 700
Credito y Construction Co.....	2HP	295 100	Frankfurt-on-the-Main: Sudwestdeutscher Rundfunkdienst.....	.....	428.6 750
Jose Lara.....	2HR	285 50	Freiburg i. Br.....	.....	577 750
Manuel y Guillemo Salas.....	2MG	284 20	Gleiwitz: Relays Breslau.....	.....	250 750
Mario Garcia Velez.....	2OK	350 100	Hanover: Nordischer Rundfunk A. G. Relays Hamburg programs.....	.....	394.7 4000
Columbia Radio & Cycle Co.....	2OL	257 100	Hanover: Nordischer Rundfunk A. G. Relays Hamburg programs.....	.....	297 750
Raoul Karmun.....	2RK	315 20	Kassel: Sudwestdeutscher Rundfunkdienst.....	.....	272.7 750
Roberto E. Ramierz.....	2TW	270 20	Kiel: Relays Hamburg.....	.....	254.2 750
Reuito Vieta Ferro.....	2TP	275 10	Konigsberg: Ostmarken Rundfunk A. G.....	.....	329.7 4000
Santiago: Alberto Ravelo.....	8BY	250 100	Langenberg: Rhineland.....	.....	468.8 2500
Tuñuen: Frank H. Jones.....	6JK	272 100	Leipzig: Mitteldentscher Rundfunk A. G.....	.....	365.8 750
Frank H. Jones.....	6KW	340 100	Muenster: Same.....	.....	241.9 1500
<b>CZECHOSLOVAKIA</b>					
Bratislava: Tues. Fri.....	OKR	300 500	Munich: Deutsche Stunde in Bayern.....	.....	535.7 4000
Brno: Radio Journal.....	OKB	441.2 300	Norddeich.....	KAV	1800 300
Prague: Kbely.....	OKK	441.2 500	Nuremberg: Relays Berlin.....	.....	303 750
Radio Journal.....	OKP	1110 1000	Stettin: Relays Berlin.....	.....	252.1 750
.....	.....	384.9 5000	Stuttgart.....	.....	379.7 4000
<b>DANZIG</b>					
Danzig: Relays Koenigsburg.....	.....	272.7 1500	<b>GREAT BRITAIN</b>		
<b>DENMARK</b>					
Copenhagen: Radioadet.....	.....	337 2000	Aberdeen.....	2BD	500 1500
Hjorring: Relay station, Government.....	.....	1235 250	Bradford.....	2LS	252.1 500
Kallundborg: (Projected).....	.....	1150 7500	Birmingham: Received at Antwerp, Brussels, Rome.....	5IT	326.1 1500
Lyngby: Relay station, Government.....	.....	2400 1000	Journalmonth: Received at Antwerp, Tenerife, Jerusalem.....	6BM	491.8 1500
Odense: Relay station, Government.....	.....	810 1000	Cardiff: Received at Antwerp and Rome.....	5WA	353 1500
Ryvang: Relay station, Government.....	.....	1150 500	Chelmsford.....	2BR	.....
Soro: Ministry of War. News and weather.....	.....	1153.8 1500	Darenty: Received throughout Europe, northern Africa and Asia Minor.....	5XX	1600 16,000
Viborg.....	.....	1110 1000	Dundee.....	2DE	294.1 200
.....	.....	214.3 750	Edinburgh.....	2EH	288.5 500
<b>EGYPT</b>					
Cairo.....	SRE	255 1000	Glasgow.....	5SC	405.4 1500
.....	.....	.....	Hull.....	6KH	294 200
<b>ESTONIA</b>					
Tallin.....	.....	1200 100	Leeds-Bradford.....	2LS	277.8 500
.....	.....	408 500	Liverpool.....	6LV	297 200
<b>FINLAND</b>					
Bjorenborg: Nuoren Voiman Liiton Radioyhdistys. Daily, general.....	.....	311 200	London: Received at Tenerife, Strasbourg, Brussels, Rome, Barcelona, Tunis.....	2LO	361.4 3000
Hango: Same.....	.....	260 200	Manchester: Received at Rome.....	2ZY	384.6 1500
Helsingfors: Civil Guard.....	.....	500 1000	New Castle: Received at Brussels, Rome.....	5NO	312.5 1500
Mon, Wed, Fri. General.....	.....	375 2000	Nottingham.....	5NG	275.2 200
Helsinki: Same as Helsingfors.....	.....	275.2 200	Plymouth.....	5PY	400 200
Jyvaskyla: N. V. L. Radioyhdistis. Irregular.....	.....	297 200	Poldhu.....	2YT	.....
Laitis: Three programs weekly.....	.....	318 180	Sheffield.....	6FL	272.7 200
Mikkeli: N. V. L. R.....	.....	566 250	Stoke on Trent.....	6ST	294 200
Onni.....	.....	233 100	Swansea.....	58X	294 200
Pietarsaari: Same as Jakobstad.....	.....	254.2 100	<b>HAWAII</b>		
Pori.....	.....	561 500	Honolulu: Marion A. Mulrony.....	KGU	270 500
Tampere: Same as Tammerfors.....	.....	400 250	<b>HAITI</b>		
St. Michael: N. V. L. R.....	.....	250 250	Port au Prince.....	11HK	361.2 1000
Tammerfors: Relays Hfors.....	.....	.....	<b>HUNGARY</b>		
Uleaborg: Relays Hfors.....	.....	.....	Budapest: Meugeytemi Radio Magyar Tavirati Iroda. Broadcasts market reports and news.....	MTL	555.6 2000
<b>FRANCE</b>					
Agen: Department of Lot et Garonne.....	2BD	297 250	.....	1050 400	.....
Angers: Radio Anjou.....	.....	275.2 500	<b>ICELAND</b>		
Bezier.....	.....	95 100	Reykjavik.....	.....	333.3 100
Biarritz: Cote d'argent.....	.....	200 1000	<b>INDIA</b>		
Bordeaux: Ministry of Posts, Telegraphs and Telegraphs.....	.....	238.1 500	Bombay: Bombay Presidency Radio Club.....	2FV	387 100
Lafayette.....	.....	419 1500	Walter Rogers & Co.....	2AX	320 50
Caen: Radio Club.....	.....	277.8 1500	Calcutta: Radio Club of Bengal.....	2BZ	800 500
Dijon.....	.....	207.5 1000	Owner not reported.....	5AF	425 1500
Greenoble: Ministry of Posts, Telegraphs and Telephones.....	.....	588.2 1500	Karachi: Karachi Radio Club.....	.....	425 40
Juan Les Pines.....	.....	230 500	Madras.....	2GR	400 200
Issy-les-Moulineaux: Ministry of War.....	QGA	1800 500	Rangoon: Radio Club of Burma and Wireless Club of Burma. Broadcasts musical programs every Sunday.....	21Z	350 40
Lille.....	.....	287 500	<b>IRELAND—NORTH</b>		
Limoges.....	.....	330 500	Belfast.....	2BE	306.1 1500
Lyon: Dubanchet & Troillet, Station Radio Lyon.....	.....	291 500	<b>IRISH FREE STATE</b>		
Dubanchet & Troillet, Station Radio Lyon.....	.....	291.3 1500	Cork.....	6CK	400 1000
Ministry of Posts, Telegraphs and Telephones, Station La Dona, named for suburb in which located.....	YN	480 1000	Dublin: Government.....	2RN	319.1 1500
Marsailles: Ministry of Posts, Telegraph and Telephones.....	.....	300 1000	<b>ITALY</b>		
Mont de Marsen.....	.....	390 300	Genoa (projected).....	.....	272.7 1500
Montpellier: Radio Montpellier station.....	.....	338 200	Milan.....	13H	322.6 1500
Nice.....	.....	362 1000	Unione Radiofonica Italiana.....	1RC	320 1500
Paris: Eiffel Tower station. Ministry of Posts, Telegraphs and Telephones.....	FL	2650 4000	Naples: Unione Radiofonica Italiana.....	1NA	333.3 1500
Journal Petit Parisien.....	5NG	333 500	Rome: Unione Radiofonica Italiana. Broadcasts concerts and news, 8:30 to 11 o'clock pm daily. Receptions reported at Antwerp, Jerusalem, Lille, Smyrna, Damascus, Barcelona, Tunis and Alexandria. This is at present the station best received throughout the Levant.....	1RO	449 3000
Lucien Levy.....	.....	350 500	Palero (projected).....	1CP	500 2000
Petit Parisien. Reception reported at Rome Societe Francaise Radioelectrique.....	FL	341 1000	Venice (projected).....	.....	254.2 1500
Societe Francaise de Radioelectrique.....	SAJ	1780 100	<b>JAVA</b>		
Cie. Francaise de Radiophonie. Reception reported at Tenerife, Jerusalem, Brussels, Rome, Teheran, Smyrna, Barcelona.....	.....	1750 4000	Bandoeng: Vereeniging van Radio Amateurs voor Bandoeng en Omstreken.....	No call	310 6
Superior School of Ministry of Posts, Telegraphs and Telephones. Reception reported at Rome.....	.....	447.8 5000	Batavia: Bataviasche Radio Vereeniging.....	JPC	220 40
Paris: Radio Paris.....	.....	1750 3000	Soerabaja: Two concerts weekly.....	.....	140 500
Ecole Superieure.....	FPFT	458 1000	.....	.....	.....
Pic du Midi.....	.....	350 1000	.....	.....	.....







# LEARN RADIO and find

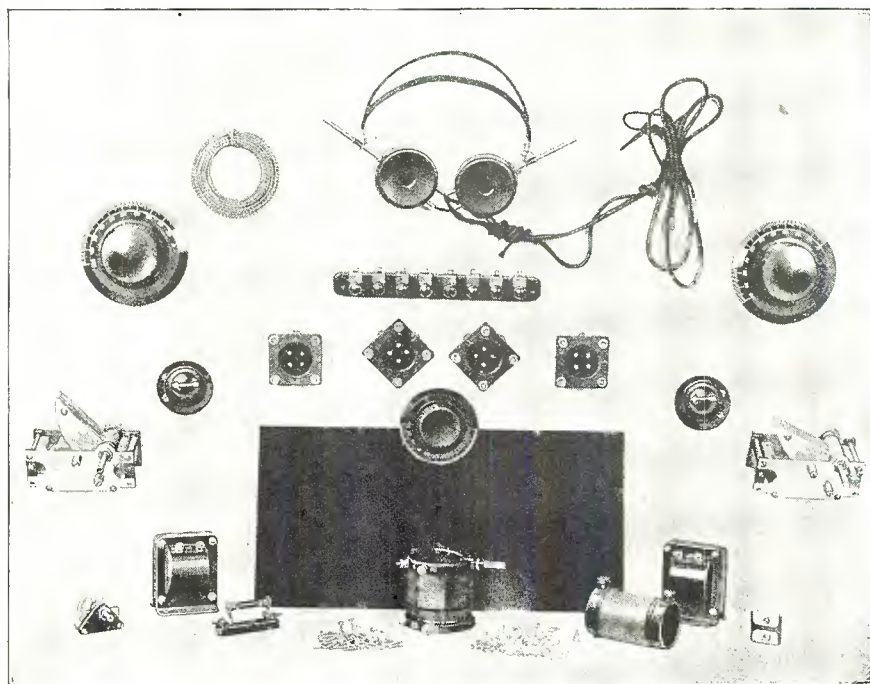

**Good Pay from the Start  
Rapid Advancement,  
Glorious Adventure and  
Phenomenal Success in  
A Life Profession of  
Fascinating Brain-work.**

With these parts you can build 12 different circuits.

The Peerless Signagraph for code instruction.

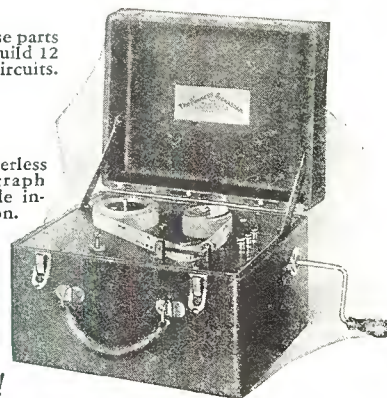

**Free with course, all this first-quality equipment for experimental work!**

## You can learn at home!



R. L. DUNCAN, Director,  
Radio Institute of America.  
Author of several volumes  
on radio

Here is your big opportunity! Radio pays hundreds of millions in salaries each year. In a few years the industry has progressed from almost nothing to one of the most important in the world. And the big demand for trained men continues in all the branches of radio. *Are you going to plod along at a thirty-five dollar a week job*

*when REAL MONEY is waiting for you in radio?*

Our graduates are earning big money as radio designers, as executives with large radio organizations, in broadcasting work, as skilled mechanics, assemblers, servicemen and radio dealers. We have trained thousands of men to become successful radio operators on ships traveling to far corners of the globe where they meet excitement and adventure—to become radio operators in shore stations, sending and receiving radio traffic with countries across the two oceans. And now Opportunity is knocking at your door.

### *A Brand-new Course Offered by the World's Oldest Radio School*

After years of experience the Radio Institute of America has evolved a new radio course—the most up-to-date of any offered today. It starts with the fundamentals of radio and carries you

**RADIO INSTITUTE OF AMERICA**  
Dept. B-1 326 Broadway, New York City

through the most advanced knowledge available. The work has been prepared in simplified form by men who have written many volumes on radio.

*Radio Institute of America backed by RCA,  
G-E and Westinghouse*

Conducted by the Radio Corporation of America and enjoying the advantages of RCA's associates, General Electric and Westinghouse, the Radio Institute of America is equipped to give—and does give—the finest radio instruction obtainable anywhere in the world.

### Home Study Course

Moreover you need not sacrifice your present employment for you can **STUDY AT HOME** during your evenings and other spare time. Thousands have successfully completed RIA training and have advanced to important radio positions. So can you with this new course.

### Just Off the Press

This new catalog describing the course is just coming off the press. If you want to learn more about the lucrative and fascinating profession of radio send the coupon now for your copy.



RADIO INSTITUTE OF AMERICA, Dept. B-1  
326 Broadway, New York City  
Dear Mr. Duncan:  
Please send me your new catalog. I want to know more about your new radio course.

Name.....  
Address.....



# Scott Worlds Record Super Ten Has Electric Phono Pick-Up

Phonograph Reproducer and Sturdy Power Amplifier System Make  
This Super an Ideal Entertainment Combination

**R**EADERS of our magazine who have been following the various Worlds Record super combinations which we have described from time to time will be interested in a novel radio and phonograph combination by means of which the receiver may be brought up to the highest form of entertainment value, combining as it does an ideal trio of selectivity, tonal quality and ample volume for all purposes. Functioning primarily as a ten tube superheterodyne, excellent quality may be secured by virtue of the power amplifier used in conjunction with the receiver, this combination serving to take care of faithful reproduction of broadcast music. With an electric pick-up scheme, such as shown in Figure 1, where the United electric pick-up is utilized, the listener may bring into play phonograph music with results which were never secured under the old form of phonograph reproduction. Therefore, the phonograph-radio combination makes it an ideal one from the standpoint of the set owner who wishes to avail himself of not only the music as broadcast, but wishes to repeat at will certain selections which he may have on the phonograph and which appeal to him.

#### Uses Antenna Connection

In order to secure as high a degree of initial radio frequency amplification as is possible in the present design of the Worlds Record Super Ten, two stages of tuned radio frequency have been placed ahead of the first detector, energy being secured from the antenna through the primary winding of the first radio

transformer, so that a fairly small antenna will suffice to deliver good signal intensity to the first detector after this energy has been amplified by the two radio frequency stages. This method of energy supply has been found quite stable and capable of giving uniform satisfaction in operation under practically all conditions. This feature of two tuned r.f. stages ahead of the detector is also responsible for the fact all stations appear at only one position on the oscillator dial.

The two radio frequency grid circuits and the grid circuit of the first detector are tuned by a three gang condenser of a .00035 mfd capacity, each of the three sections of this triple gang having a small balancing capacity across each of the major capacities. This is for the purpose of allowing the operator a chance to peak these three stages at resonance for best results. To further enable the operator to gain a degree of flexibility which might not otherwise be afforded, a .000025 mfd midget condenser has been located across the main section of the first .00035 mfd gang, so that the operator when desiring to work his receiver against interference may shift this capacity slightly and thereby gain true resonance with the incoming signal.

For tuning the oscillator, a single .00035 mfd condenser is utilized, this being the one placed on the drum dial shown at the right in the photograph, Figure 2, while the three gang condenser is attached to the drum dial shown at the left in this same photograph. The knob at the left which is labelled "distance" represents the .000025 mfd midget condenser previously referred

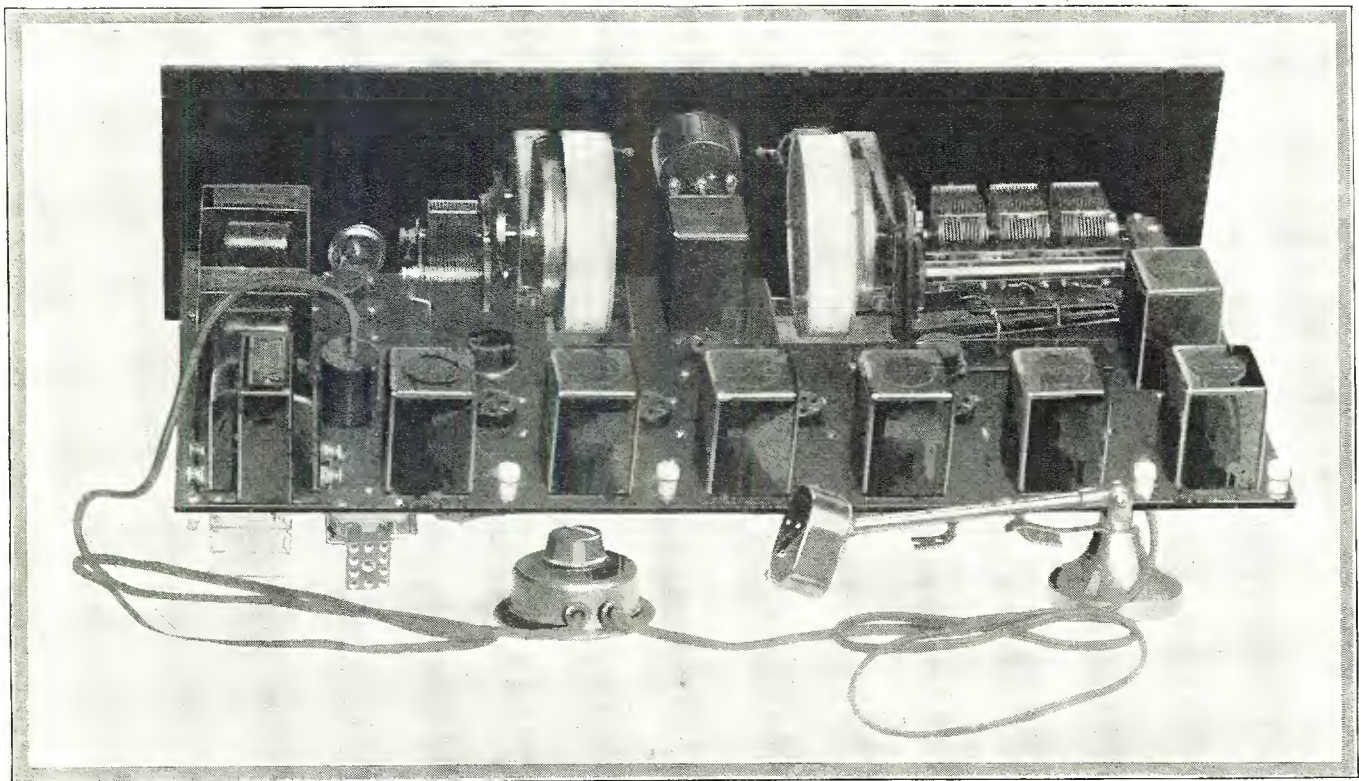

*Figure 1. This photograph shows a rear view of the World's Record Super Ten with a United electric phonograph pick-up plugged in on the second detector stage. By this means it is possible to play phonograph records on the receiver*

(This receiver tested and all illustrations made in our laboratory)



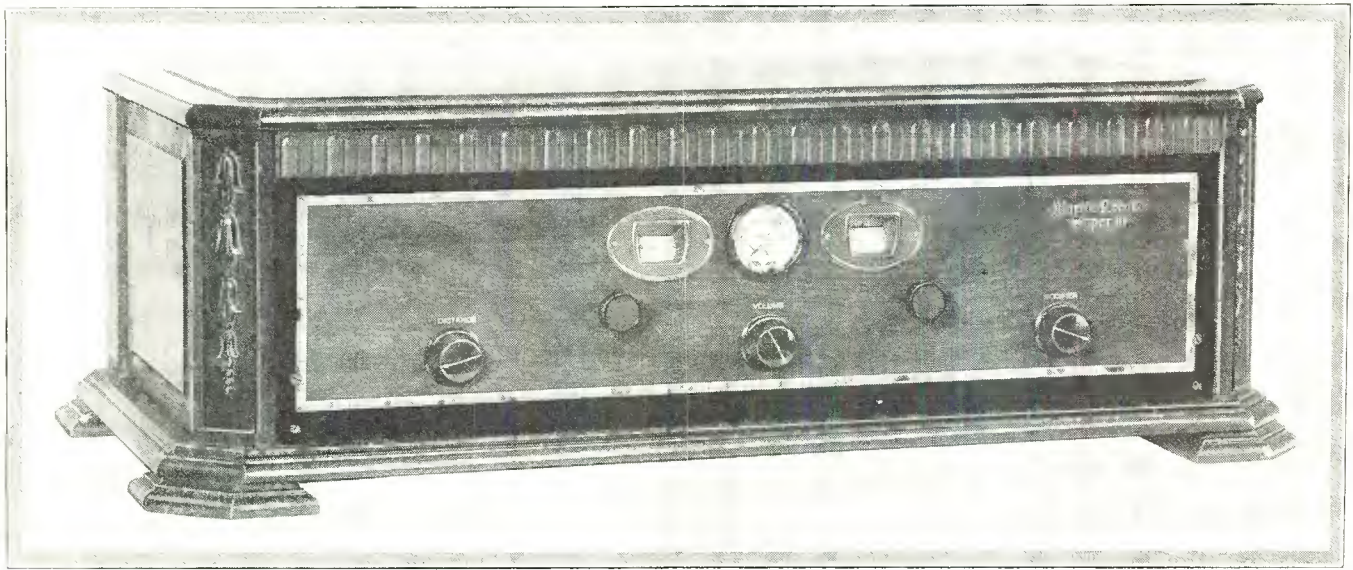

Figure 2. Above is shown a close-up view of the World's Record Super Ten in an attractive cabinet

to, while the combined 15 ohm rheostat and filament switch governing the filaments of the first and second radio frequency amplifiers is located at the center of the front panel, Figure 2, and the 400 ohm potentiometer used for biasing the grids of the first, second and third intermediate stages is located at the extreme right. The meter shown between the two drum dials on the front panel in Figure 2 is a 0-8 d.c. voltmeter located across the intermediate frequency tubes and which serves as a guide to the operator in keeping the proper voltage applied to these amplifier filaments.

Detection in the first detector is by means of a .00025 mfd grid condenser spanned by a 3 megohm leak, the grid return of this tube being to the positive side of the filament so as to afford the recommended bias for the 201-A tube. In the plate circuit of the first detector a radio frequency choke has been employed which, with a .0001 mfd bypass condenser between the plate and the filament, serves to bypass any stray radio frequency energy that has passed through the detector and which might be undesirable in the intermediate frequency train.

Four stages of intermediate frequency amplification are used with two Selectone B500 and two Selectone B510 transformers, these being of the long wave type. Close matching of the long wave Selectones gives this set an inherent selectivity and amplification. The radio frequency transformers shown in the schematic

circuit as being ahead of the first detector are of the type B520, while the oscillator is a type B540.

Instead of grid condenser and leak detection in the second detector, 4.5 volt bias is used to give rectification with greater stability than the form previously mentioned. The plate circuit of the second detector is likewise protected with an r. f. choke and a .002 mfd bypass condenser.

Has Output Transformer.

In the audio end of the Worlds Record Ten two stages of amplification are used, Thordarson R200 transformers being selected for these positions, on account of their faithful amplifying properties which give the receiver an all around tone quality so widely sought after. In addition a Thordarson R76 output transformer is provided as a means of keeping the high voltage in the power stage from the winding of the speaker, which in tests made in our laboratory was a Jensen dynamic cone driven from a six volt source for the energizing windings. The full rounded tones from such a speaker makes a very desirable accompaniment for this receiver.

Radio frequency control of the receiver is by means of the 15 ohm rheostat shown in the schematic which governs the filaments of the first and second radio frequency amplifier tubes. The first detector filament control is through a 30 ohm rheostat in

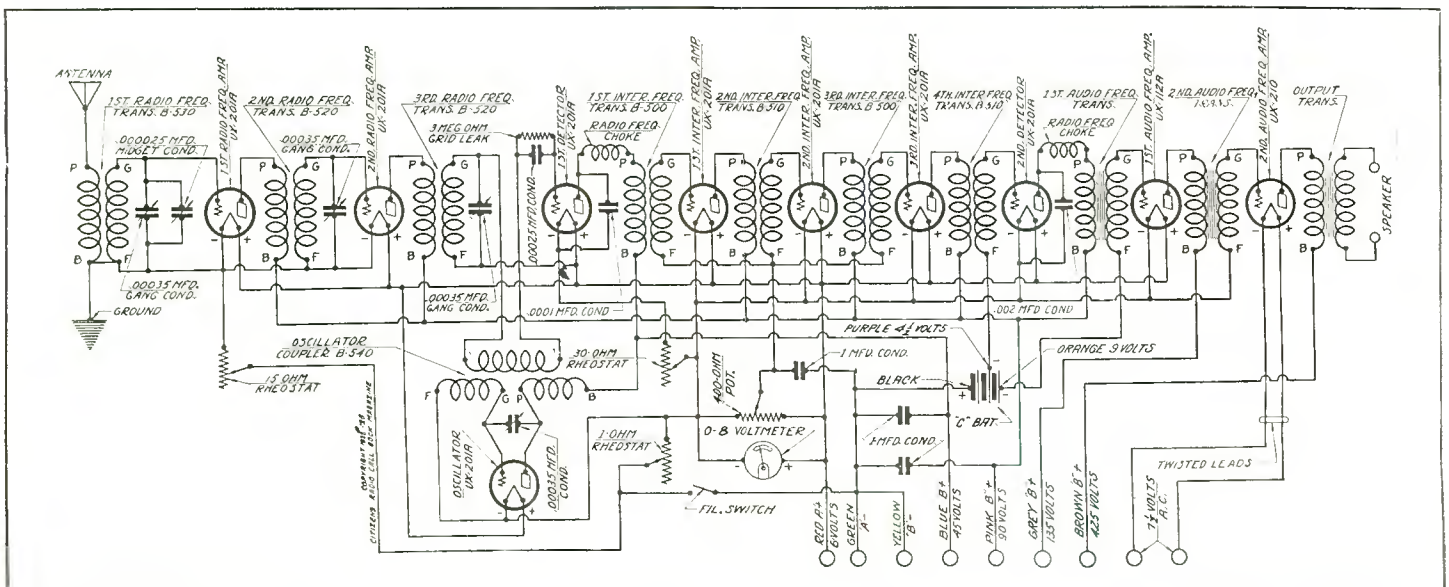

Figure 3. In this diagram is shown the schematic wiring for the construction of the World's Record Super Ten, which may be easily wired up according to the diagram or to the one shown in Figure 4







shifted by means of a wooden stick sharpened like a screw driver. The one at the extreme right in the graphic picture, and the one in the middle of the three gang unit, are first shifted until the signal on that stage comes in at about the same setting as on the oscillator. Then the one to the left is shifted until greatest volume is secured. The panel midget condenser should be half-in and half-out during this adjustment. When all three trimmers are adjusted on a weak signal to give greatest volume it will be found that by use of the panel midget it will be possible to clear up interference between two stations and secure selectivity that might not otherwise be possible with fixed trimmers on those stages. In starting to trim the three gang condenser it might be easiest for the operator to screw all the trimmer capacities all the way in, then shift the middle one and the left one a little at a time until the highest volume is secured.

**Getting Strongest Signal**

Of course by turning these trimmers in and out it is possible to shift the appearance of a given station on the left dial either up or down by four or five degrees, and in some cases more. However, the idea should be to shift the trimmers so the left dial readings will match the right dial readings. It is advisable to do this on a station like KDKA, after which the two will track fairly well throughout the entire range. With the present broadcast situation and during the winter time the owner should be able to use a distant station like KFI as a means of balancing his receiver, assuming of course, he has average antenna and ground conditions. With the present allocations the local stations in the metropolitan centers should not prevent the reception of outside stations as long as signal intensity is at a fair level.

**Using Phonograph Pickup**

When it is desired to convert the radio set into an amplifier for use with the electric phonograph pickup unit such as is shown in the photograph in Figure 1, all that is necessary is to remove the second detector from its socket and insert in its place the plug for the electric pickup, this plug having the plate and filament prongs connected so the magnetic impulses from the windings of the pickup will go into the primary of the first audio and be amplified through the audio train and out into the speaker. Those who have not yet heard the electric phonograph pickups may expect somewhat of a surprise as to the tone quality that is secured through the newer form of phonograph reproduction. A suitable volume control is provided on the pickup unit by means of which the listener may alter the volume at will.

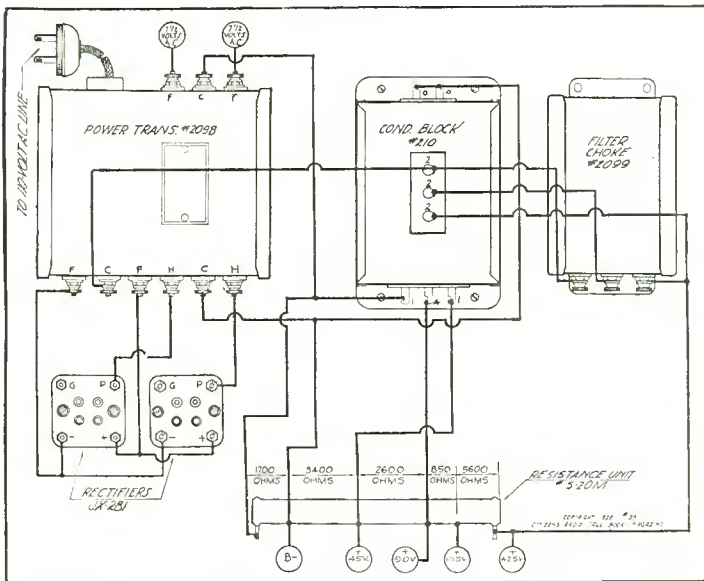

Figure 6. Placing the apparatus involved in the Thordarson power amplifier as shown in the photograph in Figure 5, the wiring of this unit may be accomplished by consulting this graphic illustration shown above. The wiring may be done with twisted insulated wire, or if the builder desires it may be accomplished with solid bus bar wire

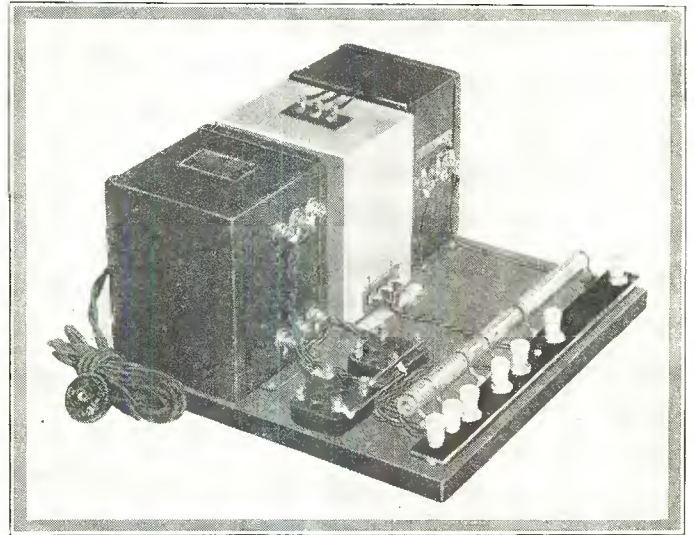

Figure 5. Above may be seen the Thordarson full wave power supply which is used for supplying receiver voltages and power voltages for the World's Record Super Ten. It should be wired up in accordance with the diagram shown on this page, Figure 6

**List of Parts**

Parts used in the construction of the model described in the foregoing article are as follows:—

**RECEIVER**

- 1—Remler .00035 mfd variable condenser
- 1—Remler 3-gang .00035 mfd variable condenser
- 2—Remler universal drum dials
- 2—35 Remler r. f. chokes
- 2—B500 Selectone transformers
- 2—B510 Selectone transformers
- 2—B520 Selectone r. f. transformers
- 1—B-530 Selectone r. f. transformers
- 1—B-540 Selectone oscillator
- 2—R-200 Thordarson audio transformers
- 1—R-76 Thordarson output transformers
- 1—Cater Imp 400 ohm potentiometer
- 1—Carter heavy duty rheostat, 1 ohm
- 1—Carter 15 ohm rheostat with switch
- 2—Carter tipjacks
- 2—Carter .00025 grid condensers
- 1—Carter .002 fixed condenser
- 1—Carter .0001 fixed condenser
- 1—340 S-M midget variable condenser
- 10—9044 Benjamin sockets
- 1—8629 pair Benjamin brackets
- 4—Tobe 1 mfd by-pass condensers
- 1—Tobe 3 megohm grid leak
- 1—Jones multiplug, 10 contact
- 1—135 Jewell 0-8 volt voltmeter
- 1—Pkg. Kester radio solder
- 1—Lignole 7"x26"3/16" drilled and engraved panel
- 1—Formica 10"x26"x3/16" drilled sub-panel
- 60—Kellogg solder lugs
- 40—Ft. Aeme flexible Celatsite wire
- 2—XL binding posts
- 1—Ekko ground clamp
- Miscellaneous—lugs, nuts, screws, etc.

**POWER SUPPLY**

- 1—2098—Thordarson transformer
- 1—2099—Thordarson choke coil
- 1—R210 Tobe condenser block
- 2—530 Frost sockets
- 1—S-20-M Carter resistance
- 7—XL binding posts
- 1—Wood baseboard 9"x12"
- 1—Micarta binding post strip 8"x3/4"x3/16"





You really haven't heard radio in all its perfection until you use the

## Madison-Moore INTERNATIONAL ONE·SPOT Batt'ry-less Transformer

**T**RULY, the "International One·Spot," because, in addition to reports of superb reception from all four borders of the country, we are receiving foreign countries.

These reports enthusiastically praise the MADISON-MOORE Transformer as the finest ever designed. Its tremendous, undistorted volume has been sought but never attained in any other instrument.

This "International One·Spot Transformer" operates on a frequency of 480 kilocycles and no transformer is really a "One·Spot" which operates at a lower frequency than this.

The MADISON-MOORE surpasses in ease of operation; does away with the bother of batteries. It has positively no hum. It is the **ONLY** true ONE·SPOT Transformer!

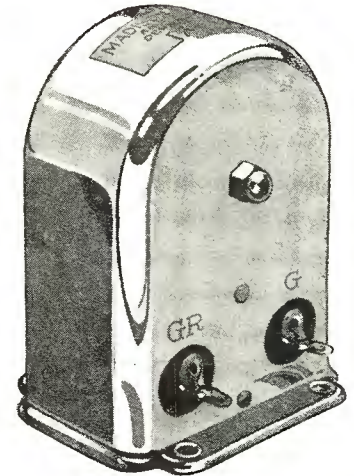

Type AC Madison-Moore International One·Spot Batt'ry-less Transformer

*Your radio dealer should have them. If he can't supply you, send to us*

MADISON-MOORE RADIO CORPORATION  
2524 L. Federal Boulevard  
Denver, Colorado - U. S. A.

# MADISON~MOORE

*The Finest RADIO APPARATUS in the World!*

*Tell 'Em You Saw It in the Citizens Radio Call Book Magazine*





Patrick H. Barnes, winner of gold cup awarded to most popular announcer of 1927. He is the first announcer to win two cups, having won the silver cup as second most popular announcer of 1926. Heard from Station WHT, Chicago







Dorothy and Ruth Weidergott. The Harmony Song Birds of Station WCMA, Culver, Ind.



Mrs. Julian Heath, who gives the daily menu talk every afternoon over WJZ, N. Y. City



Virginia Swanson, relief hostess of WOW, Omaha, Neb.

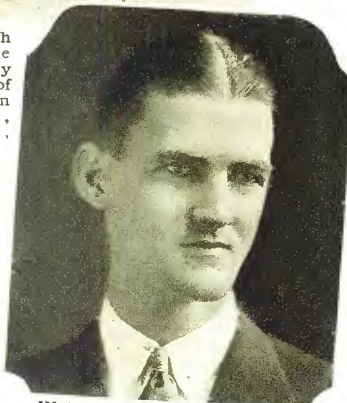

Walter N. Campbell, announcer and director of Station WLAC, Nashville, Tenn.



Chappie O'Donnell, who renders popular songs with Uke accompaniment over Station WHAR, Atlantic City, N. J.



Charles Robinson, basso of the National Musical Comedy Troupe heard over the Network Stations on Saturday Nights through WEAF, N. Y. City



Chappie O'Donnell and her Sunshine Broadcasters Club, heard over Station WHAR, Atlantic City, N. J.



Norman Link, staff artist of Station WOWO, Ft. Wayne, Ind.



Joe Faassen, winner of second place in the 1927 contest for popular announcers. Heard over KSO, Clarinda, Iowa

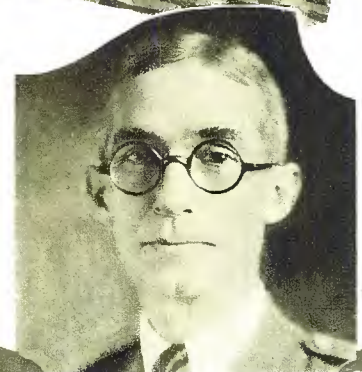

General Leigh R. Gignilliat, Supt. of Culver Military Academy, who broadcasts regularly over Station WCMA, Culver, Ind.





Judith C. Waller, Director of Stations WMAQ and WQJ, Chicago, Ill.



Seaside Hotel Trio, heard over WHAR, Atlantic City, N. J.



Prof. R. A. Dhossche, Flute and Piccolo Soloist and Director of the Magnolia Refinery Band, Station KFDM, Beaumont, Texas



Harold E. Gray, General Manager of WJAY, Cleveland, O.



Emerson Gill, Director of the Bamboo Garden Orchestra, heard over WTAM, Cleveland, Ohio



June Parker, Character Singer of Station KFWE, Hollywood, California



Albert Ryerson, Announcer and Studio Manager of Station WCAE, Pittsburgh, Pa.



Albert D. Hodges, Technical Director of Station KPO, San Francisco, California



Magnolia Glee Club, Miss Nellie Howland, Director, Station KFDM, Beaumont, Texas

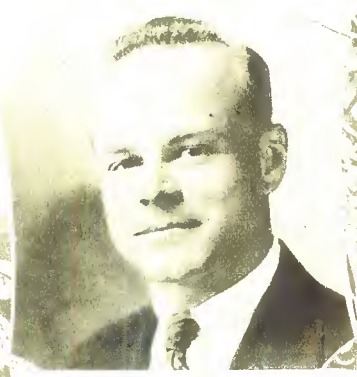

Leo Smith, Announcer and Director of Station KFDM, Beaumont, Texas





Neptune Male Quartette; Carroll H. Hoagland, first tenor and director; Howard M. Talbot, second tenor; Lester A. Dick, first bass and F. Edward Fessenden, second bass. Heard over Station WHAR, Atlantic City, N. J.



"Dr. Mu," Chinese Philosopher who presents the "Music and Musings of Dr. Mu" every Thursday Evening at eight o'clock through Station WABC, Richmond Hill, N. Y.



Alfredo Meunier, leader of the Capitolian Band and Concert Pianist heard over Station CKLC, Calgary, Alberta, Canada



Mabelle A. Tupper, whistler, heard over KSEI, Pocatello, Idaho



J. R. Foster, Manager and chief announcer of Station CKLC, Calgary, Alberta, Canada



Hotel Winthrop Dinner Hour Trio, a feature of KMO, Tacoma, Wash.



Marie Kieny, Hostess and Studio Accompanist of Station WOW, Omaha, Neb



Clarence Crary, the entertaining announcer of KFON, Long Beach Calif.



Lanney Young, crooning contralto heard over the Piggly Wiggly Station, KFON, Long Beach, Calif.

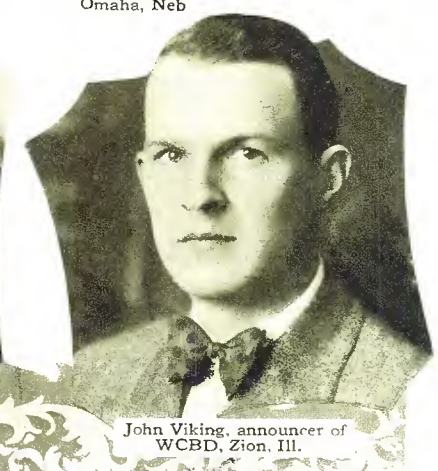

John Viking, announcer of WCBD, Zion, Ill.



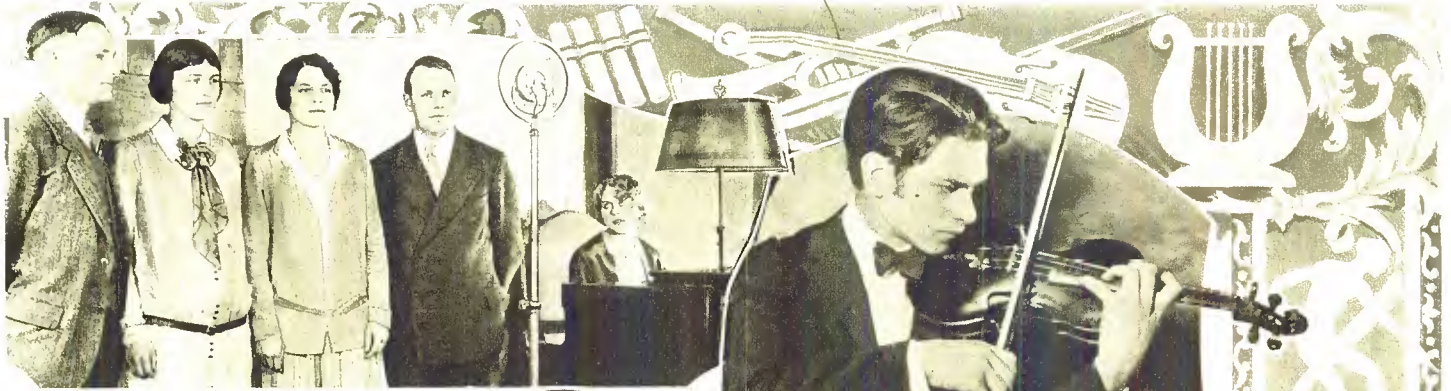

The Moody Bible Institute Quartette. Wendell P. Loveless, tenor; Helen Hargis, soprano; Frances Waffle, contralto; William E. King, basso, and Elsie M. Gustafson, pianist, heard over Station WMBI, Chicago, Ill.



Michael Weiner, violinist, heard over WBAL, Baltimore, Md.



Elmer Herling, baritone of KPO, San Francisco, Calif.

William Madden, musical director of WTAM, Cleveland, Ohio



John Porlier, The Young Whispering Tenor heard over WGBS, N. Y. City



Richmond Police String Band, regular entertainers over WRVA, Richmond, Va.



Natalie Giddings, director and announcer of the Crosley Woman's Hour, every morning, from WLW, Cincinnati, O.



Stan Lee Broza, chief announcer of WCAU, Philadelphia, Pa.

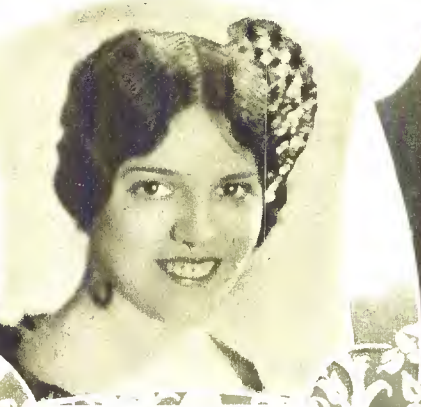

Volly Endriss, original crooning contralto, also hostess and program director of Station WWRL, Woodside, N. Y.



George Hartrick, popular baritone who broadcasts from Station WWNC, Asheville, N. Car.







Curt Pejerson, baritone and announcer of WJZ, N. Y. City



The Ipana Troubadours, heard over the Network Stations through WEA, N. Y. City



R. Derks, heard over Station WCAZ, Carthage, Ill.



Ruth Heizer, contralto, well known concert artist, heard over KYW, Chicago, Ill.



George Wood, announcer KOIL, Council Bluffs, Iowa



Jim Clancy announcer of the vaudeville program from the Hartford Theater each Thursday, from Station WTIC, Hartford, Conn.



Morene Ross Jacobsen, soprano, heard over KSEI, Pocatello, Idaho



Eugene Baker, assistant announcer of KEX, Portland, Ore.



Helen Remy, pianist of WLBV, Mansfield, Ohio



Ruth Kleckner, pianist of WMAK, Buffalo, N. Y.



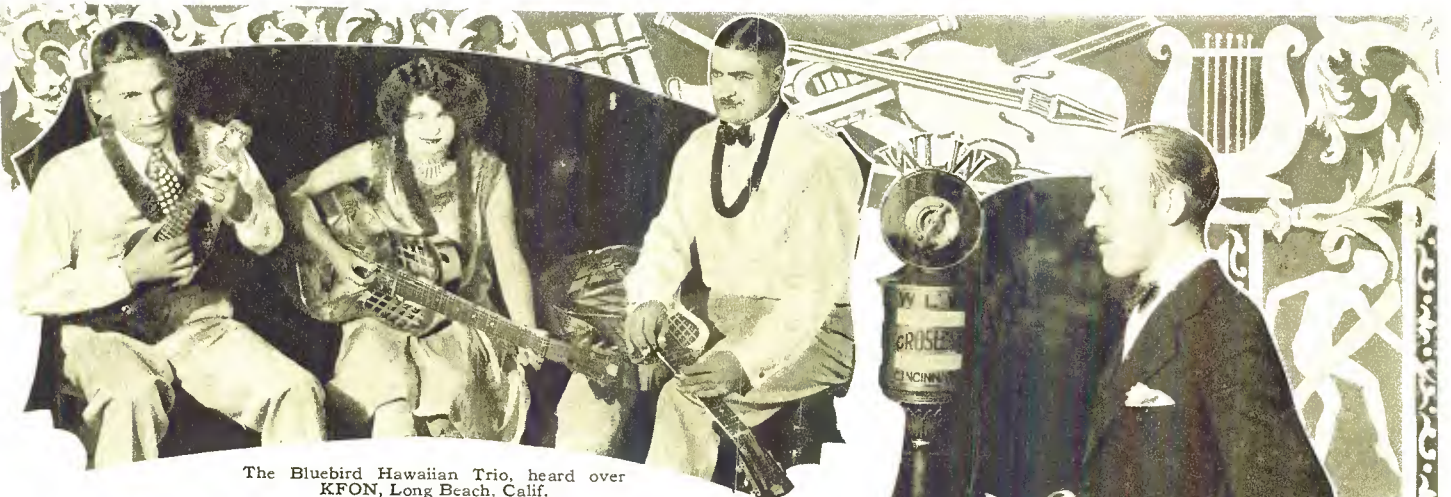

The Bluebird Hawaiian Trio, heard over KFON, Long Beach, Calif.



Wm. Stoess, Musical Director of WLW, Cincinnati, Ohio



Norman Sweetser, announcer of WJZ, N. Y. City



Vaughn De Leath, alto, heard over Station WJZ, N. Y. City



George O'Brien, leading tenor of the National Light Opera Co. and a member of the National Light Opera Quartette, heard over the network Stations through WEAJ, N. Y. City



Fred Schneider, chief operator of Station WOWO, Ft. Wayne, Ind.



Walter B. Stiles, owner and director of Station WOOD, Grand Rapids, Mich.



Arthur Rekart, Chief Engineer of Station WOWO, Ft. Wayne, Ind.



E. F. Grossman, operating engineer of the National Broadcasting Co., making final tests of apparatus at Auditorium Theater, Chicago, from where portions of the Opera are being broadcast during the Balkite Hour, through the Stations of the Blue Network from WJZ, N. Y. City



Melville Ray, tenor, heard over WLW, Cincinnati, Ohio





KWTC Classical Trio, Santa Ana, Calif., Harold Mathews, oboe; Adeline Cochems, piano; Lyle Roberts, clarinet, and Kinsley Hancock, announcer

Marie Winters, staff pianist of Station WEHS, Evanston, Ill.



"Al and Pete," Al Cameron and Pete Bontsema, heard over KYW, Chicago, Ill

The Famous National Barn Dance Fiddlers, popular with Saturday Night Radio fans. Heard over WLS, Chicago, for over three years



Olga Mundy, singer of popular and novelty songs through Station WCAE, Pittsburgh, Pa.



Art Billquist, baritone, exclusive artist of WCFL, Chicago, Ill.



Bettie Sale Stewart, who presents original negro sketches every Friday evening over KOMO, Seattle, Wash.



E. Russell Wightman, announcer and manager of Station KPFA, Gunnison, Colo.



Herbie Koch, organist, heard from Capitol Theater, Des Moines, Iowa, through Station WHO



Mr. and Mrs. Fred Thieleker, Swedish artists heard over WRVA, Richmond, Va.



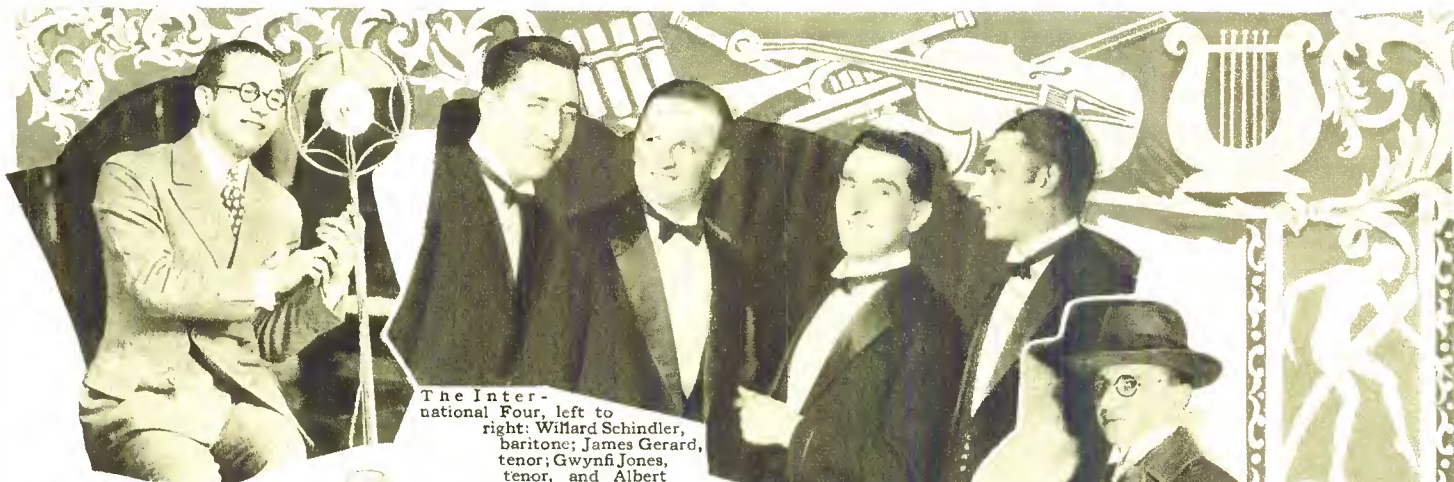

The International Four, left to right: Wilhard Schindler, baritone; James Gerard, tenor; Gwynfi Jones, tenor, and Albert Gillette, bass, heard over Station KGO, Oakland, Calif.

John F. Cini, announcer of WLBY, Iron Mountain, Mich.



Liborius Hauptmann, pianist and orchestra conductor who is musical director of Station KGW, Portland, Ore.

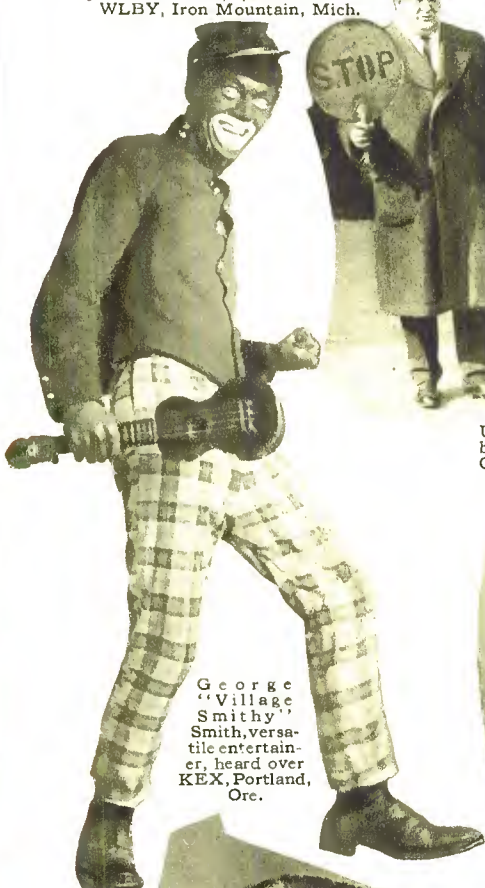

George "Village Smithy" Smith, versatile entertainer, heard over KEX, Portland, Ore.



Uncle Bob and some of the members of the "Curb is the Limit Club," Station KYW, Chicago, Ill.



Harold Palmer, associate announcer of WOW, Omaha, Neb.



Lydia Dozier, operatic soprano, heard over WLW, Cincinnati, Ohio



G. Donald Gray, chief announcer, Station KOMO, Seattle, Wash.



Doris Dolan and Clarence Crary, known as "Doris and Clarence," a daily feature over KFON, Long Beach, Calif. Mr. Crary is also assistant announcer of the Station



G. Dare Fleck, Program Director of Station KDKA, Pittsburgh, Pa.





Fred Lynch, Tenor, on Totem Broadcaster Staff of KOMO, Seattle, Wash.



Dare Sisters, Harmony Singers heard over the Piggly Wiggly Station KFON, Long Beach, Calif.

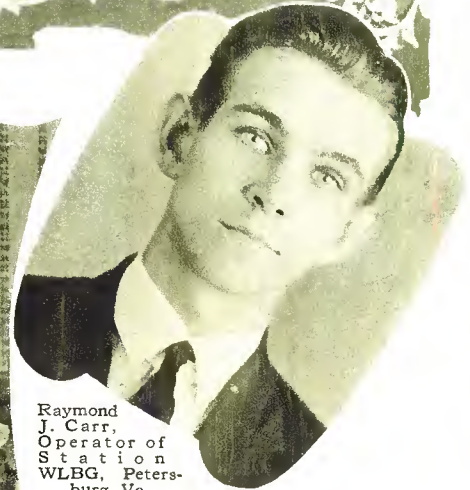

Raymond J. Carr, Operator of Station WLBG, Petersburg, Va.



E. Paul Hamilton, Managing Director of Station WOR, Newark, N. J.



Earl Hoffman, leader of the Chez Pierre Orchestra heard through Station WCFL, Chicago, Ill.

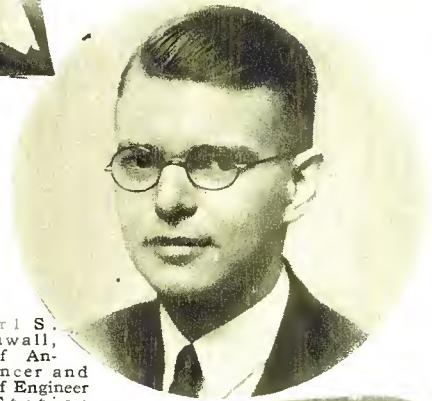

Carl S. Tunwall, Chief Announcer and Chief Engineer of Station KFJY, Ft. Dodge, Iowa



Geo. H. Lawrence, Announcer Station WSIX, Springfield, Tenn.



"The Voice of Columbia," the masked announcer, heard over the Columbia Broadcasting System, N. Y. City



Austin Wylie, leader of popular dance orchestra heard over WTAM, Cleveland, Ohio



Jack W. Pilley, Announcer and Studio Manager of KFCR, Santa Barbara, Calif.





S. L. Rothafel, "Roxy," well-known to all broadcast listeners, heard over the Blue Chain Stations, through WJZ, N. Y. City

Chuck Haynes and Ray Ferris, "Harmony Slaves," who broadcast over WCFL and WQJ, Chicago, Ill.

Max Steindel, director of Steindel String Quartette, heard over KMOX, St. Louis, Mo.



Billie Allen Hoff, heard over WCFL and KYW, Chicago, Ill.



Major J. Andrew White, dean of broadcasters and vice president of Columbia Broadcasting System, N. Y. City



Gerald L. King, manager of Station KFWE, Hollywood, Calif.



Jack Don, dispenser of Hawaiian music over KSL, Salt Lake City, Utah



Harold Serungard, announcer of KDLR, Devils Lake, N. Dak.



Stuart Barsby, announcer and business manager of KLZ, Denver, Colo.



Robert S. Childe, assistant announcer and pianist of WGHP, Detroit, Mich.





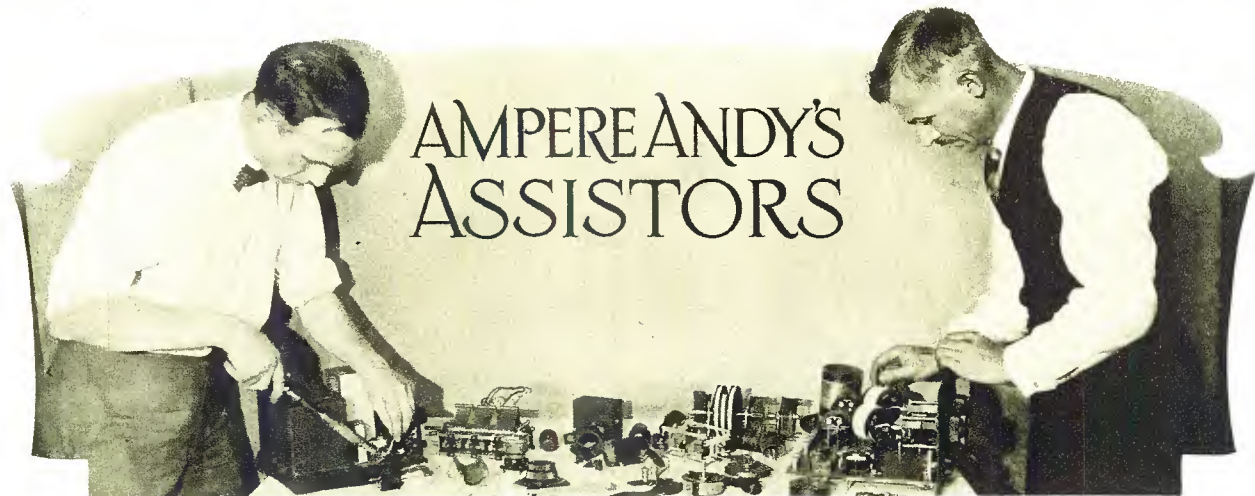

## AMPERE ANDY'S ASSISTORS



### Cleaning a Storage Battery

A storage battery which has been in use for a while accumulates a considerable amount of acid impregnated dirt on its surface. Clothes, coming in contact with the battery, are often mutilated by the acid burns. A convenient method for cleaning the top of the storage battery is to place it under a hydrant and let the water run over it. This, of course, with the vent caps in place. While the water is running over the battery, vigorously scrub the surface with an old scrubbing brush, which will remove the acid and dirt. After the battery has been thoroughly cleaned with water, go over the battery again with a strong solution of ammonia or baking soda. This will neutralize any acid remaining. Flush it again with water and then set the wet battery in the sun or some place where a free circulation of air is available, where the excess water will quickly evaporate.

### A Unique Hydrometer

A unique hydrometer has recently been placed upon the market, the advantages of which are immediately apparent. Unlike the average hydrometer of today, this particular device is screwed into the threaded opening in each cell, replacing the vent cap, and remains as a permanent installation. The battery is tested by squeezing the rubber bulb and allowing the electrolyte to be drawn into the glass chamber housing the float. Through an ingenious arrangement used in the construction of the hydrometer, the electrolyte slowly dribbles back into the cell and does not remain in the float chamber. Small size and perfect accuracy as to the graduation on the float characterize this new product. The hydrometer may be easily removed when filling the battery with water.

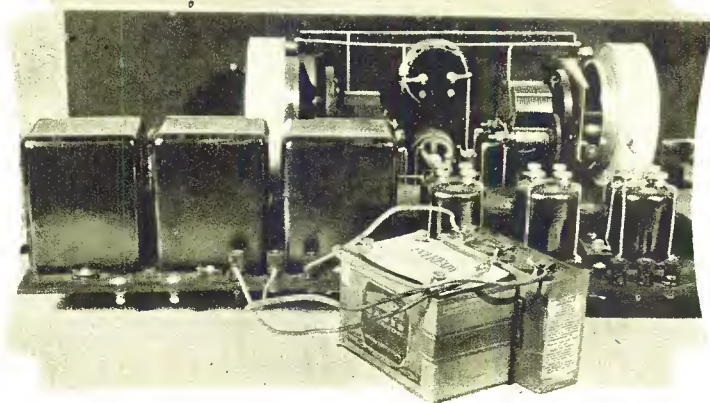
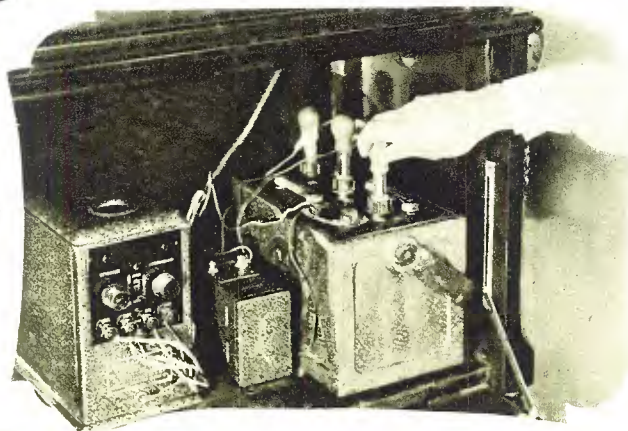

### Reducing "C" Battery Voltage

It is often necessary to use another "C" battery voltage instead of the one available. Supposing a  $22\frac{1}{2}$  volt "C" battery is being used and it is desired to use but 18 volts. This is easily accomplished by hooking a  $4\frac{1}{2}$  volt "C" battery in series with the  $22\frac{1}{2}$  volt battery in the ordinary manner, with the following exception. Instead of connecting the positive terminal of the  $22\frac{1}{2}$  volt battery to the negative terminal of the additional "C" battery, connect the positive of the  $22\frac{1}{2}$  volt battery to the positive of the smaller battery. The total voltage across the two batteries will be but 18 volts, since the voltage in the smaller battery "bucks" the voltage in the larger battery and reduces it to the required voltage.



### Eliminating Body Capacity in Tuning Condensers

Body capacity in the average tube operated receiver may be eliminated to a very great degree by reversing the connections on the tuning condenser with which the difficulty is experienced. The proper connection of the tuning condenser in the circuit is to have the stator plates connected to the grid of the tube and the rotor plates connected to the grid return, which is usually the negative "A". If the rotor plates are connected to the grid, the capacity effect between the condenser shaft, which is a part of the grid circuit, and the operator's hands, will cause a squeal. Sometimes it is necessary to place an insulating shaft on the tuning condenser to totally eliminate the difficulty, but this is only resorted to in extreme cases.

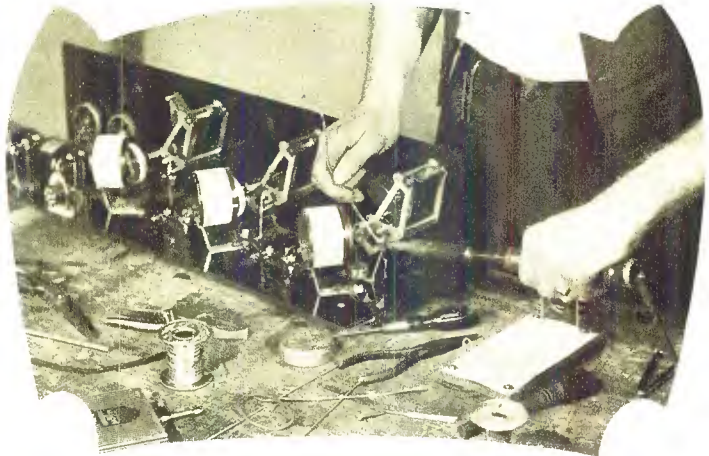

### A Carpet Insurance

It is advisable to have a bottle of an alkaline solution, such as baking soda or ammonia, beside the storage battery. Frequent testing of the storage battery with a hydrometer will eventually get some acid on the carpet or other furnishings nearby. If nothing is done to neutralize the acid drippings, a hole will be burnt in the carpet or the floor discolored. If the bottle of an alkaline solution is handy, a liberal quantity may be placed on the acid, which will immediately neutralize it and effectually prevent any damage. A solution of baking soda of the proper strength may be made by dissolving as much baking soda as will dissolve in a quantity of water. It is best to allow a layer of the soda, about one-half inch thick, to remain at the bottom of the container.



### Tightening Loose Bases on Tubes

The glass portion of a vacuum tube will sometimes work loose from the Bakelite base through constant handling. While this does not impair the working qualities of the tube itself, it is a condition which is not desirable. The sealing compound, usually placed between the Bakelite base and glass bulb, will, when carefully heated, again join the two parts. However, difficulty is sometimes experienced in repairing a tube by this method. If repeated trials do not join the parts, friction tape may be resorted to by winding a number of turns around the tube, allowing a liberal overlapping of the various layers of tape. This will serve as a permanent repair and will save the tube from being discarded.



### Reducing Tube Vibrations

Many radio receivers today are not equipped with a cushion socket to hold the detector tube. The socket normally holding the detector tube is rigidly fastened to the chassis of the receiver, and any vibration experienced by the receiver itself will be imparted to the detector tube. Due to its function in the circuit, the detector tube is very microphonic in character and, if passing traffic jars the building, the detector tube will vibrate and cause a ringing sound to occur in the loud speaker. This is extremely disturbing and often virtually spoils a program. An excellent remedy for this condition is to place a small piece of sponge rubber under each of the feet of the cabinet or console, which will effectively absorb all vibrations causing



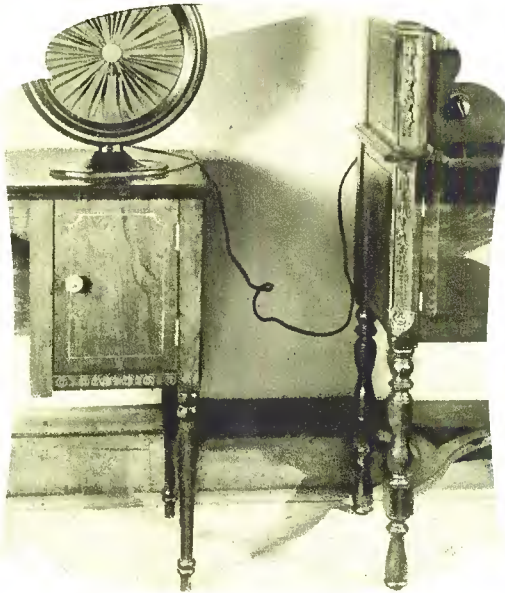

### Reducing Microphonic Noises in a Receiver

The placing of a loud speaker on top of a radio cabinet or console often produces a somewhat musical hum or roar, which slowly increases in volume until it is almost unbearable to the ear. This is caused by a condition of resonance between the vibrations of the detector tube and the vibrations of the speaker. These vibrations are transmitted through the material forming the cabinet or console. Other factors also enter into the production of this microphonic hum, but the set owner can usually overcome the difficulty by removing the speaker to some remote position from the receiver itself. This may be accomplished in a number of ways, either by hanging the speaker on a wall or setting it on a nearby table or bookcase.

### Reducing the Charging Rate of a Trickle Charger

It is sometimes desired to reduce the charging rate of a trickle charger. Many of the smaller receivers do not require the .4 ampere or .5 ampere charging rate, since the receiver does not draw sufficient current from the battery. In this respect the insertion of a suitable resistance in one of the charging leads will reduce the rectified current supplied to the battery, in a sufficient amount so as to charge it at the proper rate. A 6-ohm rheostat is ideal for this purpose. The resistance is varied so that the proper charging rate may be found by trial.

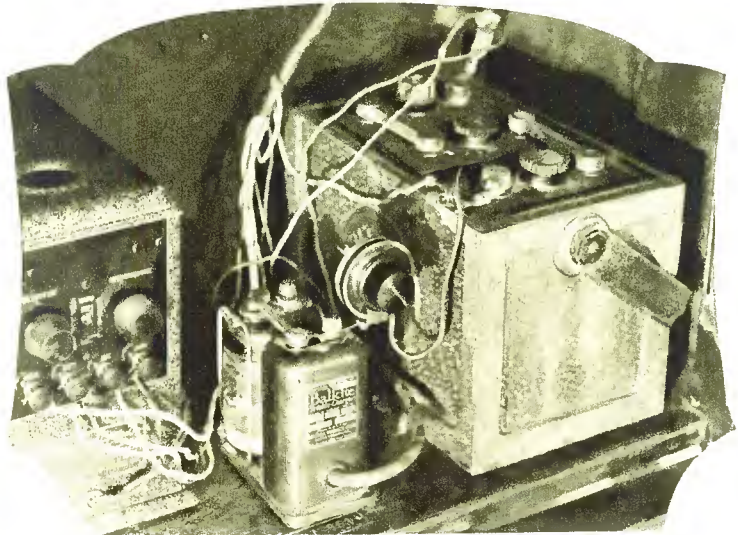

### A Handy Adjunct to a Screw Driver

Difficulty is often experienced in placing a wood or machine screw through a mounting hole in some out-of-the-way corner of the receiver. At times it is virtually impossible to use the fingers or even a pair of long nose pliers for properly starting the screw. If a heavy rubber band is pierced with a hole and the screw inserted through it, the screw will be securely held to the blade of the screw driver by slipping the rubber band over the top of the handle. This will hold the screw with sufficient strength until it is properly started in the wood. The rubber band can, therefore, at that time be easily pulled off the head due to its natural resiliency.



### A Unique Charger

A new and novel charger has just been placed on the market by a leading transformer manufacturer. This particular charger makes use of a new cartridge rectifier, which is manufactured by an Eastern concern. The advantages in the use of this charger are manifold, notably in the total lack of attention which is required in the care and upkeep of the charger. There are no liquids, moving parts, or pastes used in this charging device, which is absolutely noiseless. The charger is capable of handling  $2\frac{1}{2}$  amperes of rectified current. The only replacement necessary is that of the rectifying element itself, which is only after approximately 1000 hours of continuous operation.

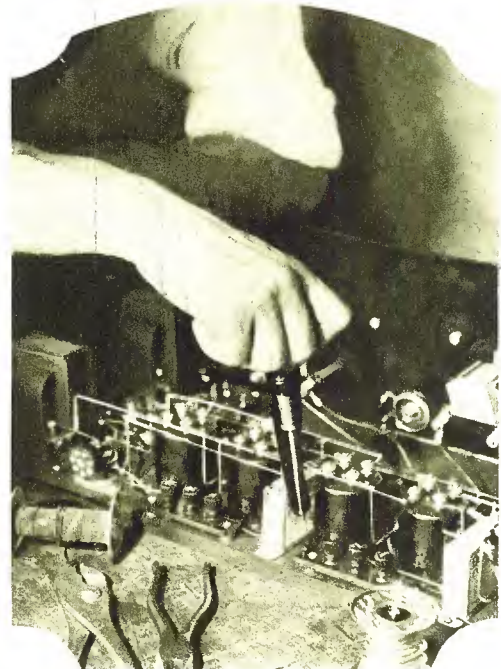



### Eliminating AC Hum in a Receiver

AC hum frequently occurs in a receiver, even though the receiver is not connected to any accessories using AC power. The hum is often picked up by a lamp or conductor in the immediate vicinity of the receiver. A common practice is to place a lamp on top of the receiver to illuminate the tuning controls. Naturally the lamp, and the lamp cord supplying the AC power to it, are in close proximity to the instruments in the receiver, which, due to their sensitive nature, pick up any interference generated in the field around the conductors. It is best to investigate all lighting fixtures in the vicinity of the receiver in attempting to eliminate the hum.

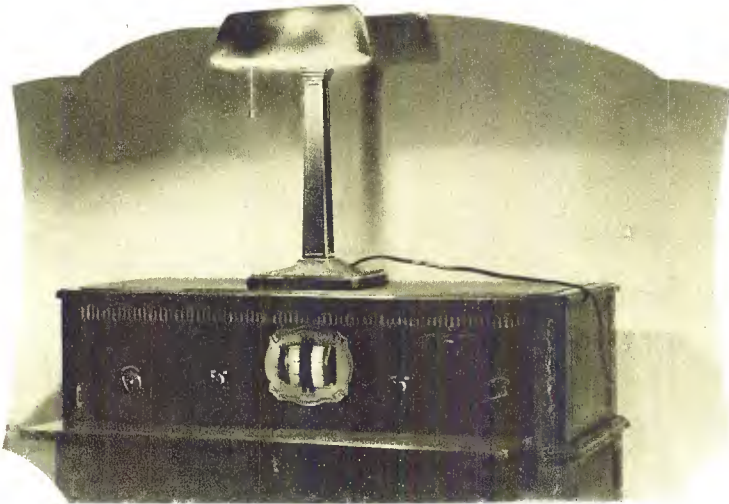

### Keep Cabinet Open While Charging Battery

It is advisable to open the doors of a console or cabinet while charging the "A" battery, so as to allow an ample circulation of air by which the gas and heat from the battery and the charger may be carried away. If the gas is allowed to collect in a closed space, such as is found in a console, it becomes a source of potential danger, since it is highly inflammable. It may be easily exploded by a lighted cigar or cigarette. Heat generated by high capacity chargers will soon warp the cabinet to a very serious degree if ample ventilation is not provided.

### An Excellent Emergency Antenna

An excellent emergency antenna may be easily made in a few minutes with a length of spare wire. About 10 feet of insulated wire, No. 18 or larger, is wrapped around the outside of the electric light drop cord, supplying electricity to the room. Sufficient capacity between the conductor in the drop cord and the wire wrapped around it is realized, so that any radio energy picked up by the electric power lines is transferred to the emergency antenna. This particular method of installing an antenna is only recommended for temporary use, since its efficiency is not as great as an outdoor antenna.

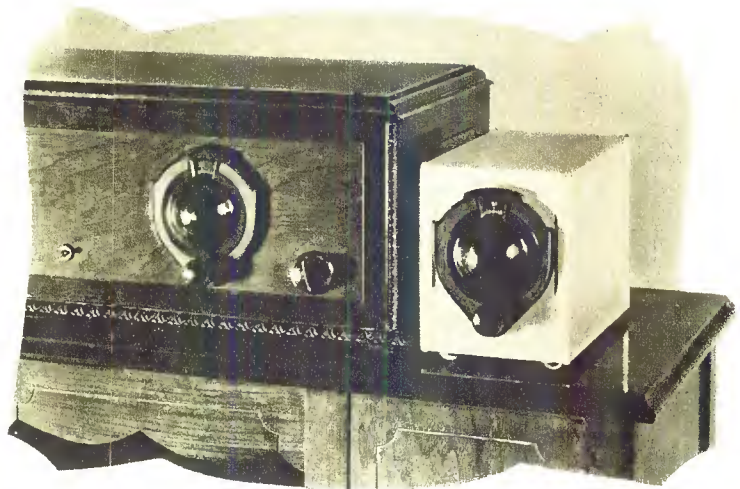

### The Use of a Wave Trap

The efficiency of a receiver may be increased to remarkable degree by the proper use of a wave trap. Sometimes local stations a short distance away have sufficient power to seriously interfere with decent reception of other stations. Condensers may be inserted in the antenna circuit to sharpen the tuning; and the antenna may be even shortened but sometimes the interference will still prevail. The use of a wave trap, however, will act as a filter, excluding the unwanted signals to a very high degree. In fact, with the proper use of a wave trap, it is possible to tune out a powerful local station but a short distance away, and receive distant stations with reasonable volume with an absolute minimum of interference.



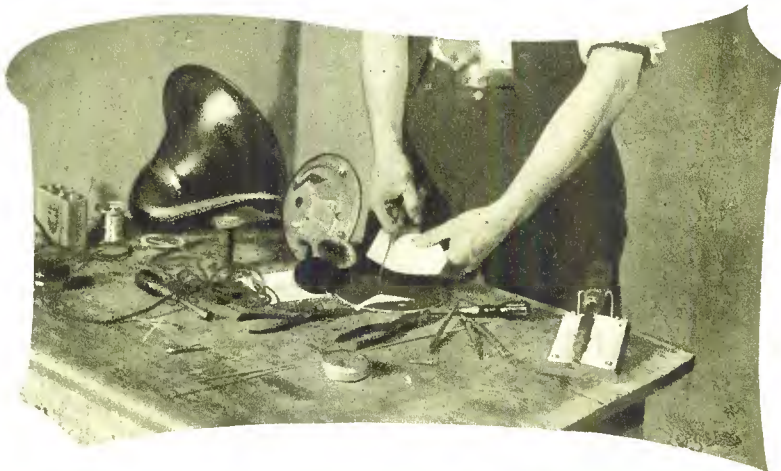

### Eliminating Rattle in Non-Adjustable Speakers

Some speakers using a non-adjustable diaphragm will rattle after being used for some time, due to the fact that the diaphragm has become bent through excessive voltages being applied to the speaker. This difficulty may be obviated to a great extent by removing the diaphragm of the unit and turning it over. This will invariably eliminate the rattle. If, however, this is not in the way of a solution, a small paper washer may be cut to fit under the diaphragm. In making a washer of this type, do not use any material which is heavier than the brown wrapping paper commonly in use. The bearing surface, as far as the washer is concerned, need only be approximately  $\frac{1}{8}$  inch to  $\frac{3}{16}$  inch in width. If necessary, insert more than one washer.

### Testing Antenna Systems

Poor efficiency is often encountered in the use of a particular antenna. Such an antenna should be immediately tested to determine whether or not it is grounded at any point. This may be easily accomplished by connecting a pair of head phones and a battery in series between the antenna and ground leads. If a click is heard in the head phones when the circuit is completed, the antenna is grounded at some point and should be carefully examined. Cracked and dirty insulators are often the cause of a grounded antenna.



### Testing a Lightning Arrester for a Short Circuit

A lightning arrester may be quickly tested to determine whether or not the electrodes are short circuited by hooking it up in series with a pair of head phones and a battery, as shown in the accompanying illustration. While listening with the head phones, complete the circuit by touching one of the cord tips to the lightning arrester. If a click is heard, the arrester is defective and should be either replaced or repaired.

### Eliminate Microphonic Noises in Small Tubes

Dry cell tubes are characteristic for their noisy operation as far as microphonic noises are concerned. This is especially true in respect to tubes used as detectors. If a piece of felt is wrapped around the glass portion of the tube and securely fastened in place, it will serve as a damper for vibrations, effectively preventing any sustained vibrations causing microphonic disturbances.

### Determining AC or DC Current

A convenient method for determining whether the power supply is DC or AC is found in the use of a common horseshoe magnet in conjunction with an old type of carbon lamp. While the lamp is burning on the unknown power supply, bring the magnet close to the glass portion of the lamp. If the current is DC, the filament will move either slightly towards the magnet or away from it, according to the polarity of the socket. If, however, the power supply is AC, the filament will oscillate violently, beating against the walls of the lamp.





# ALUMINUM

*The mark of  
Quality in Radio*

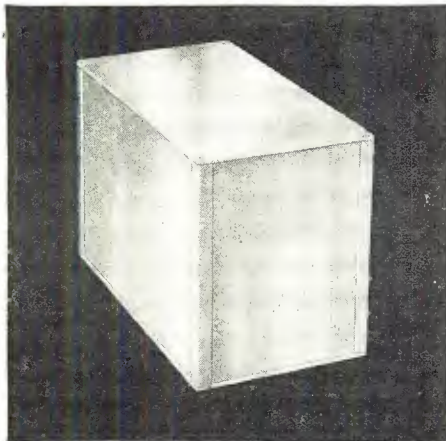

Aluminum Box Shields

*Essential in many  
popular amateur sets*

FOR greater selectivity, finer appearance, longer life, lighter weight, use Aluminum Box Shields in the set you build—and look for Aluminum Shielding in the set you buy.

Designers agree on the superiority of Aluminum for shielding. It has become an established factor in radio design—recognized alike by advanced amateur set builders and engineers responsible for commercial production.

Aluminum Company of America's standard box shields, designed especially for amateur sets, are made of heavy Alcoa Aluminum with satin-dip finish, size 5 in. x 9 in. x 6 in. high. They are easily adapted to smaller sizes. They require no soldering.

If your dealer cannot supply you with Aluminum Box Shields send us his name and we will see that he is put in position to service you promptly. Be sure to send, also, for a copy of the new edition of "Aluminum for Radio." It is free.

**THE ALUMINUM COMPANY  
OF AMERICA**

2465 Oliver Building Pittsburgh, Pa.

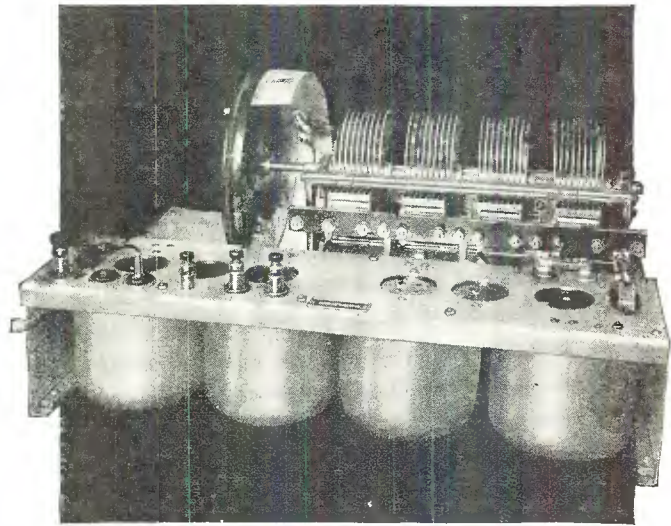

*Aluminum Shields and Other Parts  
Zenith Radio Corporation*

RADIO Engineers are using more and more Alcoa Aluminum because of the efficiency with which this *one* metal meets the widely differing conditions encountered in radio design.

In many modern sets you find Alcoa Aluminum Shielding used because of its great effectiveness at radio frequencies. You find condenser blades made of Alcoa special Aluminum sheet because of its narrow limits of tolerance, its uniformity and its lightness. You find Alcoa Aluminum foil preferred for fixed condensers. Countless screw machine radio parts of Alcoa Aluminum are being used.

Sand castings and die castings of Alcoa Aluminum make the finest chasses, sub-panels and loud speaker frames, both because of the combined lightness and strength of Aluminum and because of its permanence and finish. Aluminum, decorated in a variety of rare wood grain effects, is ideal for front panels.

Look for Aluminum in the receiving set you buy. It has come to be recognized as the mark of quality in radio. Your copy of our new booklet, "Aluminum for Radio," will be sent free on request.

**ALUMINUM COMPANY OF AMERICA**  
2465 Oliver Building Pittsburgh, Pa.

# ALUMINUM

*The mark of Quality in Radio*



# Bringing Your Infradyne Up to Its Peak Efficiency

Valuable Hints Given to Enable the Set Builder to Thoroughly Understand Set's Operation at Its Highest Value

CONSTRUCTIONAL data on the 1928 model Infradyne receiver which appeared in the September issue of the CITIZENS RADIO CALL BOOK MAGAZINE has brought in a large number of letters from individuals and set builders, who have expressed their complete satisfaction with the receiver built from these instructions. In order to answer as many of the various inquiries that have been made as is possible, we will attempt to cover in this summary some of the minor adjustments which bring the Infradyne to its peak performance.

## Setting the Trimmers

In any receiver which uses tuned radio frequency controlled by a gang condenser with single dial control, complete resonance of the radio frequency circuit is of prime importance if you are to obtain maximum distance and selectivity. The instructions which accompany the new Infradyne kit do not cover as completely as may be desired, the various features of the radio frequency amplifier, with its antenna compensator. It will be noticed that in the upper shield of the Remler 710 amplifier there are three holes provided through which the small trimmers or balancing condensers, located between the sections of the main gang condenser, can be adjusted. The trimmers which balance the second radio frequency and detector circuits will maintain resonance through the broadcast band if they are once set, since there is no disturbing factor of the antenna circuit which affects them. On the other hand, the capacity of the antenna circuit does have a varying effect upon the first radio frequency circuit and provision is made in the new Infradyne for complete compensation over the entire range of the receiver. As explained in the instructions which accompany the Infradyne, the receiver should first be balanced at a wavelength of slightly above 200 meters or approximately 1500 kilocycles. It is suggested the operator tune in some local station of about this wavelength and with the antenna com-

pensator switch set on a point three, turn the antenna compensator knob, which is the smaller of the two knobs on the antenna compensator, at about one-fourth of the arc of rotation from the extreme counter-clockwise position. Using the small wooden screw-driver which is furnished with the Remler 710 amplifier, reach down through the left hand hole in the upper shield and adjust the extreme left hand trimmer to the point of greatest selectivity, meanwhile rotating the radio frequency drum dial back and forth through a few degrees. It goes without saying this adjustment should be made while using the receiver as a five-tube single dial control and preferably using a pair of head phones plugged into the jack on the front of the receiver. After the first trimmer is adjusted, it will be found volume will increase and the selectivity of the receiver will become greater. Now, if it is possible to bring in some station 200 or 300 miles away, proceed with this same adjustment again until maximum results are obtained. Notice that no adjustment has been made of the other two trimmers, but at this time slight readjustments of both of these trimmers may be made to insure their correct setting. We must caution you as to the effect over all three of these trimmers. Very small changes in the setting are sufficient to bring the receiver completely into resonance or throw it completely out, and since the balancing condensers or trimmers are of the compression type be careful not to push down on the wooden screwdriver since this will immediately disturb the capacity of the trimmers. Now rotate the drum dial so as to tune in some station at or about 500 meters or 600 kilocycles. You will find that in order to obtain resonance at this point, it will probably be necessary to rotate the small antenna compensator knob in a clockwise direction in order to bring about complete resonance. If it is possible, tune in some station 300 or 500 miles away at this wavelength. Adjust the antenna compensator for maximum selectivity and

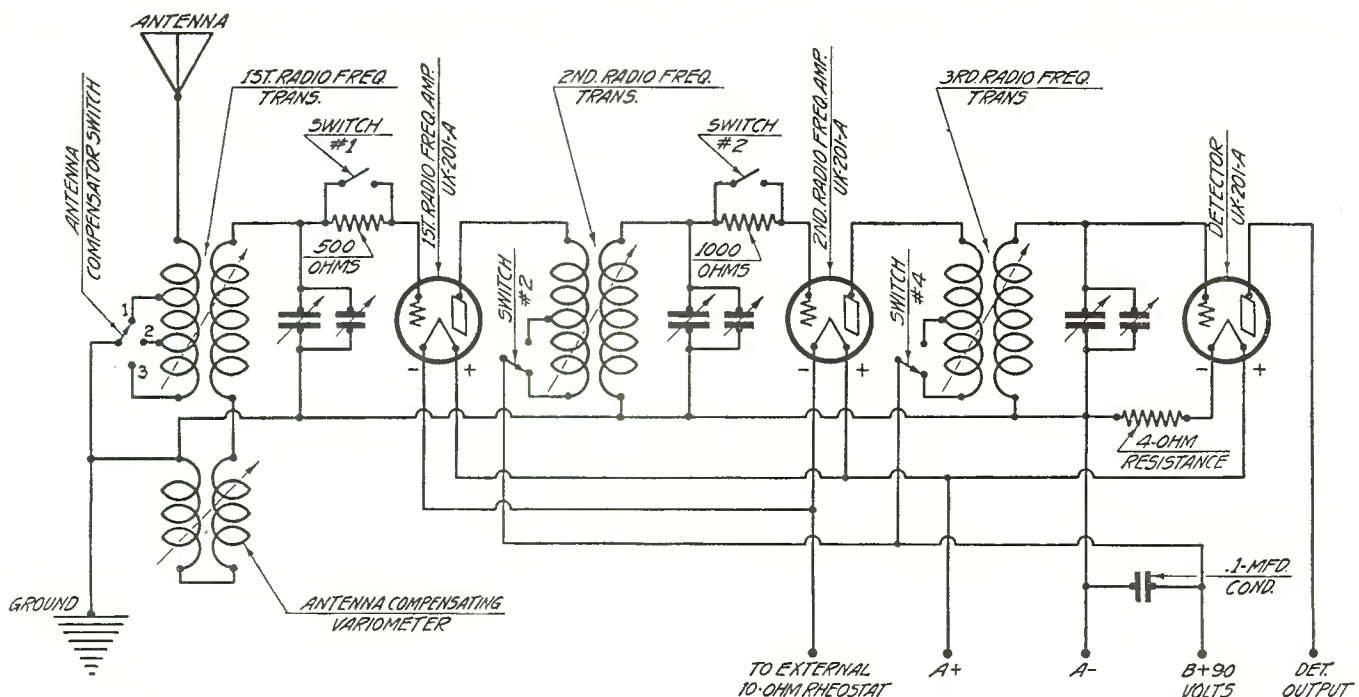

Fig. 1. Schematic diagram showing arrangement of switching controls, proper setting of which governs selectivity of the receiver



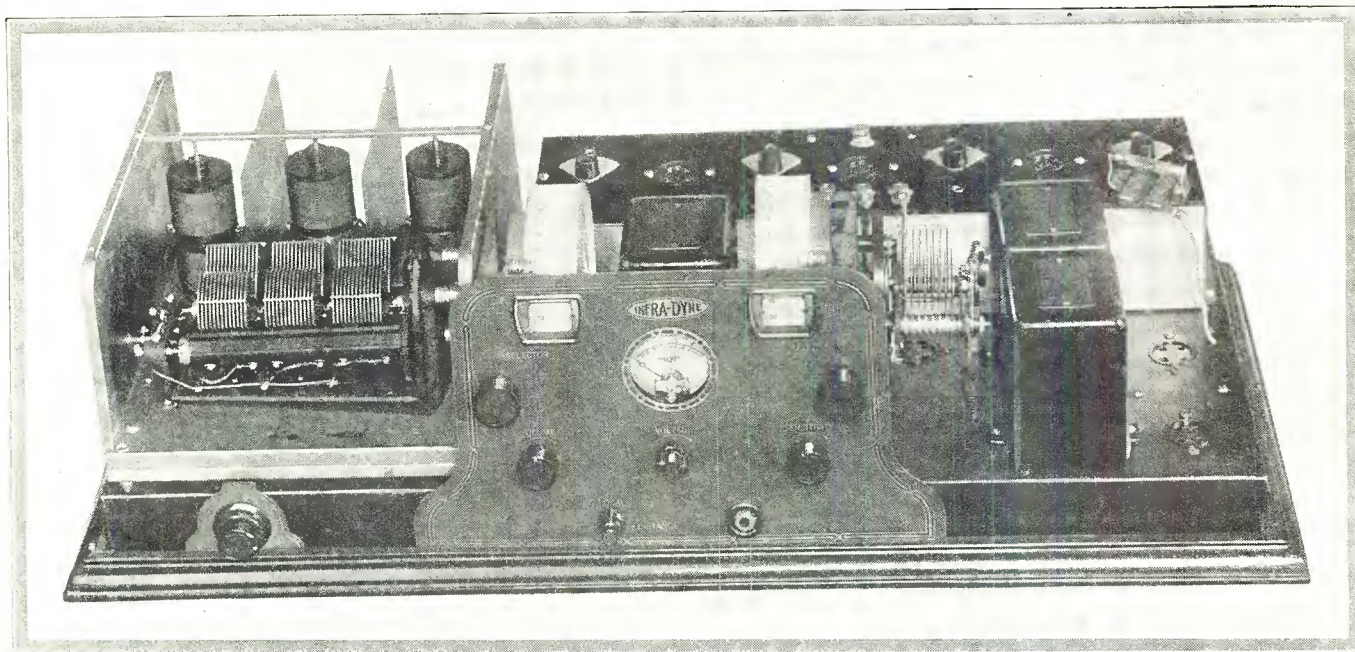

Fig. 2. Rear photograph of the completed Infradyne. This article gives intimate details of the receiver not shown in the picture

volume and then, without changing the setting of the antenna compensator, change the tuning of the r. f. circuit back to the distant station around 200 meters, and again adjust the trimmer in the first r. f. circuit for maximum selectivity and volume. This balances the radio frequency amplifier throughout the entire range and it will be found that maximum selectivity and volume will be obtained over the entire broadcast spectrum, without the necessity of adjusting the small antenna compensator knob except on extreme distant stations.

Perhaps a word might be said here to explain the system of antenna compensation used in the new Infradyne. The small knob on the antenna compensator controls a minute variometer, which is connected in the grid return circuit of the first radio frequency stage. On the lower wavelengths or higher frequencies where small changes in capacity in the tuning circuits have greatest effect, we reach resonance by means of the setting of the first trimmer condenser. On the higher wavelengths where relatively small changes in capacity do not have as great effects, resonance is secured by varying the inductance of this variometer.

#### The Selectivity Switches

Designers of the Reimler 710 radio frequency amplifier have taken into consideration the varying degrees of selectivity which are necessary in various sections of the country, depending upon the number of broadcasting stations and their distance from the location of the receiver. By removing the top shield of the amplifier, you will notice there are four two-point switches located on the base, which have "selective" and "non-selective" positions. There are actually twenty-four different combinations of position of these four switches. You will realize that it is obviously impossible for us to describe the exact setting of these different switches in order to give you exactly the results necessary in your location. For example, if all four switches are set in the "non-selective" position, the receiver becomes completely stable, will not oscillate over the broadcast band and will give desirable performance in locations where no powerful stations are nearby. On the other hand, if the first three switches are set in the "selective" position and the fourth switch, counting from the left, is set in the "non-selective" position, the receiver can be forced into oscillation by means of the volume control rheostat and the selectivity greatly increased. If the first and third switches are set on "selective" and the second and fourth are set on "non-selective," the receiver becomes highly selective and overall amplification is greater than it is with the combination suggested above.

This particular setting gives best results in one model constructed in our laboratory, which is used on the north side of

Chicago where receiving conditions are difficult due to the proximity of powerful nearby stations. On the other hand, another model of the receiver constructed in our laboratory, which is being used on the south side of Chicago where conditions are not so extreme, gives best results with the first switch set on "selective" and the other three on "non-selective." In this location and with this setting, no difficulty is experienced in obtaining 10 kilocycle selectivity on distant stations through all Chicago stations using the entire ten tubes of the receiver.

It goes without saying that it will be necessary for you to experiment with the setting of these various selectivity switches, but remember that each time you make a change the shield must be placed back on the amplifier and the receiver tuned very carefully by means of the drum dial control and the volume control rheostat. We know you will be curious to find out just what these selectivity switches actually do and a diagram of the circuit is published herewith. Switch No. 1 set on "non-selective" position introduces a 500 ohm resistance into the grid circuit of the first radio frequency circuit and in the selectivity position shorts out this resistance. Switch No. 2 set on the "selective" position decreases the number of turns in the primary of the second radio frequency transformer. Switch No. 3 is the same as switch No. 1, except that the resistor is 1000 ohms instead of 500. Switch No. 4 is the same as switch No. 2 and gives different primary turns.

#### Making the Dials Log

In the new Infradyne the radio frequency and oscillator dials follow each other, almost exactly or within a few degrees on the dial. It is suggested that some station be tuned in at approximately 100 on the radio frequency dial. You will notice a small compression type balancing condenser is located on the main oscillator condenser of the receiver. This is a shunt capacity and changes in the capacity of the balancing condenser will offset settings of the oscillator dial for the same station. Consequently, it follows if the oscillator condenser reads 95 while the radio frequency dial reads 100 the small adjusting screw located on the balancing condenser should be turned to the right slightly until the station is brought in with the oscillator dial set at 100. If the original setting of the oscillator dial was above 100, then the procedure should be followed in the same manner except that the screw on the small balancer should be turned to the left instead of to the right. Remember that very small changes in the capacity of this balancing condenser will move the setting of the oscillator dial several degrees. Caution: Do not tighten the adjusting screw on the balancing condenser too much or you may break the moulded bakelite part or damage the mica dielectric.



# Later Developments on the Thordarson Power Amplifier

Type 112 Tube Substituted Instead of 171 and Simpler Method Found for Grid Biasing

LATER development work on the Thordarson power amplifier system described on page 121 of the November issue of the CITIZENS RADIO CALL BOOK MAGAZINE has made necessary a few circuit changes in that design if full advantage is to be taken of all its possibilities.

To gain a higher voltage amplification it has been considered advisable to use a 112 tube in the first audio stage instead of the 171, as shown in the November issue.

A simpler method of securing the desired bias on the grids of the 112 and of the two 210's arranged for push-pull amplification has been worked out and is represented in the schematic diagram shown below.

In making the change from the 171 to the 112 tube the value of the C bias resistance has been altered as shown by the schematic diagram and is now a 400 ohm variable resistance, which will enable the builder to change the biasing supply to the grid of the 112 tube. Biasing voltage to the grids of the 210 tubes is secured by the drop across the full length of the same 400 ohm resistance.

As will be noticed from an inspection of the schematic circuit, there are two negative connections used on the filter condenser unit, the C minus connection going to the bottom of the 400 ohm

resistance, while the B minus connection on the filter condenser unit is connected to the B minus terminal at the juncture of the 10,000 ohm and the 400 ohm resistance.

In operation if a receiver draws over 40 milliamperes and causes the voltage regulator tube to go out, move end connector A towards center of resistance until the glow tube lights again. Also do not remove regular tube from socket while the set is in operation, as this will throw an added load on the condenser units and might damage them.

It is always considered good practice to ground the metal containers on all power apparatus, as well as the filter condenser container.

It will be observed that the condenser unit has two negatives, the one marked B minus going to the B minus terminal shown in the schematic and the one marked C minus going to the bottom of the 400 ohm resistance. In other forms of power amplifiers, these two negatives are tied together and go to the B minus connection on the amplifier; here it was desired to have a portion of the capacity across the biasing resistance.

This power amplifier unit has been found especially desirable as a means of testing electric phonographic pick-up units, as well as being used as a standard amplifier for plugging in on all types of receivers.

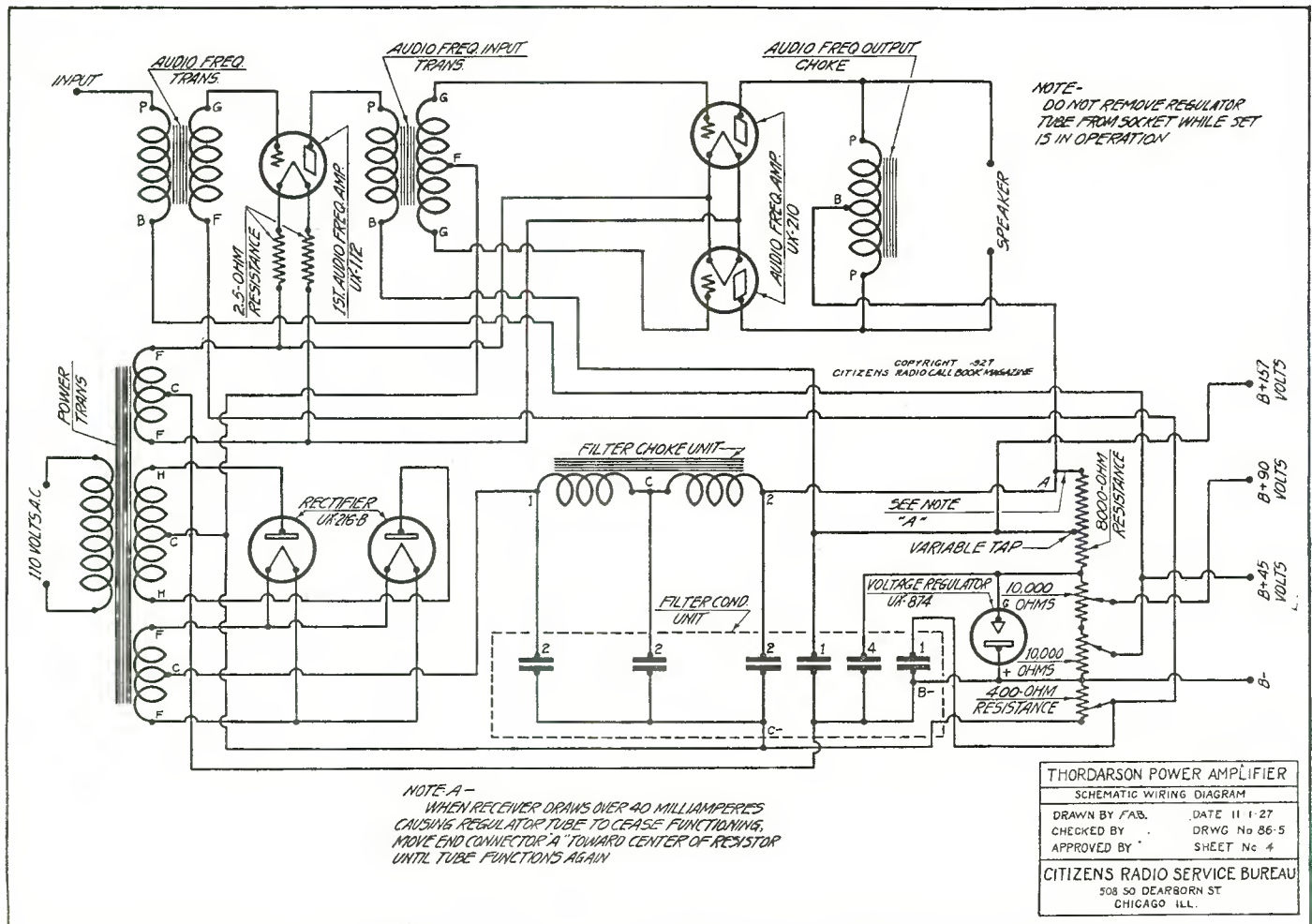



# Truvolt B Supply Designed to Gain Receiver Stability

New Arrangement Utilizes Voltage Regulator Tube to Assure Unvarying Voltages for Best Operation of Set

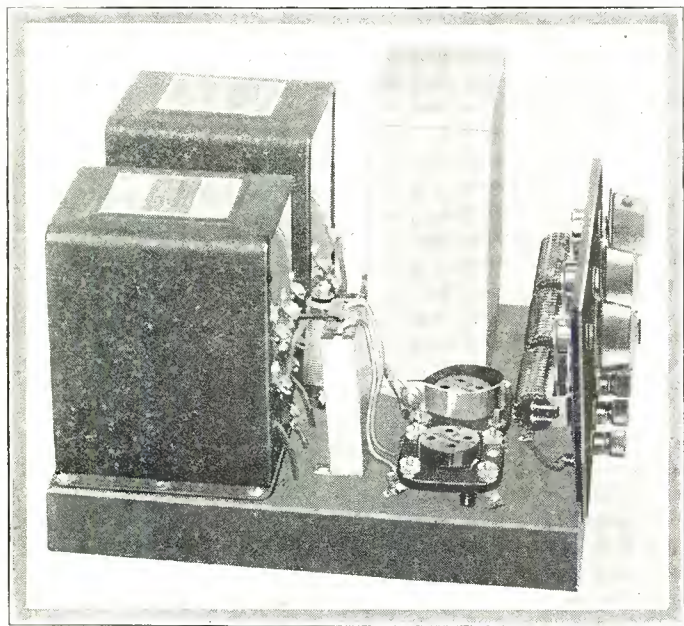

Figure 1. In this photograph is shown a side view of the Truvolt B power supply unit described in this article. Note that the second socket appears to have a metallic band around it, but this is not the case. This clip or band goes to the shell of the regulator tube type R

FOR well nigh onto three years or so home constructors and radio fans have constructed and assembled lamp socket operated B-power supply devices and eliminators. At first, the construction of such a device was quite an undertaking, and proved too much for many experimenters. In those early days of lamp socket powered radio, the home constructor had to make his own power transformers and chokes, or else use the cumbersome and costly apparatus designed for radio transmission use. Later, transformers, chokes and other essential components designed just for the purpose began to make their appearance. Then followed similar parts of improved design, improved circuits, radically new rectifiers, the voltage regulator or glow tube, special compact wire wound high ohmage resistors and a host of other such parts, until now one can easily construct, in an evening's time, with but a few simple tools and the kitchen table, a truly modern B-power supply such as illustrated in Figure 1.

The voltage regulator tube employed not only prevents any tendency toward "motor-boating" when used with sets employing resistance coupled or other such forms of audio channels, but also maintains the voltages at the various taps at constant values, regardless of the load or type of sets with which the power unit is employed. The filamentless full wave rectifier tube, the wire wound resistors, the high voltage short path condensers, all contribute to long life and freedom from trouble.

In general, B-power circuits may conveniently be divided into three parts, first, the transformer-rectifier unit, secondly, the filter unit, and finally, the vortage divider unit. Under the first classification comes the transformer which steps up the house current to a usable value and the rectifier element, commonly

a tube, which alters the form of the stepped-up current from that of an alternating nature to one of a pulsating direct form. The transformer which is selected for the purpose must be so designed that when it is in operation its core laminations will not produce a 60 cycle hum, usually the result of loose assembly. The better types of transformers now available overcome this difficulty not only by substantially clamping the core-pieces together but by imbedding the entire transformer assembly in a wax compound. Of necessity the transformer should be enclosed in a metal can which acts as a shield preventing the electromagnetic lines of force set up by the transformer intercoupling with other nearby apparatus. Of late there has been manifest a trend toward the combining of the audio channel of a radio receiver with the B-power supply device. Where such a construction is attempted this last-named consideration attains considerable importance, as there is the possibility of the audio amplifying units picking up the 60 cycle disturbance where the transformer is not enclosed in an iron can. The grounding not only of the center-taps of the several transformer windings but of the transformer can itself is highly desirable and constitutes an additional safeguard against an unstable B-power supply unit.

As to the rectifier element, there are several types which may be employed, but special attention is directed to the new Raytheon BH tube which will very satisfactorily handle currents up to and including 125 milliamperes. This is an important item because the use of this tube in B-power supply devices enables the owner to operate it from the lamp socket without the probability of running the power unit at its limit of handling capacity.

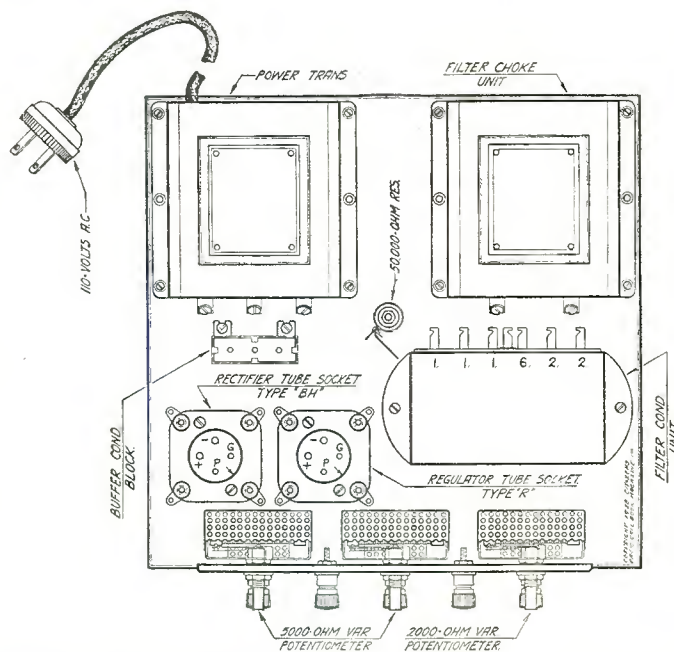

Figure 2. In this sketch is shown the manner in which the parts should be laid out for the construction of the Truvolt power supply. For wiring the reader may use either Figure 3, which is the schematic, or Figure 5, which is the graphic, the latter being generally preferred by those who are not so far advanced in the art







was connected in series with each load, the new circuit employs different resistors in "potentiometer" fashion directly across the output of the filter. The new method makes for more stable conditions, as in the old fashion any change in one of the resistance adjustments threw off all the others in the circuit. Likewise it was possible for the unskilled operator to obtain excessive voltages from some of the taps.

**Mounting Instructions**

Obtain from a tinsmith a piece of sheet metal which should be formed into an inverted tray, the side walls being 1/2 inch high and the flat surface 9 1/2 inches wide by 10 inches long. On top of the tray or chassis, as it might be called, arrange along the rear edge the National power transformer, the Tobe condenser B block and the National filter choke, in the order illustrated in Figure 2. On a piece of 1/4 inch bakelite 4 inches wide by 8 inches long mount three Electrad Truvalts, one of 2000 ohms and two of 5000 ohms. Below these resistors locate five binding posts as follows: B—, B. det., B r.f., B a.f., and B max. By means of two angles pieces mount this bakelite panel assembly on the front edge of the chassis evenly spaced in its center. At either end of the chassis and directly in front of the National apparatus fasten two sockets, the one at the left for the rectifier tube and the one at the right for the regulator tube. In the intervening space locate the buffer condenser unit and the 50,000 ohm resistor which is connected in the "keep alive" circuit of the regulator tube. The wiring is accomplished with the use of Corwico Braidite, a stranded, heavily insulated wire which when bent into position will remain that way.

The several drawings which accompany will prove helpful in the construction of B-power supply device described here.

If desired, a protective cover of perforated sheet brass, supported on a framework of 1/2 inch brass angle, may be constructed for the completed power unit. Such a cover will prevent anyone from accidentally touching any high voltage terminals. It will also prevent damage to tubes and other delicate parts and act as additional shield.

**List of Parts**

In the construction of the power supply unit described above the following parts were used:

- 1—R National power transformer
- 1—National filter choke
- 1—R Tobe filter condenser block
- 1—Tobe buffer condenser
- 2—1040 Benjamin sockets
- 1—T-20 Electrad 2000 ohm Truvalt
- 2—T-50 Electrad 5000 ohm Truvalts
- 1—B-500 Electrad Truvalt fixed resistance
- 1—B1H Raytheon full wave rectifier
- 1—R Raytheon voltage regulator
- 5—Eby binding posts
- 1—Metal chassis
- 25—Feet Corwico Braidite hookup wire
- 1—Fahnestock regulator tube clamp
- 1—Package Kester radio solder
- Miscellaneous screws, nuts, lugs, etc.

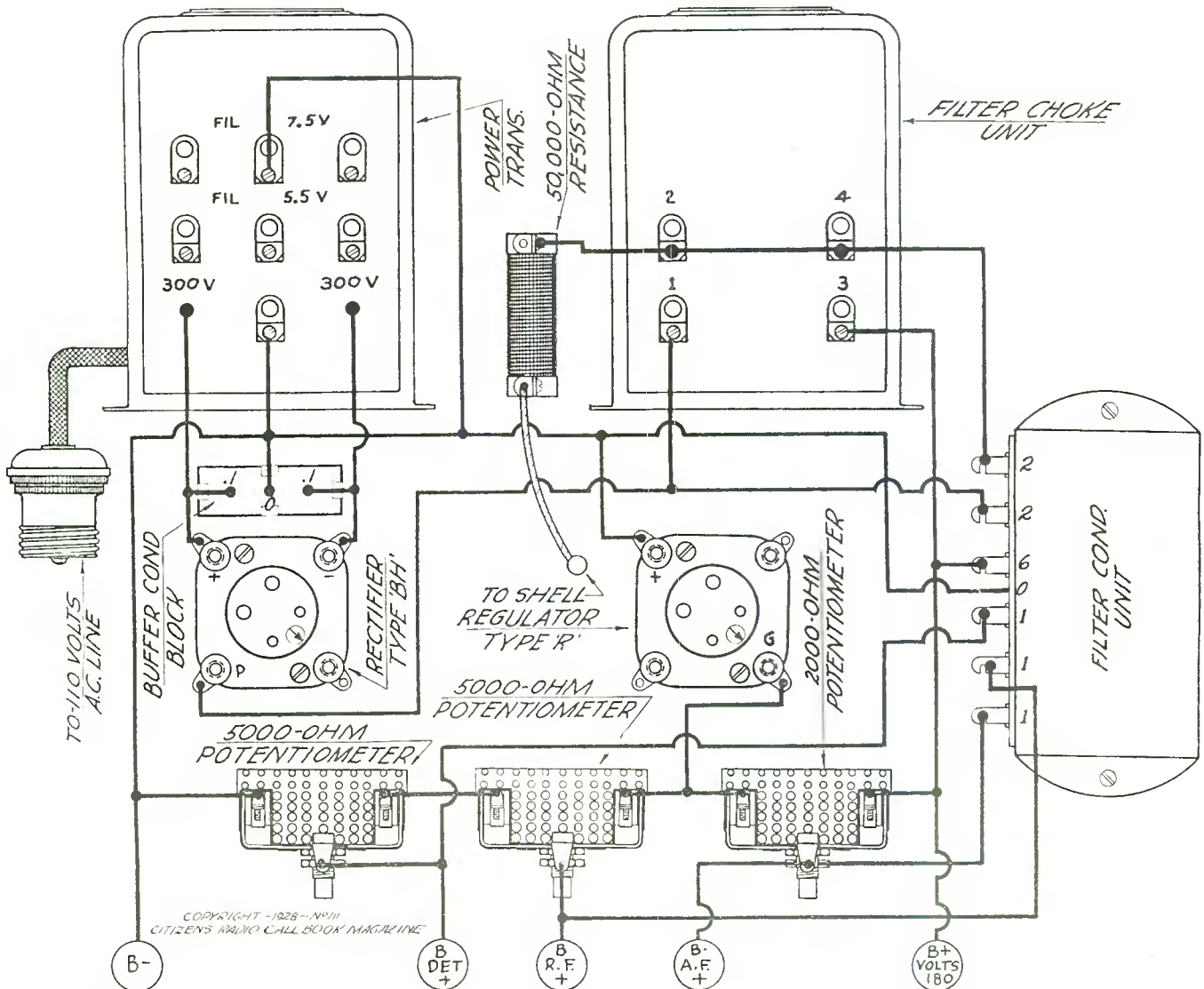

Figure 5. Graphic illustration of the Truvalt power supply is shown above. Note carefully that this diagram is only for the purpose of wiring and does not represent the actual location of the parts, for which data the reader should consult Figure 2



# Harkness Counterfonic Six Uses Tuned Audio Amplification

Receiver Designed to Emphasize Reproduction of Lower Tones  
So Necessary to Proper Harmony

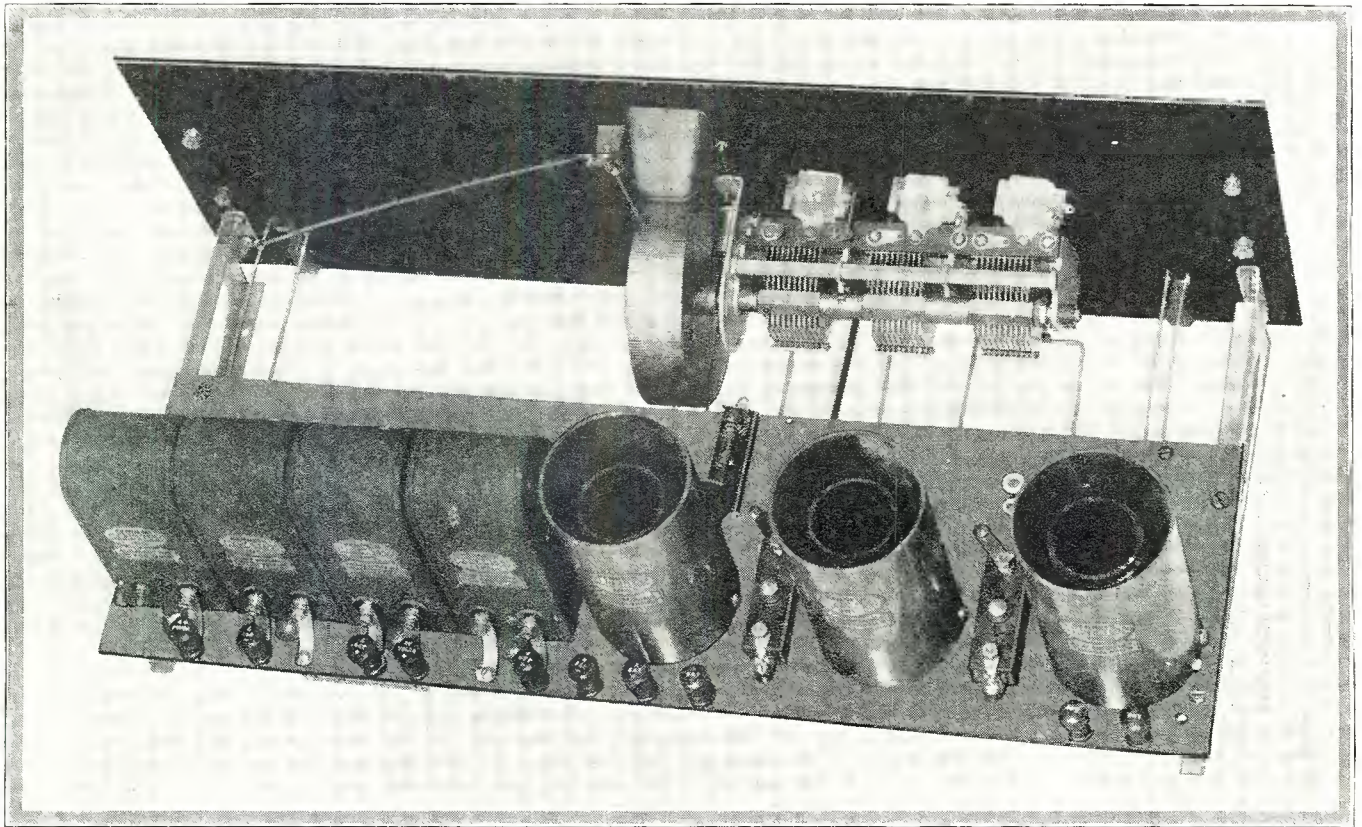

Figure 1. This photographic view shows the Counterfonic after it has been assembled and completely wired. Much time may be saved by virtue of the fact that a good deal of the apparatus is already mounted on the sub-panel

**I**N this article we are introducing a receiving set with tuned audio amplification, known as the Counterfonic Six, the rear of which is pictured above.

The audio amplifier of this set is tuned to emphasize the amplification of low tones below 200 cycles. The purpose of this is to compensate for the inability of some speakers to reproduce these low tones at their natural intensity. The audio amplifier of the Counterfonic supplies additional energy to the speaker at low frequencies and the fidelity of reproduction is thereby greatly improved. Low tones are reproduced at their natural volume. Low-toned instruments, so vitally important to orchestral music, contribute their true share to the resulting harmony of sound. The lower register of the piano is heard just as clearly as the upper register.

#### Method Is Simple

The method of tuning the audio amplifier to obtain increased amplification of low tones is simple. The tuning, of course, is not variable but is fixed by the manufacturer of the audio coupling units. The audio amplifier uses the new "double impedance" method of inter-stage coupling. This is similar to ordinary "impedance-coupling" except that choke coils, or impedances, are used as grid leaks instead of resistances. Each coupling unit contains two choke coils and one coupling or "blocking" condenser, as indicated in the schematic wiring diagram of Figure 7.

Experiments with this system of amplification revealed the interesting fact that each stage of the amplifier can be tuned to resonance at any desired low frequency by varying the capacity of the coupling condenser. The resonant frequency depends upon the inductances of the plate and grid chokes and the capacity of the coupling condenser. By tuning each stage of a three-stage amplifier to a different frequency, increased amplification is

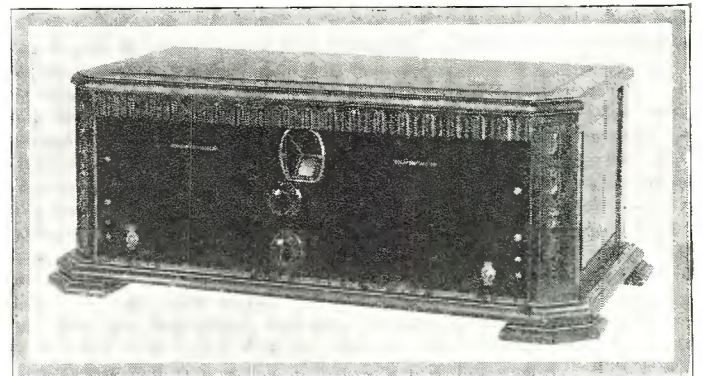

Figure 2. Placed in a Fritts cabinet the Counterfonic receiver is illustrated above



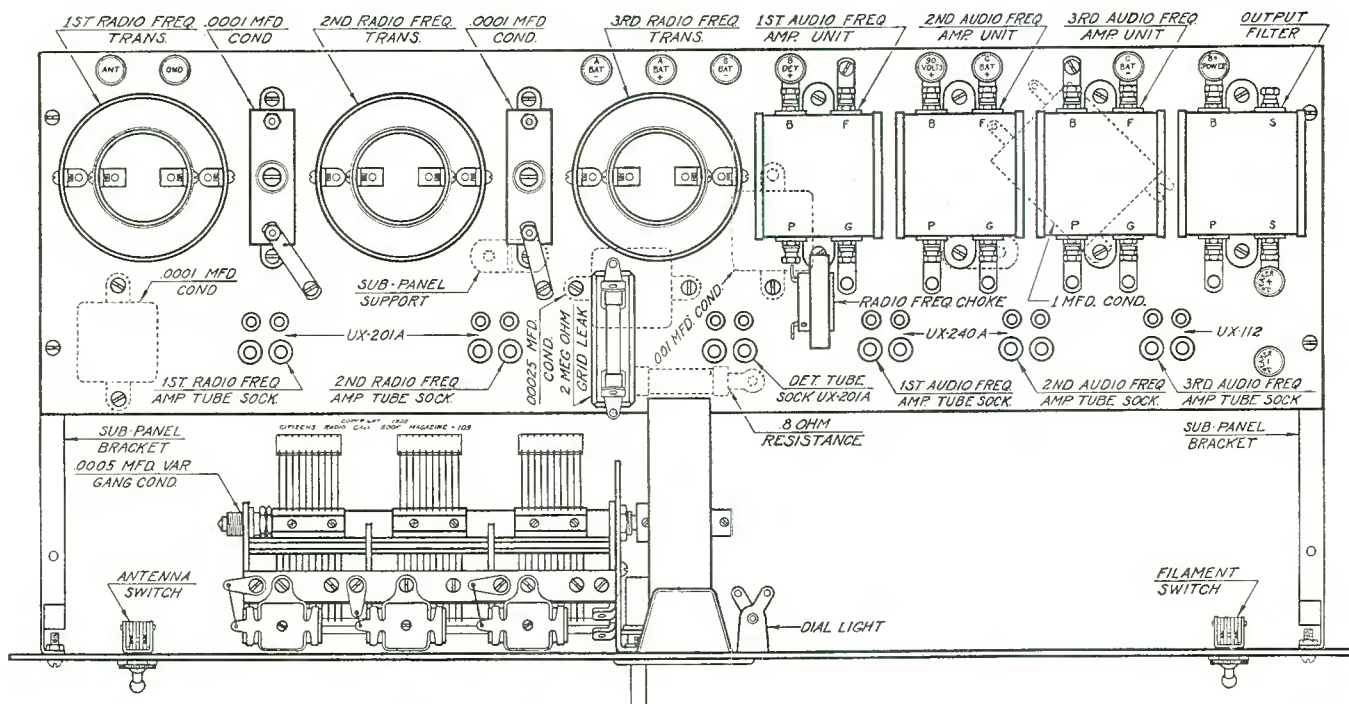

Figure 3. Layout of all parts is shown in the sub-panel illustration above and gives the builder a correct idea of what is shown photographically in Figure 1

given to a wide band of low frequencies.

In the Counterfonic Six the three double impedance audio couplers contain different values of coupling condensers; each stage is resonant at a different frequency. Combined, the three stages emphasize the amplification of frequencies between 40 and 200 cycles. The couplers are marked for use in the first, second and third stages respectively.

From the above paragraphs it will be realized that tone fidelity is the outstanding feature of the Counterfonic Six. The set was designed to give the very best reproduction which recent developments in audio amplification have made possible. When used with a good speaker the set reproduces musical sounds with a high degree of perfection. The speaker output being uniform over the entire range of audio frequencies, every tone, from the deepest bass to the highest treble, is accurately reproduced.

### Large Power Output

While the tuning of the audio amplifier is partly responsible for the tone fidelity of this set, there is another important characteristic of the audio amplifier which is also responsible. This characteristic is the unusually large undistorted power output

which can be obtained. It is recognized that to secure faithful reproduction of musical sounds the audio amplifier must be capable of handling a considerable amount of volume or power without overloading or introducing any other form of distortion. Some amplifiers have good "frequency characteristic curves" but cannot handle sufficient power; hence the tone quality is poor. However, the double impedance audio amplifier of the Counterfonic Six is extremely efficient in this respect.

In all other respects the Counterfonic Six is a highly efficient, up-to-date receiver. The important features of the set may be summarized as follows:

Stations are tuned in by turning a single knob. The radio frequency transformers and tuning condensers are accurately matched and tuning is reduced to a single control without loss of efficiency. After the set has been built the tuning condensers must be again balanced before the set is ready for continuous operation. Slight differences in capacity, caused by the wiring, tubes, etc., must be compensated for. Final adjustment is made with three "equalizing condensers" attached to the main three-gang condenser. With a screwdriver the equalizers are adjusted until the three circuits are in exact resonance. Thereafter no

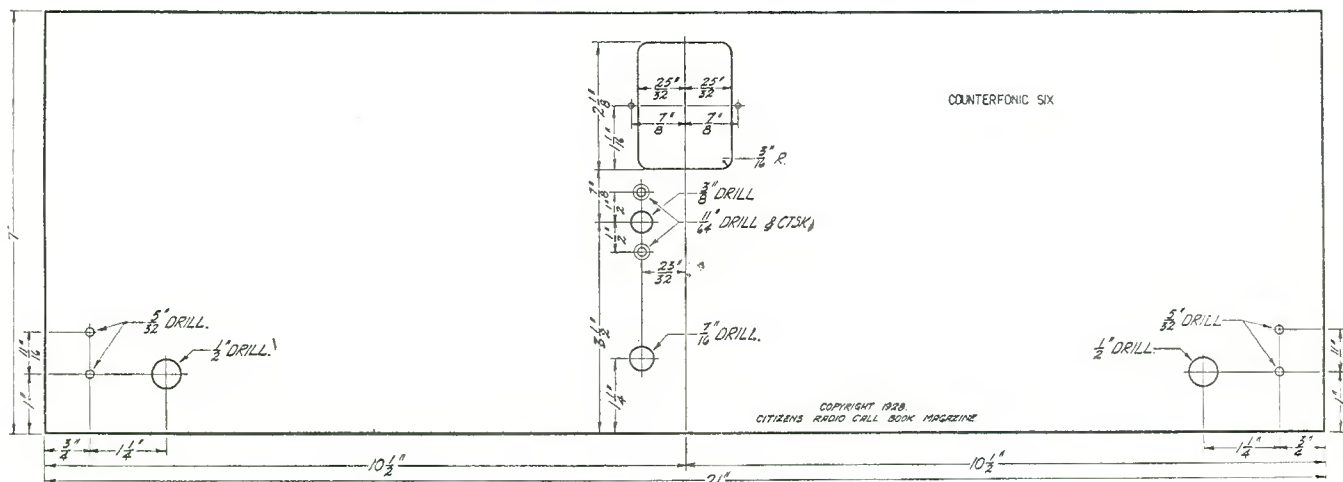

Figure 4. Front panel for this receiver may be made up from the specifications shown on the front panel sketch, although the front panels are available in drilled and engraved form, thus minimizing labor



further adjustment is required and stations are tuned in with the single control.

The Counterfonic is sharply selective. Any local station can be tuned in without interference from other stations on adjoining waves. Some distant stations can usually be tuned in while locals are on the air. The set has two stages of tuned radio frequency amplification and each r.f. transformer is shielded with copper tubing. The transformers are designed to give sufficient selectivity consistent with r.f. gain and good tone quality.

#### R.F. Stages Balanced

Each stage of the radio frequency amplifier is neutralized by a special system, easy to adjust. By neutralizing the r.f. amplifier much higher gain per stage is obtained. The set is neutralized by adjusting two "variocouplers." The maximum capacity of each neutralizing condenser is .0001 mfd. The adjustment is not delicate. It is very easy to find and, once adjusted, the neutralizing condensers need never be varied thereafter. Slight changes in tube capacity do not affect the neutralization.

Under normal conditions the Counterfonic brings in distant stations regularly on the loudspeaker. The overall amplification of the set is unusually large. The r.f. gain per stage of the radio frequency amplifier has been made as high as possible. With high mu tubes in the first two stages of the audio amplifier the voltage amplification of this end of the set is quite high.

The Counterfonic Six can be operated with any type of B-eliminator without any fluttering or "motor-boating." This trouble is automatically eliminated by the audio amplifier of the set. It is not necessary to use chokes, resistances or condensers to stop motor-boating.

It will be noticed that an audio output filter unit is included. This is considered an essential part of the set. Useful in any receiver, a speaker filter is practically essential when tuned double impedance audio amplification is used. Similarly, the radio frequency choke in the plate circuit of the detector tube is essential to prevent r.f. currents from entering the audio amplifier. Without this choke a growling sound is heard when stations are tuned in.

The use of a 1 mfd. condenser between the 90 volt line and B minus is optional. When using B batteries it is sometimes helpful. With B eliminators it is usually not necessary.



Figure 5. This photograph shows the Counterfonic when installed in a Fritts console

#### It's Easy to Build

The Counterfonic is quite easy to build. The parts are arranged on the sub-base in a straight line. This method of construction makes the wiring simple. Special connection strips, supplied with the audio couplers, are used instead of wires to join the terminals of the audio couplers to the plate and grid contacts of the tube sockets and to the binding posts at the rear of the set. Most of the wiring is under the sub-base.

The set uses standard tubes and can be operated with either A or B batteries or socket-power devices. Standard tubes are recommended for the r.f. amplifier stages and detector. In the

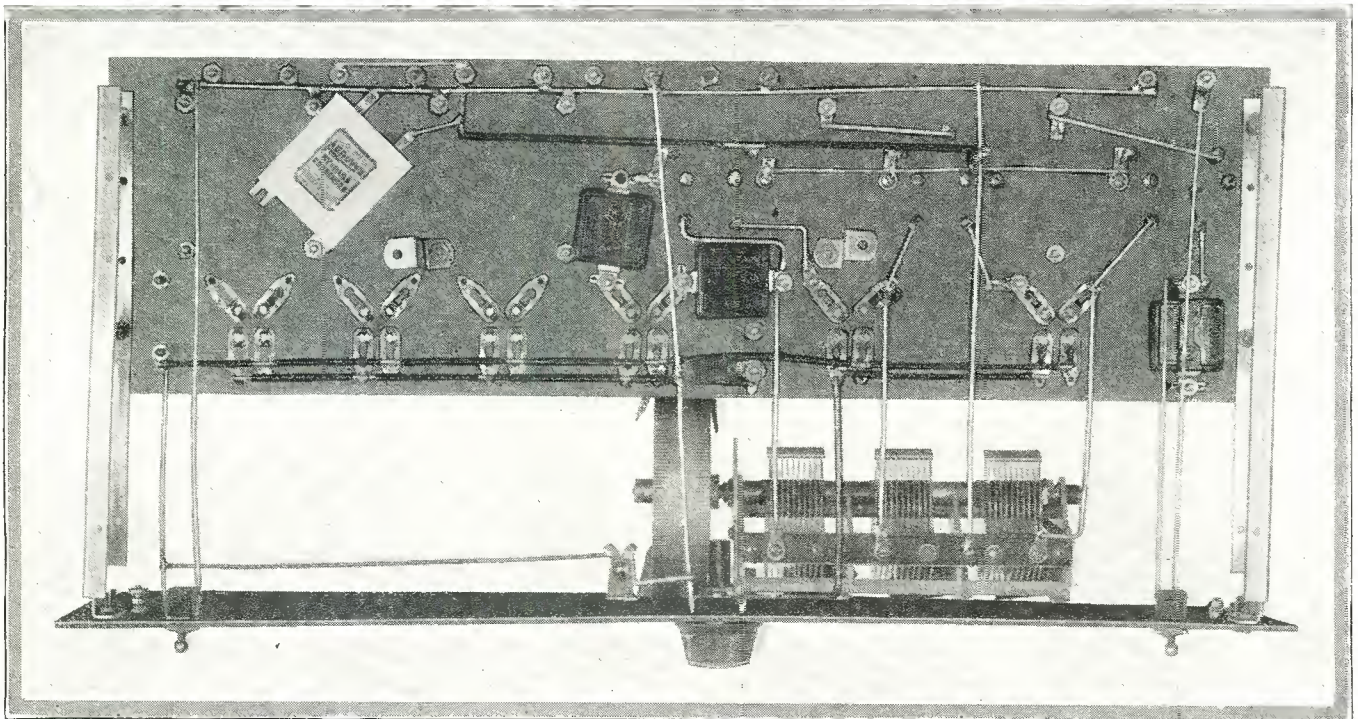

Figure 6. Practically nothing appears below the sub-panel on this receiver and the builder should have no difficulty in making a quick wiring job. For actual wiring, the novice is urged to use the graphic illustration shown in Figure 8, while the more experienced builders may avail themselves of the schematic shown in Figure 7







# Lynch-Hammarlund Five Is Simple and Economical Set

Low Cost Receiver Built Around Assembled Deck and Employs Roberts Circuit with Regenerative Detector

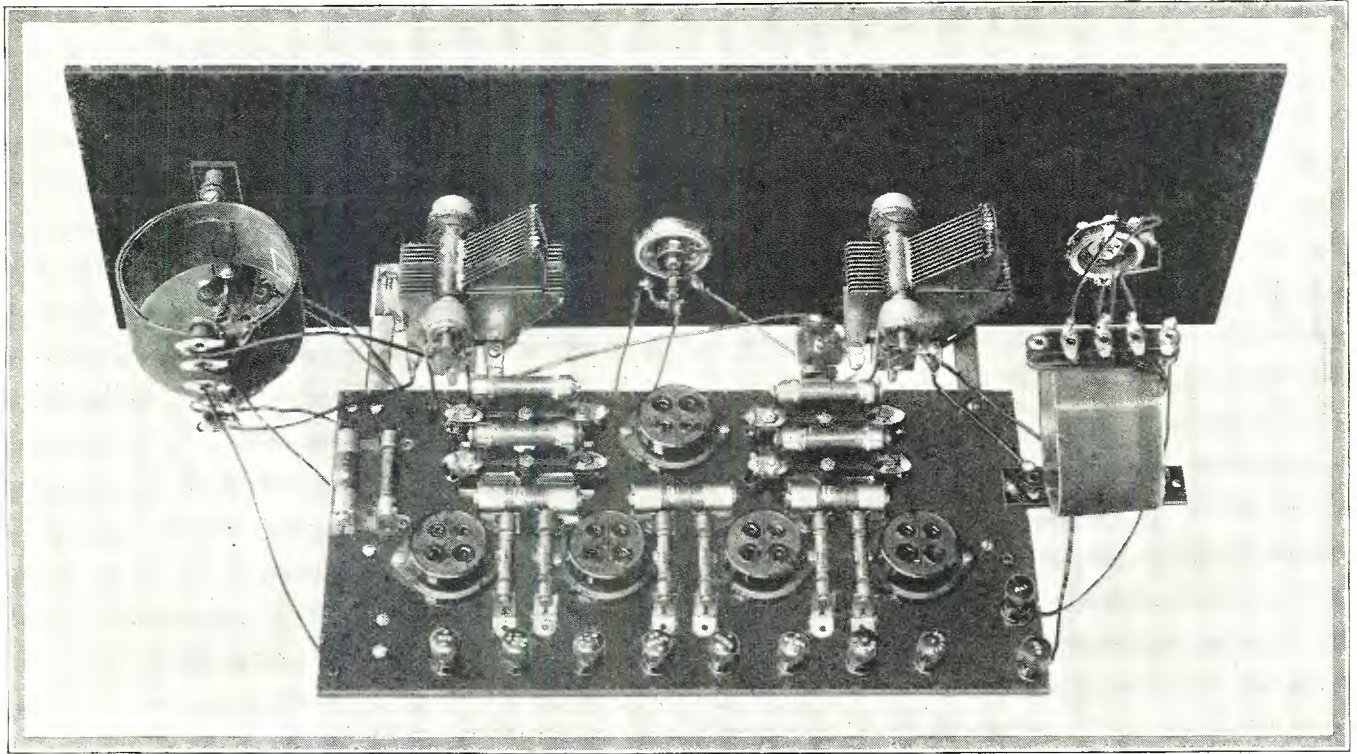

Figure 1. This photograph shows the rear view of the Lynch-Hammarlund Five, from which a clear idea may be gained of the simplicity of assembly. Everything on the sub-panel comes already assembled

Of particular interest to those who are desirous of having an efficient receiver at a low cost, the Lynch-Hammarlund Five illustrated on these pages should prove very acceptable. The receiver consists of a stage of tuned r.f., a regenerative detector and three stages of resistance coupled audio using Lynch resistors. The r. f. stage proper employs a balanced circuit of the Roberts type, whereby a small amount of energy from the plate circuit of the r. f. tube is fed to the grid circuit through a .00002 mfd condenser, which is variable to regulate the amount of feed back. Reference to the schematic circuit in Figure 2 will show on account of the point from which the plate circuit current is drawn, the feed back is reversed so the normal feed back through the capacity of the tube elements is balanced out. For this reason the circuit, when properly adjusted, will not oscillate and is extremely stable.

### Simple Layout

Important considerations in this receiver are simplicity of layout, assembly, wiring and cost. Simplicity is accounted for by the fact the sub-panel or deck includes, when purchased, the five tube sockets, three coupling resistors, four grid resistors, three coupling condensers and the grid condenser. Thus the whole audio amplifier is completely assembled ready for wiring.

Tube equipment for the receiver consists of special purpose tubes throughout, Ccco type K for the r. f. tubes, type H for the detector, two type G high Mu for the first and second audio stages and a type F power tube for the last stage.

After all wiring has been rechecked, A and B supplies may be

connected and tubes placed in the set. Turn the two tuning control knobs slowly and approximately together until the station is heard. Then readjust each one slightly until maximum volume is secured. Keeping the station tuned in, turn the screw of the balancing condenser in or out until a position is found where oscillation is at a minimum. During this process the two tuning controls should be varied to keep the station tuned at a maximum. During this adjustment keep the tickler coil turned all the way down (counter-clockwise), so regeneration will not be confused with r. f. oscillation in the balancing process.

This receiver is but one of the combinations that are possible utilizing the Lynch deck, also described elsewhere in the editorial section of this issue.

### List of Parts

The parts used for its construction are as follows:

- 1—Lynch five tube De Luxe kit which includes the following:
  - 1—Lynch .00025 mfd cartridge type fixed condenser
  - 3—Lynch .006 mfd cartridge type fixed condensers
  - 1—Lynch .2 megohm metallized resistor
  - 3—Lynch .1 megohm metallized resistors
  - 3—Lynch .5 megohm metallized resistors
- 5—Eby universal sockets
- 1—Micarta 6x12x3/16-inch sub-panel
- 4—Sets special mountings

All of this material is completely assembled on the sub-panel ready for wiring.

(This receiver constructed, tested and all illustrations made in our laboratory)



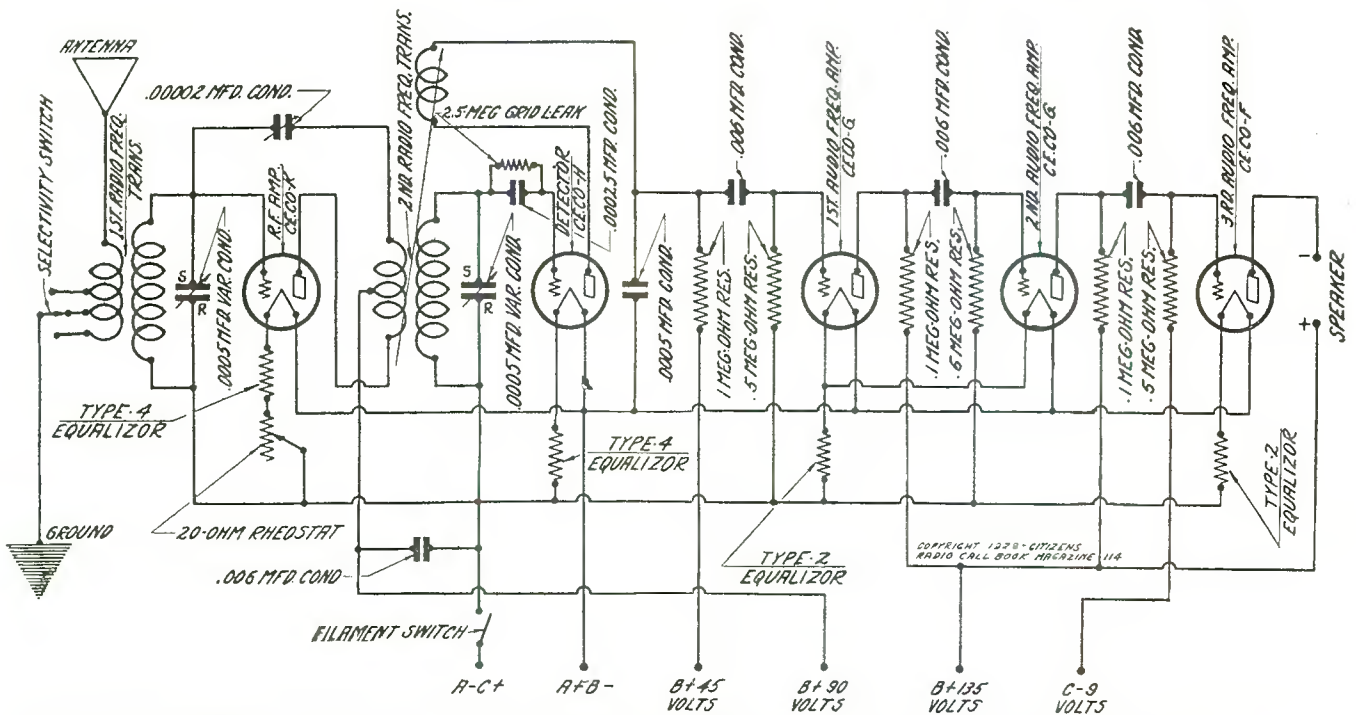

Figure 2. Schematic circuit of the Lynch-Hammarlund Five is shown in the diagram above and represents a receiver comprising one stage of tuned r. f., regenerative detector and three stages of resistance coupled audio

- 2—ML-23 Hammarlund .0005 mfd variable condensers
- 1—EC Hammarlund equalizing balancing condenser
- 1—601 Dubilier .0005 mfd fixed condenser
- 1—601 Dubilier .006 mfd fixed condenser
- 2—.4 Lynch equalizers
- 2—.2 Lynch equalizers
- 1—M-20-S Carter 20 ohm rheostat with switch
- 1—404 Carter inductance switch
- 1—11R-23 Hammarlund antenna coupler
- 1—TCT-23 Hammarlund coupler coil
- 1—Micarta 7-21x3/16-inch drilled and engraved panel

- 2—8629 Benjamin sub-panel brackets
- 2—192 Marco vernier dials
- 10—Eby engraved binding posts
- 20—Feet Acme Celatsite wire
- 1—Package Kester radio solder
- 1—Ekko ground clamp
- Miscellaneous—screws, nuts, lugs, etc.
- 1—Ceco type K tube
- 1—Ceco type H tube
- 2—Ceco type G tubes
- 1—Ceco type F tube

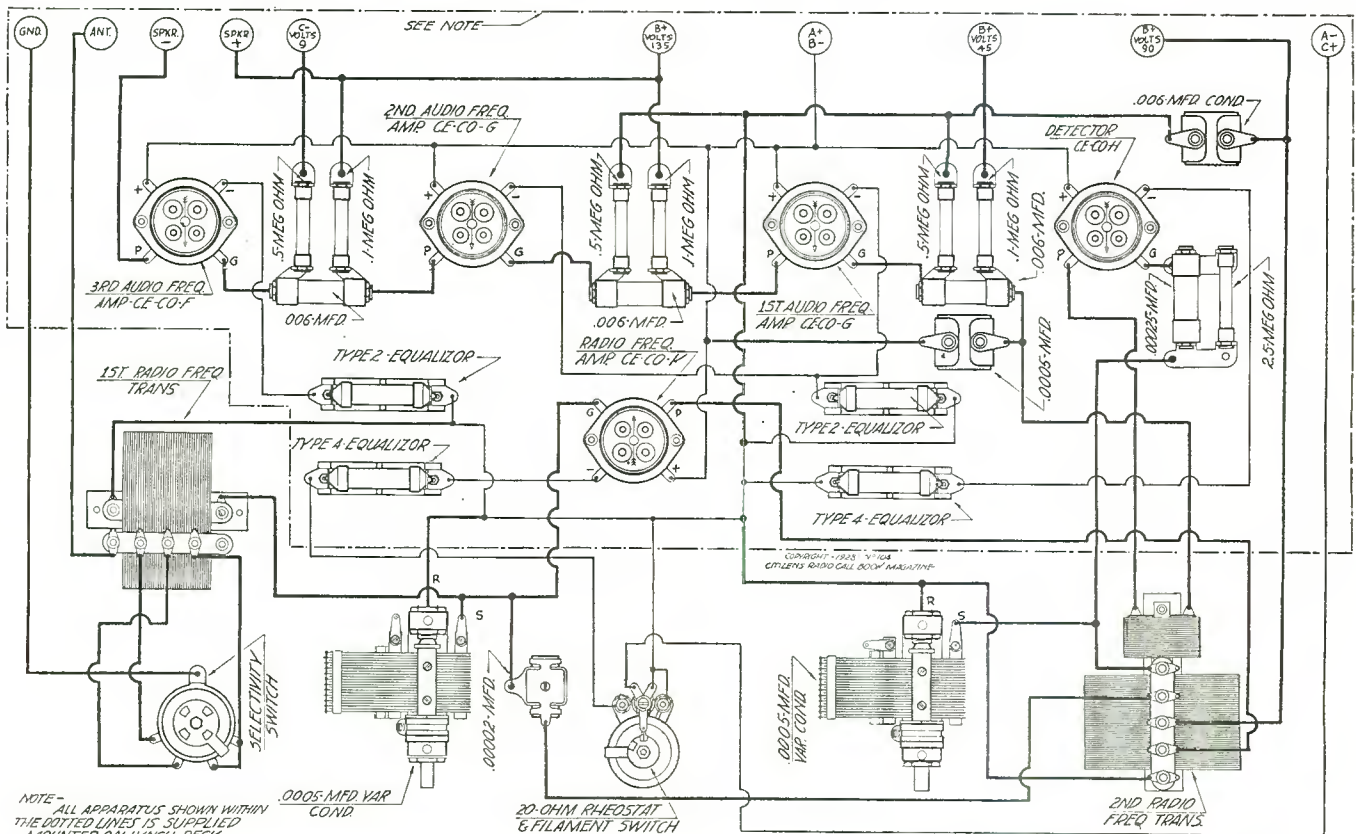

Figure 3. The above graphic diagram makes it easy for the constructor to readily wire up the receiver described in this article. All apparatus shown within the dotted lines is supplied mounted on the Lynch deck



# Power Six Is Now Converted for Alternating Current Use

Popular Bremer-Tully Kit Receiver Designed for Operation from Current Mains

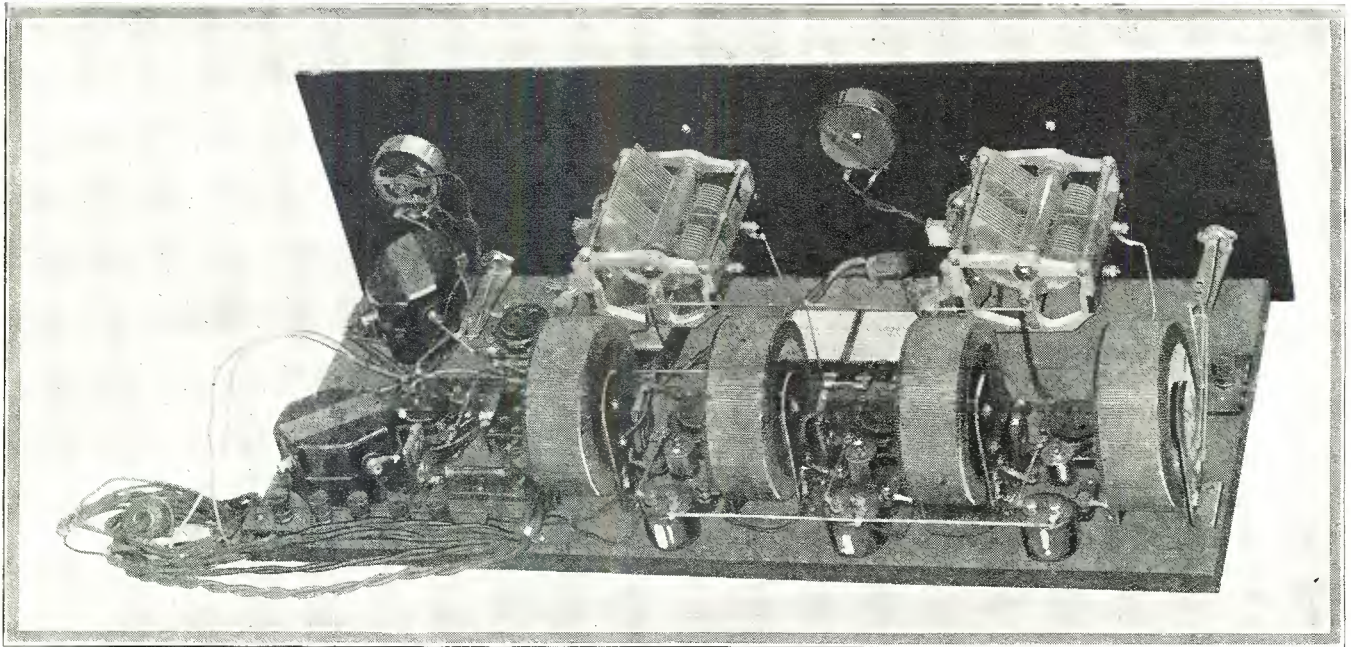

Figure 1. Rear photographic view of the Bremer-Tully Power Six Electric. The bunched wires at the left rear of the baseboard are for the filament leads from the A transformer

A HOST of experimenters, fans and set builders will be interested in the recent conversion of the Bremer-Tully Power Six for electric operation, using type 226 and 227 a.c. tubes. Many of those who have constructed previous models of this receiver, which were battery operated, may find it expedient to change over to the electric form of operation as is described in the accompanying article.

With the exception of the filament wiring and the volume control, there is not a great deal of change in the standard hook-up. Of course, the detector in this receiver is a 227 type, having the heater elements and a cathode so that this particular socket position in the receiver is different from the previous type in that it utilizes a five prong base instead of the conventional four.

The older fans in the experimental field will remember the basic idea underlying the Counterphase receiver, but for the benefit of the many newcomers we will analyze the schematic circuit shown in Figure 3.

Antenna coupling to the first tube, which is a 226, is by means of a primary with two taps, one equivalent of a short antenna and the other of a long antenna. In the particular model which was tested in our laboratories the change from long to short antenna is accomplished by means of a three point jack switch. These two degrees of antenna coupling are provided to allow the operator's adjustment of his receiver to the selectivity and sensitivity requirements of his own individual locality and antenna. Since the switch controls the taps on the primary coil, it is obvious that the amount of energy fed from the antenna into the set is thereby governed. The secondary of this Torostyle is spanned by one section of a .00035 mfd tandem condenser, on which is provided a .000027 mfd compensator for balancing out any slight inequalities due to difference in wiring between the

first and second r.f. tuned circuit. The secondary of the Type TA Torostyle has a tap for the use of a .00003 mfd Mikro Mike condenser in series with the counterphase winding, this auxiliary circuit serving to stay the tendency of the tube to oscillate.

#### Parallel Plate Feed Used

Instead of the first tube being coupled to a succeeding r.f. amplifier in the usual transformer method, this circuit makes use of an impedance coupling to a succeeding tube, represented in the schematic by a coil consisting of three windings, a .006 mfd coupling condenser and an r.f. choke. The winding of this third circuit Torostyle may be described as follows: terminal M to F is the counterphase or balancing winding, terminal P to F is the primary, while terminal G to F is the conventional secondary, of course, in this case having a tap for the counterphase circuit by means of which receiver stability is assured. Thus an examination of the schematic will show there are four tuned circuits governed by the use of two tandem condensers. Each of these sections of the tandems has its own compensator capacity, by means of which it is possible to balance all four circuits to a nicety. There are three auxiliary circuits involved in the receiver for oscillation prevention and these are represented by the M to F connection on the three Torostyles together with the three separate .00003 mfd Mikro Mike condensers, adjustment of which will be described later in the article.

Whereas in previous models the volume control has been a series resistor in the 90 volt lead to the r.f. plates, this form of control has not been found satisfactory when using alternating current tubes and as a result another method of connection has been devised and is represented in the schematic circuit by the 25,000 ohm variable resistance placed between the P terminal of

(This receiver tested and all illustrations made in our laboratory)





Figure 2. The completed receiver is shown installed in a Fritts console

the third r.f. transformer and the M terminal of the same transformer. This gives a smooth method of volume control, since the resistor is not called upon to handle any current.

In the detector circuit, where a 227 tube is used, a .00025 mfd grid condenser is used with a two megohm leak from the grid of the tube to the cathode connection, which is also common with the negative B, positive C power, ground and one end of a 625 ohm fixed resistance spanned by a 1 mfd condenser and going thence to the center tap of an 8 ohm fixed resistance placed across the 1½ volt a.e. filament terminal. This common connection also has a 1 mfd condenser between the B minus and the center of a second 8 ohm resistance placed across the 2½ volt a.c. filament terminal. The B minus connection shown in also common with the center tap of a 40 ohm resistor across the 5 volt a.e. terminals and provides the bias for the first audio stage, the bias

for the second one provided through the minus C power shown in the schematic. The primary of the detector circuit is by-passed by a .006 mfd condenser from plate to B minus. Two stages of audio coupling are used, the last tube being a 112 power tube, although a 171 may be used if desired.

These two audio couplers have been somewhat redesigned so as to give a constant impedance, which effect is gained by the use of a third or auxiliary coil in the audio coupler, this serving to give greater audio amplification without oscillation or distortion. In case the 171 tube is used with the receiver in the last stage, it is recommended that a speaker coupler be used to eliminate the possibility of damage to the speaker windings on account of the high voltage. The C battery value for the operation of the 171 power tube will run between 30 and 35 volts negative, whereas with the 112 a 9 volt dry cell will suffice.

Uses Baseboard Assembly

In building the receiver the baseboard should be of dry wood, shellacked or lacquered. Inspect all sockets carefully before mounting to insure against defects. Test all fixed condensers for short circuits before connecting. Parts which are mounted on the baseboard should be placed according to the baseboard layout diagram in Figure 4, and each part should be examined carefully to make certain that all apparatus is in perfect condition before proceeding to wire. It is recommended the Torostyles be mounted last, so as to avoid damaging them while putting in the preliminary connections. Cut and fit wires carefully before soldering so as to have a neat and finished receiver. Do not rush the wiring, as haste is likely to cause carelessness and, of course, carelessness is not a desirable factor in the building of sets. In the wiring of the filament circuit no conductor smaller than No. 16 should be used. Preferably No. 16 light weight electric light cord should be employed for the leads from the A transformer. In the wiring of the receiver it will be simpler if the filament wiring is completed first. Be sure to allow sufficient length of the lamp cord for the distance from the socket to the A power transformer, but do not exceed 3 feet in length on account of the possibility of voltage drop due to the increased resistance of the longer conductor. It would be advisable to mark each cable with the proper voltage to prevent error when connecting to the A transformer.

Connect stator terminals of variable condensers to the grid terminals of the detector and r.f. sockets, as shown in the graphic, making at the same time all connections to grid terminals on all sockets. Inasmuch as all wires connected to the grid

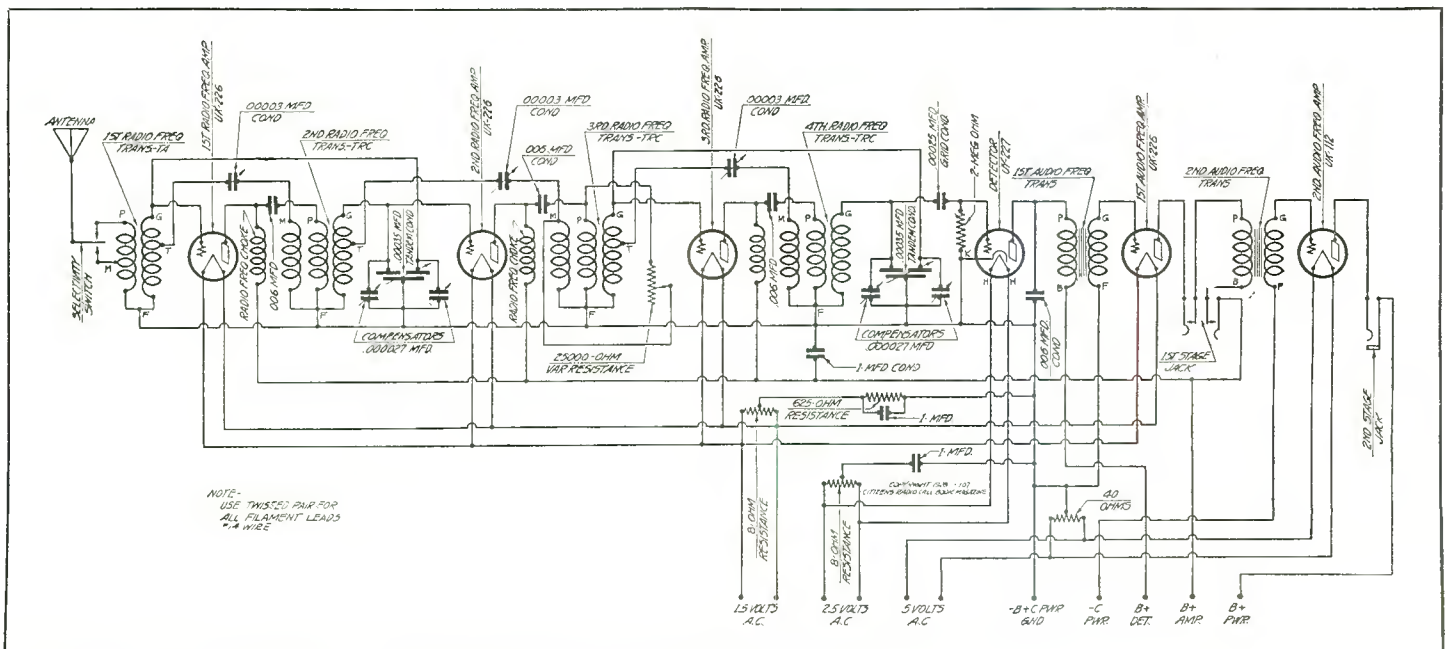

Figure 3. Above is the electric circuit for the Power Six Electric. This schematic may be used by those who are accustomed to wiring by this type of diagrams, whereas the novice should consult Figure 4 and Figure 6, the latter being the one to follow for simple wiring



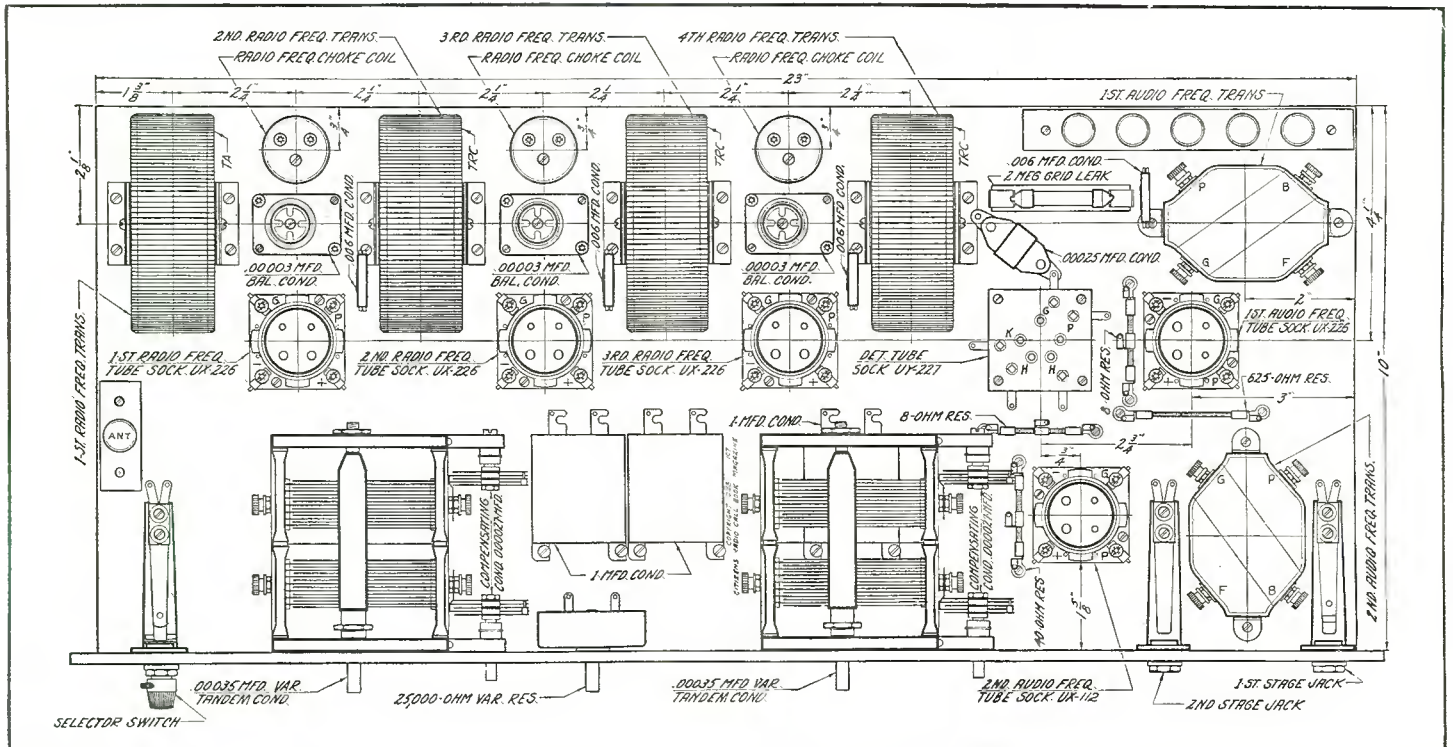

Figure 4. Baseboard layout of the Power Six Electric is illustrated in the drawing above. The front panel length is 24 inches and for that reason the baseboard should be 23 inches so as to allow a half inch at each end in case it is desired to place the receiver in a cabinet from the top. If the cabinet used is of a type where the set may be slid in from the front, then the 24 inch baseboard may be used

terminals of all sockets are highly potential, relatively, they should be made as direct and as short as possible. Also all other wires should be kept as far from grid wires as possible, especially those wires connecting to the plate terminals of all sockets. The detector grid condenser should be installed very close to the socket grid terminal, this also being advisable for the connection of grid resistance from grid to cathode.

#### Recheck Your Work

After the receiver is completely wired, the wiring should be rechecked very carefully before connecting to the power units. Tests against short circuits or wrong connections may be made by means of a voltmeter and a C battery, using the schematic diagram for reference. For greatest simplicity in control of the power, it is recommended the 110 volt switch for tuning on and off the power transformer be installed on the panel. The electric light cord from the B power unit should be plugged into the receptacle of the A power transformer. The set power switch will now operate to turn on and off both the A and B power units. After turning on the receiver, one tube should be inserted at a time, so in case of a wrong connection this fact may be determined before all tubes are placed in the set.

After checking all connections in your A and B power units, connect the antenna to the antenna position and connect the ground wire. Turn on power supply. Adjust volume control full on and tune in a station for rotating the two tuning dials at approximately the same reading. In order to adjust the tuning dial rotate the condenser so the rotor plates are just full in and flush with the stator plates of both condensers. With plates in this position, adjust both pointers to the maximum wavelength reading shown on the dials and attach them to the condenser shafts in this position.

After the wiring in this receiver has been made very carefully and apparatus spaced as shown in the baseboard layout, the proper setting of the Mikro Mike condensers will be approximately at full upward traveling of the inside or movable cylinders of these condensers. This inside cylinder moves freely when adjustment screw on top is turned, and great care should be exercised not to force the screw beyond the upper edge of the cylinder, which would result in injury to the condenser. Another way

of easily describing the proper position for these Mikro Mikes is to state that maximum results will be secured when the lower edge of the inside cylinder is about 1/16 of an inch above the upper edge of the outside cylinder. (This will not hold true, however, if there has been a deviation in placement of parts or in wiring.) Now tune in a signal at about 400 meters and adjust all four trimmers or compensator condensers to a position where the rotors are half in and half out. Reduce volume to a low point and tune signal very carefully, adjusting rear right hand trimmer condenser from full in to full out, leaving at a position giving greatest volume. Do likewise with the rear left trimmer condenser. Adjust both of the panel trimmer condensers for greatest volume. This position may be considered permanent except for tuning of weak signals when operation of the panel trimmers will facilitate sharp tuning. In cases of interference, these panel trimmers are quite useful.

#### Phonograph Pickup

If desired, the set may be operated in conjunction with an electric phonograph pick-up, an open circuit jack and a volume control being required for this purpose. In this case the jack for the phonograph connection is placed with the frame of the jack being connected to the P terminal of the first audio transformer and one side of a volume control, the center of the volume control being connected to the B terminal of the first audio transformer the switch connection on the volume control goes to B+

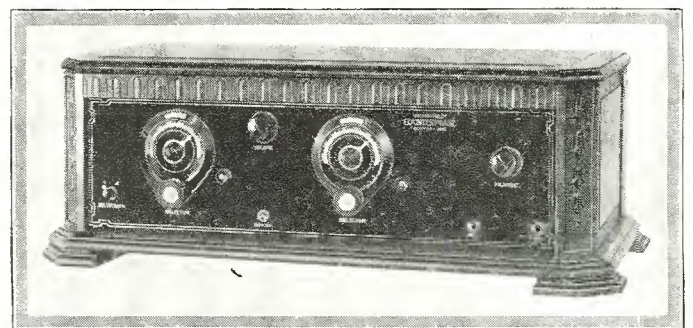

Figure 5. This photograph shows the Bremer-Tully Power Six Electric placed in a Fritts cabinet



detector, the remaining connection on the volume control going to the spring of the open circuit jack used for the phonograph pickup arrangement. This method of connection is made necessary by the fact that on account of using a five prong socket for the 227 tube, the present phonograph pickup plugs will not fit. Another virtue of this arrangement is the fact that the phonograph pickup may be permanently attached to the set and operated any time by simply turning the phonograph volume control toward the right. This volume control may be placed in the same position as used for the rheostat in the original Power Six. When the special Bremer-Tully phonograph control is turned as far as possible to the left, it disconnects the phonograph and connects the radio circuit. Referring to Figure 1 will show the builder the location of the phonograph volume control at the extreme left of the panel, looking from the rear.

While the foregoing article has been written particularly for those who are building the present kit receiver, it is felt that some mention should be made of the manner in which the Power Six can be converted for alternating current operation. Two of the chief differences between the electric model described in this article and the previous battery operated receiver, which was described sometime ago in the columns of this magazine, lie in the use of a five prong socket for the type 227 detector tube, the fifth prong representing the cathode connection on the tube, while the two filament connections are for the heater; the other variation being the elimination of the series resistance formerly used in the 90 volt lead to the plates of the three r. f. transformers and the substitution of the volume control method previously outlined in these paragraphs. Another point of departure lies in the fact that where in the battery operated receiver separate grid resistors were used in the grid circuit of the first, second and third stages, in the electric model this has not been considered necessary, since the receiver balances very easily and gives excellent radio frequency amplification. It should be noted that parallel plate feed is used in all the r. f. stages to eliminate any possibility of regeneration due to the common B supply. This feature, however, was also included in the battery operated model and its success has warranted its retention in this electric model.

In converting the battery model to the electric type, the first, second, third and fifth sockets are wired in parallel for 1½ volts a.c., with an 8 ohm fixed resistance across that supply. The

fourth socket, which is the detector, is wired for 2½ volts a.c. and also has an 8 ohm fixed resistance across its supply. The sixth tube, the power stage, is wired for 5 volts a.c. and has across that supply a 40 ohm fixed resistance. By comparing the schematic circuit shown in Figure 3 the owner of a battery operated model can readily observe the points of difference between this diagram and the one by means of which he wired his previous set.

List of parts required for the construction of the receiver previously described is as follows:

1 Bremer-Tully Power Six A.C. kit consisting of:

- 1—TA B-T Torostyle transformer
- 3—TRC B-T Torostyle transformers
- 2—LD-17 B-T .00035 mfd tandem variable condensers
- 3—B-T radio frequency chokes
- 3—B-T .00003 mfd Mikro Mike condensers
- 1—B-T 625 ohm fixed resistance
- 1—B-T 40 ohm center tap fixed resistance
- 2—B-T 8 ohm center tap fixed resistances
- 1—K-25 B-T 25,000 ohm volume control
- 1—Filament cable clamp

Other parts required:

- 1—A B-T power transformer
- 1—3-31 B-T audio coupler
- 1—2-22 B-T audio coupler
- 2—B-T dials
- 1—104 Carter double circuit jack
- 1—101 Carter single circuit jack
- 1—Carter three point jack switch No. 3
- 5—Standard sockets
- 1—Five prong socket
- 1—Cortlandt 7x24x3/16-inch panel
- 1—10x23x½-inch wood baseboard
- 4—601 Dubilier .006 mfd fixed condensers
- 1—642 Dubilier .00025 mfd grid condenser
- 3—656 Dubilier 1.0 mfd by-pass condensers
- 1—Dubilier 2 megohm grid leak
- 6—Eby engraved binding posts
- 30—Feet Acme Celatsite wire
- 1—Package Kester radio solder
- 1—Ekko ground clamp
- 1—B-T S 890 phonograph control (optional)

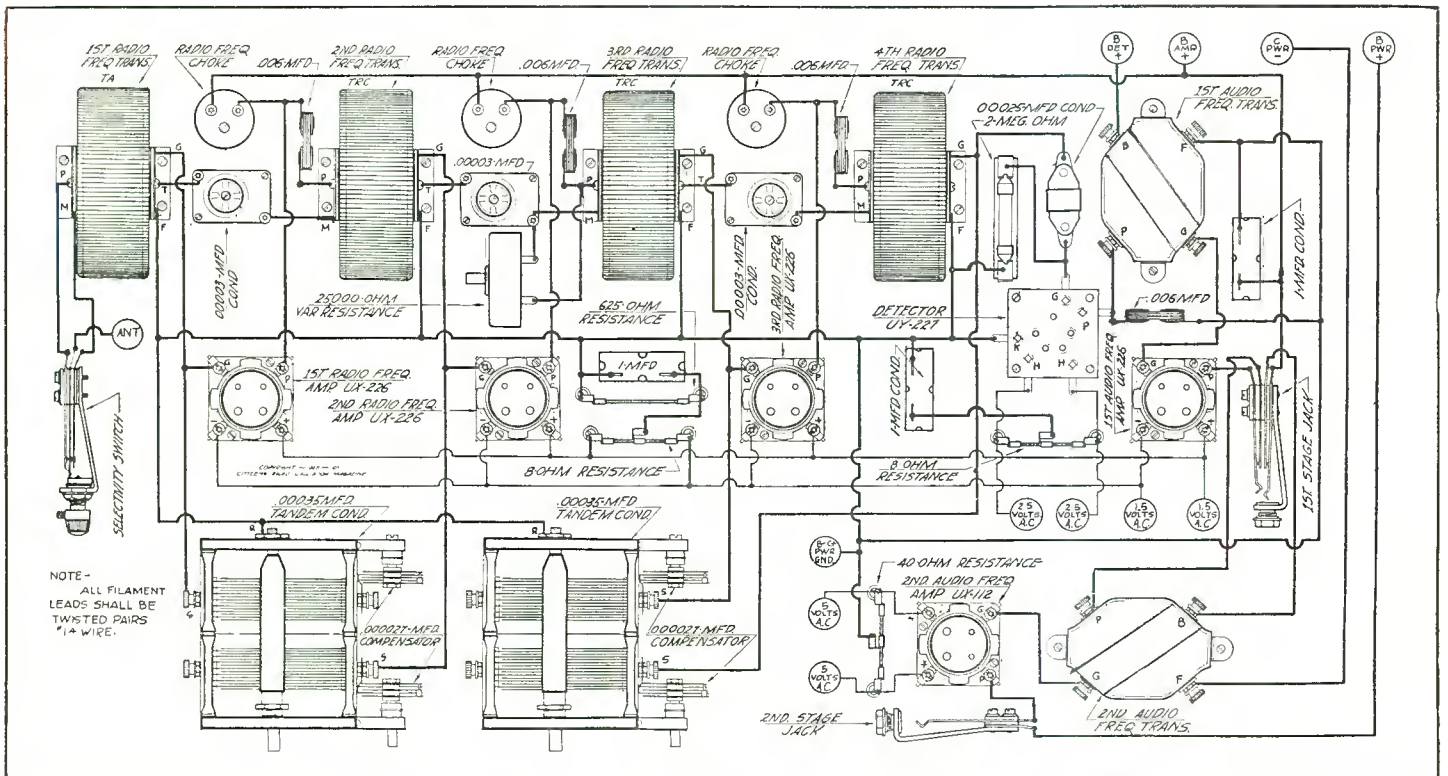

Figure 6. This graphic diagram will enable even an inexperienced builder to construct the receiver described in this article. It should be noted, however, that the parts for this set should be placed on the baseboard in accordance with Figure 4, while the set should be wired in accordance with the graphic shown above



# R. F. Circuits Are Stabilized in Phasatrol DeLuxe Seven

Two-Dial Control Serves to Tune Four Radio Frequency Stages;  
Receiver Has Push-Pull Audio

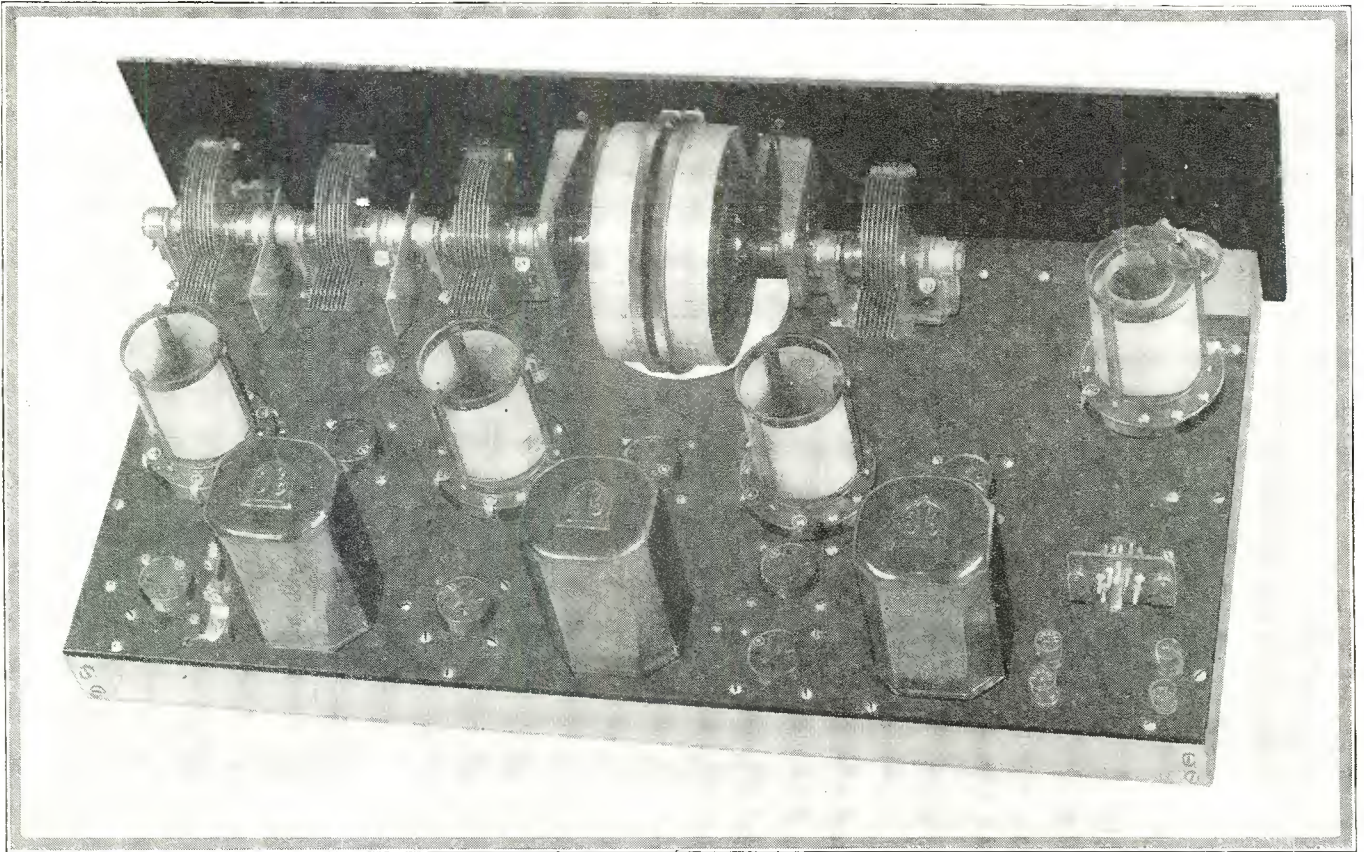

Figure 1. The above photograph shows the simplicity of assembly of this receiver. All inductances are generously spaced and electrostatic shields are provided on the three gang condenser shown at the left in the photograph

MUCH of the difficulty encountered in the operation of simple tuned radio frequency receivers has been due to the fact that when a fairly high voltage is applied to the plates of the r. f. amplifiers, these tubes exhibit a strong desire to go into oscillation. In the customary series resistance arrangement for the prevention of oscillation, the drawback has usually been the fact that not all tubes were giving their proper amplification because a single series resistance had to operate two or more tubes. The ideal condition, of course, would be a separate resistance in each radio frequency plate circuit so that full advantage might be taken of the individual amplification of each tube.

#### Phasatrol Used

This control is now available in the form of a Phasatrol made by Electrad and which is used with considerable success in the receiver described herein. Essentially the Phasatrol consists of a variable resistance and a fixed condenser mounted inside of a bakelite container. By its inclusion in the circuit a normal transformer coupled radio frequency transformer becomes in effect an inductive impedance coupled arrangement. Plate current reaches the tube (see schematic) through the resistance lying between terminal B and P of the Phasatrol unit, while radio frequency current passes through the fixed condenser into the primary 1

and 4, from which it is induced into the secondary circuit. In operation the Phasatrol unit for each tube is set at that value which is below the oscillation point and remains fixed for a given set of tubes. If the receiver is balanced on 45 volts and then the voltage is changed to 90, it is natural that the setting of the Phasatrol units will have to be altered. However, in the receiver described here, which has been tested in our laboratories, the plate voltage on the radio frequency stages has been kept at 90 and all balancing made for that value. As a matter of fact, the amplifiers work better when given a higher plate potential than with a lower one.

Inductances in the Phasatrol DeLuxe are the Aero radio frequency transformers and Aero antenna coupler, the latter having a variable primary so advantage may be taken of the different operating conditions and to change the selectivity of the set at will. The first tuned stage is operated from a single .0005 mfd variable condenser, while the second and third radio frequency stages and the detector are tuned by three Hammarlund .0005 mfd variable condensers ganged together on a common shaft. This gang arrangement has two electrostatic shields, which may be seen by referring to the photograph shown in Figure 1.

#### Has Push-Pull Audio

Audio amplification is a push-pull arrangement utilizing Tyr-

(This receiver tested and all illustrations made in our laboratory)



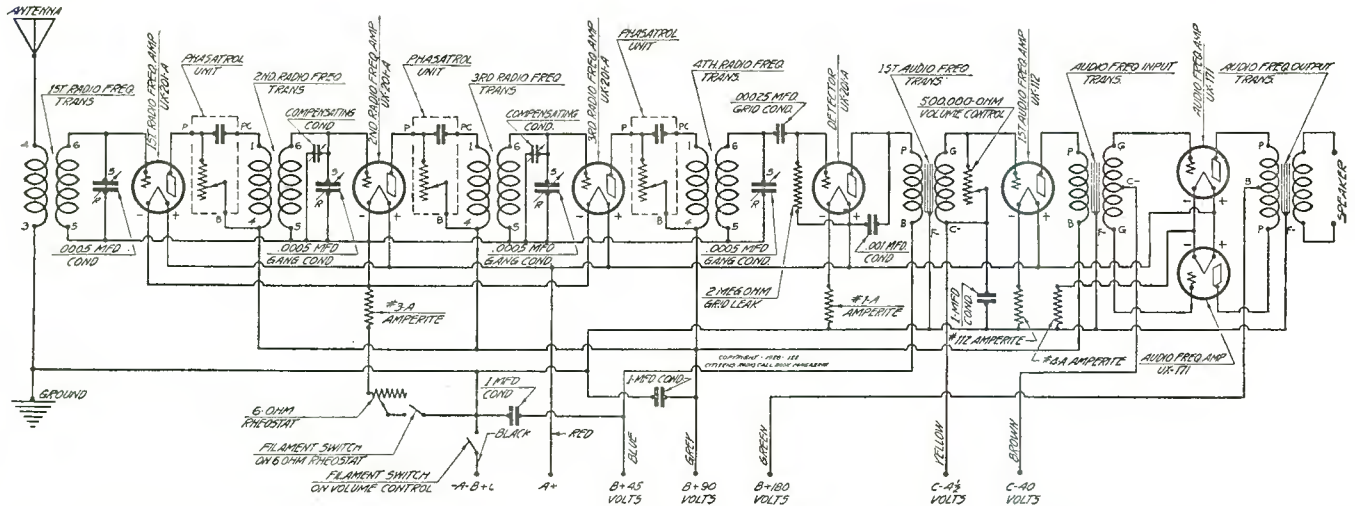

Figure 2. Electrical connections of the Phasatrol DeLuxe Seven may be found by consulting the schematic diagram given above

man input and output audio transformers, two 171's being used for push-pull in the last stage, the first audio using a 112. The output transformer, of course, has a winding from which the speaker is operated. Audio volume control is secured by means of the 500,000 ohm Tonatrol placed across the grid and C minus terminals of the first audio transformer. Since the Phasatrol units are not considered in the light of controls which are used while tuning, these have been placed on the sub-panel, where they may be adjusted and then left undisturbed. Their location is shown in the sub-panel layout illustrated in Figure 3. Inspection of Figure 3 will also show the location of the two compensating condensers which are used as a means of trimming the three stages which are ganged together on a common shaft. This balancing is necessary on account of the slight difference in wiring, but after the stages are once balanced it is not necessary to change those capacities.

**Automatic Filament Control**

Filament control is partly automatic and partly manual. The fixed stages are first, second and third radio frequency tubes placed on a No. 3-A Amperite in series with a 6 ohm rheostat.

By this means even if the rheostat is turned all the way on, the tubes cannot be operated at a higher value than their normal filament rating. The detector circuit filament is supplied through a 1-A Amperite, the first audio through a 112 Amperite and the two 171 tubes arranged for push-pull are taken care of by a 4-A Amperite.

Plates of the radio frequency stages are furnished with 90 volts. The detector plate voltage is 45 volts. The first audio plate voltage is the same as that of the radio frequency, being 90 volts, while the two tubes arranged for push-pull feed from a 180 volt source. Only two C bias values are specified, 4½ negative being supplied to the grid of the first audio while 40 volts negative is given to the grids of the tubes arranged for push-pull.

Builders, who are interested in making this receiver, will find it is a very stable one and to possess good quality reproduction. All of the necessary parts should be placed on the sub-panel in accordance with the drawing shown in Figure 3. It will be observed that ample space is allowed between inductances and transformers, while the condensers are lined up in such a manner as to reduce as much as possible the length of leads from the inductances to the condensers. Wiring of the receiver may

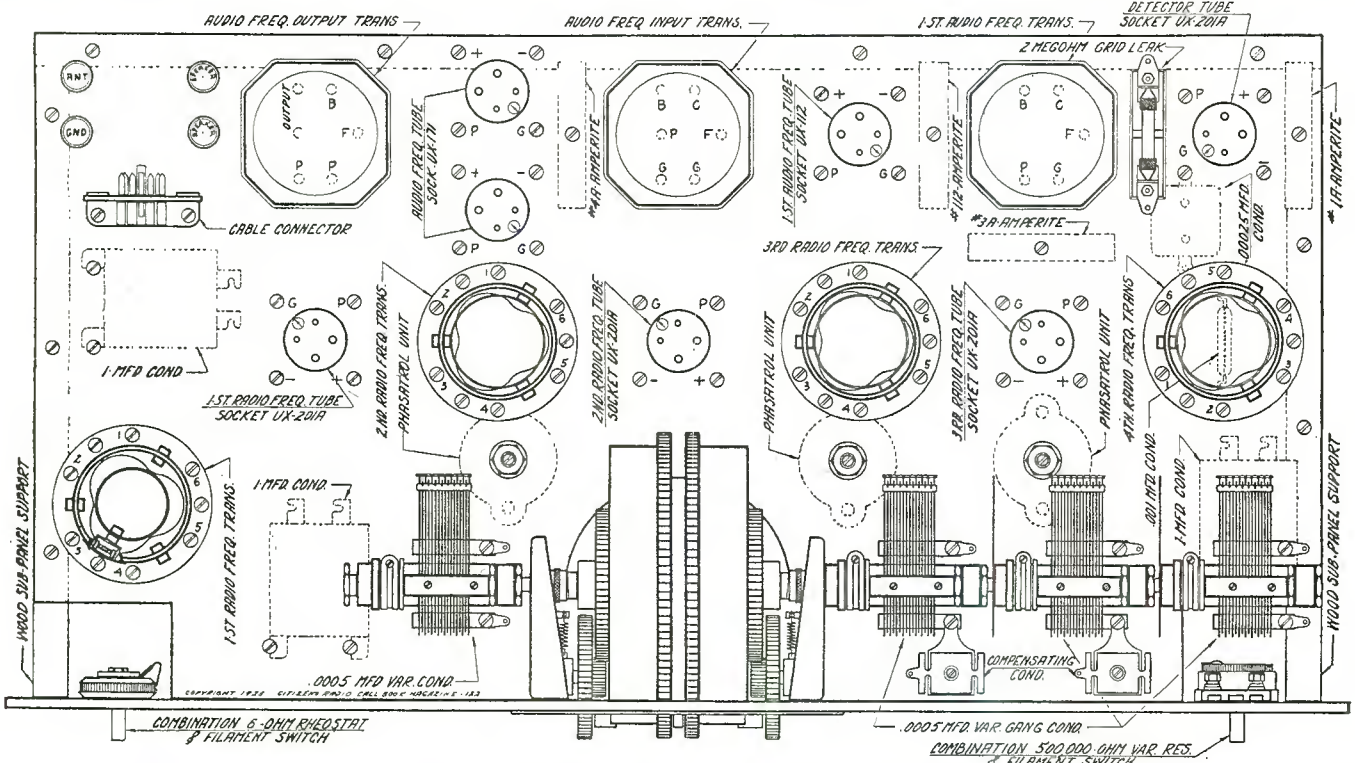

Figure 3. This illustration represents the actual placement of parts on the sub-panel and should be followed carefully as regards position of the various units



be accomplished by following either the schematic circuit shown in Figure 2 or the graphic illustration shown in Figure 7, the latter being preferable for those who are not certain as to the exact manner of hooking up the various units.

While the Phasatrols are placed underneath the sub-panel, a hole is allowed for the shaft to come up above the sub-panel, which shaft is adjusted when putting the receiver into operation by means of a small wooden rod pointed like a screw-driver. In actually connecting the Phasatrols in the circuit a wire is run from P of the desired tube to the P terminal on the Phasatrols, while the B terminal of the Phasatrol is connected with terminal four of the succeeding transformer and then connected to terminal B of the Phasatrol and terminal four of the transformer beyond. This same method of connection is carried out on all stages, so that we have in effect three resistances supplied from the single plate voltage of 90 volts. The PC connection on the Phasatrol goes to terminal one on each succeeding radio frequency transformer. The matter can be understood a little more clearly by referring to the schematic, which gives the electrical method of connection.

#### Flexible or Solid Wiring

Either solid or flexible wire may be used for hooking up the receiver, depending very largely upon the taste of the builder. While the laboratory model was assembled with flexible wire, it perhaps does not give as clean a looking job as if the work were to be undertaken with solid wire. However, one of the virtues of flexible wire lies in the fact that connections may be considerably shortened from point to point and in some cases this may be desirable. As will be observed by referring to Figure 4, which is the photographic view of the under side of the set, all bypass condensers, the Amperites and the Phasatrols are located on the bottom side of the sub-panel. A cutout is made on the sub-panel in order to allow the Tyrman dials to be located without touching the sub-panel. The cable plug is located on top of the sub-panel and may be seen by referring to the photograph in Figure 1, or the sub-panel layout illustration in Figure 3. The latter diagram also shows the location of the grid condenser and grid leak, the leak being above panel, while the condenser is below panel and attached directly to the grid terminal of the detector socket. Suitable binding posts are provided for antenna and ground con-



Figure 5. In this photograph the completed receiver is placed in a Fritts console

nections, as well as the speaker connections.

It is quite necessary that care be exercised in wiring up any receiver and this set should be no exception to the rule. After all of the wiring has been done, the builder should go over every connection and check it against the graphic illustration or the schematic, depending upon his ability to read diagrams. All soldered connections should be well made and if there is any question as to the tightness of connection, it is better to do it over rather than to allow it to remain loose and a possible source of trouble later. Make sure that the iron is quite hot so that you do

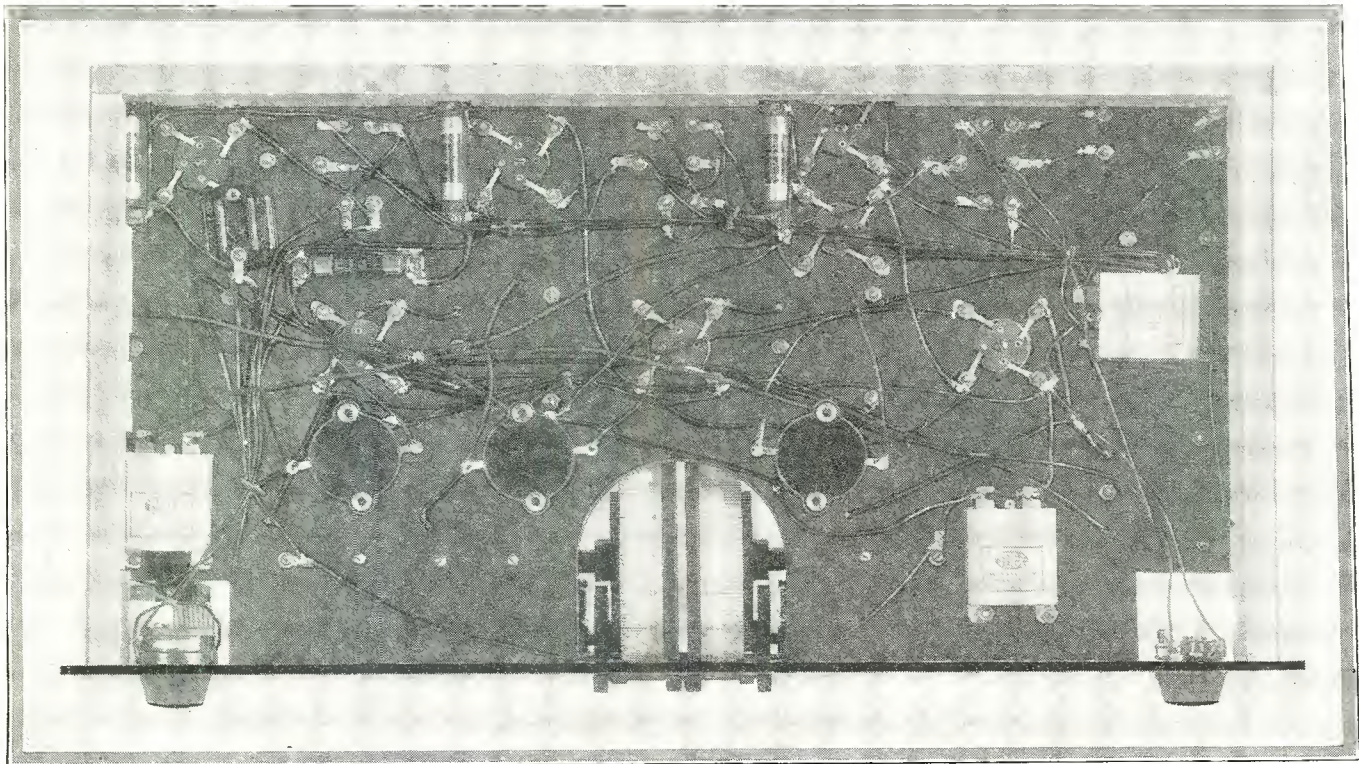

Figure 4. Photographic view of the bottom of the sub-panel. On account of flexible wire being used in this receiver, it has been possible to make connections from point to point. If solid wire is used in hooking up your receiver, the appearance of the under side would be more symmetrical but not necessarily any more effective



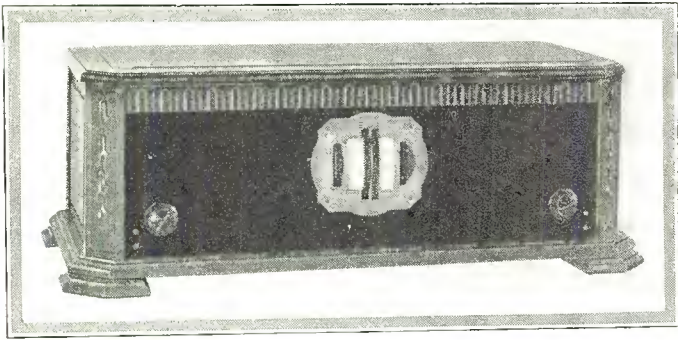

Figure 6. A Fritts cabinet is here shown with the Phasatrol DeLuxe Seven

smooth operation is gained over all stages. This is a very simple matter and should not take much of the operator's time.

The parts used for the construction of this receiver are as follows:

- 4—Hammarlund .0005 mfd variable condensers
- 2—Hammarlund balancing condensers
- 4—Aero r.f. transformers
- 1—Tyrman double vernier dial
- 1—Tyrman audio transformer
- 1—Tryman push-pull input transformer
- 1—Tyrman push-pull output transformer
- 7—9044 Benjamin sockets
- 1—660 Yaxley cable plug
- 4—Eby engraved binding posts
- 1—Lynch 2 megohm grid leak
- 1—Electrad grid leak mounting
- 3—Electrad Phasatrols
- 3—Tobe 1 mfd by-pass condensers
- 1—1-A Amperite
- 1—3-A Amperite
- 1—4-A Amperite
- 1—112 Amperite
- 1—Sangamo .00025 mfd grid condenser
- 1—Electrad Tonatrol with switch
- 1—Carter 10 ohm Imp rheostat with switch
- 1—7x24x3/16-inch Cortlandt front panel
- 1—12x23x3/16-inch Cortlandt sub-panel
- 30—Feet Acme Celatsite wire
- 4—Sontron 201A types tubes
- 1—Sontron 112 type tube
- 2—Sonatron 171 type tubes
- 1—Ekko ground clamp
- 1—Package Kester radio solder
- Miscellaneous—lugs, nuts, screws, etc.

not have what are termed "rosin joints," which appear to be solid connections but which is reality are not.

Putting Set in Operation

When operating the receiver, it will be found that the two drums are run about the same, inasmuch as the variable condensers and the inductances are pretty well balanced. However, in the case of the antenna drum, which is at the left, it is quite likely that various antenna and ground conditions may make sufficient difference in tuning, and that the first dial will either lead or lag the second one. However, this can be remedied to some extent by altering the position of the variable primary. Maximum signal strength will be secured on the antenna stage when the primary is down within the upper edge of the secondary, while least signal strength will be secured when the coil is pulled out as far as it will go. The receiver should be balanced on a station about mid-way between the upper and lower broadcast band, the Phasatrol units controlling each stage, being shifted one at a time until

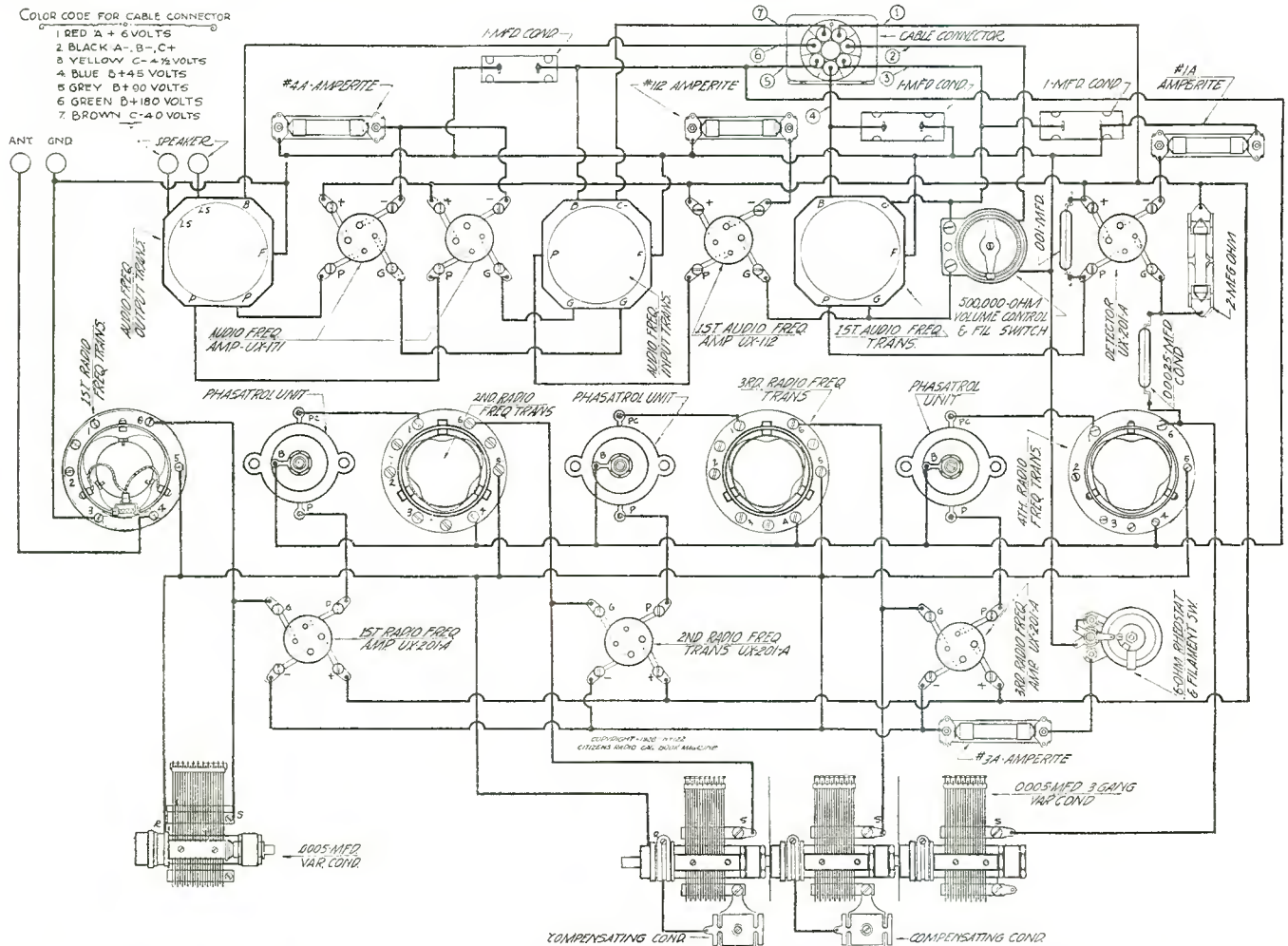

Figure 7. Above may be seen a graphic representation of the receiver. Connections should be made exactly in accordance with this diagram, although parts should be placed on the sub-panel as laid out in Figure 3



# Converting Aerodyne Six to A. C.

CONSTRUCTION of the Aero-Dyne Six for use with the new 226 and 227 a.c. tubes is a relatively simple matter.

By reference to the circuit diagram shown in Figure 1 it will be seen proper terminal voltage values are shown. No reference to the type of filament or plate supply unit is made. The reason for this is that individual set builders will probably have their own likes to be guided by in these items. The filament supply transformer should be one having windings giving 1.5, 2.5 and 5 volts. The unit supplying "B" voltage may be dry cell blocks or any high class type of "B" eliminator.

The wiring for the filaments of the tubes may be either twisted pair or bus bar wire. Bus bar will make a neater job and it is sufficiently large enough to carry the relatively large current without appreciable voltage drop. It will be well to run the wires parallel to each other and as close as possible.

Perhaps a word of caution regarding the filament voltages of the a.c. tubes will not be amiss. These tubes are extremely delicate and will not stand higher voltages than their prescribed rating for any length of time. It is preferable to make use of a low voltage a.c. voltmeter but in the absence of this, the minimum voltage with which satisfactory operation of the tube can be secured is used.

The layout and general construction of the a.c. operated Aero-Dyne is practically identical with that of the battery operated Aero-Dyne 6 shown in our November issue. The 6 ohm potentiometer is located on the sub-panel just behind the first condenser. The one-fifth ohm rheostat is mounted on the panel.

A Yaxley cable is used to connect the filament transformer to the appropriate circuits in the receiver. The connector plate is mounted just to the left of the 171 socket on the rear of the sub-panel. Wires colored green and slate are used for the 1.5 volt line, brown and red wires carry the 2.2 volts for the heater of the 227 and the black and yellow wires are for the 5 volt winding. The blue wire is not used.

Besides this Yaxley cable, eleven binding posts are used and they should be mounted in the order shown on the circuit diagram. The receiver has been stabilized against oscillation and the correct voltages as bias for the 226 tubes is specified as a negative 12 volt bias. If it is desired the receiver be operated nearer the oscillating state reduction of the negative bias to a value of about 9 volts should accomplish the desired result. A negative voltage of 40 is used for biasing the 171 tube.

When putting the receiver in operation, the 6 ohm potentiometer located on the sub-panel just to the rear of the first tuning condenser should be adjusted for minimum hum.

Below is a list of parts necessary for the construction of the receiver:

- 1—Aero-Dyne foundation unit
- 1—Aero U-16 kit of coils
- 2—S-M drum dials
- 2—S-M type 220 audios
- 5—S-M No. 511 sockets
- 4—Hammarlund .0005 condensers
- 2—Tobe 1 mfd. condensers
- 1—Tobe 2 meg. grid leak
- 1—Polymet E-Z grid leak mounting
- 1—.00025 mfd. Carter condenser
- 1—.001 mfd. Carter condenser
- 1—.0015 mfd. Carter condenser
- 1—One-fifth ohm Carter rheostat
- 1—0-200,000 ohm Carter variable resistor
- 1—Yaxley cable No. 660
- 2—Yaxley 6-ohm resistances
- 2—Yaxley 3-ohm resistances
- 1—Yaxley 300-ohm resistance
- 1—Yaxley 6-ohm potentiometer
- 1—Benjamin 5 prong socket
- 11—X-L lettered binding posts

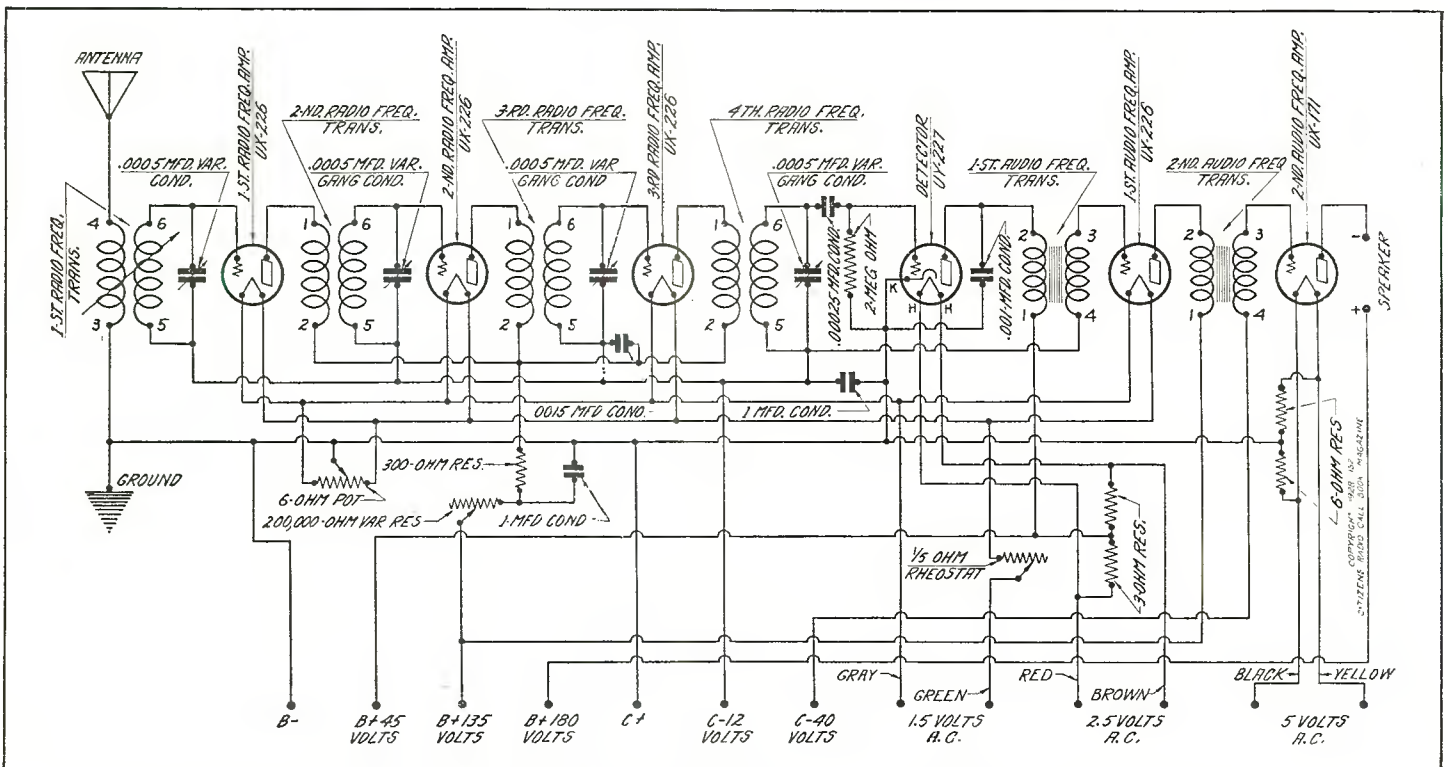

Figure 1. Schematic circuit of the Aerodyne Six arranged for electric operation is shown in the above drawing

(This receiver tested and all illustrations made in our laboratory)



# Tyrman Amplimax Is Designed for New Shield Grid Tubes

First Model of Seven Tube Superheterodyne Takes Advantage of Tremendous Tube Amplification

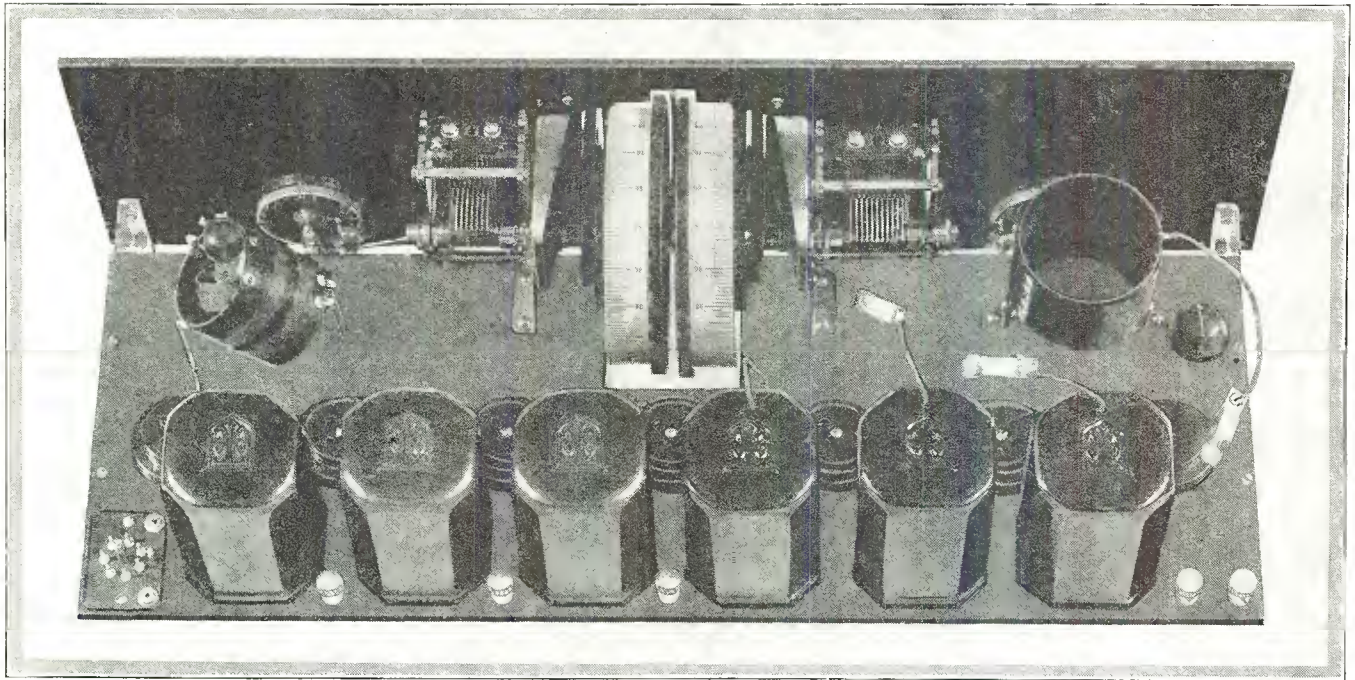

Figure 1. Rear view of the completed Amplimax Super on which extensive development work has been done in our engineering laboratories. In this photograph the tube shields are removed, to give the reader an idea of all the component parts

HAVING published the first article in the field on the actual construction of a receiver utilizing the latest tube developments in the form of the shielded grid tubes in our November issue, in the interest of superheterodyne fans we are in position to describe the first superheterodyne using this tube.

Our engineering laboratories have done considerable development work on this particular circuit and the results have been very gratifying, both from the actual operation of the receiver as well as from the standpoint of economy in the number of tubes.

In the presentation of a super of this type it has been necessary to utilize coupling forms which work with the highest efficiency in the use of the shield grid tubes. Whereas in the conventional superheterodyne intermediate stages, with which our readers are quite familiar, the transformer coupling is used, in the Amplimax it has become necessary to resort to an impedance coupling in order to take advantage of the maximum amplification of the new tubes. In addition to this it has been necessary to thoroughly shield not only the impedance units but the shield grid tubes as well. The extent to which this shielding is carried governs entirely the question of whether or not the circuit used will oscillate. Naturally oscillation is not desired and for that reason the shielding must be of a high order. On account of the average builder's inability to produce a well shielded unit from assembled parts, it has become necessary for the manufacturer to develop the complete impedance unit within its shield, this unit being shown in Figure 6. The intermediate frequency selected for operation on these impedance units is 350 kilocycles, which serves to eliminate repeat points. Also on account of the comparatively high intermediate frequency a range of only 950 kilocycles is necessary for the oscillator and for that reason a .00025 mfd condenser can be used for tuning the



Figure 2. The receiver shown in a Corbett console

(This receiver tested and all illustrations made in our laboratory)



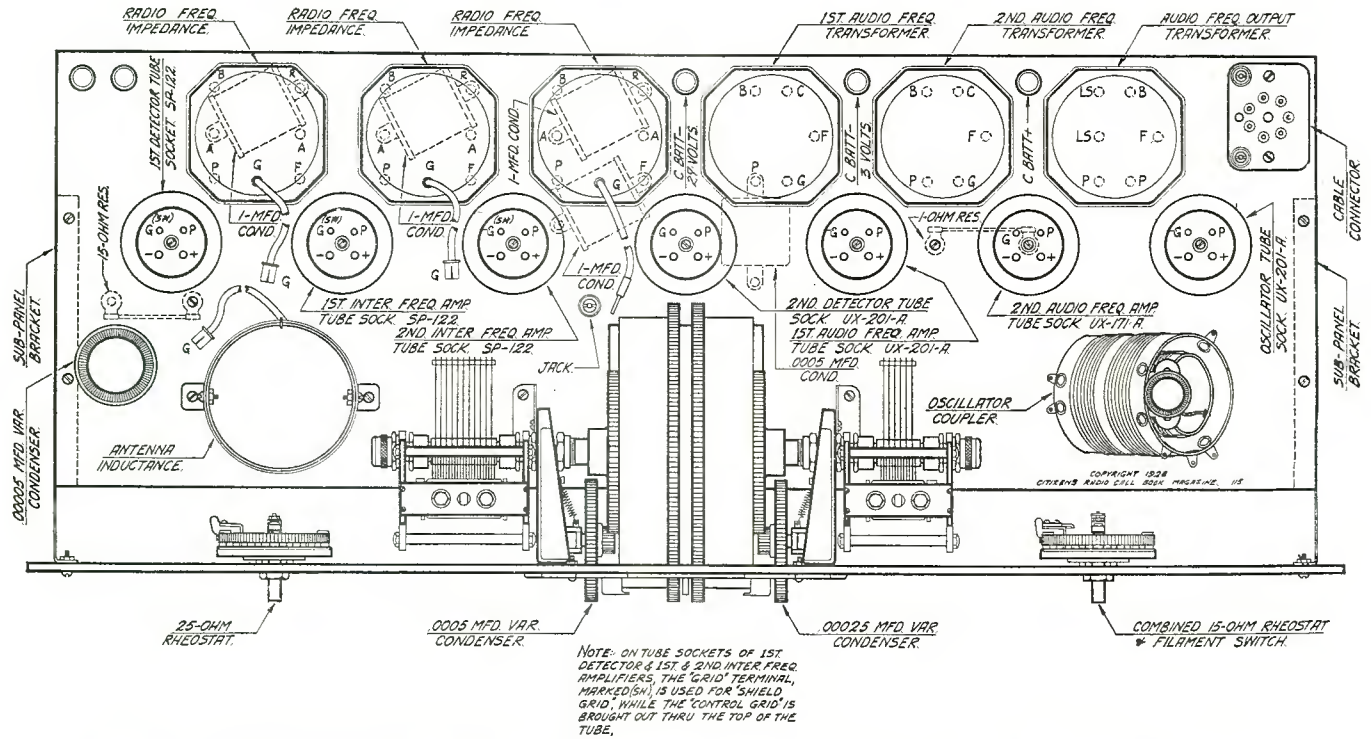

Figure 3. This sub-panel layout shows the manner in which all parts of the Amplimax are disposed

oscillator circuit.

Referring to the schematic circuit shown in Figure 7, it will be noticed that a .00005 mfd midget condenser is placed in the antenna circuit, which is necessary in view of the very short aerial which is recommended for this receiver. In laboratory tests a 2-foot antenna was found sufficient for normal purposes, while an 8-foot aerial sufficed for distance work. These values of antenna length will probably differ in accordance with the specific location in which the builder finds himself, probably a longer aerial being required for one who is in a highly shielded locality. While the ground is shown in the schematic, in some cases it is possible to work without one.

Battery consumption of the receiver is 1.35 amperes and plate drain is 25 milliamperes, when used at the voltages specified in the schematic circuit. In tests the Webster ABC unit photographed in Figure 8 was used, being a special design for operation of the Amplimax. A multiple connector is provided for

attachment to the receiver, while there are two additional cords, one for plugging into the 110 volt supply and the other with a pendant switch, which may be placed in a convenient position to control both the set and the power pack. The voltages are fixed and represent the values recommended for operation with the Amplimax receiver.

On account of the extreme care used in shielding, operation of the Amplimax is very stable, it not being possible to throw the intermediate stages into oscillation. The top leads from the first, second and third impedance units are control grid leads, the ends of which have a cap to slide over the tube cap. (See Figure 9 for detail.) The third impedance unit has a longer lead which plugs into a pup jack for connecting to the second detector grid. This is also illustrated in the graphic shown in Figure 9.

If in operation the 25 ohm rheostat shown in series with the negative terminal of the first detector and the ground does not sufficiently control the volume on the first tube, it is suggested

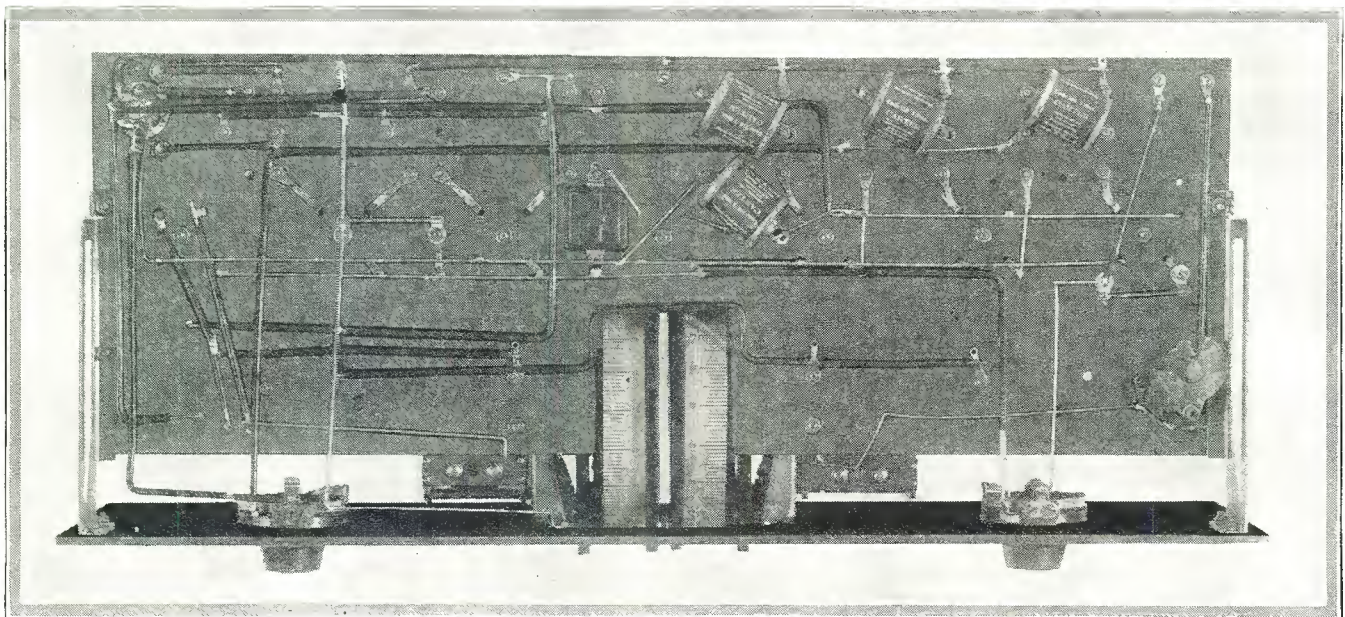

Figure 4. Bottom view of the completed Amplimax showing the wiring, fixed condensers and the .00005 mfd variable condenser, the latter at the extreme right



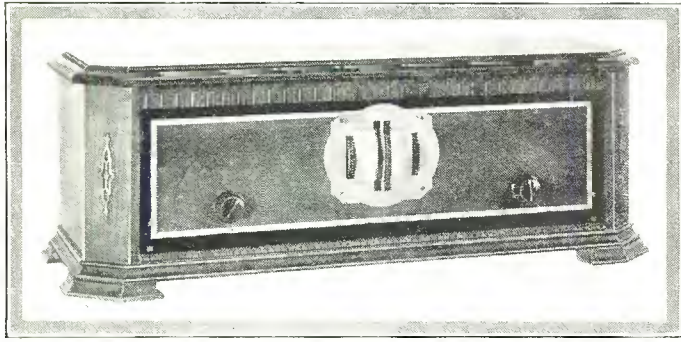

Figure 5. In this photograph the receiver has been placed in a Corbett console

that it be replaced with a 40 or 60 ohm rheostat. When using the Webster supply connect the grid return of the second audio to the gray terminal on the Yaxley No. 689 base instead of to the binding posts. Reference to the graphic diagram, Figure 9, will show that in this model the gray terminal is left blank while a binding post is provided for the C minus on the second audio transformer. When using the power supply, it is necessary to connect the C minus connection of the second audio to the unused gray on the Yaxley base, because of the fact that the power supply has the cable already attached. If this change is not made, the second audio will not receive any bias from the eliminator. For those who wish to use their present method of A, B and C supply, the binding post arrangement is satisfactory.

Due to the extreme high value of intermediate amplification, secured in a receiver, it has been felt that this super will give excellent performance under practically all conditions and the selectivity is greatly enhanced by the complete shielding. In laboratory tests it did not appear necessary to shield the oscillator or the antenna input coil.

However, in the tuning of the antenna inductance, it was found preferable to use a .0005 mfd variable in order to fully cover the range. As will be noted in the schematic circuit, the pick-up coil, 1 and 2, of the oscillator, together with the grid return of the oscillator winding, is common with the C-3 bias. Being at the

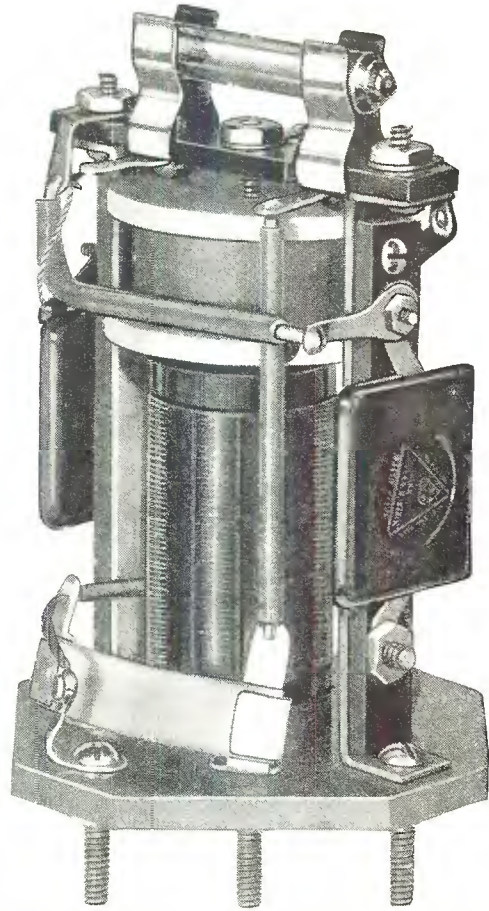

Figure 6. Component parts of the impedance coupled unit are shown in the above photograph. All of the parts shown here are those represented within the dotted lines shown in the schematic circuit, Figure 7

low potential end of the circuit, ample energy is secured without affecting the tuning portion of the first detector stage. The three 1 mfd condenser shown in the schematic between terminals

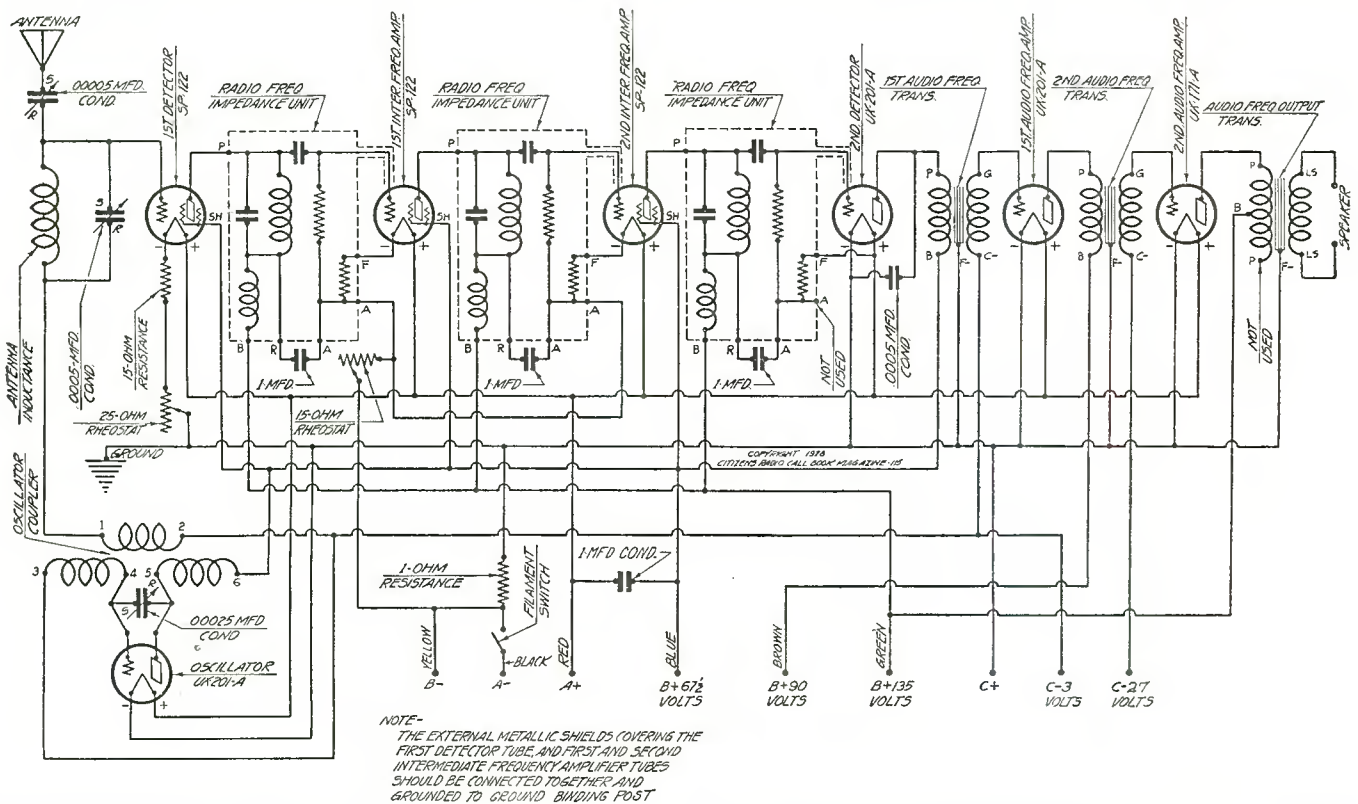

Figure 7. This schematic shows the electrical connections of the seven tube Amplimax described in the accompanying article and which may serve for those who are experienced as a means of wiring the receiver



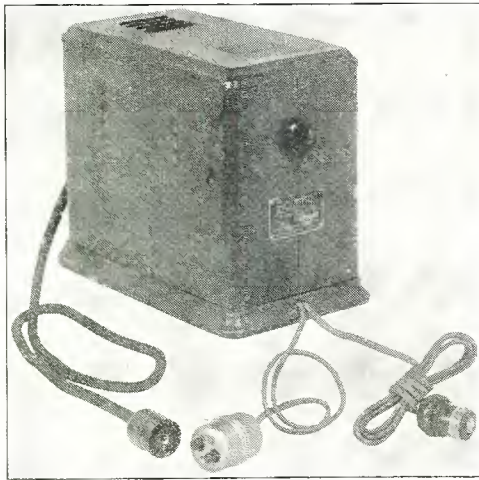

Figure 8. Above is shown the Webster AB70, supplying filament, plate and bias current for the operation of the Amplimax. Thus the receiver may be operated very satisfactorily from the light socket

shown in the list below:—

- 3—9-90 Tyrman r.f. impedances
- 1—9-80 Tyrman antenna inductance
- 2—3-30 Tyrman audio transformers
- 1—3-51 Tyrman power output transformer
- 7—Tyrman shielded sockets
- 1—Tyrman double vernier drum dial
- 1—Camfield .0005 mfd variable condenser
- 1—Camfield .00025 mfd variable condenser
- 1—622 Camfield oscillator coupler
- 1—915-K Yaxley 15 ohm rheostat with switch
- 1—4-L Yaxley resistance
- 1—Yaxley 15 ohm fixed resistance
- 1—669 Yaxley cable connector
- 1—Yaxley 25 ohm rheostat
- 1—Yaxey pup-jack
- 1—Hammarlund 50 mmf midget condenser
- 4—Carter 1 mfd by-pass condensers
- 5—XL binding posts
- 1—Carter .001 mfd fixed condenser
- 1—7x24x3/16-inch drilled and engraved Lignole front panel
- 1—8x23x3/16 drilled Celeron sub-panel
- 2—8629 Benjamin sub-panel brackets
- 30—Feet Acme Celatsite wire
- 1—Package Kester radio solder
- 1—Ekko ground clamp
- Miscellaneous lugs, nuts, screws, etc.
- 3—SP122 tubes
- 3—Ceco 201A tubes
- 1—Ceco 171A tube

R and A of each impedance unit and placed beneath the sub-panel out of sight. The terminals marked —A of all audio stages are grounded to the negative filament wire. The shields of the first, second and third sockets are connected to the ground binding post. A Yaxley 5-L resistance should be used in the power stage if a 171 tube is used instead of the 171A tube.

Parts used in the construction of the Tyrman Amplimax are

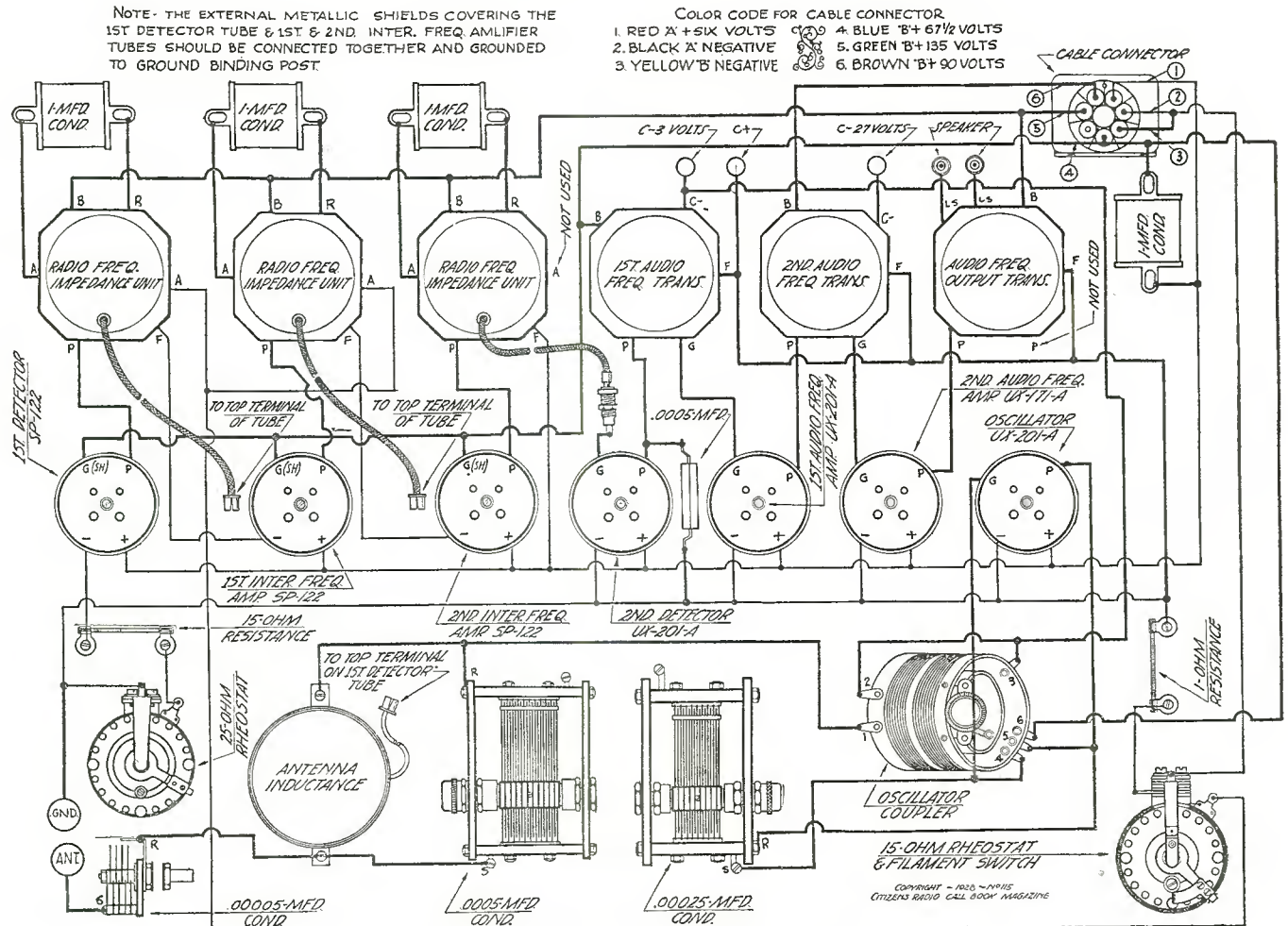
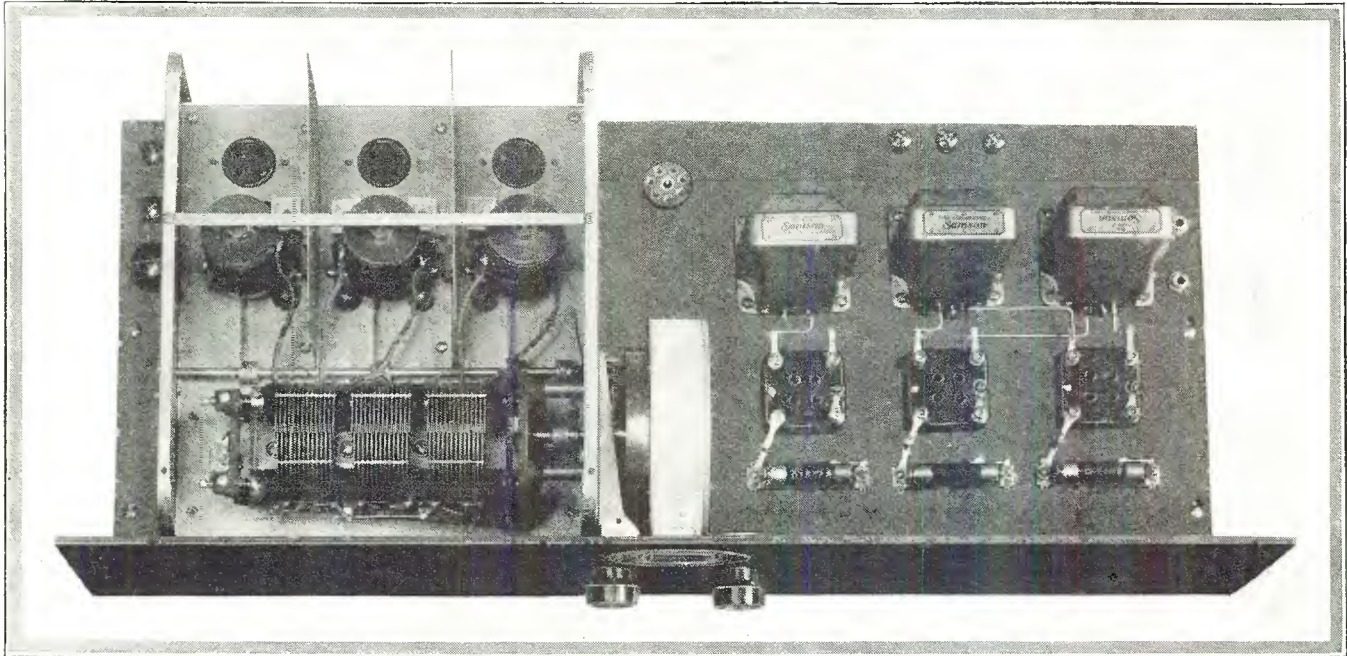

Figure 9. The graphic wiring diagram shown above will enable the builder to easily wire up the superheterodyne under discussion



# Remler Amplifier and Samson Audio in Unitune Symphonic

Simple Single Control Tuned R. F. Receiver Developed in Our  
Laboratory for Quality Reception



*Figure 1. At the left of the above photograph may be seen the Remler 710 radio frequency amplifier unit, while at the right are the Samson push-pull audio transformers and output impedance*

**G**OOD tuned radio frequency circuits will always be in demand by the set builder as well as the experimenter, especially when such circuits are arranged for faithful reproduction of broadcast programs. For that reason we believe the receiver to be described in this article will gain the interest of our readers, in whose behalf the laboratory has designed the Unitune Symphonic arrangement.

With the recent changes which have been made by the Federal Radio Commission in straightening out station allocations so that a minimum interference will be encountered, and the preponderance of chain program material available from almost every corner of the country, the demand for quality reproduction becomes more insistent. Taking this fact as a basis, our laboratory decided that three stages of tuned radio frequency properly balanced would feed sufficient energy to the audio input to allow for good volume in the home. For securing home volume and at the same time preserve fidelity of tone, push-pull audio using 112 tubes in the last stage was decided upon. One of the reasons for this decision lies in the fact that on account of the relatively low plate voltages required for the operation of this receiver, it would be possible for any standard B eliminator to be used for these plate voltages without running the risk of placing too great a burden upon such a plate supply. If desired, the set may be operated from dry batteries, although, of course, there are many who will prefer to use a B eliminator operating from the electric light socket.

### Do Work Carefully

In beginning the construction work on this receiver, it would be well to note carefully the sub-panel layout shown in Figure 2,

which will give the prospective builder an idea as to how all parts should be placed. The sub-panel used for this receiver measures 10x23 inches, while the front panel measures 24x7 inches. For the sake of symmetry it would be well to locate the center of the drum dial at the exact middle of the front panel length, this serving to throw the left hand knob for controlling the gang condenser and the right hand knob controlling the filament rheostat equidistant from the center of the panel. A suitable template by means of which the holes may be drilled for the Remler drum dial is provided with these units. Before actually going ahead with the drilling of the front panel for this purpose, it would be well to very carefully arrange the amplifier on the sub-panel and gauge the position of this amplifier unit so that when it is permanently installed the dial mechanism will run smoothly and true. Inspection of the amplifier unit will disclose the fact there are four holes, one in each corner of the amplifier can, through which the builder may mark on the sub-panel for drilling purposes. Before drilling these holes be sure to see that the amplifier unit is located properly for smooth turning of the dial, as if the amplifier unit is not trued up, there is a possibility of the dial mechanism binding.

It will be observed there are three sub-panel brackets utilized in this receiver, for the reason that it is desired to keep the sub-panel quite rigid and unless one is used in the center, as shown in Figure 2, there is a possibility of the sub-panel sagging a trifle under the weight of the apparatus. Possibly the simplest way to determine the height at which the hole should be made for the dial shaft would be to place all three sub-panel brackets on the sub-panel, affix the sub-panel to the front panel temporarily and after temporarily putting on the dial mechanism find the proper

(This receiver constructed, tested and all illustrations made in our laboratory)



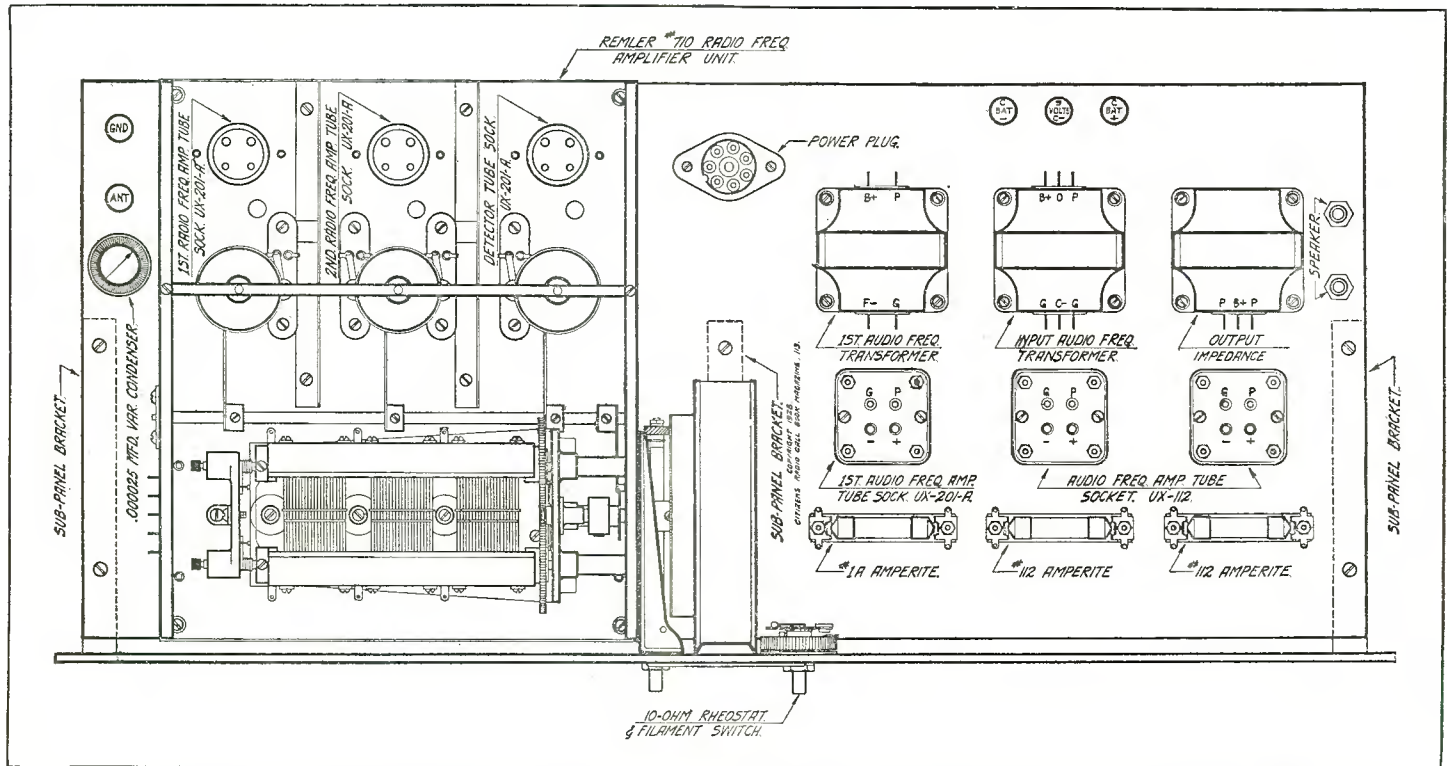

Figure 2. In this sub-panel layout may be seen the position in which each of the units is to be placed. Especial care should be exercised in locating the amplifier unit so as to allow perfect alignment of the Remler dial

height for the shaft hole. The balance of the material involved in the receiver is easy to dispose of, since an audio transformer, a socket and an Amperite are placed in three lines as disclosed in the panel layout shown in Figure 2. The power plug is located at the rear center of the sub-panel, while three binding posts are provided at the right rear. At the extreme left of the sub-panel are two binding posts and a midget condenser, the latter being in series with the antenna. At the extreme right are the two tip jacks which are used for the speaker tips.

#### Radio Section in Unit

The instructions given in this article are based upon a unit which is primarily easy to tune and which has a minimum number of controls. You will notice that the antenna compensator which is furnished with the No. 710 Remler amplifier is not shown in this circuit. If the individual builder prefers to obtain the greatest selectivity and distance getting abilities from the Unitune Symphonic, then the antenna compensator should be connected into the circuit as shown on page 66, in which case, the panel must be increased to 7x26 inches, although the base board remains the same. As the receiver is described in this article a reasonable number of distant stations can be received, although the performance of the receiver will not be equal to that of one using the antenna compensator.

Caution: The midget condenser shown on the left side of the panel is required only in very congested districts and under ordinary conditions should be short circuited.

Since the two stages of radio frequency amplification and detector are contained within the Remler 710 amplifier unit, the schematic circuit of this section of the set has not been given in this particular article, although if the reader is interested he may refer to Figure 1 on page 66, where a schematic is given covering this type of amplifier. As will be observed by examination of the schematic on page 66, the amplifier contains three radio frequency transformers, each with a variable primary actuated by the same mechanism which turns the three gang condenser. Each of the condensers in the three gang unit have an individual compensating section for balancing the stages at resonance. In the grid circuit of the first radio frequency tube is a 500 ohm fixed resistor, which may be shorted out when not desired and which serves to stabilize that particular stage, while in the second radio frequency

grid circuit is a 1000 ohm fixed resistance, which may likewise be shorted out when its use is not wanted. Another set of switches alter the number of turns used in the plate circuit of the first and second tubes. All of these adjustments are for the purpose of giving the operator considerable flexibility for use under varying conditions as to location and proximity of high power broadcasting stations. It is believed that those who build this receiver might find interesting material in the article on page 66, since that particular description confines itself to the method by which the amplifier may be brought up to its peak efficiency.

After the parts have all been placed on the sub-panel and the controls located on the front panel, the wiring may be performed by following the connections outlined in Figure 5, which is the graphic illustration for this receiver. The ground binding post should have a short length of flexible wire with a clip so that the ground may be placed on terminals three, four or five, depending on the selectivity desired. The detector terminal at the right of the unit connects to terminal P of the first audio transformer, while the F minus terminal connects to one side of the 10 ohm filament rheostat and thence through the rheostat to one end of each of the three Amperites for governing the first and second audio stages. The A plus terminal on the unit goes to the junction of the red, or plus A,

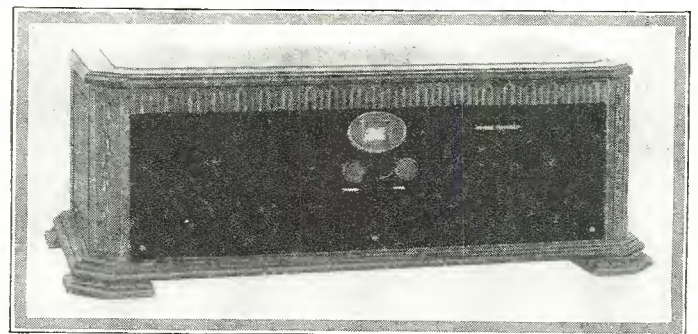

Figure 3. In this photograph the Unitune Symphonic has been placed in its Excello cabinet. The dial shown at the left governs the wavelength, while the one at the right represents a 10-ohm rheostat for controlling volume and sensitivity







must be screwed down tighter as is usually the case with the antenna compensator in the circuit. It is suggested that the balancing be done on a wave length of somewhere around 400 meters, since this will allow a compromised adjustment on both the high wave lengths and the low wave lengths. If you find that you are unable to secure high enough capacity in the first trimmer, try loosening the screws in the other two trimmers slightly and then increase the capacity of the three gang condense by turning the knob slightly to the right.

A word or two regarding the selectivity switches may be of interest to those who are building this receiver. On removing the top shield of the amplifier, the builder will observe four two-point switches located on the base, which have selective and non-selective positions. Twenty-four different combinations of position may be secured by means of these four switches, and these combinations represent varying degrees of selectivity. If all four switches are set in the non-selective position, the receiver will be quite stable, will not oscillate over the broadcast band, and will give good results in locations away from powerful stations. If it is desired to have a greater amount of flexibility and thus permit controlled oscillation, the first three switches are set on the selective position and the fourth switch, the one at the extreme right, set on non-selective. Under this arrangement the receiver may be forced into oscillation by means of the volume control rheostat and the sensitivity greatly increased. If the first and third switches are set on selective and the second and fourth on non-selective, the receiver becomes highly selective and the overall amplification is greater than it is with the combination suggested previously. It is only natural that every individual

builder will have to determine for himself the best position of these switches, since no two locations are identical and no two operating conditions the same.

The following parts were used in the construction of the Unitune Symphonic:

- 1—710 Remler radio frequency amplifier unit
- 1—110 Remler universal drum dial.
- 1—Silver-Marshall .000025 midget condenser
- 3—530 Frost sockets
- 1—Samson Symphonic audio transformer
- 1—Y Samson push-pull input transformer
- 1—Z Samson push pull output impedance
- 2—Frost tip jacks
- 1—Frost 10 ohm Gem rheostat with filament switch
- 1—Hagel 7 contact power plug
- 1—1-A Amperite
- 2—112 Amperites
- 5—Eby engraved binding posts
- 3—Karas sub-panel brackets
- 1—Formica 24x7x3/16-inch front panel
- 1—Formica 10x23x3/16-inch sub-panel
- 20—Feet Belden No. 14 tinned copper hook-up wire
- 4—Sonatron type 201 tubes
- 2—Sonatron type 112 tubes
- 1—Paekage Kester radio solder
- 1—Ekko ground clamp
- Miscellaneous lugs, screws, nuts, etc.

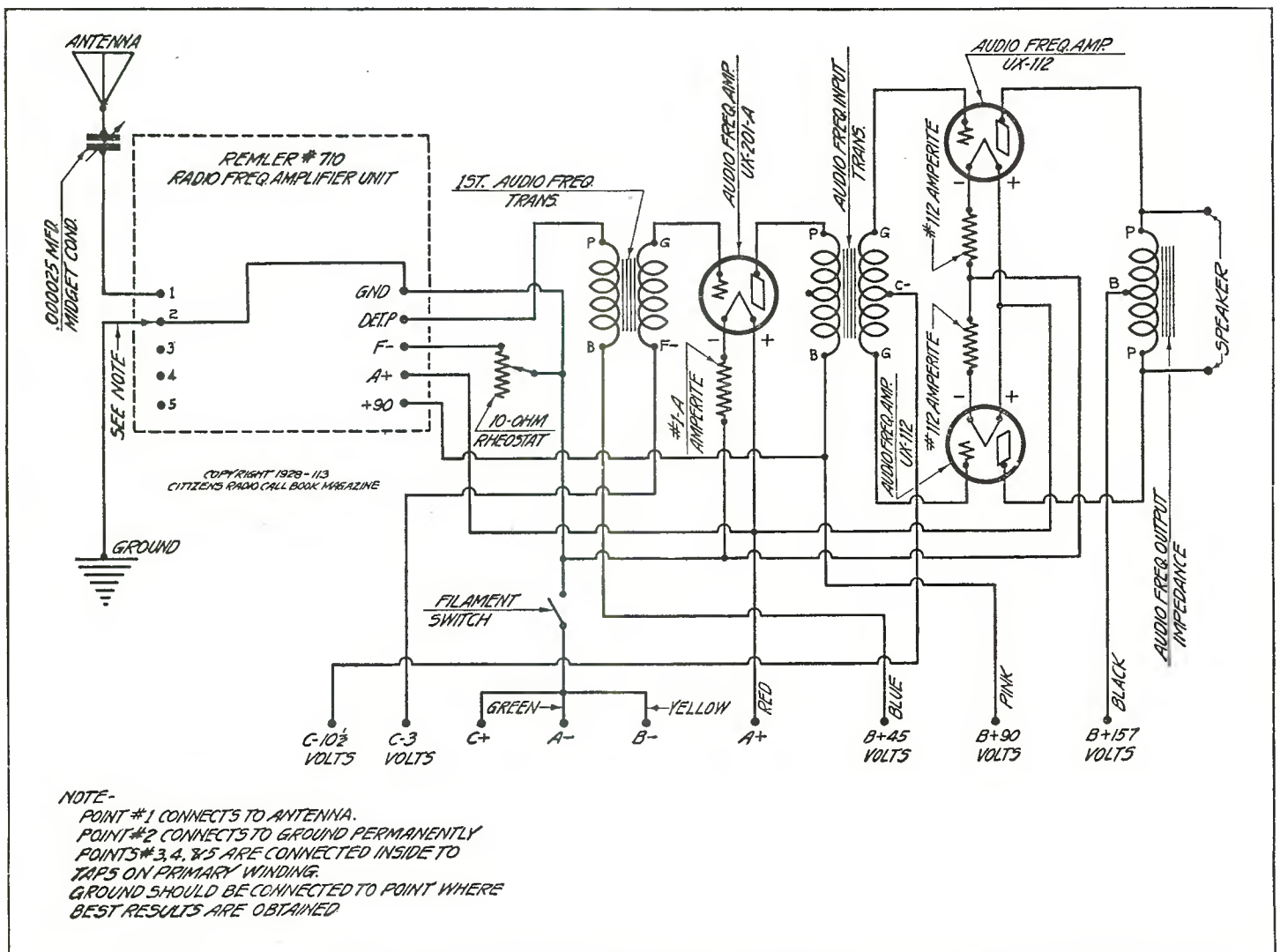

Figure 6. In the above schematic the reader will find the electrical connections for the receiver described in this article. This drawing may be used as a guide for wiring if the constructor is experienced, while for the novice the graphic shown in Figure 5 is recommended



# Universal All-Wave A. C. Tuner Used With Power Amplifier

Combination Radio and Phonograph Installation Gives Sufficient  
Undistorted Volume for Home or Dance Hall

**I**N the following paragraphs is described an unusual combination of a two tube socket-powered radio set covering all wavelengths from 18 to 3,000 meters with sensitivity and selectivity sufficient to provide adequate volume over ranges of 500 to 1,500 miles under favorable reception conditions, and a socket-powered audio amplifier capable of developing sufficient undistorted volume for a small theatre, dance hall or auditorium, operating from either the Universal all-wave two tube tuner, or only standard magnetic phonograph record pick-up. The combination Unipac amplifier and Universal all-wave tuner is especially interesting for the quality of its reproduction, and the flexibility which it allows in the matters of wavelength, and radio or phonograph use.

The combination is illustrated in the photographs accompanying this article. The Universal tuner consists of the old standby circuit of one stage of tuned radio frequency amplification and a regenerative detector, which gives very high sensitivity, extremely easy tuning, and selectivity. Two vernier drum dials control the two .00035 tuning condensers, while between these controls are the small regeneration (Gain knob) control condenser of .000075 mfd, and the volume control which varies the plate voltage of the r.f. amplifier tube. Type 227 or equivalent a.c. tubes are used in this socket-powered tuner. With the socket-powered tuner here illustrated B power (and C automatically) is obtained from the amplifier, and A power from a filament lighting transformer.

## Has Ample Power

The power amplifier is a two stage, push-pull light socket-powered amplifier which could well be used with any radio set at all or as a phonograph amplifier. It contains a first audio

stage consisting of one of the popular S-M 240 audio transformers and a 226 a.c. amplifier tube which feeds into a push-pull output stage through a 245 input transformer and a 246 output transformer, with a pair of 210 tubes used in this stage. All A, B and C power is obtained from a power supply consisting of a full-wave power transformer feeding 550 volts to the plates of the 281 rectifier tubes, 7.5 volts to their filaments, and to the 210 filaments, and 1.5 volts to the 226 tube filament. A total of about 460 to 500 volts is delivered at about 104 milliamperes, 44 milliamperes going to the two push-pull amplifier tubes, and 60 milliamperes to the voltage dividing resistors. Of this 60 milliamperes, up to 10 milliamperes is available at 45 volts, and up to 45 milliamperes is available at 90 volts for operation of any radio receiver. No voltage regulator tube is used, as the combination has been found to work entirely satisfactory without it in the case of this particular amplifier. Of the 460 to 500 volts available, this automatically divides up to give about the proper values of B and C potential to the 210 tubes.

The construction of both Universal tuner and Unipac is quite simple, requiring only a few tools and some simple wiring.

## Assembly Simple

The assembly of both the Universal tuner and the amplifier is so simple as to require practically no description. The placement and mounting of all parts is clearly illustrated in the photographs and pictorial diagrams. In the tuner, the two variable condensers are mounted upon the drum dial brackets using the small adapting washers accompanying the dials which accommodate the oversized hole in the bracket to the single hole mounting nut of the condensers. The drums are fastened on the condenser

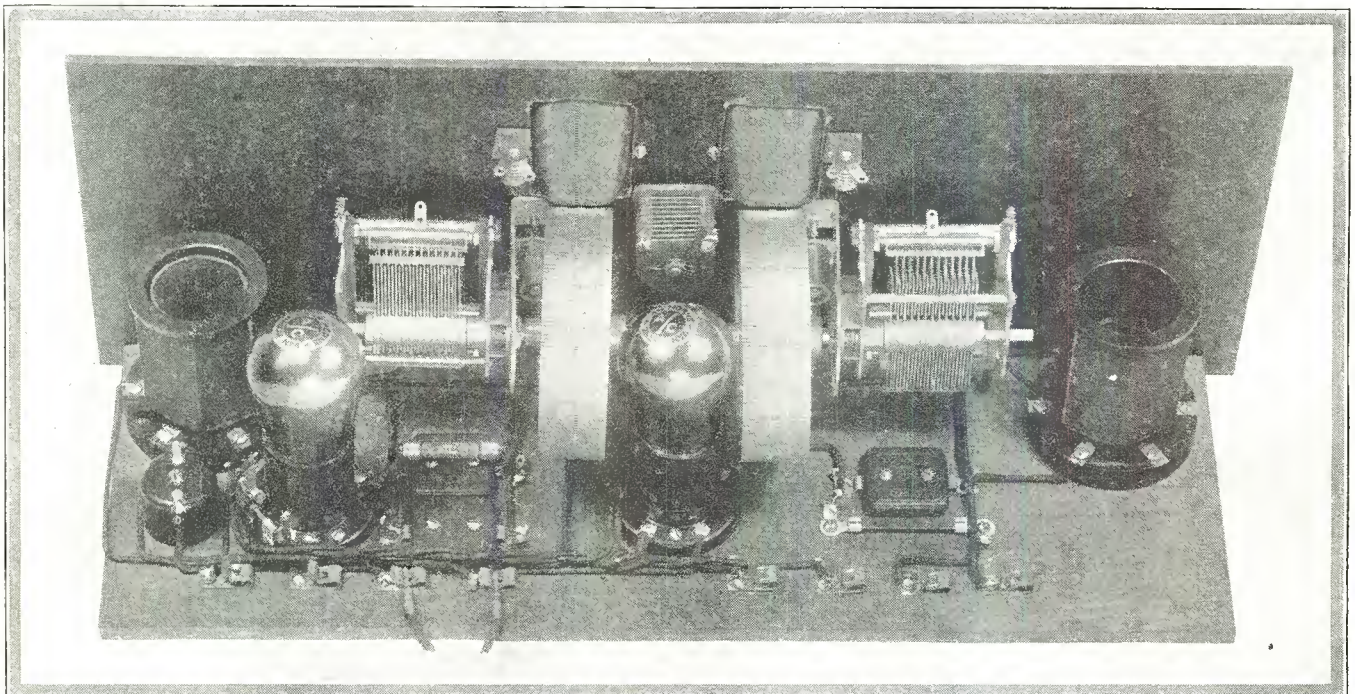

Figure 6. Rear view of the S-M Universal receiver described in this article. Note simplicity of all wiring and layout

(This receiver tested and all illustrations made in our laboratory)



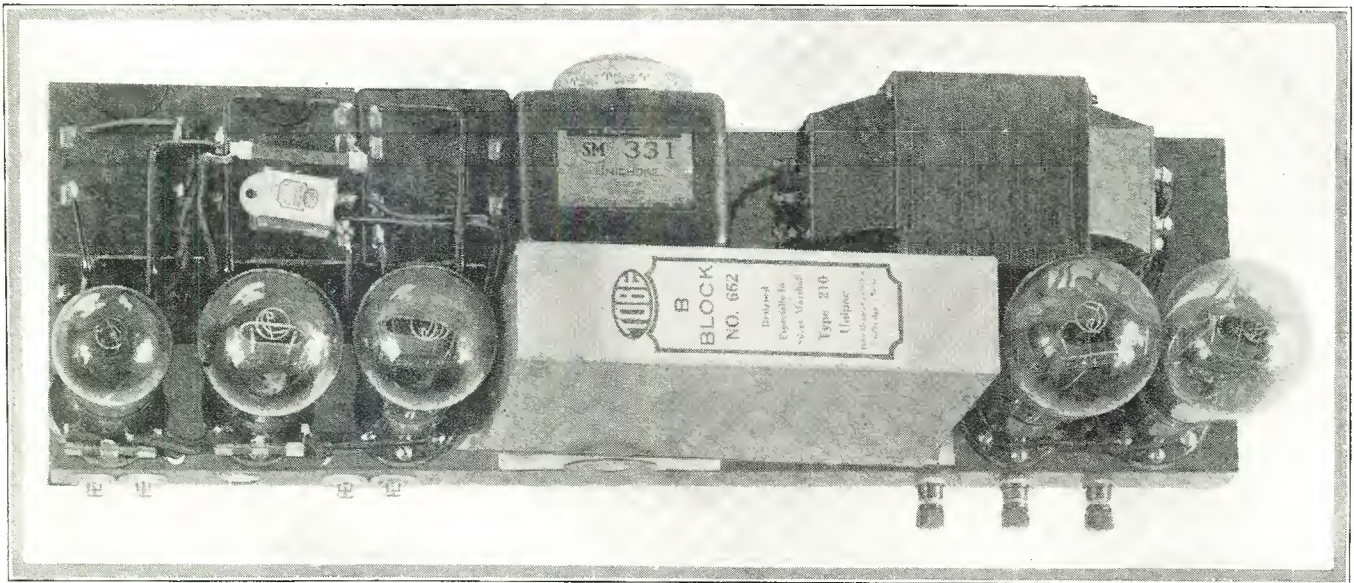

Figure 2. Full wave rectification with ample current for any conditions is obtained from the power amplifier illustrated above, which also has two 210 tubes for push-pull amplification

shafts with their edges inserted in the slots in the small drive mechanism carried in the bushing attached to the dial bracket. The brackets are fastened to the front panel by means of two screws with the drive shafts projecting through the front for knob attachment. In mounting the potentiometers, the frame should be carefully insulated from the panel, though one foot of the potentiometer, as can be seen from the diagram, is connected to the "B—" circuit which, of course, grounds to the panel. The midget regeneration condenser shaft bushing should make good contact with the panel. With these parts mounted on the panel and the latter screwed to the wooden baseboard, the various parts to go on the baseboard should be placed as seen in the photographs and drawings and screwed down.

In the socket-powered tuner illustrated and diagramed in this article, B and C power is obtained by connecting the "B—," "+45" and "+90" binding post directly to the Unipac binding posts similarly marked. A value of 2.5 volts a.c. for the heater tubes is obtained from an S-M 325 or 247 filament lighting

transformer.

Amplifier construction is clearly illustrated in the photographs and drawings herewith. The various parts are mounted upon the chassis as illustrated. The small 9720 ohm section of the 651 resistor is mounted by having certain of its lugs soldered directly or through short lengths of wire to the threaded binding post shanks. The large resistor section is mounted on long screws using 3/4-inch spacing collars to hold it beneath the chassis. The extreme outside lugs are unconnected electrically and are for mounting only. The inner lugs are for the electrical connections to the large resistor. A small 1500 ohm C bias resistor, as well as the Tobe stabilizing condenser, are shown mounted by having their lugs soldered directly to terminal lugs of the 245 input transformer. In assembly, the tipjacks and binding posts are insulated from the chassis by insulating washers, and the two small FT64 resistors are mounted directly on the "F" terminals of the two left-hand tube sockets. Care should be taken to see that their center taps do not "short-circuit" upon the mounting

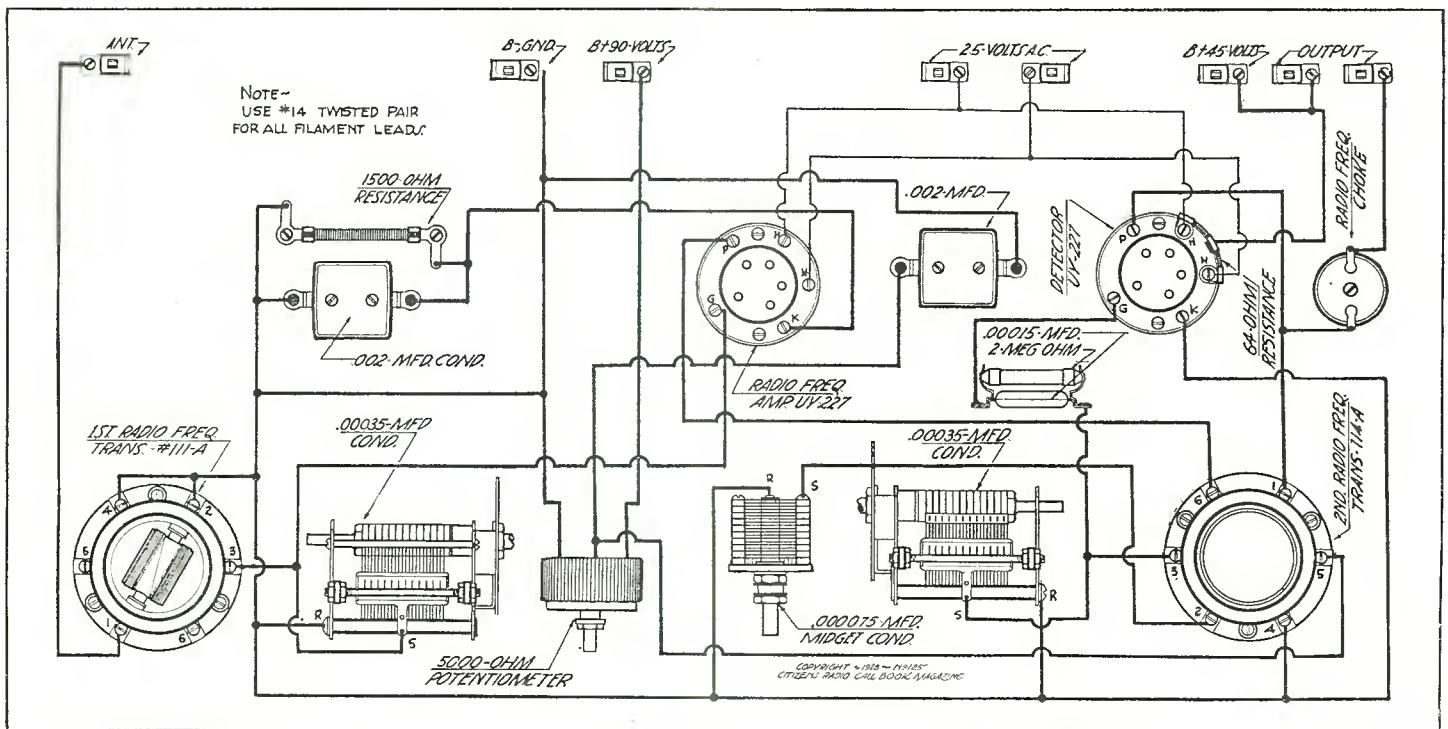

Figure 3. This graphic diagram shows the exact method of making connections for the Universal two tube tuner and should be followed by the builder in wiring up the receiver



screws of these tube sockets, which should be omitted in this particular amplifier.

**Operating the Receiver**

To operate the receiver it is merely necessary to connect it to the "B" binding post of the Unipac, to the filament transformer, and to a suitable antenna and ground to obtain satisfactory head-phone reception. Of course, two 227 tubes must be inserted in the receiver sockets. To tune the receiver, it is merely necessary to turn the volume control all the way to the right, turn the midjet condenser all in, and rotate the Selector II dial until a squeal is heard. Bear in mind that for the Universal tuner every squeal heard is a station, and once one has been located, Selector II dial should be adjusted for maximum volume of squeal followed by a similar adjustment of the Selector I dial. If the gain knob is now turned to the left slowly, to disengage the midjet condenser plates, the squeal will disappear and the signal be heard, signal volume being loudest on weak stations when the midjet condenser plates are just sufficiently disengaged to prevent the station being heard as a squeal. With the "A" range coils, that is, type 111A antenna and type 114A r.f. transformer, the range of the set is from 200 to 550 meters, while with other standard coils it may be extended down to 18 meters and up to 3,000.

The operation of the amplifier is equally simple. Once assembled, its cord and plug should be inserted in any 110 volt, 60 cycle light socket, and if it is to be operated for more than an hour at a time, the case should be left off entirely. Two 281 rectifiers should be inserted in the two right-hand sockets. One 226 should be placed in the left-hand socket and two 210 tubes in the middle sockets at the left end. If desired, the Unipac may be operated with only one 210 tube at first, the other being added later or only where high volume without distortion is required. The loud speaker should be connected to the right-hand pair of tipjacks on the Unipac, and the two output binding posts of the tuner connected to the two left-hand tipjacks. To operate the set, the receiver is tuned as usual. On local stations the volume obtained should be equal to or greater than that experienced with the majority of four, five or six tube sets, and the tone quality fine.

For phonograph operation it is simply necessary to remove the two connections from the tuner to the left-hand two tipjacks of



Figure 5. In this photograph may be seen an electric phonograph with its electrical pick-up, while at the right is shown a rear view of the S-M Universal tuner. The console table is a Southern Toy product

the Unipac and to connect these tipjacks to the cord tips of a standard magnetic phonograph pick-up such as the United pick-up. If this is done, the unit will operate as a power amplifier and will give volume and tone equal to or considerably better than that obtained from many expensive electric phonographs. As a matter of fact, a number of these amplifiers have been used in Chicago and elsewhere for providing dance music for small auditoriums and dance halls, and with one or two loud speakers

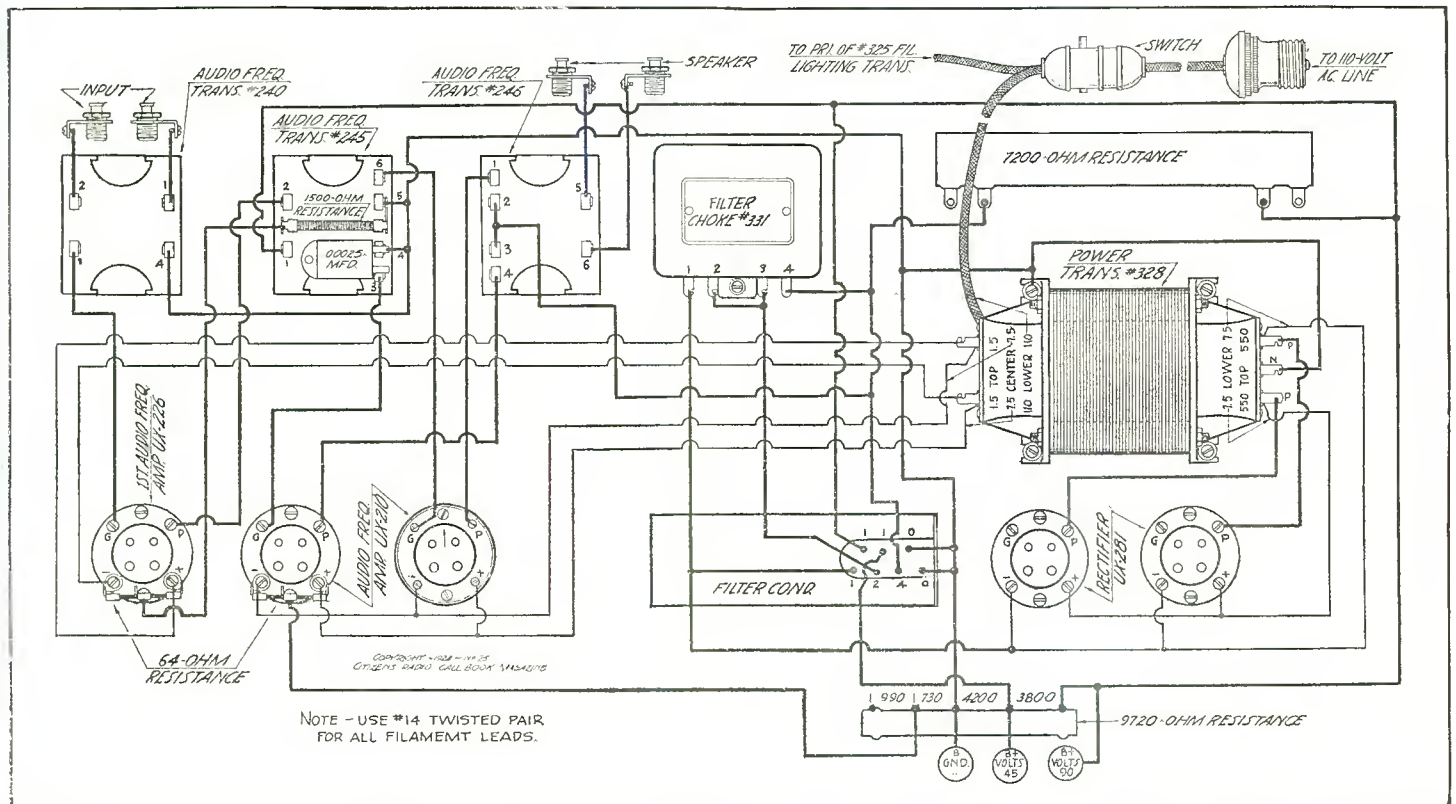

Figure 4. Above is shown graphically the method of connecting the various units in the Unipac power amplifier. Note that complete control of the receiver and power pack is secured by means of the switch shown at the top of the graphic illustration. This switch is in series with the 110 volt line, stopping and starting both the tuner and amplifier



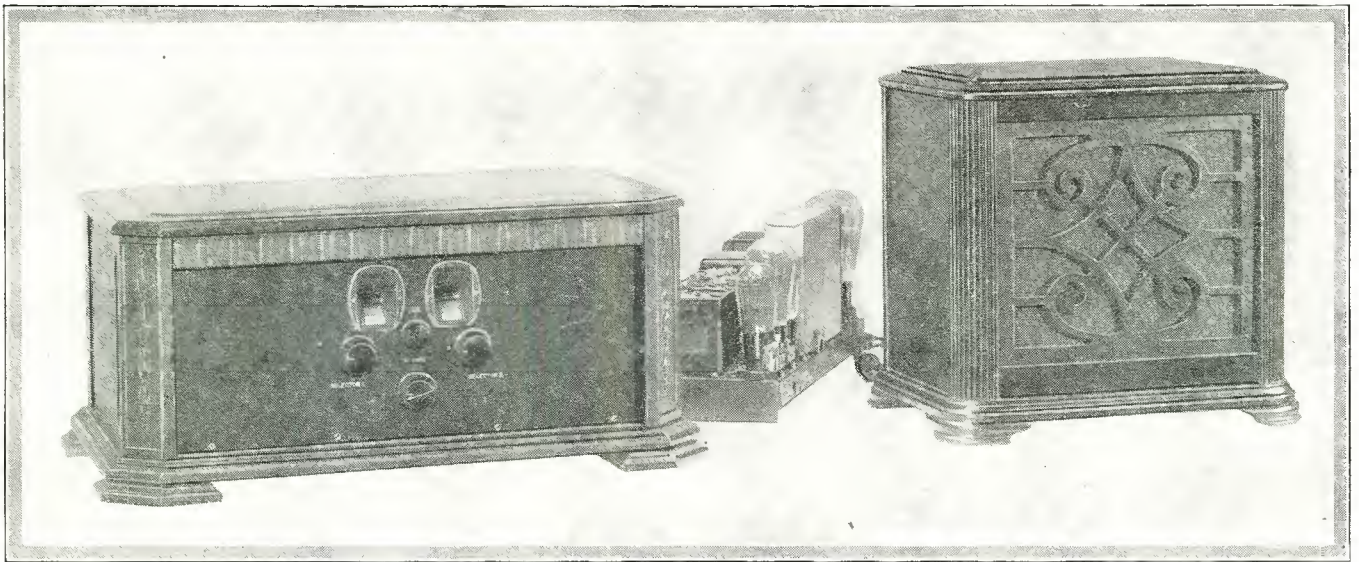

Figure 1. At the left in the photograph is shown the Universal two tube tuner operated with a. c. tubes. The power pack is shown at the center, while at the right is the Jensen dynamic cone loud speaker used for tests

connected to the output, have given ample volume.

The amplifier will produce with a standard record pick-up sufficient volume for dancing in a hall one hundred feet square, or even larger, with only one loud speaker; while with two or three loud speakers, it will give more than sufficient volume. A number of these Unipacs are used in small movie theatres with two or three loud speakers and provide phonograph music with the same volume as an original orchestra would in a theatre. Of course, the depth and richness of music delivered by the Unipac using good electrically cut records is far finer than would normally be obtained in a small theatre with the usual small theatre orchestra of a few pieces, for all of the better dance records are made with multi-piece orchestras.

**Dynamic Cone Used**

Using the Jensen dynamic cone loud speaker illustrated in Figure 1 at the right the reproduction of the combination for either radio or phonograph is truly pleasing. The Jensen speaker is available with a field requiring a 6 volt battery or trickle charger delivering 4/10 of an ampere to excite it, or, in another model, with a field which can be connected directly to the "B—" and "+90" binding posts of the Unipac.

To use either radio or phonograph at will, a double-pole, double-throw switch should be obtained and located where desired near the set and amplifier—the set can easily be placed in the upper portion of a phonograph console, with the amplifier parked somewhere below in the record compartment. The two blades of the switch should connect to the two left-hand tipjacks of the Unipac. One pair of switch contacts should connect to the output binding post of the tuner, and the other pair to the cord of the magnetic record pick-up. Thus, by throwing the switch either way, radio or phonograph music are on tap without a moment's delay.

Parts used in the construction of the Universal receiver and power amplifier were:

**(Receiver)**

- 2—320 Silver-Marshall variable condensers
- 2—805 Silver-Marshall drum dials
- 1—111A Silver-Marshall antenna coil
- 1—114A Silver-Marshall r. f. transformer
- 2—515 Silver-Marshall coil sockets
- 2—512 Silver-Marshall tube sockets
- 1—275 Silver-Marshall r. f. choke
- 1—342 Silver-Marshall midget condenser
- 1—Polymet .00015 grid condenser with clips
- 2—Polymet .002 condensers
- 1—Frost 1500 ohm grid resistor
- 1—FT64 Frost balancing resistor
- 1—Polymet 2 megohm grid leak

- 1—Frost potentiometer, 5000 ohm
- 8—Fahnestock clips
- 1—Van Doorn Universal panel 7 x 18 inches
- 1—8x17x1/2-in. Fritts baseboard with hardware such as wire, lugs, screws, etc.
- 1—Ekko ground clamp
- 1—Pkg. Kester radio solder

**(Power Amplifier)**

- 1—328 Silver-Marshall full-wave super power transformer
- 1—331 Silver-Marshall Unichoke filter system
- 1—245 Silver-Marshall transformer
- 1—246 Silver-Marshall Transformer
- 1—240 Silver-Marshall audio transformer
- 1—662 Tobe condenser bank (1, 1, 1, 2, 4)
- 5—511 Silver-Marshall tube sockets
- 1—651 Ward-Leonard S-M resistor kit
- 4—253 Frost tipjacks
- 1—661 Van Doorn steel chassis and cabinet with hardware
- 3—Eby binding posts, B—, +45, +90
- 20—ft. Corwico Braidite hook-up wire
- 2—Type CX 381 tubes
- 2—Type CX 310 tubes
- 1—Type CX 326 tube
- 2—FT64 Frost balancing resistors
- 1—F1500 Frost resistor

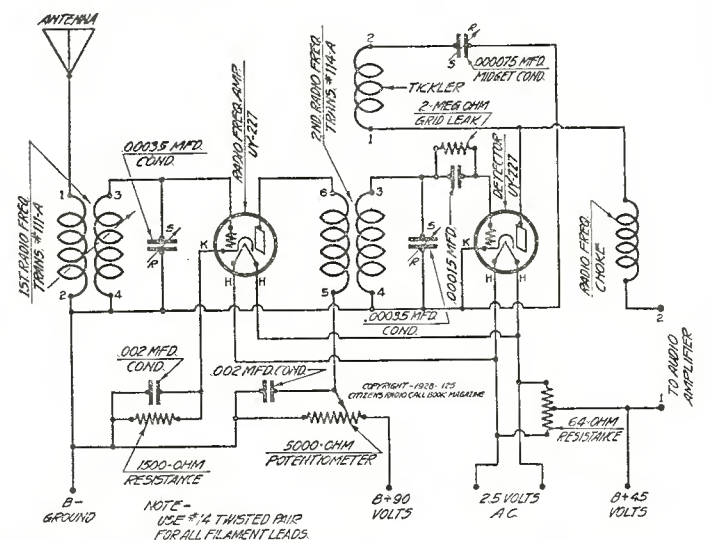

Figure 7. Above is seen the schematic circuit of the Universal tuner, which embodies a stage of radio frequency amplification and a regenerative detector. Both of the tubes used are of the 227 type, which operate from 2½ volts a. c.



# Hammarlund-Roberts Hi-Q Six for the Custom Built Fan

Complete Isolation of All Tuned Stages Results in High Amplification, Selectivity and Stability

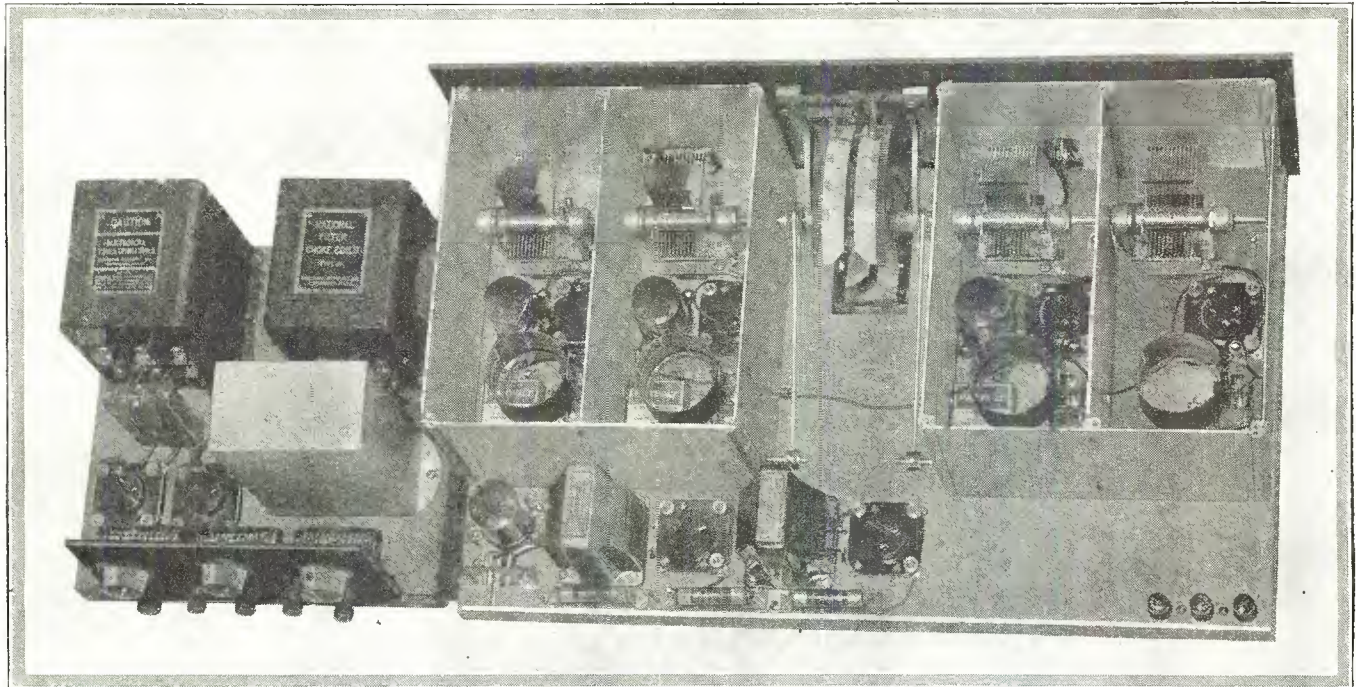

Figure 1. At the right of this photograph may be seen the latest model of the Hammarlund-Roberts Hi-Q Six assembled and tested in our laboratories. The Truolt B Supply shown at the left of the receiver is fully described on page 69 of this issue

IN keeping with a decided trend toward the custom built receiver which is now observed in the industry, the Hammarlund Roberts Hi-Q Six has been designed to meet the requirements of those who desire a custom built receiver yielding good performance, stability and economy of cost.

Primary requirements of the modern broadcast receiver are selectivity, sensitivity and tone quality. A high degree of selectivity enables the listener to tune in without interference the program he wishes to hear. Sensitivity makes possible the reception of distant stations when the operator chooses, while tone quality means faithful and lifelike reproduction of the programs transmitted by the broadcaster.

Among several of the features of this receiver which may be mentioned are: complete isolation of each of the four tuned stages by means of chokes, bypass condensers and good shielding. This means that each stage operates independently and that highest efficiency without interaction between it and other stages is secured, resulting in higher amplification, greater selectivity and complete stability. Another feature is that of automatic variable coupling, which gives maximum and uniform amplification over the entire tuning range. Another feature is good audio amplification, which with a power tube faithfully reproduces speech and music with the timbre and character of the original music. Modern construction features are employed in the new Hi-Q receiver, consisting of a steel chassis, heavy aluminum shielding, battery cable and connector and a centrally located illuminated drum dial control.

The set employs three stages of tuned radio frequency amplification, a non-regenerative detector and two stages of transformer coupled audio amplification.

As shown in the schematic circuit in Figure 5, filament control on the first, second and third radio frequency tubes is by means of a fixed resistance in the negative lead of these three tubes, this resistance serving to give a proper bias to the radio frequency grids, while a 6 ohm rheostat is placed in the positive lead and allows manipulation of this control for changing the sensitivity and volume of the receiver. The detector stage and the two audio stages are controlled by individual Amperites of the values specified in the schematic.

### Condensers Ganged

The first and second stages are tuned by means of a shaft linking the first two variable condensers to the left section of the drum dial, while the third radio frequency stage and that of the detector are tuned simultaneously by the right section of the double drum dial. Volume control is by means of the 6 ohm rheostat which is shown at the right in Figures 2 and 4, while the filament switch is shown at the left in both of these photographs. Control of the receiver has, therefore, been reduced to a minimum number of operations. Each separate stage is enclosed in an aluminum housing, which is represented in the schematic circuit, Figure 5, by the dotted lines around the three radio frequency stages and the detector. The automatic coupling method consists of primary coil moving mechanism

(This receiver constructed, tested and all illustrations made in our laboratory)



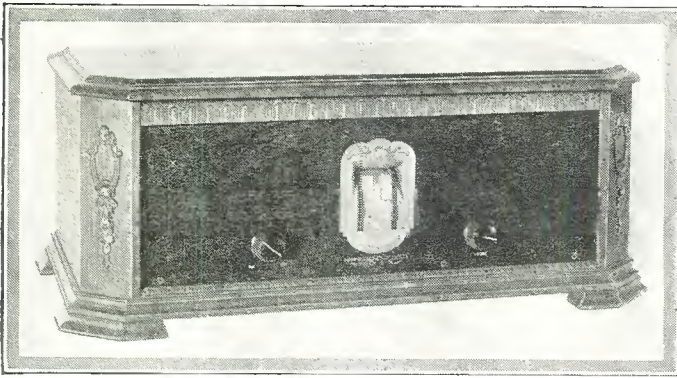

Figure 2. In this photograph the Hi-Q Six has been mounted in a Corbett cabinet

whose arms are cam operated. When the drums are turned, the cam on each shaft, working against the coil lever, raises or lowers the primaries so as to furnish a loose coupling at the shorter wavelengths and a tight coupling at the longer wavelengths, this system giving constant transfer of energy from the primary to the secondary circuits.

Assuming that the builder is ready to assemble the receiver, some attention will now be paid to this process. Note that the panel, steel chassis and shields are drilled to fit only the specified parts. This facilitates the assembly for the inexperienced builder and insures the exact placing of the specified units. It is important that the layout be followed because a change in position of some instrument may lower the operating efficiency of the receiver.

Regardless of the care taken in the manufacture and inspection of the individual parts used in this receiver, there is always a chance they may have been damaged in handling or in ship-

ment. Therefore, before assembling any of the apparatus it is well to subject it to your own personal examination and tests. The simplest test method is to procure a 4½ volt C battery and a voltmeter or a pair of head phones. When the voltmeter is used, it is placed in series with the C battery and it will register a deflection when used for testing the continuity of a coil. It will not show a deflection when testing for short circuits in condensers unless the condenser is short circuited. In the absence of a voltmeter a pair of head phones will serve as well, in this case a click being heard in the head phones if a continuous circuit exists in a winding, whereas no click will be heard after the first contact is made when testing condensers unless the condenser happens to be shorted, in which event, of course, a click will be heard each time that the test set is shunted across the condenser. Tests should be made for continuity of winding upon all radio frequency and audio frequency transformers, resistances and radio frequency chokes. Short circuit tests should also be made on all variable and fixed condensers.

Ready For Wiring

Being satisfied that all parts are in good order, the builder may proceed with the wiring of the receiver, which should be done in accordance with the graphic circuit illustrated in Figure 6. It will be noted that because of the fact a drilled steel chassis is used, a good portion of the wiring is done beneath the sub-panel so that in effect practically the only wiring not below the sub-panel consists of the grid suppressors and leads from the secondary to the tuned condensers. Examination of the photograph shown in Figure 1 will show the small amount of wire which is placed above the sub-panel. After the receiver has been completely wired in accordance with the graphic illustration previously referred to, a systematic course of testing should be followed to make sure that not even the slightest error exists in the wiring. Push the cable plug into the cable

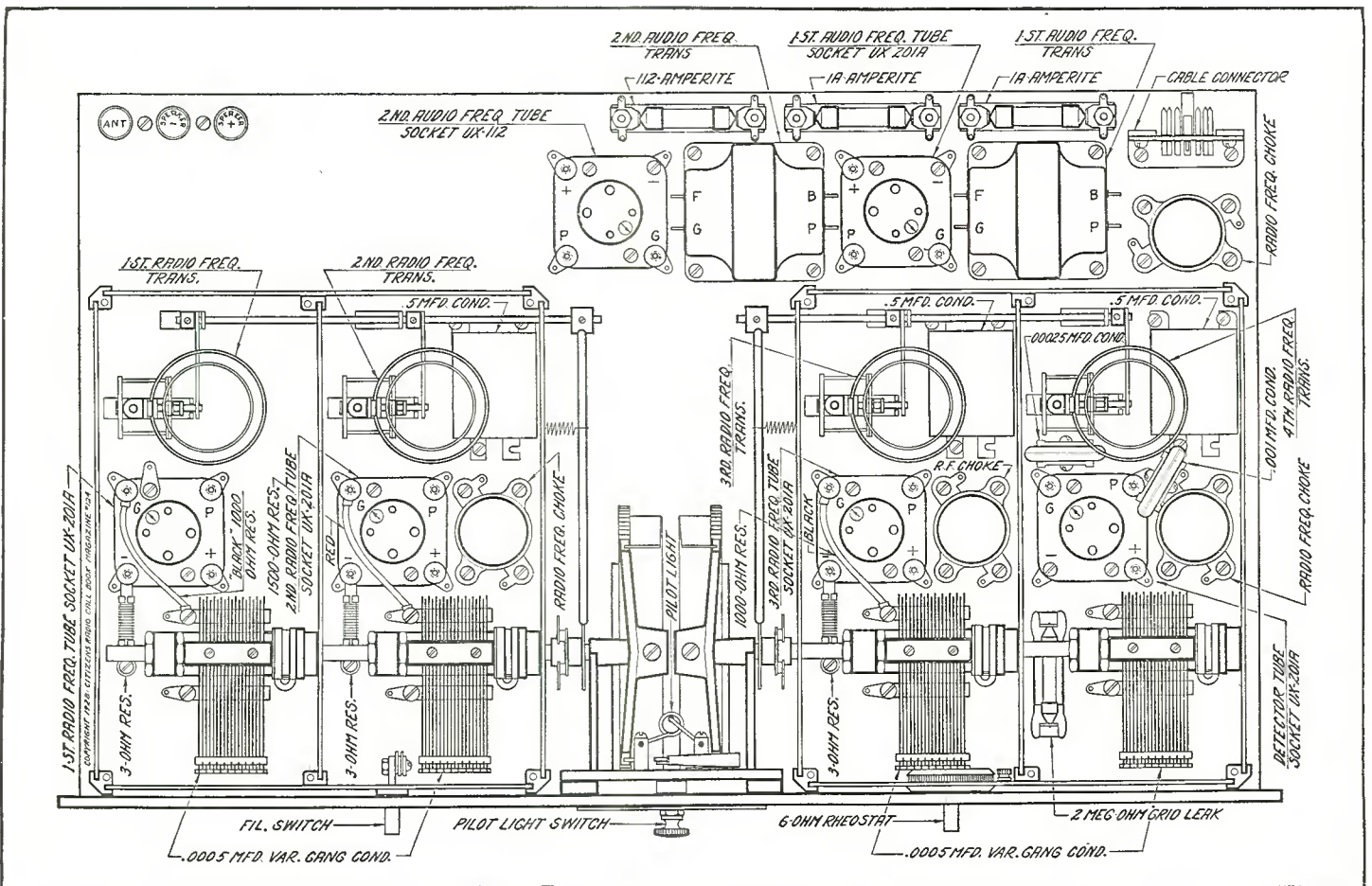

Figure 3. All parts of this receiver should be laid out in strict accordance with the sub-panel drawing shown above. Inasmuch as a suitable drilled steel chassis is provided in the foundation kit, it is only necessary to place all parts in their proper location and then begin the wiring of the receiver







terested in the simplified log sheet which we are printing on page 54).

Voltages required for the operation of this receiver in the plate section should be 67½ for the radio frequency and detector stages, 90 for the first audio and 135 for the last audio, the latter being a 112 tube. Bias voltage for this tube is 9 volts negative and for the first audio 4½ volts negative. As previously stated, a slight bias is maintained on the radio frequency grids by means of the three biasing resistors located in the negative line of the first, second and third tubes, as shown in the schematic diagram, Figure 5.

It will be observed that A negative, B negative and C positive wires are common with the ground and the shield. Therefore, operation of the receiver without antenna should give a greatly reduced signal strength, and when the ground wire is removed a still further decrease in signal strength should be noted. Stations, especially those other than locals, will disappear entirely when antenna and ground are removed, which is an indication of the amount of shielding employed in the receiver.

In operating the set, if whistles are heard and these whistles vary in pitch after the dials are turned, it may indicate incorrect adjustment of the cam system that moves the coil primaries, and it would be well to make sure they are adjusted in accordance with the instructions accompanying the kit. This whistling is different from the steady high pitched whistles present when receiving from certain stations. Such whistles are known as "heterodyne whistles" and are due to broadcast stations on about the same waves interfering with one another. They can be recognized by the fact that although their intensity may vary after the dials are turned, their pitch remains the same. This is not a fault of the set, but rather a condition with which the government has been coping for some time and is now apparently improving.

Parts used in the receiver are:—

- 1—7"x21"x3/16" drilled and engraved Micarta panel
- 1—Drilled Van Doorn steel chassis
- 4—Aluminum shields
- 3—Grid suppressors
- 3—Grid biasing resistors
- 2—Cam operating assemblers
- 2—Extension shafts for condensers, ¼"
- 1—Binding post strip
- (The above parts are included in the one foundation kit)
- 1—Hammarlund double dial
- 6—9040 Benjamin sockets
- 4—Hammarlund .0005 mfd variable condensers
- 4—Hammarlund Hi-Q r. f. transformers
- 4—Hammarlund r. f. chokes
- 3—Acme Par-Volt .5 mfd by-pass condensers
- 1—Sangamo .00025 fixed condenser
- 1—Sangamo .001 fixed condenser
- 1—Durham 2 megohm grid leak
- 1—Durham grid leak mounting
- 1—Carter 6 ohm Imp rheostat
- 1—Carter filament switch
- 1—660 Yaxley cable plug
- 2—1-A Amperites
- 1—112 Amperites
- 3—Engraved Eby binding posts
- 1—Ekko ground clamp
- 5—Ceco type 201A tubes
- 1—Ceco type 112 tube
- 1—Pkg. Kester radio solder
- 1—Samson Symphonic audio transformer
- 1—HWA-3 Samson audio frequency
- 1—Samson output transformer (Optional)
- Miscellaneous—lugs, nuts, screws, etc.

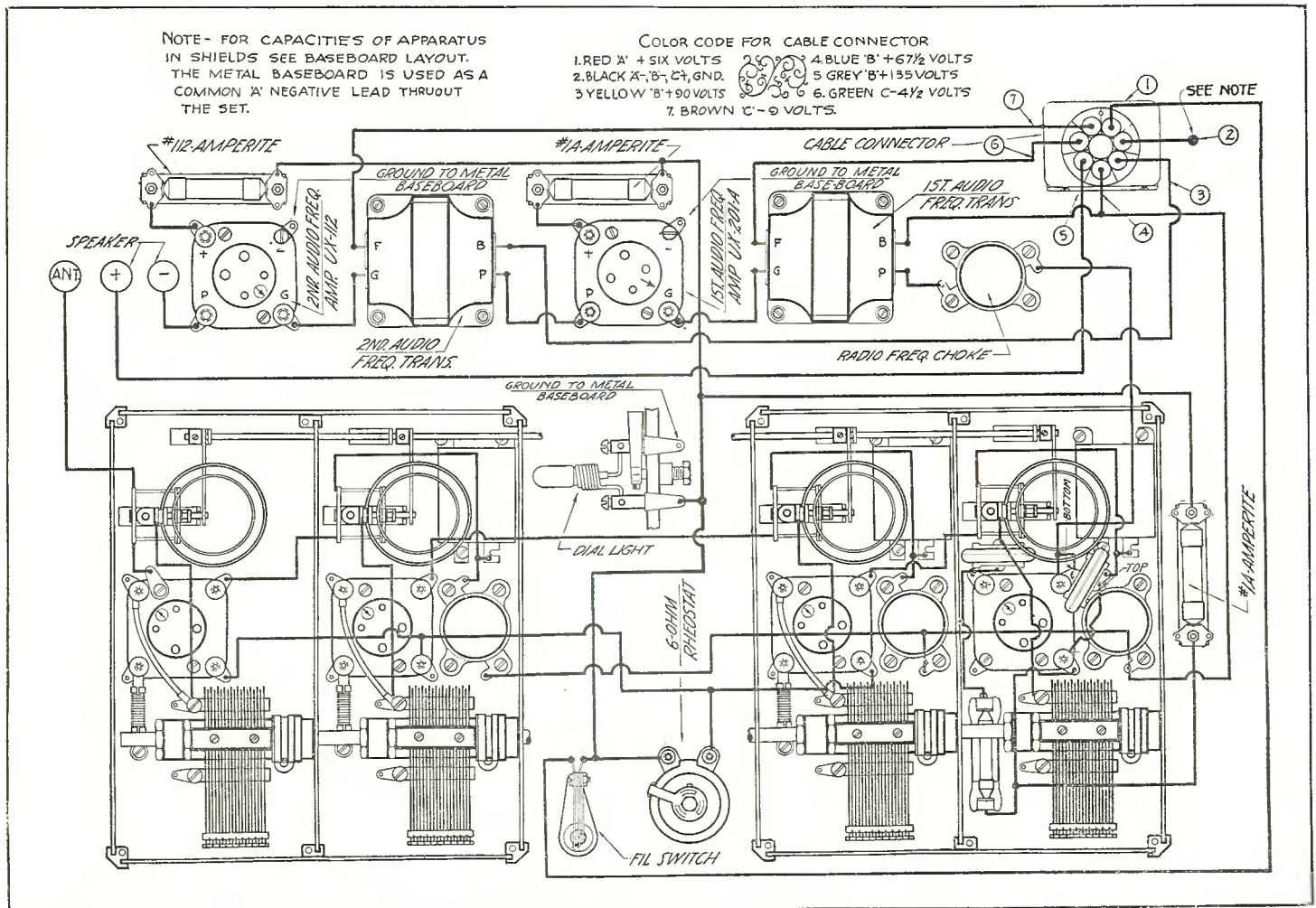
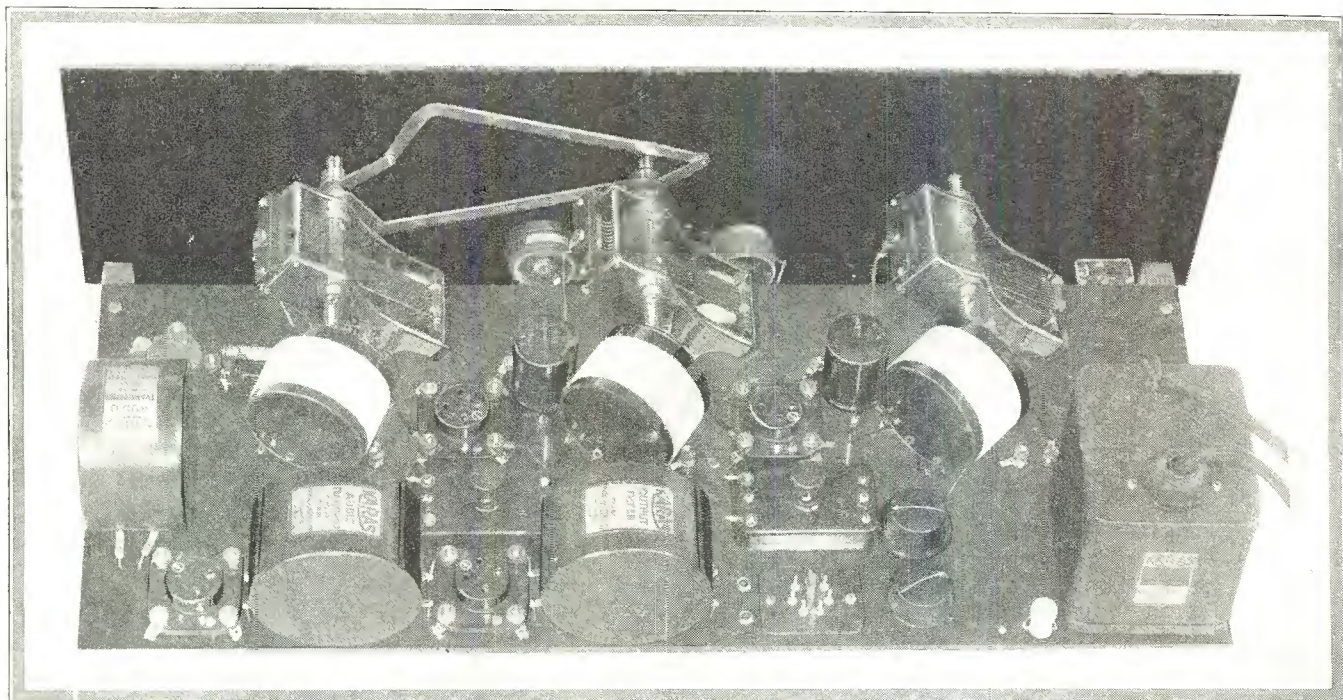

Figure 6. Here the builder may readily see how little wiring is required to connect the various units of this receiver



# Automatic Coupling Makes for DX in Karas A. C. Equamatic

Receiver Functions Just Under Point of Oscillation Over Entire Broadcast Band Through Equal Energy Transfer



*Figure 1. In this photograph may be seen the Karas A. C. Equamatic, filament power for which is secured from the Karas A. C. Former located at the right in this photograph. The plug shown in the receptacle nearest the reader is that for the B power supply, while the wires furthest from the reader are those going to the 110 volt switch on the front panel and to the cord for plugging into the light socket*

IT has always been known by radio experimenters that a proper balance of radio frequency circuits in a receiver will result in a very efficient set, but the problem has usually been to secure a balance which will remain constant over the entire wave band. In the Karas A. C. Equamatic, which is described in this article, this ideal condition has been reached by means of the constant and equal transfer of energy between the primary and secondary coils, this transfer being achieved through the mounting of the primaries on an extended shaft of the condensers so that they turn automatically with the tuning of the condenser dials. Due to the method of neutralization the tendency of the receiver to oscillate throughout the broadcast band has been stopped, and regardless of how high the radio frequency tube filaments are turned, the set will not oscillate when the operator has it properly balanced.

In addition to the fact that the receiver is stable in operation and quite sensitive to distant signals on account of its good balance, another feature may be cited, this being the fact that since the new type 226 and 227 tubes are used the operator need not worry about run down batteries. The receiver has been especially designed around alternating current tubes, so that the set delivers its maximum performance. Under average operating conditions the set should bring in good distance and should possess sufficient selectivity to enable it to be operated in the proximity of numerous broadcasting stations in the metropolitan centers.

#### Mechanical Coupling Device

As previously stated, a simple mechanical means enables con-

stant and equal energy transfer between primary and secondary coils. Each secondary coil is adjusted both as to the distance from the primary coil and as to the angular relation with respect to the primary coil at any one setting. By reason of this design and its numerous adjustments it is a very simple matter to obtain an adjustment which will allow the same transfer of energy at 200 meters as at 600 meters. When the proper adjustment has been made and the dials are operated over the broadcast band, the result is a variable coupling between primary and secondary automatically changing exactly at the proper rate to maintain the tubes at their highest point of efficiency at each wave length setting. Because of this fact it is possible to do away with the



*Figure 2. Karas A. C. Equamatic is here shown photographed in its Corbett cabinet*

(This receiver tested and all illustrations made in our laboratory)







made. This diagram is only for the purpose of wiring, the actual parts being placed in accordance with the sub-panel shown in Figure 3. Since the sub-panel is available already drilled and engraved (the engraved lines being those representing the angle at which the coils are to be placed), it is only necessary that the various units be placed in these holes and affixed to the sub-panel by means of their respective binding posts or nuts. After all parts have been located on the sub-panel, the home constructor may then go ahead with the wiring, which is depicted in Figure 7.

There are two neutralizing condensers utilized in this receiver for balancing it over the entire scale. The first one is located between the plate of the first radio frequency amplifier and the top of a 85 mh radio frequency choke. The second neutralizing condenser is placed in a like position in the second radio frequency stage. Two small fixed .00015 mfd condensers are used, one from the rotor of the first condenser to the negative terminal on the first socket and another from the rotor of the second variable to the negative terminal on the second socket.

#### Volume Control Method

As a means of governing the volume on the receiver, a 75 ohm variable resistance is placed across the primary of the third radio frequency transformer, this control being desirable for altering the radio frequency input to the detector stage. Control of the audio volume is secured by means of a 50,000 ohm potentiometer placed across the grid and filament terminals on the first audio transformer, the arm of this potentiometer leading to the grid of the first audio tube.

In the grid circuit detection is by means of a .00025 mfd grid condenser spanned by a 2 megohm grid leak. The rotor of the .00037 mfd condenser, which is ganged with the second stage, is connected to the cathode of the type 227 detector tube, which is common with the B negative and ground. In this particular detector stage it is recommended that  $22\frac{1}{2}$  to 45 volts positive be applied to the center tap of the  $2\frac{1}{2}$  volt winding, since the tube manufacturers state usually positive (or occasionally negative) biasing of the heater circuit with reference to the cathode is required for best results. This is readily accomplished by connecting the mid point of the heater winding (which in the A. C. Former is the electrical center of that particular system) to the  $22\frac{1}{2}$  or 45 volt B connection, as shown in the schematic diagram in Figure 4 and also in the graphic, Figure 7, where a wire is

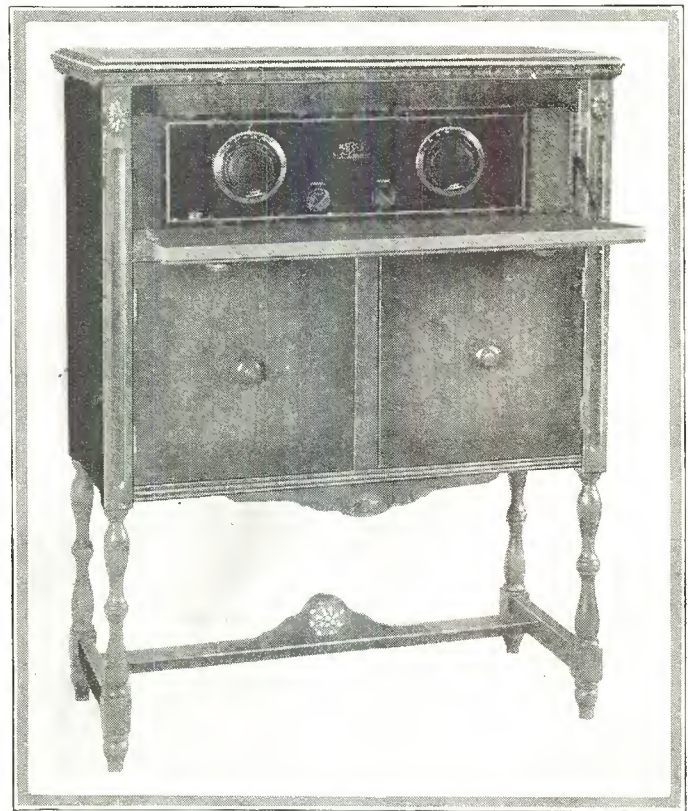

Figure 5. Illustrated above is the receiver placed in an attractive Corbett console

run from the center of the  $2\frac{1}{2}$  volt filament winding to the black terminal on the cable connector which, of course, goes to  $22\frac{1}{2}$  or 45 volts positive.

Two stages of audio transformer coupling are used with an output filter in the plate circuit of the power tube, which is a 171. The negative bias on the grid of that tube is provided by the 2000 ohm resistance in series with the center tap of the 5 volt winding. At 180 volts this will give approximately 40 volts negative bias. The negative bias on the second radio frequency is

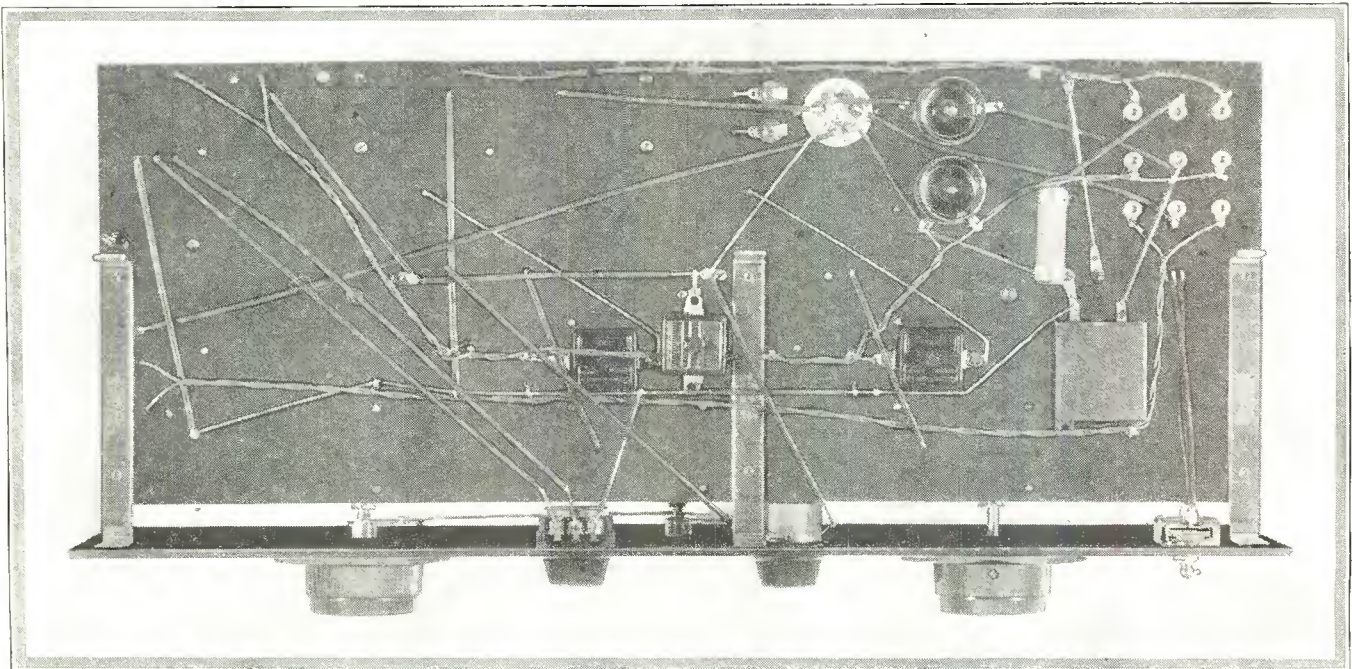

Figure 6. This photograph represents the under side of the sub-panel and shows the relatively small amount of wiring necessary for the construction of this efficient receiver. The A. C. Former has all of its connections protruding through the sub-panel so the wiring can be done below the surface. The six connections are shown in the right rear corner of the panel photographed above



provided by the voltage drop across the 2000 ohm variable resistance applied to the center tap of the 1½ volt filament windings. At 90 volts this resistance will give approximately 6 volts negative bias when the full 2000 ohms are used and, of course less depending on the setting of the rheostat. This resistance should be varied until best operation is obtained.

**Balancing the Set**

The receiver having been completely wired and all wiring checked to eliminate any possible errors or loose connections, the set may now be balanced for operation. With the adjusting thumb screws of the neutralizing condenser turned entirely up, tune the receiver to some high power low wave station. Set the .2 ohm rheostat so the receiver is just oscillating with the control and volume dials turned entirely up. Turn down the thumb screws a little at a time until the signal clears up. Now turn up the .2 ohm rheostat and rotate the dials back and forth across the point at which the station was tuned in. If the receiver still oscillates, make a slight adjustment on the thumb screws on both neutralizing condensers. A point will be found on these condensers at which the receiver will not oscillate when the .2 ohm rheostat is turned entirely up and the dials are turned over the entire range.

It is possible that in adjusting these neutralizing condensers to go too far, in other words to have too great a capacity. There is a point at which the exact adjustment may be found and this is not difficult to do.

The only other adjustment that may be made is on the first primary coil. This should be varied depending on the length of the aerial used with the receiver. It is sometimes necessary to provide maximum coupling on the first coil at the lower wavelengths due to the particular aerial being used. This adjustment can be made only in accordance with the particular conditions under which the set is being operated.

**List of Parts**

Parts necessary for the construction of this receiver are:  
1—Karas A C Former

- 2—28 Karas audio transformers
- 1—Karas output filter
- 3—17 Karas .00037 mfd variable condensers
- 3—Karas Equamatic r. f. transformers
- 2—Karas 0-100 Micrometric dials
- 3—Karas sub-panel brackets
- 1—Karas control system, including hardware
- 1—660 Yaxley cable plug
- 1—B-20 Electrad 2000 ohm fixed resistor
- 1—E Electrad Royalty variable high resistance
- 4—9040 Benjamin red top sockets
- 1—9036 Benjamin red top socket
- 1—Durham 2 megohm grid leak
- 2—85 Hammarund r.f. chokes
- 2—Samson neutralizing condensers
- 1—Carter Imp 110 volt switch
- 1—MW-75 Carter 75 ohm rheostat
- 1—MW 1/5 Carter 1/5 rheostat
- 1—MW-2 Carter potentiometer
- 1—210 Carter mfd by-pass condenser
- 2—.00015 mfd Carter fixed condensers
- 1—.006 mfd Carter fixed condenser
- 1—.00025 mfd Carter grid condenser with clips
- 2—10 Carter tip jacks
- 1—7x24x3/16-in. drilled and engraved Lignole or Formica front
- 1—9x23x3/16-in. drilled and engraved Formica sub-panel
- 40—ft. Corwico Bradite hook-up wire
- 3—Type 226 tubes
- 1—Type 227 tube
- 1—Type 171 tube
- 1—Pkg. Kester radio solder
- 1—Ekko ground clamp
- Miscellaneous lugs, nuts, screws, etc.

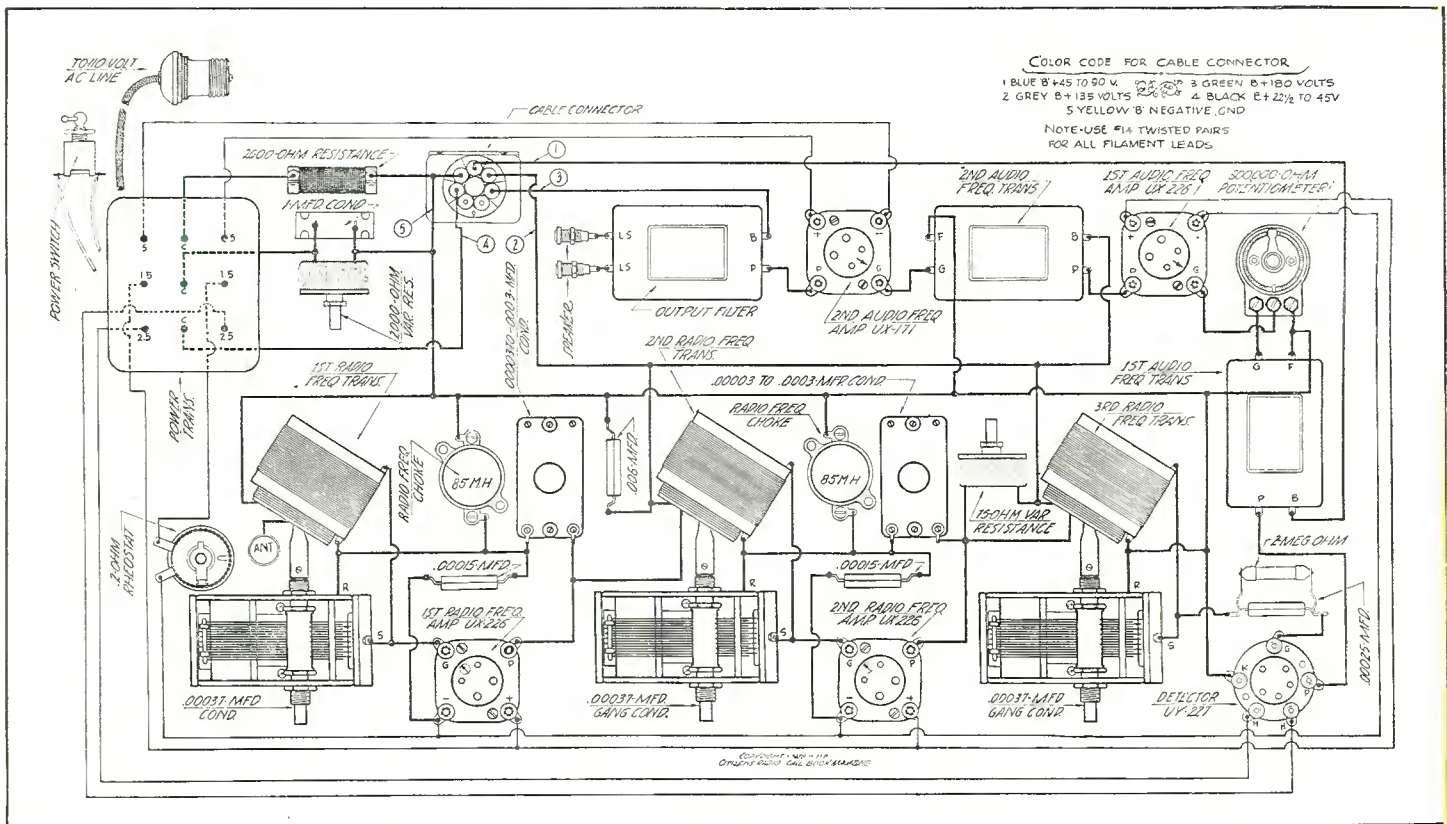

Figure 7. Even a novice may wire up a receiver such as the one here described when simple graphic illustrations like the one above are available. The power switch shown at the left rear of this diagram should be mounted on the front panel by means of a twisted pair. This controls the 110 volt line and allows the operator to turn on and off the set at will



# Vitrohm ABC Eliminator for Residents of D. C. Districts

Unique Combination for Operating Any Set Has Added Feature of Push-Pull Amplifier

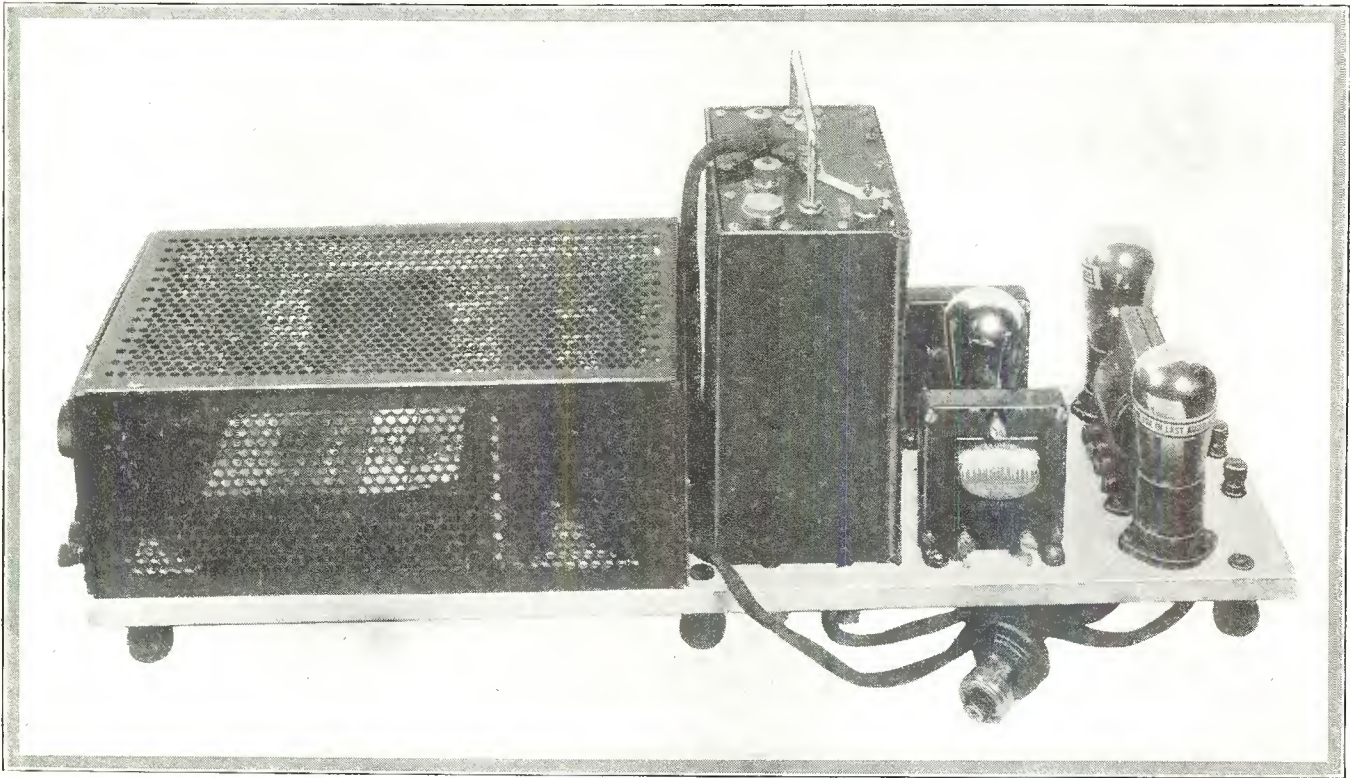

Figure 1. Shown above is the Vitrohm eliminator for D.C. districts with the push-pull power amplifier shown at the extreme right. At the left is shown the metal housing, the front of which is illustrated in the smaller photograph on this same page

FOR many years there have been thousands of individuals residing in either the downtown districts of a city or in the residential districts which are served by direct current rather than alternating current supply. During this time many have found it rather inconvenient to have a direct current source in their homes and still be faced with the necessity of using dry batteries for the plate supply and have to be constantly changing their batteries from the direct current line through a series of lamp banks. For a long time the problem of securing filament current from the direct current lines was chiefly that of having a condenser which would be of sufficient electric size to smooth out commutation ripples usually encountered in direct current lines.

### New Filter Is Used

Recently with the advent of the Abox filter, an ideal combination has been worked out involving Vitrohm resistors, an Abox filter and a power amplifier utilizing push-pull audio amplification, so that with the data now available in this article residents of direct current districts may have a complete power supply which will relieve them of any necessity of further care or inconvenience.

Two factors are at once apparent in the examination of the circuits shown in this article. The first is that the cost is low on account of the relatively small amount of apparatus involved,

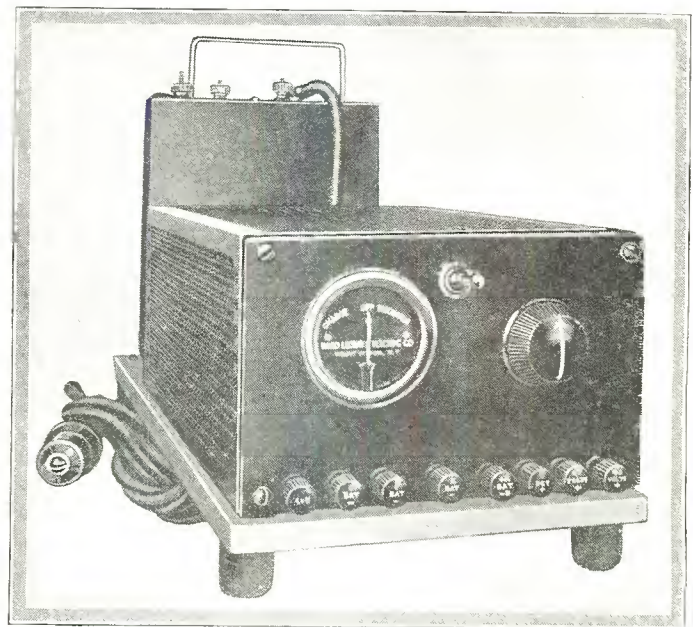

Figure 2. This is a front view of the D.C. eliminator described in this article

(This eliminator tested and all illustrations made in our laboratory)



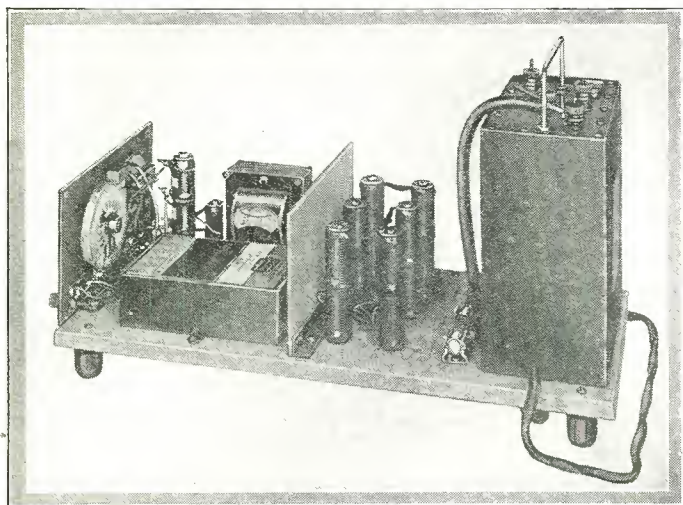

Figure 3. In this photograph is shown only the eliminator section with the housing removed

while the second lies in the fact that the construction of such an eliminator and power amplifier is quite simple and may be readily accomplished by even a novice in a very short time.

#### Pictures Tell the Story

The complete A, B and C eliminator is shown photographically in Figure 1. In Figure 2 may be seen the front end of this device, while Figure 3 shows a photograph of the eliminator section alone with the housing removed. On account of the current passed by the resistances in the eliminator and the fact that some heat is generated, safety would indicate that some method of protection be supplied and for that purpose a metallic housing or grating is provided. A view of the power amplifier alone is shown in Figure 5, where the two push-pull audio transformers are photographed with their push-pull output transformer.

This job may be made up in either the single eliminator system, or it may be made up as a combined eliminator and power amplifier, or the power amplifier may be made separately. Judging from correspondence we have had from our readers, it would appear that the greatest amount of interest would center around the eliminator itself, the next greatest on the combined eliminator and power amplifier, and the last on the power amplifier itself.

#### Schematic Shows Details

In the construction of the eliminator itself, the reader may determine from the schematic circuit in Figure 6 the parts that are required. This same information is also given in the list of parts accompanying this article. The schematic shows the eliminator to consist of, in effect, a number of fixed resistors placed in parallel, and across the 110 volt direct current source, these parallel resistors serving to drop the voltage from the 110 value to the required 6 volts, with ample current available for the operation of a receiver and its power amplifier. The filter condenser block shown in the schematic serves to iron out direct current pulsations in the supply line, and is placed with its sections going across the resistor units, which determine the voltages at the binding posts. This type of condenser is identical to that used in the ordinary power supply and performs the same work of filtering. Filtration of the A supply is accomplished by means of the Abox filter, which is shown in the schematic and which with its extremely high capacity absorbs any commutation in the low voltage section of the eliminator.

Two values of negative bias are automatically provided in this eliminator by the drop across one-half of a 5 ohm resistor located between the shell of the Abox and the negative terminal of the 110 volt d.c. supply. The C bias value secured across one-half of the 5 ohm resistor is  $4\frac{1}{2}$  volts negative, while the bias secured

across the entire resistor is 9 volts negative. The  $4\frac{1}{2}$  volts bias value is used for the input stage of the first audio transformer, if used, while the 9 volts bias is used on the input stage of the two 171 tubes arranged in push-pull and is of sufficient value for the maximum voltage supplied by the eliminator.

#### Eliminator

If the builder is interested in constructing the eliminator alone, the following is a list of parts required for its construction:

- 2—5 ampere fuses
- 1—B-1 Ferranti audio choke
- 6—B-300 Ward Leonard 300 ohm Vitrohm resistors with mounting.
- 1—507-52 Ward Leonard 11,000 ohm Vitrohm resistor with mounting
- 1—A 5 CT Ward Leonard 5 ohm Vitrohm resistor with mounting
- 1—Ward Leonard 10,000 ohm Vitrohm Adjustat
- 1—Acme Parvolt condenser block 2-2-2 .5- .5 mfd
- 1—Polymet .002 mfd fixed condenser
- 8—Eby binding posts
- 1—Abox filter unit (6 volts)
- 1—4-3/8x6-7/8x1/4-inch Transite heat baffle plate
- 1—7-1/4x17-3/4x1/2-inch Transite baseboard
- 1—5-7/8x3-15/16x1/8-inch Celeron front panel
- 1—Carter 110 volt toggle switch
- 1—Sterling polarity indicator (Charge-O-Discharge)
- 20—ft. Corwico Braidite hook-up wire
- 1—Pkg. Kester Radio solder
- Miscellaneous lugs, nuts, screws, etc.
- 1—Sangamo .002 mfd fixed condenser

#### Power Amplifier

If it is desired to build the power amplifier alone, the following list of parts is necessary:

- 1—Ferranti type AF-4C push-pull transformer
- 1—Ferranti type OP-7C push-pull transformer
- 3—Eby sockets
- 2—Eby binding posts marked "Output"

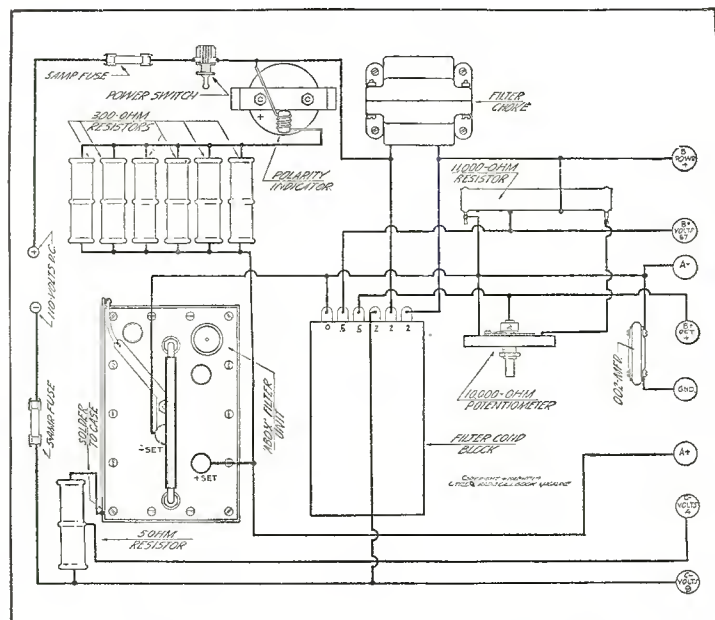

Figure 4. This is a graphic diagram of the wiring of the eliminator shown at the top of this page



- 1—Amperite type 1-A
- 2—Amperite type 112

If the builder desires to make up the entire job on a single board, the parts specified in the two lists shown above will be required, with the addition of a Transite baseboard 7-1/2x24x1-1/2-inch.

**Freedom from Hum**

Freedom from hum and troublesome noise may be attributed to the design features of the eliminator generally and specifically to the type B-1 audio choke used along with the high capacity electrolytic condenser and filter. The audio choke has a low d.c. resistance and will permit a current of over 50 milliamperes to flow through its winding. Another feature of interest in considering the Vitrohm eliminator may be learned from the fact that regardless of the number of tubes which are pulled out of the receiver, the voltage on the remaining tubes does not rise to a dangerous value. Regardless of how few or how many tubes are added in the set at anytime, the A voltages remain constant.

**Satisfaction and Permanence**

In designing the eliminator, the first thought was given to secure a circuit in a layout which would give entirely satisfactory performance permanently. Naturally with this in view it would not be possible to consider any apparatus that would break down, deteriorate or wear out. Examination of the schematic circuits in this article and of the photographs will show the rugged nature of all parts involved, which should be of interest to any set builder living in direct current neighborhoods.

All of the apparatus except the Abox filter and the two five ampere line fuses and binding posts is placed inside of a sturdy metal case perforated to provide ventilation. Once the apparatus inside the metal case is mounted and wired, it calls for no further attention. It is out of the way and danger of shocks, by virtue of the condensers, chokes and resistors being inside of the cage.

**Divided into Three Groups**

In the photograph shown in Figure 3, the reader will notice that the apparatus inside the metal case may be conveniently divided into three groups. On the left panel, which is of Celeron are mounted the Adjustat, the toggle switch to turn the elimi-



Figure 5. This photograph represents the push-pull audio amplifier end of the eliminator, whose connections are represented in the schematic circuit Figure 7 on this page

nator on and off and the polarity indicating meter. The purpose of this polarity indicating meter is to show whether the polarity of the plug in the light socket is correct.

The middle section of the eliminator consists of the Parvult filter block, the Ferranti audio choke, the two Ward-Leonard resistors 507-52, and the 5 ohm center tap resistor.

To the right of this section and extending the full width and height of the metal case is a piece of one-quarter inch Transite, effectively shielding the parts in the middle section from the six resistors mounted in parallel in the section to the right. All of the resistors in this last section are mounted in an upright position and are held securely in place by means of a star washer and a bolt running down through the Transite base.

Outside the metal case at the right in Figure 3 is mounted the Abox, which completes the apparatus required for the eliminator. Wiring of the eliminator may be accomplished by means of flexible wire or if the builder is anxious to have a clean cut wiring job, the work may be done with solid bus bar.

Reference to the graphic illustration shown in Figure 4 will show the method of connecting up the polarity indicator, which consists of three turns of wire wound around a metal loop on the back of the polarity indicating meter.

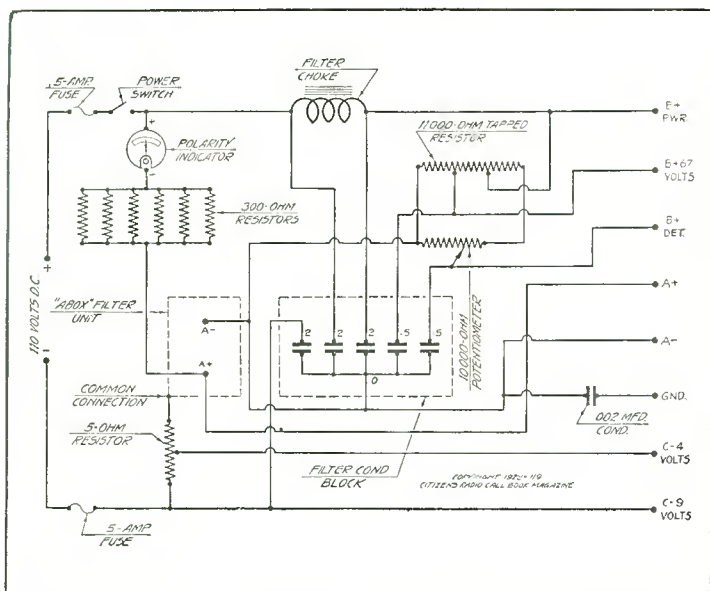

Figure 6. This schematic circuit represents the D.C. eliminator itself, while the diagram to the right represents the push-pull power amplifier. It will be noted that the binding posts are brought out so that when the two are joined together the whole unit may be readily hooked up

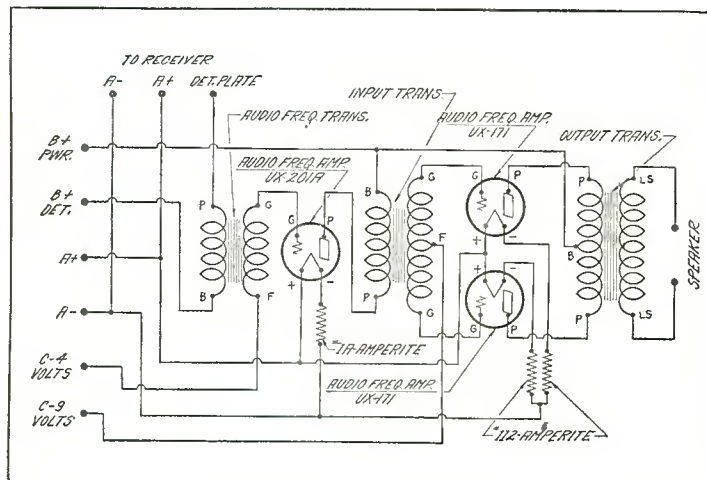

Figure 7. Schematic circuit of the push-pull audio amplifier used in conjunction with the D.C. eliminator is shown above



# Bodine Twin Eight A.C. Radio-Phone Combination

Complete Batteryless Receiver Has Added Feature of Power Amplifier, Electric Turn Table and Magnetic Pick-Up

**M**ANY radio fans who have possessed a separate set, an amplifier, a source of filament current and possibly a phonograph may have wondered whether it would be possible for a combination to be designed that would include radio or phonograph music at will and at the same time be self-contained in a suitable console for the sake of compactness and simplicity.

Recently our laboratory has tested the Bodine Twin Eight A.C. phonograph-radio combination, using a Bodine receiver, a phonograph motor made by the same concern, and a power unit

amplification and a non-regenerative detector, making a total of four tubes in all and these tubes being of the 199 type. The first radio frequency stage is tuned by a single .00035 mfd condenser, which may be seen in the photograph, Figure 1, and is located on the left hand drum dial. The second and third radio frequency stages together with that of the detector are tuned by a three-gang condenser of .00035 mfd per section, which is operated from the right hand drum dial. Further idea of the location of the drum dials may be secured by inspecting Figure 3, which is the panel layout, and Figure 9, which gives the actual connections

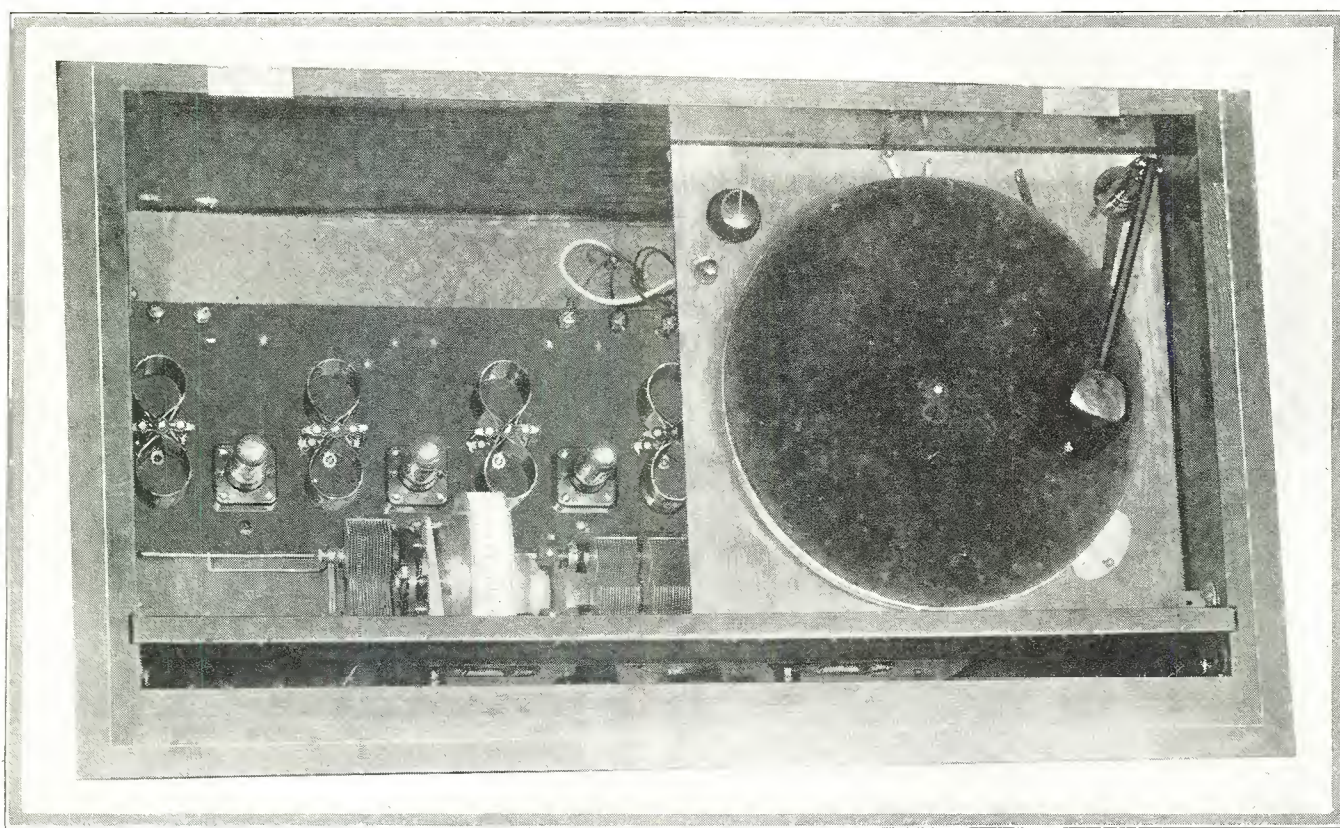

*Figure 1. Shown in this photograph is the Bodine Twin Eight A.C. receiver at the left with an electric turn table and magnetic pick-up pictured at the right. These two units are placed in the top of an Excello console*

known as the King Lear super power amplifier, which is assembled from standard parts.

Some details of the receiver itself may be gained from an inspection of the photograph in Figure 1, which is a top view of the receiver and phonograph motor. Additional details of the receiver may be learned from the baseboard layout illustration shown in Figure 3, the schematic shown in Figure 4 and the graphic in Figure 9. Frontal appearance of the receiver is indicated in a photograph in Figure 8.

#### Tuned R. F. Receiver

Examining the schematic circuit shown in Figure 4, we see the receiver itself consists of three stages of tuned radio frequency

to be made in hooking up the receiver. The use of these two tuning controls allows the operator to have a certain amount of flexibility in the antenna stage, where it is generally desired because of the difference in antenna and ground conditions. The three-gang condenser unit has three balancing capacities, which are located under the main capacities and which may be shifted by the operator in order to make the three tuned stages tune alike. These three trimmers are adjusted by means of a wooden stick sharpened at one end like a screw-driver. Assuming that no great deviation has been made by the builder in the wiring of the individual stages, it is quite likely that not a great deal of balancing will be required, although in this case actual operation of the set is the only criterion.

(This receiver tested and all illustrations made in our laboratory)



Uses 100 Mil Rectifier

Going now to the description of the power amplifier, it is observed by referring to the schematic in Figure 6 that its power is derived through the use of a QRS 100 milliamperere rectifier supplied with 550 volts each side of a center tap. The filament current for the four 199 tubes arranged in series is secured through a drop over the entire resistance train shown in the schematic, Figure 6. The plate voltages for the receiver and the amplifier are taken off the separate taps on this resistance train. Therefore, A B and C elimination of the receiver is readily accomplished. In the case of the filament supply for the first audio amplifier and the two 210 tubes arranged in pushpull, this comes from two separate 7½ volt filament windings located on the Thordarson power amplifier. The first of these 7½ volt windings supplies filaments of both of the 210 tubes, while it supplies the 112 tube when a 3 ohm resistance has been placed in each side of this filament line, these resistances serving to cut the voltage in that circuit to the proper operation of the 112 tube, and also the lighting of the dial lamps. Maximum voltage from the power amplifier is used for the plates of the two power tubes in push-pull, while lower voltages are used on the 112 amplifier, the detector and the three radio frequency stages. As is customary in all power amplifier installations, a filter choke unit is used with accompanying filter capacities, employed to smooth out the pulsating direct current furnished by the rectifier. Since the rectifier tube used in this installation is of the filamentless type, the filament winding on the power transformer which is usually employed to light the rectifier filament is now diverted into use as a means of lighting the 210 tubes arranged in push-pull. With this type of rectifier, it is necessary to have a buffer condenser of .1 mfd across each extremity of the high voltage winding, with its center tap made common with the center of the high voltage winding, which becomes the negative lead of the power system.

The input of the amplifier is connected through a three-point switch to the output of the receiver and to the electric phonograph pick-up unit, so that by manipulation of this switch the operator may throw the output of the receiver onto the power amplifier or use the output of the electric pick-up instead. A suitable 500,000 ohm variable resistance is provided across the phonograph pick-up terminals so that this control may govern the amount of energy fed into the primary of the first audio frequency transformer. When the radio set is being used, this variable resistance is out of the circuit and does not affect the volume of the receiver. This volume control may be seen mounted on the board which carries the Bodine phonograph motor and is the black knob at the left rear of the phonograph section. Next to it, in Figure 1, is the switch in series with the 110 volt feed to the motor, which allows starting and stopping of the phonograph turntable. At the right of the phonograph section is mounted the base for the electric pick-up unit, the two wires from which are led down through the board and connect onto the phonograph pick-up binding posts on the power amplifier on the shelf below.

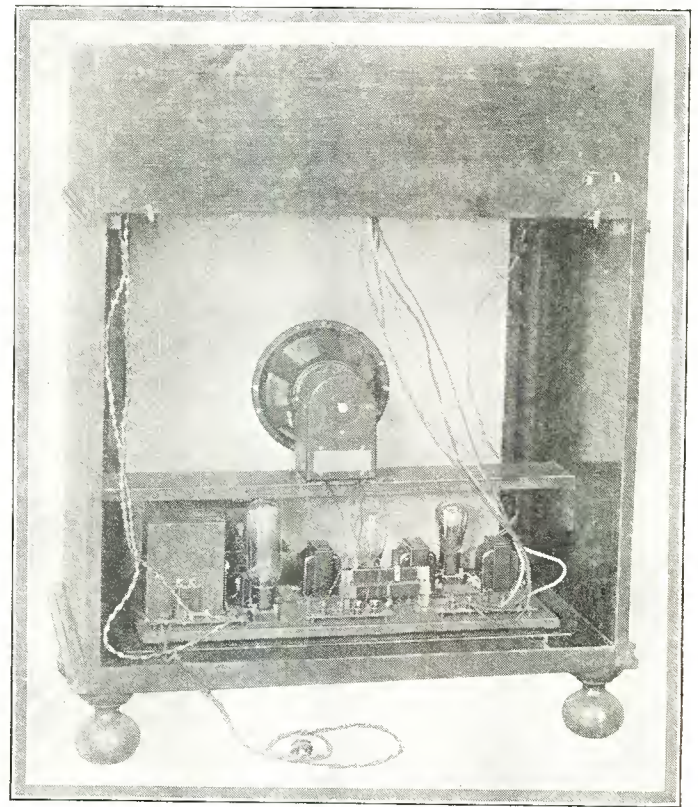

Figure 2. Rear view of the combined receiver and electric phonograph is shown above, which represents the King Lear power amplifier and a dynamic speaker mounted in the rear of the Excello console

Follow Graphic Diagrams

To insure ease of wiring and a minimum of errors on the part of the builder it is recommended that for both the receiver and the power amplifier the graphic illustrations be consulted and followed carefully. The graphic diagram of the amplifier is shown in Figure 7 and that of the receiver in Figure 9. In both of these pictorial diagrams the apparatus is placed so that all connections may be readily seen. For the positioning of the apparatus in these two units the drawings in Figure 3 and 5 should be followed, the former being the receiver layout and the latter the amplifier layout.

After the builder has completed all of the wiring in both of the units, and has checked over his work to guard against any errors, the installation may be put into commission. In the receiver four of the 199 type tubes are inserted, while in the power amplifier the 100 m.a. rectifier tube is used together with a 112 tube and two 210 power tubes. On starting the set the 2,000-ohm variable resistance should be turned so the milliammeter on the

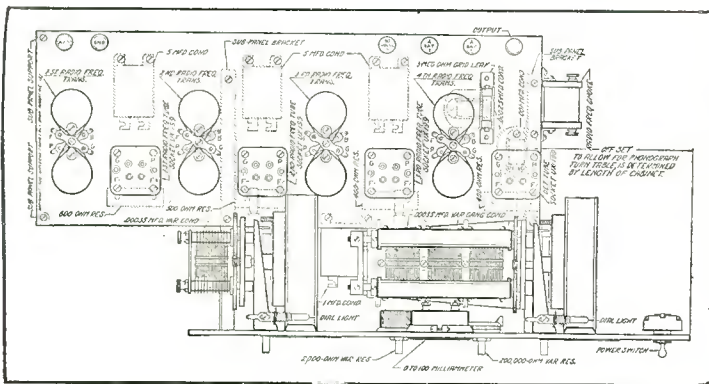

Figure 3. In the above sub-panel layout may be seen the method of assembling all parts used in the Bodine Twin Eight A.C. receiver. The space shown at the left of the drawing represents an offset, which must be provided for in order to allow the panel to be centered

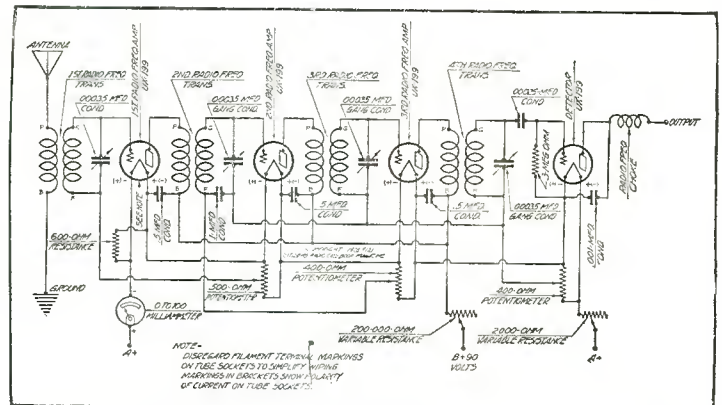

Figure 4. In this drawing the constructor will find the schematic circuit involved in the receiver described in this article



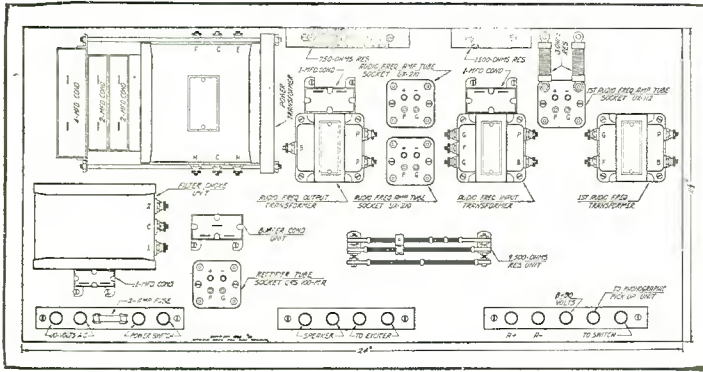

Figure 5. Above is shown a baseboard layout of the power amplifier used for providing A, B and C current in this receiver

panel reads 60 to 65 milliamperes, which will furnish sufficient current for the four 199 filaments in series. The set is then tuned as any radio frequency receiver, the left dial governing the first tuned stage, and the right the remaining two r. f. stages and the detector. When a station of medium strength has been tuned in the operator may adjust the trimmer condensers on the three-section gang condenser and peak these capacities for maximum volume on the received signal. This process is so familiar to set constructors that no further description need be given.

When it is desired to operate the set as an electric phonograph, merely turn the switch on the front panel, start up the motor by means of its switch on the motor stand, put on one of the electrically recorded records, and listen to reproduction such as was never possible on the old type phonograph.

Such a combination as has been described should prove of more than ordinary interest to the enthusiast who desires all forms of entertainment combined into a single unit.

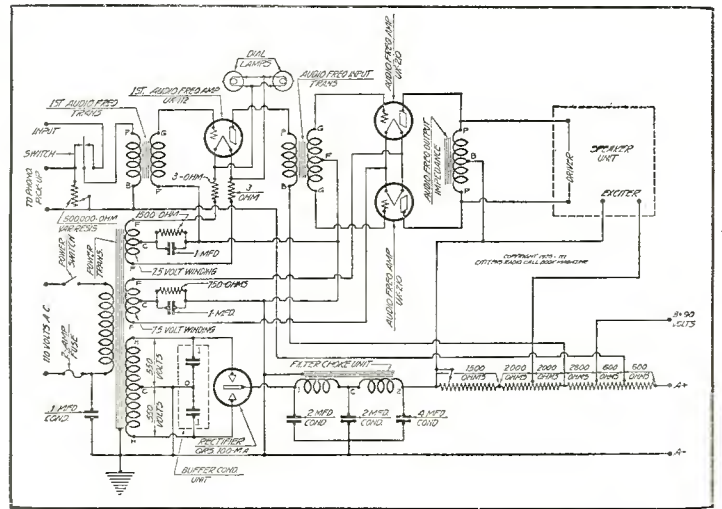

Figure 6. Electrical details of the power amplifier are set forth in the schematic diagram illustrated above

Parts used in the construction of this installation are:

(Receiver)

- 1—T-35 Bodine r. f. transformer
- 3—T-35-199 Bodine r. f. transformers
- 1—Remler 3 gang .00035 mfd variable condenser
- 1—Remler .00035 mfd variable condenser
- 2—110 Remler Universal drum dials
- 4—531 Frost sockets
- 1—Weston 0-100 m. a. milliammeter
- 3—Acme Par-volt .5 mfd by-pass condensers
- 1—Acme Par-volt 1 mfd by-pass condenser
- 1—Sangamo .00025 mfd fixed condenser

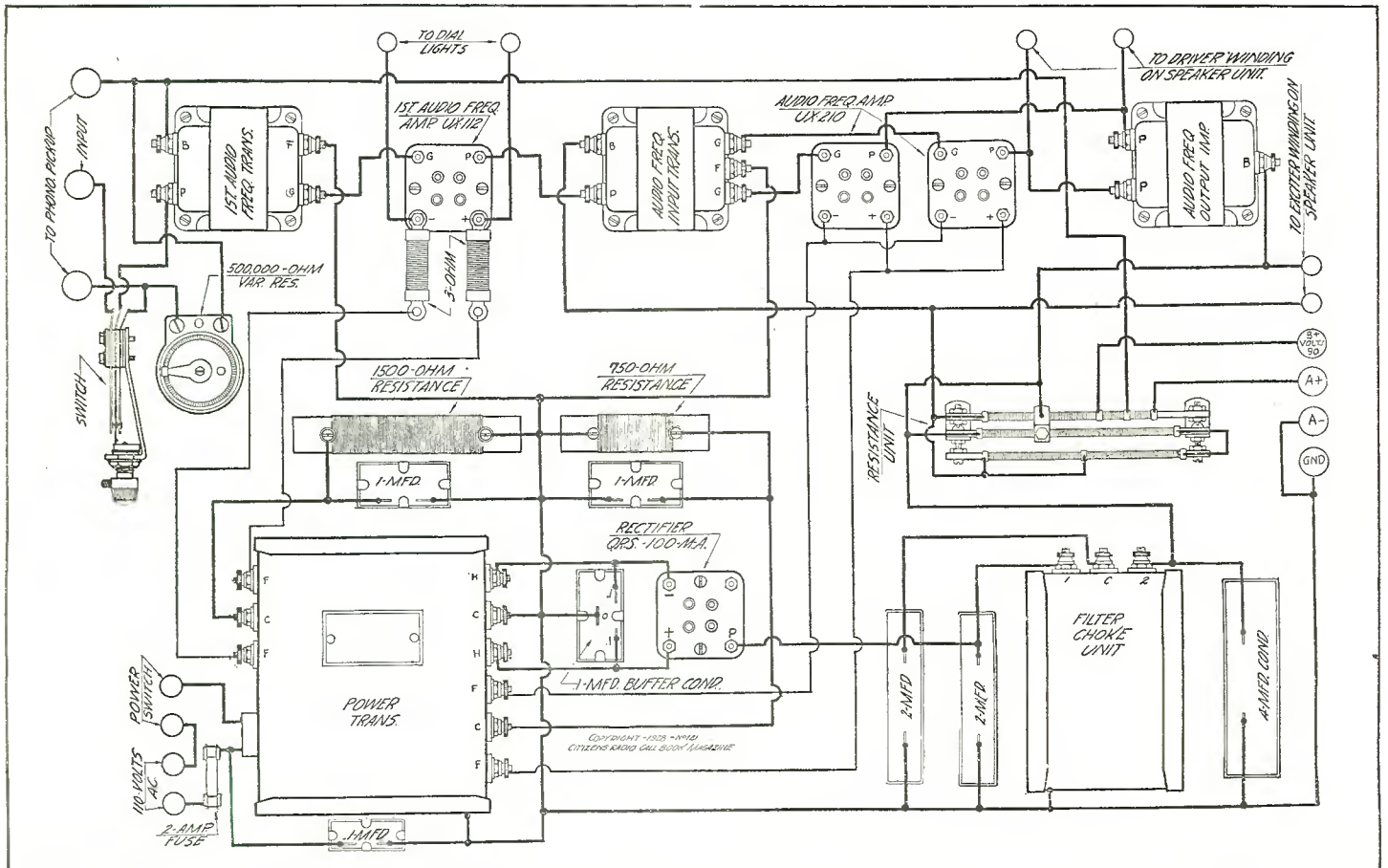

Figure 7. In constructing this power amplifier the builder would do well to follow the graphic diagram above very closely, since it shows the exact connections to be made for the power amplifier



- 1—Sangamo .001 mfd fixed condenser
- 1—Electrad 2 megohm grid leak
- 1—Electrad grid leak mounting
- 1—85 Sampson r. f. choke coil
- 1—Carter 0-200,000 ohm volume control
- 1—P-600 Carter 600 ohm fixed resistance
- 1—PA-500 Carter 500 ohm fixed resistance
- 2—PA-400 Carter 400 ohm fixed resistances
- 1—MW-2000 Carter 2,000 ohm variable resistance
- 7—Eby engraved binding posts
- 1—Hart & Hegeman 5-amp. 250-volt panel switch
- 2—Benjamin sub-panel brackets
- 1—7x18x3/16 inches drilled and engraved Courtland front panel
- 1—7x18x3/16-inch drilled Courtland sub-panel
- 1—Sub-panel, 7x18x3/16-inch
- 25—Ft. Acme Celatsite wire
- 1—Pkg. Kester radio solder
- 1—Ekko ground clamp

(Power Unit)

- 1—T-2098 Thordarson power transformer
- 1—T-2099 Thordarson choke unit
- 1—T-2408 Thordarson push-pull input transformer
- 1—T-2420 Thordarson push-pull output transformer
- 1—R-200 Thordarson audio transformer
- 4—530 Frost sockets
- 1—Acme Par-volt 4 mfd high voltage filter condenser
- 2—Acme Par-volt 2 mfd. high voltage filter condensers
- 1—Acme Par-volt .1-.1 mfd. buffer condenser
- 2—Acme Par-volt 1 mfd by-pass condensers
- 1—Acme Par-volt .1 mfd by-pass condenser
- 1—101 Carter resistance unit
- 2—H-3 Carter 3 ohm fixed resistances
- 1—P-1500-40 Carter 1500 ohm fixed resistance
- 1—P-750-60 Carter 750 ohm fixed resistance
- 15—Eby engraved binding posts
- 1—3 amp. fuse
- 2—Fuse clips
- 1—Jensen dynamic speaker

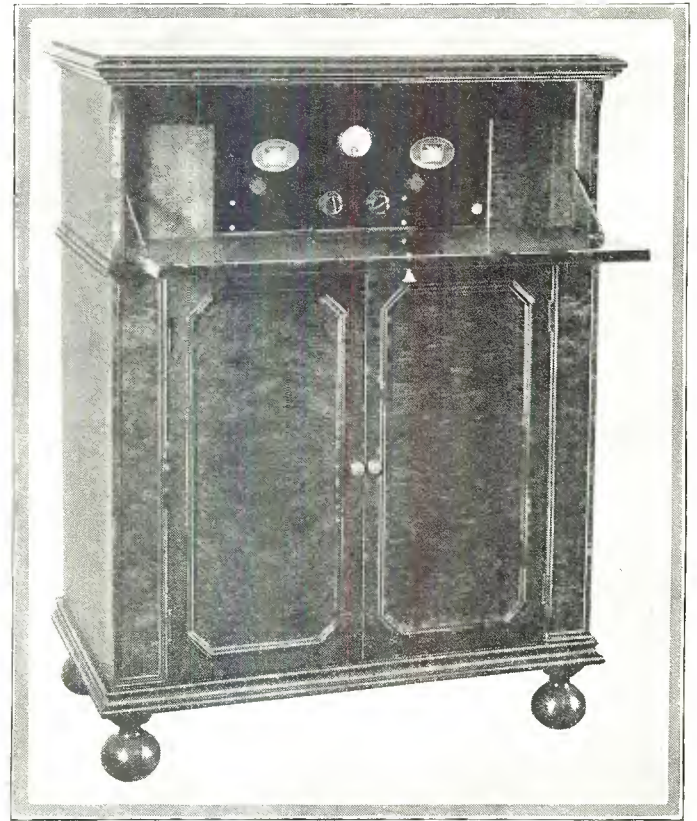

Figure 8. Front view of the Bodine Twin Eight A.C. is shown in this photograph, being mounted in an Excello console

- 25—Ft. Acme Celatsite wire
- 1—RC-10 Bodine phonograph motor
- 1—Carter 0-200,000 ohm variable resistance
- 1—Carter jack switch
- 1—QRS 100 m. a. rectifier tube

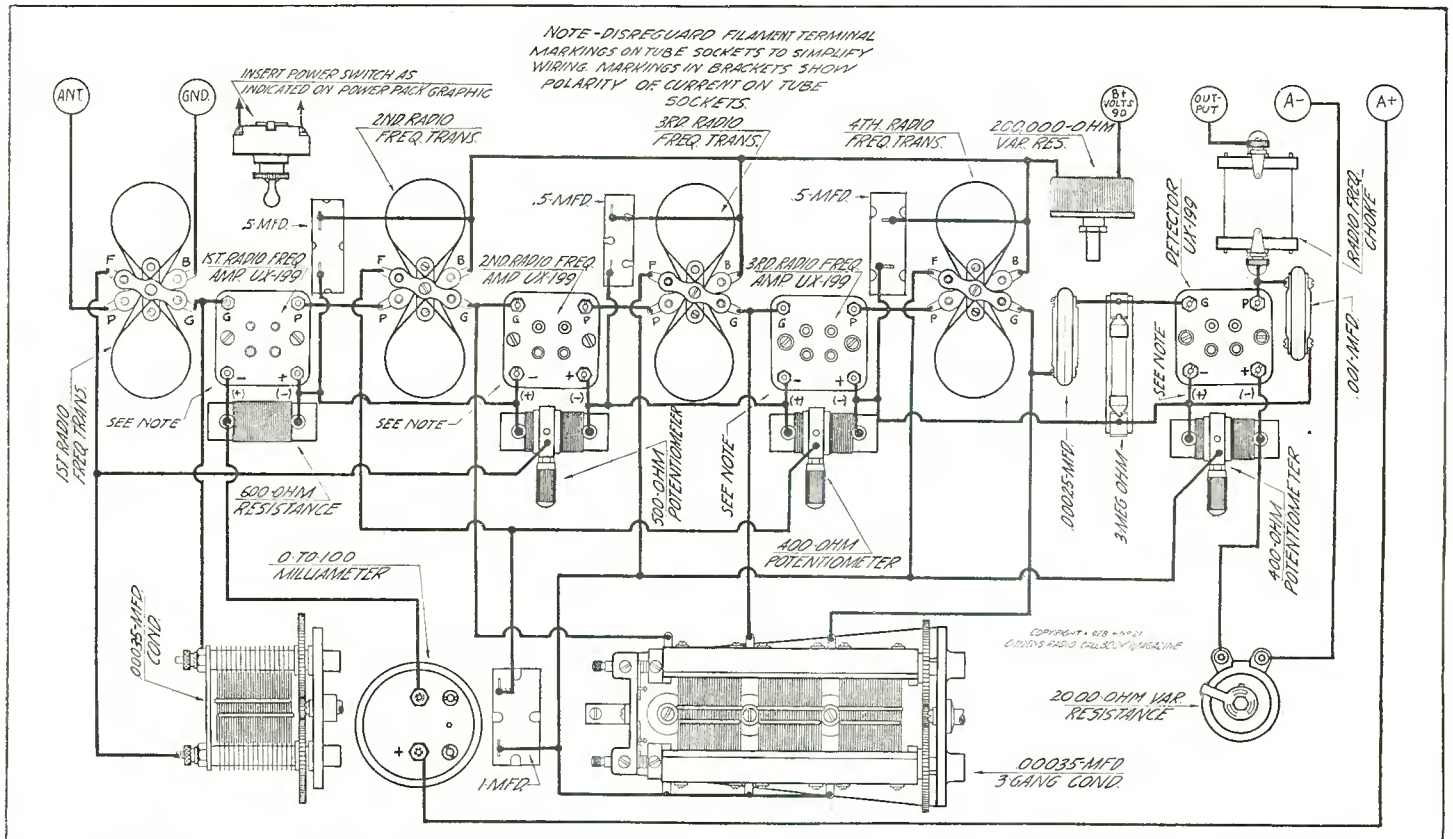

Figure 9. All wiring of the receiver may be accomplished by means of the graphic illustration shown above



# Browning-Drake A. C. Operated With Acme Power Supply

Popular Receiver Converted for Alternating Current Operation  
with Power Supply Ample to Take Care of All Demands

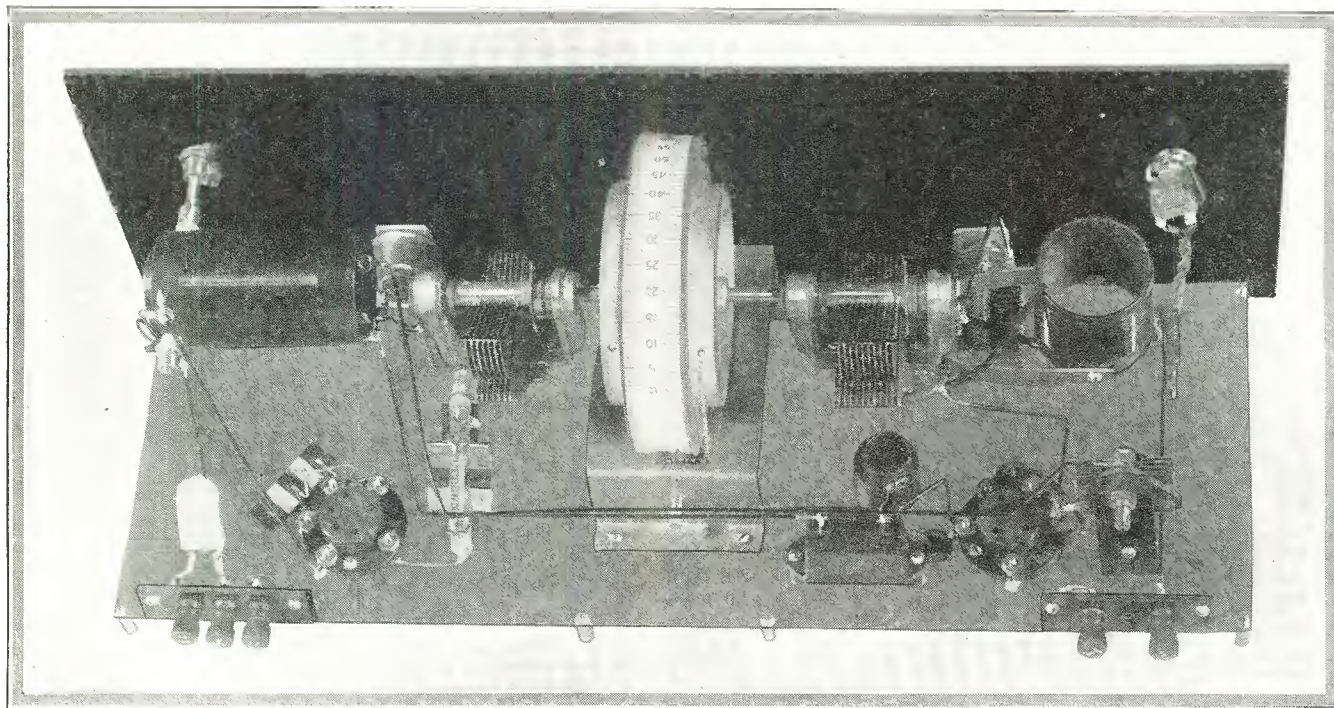

Figure 1. Rear photographic view of the Browning-Drake receiver described in this article

**G**REAT flexibility is the keynote in radio design today, since the consumer public has come to realize the many advantages of separate audio and radio frequency amplifiers. A brief review of these two systems will show why this is so.

Radio frequency material, that is, the tuning and amplifying apparatus, is usually of light weight. Recent day shielding has increased this weight somewhat, but nothing in respect to the weight of audio and power apparatus.

Audio frequency apparatus with the large amount of wire and iron core necessary to obtain good low tone reproduction has become increasingly heavy during the past two years. When

combined with power supply apparatus the weight and bulk of this end of the receiver become a problem.

By building an r.f. amplifier separately from the a.f., the part of the receiver combination which must be in view on the table can be greatly reduced in size and weight and it is light and easily moved.

The audio end of the receiver may be put away on a shelf below the table, or it may be put in a separate cabinet or closet. This makes an admirable arrangement. Prior to this time the placing of the storage battery entered into our problem, but with the arrival of a.c. tubes and the necessary apparatus for their use this last problem of clean, efficient and flexible radio is solved.

## Well-Known Circuit

The Browning-Drake circuit is so well known to radio fans and set builders the world over that it is not necessary to go into its development in 1923 by two Harvard research fellows. Since its inception, the main circuit has been changed only in minor details, although from time to time the layout of parts and the mechanical design has been brought up to date.

## Now Uses Large Tubes

One change that has been made is that a neutralization system has been developed so that a large tube may be used as the r.f. amplifier. The 201-A types of tube have some advantage over the 199 tube, though really they are not more efficient amplifiers, but the life of the 199 tubes is so short that it seemed advisable to utilize if possible the storage battery type or a.c. tubes throughout. The neutralization system consists, as will be noted from the wiring diagrams, of a number of extra turns

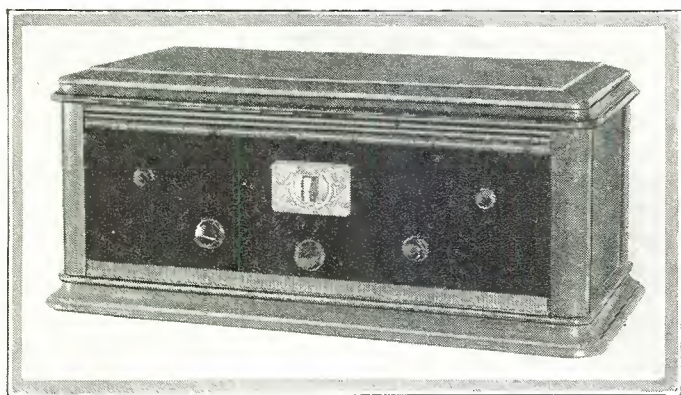

Figure 2. The receiver is here shown in an Ehlert cabinet

(This receiver tested and all illustrations made in our laboratory)







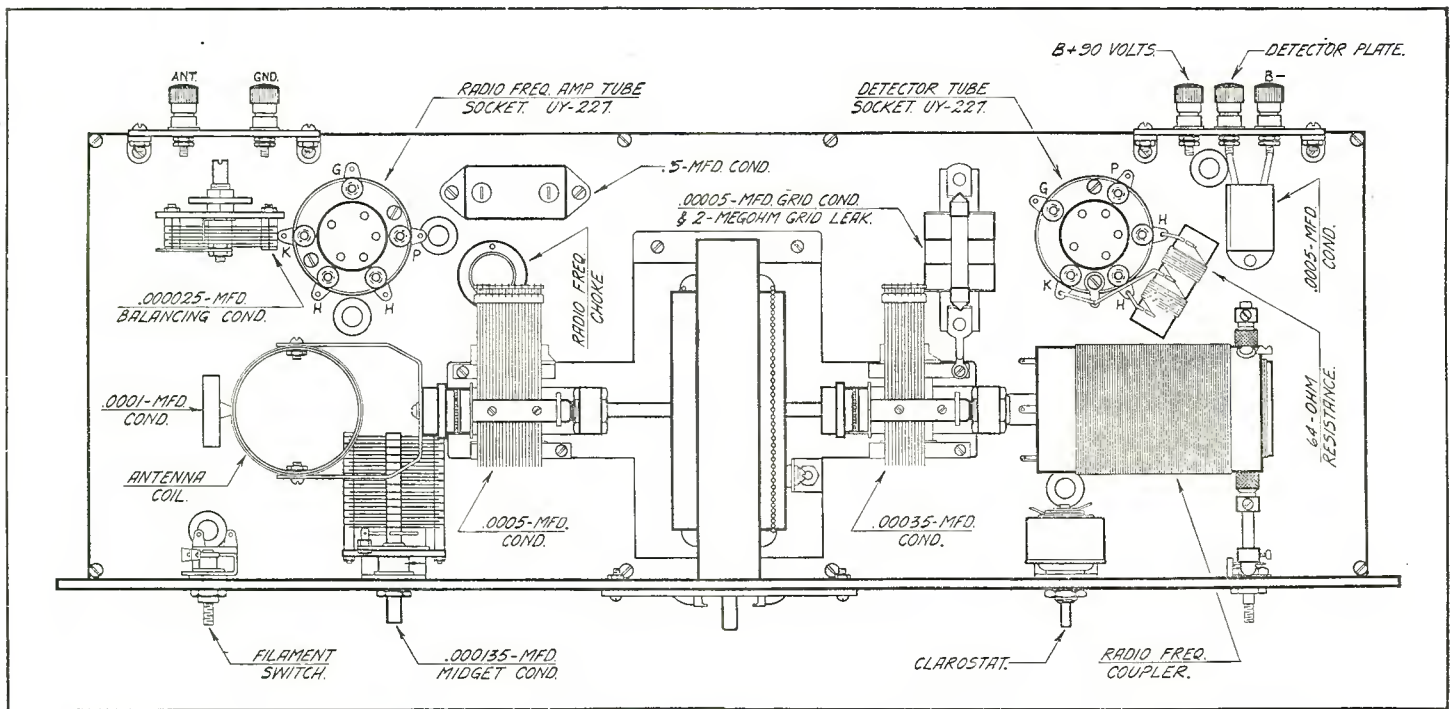

Figure 6. In this drawing may be seen the actual layout of the sub-panel for the Browning-Drake receiver

ably the local station will still be audible or can be made so by adjusting the tickler coil and turning. Now set the balance condenser in such a position that a minimum signal is obtained. The receiver is then balanced or neutralized. In case of several local stations, the one chosen for balancing should be the one operating on the lowest wavelength. Where there are no local stations, the set may be balanced by tuning in the whistle from a semi-distant station. Set the balancing condenser so that changing the tuning does not change the pitch of the whistle. Of course, the intensity or loudness of the whistle will always be affected by the thing, so do not confuse this with the pitch of the whistle.

A little experience in tuning on the part of the operator is better than detailed instructions, although a few suggestions may be useful. After the receiver has been balanced, according to the directions given, it is ready to operate. With antenna, ground, batteries, etc., connected, set the rotor coil on the B-D transformer in such a position that the secondary circuit is oscillating. Turn dial until a whistle is heard; this whistle is the carrier wave of the transmitting station beating with the oscillation of the detector tube, and will be heard if a station above the noise level is transmitting. Turn back the rotor coil so that the whistle disappears and, at the same time, adjust trimmer condenser until the signals are loudest. Readjust the tuning and the rotor coil until satisfactory volume is obtained. It will be found that the Clarostat makes an excellent volume control; it regulates the signals received without detuning the set. Always keep this Clarostat turned down as far as possible, consistent with sufficient volume. The receiver is very selective, therefore it is necessary to tune the circuits to exact resonance in order to obtain the best quality. Always regulate the volume by the Clarostat and the tickler coil—never by setting the dials off resonance. In case the builder is located in a nest of local broadcast stations, complete shield will stop any pick-up from the local stations on the coils and wires of the set so that outside stations should be easily tuned in while locals are operating.

Even an inside antenna of from 10 to 20 feet is entirely satisfactory for reception of local and semi-distant stations. As much of this as possible should be vertical. An outside antenna of 60 to 70 feet, however, is recommended for all-round purposes. The above length includes the length of the lead in. This antenna also should be as high as possible. If a tree is conveniently located, a single wire from the house to the tree is excellent. The antenna should, of course, be well insulated and located as far as possible from power lines and other electrical wires and

cables. The ground connection is best made to a cold water pipe by means of a clamp. Connections to other pipes, however, such as steam or hot water heating systems, are usually satisfactory. Having the r.f. end of our combinations in working order, we proceed to our next unit, the tone quality link in our radio chain.

#### Parts Used

Parts used in the receiver and power amplifier construction are:

##### Receiver

- 1—Browning-Drake single mount kit
- 1—Browning-Drake foundation unit
- 1—Hammarlund .0005 mfd variab'c condenser
- 1—Hammarlund .00035 mfd variable condenser
- 1—Precise .000135 mfd midget condenser
- 1—Aerovox .5 mfd locking condenser
- 1—Aerovox .0001 mfd fixed condenser
- 1—Aerovox .00005 mfd grid condenser with prongs
- 1—Durham 8 megohm grid leak
- 1—Universal Clarostat
- 1—Tobe .001 mfd fixed condenser
- 1—Yaxley filament switch
- 2—Benjamin 5 prong sockets
- 1—Browning-Drake r.f. choke
- 5—Eby engraved binding posts
- 20—Feet Corwico Braidite flexible wire
- 1—Ekko ground clamp
- 1—Package Kester radio solder
- Miscellaneous—lugs, nuts, screws, etc.

##### Power Supply

- 2—Z-3 Acme audio transformers
- 1—PT-1 Acme input transformer
- 1—PT-2 Acme output transformer
- 1—BH-1 Acme power transformer
- 2—B-2 Acme chokes
- 1—AC-2 Acme filament transformer





Figure 8. In this photograph the receiver has been mounted in an Ehlert console

- 6—Eby sockets
- 1—F1000 Polymet condenser block
- 2—Polymet 1 mfd bypass condensers

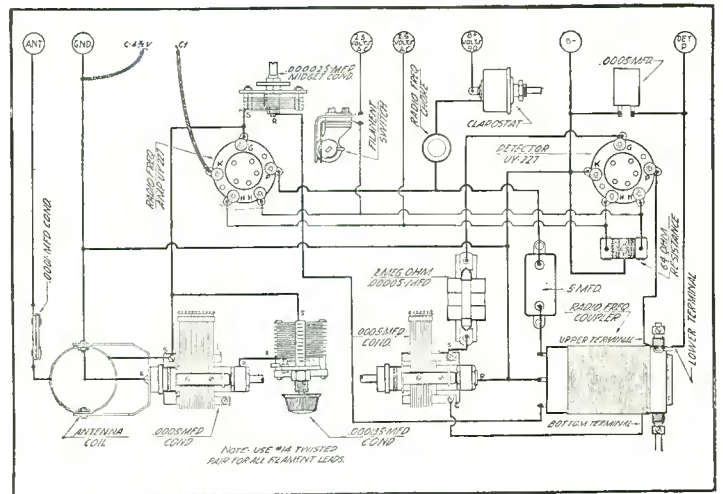

Figure 9. This is the graphic circuit by means of which the receiver should be wired

- 1—Polymet .00025 mfd fixed condenser
- 1—FT-64 Frost 64 ohm center tapped fixed resistance
- 2—CRL 4,000 ohm fixed resistors
- 2—CRL 10,000 ohm heavy duty potentiometers
- 2—CRL 2,000 ohm heavy duty potentiometers
- 1—CRL 1,000 ohm heavy duty potentiometer
- 8—XL binding posts
- 1—7x16x3/16 inch Formica panel
- 1—16x15x1/2 inch wood baseboard
- 30—Feet Corwico Braidite wire
- 1—Package Kester radio solder
- Miscellaneous—lugs, nuts, screws, etc.

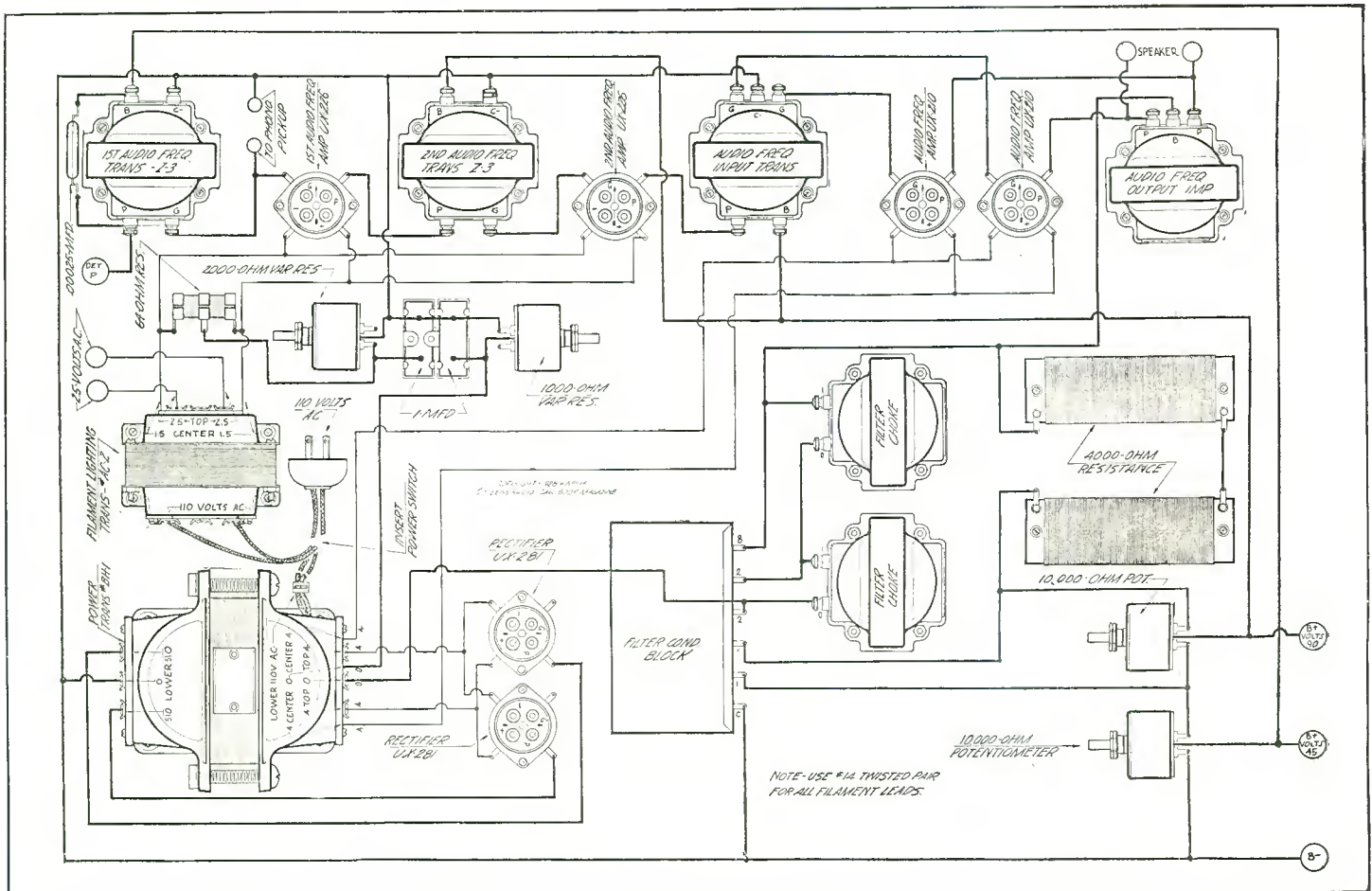

Figure 10. Above is shown a graphic representation of the power amplifier which should be followed religiously for wiring of that supply



# St. James Twin Four Built U-Shaped for Compactness

Eight-Tube Superheterodyne Greatly Simplified Using Only 21-inch Panel; Intermediates Have Small Field

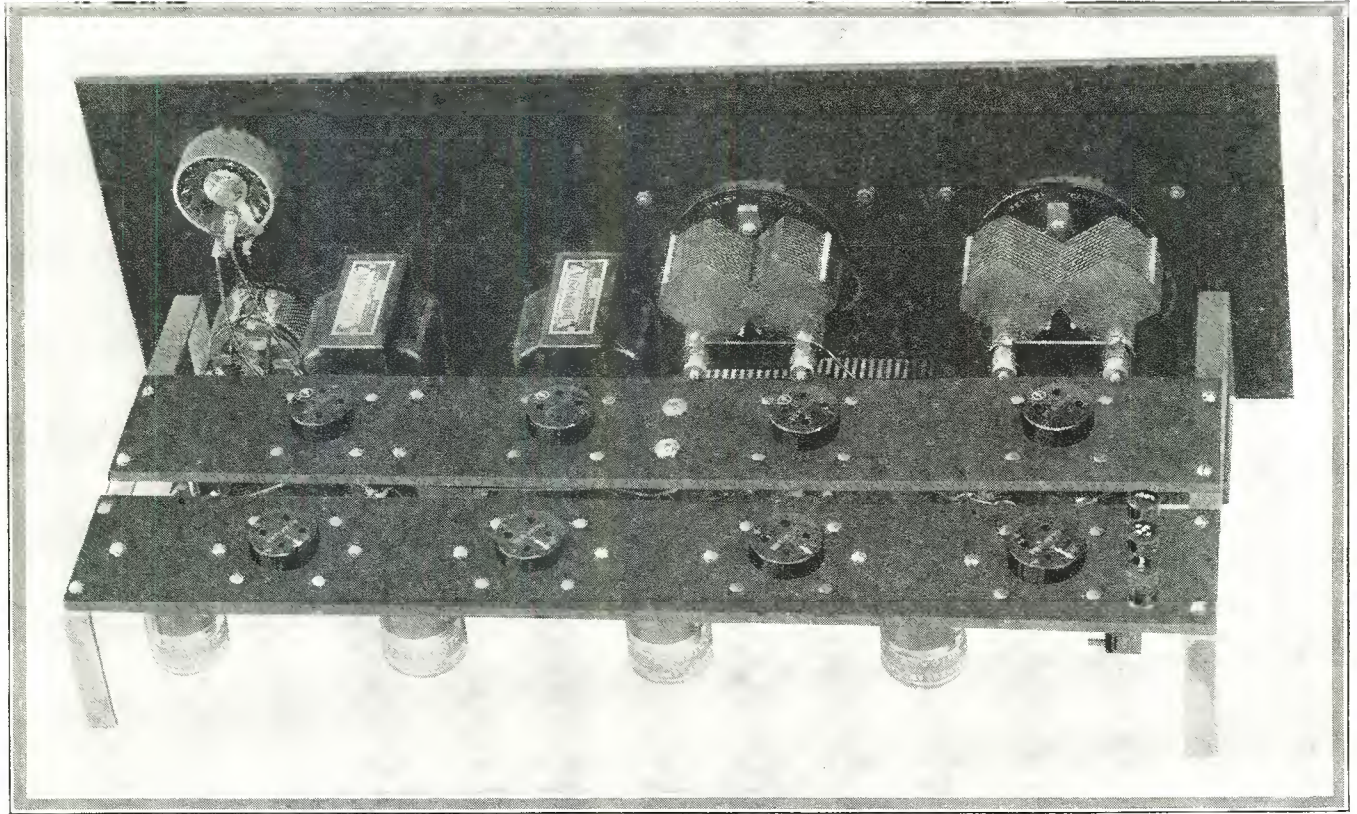

Figure 1. In this photograph may be seen the rear view of the St. James Twin Four described in the accompanying article. Note the tubes are carried on two separate strips for simplicity of wiring and compactness

READERS of all publications have been frequently exhorted to minimize the wiring involved in a receiver, because of the fact that such a receiver would necessarily function better with a small amount of wire rather than if a larger amount of wire was used. However, it is doubtful if our readers have seen many receivers in which the amount of wiring is cut down to 10 feet for all connections, which is the case in the St. James Twin Eight superheterodyne about to be described in this article. This wiring is divided into two portions, one of which is in opposition to the other. Examination of the photograph shown in Figure 1 will give the reader an idea of the U-shaped construction of the set. A still better idea may be gained from the perusal of the baseboard layout shown in Figure 2, where it will be seen that at the extreme left of the sub-panel are located the three loop terminals which lead directly to the first detector tube and to the right-hand tuning condenser. The output of the first detector is led directly into the first intermediate frequency transformer, thence into the second intermediate tube, then into the second intermediate transformer, thence to the second intermediate amplifier, into the third intermediate transformer and then into the third intermediate amplifier tube and the fourth intermediate frequency transformer. In a normal receiver the apparatus previously mentioned would be closely placed and the second detector and the ensuing material would then be extended toward the right. However, in the design of the St. James Twin Four it

was deemed advisable to make a turn and continue towards the left in the form of a "U" This physical arrangement also provides that the audio frequency section of the receiver will be opposite, or nearly so, the intermediate frequency amplifier section. Therefore, taking the strip nearest the panel at the right we have the second detector tube whose plate feeds into the first audio transformer, whose output goes to the first audio tube and whose plate goes into the primary of the second audio transformer. The output of the last named transformer is led to the grid circuit of the second audio amplifier which is a 112 tube whose plate circuit is carried to a pair of tipjacks located on the sub-panel. The oscillator coupler shown in dotted lines and the oscillator socket are located at the extreme left of the sub-panel.

#### No Oscillator Field

Because of the exceedingly small wiring used on the oscillator and the fact that it is located extremely close to its tuning condenser, practically no energy is given off by this circuit in the form of radiation and, therefore, it does not interfere with the operation of the balance of the receiver. Another feature of the set lies in the fact that on account of the minimizing of the wiring necessary for hooking-up the receiver the inherent pick-up of the set is materially reduced. Where in some receivers it is necessary to shield the set in order to cut down local pick-up, in this particular model on test it was found to be quite insensitive

(This receiver constructed, tested and all illustrations made in our laboratory)



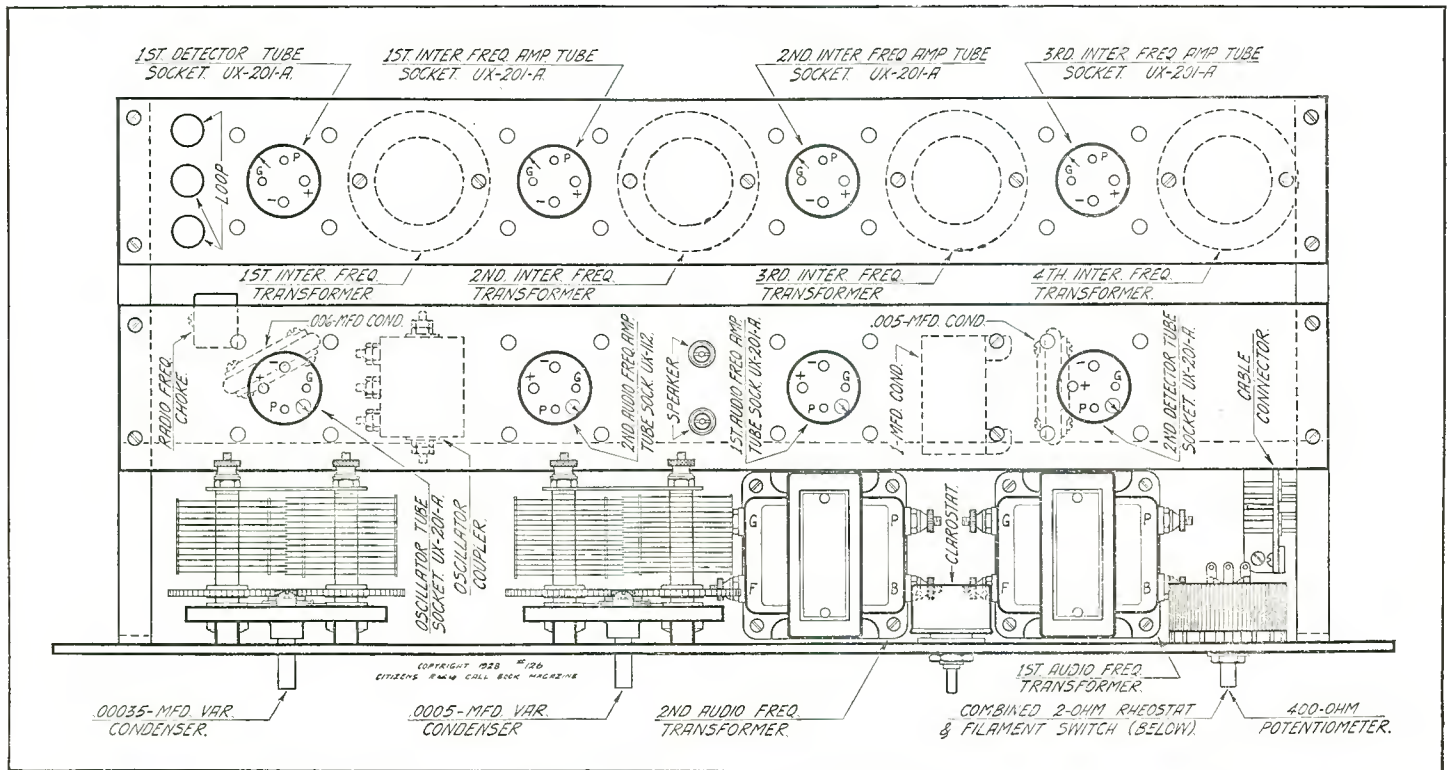

Figure 2. In this baseboard layout the reader will note the position in which each article is placed. The two audio transformers are located on a sub-panel extending across the bottom of the front panel

to local field strength and this is considered a good condition.

**Vacuum Impregnated Coils**

All of the intermediate transformers used in the receiver are St. James and are vacuum impregnated and also on account of their small physical dimensions do not create a disturbing field. Control of the amplifying property of the intermediate stages is by means of a 400-ohm potentiometer connected to the grid return of the first, second and third intermediate frequency transformers. Rectification in the second detector is by means of a separate 4½-volt C bias battery with its positive terminal connected to the center arm of the potentiometer and its negative terminal connected to the grid return of the fourth intermediate

transformer. The 400-ohm potentiometer arm is by-passed to the negative side of the filament circuit by means of a 1 mfd condenser.

**Wiring Is Very Simple**

In wiring up the receiver it is best to proceed with the two strips running parallel on the sub-panel brackets. The filament connection should be wired in first, using black Celatsite for the negative and red for the positive. The pieces may be cut 12¼ inches long, stripped and by passing through holes in lugs a firm mechanical joint is made which is easily soldered. A piece of blue Celatsite may be used to connect the positive posts on the four intermediate transformer sockets.

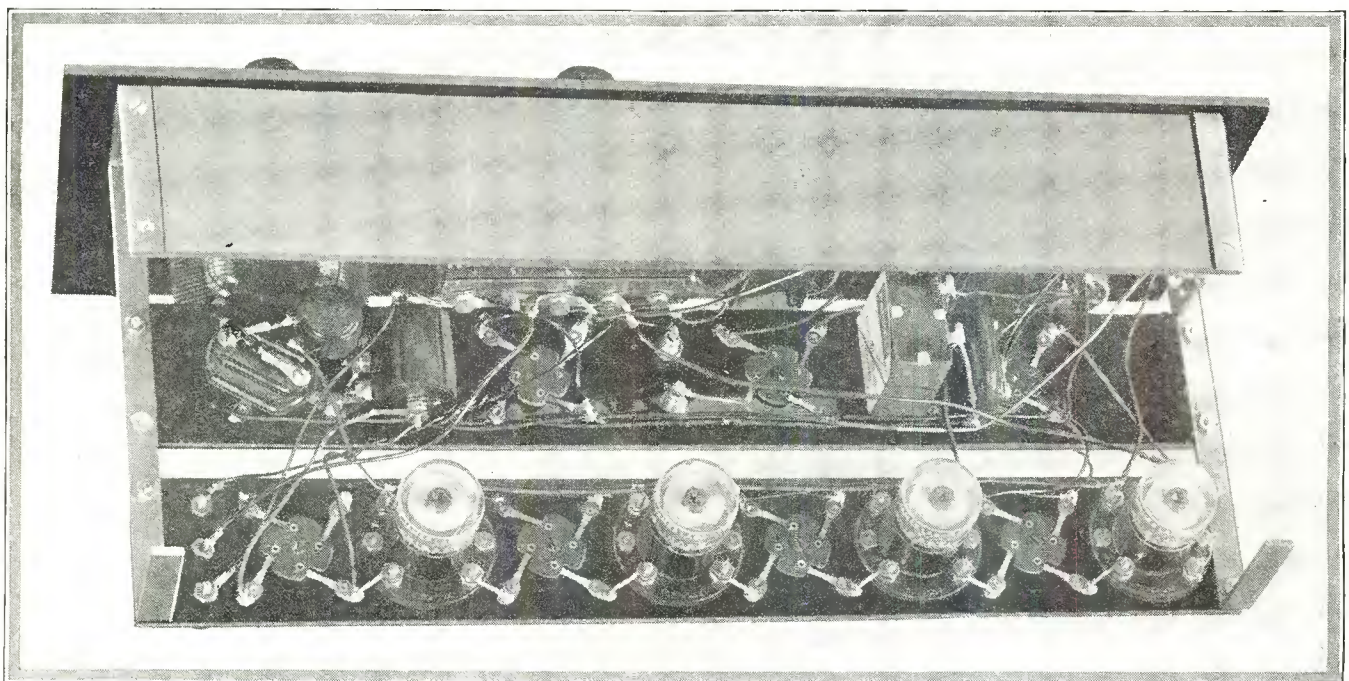

Figure 3. This photographic view shows the underside of the St. James Twin Four and gives the reader an idea as to the appearance of the set below the sub-panel



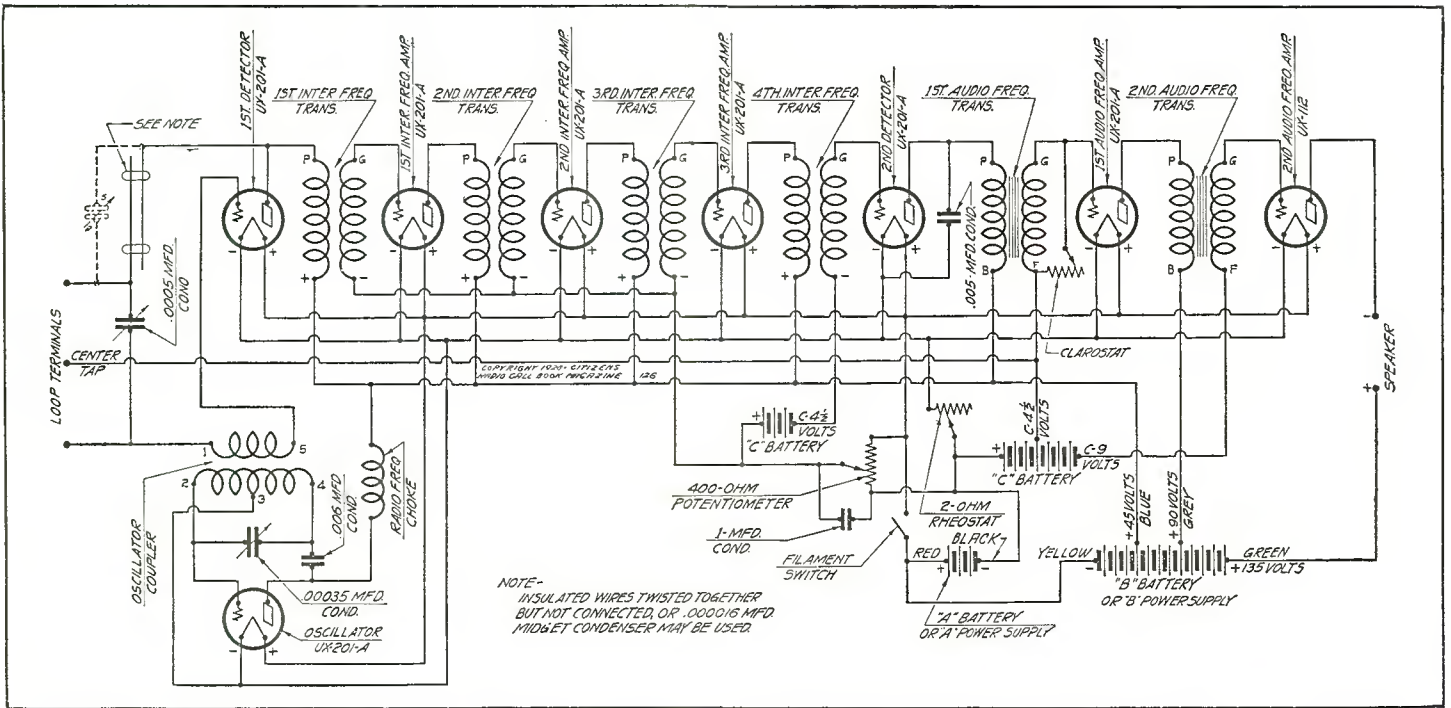

Figure 4. Schematically the receiver is illustrated above. While in the schematic two pieces of insulated wire are used as a regenerative condenser on the first detector, nevertheless for extreme flexibility it would be advisable for the builder to include a midjet condenser in the receiver

A piece of yellow Celatsite may be used for connecting the negative terminals of the first, second and third intermediate sockets, leaving about a 5-inch length from the third intermediate transformer to connect later to the center arm of the potentiometer. Terminal G of the intermediate socket leads directly to the G terminal on its respective tube, two lugs usually being sufficient to reach between these points. The oscillator coupler

connections are very simple and may be seen either from the graphic in Figure 5 or the detailed sketch shown in Figure 6.

The Frost 2-ohm rheostat is also a switch and is located on the front panel, this being the bottom control at the right in Figure 8. As the 400-ohm potentiometer is located above the rheostat, short connections supply it with positive and negative A current The negative should be connected to the clock-wise end. The

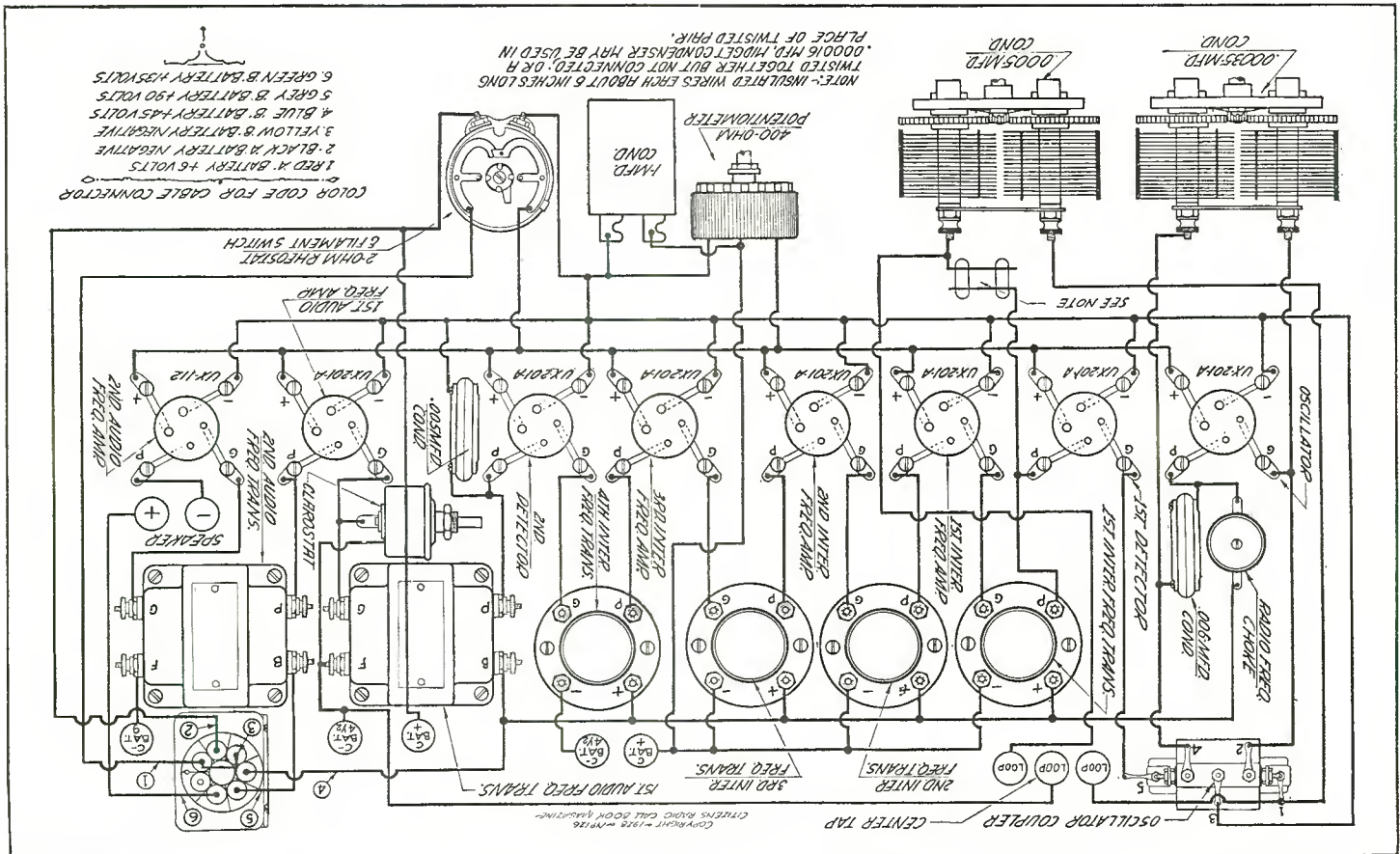

Figure 5. In this diagram is shown the graphic method of wiring a receiver, which method is exceedingly popular with the newcomers in radio. Even those experienced in set construction may be able to save some time by following this form of wiring diagram



blue terminal on the cable plug is connected to the blue Celatsite wire on the intermediates. A short lead from blue on the first intermediate goes to the r.f. choke and another from B on the first audio to blue completes this part. Lead from slate terminal of plug goes to B on second audio, and one from green of plug to one tipjack completes the plug connections with the exception of placing a short jumper between red and yellow on the plug.

All of this wiring should be done in accordance with the graphic wiring diagram shown in Figure 5, since it gives all details for hooking-up this compact receiver.

Two C batteries are shown, one for the audio frequency biasing and the other for the intermediate stage biasing. These batteries may be seen on the bottom shelf shown in Figure 3.

After tubes are inserted, cable attached to the power supply, with rheostat and switch turned off, turn on the rheostat and with the potentiometer turned to the positive side, or left side, set one dial at about the middle position of the scale, and bring the other to a point where a slight rushing noise is heard. By advancing the potentiometer to the right a point will occur where the set oscillates. Be sure to keep below this point. The filament voltage should be about  $4\frac{1}{2}$  volts and, once adjusted, will require no further attention. If twisted pair is used for the regenerative capacity of the first detector circuit, whistles will be heard when too much capacity is used and these whistles may be eliminated by untwisting slightly the pair of wires until the proper point is reached. If this setting is made at the higher waves it will hold over the band. This setting should be made just under the critical point. However, if a midget condenser is used and whistles are heard when the plates are meshed, the rotor should be turned out until the whistles disappear.

A little time spent in learning the proper tuning of the receiver will repay the operator in the results secured. The volume control while not essential, affords a wide variation in audio volume which often may be of advantage. The logging of stations will remain the same after these stations are once logged.

The receiver requires very little attention being limited only to the replacing of the C batteries, at the end of their life which in most cases runs between six and nine months. If B batteries of the dry type are used, their life will be prolonged to a great extent by changing them about.

Parts used in the building of this receiver are:

- 1—St. James upper socket strip
- 1—St. James lower socket strip
- 4—St. James intermediate frequency transformers
- 1—St. James oscillator
- 1—St. James choke coil
- 2—R-200 Thordarson audio transformers
- 1—660 Yaxley cable plug
- 1—1824 Frost 400-ohm de luxe potentiometer
- 1—S-1802 Frost 2-ohm de luxe rheostat
- 1—Remler .00035 mfd variable condenser

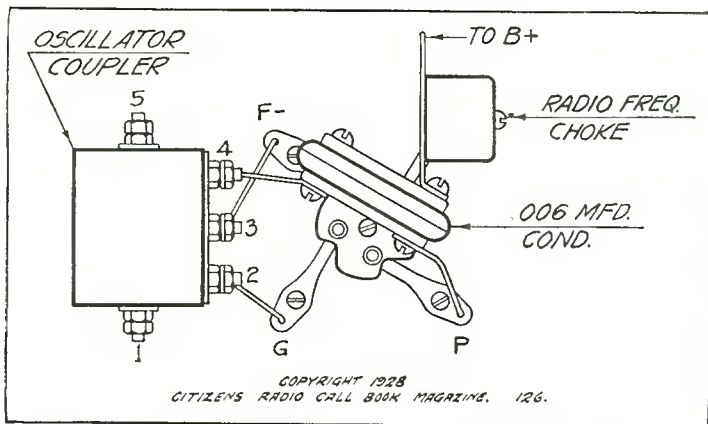

Figure 6. The drawing above represents the oscillator coupler, socket, radio frequency choke and by-pass condenser used in the St. James Twin Four. It is shown here because of its novelty and the fact that the oscillator coupler is probably the smallest in use at present and because of this fact its field is greatly reduced and does not cause inter-action with other circuits

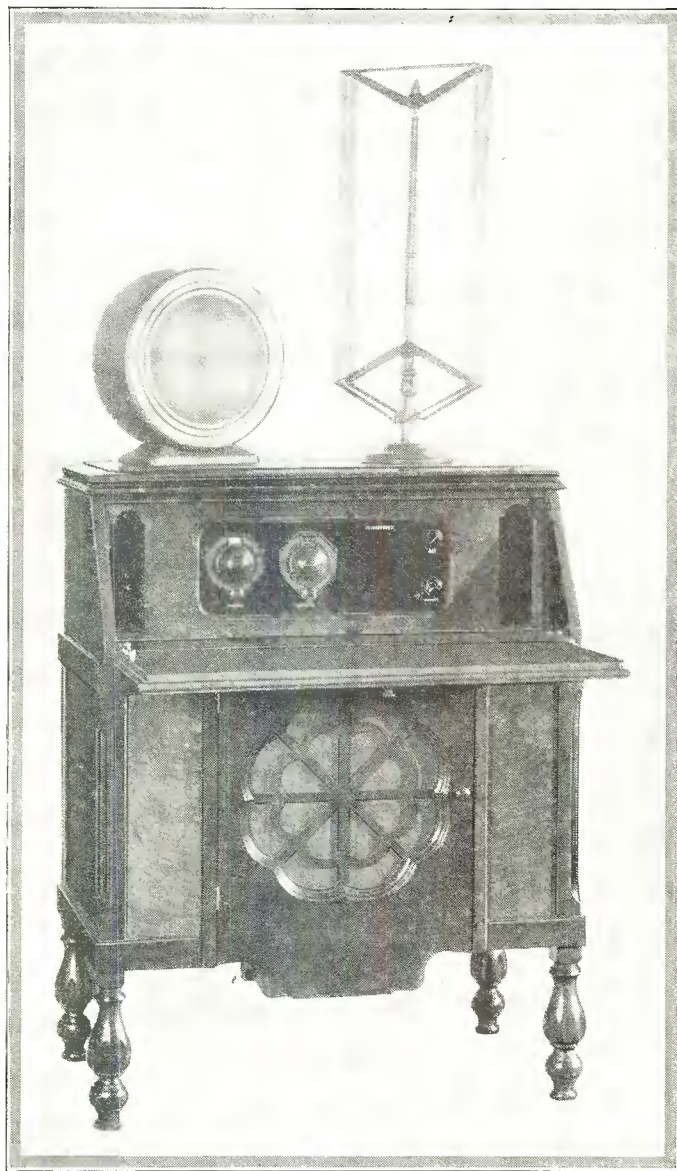

Figure 7. Above is photographed the St. James Twin Four in the Ehlert console with a Qualitone loop and a Quam speaker

- 1—Remler .0005 mfd variable condenser
- 2—Kurz-Kasch Aristocrat vernier dials
- 1—7x21x3/16 inch Lignole panel
- 1—3x8x3/16 inch Celoran strip
- 1—Clarostat
- 2—St. James special sub-panel brackets
- 15—Ft. Acme Celatsite wire
- 1—Pkg. Kester radio solder
- Miscellaneous—lugs, nuts, screws, etc.

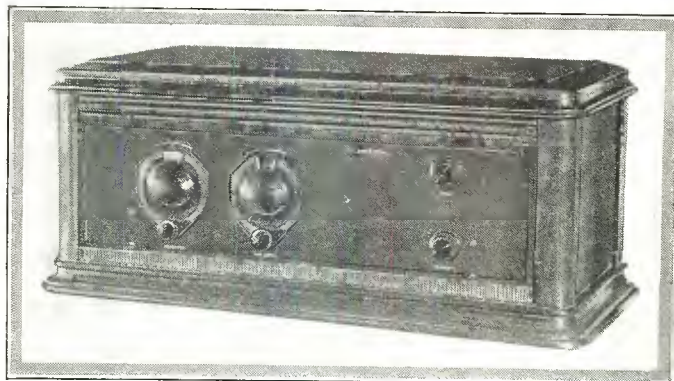

Figure 8. In this photograph the receiver has been placed in an Ehlert cabinet



# Lynch-Precision Receiver Uses Resistance Coupling

This Receiver Is a Variation of the One Described on Page 76 of This Issue and Shows the Adaptability of the Lynch Deck

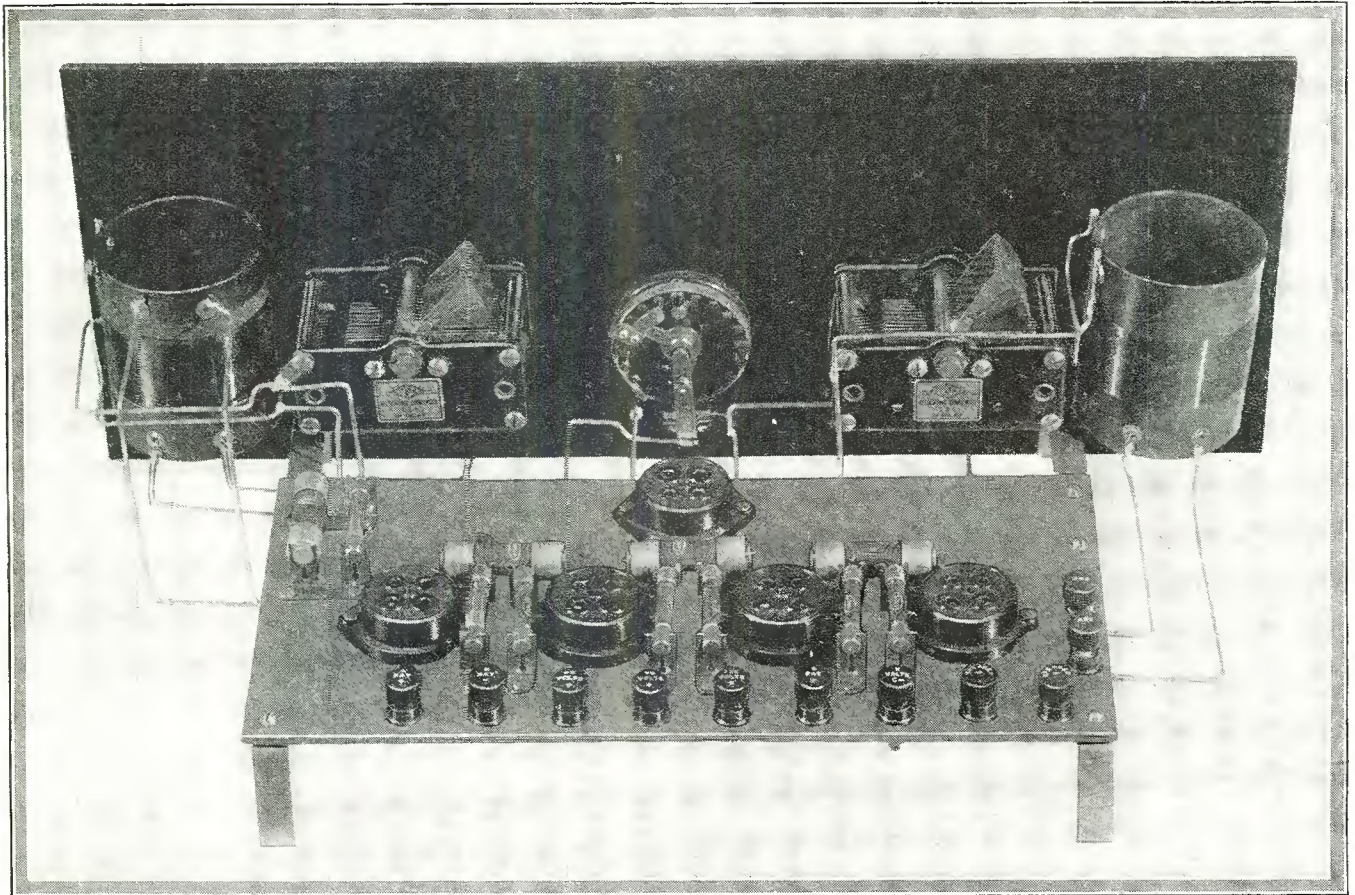

Figure 1. Rear photographic view of the receiver described in this article shows the simplicity of all parts

SHOWING the versatility of the Lynch deck which is described in another article on page 76, the present receiver utilizes the deck as the basis combined with Precision coils and Amsco tuning condensers.

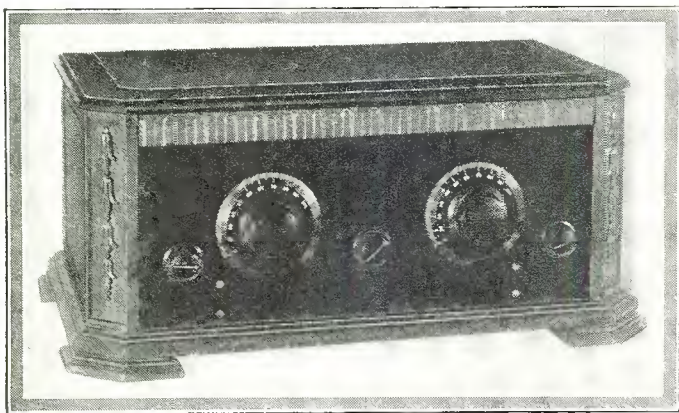

Figure 2. On completion of the receiver it has been placed in its cabinet as shown above

Referring to the schematic circuit shown in Figure 3, it will be seen that the Phasatrol is used in the plate circuit of the first tube as a means of stabilizing that tube, which is the first radio frequency amplifier. This amplifier is succeeded by a regenerative detector whose output feeds into the input circuit of the first resistance coupler. On account of using resistance coupling it has been found advisable to use high amplification tubes, and for this purpose the Ceco type G have been utilized in the first and second stages of resistance coupling, with a type F in the last stage.

#### Saves Building Time

In construction of the receiver, the builder will notice that considerable time is saved because of the fact that practically all of the apparatus shown in the photograph of Figure 1 is supplied already mounted on the Lynch deck. As a result the builder has only to run a few wires to the variable condensers and the inductances and the job is complete. In wiring the receiver it is strongly recommended that the graphic diagram Figure 4 be faithfully followed, since it is prepared in such a manner as to minimize the time needed for the constructor to wire it up.

Parts used in the construction of this receiver are:

1—Lynch deck

(This receiver constructed, tested and all illustrations made in our laboratory)



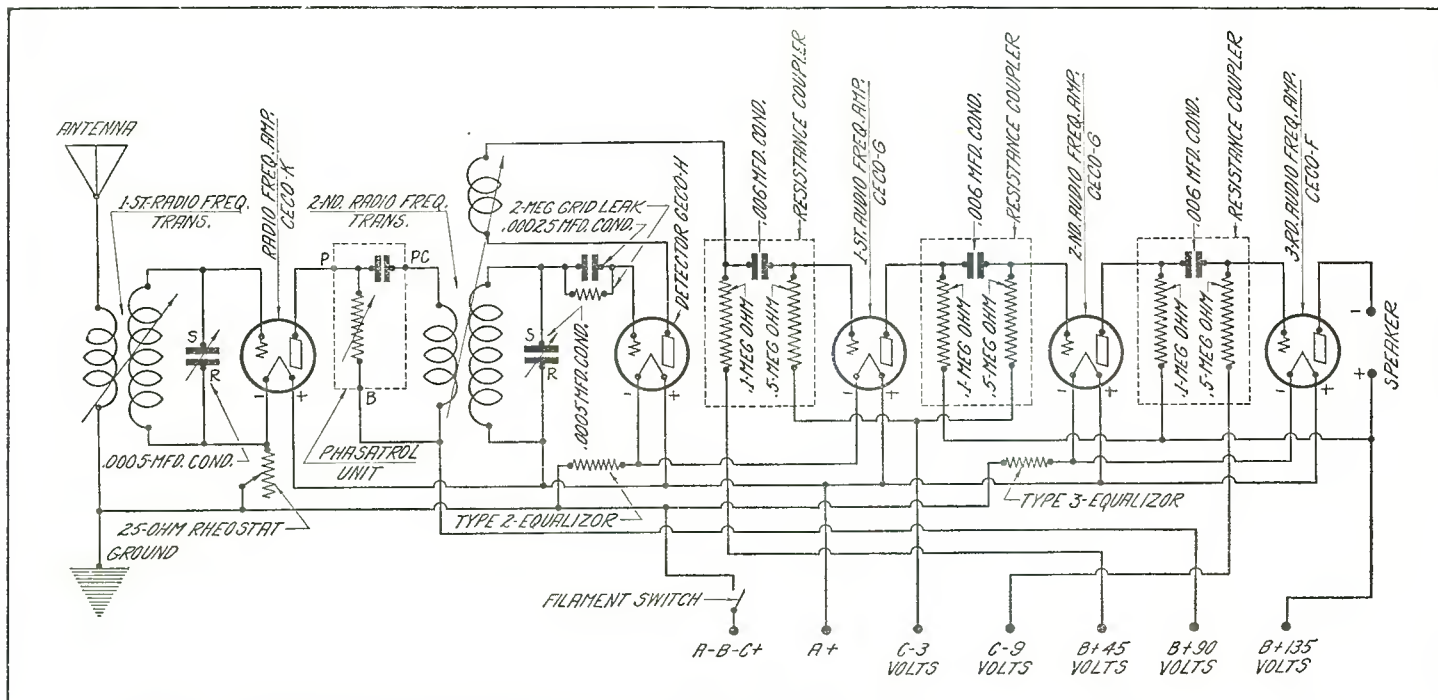

Figure 3. In this drawing are shown all of the electrical connections required for hooking up this receiver

- 2—Lynch equalizers
- 1—Electrad Phasatrol
- 11—Ely engraved binding posts
- 1—Precision antenna coil
- 1—Precision 3 circuit coupler
- 2—Amsco .0005 mfd variable condensers

- 1—Yaxley 30 ohm rheostat with switch
- 2—Kurz-Kasch plain dials
- 1—Formica 7x18x3/16-inch panel
- 18—Feet Belden hook-up wire
- 1—Package Kester radio solder
- 1—Ekko ground clamp

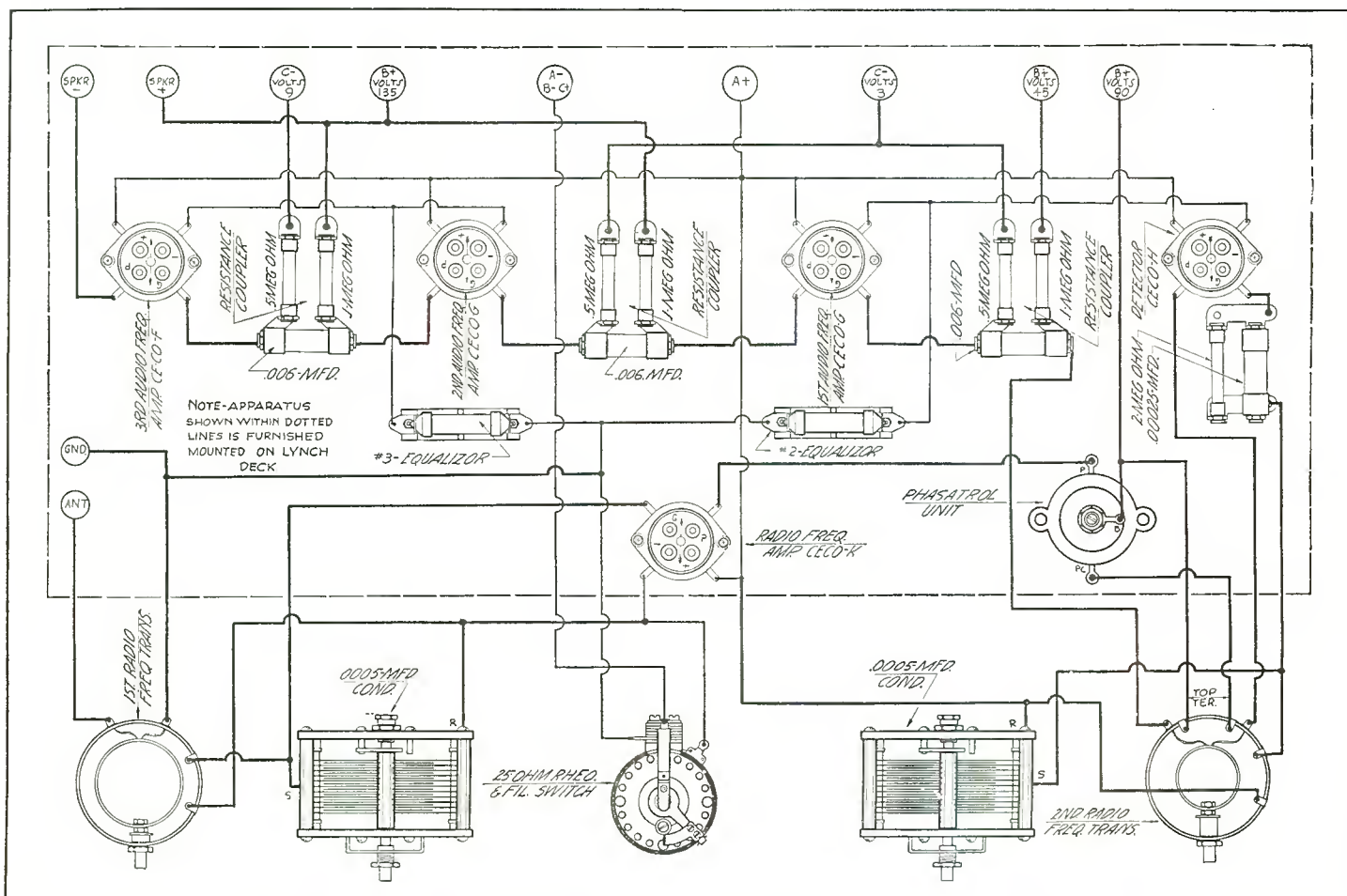

Figure 4. The above graphic diagram shows the builder how each connection is to be made. It should be noted that the apparatus within the dotted lines is furnished mounted on the Lynch deck



# Aero A. C. Seven Has Three Resistance Coupled Stages

Only Few Minor Changes Are Required to Bring This Popular Receiver Up to Alternating Current Operation

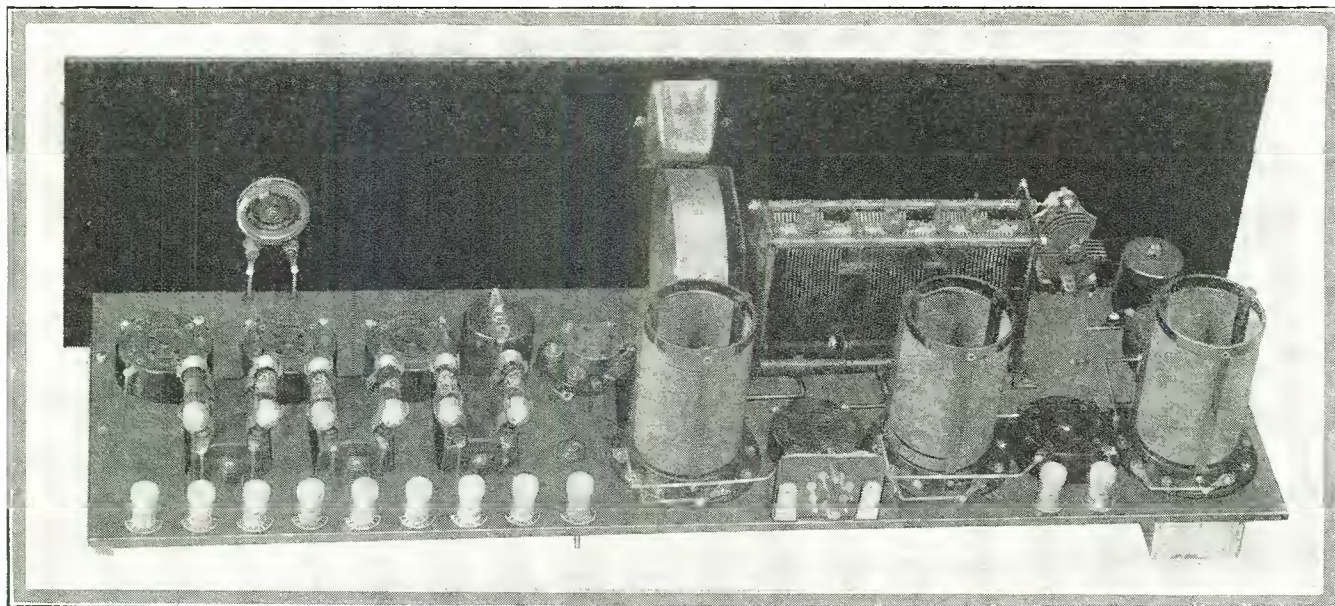

Figure 1. Rear photographic view of the Aero A.C. Seven shows the same general layout as used in our September issue, with the exception of a five-prong socket, a midget variable condenser and revised filament control for use with alternating current tubes

**K**NOWING the interest which set builders and experimenters have exhibited in the recent alternating current operated tubes, we believe it will be well to pay attention at this time to the conversion of the Aero Seven receiver to alternating current operation. This popular receiver was described for battery operation in the September issue of the CITIZENS RADIO CALL BOOK MAGAZINE on page 87. In this article it is photographed and illustrated as arranged for the use of type 226 and 227 alternating current tubes.

## Now Uses A.C.

Whereas in the previously described article the audio end of the receiver depended for its amplification upon the use of high amplification tubes, in this model, on account of using alternating current filament supply, these tubes have been eliminated and the type 226 alternating current filament tubes substituted.

In the Aero A.C. Seven there are three stages of tuned radio frequency amplification and a non-regenerative detector. The first stage, instead of being a two-coil coupler consisting of primary and secondary, consists of a single inductance known as the antenna adaptor, this inductance having a tap on its winding for the antenna. The tuning of this circuit is accomplished by means of a .000025 mfd midget condenser located between grid and filament terminals of the inductance, the latter end being grounded and common with biasing voltage of 12 volts negative. This midget condenser is located at the extreme left in the photograph, Figure 2.

## Three Stages Ganged

The second and third radio frequency stages and the non-regenerative detector are tuned by a three gang condenser operated from the single drum dial shown at the center in Figure 2.

These three stages, on account of the inductance design and the matching of the tuning capacity, tune very closely provided the builder has been careful in wiring up the receiver so that excessive leads are not run from stators to grids of the tubes. The three inductances shown in the receiver are the three coils type U12. These coils are matched in kits of three at two widely separated frequencies in the broadcast band. It has been found after considerable investigation of the subject that if two or more coils matched at one wave length, they will not necessarily match at another wave length at the other end of the broadcast band. In order to prevent the receiver from falling out of tune at one end of the dial and in at the other points of the dial, the coils are matched at the factory at 250 meters and also at 500 meters. It has been found that by matching the coils in this manner they will be sure of maintaining the same inductance over the whole broadcast band. An Amsco three gang variable condenser has been used and is provided with small compensating capacities to adjust for small differences in the wiring for tube capacities of the various stages.

## Antenna Detuning Solved

Some of the single control receivers have the first radio frequency transformer tuned by one of the units of the gang condenser. In spite of any care of matching the coils and condensers, there is no provision made against the detuning of the first stage by antennas of different electrical characteristics. This effect is not noted in the succeeding stages, as the other transformers each operate out of the plate circuits of similar tubes and hence similar capacities. A simple means has been resorted to in the design of the Aero A.C. Seven to eliminate this difficulty. As will be seen by consulting the schematic diagram in Figure 3, an antenna adaptor is used, across whose extremities

(This receiver tested and all illustrations made in our laboratory)



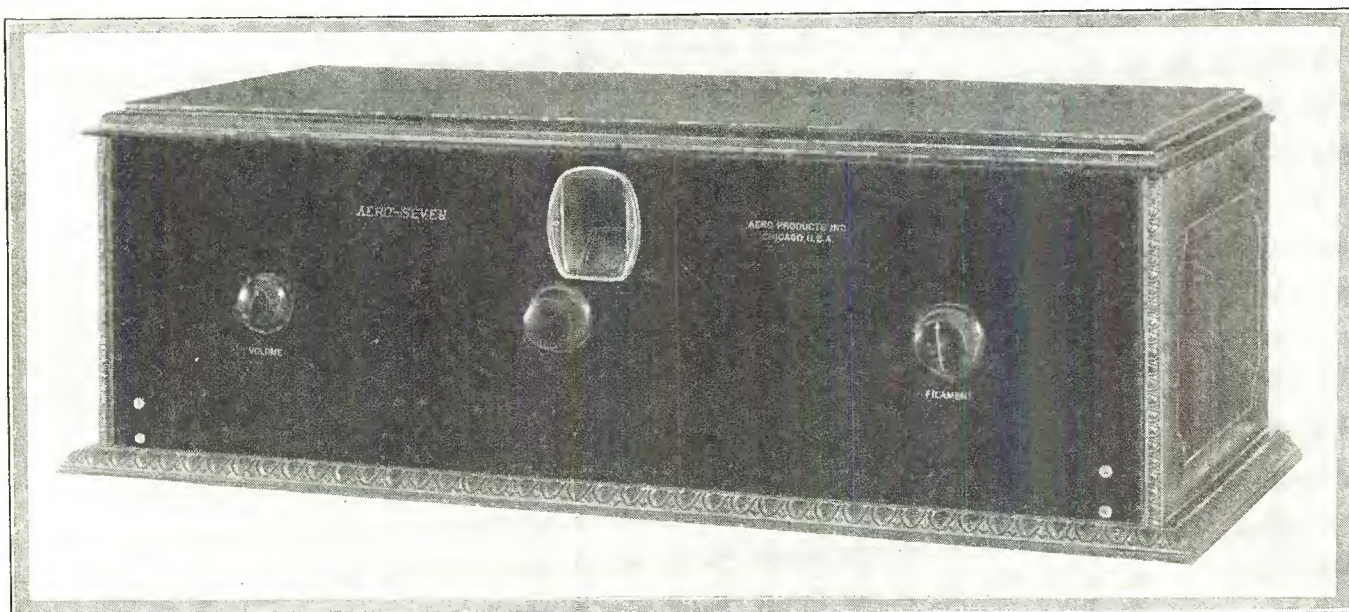

Figure 2. In this photograph the Aero A. C. Seven has been placed in a Southern Toy cabinet

is located a .000025 mfd midget condenser, which serves to tune that stage to approximate resonance, allowing the first, second and third sections of the gang condenser to work across inductances whose primaries are equal and whose plate circuits have the same capacities.

#### Different Turn Ratios

In considering the first, second and third radio frequency transformers, it should be noted by the builder that they are provided with several taps for securing a different turn ratio in the primary. This coil is an arrangement of an exceptionally efficient construction, with a primary giving the most effective coupling co-efficient with the secondary and taps so as to produce primary ratios of widely varying values on the different taps. The highest of these values is secured upon use of tap No. 1 as the plate and No. 4 as the B battery connection. In this particular receiver, however, tap No. 3 has been used on account of the type of tubes employed in the receiver.

#### Resistance Coupled Audio

In the audio end of the receiver the three stages of resistance coupling are utilized, this type of amplifier being supplied by Amsco. The input to the first resistance coupler is from the plate circuit of the detector through a radio frequency choke made by Aero, the coupling resistance in the plate circuit of this detector

tube being a .1 megohm and common with the plus 45 volt terminal. A suitable coupling condenser is located inside the resistance coupler and joins the output of the plate circuit of the detector to the input of the first audio frequency amplifier. The grid biasing resistor located in the grid lead of the first audio amplifier is 1 megohm. The plate resistor of the first audio stage is a .1 megohm, which goes to the 180 volt positive terminal, while the biasing resistor in the grid of the second stage is a .5 megohm. The biasing resistors in the first and second audio grid circuits are common and go to the minus 9 volt biasing terminal. The resistance in the plate of the second audio is a .1 megohm, while the biasing resistance in the grid of the 171, which is the power tube, is a .25 megohm and leads to the C40 ½ volt terminal. Plate supply for the first and second audio tubes is 180 volts, while this same value is also applied to the plate of the last tube either directly through the speaker or through an output transformer, as may be desired by the builder.

#### Filaments on A.C.

Filaments of the first, second, third, fifth and sixth tubes are operated from a 1.5 volt alternating current source with a .2 ohm variable resistance in series to allow the tube the proper operating voltage. Inasmuch as these tubes are especially sensitive to an overload, the operator should assure himself of the

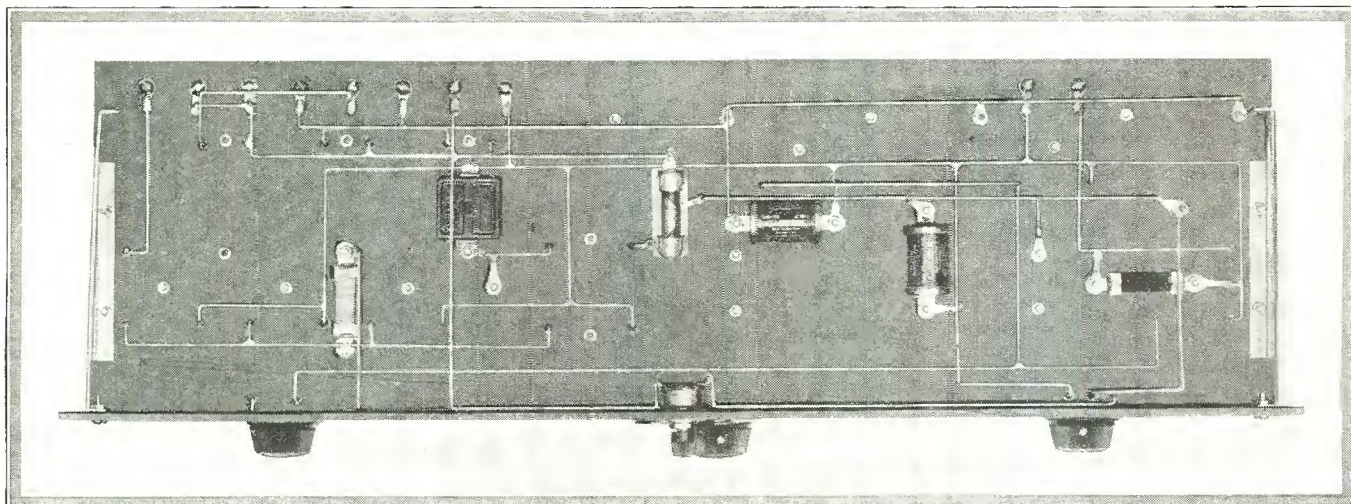

Figure 6. This photographic view of the under side of the sub-panel represents the battery operated model, in whose conversion very few changes are necessary below the sub-panel. Reference to the schematic in Figure 3 will show the actual parts required for converting this to an alternating current receiver



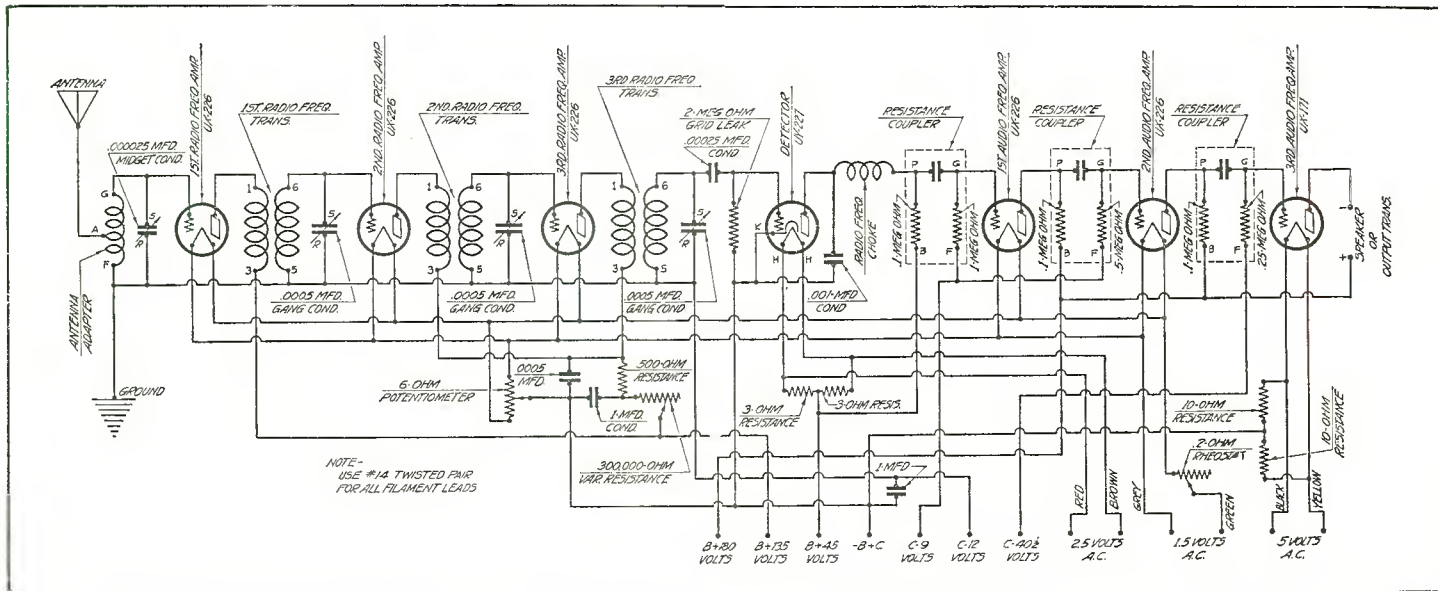

Figure 3. In this schematic are all of the details for making up the Aero A.C. Seven, or for converting the Aero Seven, which appeared in our September issue, to alternating current operation

fact that he is not using more than the rated value on these tubes. An alternating current voltmeter with a double or triple scale, on one with a total reading of 7½ volts, is worth while in determining the actual voltage placed on the tubes. The detector tube, which is a type 227, secures its heater current from the 2.5 volt alternating current windings of a standard transformer, there being no resistance placed in this circuit. In the case of the 171 power tube, the filament supply is from a 5 volt alternating current source, which is the proper value for that tube and which does not require any change in operation.

Single Control Tuning

Looking at Figure 2, which is a front view of the receiver in a cabinet, all of the tuning is accomplished by means of a single drum dial located at the center of the receiver, while the control at the left is occasionally used for bringing the receiver into resonance at a given wave length.

In the assembly of the receiver, the sub-panel is the best starting point, as most of the work may be done on it without putting on the front panel, thus allowing the work to proceed unhampered. Figure 1 shows the rear view of the receiver. On the sub-panel are located the antenna adaptor, first, second, third radio frequency sockets, the five-prong detector socket and the three sockets for the resistance coupled stages. Between the audio sockets are located the three resistor couplers mentioned previously. In addition to this the three inductances are also placed on the sub-panel, together with the antenna and ground

binding posts, the cable connector, which is used for the alternating current filament supply, and the nine binding posts required for the various voltages and the output of the last tube, where either an output transformer may be used or where the speaker may be cut in directly. All of this material may be mounted on the sub-panel first, with the midget condenser, the drum dial and the 300,000 ohm variable resistance being located on the front panel. Much of the wiring may be done on the sub-panel and then the front panel put on, or if the builder is adept at this work he may mount all the parts on the sub-panel, then put on the front panel and proceed to wire.

Follow the Graphic

In wiring the receiver it is suggested that the graphic layout shown in Figure 5 be followed very carefully, since it shows the simplest manner in which the wires may be run from one point to another.

In lining up the radio frequency stages, a screw-driver should be made from a sliver of wood or bakelite to turn the condenser screws. The midget capacity should be screwed all the way out at first and a station tuned in, preferably on the lower waves. After tuning to maximum volume the dial reading should be increased slightly. If a signal is a weak one, it will disappear by this procedure, while if a strong one it will only be diminished in volume. After this has been done, the small condensers are adjusted with the wooden screw-driver until the volume is at maximum. In the course of doing this, it may be noted that if

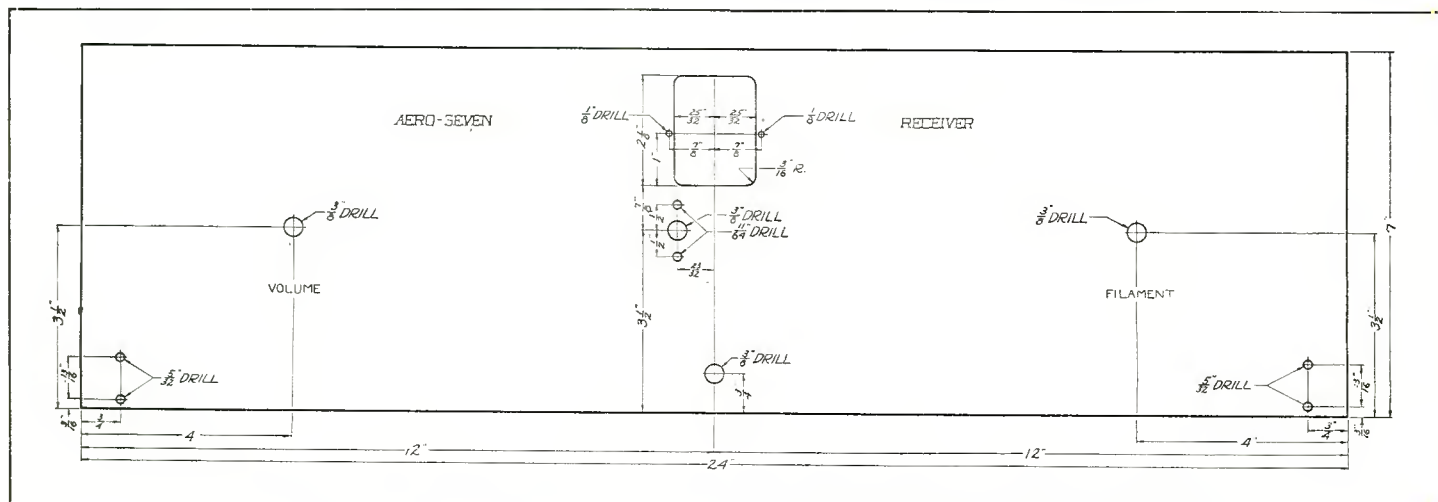

Figure 7. Front panel layout of the Aero A.C. Seven is shown in the drawing above



a perfect adjustment is approached, the receiver may oscillate. If this occurs the 300,000 ohm variable resistance located on the front panel may be changed slightly to curb the oscillatory tendency. The adjustment for maximum volume should then be completed, after which the receiver will be in condition to tune over the entire broadcast band.

**List of Parts**

Parts used in building the receiver described in this article are:

- 1—Acro 7 foundation unit
- 1—U-12 Acro r.f. transformer kit
- 1—60 Acro r.f. choke coil
- 1—Amsco .0005 mfd 3 gang variable condenser
- 1—AA-17 Acro antenna adaptor
- 1—669 Yaxley cable connector with phone jacks
- 1—Carter .0005 mfd fixed condenser
- 1—Benjamin 5 prong socket
- 6—Amsco sockets
- 1—Amsco 2 megohm grid gate and mounting
- 1—Amsco .5 megohm grid gate
- 1—Amsco .25 megohm grid gate
- 3—Amsco .1 megohm grid gates
- 1—Amsco 1 megohm grid gate
- 3—RC-1 Amsco resistor couplers
- 1—Carter .2 ohm rheostat
- 1—Silver-Marshall drum dial
- 1—Carter 110 volt switch
- 2—Carter 1 mfd by-pass condensers
- 1—Carter .001 mfd fixed condenser
- 1—Carter .00025 mfd fixed condenser
- 1—Carter 6 ohm sub-panel mounting potentiometer
- 1—Carter 300,000 ohm variable resistance
- 1—Yaxley 500 ohm fixed resistance
- 2—Yaxley 3 ohm fixed resistances
- 1—Silver-Marshall .00025 mfd midget condenser
- 1—Yaxley 10 ohm fixed resistance
- 9—XL binding posts

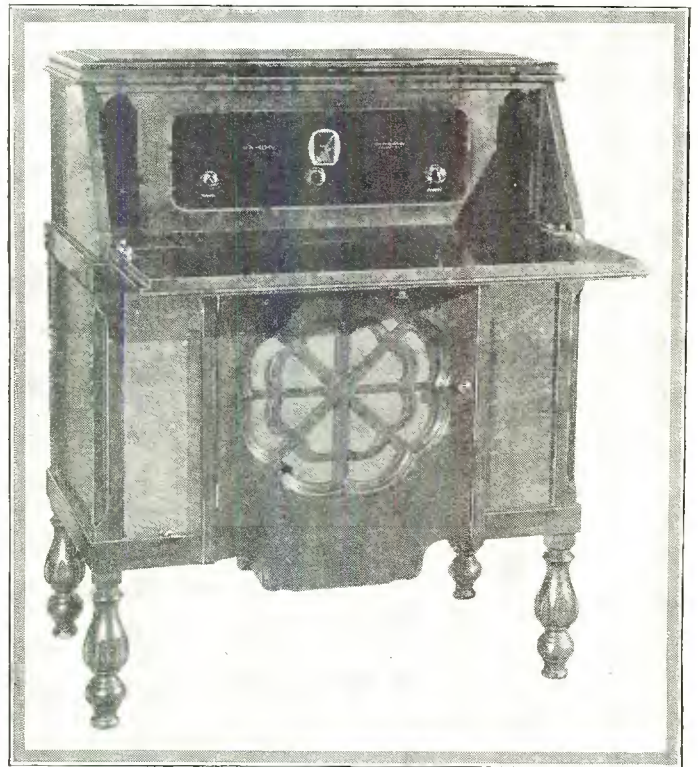

Figure 4. In the above photograph the receiver has been placed in an Ehlert console

- 30—Feet Acme Celatsite wire
- 1—Package Kester radio solder
- 1—Ekko ground clamp
- 1—Karas A.C. former
- Miscellaneous—lugs, nuts, bolts, etc.

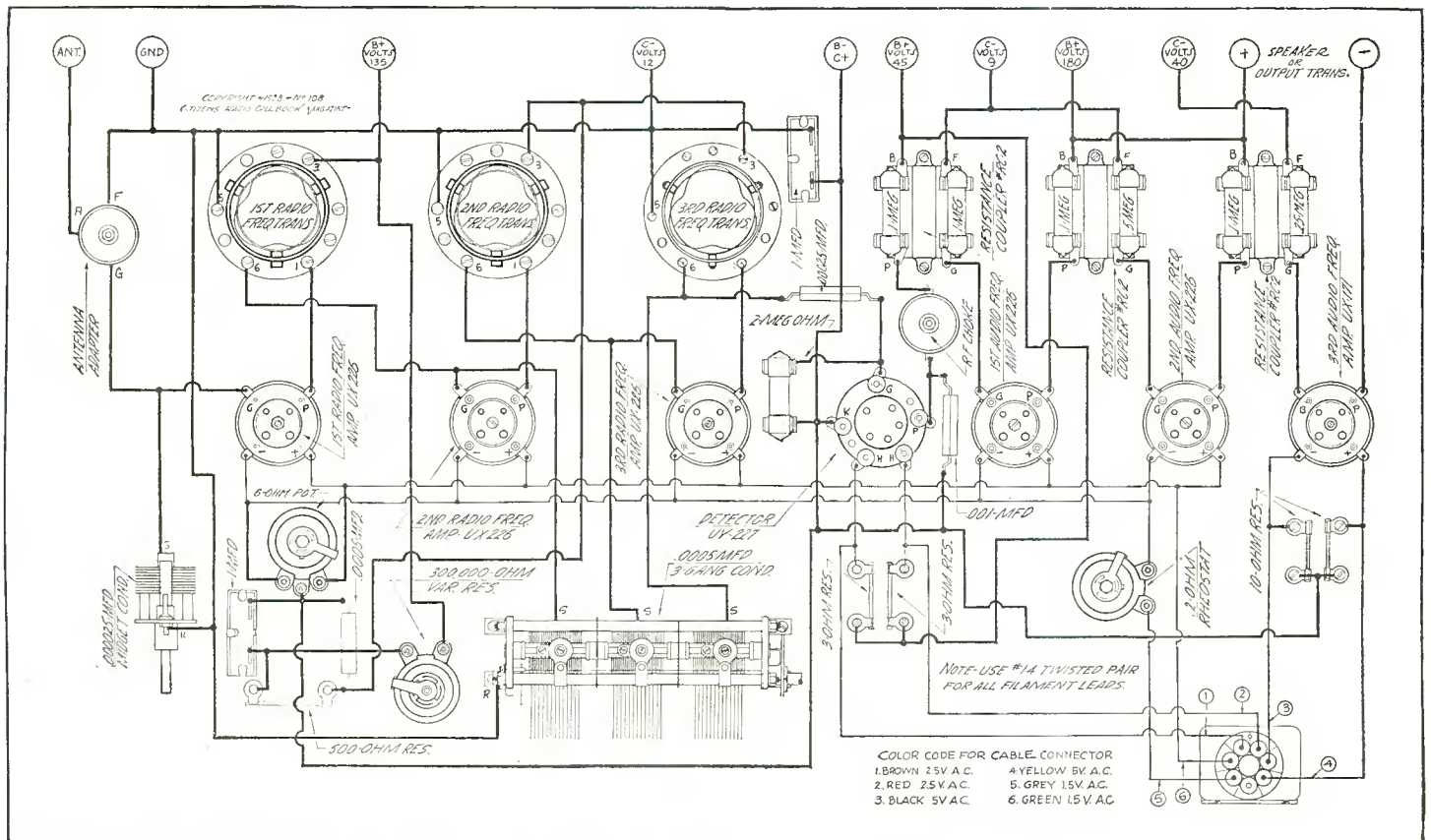

Figure 5. Set builders should use the above graphic illustration as a means of wiring their receiver, since it represents the simplest manner in which a set may be hooked up. Those who are well versed in the art may, of course, use the schematic in Figure 3, but to save time the graphic should always be followed



# Operating the Madison-Moore International One-Spot

Popular All-Electric Super Fulfills Requirements of Tone Quality, Volume and Selectivity

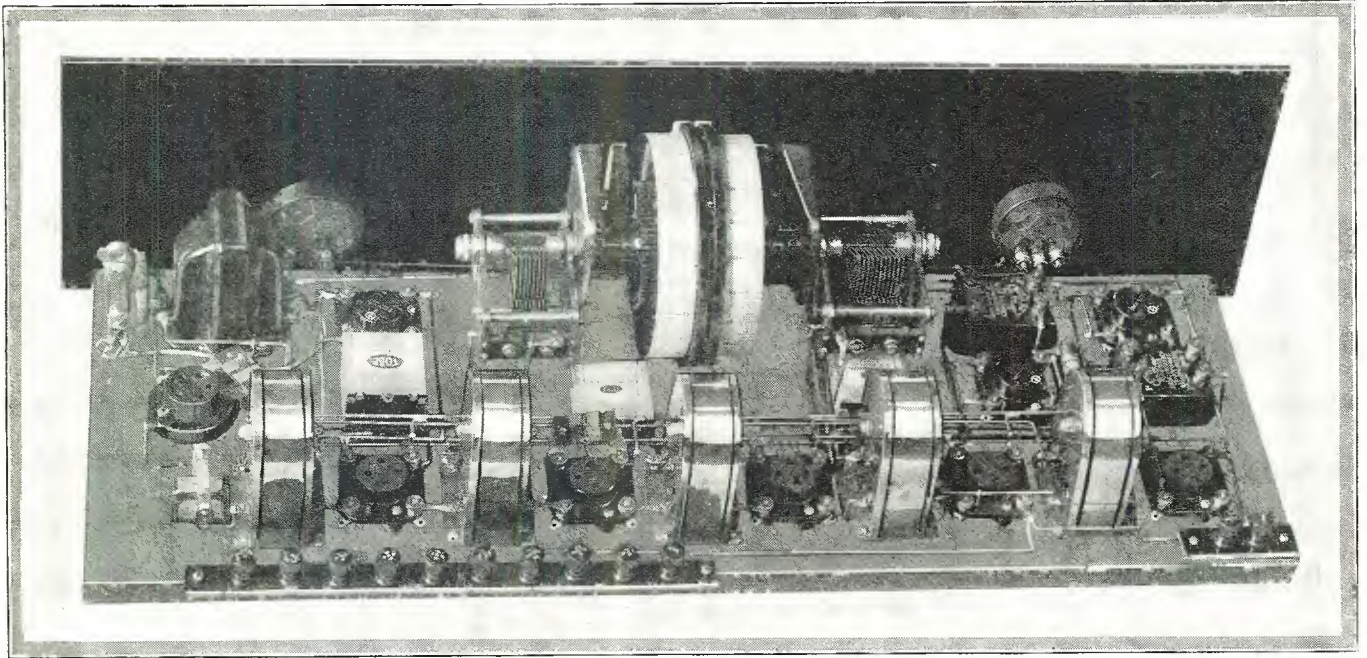

Figure 1. This photographic view shows the completed receiver after all parts have been put in place and properly wired

**M**EEETING the requirements of tone quality, ample volume and selectivity, the Madison-Moore International One-Spot is now being operated by many fans as an electric receiver. First details of this novel receiver were given to our readers in the November issue of this magazine, where full instructions were published for the assembly and wiring of both the receiver itself and its power amplifier. In this article some data on tuning the set will be given for the benefit of those who have finished their receivers and wish to operate them at maximum efficiency.

### One-Spot Well Known

The principle underlying the operation of the Madison-Moore International One-Spot is well known to our readers who have been for some time constructing these successful performers. The intermediate frequency stages are peaked at such a value that regardless of the tuning range covered by the oscillator, no repeat points will be found by the operator if the set has been properly wired. The designers of this circuit were the first ones to bring forcibly to the attention of radio fans the virtues of a super-heterodyne having no repeat points. Previous models of this receiver have been constructed by many fans and are in nightly operation throughout the country. However, with the advent of alternating current tubes, many fans have become interested in the operation of their receiver direct from the light socket and as a result have centered their attention on the building of the International One-Spot. For constructional details on the receiver and the power supply we refer our readers to the November issue of this magazine.

Radio frequency amplification ahead of the first detector is

secured in the latest Madison-Moore model by means of two untuned radio frequency transformer stages, the fact that these are untuned helping to minimize the controls and wiring in the receiver. Thus, a Qualitone loop, without the center tap arrangement feeds the input circuit of the first radio frequency amplifier and delivers the signal; which is then amplified through the two radio frequency stages and delivered with considerable intensity to the input circuit of the first detector. To insure stability in operation under strong signals and to curb any oscillatory condition in the first detector, a 1000 ohm fixed resistance has been placed between the grid terminal of the second radio frequency transformer and the grid of the first detector. Mixing of the oscillator frequency with that of the incoming frequency is secured through the magnetic coupling between the plate inductance of the oscillator coupler AC-1 and the plate of the first detector through the primary of the first intermediate frequency transformer AC-2. Reference to the schematic circuit in Figure 2 shows the method of connection by means of a jumper between the X terminal of the oscillator coupler and the X terminal of the first intermediate frequency transformer. This form of injecting energy into the first detector stage is a departure from conventional methods and is one that has been used with considerable success in the Madison-Moore receivers.

When first putting the receiver into commission, after all tubes have been placed in their respective sockets and the amplifier turned on, the operator should first turn the left-hand drum to a point about midway of its travel, turn up the 100,000 ohm variable resistance and the 500,000 ohm potentiometer and then turn the right-hand drum section until either a station or a very slight rushing noise is heard. If no station is heard at first in the loop

(This receiver constructed, tested and all illustrations made in our laboratory)



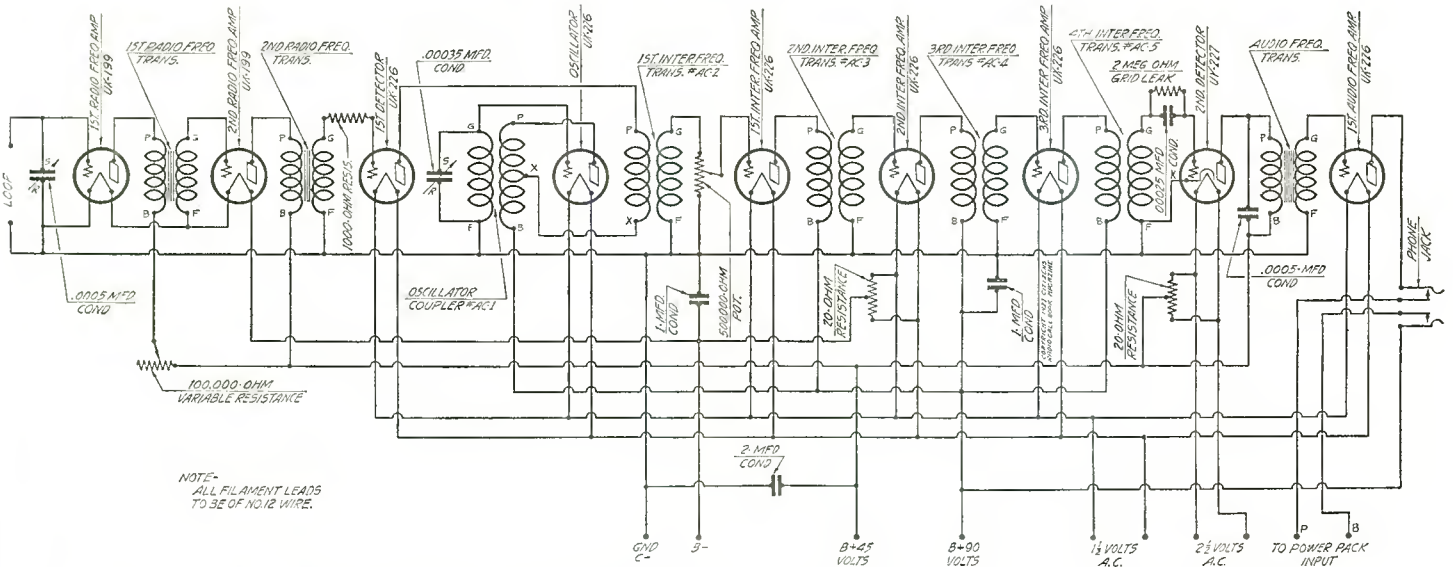

Figure 2. Schematically the circuit of the Madison-Moore International One-Spot is shown in the above wiring diagram

circuit, the dial should then be turned to another position, either higher or lower than the mid-point, and the oscillator dial turned back and forth through its travel until a condition of resonance is reached, which condition is manifest either by a slight rushing noise or the presence of a signal. For the uninitiated it would be well to tune the receiver first on a local station so as to become familiar with the operation of the receiver. After the local stations have been tuned in and logged, the operator may proceed to go after the distant ones.

Several points of interest in the operation of the receiver may be of some help to our readers. For one thing, be sure to keep the length of wire for the filament circuit of the alternating current tubes down to a minimum, so there will be no possibility of a voltage drop, which would cause these tubes to be operating below the voltage required for their best results. Also use tubes with standard characteristics so that uniform operation may be obtained throughout. This is particularly true of the two 199 stages, whose filaments are energized through the drop between the C negative terminal on the amplifier and the center of the 20

ohm resistance located across the 1 1/2 volt alternating current filament line. It should also be noted that on account of using a heater type detector tube, it is necessary for the receiver to be in operation a minute or so before the heater has warmed up sufficiently to begin passing heat by conduction to the actual electron-emitting cathode in the tube. The operator should also experiment with different values of fixed resistances in the grid circuit of the first detector, since under different operating conditions a value of resistance other than the one specified in the schematic circuit may be required. It might be well to try values of 250, 500, 750 and 1000 ohms until the particular value which gives best operation is arrived at.

On account of the complete shielding of the oscillator and intermediate inductances, the receiver is quite insensitive under local field strength pick-up. With such a receiver the operator should have no difficulty in bringing in distant stations through local broadcast transmitters. It is suggested that a good type of speaker be utilized on the set in order to take advantage of the tone quality which the receiver is capable of producing.

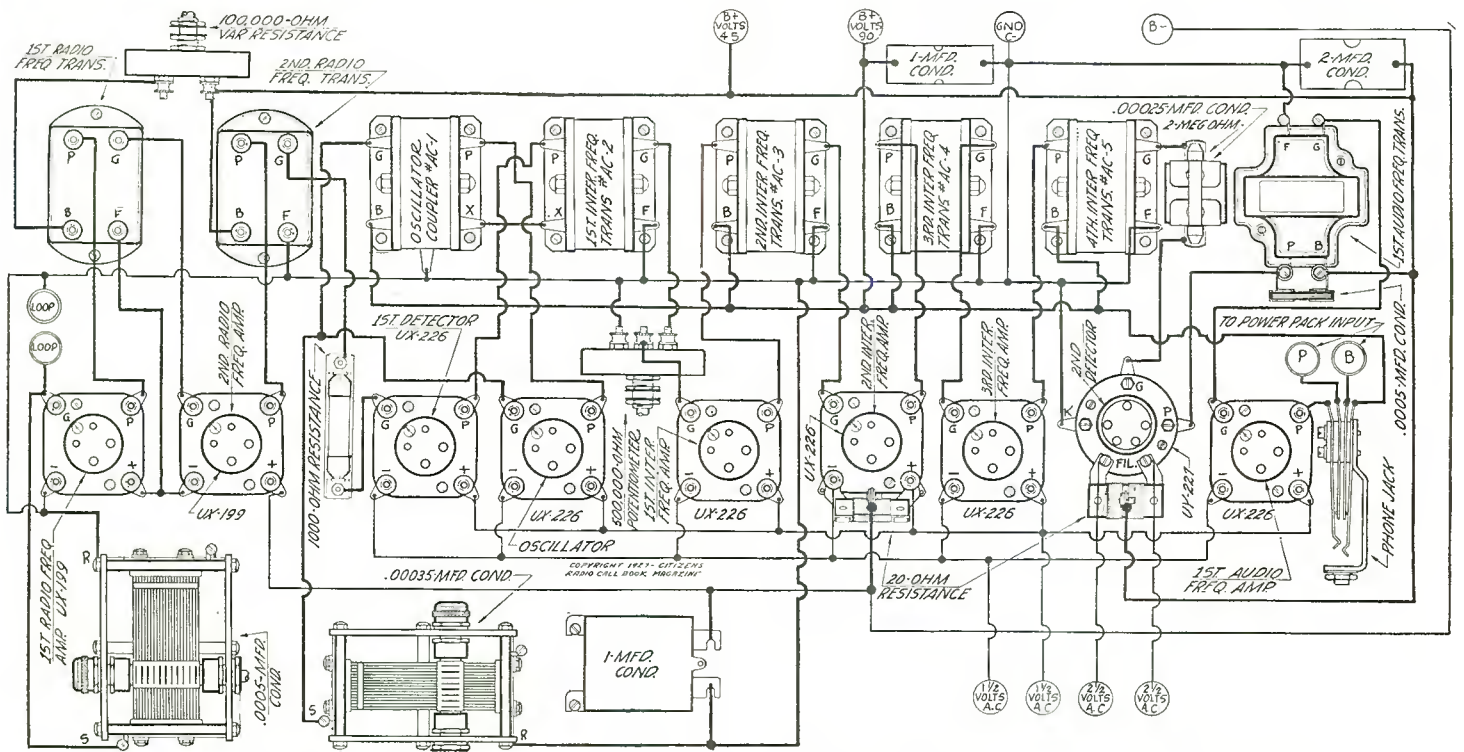
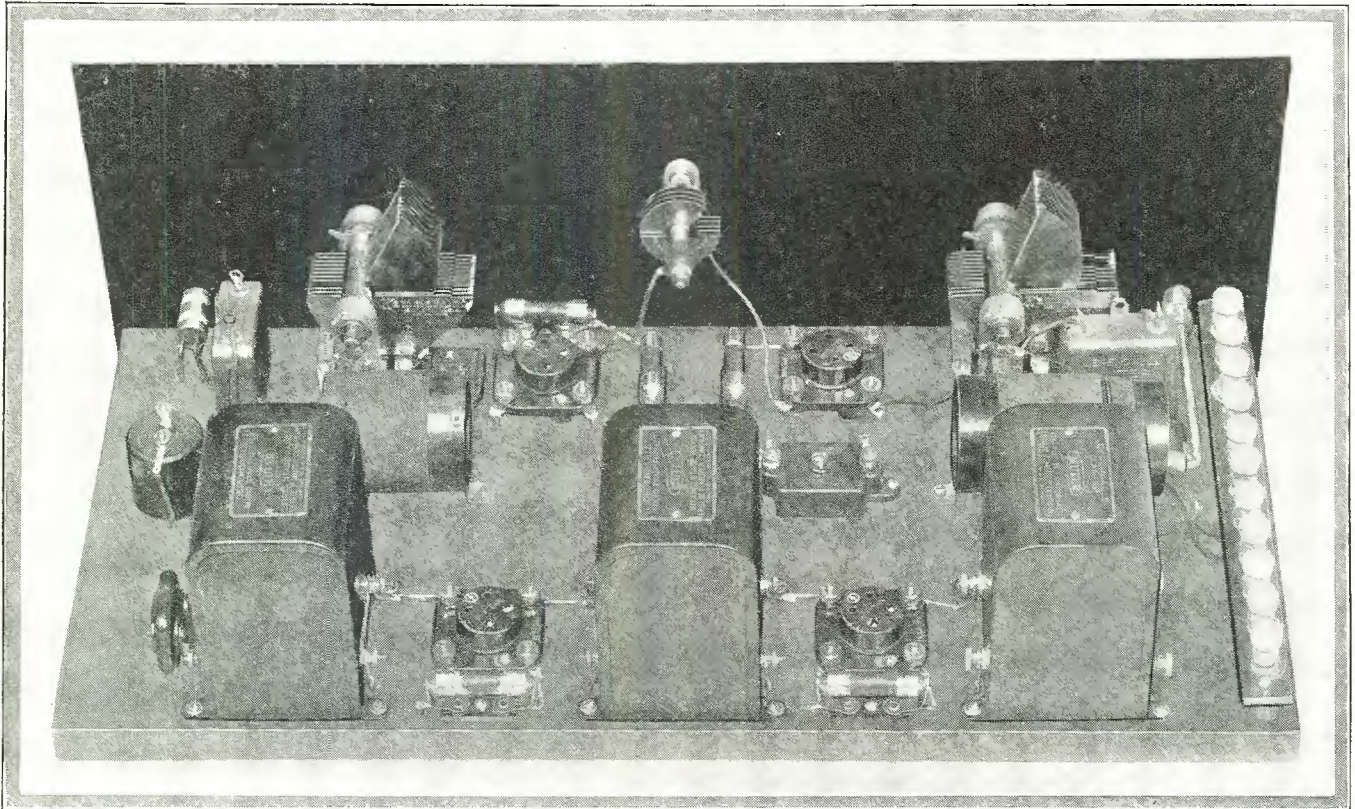

Figure 3. This graphic illustration should serve as a means of rapidly wiring up this popular receiver



# Regeneration and Impedance Coupling in Everyman Four

Simplicity of Control and Good Audio Quality Are Features of the Four Tube Receiver Popular with Many



*Figure 1. In the accompanying photograph may be seen all essential parts used in the construction of this receiver. Wavelength controls are those condensers located at the left and right of the front panel shown above, while regeneration control is gained through use of the midget condenser located at the center. The two audio transformers are shown, one at the left, one at the center, and the output filter is located at the extreme right*

**M**ANY who are not able to invest heavily in a receiver will be interested in the description about to be given on the Everyman Four, where simplicity of control, economy of parts and good quality reproduction may be obtained. The receiver has been designed around the fact that there are many who do not wish to go into a large expenditure of money and at the same time desire to secure as much entertainment as is possible from a radio receiver. Accordingly all controls have been simplified to a minimum and only the essentials of a good receiver have been included.

Referring to the schematic diagram in Figure 3, the reader will observe that the Everyman Four comprises a stage of balanced tuned radio frequency, impedance coupling to the grid circuit of the detector having a tuned grid input circuit of the first tube and a tuned plate circuit of the first tube, but with regenerative control for the second tube through the use of the .00005 mfd midget condenser shown in the schematic between the plate of the first tube and that of the second and represented in Figure 1 photographically as the midget condenser located at the center of the front panel. Wavelength control is by means of the two .0005 mfd variable condensers, the first located from grid to filament of the first tube and the second located

across the extremities of the 66 turn radio frequency coil. The first twenty turns of this coil represent the plate section of the circuit through which 67½ volts are applied to the plate of the first radio frequency amplifier. The next twenty-three turns are utilized for a balancing coupling to neutralize the tube, this balancing being represented by the .00005 mfd balancing condenser shown between the grid of the first tube and the tap on the radio frequency coil. The remaining twenty-three turns on this inductance comprise the windings which lead through a .00025 mfd grid condenser to the grid of the detector tube. A bias voltage of 4½ volts negative is applied to the grid of the first radio frequency amplifier, while the bias for the detector grid is through a three megohm grid leak to the positive A battery. As previously stated, the regeneration control for the detector is through the .00005 mfd midget condenser connected between the plate of the first radio frequency and the detector

## Uses Power Tube

In the plate circuit of the detector is located a radio frequency choke between the plate and the top terminal of the primary of the audio transformer, this primary being bypassed by a 0001 mfd fixed condenser. The first audio stage uses a 201-A tube

(This receiver constructed, tested and all illustrations made in our laboratory)



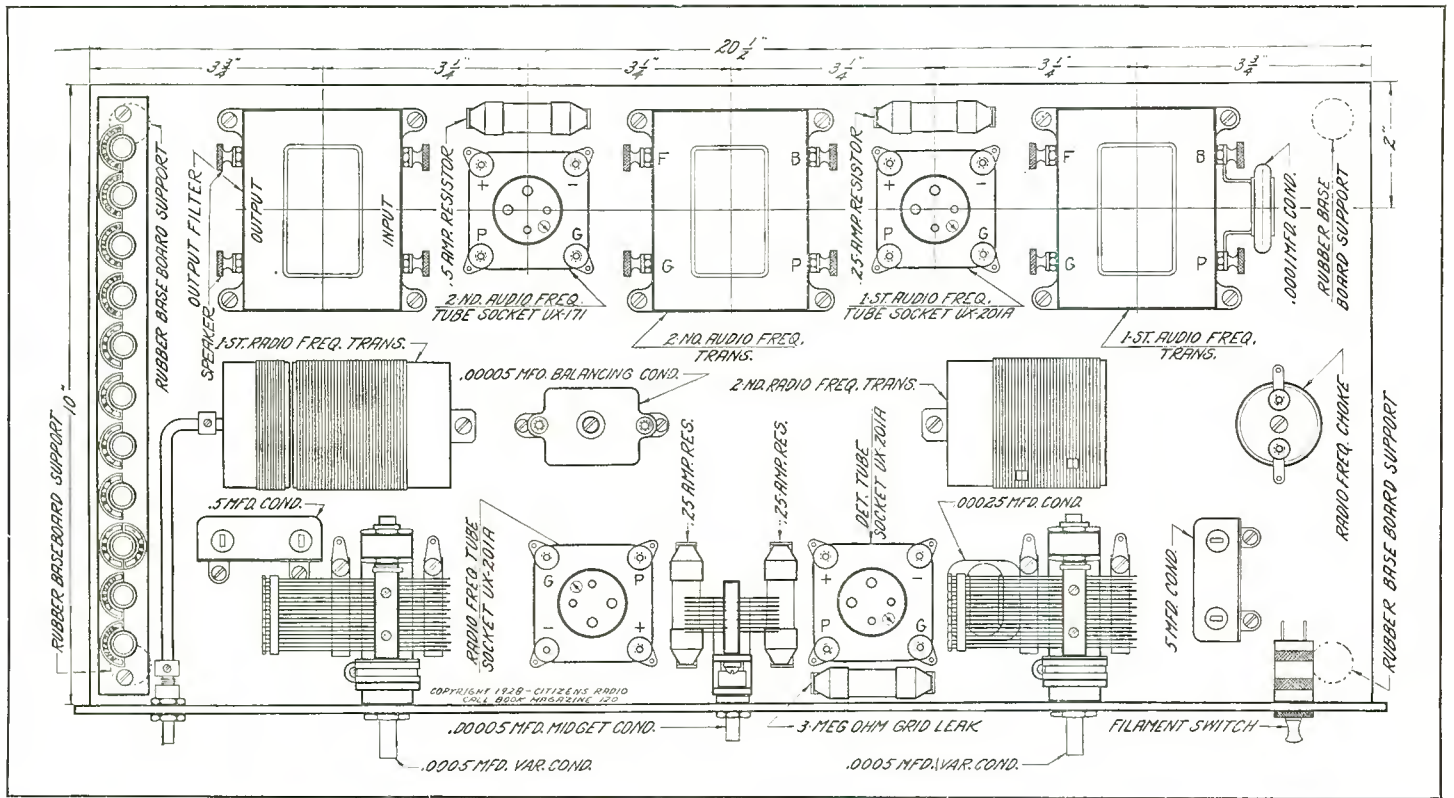

Figure 2. When laying out parts for the four tube receiver described in this article they should be placed in accordance with the baseboard assembly drawing shown above

while the second audio stage feeds into the grid of the 171 tube operated from 180 volts and with a 40 volt negative grid bias. The coupling for the speaker is secured through the audio frequency output filter represented in the schematic as comprising a choke winding with a capacitive coupling for the speaker, this insuring the operation of the reproducing apparatus without the possibility of it burning out due to the voltage used.

Filament control in the receiver is entirely automatic, being handled in the first radio frequency stage by means of a .25 am-

pere resistor, the same in the detector and first audio stages and in the 171 power tube stage by means of a .5 ampere resistor. This eliminates the necessity of any changes in the filament value during the operation of the set and with these resistances the tubes are supplied with their proper operating voltage, provided a 6 volt source is used across the A negative and A positive binding posts. A filament switch is located in the positive line so that the set may be turned on and off by the operator.

For actual placement of the apparatus involved in the con-

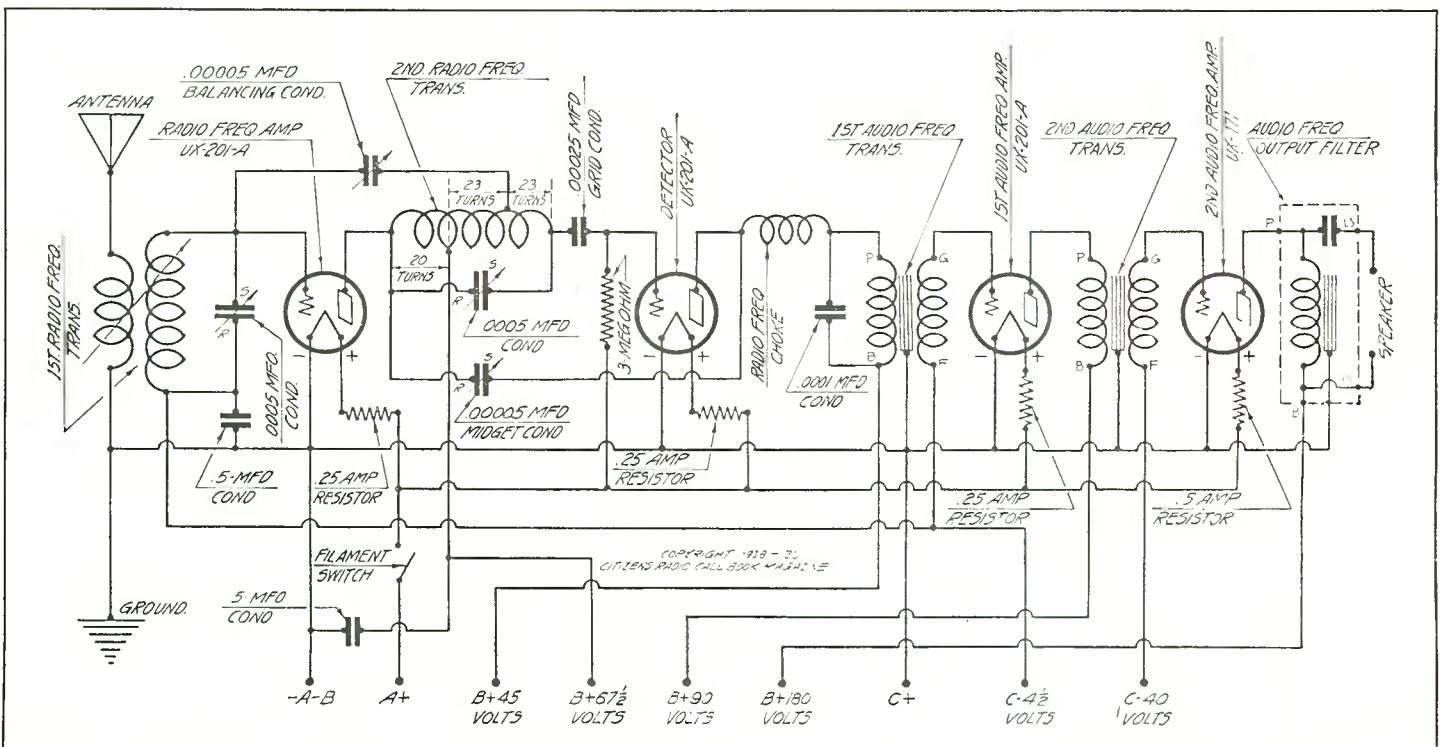

Figure 3. Schematically the wiring of the Everyman Four is illustrated above, which drawing may serve as a wiring guide for those who are accustomed to working by a schematic



struction of this receiver, the builder should follow very closely the diagram shown in Figure 2. The first radio frequency transformer which comprises a primary and secondary winding, the former being variable and extending on a movable arm to the left end control on the front panel, designated as "volume" in the photograph in Figure 5, is located far enough away from the second radio frequency transformer, which is shown at the right in the drawing in Figure 2, so that no interaction exists between these two circuits in operation. The .00005 mfd balancing condenser, which serves as a means of neutralizing the first radio frequency amplifier tube, is placed on the baseboard as shown in the baseboard layout, where it may readily be reached by the operator while balancing the set. It is suggested that the coils do not be placed closer than the distance shown in the diagram, since if they are placed closer there is a likelihood of interaction between the two circuits, which will make it more difficult for the builder to finally balance the receiver. Another reason for maintaining the coils in their respective position as shown in the diagram, Figure 2, is the fact that it is desired to keep all leads in the tuned circuit as short as possible to aid in sharp tuning and to maintain the efficiency of the receiver. Looking at the diagram in Figure 2, the builder will observe that the tuned radio stage at the left is succeeded by the detector at the right, the output of this stage going into the first audio transformer and thence towards the left until the output stage is reached in the output filter. This method of construction is a very convenient one when it is desired to hold down the physical length of the receiver and is also electrically sound because of the fact the output stage carrying audio currents does not interfere with the input stage, in which are found radio frequency currents.

#### Wire Set By Graphic

In wiring up the receiver by the graphic diagram shown in Figure 6, it should be observed that the stator of the first .0005 mfd variable condenser is connected to the outside winding of the first radio frequency transformer, which is also common with the grid of the first radio frequency tube, and one side of the .00005 mfd balancing condenser which is located on the baseboard. In the plate circuit of the first radio frequency tube it will be observed that the .0005 mfd variable condenser used for tuning that particular section of the circuit is located across the two extremities of the second radio frequency transformer, with the stator leading to the right end of the radio frequency coil, and one side of a .00025 mfd grid condenser which goes to the grid



Figure 4. In this photograph the *Everyman Four* receiver has been placed in a Fritts console

of the detector, while the rotor of this tuning condenser is common with the plate of the first tube, the left end of the second radio frequency transformer and the rotor of the .00005 mfd midget condenser placed at the center of the front panel as a regenerative control. The stator of the .00005 mfd midget condenser goes to the plate of the detector and to one side of the radio frequency choke, which is located in series with the detector plate and the P terminal on the first audio transformer, this transformer winding being bypassed by a .0001 mfd condenser. In actual operation the use of this .0001 mfd condenser is not absolutely necessary because of the presence of the midget condenser located on the panel, which serves to bypass a certain percentage of the radio frequency energy present in that plate

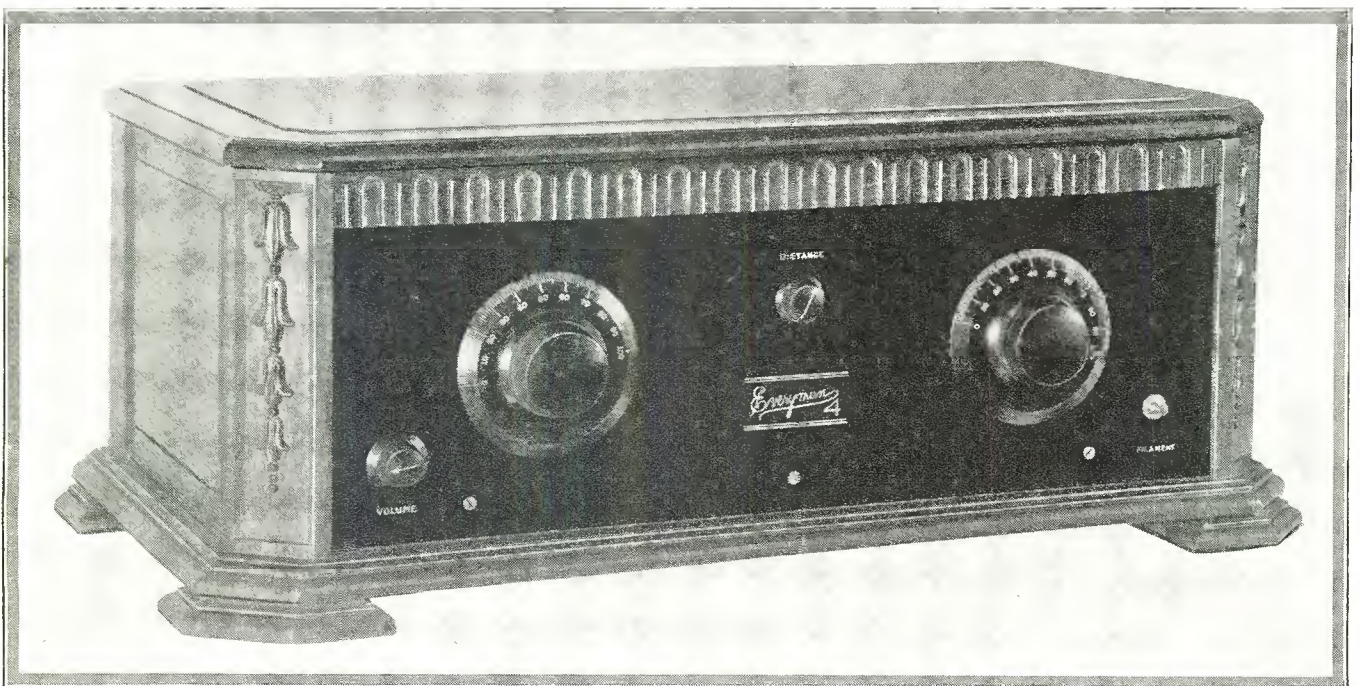

Figure 5. In this photograph is shown the *Everyman Four* installed in a Fritts cabinet



circuit. However, for the average builder it would be just as well to include this condenser and then if he found in practice that its employment is not necessary, it may be left out.

The remainder of the receiver is along conventional lines and should not present any obstacle to the builder. The first audio and second audio transformers are arranged at the rear of the baseboard in such a manner that grid and plate returns between these stages are very short. The fixed resistors used for filament control on the various stages are placed alongside of their respective sockets, as shown in the baseboard layout diagram in Figure 2, and these should be wired in accordance with the graphic diagram in Figure 6.

**Balance Set At Mid-Band**

When putting the receiver into operation, it is suggested that a station about mid way between the upper and lower broadcasting ranges be selected as the one on which the set is to be balanced. The two dials controlling the wavelength, the left hand one governing the tuned grid circuit of the first tube and the right one the tuned plate circuit, will be found to run practically alike, unless there has been a very great deviation in the amount of wire used for connecting up these two circuits. Tuning in a station at the mid point of the broadcast band, adjust the .00005 mfd balancing condenser by means of a wooden stick sharpened like a screw-driver until a point is reached where maximum volume is secured without instability or oscillation on the part of the set. During this time the midget condenser located on the front panel and which is considered a regenerative control should be set at zero, the rotor being separated from the stator. After the receiver is balanced in this fashion, the midget condenser may be turned in a trifle so as to bring up the volume through regeneration in the detector stage. After the

set has been balanced at the mid point, it should be tuned to the higher and lower wavelengths to determine if it is completely balanced. It may be that some builders would prefer having a higher amount of energy at the high wavelengths, even though the set goes into oscillation at the lower wavelengths, while on the other hand there are some who would rather balance their set for the lower wavelength stations and let the amplification fall off at the upper end of the broadcast spectrum. With a little care and with familiarity on the part of the builder with the set, no difficulty should be encountered in balancing the receiver so it will give uniform performance over both sections of the broadcast band.

It will be observed that all filament and plate voltages are of a fixed nature and for that reason the (only stability control of the set is incorporated in the .00005 mfd balancing condenser located on the baseboard. Sixty seven and a half volts are used on the plate of the first radio frequency tube, 45 volts on the plate of the detector stage, 90 volts on the plate of the first audio tube and 180 volts through the output filter on the plate of the power tube, which is a 171 type. The use of this last named tube enables full advantage to be taken of the maximum audio output of the receiver without distortion and at the same time without the use of extremely high voltages. There are only two bias values provided in this receiver, one being a 4½ volt bias for the grid of the first audio tube and the other a 4½ volt bias on the grid of the first radio frequency amplifier, this value being for stability of operation and economy in current drain. The other bias voltage is 40 volts negative, which is placed on the grid of the 171 tube and is approximately the right value for the tube when used with 180 volts on the plate. If a lower voltage than the one specified in the diagram is used on the 171 tube, it

*(Continued on Page 178)*

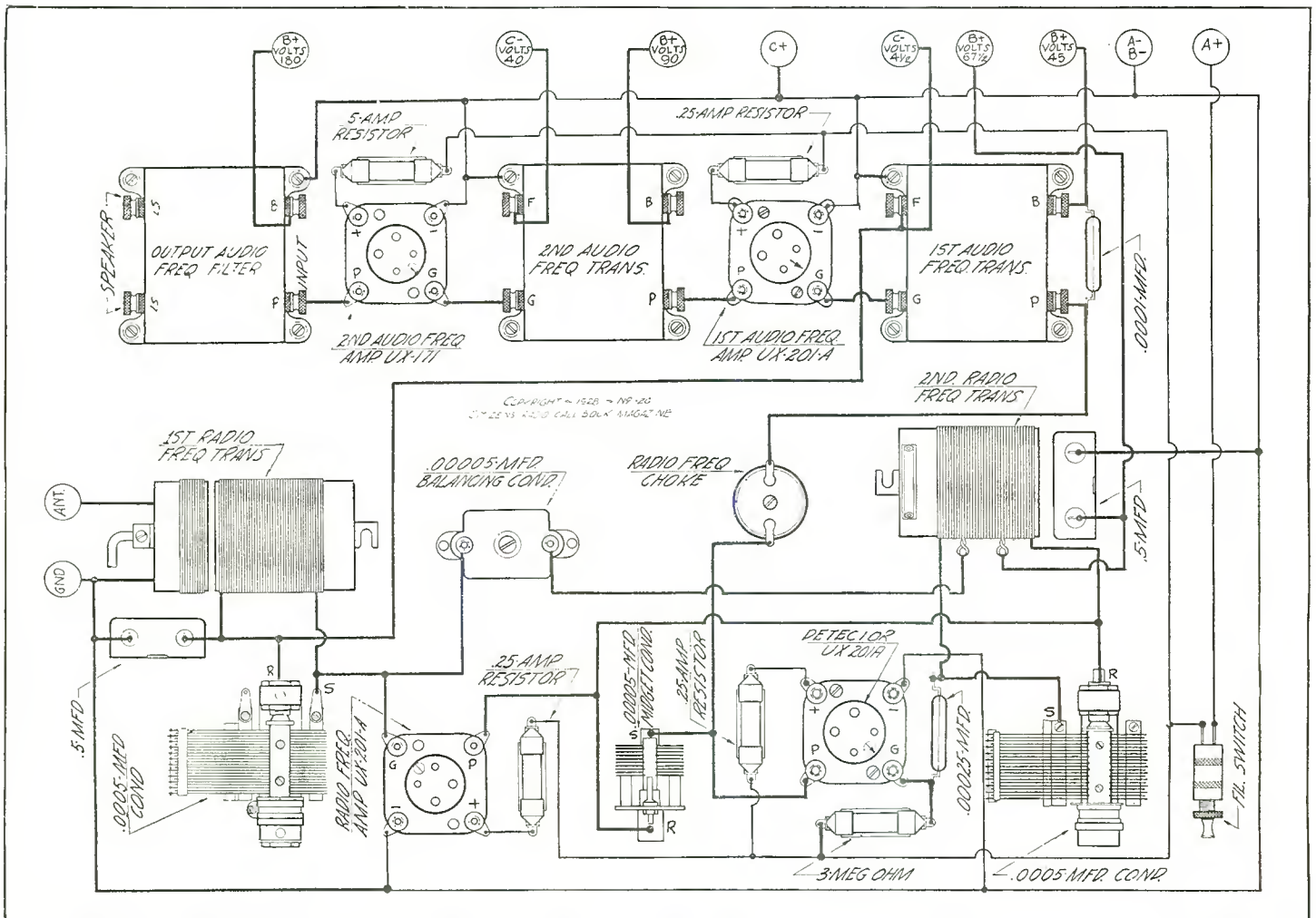

Figure 6. Those who are not acquainted with schematic wiring diagrams should utilize the above graphic as a means of wiring up the Everyman Four, the details of which are described in the accompanying article



# Silver-Marshall Shield Grid Six Uses the New Tubes

Three New Type Tubes Employed in Shielded Receiver Giving Amplification Up to Noise Level

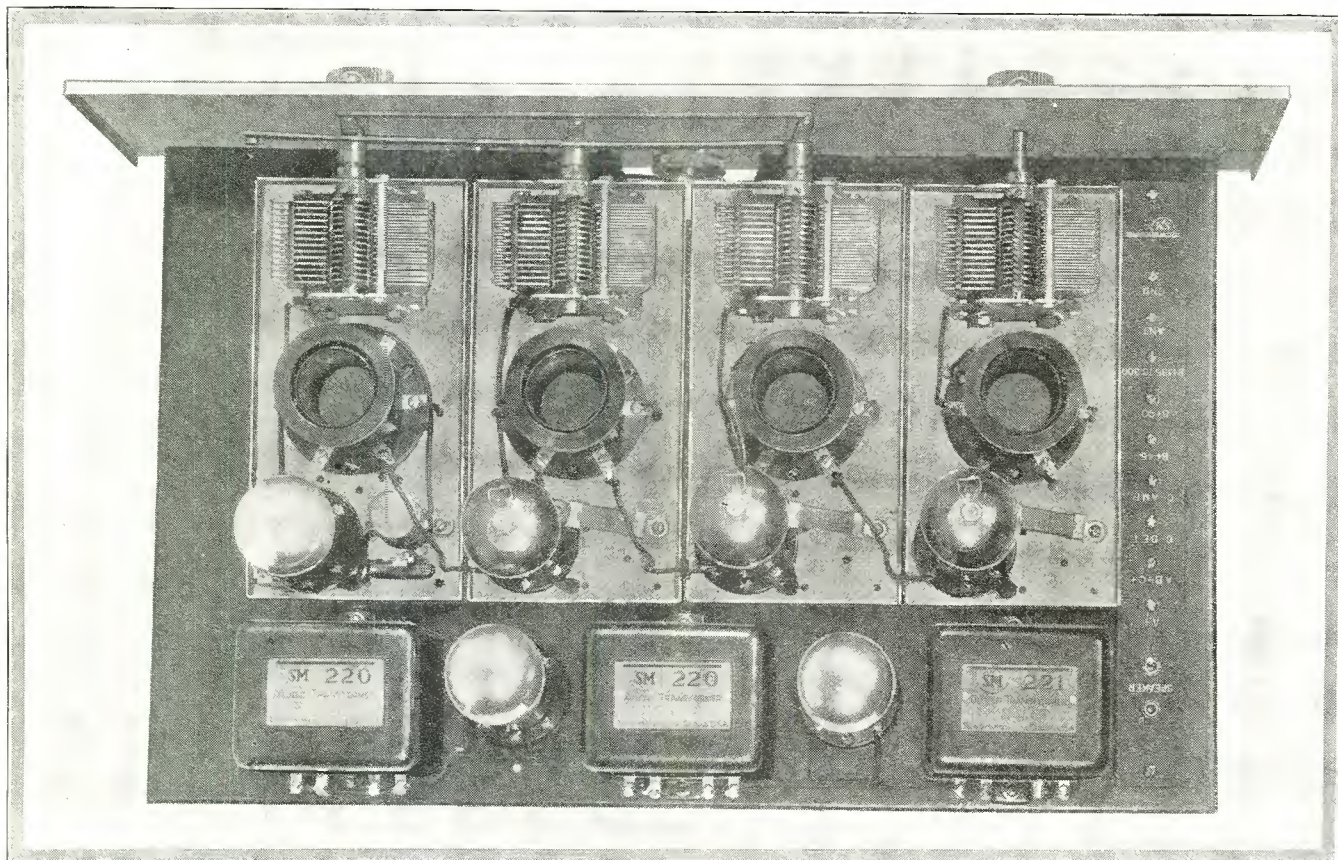

Figure 1. This photograph shows a rear view of the Silver-Marshall Shield Grid Six receiver described in the accompanying article

THE Shielded Grid Six is a six tube, completely shielded, tuned radio frequency receiver employing three r. f. amplifier stages utilizing the new shielded grid tubes, a super-sensitive detector circuit employing a 200-A detector tube at highest efficiency, and an audio amplifier capable of providing fine tone quality. The receiver is completely tuned by two tuning dials and an absolutely non-critical volume control knob which is used to reduce the volume on practically all stations heard.

It is difficult to conceive of a receiver developing so much volume on even the weakest distant stations that the volume must be reduced for satisfactory home entertainment. Yet such is the case with the Shielded Grid Six, for it approaches closely the ideal radio receiver—a set which will bring in any station which is louder than the local atmospheric noise level with loud speaker volume. It can be said the receiver will bring in any signal sufficiently louder than whatever local atmospheric noise may be experienced, with ample loud speaker volume, and beyond this, receiver sensitivity is a detriment rather than an aid. The tone quality of the receiver is not sacrificed to its extreme sensitivity and selectivity and it is perfectly possible to bring in stations almost anywhere in the country with as beautiful, satisfying tone as that of the best local programs.

#### What It Is

The receiver consists of a heavy pressed metal chassis 12 inches

deep and 19½ inches long, upon which all parts of the receiver, except the control dials, are mounted. Attached to this panel is a decorated etched bronze control panel 7 inches high and 21 inches long. On this panel are mounted two harmonizing walnut finished gold trimmed, vernier control dials marked "Station Selector I" and "Station Selector II." All tuning is done with these two dials, the settings of which are varied to tune in station after station. The dials "log" absolutely in that a station once heard at any dial setting may be brought in again at the same dial setting; and the two dials "track" sometimes within a degree of each other. In the lower center of the control panel is an absolutely non-critical volume control not affecting oscillation and serving merely to regulate the volume of received signals to a desired level. In the lower right-hand corner of the panel is an ON-OFF switch completely turning on or off all power for the entire receiver by a simple flip of the fingers. In the lower left corner of the panel is a switch of similar appearance allowing the choice of either selective or non-selective adjustments of the antenna circuit to accommodate varying lengths of antennas.

A minimum of 135 volts is required for operation and preferably 180 volts of B power. The total current consumption is very low, being only about 28 milliamperes. B batteries or a good glow-tube-equipped eliminator may be used, the B drain being very low, indeed. C batteries, as dictated by the power output tube

(This receiver tested and all illustrations made in our laboratory)



employed, are required, and a 6 volt storage battery or equivalent 6 volt A power unit. Using a standard B eliminator and A power unit, the receiver is completely light socket operated with the exception of dry C batteries which have long life and are low in cost.

Three shielded grid tubes are required for the r. f. amplifier. For the detector tube, the 200A is recommended. For the first audio amplifier, a 112 or 112A is strongly recommended, though in both detector and first audio positions 201A tubes may be used with inferior results due to overloading, so strong are the signals developed by the receiver. For both audio stages UX112A's are recommended if a plate voltage of 180 to 220 is available—as from an S-M type 652 or 652A power unit. For quality of reproduction, an S-M 675 B power unit may be employed which furnishes B power to the entire receiver at a total of 425 volts, and which is equipped with an adapter which allows the use of a UX210 super power amplifier tube in the last audio stage of the receiver.

Three stages of radio frequency amplification sharply tuned, followed by the sharply tuned detector circuit, working into a two-stage audio frequency amplifier comprise the receiver. The radio frequency amplifier circuits consist of low-loss variable condensers providing substantially even spacing of stations over the control dial scales and very low-loss, low-resistance, plug-in r. f. transformers, a condenser and a transformer being housed in each of the four r. f. stage shields. The antenna stage at the left in Figure 3 employs a special antenna coupler provided with a tapped primary allowing the use of short or long antenna at will by means of the switch in the lower left-hand corner of the panel. The three r. f. stages employ shielded grid amplifier tubes and the battery circuits of these stages are so arranged and so bypassed that, together with the effective shielding provided by the aluminum stage cans, no oscillation tendency or trouble is experienced in the receiver. A special feature of the r. f. amplifier circuit is that it does not employ the tuned impedance coupling which has been believed necessary to operation of shielded grid tubes.

The antenna stage of the receiver is tuned by the "Station Selector I," or left-hand, dial control—the left-hand variable condenser in the schematic diagram, and contained in the left-hand shield compartment of the receiver. The three variable condensers in the three right-hand shield compartments tune substantially identical circuits consisting of carefully laboratory-matched coils and condensers, and are connected together by means of a positive mechanical link. All three are tuned by the single right-hand "Station Selector II" dial. All radio frequency circuits are completely shielded, the radio frequency lead from one stage to the next passing through the small crevice between the stage compartments in slots provided in the shields for this purpose, and being insufficiently exposed to cause signal pick-up. In fact, so thorough is the shielding of the 630-SG receiver that it is practically impossible to pick up even a powerful local signal with the antenna removed; and with the two leads from the antenna coil socket to the antenna switch removed entirely, the shielding becomes completely effective.

Regulated through the use of fixed resistances, each tube has its filament voltage definitely established within correct ranges. Three separate 10 ohm resistances are used on the type UX222 tubes, and the voltage drop across each, of about 1.32 volts, is utilized for grid bias. A 2 ohm resistor, common to the filament circuits of all 222 tubes, prevents the filament voltage ever rising above 3.5 volts with a fully charged battery, while the volume rheostat of 20 ohms allows it to be turned down to a value so low as to reduce volume to practically zero. A .57 ohm resistor regulates filament voltage for the detector and two audio amplifier tubes. A "C" bias of 3 volts is used upon the detector tube (it may be increased to 4½ under certain operating conditions, or reduced to 1.5 volts for UX200A tubes) and upon the first audio tube. This low bias improves low note reproduction and handling capacity for strong signals, and, for a like reason, a plate voltage of 135 volts is employed upon the first audio stage with an optional plate voltage of from 135 to 180, 200, or even 450 on the last audio stage if a 210 output tube is used.

The stage compartments house the radio frequency portions of the circuits. Behind these compartments is the audio amplifier, progressing from right to left, with the second audio tube the left rear tube socket. The detector C bias and plate bypass condensers are contained in the detector stage compartment, as is the detector and audio amplifier resistance. The 10 ohm filament resistances for the r.f. amplifiers are contained in the compartments, and in each compartment is located, of course, a tube socket, coil socket and coil, and variable condenser. Beneath the chassis are fastened the 2 ohm resistance for the 222 tubes and the .57 ohm resistor and the two ½ mfd bypass condensers connected between the metal chassis and the +45 and +135 leads. The metal chassis is grounded to the negative side of the r.f. amplifier filament circuits and at its left end is a terminal strip carrying the loud speaker tipjacks and connection screws and connection terminals for all battery and antenna and ground lead wiring.

The wavelength range of the receiver is from 200 to 3,000 meters. Employing the standard A range coils, it is from 200 to 550 meters, and a suitable coil set consists of one 116A antenna coil and three 119A r.f. transformers. For operation from 500 to 1,500 meters, one 116D antenna coil and three 115D r.f. transformers are employed; while for operation from 1,400 to 3,000 meters, one 116E and three 115E r.f. transformers are employed. D and E range transformers are not provided with selectivity adjustment taps, since there is little congestion of stations in these higher wavelength ranges. On long waves the receiver is sensitive enough to receive European stations if any set at all can do this.

The assembly of the receiver will be quite clear upon careful inspection of the accompanying photographs which indicate the placement of all parts above and below the chassis. The 20 ohm Frost rheostat should be mounted in the hole in the projecting lip in the center of the front edge of the chassis, using the insulation washers provided to positively prevent any metallic contact between the chassis and the rheostat frame. The photographs should be carefully studied and the parts in each stage shield compartment fastened down as indicated, with care being taken to scrape bright the portion of the chassis falling beneath the stage shield pans to provide good metallic contact between shield pans and chassis. The .57 ohm resistance should have one mounting foot bent at right angles and fastened to one post of the 20 ohm rheostat. The two ½ mf. Carter condensers should be mounted in the detector stage compartment in the holes provided, using machine screws and nuts. Thus, one connection of each condenser is automatically made to the chassis. On the bottom of the chassis, a soldering lug should be placed on the front mounting screw of the 221 transformer, and under the rear mounting screw of the left-hand section of the 316B condenser, these lugs to be used for ground connections to the chassis. Under the front mounting screw-head of the "B" section 316A condenser, one end of the 2 ohm Carter resistance should be fastened, the other end of this resistance being soldered to a lug on the binding post of the Frost 20 ohm rheostat. The two mounting screws of this same variable condenser serve to hold

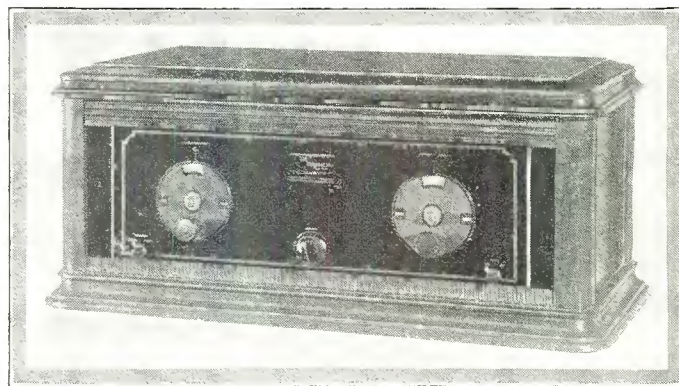

Figure 2. In this photograph the receiver is shown mounted in an Ehlert cabinet



one Fast 1 mfd condenser in position, while the two mounting screws of the left rear, or second audio tube socket, hold the second Fast 1 mfd condenser in position.

The coil sockets of the various compartments should be put in and elevated above the chassis by means of the long mounting screws and studs provided, taking care that terminal 3 of each coil socket projects directly to the right.

Before the front panel has been attached, but with all mounting done, the wiring should be put in place. It is done with flexible insulated hook-up wire, excepting only the +A, +45 and +90 bus wires which consist of lengths of bus-bar in spaghetti. In making the connections the bus-bar should be cut to length and put in place with proper size lengths of insulating spaghetti tubing slipped over it.

Every joint to be soldered should have the wire and lug separately tinned, using the tiniest pin-point of soldering paste and an amply large drop of rosin-core solder. The wire end and lug may then be joined together, using a hot iron with a drop of solder. In the r.f. amplifier sections a 4¼ inch length of wire should be allowed to extend from terminal 3 of each coil socket, and to the far end of this wire should be fastened one of the three small clips, these clips to be fastened to the top terminals of the 222 shielded grid amplifier tubes.

Connect the antenna and ground leads to the antenna and ground binding posts upon the terminal strip. Connect the A battery to the A BAT. post upon the terminal strip, using the two heaviest wires in the battery cable. Connect the red, or + terminal of the battery to the A+ post of the receiver. Connect the black, or negative, post of the battery to the A- post of the receiver. Insert all tubes in sockets, turn rheostat to left, and turn on ON-OFF switch. The detector and audio amplifier tubes should light to a cherry red if UX112A tubes are used. The volume control rheostat should be turned to the right gradually, and, when all to the right, the filaments of the 222 tubes should glow with a bright yellowish color. All tubes should extinguish with the ON-OFF switch turned to the OFF position. Remove

the A+ lead and connect successively to all remaining battery posts upon the terminal strip. In any of these positions the tubes should NOT light and should only light with the A battery properly connected. Should the tubes light with any other connections, the receiver wiring is at fault and should be carefully checked. The 4½ volt C battery should have its + lead connected to the black, or negative, lead of the A power unit. Its -3 lead should connect to the C- det. binding post of the terminal strip. The second higher voltage C battery for the last audio amplifier stage should preferably be of about 15 volts value when using a 112A on 180 volts—an extremely satisfactory operating value for this tube. The - lead of this C battery should connect to the C-AMP. post of the terminal strip.

The operation of the receiver is simple, it simply being necessary to turn it on with an ON-OFF switch, adjust the volume knob to the maximum or full right position and tune in stations which will be received with the two dials rotating approximately alike. Volume may be regulated with the volume knob and a course regulation of the selectivity of Selector I dial effected by throwing the antenna short and long switch from Short to Long position and vice versa. If the set is to be operated in a residential district 10 or 15 miles from a local broadcast station, the plate leads of the r.f. amplifier tubes should be fastened under terminal screws No. 2 of the coil sockets, which is the position of greatest volume together with extremely good selectivity. Moving the three plate leads to post 4 of the respective coil sockets increases the selectivity and decreases the volume very slightly, while connecting the plate leads to post 1 of the coil sockets gives an extremely high value of selectivity at the expense of a slight decrease in volume.

The three condensers in the stage compartments should be ganged by fastening the link motion to them and adjusting it so that all three condensers begin to interleave and hit their stop rods at the same time. After the set has been in operation, the antenna length should be cut down until some station at about 300 or 325 meters is barely audible. The right-hand condenser

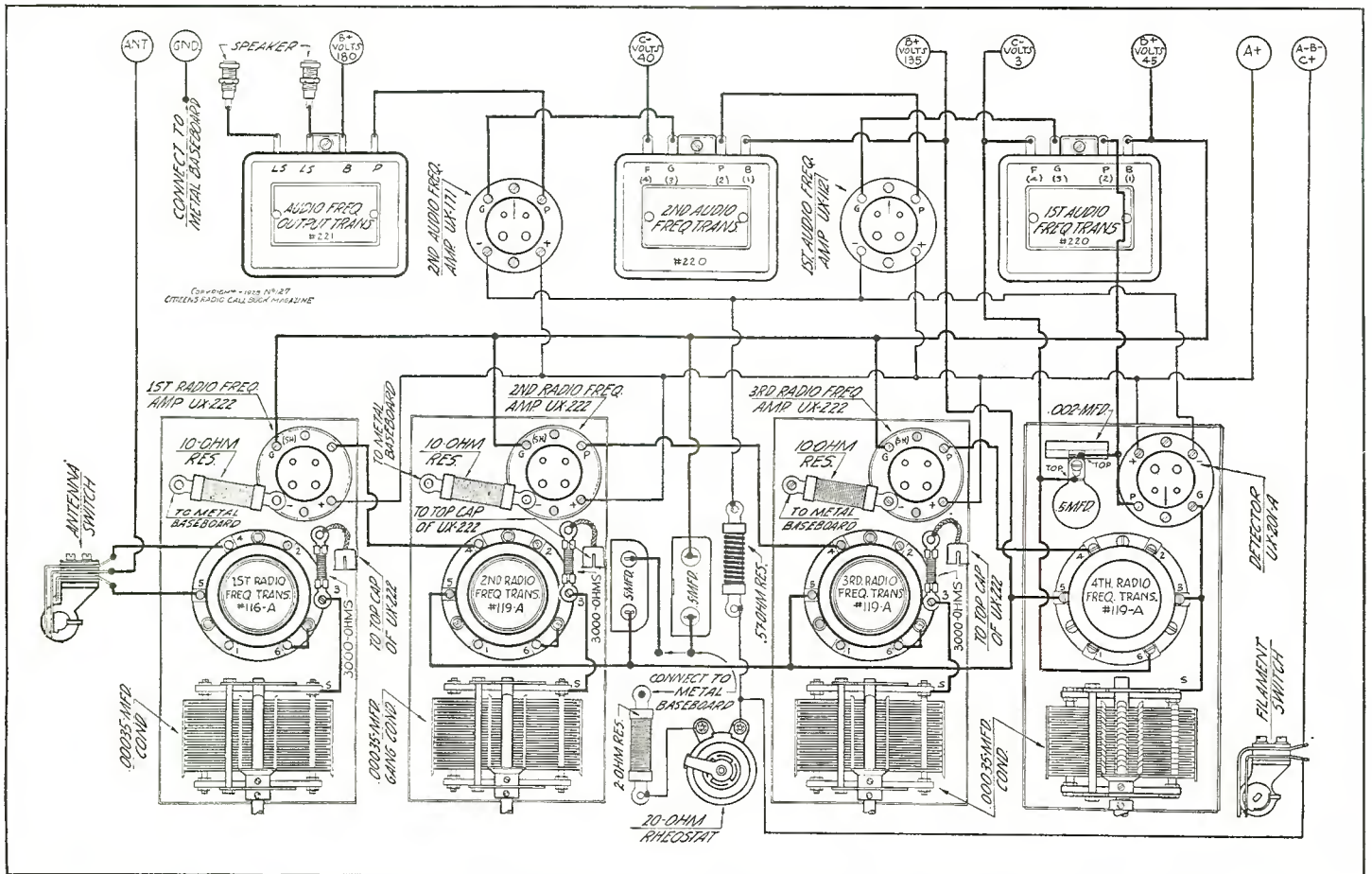

Figure 3. Wiring of the receiver may be accomplished by means of the graphic illustration shown above. This diagram should be faithfully followed by those who are not acquainted with the schematic wiring diagram



should then be loosened from the ganging and tuned individually. While the condensers are tuned together for loudest signal, the condition of loudest signal will be when the last condenser lags slightly behind the first and second condensers, and the link should be tightly locked in place at this point.

In operating the receiver, remember that it tunes exactly like any ordinary neutrodyne or non-oscillating tuned r.f. receiver and that it will not oscillate if properly assembled (except in the case of very unusual operating conditions, when it may oscillate with the plate leads connected to post 2 of the coil sockets, and with no antenna connected to the receiver). With even a 15 foot antenna connected, the set will not oscillate at any wavelength. The set in operating should give loud speaker signals upon stations barely audible upon other tuned r.f. or superheterodyne receivers, or it should give equivalent volume with far greater selectivity on any stations that may be heard with any standard tuned r.f. receiver operating on a 60 to 100 foot antenna. The Shielded Grid receiver for this test was equipped only with a 10 to 15 foot length of wire for an antenna.

For those who wish to use this receiver with a loop instead of the antenna connection, the Bodine .00035 mfd type loop is recommended and has worked very satisfactorily with this receiver. For loop operation all that is required is to omit the first stage shield 631-A, the antenna coil 116-A and the coil socket 515 in the first stage. With these parts left out, the loop should be placed across the rotor and stator of the condenser shown at the left in Figure 3, which is the first .00035 mfd tuning condenser.

This receiver has been tested for operation with UX-222, Shield plate 122, or equivalent types of screened grid tubes.

Parts used in the construction of the receiver here described are:

- 4—631-A S-M stage shields
- 2—316-A S-M variable condensers
- 2—316-B S-M variable condensers
- 4—515 S-M coil sockets
- 6—511 S-M tube sockets
- 3—119-A S-M r.f. transformers
- 1—116-A S-M antenna coil
- 2—220 S-M audio transformers
- 1—221 S-M output transformer
- 1—632 S-M triple link motion
- 1—105 Carter .5 mfd condenser
- 1—Carter .002 mfd fixed condenser
- 2—Fast 1 mfd by-pass condensers
- 1—Frost 20 ohm rheostat



Figure 4. In this photograph the Silver-Marshall Shield Grid Six is shown housed in an Ehler cabinet

- 3—Yaxley 3000 ohm grid resistors
- 2—10 Carter tipjacks
- 1—Carter 2 ohm fixed resistor
- 3—Carter 3000 ohm grid resistors
- 2—Marco walnut vernier dials
- 3—Carter 10 ohm fixed resistors
- 1—Carter .57 ohm fixed resistor
- 1—636 S-M terminal strip with terminals
- 1—633 S-M drilled and engraved metal panel, 7x21 inches
- 1—634 S-M steel chassis, 12x19 1/4 x 1 1/4 inches
- 1—22 Carter Imp short jack
- 1—Carter Imp battery switch
- 25—Fect S-M flexible hookup wire
- 1—Ekko ground clamp
- 1—Package Kester radio solder

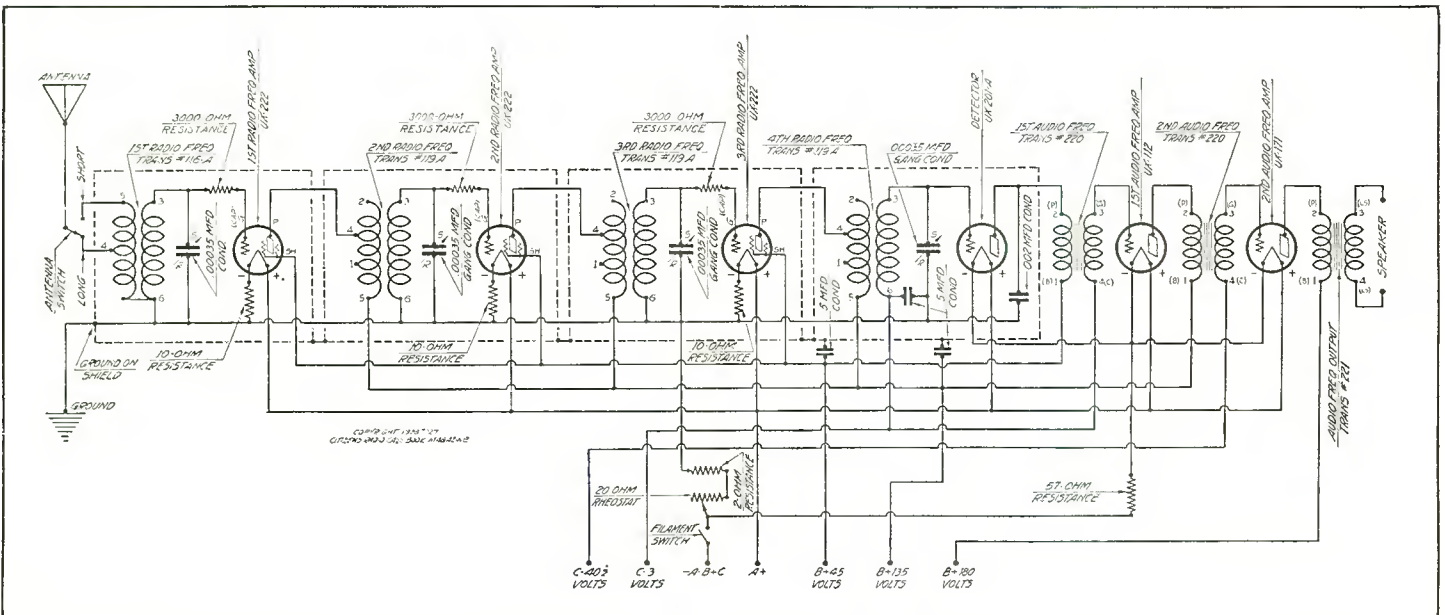

Figure 5. The electrical story of the receiver may be ascertained from the schematic diagram shown above, which may be used by those familiar with this type of drawings, although the novice is urged to use the graphic shown in Figure 3



# Citizens Shielded Five Is Fine for the Experimenter

Considerable Amplification Secured with This Recent Laboratory  
Receiver Which Has Unique Balancing Method

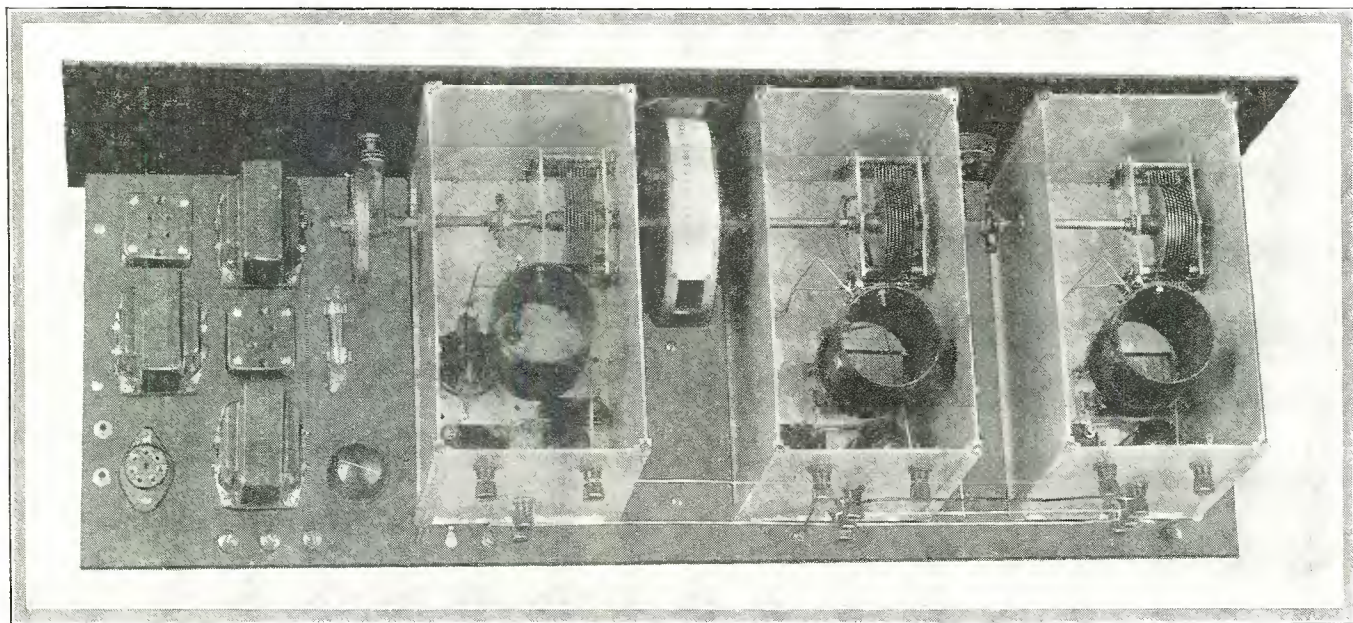

Figure 1. In the above photograph is shown the rear view of the Citizens Shielded Five described in this article

QUITE frequently the editorial and technical departments of this magazine have been requested by dyed-in-the-wool experimenters to design something which will give those who are experimentally inclined an opportunity to play with a receiver, which perhaps might be a little too complicated for the average listener.

## Our Own Design

In response to these numerous requests our laboratory for some time past has been engaged in testing out the merit of various shielding systems in a tuned radio frequency amplifier and with the result that in the receiver about to be described it is felt that excellent results may be obtained from the use of a circuit, such as is shown in the schematic diagram in Figure 2 which accompanies this article.

Basically the receiver consists of two stages of tuned radio frequency and a non-regenerative detector, to which have been added two stages of quality audio amplification, using an output transformer in the last stage for protecting the speaker windings against high voltages. Three of the sections of this receiver, which comprise the first and second radio frequency stages and that of the detector, are placed inside of an aluminum housing with the necessary interconnecting binding posts located at the rear of the aluminum shields. By referring to the photograph shown in Figure 1, the builder will readily notice the binding post connections on the rear of the shields and will observe that relatively little wire is required for hooking up these three boxes. It was felt that in order to secure as great an amplification factor as is possible, that complete shielding becomes imperative.

## R. F. In Shielded Sections

Referring to the schematic circuit shown in Figure 5, it will be noted that the first radio frequency transformer, the .00035

mfd tuning condenser, the tube socket, the 1000 ohm fixed grid resistance, the radio frequency choke and the .1 mfd bypass condenser are all located within the confines of the first shielded section. The second aluminum housing contains a .002 mfd fixed condenser, the second radio frequency transformer, the .00035 mfd gang condenser, the 1000 ohm grid resistance, tube socket, radio frequency choke and the .1 mfd coupling condenser. In the third shielded section, which is that of the detector stage, may be found the third radio frequency transformer, a .00035 mfd grid condenser, 2 megohm grid leak, tube socket, radio frequency choke and the .001 mfd bypass condenser. All of these shields are at ground potential, connecting in common to the negative A battery, the negative terminal of each of the three tube sockets, the rotors of each of the three variable condensers, the grid return of each of the three secondary inductances and the ground tap of the antenna coil. In addition the negative filament connection is common with the positive C battery and the negative connection of the B voltage.

## Receiver Single Controlled

While it would have been possible to make a double control receiver out of this set, nevertheless it was felt that the three stages would gang sufficiently well to allow the operator to secure good results over the entire scale by connecting the three variable condensers together through the Precise drum control, which is shown at the center of the drawing in Figure 4, with the actual driving mechanism located to the right of the last can shown in this same illustration. For the sake of clarity the drum mechanism and the driving mechanism are not shown in the graphic illustration shown in Figure 6.

## Audio Stages Fixed

For controlling the filament circuit of the first and second radio

(This receiver tested and all illustrations made in our laboratory)



frequency amplifiers, a 10 ohm rheostat is used, which is also a filament switch and is located at the left of the front panel shown in Figure 3. The dial at the right in the illustration just referred to represents the driving mechanism for the dial and condenser coupling. A 20 ohm rheostat in series with the filament of the detector tube is located on the sub-panel, because of the fact that after it is once set for a particular tube it does not have to be changed. Filament control of the two audio stages is automatic by means of a three-quarter ampere ballast resistor placed in the positive filament lead, going to the 201-A in the first audio stage and the 171 in the second audio stage. It, therefore, follows that there are only two controls on this receiver, if the receiver is to be made for the average listener.

#### New Balancing Control

However, if the experimenter is to use the set, it is recommended that an additional control be added, which is to consist of a 500 ohm variable resistance, preferably located on the front panel, and in series with the primary coil of the third radio frequency transformer, where it serves to balance the receiver to a point where a large radio frequency amplification value may be secured without distortion or instability. Further stabilization of the receiver may be observed in the use of the 1000 ohm fixed resistance in series with the grid circuit of the first and second amplifiers. At this point it should be noted by the experimenter that the primary coil of the second radio frequency transformer does not actually have battery current flowing through it. It is isolated from the plate circuit of the first stage by means of a .1 mfd condenser directly at the plate of the tube and a .002 mfd coupling condenser between the bottom terminal of the primary and the bottom terminal of the radio frequency choke coil, as shown in the schematic diagram, Figure 5. It should also be observed that the primary of the third radio frequency transformer does not have any current flowing through its windings, although it has a resistance in series with it between the lower terminal of the radio frequency choke, the primary of the third radio frequency transformer and one of the .1 mfd coupling condenser shown in the second radio frequency amplifier stage.

#### Values Are Critical

It is by the careful selection of the capacity value shown as the .002 mfd fixed condenser in the bottom side of the primary of the second radio frequency transformer, and the value of resistance used as a control in the primary circuit of the third radio frequency transformer that allows maximum operation of this receiver for distance, tone, stability and selectivity.

The experimenter should note that this 500-ohm variable resistance should have a minimum resistance value of not more than 50 ohms and it must necessarily be non-inductive. The use of any form of resistance other than a non-inductive one will nullify the results which are expected from the receiver. It might be interesting at this point to mention the fact that one of the manufacturers of resistances has made a special non-inductive resistance for this particular receiver design and it is shown in the list of parts which accompany this receiver.

#### Wire Set by Graphic

Before passing on to the actual operation of the receiver it might be well to take up the wiring of the set, which should be accomplished by means of the graphic diagram shown in Figure 6 which accompanies this article. Having assembled a portion of the aluminum housing, the builder may proceed with the placing of the tube socket, the radio frequency choke, the .1 mfd coupling condenser, the 1000 ohm cartridge resistance and its respective mounting, and the inductance. This inductance is provided with mounting feet so that it goes directly on the bottom of the stage shield. Before mounting the variable condenser located in each of the cans, it would be well to lay out the two sides of the cans for the hole through which the shaft is to be run. These holes for the condenser shafts should be alike to a high degree of accuracy so that when the shafts are located in position there will not be any possibility of their binding. As a means of coupling these shafts from section to section, there are three coupling flanges provided with the dial mechanism. These may be seen by inspecting the layout diagram shown in Figure 4.

#### All Shields Grounded

As previously stated, the negative terminal of all sockets in all aluminum housings is common with the bottom of the stage shield and may be connected to the shield through the mounting screw used in affixing the socket. The mounting foot on the radio frequency transformer is also connected with the shield as is the rotor of the .00035 mfd tuning condenser. This same form of connection holds true for all three stage shields.

To simplify the appearance of the diagram the binding posts on the rear of the stage shields are shown extended at the top of the graphic illustration in Figure 6. The connections as shown in this diagram are made on the inside of each rear shield. Then when the receiver is connected up for operation, busbar wire is run between binding posts at the same level, this form of connection also being shown in the graphic illustration previously mentioned.

#### Battery or Eliminator Operated

Filament current for operation of the receiver may be secured either from a storage battery or from a standard approved form of A eliminator. There are four plate voltages used on this set, 45 volts being used on the plate of the detector which is a 200-A type. The plates of the first and second radio frequency amplifiers are given 90 volts while the plate of the first audio amplifier is given 135 volts. For the plate of the power tube which is a 171 tube a voltage of 180 is provided. Two bias voltages are available, one of 9 volts negative being used on the grid of the first audio amplifier and one of 40½ negative being employed on the grid of the power tube in the last stage.

#### Operating the Receiver

In operation of the receiver it will be well to tune in a local station so as to become familiar with the manipulation of the set before trying to receive distant signals. With this type of receiver stations will naturally appear only one position on the dial and after having once been tuned in they may always be found at that particular location. During the time that the receiver is operated on local stations it will be possible to adjust



Figure 2. Mounted in an attractive console the receiver presents a very pleasing appearance for those who wish to have it in their living room



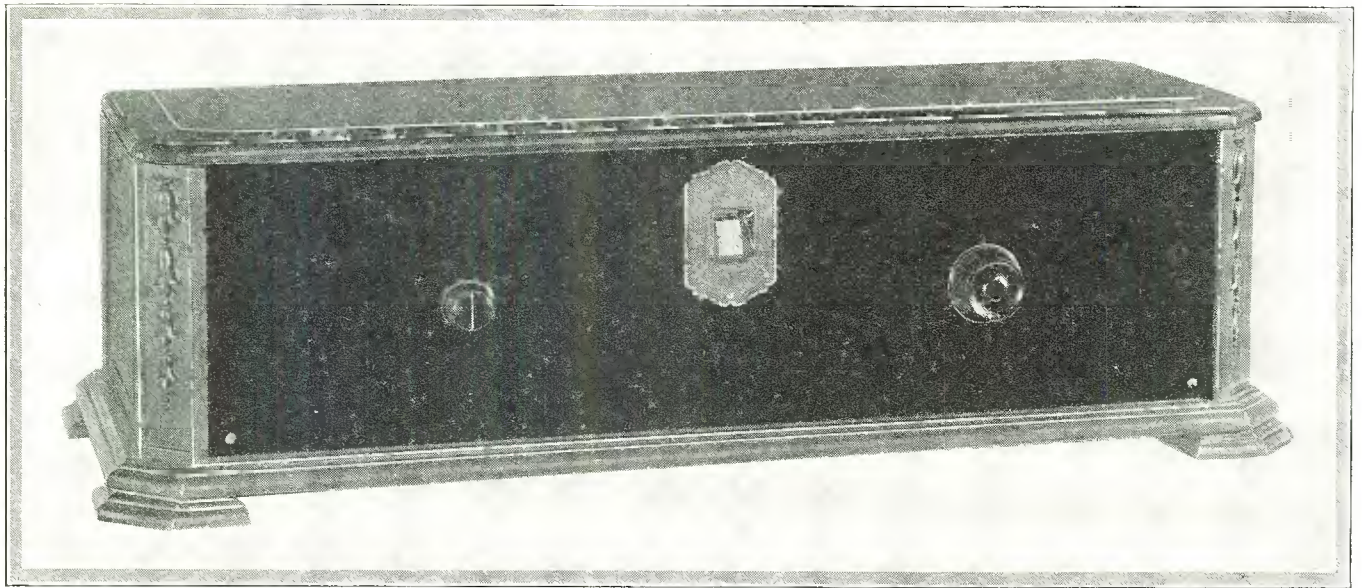

Figure 3. In this photograph the receiver is shown mounted in a cabinet for use on the table or a work bench

the 20-ohm rheostat in series with the filament of the detector tube to a point where best results are secured. It will also be necessary to change the position of the 10-ohm rheostat from time to time for either increasing or diminishing the sensitivity of the first and second radio frequency amplifier stages. Operation of the 500-ohm variable resistance, which is shown in the graphic diagram as being located on the right wall of the third stage shield should be made on a fairly weak station so that the receiver can be properly balanced. At this point it might be well to call the attention of the builder to the fact that if the balancing control is to be located in the position where it is shown in the graphic diagram it is necessary for it to be very carefully insulated from the wall of the stage shield because otherwise there is a possibility of getting a 90-volt short circuit through the arm of the resistor. For insulating it is suggested that fiber washers be secured and that an insulating bushing be placed inside of the hole through which the shaft passes.

When a weak station has been tuned in it will be found that by turning up a 10-ohm rheostat which governs the brilliancy of the first and second radio frequency amplifier tubes the sensitivity of the receiver will be very materially increased and under some conditions might go into oscillation. It is to curb the oscillatory condition of the circuit that the 500-ohm variable

resistance is used. Thus by its employment it is possible to hold the amplifier tubes just below the oscillatory condition and thereby gain a very large amplification due principally to regenerative amplifying qualities of these two tubes. Of course for best results with the receiver it should be operated when all of the shields have been placed in position on the top.

For trimming the three variable condensers the operator will observe that each of these variables has a little trimmer plate located at the left of each main section which may be shifted closer or farther away from the main section of the condenser and which serves to increase or decrease the over-all capacity of these units. When lining up the condensers, the builder should be careful to see that when the shaft couplings are put on the condenser plates in each section should be either all in or all out, the former position being preferable.

Parts used in the construction of the Citizens Shielded Five are as follows:

- 3—Precise .0005 mfd variable condensers
- 1—Precise drum dial
- 3—Precision r.f. transformers
- 3—Hammarlund couplings
- 3—85 Hammarlund r.f. chokes
- 3—530 Frost sockets

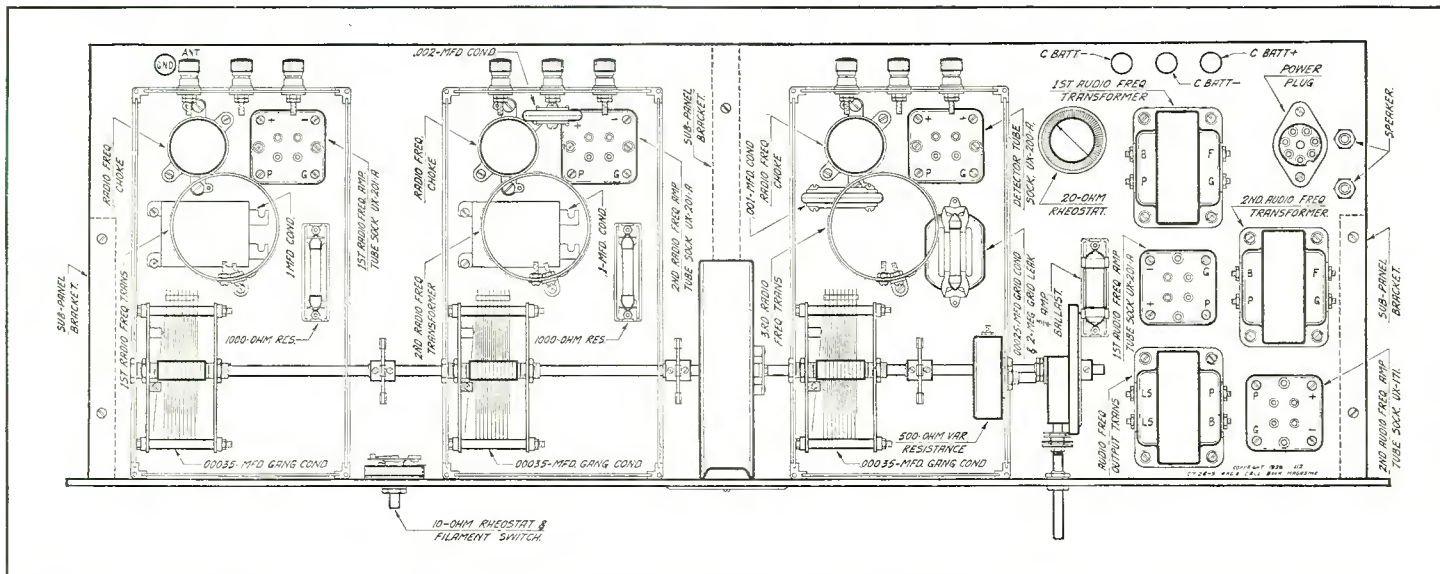

Figure 4. The diagram shown in the above drawing is one that represents the actual placement of the parts involved in this receiver. It should be noted that considerable of the apparatus is located in the shielded cans. The audio stages, however, are not shielded and are placed at the right of the sub-panel as shown above



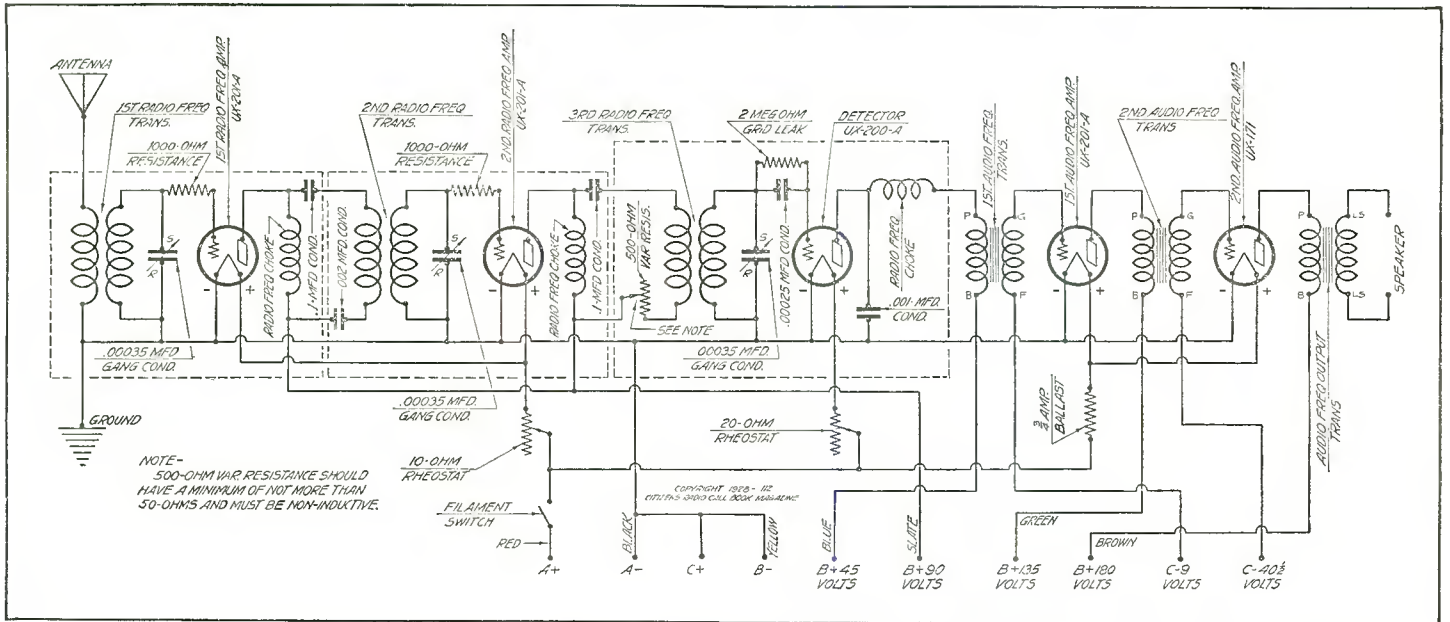

Figure 5. In this diagram are shown the electrical connections for building the Citizens Shielded Five. Those portions of the circuit which are contained within the aluminum housing are shown in dotted diagrams in this schematic circuit

- 2—531 Frost sockets
- 1—Frost 10-ohm Gem rheostat with switch
- 1—Frost 20-ohm Gem rhesotat
- 2—Frost tipjacks
- 2—Halldorson audio transformers
- 1—Halldorson output transformer
- 1—Hagel 7 contact power plug
- 2—Acme Par-volt .1 mfd by-pass condensers
- 1—Frost 2000-ohm non-inductive variable resistance
- 1—Sangamo .00025 mfd fixed condenser with prongs
- 1—Sangamo .001 mfd fixed condenser
- 1—Sangamo .002 mfd fixed condenser
- 2—Daven No. 50 mountings

- 2—Daven 1000-ohm grid resistors
- 1—Daven 3/4 amp. filament ballast
- 18—Eby binding posts
- 3—ALCO aluminum cans
- 3—Karas sub-panel brackets
- 1—8x30x3/16 inch panel
- 1—10x39x3/16 inch sub-panel
- 30—Ft. Acme Celatsite wire
- 1—Pkg. Kester radio solder
- 1—Ekko ground clamp
- 1—Daven 2 megohm grid leak
- Miscellaneous—lugs, nuts, bushings, screens, etc.

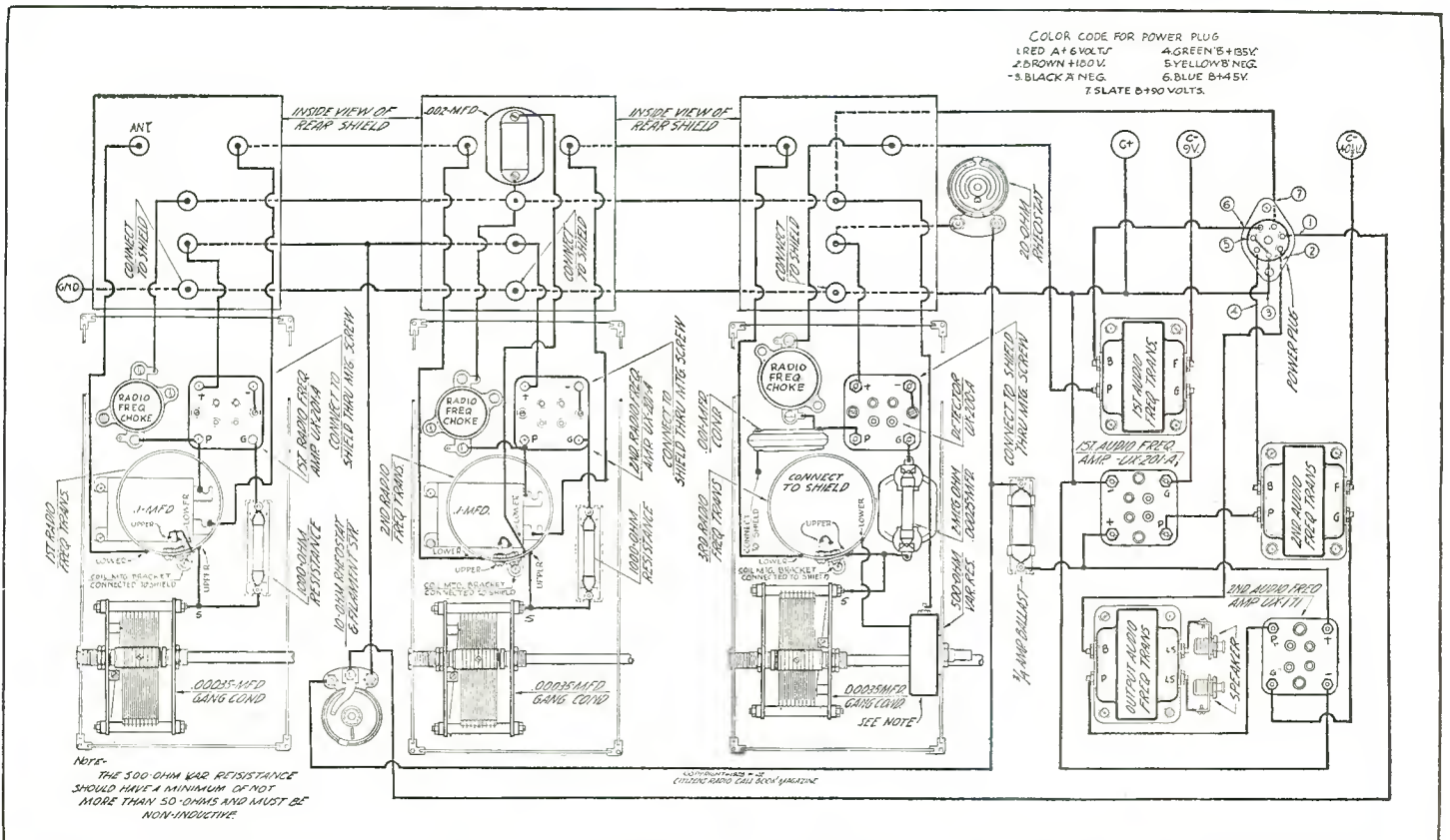

Figure 6. Actual connections for the receiver are disclosed in the above graphic illustration, which should be followed carefully by the set builder



# Compact Remler Super Built for Alternating Current Operation

Popular Model of Superheterodyne Considerably Simplified When Used with A. C. Tubes

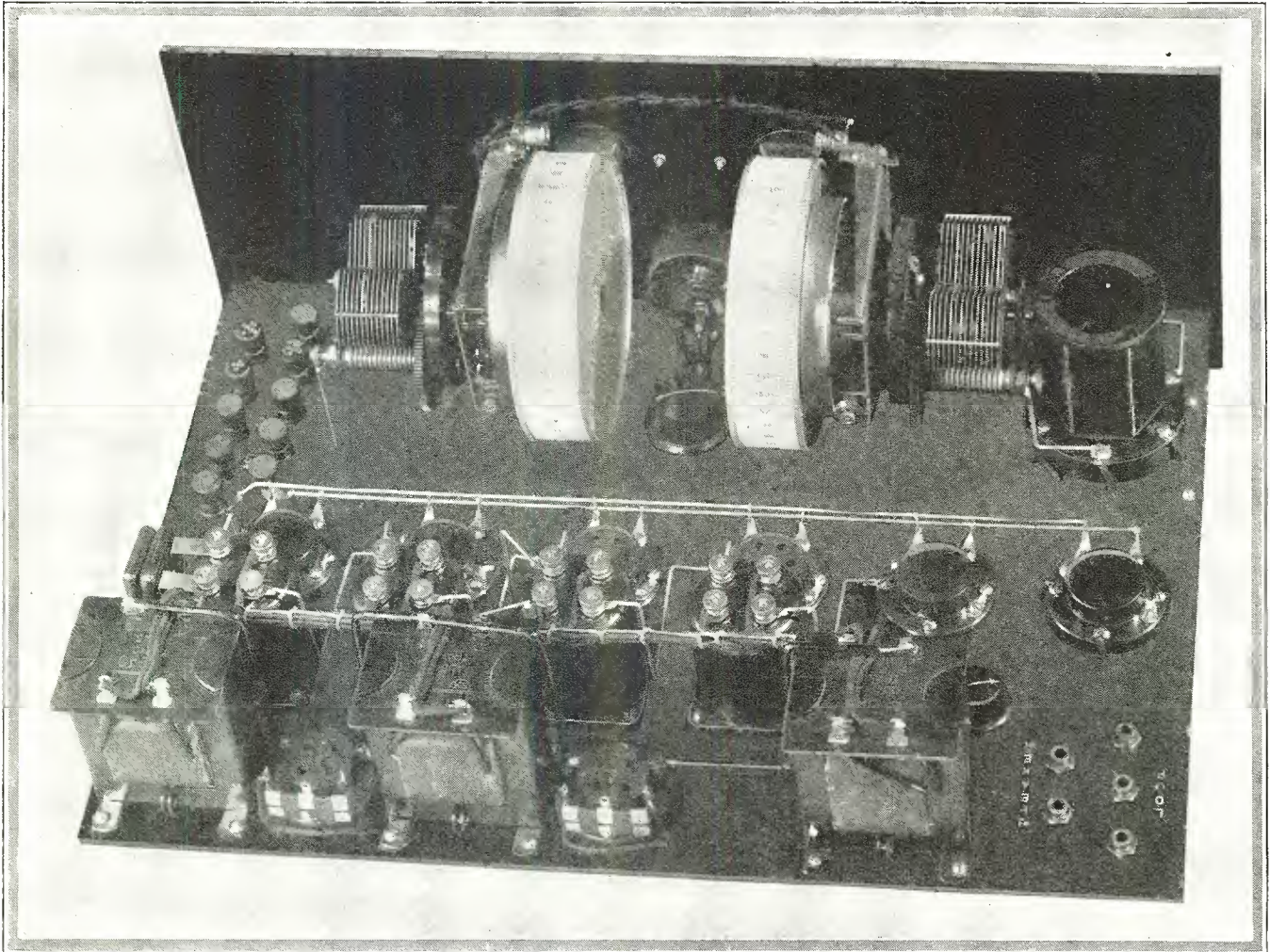

Figure 1. In this photograph may be seen the rear view of the Remler A. C. Super described in the accompanying article

READERS of this magazine remember with interest the previous versions of the Remler superheterodyne which have been printed from time to time. Present-day interest on the part of the public seems to indicate that receivers should be electrically operated, and it is in response to the demand of many fans acquainted with previous models that the Remler receiver has now been converted to alternating current operation by means of the 226 and 227 type tubes.

One of the features of the receiver that may be of interest is the fact that the tuning of it is so simple that even a novice may secure good results, while its tone quality is unusually good for a superheterodyne. A point of interest to the alternating current fans may be seen from the fact that the receiver derives all of its power from any 60 cycle alternating current home light socket. The entire set is self-contained and may be placed either in an oversized cabinet to accommodate the receiver and power amplifier, or it may be placed in a console with the receiver at the top and the power amplifier at the bottom, although for best results the power supply should not be kept too far away from the receiver on account of the possibility of voltage drop in the

alternating current filament supply lines. The only external equipment required is a loop such as the Bodine, which was tested with the receiver, and a good speaker. On account of the fact there are no batteries to run down, the servicing problem becomes one of occasional tube replacement only.

In keeping with the simplicity of the receiver, the reader will observe that on account of the small number of parts, the set's initial cost has been materially reduced, so that it would appeal to those who desire a good quality receiver at a moderate expenditure of money.

A description of the individual circuit sections may be of help to the prospective builder. There are three knobs on the front panel. The two drums control the .00035 variable condensers, one for the loop and one for the oscillator, both of these drums having high reduction vernier drivers and well spaced scales numbered from zero to 200. In tuning, both of the dials track quite closely. The center knob controls volume from zero to maximum and is a 5000 ohm potentiometer governing the input to the first, second and third intermediate frequency amplifier tubes. This control is not critical after setting, but if turned too far to the

(This receiver tested and all illustrations made in our laboratory)



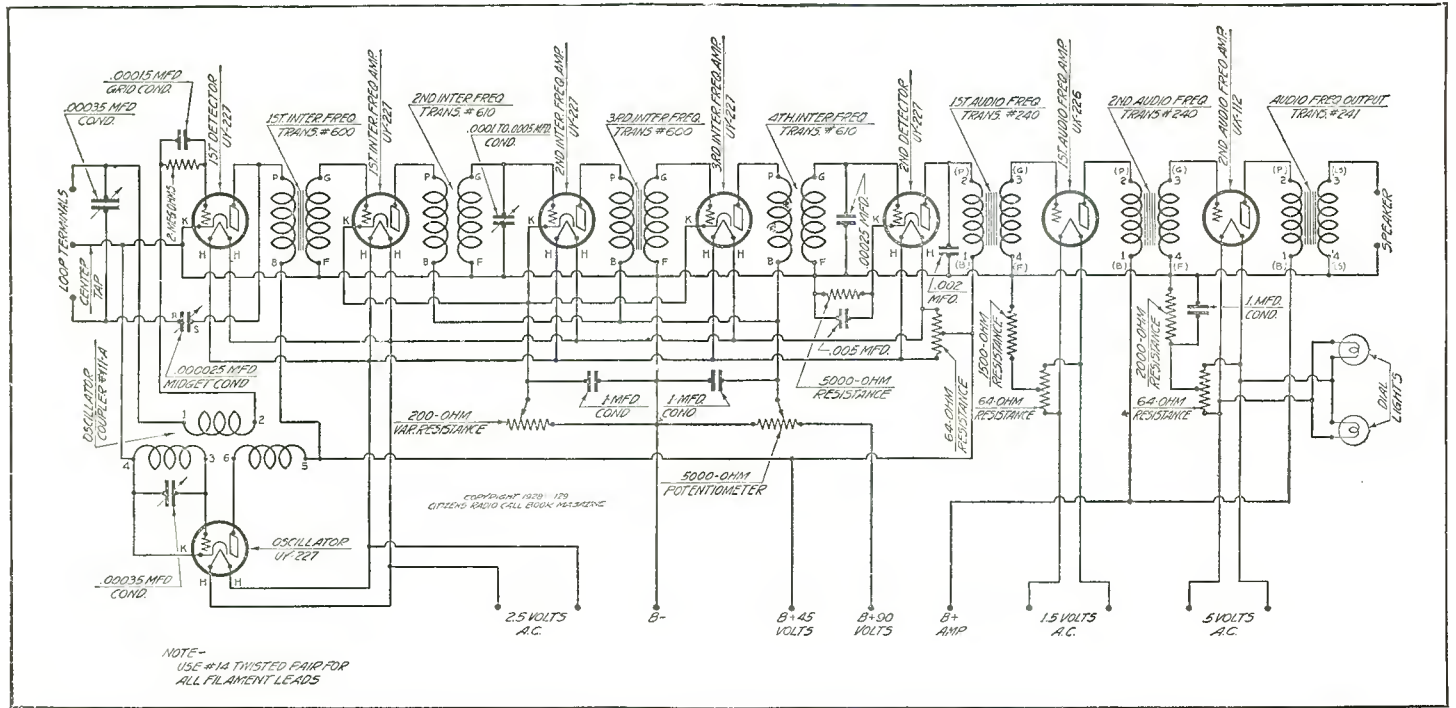

NOTE-  
USE #14 TWISTED PAIR FOR  
ALL FILAMENT LEADS

Figure 2. Schematic circuit showing all details of the receiver is given above and should be consulted by the experimenter who wishes to learn the electrical story of the set

right there is a possibility it will cause the amplifier to block.

Looking at Figure 1, one sees the rear view of the receiver. At the right front is the plug-in oscillator coil close by its respective

tuning condenser attached to the Remler drum dial. In the center on the front panel is the 5000 ohm variable resistance, while the knob controlling the radio frequency amplifier C bias is shown

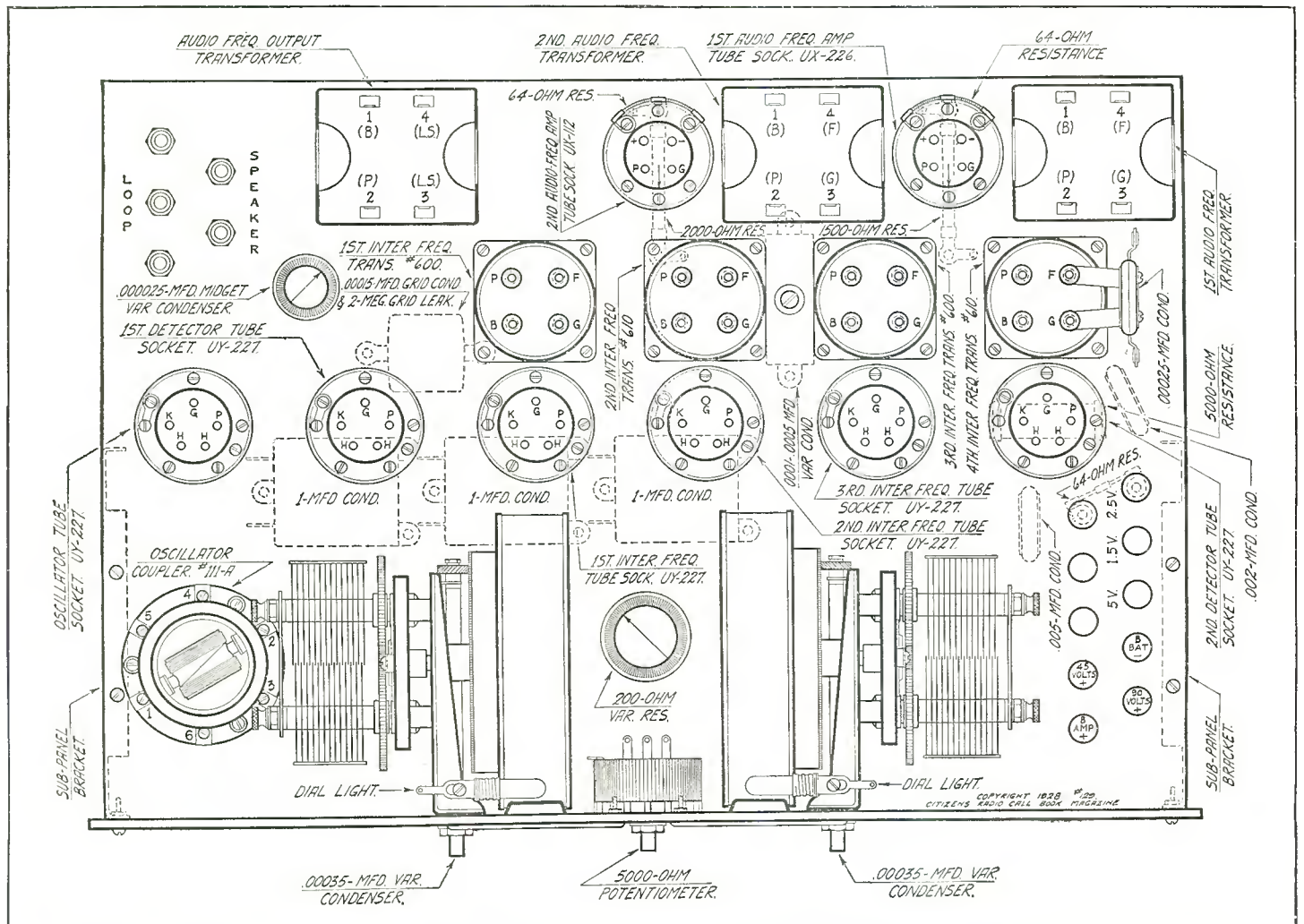

Figure 3. The above baseboard layout shows the actual position in which all units of this receiver must be placed in order to make it a compact one



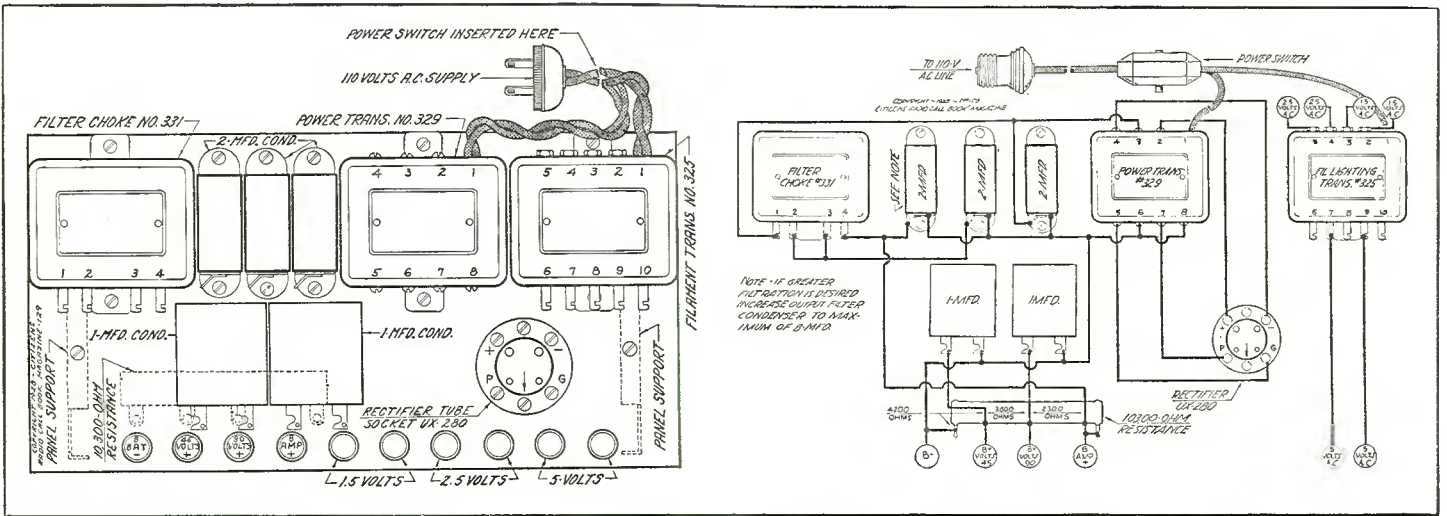

Figure 4. Parts for the power amplifier used with this receiver should be laid out in accordance with the panel layout shown above

Figure 5. The novice should wire up the power amplifier by means of the graphic illustration shown above

mounted on the sub-panel between the two drums. To the left of these controls is the drum and condenser for tuning the loop circuit. At the rear of the sub-panel are located the two Silver-Marshall audio transformers and a S-M output transformer. Speaker tip jacks are placed on the sub-panel at the right corner

(Figure 1), while the loop tip jacks are placed in the same position. The midget condenser which controls the regeneration of the loop circuit may be seen close to the speaker tip jack. Suitable binding posts for the voltages are shown at the other extremity of the sub-panel and are laid out so as to match up with

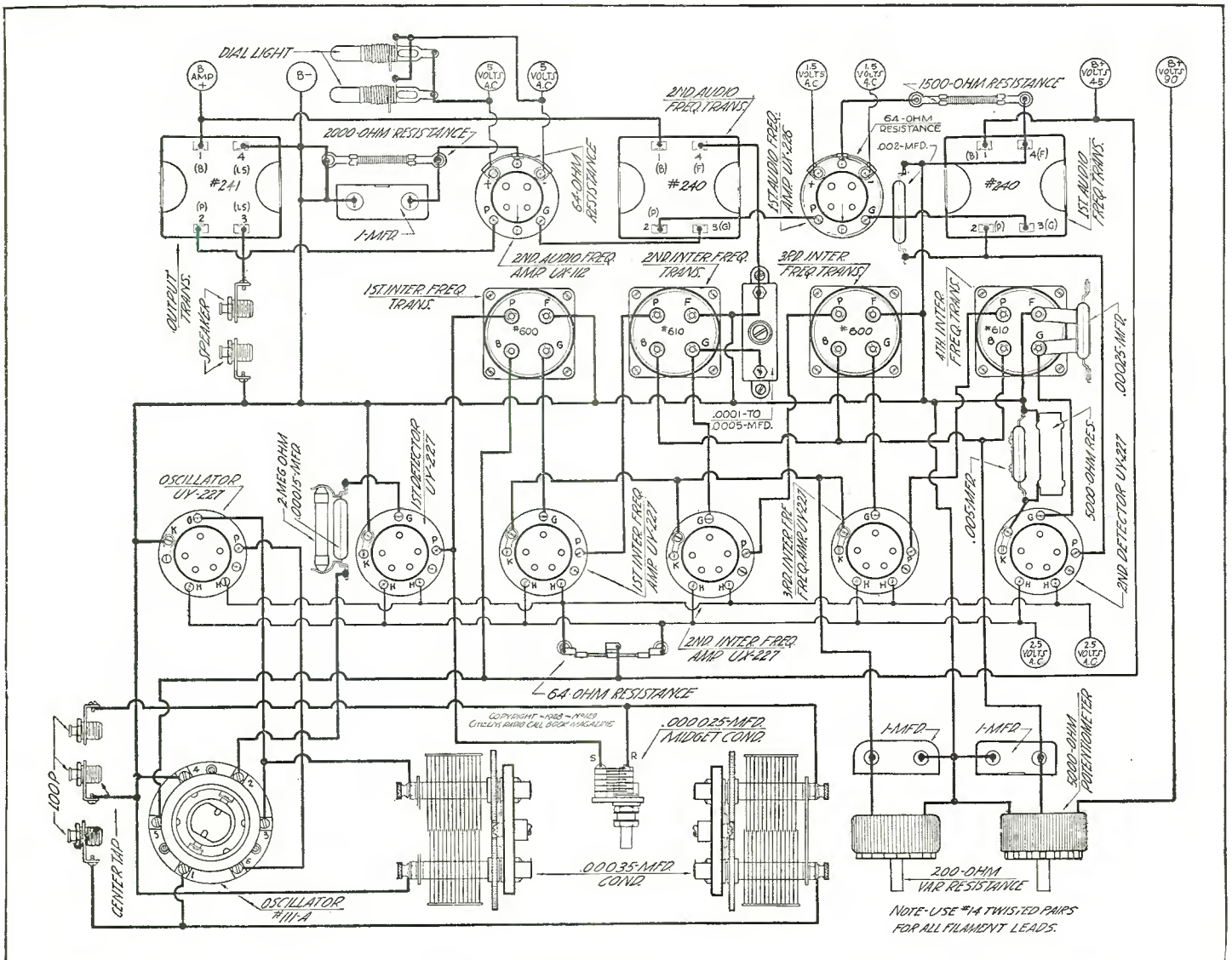

Figure 6. Those not able to use a schematic diagram in wiring their receiver should follow exactly the method of connection shown in the graphic diagram printed herewith



the proper binding posts on the power amplifier.

The power amplifier consists of a power transformer, condenser block, filament transformer and filter choke, with tube sockets and binding posts all located on a 7x12-inch chassis. The resistors for this amplifier are located below the chassis.

One of the reasons for the selection of the 45 kilocycle amplifier for use in this set was the fact of its simplicity, the availability of transformers, and the fact that thousands of sets using them and now in use could easily be converted to the newer circuit using many of the old parts. Selectivity of the set is quite good and allows of ten to fifteen kilocycle separation of powerful local and weak out-of-town stations.

To operate the set turn the midget condenser all out, connect the Bodine L-350 to the loop binding post and tune in a station with the two drums. Set the C bias potentiometer, located on the sub-panel, so that one-eighth or one-fourth of its total resistance is in the circuit, which will give about one-half to one volt negative bias on the r.f. amplifier grids. A good starting point would be KDKA tuned at 53 on the loop and 46 or 58 on the oscillator. If the volume knob is tuned all the way to the left, no signal will be heard. Advancing it to the right up to the oscillation point would increase the volume; if the volume knob is tuned too far to the right only squeals will be heard. If the midget condenser governing the loop circuit is turned in too far, squeals will be heard. This condenser should be adjusted on a station around 220 meters and then left alone. The oscillator coupler rotor should generally be set at about a 45 degree position. The rotor should be set on a weak 300 or 325 meter station to produce greatest volume and best selectivity on either the upper or lower oscillator dial setting. The X-L Variodenser located between the second and third intermediate transformers should be adjusted on a weak signal for the sharpest signals and sharpest tuning.

Parts for the receiver described above are as follows:

**Receiver**

- 2—110 Remler universal drum dials
- 2—600 Remler interstage transformers
- 2—610 Remler tuned stage transformers
- 2—638 Remler .00035 mfd variable condensers
- 2—240 S-M audio transformers
- 1—241 S-M output transformer
- 6—512 S-M five prong tube sockets
- 3—511 S-M tube sockets
- 1—515 S-M coil socket
- 1—111A S-M coil
- 2—540 S-M pairs mounting brackets
- 1—340 S-M midget condenser
- 1—Polymet .00015 mfd grid condenser with clips
- 1—Polymet .00025 mfd fixed condenser
- 1—Polymet .002 mfd fixed condenser
- 1—Polymet .005 mfd fixed condenser
- 1—Polymet 2 megohm grid leak
- 3—Tobe 1 mfd by-pass condensers
- 1—F1500 Frost 1500 ohm fixed resistor

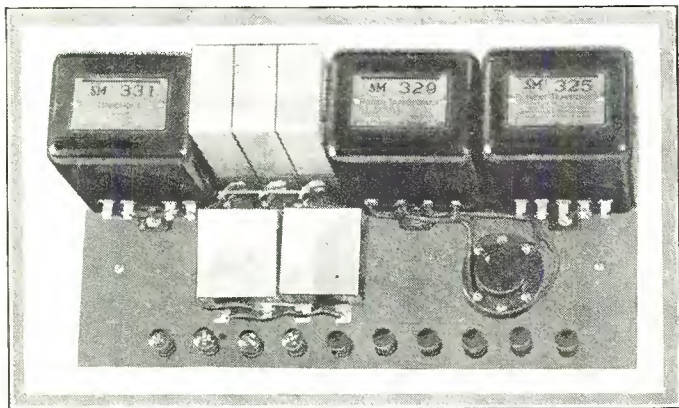

Figure 7. This photograph shows a top view of the Silver-Marshall power supply designed for use with the Remler A. C. Super

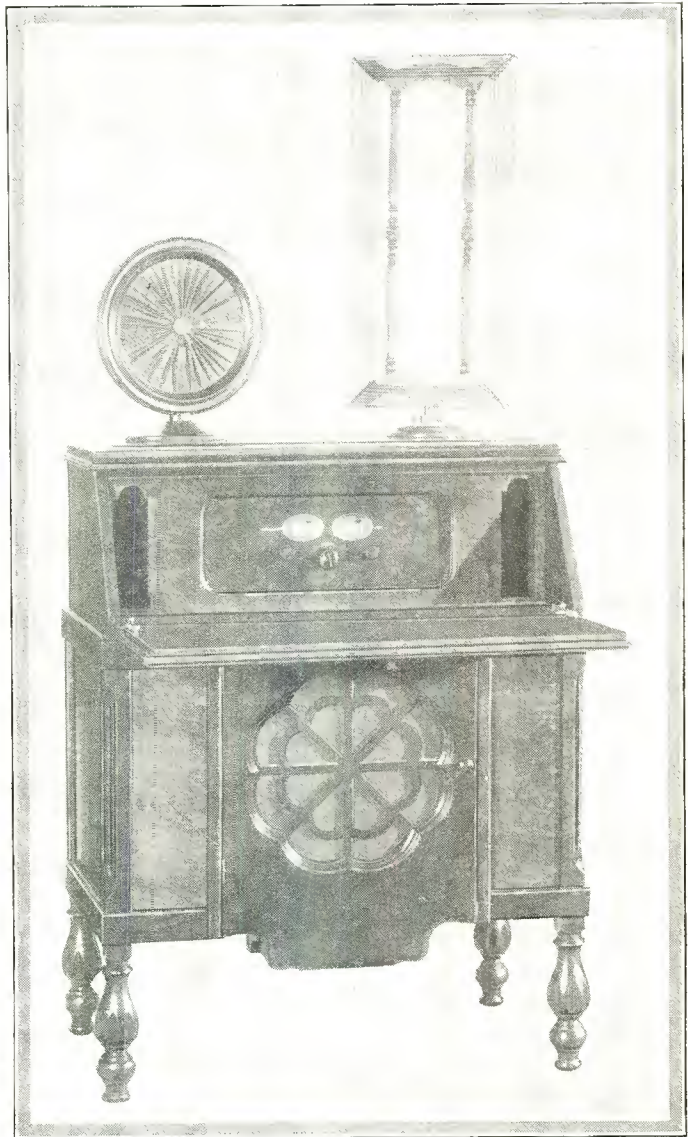

Figure 9. In the above photograph the Remler A. C. Super has been mounted in an Ehler console and is operated from a Bodine loop and a Sonochorde speaker

- 1—F2000 Frost 2000 ohm fixed resistor
- 3—FT64 Frost 64 ohm center tap fixed resistance
- 5—253 Frost tip jacks
- 1—No. 1835 Frost 5000 ohm de luxe potentiometer
- 1—Polymet 5000 ohm fixed resistor
- 1—No. 1822 Frost 200 ohm de luxe potentiometer
- 1—G XL variodenser
- 10—Eby binding posts
- 1—Formica panel, 7x18x3/16 inches
- 1—Formica sub-panel, 12x17x3/16 inches
- 25—Feet Corwico Braidite wire
- 1—Package Kester radio solder
- Miscellaneous—lugs, nuts, screws, etc.

**Power Supply**

- 1—329 S-M power transformer
- 1—331 S-M Unichoke
- 1—325 S-M filament transformer
- 1—511 S-M tube socket
- 1—540 S-M pair mounting brackets
- 1—659 Ward-Leonard resistor
- 1—Formica power unit base, 14x7x3/16 inches
- 3—Tobe 2 mfd 400 volt condensers
- 2—Tobe 1 mfd 300 volt condensers
- 10—Eby binding posts
- 10—Feet Corwico Braidite wire
- 1—Package Kester radio solder



# The New H. F. L. 1928 Nine-in-Line May Be Run With Batteries or A. C.

Arcturus Tubes Allow Alternating Current Operation  
with Total Absence of Hum

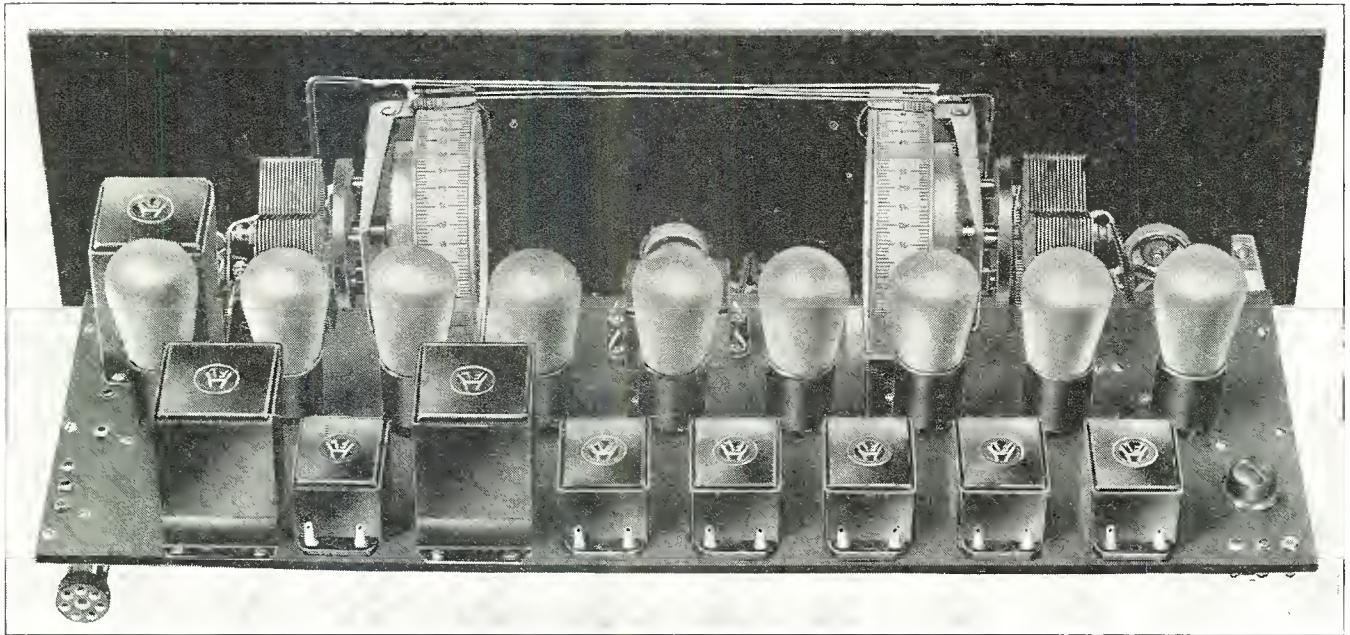

Figure 1. This photograph shows the rear view of the completed Nine-in-Line receiver, which may be operated from storage batteries or with a. c. tubes, very trifling changes being involved in the latter form of operation

EDITORIAL departments of this magazine for the past thirty days have been besieged with questions from readers as to the manner in which existing popular superheterodynes may be converted for alternating current operation. In the case of the receiver about to be described there are many Nine-in-Line supers which have been giving unvarying good performance to their owners, but these individuals are now desirous of securing full alternating current operation for their set without the intermediary of batteries or chargers. It is in response to these requests that we are presenting in this article the Nine-in-Line receiver which may be either operated as a direct current set from storage batteries, or with minor changes arranged so that it will operate with the Arcturus tubes from the alternating current mains.

#### Few Changes Needed

Those who have already built the previous model of this receiver will recognize by an inspection of the schematic circuit given in this article that very few changes are necessary for the use of alternating current tubes, especially if the type of tube used in this particular set is utilized. No matter what sort of circuit or system is used in a receiver, the inevitable question of performance comes up. To the average radio set owner performance means, first of all, the ability to bring in distant stations. Other considerations are, of course, tone quality, selectivity, volume and ease of operation. In general, however, sensitivity is the main requisite. The receiver under description has covered these five points, as those who have built it will state.

#### Uses Five I.F. Transformers

Some of the sensitivity of the Nine-in-Line is due to the intermediate amplifier, which consists of four stages. The input transformer has an iron core which allows a wide band of frequencies to be amplified and the presence of the iron tends to permit a greater amplification than otherwise. The next transformer is of the same iron core type, but the third one is a sharply tuned intermediate having no iron in its core. The fourth intermediate is the same as the first two, while the fifth is sharply tuned, which still further increases the selectivity of the amplifier as a whole. Thus it will be seen that the overall characteristic of the amplifier is one of good amplification and selectivity.

#### Minimizes Harmonics

Immediately preceding the intermediate amplifier is the usual detector and oscillator combination. These circuits are standard in all receivers of this type. The oscillator unit has been designed especially for the receiver and is very compact, operating with a minimum of harmonics and being practically fieldless because of its small physical dimensions. The radio frequency choke, which is used in conjunction with the oscillator, tends to stabilize the circuit as a whole and aids in isolating the oscillator from the balance of the receiver, doing away with interaction between this circuit and the balance of the set.

The usual regenerative detector is used and regeneration is accomplished by means of the .000045 mfd midget condenser shown in the schematic diagram in Figure 3, and in the graphic, Figure 5. This midget condenser is located on the extreme left

(This receiver tested and all illustrations made in our laboratory)



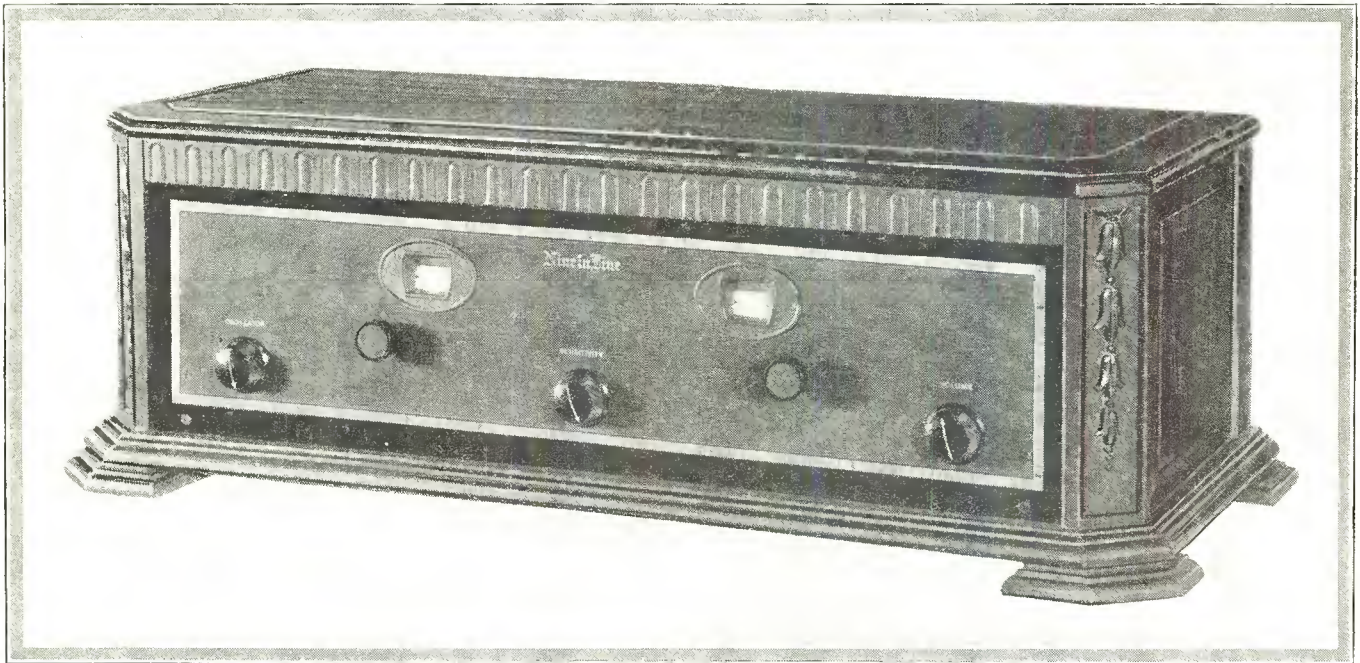

Figure 2. In the above photograph the receiver has been mounted in an attractive cabinet

rear of the sub-panel, as is shown in the layout in Figure 4. This adjustment need not be used ordinarily, as the receiver is quite sensitive without it. However, for distant stations it will be of value, inasmuch as it will sensitize the first detector and make it more susceptible to weak signals. It need be adjusted only once on a distant station and then left in that position. A Qualitone loop is used for furnishing the signal input to the grid of the first detector. Those who examine the schematic circuit of this receiver will notice that all of the tubes except the oscillator make use of a negative grid bias of three volts. This feature greatly decreases the plate current consumption in the intermediate stages and helps somewhat on the selectivity and tone quality of the receiver.

**Handles Lower Notes**

Two well designed audio transformers handle the lower notes creditably, while the output transformer serves to reduce the output impedance to a value which matches approximately standard speakers on the market. This transformer further serves to isolate the direct current plate potential and pass only pure alternating current for the speaker. This saves the speaker magnets from demagnetization and allows the reproducer to handle a greater load with much better tone.

The drawings which accompany this article explain fully the layout of parts and their proper wiring. Looking at the sub-

panel layout in Figure 4, the reader will note that the tubes, reading from the left end of the sub-panel, are as follows: first detector, first intermediate, second intermediate, third intermediate, fourth intermediate, second detector, oscillator, first and second audio.

**Uses Arcturus Tubes**

Realizing there is a great demand for set builders for a set using alternating current tubes which may be run direct from the usual light cord, the designers of the Nine-in-Line have adapted their circuit to the use of alternating current tubes, those utilized in the present test having been made by Arcturus.

**Study Diagram Carefully**

An hour of study on the diagrams will save much time for the builder when the actual construction of the receiver is started. The reader has probably already noticed the drawings accompanying this receiver and will have observed that Arcturus tubes are specified. Under tests the receiver operated entirely satisfactorily, without any discernible hum. These tubes are of the heater type and the cathode is connected inside to what normally would be the positive filament prong. For this reason in wiring the receiver all grid returns must eventually go to the positive filament line through their respective C batteries. This includes all by-pass condensers which would normally connect to the negative

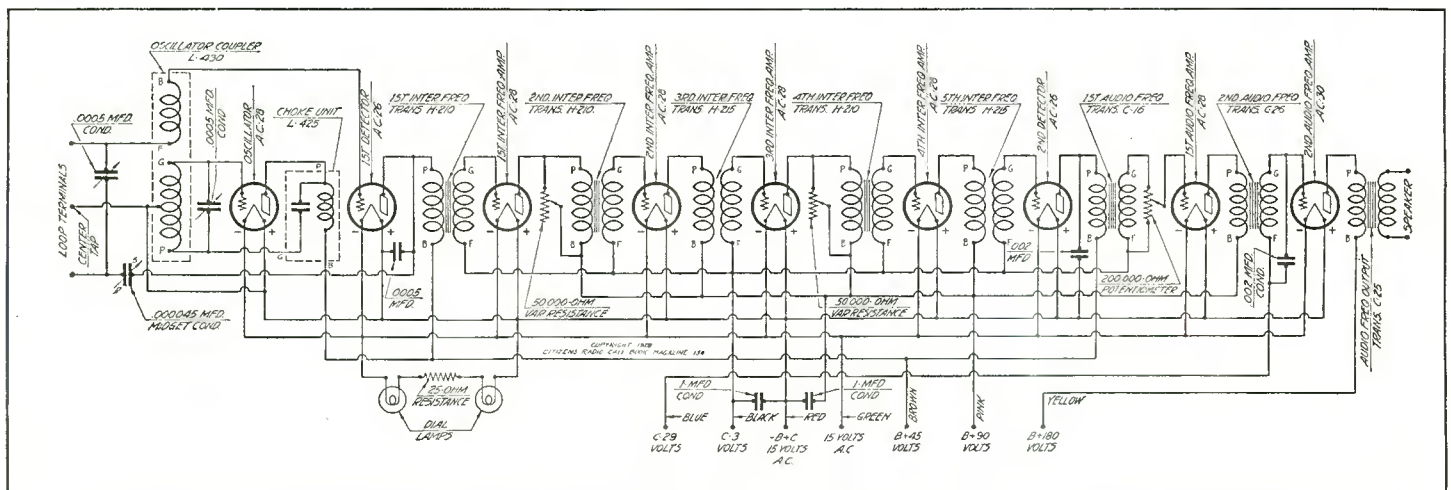

Figure 3. The electrical connections required in the Nine-in-Line receiver are shown in the schematic above



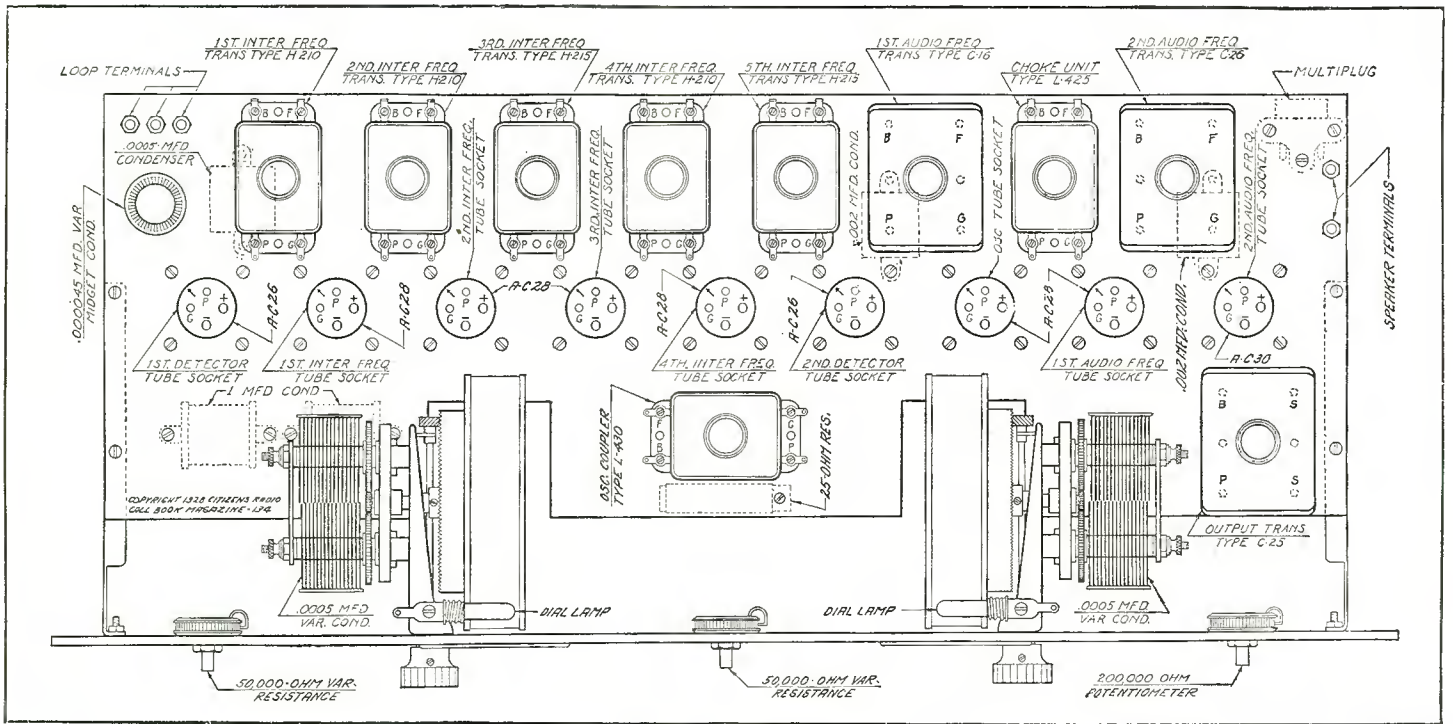

Figure 4. The builder is urged to lay out all parts strictly in accordance with the sub-panel layout shown in the above drawing

filament. The regular Jones cable plug is used for connecting power to the set and in the alternating current model which is described here the C battery connects to the cable instead of plugging in on the sub-panel. The sub-panel C battery jacks are not used in the alternating current model.

**Bias on Intermediates**

For alternating current operation three to four and one-half negative bias is used on the intermediate transformers, second detector and the first audio transformer, while 30 to 40 volts is

used on the grid of the last audio tube. Those who have already built this receiver for the storage battery operation will observe that the three-quarter ampere Daven ballast and the two rho-stats will not be needed in the construction of the alternating current receiver. In place of the 6 volt storage battery a 50 watt filament transformer furnishes the 15 volts required for the filaments of all tubes.

**Stabilizing the I. F. Stages**

Two Carter 50,000 ohm variable resistors are used to stabilize

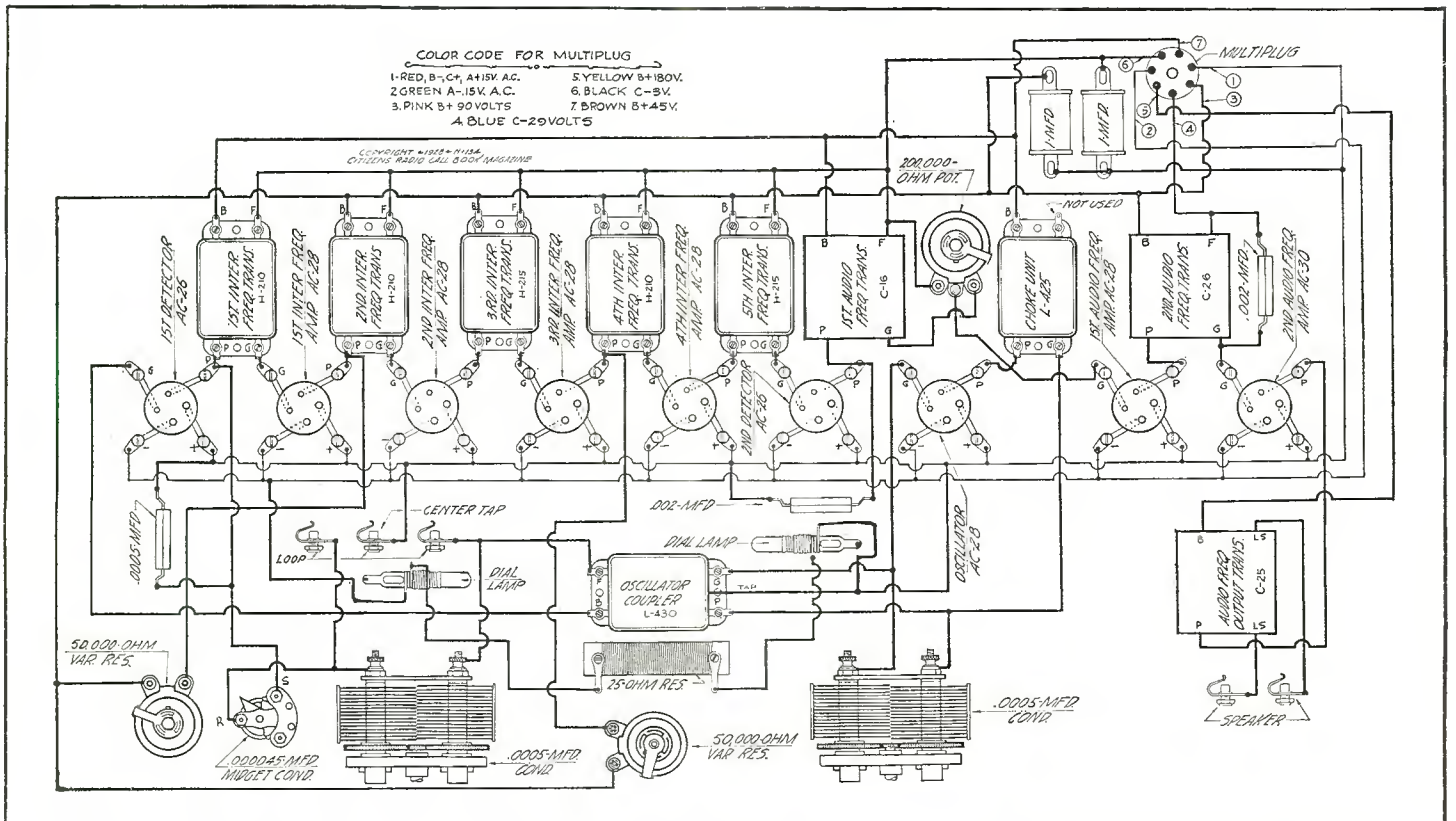

Figure 5. All wiring of this receiver should be accomplished in accordance with the graphic wiring diagram which is printed above



the r. f. amplifier. On the battery operated set this operation is accomplished through the rheostats. A Carter 25 ohm fixed resistance is used in series with the dial lights to furnish them with the proper voltage from the 15 volt alternating current source. The lights are wired in series so that if one should burn out, the other would not be damaged by the increased voltage that would be thrown across it. In wiring the set the important point to be remembered is that the red lead must connect to the positive side of all tube sockets. Externally the red lead connects to one side of the filament lighting transformer (the green lead going to the other side), and the red lead connects also to the B negative and C positive terminals.

### Three Kinds of Tubes

Tubes used in this receiver are manufactured in three forms, amplifier, detector and power amplifier. It will be noticed that the two detectors are of the 26 type, the five amplifiers and the oscillator being of the 28 type, and the power amplifier of the 30 type. Under test the alternating current model Nine-in-Line handled exceedingly good volume and fine tone quality. Its operation was satisfactory in every way.

While on the subject of the heater type of tubes, it would be worthwhile to bring to the attention of the builder the fact that these tubes and all others using a heater require about a minute to build up enough heat to function properly. This is an important point to remember in testing and matching the tubes in the intermediate amplifier for their present position.

### Drilled Sub-panel

Prospective builders of this receiver will be able to save considerable time in their assembly of the set by virtue of the fact that a drilled sub-panel is available and all that he needs to do is to place the parts on the sub-panel and mount them in their specified positions. In the event the builder does not secure a drilled panel, he may do the drilling in accordance with the general layout shown in Figure 4.

### Loop Condenser at Left

In looking at the drawing just referred to, the builder will notice that the tuning condenser for the loop circuit is located at the left, where it is closest to the loop terminals, while the oscillator condenser is located at the right in close proximity to the oscillator coupler located at the center of the sub-panel. Two Remler drum dials are used for ease of tuning. At the left of the sub-panel layout diagram may be seen on the front panel one of the 50,000 ohm variable resistances which is used as a control across the primary of the second intermediate frequency transformer. The second 50,000 ohm variable resistance which is located at the center of the front panel is placed across the primary of the fourth intermediate frequency transformer. These two variable controls serve to increase or diminish the amount of energy in the intermediate amplifier circuit. The 200,000 ohm potentiometer shown at the right of the front panel in Figure 4 is placed across the grid and filament terminals of the first audio frequency transformer and serves as a control for the audio volume of the receiver.

### Check Your Wiring

In operation, after all wiring has been carefully checked and tubes placed in their respective sockets, the left hand drum dial is turned to a given point on its scale and the right hand dial turned until a signal is heard. During this process it may be necessary to advance the first and second 50,000 ohm variable resistances to increase the sensitivity of the receiver if the tuning is being done on an out of town station. After a station has once been tuned in, the operator will readily be able to adjust the receiver for its maximum performance. The midget condenser which is shown on the left rear of the sub-panel should be balanced for a station about mid-point of the broadcast band and it may then be left untouched. If this midget condenser is turned in too far, this fact will be manifest by the squeal which is heard. The squeal may be stopped by turning the rotor of this condenser towards zero.



Figure 6. In this photograph the Nine-in-Line has been placed in a console and is operated with a Qualitone loop

### List of Parts

Parts used in building the A. C. Nine-in-Line are:

- 3—H-210 H. F. L. transformers
- 2—H-215 H. F. L. transformers
- 1—C-16 H. F. L. audio transformer
- 1—C-25 H. F. L. output transformer
- 1—C-26 H. F. L. audio transformer
- 1—L-425 H. F. L. r. f. choke
- 1—L-430 H. F. L. r. f. transformer
- 1—AC-15 H. F. L. filament transformer
- 9—9044 Benjamin sub-panel sockets
- 2—8629 Benjamin sub-panel brackets
- 2—Remler 110 illuminated drum dials, 1 right, 1 left
- 2—163 Remler .0005 mfd variable condensers
- 2—Carter 1 mfd by-pass condensers
- 1—Carter .0005 mfd. fixed condenser
- 2—Carter .002 mfd fixed condensers
- 8—Carter tipjacks
- 2—Carter 50,000 ohm variable resistors
- 1—Carter 200,000 ohm variable resistor
- 1—Jones type BM multiplug
- 1—Celeron, Formica or Lignole 7x26x3/16 inch drilled and engraved front panel
- 1—Celeron or Formica 8x24x3/16 inch drilled sub-panel
- 30—ft. Acme Celatsite wire
- 1—pkg. Kester radio solder
- 1—Carter 25 ohm fixed resistance
- Miscellaneous lugs, screws, nuts, etc.



# Samson Supply Furnishes All Receiver and Amplifier Voltages

Sturdy Combination Using 281 Rectifier Tube and Regulator Has Push-Pull Audio Included

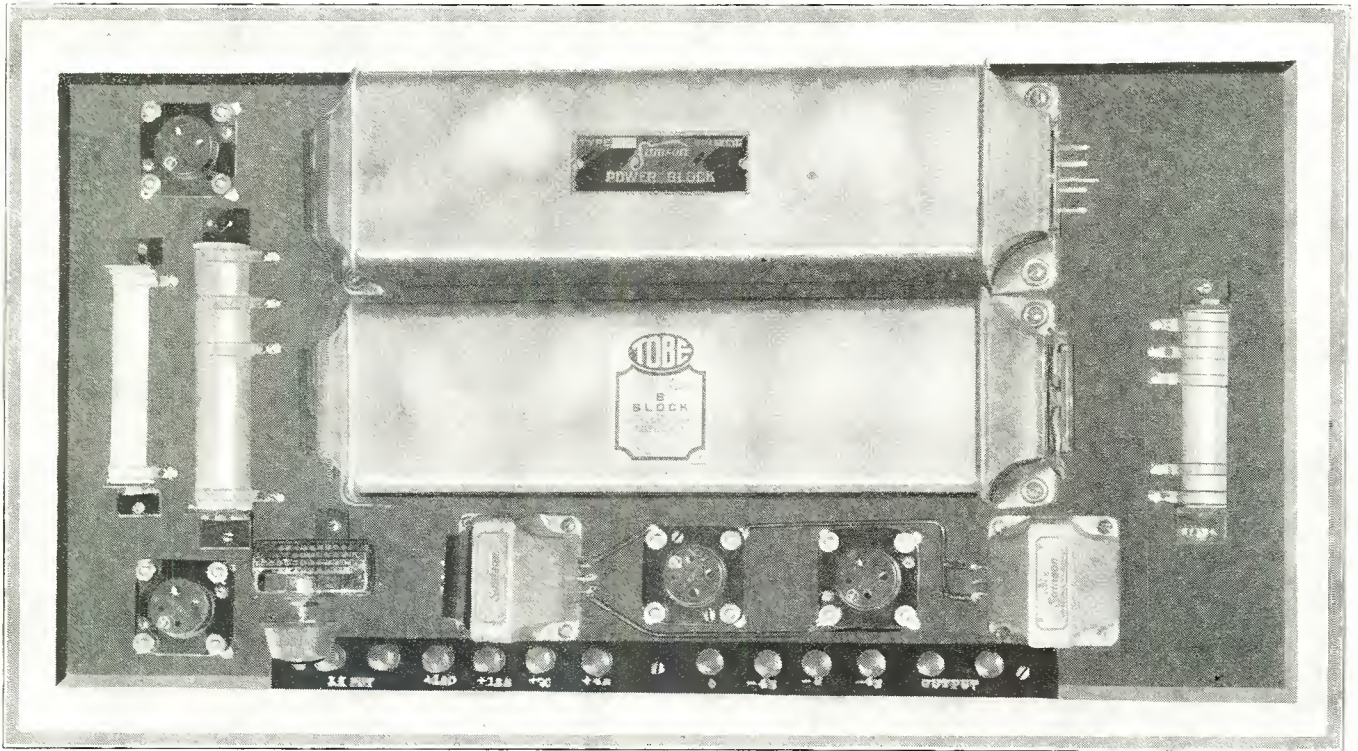

Figure 1. In the above photograph may be seen the compact Samson power supply described in the accompanying article

WITH the insistent demand for high quality reproduction it is only natural that public taste is rapidly centering itself on power amplifier systems that are sturdy enough to meet all requirements and whose cost is not excessive. Simplicity of control, sturdiness of the apparatus and unvarying values of voltage are some of the requirements which have been met in the Samson power amplifier system described in this article, which amplifier has been thoroughly tested in our laboratories.

As it is shown by the schematic diagram in Figure 2, the amplifier consists essentially of a power block containing a primary for the 110 volt alternating current, a high voltage winding for supplying the rectifier tube, a filament winding for the filament supply of the two 210 tubes arranged in push-pull and a filter choke for ironing out the pulsations in the rectified output of the 281 tube. All of this material is located within a metal container shown in the photograph in Figure 1, and with suitable connections coming down through the baseboard or subpanel, as the case may be, so that the majority of wiring may be done underneath the baseboard or sub-panel. The Tobe filter block is likewise enclosed in a single metal container of the same general dimensions as the power units and may also be seen by referring to the photograph in Figure 1.

The four sockets, audio frequency input transformer, audio frequency output impedance and the necessary variable and fixed resistances are located on top of the baseboard, with the binding

post strip conveniently placed so as to simplify as much as possible the carrying of wires from the resistance units to their respective positions on the binding post strip.

Referring again to the schematic in Figure 2, the reader will observe that the output of this radio set goes to the input binding posts on the audio frequency input transformer, whose secondary leads to the grids of two 210 tubes arranged in push-pull. The plates of these two power tubes are connected across the extremities of an audio frequency output impedance, whose center tap receives the high voltage tap from the power supply! The speaker leads are placed on binding posts across the two extremities of the audio frequency output impedance.

### Has Safety Switch

In order to safeguard the operation of the set as much as possible by those who are not quite familiar with power amplifiers, the negative return line of the high voltage winding has been purposely broken and cut in through two of the terminals on the socket which holds the type 874 regular tube. Thus if the regulator tube is removed from its socket, the set becomes inoperative. When the 874 tube is placed in the socket, two of its connections complete the high voltage circuit and the set is ready for operation. This is done so that in the event the regulation tube is pulled out, the condenser used in the amplifier will not be subjected to a voltage strain which might occur without the stabilizing influence of the 874 regulator tube.

All of the apparatus required for the use of the constructor in

(This amplifier tested and all illustrations made in our laboratory)



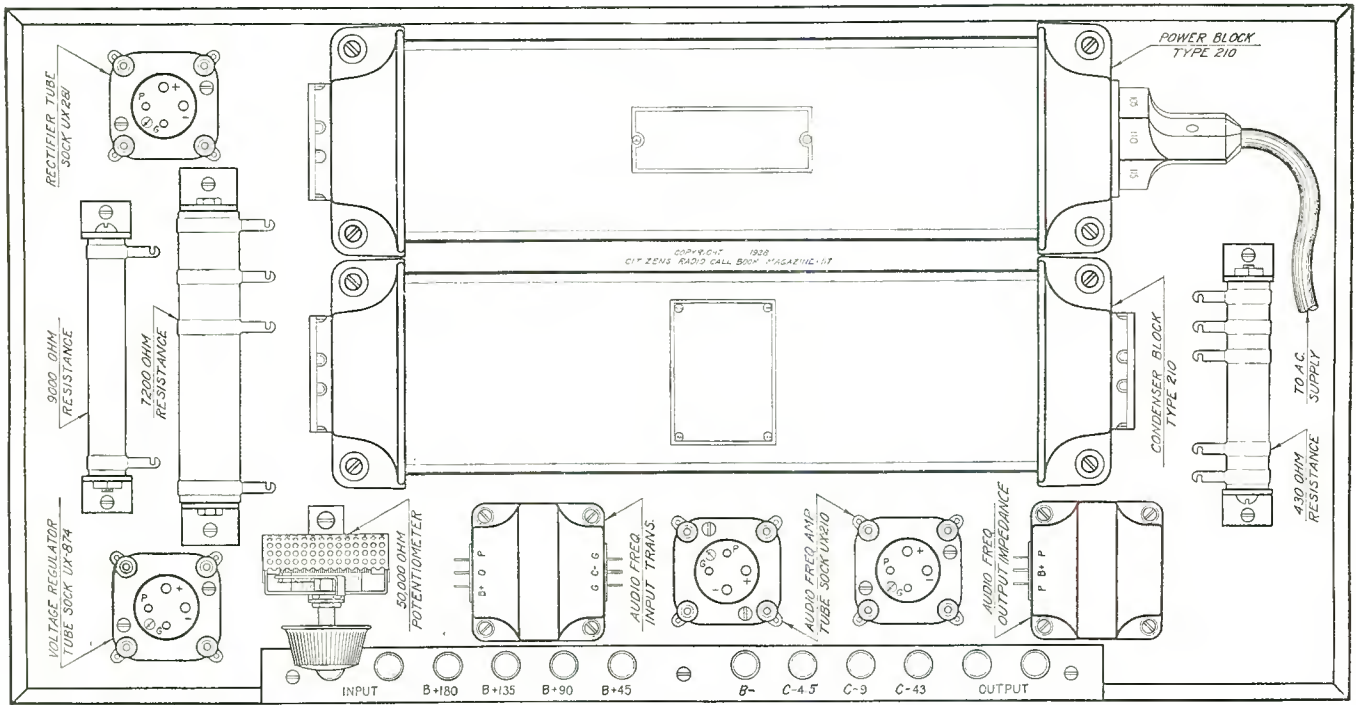

Figure 4. To simplify the work of the constructor, the baseboard layout is given above so that all parts may be placed in accordance with this illustration

building this power amplifier should be laid out in accordance with the photograph shown in Figure 1, and the layout in Figure 4, while the wiring of the power supply may be made either from the graphic illustration shown in Figure 3, or the schematic diagram shown in Figure 2.

All voltages supplied by the unit are of a fixed nature, with the exception of the plus 45 volt lead, which is controlled by means of a 50,000 ohm variable resistance located between the 90 volt terminal and the B 45. This enables the operator to supply the detector circuit with any voltage between zero and 45. The

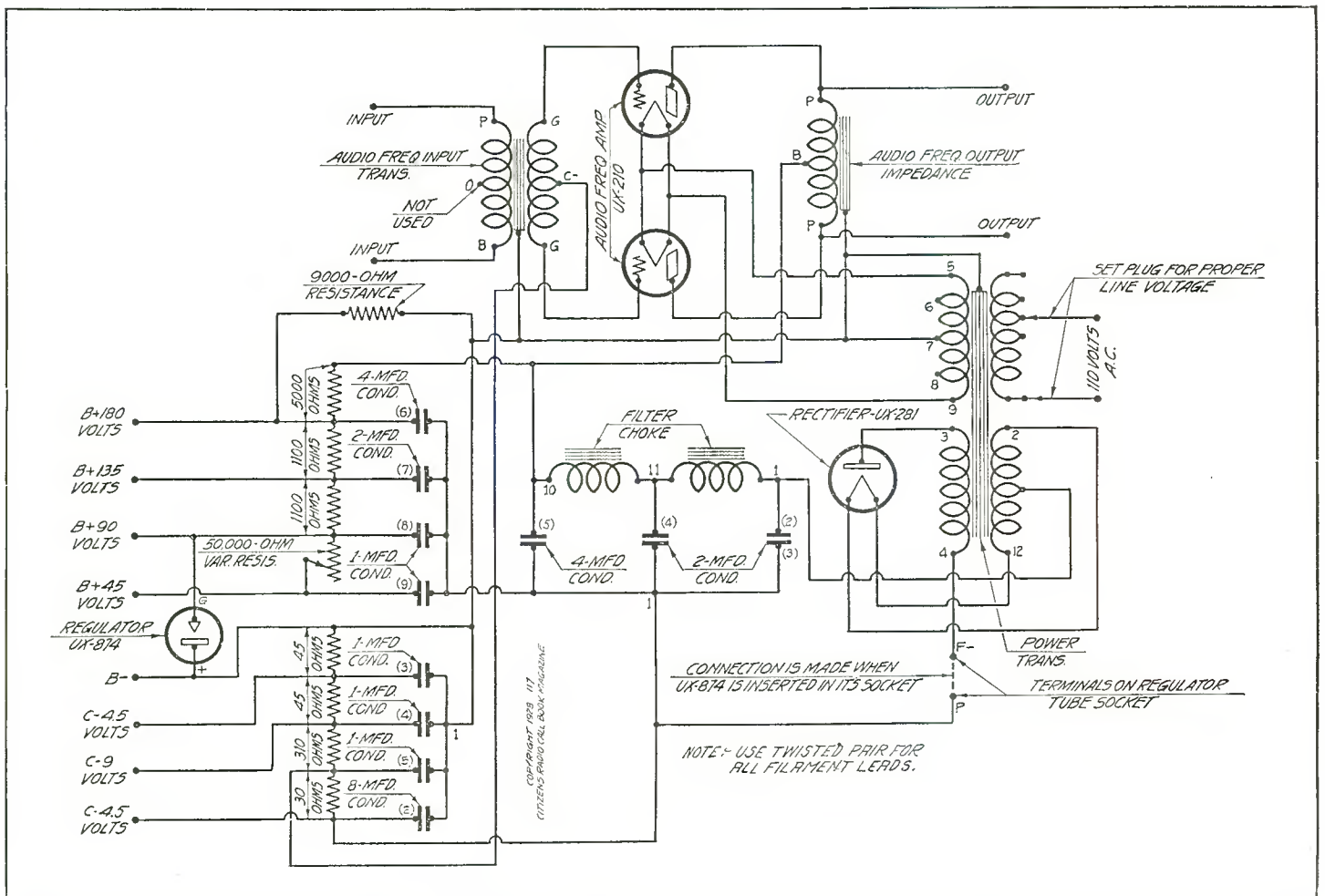

Figure 2. Schematic circuit of the Samson power supply is shown above and will serve for wiring by the experienced set builders



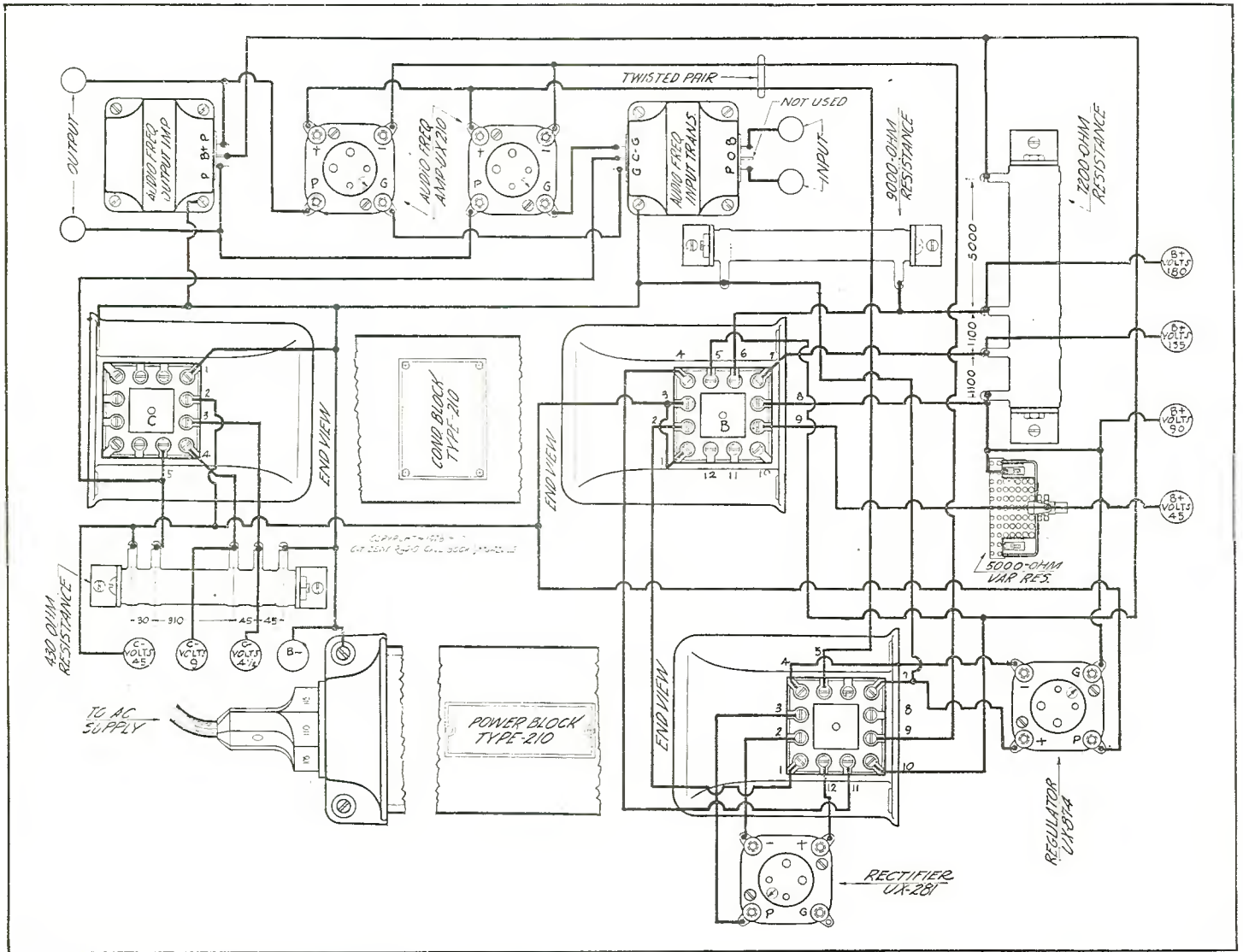

Figure 3. This illustration represents the graphic method of wiring up the amplifier and is much in demand by beginners in radio or others who are not certain of their ability to read a schematic diagram

voltage regulator tube is located across the negative B terminal and the 90 volt positive lead, so that its current drain acts as a stabilizing influence over the voltage available in that particular section of the resistance train. One tap is provided for a plate voltage of 135, another is provided for a voltage of 180, while the top end of the resistor gives the maximum voltage available, which is carried to the plates of the 210 tubes shown in push-pull arrangement.

Three bias voltages are supplied by the power unit, each through a separate bias resistor provided with its accompanying bypass capacity. The negative 4½ volt bias is supplied through the drop across a 45 ohm resistor located between B negative and the C negative 4½ volt terminal, this resistance being bypassed by a 1 mfd condenser. The negative 9 volt bias is supplied by the drop across a second 45 ohm resistance bypassed by a 1 mfd condenser. The bias for the grids of the 210 tubes is secured through a 300 ohm resistance in series with the previous two 45 ohm resistances, this last resistance also being bypassed by a 1 mfd condenser. A separate 45 volt bias, which is carried to a binding post, is provided across the 30 ohm section at the bottom of the bias resistance strip and is, of course suitably bypassed by an 8 mfd bypass condenser, this 45 volt bias tap being common with the return of the bypass condensers across the filter choke and with the bypass condensers across the high voltage section of the resistance train.

All of the metal cases containing the power block and the B

block are grounded to negative B, as well as the iron core of the first audio frequency input transformer, the audio frequency output impedance and the core of the transformer contained within the power block housing.

#### List of Parts

The following is a list of parts used in the construction of the Samson power supply:

- 1—210 Sampson power block
- 1—Sampson push-pull input transformer
- 1—Sampson push-pull output impedance
- 1—210 Tobe-Sampson condenser block
- 1—Harfield 7,200 ohm resistor
- 1—Harfield 430 ohm resistor
- 1—Harfield 9,000 ohm "plug-in" 4-watt resistor
- 1—Electrad 50,000 ohm Tru-volt resistor
- 4—1040 Benjamin sockets
- 12—Eby engraved binding posts and bakelite strip for mounting
- 1—12"x20"x½" wood base-board
- 1—Sonatron type 281 tube
- 2—Sonatron type 210 tubes
- 20—Ft. Acme flexible Celatsite wire
- 1—Pkg. Kester radio solder
- Miscellaneous—lugs, nuts, screws, etc.



# Abox ABC Eliminator Built to Run Receivers From Power Mains

High Capacity Filter Used to Eliminate Hum in Filament Source  
Forms Basis of This Desirable Combination

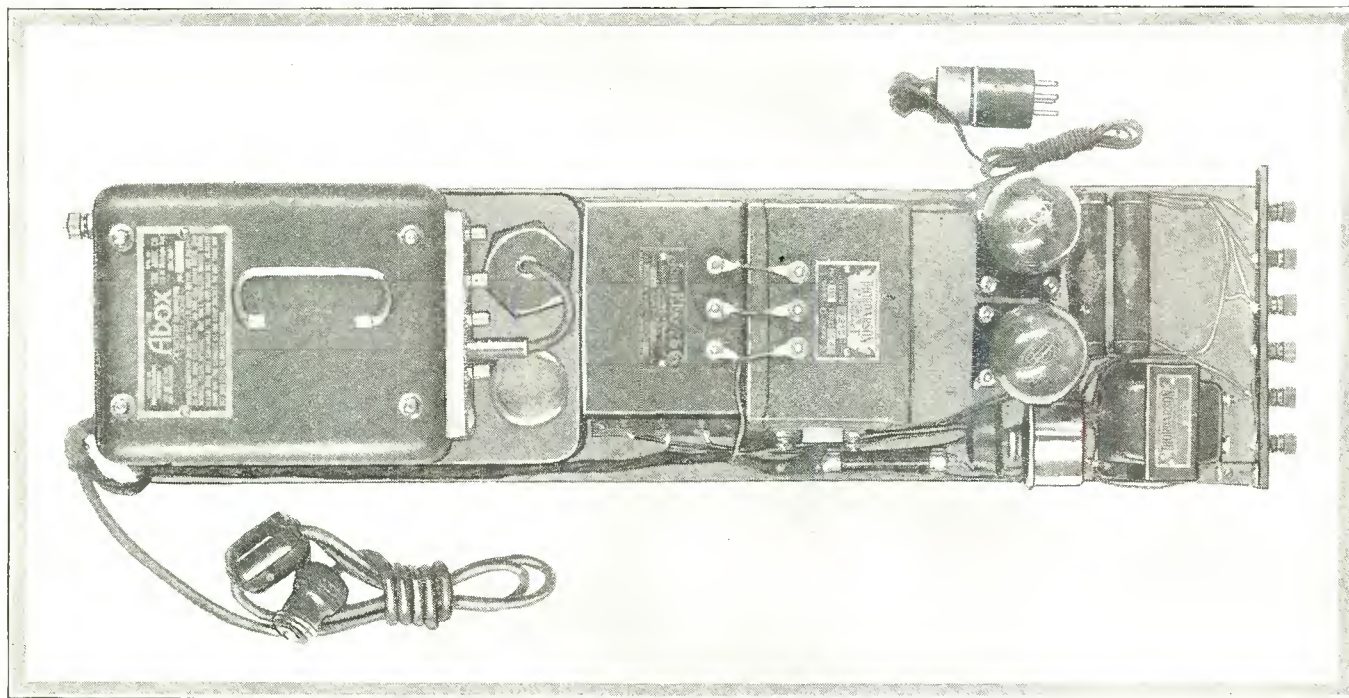

Figure 1. In the above photograph at the left is shown the Abox rectifier and filter, the condenser block, the high voltage Thordarson transformer and the necessary tubes and resistances

COMPLETE elimination of batteries, the convenience of attaching the radio set to the light socket, like any other electric appliance, is the most desirable feature to be found in any receiver. The trouble and expense of battery charging or frequent replacement of dry batteries is the one thing most people object to in the operation of a radio set and has been a great hindrance to the universal popularity of radio.

Aside from the economic saving which is effected, the convenience of full electric power at all times, with no attention other than turning the house light current "on" or "off" more than repays for the moderate additional cost necessary to convert any radio set into an a.c. house-current receiver.

## Complete Eliminator

The A, B and C eliminator and super power amplifier described in this article, and which can be built by anyone at a moderate cost, is offered for those desiring a.c. operation. It embodies a perfect A eliminator, a power amplifier using the new power tubes of greatest amplification, and a B and C eliminator supplying as high as 300 volts. It represents, theoretically, mechanically and operatively, probably the finest thing in a complete battery eliminator and super power amplifier that may be constructed.

One of its salient features is its universal adaptability to any existing radio receiver of nine standard  $\frac{1}{4}$  ampere tubes or less, with no changes in the wiring or tubes of the set. It does not affect the operation or tuning of the set, except making it equivalent in power output to any receiver made and operating it with great efficiency entirely from the alternating current line, with no batteries or battery substitutes of any kind.

The selection of parts was made with a number of things in mind. The laboratory model has been in the process of development over a period of nearly a year and every part has been carefully tested to meet all requirements.

First, efficiency, reliability, adaptability for the circuit, and simplicity. Second, ease of assembly, so as to simplify the construction of the complete unit; and, third, compactness, so that the completed eliminator and amplifier might be placed in any battery table or console.

The most critical instrument is the A supply. For this the Abox A battery eliminator is ideal. It is a true storage battery eliminator, suppressing the alternating current component to such a degree that it is inaudible even with the tremendous amplification of the power amplifier. The slightest variation in the filament circuit would be particularly noticeable in this unit, while under ordinary conditions it would not bother.

## Large Capacity Filter

The efficiency of the Abox A eliminator is due mainly to the tremendous capacity of the electrolytic condensers used in the filter circuit which is embodied in the unit. These have a capacity of several hundred microfarads, obtained by virtue of the unusual arrangement of nickel and steel plates immersed in a non-acid caustic solution which constitutes the condenser. The plates form one side of the condenser, and the solution the other. When an electrical current is passed through the unit, films of hydrogen and oxygen form over the entire surface of the plates. This film is infinitesimally thin and forms the dielectric of the condensers. As a condenser increases in capacity as the thickness of the dielectric decreases, this film is no doubt responsible to a large

(This amplifier tested and all illustrations made in our laboratory)



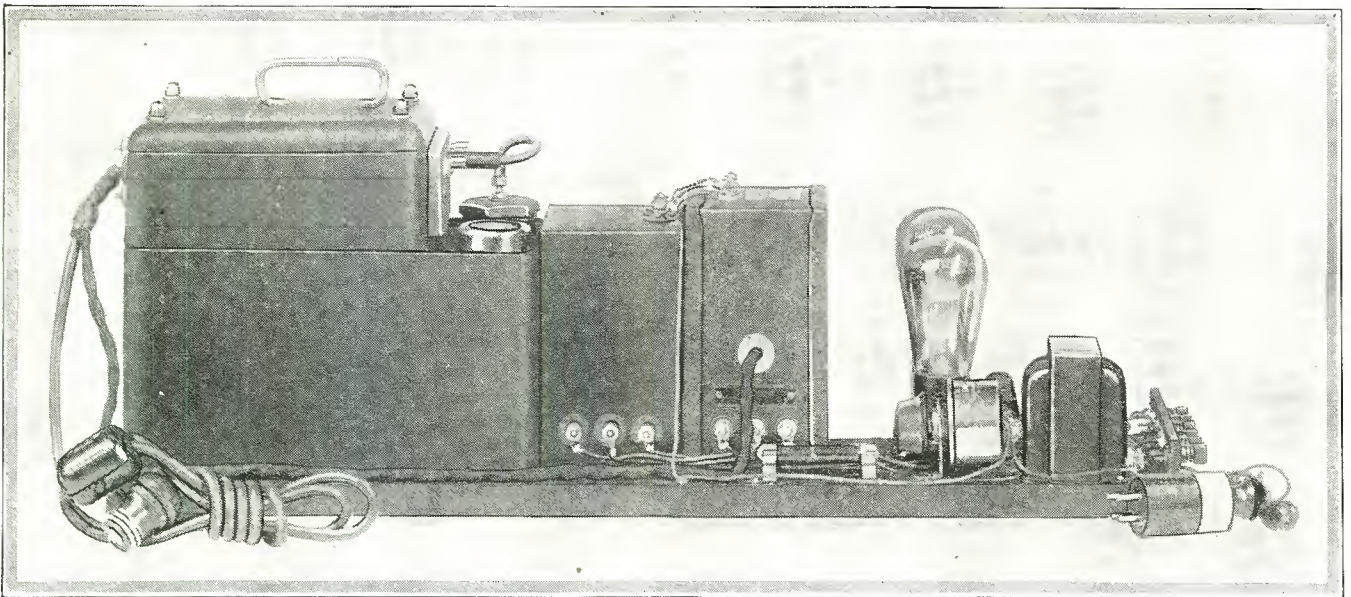

Figure 2. This photograph shows the side view of the apparatus used in the Abox ABC eliminator. The Abox and the Thordarson compact line cords are parallel, as shown at the left of the illustration and a snap switch placed in series so that this switch will start and stop the entire amplifier. The plug for plugging into the grid circuit of the last audio stage of any receiver is illustrated at the right

degree for the tremendous capacity obtained.

The Thordarson power compact is equipped with a lead to be run to the light socket. In this unit it is attached to the cord leading to the Abox so that both units may be connected to the light socket with the same wire and controlled with a single switch. Shorten the compact cord to the required length, bare the ends of the wire and splice them to the Abox cord, taping well when finished.

Toward the end of the Abox cord, a series "on" and "off" switch is inserted. This controls the entire unit and the set.

When the unit is completed and ready to attach to the set, the power amplifier is connected by means of a long, flexible lead attached to the grid prong of a tube base from which the bulb has been removed. This is then inserted in the socket of the last audio tube in the receiver.

Parts required for building the Abox ABC eliminator are:

1—Abox A battery eliminator

- 1—Thordarson 210 power compact
- 1—Fast 210 condenser block
- 1—Heavy duty Clarostat
- 1—R76 Thordarson output transformer
- 2—Benjamin base mounting sockets
- 2—Amsco 10,000 ohm ten watt resistors
- 1—Amsco 1,000 ohm five watt resistor
- 1—Amsco resistor mountings
- 1—Binding post strip, 1x6½x3/16, with six posts and mounting brackets
- 1—Series "On" and "Off" switch
- 1—UX type base with tube removed
- 8—Feet flexible wire or one cord of phone wire
- 1—Roll Belden rubber covered flexible hook-up wire
- 1—Baseboard, 6½x25x1-inch
- 1—Ceco R81 rectifying tube
- 1—Ceco L10 power amplifying tube

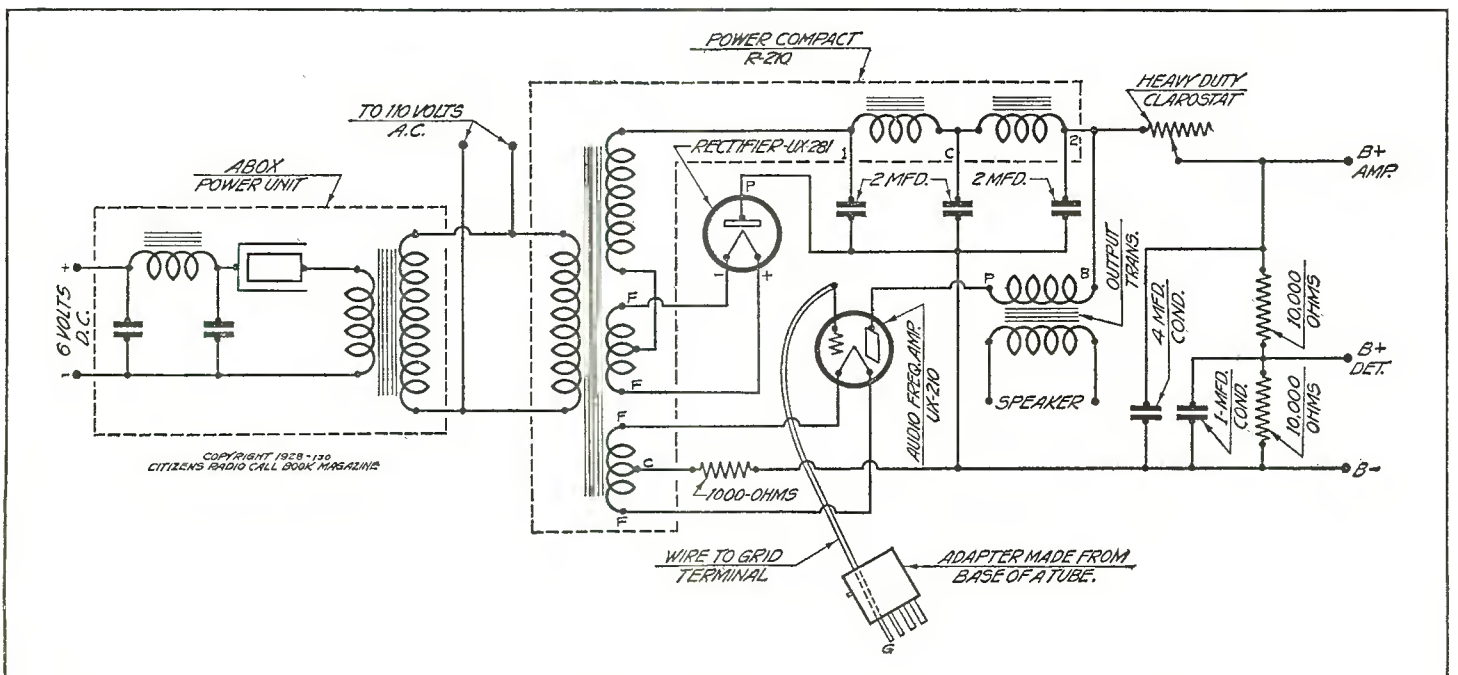
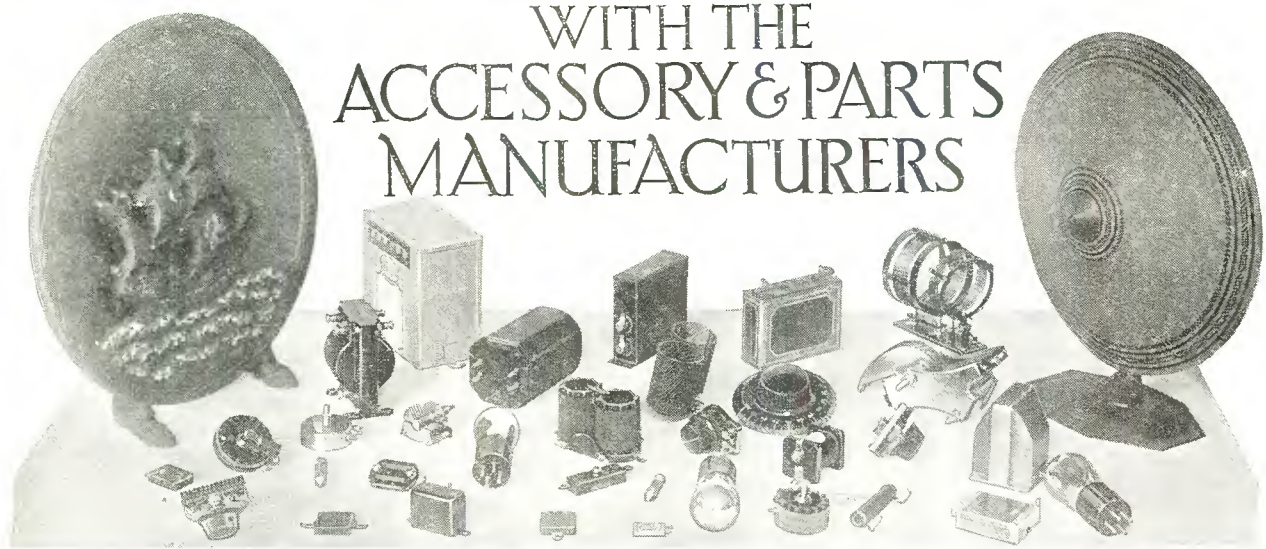

Figure 3. In the above schematic circuit the builder will find all the necessary electrical details for wiring up this power amplifier and filament supply device





## WITH THE ACCESSORY & PARTS MANUFACTURERS

Readers desiring any further information on products shown in these columns, may secure full data on writing to the Accessory and Parts Department, care of this magazine. Be sure to specify name of product on which information is desired

# Popular Demand Is for Home Assembled Cone Speaker

Quality Reproduction Possible with Ensco Kit; Directions are Simple  
and Finished Product Well Worth the Builder's Time

ENGINEERS, musicians and acoustical experts are today fairly well agreed that for real quality of reproduction and fidelity of tone the large cone speaker, generally three feet in diameter, cannot be equalled. It is only necessary for the average listener to hear a good speaker to become convinced of this fact.

Many set builders have wished to take advantage of the fine reproducing qualities of a cone speaker and yet have not cared to make an outlay for the manufactured product. However, many are now finding that such a speaker may readily be assembled through the purchase of an Ensco kit of parts. With this kit and an hour's work in assembling the builder may thus obtain a three-foot cone, secure excellent reproduction and save considerably in the operation. In selling the speaker in kit form, the excessive cost of packing and shipping is eliminated, making it possible for anyone to own one of these big cone reproducers.

In the illustration shown in Figure 1 is a photograph of the Ensco pedestal type speaker, which is proving popular with many radio owners at the present and which may readily be assembled by following a few simple directions.



Figure 1. In the photograph above is shown the front of an Ensco pedestal speaker, this type being popular with many builders

The speaker may be constructed in the form shown in Figure 1 or in either the wall type or console type. It would appear, however, that most of the interest is centered around the pedestal type of speaker illustrated in this article, although there are many who would, on account of conditions within the home, prefer the wall type shown in Figure 2.

After securing the Ensco cone speaker kit, the builder should read carefully all of the instructions given for assembling it before doing any of the work. This is to familiarize himself with the general idea underlying the home assembly of a cone speaker and after he has fully understood the instructions he is ready to go ahead with this work. In order to save as much of the builder's time as possible, the Ensco designers have provided a sheet of Phonotex, which is already marked both front and rear, the front being the decorative border shown in Figure 1, while the rear shows the lines around which the sheet is to be cut. The Phonotex sheet is to be laid down flat and cut out along the circle stenciled on the outer line. A segment also indicated on the sheet is then cut out. The cutting of the segment is done so



that the two edges may be pulled together and the cone shaped, a flap being left for glueing the two edges together so that the cone will remain in that shape. When the cone is ready to paste, take a blunt instrument such as the back of a knife and score the line marked "bend on this line." This allows the edge to be turned back when the cone is completed.

Now pull down the two edges of the cut out section together so

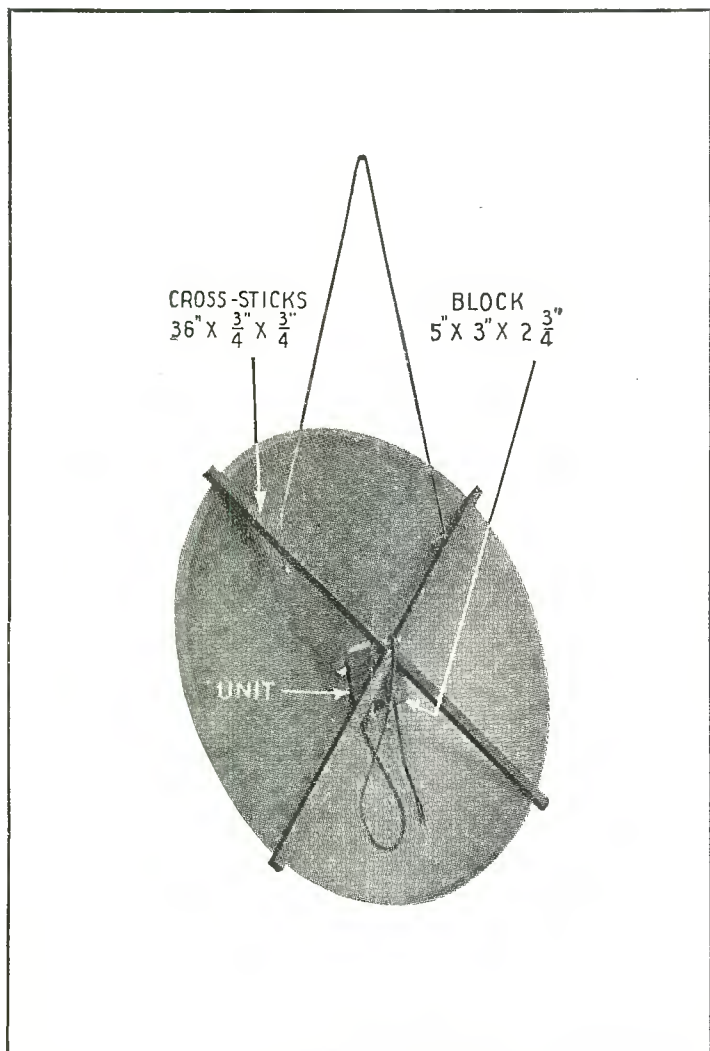

Figure 2. In the above photograph the reader may see the Enesco type speaker, the dimensions of the frame being given in the illustration

that one edge fits over space marked "glue here." On this space spread a thin coat of cement, a can of which is provided in the kit. Be sure to pull the cone into shape with due regard of the style of the speaker to be constructed. If the wall or pedestal type is to be made, the design should be on the outer or convex side of the cone. Turn the sheet with the design downward and proceed to paste by spreading glue along the space marked "for glue." Press the edges together by pressing gently at the seam, starting at the inner apex and working outward. Allow the cone to dry for a few minutes, or until the cement is hard and then paste in the small cone, which is cut from a corner of the sheet and which is also plainly stenciled thereon. This small cone goes on the inner apex when a pedestal or wall cone is built and on the outer apex when the console type is made. The small cone makes the large cone rigid. When the cone is completed, lay it face down and bend back the edge along the scored line.

In the illustration shown in Figure 2, the Enesco wall type speaker is shown. For mounting the wall type speaker a hub is furnished with four dowels matched to a block. These four dowels are inserted in the hub and glued in place so that each leg is of the same length.

By inserting the opposite sticks first and sighting through the other two holes two dowels can be brought to the exact center and glued, and when the other two are placed in the hub they should match perfectly. The unit is then mounted and fastened by two screws through the mounting plate. For wall mounting a cord is attached to two dowels about one-half way to the center.

When mounting the unit be sure that the drive pin is in line with the center of the cross stick. Next attach the drive pin extension and the mounted cone. The cone is clamped to the drive pin extension with the two metal apices and two nuts.

Some idea of this detail may be learned by referring to the upper portion of Figure 3 in this article. One metal apex is placed on each side of the main cone apex. The center should be mounted in such a way that the bent up flange rests lightly on the arms of the frame without putting any tension or strain on the pin. In the wall type the flange of the cone is now attached to the arms of the frame with four thumb tacks.

In Figure 3 is shown a detailed sketch of the Enesco unit, whose single magnet is made of high grade tungsten steel marked as NS in the sketch. The air gap G of the unit is located at the center of the coil C, this serving to reduce the magnetic leakage. The only adjustment which the builder may find necessary to make is to regulate the air gap. If the cone chatters, the gap is too small. A slight turn of the nut A in a clockwise direction facing the back of the speaker will open it. If the gap is too wide, the volume will be low. Nut A is then turned about one-eighth of a turn in the opposite direction. Naturally when turning nut A it will be necessary to make a like adjustment on B, so these two nuts will always be tightly clamped against the armature bar.

Should any trouble be encountered in operating the speaker, it is best to remove the cone and test the unit separately instead of trying to readjust the unit while in the speaker. To test, simply connect the unit to the set and hold it against the apices of the finished cone. The unit should then work excellently in this fashion. If it does and if the assembled speaker does not work, it indicates that the cone is pushing in or out on the drive pin and changing the unit adjustment. This can be rectified in taking extreme care in assembling.

The speaker described in this article will operate on any radio set that will operate a speaker. It may be used on any voltage from 90

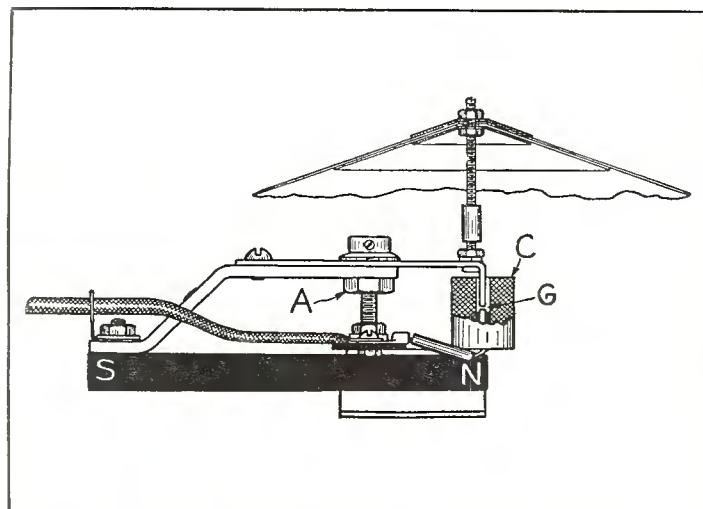

Figure 3. In this illustration the coil is shown in section, exposing the pole tips and air gap. Adjustment is made by nuts A and B

to 250 volts and works well with all of the modern tubes from the 201-A to the 210 types. The tonal frequency range is quite wide and excellent quality of reproduction may be secured. If the speaker is used with voltages over 250, it is suggested that an output filter and an output transformer be used in order to isolate the direct current plate potential from the windings of the unit.



## Electrad Designs Resistance Kit

Truvolt resistors, both fixed and variable, are enjoying the distinction of being exclusively recommended for the Hammarlund-Roberts Hi-Q Six B power supply unit.

In order to meet the demand for Truvolts resulting from this recommendation, Electrad, Inc., 173 Varick St., New York, manufacturers of Truvolts, have designed a special resistance kit for use with Hi-Q.

A photograph of the variable Truvolt is shown below.

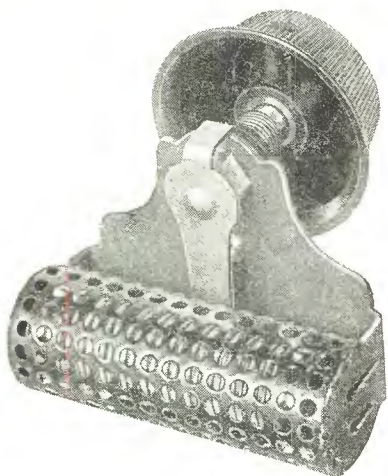

The kit is in attractive box form and contains four special resistors, designated respectively No. 1, 2, 3 and 4. It is the company's intention to carry these designations without values or type numbers in all literature on the Hi-Q power unit, because the resistors so designated are especially designed for use only with the Hi-Q.

In connection with this resistance kit, 25,000 Hi-Q booklets are being printed. These will carry full information on the Hi-Q Six B power supply unit, together with diagrams showing how the Truvolt resistors in the Electrad kit are to be incorporated. The kit containing these resistors lists at \$10.85.

## De Jur Air Cooled Power Rheostat

Designed and made specially for high current carrying capacities, the rheostat shown below has a large refractory base, 2¾ inches diameter, and is a single hole mount.

Resistance element is of the highest and best quality resistance wire obtainable (having the lowest rising temperature coefficient), wound on best grade India mica imbedded in grooves, and is covered with a high heat refractory cement, making the element permanent and everlasting, tightly fastened to the base.



The contact arm rides smoothly over the surface of the resistance. Soldering lugs are supplied for convenient connections. It is made in the following ohmages as standard: 2, 3, 5, 6, 10, 15, 20, 30, 50, 100 and 200 ohms. This rheostat can also be made up with an extra connection and used as a potentiometer in any of the above ohms.

Furnished complete with bakelite knob. List price, \$2.50. Made by De Jur Products Company, 199 Lafayette St., New York.

## Magnaformer Reports Records

Many of our readers who have followed the construction articles dealing with the Magnaformer 9-8 receiver published in our September and November issues have now had the opportunity to build their receivers and try them out in various ways. The results achieved in many instances read almost like a log book of the world's broadcasting stations. Such countries as China, Japan, Australia, New Zealand, Porto Rico, England, Cuba, Brazil, Mexico, Canada and other foreign ports have been received on the loud speaker from the United States. Enthusiastic fans have sent lists of stations received ranging all the way from a dozen stations to ninety-eight. In each instance the owner doesn't fail to state the tone quality of the reception was most clear and lifelike.

As our readers will recall, the outstanding characteristic of the Magnaformer 9-8 receiver is the intermediate transformers with which the combination 9- and 8-tube receiver is equipped. An unusual feature in these transformers is, that they are laboratory sealed and peaked at precisely 69.73 kilocycles, each coil being exactly matched with each and every other one. Each of the Magnaformer r.f. transformers supplies double amplification to each r.f. stage, thus supplying the greatest possible selectivity and great distance-getting sensitivity.

The designers state the first of the many reports on D-X reception was received from K. G. Ormiston and party of witnesses from Los Angeles. On the night of September 11, 1927, Mr. Ormiston's party logged Tokio, Japan and Sydney and Melbourne, Australia. This performance was subsequently repeated on several occasions.

After this the reports began coming in thick and fast. R. C. Anderson, a Long Beach jeweler, with a home-built Magnaformer, reported five 6,000- to 9,000-mile distant stations from the Eastern hemisphere, including 1YA of Auckland, New Zealand; 2BL from Sydney, Australia; 5CL from Adelaide, Australia; JOAK from Tokio, Japan, and sixty-one Western hemisphere stations from the Atlantic to the Pacific.

## Southern Toy Table

This table is made of genuine mahogany or walnut. The top is five-ply. Finished with high grade lacquer, rubbed to a piano finish. It is a handsome addition to other household furniture, and is shown below.

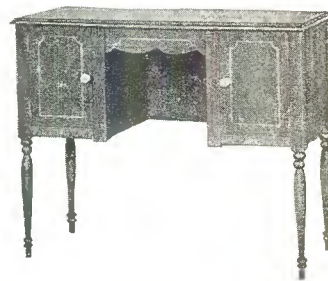

Table No. 37—Top, 17x36 inches. Height, 28 inches. Battery compartments 8 inches wide, 10¾ inches high and 14 inches deep.

This radio table was brought out to meet an insistent demand from radio owners for a table of this character. It is made at a reasonable price according to our highest ideals of workmanship and finish.

The finish is the best that we know how to produce—and we make fine piano benches that require the highest grade finish.

The battery spaces are ample for storage battery, dry batteries, eliminators or rectifiers.

The height of table is just right—28 inches. The leg room is ample. The design in general is chaste and pleasing. It is securely packed and protected in a strong wooden crate. Made by Southern Toy Co., Inc., Hickory, N. C.





## The Efficiency of Amsco Products

IS REFLECTED IN the general specification of AMSCO in preeminently successful circuits and receivers.

And efficiency has not been sacrificed to achieve Amsco's low prices, which may be credited to the economies of efficient manufacturing rather than to skimping in quality of material or workmanship.

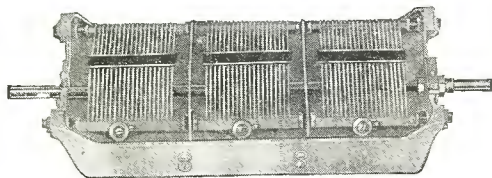

THE DUOSPACE Three gang condenser has been described by engineers as the finest ever designed for single control operation. In justification of this description one may consider the rigid cast aluminum frame that preserves the laboratory alignment regardless of the method and manner of mounting, the extra spacing between plates that reduces the possibility of capacity variation between sections, and the compensating condensers on each section by which it is possible to adjust for capacity discrepancies in the radio frequency circuits.

*Descriptive literature on the DUOSPACE condenser and other essential radio parts, is yours for the asking from*

AMSCO PRODUCTS, Inc.

416 Broome Street \* \* New York City

Our catalog of fine radio products  
is yours on request

## New Webster A.C. Power Unit

Dealers, jobbers, and radio set manufacturers throughout the radio industry are giving their greatest attention at the present time to determining the easiest and best method of building a.c. receivers or rebuilding battery receivers into sets which employ the new a.c. tubes.

All wish to avoid as far as possible revolutionary rebuilding of sets and are striving to avoid rendering obsolete all the parts of the battery receivers in use or in hand, and the method of rebuilding receivers that is the most simple and produces the best results is going to be the most popular.

The new a.c. power unit recently evolved by the Webster Company, 860 Blackhawk Street, Chicago, the manufacturer of the well known Webster B and BC socket power units, makes it possible for distributors, set manufacturers or anyone familiar with battery receivers to easily convert battery sets into the latest improved a.c. tube receivers.

That dealers may avail themselves of the present wonderful opportunity to sell their customers a less expensive proposition than a new

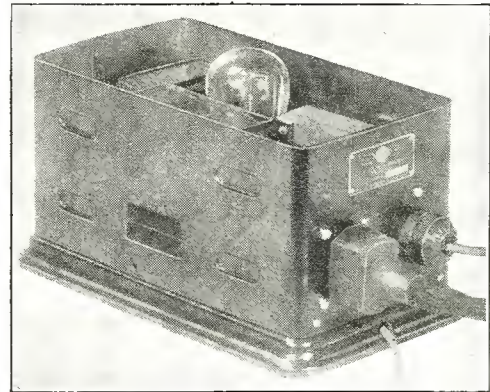

set and meet the demand for a.c. receivers, the Webster unit has been developed using as a basis the well known Webster B unit, in which the B transformer is provided with special windings for the filament lighting on the radio and audio tubes as well as the detector tube and the 171 power tube in the last audio stage.

The accompanying illustration shows the Webster a.c. power unit for a receiver of commercial manufacture employing the 226 R. C. A. tubes for the radio and audio stages, 227 tube for the detector and the 171 power tube for the last stage. The power unit provides all the a.c. and d.c. voltages as well as the necessary grid bias for the power tube.

There are two separate windings for the 226 tubes; one for the radio frequency group and one for the audio. This is to prevent voltage variations in the audio filaments when adjusting the filament voltage of the radio frequency stages. It is, however, impossible to build the a.c. units for general distribution applicable to all the receivers or all the a.c. tubes on the market. These units are made in standard production for R. C. A. tubes as above mentioned and also for supplying the current for a.c. tubes requiring 15 volts on the filament such as the Arctures tubes, as well as those requiring 3 volts such as the Sovereign and Kellogg.

All circuit wiring is brought out through a multiple connection as shown in the illustration. In this unit all voltages from the unit are brought out through a multiplug connection and a second receptacle is provided for a standard 2-prong plug attached to the cord running from the radio set control switch. In this way the unit may be completely controlled automatically from the receiver control switch.

Tell 'Em You Saw It in the Citizens Radio Call Book Magazine





# AERO-SEVEN RECEIVER

# 10-Kilocycle Selectivity

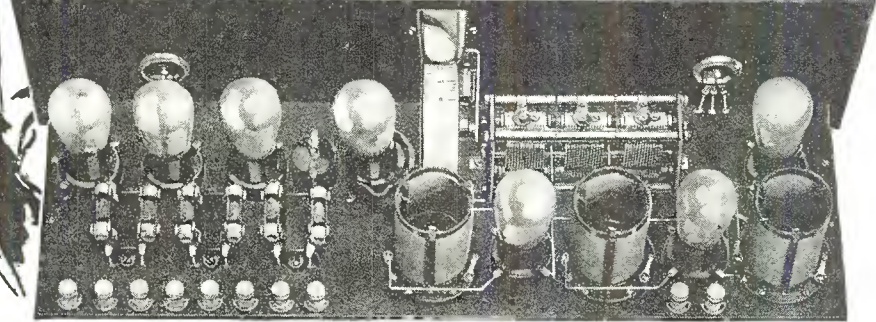

**Utilizing  
New 340  
Tubes  
Unique Features**

The Aero-Seven Receiver is the biggest hit of the present radio season. Thousands of fans and set builders have built this popular circuit. It is a new tried and tested tuned R.F. circuit incorporating the most modern radio improvements at a popular price. It is a distinct innovation in a tuned R. F. receiver, utilizing three stages of R. F. and three stages of audio. Circuit is built around the famous improved Aero Universal Coils, with improved AmSCO S. L. tuning 3-gang condenser, S-M single-control drum dial and the tried and tested parts of other famous manufacturers. Such names as Carter, X-L, Westinghouse, Aero, AmSCO, and Silver-Marshall assure you of a circuit that is the final word in perfection.

Distinct features are: the new Hi-Mu tube at input and in R. F. stages, potentiometer control, higher amplification, 10-kilocycle selectivity and true single control.

It requires no shielding as with the small Aero coils, direct pick-up is negligible and coupling between coils is the very minimum. The coils are twice-matched at both high and low frequencies of the broadcast band, thus eliminating many difficulties in single dial control and overcoming one of the principle causes of disappointments.

### New and Unique Hookup 3 Stages of Radio Frequency 3 Stages of Audio Amplification

The Aero-Seven has a new and unique hook-up that incorporates three stages of R. F. and three stages of audio. There are two stages of tuned radio frequency and a special coupling stage, the secondary function of which is to prevent antenna detuning, thereby giving single control which is both theoretically and practically perfect. This independent antenna circuit is of a new and efficient design and employs a resistance connected between the antenna and ground insulating to the first grid circuit. Five CX340 tubes are used—3 in the R. F. circuit, one detector and one in the audio.

In the three audio stages, one 171 power tube is used, one 201A tube and the one CX340 tube in the input.

The circuit, therefore, is different from the usual 7-tube R. F. circuits, which variations contribute to its optimum selectivity, perfect quality and thrilling volume.

The combination of all the various parts, the matching of the Aero Universal Coils, together with the AmSCO compensating 3-gang condenser, with true single control and potentiometer control, greatly simplifies operation and tuning, while adding efficiency to the circuit.

### First Use of New CX340 Tubes— 1-6/10 Times Better

Utilizing the new CX340 Cunningham tubes in place of the usual 201A, gives the Aero-Seven the distinction of being the first circuit using this superior method. CX340 tubes are 1-6/10 times more effective than 201A tubes, having a 5-volt filament and .25 amperes; plate, 180 volts maximum. In this receiver 90 volts is used constantly on the plate for the R. F. circuit, something seldom attempted but efficiently worked out here. It is a High Mu tube, having a high amplification factor (Mu-30) and is used both as a detector and as a radio and audio amplifier. The Aero-Seven is specially designed to operate with this new and better CX340 tube and the results secured will be a pleasing revelation to you. It is surprising what tone and volume is secured with a minimum use of current.

### 10 Kilocycle Selectivity Now a Real Fact

Ten kilocycle selectivity is OPTIMUM Selectivity. It means a receiver that tunes sharply enough to elim-

inate interference and yet does not tune so sharply as to cause distortion. It is the ideal tuning characteristic "Optimum tuning," says the engineer, when he means a perfect set.

Why bother with anything but the best? Why put up with anything but 10-kilocycle selectivity, as represented in the Aero-Seven circuit?

Due to the low-loss construction of the coils and condensers in the Aero-Seven and the great selectivity introduced into the circuit itself, you get selectivity so sharp that you cannot get two stations at one time under present broadcast regulations, at the same time providing adequate frequency margin to prevent high "cut off"—distortion.

Imagine what this means in perfect radio reception. Selectivity, the ability to tune in clearly, sharply, without fear of disturbance in getting the station you want whenever you want it—that's something every radio fan has long desired. It is an actuality in the Aero-Seven—a feature that is necessary in an up-to-date circuit—a feature that you get in the Aero-Seven when you build it.

### New, Modern, Proved Features in Aero-Seven

- 10 Kilocycle selectivity.
- Uses new CX340 tubes instead of 201A.
- 3 stages of R. F.
- 3 stages of audio amplification.
- Extreme D-X reception.
- Potentiometer control.
- Silver-Marshall single drum dial.
- True single control.
- Aero Coils are twice matched at both high and low frequencies.
- AmSCO adjustable condensers.
- Carter resistances.
- Westinghouse Foundation Unit.
- X-L Posts.
- High quality parts throughout.
- Range below 200 to above 550 meters (1,500-500 KC).
- Low loss characteristics throughout.
- Perfectly compensated—variation in antenna circuit doesn't affect it.
- Wiring underneath sub-panel.
- Simple construction.
- Easy to build in quick time.
- The most popular-priced 7-tube circuit.
- For true tone, D-X, selectivity and volume, plus easy control, it represents a decided forward step in radio advancement.

The adjustable compensators on the AmSCO condensers facilitate the equalization of circuits, solving the major problem of tandem tuning.

Here is one of many testimonials that speaks for itself:

DEPARTMENT OF POLICE, CITY OF ST. LOUIS  
Gentlemen:

I recently constructed the Aero Seven, and I must state that it is without question the best receiver I have ever constructed, or heard. The selectivity is as perfect as can be expected, and the volume of the set is wonderful. Gives the most life-like reproduction that I have ever heard, and since constructing the receiver, three of my friends have done likewise. The principal secret of success in the Aero Seven is not only due to the fine parts used, but—the wonderful Aero Coils, to which I believe there is no equal.

Yours very truly,  
C. MILTON DAVIS,  
2341a South 11th St., St. Louis, Mo.

### An Opportunity for Set Builders

The set builder will find the Aero-Seven a most profitable receiver to build. It is an extremely simple circuit—efficient, high grade and having a record of exceptional performance. It could hardly be duplicated in a factory-built set at double the cost.

You can make big money building this set for your friends and get a real "kick" out of it yourself.

Complete parts, drilled and engraved panels and foundation units are being distributed through the jobbing trade and are available at leading radio stores everywhere. If your dealer cannot supply you, order direct, giving your dealer's name and we will see that you are supplied promptly. Mail coupon below for complete facts—NOW!

### List of Aero-Seven Parts for Battery Operation

	List Price
1 Aero Seven Foundation Unit.....	\$12.00
1 Aero TRF Kit, Code U-12 (3 coils).....	12.00
1 Aero Choke No. 60.....	1.50
1 Silver-Marshall Drum Dial.....	3.00
1 Carter Battery Switch D.....	.65
1 Carter 200-ohm "IMP" Potentiometer.....	1.25
1 Carter 6-ohm "IMP" Rheostat.....	1.00
1 Carter H-1000 Resistor.....	.30
1 Carter H-1 Resistor.....	.25
1 Carter .00025 Mfd. Condenser with Clips....	.50
1 Carter .001 Mfd. Condenser.....	.50
2 Carter 1/2 Mfd. Bypass Condensers.....	1.80
10 X-L Binding Posts, Lettered—Aerial, Ground A+, A—, 2C—, B90+, Amplifier, B+, Speaker+, Speaker—....	1.50
1 AmSCO Floating Socket.....	1.00
6 AmSCO Plain Sockets @ \$0.50.....	3.00
1 AmSCO .0005 Mfd. Triple Condenser.....	11.25
1 AmSCO Grid Gate Mounting.....	.30
1 AmSCO 5 Mgr. Grid Gate.....	.50
1 Kit AMSCO Aero-7 Resistance Compled Audio .....	7.00
Screw Assortment and Bus Bar.....	.25
List .....	\$59.55

Aero Products, Inc.  
1768 Wilson Ave., Dept. 301, Chicago

Dear Sirs: Please send me construction data and all the facts in building the new Aero-Seven Receiver.

Name.....

Address.....

**AERO PRODUCTS, INC., 1768 Wilson Ave., Dept. 301, Chicago, U. S. A.**  
Associated Manufacturers  
AmSCO, Aero, Carter, Westinghouse-Micarta, Silver-Marshall, X-L



# The New Vernier Port Dial Can be illuminated



Bring your set up-to-date with this Dial

**T**HIS new translucent Vernier Port Dial with genuine bakelite housing affords you a real opportunity to bring your present set up-to-date and also improve its beauty and efficiency. You must install these dials to appreciate what wonderful improvements they will make.

You may have this dial to match the panel of your radio. Furnished in black, mahogany or walnut finish. The graining of the colored dials is exquisite, obtained by an exclusive Kurz-Kasch process!

For those who have this type of dial and desire the latest illuminated effects, the translucent plate can be had separately ready to install.

If your dealer cannot supply you, tell us about it.



No. 92

1 1/4" Fleur de lis Top 1/4" with set screw



No. 93

1 3/4" Plain Stippled Top 1/4" with set screw

THE KURZ-KASCH COMPANY  
Dayton, Ohio

# KURZ KASCH

*Aristocrat Dials and Knobs*

## Polymet Block Condensers

Working voltage under which these condensers are to operate has been carefully studied and only the proper condenser sections incorporated in these blocks. Polymet block condensers not only improve the appearance of the set, but also simplify the wiring and save time and space in assembling.

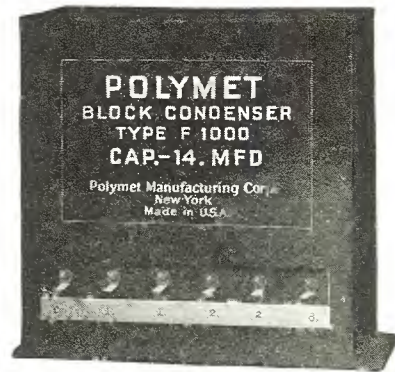

The type of condensers used in each section follows the voltage requirements of the circuit as prepared by the tube manufacturers. Polymet blocks have been recommended for Raytheon, Q. R. S., Amertran power pack, Thordarson power pack and other popular circuits.

## Filter Condensers

Polymet-filter condensers comprise a line of thoroughly efficient paper dielectric condensers for use in radio receivers, B eliminators and power packs.

Only the highest grade of foil and specially prepared linen paper are used in their manufacture.

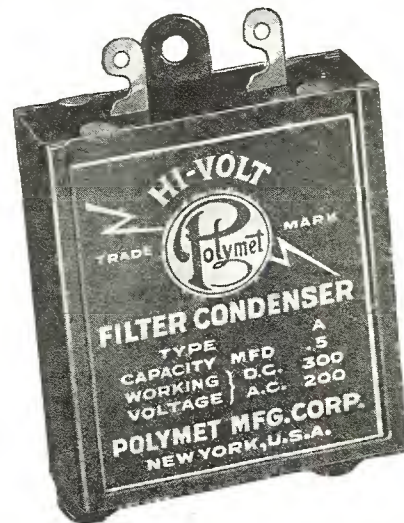

Polymet condensers are non-inductive and the special process of impregnating insures a high working voltage, long durability and also prevents leakage.

Polymet filter condensers in all popular capacities, are made by Polymet Mfg. Corp., 599 Broadway, New York City.



## A QUALITY CATALOG

*from a Quality House*

"GOOD APPARATUS PAYS"

1928 Catalog listing newest in radio at lowest prices. Cash in on the experience of the engineers of this Recognized Radio House. Dealers, write today!

**NATIONAL RADIO COMPANY**

227 W. Madison St. Dept. 21 Chicago



# Complete Kit of Parts for the New HARKNESS Counterfonic Six

—the set with *tuned audio amplification*

An entirely new and patented method of audio amplification is used in the Harkness Counterfonic Six, the latest and greatest achievement of Kenneth Harkness, widely known radio inventor and authority.

With this new "tuned double impedance" audio amplifier, the Counterfonic reproduces music and the human voice with a more natural, life-like quality than has ever before been attained in radio. If you build the Counterfonic you will hear the finest reproduction which modern developments in audio amplification have made possible.

Many other new and exclusive features are embodied in the Counterfonic Six. A new method of shielding, effective and efficient. A new system of neutralization, easy to adjust and which permits high radio frequency gain per stage. The set is ultra-sensitive. Every point on the dial is alive. Distant stations come rolling in, night after night.

The selectivity is perfect—just enough to prevent interference, not too much to affect tone quality.

There is just one tuning knob and one volume control. Tuning is reduced to a single control without loss of efficiency. The r.f. transformers and tuning condensers are accurately matched.



**Greatest Value in Radio Today!**

Kit contains everything for building the Harkness Counterfonic Six. Front and sub-panels drilled and engraved. Assembly and wiring fully explained in step-by-step instructions accompanying kit.

**LIST PRICE**

**\$68<sup>50</sup>**

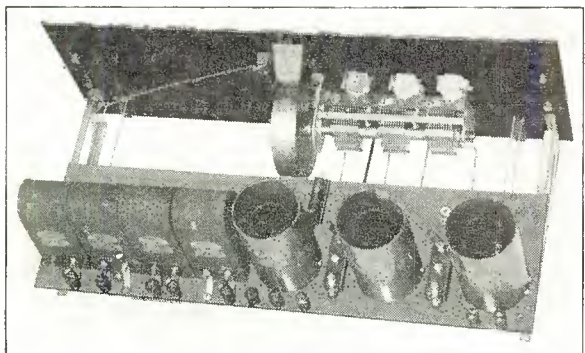

### Contents of Kit

1 Bakelite front panel, 7 x 21", drilled and engraved.....	\$5.00
1 Bakelite sub-panel, 5 3/4 x 20", drilled, with six tube sockets attached.....	4.50
1 Pair Harkness sub-panel brackets, 9 1/2" long.....	1.00
3 Harkness R.F. transformers....	6.00
3 Harkness coil shields.....	3.00
3 Harkness double impedance tuned audio couplers, 1st, 2nd and 3rd stage types.....	22.50
1 Harkness audio output filter unit.....	5.00
1 Harkness radio frequency choke.....	1.00
1 U.S.L. 3-gang condenser, .00035 mfd.....	6.00
3 Hammarlund equalizer condensers.....	1.50
1 Silver-Marshall drum dial.....	3.00
1 Carter 10 ohm midge rheostat, with knob.....	.55
2 Saturn toggle switches.....	1.30
1 Carter fixed resistance, 4/5 ohm.....	.25
3 Aerovox fixed condensers, .001, .00025 and .0001.....	1.10
1 Aerovox by-pass condenser, 1 mfd.....	.90
1 Aerovox grid leak mounting....	.25
1 2 megohm grid leak.....	.40
2 X-L or Wizard Variodensers, .0001 mfd.....	3.00
12 Eby binding posts.....	1.80
Lugs, screws, nuts, panel supports, etc.....	.45
<b>Complete Parts.....</b>	<b>\$68.50</b>

### Big Discounts to Dealers and Set-Builders

You can make lots of money building Harkness Counterfonic Receivers for your friends. As our authorized agent you can buy the complete kit of parts at a big discount and make a large profit on the sale of the finished set and accessories. Write today for our agency proposition, or check and mail the coupon below.

**MAIL THIS COUPON NOW!**

**Kenneth Harkness, Inc.**  
74 Cortlandt Street  
New York City

Without obligation, send me free literature on the Harkness Counterfonic Six and full details of your agency proposition.  
I am a

dealer       set-builder

You can build the Counterfonic Six in less than three hours with the complete kit of parts prepared for your convenience by Kenneth Harkness, the designer of the set. The kit contains everything needed to build the set. No experience is necessary. Even if you have never attempted to build a radio set before you will find you can build the Counterfonic without any difficulty. The assembly and wiring are fully and clearly explained in the instruction folder accompanying the kit.

By building the Counterfonic you save money. A factory-built set with the receiving range, volume and selectivity of the Counterfonic Six would cost two or three times as much.

If your local radio dealer does not carry the Harkness Counterfonic Kit in stock, mail your order directly to the manufacturer, at the address below, and the complete kit will be sent to you at once.

If you do not want to build the set yourself, write us and we will arrange to have it built for you.

**Dealers and Set-Builders. We allow liberal discounts.**

**Mail the coupon for details of our agency proposition.**

**KENNETH HARKNESS Inc.**

74 Cortlandt Street

New York City

Sales Representatives: Aaron Siedman & Co., 307 N. Michigan Ave., Chicago, Ill.

Print Name.....

Full Address.....



# Silver **A** Beauty POWER

For Your Present Set or the  
Set you eventually buy



Our 4-volt "A" Eliminator  
Fits Into All Radiola Consoles

## The Perfect "A" Eliminator

Perfect, because its principle is simple and correct!

THE 110 volts Alternating Current is scientifically reduced with the famous "Silver Beauty" transformer coil to deliver the proper voltage to an especially developed dry, noiseless rectifier, which transforms the electricity to direct current. This current of exact voltage is then transmitted through a patented special filter which clarifies the current, eliminating all foreign noises caused by rectifier or generator.

The result! A smooth, noiseless, constant "A" current supply that makes radio reception the pleasure it is intended to be.

Silver Beauty is the outstanding "A" eliminator today. Nothing equals it. Endorsed by prominent radio engineers—adopted by leading distributors and dealers—approved by thousands of users.

These are sufficient reasons for making Silver Beauty your final choice.

### Silver Beauty "B-C" Unit Does away with "B" and "C" batteries

Embodies every up-to-date refinement and principle, insuring smooth, un-failing reception. As beautiful as it is efficient.

No. 450  
180 Volts—  
40 Milli-  
amperes  
**\$45**

No. 460  
135 Volts—  
35 Milli-  
amperes  
**\$35**

Individual  
adjustment  
adapted  
to all sets

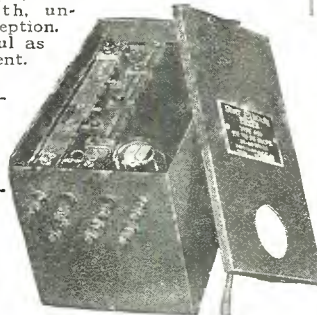

PRICES
\$ <del>39</del> <sup>50</sup>
6-volt—2 amp.
\$ <del>43</del> <sup>50</sup>
6-volt—3 amp.
\$ <del>39</del> <sup>50</sup>
4-volt— $\frac{1}{2}$ -amp. \$2 Higher West of Rockies

## New Translucent Plate

Designed for set builders and fans who desire an illuminated dial, the Kurz-Kasch Co. of Dayton, Ohio, is now marketing a separate translucent plate, which when placed in the present type of Aristocrat port-vernier dial will make it possible for the user to place a dial light in the rear of the set so the plate may be illumined.



Above is a reproduction of the vernier dial with the translucent plate. One of the features of the dial lights is the fact that since it is made of bakelite no body capacity is experienced by the user when turning the dial. This feature makes it highly desirable in circuits where there is a possibility of body capacity through conduction to the dial and where the builder desires to eliminate it.

## Set Builders Attention!

YOU will find a lot of good circuits in this issue of the Call Book and we can supply you with all the necessary parts of highest quality only. If you buy from us you will also know that you will get the best discount you can get and, in addition, courteous and square treatment.

Quotations on request. Six years serving  
the set builder

Chicago Radio Apparatus Company  
Inc.

415 South Dearborn Street  
Harrison 2276 Chicago, Illinois

### Silver **A** Beauty POWER

Replaces "A" storage battery and charger.

Has full wave "dry" rectification.

Maintains required voltage in uniform, constant flow.

Operates automatically by moving a switch.

Economical—uses minimum amount of current [about 1-10 cost of using electric iron].

Has rheostat control for additional refinement in voltage and reception.

Gives maximum power to radio tubes and lengthens their life.

No acids to test or spill.

Satisfactory Results  
Guaranteed

### SILVER BEAUTY CHARGERS

Employing an entirely new method of rectification. Two models—with or without bulbs.

See Your Dealer or Jobber

### Triple-A-Specialty Company

Manufacturers of the famous Silver Beauty Chargers

312-316 South Hamilton Ave.  
CHICAGO, ILLINOIS





# assemble *the* **Ensco**

**"THE WORLD'S FINEST LOUD SPEAKER"  
in less than an hour**

*at a fraction of the cost*

Approved by all leading radio magazines.

The Ensco distortionless unit, the most remarkable invention in reproducing apparatus.

Ensco is used and endorsed by Frank L. Brittin, "Bob" Casey, Volney Hurd, H. G. Cisin, Arthur Lynch, W. G. Many, Capt. Robert Wood, and many other experts.

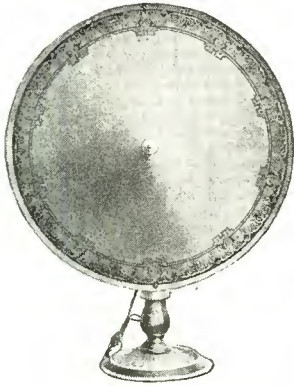
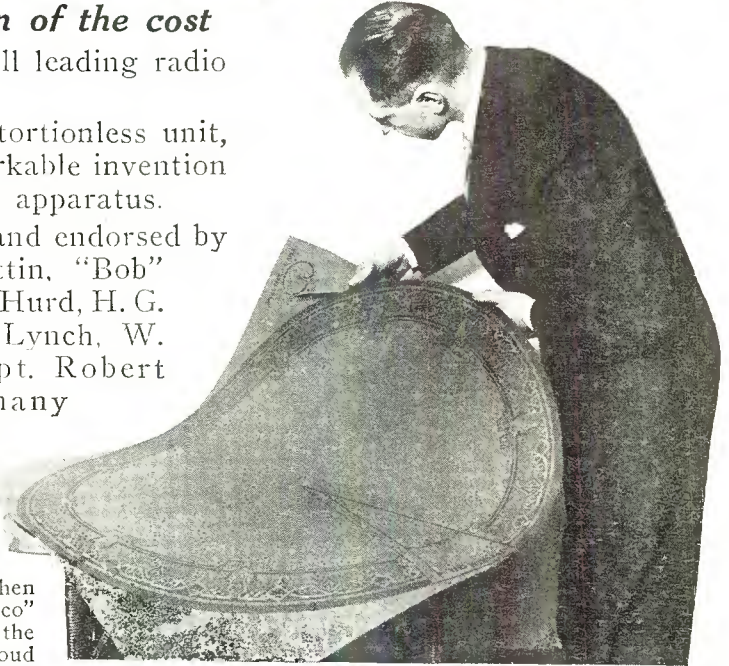

### The Two-Foot Pedestal

Equally as well made and as beautiful as the three-foot model, but smaller. Can be used on top of the set or on any other piece of furniture. Complete Kit, including pedestal. Polychrome finish.

Model F-135-24.....\$13.50  
In Canada..... 17.50



### The Standard and Wall Models

Two or Three Foot

The wall model kits are furnished with a hard wood wall frame for easy mounting. Made in two and three foot sizes. The standard Kit is used for making console models and roll or book type speakers as described in instruction book—same as wall Kit, but without frame. You can make your own wall frame if desired.

Standard Model, 2 or 3 Feet  
Either Size.....\$10.00  
In Canada..... 11.50  
Wall Model 2 or 3 Feet  
Either Size.....\$11.00  
In Canada..... 12.50

**W**HY pay a high price for a manufactured speaker when you can buy an "Ensco" Kit and assemble the "World's Finest Loud Speaker" at a fraction of the cost. No manufactured speaker, regardless of price, will give you any better reproduction.

### The Simplest Cone to Assemble

The "Ensco" Single Cone is by far the simplest cone to assemble, no mechanical or radio knowledge is necessary. If you can use a pair of scissors, a screwdriver and a pair of pliers, you can build the "Ensco" as perfectly as an expert mechanic. Within an hour from the time you start work, you will be enjoying music the like of which you never thought possible.

### Compare— Let Your Ear Be the Judge

Don't take our word for it. Go to your dealer, or any of the offices listed below. Hear the "Ensco" in competition with any speaker, no matter what the price. Then, and only then, will you know the difference between ordinary and "Ensco" reproduction. The bass notes, the founda-

tion of all music, come booming through in their true relation. The higher notes are equally free from choking or distortion. The tone is clear as a bell, without the slightest trace of mechanical noise.

### Absolutely Guaranteed

The "Ensco" is backed by a guarantee that means something. All "Ensco" units are guaranteed to give satisfaction. After purchasing the "Ensco" Kit, you have ten days' trial in which you may test the speaker and return it if not satisfactory. Your money will be promptly refunded.

### The Art Models

The first in the field, the "Ensco" is naturally the first to bring out Art Models. The beautiful pedestals must be seen to be appreciated, no picture could do justice to the handsome polychrome finishes. The "Ensco" is now available in two- and three-foot pedestals, which will make any woman glad to have them in her living room.

### Go to Your Dealer

Ask your dealer for a demonstration, then let your ear decide for you. If your dealer has not been supplied, you can order direct from us by using the coupon. You are fully protected by our guarantee.

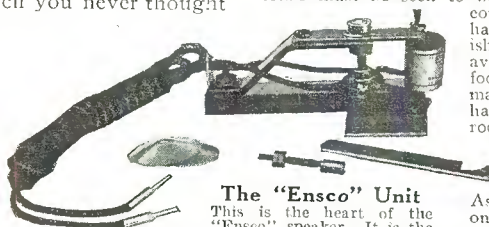

### The "Ensco" Unit

This is the heart of the "Ensco" speaker. It is the only direct-drive unit, which satisfactorily operates a 3-foot cone. It has no transmission arms or levers to reduce the motion of the armature. The "Ensco" Unit is fully patented. Can be used with up to 250 volts without protection and up to 500 with an output system.

If your dealer has not been supplied—  
Send this coupon

## ENGINEERS' SERVICE COMPANY



25 Church St.  
NEW YORK  
28 E. Jackson Blvd.  
CHICAGO

73 Cornhill  
BOSTON  
331 Bay Street  
TORONTO, ONT.

144 2nd Street, San Francisco, Cal.

### ENGINEERS' SERVICE CO.

Send to nearest office

	U.S. Prices	Canada Prices	I am enclosing
2-foot Standard Kit	\$10.00	\$11.50	Check
3-foot Standard Kit	10.00	11.50	Money Order
2-foot Wall Kit	11.00	12.50	Cash (registered letter)
3-foot Wall Kit	11.00	12.50	Send C.O.D.
2-foot Pedestal Kit	13.50	17.50	(All shipping charges paid on Standard and Wall Kits only)
3-foot Pedestal Kit	17.50	22.50	

Name.....  
Address.....  
City..... State.....



AMER TRAN - AMER TRAN - AMER TRAN - AMER TRAN

# Fidelity of REPRODUCTION

**AMERTRAN Presents**  
a new completely  
assembled audio  
unit

The  
**AMERTRAN**  
Push-Pull Power  
Amplifier

**\$60.00**

*Without Tubes East  
of the Rockies*

The AmerTran Push-Pull Power Amplifier is a new completely assembled two-stage unit, containing a first stage AmerTran DeLuxe followed by AmerTran Input and Output Transformers for Power Tubes. When operated from a power source supplying sufficient voltage (such as the new AmerTran A B C Hi-Power Box), the input to the speaker is almost perfect, and fidelity of reproduction is limited only by the ability of the speaker. Distortion, from tube harmonics and A C hum, is reduced to a minimum. The energy output to the speaker is increased, especially at the lower musical frequencies. This means greater clarity of tone at low or high volume.

The amplifier is easily connected to the detector of any good receiver, replacing its audio amplifier. It is equipped with four sockets, two for power tubes, and a four-prong and a five-prong socket in the first stage for either a standard amplifying tube of the UX-201 A type, or a UY-227 A C tube. Using the latter tube, the amplifier can be entirely A C operated.

\* \* \* \*

AmerTran Push-Pull Amplifier as a complete unit is licensed under patents owned or controlled by the Radio Corporation of America and must be sold complete with tubes. It is built in several types, depending on the type of power tubes preferred. Type 2 AP-10 is designed for 210 tubes and type 2 AP-71 for 171 tubes. The difference is only in the Push-Pull output transformers.

This completely wired licensed AmerTran Push-Pull Amplifier is on display and demonstration at stores displaying the sign "Authorized AmerTran Dealer." Send for complete literature on this new AmerTran Unit.



**AMERICAN TRANSFORMER CO.**  
178 Emmet Street Newark, N. J.

"Transformer Builders for Over 26 Years"

## Qualitone DeLuxe Loop

Woodwork used in the Qualitone loops, the DeLuxe type of which is illustrated below, is selected solid walnut, hand rubbed, natural finish. The DeLuxe woodwork is turned wood of pleasing period design and harmonizes with surroundings to suit the most exacting taste. The wire spacers are made of best insulated material, reducing losses to a minimum. Well insulated, flexible stranded wire covered with brown silk braiding is used on all Qualitone loops.

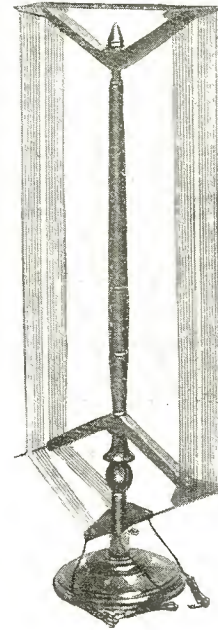

Three long leads for readily connecting loop to receiver are furnished. All Qualitone loops are provided with a removable center tap, and either two or three leads may be used as desired. The DeLuxe model turns within a radius of 5½ inches, while the Qualitone model turns within a radius of 7½ inches. All Qualitone loops are designed for use with .0005 mfd condensers and are specified in the popular circuits of the year.

Dimensions on the DeLuxe are: Erected 29 inches x 11 inches x ¾ inches, packed 5 inches x 8 inches x 19 inches. Shipping weight, 4 lbs. Priced at \$12.50. Manufactured by Duro Metal Products Co., 2649 N. Kildare Avenue, Chicago, Illinois.

## New Baldwin "99" Speaker

One of the most popular speakers of this season is the Baldwin "99," which is illustrated in this article. The merits of this speaker may be classified under the three following headings:

*(Continued on page 166)*

### The Big Friendly Radio House Complete Parts **Remler A. C. Super and Power Supply**

WHEN you get our 1928 Catalog, you can have popular, nationally-advertised kits, parts, eliminators and accessories at prices that are real values.

Our dealer catalog, which lists everything in radio, means more real profit for you. Standard quality at the right price.

*Write for our big Catalog*

**WESTERN RADIO MFG. CO.**  
128 West Lake St. Dept. MO Chicago, Ill.



# Step A Year Ahead with the "Everyman 4"

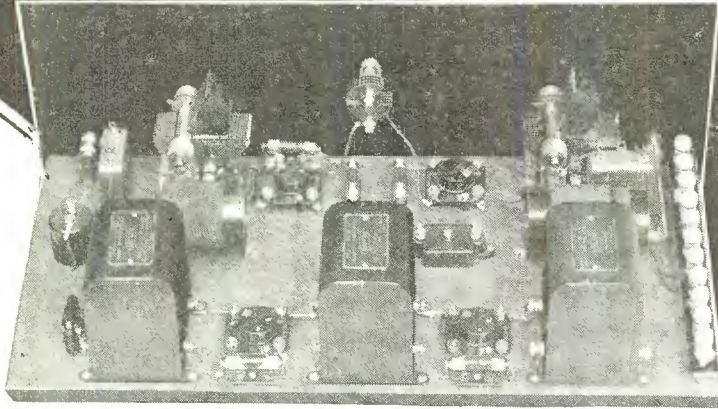

Build the World's  
4 Premier  
Tube Set

For all Amateur or Professional Set Builders who want wonderful long distance, remarkable selectivity and faultless natural tone quality without the trouble making complications of multiple tubes—the Everyman 4 shows the way to satisfaction. In this magnificent set Radio Engineers and practical set builders have combined to give you a four tube set which out-performs nearly all six tube sets—and yet is simple to build, easy to operate, and dependable in performance. Simplicity of assembly and operation are outstanding characteristics of the Everyman 4 which appeal to every set builder and every user.

## Big New York Sensation!

IN New York, where the Everyman 4 was first introduced, its simplicity and dependability resulted in the greatest popularity ever attained by a four tube circuit. The unusual selectivity of this set under New York's "crowded air" conditions proved a surprise to many experts. Volume even on D.X. stations is surprisingly good. Tone quality throughout the entire audio range is a delight to all those using the set.

The satisfaction of thousands of fans who have already built the Everyman 4 is illustrated by the following letter from Sidney Greenstein, of 828 Dawson St., New York City: "I have built hundreds of receivers, of all types. That is, from a 1-tuber to an 8-tuber, and never yet have I been so pleased as with the results obtained with Everyman 4. It is simple to tune, voluminous and a bear for distance. The quality is just flawless. Really it seems too good to be true. Why, it is as simple to tune in KOA, the General Electric station at Denver, as a local. It happened to be my hard luck, that when I installed this set, someone had cut down my antenna. It was necessary for me to use a makeshift indoor antenna. I expected just moderate results. But, what a surprise I received! WGY rolled in like a local. Well, why go on. The set is just a peach, and that's all there is to it."

The opinion of qualified radio experts is shown by the fact that the technical editors of two of the largest newspapers in the two largest American cities both tried out the Everyman 4 and found it to out-perform most six tube sets.

### Feats of Reception Reported by Builders in New York City

A builder of the Everyman 4 in Newark has no trouble in getting WPG, Atlantic City, at 3 P. M., with WAAM and WAAT on the air. Not a trace of interference.

A radio fan on University Ave., listens to WBBM, Chicago, and WTAM, Cleveland, while WRNY is on full power.

WNYC was separated from WVEF without any trace of interference at a distance of 500 feet from WNYC transmitting aerial. (Impossible with other sets having more tubes and costing twice as much to build.)

WOC—at Davenport—at all times just like a local station.

40 stations in one hour. Partial list of stations received: WOC, Davenport; WLS, Chicago; WBBM, Chicago; WEAS, Virginia Beach, Virginia; WTAM, Cleveland; KDKA, East Pittsburgh; WGY, Schenectady.

Western stations on loud speaker during early evening hours while locals are on. And what volume!

### Complete List of Quality Parts, Only \$53.85

2—Hammarlund .0005 mfd. variable condensers.....\$11.00	1—800 Muter grid leak mounting...\$ 0.15
1—Hammarlund .00005 mfd. midget Condenser..... 1.75	1—305 Muter .00025 mfd. grid condenser..... .40
1—7x21x3/16 in. drilled and engraved Micarta panel..... 3.75	1—301 Muter .0001 mfd. fixed condenser..... .75
2—Twin-coupler "Every Man" Coils..... 5.00	2—507 Muter .5 mfd. by-pass condensers..... 1.50
4—9040 Benjamin sockets..... 3.00	1—2750 Muter radio frequency choke..... 1.50
11—XL Binding posts..... 1.65	3—1700 Muter tubestats..... 1.50
1—10x20 1/2 base board..... 1.80	1—1730 Muter tubestat..... .50
1—3300 Muter audio transformer..... 7.00	1—1900 Muter variall balancing condenser..... .75
1—3320 Muter audio transformer..... 7.00	
1—2700 Muter clarifier..... 5.00	
1—3730 Muter 3 megohm grid leak..... .50	
1—1600 Muter filament switch..... .35	
	\$53.85

Specified Parts Insure Best Results

## This is the Set for YOU TO BUILD Can Be Built in One Hour!

See your Dealer for Everyman-4 parts and full directions for assembly. You may also write Everyman 4, Dept. 502-A, 76th and Greenwood Ave., Chicago, for folder giving full information on this world's greatest 4 tube set.

#### Associated Manufacturers

Leslie F. Muter Co. Chicago, Ill.      Twin Coupler Co. Poughkeepsie, N. Y.      Hammarlund Mfg. Co. New York, N. Y.  
Benjamin Elec. Mfg. Co. Chicago, Ill.      X-L Radio Laboratories Chicago, Ill.

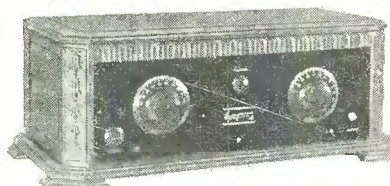

### Professional Set Builders!

will find in the Everyman-4 a Real Producer. Write us for full information.

EVERYMAN 4  
Dept. 502-A  
76th and Greenwood  
Chicago, Ill.

Gentlemen: Kindly rush folder giving full information regarding the Everyman 4.

Name.....  
Address.....  
City.....  
State.....



If your aerial is giving you trouble or poor reception~

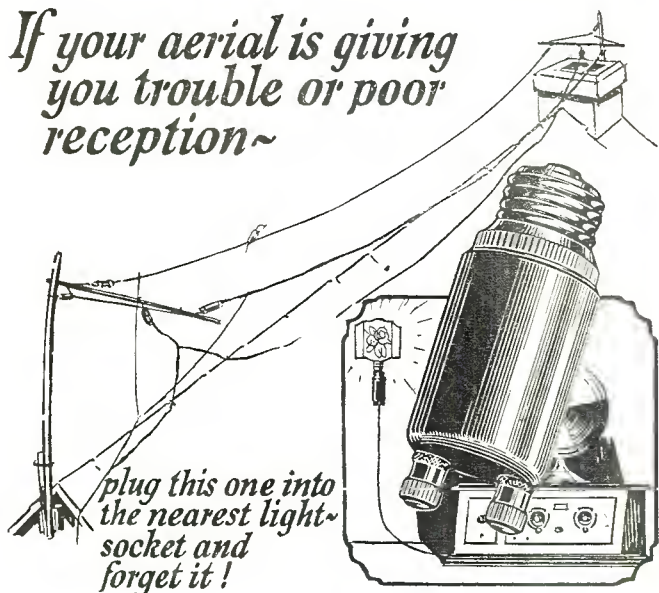

plug this one into the nearest light-socket and forget it!

Dirty wires and corroded connections are the faults of most outdoor aerials. It takes time, money and trouble to keep them in efficient shape. So why be bothered when a Dubilier Light-Socket Aerial will do the job better, and do it indefinitely without care or attention? Just connect this modern aerial to your set and plug in. It uses absolutely no current, requires no lightning arrester, and improves reception by reducing both static and interference. Your dealer will let you prove it with a five-day, money-back guarantee. **Price \$1.50**

# Dubilier Light-Socket Aerial

### METALEAK—for accuracy

Grid-leaks must be accurate and must be noiseless or they are of no value at all. To avoid tubular grid leaks of doubtful quality ask for Dubilier Metaleaks. Most good dealers carry them in all standard resistances.

Prices—20,000 ohms to 200,000 ohms ..... 65c  
1/4 meg. ohms to 5 meg. ohms ..... 40c

### Build Your Own A B C Power Unit

In economy and dependability no form of radio power can compare with a Dubilier-equipped light-socket power unit. Dubilier condenser blocks, type 350 BA-1, 2 and 3 are built expressly for use with the new Raytheon type BA rectifying tube. Dubilier's high factor of safety and unusually long life assure an adequate and constant source of A B C Power night after night, month after month.

**Dubilier** Condenser Corporation  
4377 Bronx Blvd., New York

(Continued from page 164)

First, those excellences which come to it by virtue of the use of the Baldwin balanced armature unit; second, those advantages peculiar to the particular type of tone chamber employed, and third, the advantages of appearance in its artistic design.

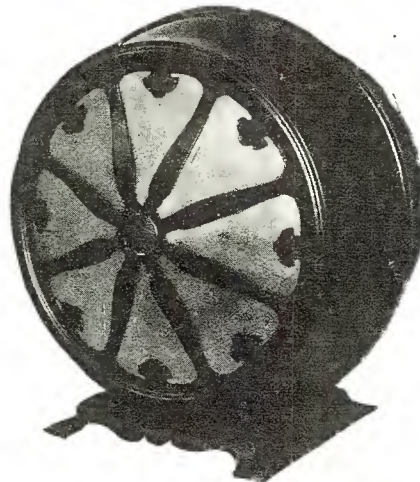

The Baldwin armature in the unit is balanced between four points on two pole pieces. These four points operate on both the push and pull phases of the electrical impulses which flow from the set. The tone chamber employed in the "99" speaker is quite ingenious. It is made of a material recently developed composed largely of wood, which when formed assumes two hard outer surfaces, which give it mechanical strength, but retains a soft and pithy inner core. This soft core will not respond to the vibrations of the unit itself and, therefore, the walls of the tone chamber are entirely silent.

The unit is furnished in bronze with a lighter shade of silk shielded by an artistic grill. It is furnished in two models, a table model 14 inches in height and a pedestal model 49 inches in height. The table model is illustrated above. Manufactured by Nathaniel Baldwin, Ins., and distributed by J. W. & W. L. Wolf, 227 Fulton Street, New York City.

### Hagel Bakelite Power Plugs

Constructed entirely of genuine bakelite throughout the Hagel power plug and cable, several forms of which are illustrated in this column, should be of interest to professional set builders.

In the illustration below is shown the bracket socket type, the pins being firmly imbedded in bakelite so they will not loosen while the receiver is being soldered. This form of bracket socket

(Continued on page 168)

## The Big Friendly Radio House Complete Parts Aero A. C. Seven T. R. F. Receiver

WHEN you get our 1928 Catalog, you can have popular, nationally-advertised kits, parts, eliminators and accessories at prices that are real values.

Our dealer catalog, which lists everything in radio, means more real profit for you. Standard quality at the right price.

Write for our big Catalog

**WESTERN RADIO MFG. CO.**  
128 West Lake St. Dept. MO Chicago, Ill.



"Fans, Dealers, Set-Builders!

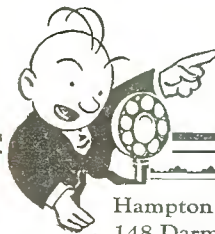

Mail This Coupon Today!"

**Stop, Mr. Radio Bargain Hunter! Here's What You're Looking For! And Now's the Time to Buy!**

Hampton-Wright  
148 Darmody Building  
Indianapolis, Ind.

Dear Sirs: I'm interested in your surprising bargains in radio parts and accessories. Send me one of your catalogs today.

Name \_\_\_\_\_  
Street \_\_\_\_\_  
City \_\_\_\_\_  
State \_\_\_\_\_

MAIL the above coupon for Hampton-Wright's New Catalog of Radio Parts and Accessories, "The Book of a Thousand Radio Bargains." You'll be surprised at the new low prices available on the best radio merchandise, made by the world's best-known manufacturers. And in addition to surprisingly low prices, our service is fast, thorough and conscientious. Thousands of fans over the country endorse Hampton-Wright. So will you if you mail the coupon. And do it TODAY!

"Keeping Pace with Radio"

**HAMPTON-WRIGHT**  
RADIO PARTS AND ACCESSORIES  
DARMODY BUILDING + + + INDIANAPOLIS

Mail the Coupon TODAY!

# TRIMM

## Quality Reproducers



**CONCERTO GRANDE**  
17" diameter  
West of Rockies, \$16.00  
\$16.75  
Canada, \$22.00

**CONCERTO**  
14" diameter  
West of Rockies, \$10.00  
\$10.75  
Canada, \$13.50

Tune in on any program—Band Concert, Opera or Market Report—it's all the same to the new Trimm Cones. Volume, melody and distinctness, the three most desired features of radio reproduction, are there undeniably. And it's a beautiful cone, in forest brown, with gold decoration.

Free edge of cone fully protected. Unit, built on the balanced armature principle, will take maximum amplification of power and semi-power tubes without blasting or distortion. Ruggedly built; all parts rust-proofed.

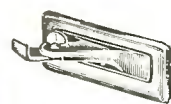
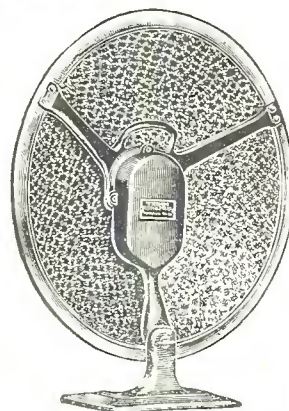

Rear view, showing handy handle, removable base and wall mounting bracket.

Trimm Cones are packed in special wire-bound wooden containers, assuring transportation and delivery in perfect condition.

TRIMM Concert Speaker—a wonderful horn, 22 inches high, with 15-inch bell, \$25.00.  
TRIMM Entertainer, horn 19½ inches high, with 12-inch bell, \$17.50.  
TRIMM Home Speaker, stands 18 inches high, with 12-inch bell; a tremendous value at \$10.00.  
TRIMM Professional Headsets. Used by Dr. Donald McMillan in his last three Arctic expeditions, \$5.50.

**TRIMM**  
RADIO MANUFACTURING COMPANY  
847 W. Harrison St.  
CHICAGO  
U.S.A.  
ESTABLISHED 1922



# Acme ANTENNA

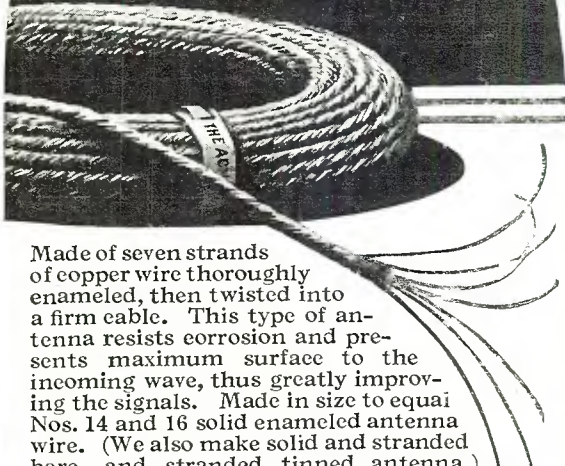

Made of seven strands of copper wire thoroughly enameled, then twisted into a firm cable. This type of antenna resists corrosion and presents maximum surface to the incoming wave, thus greatly improving the signals. Made in size to equal Nos. 14 and 16 solid enameled antenna wire. (We also make solid and stranded bare, and stranded tinned antenna.)

### Acme Loop Antenna

Sixty strands of No. 38 bare copper wire for flexibility, 5 strands of No. 36 phosphor bronze to prevent stretching. Green or brown silk covering; best loop wire possible to make.

### Acme Flexible Celatsite

A cable of fine, tinned copper wires with non-inflammable Celatsite insulation. Ideal for sub-panel or point-to-point wiring. Strips easily, solders readily. Nine beautiful colors; sold only in 25 ft. coils, in cartons colored to match contents.



### Acme Solid Celatsite

Tinned copper bus bar hook-up wire with non-inflammable Celatsite insulation, in 9 beautiful colors. Strips easily, solders readily, won't crack at bends. Sizes 14, 16, 18, 19; 30 inch lengths.



### Acme Spaghetti Tubing

Oil, moisture, acid proof; highly dielectric —used by leading engineers. Nine colors, for wire sizes 12 to 18; 30 inch lengths. (We also make tinned bus bar, round and square, in 2 and 2½ ft. lengths.)

### Acme Battery Cable

A rayon-covered cable of 5, 6, 7, 8 or 9 vari-colored Flexible Celatsite wires for connecting batteries or eliminator to set. Plainly tabbed; easy to connect. Gives set an orderly appearance. One to a box, with or without terminals.



Send for Folder

Dealers—Write Dept. C for catalog inserts and discounts  
**THE ACME WIRE CO.**  
 Main Office and Works, NEW HAVEN, CONN.  
 Branches at  
 New York, 52 Vanderbilt Ave., Chicago, 427 West Erie St.  
 Cleveland, Guardian Bldg.

(Continued from page 166)

may be used either on baseboard models or above or below the sub-panel.

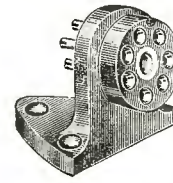

With the demand for sub-panel construction, the sub-panel type of plug which is shown below is designed by Hagel to simplify receiver wiring. As in the previous model noted, the plug is made entirely of bakelite and the color code marking is stamped directly on the bakelite so that the builder does not have to worry about losing a color.

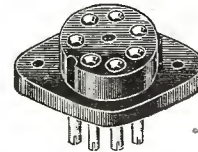

In the illustration below is shown the Hagel cable head, the housing of which is also made of bakelite, while the pin separator is made of the same material.



On account of the bakelite construction, the units will not be affected by heat or moisture, will not deteriorate with age, will not corrode the contacts and will not burn when exposed to heat.

These items are manufactured by Eugene A. Hagel, 1035 East 76th Street, Chicago, Illinois.

## Karas Set Conversion Method

Converting present battery operated receivers to true alternating current operation is now possible by the simple expedient of using the new Karas AC Former and the new Carter adaptor cable harness, the former being illustrated below.

All that is necessary to do is to take out the present battery operated tubes, insert the adaptors, attach the other end of the cable harness to the Karas AC Former and put in the alternating current tubes.

Different harness arrangements are available for various receivers.

The Karas AC Former represents the results of careful engineering and painstaking workmanship. Correct voltages for the operation of the standard 1½, 2½, 5 and 7½ volt tubes are

(Continued on page 170)

## The Big Friendly Radio House Complete Parts "New" Browning-Drake with Power Supply

WHEN you get our 1928 Catalog, you can have popular, nationally-advertised kits, parts, eliminators and accessories at prices that are real values.

Our dealer catalog, which lists everything in radio, means more real profit for you. Standard quality at the right price.

Write for our big Catalog

**WESTERN RADIO MFG. CO.**  
 128 West Lake St. Dept. MO Chicago, Ill.

**ACME WIRE**  
 MAKES BETTER RADIO



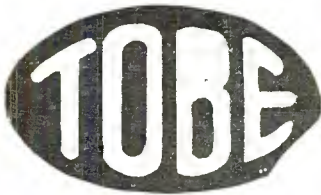

Trade Mark Reg'd U. S. Pat. Office



Filter No. 1

# RADIO Interference FILTERS

## Tobe Radio Interference Filter No. 1

Radio interference from household motors on oil burners, under-grate blowers, electric refrigerators and elevators,—has been the source of widespread annoyance. Smaller motors on vibrators, sewing machines, etc., also cause a great deal of trouble.

In its RADIO INTERFERENCE FILTER NO. 1 Tobe Deutschmann Company presents a small and compact piece of equipment, for use with household appliances employing power up to and including ½ H.P. This covers the usual range. Its design incorporates means for prevention of damage to commutators which may occur when condensers only are used, and was developed by Sewall Cabot, member I.R.E.

The TOBE RADIO INTERFERENCE FILTER NO. 1 is intended to be connected directly to the interference appliances and **not** to the Radio set. In the case of motors, it should be cut in close to the brushes. A wiring diagram is printed directly on the label which makes its connection easy and simple. Five leads are provided, so that no additional wire is required. Wire and case conform to standard code practice.

**Price: Tobe Radio Interference Filter No. 1, \$10.00**

*Send for Pamphlet C-1*



Filter No. 2

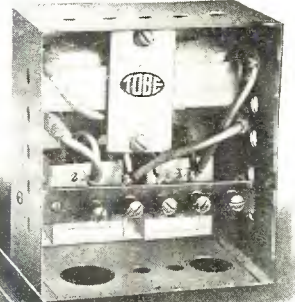

## Tobe Radio Interference Filter No. 2

The TOBE Radio Interference Filter No. 2 is a newly developed piece of Power Equipment which will handle motors and other appliances up to 5 H.P. at 220 volts.

It is built in accordance with code requirements, in a ventilated metal box, for attachment to wall or machinery. The equipment is not enclosed in wax, but is entirely in the open, so as to be properly cool. Terminals are brought out to a Bakelite terminal strip with heavy screw posts, and cutouts are provided in the bottom of the box, for attachment to standard BX or Conduit.

A complete wiring diagram is supplied inside the covers.

Designed for house elevator motors, motor generator sets, and other types of interfering electrical apparatus too large to be handled by the No. 1 Filter.

Finished in the characteristic TOBE silvered finish.

**Price, \$15.00**

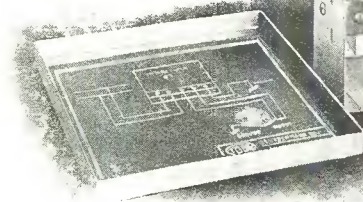

**TOBE DEUTSCHMANN COMPANY,**

Engineers & Manufacturers of Technical Equipment

Cambridge, Mass.

We are now offering a Vacuum Tube Static Characteristic Test Set for the new A. C. Tubes. Rugged in construction, ease in operation and accurate in results. Accommodates all makes and types of A.C. Tubes having filament voltages up to 15 volts.

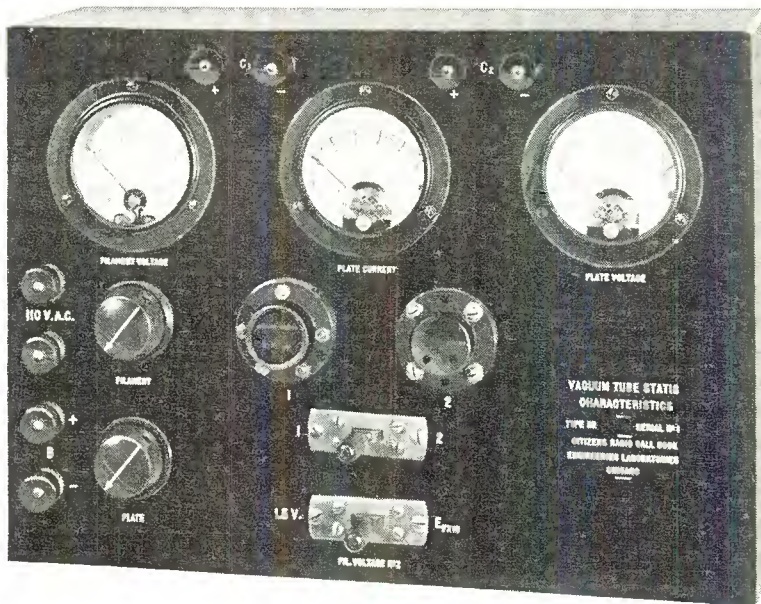

We also have available a Vacuum Tube Static Characteristic test set for the new Shielded Grid tube types UX-222 and CX-322. Also combinations of Shield-Grid and A. C., Shield-Grid, A.C. and D.C. Tubes. Prices and information on request.

*We are equipped to do any type of measurement or calibration work*

**CITIZENS RADIO ENGINEERING LABORATORIES**

Dept. C2—508 South Dearborn Street

Chicago, Illinois



# The right speaker for YOUR set!

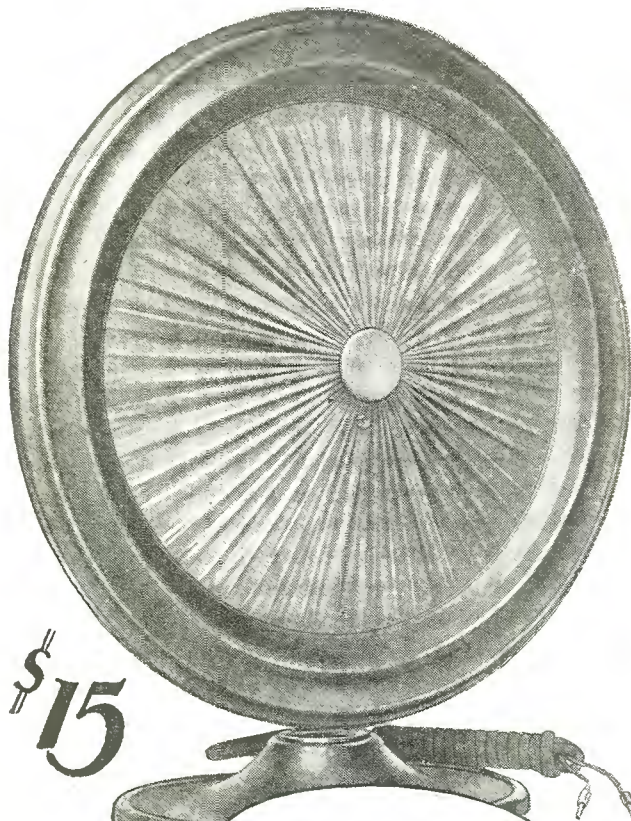

\$15

## The SONOCHORDE Junior

WHY bother experimenting any more? Here's *absolute satisfaction* in a radio speaker! Its smooth-as-velvet tone qualities will amaze you. Sonochorde faithfully reproduces any program—whether local or far distant. And Sonochorde beauty equals its performance! Its rich silk front and mahogany finished frame win instant approval. Get the best in radio—a Sonochorde!



Model A—2 slightly larger. Like the Junior, it has a silk front and protected back—greater volume, more decorative. A Masterpiece.

*If your dealer cannot supply you, send check or money order and we will ship one to you immediately.*

**BOUDETTE MFG. CO.**  
Chelsea, Mass.  
Dept. F

(Continued from page 168)  
assured. The AC Former is made by the Karas Electric Co., 4026 N. Rockwell Street, Chicago, while the harness for the conversion of battery receivers to alternating current receivers is

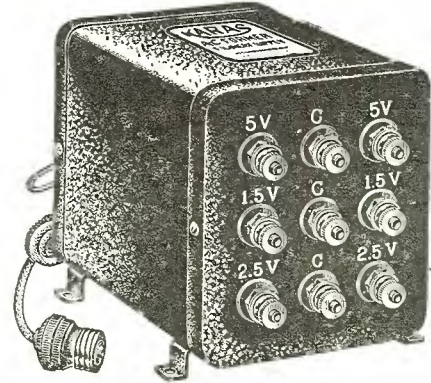

manufactured by the Carter Radio Co., 300 South Racine Avenue, Chicago.

### Placing Speaker to Best Advantage

Programs now available have become so great that they deserve the finest speaker radio science can construct.

In choosing a speaker suitable for the best reproduction, care and thought are required. But after all, the speaker alone is not all that is required. The location of the speaker within the home requires additional attention.

It is a well known fact that a speaker located directly above or on the radio set itself is not desirable. A simple test of this is to place the speaker first on the left of the set and then on the right; it will be noticed that distortion will occur when the speaker coils come within the radio frequency field of the r.f. tuning units.

As most speakers are equipped with a short cord, it is impossible to locate the speaker very much further away from the set than a few feet.

This, however, can be easily overcome; merely connect the speaker cord tips to a Birnbach extension cord connector and with the aid of a Birnbach extension cord of 10, 20, 30, 40, 50 or 100 feet, place the speaker in any part of the room which is not only appealing to the eye but also produces the ideal acoustic values.

The cord may be hung on small cup hooks on the wood work and will not be unsightly or cause anyone to trip over it.

### Sterling 6 Volt Socket Power

In the perfected R-93 "Dri-A" 6 volt unit, Sterling engineers have satisfied the demand for a socket power having capacity, reliability, convenience, and popular price.

The heart of this unit is a dry electro-static type condenser,  
(Continued on page 172)

# CARTER PARTS

Prevail in the better circuits among which are:

- |                                   |                        |
|-----------------------------------|------------------------|
| Bremer-Tully AC Power Six         | Harkness Counterphonic |
| Lynch-Hammarlund Five             | Vitrohm DC Eliminator  |
| Karas AC Equamatic                | Tyrman Amplimax 70     |
| Bodine Electric                   | Aero-dyne AC           |
| Silver-Marshall Shielded Grid Six |                        |

As described in this issue

Any dealer can supply



In Canada: Carter Radio Co., Ltd., Toronto

**CARTER RADIO CO., Chicago**



*Yes Sir!*

I've been making a nice little living two years now, making Radio for my friends.

When those NATIONAL Power Transformers and Chokes came out, I didn't have to be sold.

Why.—I knew all about NATIONAL CO., anyway—they put the BROWNING DRAKE on the map. Yes—I must have made over 200 B-D sets, all with NATIONAL Stuff. They were first.

Well—so I'm using the NATIONAL Power Units—and say,—they're right, too! Making a new B-Power Unit now—the Tru-volt B-Supply.

Has it NATIONAL Stuff in it?

**Yes Sir!**

I always use the genuine.

**NATIONAL  
RADIO PRODUCTS**

*Write for Bulletin C-124*

**NATIONAL CO., INC.**

**W. A. READY, PRES.**

**MALDEN, MASS.**



**NATIONAL Power Transformer**

A heavy-duty transformer for 110-120 volts, 60 cycles A.C. Capable of handling the largest sets. Center tapped 7.5 and 5 volt secondaries are provided for filaments of both UX-210 and UX-171 Power Tubes. Made in two types—Type R has 300 volts secondary each side of center. List price, \$12.50. Type U has both 300 and 230 volts each side of center. List price, \$14.50.

**NATIONAL No. 80  
Filter Chokes**

Two heavy chokes in single case to match NATIONAL Power Transformer. For use in filter circuits of B-Power Supplies and Power Amplifiers. Cased to match the NATIONAL Power Transformer. List price, \$10.00.

**In the Season's Best Sets**

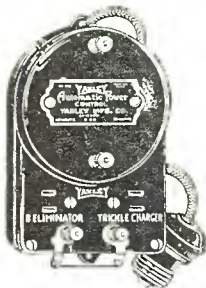

**Automatic Power Control**

Switches on the B eliminator and cuts out the trickle charger when you turn on the set. The B eliminator is cut out automatically and the trickle charger cut in when the set is turned off. Controls both B eliminator and trickle charger in combination or switches either eliminator or charger separately when either is installed alone.

No. 411—Series Type.....\$5.00

**YAXLEY MFG. COMPANY**  
Dept. C, 9 So. Clinton St.  
Chicago, Ill.

**YAXLEY**  
APPROVED RADIO PRODUCTS

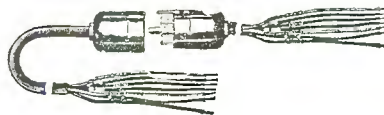

**Cable Connector Plug**

Just take this article in your hands but once and you will be completely sold on its many merits. It will enable you to turn a messy maze of battery connections into one neat, compact, good looking job. Has polished Bakelite plug with phosphor bronze contact springs that assure positive contact at all times.

No. 660—Cable Connector Plug, complete .....\$3.00

No. 670—For Binding Post Connections, complete ..... 3.50

**FEATURED IN  
the Most Prominent  
HOOKUPS INCLUDED  
IN THIS ISSUE**

Magnaformer  
A. C. Aerodyne 6  
St. James Twin 4  
Madison-Moore International One Spot  
Tyrman Amplimax 70  
Karas A. C. Equamatic

**Reliable in Operation**

**Air-Cooled Rheostat**



This Rheostat possesses a smooth, quiet action, with an extremely close adjustment that permits building up of filament voltage to just the right point and keeps it there throughout reception. Base is of Bakelite, as is also the knob furnished with every Rheostat.

Air-Cooled Rheostat—2 to 100 ohms.....\$1.35



**Midget Battery Switch**

An efficient filament control switch. Quick make and break. Furnished complete with "Off" and "On" Plate, as illustrated. This switch is standard equipment in over a million of the best sets in use today.

No. 10—Midget Battery Switch.....50c

**Radio Convenience  
Outlets**



These Convenience Outlets make it easy to have the radio set in one room and the batteries in the basement or closet, and one or more loud speakers in any distant room of the house. Plug for battery connections cannot be inserted incorrectly.

No. 135—For Loud Speaker.....\$1.00

No. 137—For Battery Connections..... 2.50

No. 136—For Aerial and Ground..... 1.00



# There's money for you in RADIO

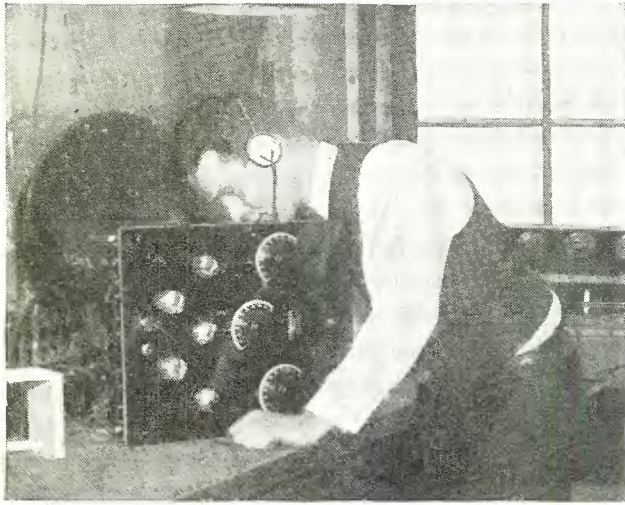

**Wonderful opportunity for ambitious men to win success in this fast-growing profession**

The Radio industry is expanding so rapidly that trained men are at a premium. There is a constant, urgent demand for operators—factory superintendents—engineers—service men—designers—salesmen.

There is no better way for you to succeed in this fascinating business than to study the Radio Course of the International Correspondence Schools. This course is new and complete. It was written by practical authorities in this field. It is endorsed by leading radio experts and radio manufacturers.

Quincy J. Workman, of Scranton, Penna., writes that he has "nearly doubled his salary" since he took up the I. C. S. Radio Course. He is now manager of the Radio Department of a large store.

J. B. McCune, of Donora, Penna., writes that the I. C. S. Radio Course enabled him to start a radio business of his own. This same course enabled John M. Paynter, of the U. S. Lighthouse Service, Charleston, S. C., to get a position as Radio Operator and Ship's Electrician. Scores of other men in radio factories, laboratories and stores report similar progress.

You, too, can get in on the ground floor if you act quickly. But don't delay too long. Mark and mail the coupon today and let us tell you all about the I. C. S. Radio Course and what it can do for you.

**Mail the Coupon for Free Booklet**

INTERNATIONAL CORRESPONDENCE SCHOOLS  
Box 8318-C, Scranton, Penna.

Without cost or obligation, please tell me how I can qualify for the position or in the subject, before which I have marked an X:

**RADIO**

- |   |  |
|---|--|
| <input type="checkbox"/> Electrical Engineering | <input type="checkbox"/> Architect               |
| <input type="checkbox"/> Electric Lighting      | <input type="checkbox"/> Architects' Blueprints  |
| <input type="checkbox"/> Mechanical Engineer    | <input type="checkbox"/> Contractor and Builder  |
| <input type="checkbox"/> Mechanical Draftsman   | <input type="checkbox"/> Architectural Draftsman |
| <input type="checkbox"/> Machine Shop Practice  | <input type="checkbox"/> Concrete Builder        |
| <input type="checkbox"/> Railroad Positions     | <input type="checkbox"/> Structural Engineer     |
| <input type="checkbox"/> Gas Engine Operating   | <input type="checkbox"/> Chemistry               |
| <input type="checkbox"/> Civil Engineering      | <input type="checkbox"/> Automobile Work         |
| <input type="checkbox"/> Surveying and Mapping  | <input type="checkbox"/> Airplane Engines        |
| <input type="checkbox"/> Metallurgy             | <input type="checkbox"/> Navigation              |
| <input type="checkbox"/> Steam Engineering      | <input type="checkbox"/> Agriculture and Poultry |
| <input type="checkbox"/> Pharmacy               | <input type="checkbox"/> Mathematics             |

**BUSINESS TRAINING COURSES**

- |   |   |
|---|---|
| <input type="checkbox"/> Business Management            | <input type="checkbox"/> Salesmanship           |
| <input type="checkbox"/> Industrial Management          | <input type="checkbox"/> Advertising            |
| <input type="checkbox"/> Personnel Organization         | <input type="checkbox"/> Better Letters         |
| <input type="checkbox"/> Traffic Management             | <input type="checkbox"/> Show Card Lettering    |
| <input type="checkbox"/> Business Law                   | <input type="checkbox"/> Stenography and Typing |
| <input type="checkbox"/> Banking and Banking Law        | <input type="checkbox"/> Business English       |
| <input type="checkbox"/> Accountancy (including C.P.A.) | <input type="checkbox"/> Civil Service          |
| <input type="checkbox"/> Nicholson Cost Accounting      | <input type="checkbox"/> Railway Mail Clerk     |
| <input type="checkbox"/> Bookkeeping                    | <input type="checkbox"/> Common School Subjects |
| <input type="checkbox"/> Private Secretary              | <input type="checkbox"/> High School Subjects   |
| <input type="checkbox"/> Spanish                        | <input type="checkbox"/> Illustrating           |
| <input type="checkbox"/> French                         | <input type="checkbox"/> Cartooning             |

Name \_\_\_\_\_  
Address \_\_\_\_\_

(Continued from page 170)

similar in action to that in the approved "B" power units. This compact condenser—the creation of Sterling's own laboratories—is made from foil and specially processed paper. Combined with chokes in the unit, it possesses remarkably high capacity. It delivers three amperes, at normal rate.

The Sterling "Dri-A" unit is designed to use the new full

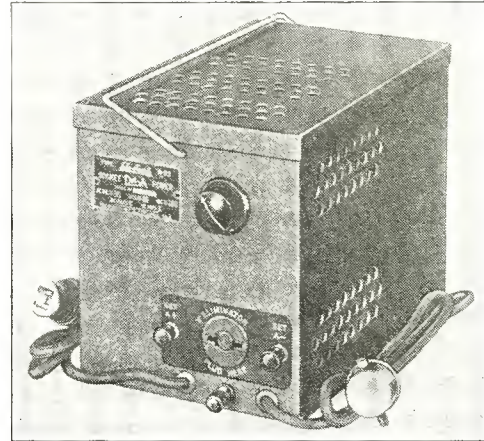

wave Tungar bulb, which delivers the smoothest possible filament supply, and produces the least possible hum. Long experience has proved the great reliability of this type rectifier.

Months of continuous service of the R-93 "Dri-A" on the larger sets have proved its ability to deliver continuous current without any attention whatever.

Sterling engineers have answered the question of voltage control by the use of a reliable voltage-limiting cutout. The exact amount of voltage for any number or combination of tubes consuming up to 3 amperes of current is adjusted by rheostat. This rheostat adjustment not only insures full six volts at the tube filaments, but in localities where the house lighting supply drops below normal voltage a slight turn of the rheostat will fully compensate low a. c. line voltage.

The R-93 operates from 115 volts, 60 cycle, A. C. 6 volts, 3.0 amperes. Size—7x11x8 inches high. Net weight, 23½ lbs. Lots of six, shipping weight, 165 lbs. List price Sterling R-93 "Dri-A" including 3-ampere full wave bulb, \$39.50.

## Sterling "B-C" Power Supply

This universal model Sterling "B-C" unit will operate any radio set using up to 100 milliamperes—without hum. Maximum voltage is 180 volts. "C" voltage 40 volts. Independent and variable voltage regulation is provided for both detector and r. f.



**FLECHTHEIM**  
*Superior*  
**Condensers**



**FLECHTHEIM**  
**FILTER**

**By-Pass—Filter**  
**Buffer**  
**High Tension**  
**Transmitting**  
**All Standard Sizes**  
**Accurate Capacity**  
**Rating—Dependable**  
**for Continuous Duty**

Write for Catalogue

**A. M. FLECHTHEIM & CO., Inc., Dept. CB**  
136 Liberty Street  
New York, N. Y.



# ACCURATE TO 1-5 of 1%

THE rated inductance of some of our coils are really accurate to 1/5th of 1%. All of them are accurate to 1%. That is why Precision *Diamond Cut* Coils are better. That is why you can use them in gang condenser work. Wherever accuracy is desired you will more and more see Precision *Diamond Cut* Coils specified. The diamond cut bakelite form assures a rigid coil and accurate spacing. Rigidity of the form is particularly necessary in gang condenser work.

## The Citizens Shielded Five Uses A Precision *Diamond Cut* Coil



Type  
3B  
\$3.75

The engineers wanted only the best material in the set which was to bear the name of this magazine. Therefore they picked a Precision *Diamond Cut* Coil. You will see our coils specified in many other circuits. When you have Precision Coils in your set you **know** the coil is right.

Send for our new catalogue

**PRECISION COIL CO., Inc.**

207 Centre Street

New York, N. Y.

# When you need Resistance

WHETHER for power unit or set, just think of Clarostat. It's reliable—just as reliable as any wire-wound resistance, when used within its rated current-carrying capacity. It provides exact resistance required—not a few ohms above or below, but the exact value to the ohm. And it stays put, although always ready to correct for changes in the radio circuit.



VOLUME CONTROL  
**CLAROSTAT**

A little fellow but a giant for work in the radio set. Compact, neat, convenient, with 0-500,000 ohm range in several turns of knob. Micrometric adjustment. One-hole mounting. Convenient screw terminals. Many applications in present-day sets. Price, \$1.50.

### Standard Clarostat

The "old reliable" in B-power units and receivers. Compact, neat, 0-5,000,000 ohm range in several turns of knob. Micrometric adjustment. One-hole mounting. Convenient clip and screw bracket terminals. Supplied with mounting bracket for base-board mounting. Ideal for voltage control in B-power units. 20-watt rating. Price, \$2.25.

### Power Clarostat

The big brother of Clarostat family. Husky enough for real work in A-B-C power units. A.C. tube control, line-voltage control, power amplifiers, and in electrified sets in general. Available in three ranges — 0-10, 25-500, and 200-100,000 ohms. Range covered in several turns of knob. Micrometric adjustment. Screw terminals. One-hole mounting. 40-watt rating. Price, \$3.50.

Be sure you get **GENUINE** Clarostats—in the green box and stamped with the name Clarostat on the shell. Don't be fooled by imitations, which do not extend beyond general appearance.

Ask your dealer to show you the three types of Clarostats and to give you literature. Or write us direct.

**AMERICAN MECHANICAL LABORATORIES, Inc.**

Specialists in Variable Resistors

285 N. Sixth St. : : Brooklyn, N. Y.



# Set Builders—Dealers!

We want **ONE** live-wire in every town to become a **Thompson Super Seven**—official service station—are you the man? We have an interesting proposition to those selected. Wire or write air mail today—Attention salesmanager

### The Thompson Super Seven

Is startling setbuilders all over the country with its phenomenal ability to get distance through locals. Too much power is the verdict of every builder, with tonal quality that's a revelation.

#### 10 K.C. Selectivity

Selectivity that's positive, not on one station but on all. Stations snip in one after another. The heart of the receiver—Halldorson long wave transformers are designed to give high amplification over a narrow band of only ten K.C. The selectivity is such that interference from local stations while receiving distance is impossible. Thirty to forty out-of-town stations through Chicago locals is easy, small stations you've never heard before.

#### Greater Distance

You'll get greater distance than you ever dreamed possible with any receiver. Think what it means to have stations from coast to coast pound in just like locals. The Thompson Super Seven will get them for you. Read about Halldorson Transformers and judge for yourself why.

#### Easy to Sell

You know how easy it is to sell your pet receiver—the one you use yourself. That's how easy it is to sell every Thompson Super Seven, especially when you consider that it's the lowest priced quality kit on the market. Get your parts today, a few hours' work, and you have the finest performing receiver money can buy.

#### Audio and Output Transformers

Halldorson transformers are built different than

other transformers. A new method of construction, a silicon steel core built up of one-piece laminations not only enables us to build them of moderate size but delivers that one essential requirement of perfect reproduction—amplification of overtones.

#### Overtone Amplification

Overtone amplification is the ability of the transformers to amplify the weak overtones of both music and speech with true fidelity. In Halldorson Overtone transformers there is no over-accentuation of any frequencies, but perfect amplification over the entire audio range.

#### Will Improve Any Set

If your receiver does not give the tonal quality you would like, or if you want the finest tone quality with terrific power, use Halldorson Overtone audio and output transformers in every receiver you build. Halldorson transformers are being used by the largest set manufacturers in the country. What better proof of their merit?

#### Halldorson Long Wave Transformers

Precision methods make possible a transformer with a tremendously high gain per stage. Peaked between 41 and 45 K.C. they may be used in any receiver using long wave transformers. They will increase the amplification of the intermediate amplifiers several hundred times.

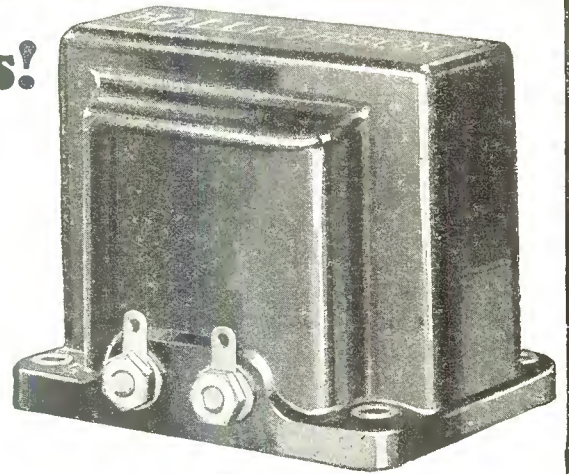

# Halldorson Overtone *Audio* Transformer

Get the facts today on all Halldorson precision products—mail the coupon.

Enclosed find two cents in stamps for complete data on the Thompson Super Seven and Halldorson Overtone Transformers.

Name.....

Address.....

**THE HALLDORSON COMPANY**

Factory: 4745 N. Western Ave.

Chicago, Ill.—Office, 607 Brooks Bldg.



## No More Short Circuits!

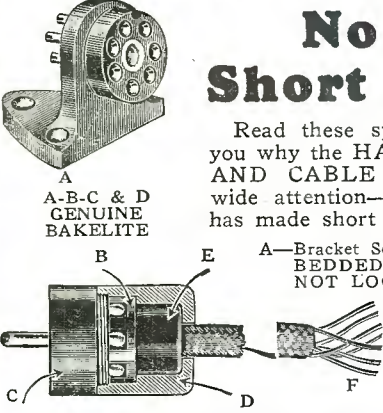

Read these specifications! They tell you why the HAGEL POWER PLUG AND CABLE is attracting country-wide attention—and show you how it has made short circuits impossible!

**A**—Bracket Socket. PINS FIRMLY EMBEDDED IN BAKELITE—WILL NOT LOOSEN IN SOLDERING.

**B**—Insulator (Leak-Proof) PROJECTIONS SEPARATE CONTACTS—IMPOSSIBLE FOR STRAY WIRES TO SHORT CIRCUIT.

This Insulator cannot rotate on soldered heads, consequently NO CIRCULAR FILM OF SOLDER CAN FORM ON IT CONNECTING CONTACT HEADS.

**C**—Contact Mounting, Pilot and Key.  
**D**—Cap.  
**E**—Soft Rubber Bushing compressed around Braid of Cable. PREVENTS TWISTING OF CONDUCTORS AND RELIEVES SOLDERED CONNECTIONS OF ALL PULL STRAIN.  
**F**—Seven Conductor Cable. Wires in colored rubber RMA Standard Colors. BROWN BRAID.

### HAGEL POWER PLUG & CABLE

U. S. and Foreign Patents Pending

Plug and Cable Only.....	\$2.25
Sockets: Bracket Mounting.....	.75
Flush Mounting.....	.30
Binding Post.....	1.25
Wall Outlet.....	.75

—and these important features are not combined in any other plug

## EUGENE A. HAGEL

1035 East 76th Street Chicago, Illinois

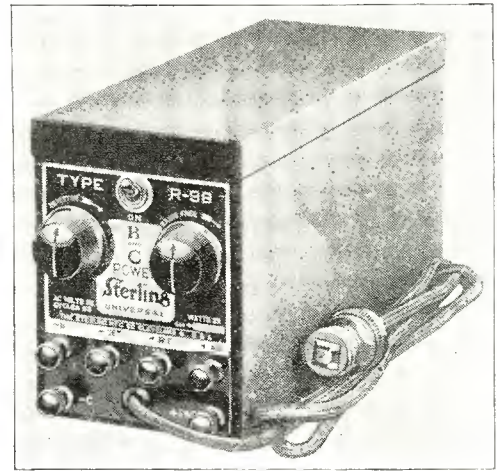

Price without tube, \$33.50. B H Raytheon Tube, \$4.50. Made by the Sterling Manufacturing Company, 2831-53 Prospect Avenue, Cleveland, Ohio.

### Acme Single Free-Edge Cone

The Acme Apparatus Co., 37 Osborn Street, Cambridge, Massachusetts, have recently developed in their research laboratories a smaller speaker than their standard, having a single free-edge cone of 11 inches in diameter. All the faithfulness of reproduction inherent in their double free-edge cone is maintained in this unit, which is illustrated below.



The actuating unit is of different design, but of the same rugged construction. As with the other models, plate currents up to 25 milliamperes may be safely used, the manufacturers stating that the DC component of the current is an aid to the operation of the speaker.

## 6 TUBE SUPERPHONIC

Radio ALL PARTS MOUNTED

All Metal Chassis Shielded Ready to Wire

Only \$16.95

Can be wired in a few minutes

**FREE!**  
6 TUBES  
UX 201-A TYPE  
Tested and Matched

COAST TO COAST RECEPTION

An amazing value that can't be beat! Latest 6-tube tuned radio frequency circuit. Extremely selective, marvelous sensitivity. Three stages of radio frequency, detector and two stages of low ratio audio frequency, for improved tone quality. Two-way control. Straight line frequency condensers. All metal chassis. Shielded. Clear and realistic reception guaranteed. Beautiful black front panel (7"x18"); ornamental design, degree and kilocycle markings in gold. Metal panel and sub-panel. Complete chassis. No extra parts to buy. All parts mounted. Simply connect a few wires. No special tools needed. Kurz-Kash indicator knobs. New type UX sockets. All hook-up wire and colored battery cable included. Value \$60.00, our price \$16.95.

### SIMPLE WIRING DIRECTIONS

Very easy to wire this set with the instructions we furnish. Just connect a few wires. All you have to do is to follow numbers. That is all. Can be wired in a few minutes by anyone. No radio knowledge needed. Make money by wiring these sets in your spare time and selling them to your friends.

NO RADIO KNOWLEDGE NEEDED!

## SEND NO MONEY

Just write your name and address on a post card and ask us to send you this great outfit together with 6 tubes. We will ship them right away. When they arrive, pay only \$16.95 plus a small delivery charge. (Foreign countries send \$19.50 with order. We pay shipping charges.)

**RADIO EQUIPMENT CO.** 549 South Wells Street  
Dept. 1, Chicago, Ill.

# -KITS-

**Headquarters on Following Circuits**  
GET OUR WHOLESALE PRICES FIRST

The Aero A. C. Seven	Browning-Drake
Remler A. C. Super	High Frequency Lab.
Silver-Marshall Universal	Magnaformer
Hammarlund-Roberts Hi-Q Six	Truvolt B Power Supply Unit
World's Record Super Ten	Tyrman Amplimax "70"
Phasatrol De Luxe	Lynch-Hammarlund "5"

**1928 NEW CATALOG—JUST ISSUED**  
Mail orders promptly filled—24 hour service assured. Get this new 1928 catalog issued. Use Keystone service.  
Full Line of Cabinets, Consoles and Tables

**KEYSTONE RADIO COMPANY**  
111 North 4th Street, PHILADELPHIA, PA.





# PARVOLT

## WOUND CONDENSERS

IT is not "horse sense" to jeopardize the success of a circuit or the investment made in the parts by the use of inefficient by-pass or filter condensers.

Parvolt Wound Condensers are made in three service voltage ratings and in a wide variety of capacities and styles. Use them wherever the circuit calls for capacity. Their use is assurance of

Continued accuracy within 10 per cent of rating.

Continuous duty at full rated voltage.

Available in capacity and voltage ratings suitable for all radio and audio frequency by-pass and filter work.

Series A 400 Volt Duty	Mfds.	Series B 800 Volt Duty
\$0.85	0.1	\$1.25
.95	0.25	1.50
1.00	0.5	2.00
1.25	1.0	2.50
2.25	2.0	3.50
4.00	4.0	6.00

**Series C—1,000 Volt Duty**

1 Mfd.—\$5.00; 2 Mfds.—\$7.00; 4 Mfds.—\$12.00. Buffer Condensers 0.1 Zero—0.1 Mfd.—\$1.75.

CONDENSER GROUPS		List
For R171	.....	\$12.00
For R210	.....	15.00
Raytheon ABC	.....	17.50
Q. R. S. (400 mil. tube)	.....	19.00
Special 4-4-2-2-1-1	.....	13.00

# Tyrman "70"

Shielded Grid Amplimax

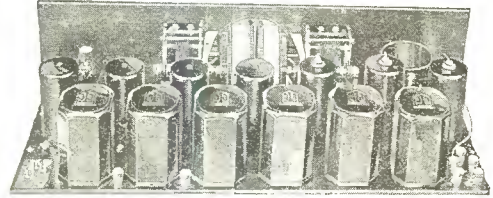

THE Tyrman "70" Amplimax Receiver, using the newly developed shielded grid tube in a remarkably efficient impedance-coupled super-heterodyne circuit, is unquestionably the finest receiver ever developed and made available to the general public. Its combined sensitivity, selectivity, volume and marvelous tone-quality surpasses that of any other receiver of today. Actual demonstrations have proven 3000 mile loud-speaker reception on a 6 foot indoor antenna. The receiver is absolutely free from harmonics and covers the entire broadcast band with full volume on all stations. It has a positive 10 Kilocycle separation and will "cut through" powerful local stations in congested metropolitan districts such as Chicago and New York. The Tyrman "70" is surprisingly inexpensive in operation and actually uses only a fraction of the power required on other supers.

This receiver can be truly considered to be the superlative receiver which everyone has been waiting for. In fact it will completely satisfy the most critical in their expectations. All instruments are scientifically matched, subjected to the most rigid tests and fully guaranteed.

**List of Parts Required to Build the Tyrman "70" Receiver**

3—Tyrman Type 9-90 R.F. Impedance.....	\$12.50	\$37.50
1—Tyrman Type 9-80 Antenna Inductance....	3.00	3.00
2—Tyrman Type 3-30 Audio Transformers....	8.00	16.00
1—Tyrman Type 3-51 Power Output Trans. ....	10.00	10.00
7—Tyrman Shielded Sockets.....	1.25	8.75
1—Tyrman Double Vernier Drum Dial.....	10.00	10.00
1—Camfield .0005 Condenser, Single.....	6.00	6.00
1—Camfield .00025 Condenser, Single.....	5.50	5.50
1—Camfield Type 622 Oscillator Coupler.....	3.50	3.50
1—Yaxley 15 ohm Switching Rheostat 915K.....	1.75	1.75
1—Yaxley 4L Resistance.....	.15	.15
1—Yaxley 15 ohm Resistance.....	.15	.15
1—Yaxley No. 669 Cahle.....	3.25	3.25
1—Yaxley 25 ohm Rheostat.....	1.35	1.35
1—Yaxley Pup Jack.....	.15	.15
1—Hammarlund 50 mmf. Midget Condenser..	1.75	1.75
4—Carter 1 mfd. Condensers.....	1.25	5.00
1—Carter .001 Mica Condenser.....	.50	.50
5—XL Binding Posts.....	.15	.75
1—7x24 in. Front Panel Drilled.....	6.00	6.00
1—8x23 in. Sub Panel Drilled.....	5.50	5.50
1—Pr. Benjamin Brackets.....	.70	.70
<b>TOTAL.....</b>	<b>\$127.25</b>	

Special arrangements have been made with a prominent manufacturer of dry power units to supply a combination "A," "B," and "C" power device of superior design, for use with this receiver, if light socket operation is desired.

FURTHER DETAILS AND COMPLETE LITERATURE WILL BE IMMEDIATELY FURNISHED UPON RECEIPT OF 10c IN STAMPS.

## We Specialize in Super-Heterodyne Parts

*Distributors for*

SCOTT'S WORLD'S RECORD	MAGNAFORMER
TEN	MELO HEALD ELEVEN
TYRMAN TEN	MELO HEALD HOT-SPOT
TYRMAN "70"	FOURTEEN
VICTOREEN	HAMMARLUND-ROBERTS
AERO AC SEVEN	HI Q SIX
	KARAS EQUAMATIC

**We Are Wholesale Distributors of All Standard Radio Merchandise**

### DEALERS WANTED EVERYWHERE

*Write for Catalogue and Discounts*

## Nelson Electric Company

Telephone Wabash 8719

508 South Dearborn Street Chicago, Illinois

*Liberal Discounts—Immediate Deliveries*



**THE ACME WIRE COMPANY**  
New Haven, Connecticut





There's a real kick  
in these new audio  
transformers—

*volume, tone,  
and true  
reproduction  
combined*

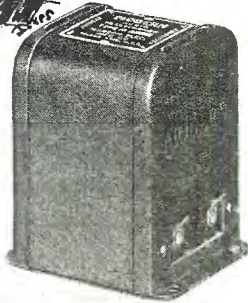

**MODERN  
Type M  
Transformers**

NEVER has the radio enthusiast been offered in one unit, such a splendid combination of audio amplifying characteristics as is found in the new Modern Type M Transformers. Large cores, high inductance, perfect proportioning of windings, and impedance to match the parts with which they must work, combine to produce faithful reproduction of all tone values and better volume. Use the coupon for complete information.

**MODERN**

**"B" Compact**

*Price Not Including  
Raytheon tube*

**\$26.50**

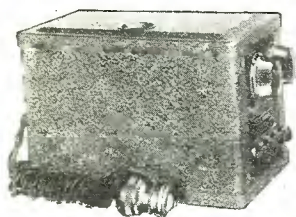

Don't continue to wonder whether or not a "B" power unit will operate your set satisfactorily. Write for the booklet that tells you how to use a "B" power unit and why a Modern "B" Compact will serve you better than any other "B" current supply. Designed and manufactured by engineers and proven dependable in daily use through two seasons.

**THE MODERN ELECTRIC MFG. CO.  
TOLEDO, OHIO**

The Modern Electric Mfg. Co., Toledo, Ohio. CB1

I enclose 2c stamp. Please send.....Type M Circuits,  
.....Booklet, "How to properly operate a B power unit."

Name.....

Address.....

City.....



**Arcturus A. C. Tubes**

Alternating current tubes fall into two general categories, the filament emitter, or "raw a. c." tube, and the filament heater type.

The Arcturus a. c. tubes fall in this last group. The filament heater operates from a potential of fifteen volts and consumes a current of .35 amperes. Aside from the electrical advantages of this design the volt ampere characteristics of the filament are of particular convenience to the enthusiast or service man altering receivers for a. c. operation. Also, it is quite practical to operate all heaters in parallel without the use of extra heavy leads, making it possible, in many instances, to utilize the original filament wiring of a receiver.

One side of the cathode is connected to the heater, adapting



the tube to the standard four prong UX base, again limiting the number of changes which must be made for a. c. operation.

The Arcturus tubes are made in four types, detector, amplifier, high Mu and power tubes, all of which are of the heater design. Potentiometers are thereby eliminated from the circuits, and consistent grid and filament wiring may be used throughout the circuit.

The filament heater of the Arcturus tube is of carbon, operating at a temperature considerably lower than that of the usual carbon incandescent light, thereby insuring exceptionally long life to the tube. While the tubes on life test as yet show no indication of approaching the end of their usefulness, comparison of the Arcturus filament consuming 4.5 watts to the candle power with a filament of the usual carbon lamp consuming 3.5 watts per candle power would indicate a theoretical life well in excess of 1,000 hours.

**The Big Friendly Radio House  
Complete Parts**

**World's Record Super  
Ten and Power Pack**

WHEN you get our 1928 Catalog, you can have popular, nationally-advertised kits, parts, eliminators and accessories at prices that are real values.

Our dealer catalog, which lists everything in radio, means more real profit for you. Standard quality at the right price.

*Write for our big Catalog*

**WESTERN RADIO MFG. CO.**  
128 West Lake St. Dept. MO Chicago, Ill.



**Colored Rubber  
Acid Proof  
Battery Cable**  
For Every Circuit and Purpose

These Battery Cables are composed of Stranded Wires insulated with Colored Rubber and enclosed in an attractive Braid over all wires. For use in connecting A, B and C Batteries or Eliminator to Set. Furnished with brass soldered lug terminals on all ends for neat and quick



attaching of cable to batteries or eliminator. Each wire of separate Solid Color. Made in 5, 6, 7, 8, 9 or 10 Wires.

110- 5 Wires 54 inches.....	\$0.50
111- 6 Wires 54 inches.....	.60
112- 7 Wires 54 inches.....	.70
113- 8 Wires 54 inches.....	.85
126- 9 Wires 54 inches.....	1.00
119-10 Wires 54 inches.....	1.15
114- 5 Wires 10 foot.....	1.25
116- 6 Wires 10 foot.....	1.55
117- 7 Wires 10 foot.....	1.85
118- 8 Wires 10 foot.....	2.15
127- 9 Wires 10 foot.....	2.45
128-10 Wires 10 foot.....	2.75

**Battery Connectors**

Made of Stranded Wires, insulated with rubber and covered with a distinctive braid. All ends assembled with brass soldered lug terminals to fit the binding post or clips on all batteries. A handy accessory for use in connecting Dry Cell "A" Batteries, B and C Batteries. Carton contains 25 of each size.

PC 3- 3-in. Connectors.....each.	\$0.04
PC 6- 6-in. Connectors.....each.	.05
RC 8- 8-in. Connectors.....each.	.06
RC12-12-in. Connectors.....each.	.07



# BIRNBACH

**Bakelite Tuners in Duco Colors**



Decidedly new and attractive. Make your set not only look better and different, but perform better. This 3-Circuit Tuner is wound on colored Bakelite and will improve any Circuit. A marvel for performance. Use BIRNBACH TUNERS for best tone quality, long range distance, and volume. Tuning range 200 to over 550 meters.

- 60. Red Bakelite Three Circuit Tuner for... .0005 Condenser..\$2.00
- 60. Green Bakelite Three Circuit Tuner for... .0005 Condenser.. 2.00
- 60. Red Bakelite Radio Frequency Coil for... .0005 Condenser.. 1.25
- 60. Green Bakelite Radio Frequency Coil for... .0005 Condenser.. 1.25
- 635. Red Bakelite Three Circuit Tuner for... .00035 Condenser.. 2.00
- 636. Red Bakelite Radio Frequency Coil for... .00035 Condenser.. 1.25

**"180" Bakelite 3-Circuit Tuner in Duco Colors**

This Tuner is larger in size than our No. 60 and in this form it is the most efficient TUNER ever designed. Distant stations can be tuned in with greater volume and the very best tone quality. For use with .0005 Mfd. Condenser. Tuning range 200 to over 570 meters.



- No. 180...BIRNBACH Colored Bakelite 3-Circuit Tuner.....\$3.50
- No. 180...BIRNBACH Colored Bakelite Radio Frequency Coil.... 1.50

If your dealer cannot supply you, write us

BIRNBACH RADIO CO., 254 West 31st St., New York City

**Loud Speaker Extension Cord Units**

You can move your Loud Speaker into any room desired—Bedroom, Kitchen, Dining Room, Baby's Room, Living Room. A BIRNBACH EXTENSION CORD UNIT improves the tone quality when power tubes are used, by placing the Speaker away from the Set. Made in six sizes and furnished complete with Connector.

166...10 foot, complete.....	\$0.75
120...20 foot, complete.....	1.00
121...30 foot, complete.....	1.40
122...40 foot, complete.....	1.80
123...50 foot, complete.....	2.20
124...100 foot, complete.....	4.20



**Replacement Cords**

These Five Foot Cords are to be used for replacement of worn Loud Speaker or Head Set Cords.



- 102...Loud Speaker Cord Pin Tips.....\$0.35
- 103...Loud Speaker Cord Pin and Spade Tips......35
- 106...Loud Speaker Cord Pin and Eye Tips......35
- 104...Head Set Cord Pin Tips......50
- 105...Head Set Cord Pin and Spade Tips......50
- 107...Head Set Cord Pin and Eye Tips......50

**'400' Bakelite Post Strip**

A new and convenient strip for sub-panel mounting, moulded in Bakelite with 9 characters engraved. Packed in individual cartons.

No. 400...Birnbaeh Bakelite Post Strip, each.....	\$0.65
---	--------

# A Family of Superior Radio Products

Recommended by the Leading Engineers

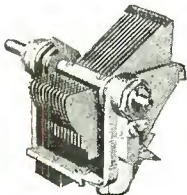

**The "Midline" CONDENSER**

Soldered brass plates with tie-bars; warpless aluminum alloy frame; ball bearings; bronze clock-spring pigtail; full-floating, removable rotor shaft permits direct tandem coupling to other condensers. Made in all standard capacities.



**Illuminated DRUM DIAL**

Makes single-control of multiple circuits practicable. Two circuits tuned as one, or individually. Translucent wave length scales illuminated from back. Beautifully embossed, oxidized bronze escutcheon plate gives distinction to panel.



**EQUALIZER**

For neutralizing R. F. circuits or equalizing multiple tuning units. Small size fits limited space. Bakelite base, mica dielectric, phosphor-bronze spring plate.

**HAMMARLUND PRODUCTS**

Are Officially Specified for the Following Circuits

Featured by CITIZENS RADIO CALL BOOK

- HAMMARLUND-ROBERTS HiQ Six
- EVERY-MAN FOUR
- LYNCH-HAMMARLUND
- KARAS A. C.
- EQUAMATIC
- HARKNESS
- COUNTERFONIC
- TYRMAN AMPLIMAX
- PHASATROL DE LUXE

Write for Folders

HAMMARLUND MANUFACTURING CO. 424-438 W. 33rd St. New York

For Better Radio  
**Hammarlund**  
PRECISION PRODUCTS

**Radio-Frequency CHOKE COIL**

Special winding and impregnating gives minimum distributed capacity for a given inductance and provides extremely high impedance to all broadcast frequencies. Distinctive Bakelite case. Two sizes: 85 and 250 millihenries.

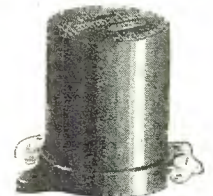

**The Improved "HAMMARLUND, JR"**

A new, high-ratio midget condenser with all the distinctive Hammarlund features—plus sturdier, simplified construction. Has new locking device for fixing rotor plates in any position. Knob included.

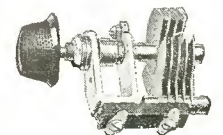

**New AUTO-COUPLE**

Specified for Hammarlund-Roberts HiQ Six Receiver. Essentially the same as previous model, but designed for use with the new Hammarlund Drum Dial.

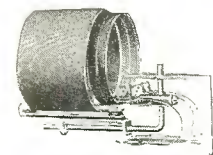

Tell 'Em You Saw It in the Citizens Radio Call Book Magazine



# DeJUR

## RESISTANCE SPECIALISTS

MANUFACTURERS OF ELECTRICAL AND RADIO  
RHEOSTATS, CONTROLLERS AND REGULATORS SINCE 1912

### CONDENSERS

Single - Double - Triple. In All Capacities

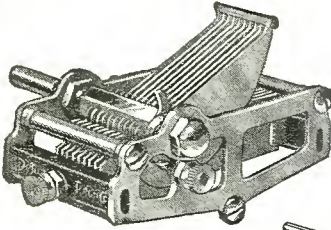

Moulded Bakelite insulation outside electrostatic field suspends stator plates which bear only on one point. Condenser frame grounded to rotor, eliminates all hand capacity. End tie bar of rotor plates keeps spacing uniform.

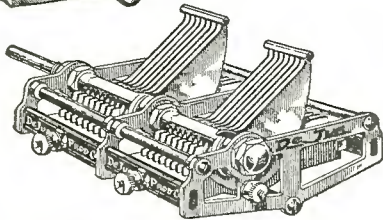

End plates of brass, finished in highly polished nickel. Direct electrical connection made from rotor to frame by spring phosphor bronze pig-tail connector. Small phase angle difference; low minimum capacity.

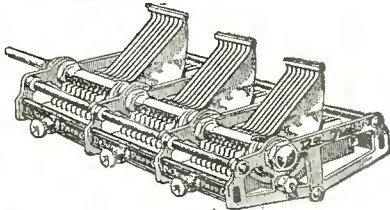

New Improved  
High Heat  
High Ohm  
High Watt  
Air-Cooled

### Power Rheostat

"With the Element That  
Cannot Burn Out"  
For Socket Power Sets and  
Eliminators

Designed and made specially for high current carrying capacities. Large refractory base. 2 3/4 in. diameter. Single hole mount.

Resistance element of best quality resistance wire (having lowest rising temperature co-efficient) wound on best grade India Mica imbedded in grooves, and covered with a high heat refractory cement, making the element permanent and everlasting, tightly fastened to the base.

Made in the following ohmage as standard: 2-3-5-6-10-15-20-30-50-100-200 Ohms. Also made up with an extra connection and used as a Potentiometer in any of the above ohms. Furnished complete with Bakelite knob.



### Combination Switch and Air Cooled Metal Rheostat

Simplifies the panel by eliminating switch. This new DeJur Rheostat acts as switch and volume control. It is sturdy and efficient and the metal frame will not bend or warp. Shaft alignment is permanent and contact perfect. One hole mount.

Write for new 1928 Catalog of all  
DeJur Guaranteed Radio Products

## DeJUR PRODUCTS CO.

199 LAFAYETTE STREET, NEW YORK CITY

## Regeneration and Impedance Coupling

(Continued from Page 133)

is recommended that the builder refer to the literature accompanying his particular 171 tube, so that the proper bias voltage may be determined for use with other voltages than 180 volts on the plate.

Operation of the receiver in congested metropolitan sections may make it necessary to keep the primary coupling of the first radio frequency transformer removed as far as possible from the secondary of this circuit to cut down interference. However, the same effect may be secured after a fashion by reducing the length of the antenna when the set is to be operated in a congested district. The manipulation of this coupling control which extends to the front panel of the receiver may also be used when it is desired to reduce the amount of volume secured from a given station, the reduction in volume being secured when the primary is farthest away from the secondary and conversely the greatest volume being secured when the two coils are closely coupled.

### List of Parts

Parts used in the construction of this receiver are shown in the accompanying list:—

- 2—Hammarlund .0005 mfd variable condensers
- 1—Hammarlund .00005 mfd midget condenser
- 2—"Every Man" twin-coupler coils
- 4—9040 Benjamin sockets
- 11—XL binding posts
- 1—3300 Muter audio transformer
- 1—3320 Muter audio transformer
- 1—2700 Muter output
- 1—1600 filament switch
- 1—3730 Muter 3 megohm grid leak
- 1—800 Muter grid leak mounting
- 1—305 Muter .00025 mfd grid condenser
- 1—301 Muter .0001 mfd fixed condenser
- 2—507 Muter .5 mfd by-pass condensers
- 1—2750 Muter radio frequency choke
- 3—1700 Muter Tubestats
- 1—1730 Muter Tubestat
- 1—1900 Muter Variall balancing condenser
- 1—Micarta 7"x21"x3/16" drilled and engraved panel
- 3—Sonatron type 201-A tubes
- 1—Sonatron type 171 tube
- 25—Ft. Belden flexible hook-up wire
- 1—Pkg. Kester radio solder
- 1—Ekko ground clamp

Miscellaneous—lugs, Nuts, Screws, etc.

## The Big Friendly Radio House Complete Parts

### Karas A. C. Equamatic

WHEN you get our 1928 Catalog, you can have popular, nationally-advertised kits, parts, eliminators and accessories at prices that are real values.

Our dealer catalog, which lists everything in radio, means more real profit for you. Standard quality at the right price.

Write for our big Catalog

## WESTERN RADIO MFG. CO.

128 West Lake St.

Dept. MO

Chicago, Ill.



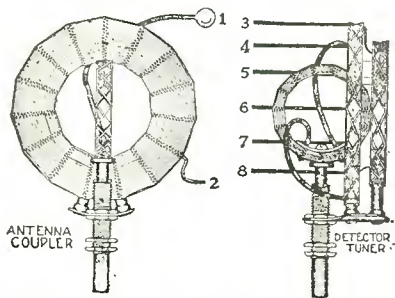

THE "LYNCH 5" model was built around SICKLES COILS. You can expect to duplicate the exceptional results only with the same SICKLES COILS. These are the same standard high quality accurately calibrated coils which have had no superior during the past five years. Specially designed for the "LYNCH 5."

**COIL SET NO. 28, \$4.50**

*There are Sickles Diamond Weave Coils for all leading circuits*

**THE F. W. SICKLES COMPANY**  
144 Union Street Springfield, Mass.

No. 30	Shielded Trans-former	Coil Prices \$2.00 each	No. 25	Aristocrat	Coil Prices \$8.00 set
No. 24	Browning-Drake	7.50 set	No. 28	Lynch 5	4.50 set
No. 18A	Roberts	8.00 set	No. 19	Acme Reflex	4.50 set
			No. 20	Craig	4.50 set

*The* **TEMPLE**  
*air column-speaker*

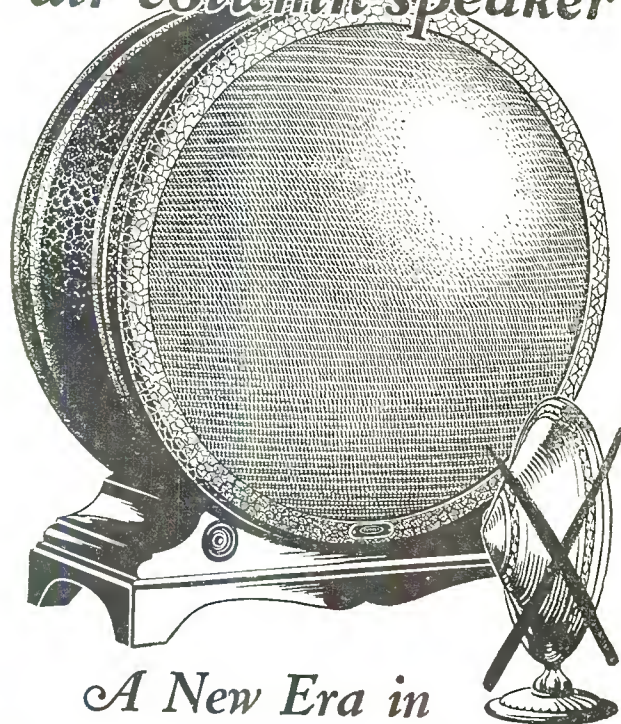

*A New Era in*  
**Tone Reproduction**

The TEMPLE SPEAKER ushers in a new era in tone reproduction that is today the sensation of the radio world. Its long air column principle has been developed by one of the foremost radio engineers—a man with a national reputation.

Radio fans and dealers by the thousands—from coast to coast—are switching to TEMPLE SPEAKERS. They insist on the best—that's TEMPLE—without an equal in richness and purity of tone. Ask your nearest dealer for a convincing demonstration on a TEMPLE COMPARATOR. You will agree that TEMPLE indeed has brought you something finer in speakers.

Temple Models Priced at \$29.00  
—\$48.50—\$65.00—\$85.00

**TEMPLE, INC.**  
213 S. Peoria St., Chicago

The Best Radio Set Made

Is Only as Good as Its Speaker



**NOT A CONE**

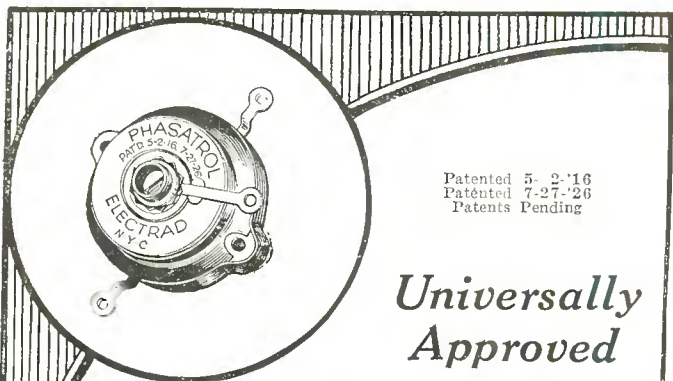

Patented 5-2-16  
Patented 7-27-26  
Patents Pending

*Universally Approved*

**"PHASATROL"**

Reg. U S. Pat. Off.

*A True Balancing Device for Radio Frequency Amplifiers*  
**\$2.75**

In a receiver of new design, fans often find the simple way to solve the neutralization problem is by simply installing PHASATROLS.

The PHASATROL De Luxe described in this issue incorporates the Phasatrol balancing system to control radio frequency oscillation and eliminate distortion.

Very easy to install in any R. F. receiver. Once adjusted no further adjustments required.

Write for FREE PHASATROL hook-up circular for many popular circuits

Dept. 72-B, 175 Varick St., New York, N. Y.

**ELECTRAD** Inc.

*Tell 'Em You Saw It in the Citizens Radio Call Book Magazine*



*The New*  
**Model 28-H. F. L.**  
**NINE-IN-LINE Receiver**

On November twentieth, a committee of broadcast listeners met to select an ideal receiver for the listening public.

After testing six nationally famous receivers (all having nine or more tubes) their unanimous choice was the 1928

**NINE-IN-LINE**

6200 Miles—Los Angeles to  
 Berlin with A. C. TUBES

*Designed for operation with standard  
 battery equipment — or direct  
 from the light socket.*

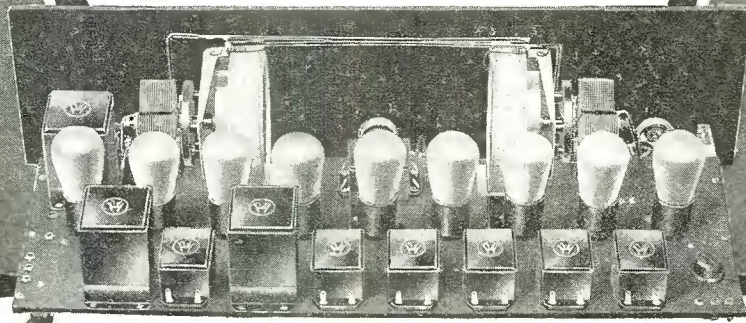

*The* **HIGH FREQUENCY  
 LABORATORIES**

*28 No. Sheldon St. ~ Chicago, Ill.*

**LISTENERS - JOBBERS - DEALERS - Write for Information Etc.**

*Tell 'Em You Saw It in the Citizens Radio Call Book Magazine*



# The Sensational A. C. Operated NINE-IN-LINE

Is Possible Through the Co-Operation of These  
Famous National Manufacturers

## Condensers and Dials

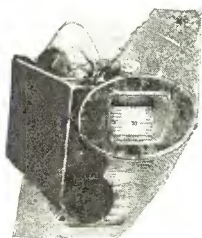

The finest tuning assembly ever designed. Illuminated dials, beautiful bronze escutcheon plate, electrically insulated control shaft, 360 degree drum dial, worm gear vernier. Absolutely no back lash. Tuning is a real pleasure when the instruments are designed by

**REMLER**

## Cone Speaker



Beauty in appearance and tone. This speaker will add charm to the finest living room. Finished in gold and polychrome. 24 inch, free edge single face. Reproduces the entire musical range perfectly. Insist upon an

**ENSCO**

## Radio and Audio Frequency Transformers

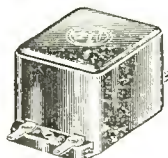

The great sensitivity and selectivity of the NINE-IN-LINE is due to these units. A special aging process insures consistent operation in the receiver. Sold in sealed nets, they are fully guaranteed in every way.

The H. F. L. Audio Transformers reproduce every single note with absolute fidelity.

The new 15 volt, 50 watt heater transformer furnishes the proper filament current to the A. C. tubes.

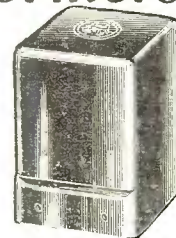

**THE HIGH FREQUENCY LABORATORIES**

## Condensers and Resistances

Smooth running, simple, and of great strength, these accurate resistors will outwear a receiver.

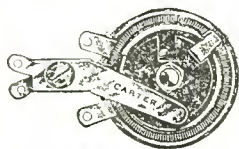

The fixed condensers are noiseless, constant, compact and dependable. Specified by radio engineers. For permanency say

**CARTER**

## POWER CONNECTIONS

Safety from shocks, short circuits and incorrect connections. Meets Fire Underwriters' requirements. Disconnects all power in one operation. Play safe, specify a

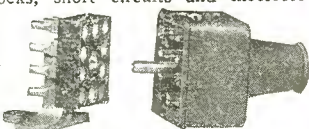

**JONES MULTI-PLUG**

## ANTENNA

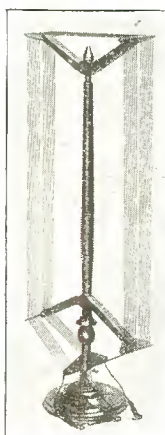

For long distance reception. Specified for the Nine-in-Line. Designed for maximum selectivity. Cuts out all undesirable stations. Graceful, strong, and efficient.

Satisfaction guaranteed with a

**Qualitone**

Duro Metal Products Co.  
2649 N. Kildare Ave.  
Chicago, Ill.

## SOCKETS AND BRACKETS

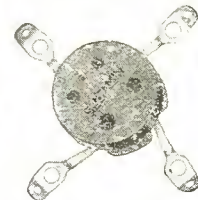

Made of bakelite with full floating receptacle. These sockets eliminate tube howling and contact noises.

The rigid, nickered steel brackets support the entire assembly. Made only by

**BENJAMIN**

## PANELS

Drilled and Engraved  
**CELORON  
LIGNOLE  
FORMICA**

# ARCTURUS TUBES



# Guaranteed Radio Service

REPAIRING, DESIGNING, REMODELING, AND TESTING

*The Largest and Most Complete Radio Laboratory  
and Service Station Available to the Radio Public*

THIS highly efficient organization with trained service men, together with a completely equipped laboratory, is at your disposal for repairing, testing and advice on all type radio receivers, battery eliminators and power units. Our experience in this field has helped all our clients to enjoy better and continuous radio reception. All laboratory instruments used in testing and repairing are modern and up-to-date, insuring rapid and accurate location of trouble involved in your receiver.

Being specialists in the radio field, we are in an excellent position to repair, rebuild, and design any type receiver you wish to have serviced. Send us your receiver today and let us give you an estimate for repairing and remodeling with all latest developments.

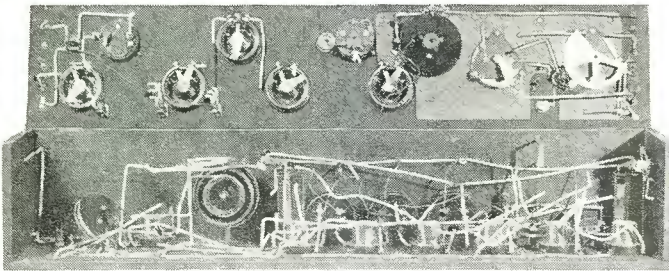

Before Remodeling

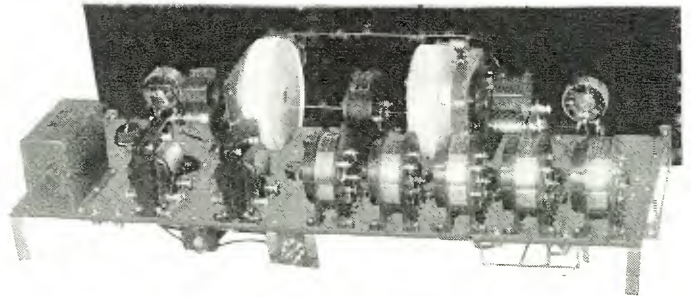

After Remodeling

All receivers and power units serviced are given a final test for quality, selectivity and sensitivity in a completely shielded room where all internal noises are absolutely eliminated, thus insuring noise-free reception, which is vital to satisfactory performance.

Remember—the confidence of many leading manufacturers has been placed in this laboratory. The Radio Service Laboratories will give you the same conscientious service that the manufacturer himself, would give you. It is more practical and wise to bring your problems here than to some irresponsible radio man who is unfamiliar with the merchandise you wish serviced. This is an era of specialized effort and our charges are no more than you would pay for inferior workmanship.

If you are unable to personally deliver the receiver or unit you wish to have serviced, securely pack it in a strong box with plenty of cushioning material such as excelsior, and ship it to us via American Railway Express, prepaid. It is not necessary to ship the cabinet or accessories.

## RADIO SERVICE LABORATORIES, Inc.,

508 South Dearborn Street

Telephone: Harrison 2870

CHICAGO, ILL.



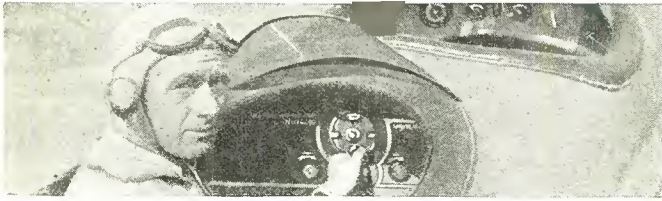

## High in Public Favor

IN the air, where dependability is all important, and in the home, where quality is so vital, the Victoreen Super merits unquestioned leadership.

Listen to a Victoreen Super for just one moment, and you will easily recognize the tonal superiority over what has been called good reception! Build a Victoreen Super and learn, first hand, of its great simplicity and reliability. Learn why thousands and thousands of Victoreen enthusiasts eagerly watch for new developments which they consider authentic steps in the progress of Radio.

### Victoreen Radio Frequency Transformers

**No. 170—For Storage Battery Tubes**

**No. 171—For Dry Battery Tubes**

The very heart of the Super Circuit! These units are instruments of great precision, being matched and tuned to within one-third of one per cent and eliminating the necessity of tube matching.

**Price \$7.00**



### Victoreen "112" Audio Transformer Unit

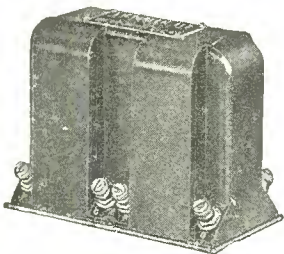

Designed to handle up to 400 volts of B battery supply, this unit is especially adapted to the Western Electric cone and other high grade speakers. The transformer consists of two stages of audio amplification in one case and is designed for use with two 112 power tubes.

**Price \$22.00**

### Victoreen Power Supply

The Victoreen Power Supply Circuit is designed to yield high plate voltage and will operate the 112 Audio Transformer Unit at maximum efficiency.

The output of this power supply when used with a 210 power tube is approximately 475 volts. It has double wave rectification which requires less condenser capacity to eliminate hum.

There is a new thrill for you in the new Victoreen A.C. Receiver. Send today for 1928 blue prints of the new hook-up; also the world famous Victoreen.

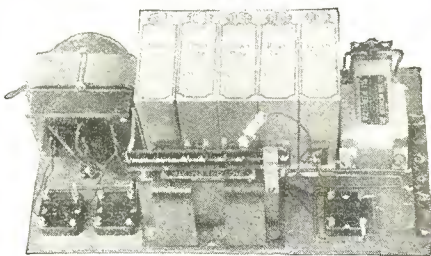

**The GEORGE W. WALKER Co.**  
 MERCHANDISERS OF VICTOREEN RADIO PRODUCTS  
 2825 CHESTER AVENUE CLEVELAND OHIO

# Victoreen

# Lowest Wholesale Prices!

*Our eggs are all in one basket.*

*We have to make a success of Allen-Rogers-Madison, Inc., or go broke.*

*We're not going broke.*

*Because we're going to continue to give you the best merchandise and the best service obtainable anywhere.*

*We're not going to blow about the products we sell unless they deserve it. Our Buying Guide tells the truth. And we're pretty tough critics too.*

*A whole lot of Radio advertising is pure bunk. As the fellow said, "They don't lie—they just handle the truth carelessly."*

*Think of how many times you have bought merchandise on the advertising and then have been disappointed with the results. You have simply been gypped—that's all.*

*Barnum's circus methods are still in use—we won't use them. We may be foolish—even so, our self respect won't let us lie to you.*

*Remember this—if it's good, we have it; and if we have it, it's bound to be good.*

*And our price policy—stated below—guarantees you the lowest prices obtainable anywhere.*

*And our SAME-DAY SHIPPING SERVICE gives you the merchandise when you need it.*

### Our Price Policy

We endeavor to sell day by day for less than the prices of our legitimate competitors.

Remember, when comparing prices, that we allow a cash discount of 3%.

Compare our prices with others. If they quote lower than we do, furnish name of concern and catalog page number and we will meet their price.

### Send for Our 1928 Buying Guide

Your copy of the free 1928 Buying Guide is ready for you—one hundred pages chock-full of bargains on all latest Radio Parts, Accessories and Sets.

Catalog C also lists electrical supplies, household appliances, golf and tennis accessories, bags, trucks, etc.—at the same low prices.

# Allen-Rogers-Madison

INCORPORATED

35 WEST 31<sup>ST</sup> ST.

NEW YORK, N.Y.



# Every type and range to meet your need



Send for  
this free  
Booklet

EVERY professional or home set builder, transmitter and set owner should possess a copy of this book. It contains helpful information on the use of testing instruments, as well as a complete listing of Weston radio models. Inform yourself on the superior features of these designs, which embody all the refinements of Weston's forty years' experience as makers of the world's precision standards.

## Thermo Instruments for Radio Transmitters

The Thermo-Couple type of ammeter, originated and developed by Weston, is one of the most noteworthy of all contributions to the art of electrical measurement.

These instruments are now made in 2" and 3 1/4" sizes for the measurement of high frequency antennae currents. All the objections to the "hot wire expansion" type of instruments—such as sluggish indications, zero shift with consequent errors and lack of compensation against changes in surrounding temperature, or in the temperature of the instrument itself,—are fully overcome in the Weston Thermo-Couple type. These instruments will also accurately measure alternating currents of low frequency as well as give correct indications on direct current service.

### D. C. Model 489 1000 ohms per volt

A remarkably fine instrument with high internal resistance for giving true voltage measurement of the output of B-Eliminators, as well as for D. C. voltage testing.

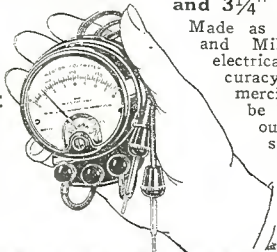

Models  
489  
and  
528  
for  
D.C.  
and  
A.C.  
Testing



Portable instruments of the same size as shown held in the hand below. Black bakelite case for D. C. and mottled red and black bakelite for A. C. Handy and accurate models for testing battery operated sets and the new A. C. tube receivers.

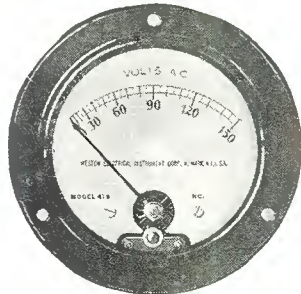

A complete line of D. C. and A. C. Panel Instruments—2" and 3 1/4" diam.

Made as Voltmeters, Ammeters and Milliammeters. Unusual electrical characteristics. Accuracy of 2% on any commercial frequency and may be left in circuit continuously. High internal resistance and excellent damping. Exquisite design and workmanship, yet moderately priced.

## WESTON ELECTRICAL INSTRUMENT CORP.

1 Weston Ave., Newark, N. J.

Please send to the following address a free copy of the booklet "Weston Radio Instruments."

Name..... Check the following:  
 City..... Set Builder   
 County..... Transmitter   
 State..... A. C.  D. C.

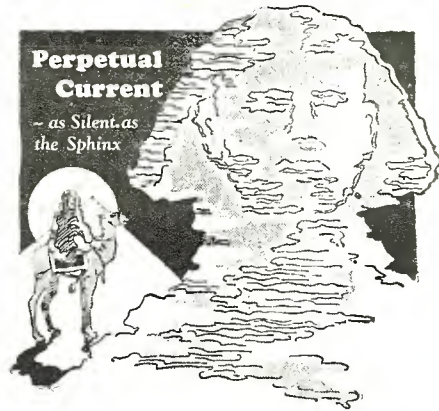

## WEBSTER BONE-DRI LIGHT SOCKET POWER

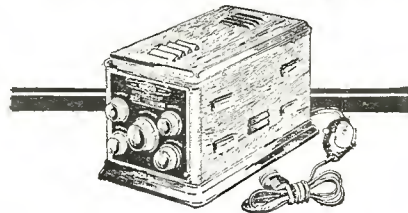

## ELECTRIFY your Radio without "revolutionary" rebuilding of set

All power from light socket automatically controlled from "A" unit "on" and "off" switch. Webster B and BC units give minute regulation up to 180 volts (plus) for quality reception.

**Price \$23.00 to \$38.00**

Raytheon Tube \$4.50 extra

Those who bought Webster last year are our best boosters—they are satisfied.

Any set owner examining the working parts inside the case can see at once the Webster is dependable for years to come. A try-out convinces any owner of a good radio that the Webster unit gives amazingly improved reception.

## Webster "Bone-Dri" A with Elkon Rectifier \$39.50

For any set requiring up to 2 1/2 Amp. Equipped with control switch and line voltage control.

With the Webster A-10 Elkon equipped and B or BC units Raytheon equipped, you can completely electrify any battery receiver without "revolutionary" rewiring of set.

If your dealer will not supply Webster units, don't take a substitute. It will pay you to write us for address of distributor nearest you and complete booklet.

**THE WEBSTER COMPANY**  
860 Blackhawk Street Chicago, Ill.





## The Universality of AMSCO PRODUCTS

like their electrical efficiency, is at-  
tested by their almost universal use.

There is no radio arrangement in  
the world, in which Amsco Products  
cannot be employed with the attain-  
ment of the highest efficiency . . . . .

*As a matter of fact there are very  
few circuits in which Amsco is not  
represented.*

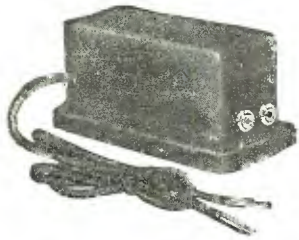

THE ORTHOPHONE is recommended by all  
power tube manufacturers for use in the  
output circuit of receivers. It plugs in instantly  
between speaker and set, protecting the  
speaker against dangerous current surges, adds  
the touch of realism to the low frequencies,  
and increases the volume your speaker can  
deliver without distortion and rattling.

In bakelite, mottled green, walnut, mahogany  
and oak, it matches the most luxurious  
cabinet, yet it is small enough to go in any  
radio set if interior mounting is preferred. Six  
dollars at your dealer, or direct from

AMSCO PRODUCTS, Inc.

416 Broome Street ' ' New York City

Our catalog of fine radio products  
is yours on request

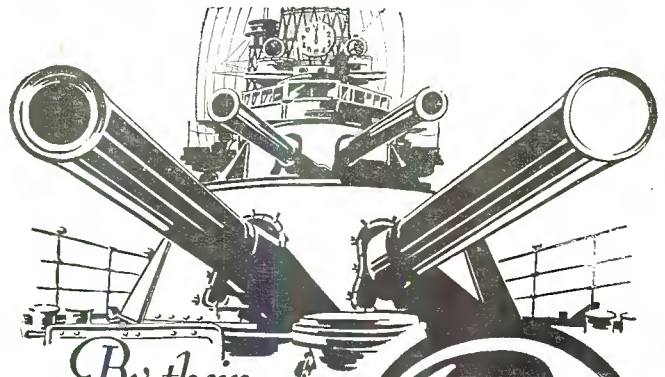

*By their*  
**POWER**  
*you'll know them!*



**A**s a powerful battle-  
ship plows its way  
through a stormy sea, Polymet Condensers  
take on the mighty power requirements of  
modern radio and deliver steady and con-  
tinuous service at their rated working vol-  
tages. Polymet Condensers do not melt  
down or blow up — *they stand up*, giving  
the utmost value for the money in working  
voltage, durability and dependability.

### Polymet Block Condensers

The working voltage under  
which these condensers are  
to operate has been care-  
fully studied and only the  
proper Condenser sections  
incorporated in these  
blocks. Poly Block Con-  
densers not only improve  
the appearance of the set,  
but also simplify the wiring  
and save time and space in  
assembling.

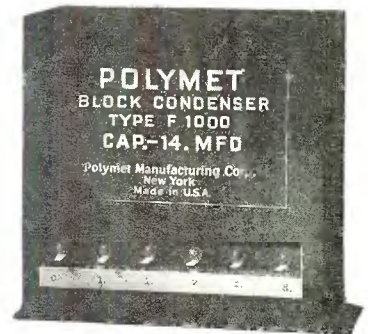

### Polymet High-Volt Filter Condensers

Polymet Condensers are Non-  
Inductive and our special  
process of impregnating makes  
them superior. Made in all  
popular capacities.

*Write for complete information regarding Polymet  
parts and catalog of all Polymet Radio Essentials.*

**POLYMET MANUFACTURING CORPORATION**  
609 Broadway, New York City

# POLYMET CONDENSERS



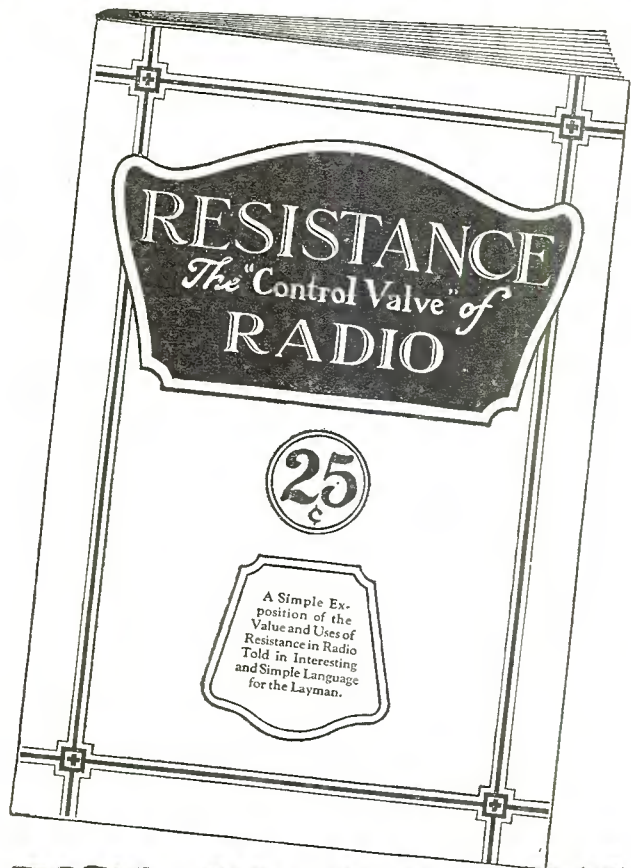

# LYNCH

## Resistance in Radio

This compact hand-book, "Resistance the 'Control Valve' of Radio," tells you all about the uses and importance of resistance in radio. Contains a wealth of interesting, dependable information on resistors, equalizers, grid leaks, and other important radio devices.

Your knowledge of the latest improvements in radio reception is not complete until you have read this booklet. Learn why resistance is important in the operation of every electrical and radio device. A copy of this reliable manual costs only 25 cents. Return the coupon with your quarter today or see your nearest dealer.

**ARTHUR H. LYNCH, Inc.**  
*General Motors Building*  
 1775 Broadway, at 57th Street  
 NEW YORK CITY  
*Sales Offices in Most Large Cities*

ARTHUR H. LYNCH, Inc.  
 1775 Broadway, New York City  
 Gentlemen:  
 Please send me a copy of your booklet "Resistance the 'Control Valve' of Radio." I am enclosing 25 cents.

Name.....  
 Street.....  
 City..... State.....

C. R. C. B.-1

# X-L Products

## 100% INCREASED RECEPTION ON LOW WAVE LENGTHS

Greater distance, volume, clarity, stability and easier, quicker tuning with X-L Vario-Denser in your circuit.

**MODEL "N"** Micrometer adjustment easily made, assures exact oscillation control. Capacity range 1.8 to 20 MFD. Price \$1.00



Used in every high grade circuit or receiver today, including

- Strobodyne
- Loftin-White
- Qualitone 6
- Improved Aristocrat
- Best's Super-Heterodyne
- B-T Power Six
- Hammarlund-Roberts
- Daily News 4
- Quadriformer 6
- and many others

**MODEL "G"** gives positive grid bias on all sets. Capacity range, Model G-1, .0002 to .0001 Mfd.; Model G-5, .0001 to .0005 Mfd.; Model G-10, .0003 to .001 Mfd. Price each with grid clips, \$1.50.

Varlo-Denser



Bakelite Insulated

**X-L BAKELITE INSULATED PUSH POSTS.** Convenient, simple, permanent connections which you do not have to remember to tighten. Just push down the X-L, insert wire, remove pressure, connection will stay tight; vibration will not loosen; releases instantly. All standard markings or boxed in complete sets for popular circuits. Price each 15 cents.

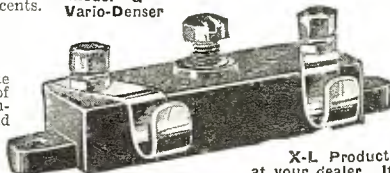

X-L Products

at your dealer. If he cannot supply you, write direct.

**FREE.** New, big, up-to-date book of wiring diagrams of latest circuits including Loftin-White Constant Coupled. Send for your copy today. INVESTIGATE the Goodwin Aperiodic Detector Circuit.

**X-L RADIO LABORATORIES**  
 2422 North Lincoln Ave. Chicago, Illinois

**OPERATE** with Wireless Egert when you purchase your merchandise. We can specify the exact resistor, meter, coil, etc., for your purpose. We are **TECHNICAL DEALERS** in receiving and transmitting, for Broadcast and Short Wave apparatus.

### CONSULT US

*We stock complete lines of*

- |               |          |                 |
|---------------|----------|-----------------|
| ACME          | AMERTRAN | AERO            |
| CARDWELL      | WESTON   | HAMMARLUND      |
| GENERAL RADIO | KARAS    | RADIO ENG. LAB. |

# Q. S. T.

There is a world wide opportunity for experimenting on Short Waves. Start as the rest have started. Let us furnish you, **FREE**, a Short Wave and Transmitting Catalogue, embodying the most advanced apparatus used in the present day.

179  
Greenwich  
Street  
New York  
N. Y.

Tel.  
Cortlandt  
5275-2085

Write Us for Our Special Prices—Mail Orders Promptly Filled



# Save 1/2! 30 days FREE TRIAL Satisfy yourself

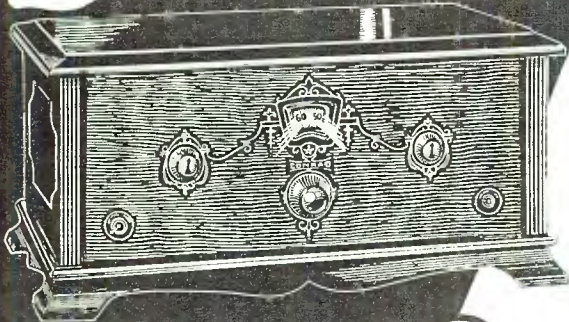

**COMPLETELY SHIELDED  
Genuine Licensed Circuits**  
Manufactured under license grants of  
**Radio Corporation of America**  
and affiliated companies

The set that's the talk of the radio trade. Acknowledged as the greatest radio value. A Con-Rad six tube completely shielded chassis with single illuminated dial control. Absolutely the latest in radio receivers. Manufacture under license grants, insures highest quality; chassis incorporates all the features found in most efficient receivers. Complete shielding insures freedom from all foreign noises. Very selective and sensitive. Brings in long distance stations with wonderful tone and volume. Both table and console cabinets come in the newest styles and most beautiful woods. All are well constructed, carefully finished and will add beauty to any room.

**Prove It Yourself—30 Day Free Trial**

Quality and price are what you are most interested in. A Con-Rad receiver is ready to undergo any test you demand. Try it in your home on our 30 day Free Trial offer and be satisfied. If you are not, return the receiver to us and your money will be refunded. You must be satisfied!

**MAIL COUPON NOW!**

Write today for complete information. Our catalog gives full details of the Con-Rad line of 1928 and our liberal 30 day Free Trial offer.

**CON-RAD 6**  
SINGLE DIAL CONTROL

**6 TUBE SETS**

Completely assembled

**\$34.75**  
to **\$66.66**  
RETAIL PRICES

**BIG DISCOUNTS**  
to Agents and Dealers

Demonstration set sent on Free Trial. Make big money working full or spare time taking orders for Con-Rad Radios. Write today for special prices and proposition.

**CONSUMERS RADIO COMPANY**

Dept. 101 4721 Lincoln Ave., Chicago, Ill.

CONSUMERS RADIO CO.,  
4721 Lincoln Ave., Dept. 101  
Chicago, Ill.

Gentlemen:

Please send me full particulars and catalog of the Con-Rad Line of 1928 and your 30 day Free Trial offer. No obligation.

Name.....

Street.....

City.....State.....

**Total Shielding**

**The Vee Dee NO. 250 Cabinet**

for Leading Kits

B-T-POWER SIX COUNTERPHASE  
 B-T-POWER SIX ELECTRIC  
 SILVER COCKADEY 2  
 QUADRAPHASE VE  
 BEST LINCOLN SUPERN  
 S-M SHIELDED SIX  
 S-M LABORATORY MODE  
 WORDS RECORD SUPER EIGHT  
 KARAS TWO DIAL EQUAMATIC  
 EIGHT TUBE STROBODYNE  
 BODINE TWIN EIGHT  
 THOMPSON SUPER  
 HAMMARLUND-ROBERTSHAW  
 BROWNING-DRAKE  
 AERO SIX  
 ETC.

List Price, Including Panel, F. O. B. Factory **\$18.00**  
 Inside Dimensions, 23"x12"x7" or 8"  
 Packed in Strong Carton  
 Special Chassis, Size 11x20x1/2  
 List Price, \$2.10

## 100% Shielding!

Do away with "man-made" interference by housing your radio in this all metal—all shielded cabinet—possessing the beauty of natural wood grain finishes combined with the efficiency of all metal construction, at low prices made possible through large scale production.

Manufacturers of leading kits have recommended Vee Dee 100% shielded metal cabinets for better service and better reception.

The cabinet illustrated here is "made-to-order" for the fifteen famous, popular kits mentioned. The spacious interior dimensions make this cabinet readily adaptable for practically any kit on the market.

*Manufacturers, Jobbers—Write for Further Particulars*

**THE VAN DOORN COMPANY**  
160 North LaSalle Street  
Chicago, Ill.  
FACTORY: QUINCY, ILL.



# FERRANTI

Audio Frequency Transformers

2 TYPE AF-3 *or* 2 NEW TYPE AF-5

*Give More and Better Amplification Than Any Other Audio Combination operating under identical conditions with standard equipment*

Ferranti stands behind this claim of superiority.

Try either of these marvelous amplifier combinations. Compare it with others, and you will be convinced of the outstanding merit of these Ferranti audio frequency amplifiers.

**Exclusive Design Features Are Responsible for Ferranti Superiority**

We ask you to look at the inside of a Ferranti Transformer. See a Ferranti knockdown display at your dealer's or jobber's. Note the special divided winding on lantern cage coil forms. Note the special laminations. Note the freedom from compound.

Every ounce of material in a Ferranti Transformer is there for a purpose: to give you the very finest reproduction from your speaker.

SPECIFIED FOR POPULAR ELIMINATORS AND RECEIVERS

**B1 CHOKE**  
for Vitrohm D. C. Eliminator

Low resistance—handles current from 50 to 100 milliamperes.

\$10

**TYPE AF-4 TRANSFORMER**

Accepted everywhere as the best transformer at the price. Specified exclusively for Magnaformer Circuit.

\$8.50

PUSH-PULL UNITS FOR VITROHM D. C. ELIMINATOR—POWER AMPLIFIER

**TYPE AF-4C**  
INPUT  
\$9.00

**TYPE OP-7C**  
OUTPUT  
\$9.00

Type AF-3 Transformer.....\$12      Type AF-5 Transformer.....\$14

Type AF-3C Push-Pull Intermediate.....\$13      Type OP-8C Push-Pull Output.....\$11

Bulletins 1 to 13 give helpful information on better audio amplification, along with prices and details on other Ferranti Transformers not listed here.

*There is no charge. Send for it today*

**FERRANTI, INC.**

130 West 42nd Street, New York, N. Y.

FERRANTI, Ltd.  
Hollinwood, England

FERRANTI  
ELECTRIC, Ltd.  
Toronto, Ontario, Canada

The Big Friendly Radio House  
Complete Parts  
**Nine in Line A. C.  
Operated**

WHEN you get our 1928 Catalog, you can have popular, nationally-advertised kits, parts, eliminators and accessories at prices that are real values.

Our dealer catalog, which lists everything in radio, means more real profit for you. Standard quality at the right price.

*Write for our big Catalog*

**WESTERN RADIO MFG. CO.**  
128 West Lake St. Dept. MO Chicago, Ill.

**ATTENTION~ SET-BUILDERS AND DEALERS ~**

LET US FURNISH YOU FREE the most complete radio catalogue on the market today.

We can furnish parts specified in the **CITIZENS RADIO CALL BOOK.**

We Carry the Following Lines—Also Many Others

Acme	Tyrman	Kingston	Hammariund	Accusti-Cone	Kodel
Aero	Corbett	Victoren	Perryman	Clarostat	Karas
Tobe	Bodine	Thordarson	Sterling	Benjamin	Marco
QRS	National	Centralab	Sangamo	Yaxley	Lynch
Eby	Jewell	Camfield	Silver Marshall	Samson	Remler

EVERY SET BUILDER AND DEALER should have the NEW **SIMPLEX RADIO CATALOGUE**

THE SIMPLEX RADIO SUPPLY COMPANY  
3319 Washington Blvd., St. Louis, Mo.  
Wholesale Only

*Free* **100 PAGE CATALOG**

# EBY



## SOCKETS

Eby Sockets are designed to give you better radio reception. Reception is dependent on socket contact and EBY Sockets have the most scientifically perfect type of contact known—the 3-point wiping spring contact. Contact prongs are snugly enclosed—they can't spread. List Price 40c.



## BINDING POSTS

EBY Posts have been the standard of quality for more than six years. Specified in most of the popular circuits and standard equipment on the majority of the better known receivers. The tops can't come off! List price 15c.

**THE H. H. EBY MFG. CO., Inc.**  
4710 Stenton Ave. Philadelphia, Pa.



# RADIO DEALERS!

## Hamilton-Carr Corporation

### Enables You to Centralize Your Buying

Radio Dealers can do away with the annoyance of buying from a large number of sources, by keeping our catalog handy. It has been carefully compiled after an exhaustive study of all radio sets and accessories on the market. Prices are sensational—our tremendous buying power enables us to offer values in radio merchandise that will amaze you.

#### All Call Book Kits and Parts in Stock

We have ready for immediate shipment all parts and accessories for B-T A. C. Power Six, Hammarlund-Roberts Hi-Q Six, Tyrman Amplimax 70, World's Record Super-Ten, Bodine Electric Radio and Phonograph, Unitone Symphonic, Lyneh Hammarlund Five, Silver-Marshall Shielded Grid-Six, Karas A. C. Equamatic, New Browning-Drake, Aero A. C. Seven, Phasatrol De Luxe, Silver-Marshall Universal, Remler A. C. Super.

#### Hamilton-Carr Service

Your orders are handled with the greatest expedition, being shipped when you want them. We have built our reputation on our prompt attention to the wants of our dealers. The thousands of dealers now buying from us, show how successful we have been.

#### Nationally Advertised Accessories

All the fast-selling, nationally advertised accessories, parts and kits are shown in the new Hamilton-Carr Catalog. Many of these are advertised in this magazine now or have been in the past. All the recognized successful methods of converting old sets into electric sets are explained.

#### A. C. All-Electric Sets

The *Hamilton-Carr Catalog* has a complete showing of 6, 7 and 8 tube, all-electric sets, to meet the new demand for this type of set. Sets use 226 and 227 A. C. tubes. No Batteries or Eliminators.

Also a full line of battery-operated sets and "A" and "B" eliminators. All sets are beautifully cased in burlled walnut, in either table or console models.

Keep our catalog handy. You will find it contains everything you want in Radio. The thousands of amazing values have made us the buying center for radio dealers.

#### DEALERS' 1928 CATALOG

Of course, you want this new *Hamilton-Carr Catalog*. Write today on your business stationery. It is packed from start to finish with the greatest values ever offered.

**Hamilton-Carr Corporation, Dept. 340, 711 W. Lake St., Chicago, Ill.**

# FROST-RADIO

## DE LUXE APPARATUS

#### Frost Gem Rheostats and Potentiometers

The Frost Gem Rheostat is a mighty good small rheostat. It is supplied in plain or switch type, in 7 convenient resistances from 3 to 30 ohms, and a potentiometer of the same size is made of the same fine materials as our larger rheostats, the Gem offers you much in small dimensions. Diameter only 1 1/2 in., depth 11/32 in. Has Bakelite pointer knob, smoothly working contact arm, and resistance element is wound on flexible Bakelite strip. For best results in small space use Gem Rheostats and Potentiometers.

Series 1900 (Plain) Gem Rheostats.....\$0.75  
Series S 1900 (With Switch)..... 1.00  
Gem Potentiometers, 200 and 400 ohm.... 1.00

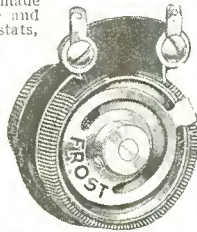

FROST-RADIO

#### Frost Variable High Resistances

Think of a variable high resistance with a marvelously smooth regulation over entire range of resistance strip, free from friction and almost totally without wear, due to roller contact arm. No jerks—no jumps—no dead spots—no sudden increases or decreases in volume. Just stepless, perfect regulation. Has Bakelite shell and cover, and engraved Bakelite pointer knob. Adopted as standard by leading set manufacturers, and countless thousands are in use in home built sets. Supplied in 2 or 3 terminal type, in wide range of resistances from 2,000 to 500,000 ohms.



FROST-RADIO

and with or without switch, 2 or 3 Terminal Type, less switch, \$1.75.  
2 or 3 Terminal Type, with switch, \$2.10.

**HERBERT H. FROST, Inc.**  
Main Offices and Factory: ELKHART, IND.

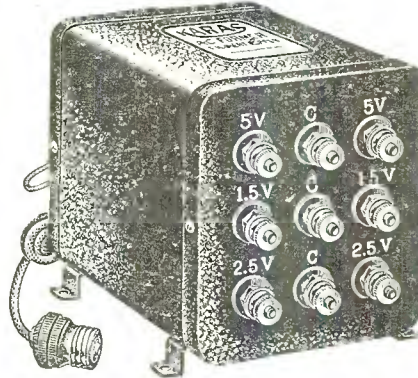

**Karas  
A-C-  
FORMER  
Filament  
Supply  
Type 12  
List Price**

**\$13.50**

# NO HUM!

At last you can step down your 110 volt A. C. house current to operate your set with standard A. C. tubes, such as Cunningham, RCA and CeCo, without having to use separate device for center tap, and with **ABSOLUTELY NO HUM!** Let the Karas A. C. Former Filament Supply, Type 12, replace your "A" Battery and charger. Will operate eight 1 1/2-volt Type 226 or 326 Tubes, two 2 1/2-volt Type 227 or 327 Tubes, and two 5-volt Type 177 Tubes at one time. Compact, powerful, sturdy and built the Karas Way—by precision methods. Write for complete information about the new Karas A. C. Former, as specified in the Karas A - C - Equamatic described on other pages of this issue, and also data on the Knickerbocker 4 and Karas 2-Dial Equamatic.

**Karas Electric Co.**  
4026-A N. Rockwell St.  
CHICAGO







*I want every set-builder and dealer to have a copy of this 116 page wholesale radio catalog*  
Sumner Harris

President  
The Harco Co.

SETS—KITS—PARTS  
ACCESSORIES AND  
FURNITURE—

Everything for the  
Radio Dealer and  
Set Builder

FREE  
CATALOG



COUPON

Date.....  
THE HARCO COMPANY  
1259 So. Wabash Ave., Chicago, Ill.  
Gentlemen: Please send me your free catalog.

Name.....  
Address.....  
City..... State.....  
 DEALER     SET BUILDER     AMATEUR

# KINGSTON

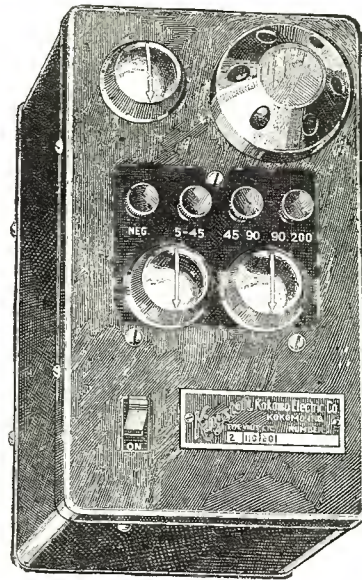

## For Perfect Reception

THE KINGSTON will maintain the radio set always at its perfection peak. It contains no acid or solution, operates without vibration or noise and will not heat. There are provided three different voltage terminals, each adjustable over a wide range, making possible any desired voltage from 5 to 200. A fourth variable voltage may be easily had, if desired, by connecting a separate variable resistor to one of the terminals. The primary or main current supply is controlled by a rheostat, making it possible to reduce the current entering the unit to the amount actually required for any individual set, thus protecting the set against overload.

Handsomely finished in satin black. Size: 9 inches long, 5 1/4 inches wide, 8 1/4 inches high. The Raytheon 125 milliamper type BH tube is used as rectifier. Fully guaranteed.

### PRICES

Type 2, for 110-120 Volt AC 50 or 60 Cycle Current, \$35.00.

For receiving sets having not more than eight tubes and not having type UX171 power tube or equivalent.

Type R, same as type 2, but equipped with automatic control to switch Unit or on off when switch on radio set panel is turned, \$37.50.

Type 2A, for 110-120 Volt AC 50 or 60 Cycle Current, \$42.50.

For all sets using type UX171 power tube or equivalent and for all large sets having nine or more tubes.

Type RA with automatic control switch, \$45.00.

Type 2C, for 110-120 Volt AC 25, 30 or 40 Cycle Current, \$47.50.

Type RC with automatic control switch, \$50.00.

Prices include Type BH Raytheon Tube

**KOKOMO ELECTRIC COMPANY**  
KOKOMO INDIANA



When you ask for Lincoln Transformers and Lincoln Fixt Inductance Coils insist upon those made by Rex Laboratories, Inc.—which are the original and *only genuine* Lincoln Quality Products, and without which the building of a LINCOLN QUALITY RECEIVER is an impossibility.



Trade Mark

Reg. U. S. Pat. Off.

A LINCOLN QUALITY RECEIVER constructed according to our specifications will abundantly compensate you for all disappointing experimentation to date. You will enjoy acute selectivity with tremendous amplification and fidelity of tone, avoid 40% to 60% of extraneous noises, hear distant stations with the volume and quality of locals and possess a set that will be the envy of all your friends.

Sold by the best retailers and jobbers everywhere. If your dealer cannot supply you we will tell you where to buy them.

Write for detailed construction data and diagrams of the new simplified REX QUALITY A. C. RECEIVER (our latest development)—using Lincoln Quality parts—of remarkable interest and importance. Sent for 50c. Also Push-pull 210-Power Amplifier and B-Supply diagrams and data—50c set.

**REX LABORATORIES, Inc.**

*Sole Manufacturers of Lincoln Quality Products*

341 The Arcade

Cleveland, Ohio



**Such Leadership must be deserved!**

Durham Resistors and Powerohms, adopted by leading set manufacturers, are the FIRST choice in all successful circuits where constant quality is the ultimate consideration.

International Resistance Co., Dept. R, 2 1/2 So. 20th St., Philadelphia



RESISTORS & POWEROHMS

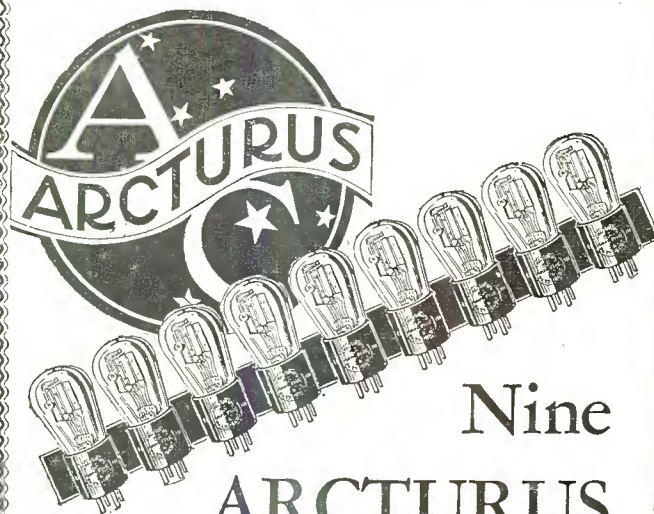

## Nine ARCTURUS A-C Tubes in Line

ARCTURUS tubes—four prong base heater tubes, of course—are specified in the A-C model of the Nine-in-line super—perhaps the finest receiver available to the broadcast enthusiast today. ARCTURUS is chosen because *no other A-C tubes would do the work.*

Other very excellent receivers are less rigid in their requirements than the super-heterodyne, but the points of excellence that make the ARCTURUS A-C tube the only alternating current tube operable with the Nine-in-line provide a factor of safety that guarantees satisfaction with other receivers... These points of preference, listed at a glance, are—

**UNIVERSALITY OF TYPES**—standard amplifiers, high mu, detector and power tubes—tubes for all receivers.

**STANDARDIZATION**—all Arcturus tubes have four prong bases fitting the standard socket without additional wiring of any kind. They are all of the heater type and operate from the same potentials.

**ELIMINATION OF HUM**—heater tubes, properly designed and operating with a high potential low current heater have the lowest possible hum factor.

**CONVENIENCE**—standard bases and sockets—low current wiring—available transformers.

**LONG LIFE**—electrical and mechanical perfection, a negative temperature coefficient heater.

Your favorite receiver can be Arcturized, simply and quickly, by yourself or by a local service station. Your dealer can supply you with an Arcturized circuit of your set, or write directly to—

**ARCTURUS RADIO COMPANY**

255 Sherman Ave., Newark, N. J.



# LOOK!

Everybody uses Tubes—now's the chance to pep up your set with new Tubes.



For a limited time the publishers of the Citizens Radio Call Book Magazine will give one genuine CeCo Tube with each one year's subscription.

List price of tube is \$1.75, therefore your subscription costs you nothing, as the subscription price is only \$1.75 per year. This offer is for a limited time only—so rush your subscription in at once. No limit to number of tubes—one for each one year's subscription—two tubes for a two year subscription or two single subscriptions; three tubes for three year subscription or three single yearly subscriptions, etc. These tubes are genuine first quality and guaranteed.

Use the coupon below. Send check, money order or currency (register currency). Regular subscription price, one year, \$1.75. On this offer one A type CeCo Tube with each yearly subscription.

### COUPON

Citizens Radio Call Book Magazine  
508 S. Dearborn St., Chicago, Ill.

Please enter my subscription for.....

year(s) and send me.....genuine

A Type CeCo Tube(s) as premium. I

inclose \$..... full payment

for same.

Start subscription with:  January,

March,  September,  November

Name.....

Address.....

City.....State.....

## Changes Your Set Into a Short Wave Receiver

Sent anywhere in U. S. upon receipt of \$15.00, M. O. or C. O. D. plus postage upon receipt of \$1.00 to guarantee carrying charges (Canada and Foreign \$15.60 money order).

When ordering state kind of set so that detailed directions for use may be given if necessary. Also state type of tubes, such as UV199, UX199, WD11 or 201A.



## The SUBMARINER

Will convert your regular set into a short wave receiver and enable you to tune between 26 and 68 meters. This is equivalent to over 600 wave channels, as compared to only 94 wave channels on your regular set. This device operates with sets such as T.R.F., Neutrodyne, Super-Heterodyne, etc. It will operate with a one tube or a ten tube receiver, and no additional tubes, or batteries are required. No changes to the wiring of any of these receivers are required. It requires but a few seconds to attach or detach. Operates as a wave changer with Super-Heterodyne, and as a detector unit with others.

### SHORT WAVE

reception is practical because they penetrate better and there is less static. The "Submariner" wave band includes many powerful stations that broadcast programs. You may also learn code by listening to amateurs from all parts of the world. You will have one of the most efficient short wave receivers when the "Submariner" is attached to your set. Nothing else like it on the market. Get a "Submariner" so you may have command of the short wave activities as well as the broadcast band.

### ORDER TODAY

We guarantee the "Submariner" to operate with your receiver  
ADDRESS

J-M-P MANUFACTURING COMPANY, Inc.

Department 111

Milwaukee, Wisconsin

## In the Heart of Cleveland AUDITORIUM HOTEL

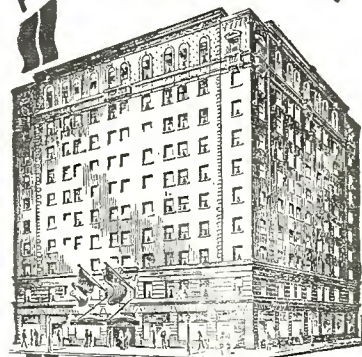

EAST 6TH AND ST. CLAIR AVE.

### TO THE PUBLIC:

Are you wondering why we have built "Another" Hotel in Cleveland. One must have a good reason for spending nearly two million dollars. We have a reason worth far more than that.

Every hotel operator gives "His best efforts for your comfort." We have centered our efforts around one ideal desire. "To make you happy."

There must be something back of that desire. You can easily prove it by coming here just once.

Sincerely yours,  
GEORGE J. PAUL  
Managing Director



# The Citizens Radio Call Book

Possesses the Finest Radio Drafting Room in the World

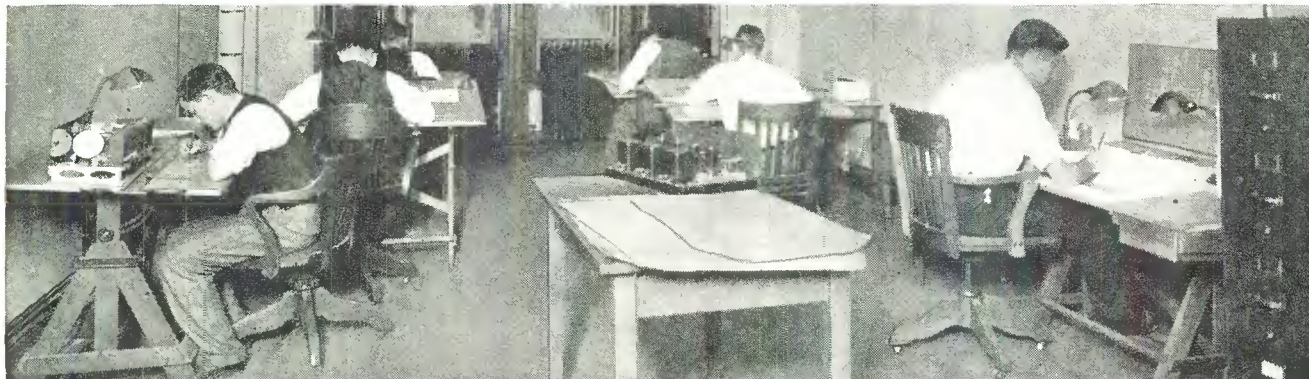

This staff of highly trained draftsmen is continually preparing the most accurate and complete full size blueprints of radio receivers and power packs obtainable.

Blue prints are available on all circuits described in the CALL BOOK. Each set of prints is composed of all the necessary drawings prepared in such complete detail and accuracy as to enable an inexperienced builder to duplicate in every respect the receivers built in our laboratory, thus assuring positive success and the greatest satisfaction.

## Please Order Blue Prints by Number and Name

No. 3	Qualitone 5 Tube T. R. F. Receiver (5 drawings).....	\$1.50	No. 76	Tyrman Ten (5 drawings).....	1.50
No. 4	Browning-Drake 5 Tube Receiver using National Impedaformers.....	1.40	No. 79	Silver-Marshall High Amplification Super-heterodyne Receiver (5 drawings).....	1.50
No. 8	15 to 550 Meter Receiver.....	1.40	No. 81	1928 Infradyne.....	1.25
No. 9	Improved St. James Super-heterodyne Receiver.....	1.40	No. 82	Thompson Super-heterodyne Receiver (5 drawings).....	1.50
No. 11	9 Tube 45 K. C. Super-heterodyne Receiver.....	1.40	No. 83	"Best Lincoln" Super-heterodyne Receiver.....	1.40
No. 12	Madison-Moore Super-heterodyne Receiver using 201-A Tubes.....	1.40	No. 84	Two Control Equamatic Receiver (5 drawings).....	1.50
No. 13	Browning-Drake 5 Tube Receiver Using Acme Impedance Amplifier.....	1.40	No. 85	Citizens Super Nine (5 drawings).....	1.50
No. 14	Browning-Drake 4 Tube Receiver Using Audio Frequency Amplification.....	1.40	No. 86	Thordarson Power Amplifier (5 drawings).....	1.40
No. 18	An Efficient 5 Tube Receiver Using Space Wound Coils.....	1.40	No. 87	Improved Aero Dyne Six (5 drawings).....	1.50
No. 32	Scott "World's Record" Super Eight.....	1.40	No. 89	The New Victoreen Universal Super-heterodyne.....	1.40
No. 33	Bremer-Tully Power Six.....	1.40	No. 91	Lincoln Quality Receiver (5 drawings).....	1.50
No. 36	Monotone Receiver.....	1.40	No. 92	Improved Camfield Duoformer Seven (5 drawings).....	1.50
No. 37	Madison-Moore "One-Spot" Receiver.....	1.40	No. 93	Knickerbocker Four (5 drawings).....	1.50
No. 44	Melo-Heald Super-heterodyne—11 Tube.....	1.40	No. 94	Silver-Marshall A. C. Shielded Six.....	1.25
No. 45	Shielded Localized Control Receiver.....	1.40	No. 95	La Peer A. R. Nine (5 drawings).....	1.50
No. 46	A 100 K. C. Super Using Air Core Transformers.....	1.40	No. 97	Camfield Super Selective Ten (5 drawings).....	1.50
No. 47	The "Phasatrol Five" (5 drawings).....	1.50	No. 98	Madison Moore International One Spot and Power Pack (6 drawings).....	1.50
No. 48	The Citizens Super Eight.....	1.40	No. 99	Magnaformer 9-8 A. C. (5 drawings).....	1.50
No. 50	Camfield Super-Selective Nine "Revised" (5 drawings).....	1.50	No. 100	Tyrman Super Ten for "A" Elimination (5 drawings).....	1.50
No. 52	Improved Nine-in-Line Super Using 201-A Tubes (5 drawings).....	1.50	No. 105	Camfield Shielded Grid Seven (5 drawings).....	1.50
No. 53	Compact "B" Supply with Voltage Regulator Tube.....	1.40	No. 106	R. C. S. Octa-Monic Receiver.....	1.15
No. 54	Self Modulated Oscillator.....	1.40	*No. 107	Bremer-Tully A. C. Power Six.....	1.40
No. 55	30 K. C. Super-heterodyne Receiver.....	1.40	*No. 109	Harkness Counterfonic 6-Tube Receiver.....	1.40
No. 56	Improved Browning-Drake.....	1.40	*No. 111	Tru-volt "B" Supply.....	1.40
No. 58	"World's Record" Super Nine.....	1.40	*No. 112	Citizens Shielded 5 Receiver (5 drawings).....	1.50
No. 61	An Electrically Operated T. R. F. Receiver (Receiver only) (5 drawings).....	1.50	*No. 113	Unitone Symphonic 6-Tube Receiver (5 drawings).....	1.50
No. 63	Portable "B" Eliminator Test Set (5 drawings).....	\$1.50	*No. 115	Tyrman Amplimax "70" (Shielded Grid) 5 drawings.....	1.50
No. 64	Aero Seven Tube T. R. F. Receiver (5 drawings).....	1.50	*No. 116	"New" Browning-Drake with Power Supply (8 drawings).....	1.80
No. 66	QRS—ABC Unit used in conjunction with No. 61.....	1.40	*No. 117	Samson "B" Supply and Power Amplifier.....	1.30
No. 68	Improved Remler 45 K. C. Super-heterodyne Receiver (5 drawings).....	1.50	*No. 118	Karas A. C. Equamatic (5 drawings).....	1.50
No. 70	Improved Nine-in-Line (5 drawings).....	1.50	*No. 120	Every-Man Four.....	1.40
No. 71	"Hot Spot" Fourteen.....	1.40	*No. 121	Bodine Electric Radio & Phonograph (8 drawings).....	1.80
No. 72	Raytheon ABC Unit.....	1.40	*No. 122	Phasatrol DeLuxe 7-Tube T.R.F. Receiver (5 drawings).....	1.50
No. 73	Magnaformer Super-heterodyne Receiver (5 drawings).....	1.50	*No. 123	World's Record Super Ten & Power Pack (6 drawings).....	1.60
No. 74	Eight-in-Line Super-heterodyne Receiver.....	1.25	*No. 124	Hammarlund-Roberts Hi-Q Six.....	1.40
			*No. 125	Silver-Marshall Universal & Power Pack (7 drawings).....	1.70
			*No. 126	St. James Twin Four.....	1.40
			*No. 129	Remler A. C. Super & Power Supply (9 drawings)....	1.90

## Full Size Graphic Wiring Diagrams

No. 20	Silver-Marshall Improved 7 Tube Super-heterodyne Receiver.....	\$0.60	No. 59	Control.....	.60
No. 21	All American 5 Tube Toroid Receiver.....	.60	No. 65	National Browning-Drake with Power Amplifier.....	.60
No. 22	Premier 5 Tube T. R. F. Receiver.....	.60	No. 77	St. James Semi-Portable Receiver.....	.60
No. 26	4 Tube Non-Radiating Receiver using Audio Frequency Amplification.....	.60	No. 78	Silver-Marshall Unipac.....	.60
No. 27	5 Tube Non-Radiating Receiver using Resistance Coupled Amplifier.....	.60	No. 88	Two-Tube Browning Drake with Power Supply.....	.60
No. 38	Premier 6 Tube T. R. F. Receiver.....	.60	No. 101	World's Record Economy Super 8.....	.60
No. 39	Unicontrol Nine-in-Line Super-heterodyne Receiver.....	.60	*No. 108	Aero A. C. Seven T.R.F. Receiver.....	.60
No. 40	Inexpensive 5 Tube T. R. F. Receiver.....	\$0.60	*No. 110	Lynch-Amsco 5-Tube Receiver.....	.60
No. 41	Samson Special T. C. Receiver.....	.60	*No. 114	Lynch-Hammarlund 5-Tube Receiver.....	.60
No. 43	Six Tube T. R. F. Receiver using Alden Localize		*No. 119	A-B-C Eliminator for D. C.....	.60
			*No. 127	Silver-Marshall Shield Grid Six.....	.60
			*No. 134	Nine-in-Line A. C. Operated.....	.60

\*Circuits described in present issue.

Any of the above blue prints will be sent postpaid by return mail upon receipt of the proper amount or they can be obtained from any of the Radio jobbers advertising in this publication

## CITIZENS RADIO SERVICE BUREAU

508 So. Dearborn Street

7th Floor

Chicago, Illinois



# St. James Twin '4'

Latest  
Design

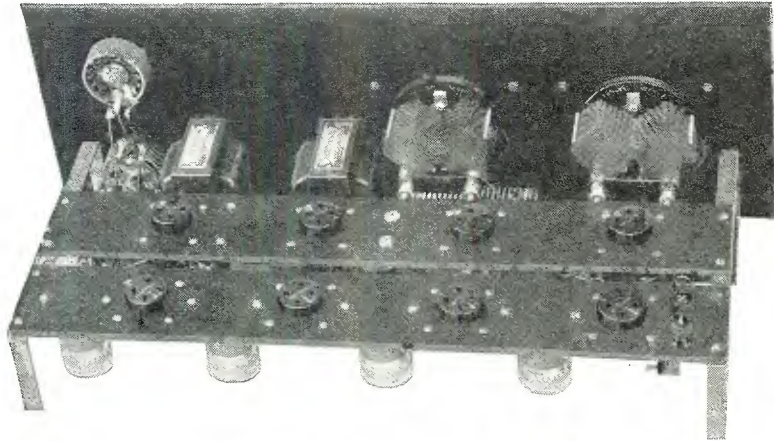

Using  
"U"  
Circuit

## Radio's Lowest-Priced Super Circuit

HERE is good news for the home set builder—a high-quality receiver made up of standard high grade parts throughout—at a price far below anything on the market.

The St. James Twin "4" is a remarkable circuit from the standpoint of tone quality, long-distance reception and selectivity. It is even more remarkable when you consider its low cost and extreme simplicity of construction. Anyone can build this circuit quickly, economically and perfectly.

Look at the list of parts and you will readily understand why this is a dependable circuit. Look at the "twin" arrangement of two sub-panel strips, each with four built-in sockets, and you will see why the "Twin 4" is so easy and economical to build.

### 10 Feet of Wiring

Then look at the perfectly simple wiring arrangement. Ten feet of wiring make all the necessary connections. Nothing can go wrong. No short circuiting is possible. Every connection is made direct, with no winding around endlessly. There's nothing else quite like the St. James, because no other circuit can be built so economically and easily.

## New D-X Records Established

St. James Laboratories,  
Chicago, Ill.

Gentlemen:

The following results, which I had confirmed by the station, speak for themselves and it is such results that made me and have kept me a staunch believer in St. James products.

With my St. James "Super" I have never been forced to the popular delusion that DX is hopeless during the summer months, as I can pick up distant stations at any time with satisfactory results except when severe electrical storms interfere.

When it is considered that W.Q.J., W.E.B.H., W.I.B.O. and W.B.B.M. are all located within one-half to two miles from me and in different directions it shows extraordinary selectivity.

Of further importance is the fact that weather conditions have no effect on the efficiency or match of the St. James transformers.

At 11:45 P. M. (C.S.T.) on Saturday evening, July 31, a rainy night and with the local stations going full blast, I tuned in K.F.I. of Los Angeles and listened to them without an interruption until 12:30.

To prove that this was not due to some peculiar condition at the time I again tuned in K.F.I. at 11:00 P. M. (C.S.T.) Sunday evening, August 1, another rainy night with local stations going, and listened to them without interruption until they signed off at 12:30.

Both receptions were on the loud speaker with more volume than I cared to use and with good quality.

Believing that exceptional efficiency in a product is deserving of acknowledgment is my reason for writing this.

Very truly yours,  
FRED B. GLENNON.

Naval Hospital, San Diego, Calif.  
9 Oct., 1927.

Dear Mr. St. James:

Last nite, 8 Oct., was my best reception this season—fifty-six stations played on St. James Super-Loud Speaker, one audio stage. Most distant stations among them being KDKA (Pittsburgh), PWX (Cuba), WSM (Nashville), KWKH (Shreveport, La.), WMAK (Buffalo), 4YA (New Zealand), 2BL (Sidney, Australia), JOAK (Japan). Not too bad for the season, eh? When old winter comes we'll have some real reception.

Best wishes,

Lt. C. H. Forth, U.S.N.

Dec. 5, 1927.

I applied your suggestions to my St. James. It sure knocked the bugs out of it. It works better than some \$500 sets I have listened to. It has volume galore with quality to spare. For distance it's right there and cuts through like lightning.

S. D. Mourning, Jerseyville, Ill.

Utica, N. Y., Dec. 27, 1927

I have consistently for the past two weeks had KFI with its Rock-a-Bye-Bay signing off, practically every night. The longest distance received is Buenos Ayres (South America), and I hope for Japan on the new hook-up.

E. J. Malley, Secy., Auto Club.

Tell 'Em You Saw It in the Citizens Radio Call Book Magazine



# The Famous 'U' Circuit

## What is the 'U' Circuit?

Did it ever occur to you that a radio receiver functions much like a camera?

Radio waves and light waves have much in common, as both are subject to reflection, refraction, diffraction and absorption.

It is easy to note the effects when light is handled, and enables us to appreciate what happens to our radio wave. A camera which leaked light at the bellows or plate holder could not reproduce the image clearly, nor will a radio receiver reproduce properly if energy is allowed to impress itself any old place in the wiring system.

The receiver must be immune to signals excepting through the proper channels, the loop or coil collector. Shielding accomplishes but little and the St. James Laboratories have developed a new and effective method in the use of a U circuit.

If we consider the wiring in a set and exposed devices as being capable of picking up a portion of all energy and disturbances which set up a field, it becomes evident that it is a detriment to the receiver.

A column of water in a pipe has a certain pressure existing throughout its height, but we can balance out this pressure by heaving the pipe in the form of a U. The water in the pipe is now at a state of rest, and may be affected by external pressures.

Our receiver is likewise constructed, the wiring forming a U by turning back one-half of the system to oppose the other, thus balancing out such energy as might be impressed upon the wiring.

It is much more sensitive to energy coming through the proper inlet and amplifies to more perfect reproduction, than if parasite disturbances were allowed to flow at will. It is necessary, too, that the inductances, and other devices be as small as possible so that their exposure to fields will be likewise small, and the St. James Intermediate transformers, and other devices are ideal for this purpose, as no coil is over one inch in diameter. But ten feet of wire is required to make the connections, and five inches wires the oscillator circuit.

The advantages of the system are self-evident, and with the high degree of accuracy in the St. James parts, the use of the best parts available from responsible manufacturers assure the builder a radio receiver at small cost, capable of being constructed by anyone, which will compare with the highest price set, in tone power and selectivity.

The U circuit may be constructed in two models, the Upright Eight and the Twin Four, complete plans and instructions which are now ready.

## Parts by Leading Manufacturers

4 St. James Transformers @ \$7.50	
1 St. James Oscillator.....	\$30.00
1 St. James Choke Coil.....	5.00
2 Celoron Strips with built-in Benjamin redtop sockets @ \$2.80	1.50
Lignole two-tone Panel (7x21)....	5.60
No. 1824 Frost Potentiometer.....	5.00
No. 51802 Frost Rheostat and Switch	1.25
2 Frost Tip Jacks @ \$0.10.....	1.35
No. 638—Remler Tuning Condenser, .00035.....	.20
No. 639—Remler Tuning Condenser, .0005.....	5.00
Yaxley Cable Plug.....	2.50
2 No. R200 Thordarson Audio Transformers @ \$8.00.....	16.00
Sangamo Bypass condenser, 1 mf.	1.25
Acme Parvult condenser .006.....	.70
Acme Parvult condenser .002.....	.50
2 St. James Brackets.....	.75
1 Clarostat.....	1.50
Celastite Wire.....	.30
Total list price.....	\$83.40

### Optional Parts

2 Remler Dials @ \$1.00.....	\$ 2.00
------------------------------	---------

### Accessories Recommended

Quam Speaker.....	\$17.50
Bodine Loop.....	12.50
Ehlert Radio Cabinet, as desired.	

Electrical operation is the talk of today. The St. James Twin "4" can be made a complete electrically operated set. And the beauty of it is that you can operate it either way, with batteries or socket power, just as you wish, without making any changes in the circuit. No need to buy expensive A-C tubes—no worrying about tubes blowing out—just smooth, care-free, dependable service that can't be beat.

Back of the St. James Twin "4" stands the best brains of the radio industry—the leading, reliable manufacturers whose reputation means complete satisfaction to the user.

Those who have built other St. James circuits will tell you that they can't be beat. In the Twin "4" you have one that is up to date and way ahead of anything else. Builders of the "Upright 8" can easily convert their sets to the Twin "4," likewise the latter can be easily changed over for semi-portable or full portable operation for summer use.

## YES—We Have Full-Size Plans

One of the outstanding features of the St. James Twin "4" is its very simple construction. Our complete, full-size blue prints, diagrams and the easy instruction sheet makes it possible to build this exceptional receiver in very little time. You will wonder at the ease with which you can do it. You will say, as many other have said, "The easiest wiring and building job there is."

## Your Guarantee of Satisfaction

The following leading manufacturers whose parts are used to build this new St. James Wonder Circuit, assure you of getting real service and value. These parts are for sale by leading jobbers and dealers everywhere:

St. James Intermediate Transformers  
Remler Condensers and Dials  
Celoron Panels  
Benjamin Sockets  
Frost Rheostats and Parts  
Clarostat

Thordarson Audio Transformers  
Yaxley Cable Plug  
Sangamo Condensers  
Acme Wire and Condensers  
Bodine Loop  
Quam Speaker  
Ehlert Cabinet

Get the facts on this remarkable new circuit NOW. Save money by building it. Its high quality and low price speaks for itself. Mail the coupon and get the facts.

## ST. JAMES LABORATORIES

123 N. Sangamon St., Dept. 11 • Chicago

### MAIL THIS COUPON NOW

ST. JAMES LABORATORIES,  
123 N. Sangamon St., Dept. 11,  
Chicago, Ill.

Dear Sirs:

Please send me complete facts regarding the St. James Twin "1," the circuit that is making D-X records and which is entirely different and easier to build.

I enclose \$1.25 for complete life-size blue prints and diagrams.

I enclose \$36.50 for St. James Parts, including 4 transformers, oscillator and choke, to be sent postpaid, to build this receiver, which I am unable to buy locally.

Your Name.....

Address.....

City.....

State.....

Tell 'Em You Saw It in the Citizens Radio Call Book Magazine



# Gerald M. Best announces his masterpiece

The word spread like wildfire. Gerald M. Best, Technical Editor of "RADIO," published in San Francisco since 1917, has given the radio world a really different Super Heterodyne capable of bringing in the long distance stations like locals—capable of clean cutting 10 kilocycle separation. It uses four shielded grid tubes—gives you the most uncanny performance—the quietest reception you have ever heard. Background noises are minimized. It's a remarkably quiet set to operate. Simple, too. Only two controls for tuning. Completely shielded in seven beautifully designed copper cases. And the parts sell for about a hundred and a quarter. Gives you more for your money—by far—than more expensive supers. Easy to build if you follow Gerald Best's instructions in full size working prints, made from the original drawings. The whole set of prints and instruction pamphlet costs one dollar. Follow the new SUPER every month in "RADIO." You can buy it at most news stands but it's far safer to subscribe for six months at the special rate of one dollar and get the new Super ideas directly from headquarters every month. Why not send us two dollars today—get the package of full size working instructions and a six month subscription to "RADIO" as well. It's the best investment you can make. "RADIO" is the magazine without the bunk—the A-B-C of Radio's X-Y-Z.

---

## Complete Full Size Working Prints and Detailed Constructional Data For One Dollar

---

*Clip the coupon. Send it now. Get the full size working sketches of the 1928 Gerald M. Best Super Heterodyne. Edition limited.*

**Pacific Radio Publishing Company, Publishers of "RADIO"**  
433 Pacific Building, San Francisco, California

Here is \$1.00. Send me, at once, postpaid, the complete full size working instructions for building the new 1928 SUPER by Gerald M. Best. (If you want to subscribe to RADIO for 6 months at the special price of \$1.00, include an extra dollar with this coupon.)

Name.....Address.....





## Faithful Service

The function of a power resistance is to control voltage and current—accurately—permanently—silently.

AEROVOX PYROHMS used with GOOD equipment make a BETTER power unit.

AEROVOX PYROHMS are built to last—are used by more than 20 leading power unit manufacturers.—This is conclusive evidence of their reliability—accuracy—worthiness.

Made in all values of resistance for continuous duty at 20, 40, 100 and 200 watts.

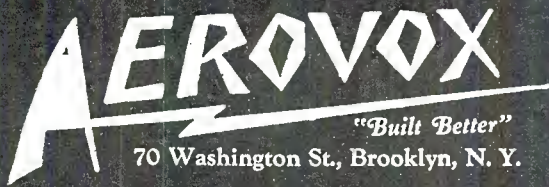

## The New "99" Baldwin

How genuine is the satisfaction that comes to the owner of a Baldwin "99." Its beauty and its ability to satisfy the sensitive ear of the most critical music devotee, represents an achievement in radio acoustics in which Baldwin has been the leader for more than 15 years.

**THE NAME AND ITS QUALITY IS KNOWN THE WORLD OVER**

Look for the "99"

Gold Button on the grill  
Hear it at your dealer's,  
**\$28.50**

Send for literature on Baldwin Units—Phono-Speakers, Adapters and Head Phones. "Imitated but Never Duplicated."



Send for Booklet

J. W. & W. L. WOOLF  
227-229 Fulton St.  
New York City

Distributors & Importers for  
**NATHANIEL BALDWIN, Inc.**

In Canada: Baldwin International, Ltd., Toronto

# In Keeping With Your Radio

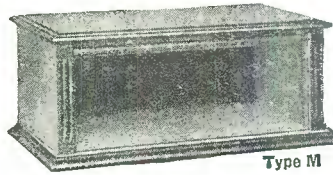

Type M

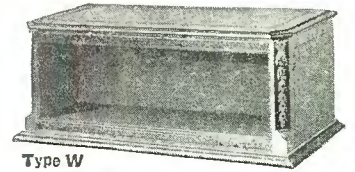

Type W

BEAUTY in your radio is in the cabinet. Install it in a Signal Cabinet—one you will be proud to own. In either Walnut or Mahogany finish, a Signal Cabinet will blend itself with your other furnishings. And, the Signal Cabinet is as carefully built as the set itself. All wood is properly matched to secure the fine grain and perfect color so distinctive in Signal Cabinets. All Signal Cabinets have the same high gloss lacquer finish.

### Sematic Sending Key



The latest development in the Radio field. Nothing quite like it offered operators today. Highly finished nickel parts—sturdy but simple construction—a high grade sending key, made to relieve fatigue in sending. Just the key operators want—sells for \$15.

### DEALERS

Signal Radio products are proving profitable items for hundreds of dealers. It is a real dealer's line that makes good in every way with the customer. Signal Cabinets are especially attractive for dealers. Write for our sales co-operation plan and discounts.

Call for Signal Radio Products from your dealer—and get real satisfaction

**SIGNAL ELECTRIC MFG. COMPANY**  
MENOMINEE, MICHIGAN

**SIGNAL**

## The "Power" A. C. TUBE ADAPTER

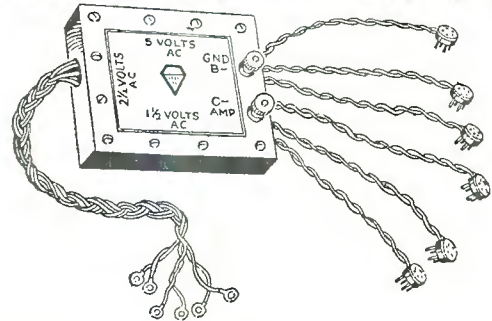

Designed to accommodate all the popular battery receivers and the average 4, 5, 6 and 7 tube receivers of T. R. F. or Neutrodyne type. This adapter allows easy change from battery receiver into the most modern type of electrical sets. The adapters plug into tube sockets or receiver, A. C. tubes are inserted into adapters, and cable is attached to Power Unit.

Prices range from \$12.00 to \$20.00  
Write for price list

*Harold Power, Inc.*

Manufacturers of Socket Power Devices  
Licensed under patents owned and/or controlled by the  
Radio Corp. of America  
**MEDFORD, MASS.**





# SM

## New!

# All-Wave Tuners and Unipacs

**L**OOK at it—the prettiest little tuner you ever laid eyes on, to go with any two stage power amplifier or Unipac, all light-socket operated, and costing only \$31.50 for the complete kit. The S-M 642-AC Universal All-

Wave Tuner is a two tube A.C. receiver, using interchangeable coils to cover all waves from 18 to 3,000 meters at will, and is equipped with illuminated drum dials, beautifully decorated metal panel, and all modern refinements. The circuit is the popular and efficient one stage of RF amplification and regenerative detector, and its DX range 500 to 1,500 miles or more. A 642-AC Universal All-Wave Tuner and one of the new 682-210 two stage push-pull 210 Unipac power amplifier and ABC power plant is the finest medium range receiver money can buy, with tone absolutely unequalled. The 642-AC kit, complete to the last screw and lug, is priced at \$31.50, for use with any two-stage audio amplifier at all.

The Universal All-Wave Tuners are a series of the neatest, snappiest sets you can build, low in cost but great in dependable performance and real value. Model 642 is a two tube battery operated tuner at \$29.50; Model 644 the same tuner plus two audio stages, making a "wow" of a four tube set with 1,500 mile loud speaker range at \$42.50, complete. Model 644-AC is a four tube socket powered all wave tuner priced at \$54.00, deriving all power from the 684 ABC power unit kit at \$32.50—just \$86.50 for a complete four tube all wave set with ABC power unit included that will give sweeter results than any of the popular six tube, one dial sets.

Or if you want, you can build the three tube model Universal Tuner to precede all standard high quality one stage power amplifiers—or you can build the new screen grid tube into any of these tuners.

Complete blueprints and instructions for all models. 25c.

## S-M Unipacs Socket Powered Amplifiers

New Unipac amplifiers are just being released—power amplifiers for every need, giving the finest quality of reproduction you can possibly demand. Each model contains the famous push-pull 210 amplifier stage first introduced by Silver-Marshall, as well as its own complete ABC power plant operating from any 110 volt, 60 cycle lamp socket.

Model 681-210 is a single stage push-pull amplifier using two UX-210 tubes with an undistorted power output of over 5,000 milliwatts—up to several hundred times clearer than that of ordinary receivers. It can be used with any set equipped with at least one stage of AF amplification to boost volume, eliminate B batteries and give finer quality than you can get from any other power amplifier or receiver on the market. Type 681-210 has a self-contained power supply using one or two UX-281 rectifier tubes at will and a UX-874 voltage regulator tube to hold receiver B voltages, supplied by the Unipac, absolutely constant.

The new Unipac case is 17¼" long, 10¼" high, and 9¾" wide—large enough to accommodate the Unipac and an extra audio stage if desired, as well as an A power transformer to enable the 681-210 to supply receiver ABC power when A.C. tubes are used. Price, 681-210 KIT, ready to assemble, \$83.25; or 681-210 WIRED Unipac, ready to use, \$93.25.

Model 682-210 is a complete two stage amplifier for phonograph or radio containing the 210 push-pull output amplifier stage of the 681-210 plus a first audio stage using a UX-226 tube and a S-M 220 transformer. Type 682-210 will furnish A, B and C power to an A.C.-tube-equipped receiver as well as complete audio amplification of the finest imaginable quality. Price, in same case as 681-210, \$97.75 for 682-210 KIT, or \$107.75 for 682-210 WIRED Unipac, ready to use.

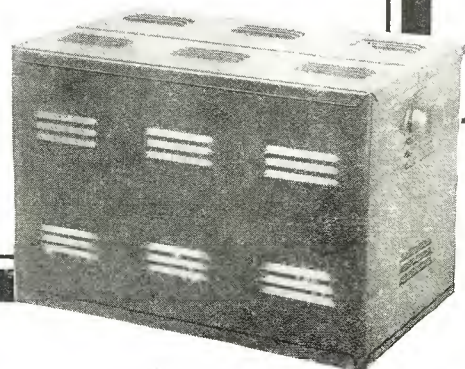



# SM

# New! Shielded Grid Six

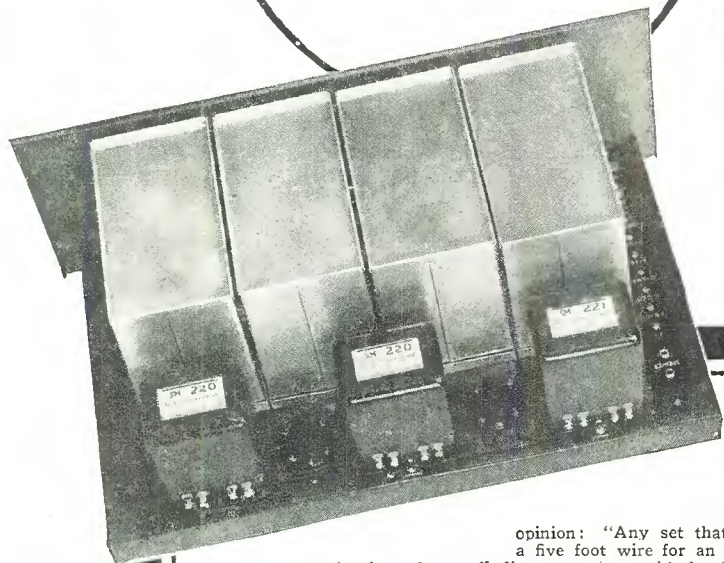

"If it will do only a quarter of what you claim, it's the set of sets," said a prospective builder of one of the first of the new Shielded Grid Six receivers. Then he built the set, came back the next day, and gave his

opinion: "Any set that will bring in East and West Coast stations with a five foot wire for an antenna, that will give ten to fifteen kilocycle separation from locals and get all distant stations with local volume and tone quality—that's my idea of some well, that's the receiver for me!"

The new Shielded Grid Six receivers, using three stages of tuned RF amplification with screen grid tubes, followed by a super sensitive detector and the famous S-M two stage audio amplifier, are just about the finest receivers you can build. They have consistently "trimmed" every receiver against which they have been tested, even new screen grid superheterodynes, yet they're so simple and easy to build, so sure and positive in their operation—with no tricky adjustment—that you'll simply fall in love with them after your first five minutes of tuning. And the Shielded Grid Sixes offer all the refinements of two and three hundred dollar factory sets, in shielding, all-metal assembly, bronze front panel, dual control vernier dials and appearance that is a joy to the eye of the connoisseur or the engineer alike—a beauty that creates instantaneously the desire to own the finest of sets—a Shielded Grid Six.

## Unconditional Guarantee

So truly remarkable is the performance of the Shielded Grid Sixes, with their superheterodyne selectivity, marvelous tone, and uncanny DX ability, that they are offered in kit form, ready to put together using only screw-driver, pliers, and soldering iron, with the following guarantee.

If they don't give equal or better performance, to your absolute satisfaction, than any other set you've ever used, just rebox and send back the parts and get your money back!

Could anything be fairer—and has any other set ever been offered to you that impressed its makers as being good enough to justify such a guarantee?

Don't waste time—get your Shielded Grid Six now and learn what 1928 radio reception really is—as far ahead of anything you've known as the new Ford is ahead of the old.

Two models of the Shielded Grid Six receivers using screen grid tubes are available, type 630-SG and 630-LSG.

The 630-SG receiver is a six tube TRF set employing three stages of screen grid RF amplification, a super-sensitive detector, and two audio stages with a wavelength range of 200 to 550 meters with coils furnished, or up to 3,000 meters with other standard plug-in coils. It is designed for antenna operation with a 15 to 30 foot antenna indoor or outdoor, or with a loop, if desired, upon removal of antenna coil. The complete kit, including every nut, screw and lug required, down to the last part, is priced at \$97.00, with complete building instructions and blueprints.

The 630-LSG receiver is exactly the same as the 630-SG model except that it is intended for loop antenna operation only using any standard .00035 loop. The complete kit, including all parts, is priced at \$91.50.

## New 440-SG Three Stage 112 Kilocycle Screen Grid Amplifier

The S-M 440 Time Signal Amplifier—the popular copper and brass 112 K.C. shielded RF amplifier is now available in a new model for screen grid tubes, far more sensitive even than is the original 440. Model 440-SG Jewelers Time Signal Amplifier uses three RF amplifier stages with UX-222 or equivalent screen grid tubes and a super-sensitive detector, with the most tremendous amplification obtainable from any known long wave amplifier. Ready to operate, laboratory tested and calibrated, price \$40.00, unconditionally guaranteed superior to any long wave amplifier constructed of individual parts.

**SILVER-MARSHALL, Inc.**  
836 West Jackson Blvd. Chicago, Ill.

**SILVER-MARSHALL, INC.**  
836 W. Jackson Blvd., Chicago

- Please send me the following data:
- ..... Complete Shielded Grid Six blueprints and instructions for which I enclose 25c.
  - ..... Complete Unipac instructions, for which I enclose 25c.
  - ..... Complete Universal All Wave Tuner blueprints and instructions, for which I enclose 25c.
  - ..... All circulars upon new S-M developments in A. C. operation, power amplification, audio quality, RF amplification, and short wave fields for which I enclose 6c postage.

Name.....  
Address.....  
City.....



**SM**

**All Silver-Marshall Kits and Parts in Stock for Immediate Delivery**

**Improved Laboratory Super Parts**  
*Write for our free building plan*

UNIPACS, all types, wired and unwired—also the Reservoir B, wired and unwired.

*If it is in the Call Book we have it in stock for you.*

New Silver-Marshall Universal All-Wave Tuner Kits in stock. Also the Remarkable New S-M Shielded Grid Six. Ordered Today — Shipped Today.

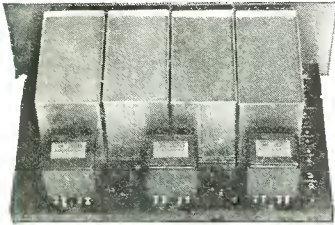

*Write for our catalog*

**WALTER ASHE RADIO CO.**  
211 North 10th St. Louis, Mo.

**SM**

**Dealers' and Set Builders' Headquarters**

We can supply parts for all Call Book Circuits and Receivers featured in any magazine. Send for our complete catalogue and discounts to dealers and set-builders. We ship your order the day received.

*A Few of Our Nationally Known Lines*

Acme  
Aero  
Samson  
Electrad  
Remler  
Hammarlund  
Silver-Marshall

**Official Distributors for Silver-Marshall**

*We can make immediate delivery on 2 tube Tuners, Unipacs and the new Shielded Grid Shielded Six*

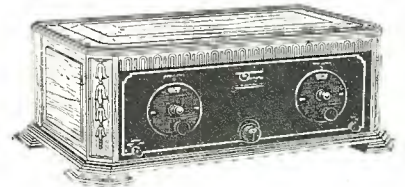

**GRAYMORE RADIO CORP.**  
142 Liberty Street New York City

**SM**

**Custom Builders**

**T**HE best automobile bodies are custom built; the best wearing apparel is custom made. The best in Radio must be custom built.

We are authorized to build, repair and rewire all Silver-Marshall circuits. We are experts on the new shielded grid tube circuits and can bring your old Shilded Six up to date at a nominal cost.

**General Radio Service Laboratories**  
148 Greenwich St. New York, N. Y.

**SM**

**Every Radio Dealer Should Write for Our Discounts**

The New S-M Two Tube Tuner and the S-M Two Stage 210 Push Pull Amplifier Kits are in stock. Also the remarkable S-M Shielded Grid Six Kits at \$97 list for short antenna, or \$91.50 list for loop operation!

We are Distributors for S-M Products. LC-28 Receiver, LC-28 Unipac, Magnaformer 9-8, Harkness Counterfonic 6, Excello and Corbett Cabinets, Qualitone Loops, Amplion Speakers, Zetka Tubes, and many other lines.

**RADIO SERVICE COMPANY**  
P. O. Box 34, Dept. C Knoxville, Iowa



**CO-OP MONTHLY**

Dealers' Net Price Catalog of RADIO, ELECTRICAL DEVICES and APPLIANCES

*Write for your copy—it's FREE*

**Co-Op Electric Supply Co.**

33 N. Union Street CHICAGO, ILL.

80 39th Street BROOKLYN, N. Y.

**FEDERAL RADIO COMPANY**  
1372 BROADWAY. DETROIT, MICH.

We Are Authorized Distributors for

**SM SILVER-MARSHALL**

Write to Federal for information on any SILVER-MARSHALL set or equipment. Our stocks are complete at all times. The Federal Radio Co. are distributors, also, for other nationally famous makes. We give the fastest service in America! Ask us for our special discounts!!



**SM**

**Fastest  
Mail Order  
Service West of the Rockies**

WE carry a complete line of practically every known radio part and accessory. Whether it is a complete kit or an individual part you'll find it in our stock. And, we make immediate shipment—24-hour service. In other words, we combine quality products with a service that is not to be obtained anywhere else west of the Rockies.

**SET BUILDERS:**—Write for our discount sheets and catalog. We can save you money. Maximum discounts to dealers.

Send your order to us for the Improved Shielded Six, Silver-Marshall Unipacs, or any S-M products. We can supply complete or individual parts for any circuit described in this magazine, or parts for any standard hook-up.

Get acquainted with "The Radio Parts Jobbers" of the Northwest—your first order will make you our steady customer.

Mail Orders Solicited

**WEDEL COMPANY**

Established 1888

520 Second Avenue

Seattle, Wash.

**Get Your Silver-Marshall Parts  
QUICK**

from **W. C. Braun Company**  
Official Wholesale Distributors

**SM**

We are wholesale distributors for all Silver-Marshall products. A complete stock of parts is on hand for immediate shipments to fill dealers' requirements anywhere.

**Everything in Radio**

We carry the largest and most carefully selected line of radio goods in the country—the lines of the leading manufacturers of sets, parts, kits and accessories.

Mail orders given special attention. We are fully equipped to serve dealers on mail orders promptly and efficiently. Our new 214-page dealers' catalog lists over 4000 items in radio, electrical goods, sporting goods and allied lines that keep the dealers' business humming twelve months of the year. Write for free copy of this catalog on your letterhead and learn about our successful dealer plan.

**W. C. BRAUN COMPANY**

*Pioneers in Radio*

565-569 W. Randolph St.

**CHICAGO**  
ILLINOIS

**RADIO CATALOG free**

**2000  
Exceptional  
Radio  
Values**

**1928  
WHOLESALE  
CATALOG**

**RADIO  
of  
Sets, Kits  
and  
Everything  
in Radio**

**LOWEST  
PRICES  
to  
DEALERS**

Send Today for  
This Great Book

Compiled exclusively for dealers in radio sets, radio parts and for set builders. An amazing catalog containing the newest things in the world of radio.

Unbeatable values in radio parts, kits and supplies of National fame. A complete array of cabinets and consoles, in all the latest styles, finishes and popular sizes, and at unmatched prices.

**SILVER MARSHALL AC PARTS IN STOCK.** 630A Kit, retail price, \$99.00; 6S2A Kit, retail price, \$36.50. Liberal discounts to the trade. Immediate delivery.

**SHORT WAVE SECTION**—Our catalog contains a section devoted to a showing of the highest grade short wave receiving and transmitting apparatus. Also the finest electrical appliances for use in the home.

**WRITE TODAY**—Whatever your radio needs may be, you will find them in our 1928 catalog. Write for a copy today.

**SHURE RADIO COMPANY**

343 F. WEST MADISON STREET, CHICAGO, ILLINOIS

Shure service means sure profits. You can take orders direct from our illustrated list or price catalog. The high quality of our products eliminates loss. Large stocks offer you a large selection. Our speedy shipments insure your customers' good will and bigger profits for you.

**SM**

SILVER-MARSHALL  
SPECIALISTS

**CUSTOM  
BUILT  
SPECIAL!**

**Set Builders and Dealers**

We carry the largest stock of parts in the "Middle West." We have been located here for six years. Look us up in Dun's and Bradstreet's. Do business with a responsible concern and get the parts that are specifically stated, with no substitutions, in all kits.

Distributors for the Following Lines

AERO COILS  
ABOX A SUPPLY  
ALL AMERICAN  
AMERTRAN  
AMSCO  
AMPERITES  
ACME  
BALKITE  
BREMER-TULLY  
BODINE  
BENJAMIN  
BROWNING-DRAKE  
CECO TUBES  
C. R. L.  
CAMFIELD  
CARTER  
DAVEN

DUBILIER  
ELKON  
EBY  
EAGLE  
ELECTRAD  
FROST  
FRITTS CABINETS  
FERRANTI  
F. R. P.—G. R. P.  
HAMMARLUND  
H. F. L.  
9 IN LINE  
JEWELL  
KODELL  
KARAS  
KURZ-KASCH  
LYNCH  
LINCOLN

MARCO  
MAJESTIC  
MAGNAFORMER  
MADISON-MOORE  
MELO-HEALD  
REMLER  
SILVER-MARSHALL  
SAMSON  
SCOTT  
STROBODYNE  
TYRMAN  
THORDARSON  
TOBE  
UTAH  
VICTOREEN  
WEBSTER  
X L RADIO LAB.  
YAXLEY

Write for Our Discount Sheet

**KOPLOY & ROSS**

1306 Randolph Street

Detroit, Mich.



**DEALERS AND SET BUILDERS—**  
 SEND FOR YOUR  
**FREE COPY—**

**RADIO BUILDERS' GUIDE**



*Wholesale prices on*  
 S-M Parts, including Improved A. C. Shielded Six Improved Laboratory Model Super S-M Unipacs Etc.

*Wholesale prices on*  
 Victoreen Best Lincoln Hammarlund Bremer-Tully Etc., etc.

References: Dun's or Bradstreet's or your banker  
 Prompt Shipments—Lowest Prices  
**Serlin & Co., 1415 Broadway, Detroit, Mich.**

*The Big Friendly Radio House*  
**Complete Parts**  
**Silver-Marshall**  
**Universal & Power Pack**

WHEN you get our 1928 Catalog, you can have popular, nationally-advertised kits, parts, eliminators and accessories at prices that are real values.

Our dealer catalog, which lists everything in radio, means more real profit for you. Standard quality at the right price.  
*Write for our big Catalog*

**WESTERN RADIO MFG. CO.**  
 128 West Lake St. Dept. MO Chicago, Ill.

**Professional Set Builders**

*We Are Extremely Desirous of Your Opinion on the Following Subject*

IT has been under discussion by our technical staff—upon the advisability of running in each issue of the Citizens Radio Call Book—a section devoted to matters of interest to the professional who builds sets for re-sale and those who build more than one set. This section to contain laboratory data and other valuable matter relative to the very latest type of sets, power packs, A. C. operation, and a general fund of information and of value and assistance to the professional and advanced experimenter who does not have the facilities and a fully equipped laboratory at his command.





If you desire such a section we will install same, provided you will write us—briefly—simply stating you would like to see such a section.



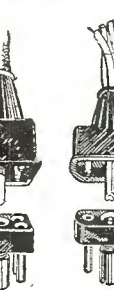

*Write F. A. HILL, Editor*

**CITIZENS RADIO CALL BOOK**  
 508 South Dearborn Street Chicago, Illinois

**PLEASE WRITE NOW**

**Jones**  
**MULTI-PLUG**  
 THE STANDARD SET CONNECTOR

12 Contact    10 Contact    7 Contact    5 Contact    Loop Color Cap

Type BM

With the present day sets having many power supply leads, Multi-Plugs are essential. The line this year embraces Multi-Plugs with as many as twelve contacts and five different types of socket mountings. Small illustration shows the bracket mounting (BM) most commonly used by set builders. Prices are materially reduced this year. See your dealer for price sheet or write direct to

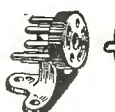
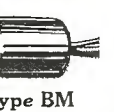
**HOWARD B. JONES**  
 2300 Wabansia Ave.  
 CHICAGO





**\$75 to \$125 Weekly**  
**Charging Batteries**  
**\$5 Down Starts You**

Let me show you how to make big money right from the start. I've prepared a FREE book explaining all details. First week's profit pays for all equipment. You can get all the battery charging business in your community with my Service Station Charger—it's years ahead of ordinary chargers—handles 50% to 70% more batteries. I explain everything—start you in a business of your own and put you on the way to big money. Write for FREE Book.

**C. F. HOLMES, Chief Engineer, Dept. 15**  
 Independent Electric Works, 5116 Ravenswood Ave., Chicago

**FREE BOOK Just Out**

**In New York**  
*stay at the*  
**ABERDEEN**  
**HOTEL**

17 West 32nd St., near 5th Ave.  
 Close to Pennsylvania Station—accessible to everything! Every modern hotel convenience and service.

Rooms with bath **\$2.50** ALWAYS available

JOHN F. DOWNEY, Managing Director



# Tyrman "70"

## Shielded Grid Amplimax

Using Type SP122 Tubes

### for A-C or Battery Operation

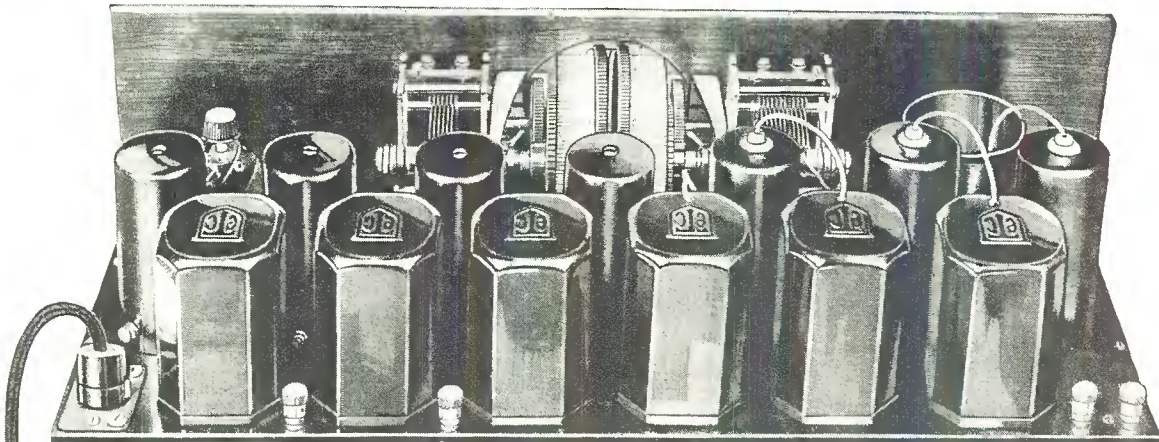

Brings in **JAPAN-AUSTRAL A**  
with **VOLUME** and **QUALITY**

#### WEBSTER "70"

A Real Companion for the Tyrman "70"

Webster "10" ("A" Power Unit). Operates any set from 4 to 10 tubes.

Until now all claims for distance, selectivity, volume and tone quality have been based upon number of tubes employed.

Now greater results are obtained through Tyrman Laboratories by the development of the Tyrman "70" without distortion or oscillation.

Build this new receiver and be the first to benefit by this revolutionary improvement.

**Tyrman Electric Corp.**  
141 West Austin Avenue, Chicago, Ill.

POSTAL TELEGRAPH - COMMERCIAL CABLES			
RECEIVED AT SO. LA SALLE CHICAGO	TELEGRAMS TO ALL AMERICA	CABLEGRAMS TO ALL THE WORLD	<small>This is a collect Telegram or Cablegram unless otherwise indicated by signal on the check or fee the address.</small> DAY LETTER NIGHT LETTER NITE NIGHT TELEGRAM LCO DEFERRED CITY CABLE LETTER WLT   WEEK END LETTER
STANDARD TIME INDICATED ON THIS MESSAGE			
GSA574 41 4 EXTRA NL		1927 DEC 21 PM 11 35	
TYRMAN ELEC CORP		1806	
141 WEST AUSTIN AVE CHICAGO ILLS			
CONGRATULATIONS TYRMAN SEVENTY RECEIVED BRISBANE AUSTRALIA SIDNEY AUSTRALIA WITH VOLUME AND QUALITY OF LOCAL STATIONS ALSO ALL THREE JAPANESE STATIONS VERY CLEAR STOP SIMPLICITY OF TUNING REMARKABLE STOP STATIONS WERE TUNED IN AS EASILY AS AMERICAN BROADCASTERS			
H G WILLIAMS WILLIAMS AND KLENTZ CO.			

#### Mail Coupon Today!

TYRMAN ELECTRIC CORP.  
Dept. CB, 141 W. Austin Ave.  
Chicago, Illinois  
Gentlemen:  
Kindly send me, gratis, special literature describing the Tyrman "70" Shielded Grid Amplimax in detail.

Name.....  
Address.....  
City..... State.....



# Tyrman "70"

Shielded Grid Amplimax

Using the New Shielded Grid Tube

We have in stock all parts as specified in this issue of the Citizens Call Book to build this marvelous receiver. Write us for price list.

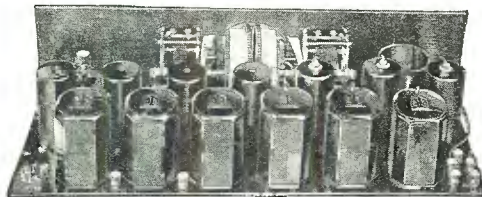

Dealers and set builders write for our up to the minute Bulletin on all popular circuits, kits and parts. A complete stock is carried. Send us your name and address by post card or letter.

## You Will Profit by Our Prices

OUR LABORATORY is completely equipped for service to the set builder. Matching, Measuring and Calibrating accurately done. Write us about your troubles; no charge for information.

### DISTRIBUTOR FOR

Tyrman, Silver Marshall, Remler, Frost, Camfield, Scott, Thordarson, Jewel, Carter, Webster and Other Nationally Advertised Lines

## JAMES C. GORDON CO., Inc.

1213 Pine Street

St. Louis, Missouri



## Guarantees Immediate Delivery on the

# Tyrman "70"

Shielded Grid Amplimax

The Tyrman "70," after many months of comparative tests, has proved itself to be far superior in Selectivity, Sensitivity, DX Reception, and Volume.

It is in our opinion the finest radio receiver on the market today, embodying as it does, every up-to-date principle that can lend any improvement to radio reception. It is distinctly a Quality Receiver.

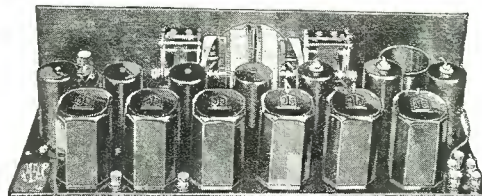

### Shieldplate Tube—Type SP 122—Shielded Grid

Specified and used exclusively in the Tyrman "70." Endorsed and approved by leading authorities.

### Rush Delivery Service on the Following Kits and Parts

- |                   |                   |                     |
|-------------------|-------------------|---------------------|
| Magnaformer 9-8   | Ramler 8          | Karas Equamatic     |
| Victoreen Super 8 | Lincoln 9         | Thordarson Products |
| Camfield Super 9  | Shieldplate Tubes | National Products   |
| Tyrman Ten        | Camfield Seven    | Samson Products     |

DISTRIBUTORS FOR SPARTON, AC DAYTON, TYRMAN "70," ALL-AMERICAN AND STEINITE SETS

## THE M. & M. CO.

500 Prospect Avenue  
22 East Front St., Youngstown, Ohio

Cleveland, Ohio  
131 East Market Street, Akron, Ohio

MAIL THIS COUPON TODAY!

THE M. & M. COMPANY,  
500 Prospect Avenue, Cleveland, Ohio

Please send complete information on the Tyrman "70," the Shieldplate Tubes, and your new 1928 Radio Catalog, free of charge.

Name.....

Address.....State.....



# And Now Radio's Greatest Discount Catalog

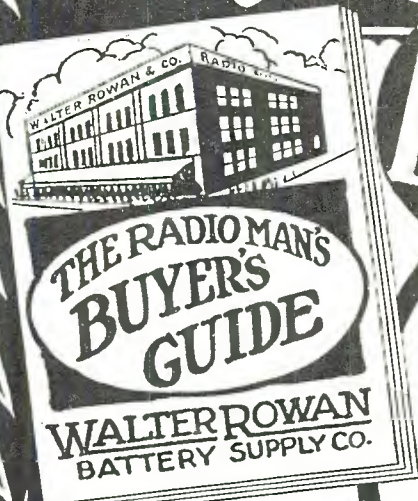

**FREE**  
Write Today for **FREE COPY**

**Professional Set Builders and Dealers**  
The Tyrman "70" is the newest sensation in radio. It combines the successful experiments of the country's leading radio engineers. Complete article in this issue. We can furnish, immediately, all parts for the famous

## Tyrman "70"

Shielded Grid Amplimax

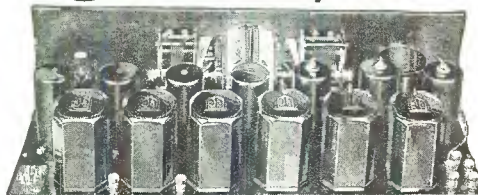

**Build**  
the circuits recommended by Citizens Radio Call Book. We have in stock all kits as shown in this magazine and all other radio publications. Lowest prices to Professional Set Builders and Dealers.

**Buy Direct**  
from the largest Radio Jobbing House in the middle west and save money on all radio equipment. Fill in the attached coupon and mail to us TODAY. You will be amazed at the many Radio Bargains displayed in our new 1928 catalog.

**Professional Set Builders!**  
This catalog contains everything worth while in radio. Fill in the attached coupon and mail today.

**WALTER ROWAN BATTERY SUPPLY CO.**  
225-231 N. Peoria St. Chicago, Ill.

Walter Rowan Battery Supply Co.  
Dept. CB, 225 N. Peoria St.  
Chicago, Illinois  
Please send, without obligation to me, your 1928 Radio DISCOUNT Catalog.

Name.....  
Address.....  
City.....State.....

# Shieldplate Type S.P. 122 Shielded Grid Tube



## Endorsed and Approved

by such leading radio engineers as Ernst Tyrman, K. A. Hathaway, Gerald M. Best, and such excellent authorities as Citizens Radio Call Book, Radio News, Radio Broadcast, Popular Radio, Radio Engineering, Radio World, Radio Listeners Guide, and all leading metropolitan newspapers.

**GUARANTEED**  
The Shieldplate Tube Corporation guarantee these tubes to be mechanically perfect or your money cheerfully refunded.  
Type SP122—Price  
**\$6.50**

**Specified Exclusively**  
for use with the  
**Tyrman "70"**  
Shielded Grid Amplimax  
Best's Super—S-M Shielded Grid Sixes and all circuits using shielded grid tubes.



Sold by all reliable Jobbers and Dealers

Manufactured by  
**SHIELDPLATE TUBE CORP.**  
208 So. LaSalle St. Chicago, Ill.

Shieldplate Tube Corp.  
Dept. CB, 208 S. LaSalle St.  
Chicago, Illinois

Gentlemen:  
Kindly send FREE Booklet describing the Shieldplate Tube, type SP 122, and its many uses.

Name.....  
Address.....  
State.....

**MAIL COUPON for COMPLETE LITERATURE**

Tell 'Em You Saw It in the Citizens Radio Call Book Magazine



# A Sensational Success!

**They are Enthusiastic**

Being absolutely pleased with the Eliminator bought from you last June, it is really a pleasure for me to order two more for some of my relatives. Find enclosed money order.—  
Leopold O'Reilly, Montreal, Que.

Your Eliminator is certainly working fine. I have it hooked up to a 6-tube No. 20 Atwater Kent, and I get a better reception than I have had since I owned the set.—  
John W. Jackson, Painesville, O.

The Eliminator I purchased from you six months ago has given perfect satisfaction. I have it connected to a six-tube Columbia and get better results than I ever had with "B" batteries.—  
Bernard V. Dugan, Lockport, N. Y.

I have one of your Eliminators purchased from you last winter. It has been in use constantly ever since and I want to say it has been perfection in every respect and cannot be beat by any other.—  
Fred H. Kembel, Hastings, Neb.

**You will be enthusiastic, too**

## Townsend "B" Socket Power

**Approved**

and passed by the rigid laboratory tests of Popular Radio and Radio News

*Over 25,000 sold the first 6 months*

—Overwhelming evidence that VALUE is quick to be recognized and appreciated. Unsurpassed quality is built into the Townsend "B" Socket Power Unit with money saved by unified production methods and lower merchandising costs.

You get more—you pay far less—for the most remarkable value in Radio today. New thousands of Radio set owners are learning this daily by installing Townsend "B" Socket Power.

Sold on REAL GUARANTEE OF MONEY BACK IF NOT SATISFIED. Delivers up to 100 volts on any set, on DC. or AC.—any cycle. Full tone, clarity and volume.

### SEND ORDER TODAY

Simply fill out the coupon and slip it into an envelope with only \$1.00 and mail at once. Your Townsend "B" Socket Power Unit will be sent promptly. Deposit only \$5.85 plus postage with the postman. Try out for 10 days—then if it does not do everything we say, return it to us and purchase price will be refunded.

TOWNSEND LABORATORIES  
Dept 26  
713 Townsend St., Chicago, Ill.

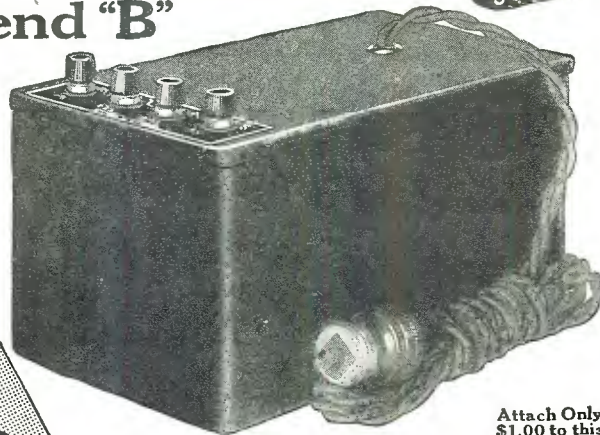

Attach Only \$1.00 to this Coupon

Complete \$6.85 \$1.00 Down Balance C.O.D.

Send for Literature

TOWNSEND LABORATORIES  
713 Townsend St., Dept. 26 Chicago, Ill.  
Gentlemen: Attached find \$1.00. Kindly send at once Townsend "B" Socket Power Unit, C.O.D. for \$5.85, plus postage, on guaranteed 10-day free trial.

Name .....

Address .....

City..... State.....

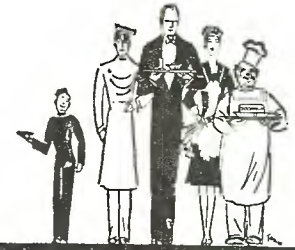

AT YOUR SERVICE

THE  
**WHITEHALL HOTEL**  
100" ST. AND BROADWAY  
NEW YORK

THE ideal hotel selection when you visit New York. All rooms have both bath and shower and at rates of \$5 per day for two! A perfect hotel. Ample parking space and near numerous garages.

Exceptional Restaurant  
J. J. McAULIFFE—Res. Manager

**Dealers Repair Service**

Let us do your repair work. We will construct, repair, rebuild any type receiver, power pack, eliminator.

Work fully guaranteed and will be done for dealers cheaper than you can do it yourself.

Write us your problems and ask for estimate on any job. Quick service to dealers.

**Radio Service Laboratories**  
Incorporated  
508 So. Dearborn Street  
Tel. Wabash 1900 Chicago, Ill.

**Citizens Radio Amateur Call Book**

Containing all the Amateur Transmitting Stations in the World and complete list Commercial and Ship Stations.

Used by all amateurs and many Commercial and Ship Stations.

Single copies, \$1.00 in U. S. A.  
\$1.10 Foreign, Postpaid

**CITIZENS RADIO AMATEUR CALL BOOK**  
508 So. Dearborn Street, Chicago, Ill.

## Expert Service ~ Power Packs ~ A and B Eliminators ~ Receivers

Complete equipment for testing and repairing all types of power packs, "A" and "B" eliminators and radio receivers.

Let us modernize your receiver with the correct "A" and "B" power units. We will design or construct any type power unit you may desire.

If you are not obtaining proper results from the receiver or power pack unit, send

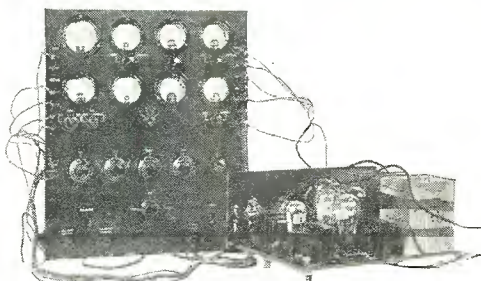

it to us today and we will give you an estimate for repairing and remodeling it with all the latest developments.

All work is given a test for actual performance before being returned, together with a final test in a completely shielded room, thereby eliminating all internal noises. Each receiver and power amplifier is also given special mechanical test for quality, thus assuring perfect reception.

**RADIO SERVICE LABORATORIES, Inc., 508 South Dearborn Street, Chicago, Ill.**



**QUALI-TONE**



Price \$10.00

*Specified for*

St. James  
Magnaformer  
Melo Heald  
La Peer  
Tyrman  
Shielded  
Grid 7  
Economy 9

Madison-  
Moore  
World's Rec-  
ord Super 9  
9 In Line  
Lincoln Qual-  
ity Super  
and all circuits  
using .0005  
condensers



**HOLDS TWO  
WORLD'S  
RECORDS**  
for DX Reception

*Ask your jobber  
or*

**DELUXE**



Price \$12.50

**For**

**Selectivity,  
Distance,  
Tone, Beauty**

**COLLAPSIBLE  
ADJUSTABLE**

**DURO METAL PRODUCTS COMPANY**  
2649 North Kildare Avenue  
Chicago, Illinois



Licensed by Technidyne Corporation under U. S. Patent 1593658, July 27, 1926.

**For  
Hair-line  
Control!**

**TRUVOLT**

*An All-Wire Variable Power Resistor*

When hair-line control of voltage is necessary, many engineers specify the use of Truvolt—the new all-wire voltage potentiometer. The Truvolt B-Supply unit, described in this issue, is built with Truvolts for superfine control of voltage.

Air cooled like the great aviation motors; permanently accurate; long life. Potentiometer control; positive metallic contact; nichrome wire resistance; very low temperature coefficient.

Twenty-two Stock types with resistances up to 50,000 ohms. All rated at 25 Watts! Price \$3.50 each.

*Also full line of fixed and tapped wire resistances*

Write for FREE Resistance Circular

Dept. 236, 175 Varick St., New York, N. Y.

ELECTRAD Inc.

JENSEN DYNAMIC CONE RADIO SPEAKER

Cabinet Design of Models D44 and D45



FOR PERFECT REPRODUCTION

The Jensen Dynamic Speaker has no characteristic tones of its own. Its design enables it to reproduce all sounds audible to the human ear with equal fidelity. Its tonal range is the greatest ever achieved in a radio loud speaker.

The D-44 can be connected directly to any radio set in place of other speakers, but being a true Power Speaker it is also adaptable for use with power amplifiers, as it will reproduce perfectly when subjected to the full undistorted output of a 210 vacuum tube or its equivalent.

Model D44 Jensen Dynamic Speaker (with 6-volt field).....	\$65.00
Model D4 Jensen Dynamic Speaker, unit only (with 6-volt field).....	47.50
Model D45 Jensen Dynamic Speaker (with 90-volt field for use with power packs, etc.).....	67.50
Model D5 Jensen Dynamic Speaker, unit only (with 90-volt field for use with power packs, etc.).....	50.00

*If your local dealer can't supply you order from nearest office*

JENSEN RADIO MFG. COMPANY

1136 Pure Oil Bldg., Chicago, Ill.      212 Ninth St., Oakland, Cal.

The Big Friendly Radio House  
Complete Parts



WANTED!

PROFESSIONAL Set Builders, Radio Dealers, and Fans in every community to introduce and become our Factory Representative on the newest, most revolutionary radio development in the history of the industry . . . the SUPER HILODYNE Circuit, a radio circuit that is modern and independent.



# Now!

## 2 Radio Magazines for the price of one

Citizens Radio Call Book and "RADIO"—both for the price of "RADIO" alone. A full year subscription to both of these leaders in the radio magazine field for only \$2.50. Copies of both these magazines when purchased from a news dealer over a period of a year would cost you \$5.00. You save exactly \$2.50 by subscribing NOW. The publishers of these two magazines will cooperate to the fullest extent in the future for betterment of the radio parts business—for more extensively popularizing the better class of radio circuits—for giving you the down-to-the-minute ideas in radio just as soon as they are announced. You can hardly afford to pass up this liberal subscription offer. The saving is a big one. Both magazines mailed right to your address for a full year for the price of one. Think it over! Then clip the coupon—attach your check, money order or stamps to it—mail today, before you turn this page. If you are already a subscriber to either magazine you can extend your subscription for another year and get in on this great offer.

**The Coupon Saves  
You \$2<sup>50</sup>. Now  
is the time to**





# Hi-Q SIX

*The Best in Radio Must be* **CUSTOM-BUILT**

*Six Super Features  
Make This New*

## CUSTOM-BUILT Hi-Q SIX

*the Leading Set  
of the Year!*

This CUSTOM-BUILT instrument is not only the greatest radio advance of recent years but is equally remarkable both in its low cost and in the profits it is making for those who are building and selling it.

*First.* its circuit is the final expression of three solid years of research and scientific development.

*Second.* it employs only the very finest parts available, all having been selected for perfect synchronization.

*Third.* its Automatic Variable Coupling effects even and maximum amplification over the entire tuning range.

*Fourth.* each of its four tuned stages is completely isolated by means of chokes, by-pass condensers and heavy aluminum shields. Each stage operates independently without interstage coupling.

*Fifth.* symphonic audio amplification, plus a power tube, produces natural tone quality which is nothing short of a revelation.

*Sixth.* the Hi-Q Six can be built at a cost of only \$95.80 for all parts. The finished CUSTOM-BUILT instrument is unequalled by ready-made sets at least \$100 higher in price.



## *The Best In Radio Must Be* **CUSTOM-BUILT!**

**T**O meet the exacting requirements of individual reception areas—to meet the personal preferences of individual tastes—and to meet the desires of those intelligent persons who appreciate the advantages of truly fine handiwork—the *best in radio* MUST BE CUSTOM-BUILT!

The new Hi-Q SIX is exclusively a CUSTOM-BUILT Receiver—an instrument created and perfected by the engineering brains of ten of America's leading radio manufacturers. In this remarkable instrument every modern constructional feature has been incorporated; each part is the very finest known to radio science, and the entire group has been purposely selected for perfect synchronization.

The result is a receiver that establishes totally new standards in every department in which radio engineers have sought improvements—increased sensitivity, greater power output, keener selectivity and tonal qualities that are nothing short of a revelation.



If you want to save at least \$100 on America's finest receiver or if you want to make big, easy profits CUSTOM-BUILDING the Hi-Q Six, send 25c now for this fully illustrated 48-page Construction Manual.



**HAMMARLUND-ROBERTS, Inc.** - - 1182 Broadway, Dept. T, New York City

*Associate Manufacturers*





# Hi-Q\* SIX The Best in Radio Must be CUSTOM-BUILT

Created by America's Leading Manufacturers  
Endorsed by America's Leading Engineers  
AND SOLD BY AMERICA'S LEADING JOBBERS!

JUST as water must find its own level, so a quality idea created by sincere minds and built of honest materials must be sponsored and sold by merchants of highest business integrity. Apply the thought to the Hammarlund-Roberts Hi-Q SIX Receiver, for this remarkable CUSTOM-BUILT Instrument has so conclusively proved its value that today its circuit and approved parts are both recommended and sold by

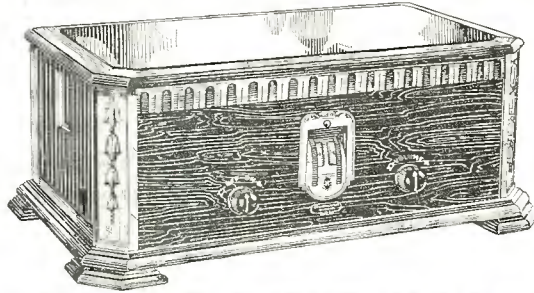

those distributors whose names are a silent testimony of endorsement.

Practically every important radio jobber and dealer in the United States recommends the advanced Hi-Q SIX Receiver. Further than this, over 3500 professional builders find it the heart of their business. Beyond this, the records show uncounted thousands of users who have discovered in the Hi-Q SIX the *supreme instrument of the year!*



HAMMARLUND-ROBERTS, INC., DEPT. T, 1182 BROADWAY, NEW YORK CITY

## LEWIS RADIO JOBBERS

"The House of Service"

Philadelphia, Pa.

DISTRIBUTORS FOR THE FOLLOWING POPULAR CIRCUITS:

- |                               |                             |
|-------------------------------|-----------------------------|
| AERO AC SEVEN                 | WORLD RECORD SUPER 10       |
| KARAS AC EQUAMATIC            | PHASATROL DE LUXE           |
| LYNCH HAMMARLUND FIVE         | EVERYMAN FOUR               |
| TRUVOLT B POWER SUPPLY UNIT   | UNITUNE SYMPHONIC           |
| SILVER MARSHALL SHIELD GRID 6 | HAMMARLUND ROBERTS HI-Q SIX |
| SILVER MARSHALL UNIVERSAL     | REMLER AC SUPER             |
|                               | HARKNESS COUNTER-PHONIC     |

We carry the largest and most complete stock of QUALITY RADIO PARTS in the East. Check the above list of Kits and you will agree it is a complete one. And we can make 24-Hour Delivery on all lines we distribute—"Making the best better"—that's LEWIS SERVICE.

OUR 1928 CATALOGUE is a "Money-Saver." It is very complete and contains our entire list of Radio Lines. WRITE FOR IT TODAY!

SERVICE—Our sales extend to 48 states—and then some. National Distribution and Service

REMLER—RAY-O-VAC—WEBSTER—EAGLE TOBE—BOSCH—ACME—THORDARSON

## LEWIS RADIO JOBBERS

Send for our catalogue today

DISTRIBUTORS FOR BOSCH RADIO PRODUCTS  
45 North Seventh Street, Dept. A  
PHILADELPHIA, PA.

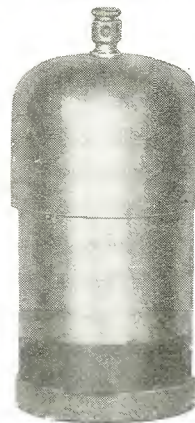

## Make Your Radio a "MODERN" Shielded Set

No unshielded set complete without them, no reception as perfect as it could be with them. "MOERN" Shields give each tube a chance to function unhampered by interference from magnetic and static fields, prevalent in all unshielded sets regardless of make or hook-up as many interferences, some of which sound like static, are manufactured within the set itself and can only be remedied by metallic grounded shields. "MODERN" Shields protect the tubes from microphonic sound waves by insulating them from the surrounding ether air by three rubber tipped spring fingers inside of shield which press tightly against the tube, arresting any vibrations set up by jars, sound waves or telephonic vibrations in the cabinet; the rubber tips eliminate any possible conductive leakage from shield to tube. "MOERN" Shields confine the heat around the tube, causing quicker

action, greater efficiency, less power, longer battery life and modified summer static. "MOERN" Shields are recommended for sets or tubes that squeal, whistle, howl, choke, snap or produce indistinct or mushy reproduction. Tone and volume are greatly improved by their use. "MOERN" Shields should be placed over each tube in the set to obtain maximum results, connect copper wire in series to binding post on each shield and to ground post on set. "MOERN" Shields are pressed from special alloy metal fitted with rubber cushion base which eliminates transmission of telephonic vibrations to the tubes, each shield is adjustable to any tube, height or spring tension desired. The base of each shield is dipped in a special insulation to assure against shorts or grounds in their application. Complete instructions come with each shield. "MODERN" Shields retail for \$1.00 each, none genuine without the "MODERN" trade mark. If you can not obtain "MOERN" Shields from your local dealer, send us your check or P. O. money order and Shields will be mailed to you P. P. prepaid.



"Modern" Laboratories  
207 Washington St. Owosso, Mich.  
Amateur Laboratory and Counselor Service  
at Nominal Fees.





**Hi-Q SIX**  
*The Best in Radio Must be* **CUSTOM-BUILT**

**LOOK!! IT'S FREE!!**

**DEALERS & PROFESSIONAL SET BUILDERS**

*Your BIG NEW 1928 Catalog Is NOW READY!*

Contains nationally known Parts and Kits at Maximum Discounts

**HAMMARLUND ROBERTS HI-Q SIX KITS IN STOCK**

**SILVER MARSHALL SHIELDED GRID TUBE KITS IN STOCK**

Yaxley	Marco	Karas
Carter	Eby	Aero Coil
Acme	Amseo	Weston
Samson	Silver-Marshall	Benjamin
Tobe	Hammarlund	Precision Coil
Daven	Electrad	General Instruments

**IN STOCK ALL THE CIRCUITS** described in this issue

*Send for Catalog Now—It's FREE!*

**S. HAMMER RADIO COMPANY**  
 305 Atkins Avenue, Brooklyn, New York

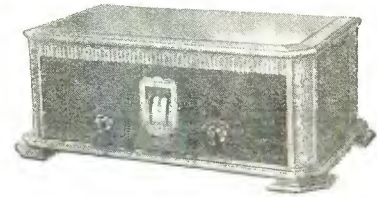

Headquarters for

**Hammarlund**  
**ROBERTS**  
**Hi-Q SIX**

*Complete Parts and Accessories*

We are prepared to supply set builders with every item required for building the Hi-Q Six. Assure successful operation by purchasing authorized parts and accessories from one source.

**GUARANTEE**

We guarantee the successful operation of every receiver built from parts purchased of us. If you can't make it work, we will. Send for catalog of parts and kits.

*Kit Headquarters*

**ALLEN-ROGERS-MADISON, Inc.**  
 35 West 31st Street New York, N. Y.

All Parts in Stock for

**Hammarlund-Roberts Hi-Q Six**

AS WELL AS ALL OTHER HIGH QUALITY PARTS, KITS, ACCESSORIES AND CABINETS

*"We Offer the Largest Selection of Radio Kits in America"*

Send today for our 1928 Illustrated Retail Catalog and our Wholesale Discount Sheet and Radio Kit Book—Winter, 1927-28 edition just off the press.



WHOLESALE DISTRIBUTORS  
 345 WEST MADISON ST. CHICAGO, ILL.

EXCLUSIVE WISCONSIN DISTRIBUTOR

for the

**Famous Hammarlund-Roberts HI-Q Six Receiver**

It is by far the best custom-built receiver on the market. Very selective and has a wonderful tone quality. Write today for descriptive literature and price list.

**RADIO PARTS COMPANY**  
 309 State Street Milwaukee, Wis.

**Set Builders' and Dealers' HEADQUARTERS**

*Send for our latest catalogue with wholesale discount*

We are the largest distributors for Hammarlund Roberts Hi-Q Six Kits and parts as well as all the latest Silver Marshall products. We receive daily shipments from factory and can make immediate shipment on receipt of order. The above shown lines are just a few of the many we handle.

**CLARK & TILSON, Inc.**  
 122 Chambers Street New York City

- Abox
- All American
- Amperites
- Benjamin
- Carter
- Daven
- Dubilier
- Durham
- Electrad
- Hammarlund
- Hammarlund-Roberts
- Igrad
- Marco
- Pacent
- Raytheon
- Sangamo
- Silver-Marshall
- Supercraft
- Thordarson
- Ward-Leonard

*The Big Friendly Radio House*  
 Complete Parts

**Hammarlund-Roberts Hi Q Six**

WHEN you get our 1928 Catalog, you can have popular, nationally-advertised kits, parts, eliminators and accessories at prices that are real values.

Our dealer catalog, which lists everything in radio, means more real profit for you. Standard quality at the right price.

*Write for our big Catalog*

**WESTERN RADIO MFG. CO.**  
 128 West Lake St. Dept. MO Chicago, Ill.





# Orchestrion CONE

RADIO reproduction that faithfully retains the microphone quality is the achievement of the Orchestrion Cone. The varying qualities of human voice—delicate stringed instruments, or bass of an organ are never lost in the Orchestrion.

The Orchestrion Cone is enclosed in a rich, attractive two-tone mahogany cabinet of chaste design, with a plywood grill backed by silk cloth.

Write direct, if your dealer cannot supply

## THE RADIO CABINET CO.

2118 North Gale St.  
INDIANAPOLIS,  
INDIANA

Quality of tone is assured by the full 12-inch diaphragm and of the advanced design of the Orchestrion Cone Unit. Ruggedly constructed, it withstands perfectly the heavy volume of power tubes and amplifiers. A real quality value at

**\$15.00**

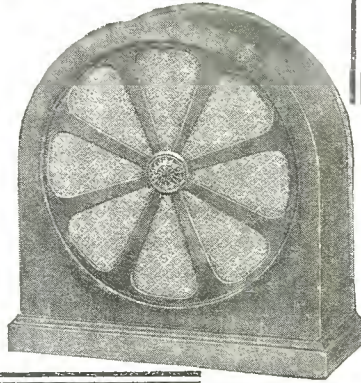

## The Big Friendly Radio House Complete Parts Bremer-Tully A. C. Power Six

WHEN you get our 1928 Catalog, you can have popular, nationally-advertised kits, parts, eliminators and accessories at prices that are real values.

Our dealer catalog, which lists everything in radio, means more real profit for you. Standard quality at the right price.

Write for our big Catalog

WESTERN RADIO MFG. CO.  
128 West Lake St. Dept. MO Chicago, Ill.

## Beautiful, Durable CELORON PANELS for These Popular Kits

The Tyrman Ten:		
Front Panel.....each	\$6.70	Sub-Panel.....each \$5.40
The Tyrman Seventy:		
Front Panel.....each	\$6.00	Sub-Panel.....each \$5.40
Melo-Heald Super-heterodyne:		
Front Panel.....each	\$6.00	Sub-Panel.....each \$3.36
The "Hot-Spot" Melo-Heald Fourteen:		
Front Panel.....each	\$7.20	Sub-Panel.....each \$6.02
Aero Seven Tube T.R.F.:		
Front Panel.....each	\$6.10	Sub-Panel.....each \$5.20
B.-T. Power Six:		
Front Panel.....each	\$5.72	
St. James Upright Eight Super-heterodyne:		
Sub-Panels (2).....Per set of 2.....		\$6.00
Karas Equamatic—2 Dial:		
Front Panel.....each	\$5.50	Sub-Panel.....each \$6.00
"World's Record" Super Ten:		
Front Panel.....each	\$6.30	Sub-Panel.....each \$6.50
Magnaformer Super-heterodyne:		
Front Panel.....each	\$6.40	Sub-Panel.....each \$6.50
Victoreen Super-heterodyne:		
Front Panel.....each	\$5.64	
Victoreen Universal Super-heterodyne, Single Dial:		
Front Panel.....each	\$5.80	
H.F.L. Nine-in-Line, Model 28:		
Front Panel.....each	\$6.20	Sub-Panel.....each \$5.70
Knickerbocker 4:		
Front Panel.....each	\$3.00	Sub-Panel.....each \$3.90
Lapeer A.R. 9:		
Front Panel.....each	\$0.00	Sub-Panel.....each \$0.00
Thompson Super 7:		
Front Panel.....each	\$5.24	Sub-Panel.....each \$4.58
Thordarson Power Amplifier:		
Front Panel.....each	\$0.00	Sub-Panel.....each \$0.00
Camfield Super Selective 10:		
Front Panel.....each	\$6.90	Sub-Panel.....each \$8.06
Camfield Seven:		
Front Panel.....each	\$7.32	Sub-Panel.....each \$6.58
National Browning-Drake:		
Front Panel.....each	\$0.00	Sub-Panel.....each \$0.00
Citizens Super 4:		
Front Panel.....each	\$5.80	Sub-Panel.....each \$6.28
Popular Mechanics:		
Front Panel.....each	\$4.46	Sub-Panel.....each \$4.92
Sub-Panel with Am. Radio Hardware Sockets Mounted.....each		\$5.50

If Your Dealer Can't Supply You Order from  
**THE CELORON CO., Bridgeport, Pa.**

## SET BUILDERS!

A complete line of the very latest  
KITS and PARTS  
STANDARD APPLIANCES  
STANDARD PARTS  
Get the Lowest Prices!

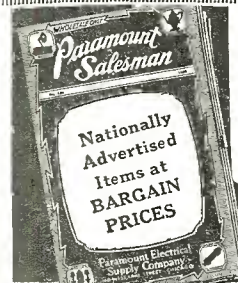

← FROM THIS BOOK Write for it!

WHOLESALE ONLY

**Paramount**  
ELECTRICAL SUPPLY COMPANY  
602 W. Adams St., Dept. 51, Chicago

## IT'S HERE! You Will Like It—and Profit!

### THE WORLD'S GREATEST

#### RADIO CATALOG

Now Free—Send for your copy today!

New kits featured include: Aero—Bodine—Camfield—Citizens—H.F.L.—Infradyne—Karas—Melo-Heald—Scott's—Silver Marshall—St. James—Tyrman—etc.

Complete stock carried. Prompt, efficient, dependable service, always.

Established 1918

The best in Radio—at a big saving—all under one roof. You don't need to look elsewhere. Contains all the information you need.



TELEPHONE MAINTENANCE CO.  
123 S. Wells St., Dept. 75 Chicago, Illinois

**CHICAGO'S OLDEST RADIO HOUSE**

WHOLESALE ONLY!

## FREE!

## GREAT EASTERN RADIO BROADCAST

Send for the latest Monthly Flier from Philadelphia's Great Radio Mail Order House. 24-hour shipping service means QUICK ACTION for Radio Dealers.

### SPECIAL!

**VT-1**  
U. S. Navy Western Electric Detector TUBES \$1.00 ea. **12 for \$10**



All up-to-the-minute Kits and Sets  
Aero A C Seven  
Citizens Shielded Five  
Everyman Four  
New Hammerlund-Roberts H1-Q6  
All latest Silver-Marshall Kits  
Official Browning-Drake  
The very latest line of accessories  
Get Our Prices First!

LARGEST RADIO MAIL ORDER HOUSE IN THE EAST!  
We carry all latest Standard make Parts and Accessories

**GREAT-EASTERN-RADIO-CO** 525 MARKET ST. PHILA. PA.





Send for  
this  
catalog.  
It is  
free

Beware  
of the  
Higher Cost  
of the  
Lower  
Price

The Detroit Electric Company has been in business since 1883, and the policy is just as it always has been. The selling of high grade merchandise manufactured by responsible manufacturers of substantiability, manufacturers responsible for the very Radio Industry itself.

**DETROIT ELECTRIC COMPANY**  
101 E. Jefferson Avenue Detroit, Mich.

**get!** **FOR YOUR ELIMINATOR**

**Pure Direct Current**

Bee Cee Filter Condenser Compact  
BROWN & CAINE

**DEPENDABLE**

THERE is a Bee Cee Filter Condenser Compact for use in every type of battery eliminator and power amplifier. Especially designed for its specific work, each Compact may be depended upon to render a pure, even, rectified current, with permanent capacity assured.

Bee Cee Filter Condensers can be had in capacities from 1 MFD to 4 MFD for filter and by-pass work. Conservatively rated — and Halowax impregnated!

At your dealers, or write direct to Dept. C-B-1 2317 Calumet Avenue, Chicago

*Because these units are the most delicate electrical devices used in radio, it is essential that you insist on Bee Cee quality.*

**BEE CEE Filter Condenser COMPACTS**

**BROWN & CAINE INC.**  
BROWN & CAINE, Inc.  
Chicago  
Atlanta Cleveland Denver  
Kansas City, Mo. Los Angeles Portland

**SYD**  
LIFE LONG  
"B" BATTERY

**UNCONDITIONAL 2-YEAR GUARANTEE**  
It's Quality—Not Price—That Makes a Real Battery

Type B2  
100 Volts  
with a  
Charger,  
\$15.50

145 Volts  
with a  
Charger,  
\$21.50

The SYD Battery pictured above is a storage "B" Battery made of Edison Elements, which have nickel and iron in their construction. The solution used is a preserver of nickel and iron, thereby giving the battery practically unlimited life.

SYD Batteries are built to give the user real value for every dollar he invests. Only the finest materials are used in their construction. Remember that the quality of the battery and not the price determines its worth. That's why SYD Batteries are preferred and used by thousands.

**TESTED AND FOUND SATISFACTORY BY THE CHICAGO DAILY NEWS RADIO LABORATORY. ALSO BY POPULAR RADIO LABORATORIES, NEW YORK CITY**

Manufactured and Sold Exclusively by  
**LYD STORAGE "B" BATTERY CO.**  
1464 South Wabash Ave., Chicago

MAIL ORDERS FILLED

**PRECISE PRODUCTS**  
No. 2000  
ILLUMINATED TYPE  
MASTER DRUM DIAL  
ASSEMBLY

Including  
No. 1770—Drum Dial  
No. 1776—Escutcheon Plate  
No. 1540—Bracket  
No. 1927—Friction Drive  
No. 1900—6" Friction Shaft  
No. 1919—Knob

The drum dial is of the illuminated type having a viscoloid band graduated from zero to 180. The friction drive is smooth and positive in action. The escutcheon plate is rich in appearance and artistic in design. We recommend the No. 1580 removable shaft condenser with compensator for an ideal assembly, while our No. 1120 insulated coupler (or No. 1730 non-insulated) affords ideal means of connecting master assembly to condensers. List \$6.25.

**No. 940 MICRODENSER**  
Very rugged. Has pigtail connections. Low minimum capacity. Made entirely of brass, in five different capacities.

10 mmf.....	\$1.25	55 mmf.....	\$1.65
30 mmf.....	1.50	100 mmf.....	1.75
135 mmf.....	2.00		

100 mmf.

**No. 1580 CONDENSER**  
This is a removable shaft type. A condenser of very rugged build that lends itself to all assembly conditions. May be grouped together, spaced any distance apart, or mounted to panel or sub-base.

**Specifications**  
Brass rotor and stator plates. Aluminum end plates 3/32" thick. Compensator. Automatic tension on rotor. Ball race bearings. Ideal for drum dial and friction drive assembly. Made in the following capacities:

.00025.....	\$3.25	.00035.....	\$3.75
.0005.....	4.00		

**PRECISE MFG. CO.**  
254 Mill St., Rochester, N. Y.





Radio dealers recommend and use the

# ekko Ground Clamp

because it eliminates the high percentage of radio troubles due to faulty ground

Imperfect ground contacts are responsible for a high percentage of all radio troubles. The ekko Clamp eliminates these troubles by insuring perfect contact. Radio dealers know this. That is why they include an ekko Clamp with radio set installations and instruct their service crews to use it in replacing old faulty grounds.

The hardened steel points of the ekko Clamp bite through paint, rust, dirt, corrosion or any other insulation. Its positive contact insures full signal strength. Easy to use. Ground wire screws to Clamp. Clamp attaches to nearest pipe by a turn of the screw. Non-corrosive, permanent. Finished in white nickel. Fits 1/4 to 1 1/4 inch pipe. At your dealer's.

25¢



### Radio Dealers:

The ekko Clamp is supplied in lots of ten in an attractive counter display that helps you sell this most popular of all ground clamps.

## The Ekko Company

111 West Monroe Street, Chicago, Ill.

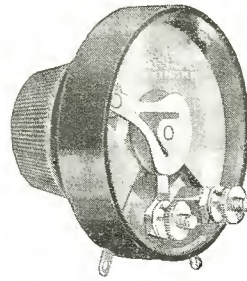

## CENTRALAB Radiohm RX-100

A standard unit with a new taper of resistance specially to control volume with the new AC tubes.

In battery type tube circuits, a variable resistance in R. F. plate circuit or R. F. filament circuit cannot be used with AC tubes, since it introduces an AC hum. The Centralab RX 100 Radiohm works O. K. because of minimum capacity and smooth, noiseless action.

Insert in the grid circuit of one of the R. F. stages, or directly across antenna coil. No affect on filament or plate potentials. Insures balance. Eliminates a source of AC hum. In "super" circuits, place this Radiohm in the grid of the intermediate frequency that is not sharply tuned.

Another helpful method of keeping an AC circuit in balance is a Centralab Power Rheostat of 50 ohms inserted in the primary of the transformer. It will compensate for any line fluctuation—increasing the life of the tubes and hold the entire circuit to the point of best operating efficiency.

Other products of Centralab are Radiohms, Modulators, Potentiometers, Power Rheostats and Heavy Duty Potentiometers—Folder 328 describes them all.

### CENTRAL RADIO LABORATORIES

26 Keefe Avenue

Milwaukee, Wisconsin



## SAVE 50%

No better "A" Socket Power Unit can be obtained even at twice this amazingly low price. Combines all the efficiency of plate current with the undoubted convenience of socket power. No bothersome hauling around of batteries to be charged. No hum or noise. Highest quality. Westinghouse electric equipment. Operates on 50 or 60 cycles at 110 volts A. C. Thousands of satisfied users prove the worth of World Power Units. Approved by rigid tests of Radio News and other leading Laboratories.

World  
"A" Socket Power  
Unit  
\$13.75



Send No Money Just name and address and we will ship day order is received by express. C. O. D., subject to examination on arrival. 5% discount for cash in full with order. NOW is the time to do it.

### WORLD BATTERY COMPANY

1219 So. Wabash Ave. Dept. 63 Chicago, Ill.

STATION  
WSBC  
Owned and operated by World Battery Co.

## FRITTS RADIO CABINETS

ARE MASTERPIECES IN SOLID WALNUT

Their leadership is maintained strictly on fine workmanship, character in design and lasting beauty.

### STANDARD SUPER

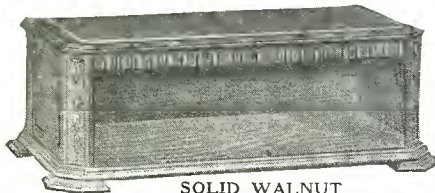

SOLID WALNUT

The Standard Super model is the original Italian Chest Type in Walnut—SOLID WALNUT. Four Post construction. Top and sides have raised panel effect. Decorations slightly Polychromed.

Our line includes also, Consolelets and Radio Tables. Descriptive leaflets and prices upon request.

### D. H. FRITTS & COMPANY

604 Hearst Square, Dept. CB3

Chicago, Ill.

## A New Hotel Without "UPS"!

IT'S NEVER BEEN DONE BEFORE  
One Price for All the Rooms



THE 12-story fireproof Cornish Arms Hotel, just opened, has eliminated all the hokum of "up" prices. This convenient and comfortable new hotel has only one price for a single room and bath, \$3.00 per day. Single room for two, with bath, \$4.50. Remember, there are no "ups." There's a bath with every room: 340 rooms to select from. Excellent restaurant service at moderate prices.

5 minutes to Times Square, 5 minutes to Pennsylvania Station, 8 minutes to Grand Central, and near all Steamship Lines.

Come and Compare

## Cornish Arms Hotel

West 23d Street, at Eighth Avenue, New York



# BENJAMIN

## Red Top Cle-Ra-Tone Sockets

Improve the  
Appearance of  
the Set

Easier to Establish  
Correct Position  
of Tube and  
Prongs

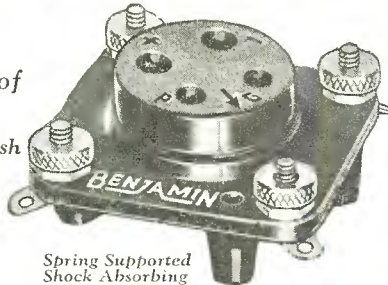

Spring Supported  
Shock Absorbing

Tube "floats" on finely tempered springs. One-piece terminal to tube connection. Knurled nuts for binding post connection or handy lugs for soldering. Benjamin Cle-Ra-Tone Sockets have been the choice of practically every prominent circuit for several years. Among the most recent hook-ups for which they have been specified are:

- |  |                        |                     |
|--|------------------------|---------------------|
| Strobodync                               | Hammarlund-Roberts HiQ | Nine-in-Line Plus   |
| Melo Heald Fourteen                      | Magnaformer 9-8        | St. James Super     |
| Scott Super-10                           | World's Record 10      | L. C.-28            |
| Knickerbocker 4                          | Aero A. C. Seven       | St. James Twin Four |
| Truvolt B Supply                         | Lynch Hammarlund Five  |                     |
| Browning Drake with Acme Power Amplifier |                        |                     |
| Karas A. C. Equamatic                    | Samson PABC 4          | Phasatrol Deluxe    |
- Ask your dealer to show you the new Benjamin "Green-Top" 5-prong, "Y" type socket for A. C. tubes.

Benjamin Electric Mfg. Co.

247 W. 17th St. New York  
120-128 S. Sangamon St. Chicago  
448 Bryant St. San Francisco

Manufactured in Canada by the Benjamin Electric Mfg. Co. of Canada, Ltd., Toronto, Ontario

# Shanco

Grip-tite

## Battery Clips

4 Sizes

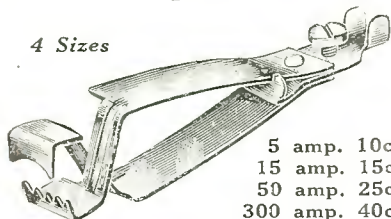

- 5 amp. 10c
- 15 amp. 15c
- 50 amp. 25c
- 300 amp. 40c

**S**HANCO Griptite Battery Clips assure free and uninterrupted flow of electrical current. There are no springs to heat up, burn or drop out. Made of powerful-tension, tempered spring steel, solidly riveted together, with all parts electro lead plated before assembly. This uniform lead coating is positive assurance against corrosion at the joints. Acid-resisting. Jaws open wide and are easily applied. The Griptite bulldog teeth are so arranged that the clip cannot fall over and "short" the battery. Terminals are wide and screws amply large for cable connections. No parts of Shanco Clips can be lost or displaced—everything is one compact, solidly built unit. Shanco Clips are approved by Radio News Laboratory and leading radio engineers; they will last longer and give greater satisfaction.

At all good radio stores and battery stations, or order direct from this advertisement, giving dealer's name. Dealers and jobbers write for discounts and special proposition.

**Shanklin Manufacturing Company**  
Dept. 24, Springfield, Illinois

# FREE!!

## Genuine Ward Electric Soldering Iron



Lists for \$1.70

### Everyone Needs a Good Electric Soldering Iron

The Famous WARD needs no introduction. Heating Elements will not burn out; either A.C. or D.C., 105-115 volts draws 100 watts. Six feet of heater cord, standard 2-piece separable plug, mahogany finish handle, brass plated barrel, 3/8-in. diamond-shaped tip, temperature 500 degrees maintained, handle remains cool. Handles insulated against possible short. A genuine high-grade electric iron. Lava rock core approved and listed as standard by Underwriters Laboratories. Sold regularly for \$1.70.

*A most useful household article. Can be used to solder anything that requires soldering*

Send in the coupon below and receive the iron absolutely free with a year's subscription to the Citizens Radio Call Book Magazine—total value \$3.50, for only \$1.75. Hurry—this offer is limited—mail coupon today.

*Iron Is Guaranteed by Manufacturer for  
One Year—Hurry—This Offer  
Is Limited*

**Citizens Radio Call Book Magazine**  
508 So. Dearborn Street, Chicago, Ill.

Here's my \$1.75. Please send me a Ward Electric Soldering Iron free and enter my subscription for the Citizens Radio Call Book Magazine for one year starting with the

Jan.  March  Sept.  Nov. issue.

Name.....

Address.....

City..... State.....



**OK**  
for Every Circuit

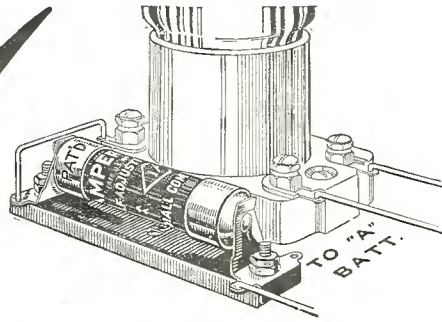

**T**UBE performance can be perfect—and tube life prolonged—only by keeping the tube filament voltage, or temperature, constant, despite variations in "A" battery voltage. AMPERITE alone does this—and it does it automatically. That is why AMPERITE is specified by every radio engineer—and is indispensable in every radio circuit. Takes the "guess", inconvenience and unsightliness out of panel rheostats. Simplifies wiring, panel design and tuning. Proved for 6 years. Entirely different from—and must not be confused with—fixed filament resistors. Particularly necessary with battery eliminators. Order AMPERITE by name. Accept nothing else. Price \$1.10 with mounting (in U.S.A.). For sale by all dealers.

**FREE**

Write for "Amperite Book" of season's best circuits and latest construction data. Address Dept. CCB1.

*Radial Company*  
50 FRANKLIN ST., NEW YORK

# AMPERITE

REG. PAT. OFF.

The "SELF-ADJUSTING" Rheostat

**Sensational! Prices Reduced**  
Continental Standard Meter Test  
RADIO TUBES  
Formerly \$1.75  
Now Only **\$1.00**

The greatest and most sensational price reduction ever offered in high quality, standard, meter test guaranteed radio tubes. Genuine "firsts" of our very best grade. Increased production and large volume business enables us to offer tubes at the standard price of only \$1.00. Never before has a standard quality radio tube been offered to the public at this low price. Take advantage of this opportunity now to get your radio tubes at a real saving.

X200A.....	\$2.50	X281.....	\$6.00
X112.....	2.50	X210.....	7.50
X171.....	2.50	C226.....	3.00
X280.....	4.00	C227.....	6.00

For sale by progressive dealers. If your dealer cannot supply, order direct, giving his name.

Dealers and Jobbers: Write for special offer  
**CONTINENTAL CORPORATION**  
179 W. Washington St., Dept. CB3, Chicago, U. S. A.



## Professional Set Builders...

Do you wish us to send you some of the inquiries we receive from those in your locality who wish to have receivers built to order for them? If so, send your name and address at once to

F. A. RYDER  
**Radiart Laboratories Co.**  
19 S. La Salle St., Chicago, Ill.



**Pep up your set with a WorkRite Cone Speaker**  
Greater volume—wider tone range—greater distance with this double magnet cone speaker, combine to give you greater pleasure from your radio set.  
**U. S. Electric Corporation**  
WorkRite Division  
CLEVELAND OHIO

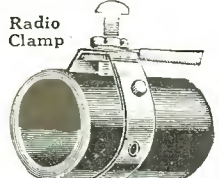

**Blackburn Ground Clamps**  
Telephone companies using MILLIONS. Adjustable—fits any size pipe. Requires no pipe cleaning—screw bores through rust and scale. Send 12 cents for sample and postage.  
**BLACKBURN SPECIALTY CO.**  
1968 E. 66th St. Cleveland, Ohio



**Raytheon**  
LONG LIFE RECTIFYING TUBE  
TYPE BH—Standard for "B" Power Units, 125 m.a., 300 volts, \$4.50.  
TYPE BA—For complete A-B-C Power, 350 m.a., \$7.50.  
**Raytheon Manufacturing Company** Cambridge, Mass.



**"CHICAGO" HEAVY DUTY "B"** is the only battery on the market carrying a six months' unconditional guarantee. Dealers, Agents: Write today for discounts and details of our exclusive selling franchise. We make a complete line of Dry Cell Batteries for every radio requirement.  
**AUSTIN ACCESSORIES MFG. CO.**  
12 S. Clinton St. Chicago, Ill.

**Complete Parts for the Every Man 4 Circuit Supplied by**  
**THE HARRY ALTER CO.**  
18th and Michigan Chicago, Ill.  
Wholesale Only

**Official Distributor for the Everyman-4**  
We have complete parts in stock for this new low priced receiver. Send us your order. PROMPT TWENTY-FOUR HOUR SERVICE ASSURED.  
WRITE TODAY FOR COMPLETE CATALOG in Case You Do Not Have It  
**W. C. BRAUN COMPANY, Pioneers in Radio**  
595 West Randolph Street Chicago, Illinois

**\$5.50 buys this famous cabinet!**  
The Iveyline  
BUY direct from us and save money. Your choice in either gleaming mahogany finish or solid walnut. All orders shipped within 12 hours of receipt. You can't beat this Iveyline cabinet. Order today or write for catalogue.  
SIZES range from 7x18x10 to 7x30x12. Mahogany finish, \$5.50 to \$8.75. Solid Walnut, \$6.50 to \$10.50, f.o.b. Hickory. 12-hour service. Write for catalogue.  
**SOUTHERN TOY CO., Manufacturers, HICKORY, N. C.**



Radio fans: Buy Fast condensers from your dealer and get reliable service and long life because of higher insulation resistance and non-inductivity. Manufacturers, send us your specifications for your set condensers, A-C eliminator blocks, etc. Jobbers, dealers: Write for price list and catalog.  
**JOHN E. FAST & CO.**  
3982 Barry Av., Dept. CB4, Chicago



# SET BUILDERS TAKE NOTICE

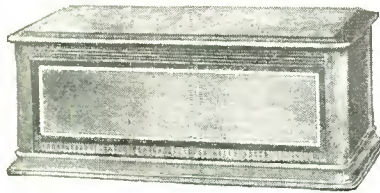

Super Excellent Cabinets,  
10 or 12" deep

Set Builders who have seen and who are using our Cabinets tell us that they cannot see how the other manufacturers of Cabinets can get rid of their merchandise.



EHLERT'S  
RADIO DESK

Do you know that the Bosses of the firms that make the Nine-in-Line circuit the Tyrman 10 circuit, the Scott's World Record 10, the Campfield Super-Selective 10 have bought our Cabinets for use in their own homes because our Cabinets are so far superior in appearance, construction and finish than any Cabinets that they have seen?

If you want to give your prospective customers a treat, show them the set that you are building in our Cabinets. It will help you to make the sale quicker, your customer will be better satisfied and due to the fine appearance you will have many re-orders. We have in stock for immediate delivery Cabinets, Consoles, Speaker Consoles and Radio Desks to take any set with front panel not larger than 8x30.

If upon receiving one of our Cabinets you do not find it a great deal prettier, better constructed and by far a better finish, you can return it and we will refund your money and express charges.

If you cannot get Ehlert's Excellent or Super-Excellent Cabinets from your jobber or dealer, send your order in direct for immediate attention. Catalog of complete line and special discount to set builders sent upon request.

Write today

## Ehlert

Radio Furniture Co.

Manufacturers of  
Fine Radio Furniture  
2468 Lincoln Avenue  
Chicago, Ill.

Phone Diversey 2566



# BRAIDITE

"The Braid Slides Back"

A New and Better  
Hook-Up Wire

Specified in All  
Popular Circuits



BRAIDITE is the one hook-up wire you cannot scorch or burn with a soldering iron. Another exclusive feature of Braidite is the ease with which the braid can be drawn back for soldering and then replaced, leaving no exposed sections of bare wire. Braidite is specified in the following and many other popular circuits: Reuler Super-Net and Power Supply, S. M. Super-Net and Power Supply, Aero AC 7, Vitrolm DC Eliminator, Truvolt "B" Power Supply and Karas Electric. Use Braidite in the next circuit you build. If your dealer cannot supply you write us direct.

25 Ft. Stranded Braidite...35c  
25 Ft. Solid Braidite...30c  
Made in red, green, yellow, brown and black.

### "Corwico" Products

- Antenna Wire (Solid, Stranded and Braided)
- Braidite Hook-Up Wire
- Complete Aerial Kits
- Magnet Wire
- Battery Cable
- Bus Bar Wire
- Hook-up Wire
- Lead-in Wire
- Annunciator Wire
- Loop Aerial Wire
- Litz Wire
- Flexible Wire

"Corwico" Radio Wires are sold by leading dealers everywhere. Write for interesting FREE booklet on radio wires and their uses.

Cornish Wire Co., 30 Church St., New York

# ELKAY

TRADE MARK REG.

## SUPPRESSOR

Controls the Squeals

Fit into the grid circuit of any tuned R. F. set and stop the tendency to "boil" over. Just a few minor changes in the wiring; you can easily do it yourself. Price, 75c each, unmounted; \$1.00 mounted. Satisfaction or money returned promptly. Can be used wherever grid resistances are specified, as in L. C. 28, Hi-Q 28 or Silver-Marshall T. R. F. When ordering, describe your set: type of circuit, number of tubes before and after detector, etc.

Elkay Tube Equalizers—also in cartridge form, replace the old variable rheostats on all but first R. F. stage. Adjust themselves automatically to working voltage of any tube made. Unmounted, 50c; mounted, 75c.

The Langbein-Kaufman Radio Co.,

Dept. C,  
62 Franklin Street,  
New Haven, Conn.

Makers of Elkay A. C. and Battery-operated Receivers

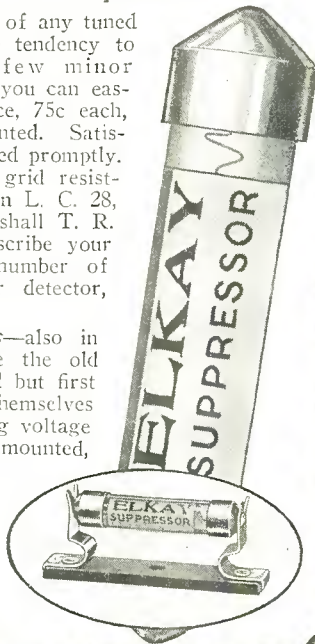

# Sovereign

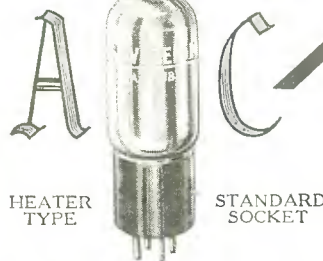

Bring  
Your Set  
Up to Date

Leading radio engineers approve and endorse the Sovereign Heater Type A-C Tube. They know that A-C Tubes give results that can be obtained in no other manner.

Think—with A-C Tubes all you ever will have to do is press a button—switch on your set just as you switch on an electric light. There's no bother with "A" batteries or "A" battery eliminators, or battery chargers, no noise, no microphonics—nothing but pure, round undistorted tones.

Bring your set up to date. If your dealer cannot supply you with Sovereign A-C Tubes for standard sockets, write us. Special booklet with diagrams free. Write.

- No Hum!
- No Noise!
- No "A" Batteries
- No "A" Battery Eliminators
- No Microphonics

Sovereign Electric & Manufacturing Company  
123 North Sangamon Street  
Chicago, Illinois



ESTABLISHED 1913

CHICAGO, ILLINOIS

# UP-TO-DATE MACHINE WORKS

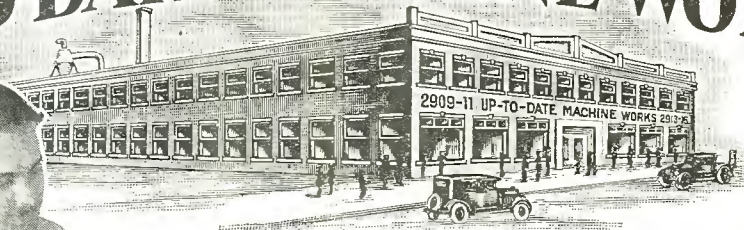

**SENT  
ON  
TRIAL**



## THE FIRM BACK OF THE UP-TO-DATE HOME CRAFTSMAN SHOP

15 years a standard in mechanical perfection. The basis of our fifteen years of success in mechanical production is the guarantee placed on every one of our over 1000 commodities. "We place an absolute guarantee on all of our products. If satisfaction is not yours on the receipt of your order, without

question or delay, every cent of your purchase is refunded."

Such is the organization back of the Up-to-Date Home Craftsman Shop, which is manufactured, distributed and guaranteed by the Up-to-Date Machine Works.

We place this article here because we feel safer when purchasing from a reliable firm of many years' standing and we know that you bear the same attitude.

**ONLY  
\$10  
DOWN**

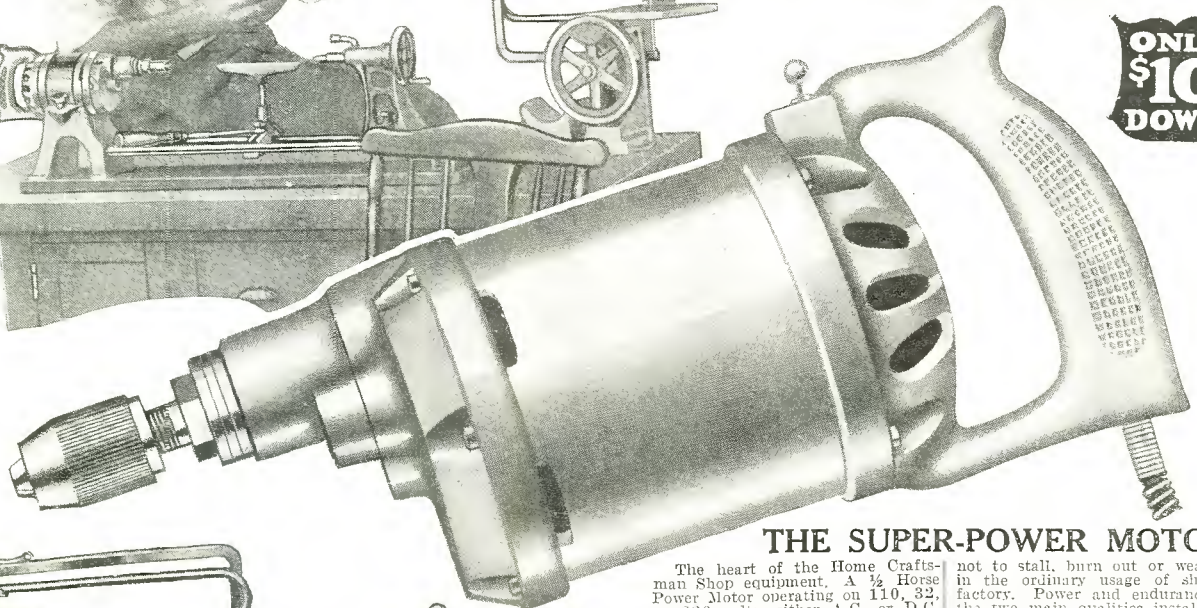

## THE SUPER-POWER MOTOR

The heart of the Home Craftsman Shop equipment. A 1/2 Horse Power Motor operating on 110, 32, or 220 volts, either A.C. or D.C. (Current. This motor is positively the latest development in Electric motor equipments. The motor will operate to perfect satisfaction a 4" jointer, a 12" or 16" band saw, a (10"x34") lathe, a 12" jig saw, and a 6" circular saw. Never before the Up-to-Date Motor has such power been realized in a drill motor, which we guarantee

not to stall, burn out or wear out in the ordinary usage of shop or factory. Power and endurance are the two main qualities installed in our motor.

Notice the design, a convenient, easy grip, a sturdy Aluminum housing, the spindle in dead line center with the grip so as to assure perfect alignment when drilling. For further details on this remarkable motor and the perfected craftsman shop it operates, Mail the coupon below, today.

4" Jointer—Accessory to Up-to-Date Shop

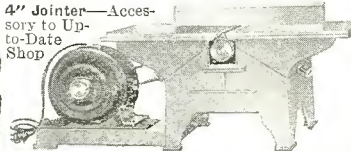

Our latest development—a 12" band saw, operated with the regular Up-to-Date Motor. This saw has a tilting table, a miter and side and depth gauge. Send for details.

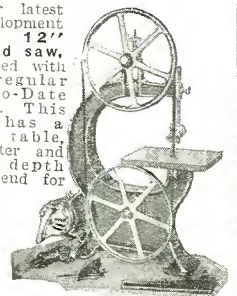

## GUARANTEE

After receipt of the Up-to-Date Home-Craftsman's Shop, if you are not satisfied, without question or delay every cent refunded and return express charges paid.

**YOUR** own terms on purchase. \$10.00 down—balance arranged to your convenience. Liberal discount for cash.

## OUR EDUCATIONAL AND BLUE PRINT DEPARTMENTS

Under personal supervision of Master Craftsman Eugene E. Maurer, offers special correspondence crafts course, giving in simple detail full information on home handicraft. Blue print service giving plans and details for making hundreds of pieces of wood handicraft included in this course FREE to our users. Individual headstock furnished where no electricity is available or to operate from an individual motor, gasoline engine, or line shaft. Note circular saw and lathe arrangement.



Use our shop for 10 days at our expense. If not satisfied—return—express charges collect.

## 10 DAY FREE TRIAL

Mail This for Full Particulars to  
**UP-TO-DATE MACHINE WORKS**  
2915 S. Wabash Ave., Chicago, Ill.

MANAGER, Dept. V:—Without any obligation, please send me all particulars about your shop, 10-day free trial, free blue prints, free crafts course. Also \$10.00 down payment offer.

NAME.....

ADDRESS.....

## UP-TO-DATE HOME CRAFTSMAN SHOP

An Advanced Development in Home Craftsman Shop Equipment

The Up-to-Date Electrical Home Craftsman Shop can be used in any home lighting fixture, thus making of your old-fashioned work bench a complete machine shop, made of a Super-power Motor, an accurate Lathe (10"x34"), a 6" circular saw, which features the bevel, miter, side and depth gauges, a Tilting Table, Jig saw, and all accessories for buffing, grinding cleaning and all portable or sta-

tionary drilling and sawing. This collection of electrically driven tools, complete in every detail, will make you an advanced craftsman. Master mechanics have designed and skilled engineers have constructed this equipment which, after inspection, you will agree is the best of its kind. For those who build, invent, create and construct at home, it is unexcelled. Our literature gives all details.



With the New **SHIELD-GRID TUBES**

Use **BRAXTON-KING IMPEDANCES**



Plug-in  
Shielded  
R.F.

**SUCCESS** with the new Shield-Grid Tubes depends on the R. F. coupling impedances used. To be safe and sure, install these latest Braxton-King units specially designed for the purpose. Fully shielded, laboratory-matched to precise limits, sealed, tested, and guaranteed.

Fits any  
standard  
UX socket

**\$7.50**  
EACH,

Retail List

To get the tremendous gain-per-stage offered by shield-grid tubes, put B-K Impedances in your set. If your dealer is not yet stocked, order from factory. Jobbers and dealers, write or wire for samples, catalogue sheets, discounts.

**BRAXTON-KING**

Shielded, Plug-in

Intermediate Transformers



Fits any  
UX socket

are the last word for intermediate stages with standard tubes. Fully shielded, very stable. Fit any UX socket. Only 2 1/2 in. high, 1 1/2 in. wide. Air-core, sharply peaked, laboratory-matched in sets.

Set of 4.....\$18.00  
Oscillator Coupler..... 2.00

**MISSISSIPPI VALLEY RADIO CO.**

914 PINE STREET

ST. LOUIS, MO.

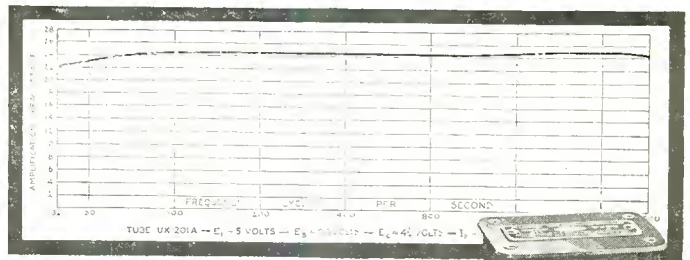

The curve proves the **TONE**

Consider the left end of the curve shown on the graph above as the *lowest* note your ear can detect. Follow the curve to the right as you go through every frequency of sound to the *highest* note your ear can hear. See how little it varies in the degree to which each note is amplified. This curve is laboratory proof of the Sangamo Transformer's ability to give you better radio reproduction—shows how faithfully it will reproduce all tones within range of the human ear.

Sangamo Transformers enable you to get maximum results from power tubes—they improve any receiver. Insist on Sangamo!

Type "A" for usual transformer coupled amplifier.

Type "B" input for "push-pull."

Type "C-171" output for "push-pull" (171 tube).

Type "D-210" output for "push-pull" (210 tube).

Type "E" output impedance (30 henrys).

Type "F" plate impedance (200 henrys).

**SANGAMO ELECTRIC COMPANY**

Springfield, Illinois

**WARD**

**Electric Soldering Irons**

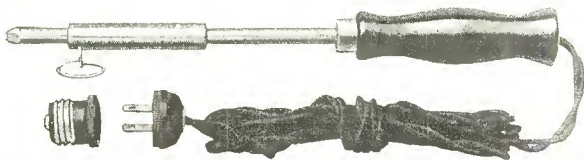

No. 212—\$1.40

A complete line of soldering irons designed for radio work—or wherever a soldering tool is required.

Repeat orders, over a period of years, from the leading jobbers throughout the country prove beyond anything we could ever tell you that the workmanship and quality of these irons is of the best. If your local dealer cannot supply you, write us direct.

Heavy Irons for Manufacturers

Jobbers, Dealers—Write for  
Special Discount

**WARD MFG. COMPANY**

941 Wellington Avenue

Chicago, Illinois

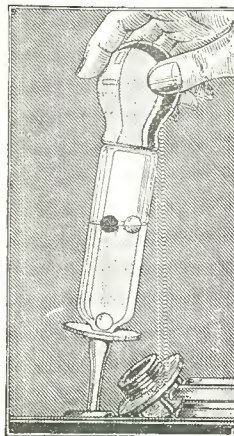

**FREE!**

**A High Grade HYDROMETER**

Lists for 75 Cents

Send in coupon below and receive this Hydrometer free with a one year's subscription to the Citizens Radio Call Book Magazine.

Every radio set needs a Hydrometer. It tells you instantly the condition of your battery. This is the famous Chaslyn Hydrometer, sold regularly for seventy-five cents.

Regular subscription price is \$1.75, Hydrometer 75c—\$2.50 value—for only \$1.75. Hurry, this offer is limited.

**COUPON**

CITIZENS RADIO CALL BOOK MAGAZINE  
508 So. Dearborn Street, Chicago, Ill.

Here's my \$1.75. Please send me the Chaslyn Hydrometer free and enter my subscription for one year to the Citizens Radio Call Book Magazine. Start subscription with  January  March  September  November issue.

Name.....  
Address.....  
City.....State.....



# DEALERS-BIG DISCOUNTS

## WHOLESALE RADIO SUPPLIES

### SET BUILDERS

Make more money by getting into radio and electrical goods and do good business 12 months of the year. Our big catalog shows huge stocks of standard radio parts, sets, kits, at lowest rock-bottom wholesale prices together with electrical goods, etc. Fast service. Guaranteed goods of leading makers. Thousands of dealers prefer our service. Wonderful special offers on sets, tubes, batteries. Get your free copy NOW before you buy.

**BARAWIK COMPANY**  
Dept. 811 Chicago, U. S. A.

## CORTLANDT RADIO PANELS

for ALL CIRCUITS IN STOCK

BEAUTIFULLY DECORATED      CORRECTLY DRILLED

Special Panels Made to Order

**Cortlandt Panel Engraving Co.**  
165 Greenwich St. New York City

Mid-West Sales Office:  
AARON, SIEDMAN & CO., 307 N. MICHIGAN AVE., CHICAGO, ILL.

## HOTEL FORT SHELBY

Lafayette and First, Detroit

New 22-Story Addition

equipped with every advanced feature of accommodation, including SERVIDORS

WHETHER your choice be one of the very comfortable rooms at \$2.50, \$3 or \$4, or one of the especially large rooms or fireplace suites in the new addition, with an entrancing view of city, river and Canadian shore, you will enjoy a special sense of value in Hotel Fort Shelby.

Convenient to all downtown and to all transportation. Shopping, theatrical, financial and wholesale districts within five minutes' walk. Garage in connection.

Cars delivered without service charge.

Brochure on request



# The Sheridan Hotel

## MINNEAPOLIS

MARQUETTE AT 11TH STREET

THIS beautiful new transient and residential hotel is ideally located. Modern and fireproof with every service thoughtfully arranged for your comfort. 450 rooms; also 100 car garage in building. Write for reservation.

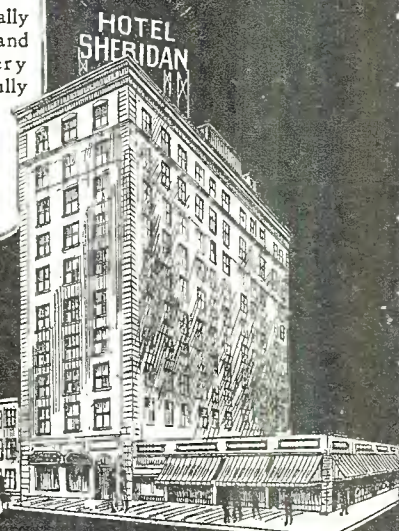

### SIMPLE—ACCURATE

## SOS HYDROMETER

No glass floats to break or stick. A never failing battery tester, used in all parts of the world. The three balls tell you at a glance the state of your battery. Used as standard equipment in millions of Glass-Cased Batteries and Power Units by the Leading Battery Manufacturers.

EASIEST TO READ      NOTHING TO BREAK

Swim all three—charged fully.  
Sinks the white—charge still right.  
Sinks the green—charge is lean.  
Sinks the red—charge is dead.

Ask your dealer. If he can't supply, send 75c to us.

Chaslyn Corrosion Cure for Battery Terminals protects contacts. A large tube lists at 30c.

**THE CHASLYN COMPANY**  
4607 Ravenswood Ave. Chicago, Ill.

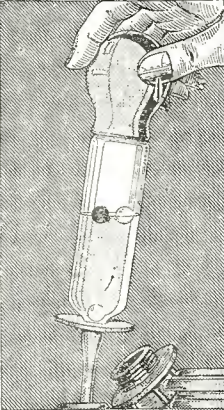

# \$2

brings this

### Amazing Discovery For Any Radio

SATISFACTION GUARANTEED

# Get Distance

Why confine your radio programs to a few local stations when the expansive concerts, dance music and lectures of hundreds of big cities are ready for you? With every order for our treatise, "The Distance Getter," we include FREE our wonderful New Distance Transformer. Tune your set according to our special instructions and presto—the distant stations roll in!

Your money instantly refunded if you are not satisfied. The attachment furnished free with the "Distance Getter" alone is worth the price. Results beyond all expectations. Cuts thru local stations like a knife.

writes Galloway of Chicago, Ill. "Send three more for my friends. I get Denver and Calif. easily," says Homes, Palos, Ill.

**MAIL COUPON TODAY**

**HAZLETON LABORATORIES**  
4554 Malden St., Dept. X, Chicago, Ill.

Send me Distance Getter, postpaid. Enclosed find \$2.00 (M.O., stamps or check.)  
Send C.O.D., plus small postage added.  
Also send 100-page Radio Catalogue Free.

Name.....  
Address.....  
City..... State.....





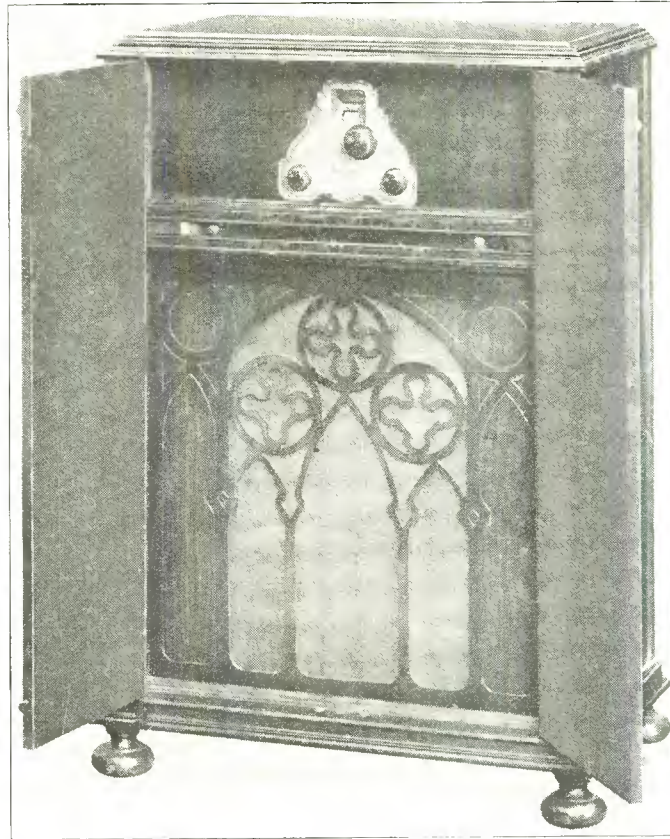

## The Newest—the Classic Console

The exquisite beauty of the Chillicothe Radio Console is creating a sensation among radio owners. Every set owner desires the enhancing artistry, so accurately expressed in this most attractive and convenient cabinet. "The Classic" Console is faultlessly constructed of genuine black walnut, "that master of woods."

A long air column Newcombe-Hawley horn with Baldwin unit,—standard equipment.

Sufficient space in lower compartment for all types of battery and electrical equipment.

A walnut panel which will accommodate all sets up to 26½"x9".

The above are additional advantages of this Chillicothe Console.

Here—in this new creation by the Chillicothe Furniture Company, you will find authentic, distinctive design, simplicity and unsurpassed convenience,—truly a pleasant combination.

Interesting booklets on Chillicothe radio cabinets will be cheerfully mailed upon request. A letter to Department C, Chillicothe Furniture Company, Inc., Chillicothe, Missouri, will demonstrate how these cabinets will improve your set.

### CONSTRUCTION

The same ideals which the Chillicothe Furniture Company has at all times expressed in the construction of their genuine Walnut Dining Room Suites, have been carried into this new field of radio cabinets, and built in "the Walnut center of America," by this reliable firm, you are assured of a radio cabinet superb.



*"Built in the Walnut Center of America"*

**CHILLICOTHE**  
**RADIO CABINETS**  
 CHILLICOTHE FURNITURE COMPANY  
 INCORPORATED  
 CHILLICOTHE, MISSOURI

*Tell 'Em You Saw It in the Citizens Radio Call Book Magazine*



# Index to Advertisers

**A**

Aberdeen Hotel.....202  
 Abox Co.....10  
 Acme Apparatus Co.....9  
 Acme Wire Co.....168-175  
 Aero Products Co.....3-45-159  
 Aerovox Wireless Corp.....197  
 Algonquin Electric Co.....207  
 Allen-Bradley Co.....51  
 Allen-Rogers-Madison, Inc.....183-211  
 Alter Co., The Harry.....216  
 Aluminum Co. of America.....65  
 American Mechanical Laboratories.....173  
 American Transformer Co.....164  
 Amsco Products Co.....158-185  
 Arcturus Radio Co.....191  
 Ashe Radio Co., Walter.....200  
 Austin Accessories Mfg. Co.....216

**B**

Barawik Co.....220  
 Belden Mfg. Co.....29  
 Benjamin Electric Co.....215  
 Birnbach Radio Co.....177  
 Blackburn Specialty Co.....216  
 Bodine Electric Co.....17  
 Boudette Mfg. Co.....170  
 Braun Co., W. C.....2-201-216  
 Bremer-Tully Mfg. Co.....5  
 Brown & Caine.....213  
 Browning-Drake Corp.....8

**C**

Carter Radio Co.....170  
 C. E. Mfg. Co.....Back Cover  
 Celoron Co., The.....212  
 Central Radio Laboratories.....214  
 Chaslyn Co.....220  
 Chicago Radio Apparatus Co.....162  
 Chicago Salvage Stock Co.....223  
 Chicago Solder Co.....31  
 Chillicothe Furniture Co.....221  
 Citizens Radio Amateur Call Book.....206  
 Citizens Radio Service Bureau, Blue Prints.....193  
 Citizens Radio Engineering Labs.....169  
 Clark & Tilton, Inc.....211  
 Cloverleaf Mfg. Co.....Third Cover  
 Consumers Radio Co.....187  
 Continental Corp.....216  
 Co-operative Electric Supply Co.....200  
 Cornish Arms Hotel.....214  
 Cornish Wire Co.....217  
 Cortlandt Panel Engr. Co.....220

**D**

De Jur Products Co.....178  
 Detroit Electric Co.....213  
 Deutschmann Co., Tobe.....169  
 Dubilier Condenser & Radio Corp.....166  
 Duro Metal Products Co.....207

**E**

Eby Mfg. Co., H. H.....188  
 Egert, R. W.....186  
 Ehlert Radio Furn. Co.....217  
 Ekko Co.....214  
 Elliott Radio Corp.....224  
 Electrad, Inc.....179-207  
 Engineers Service Co.....163  
 Excello Products Co.....39

**F**

Fansteel Products Co.....21  
 Fast & Co., John E.....216  
 Federal Radio Co.....200  
 Ferranti, Inc.....188  
 Flechtheim & Co., A. M.....172

Formica Insulation Co.....49  
 Fort Shelby Hotel.....220  
 Fritts & Co., W. H.....214  
 Frost, Inc., H. H.....189

**G**

General Radio Co.....37  
 General Radio Service Labs.....200  
 Gordon, Inc., James C.....204  
 Gray & Danielson.....53  
 Graymore Radio Co.....200  
 Great Eastern Radio Co.....212

**H**

Hagel, Eugene A.....174  
 Halldorson Co.....173  
 Hamilton-Carr Co.....189  
 Hammarlund Mfg. Co.....177  
 Hammarlund-Roberts Co.....209-210  
 Hammer Radio Co., S.....211  
 Hampton-Wright Co.....167  
 Harco Co., The.....190  
 Harkness, Inc., Kenneth.....161  
 Hazelton Laboratories.....220  
 High Frequency Laboratories.....180-181

**I**

Illinois Transformer Co.....1  
 Independent Electric Co.....202  
 International Correspondence Schools.....172  
 International Resistance Co.....191

**J**

Jensen Radio Mfg. Co.....207  
 Jewell Electrical Instrument Co.....23  
 J. M. P. Mfg. Co.....192  
 Jones Co., Howard B.....202

**K**

Karas Electric Co.....7-189  
 Keystone Radio Co.....174  
 Kokomo Electric Co.....190  
 Koploy & Ross.....201  
 Kurz-Kasch Co.....160

**L**

Langbein & Kaufman.....217  
 Lewis Radio Jobbers.....210  
 Lignole Corporation.....15  
 Lynch, Inc., Arthur H.....186

**M**

Madison-Moore Radio Corp.....64  
 Midwest Radio Corp.....19  
 Mississippi Valley Radio Co.....219  
 Modern Electric Mfg. Co., The.....176  
 Modern Laboratories.....210  
 M. & M. Co.....204  
 Muter Co., L. F.....165

**N**

National Company.....171  
 National Radio Co.....160  
 National Radio Institute.....27  
 Nelson Electric Co.....175  
 New Auditorium Hotel.....192

**P**

Pacific Radio.....196  
 Paramount Electric Supply Co.....212  
 Pierson Company.....33  
 Polymet Mfg. Co.....185  
 Power, Inc., Harold J.....197  
 Precise Mfg. Co.....213  
 Precision Coil Co., Inc.....173

**R**

Radex Mfg. Co.....55  
 Radiall Company.....216  
 Radiart Laboratories.....216  
 Radio Association of America.....35  
 Radio Cabinet Co.....212  
 Radio Equipment Co.....174  
 Radio Institute of America.....59  
 Radio Parts Company.....211  
 Radio Service Company.....200  
 Radio Service Laboratories.....182-206  
 Raytheon Mfg. Co.....216  
 Rex Laboratories, Inc.....191  
 Rowan Battery Supply Co.....205

**S**

Samson Electric Company.....6  
 Sangamo Electric Co.....219  
 Scott Transformer Co.....11-12-13-14  
 Serlin & Company.....202  
 Shure Radio Co.....201-211  
 Shanklin Mfg. Co.....215  
 Sheridan Hotel.....220  
 Shieldplate Tube Corporation.....205  
 Sickles Co., F. W.....199  
 Signal Electric Mfg. Co.....197  
 Silver-Marshall Co.....198-199  
 Simplex Radio Supply Co.....188  
 Sonatron Tube Co.....Second Cover  
 Southern Toy Co.....216  
 Sovereign El. & Mfg. Co.....217  
 Sterling Mfg. Co.....47  
 St. James Laboratory.....194-195  
 Straus & Schram.....25  
 Syd Battery Co.....213

**T**

Telephone Maintenance Co.....212  
 Temple, Inc.....179  
 Thordarson Electric Mfg. Co.....41  
 Townsend Radio Corp.....206  
 Trimm Radio Mfg. Co.....167  
 Triple A Specialty Co.....162  
 Tyrman Electric Corp.....203

**U**

Up-to-Date Mach. Wks.....218

**V**

Van Doorn Co., The.....187

**W**

Walker Co., The George W.....183  
 Ward Leonard Electric Co.....43  
 Ward Mfg. Co.....219  
 Webster Co., The.....184  
 Wedel Company.....201  
 Western Radio Co.....164-166-168-176-178-188-202-207-211-212  
 Weston Electrical Instrument Corp.....184  
 Whitehall Hotel.....206  
 Wolf, J. W., & W. L.....197  
 Work-Rite Mfg. Co.....216  
 World Battery Co.....214

**X**

X L Radio Laboratories.....186

**Y**

Yaxley Mfg. Co.....171



# Attention DEALERS *and* SET BUILDERS

---

Our New Wholesale Department  
Is Ready to Serve You

---

## A Three-Fold Service

- 1. Price** As a dealer or set builder you are entitled to our rock-bottom wholesale prices. Save money by buying from our new wholesale department.
- 2. Quality** Everything we handle is fully guaranteed. You *must*—and *will* be satisfied.
- 3. Service** We are authorized distributors of practically all standard radio lines. We carry the largest radio stock in the world. 12 hour service guaranteed on mail orders.

If it is in radio, we have it! All parts for the latest circuits as described in this issue of the Call Book. All the latest accessories. No need for you to bother shopping around.

## Free Catalog

Come up to our wholesale department and get a copy of our free catalog. If you can't come, write us for a copy.

## CHICAGO SALVAGE STOCK STORE

Wholesale Department CB

509 S. State St.

Phone MAIn 0920

Chicago, Ill.



**DOWN**

**Brings You Guaranteed "A" or "B" Eliminator**

**Electrifies Any Radio**

**Completely Replaces Batteries**



**No Battery  
No Charger  
No Bulbs  
No Hum  
Nothing to  
Wear Out  
Or Replace**  
COMPLETE  
**\$32<sup>50</sup>**

**Completely  
Replaces  
"B"  
Batteries**  
Easy to At-  
tach Plug  
Into Electric  
Light Socket  
COMPLETE  
**\$29<sup>50</sup>**

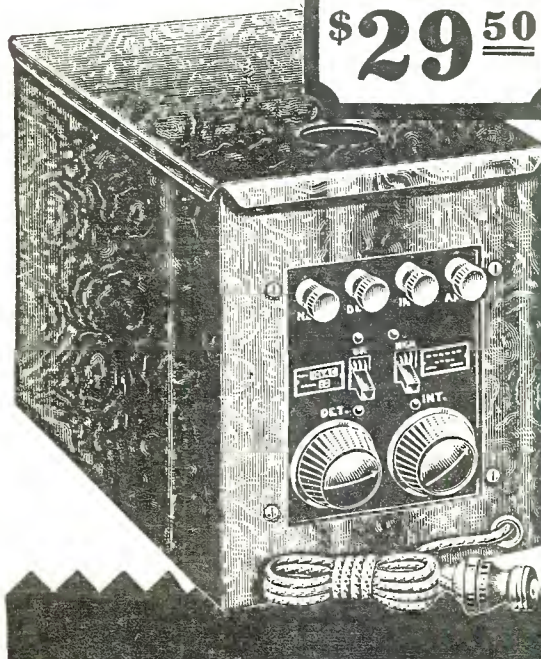

**Super-Power "A" Eliminator**

UNCERTAIN storage batteries with their changing power, chargers and other bothers and expenses are done away with. This eliminator is **not a battery charger combination but completely and permanently replaces "A" Batteries.** It consists of a large capacity rectifier which changes the alternating house lighting current into direct current. Then a highly efficient heavy duty filter system of extremely high capacity changes the pulsating direct current from the rectifier into smooth, even current for lighting the filament in the radio tubes. Smooth, constant, unvarying, humless current for your radio. Anyone can install this eliminator in a few minutes. Simply connect between electric light socket and the radio and your set is instantly supplied with current used only when it is in use. Works perfectly whether used daily or only at long intervals. No moving parts to wear out. Operates from light socket 110-120 volts, 50-60 cycle A. C., output 6 volts for all sets up to 10 tubes with or without power tubes. Fool-proof in operation. Now sold direct at astonishingly low price.

**Super-Power "B" Eliminator**

Used with any good "A" Eliminator, this "B" Eliminator completely electrifies any radio. Battery troubles are forever ended. You operate your radio as easily as you turn on a light.

**Complete with Raytheon Tube** — This Super-power "B" Eliminator can be used with any set up to 12 tubes. It comes complete with full wave rectifying 125 mil Raytheon tube, making possible the delivery of great current at a high voltage. This Raytheon tube has indefinite life as it has no filament to burn out. Delivers up to 180 volts.

The case is beautifully finished in olive green Duco, with black panel etched in gold. Equipped with rubber-covered cord and socket plug. High voltage taps and variable adjustments enable the use of new power tubes. Operates from 110-120 A. C., 50-60 cycle current. Has tap for intermediate voltage on which 67½ to 90 volts may be obtained. The detector tap will supply 22½ to 67½ volts. Variable adjuster will deliver any desired detector voltage. On and off switch and high and low voltage switch are integral parts of the eliminator. No additional switches or cords are necessary.

**Only \$1.00 Down—Then Test Before You Buy**

Indicate on the coupon below which eliminator you wish. Pin a dollar bill to the coupon and mail it to us. We will send you the Eliminator you want to test. If you want both eliminators send two dollars and mark coupon accordingly. You test them for 30 days before you pay another cent. Balance on easy installments when you are satisfied.

**New Low Prices**

Our great buying power and direct sales method enables us to offer both eliminators at tremendous savings. The "A" Eliminator, easily worth over \$40.00 and more, can be had here for \$32.50—only \$1.00 and balance on easy payments. The "B" Eliminator sells for the cash price of \$37.50 and more but by buying direct on easy payments you can have it for only \$29.50.

**Elliott Radio Corporation**

709 West Lake St. Dept. 397. Chicago, Illinois

**Mail  
Coupon  
NOW!**

**Mail This Coupon NOW!**

**Elliott Radio Corporation, Dept. 397  
709 West Lake Street, Chicago, Ill.**

Attached find \$1.00 for which you agree to send me ( ) "A" Eliminator at \$32.50 ( ) "B" Eliminator at \$29.50 (send \$2.00 if both are desired) as described in your ad. Full particulars will be sent me by return mail and my money refunded if I do not accept your offer.

Name.....  
Address.....  
City..... State.....



**SCOTT TRANSFORMER CO.**  
7620 EARL LAKE TERRACE  
CHICAGO

CHICAGO  
CINCINNATI  
CLEVELAND

PHONE  
ROSELAND 7-6611

Cloverleaf Mfg. Co.,  
2714 S. Canal St.,  
Chicago, Ill.

Gentlemen:  
I have found that Subantenna gives greater distance consistently, than any other form of pick-up system.

I also find reception is nearly always perfectly clear when using a Subantenna, particularly on days and evenings when static conditions are impossible to combat with a loop or overhead wire.

We use a Subantenna on our laboratory set in which all Selectone Long Wave transformers are tested, and I have chosen Subantenna for my own personal set at home.

Very truly yours,  
*E. H. Scott*  
SCOTT TRANSFORMER CO.

CIRCUIT DIAGRAM  
OF SCOTT  
WORLD'S RECORD  
SUPER 10  
WILL BE SENT  
UPON REQUEST

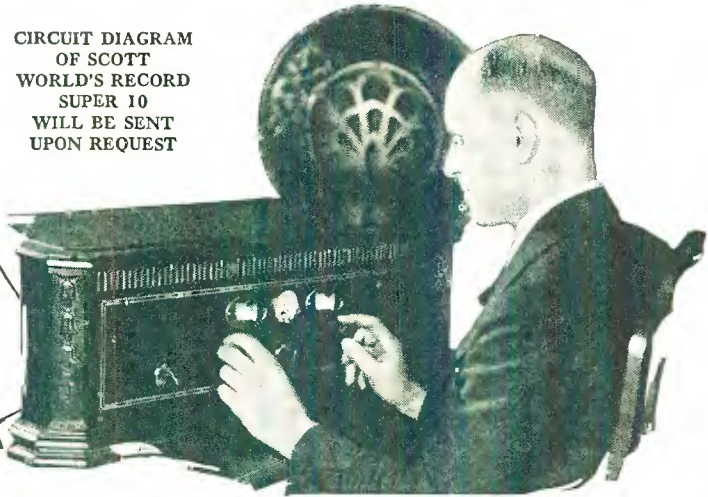

**By Test**

The fact that Mr. E. H. Scott, whose fondness for far distant reception led him and his World's Record Super 10 into the spotlight of world-wide fame, endorses and uses a Subantenna in his laboratory work and at home is conclusive proof of the merit of this device.

**SUBANTENNA**

proved best for DX  
by designer of the  
**9400 MILE**  
**SCOTT WORLD'S RECORD Super 10**

Read the letter reproduced above. It contains the official answer to the question foremost in the mind of the inveterate DX listener. "DOES Subantenna increase distance?" E. H. Scott, the inventor of the WORLD'S RECORD SUPER 10—the receiver holding more distance records than any other, says Subantenna DOES. He says it not only increases distance but that it gives absolute clarity on far-away stations when a loop or up-in-the-air aerial brings mostly static and noise. Thousands of fans, hundreds of whom have so written, confirm Mr. Scott's finding. For instance, J. White of Brooklyn, N. Y., picked up Sydney, Australia—10,144 miles away—with a Subantenna. Reception was clear, but the instant he switched to a 200 ft. up-in-the-air aerial, the reception became a jumble. From all parts of the world come letters describing truly amazing distance tests in which Subantenna asserts its superiority.



**Listen in on Static-Free Ground Waves  
Enjoy Louder, Clearer, Better "Distance"**

The picture at the right explains why Subantenna brings in far distant stations when other types of "pick-up" fail. Subantenna, as the picture shows, intercepts only the ground component of the wave. This wave is always practically pure and static free. Hence, the radio signal dominates and comes in clearly regardless of the condition in the air. Result—loud, clear DX, irrespective of the weather or the season.

**Authorities and Thousands of Users Prove  
Amazing Merit of SUBANTENNA**

**AUSTRALIA**  
John White of Brooklyn, New York, has verifications from station 2FC, Sydney, Australia, and 3AR, Melbourne, Australia, of reception made possible by a SUBANTENNA.

**CUBA and SOUTH AMERICA**  
"To show you that I received a program from Stationi PWX in Havana,

Cuba, I enclose herewith a verification card from that station. On January 28th, I received a program on my set broadcasted from Buenos Aires, South America, at 10:15 in the evening. Many other long-distance stations have been heard on my set after installing the Subantenna. I never could receive such distance on my outside antenna."—W. C. F., Chicago, Ill.

**"MORE STATIONS—NO STATIC"**

"I get plenty of stations with my Subantenna, on the loud speaker, that I have never been able to reach with my outside aerial. It absolutely cuts down interference to the minimum, cuts static out too—not just partly out—but all out."—H. S. M., North Carolina.

**CLOVERLEAF Lifetime "B" Eliminator**



**85 Mil. Tube**

A new, better, advanced type "B" at a new, lower price than any other unit of equal capability. Supplies fixed voltages of 22-45-90-135 and 180 volts for power tube from permanent, non-adjustable taps. No "motor-boating". Will run any standard set. The true lifetime eliminator, because built of the finest quality materials that money can buy. Guaranteed for two years. Test! FREE. Mail coupon for full details of FREE TRIAL OFFER.



**and Cloverleaf AUTOMATIC A and B CONTROL**

Localizes control of "A" battery, trickle charger and "B" Eliminator in the switch on your set. Installed in a minute. Never needs attention. When you turn your set "off" the Cloverleaf Control automatically turns the tubes off, the "B" Eliminator off, and the trickle charger on. When the set switch is turned "on," the opposite takes place. Try at our risk. Check coupon for full details.

**FREE TRIAL**

Make this Convincing Test at Our Risk  
Install Subantenna. Leave your old aerial up. Select a bad night when DX is almost impossible with the ordinary aerial. Make a comparison station for station, connecting first your aerial, then Subantenna. If, from stations that are just a mess of jumbled noise with the old aerial, you don't get reception that rivals local in sweetness and clarity the instant you switch to Subantenna, this test is Free. Obtain a Subantenna from your dealer or send coupon at once for scientific explanation of Subantenna and for particulars of GUARANTEE and FREE TRIAL OFFER. SEND COUPON NOW!

**CLIP and MAIL AT ONCE**

CLOVERLEAF MFG. CO.  
2713-R Canal St., Chicago, Illinois  
Tell me all about SUBANTENNA; your unqualified unconditional guarantee and your FREE TRIAL OFFER. Also send me particulars of  
 Cloverleaf LIFETIME "B" Eliminator  
 Cloverleaf Automatic A and B Control  
 Send FREE Circuit Diagram of Scott World's Record Super 10

Name.....  
Street.....  
Town..... State.....

**CLOVERLEAF MFG CO.**  
2713-R CANAL ST. CHICAGO, ILL.



# No Falling Off

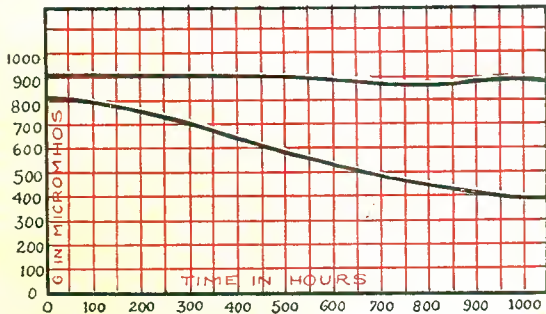
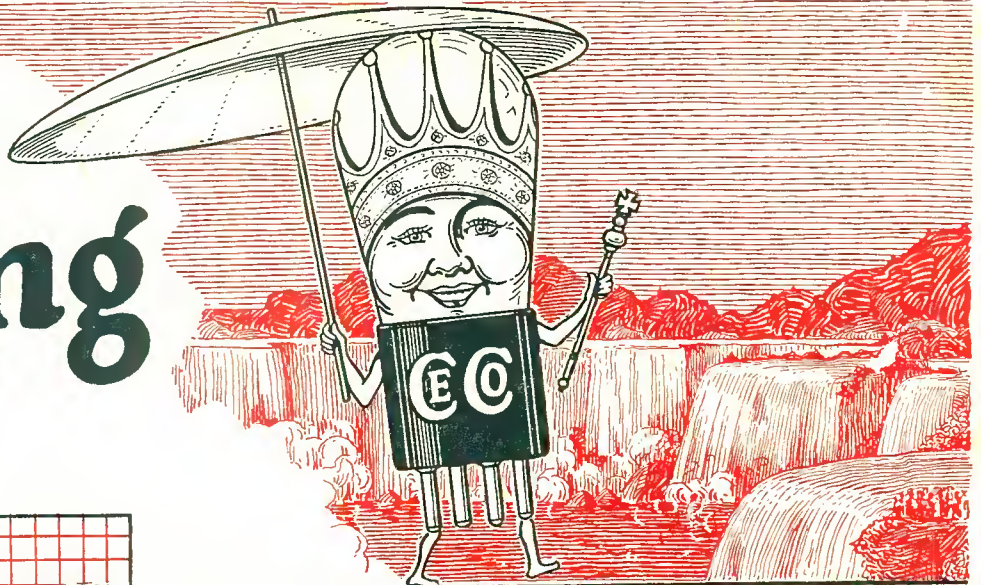

**CeCo Tubes**  
Avg. of 27  
Other Makes

THE above chart graphically illustrates the longer life and steadier performance of CeCo Tubes as shown by an unbiased test of CeCo Tubes in comparison with twenty-seven other makes.

The test was conducted by a nationally known set manufacturer (name on request).

CeCo Tubes prove to be as efficient after 1,000 hours of use as when new. In fact, hundreds of instances have been called to our attention by users where CeCo Tubes have performed for over 2,000 hours without apparent deterioration.

Experiences like these, together with a noticeable improvement of tone, clarity and volume resulting from the use of CeCo Tubes, have secured the recommendations of well-known radio authorities such as

ARTHUR H. LYNCH  
GLENN H. BROWNING  
LAWRENCE M. COCKADAY

GERALD M. BEST  
KENNETH HARKNESS  
VOLNEY HURD

HERMAN BERNARD  
KEITH HENNEY  
JAMES MILLEN

*There's a CeCo Tube for Every Radio Need*

GENERAL PURPOSE TUBES

SPECIAL PURPOSE TUBES

A. C. TUBES

POWER TUBES

RECTIFIERS

*Ask your dealer to help you select the types best suited to your set*

**C. E. MFG. CO., Inc., Providence, R. I.**

*Largest plant in the world devoted exclusively to making of Radio Tubes*

