

SPRING
EDITION

CITIZENS

50¢

Radio Call Book N.S.E. Magazine

and Scientific Digest



RADIO • TELEVISION • MECHANICS

HOWARD RADIO

*Tone
Beyond
Compare!*

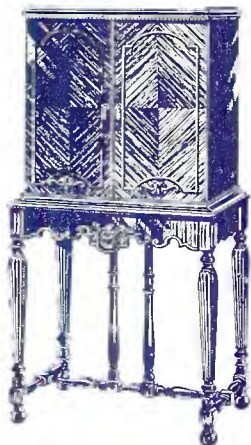

The Green Diamond Console Model—beautiful cabinet of matched walnut, rich subdued finish. Magnavox Dynamic Speaker built in. Complete, less tubes.

\$245

The 1929 Howard Green Diamond Eight (9 Tubes including Rectifier) DYNAMIC SPEAKER

Selective to a degree almost unbelievable—a distance getter.

Howard Receivers always have been quality products. To really know the difference between a Howard Green Diamond Eight and an ordinary radio set, ask your dealer to lift the condenser shield of a Green Diamond. You'll marvel at the workmanship and watch-like perfection.

It is this excellence of construction, coupled with years of experience in radio engineering that insures Howard superiority. Any radio authority will tell you "if it's a Howard it's correctly designed and built."

*Other Howard Models to \$2500.
Ask for Illustrated Booklet.*

HOWARD RADIO COMPANY
4949 North Crawford Avenue
CHICAGO
Phone—Independence 1122

for—

110 Volt Direct Current

A new 6-Tube Howard Table Model electrically operated receiver attaching to any light socket which supplies 110 volt Direct Current. (No batteries needed.) Price, less tubes,

\$135

Licensed by R.C.A. and Associated Companies

BRAUN offers you SEASONABLE Lines Radio-Electrical-Auto Supplies SPORTING Goods

New Developments in Radio

No industry in the world's history has attracted so many inventors and experimenters as the radio industry. Something new is always on tap. Contrast the old wireless days with the modern electrically operated talking radio. Think of what is still to come when perfected television, telephony, short wave control, etc., are fully realized.

In keeping with the policies of *Wholesale Radio Headquarters* (W. C. Braun Company), our service lies in testing out and determining which of these newest marvels are practical, salable and usable for the greatest number. Our task is to study the multitude of new merchandise, select those items that are thoroughly proved and reliable, and make it easy for the public to secure these while they are still new.

A huge and varied line of standard radio merchandise is carried in stock for quick shipment to all parts of the country. This service assures the dealer and set builder of *everything he needs*, all obtainable from one house, without shopping around at dozens of different sources. It saves considerable time, trouble and money. For example, when you want a complete radio set or parts for a circuit, you also will want a cabinet, loud speaker, tubes and other supplies and accessories. You know that at Braun's you can get everything complete in one order, and thus save days and weeks of valuable time, besides a considerable saving in money.

New Lines for Spring and Summer

Here, all under one roof, is carried the world's largest stocks of radio sets, kits, parts, furniture, speakers and accessories for the radio season, portable radios and phonographs for summer trade and a complete line of auto tires, tubes and supplies, electrical and wiring material, camping and outing equipment, tents, golf goods, sporting goods; in fact, a complete merchandise line to keep business humming every day, every week and every month in the year.

Do You Get Our Catalog?

If you don't receive our catalog, by all means send us a request on your letterhead to insure getting each new edition as promptly as it comes out. Braun's Big Buyers' Guide is crammed full of bargains and money-making opportunities that you cannot afford to pass up.



W. C. BRAUN Co.
Pioneers in Radio
596 E. W. Randolph St.
CHICAGO
ILLINOIS

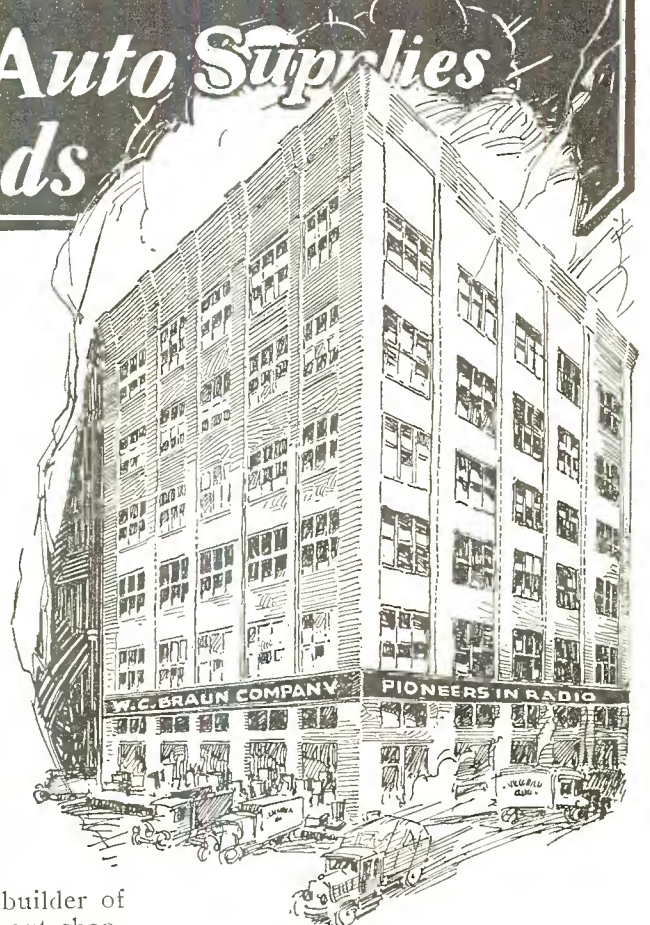

**MORE BUSINESS
NEW LINES
SPRING and SUMMER
STIMULATORS**

**RADIO SETS, KITS, PARTS
SHORT WAVE, TELEVISION
SPEAKERS, SUPPLIES
PORTABLE RADIOS and
PHONOGRAPHS
AUTO TIRES and
ACCESSORIES**

**ELECTRICAL GOODS
Wiring, Fixtures, Etc.**

**SPORTING GOODS
Outing Clothing, Baseball,
Golf Goods, Etc.**

**HOUSEHOLD SPECIALTIES
Vacuum Cleaners, Phonographs,
Electrical Toys**

New Super-Powerful Super Outperforms Set that Shattered All DX Records

New AC Shield Grid Super Outclasses Receiver that Spanned 10,000 Mile Gap between San Diego and Iceland

Recent tests of a new and very remarkable Receiver disclose a unique radio instrument that surpasses anything and everything on the market for consistent long distance reception with full loud speaker volume, including the world famous Magnaformer 9-8 DC battery operated Super, which Receiver, until the present time, has held the record in this country for DX reception. Consistent loud speaker reception on this Receiver of many broadcasting stations located in many countries from 6,000 to 10,000 miles distant, including 2LO London; VPSS Hong Kong, China; 1YA Auckland, New Zealand; 2BL Sydney, Australia; 5CL Adelaide, Australia; JOAK Tokio, Japan; JOIK Sapporo, Japan; JOCK Nagoya, Japan; Danziger Rundfunk Station, Danzig, Germany (9,000 miles); 2RN Dublin, Ireland and G2SH Akureyri, Iceland—have been officially reported and verified.

The greatest verified long distance broadcast reception ever reported was achieved by Mr. William MacDonald on a Magnaformer Receiver located in his home near San Diego, California, when he brought in station GS2H Akureyri, Iceland—over 10,000 miles distant from San Diego. But this new super-powerful "Super" Receiver easily outperforms the Magnaformer that smashed all existing DX records.

New Coil Does the Trick

Ever since developing and perfecting the original Magnaformer Receiver the Engineers of the Radiart Laboratories have been endeavoring to develop a still better Receiver. During the first week of December they suddenly succeeded beyond their most sanguine expectations through the development and perfecting of a new Magnaformer Long Wave Intermediate Radio Frequency Transformer that successfully harnesses the broad tuning tendencies of the AC Shield Grid Tubes and makes them tune as sharply as the AC No. 227 tubes, retaining the tremendous amplification factor and extreme sensitivity of these Tubes.

Unique and Exclusive Features

This new job is 100% shielded. The radio frequency tubes and coils are in a separate shielded section by themselves and each stage containing a tube and coil is additionally and separately shielded from the other coils and tubes inside of the large shield. The audio frequency end is shielded by itself and is entirely separated from the other parts of the set. Then there is another large shield that is entirely separated from the other two that shields the tuning condensers and the oscillator coil.

Another advantageous feature of this new set is the plug-in oscillator coil scheme. This permits the set to be operated on the low wave stations as well as the broadcast waves. Two coils are provided for this purpose and all that is necessary to do is to take out one coil and plug in the other wherever you want to change from one wave band to the other.

As stated before a new Magnaformer Intermediate Long Wave Radio Frequency Transformer has been perfected for the AC Shield Grid tube stages. This new transformer is known as RF No. 51. The original Magnaformer Intermediate Coil known as RF No. 61 is retained in the AC No. 227 R. F. stages.

This new Magnaformer Receiver known as the Magnaformer AC-29 is a 10 tube All Electric AC job containing 2 of the New High Amplification AC Shield Grid Tubes, 5 Heater Type No. 227 AC Tubes, 2 No. 281 Rectifier Tubes and 1 No. 250—450 volt Output Power Tube.

The job is controlled with a single dial and has a self-contained A, B & C Power supply including a large filter condenser which delivers all of the current for all of the A, B & C voltages for all of the tubes in the set.

Excels On These Points of Performance

The original Magnaformer is a prime favorite with high class custom set builders who cater to the most particular and

exact, well-to-do customers who want only the very best and are willing to pay for it. It is an outstanding and superior Receiver from several viewpoints:

1st—Its extreme Sensitivity, which enables it to bring in stations from 6,000 to 10,000 miles distant on the loud speaker at night and from 1,000 to 1,500 miles daylight reception.

2nd—Its truly marvelous Tone Quality, which is pronounced by expert musicians to be far superior to the tone quality of

the elimination of harmonic repeats which were somewhat bothersome when the old set was located near a powerful broadcasting station that transmitted over a broad band; the new job having no harmonic repeats and still retaining the inherent selectivity of the old job, is much preferable.

The new job, on account of the perfect Intermediate Coils, retains the same remarkable Quietness of Operation on DX as the old job.

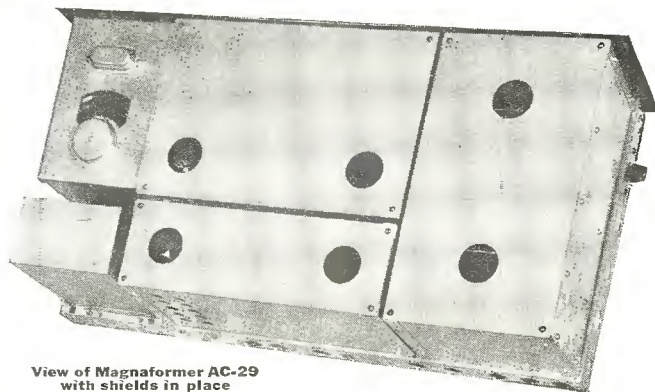

View of Magnaformer AC-29 with shields in place

any other receiver at any price whether factory built or custom built.

3rd—Its tremendous Volume, developed by reason of the perfection of design and construction of the Long Wave Intermediate Transformers.

4th—Its extreme Selectivity, enabling it to cut through the most powerful local stations with 10 kilocycle separation with a dead spot in between.

5th—Its remarkable Quietness of Operation on DX—no sound other than the music or voice is heard (no roaring, hissing nor scratching sounds usually present in other receivers) also resulting from the perfection and efficiency of the Intermediate Transformers.

6th—Its Ease of Tuning, permitting the tuning-in of distant stations by those inexperienced in DX reception.

7th—Beauty of individual parts and their arrangement in the receiver and the attractiveness of the set as a whole. And

8th—The simplicity and ease of wiring and the short time required to do the job.

Ultra-Modern Design—1931 Style

The new Super-Powerful Magnaformer has been designed to retain and improve upon every one of the good qualities of the original Magnaformer 9-8—and to eliminate the few features which prevent the old job from being strictly modern, such as battery or eliminator operation, employment of DC tubes, two-dial control and harmonic repeats on powerful local stations—and no provision for reception of short waves.

The new job is ultra-modern—1931 style. It delivers a brilliancy of reception that is unique. It has greater sensitivity on account of the employment of the powerful and super-sensitive AC Shield Grid Tubes, permitting it to bring in low powered 10 to 100 watt stations 500 to 3,000 miles distant, and to bring in high powered stations from 6,000 to 10,000 miles distant with much more volume and greater ease—and to bring in far greater distance and many more stations during the daylight hours.

The marvelous Magnaformer Tone Quality has been retained and improved upon from the standpoint of the quality of tone on DX reception. On the new job stations 3,000 miles distant come in on the loud speaker with the same true tone quality as local stations.

On account of the employment of a 250 Power Tube in the last audio stage far distant stations can now be received with much greater volume than ever.

The Selectivity is greater on account of

the new job has quite an advantage over the old job on account of being controlled with a single dial. This feature makes the new job much more desirable on the part of the women folks who do not like to handle two dials, and is the only super we know of that is of single dial control.

The 100% shielding feature of the new job protects and hides the component parts. The shielded compartments are designed with the idea of attractiveness in view, the job being very compact and extremely business-like and aristocratic looking. The sub-panel including the complete A, B & C Power Supply and Filter Condenser measures only 11 1/2 x 23 inches.

On account of the incorporation of the A, B & C Power Supply and Filter Condenser on the sub-panel with the set itself the wiring requires a slightly longer time than the old job but because of the simplicity of the arrangement of parts the wiring of the set is a considerably easier job than on the original Magnaformer. This is quite an achievement since the wiring of the original Magnaformer is acknowledged by all professional set builders to be the simplest of any Super set ever designed.

The Story of Magnaformer Coils

The advanced electrical design and absolute mechanical precision of Magnaformer Long Wave Radio Frequency Transformers account for the marvellously true tone quality of the New Magnaformer AC-29 Receiver. These R. F. Transformers are strictly a laboratory product—the result of a great many experiments and tests extending over a long period of time. The object of these tests and experiments was to develop and perfect a very superior precision instrument that could be duplicated by the thousands—each and every duplicate having EXACTLY the same characteristics as the master coil itself.

All Magnaformer Coils are Precisely Alike—Uniform and Unalterable—Nothing Can Change Them

These tests and experiments have proved highly SUCCESSFUL. Each Magnaformer is to all intents and purposes EXACTLY like every other Magnaformer. Only by the employment of elaborate laboratory apparatus can even the expert technician discover the slightest difference. It is this

EXACT matching of Magnaformers—and building them so carefully and mechanically perfect that they stay EXACTLY MATCHED under all sorts of conditions that insures the exclusive degree of True Tone Quality and extremely high amplification that the New Magnaformer AC-29 possesses.

Every Magnaformer Coil is peaked exactly to a certain definite wave length, 69.73 kilocycles (4300 meters). This peaking is all done in the laboratory by thoroughly trained experts. Each and every Magnaformer Coil can pass ONLY the same identical length of wave. Therefore the full and complete wave-band with 100% of its vital, quality-producing, harmonic-carrying side-bands is positively and easily passed through all of the Radio Frequency amplifying stages and reaches the detector in perfect form—all side-bands intact. This extraordinary performance of Magnaformer Coils naturally results in as nearly perfect tone quality as it is possible to achieve. And in no other manner can True Tone Quality be achieved.

Has Self-Contained Power Supply

Everyone who has seen and heard this new Magnaformer Super-Powerful Receiver seems immediately to decide that it is an innovation—a very long stride in advance of the field. Comments by the engineers examining and testing the set indicate that to their belief it is five years ahead in design and that it will be a long, long time before another set will be developed, even by the Radiart Laboratories, that will surpass this job.

There recently has been a feeling of the need of a set that will operate perfectly with the new and popular Dynamic Speakers. This AC Shield Grid Magnaformer is the answer.

All other custom built Super Receivers have all or at least part of the power equipment located outside of the set itself. Professional custom set builders, and especially those who buy custom-built receivers, indicate a keen desire to have everything incorporated inside the set itself and nothing outside of the set except a wire that connects the set to the electric light plug. This new job meets all of these desires in what appears to be a perfect manner. It is the only custom-built Super having a 100% self-contained humless and noiseless A, B & C Power Supply.

At the present time the set is being heralded by radio experts of the leading technical magazines. They seem to realize that this very up-to-date job is a tremendous step forward in modern "Super" construction. From talking with the engineers who have designed this new job it was learned that many months have been spent in developing the humless and noiseless power supply and that the Power Units made for use with this set are subjected to very severe tests before leaving the laboratories in order to insure that there will be none of the trouble that is usually experienced with other units after they have been in operation some time.

Free Wiring Diagrams Available

Custom Set Builders, Owners of Custom Built Receiver Service Stations and all those wishing to secure the delightful thrill of extreme DX reception coupled with remarkable tone quality are urged to send a request to Mr. Frank A. Ryder, 1022 Association Bldg., Chicago, Illinois, for complimentary copies of the schematic and part-to-part wiring diagrams and complete detailed, easy-to-follow wiring instructions for building the Magnaformer AC-29 in a very short time; also the name and address of the nearest jobber or dealer carrying complete parts for this receiver in stock for immediate delivery. The price of the complete parts for this wonderful receiver is very low indeed considering their high quality and the extraordinary results they achieve.

Exclusively Specified for the NEW Super-Powerful Magnaformer AC-29 REMLER

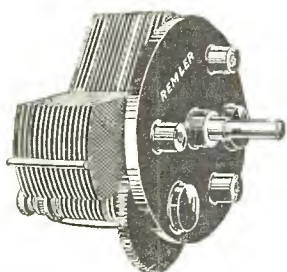

2 No. 639 Condensers

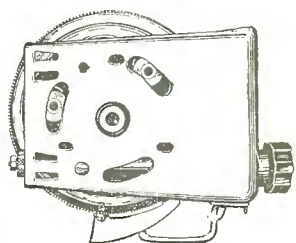

1 No. 112 Single Control Equalizer

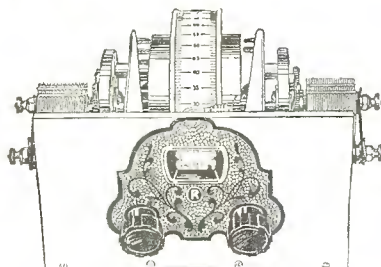

1 No. 110 Single Drum Dial

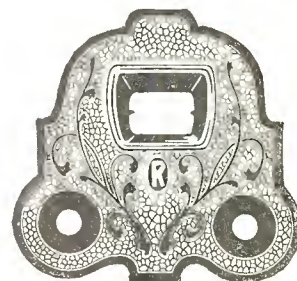

1 No. 1103 Escutcheon Plate

WITH the Remler Twin Rotor Condenser body capacity effects are entirely absent and no distinction is necessary as between stator and rotor. Both sets of plates rotate and are insulated from the dial and dial shaft. The dial rotates through 360 degrees and therefore gives unusually great dial separation of stations at all wavelengths.

The Remler Drum Dial permits a quiet, velvet smooth, vernier control. It is mounted back of the panel. Only an attractive, etched bronze escutcheon plate and the bakelite control knob are on front of panel. The drum is divided into 200 divisions—two for each broad-

cast channel. There is ample room to write in wavelengths or frequencies. The calibration strips are of heavy white cardboard printed in black; held rigidly in place yet readily removable and renewable. A 6-volt lamp with bracket is supplied for illumination.

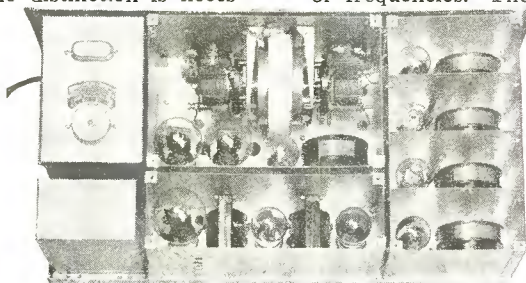

Rear View of the NEW Magnaformer AC-29 with Tops of Shielded Sections Removed Showing Specified Ferranti & Remler Parts

The Remler Single Control Equalizer is used in conjunction with the Remler No. 110 Universal Drum Dial. It provides for the separate vernier adjustment of the capacity of one of the condensers over a capacity range represented by twenty divisions on the dial. For further information address Remler, 260 1st St., San Francisco, Calif.



AUDIO FREQUENCY TRANSFORMERS AND RADIO PRODUCTS

receive preference by engineers who know

Real audio transformers with flat curves. Special output transformers for all speakers and tubes. High grade iron core chokes for "B" Eliminators. Three range portable meters. 1,000 ohms per volt. 10/50/250 scale. Three

range portable meters. 200 ohms per volt. 150/7½ volt and 15 Mill. scale with switch. By-pass Condensers—2MF—400 volt and 200 volt. Circulars sent on request.

2 Ferranti AF4 Audio Frequency Transformers are specified for
the NEW Magnaformer AC-29

Write for details of the new Ferranti Push-Pull Licensed Power Amplifiers for 171, 210 and 250 tubes

Send 15c in coin for copy of 1929 Ferranti Year Book

FERRANTI, LTD.
Hollinwood
England

FERRANTI, INC.
130 West 42nd St.
New York, N. Y.

FERRANTI ELECTRIC
LIMITED
Toronto, Canada

AEROVOX

BUILT BETTER
CONDENSERS AND RESISTORS

For the NEW Magnaformer AC-29

How Do You Buy Condensers?



**AEROVOX
FILTER BLOCKS**

The Complete
AEROVOX LINE
Includes

CONDENSERS

- Filter Blocks
- Buffer Blocks
- Socket Power
- High Voltage
- Transmitting
- Bypass
- "A" Power
- Bakelite Moulded Mica
- Condensers
- Interference Filters

RESISTORS

- Pyrohm Heavy Duty
- Edison Base Pyrohms
- Tapped Pyrohms
- Wire Wound Units
- Grid Suppressors
- Center-Tapped Units
- Non-Inductive Lavite
- Grid Leaks
- Resistorformer Kits
- Resistor Mountings

Most filter condenser blocks are bought merely on the basis of price and their voltage ratings.

In view of the many overrated condensers now on the market, the only dependable indicator to use in buying condensers is their insulation specifications and the care with which they are tested.

The Aerovox Wireless Corporation makes no secret of the insulation specifications of their filter condensers and filter condenser blocks. This information is contained in detail in the 1928-1929 catalog.

The next time you buy filter condensers or blocks make your comparisons on the basis of insulation specifications, voltage rating and price. On that basis Aerovox Filter Condensers and Blocks will undoubtedly be your choice.



is a free monthly publication that will keep you abreast of the latest developments in radio. Your name will be put on the mailing list free of charge on request.

RADIART Engineers specify Aerovox Special No. TH 862, 12 mfd. Filter Condenser exclusively, to be used in connection with their No. 250 A, B & C Power Supply Unit for their New Super-Powerful Magnaformer AC-29 because of the exceptional ability of Aerovox Condensers to withstand voltage strains and because of their liberal capacity factor.

OTHER Aerovox Condensers specified by Radiart Engineers for their New Magnaformer Receiver are as follows: 2 Aerovox 1 mfd. By-pass Condensers, No. 200-S; 2 Aerovox .00025 Fixed Grid Condensers, No. 1475, with mountings; 1 Aerovox .001 Fixed Condenser, Type 1450. 2 Aerovox 2 meg-ohm Grid Leaks No. 1082 are also exclusively specified.

A Complete Catalog with illustrations and detailed descriptions may be obtained free of charge on request.

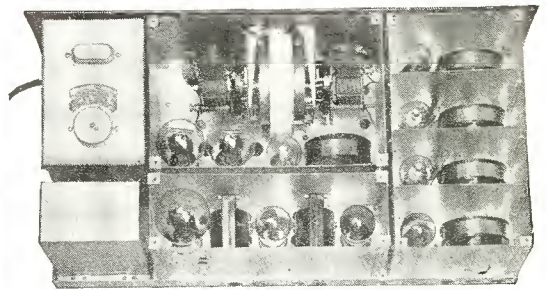
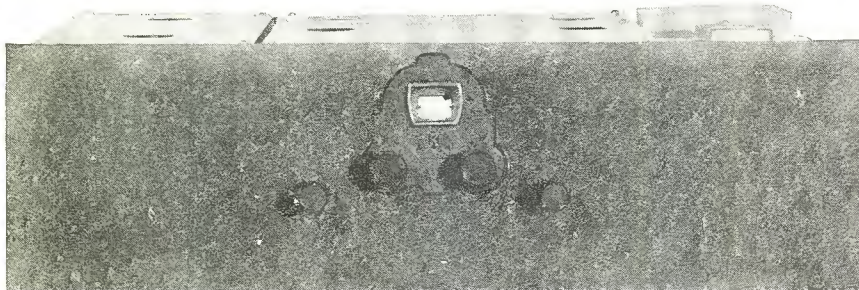

Magnaformer AC-29 Showing Aerovox Condenser in Upper Right Hand Corner—In Lower Left Hand Corner

AEROVOX WIRELESS CORP.

70 WASHINGTON ST.
BROOKLYN, N.Y.

Always First with the Latest!

Magnaformer

Magna—The dictionary definition of "magna" (Latin) is "great"; the definition of "former" is "creator". Thus, we have the "Great Creator, truly a name emblematic of the astonishing accomplishments of the Magna-former.

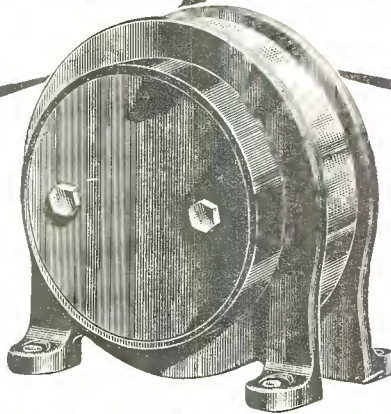

Get Your Kits from W. C. BRAUN CO.

Official Wholesale Distributors

Complete parts for this remarkable new receiver are already in our stocks! To give our Dealer and Set Builder friends instant service, we take this means of offering these kits direct from this page. No delay! Quick shipment! Gives you opportunity to get behind this fine receiver at once.

Make this your wholesale headquarters. Everything in sets, kits, parts, accessories. Make the best of 1929 with Braun service to back you up!

If you do not have a copy of our 1929 Catalog, request it now!

LIST OF PARTS	
2 Magnaformer Intermediate Shield Grid R. F. Transformers.....	\$12.00
2 Magnaformer Intermediate R. F. Transformers.....	12.00
1 Long Wave Uncoupler Oscillator	5.00
1 Radiart Drilled Sub-Panel with 10 Mounted Sockets.....	12.00
1 Radiart Drilled Metal Front Panel, 7x24 in.....	6.00
1 Radiart 250 Power Unit.....	45.00
1 Radiart 5 Panel Audio Unit Shield.....	4.00
1 Radiart 8 Panel R. F. Unit Shield.....	5.50
1 Radiart 5 Panel Control Unit Shield.....	5.50
1 Radiart Bakelite Tip Jack Panel	.25
1 Radiart Bakelite Condenser Panel	.25
1 Radiart Bakelite Plug-in Oscillator Panel.....	.50
1 Radiart Bakelite Plug-in Oscillator Bottom Panel.....	.50
2 Shield Grid Clips Cable Leads...	.50
Bolts, Screws, Nuts, Bushings, Solder Lugs (Radiart).....	1.25
Cables and Hook-Up Wire (Radiart).....	.50
1 Yaxley 20 ohm Center Tapped Resistance.....	.30
1 Yaxley 1,000 ohm Resistance.....	.35
7 Yaxley Insulated Tip Jacks.....	.85
1 .00045 Midget Regenerative Condenser with Bracket.....	1.75
2 Ferranti A.P. 4. Audio Transformers.....	17.00
2 Remler 639. Universal S.L.W. .0005 mfd. Variable Condensers	10.00
1 Remler 110. Single Control Universal Drum Dial.....	4.50
1 Remler 112. Single Control Equalizer.....	5.50
2 Remler 110-4 BR. Knobs.....	.40
1 Remler 750-12 Knob.....	.20
1 Remler 1103. Esetcheon Plate.....	1.75
1 Frost. 200,000 ohm Variable High Resistance.....	2.00
1 Frost Special 500,000 ohm Tapered Variable High Resistance Unit with Switch.....	3.00
1 Samson 125. R. F. Choke.....	2.25
6 General Radio 274-J. Jacks for Plug-in Oscillator Panel.....	.60
6 General Radio 274-P. Plugs for L. W. Uncoupler.....	.60
1 Aerovox Special 12 mfd. Filter Condenser.....	18.00
2 Aerovox 1 mfd. By-Pass Condensers.....	1.80
2 Aerovox .00025 Fixed Grid Condensers, with Mount.....	.80
1 Aerovox .001 Fixed Condenser.....	.40
2 Aerovox 2 megohm Grid Leaks.....	.30
1 Electrad. 1250 ohms Fixed Resistance.....	.85
Complete Kit of Parts, List Price	\$183.95
Extra Equipment for Long and Short Wave Antenna and Short Wave Loop.....	\$ 19.10
Completely Wired Chassis, extra, net.....	25.00

MAIL

W. C. BRAUN CO.
589 W. Randolph Street
CHICAGO

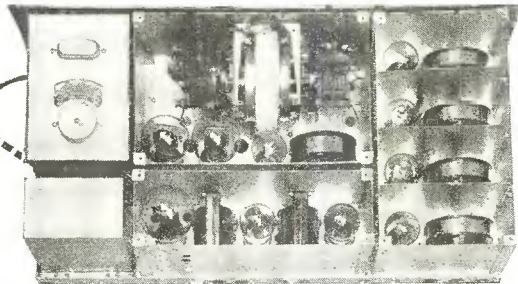

Showing Receiver with Shields Removed

Dear Sirs:

- Enclosed is remittance to cover my order for complete new Magnaformer A.C. 29 kit of parts as specified in Citizens Radio Call Book article in January, 1929, issue.
- (NOTE: Enclose remittance based upon list price, less usual setbuilders' and dealers' discounts.)
- Send above kit C.O.D., less discount.
- If Long and Short Wave Antenna and Short Wave loop is desired, put "x" in this square.
- If complete wired chassis at \$25.00 net price is desired, mark "x" in this square.
- Send new 1929 Catalog.

NAME.....
ST. AND NO.....
CITY.....STATE.....

YOUR ORDER NOW!

W. C. BRAUN COMPANY

Pioneers in Radio

589 West Randolph Street

CHICAGO ILLINOIS

Citizens Radio Call Book Magazine

AND SCIENTIFIC DIGEST

C. O. STIMPSON, President
E. H. JAUDON, Vice-President
D. H. BELL, Secretary-Treasurer
H. ANHEISER, Assistant Treasurer

Established 1921

Executive Offices:
508 So. Dearborn St., Chicago, Ill.

Member Audit Bureau of Circulations

F. A. HILL, Managing Editor
RICHARD K. PEW, Technical Editor
C. B. BENSON, Advertising Manager
M. R. HARRIS, Circulation Manager

JANUARY, 1929

Published January, March, September, November

Vol. 10, No. 1

CONTENTS THIS ISSUE

Latest U. S. Broadcast Station List.....	8-28
U. S. Broadcasting Stations by States.....	30
U. S. Broadcasting Stations by Frequency.....	32
Canadian Stations.....	34
Short Wave Phone and Telegraph Stations.....	34
Foreign Broadcast Stations.....	34
Foreign Broadcast Stations (continued).....	35
Log Chart.....	36
Ampere Andy's Assistors.....	38, 39, 40
Silver-Marshall Shield Grid Six and Power Supply.....	44, 45, 46
Remler A.C. Power Amplifier.....	47, 48
Aero A.C. 21 Chronophase Receiver.....	49, 50, 51
Sangamo Push-Pull Amplifier.....	52, 53
Tyrman 72 A.C. Superheterodyne.....	54, 55, 56
AmcrTran Power Amplifier.....	57, 58
Hammarlund-Roberts A.C. Junior Receiver.....	59, 60, 61
Victoreen Duplex Power Amplifier.....	62, 63
Aero Short Wave Converter.....	64, 65
HFL Special Superheterodyne.....	66, 67, 68
Silver-Marshall 730 Four Tube Set.....	69, 70
Vee Products Shield Grid Receiver.....	71, 72, 73
Silver-Marshall Auditorium Amplifier with Double Turntable.....	74, 75
Magnaformer 1929 A.C. Shield Grid Super.....	76, 77
Junior Two Tube Receiver.....	78, 79
Professional Set Builders' Department.....	80, 81, 82, 83, 84, 85
Citizens Laboratory Amplifier.....	86
Citizens Interference Locator.....	87, 88
Practical Television.....	89, 90, 91, 92
ABC of Radio.....	93, 94, 95, 96, 97
Five and One-half Mile Bridge Across James River.....	98
Three-Bladed Airplane Propeller Now Being Tested.....	99
New Movie Film More Pervious to Light.....	100
Every Man His Own Traffic Cop.....	101
New Turbine Operated by Waves.....	102
Test Made for Radium Poisoning.....	103
With the Accessory and Parts Manufacturer.....	104, 105
Blue Print Page.....	127
Index to Advertisers.....	174

In This Issue

THAT variety is the spice of life applies just as well in the radio business as in anything else. This statement is quite well borne out by a reference to the contents of this issue, where any radio man, regardless of his desires, is sure to find something of real interest to him. There are amplifier combinations for those who wish power amplifiers or dealer's demonstration amplifiers. There are a. c. superheterodynes for those who wish that type. There are short wave converters for those who wish to broaden the usefulness of their present receiver.

Added to the regular list of articles in this issue, there are three departments that are crammed full of helpful hints and suggestions, these being the one for the professional set builder, the department on practical television and the ABC of Radio, the latter department having been established last issue and now going in full swing, with considerable interest being manifest in this department by the younger generation and also the newcomer in radio, regardless of his age.

We are very hopeful that by this time the frenzied changing of wavelengths and call letters has come to an end. Latest advices from our Washington correspondent state that only very few changes may be anticipated in the future. The broadcast list printed in this issue is corrected up to within three days of going to press and we have every assurance that there will be very, very few changes and these only of a minor nature. In this present broadcast list, there is a cross reference idea employed for stations having two call letters. For example: KYW operates under another call known as KFKX. In the list KYW carries all of the pertinent data relating to the station, whereas under the heading of KFKX there is a note referring the reader to KYW for further information.

Interest in television is still running at a high pitch, being particularly aroused now with the announcement of the formation of a company to take over the Jenkins patents and to put the Jenkins scanner on the market. In addition to that, the company is rushing the completion of a 5000 watt transmitter, which should insure a very strong signal to all parts of the country, so that television enthusiasts should have no trouble in the future in getting excellent images from this station.

The Editor.

Copyright, 1929, by Citizens Radio Service Bureau, Incorporated, Publishers. Requests for permission to reprint any articles or other matter contained herein must be made in writing to the executive offices.

Citizens Radio Call Book Magazine is published four times a year and is on sale approximately the first of January, March, September and November. Subscription price \$1.75 per year in U. S. A. Canada and Foreign \$2.00 per year, payable in advance. Single copies 50 cents. Remit by check, draft or P. O. order. No foreign stamps or coins accepted. Mail subscriptions to 508 So. Dearborn Street, Chicago. We will not be responsible for cash sent for subscriptions unless registered.

Citizens Radio Call Book Magazine is for sale on all newsstands in the United States and Canada; also Department Stores and Book Stores; also can be purchased in most radio stores. Paris, France, Brentanos, Ave de L'Opera. England, R. A. Rothermel, Ltd., 24-26 Maddox St., Regent St., London, and W. H. Smith & Sons, London. Australia, McGills Agency, 179 Elizabeth St., Melbourne.

Advertising Representatives:

Chicago—A. B. Mills, 508 So. Dearborn St. Wabash 1901.
New York—(Branch Office)—154 W. 42nd St. Longacre 1063.

Entered as second class matter November 15, 1928, at the Postoffice at Chicago, Illinois, under the act of March 3, 1879



Reap Big Dividends from this Investment in Tone Quality

A Thordarson Power Amplifier (Home Constructed) Will Transform Your Radio Into a Real Musical Instrument

WITH the insistent demand for quality reproduction, power amplification has become a vital radio necessity. Today, it is hard to find a radio set manufacturer who does not employ one or more power tubes in the output stage of his receiver.

There is no need, however, for you to discard your present radio instrument in spite of the fact that it is out-classed by newer models with power amplification. You can build a Thordarson Power Amplifier which, attached to your receiver, will provide a fullness and richness of reproduction that will equal or surpass the finest offerings of the present season.

Thordarson Power Amplifiers are exceedingly easy to assemble, even for the man with no previous radio experience. Only the simplest tools are used. Specific instructions with clear-cut photographs, layouts and diagrams insure success in home construction.

Whether your present receiver is factory made or custom built one of these amplifiers may be attached with equal ease. In fact, most Thordarson Amplifiers require absolutely no changes in

the wiring of the receiver itself, attachment being made by means of a special plug which fits the last audio socket of the receiver.

Thordarson Power Amplifiers for the home constructor and professional set builder range from the simple plate supply unit up to the heavy-duty three stage units employing the 250 type power tube in push-pull arrangement. These power amplifiers cover the requirements for every purpose and every pocket-book. They may be used with any type of horn, cone or dynamic speaker.

With a background of over thirty-three years manufacturing quality transformers, it is only natural that so many manufacturers of receiving sets of undisputed superiority have turned to Thordarson as the logical source of their audio and power supply transformers. The discriminating home constructor will do well to follow the lead of these manufacturers when buying his power amplifier.

Write to the factory today, enclosing 25c for the new "Power Amplifier Manual"—just off the press.

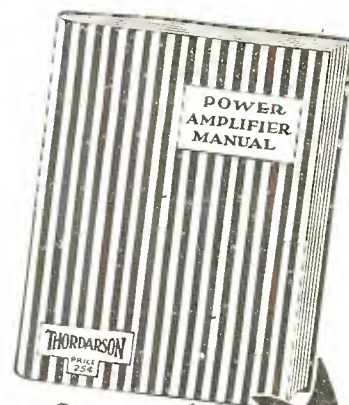

New!

No Amateur or Professional Set Builder Should Be Without This Book—

"POWER AMPLIFIER MANUAL"

A simple, yet complete, treatise on the subject of audio and power amplification, including full information on building, servicing, and testing power amplifiers in general. Also contains detailed specific construction data on twelve individual power units, with clear-cut layouts and diagrams of each.

25c

Send 25c in Cash or Stamps for This New Book—
Just Off the Press!

MAIL THIS COUPON TO-DAY!

THORDARSON ELECTRIC MANUFACTURING CO.
500 West Huron Street, Chicago, Illinois

Gentlemen: Please send me your new "Power Amplifier Manual" for which I am enclosing 25c.

Please send me free of charge your instruction sheet on the amplifier I have checked below:

171 Single 171 Push-Pull 210 Single 210 Push-Pull (1 Stage) 210 Push-Pull (2 Stage) 250 Single (1 Stage) 250 Single (2 Stage) 250 Push-Pull (3 Stage) 210 Phonograph Amplifier

Name.....

Street and No.....

Town..... State.....

3586 A

THORDARSON RADIO TRANSFORMERS

SUPREME IN MUSICAL PERFORMANCE

Tell 'Em You Saw It in the Citizens Radio Call Book Magazine and Scientific Digest

American Broadcasting Stations

Station assignments shown in the following pages became effective November 11th, allocations having been made by the Federal Radio Commission. This list is revised from issue to issue in accordance with such reallocations as the Commission may make.



Initials such as E, C, M, and P denote Eastern, Central, Mountain and Pacific time. No wavelength is given in this list, but frequency is stated, which is the new method of designation recommended by the Federal Radio Commission.



KDKA

980 kc, East Pittsburgh, Pa., Westinghouse E. & M. Co., 50,000 w. E.

KDLR

1210 kc, Devils Lake, N. D., Radio Electric Co., 100 w.

KDYL

1290 kc, Salt Lake City, Utah, Intermountain Broadcasting Corp., 1000 w, M, "On the Air, Goes Everywhere." Shared.

KEJK

1250 kc, Beverly Hills, Calif., R. C. MacMillan, 500 w, P, Shared.

KELW

780 kc, Burbank, Calif., Earl L. White, 500 w, P, "The White Spot of the San Fernando Valley." Shared.

KEX

1180 kc, Portland, Ore., Western Broadcasting Co., 5000 w, P, "A Public Service Necessity." Shared.

KFAB

770 kc, Lincoln, Neb., Nebraska Buick Automobile Co., 5000 w, C, "Home, Sweet Home." Shared.

KFAD

620 kc, Phoenix, Ariz., Electric Equipment Co., 500 w, M, "Phoenix, Where Winter Never Comes."

KFBB

1360 kc, Havre, Mont., F. A. Buttrey Co., 250 w, M.

KFBK

1310 kc, Sacramento, Calif., Kimball-Upson Co., 100 w, P.

KFBL

1370 kc, Everett, Wash., Leese Bros., 50 w, P, "The Voice of Puget Sound." Shared.

KFBU

600 kc, Laramie, Wyo., Bishop N. S. Thomas, 500 w, M, "The Top of the World."

KFCB

1310 kc, Phoenix, Ariz., Nielsen Radio Supply Co., 100 w, M, "Kind Friends Come Back."

KFCR

1500 kc, Santa Barbara, Calif., Santa Barbara Broadcasting Co., 100 w, P.

KFDM

560 kc, Beaumont, Tex., Magnolia Petroleum Co., 500 w, C, "Kall for Dependable Magnolene." Shared.

KFDX

1210 kc, Shreveport, Pa., First Baptist Church, 100 w, C, Shared.

KFDY

550 kc, Brookings, S. D., State College, 500 w, C, Shared.

KFEC

1370 kc, Portland, Ore., Meier & Frank Co., 100 w, P, "Known for Every Courtesy." Shared.

KFEL

940 kc, Denver, Col., Eugene P. O'Fallon, Inc., 250 w, M, "The Argonaut Station." Shared.

KFEQ

560 kc, St. Joseph, Mo., Scroggin & Co., 2500 w, C, Shared.

KFEY

1210 kc, Kellogg, Idaho, Union High School, 10 w, P, "The Voice of the Coeur d'Alenes."

KFGQ

1310 kc, Boone, Iowa, Boone Biblical College, 10 w, C.

KFH

1300 kc, Wichita, Kan., Hotel Lassen, 1000 w, C, "Kansas' Finest Hotel, in the Very Heart of God's Country." Shared.

KFHA

1200 kc, Gunnison, Colo., Western St. College of Colorado, 50 w.

KFI

640 kc, Los Angeles, Calif., Earl C. Anthony, Inc., 5000 w, P, "National Institution."

KFIF

1420 kc, Portland, Ore., Benson Polytechnic School, 50 w, P.

KFIO

1230 kc, Spokane, Wash., North Central High School, 100 w day, P.

KFIU

1310 kc, Juneau, Alaska, Alaska Electric Light & Power Co., 10 w, "A Voice From the Far North."

KFIW

940 kc, Hopkinsville, Ky., The Acme Mills, Inc., 1000 w, C.

KFIZ

1420 kc, Fond du Lac, Wisc., Fond du Lac Commonwealth Reporter, 100 w, C.

KFJB

1200 kc, Marshalltown, Iowa, Marshall Electric Co., 100 w, C, "Marshalltown, the Heart of Iowa."

KJFF

1470 kc, Oklahoma City, Okla., National Radio Mfg. Co., 5000 w, C, "Radio Headquarters of Oklahoma." Shared.

KFJI

1370 kc, Astoria, Ore., Geo. Kincaid, 50 w, P, Shared.

KFJM

550 kc, Grand Forks, N. D., University of North Dakota, 500 w, C, Shared.

KFJR

1300 kc, Portland, Ore., Ashley C. Dixon & Son, 500 w, P, Shared.

KFJY

1310 kc, Ft. Dodge, Iowa, C. S. Tunwal, 100 w, C, Shared.

KFJZ

1370 kc, Ft. Worth, Texas, Henry Clay Allison, 100 w, C.

KFKA

880 kc, Greeley, Colo., Colorado State Teachers College, 500 w, M, Shared.

KFKB

1130 kc, Milford, Kan., KFKB Broadcasting Ass'n, 5000 w, C, "The Sunshine Station in the Heart of the Nation."

KFKU

1220 kc, Lawrence, Kan., University of Kansas, 1000 w, C, "Up at Lawrence on the Kaw." Shared.

KFKX

See under KYW.

KFKZ

1200 kc, Kirksville, Mo., Northeast Missouri State Teachers College, 50 w, C, "Kirksville, the Home of Osteopathy."

KFLV

1410 kc, Rockford, Ill., A. T. Frykman, 500 w, C.

KFLX

1370 kc, Galveston, Texas, Geo. Roy Clough, 100 w, C.

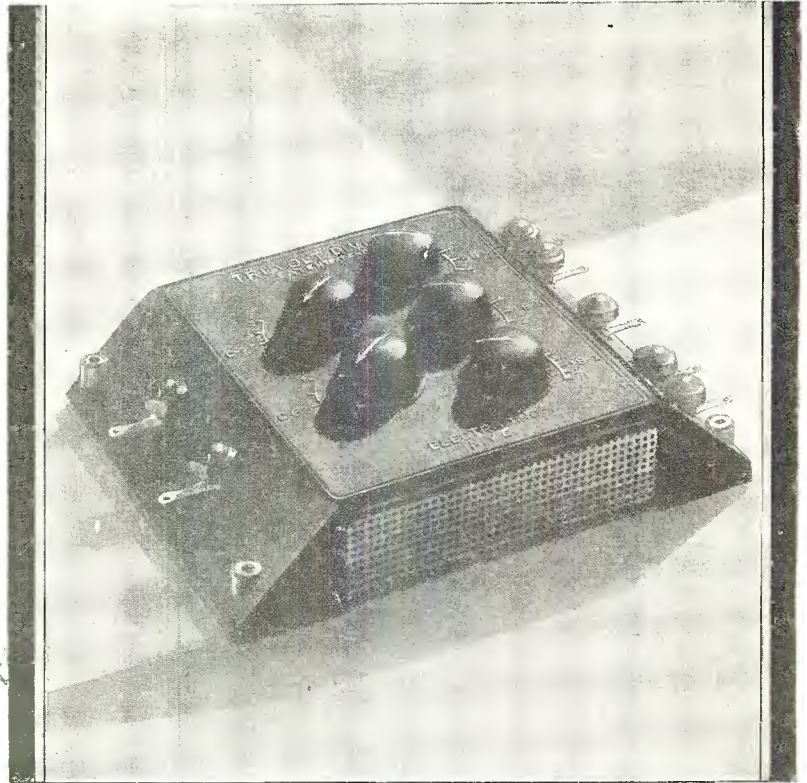

TRUVOLT

DIVIDER *Correct Voltage*

A NOTABLE advance in the control of filtered voltage — the new Electrad TRUVOLT Divider combines in one compact unit, variable, wire-wound resistances with handy knobs that regulate desired voltage for any receiver using up to twelve tubes.

Think of the trouble it saves! No guessing—no complicated mathematical calculations—no voltage-regulating tubes—no fixed resistances of uncertain value—no superfluous wiring.

The knob settings have been calibrated in the Electrad laboratories to give exact voltage wanted from any type battery eliminator — plus a smooth, graduated control for any in-between value.

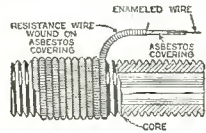

Electrad Wire-wound Resistances are superior in principle and workmanship. They last longer, give more accurate voltages and smoother operation.

WHERE you want it
WHEN you want it
HOW you want it!

A handsome molded Bakelite, ventilated case that can be mounted on the base or sub-panel, or used as the front panel of your eliminator. Easily accessible input and output terminals. Three "B"

voltage regulator-knobs and two for "C" bias. Price \$12.50 at your Dealers.

Mail the coupon for TRUVOLT DIVIDER Manual and other Power-Pack information.

ELECTRAD

ELECTRAD, Inc., Dept. EA-1, 175 Varick Street, New York

Send me free copy of TRUVOLT DIVIDER MANUAL and other Electrad Voltage-Control Data

Name _____
 Street _____
 City _____ State _____

Tell 'Em You Saw It in the Citizens Radio Call Book Magazine and Scientific Digest

KFMX

1250 kc, Northfield, Minn., Carleton College, 1000 w, C. Shared.

KFNF

890 kc, Shenandoah, Iowa, Henry Field Seed Co., 500 w, C, "Known for Neighborly Folks." Shared.

KFON

1250 kc, Long Beach, Calif., Nichols & Warriner, Inc., 1000 w, P, "Where Your Ship Comes In." Shared.

KFOR

1210 kc, Lincoln, Neb., Howard A. Shuman, 100 w, C.

KFPL

1310 kc, Dublin, Texas, C. C. Baxter, 15 w, C, "Baxter's Place."

KFPM

1310 kc, Greenville, Texas, The New Furniture Co., 15 w, C, "Biggest Little Ten Watts on the Air."

KFPW

1340 kc, Siloan Springs, Ark., Rev. Lannie W. Stewart, 50 w.

KFPY

1390 kc, Spokane, Wash., Symons Investment Co., 500 w, P.

KFQA

See under KMOX.

KFQB

1240 kc, Ft. Worth, Texas, W. B. Fishburn, Inc., 1000 w, C. Shared.

KFQD

1230 kc, Anchorage, Alaska, Anchorage Radio Club, 100 w. Shared.

KFQU

1420 kc, Holy City, Calif., W. E. Riker, 100 w, P. Shared.

KFQW

1420 kc, Seattle, Wash., KFQW, Inc., 100 w, P. "Gateway to Alaska and the Orient." Shared.

KFQZ

850 kc, Hollywood, Calif., Taft Radio & Broadcasting Co., Inc., 1000 w, P.

KFRC

610 kc, San Francisco, Calif., Don Lee, Inc., 1000 w, P.

KFRU

630 kc, Columbia, Mo., Stephens College, 500 w, C, "Where Friendliness is Broadcast Daily." Shared.

KFSD

600 kc, San Diego, Calif., Airfan Radio Corp., 500 w, P.

KFSG

1120 kc, Los Angeles, Calif., Echo Park Evan. Assn., 500 w, P, "The Church of the Air."

KFUL

1290 kc, Galveston, Texas, W. H. Ford, 500 w, C, "The City of Perpetual Sunshine."

KFUM

1270 kc, Colorado Springs, Colo., W. D. Corley, 1000 w, M, "Known for Unsurpassed Mountain Scenery." Shared.

KFUO

550 kc, St. Louis, Mo., Concordia Theological Seminary, 500 w, C, "The Gospel Voice." Shared.

KFUP

1310 kc, Denver, Colo., Fitzsimmons General Hospital, 100 w, M.

KFUR

1370 kc, Ogden, Utah, Peery Building Co., 50 w, M.

KFVD

700 kc, Culver City, Calif., W. J. McWhinnie, 250 w, P.

KFVS

1210 kc, Cape Girardeau, Mo., Hirsch Battery & Radio Co., 100 w, C, "The City of Opportunity." Shared.

KFWB

950 kc, Los Angeles, Calif., Warner Bros. Broadcasting, 1000 w, P. Shared.

KFWC

1200 kc, Ontario, Calif., J. R. Fouché, 100 w, P, "The Voice of the Orange Empire." Shared.

KFWF

1200 kc, St. Louis, Mo., St. Louis Truth Center, Inc., 100 w. Shared.

KFWI

930 kc, San Francisco, Calif., Radio Entertainments, Inc., 500 w, P. Shared.

KFWM

930 kc, Oakland, Calif., Oakland Educational Society, 500 w, P, "The Most Good to the Most People." Shared.

KFXD

1420 kc, Jerome, Idaho, Service Radio Co., 50 w, M.

KFXF

940 kc, Denver, Colo., Pikes Peak Broadcasting Co., 250 w, M. "The Voice of Denver." Shared.

KFXJ

1310 kc, Edgewater, Colo., R. G. Howell, 50 w, M, "America's Scenic Center." Shared.

KFXR

1310 kc, Oklahoma City, Okla., Exchange Avenue Baptist Church, 100 w, C.

KFXY

1420 kc, Flagstaff, Ariz., Mary M. Costigan, 100 w, M.

KFYO

1420 kc, Breckenridge, Texas, Kirksey Bros. Battery & Elec. Co., 100 w, C, "Breckenridge, the Dynamo of West Texas."

KFYR

550 kc, Bismarck, N. D., Hoskins-Meyer, 500 w, C. Shared.

KGA

1470 kc, Spokane, Wash., Northwest Radio Service Co., 5000 w, P.

KGAR

1370 kc, Tucson, Ariz., Citizen's Publishing Co., 100 w, M. "Way Out on the Desert."

KGB

1360 kc, San Diego, Calif., Pickwick Broadcasting Corp., 250 w, P, "Music for the Sick."

KGBU

900 kc, Ketchikan, Alaska, Alaska Radio & Service Co., 500 w. Shared.

KGBX

1370 kc, St. Joseph, Mo., Foster-Hall Tire Co., 100 w.

KGBZ

930 kc, York, Nebr., Geo. R. Miller, 500 w, C. "The Swine and Poultry Station." Shared.

KGCA

1270 kc, Decorah, Iowa, Chas. W. Greenley, 50 w, C. Shared.

KGCB

1370 kc, Enid, Okla., Wallace Radio Inst., 100 w, C.

KGCI

1370 kc, San Antonio, Texas, Liberto Radio Sales, 100 w, C, "Radio Sam at San Antonio."

KGCM

1420 kc, Concordia, Kan., Concordia Broadcasting Co., 50 w.

KGCR

1210 kc, Brookings, S. D., Cutler's Radio Broadcasting Service, Inc., 100 w.

KGCU

1200 kc, Mandan, N. D., Mandan Radio Association, 100 w, M, "The Voice of the West."

KGCV

1420 kc, Vida, Mont., First State Bank of Vida, 10 w, M.

KGDA

1370 kc, Dell Rapids, S. D., Home Auto Co., 15 w.

KGDE

1200 kc, Barrett, Minn., Jaren Drug Co., 50 w, C.

KGDM

1150 kc, Stockton, Calif., E. F. Pepper, 50 w.

KGDP

1210 kc, Pueblo, Colo., Boy Scouts of America, 10 w, M.

KGDR

1500 kc, San Antonio, Texas, Joe B. McChane, 100 w, C.

KGDY

1200 kc, Oldham, S. Dak., J. Albert Loesch, 15 w, C.

KGEF

1300 kc, Los Angeles, Calif., Trinity Methodist Church, 1000 w, P. Shared.

KGEK

1200 kc, Yuma, Colo., Bechler Elec. Equip. Co., 50 w, M. Shared.

KGER

1370 kc, Long Beach, Calif., C. Marwin Dobyns, 100 w, P, "The Service Club of the Air."



Clear Silver Tones

*straight from the
microphone to you!*

On The Air 52

sparkling, tuneful, wonderfully entertaining broadcast programs, featuring the music you like to hear played the way you like to hear it.

Over WOR and the Columbia Broadcast Chain of 20 stations every Monday evening at 8:30 Eastern Time; 7:30 Central Time.

THERE is a quality in CeCo Tubes that is rarely encountered in any other tube—a clearness, roundness, naturalness of tone that gives any type of radio reception a new beauty.

Only the finest materials, painstakingly employed by skillful craftsmen—the ablest direction of trained laboratory experts, could make such performance possible.

And yet CeCo Tubes (and there is one for every radio need) cost no more and last longer.

Ask for our booklet "Getting the most out of your Radio"

CeCo MFG. CO., Inc. . . . Providence, R. I.

- KGEW**
1200 kc, Ft. Morgan, Colo., City of Ft. Morgan, 100 w, P. Shared.
- KGEZ**
1310 kc, Kalispell, Mont., Flathead Broadcasting Association, 100 w, M. "Located in the Switzerland of America—The Beautiful Flathead Valley."
- KGFF**
1420 kc, Alva, Okla., Earl E. Hampshire, 100 w, C.
- KGFG**
1370 kc, Oklahoma City, Okla., Faith Tabernacle Assn., 100 w, C. "The Whole Gospel to the Whole World."
- KGFH**
1000 kc, Glendale, Calif., Frederick Robinson, 250 w, P.
- KGFI**
1310 kc, San Angelo, Texas, San Angelo Broadcasting Co., 100 w, C. "The Voice of West Texas."
- KGFJ**
1420 kc, Los Angeles, Calif., Ben S. McGlashan, 100 w, P. "Keeps Good Folks Joyful"
- KGFK**
1200 kc, Hallock, Minn., Kittson County Enterprise, 50 w, C.
- KGFL**
1370 kc, Raton, N. Mex., L. A. Hubbard, 50 w, M.
- KGFW**
1420 kc, Ravenna, Neb., Otto F. Sothman, 50 w.
- KGFX**
580 kc, Pierre, S. D., Dana McNeil, 200 w daytime, C.
- KGGF**
1010 kc, Picher, Okla., D. L. Council, M.D., 500 w, Shared.
- KGGH**
1310 kc, Cedar Grove, La., Bates Radio & Electric Co., 50 w, C.
- KGGM**
1370 kc, Albuquerque, N. Mex., Jay Peters, 100 w.
- KGHA**
1200 kc, Pueblo, Colo., Geo. H. Sweeney, 50 w, M.
- KGHB**
1320 kc, Honolulu, Hawaii, Radio Sales, 250 w.
- KGHD**
1420 kc, Missoula, Mont., Elmore-Nash Broadcasting Co., 50 w, M.
- KGHF**
1320 kc, Pueblo, Colo., Ritchie & Finch, 250 w, M.
- KGHG**
1310 kc, McGehee, Ark., Chas. W. McCollum, 50 w.
- KGHI**
1500 kc, Little Rock, Ark., Berean Bible Class, 100 w.
- KGHL**
950 kc, Billings, Mont., Northwestern Auto Supply Co., 500 w, M.
- KGHZ**
1500 kc, Richmond, Tex., Ft. Bend County School Board, 50 w, C.
- KGIO**
1320 kc, Idaho Falls, Ida., Jack W. Duckworth, Jr., 250 w, M. Shared.
- KGIQ**
1320 kc, Twin Falls, Ida., Stanley M. Soule, 250 w, M. Shared.
- KGIR**
1360 kc, Butte, Mont., Symons Broadcasting Co., 250 w, M. Shared.
- KGIW**
1420 kc, Trinidad, Colo., Trinidad Creamery Co., 100 w, M.
- KGJF**
890 kc, Little Rock, Ark., First Church of the Nazarene, 250 w.
- KGKB**
1500 kc, Goldthwaite, Tex., Eagle Publ. Co., 100 w, C.
- KGKL**
1370 kc, Georgetown, Tex., M. L. Cates, 100 w, C.
- KGKO**
570 kc, Wichita Falls, Tex., Wichita Falls Broadcasting Co., 250 w, C.
- KGQ**
790 kc, Oakland, Calif., General Electric Co., 10,000 w, P.
- KGRC**
1370 kc, San Antonio, Texas, Gene Roth & Co., 100 w, C.
- KGRS**
1410 kc, Amarillo, Texas, Gish Radio Service, 1000 w, C. Shared.
- KGTT**
1420 kc, San Francisco, Calif., Glad Tidings Temple, 50 w, P. "Voice of Glad Tidings." Shared.
- KGU**
940 kc, Honolulu, Hawaii, Marion Mulrony, 500 w. "In the Land of Sunshine, the Future Playground of America."
- KGW**
620 kc, Portland, Ore., Oregonian Pub. Co., 1000 w, P. "Keep Growing Wiser."
- KGXX**
1420 kc, Sandpoint, Idaho, C. E. Twiss, 15 w, P.
- KG Y**
1200 kc, Lacey, Wash., St. Martins College, 10 w, P. "Out Where the Cedars Meet the Sea." Shared.
- KHJ**
900 kc, Los Angeles, Calif., Don Lee, Inc., 1000 w, P. "Kindness, Happiness, Joy."
- KHQ**
590 kc, Spokane, Wash., Louis Wasmer, Inc., 1000 w, P. "In the Friendly City."
- KICK**
1420 kc, Red Oak, Iowa, Atlantic Automobile Co., 100 w daytime. Shared.
- KIDO**
1250 kc, Boise, Idaho, F. L. Hill & C. G. Phillips, 1000 w, P.
- KJBS**
1100 kc, San Francisco, Calif., Julius Brunton & Sons Co., 100 w, P. "The Voice of the Storage Battery." Shared.
- KJR**
970 kc, Seattle, Wash., Northwest Radio Service Co., 5000 w, P.
- KKP**
1370 kc, Seattle, Wash., City of Seattle, 15 w, P. Shared.
- KLCN**
1290 kc, Blytheville, Ark., Daily Courier-News, 50 w, C.
- KLDS**
See under KMBC.
- KLRA**
1390 kc, Little Rock, Ark., Arkansas Broadcasting Co., 1000 w. Shared.
- KLS**
1440 kc, Oakland, Calif., Warner Bros., 250 w, P. "The City of Golden Opportunity." Shared.
- KLX**
880 kc, Oakland, Calif., Tribune Pub. Co., 500 w, P. "Where Rail and Water Meet." Shared.
- KLZ**
560 kc, Dupont, Colo., Reynolds Radio Co., Inc., 1000 w, M. "The Pioneer Station of the West."
- KMA**
930 kc, Shenandoah, Iowa, May Seed & Nursery Co., 500 w, C. "Keeps Millions Advised." Shared.
- KMBC**
950 kc, Independence, Mo., Midland Broadcasting Co., 500 w, C. "The Station Dedicated to Knowledge, Liberty, Divinity and Service." Shared.
- KMED**
1420 kc, Medford, Ore., W. J. Virgin, 50 w, P. "See Crater Lake."
- KMIC**
1120 kc, Inglewood, Calif., James R. Fouch, 500 w, P.
- KMJ**
1200 kc, Fresno, Calif., The Fresno Bee, 100 w, P.
- KMMJ**
740 kc, Clay Center, Neb., The M. M. Johnson Co., 1000 w daytime, C. "The Old Trusty Station."
- KMO**
1340 kc, Tacoma, Wash., KMO, Inc., 500 w, P. Shared.
- KMOX**
1090 kc, Kirkwood, Mo., Voice of St. Louis, Inc., 5000 w, C.
- KMTR**
570 kc, Hollywood, Calif., KMTR Radio Corp., 1000 w, P. "Your Friend in Hollywood." Shared.
- KNX**
1050 kc, Hollywood, Calif., Western Broadcast Co., 5000 w, P. "The Voice of Hollywood."

Startling Price Reductions

On Everything In RADIO

Buy Now!

Allied has cut prices to the bone—your big profits in radio can now be bigger—no need to wait any longer. This new low level of prices places before you the season's outstanding values.



Brand New Catalog for 1929

A pre-inventory sale that is featuring some of the most drastic price reductions known to radio. Everything in our tremendous stock is offered in this sale—and this large new catalog has been prepared to bring before you this tremendous array of radio values.

Every branch of the radio industry is represented—appealing to set builders interested in parts and kits—to dealers interested in the new sets and modern accessories—as well as agents who are interested in tying up with one of the season's most successful lines of A. C. and D. C. receivers.

Wholesale Prices

Selling as we do on an exclusively wholesale basis, the prices we now offer you are establishing new standards in radio values—new A. C. sets as low as \$32.95—attractively designed consoles for as low as \$16.25. Corresponding values are offered in kits, parts and accessories in nationally-advertised, quality merchandise—the products of the country's foremost radio manufacturers.

**The Catalog is Free
Send for Your Copy Now**

Knight Receivers for A. C. and D. C. operation have established an enviable record for performance. See them in this new large catalog.

Allied Radio

CORPORATION

711 W. LAKE ST. Dept. C-2 CHICAGO

KOA

830 kc, Denver, Colo., General Electric Co., 12,500 w, M.

KOAC

560 kc, Corvallis, Ore., Oregon State Agricultural College, 1000 w, P, "Science for Service." Shared.

KOB

1180 kc, State College, N. M., N. M. College of Agri. & Mech. Arts, 10,000 w, M, "The Sunshine State of America." Shared.

KOCW

1420 kc, Chickasha, Okla., Chickasha Broadcasting Co., 100 w, C.

KOH

1370 kc, Reno, Nevada, Jay Peters, Inc., 100 w.

KOIL

1260 kc, Council Bluffs, Iowa, Mona Motor Oil Co., 1000 w, C, "The Hilltop Studio."

KOIN

940 kc, Portland, Ore., KOIN, Inc., 1000 w, P, "The Station of the Hour."

KOL

1270 kc, Seattle, Wash., Rhodes Department Store, 1000 w, P, Shared.

KOMO

920 kc, Seattle, Wash., Fisher's Blend Station, Inc., 1000 w, P.

KOOS

1370 kc, Marshfield, Ore., H. H. Hanseth, 50 w, P.

KORE

1420 kc, Eugene, Ore., Eugene Broadcast Station, 100 w, P.

KOW

1390 kc, Denver, Colo., Associated Industries, Inc., 500 w, M, "The KOW Station Away Out West." Shared.

KPCB

1210 kc, Seattle, Wash., Pacific Coast Biscuit Co., 100 w, P, Shared.

KPJM

1500 kc, Prescott, Ariz., Frank Wilburn, 100 w, M.

KPLA

570 kc, Los Angeles, Calif., Pacific Development Radio Co., 1000 w, P, Shared.

KPO

680 kc, San Francisco, Calif., Hale Bros. & The Chronicle, 5000 w, P, "The City of the Golden Gate."

KPOF

880 kc, Denver, Colo., Pillar of Fire, Inc., 500 w, M, Shared.

KPPC

1200 kc, Pasadena, Calif., Pasadena Presbyterian Church, 50 w, P, Shared.

KPQ

1210 kc, Seattle, Wash., Archie Taft & Louis Wasmer, 100 w, P.

KPRC

920 kc, Houston, Texas, Houston Printing Co., 1000 w, C, "Kotton Port Rail Center." Shared.

KPSN

950 kc, Pasadena, Calif., Pasadena Star-News, 1000 w, P, Shared.

KQV

1380 kc, Pittsburgh, Pa., Doubleday-Hill Elec. Co., 500 w, E, "The Smoky City Station." Shared.

KQW

1010 kc, San Jose, Calif., First Baptist Church, 500 w, P, "For God and Country."

KRE

1370 kc, Berkeley, Calif., First Congregational Church, 100 w, P, Shared.

KRGV

1260 kc, Harlingen, Texas, Harlingen Music Co., 500 w, Shared.

KRLD

1040 kc, Dallas, Texas, KRLD, Inc., 10,000 w, C, "Down Where the Blue Bonnets Grow." Shared.

KRMD

1310 kc, Shreveport, La., Robert M. Dean, 50 w, shared, C.

KRSC

1120 kc, Seattle, Wash., Radio Sales Corp., 50 w daytime, P.

KSAC

580 kc, Manhattan, Kan., Kansas State Agricultural College, 500 w, C, Shared.

KSBA

1450 kc, Shreveport, La., W. G. Patterson, 1000 w, C, "Keep Shreveport Before America."

KSCJ

1330 kc, Sioux City, Iowa, Perkins Bros. Co., 1000 w, C, Shared.

KSD

550 kc, St. Louis, Mo., Pulitzer Pub. Co., 500 w, C, Shared.

KSEI

900 kc, Pocatello, Idaho, KSEI Broadcasting Assn., 250 w, M, "Kummunity Southeast Idaho."

KSL

1130 kc, Salt Lake City, Utah, Radio Service Corp., 5000 w, M, "The Voice of the Intermountain Empire."

KSMR

1200 kc, Santa Maria, Calif., Santa Maria Valley R. R. Co., 100 w, P, "The Valley of Gardens."

KSO

1380 kc, Clarinda, Iowa, Berry Seed Co., 1000 w, C, "Keep Serving Others."

KSOO

1110 kc, Sioux Falls, S. D., Sioux Falls Broadcasting Assn., 1000 w daytime, C.

KSTP

1460 kc, Westcott, Minn., National Battery Broadcasting Co., 10,000 w, C.

KTAB

550 kc, Oakland, Calif., Associated Broadcasters, 500 w, P, "Knowledge, Truth and Beauty." Shared.

KTAP

1420 kc, San Antonio, Texas, Robert B. Bridge, 100 w, C, "The World's Biggest Little Station."

KTBI

1300 kc, Los Angeles, Calif., Bible Institute of Los Angeles, 1000 w, P, Shared.

KTBR

1300 kc, Portland, Ore., M. E. Brown, 500 w, P, Shared.

KTHS

800 kc, Hot Springs, Ark., Chamber of Commerce, 5000 w, C, "Kum to Hot Springs." Shared.

KTM

780 kc, Santa Monica, Calif., Pickwick Broadcasting Corp., 500 w, P, "The Station with a Smile." Shared.

KTNT

1170 kc, Muscatine, Iowa, Norman Baker, 5000 w, C, "The Voice of the Iowa Farmers' Union." Shared.

KTSA

1290 kc, San Antonio, Texas, Lone Star Broadcast Co., 1000 w, C.

KTUE

1420 kc, Houston, Texas, Uhalt Electric, 5 w, C.

KTW

1270 kc, Seattle, Wash., First Presbyterian Church, 1000 w, P, Shared.

KUJ

1500 kc, Longview, Wash., F. W. Lovejoy & R. W. Kerfoot, 10 w, P, Shared.

KUOA

1390 kc, Fayetteville, Ark., University of Arkansas, 1000 w, C, Shared.

KUOM

570 kc, Missoula, Mont., State University of Montana, 500 w, M.

KUSD

890 kc, Vermilion, S. Dak., University of South Dakota, 500 w, C, Shared.

KUT

1120 kc, Austin, Texas, University of Texas, 500 w, C, "Come to University of Texas." Shared.

KVI

1340 kc, Tacoma, Wash., Puget Sound Radio Broadcasting Co., 1000 w, P, "Puget Sound Station." Shared.

KVL

1370 kc, Seattle, Wash., Arthur C. Bailey, 100 w, Shared.

KVOO

1140 kc, Tulsa, Okla., Southwestern Sales Corp., 5000 w, C, "The Voice of Oklahoma." Shared.

KVOS

1200 kc, Bellingham, Wash., L. Kessler, 100 w, M, Shared.

KWBS

1500 kc, Portland, Ore., Schaeffer Radio Co., 15 w, P.

KWCR

1310 kc, Cedar Rapids, Iowa, Harry F. Paar, 100 w, Shared.

KWEA

1210 kc, Shreveport, La., William E. Antony, 100 w, C, Shared.

KWG

1200 kc, Stockton, Calif., Portable Wireless Tel. Co., 100 w, P, Shared.

KWJJ

P, "The Voice from Broadway."
1060 kc, Portland, Ore., Wilbur Jerman, 500 w,

KFI

**IN A STEEL BAN () JILD NG
ON A
10 FT. ANTENNA
WITH
TREMENDOUS VOLUME!**

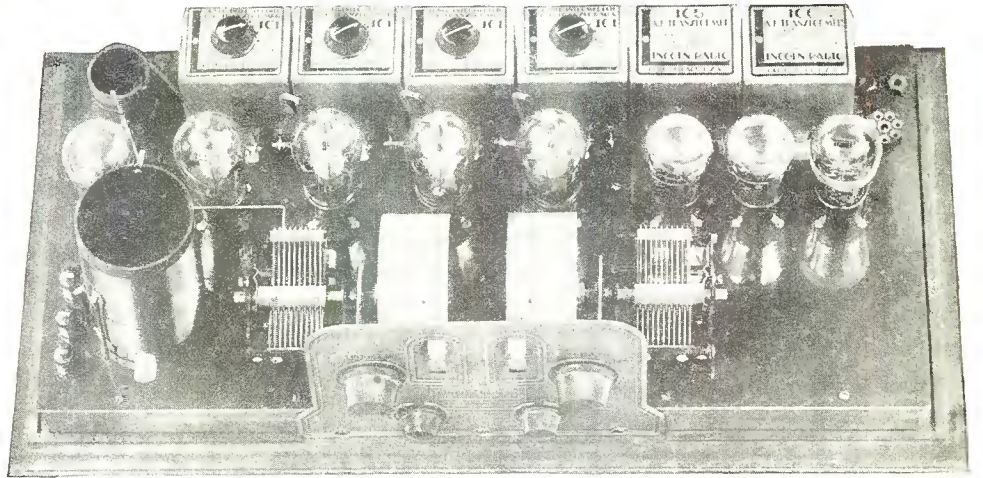

That's the Performance of the Lincoln 8-80 in the Heart of Chicago

Set Builders report: Telegram, Nov. 28th—"JAPANESE STATIONS RECEIVED ON LINCOLN SUPER JOAK, JOIK, JOBK." TOKYO, JAPAN; SAPPORO, JAPAN; OSAKA, JAPAN; BROUGHT IN THROUGH THE MANY STATIONS AROUND 300 METERS.

"SIX PACIFIC COAST STATIONS WITHOUT ANTENNA OR GROUND."—From Illinois

"Being an ardent DX fan and having constructed and used practically all of the standard supers and tuned radio frequency outfits and having personally constructed and experimented with intermediate super transformers and equipment, I find the Lincoln 8-80 the best answer to all DX requirements. Only an experienced set builder can fully appreciate what it means to have solved for him such problems as having a proper means of matching an intermediate transformer to any tube's individual characteristics. Tone quality, simplicity of operation, the ease with which outside stations can be brought in and the fact that the price is within the range of all, make this the first set that I feel I could conscientiously recommend to everybody."

"75 stations logged before the new allocation of stations from a Chicago hotel, where 75 other receivers could not get out."

PRACTICALLY EVERY LINCOLN 8-80 OWNER REPORTS THIS WONDERFUL PERFORMANCE

NOT A SINGLE BUILDER HAS ASKED FOR HIS MONEY BACK OR WISHED TO RETURN HIS LINCOLN 8-80

A WORD TO THE CUSTOM SET BUILDERS

You can out-demonstrate, out-perform any competitive equipment in your territory. You can pull in station after station in every degree of the dial with perfect tone quality of your local station. All this without a squeal, and only using a small part of your available power, and at a price without competition. You can convince your customer in one short demonstration.

The price of complete kit for the Lincoln 8-80 is \$92.65.

Due to the new principles involved, every 8-80 works exactly alike, and you can get the same results as our finest laboratory model.

If you want an evening full of straight-from-the-shoulder super-heterodyne dope written by an engineer who has played with every super going in the last few years, send 25 cents for William H. Hollister's "Secret of the Super," using the coupon below.

LINCOLN ENGINEERING SERVICE ON STANDARD KITS

Order today for immediate shipment any of the following Lincoln-Guaranteed complete kits:

Sargent-Raymont Seven (S-M 710) kit.....	\$120.00	Tyrman 80—super	\$199.50
S-M 720 Screen Grid Six.....	72.50	Tyrman 72 receiver kit.....	98.50
S-M 720 Screen Grid Six—factory wired	102.00	Tyrman 72 AC, with power pack.....	153.50
1929 Laboratory Superheterodyne.....	95.70	H. F. L. Isotone 10-tube super.....	195.00

LINCOLN RADIO CORPORATION
329 SOUTH WOOD ST. ← CHICAGO - ILLINOIS.

Authorized Distributors for Lincoln 8-80
WESTERN RADIO MFG. CO.
 128 W. Lake St., Chicago
WALTER RDWAN CO.
 833 Washington St., Chicago
ELECTRIC & RADID SUPPLY
 22 N. Franklin St., Chicago
W. C. BRAUN CO.
 563 W. Randolph St., Chicago
CHICAGO RADID APPARATUS CO.
 415 S. Dearborn St., Chicago

LINCOLN RADIO CORP. (Dept. C)
 329 South Wood St., Chicago, Ill.
Send me your catalog, listing a complete line of 1929 kits for custom building.
Enclosed find 25c. for which send me William H. Hollister's new book "The Secret of the Super."

Authorized Distributors for Lincoln 8-80
RADIO SUPPLY COMPANY
 912 Broadway, Los Angeles
WHOLESALE RADIO SERVICE
 6 Church St., New York City
HDRACE HILLS
 200 Davis St., San Francisco
KLADAG RADID LABRATORIES
 Kline Bldg., Kent, Ohio
HENRY L. WALKER CO.
 27 E. Jefferson St., Detroit, Mich.

Name.....
 Address.....

KWK

1350 kc, St. Louis, Mo., Greater St. Louis Broadcasting Corp., 1000 w, C. Shared.

KWKC

1370 kc, Kansas City, Mo., Wilson Duncan Broadcasting Co., 100 w.

KWKH

850 kc, Kennonwood, La., W. K. Henderson, 20,000 w, C. Shared.

KWLC

1270 kc, Decorah, Iowa, Luther College, 50 w, C. Shared.

KWSC

1390 kc, Pullman, Wash., State College of Washington, 500 w, P, "The Voice of the Cougars." Shared.

KWTC

1500 kc, Santa Ana, Calif., Pacific Broadcasting Fed., 100 w, P, "Kum West to California." Shared.

KWWG

1260 kc, Brownsville, Texas, Chamber of Commerce, 500 w, C, "Good Night, World." Shared.

KXA

570 kc, Seattle, Wash., American Radio Tel. Co., 500 w, P. Shared.

KXL

1250 kc, Portland, Ore., KXL Broadcasters, Inc., 500 w, P, "The Voice of Portland." Shared.

KXO

1200 kc, El Centro, Calif., Irey & Bowles, 100 w, P.

KXRO

1420 kc, Aberdeen, Wash., KXRO, Inc., 75 w.

KYA

1230 kc, San Francisco, Calif., Pacific Broadcasting Corp., 1000 w, P.

KYW

1020 kc, Chicago, Ill., Westinghouse E. & M. Co., 5000 w, C.

KZM

1370 kc, Hayward, Calif., Leon P. Tenney, 100 w, P. Shared.

NAA

690 kc, 434.5 m, United States Navy Department, Washington, D. C., 1000 w, "Where the Time Signals Originate." E.

WAAD

1420 kc, Cincinnati, Ohio, Ohio Mechanic Institute, 25 w, E.

WAAF

920 kc, Chicago, Ill., Drivers Journal Pub. Co., 500 w daytime, C.

WAAM

1250 kc, Newark, N. J., WAAM, Inc., 500 w, E, "Sunshine Station."

WAAT

1070 kc, Jersey City, N. J., Bremer Broadcasting Corp., 300 w. Shared.

WAAW

660 kc, Omaha, Neb., Omaha Grain Exchange, 500 w daytime, C. "Pioneer Market Station of the West."

WABC

860 kc, New York City, N. Y., Atlantic Broadcasting Corp., 5000 w, E.

WABF

1440 kc, Kingston, Pa., Markle Broadcasting Corp., 250 w, E, "The Voice of Wyoming Valley." Shared.

WABI

1200 kc, Bangor, Maine, First Universalist Church, 100 w, E, "The Pine Tree Wave."

WABO

See under WHEC.

WABY

1310 kc, Philadelphia, Pa., J. Magaldi, Jr., 50 w.

WABZ

1200 kc, New Orleans, La., Coliseum Place Baptist Church, 100 w, C.

WADC

1320 kc, Akron, Ohio, Allen T. Simmons, 1000 w, E, shared, "Watch Akron Develop Commercially."

WAFD

1500 kc, Detroit, Mich., Albert B. Parfet Co., 100 w, E.

WAGM

1310 kc, Royal Oak, Mich., Robert L. Miller, 50 w, E.

WAIU

640 kc, Columbus, Ohio, American Insurance Union, 5000 w, E, shared, "The Radio Voice of the American Insurance Union."

WALK

1500 kc, Willow Grove, Pa., Albert A. Walker, 50 w, E.

WAPI

1140 kc, Auburn, Ala., Alabama Polytechnic Institute, 5000 w, C. Shared.

WASH

1270 kc, Grand Rapids, Mich., Baxter Laundries, Inc., 250 w, C. Shared.

WBAA

1400 kc, Lafayette, Ind., Purdue University, 500 w, C. Shared.

WBAK

1430 kc, Harrisburg, Pa., Pennsylvania State Police, 500 f, daytime, E, "The Voice of Pennsylvania."

WBAL

1060 kc, Baltimore, Md., Consolidated Gas, Elec. Co., 5000 w, E, shared, "The Station of Good Music."

WBAP

800 kc, Ft. Worth, Tex., Carter Publications, Inc., 50,000 w, C. Shared.

WBAW

1490 kc, Nashville, Tenn., Waldrum Drug Co., 5000 w, C. Shared.

WBAX

1210 kc, Wilkes-Barre, Pa., John H. Stenger, Jr., 100 w, E, "In Wyoming Valley. Home of the Anthracite."

WBBC

1400 kc, Brooklyn, N. Y., Brooklyn Broadcasting Corp., 250 w. Shared.

WBBL

1370 kc, Richmond, Va., Grace Covenant Presbyterian Church, 100 w, E, "Richmond, the Gateway North and South."

WBBM

770 kc, Chicago, Ill., Atlas Investment Co., 25,000 w, C.

WBBR

1300 kc, Rosville, N. Y., People's Pulpit Association, 1000 w, E, shared, "Watch Tower."

WBBW

1200 kc, Norfolk, Va., Ruffner Junior High School, 100 w, E.

WBBY

1200 kc, Charleston, S. C., Washington Light Infantry, 75 w, E, "The Seaport of the Southeast."

WBBZ

1200 kc, Ponca City, Okla., C. L. Carrell, 100 w, C.

WBCN

See under WENR.

WBET

1360 kc, Medford, Mass., Boston Transcript Co., 500 w, E. Shared.

WBIS

See under WNAC.

WBMH

1310 kc, Detroit, Mich., Braun's Music House, 100 w, E.

WBMJ

1500 kc, Wilkesburg, Pa., Rev. J. W. Sproul, 100, E.

WBMS

1450 kc, Union City, N. J., WBMS Broadcasting Corp., 250 w.

WBNY

1350 kc, New York, N. Y., Baruchrome Corp., 250 w, E, shared, "The Voice of the Heart of New York."

WBOQ

See under WABC.

WBOW

1310 kc, Terre Haute, Ind., Banks of Wabash Broadcasting Assn., 100 w, C. "On the Banks of the Wabash."

WBRC

930 kc, Birmingham, Ala., Birmingham Broadcasting Co., 500 w, C, "The Biggest Little Station in the World."

WBRE

1310 kc, Wilkes-Barre, Pa., Louis G. Baltimore, 100 w, E.

WBRL

1430 kc, Tilton, N. H., Booth Radio Laboratories, 500 w, E. Shared.

WBSO

780 kc, Wellesley Hills, Mass., Babson's Statistical Org., Inc., 100 w, daytime, E.

WBT

1080 kc, Charlotte, N. C., C. C. Coddington, 10,000 w, E, shared, "The Queen City of the South."

WBZ

990 kc, East Springfield, Mass., Westinghouse E. & M. Co., 15,000 w, E, shared, "The Broadcasting Station of New England."

The phantoms of music now become REALITY!



INSTRUMENTS—golden notes—formerly lost to radio now come through the broadcast receiver in full tonal beauty. No longer does the bass viol come in thinly on overtones alone—no more do the shrill notes of the piccolo at top register die away in a shrill, reedy absurdity. The modern radio has TONE!

Better broadcasting—better tubes—better speakers—but it has remained for Sangamo to build transformers to match these improvements. And particular attention is called to Sangamo Push-pull Input Transformer has an extremely high primary inductance to secure faithful

amplification of low notes and an accurately divided secondary insures practically identical frequency characteristics. There are Sangamo Push-pull Output Transformers to match the impedance of the various type power tubes and special Output Transformers for dynamic speakers.

In the Sangamo line there are transformers which permit set builders and manufacturers to produce the real tone fidelity. Are you ready for us to send you the data?

Sangamo Condensers

Molded in Bakelite—unchanging value under all conditions of service.



Tone!

- “X” Line Transformers**
 Type AX straight audio amplification, list price.....\$6.00
 Type BX Push-pull Input unit, list price.....\$6.50
 Type CX-171 Push-pull Output transformer, for 171 or 250 power output tubes for cone speaker, list price..\$6.50
 Type DX, same as CX except for 210 and 112 power tubes, list price.....\$6.50
 Type HX Push-pull Output for 171 or 250 Power output tubes to match the impedance of moving coil of Dynamic loud speakers, list price.....\$6.50
 Type GX, same as HX except for 210 and 112 power tubes, list price.....\$6.50
 Type E output choke to match impedance of the various type power tubes, list.....\$5.00

“A” Line Transformers
 (Similar to “X” line but with special core metal to give slightly better curve)

- Type A straight audio amplification, list price.....\$10.00
 Type B Push-pull Input transformer for all tubes, list price.....\$12.00
 Type C-171 Push-pull Output, for 171 or 250 type power tubes with cone speaker.....\$12.00
 Type D-210, same as C except for 210 and 112 power tubes.....\$12.00
 Type H-171, Push-pull Output for 171 or 250 power tubes for Dynamic speaker.....\$12.00
 Type G-210, same as type H except for 210 and 112 tubes, list price.....\$12.00
 Type F Plate Impedance for use as a choke to prevent oscillation and for impedance coupled amplifiers, list.....\$5.00

SANGAMO

ELECTRIC COMPANY

Springfield, Illinois

For 29 years preeminent manufacturers of electrical precision instruments

Tell 'Em You Saw It in the Citizens Radio Call Book Magazine and Scientific Digest

WBZA

990 kc, Boston, Mass., Westinghouse E. & M. Co., 500 w, E. Shared.

WCAC

1330 kc, Storrs, Conn., Connecticut Agricultural College, 500 w, E, shared, "Voice From the Nutmeg State."

WCAD

1220 kc, Canton, N. Y., St. Lawrence University, 500 w, daytime, E, "The Voice of the North Country."

WCAE

1220 kc, Pittsburgh, Pa., Kaufman & Baer Co. 500 w, E, "Where Prosperity Begins."

WCAH

1430 kc, Columbus, Ohio, Commercial Radio Service Co., 250 w, E. Shared.

WCAJ

590 kc, Lincoln, Neb., Nebraska Wesleyan University, 500 w, C. Shared.

WCAL

1250 kc, Northfield, Minn., St. Olaf College, 1000 w, C, shared, "The College on the Hill."

WCAM

1280 kc, Camden, N. J., City of Camden, 500 w, E. Shared.

WCAO

600 kc, Baltimore, Md., Monumental Radio, Inc., 250 w, E, "The Gateway of the South."

WCAP

1280 kc, Asbury Park, N. J., Radio Industries Broadcast Co., 500 w, E. Shared.

WCAT

1200 kc, Rapid City, S. D., South Dakota State School of Mines, 100 w, M.

WCAU

1170 kc, Philadelphia, Pa., Universal Broadcasting Co., 5000 w, E, "Where Cheer Awaits U."

WCAX

1200 kc, Burlington, Vt., University of Vermont, 100 w, E, shared, "The Voice of the Green Mountains."

WCAZ

1070 kc, Carthage, Ill., Carthage College, 100 w, daytime.

WCBA

1500 kc, Allentown, Pa., Musselman & B. Bryan, 100 w, E. Shared.

WCBD

1080 kc, Zion, Ill., Wilbur Glen Voliva, 5000 w, C. Shared.

WCBM

1370 kc, Baltimore, Md., Hotel Chateau, 100 w, E.

WCBS

1210 kc, Springfield, Ill., Dewing & Meester, 100 w,

WCCO

810 kc, Anoka, Minn., Washburn-Crosby Co., 15,000 w, C, "Service to the Northwest."

WCDA

1350 kc, New York City, N. Y., Italian Educational Broadcasting Co., 250 w, E. Shared.

WCFL

970 kc, Chicago, Ill., Chicago Federation of Labor, 50,000 w, C, shared, "The Voice of Labor."

WCGU

1400 kc, Coney Island, N. Y., U. S. Broadcasting Corp., 500 w, E. Shared.

WCLE

1500 kc, Long Beach, Long Island, N. Y., Arthur Paske, 100 w, E, shared, "The Voice of Community Service."

WCLO

1200 kc, Kenosha, Wis., C. Whitmore, 100 w, C. Shared.

WCLS

1310 kc, Joliet, Ill., WCLS, Inc., 100 w, C. Shared.

WCMA

1400 kc, Culver, Ind., Culver Military Academy, 500 w, C, shared, "The Voice of Culver."

WCOA

1120 kc, Pensacola, Fla., City of Pensacola, 500 w, E, "Wonderful City of Advantages."

WCOC

880 kc, Columbus, Miss., Crystal Oil Co., 500 w, C.

WCOH

1210 kc, Greenville, N. Y., Westchester Broadcasting Corp., 100 w, E. Shared.

WCRW

1210 kc, Chicago, Ill., Clinton R. White, 100 w, C. Shared.

WCSH

940 kc, Portland, Me., Congress Square Hotel Co., 500 w, E, "The Voice From Sunrise Land."

WCSSO

1380 kc, Springfield, Ohio, Wittenberg College, 500 w, E. Shared.

WCWK

1230 kc, Ft. Wayne, Ind., Chester W. Keen, 500 w, C, daytime.

WCX

See under WJR.

WDAE

620 kc, Tampa, Fla., Tampa Publishing Co., 1000 w, E, "WDAE, the Voice of the Times at Tampa."

WDAF

610 kc, Kansas City, Mo., Kansas City Star Co., 1000 w, C, shared, "Enemies of Sleep."

WDAG

1410 kc, Amarillo, Texas, J. Lawrence Martin, 1000 w, C, shared, "Where Dollars Always Grow."

WDAH

1310 kc, El Paso, Texas, Trinity Methodist Church, 100 w, M.

WDAY

1280 kc, Fargo, N. D., WDAY, Inc., 1000 w, C. Shared.

WDBJ

930 kc, Roanoke, Va., Richardson-Wayland Elec. Corp., 250 w, E, shared, "The Magic City."

WDBO

620 kc, Orlando, Fla., Rollins College, Inc., 1000 w, E, shared, "Down Where the Oranges Grow."

WDEL

1410 kc, Wilmington, Del., WDEL, Inc., 500 w, E, shared, "First City of the First State."

WDGY

1390 kc, Minneapolis, Minn., Dr. Geo. W. Young, 500 w, C. Shared.

WDOD

1280 kc, Chattanooga, Tenn., Chattanooga Radio Co., Inc., 1000 w, C.

WDRC

1330 kc, New Haven, Conn., Doolittle Radio Corp., 500 w, E. Shared.

WDSU

1270 kc, New Orleans, La., Jos. H. Uhalt, 1000 w, C.

WDWF

1210 kc, Cranston, R. I., Dutee W. Flint, 100 w, E. Shared.

WDZ

1070 kc, Tuscola, Ill., James L. Bush, 100 w, daytime. Shared.

WEAF

660 kc, Bellmore, N. Y., National Broadcasting Co., Inc., 50,000, w, E.

WEAI

1270 kc, Ithaca, N. Y., Cornell Univ., 500 w, E.

WEAM

1370 kc, Plainfield, N. J., W. J. Buttfield, 100 w, E. Shared.

WEAN

550 kc, Providence, R. I., The Shepard Co., 250 w, E, "We Entertain a Nation."

WEAO

550 kc, Columbus, Ohio, Ohio State University, 750 w, E. Shared.

WEAR

1070 kc, Cleveland, Ohio, WTAM and WEAR, Inc., 1000 w, E. Shared.

WEBC

1280 kc, Superior, Wis., Head of The Lakes Broadcasting Co., 1000 w, C. Shared.

WEBE

1210 kc, Cambridge, Ohio, Roy W. Waller, 100 w, E.

WEBQ

1210 kc, Harrisburg, Ill., Tate Radio Co., 50 w, C. Shared.

WEBR

1310 kc, Buffalo, N. Y., H. H. Howell, 100 w, E, "We Extend Buffalo's Regards."

WEBW

600 kc, Beloit, Wis., Beloit College, 350 w, C, daytime.

WEDC

1210 kc, Chicago, Ill., Emil Denmark, Inc., 100 w, Shared.

WEDH

1420 kc, Erie, Pa., Erie Dispatch-Herald, 30 w, E.

“Almost as Good as a Victoreen”— The Greatest Compliment That Can Be Paid Any Receiver

YOU can still build better than you can buy. This is a proven fact. There are features in a Victoreen Super, either “A.C.” or “D.C.” which cannot be had in any factory built set. The selectivity, sensitivity, tone quality and reliability of a Victoreen is positively unequalled by any “production” receiver on the market.

Victoreen Parts are the standard of quality

There is no real substitute for them, and for what they do. Victoreen developments are continually in advance of the times, yet they never are offered to the public until the most exhaustive tests have proven their merit.

[[Build with genuine Victoreen Parts and you will have a receiver that knows no superior]]

The Victoreen “A.C.” Super

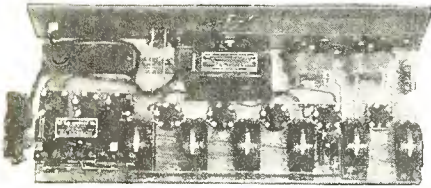

Compact in assembly, and free from frills, this 1929 Victoreen “A.C.” Circuit knows no superior. Its results will meet the requirements of the most exacting critic. The essential parts are all Victoreen built. The heart of this circuit is the

New 172 R.F. Transformer

The finest obtainable for radio frequency amplification. It represents a marked improvement over the previous type 170—which for five years has been known as the standard of comparison. Each transformer is tuned and matched to a precision of less than 1/3 of one per cent. **\$8.00.**

The new 152 Coupling Unit.....**\$6.00**
The new 162 Antenna Coupler.. **4.00**

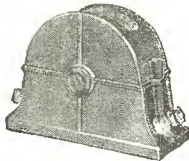

“216” Choke

Intended for use in the Victoreen Power Supply. A product of standard

Victoreen quality, designed for 110 volt A.C. 60 cycle. No. 216 A is 110 volt, 25 cycle. Same case as the 112 Audio Transformer. Price **\$15.00.**

Victoreen “C” Power Supply

The Victoreen 516 “C” Supply serves to eliminate the use of C batteries. It furnishes four voltages at one time, 45 and 90 volts fixed and two variable, 0 to 45 volts and 45 to 90 volts. The Victoreen 516 “C” Supply will be found more than advantageous as it supplies a voltage which may be varied to suit the detector requirements of the receiver.

Victoreen “B” Power Supply



The New Victoreen power supply is designed to furnish 45, 90, 180 and 450 volts and is intended for use with a UX 250 power tube in the last stage. It is not intended for loads greater than 100 mils DC. This power supply contains two voltage regulator tubes so that the 90, 180 volt taps are supplied with a constant potential.

“112” Audio Transformer



Outstanding in performance for Audio amplification. Contains both the first and second stages in the one case.

Famous for its splendid tonal quality and freedom from distortion. Uses two “112” tubes and up to 450 volts of “B.” Price **\$22.00.**

“327” Filament Transformer

Contains two separate 2½ volt windings, and one 5 volt winding. Will supply five UY 227 tubes from each 2½ volt winding, and two UX 112A’s or one UX 210 tube from the five volt taps. Also has leads for lighting dial light. Same case as 112 Audio Unit. Price **\$22.00.**

BLUE PRINTS SENT FREE— USE THE COUPON

The New Victoreen 1929 A. C. Circuit, the new Universal D. C., the Victoreen “B” Power Supply and the Victoreen “C” Supply. Check the ones you wish.

Please send, without charge, the following Victoreen Blue Prints.

- Victoreen A.C. Circuit
- Victoreen D.C. Circuit
- Victoreen “B” Power Supply

Name.....
Street No.....
Town..... State.....

THE GEORGE W. WALKER COMPANY

Merchandisers of Victoreen Radio Products
2825 Chester Ave., Cleveland, Ohio

Victoreen

STANDARDIZED RADIO PARTS

- WEEI**
590 kc, Boston, Mass., Edison Elec. Illum. Co., 500 w, E, "The Friendly Voice."
- WEHS**
1310 kc, Evanston, Ill., Victor C. Carlson, 100 w, C. Shared.
- WELK**
1370 kc, Philadelphia, Pa., Howard R. Miller, 100, E.
- WEMC**
590 kc, Berrien Springs, Mich., Emmanuel Missionary College, 1000 w, C, "The Radio Light-house."
- WENR**
870 kc, Chicago, Ill., Great Lakes Radio Broadcasting Co., 5000 w, C, "Voice of Service."
- WEPS**
1200 kc, Gloucester, Mass., Matheson Radio Co., Inc., 100 w, E. Shared.
- WEVD**
1300 kc, Woodhaven, N. Y., Debs Memorial Radio Fund, 500 w, E. Shared.
- WEW**
760 kc, St. Louis, Mo., St. Louis University, 1000 w, daytime, C.
- WFAA**
1040 kc, Dallas, Texas, Dallas Morning News, 5000 w, C, "Working for All Alike." Shared.
- WFAN**
610 kc, Philadelphia, Pa., Keystone Broadcasting Co., Inc., 500 w, E.
- WFBC**
1200 kc, Knoxville, Tenn., First Baptist Church, 50 w, E.
- WFBE**
1200 kc, Cincinnati, Ohio, Park View Hotel, 100 w, E.
- WFBG**
1310 kc, Altoona, Pa., William F. Gable Co., 100 w, E, "The Original Gateway to the West and We Wish You All the Very Best."
- WFBJ**
1370 kc, Collegeville, Minn., St. Johns University, 100 w, C, "In the Heart of the Landscape Paradise."
- WFBL**
900 kc, Syracuse, N. Y., The Onondaga Co., Inc., 750 w, E, "When Feeling Blue, Listen." Shared.
- WFBM**
1050 kc, Indianapolis, Ind., Indianapolis Power & Light Co., 25,000 w, C.
- WFBR**
1270 kc, Baltimore, Md., Baltimore Radio Show, Inc., 250 w, E, "Home of the Star Spangled Banner."
- WFDF**
1310 kc, Flint, Mich., Frank D. Fallain, 100 w, E.
- WFI**
560 kc, Philadelphia, Pa., Strawbridge & Clothier, 500 w, E. Shared.
- WFJC**
1450 kc, Akron, Ohio, W. F. Jones Broadcasting, Inc., 500 w, E. Shared.
- WFKD**
1310 kc, Frankford, Pa., Foulkrod Radio Eng. Co., 50 w, E.
- WFLA**
900 kc, Clearwater, Fla., Clearwater Chamber of Commerce, 1000 w, E, "Inviting the World to the Springtime City." Shared.
- WGAL**
1310 kc, Lancaster, Pa., Lancaster Elec. Sup. & Const. Co., 15 w, E, "World's Gardens at Lancaster."
- WGBB**
1210 kc, Freeport, N. Y., Harry H. Carman, 100 w, E, "The Voice of the Sunrise Trail." Shared.
- WGBC**
1430 kc, Memphis, Tenn., First Baptist Church, 500 w, C. Shared (Sunday only).
- WGBF**
630 kc, Evansville, Ind., Evansville on Air, 500 w, E, "Gateway to the South."
- WGBI**
880 kc, Scranton, Pa., Scranton Broadcasters, Inc., 250 w, E. Shared.
- WGBS**
1180 kc, Astoria, L. I., N. Y., Gimbel Bros., Inc., 500 w, E.
- WGCM**
1210 kc, Gulfport, Miss., Gulf Coast Music Co., Inc., 100 w, C.
- WGCP**
1250 kc, Newark, N. J., May Radio Broadcast Corp., 250 w. Shared.
- WGES**
1360 kc, Chicago, Ill., Oak Leaves Broadcasting Corp., 500 w, C, "World's Greatest Entertainment Service." Shared.
- WGH**
1310 kc, Newport News, Va., Virginia Broadcasting Co., Inc., 100 w, E.
- WGHP**
1240 kc, Fraser, Mich., George Harrison Phelps, Inc., 750 w, E.
- WGMS**
See under WLB.
- WGN**
720 kc, Chicago, Ill., Tribune Co., 25,000 w, C.
- WGR**
550 kc, Buffalo, N. Y., Federal Radio Corp., 1000 w, E, "Key City of Industry." Shared.
- WGST**
890 kc, Atlanta, Ga., Georgia School of Technology, 250 w, E, "The Southern School with the National Reputation." Shared.
- WGY**
790 kc, South Schenectady, N. Y., General Electric Co., 50,000 w, E.
- WHA**
570 kc, Madison, Wis., University of Wisconsin, 750 w, C. Shared.
- WHAD**
1120 kc, Milwaukee, Wis., Marquette University 250 w, C. Shared.
- WHAM**
1150 kc, Rochester, N. Y., Stromberg-Carlson Tel. Mfg. Co., 5000 w, E.
- WHAP**
1300 kc, New York, N. Y., Defenders of Truth Society, Inc., 1000 w, E. Shared.
- WHAS**
820 kc, Louisville, Ky., The Courier Journal Co. & Louisville Times Co., 10,000 w, C.
- WHAZ**
1300 kc, Troy, N. Y., Rensselaer Polytechnic Institute, 500 w, E. Shared.
- WHB**
950 kc, Kansas City, Mo., Sweeney Automobile School Co., 1000 w, C, "Kansas City, Mo., the Heart of America." Shared.
- WHBC**
1200 kc, Canton, Ohio, St. John's Catholic Church, 10 w, E.
- WHBD**
1370 kc, Bellefontaine, Ohio, First Presbyterian Church, 100 w, E, "Ohio's Highest Point."
- WHBF**
1210 kc, Rock Island, Ill., Beardsley Specialty Co., 100 w, C.
- WHBL**
1410 kc, Sheboygan, Wis., Press Pub. Co., 500 w, C. Shared.
- WHBP**
1310 kc, Johnstown, Pa., Johnstown Automobile Co., 100 w, E, "The Voice of the Friendly City."
- WHBQ**
1370 kc, Memphis, Tenn., Broadcasting Station WHBQ, Inc., 100 w, C.
- WHBU**
1210 kc, Anderson, Ind., Citizens Bank, 100 w, C, "First Hoosier Bank on the Air."
- WHBW**
1500 kc, Philadelphia, Pa., D. R. Kienzle, 106 w, E.
- WHBY**
1200 kc, West De Pere, Wis., St. Norbert's College, 100 w, C.
- WHDF**
1370 kc, Calumet, Mich., C. C. MacLeod, 100 w, C.
- WHDI**
1390 kc, Minneapolis, Minn., Wm. Hood Dunwoody Ind. Inst., 500 w, C.
- WHEC**
1440 kc, Rochester, N. Y., Hickson Electric Co., Inc., 500 w, E. Shared.
- WHFC**
1310 kc, Cicero, Ill., Goodson & Wilson, Inc, 100 w, C. Shared.
- WHK**
1390 kc, Cleveland, Ohio, Radio Air Service Corp., 1000 w, E, "Cleveland's Pioneer Station." Shared.

FACTORY TO YOU—SAVE 50%—COMPARE WITH COSTLIEST OUTFITS BEFORE YOU BUY

Enjoy a powerful new **Miraco** ^{set or complete outfit} **30 DAYS FREE** AC Electric or Battery

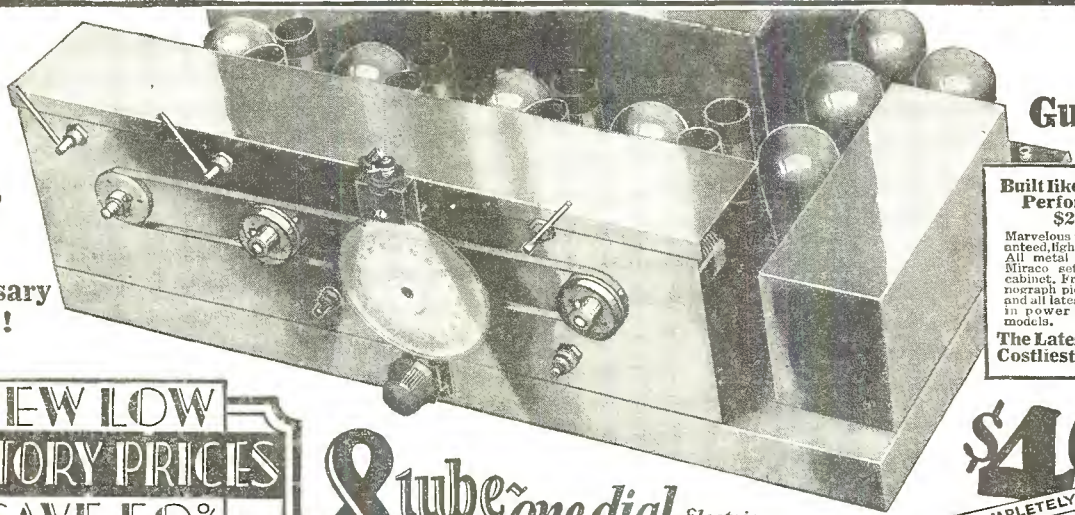

3 Year Guarantee

Get Our Send No Money 9th Anniversary Offer!

Built like, Looks like, Performs like a \$200 set
Marvelous new 3-year guaranteed, lighted 1-dial control. All metal Super Shielded Miraco set, removed from cabinet. Front switch, phonograph pick-up connection and all latest features. Built in power section on AC models.
The Latest, Finest and Costliest Construction

\$49⁸⁸
COMPLETELY ASSEMBLED

NEW LOW FACTORY PRICES SAVE 50%

Wide Selection of Beautiful Cabinets AC or Battery Sets

30 DAYS HOME TRIAL

A popular walnut Hi-Boy Console, with drop-leaf desk. Beautiful two-tone finish. Rare bargain!

Beautifully graceful Spinet console, genuine two-tonewalnut. Choice of speakers. Also comes in Electric Phonograph-Radio Combination.

A new-type arm-chair console. Genuine walnut. Very pretty. Low priced. Electro-Dynamic or Magnetic-Power Speakers.

At right, a Lo-Boy console, walnut finish, that costs little. A gem!

Above, popular inexpensive combination. Set on Table Speaker (sold separately).

Metal or wood compact style cabinets. Wood cabinets in walnut or new shaded silver-chrome finishes. Cathedral Electro-Dynamic or Magnetic-Power Speaker to match!

8 tube ~ one dial ^{Electric Lighted} **MIRACO** TRADE MARK REGISTERED

CATHEDRAL TONED, SUPER SELECTIVE, POWERFUL DISTANCE GETTERS

Celebrating its 9th successful year, America's big, old, reliable Radio Corporation springs a genuine sensation in high-grade sets. With its latest, Super-powered, 1-dial Miracos—the All Electric wholly self-contained, hum-free, AC-8 and AC-9, using AC tubes or the new 8-tube models for batteries or Eliminators—you are guaranteed values and savings unsurpassed in the fine set field.

BIG DISCOUNTS
Exclusive Territory to User-Agents on **BATTERY OR AC ELECTRIC OUTFITS**

Compare a Miraco with highest-priced radios, for 30 days in your home. Surprise and entertain your friends—get their opinions. Unless 100% delighted, *don't buy it!* Return everything—the complete outfit—at our expense. Your decision is final—absolutely!

Only exceptionally fine radios, of the very latest approved type, at rock-bottom prices, could possibly back up so liberally unconditional a guarantee. Send coupon now for *Amazing Special Factory Offer!*

Don't Confuse with Cheap Radios
With its rich, clear Cathedral tone,

Miraco Outperforms 'em All in Chicago
On the Miraco Unitune, to start with, will say: I got to date 61 stations outside of Chicago, from the Pacific Ocean to the Atlantic Ocean, and from Anchorage, Alaska, to the Gulf of Mexico, and I tried the set with 3 different antennas. That is an outside aerial 152 feet, an inside aerial 20 feet, and

hum-free operation, tremendous “kick” on distant stations and razor-edge selectivity—with its costly sturdy construction, latest features, including phonograph pick-up connection, ease of tuning, beauty, and economy—a Miraco will make you the envy of many whose radios cost 2 to 3 times as much!

Many thousands of Miracos—bought after 30 day home comparisons—are cutting through locals and getting coast to coast with the tone and power of costly sets, their delighted users report. Miracos are laboratory-built with finest parts, and embody 9 years' actual experience in constructing fine sets. Approved by Radio's highest authorities.

Deal Direct with Big Factory
Everything reaches you splendidly packed and rigidly tested to insure your instant enthusiasm. Enjoy the outfit 30 days—then decide. Liberal 3-year guarantee on each set. Play safe, save lots of money, and insure satisfaction by dealing direct with Radio's old, reliable builders of fine sets—9th successful year.

light socket. I want to say that your set does outperform the other sets I have. I put it up against a World Record Super 9 and beat that one. Then I put it up against a (names expensive make), and beat that one. Next I put it up against a Neutrodyne and beat that one. HARRY KOPP, 6555 South Poeria Street, Chicago, Illinois.



AC-8—\$71.50

Unbeatable value in a 3-year guaranteed Super Shielded Metal Chassis.



Also New, More Powerful Battery Sets

The newest and latest in battery operated sets, designed with same advanced features used in electric sets! Same wide choice of cabinets! Highest quality, amazingly low priced!

MIDWEST RADIO CORPORATION, 531-RJ Miraco Building, Cincinnati, Ohio

BEAUTIFULLY ILLUSTRATED CATALOG, AMAZING SPECIAL FACTORY OFFER, TESTIMONY OF NEARBY USERS—All the proof you want—of our honesty, fairness, size, financial integrity, radio experience and the performance of our sets—including Amazing Factory Offer—sent with catalog.



Free!

MIDWEST RADIO CORPORATION
Pioneer Builders of Sets—9th Successful Year
531-RJ Miraco Bldg., Cincinnati, Ohio

THIS COUPON IS NOT AN ORDER

WITHOUT OBLIGATION, send free catalog, Amazing Special Factory Offer, testimony of nearby users, etc. User Agent Dealer
 Check here if interested in an **EXCLUSIVE TERRITORY PROPOSITION**
NAME _____ ADDRESS _____

WHN

1010 kc, New York, N. Y., George Schubel, 250 w, E, "Voice of the Great White Way." Shared.

WHO

1000 kc, Des Moines, Iowa, Bankers Life Co. 5000 w, C. "W-H-O, Who? Banker's Life, Des Moines." Shared.

WHOH

830 kc, Gloucester, Mass., Matheson Radio Co., Inc., 1000 w, E.

WHPP

1420 kc, New York, N. Y., Bronx Broadcasting Co., 10 w, E. Shared.

WHT

1480 kc, Deerfield, Ill., Radiophone Broadcasting Corp., 5000 w, C. Shared.

WIAD

1370 kc, Philadelphia, Pa., Howard R. Miller, 100 w, E.

WIAS

1420 kc, Ottumwa, Iowa, Poling Electric Co., 100 w, daytime, C. Shared.

WIBA

1210 kc, Madison, Wis., Capital Times-Strand Theater Station, 100 w, C.

WIBG

930 kc, Elkins Park, Pa., St. Paul's P. E. Church, 50 w, daytime, E.

WIBM

1370 kc, Jackson, Mich., C. L. Carrell, 100 w.

WIBO

570 kc, Desplaines, Ill., Nelson Bros, Bond & Mortgage Co., 1000 w, C. Shared.

WIBR

1420 kc, Steubenville, Ohio, Thurman A. Owings, 50 w, E, "Where Investments Bring Results."

WIBS

1450 kc, Elizabeth, N. J., New Jersey Broadcasting Co., 250 w, E.

WIBU

1310 kc, Poynette, Wis., W. C. Forrest, 100 w, C.

WIBW

1300 kc, Topeka, Kan., C. L. Carrell, 1000 w, C, "Topeka—Where Investment Brings Wealth." Shared.

WIBX

1200 kc, Utica, N. Y., WIBX, Inc., 100 w, E.

WIBZ

1500 kc, Montgomery, Ala., Alexander D. Trum, 15 w, C, "We Interest Business Zeal."

WICC

1190 kc, Easton, Conn., Bridgeport Broadcasting Station, Inc., 500 w, E, "The Industrial Capital of Connecticut." Shared.

WIL

1420 kc, St. Louis, Mo., Missouri Broadcasting Co., 1000 w, C, "A Wave Length Ahead." Shared.

WILL

890 kc, Urbana, Ill., University of Illinois, 250 w, C. Shared.

WINR

1210 kc, Bayshore, N. Y., Radiotel Mfg. Co., 100 w, E, shared, "The Garden Spot of Long Island."

WIOD

1240 kc, Miami Beach, Fla., Isle of Dreams Broadcasting Co., 1000 w, E, "Wonderful Isle of Dreams." Shared.

WIP

610 kc, Philadelphia, Pa., Gimbel Bros., Inc., 500 w, E, "Watch Its Progress."

WISN

1120 kc, Milwaukee, Wis., Evening Wisconsin Co., 250 w, C.

WJAD

1240 kc, Waco, Texas, Frank P. Jackson, 1000 w, C, shared, "Waco, Texas, All Around It."

WJAG

1060 kc, Norfolk, Neb., Norfolk Daily News, 1000 w, C, shared, "Home of the Printer's Devil."

WJAK

1310 kc, Kokomo, Ind., J. A. Kautz, 50 w. Shared.

WJAR

890 kc, Providence, R. I., The Outlet Co., 250 w, E, "The Southern Gateway of New England."

WJAS

1290 kc, Pittsburgh, Pa., Pittsburgh Radio Supply House, 1000 w, E.

WJAX

1260 kc, Jacksonville, Fla., City of Jacksonville 1000 w, E, shared, "WJAX—W for Wonderful, JAX for Jacksonville."

WJAY

1450 kc, Cleveland, Ohio, Cleveland Radio Broadcasting Corp., 500 w, E. Shared.

WJAZ

1480 kc, Mt. Prospect, Ill., Zenith Radio Corp., 5000 w, C. Shared.

WJBB

1010 kc, Sarasota, Fla., Sarasota Chamber of Commerce, 250 w, E, "The Pioneer Semi-Tropical Business Journal."

WJBC

1200 kc, LaSalle, Ill., Hummer Furniture Co., 100 w, C. Shared.

WJBI

1210 kc, Red Bank, N. J., Robt. S. Johnson, 100 w, E. Shared.

WJBK

1370 kc, Ypsilanti, Mich., Ernest F. Goodwin, 50 w, C.

WJBL

1200 kc, Decatur, Ill., Wm. Gushard Dry Goods Co., 100 w, C. Shared.

WJBO

1370 kc, New Orleans, La., Valdemar Jensen, 100 w, C.

WJBT

See under WBBM.

WJBU

1210 kc, Lewisburg, Pa., Bucknell University, 100 w, E, shared, "In the Heart of the Keystone State."

WJBW

1200 kc, New Orleans, La., C. Carlsen, Jr., 30 w, C, shared, "The Serve You Broadcasting Station at New Orleans."

WJBY

1210 kc, Gadsden, Ala., Electric Cons. Co., 50 w, C.

WJJD

1180 kc, Moosheart, Ill., Loyal Order of Moose, 20,000 w, C, shared, "Every Child Is Entitled to a High School Education and a Trade." Shared.

WJKS

1360 kc, Gary, Ind., Johnson-Kennedy Radio Corp., 500 w, C. Shared.

WJR

750 kc, Pontiac, Mich., WJR, Inc., 5000 w, E.

WJSV

1460 kc, Mt. Vernon Hills, Va., Independent Pub. Co., 10,000 w.

WJZ

760 kc, New York City, N. Y., Radio Corporation of America, 30,000 w, E.

WKAQ

580 kc, San Juan, Porto Rico, Radio Corp. of Porto Rico, 500 w, E, "Porto Rico, The Island of Enchantment in the Caribbean Sea." Shared.

WKAR

1040 kc, East Lansing, Mich., Michigan State College, 500 w, daytime, E.

WKAU

1310 kc, Laconia, N. H., Laconia Radio Club, 100 w, E, "The Voice of the Winnepesaukee Lake Region."

WKBB

1310 kc, Joliet, Ill., Sanders Bros., 100 k, C. Shared.

WKBC

1310 kc, Birmingham, Ala., H. L. Ansley, 10 w, C.

WKBE

1200 kc, Webster, Mass., K. & B. Electric Co., 100 w, E. Shared.

WKBF

1400 kc, Indianapolis, Ind., Noble Butler Watson, 500 w, C, shared, "We Keep Building Friendships."

WKBH

1380 kc, LaCrosse, Wis., Callaway Music Co., 1000 w, C. Shared.

WKBI

1310 kc, Chicago, Ill., Fred L. Schoenwolf, 50 w, C. Shared.

WKBN

570 kc, Youngstown, Ohio, W. P. Williamson, Jr., 500 w, E. Shared.

WKBO

1450 kc, Jersey City, N. J., Camith Corp., 250 w, E. Shared.

WKBP

1420 kc, Battle Creek, Mich., Enquirer-News Co., 50 w, E.

WKBQ

1350 kc, New York, N. Y., Standard Cahill Co., Inc., 250 w, E. Shared.

WKBS

1310 kc, Galesburg, Ill., Permil N. Nelson, 100 w, C. Shared.

WKBT

1420 kc, New Orleans, La., First Baptist Church, 50 w, C.

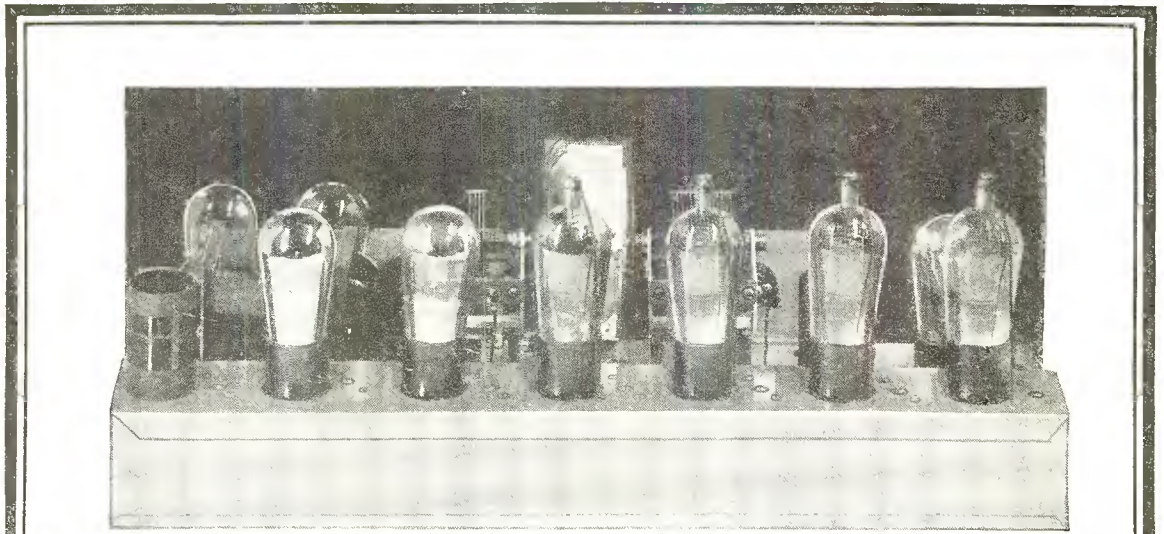

Blast your way through . . . with the super powered HFL SPECIAL NINE*

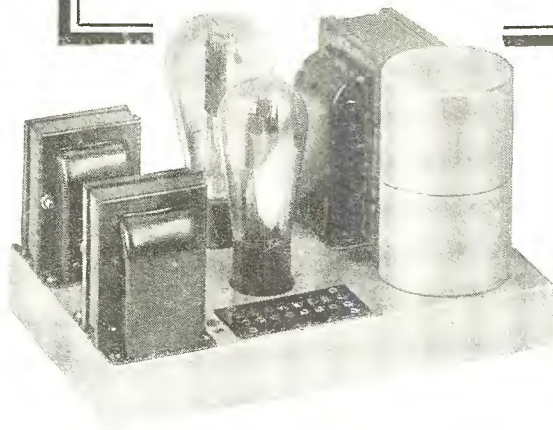

to go wrong. When you sell one, it will stay sold. It's a five year set, allowing short wave operation and excellent reproduction of television signals. The Special Nine is years ahead of everything else in the radio field. And it's priced right, too—

	List Price	Net, less 40 & 2%
D C Chassis—9 tube	\$ 95.00	\$55.86
A C Chassis—8 tube (250 external)	105.00	61.74
Set builder's wiring charge for either set	30.00	17.64
250 Power Amplifier and B supply, factory wired	77.00	45.28

Prices are without tubes. The A C set requires the 250 power amplifier and B supply for operation. The power amplifier will also operate with and furnish plate voltages to the D C Special Nine.

Wide awake set builders! Attach coupon to your business stationery and send for our new plan showing how to sell at low prices and make large profits. Mail the coupon *today*. Grasp this golden opportunity *now*!

If you have mailed a previous coupon to the High Frequency Laboratories, please do not mail this one, as you will automatically receive complete information.

HIGH FREQUENCY LABORATORIES

Office: 6-28 N. Sheldon St. Chicago, Illinois

GUARANTEED to out perform any radio set on earth. Priced at \$55.86. A set builder's money making plan that's a knockout. There's the story of the HFL Special Nine.

Radio's latest and greatest super is the chance of a life time for custom set builders. Four screen grid tubes. One dial and one spot. 250 tube power amplifier. A C heater or D C tube operation. No wonder they're selling them like wild fire.

You've never heard anything like the HFL Special Nine. Full loud speaker volume on 3,000 mile signals. Perfect selectivity that let's you get right alongside of the big boys. Tone quality that's a revelation. Absolutely no oscillation.

This HFL job is built like a Mack truck. Nothing

HFL

HIGH FREQUENCY LABORATORIES
Office 6, 28 N. Sheldon St., Chicago, Ill.

Gentlemen:

Without obligation please send literature describing the HFL Special Nine, also the new 250 Power Amplifier and B Supply. I have never mailed a coupon to you before.

Name.....

Address.....

City.....State.....

(Please print plainly)

★ Not a kit of loose parts, but a factory assembled chassis ready for wiring. Screen grid amplifier wired and tested.

- WKBV**
1500 kc, Brookville, Ind., Knox Battery & Electric Co., 100 w, C.
- WKBW**
1470 kc, Buffalo, N. Y., Buffalo Broadcasting Co., 5000 w, E, shared.
- WKBZ**
1500 kc, Ludington, Mich., K. L. Ashbacker, 50 w.
- WKEN**
1040 kc, Buffalo, N. Y., WKEN, Inc., 1000 w, E, Shared.
- WKJC**
1200 kc, Lancaster, Pa., Kirk Johnson & Co., 100 w, E.
- WKRC**
550 kc, Cincinnati, Ohio, Kodel Radio Corp., 750 w, E, "WKRC, K—Kodel, R—Radio, C—Corporation."
- WKY**
900 kc, Oklahoma City, Okla., WKY Radiophone Co., 1000 w, C.
- WLAC**
1490 kc, Nashville, Tenn., Life & Casualty Ins. Co., 5000 w, C, shared, "The Thrift Station."
- WLAP**
1200 kc, Okalona, Ky., American Broadcasting Corp. of Kentucky, 30 w, C.
- WLB**
1250 kc, Minneapolis, Minn., University of Minnesota, 1000 w, C. Shared.
- WLBC**
1310 kc, Muncie, Ind., Donald A. Burton, 50 w, Shared.
- WLBF**
1420 kc, Kansas City, Mo., Everett L. Dillard, 100 w, C, "Where Listeners Become Friends."
- WLBG**
1200 kc, Petersburg, Va., Robert Allen Gamble, 100 w, E.
- WLBH**
1420 kc, Farmingdale, N. Y., Joseph J. Lombardi, 30 w, Shared.
- WLBL**
900 kc, Stevens Point, Wis., Wisconsin Department of Markets, 2000 w, daytime, C, "Wisconsin, Land of Beautiful Lakes."
- WLBO**
1310 kc, Galesburg, Ill., Fred Trebbe, Jr., 100 w, C. Shared.
- WLBV**
1210 kc, Mansfield, Ohio, Mansfield Broadcasting Association, 100 w, E.
- WLBW**
1260 kc, Oil City, Pa., Petroleum Telephone Co., 500 w, E.
- WLBX**
1500 kc, Long Island City, N. Y., John N. Brahy, 100 w, Shared.
- WLBZ**
620 kc, Dover-Foxcroft, Me., Thompson L. Guernsey, 250 w, E.
- WLCI**
1210 kc, Ithaca, N. Y., Lutheran Assn. of Ithaca, 50 w, E.
- WLEX**
1420 kc, Lexington, Mass., Lexington Air Station, 100 w, E, Shared.
- WLIB**
See under WGN.
- WLIT**
560 kc, Philadelphia, Pa., Lit Brothers, 500 w, E, shared, "The Quaker City Siren."
- WLOE**
1500 kc, Chelsea, Mass., William S. Pote, 100 w, Shared.
- WLS**
870 kc, Crete, Ill., Agricultural Broadcasting Co., 5000 w, C, shared.
- WLSI**
See under WDWF.
- WLTH**
1400 kc, Brooklyn, N. Y., Voice of Brooklyn, Inc., 500 w, E, Shared.
- WLW**
700 kc, Mason, Ohio, Crosley Radio Corp., 50,000 w, E, Shared.
- WLWL**
1100 kc, New York, N. Y., Missionary Society of St. Paul, 5000 w, 6-8 pm, E, Shared.
- WMAC**
570 kc, Casenovia, N. Y., Clive B. Meredith, 250 w, E, shared, "Voice of Central New York."
- WMAF**
1360 kc, Dartmouth, Mass., Round Hills Radio Corp., 500 w, E, Shared.
- WMAK**
900 kc, Martinsville, N. Y., WMAK Broadcasting System, Inc., 750 w, E, Shared.
- WMAL**
630 kc, Washington, D. C., M. A. Leese Co., 250 w, E, Shared.
- WMAN**
1210 kc, Columbus, Ohio, W. E. Heskitt, 50 w, E.
- WMAQ**
670 kc, Chicago, Ill., Chicago Daily News, Inc., 5000 w, C.
- WMAY**
1200 kc, St. Louis, Mo., Kingshighway Presbyterian Church, 100 w.
- WMAZ**
890 kc, Macon, Ga., Mercer University, 250 w, E, shared, "Watch Mercer Attain Zenith." Shared.
- WMBA**
1500 kc, Newport, R. I., LeRoy Joseph Beebe, 100 w, E.
- WMBC**
1420 kc, Detroit, Mich., Michigan Broadcasting Co., Inc., 100 w, E.
- WMBD**
1440 kc, Peoria Heights, Ill., Peoria Heights Radio Laboratory, 500 w, Shared.
- WMBF**
560 kc, Miami Beach, Fla., Fleetwood Hotel Corp., 500 w, E, shared, "Wonderful Miami Beach Fleetwood."
- WMBL**
1310 kc, Lakeland, Fla., Benford's Radio Studios, 100 w, E, "Lakeland—The City of Heart's Desire."
- WMBM**
1500 kc, Memphis, Tenn., Seventh Day Adventist Church, 10 w, C.
- WMBO**
1370 kc, Auburn, N. Y., Radio Service Laboratories, 100 w, E.
- WMBQ**
1500 kc, Brooklyn, N. Y., Paul J. Gollhofer, 100 w, Shared.
- WMBR**
1210 kc, Tampa, Fla., F. J. Reynolds, 100 w, E, "WMBR, Everything for Radio at Tampa, Fla."
- WMBS**
1430 kc, Lemoyne, Pa., Mack's Battery Co., 500 w, E, Shared.
- WMC**
780 kc, Memphis, Tenn., Memphis Commercial Appeal, Inc., 500 w, C, "WMC, Memphis, Down in Dixie."
- WMCA**
570 kc, Hoboken, N. J., Greeley Square Hotel Co., 500 w, E, shared, "Where the White Way Begins."
- WMES**
1500 kc, Boston, Mass., Massachusetts Educational Society, 50 w, Shared.
- WMMN**
890 kc, Fairmont, W. Va., Holt Rome Novelty Co., 250 w, E.
- WMPC**
1500 kc, Lapeer, Mich., First Methodist Protestant Church, 30 w, E, "Where Many Preach Christ."
- WMRJ**
1420 kc, Jamaica, N. Y., Peter J. Prinz, 10 w, E, shared, "The Gateway of the Sunrise Trail."
- WMSG**
1350 kc, New York, N. Y., Madison Square Garden Broadcast Co., 250 w, E, Shared.
- WMT**
1200 kc, Waterloo, Iowa, Waterloo Broadcasting Co., 100 w, C, Shared.
- WNAC**
1230 kc, Boston, Mass., The Shepard Stores, 500 w, E.
- WNAD**
1010 kc, Norman, Okla., University of Oklahoma 500 w, C, shared, "The Voice of Soonerland."
- WNAT**
1310 kc, Philadelphia, Pa., Lenning Brothers Co., 100 w, E.
- WNAX**
570 kc, Yankton, S. Dak., Gurney Seed & Nursey Co., Dakota Radio Apparatus Co., 500 w, C, Shared.
- WNBF**
1500 kc, Endicott, N. Y., Howitt-Wood Radio Co., 50 w, E, "The Voice of the Triple Cities."
- WNBH**
1310 kc, New Bedford, Mass., New Bedford Broadcasting Co., 100 w, E, shared, "The Gateway to Cape Cod."

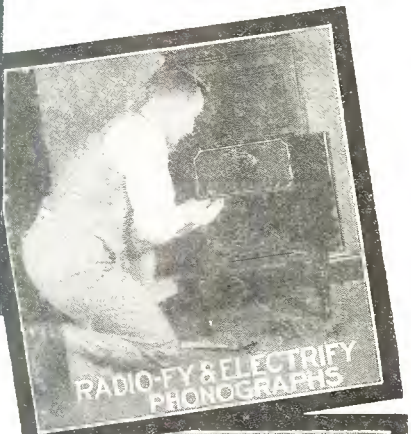
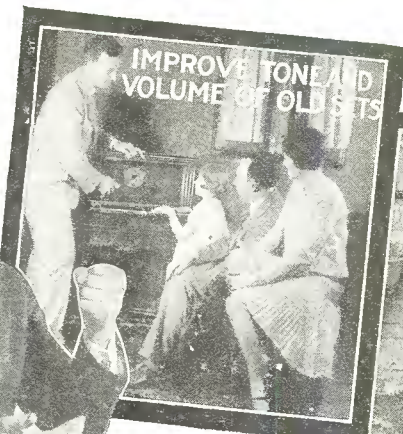

Send Coupon Below for FREE Radio Idea Book

5 Easy Ways to Make \$3.00 an hour in Your Spare Time in RADIO

Each of these plans, developed by the Radio Association of America, is a big money-maker. Set owners everywhere want to get rid of static, to have their sets operate from the electric light socket, the tone improved, and the volume increased, and transformed into single-dial controls. Phonograph owners want their machines electrified and radiofied. If you learn to render these services, you can easily make \$3.00 an hour for your spare time, to say nothing of the money you can make installing, servicing, repairing, building radio sets, and selling supplies.

Over \$600,000,000 is being spent yearly for sets, supplies, service. You can get your share of this business and, at the same time, fit yourself for the big-pay opportunities in Radio by joining the Association.

Join the Radio Association of America

A membership in the Association offers you the easiest way into Radio. It will enable you to earn \$3.00 an hour upwards in your spare time—train you to install, repair and build all kinds of sets—start you in business without capital or finance an invention—train you for the \$3,000 to \$10,000 big-pay radio positions—help secure a better position at

bigger pay for you. *A membership need not cost you a cent!*

The Association will give you a comprehensive, practical, and theoretical training and the benefit of its Employment Service. You earn while you learn. Our cooperative plan will make it possible for you to establish a radio store. You have the privilege of buying radio supplies at wholesale from the very first.

Earned Over \$500.00 In His Spare Time

Frank J. Deutsch, Penn.: "I have made over \$500 out of Radio in my spare time. Yours is a great plan for ambitious men."

A Radio Engineer In One Year

Claude DeGraves, Canada: "I knew nothing about Radio when I joined the Association a year ago. I am now a member of the engineering staff of the DeForest Company and my income is 225% greater than at the time I joined."

Doubles Income In 6 Months

W. E. Thon, Chicago: "You have an excellent plan. Six months after I enrolled I secured the managership of large Radio store and doubled my income."

ACT NOW—If You Wish the No-Cost Membership Plan

To a limited number of ambitious men, we will give Special Memberships that may not—need not—cost you a cent. To secure one, write today. We will send you details and also our book filled with dollars-and-cents radio ideas. It will open your eyes to the money-making possibilities of Radio.

Radio Association of America
4513 Ravenswood Ave., Dept. RCB-1 Chicago, Ill.

Radio Association of America
Dept. RCB-1, 4513 Ravenswood Ave., Chicago, Ill.

Gentlemen: Please send me by return mail full details of your Special Membership Plan, and also copy of your Radio Idea Book.

Name.....

Address.....

City..... State.....

WMBH

1420 kc, Joplin, Mo., Edwin Dudley Aber, 100 w, C, "Where Memories Bring Happiness."

WMBI

1080 kc, Chicago, Ill., Moody Bible Institute, 5000 w, C, shared, "The West Point of Christian Service."

WMBG

1210 kc, Richmond, Va., Havens & Martin, Inc., 100 w, E, "The Daytime Station."

WNBJ

1310 kc, Knoxville, Tenn., Lonsdale Baptist Church, 50 w, C.

WNBQ

1200 kc, Washington, Pa., John Brownlee Spriggs, 15 w, E, "The Voice of Washington, Pa."

WNBQ

1500 kc, Rochester, N. Y., Gordon P. Brown, 15 w, E.

WNBK

1430 kc, Memphis, Tenn., John Ulrich, 500 w, C. Shared.

WNBW

1200 kc, Carbondale, Pa., Home Cut Glass & China Co., 5 w, E.

WNBX

1200 kc, Springfield, Vt., First Congregational Church, Inc., 10 w, E. Shared.

WNBZ

1290 kc, Saranac Lake, N. Y., Smith & Mace, 10 w, daytime, E.

WNIJ

1450 kc, Newark, N. J., Radio Investment Co., 250 w, E, shared, "The Voice of Newark."

WNOX

560 kc, Knoxville, Tenn., Stercki Bros., 1000 w, C, shared, "Smoky Mountain Station."

WNRK

1440 kc, Greensboro, N. C., Wayne M. Nelson, 500 w, E.

WNYC

570 kc, New York, N. Y., Department of Plant & Structures, 500 w, E, shared, "Municipal Broadcasting Station of the City of New York."

WOAI

1190 kc, San Antonio, Texas, Southern Equipment Co., 5000 w, C, shared, "The Winter Playground of America."

WOAN

600 kc, Lawrenceburg, Tenn., Church of the Nazarene & Vaughan School of Music, 500 w, C, shared, "Watch Our Annual Normal."

WOAX

1280 kc, Trenton, N. J., Franklyn J. Wolff, 500 w, E, shared, "Trenton Makes, the World Takes."

WOBT

1310 kc, Union City, Tenn., Titsworth's Radio & Music Shop, 15 w, C.

WOBV

580 kc, Charleston, W. Va., Charleston Radio Broadcasting Co., 250 w, E. Shared.

WOC

1000 kc, Davenport, Iowa, Palmer School of Chiropractic, 5000 w, C. Shared.

WOCL

1210 kc, Jamestown, N. Y., A. E. Newton, 25 w, E.

WODA

1250 kc, Paterson, N. J., Richard E. O'Dea, 1000 w, E, "The Voice of the Silk City."

WOI

560 kc, Ames, Iowa, Iowa State College, 3500 w, C. Shared.

WOKO

1440 kc, Mt. Beacon, N. Y., Harold E. Smith, 500 w, E. Shared.

WOL

1310 kc, Washington, D. C., American Broadcasting Co., 150 w, daytime, E.

WOMT

1210 kc, Manitowoc, Wis., Mikado Theater, 100 w.

WOO

1500 kc, Philadelphia, Pa., John Wanamaker, 100 w, E.

WOOD

1270 kc, Grand Rapids, Mich., Walter B. Stiles, Inc., 500 w, C, shared, "The Voice of the Whispering Pines."

WOQ

610 kc, Kansas City, Mo., Unity School of Christianity, 1000 w, C. Shared.

WOR

710 kc, Newark, N. J., L. Bamberger & Co., 5000 w, E.

WORD

1480 kc, Batavia, Ill., People's Pulpit Association, 5000 w, C, shared, "The Watch Tower—Radio WORD."

WOS

630 kc, Jefferson City, Mo., State Marketing Bureau, 500 w, C, shared, "Watch Our State."

WOV

1130 kc, New York, N. Y., International Broadcasting Corp., 1000 w, E.

WOW

590 kc, Omaha, Neb., Woodmen of the World, 1000 w, C, shared, "The Omaha Station."

WOWO

1160 kc, Ft. Wayne, Ind., Main Auto Supply Co., 10,000 w, C. Shared.

WPAP

See under WQAO.

WPAW

1210 kc, Pawtucket, R. I., Frank Crook, Inc., 100 w, E, "The City of Diversified Industries." Shared.

WPCC

570 kc, Chicago, Ill., North Shore Congregational Church, 500 w, C. Shared.

WPCH

810 kc, New York, N. Y., Concourse Radio Corp., 500 w.

WPG

1100 kc, Atlantic City, N. J., Municipality of Atlantic City, 5000 w, E. Shared.

WPOR

See under WTAR.

WPRC

1200 kc, Harrisburg, Pa., Wilson Printing & Radio Co., 100 w, E.

WPSC

1230 kc, State College, Pa., Pennsylvania State College, 500 w, day, E, "The Voice of the Nittany Lion."

WPSW

1500 kc, Philadelphia, Pa., Philadelphia School of Wireless Telegraphy, 50 w, E, "First Wireless School in America."

WPTF

680 kc, Raleigh, N. C., Durham Life Insurance Co., 10,000 w, E. Shared.

WQAM

1240 kc, Miami, Fla., Electrical Equipment Co., 750 w, E. Shared.

WQAN

880 kc, Scranton, Pa., Scranton Times, 250 w, E. Shared.

WQAO

1010 kc, New York, N. Y., Calvary Baptist Church, 250 w, E.

WQBC

1360 kc, Utica, Miss., Utica Chamber of Commerce, 300 w, C.

WQBJ

1200 kc, Clarksburg, W. Va., John Raikes, 65 w, E.

WQBZ

1420 kc, Vierton, W. Va., J. H. Thompson, 60 w, E.

WRAF

1200 kc, La Porte, Ind., The Radio Club, Inc., 100 w. Shared.

WRAC

1370 kc, Erie, Pa., C. R. Cummins, 50 w, E.

WRAW

1310 kc, Reading, Pa., Avenue Radio & Electric Shop, 100 w, E, "The Schuylkill Valley Echo."

WRAX

1440 kc, Philadelphia, Pa., Berachah Church, Inc., 250 w, E.

WRBC

1240 kc, Valparaiso, Ind., Immanuel Lutheran Church, 500 w, C, "World Redeemed by Christ."

WRBI

1310 kc, Tifton, Ga., Kent's Furniture & Music Store, 20 w, E. Shared.

WRBJ

1500 kc, Hattiesburg, Miss., Woodruff Furniture Co., 10 w, C.

WRBL

1200 kc, Columbus, Ga., Roy E. Martin, 50 w, E.

A-C Operation

Tyrman "80"

Dynamic Speaker

A-C Shielded Grid Tubes



UX350 Short Wave

OR 310 Plug-in Coils

Power Phonograph

Amplifier Tube

Instant Success!!

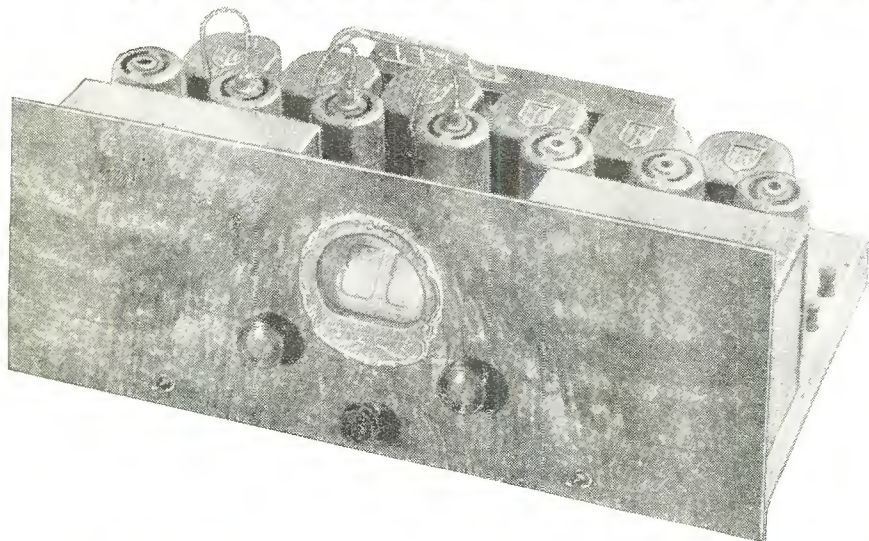

Amid all the fanfare of Custom Built Radio, there is one outstanding fact and that is Dealers and Set Builders are turning to Tyrman. There is no greater proof of success than repeat sales. That's the acid test!

Thank You

We want to take this opportunity to assure our thousands of friends that we appreciate your support. Such wonderful response to Tyrman products obligates us to continuous progress, offering only the finest products and to anticipate your demand in performance, design and value.

Is It Any Wonder Tyrman Leads?

Tyrman Engineers were the first to introduce the Shielded Grid principle. Now, a year later, other manufacturers adopt it as a feature. With a knowledge and experience unsurpassed in Shielded Grid, it was only natural that Tyrman should be the first to successfully employ A-C Shielded Grid Tubes in a completely A-C operated receiver. Again Tyrman introduces the "Year Ahead" radio.

You Can Easily Prove It

No need to take our word for it. Send for diagrams and descriptions. You will quickly recognize that the Tyrman "80" is not just another circuit of assembled parts. You will agree with thousands of others that it is a truly engineered receiver, every part designed to co-ordinate and interlock with each other, creating in the final assembly an A-C Receiver unrivalled for Sensitivity, Selectivity, Distance, Power and Tone.

FREE Send coupon for book of diagrams and descriptions and see for yourself why Dealers and Set Builders are so enthusiastic in their praise of Tyrman.

Tyrman Imperial "80"

Custom-Bilt Shielded Grid

Complete A-C Socket Operation using A-C Shielded Grid Tubes—Improved Circuit Design incorporating many advanced features and refinements—350 or 310 Power Amplifier—Permanent Phonograph Connection—Plug-in coils for Short Wave Reception—Dynamic Speaker operation direct from Power Supply—10 K. C. Selectivity, One Spot—Unequaled Sensitivity and Stability. Brings in Distance with tremendous volume. Marvelous Tone Quality.

Beautiful, Rich Appearance

Front Panel solid walnut on steel. Illuminated Drum Dials of special design.

Easily and Quickly Assembled

All essential parts made of finest quality materials with special tools and dies to assure duplication of laboratory model. Wiring automatically insulated and grounded.

Parts Complete—No Extras

Parts, including wired Power Supply, set of long and short wave plug-in coils, etc., complete, \$199⁵⁰

Completely assembled and tested, \$20.00 additional.

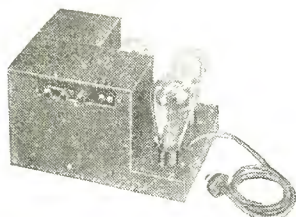

Tyrman "80" Power Supply
A powerful Power Supply designed solely for the Tyrman "80". Phone tips provided for any type speaker. Directly energizes field of dynamic speaker. Compact, completely wired. No adjustments.

TYRMAN ELECTRIC CORPORATION

319 W. Superior Street, Chicago, Illinois

TYRMAN ELECTRIC CORPORATION
319 W. Superior Street, Chicago, Ill.
Send me free literature describing Tyrman "80" A-C Shielded Grid Receiver.

Name

Address

WRBQ

1210 kc, Greenville, Miss., J. Pat Scully, 100 w, C.

WRBT

1370 kc, Wilmington, N. C., Wilmington Radio Association, 50 w, E.

WRBU

1210 kc, Gastonia, N. C., A. J. Kirby Music Co., 100 w, E.

WRBW

1310 kc, Columbia, S. C., Paul S. Pearce, 100 w, E.

WRC

950 kc, Washington, D. C., Radio Corporation of America, 500 w, E, "The Voice of the Capital."

WREC

600 kc, Whitehaven, Tenn., WREC, Inc., 500 w, Shared.

WREN

1220 kc, Lawrence, Kan., Jenny Wren Co., 1000 w, C. Shared.

WRHM

1250 kc, Fridley, Minn., Rosedale Hospital Co. Inc., 1000 w, C, shared, "Welcome Rosedale Hospital, Minneapolis."

WRJN

1370 kc, Racine, Wis., Racine Broadcasting Corp., 100 w, C. Shared.

WRK

1310 kc, Hamilton, Ohio, S. W. Doron & John C. Sladc, 100 w, E, "The Voice of Hamilton."

WRNY

1010 kc, New York, N. Y., Experimenter Pub. Co., 250 w, E. Shared.

WRR

1280 kc, Dallas, Texas, City of Dallas, 500 w, C. Shared.

WRUF

1470 kc, Gainesville, Fla., University Radio Service Co., 5000 w, E. Shared.

WRVA

1110 kc, Richmond, Va., Larus Bros. & Co., Inc., 5000 w, E, "Carry Me Back to Old Virginny."

WSAI

800 kc, Mason, Ohio, Crosley Radio Corp., 5000 w, E, shared, "The Gateway to Dixie."

WSAJ

1310 kc, Grove City, Pa., Grove City College, 100 w, E.

WSAN

1500 kc, Allentown, Pa., Allentown Call Pub. Co., 100 w, E, shared, "We Serve Allentown Nationality."

WSAR

1450 kc, Fall River, Mass., Doughty & Welch Electrical Co., Inc., 250 w, E. Shared.

WSAZ

580 kc, Huntington, W. Va., McKellar Electric Co., 250 w, E. Shared.

WSB

740 kc, Atlanta, Ga., Atlanta Journal Co., 10,000 w, E, "The Voice of the South."

WSBC

1210 kc, Chicago, Ill., World Battery Co., Inc., 100 w, Shared.

WSBT

1230 kc, South Bend, Ind., South Bend Tribune, 500 w, C. Shared.

WSDA

See under WSGH.

WSEA

780 kc, Portsmouth, Va., Virginia Broadcasting Co., Inc., 500 w, E, shared, "The Voice of Tidewater Virginny."

WSGH

1400 kc, Brooklyn, N. Y., Amateur Radio Specialty Co., 500 w, Shared.

WSIX

1210 kc, Springfield, Tenn., 638 Tire & Vulcanizing Co., 100 w, C.

WSKC

1410 kc, Bay City, Mich., James E. Davidson, 500 w, E, "Where the Summer Trail Begins."

WSM

650 kc, Nashville, Tenn., National Life & Accident Ins. Co., 5000 w, C, "We Shield Millions."

WSMB

1320 kc, New Orleans, La., Saenger Theaters, Inc., & Maison Blanche Co., 750 w, C, "America's Most Interesting City."

WSMD

1310 kc, Salisbury, Md., Tom F. Little, 100 w, E.

WSMK

570 kc, Dayton, Ohio, Stanley M. Krohn, Jr., 200 w, C, "The Home of Aviation."

WSPD

1340 kc, Toledo, Ohio, Toledo Broadcasting Co., 500 w, E. Shared.

WSRO

1420 kc, Middletown, Ohio, Harry W. Fahrlander, 100 w, C, "We Sell Radio Only."

WSSH

1420 kc, Boston, Mass., Tremont Temple Baptist Church, 100 w, E, shared, "Stranger's Sunday Home."

WSUI

580 kc, Iowa City, Iowa, State Univ. of Iowa, 500 w, C, shared, "The Old Gold Studio."

WSUN

See under WFLA.

WSVS

1370 kc, Buffalo, N. Y., Seneca Vocational School, 50 w, E, "Watch Seneca Vocational School."

WSYR

570 kc, Syracuse, N. Y., Clive B. Merewith, 250 w, E. Shared.

WTAD

1440 kc, Quincy, Ill., Illinois Stock Medicine Broadcasting Corp., 500 w, Shared.

WTAG

580 kc, Worcester, Mass., Worcester Telegram Pub. Co., Inc., 250 w, E, "The Voice From the Heart of the Commonwealth."

WTAM

1070 kc, Cleveland, Ohio, WTAM & WEAR, Inc., 3500 w, E, shared, "The Voice From the Storage Battery."

WTAQ

1330 kc, Eau Claire, Wis., Clyde S. Van Gordon, 1000 w, C. Shared.

WTAR

780 kc, Norfolk, Va., Reliance Electric Co., Inc., 500 w, E. Shared.

WTAW

1120 kc, College Station, Texas, Agri. & Mech. College of Texas, 500 w, C. Shared.

WTAX

1210 kc, Streator, Ill., Williams Hardware Co., 50 w, Shared.

WTAZ

1210 kc, Richmond, Va., W. Reynolds, Jr., and T. J. McGuire, 15 w.

WTBO

1420 kc, Cumberland, Md., Cumberland Electric Co., 50 w, E.

WTBQ

1500 kc, Wilmington, Del., E. Brandt Boylan, 100 w, E.

WTFI

1450 kc, Toccoa, Ga., Toccoa Falls Institute, 500 w, E.

WTHS

1310 kc, Atlanta, Ga., Atlanta Technological High School, 100 w, C. Shared.

WTIC

600 kc, Hartford, Conn., Travelers Insurance Co., 250 w, E, shared, "The Insurance City."

WTMJ

620 kc, Brookfield, Wis., Milwaukee Journal, 1000 w, C. Shared.

WWAE

1200 kc, Hammond, Ind., Dr. Geo. F. Courier, 100 w.

WWJ

920 kc, Detroit, Mich., The Detroit News, 1000 w, E.

WWL

850 kc, New Orleans, La., Loyola University, 5000 w, C. Shared.

WWNC

570 kc, Asheville, N. C., Chamber of Commerce, 1000 w, E.

WWRL

1500 kc, Woodside, N. Y., Wm. H. Rouman, 100 w, Shared.

WWVA

1160 kc, Wheeling, W. Va., John C. Stroebel, Jr., 5000 w, E. Shared.

Insist on the Original

for Better Results in Shielded Grid Circuits

Marvelous Results

with SHIELDPLATE A-C Shielded Grid Tubes

Months of Actual Performance Prove Stability and Long Life

SHIELDPLATE Shielded Grid Tubes

for Battery and A-C Operation

Improved Design Means Tone Power and Efficient Performance
 Rugged Construction Assures Long Life



Shieldplate SP 122 A-C Tube Note rugged construction

The wonderful performance and efficiency of D-C Shielded Grid Tubes, first introduced by Shieldplate, is again duplicated—Yes, even surpassed in SHIELDPLATE A-C Shielded Grid tubes.

Shortly after the introduction of the D-C Shielded Grid Tubes, Shieldplate Engineers, foreseeing the trend to A-C operation, began the development of the A-C Shielded Grid Tube. Now after months of actual performance, SHIELDPLATE A-C Shielded Grid Tubes have proved dependable, efficient and long lived when employed in circuits especially designed for their use.

Send for Free Descriptive Literature

See for yourself why SHIELDPLATE A-C Shielded Grid Tubes are outstanding in performance, long lived, and how they can be used in various ways for radio and television.

Shieldplate Tube Corporation
 Dept. 119—4049 Diversey Avenue
 CHICAGO, ILLINOIS

ALSO "Diatrons" Radio Tubes for Every Purpose

SHIELDPLATE TUBE CORPORATION
 Dept. 119, 4049 Diversey Ave., Chicago, Ill.
 Send me descriptive literature of Shieldplate tubes. I am particularly interested in _____ A-C _____ D-C.
 Name _____
 Address _____
 My Jobber _____

Tyrman "72" Custom-Built Shielded Grid

Battery Operation using D-C Shielded Grid Tubes
 or
 Complete A-C Operation using A-C Shielded Grid Tubes

A unique circuit design that provides an advanced Shielded Grid receiver for those who prefer battery operation or who are in a locality where A-C Power is not available. Even if assembled for Battery Operation the "72" can be converted to complete A-C Socket Operation by making a few simple changes. Sensitivity, Selectivity, Distance, Tone, Quality comparable only to the Tyrman "80." Send for free descriptive literature and diagrams showing both A-C and D-C circuits.

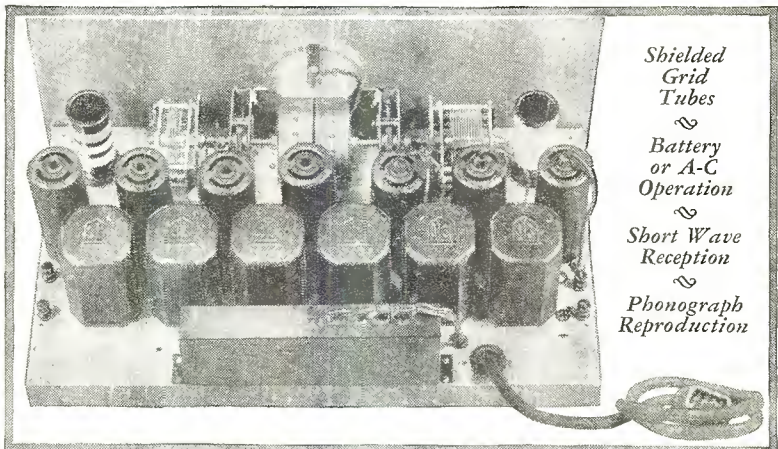

This shows the symmetrical layout of the Tyrman "72." Easily and quickly assembled.

Shielded Grid Tubes
 Battery or A-C Operation
 Short Wave Reception
 Phonograph Reproduction

In appearance the "72" resembles the "80". Front Panel is metal with walnut finish. Equipped with the New Tyrman Illuminated Double Drum Dial. 110 A-C switch and phonograph jack on front panel. Plug-in coils can be used for short wave reception. Like the "80" all parts for the "72" are specially built to insure uniformity. Parts complete including wire, lugs, etc. **\$98.50** List Price ready to assemble, less tubes.

"72" Power Supply for A-C Socket operation \$55.00 List
 Complete set of short wave coils \$10.00 List.

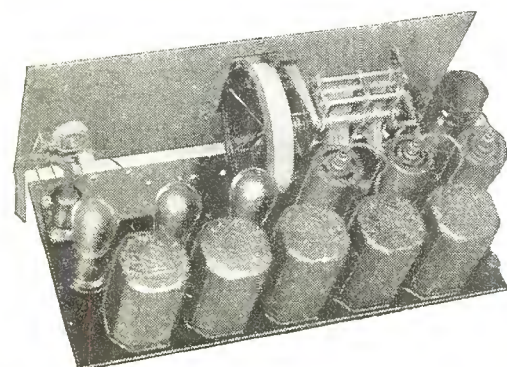

Tyrman "60" Custom-Built Shielded Grid

A QUALITY RECIEVER At a Low Price

The Tyrman "60" is a six tube receiver designed for battery or eliminator operation. Uses three Type 22 Shielded Grid tubes. Combines many features of the famous "70." For Appearance, Tone, Selectivity and Distance the Tyrman "60" sets a new standard in a quality receiver at a low price. Parts packed complete, ready to assemble **\$69.50**

TYRMAN ELECTRIC CORPORATION, CHICAGO, ILL.

TYRMAN ELECTRIC CORPORATION
 322 W. Superior St., Chicago, Ill.
 Send me free descriptive literature and diagrams of the (____ "72" A-C) (____ "72" D-C) (____ "60" D-C) Tyrman Custom Built Receivers.
 Name _____
 Address _____

U. S. Broadcasting Stations Listed by States

- ALABAMA**
 Auburn, WAPI
 Birmingham, WBRO, WKBC
 Gadsden, WBYJ
 Montgomery, WIBZ
- ALASKA**
 Anchorage, KFQD
 Juneau, KFIU
 Ketchikan, KGBU
- ARIZONA**
 Flagstaff, KFXV
 Phoenix, KFAD, KFGB
 Prescott, KPJM
 Tucson, KGAR
- ARKANSAS**
 Mlytheville, KLCN
 Fayetteville, KUOA
 Hot Springs, KTHS
 Little Rock, KLRN, KGHI,
 KGH
 McGehee, KGHG
 Siloam Springs, KFPW
- CALIFORNIA**
 Berkeley, KRE
 Beverly Hills, KEJK
 Burbank, KELW
 Culver City, KFVD
 El Centro, KXO
 Fresno, KMJ
 Glendale, KGFH
 Hayward, KZM
 Hollywood, KFQZ, KMTR,
 KXN
 Holy City, KFQU
 Inglewood, KMIC
 Long Beach, KFOR, KGER
 Los Angeles, KEJK, KFI,
 KFSG, KGEF, KFWB,
 KGFJ, KHL, KPLA, KTHI
 Oakland, KFWM, KGO, KLS,
 KLN, KTAP
 Ontario, KFVO
 Pasadena, KPPC, KPNS
 Sacramento, KPBK
 San Diego, KFSD, KGB
 San Francisco, KFRC, KFVI,
 KFTT, KJBS, KPO, KYA
 San Jose, KOW
 Santa Ana, KWTC
 Santa Barbara, KFGR
 Santa Maria, KSMR
 Santa Monica, KTM
 Stockton, KGDM, KWG
- COLORADO**
 Colorado Springs, KFUM
 Denver, KFEL, KFUP, KFXX,
 KOA, KOW, KPFP
 Dupont, KLZ
 Edgewater, KFXJ
 Fort Morgan, KGEW
 Greeley, KFKA
 Gunnison, KFHA
 Pueblo, KGPD, KGHF, KGHA
 Trinidad, KGIW
 Yuma, KGK
- CONNECTICUT**
 Easton, WICC
 Hartford, WTIC
 New Haven, WDRO
 Storrs, WCAC
- DELAWARE**
 Wilmington, WDEL, WTBO
- DISTRICT OF COLUMBIA**
 Washington, NAA, WMAL,
 WRC, WRHF
- FLORIDA**
 Clearwater, WFLA
 Gainesville, WRUF
 Jacksonville, WJAX
 Lakeland, WMLB
 Miami Beach, WIOD, WMBF,
 WQAM
 Orlando, WDBO
 Pensacola, WCOA
 Sarasota, WJBB
 Tampa, WDAE, WMBR,
- GEORGIA**
 Atlanta, WGST, WSB, WTHS
 Columbus, WRBL
 Macon, WMAZ
 Tifton, WRBI
 Toccoa, WTFI
- HAWAII**
 Honolulu, KGHB, KGU
- IDAHO**
 Boise, KFAU
 Idaho Falls, KGIO
 Jerome, KFXY
 Kellogg, KPEI
 Pocatello, KSEI
 Sandpoint, KGXX
 Twin Falls, KGIQ
- ILLINOIS**
 Bataria, WORD
 Carthage, WCAZ
 Chicago, KYIV, WAAF,
 WFL, WCRV, WEDC,
 WENR, WGES, WKBI,
 WPCC, WSBC, WGN,
 WMAQ, WMBI, WBBM
 Cicero, WHEC
 Crete, WLS
 Decatur, WJBL
 Deerfield, WHT
 Desplaines, WIBO
 Evanston, WEHS
 Galesburg, WLBO, WKBS
 Harrisburg, WEHQ
 Joliet, WCLS, WKBB
 La Salle, WJHC
 Mooseheart, WJJD
 Mt. Prospect, WJAZ
 Peoria Heights, WMBZ
 Quincy, WTAD
 Rockford, KRLD
 Rock Island, WHEF
 Springfield, WGBS
 Streator, WTAX,
 Tuscola, WJZ
 Urbana, WLL
 Zion, WCBD
- INDIANA**
 Anderson, WHBU
 Brookville, WKBY
 Crown Point, WLBT
 Culver, WCMA
 Evansville, WGBF
 Fort Wayne, WCWK, WOWO
 Gary, WJKS
 Hammond, WYAF
 Indianapolis, WFBI, WKBF
 Kokomo, WTAK
 La Porte, WRAF
 Muncie, WLBC
 South Bend, WSBT
 Terre Haute, WBOW
 Valparaiso, WIBC
 Lafayette, WBAA
- IOWA**
 Ames, WOI
 Boone, KFGQ
 Cedar Rapids, KWCR
 Clarinda, KSO
 Council Bluffs, KOIL
 Davenport, WOC
 Decatur, KGCA, KWLO
 Des Moines, WHO
 Ft. Dodge, KFJY
 Iowa City, WSUI
 Marshalltown, KFJB
 Muscatine, KTNT
 Ottumwa, WIAS
 Red Oak, KICK
 Shenandoah, KPNF, KMA
 Sioux City, KSCJ
 Waterloo, WMT
- KANSAS**
 Concordia, KGCN
 Lawrence, KFBU, WREN
 Manhattan, KSAO
 Milford, KFBR
 Topeka, WIBW
 Wichita, KFH
- KENTUCKY**
 Hopkinsville, KFIW
 Louisville, WHAS
 Okaloona, WLAP
- LOUISIANA**
 Cedar Grove, KGGH
 Kennonwood, KWEH
 New Orleans, WABZ, WCBF,
 WJBO, WJRW, WKBT,
 WSMF, WWL, WDSU
 Shreveport, KFDC, KSBA,
 KWEA, KRMD
- MAINE**
 Bangor, WABI
 Dover-Foxcroft, WLBZ
 Portland, WCSH
- MARYLAND**
 Baltimore, WCAO, WCBM,
 WSBF, WJES
 WRAL, WFRB
 Cumberland, WTBO
 Glen Morris, WBAL
 Salisbury, WSMD
- MASSACHUSETTS**
 Boston, WBZA, WEEL, WNAC,
 WSSB, WJES
 Chelsea, WLOB
 Dartmouth, WMAF
 East Springfield, WBZ
 Fall River, WSAR
 Gloucester, WEPS, WHOH
 Lexington, WLX
 Medford, WBET
 New Bedford, WNBH
- MINNESOTA**
 Anoka, WCCO
 Barrett, KGDE
 Collegeville, WFBJ
 Fridley, WRHM
 Hallock, KGFK
 Minneapolis, WDCY, WHDI,
 WLB
 Northfield, KFMP, WCAL
 Westcott, KSPF
- MISSISSIPPI**
 Columbus, WCOG
 Greenville, WBRQ
 Gulfport, WGM
 Hattiesburg, WRB
 Utica, WQBC
- MISSOURI**
 Cape Girardeau, KFVS
 Columbia, KFBU
 Independence, KMBC
 Jefferson City, WOS
 Joplin, WMBH
 Kansas City, KWKC, WDAF,
 WHB, WLRF, WOQ
 Kirksville, KFZ
 St. Joseph, KGBX, KFEO
 St. Louis, KFWE, KSD,
 KWK, WEW, WIL, WMAX,
 KMOX, KFUO
- MONTANA**
 Billings, KGHL
 Butte, KGIR
 Havre, KPBB
 Kalispell, KGEZ
 Missoula, KUOM, KGHD
 Vida, KGCS
- NEBRASKA**
 Clay Center, KMMJ
 Lincoln, KFAB, KFOR, WCAJ
 Norfolk, WJAG
 Omaha, WAAW, WOW
 Ravenna, KGFV
 York, KGBZ
- NEVADA**
 Reno, KOH
- NEW HAMPSHIRE**
 Laconia, WKAV
 Tilton, WBRL
- NEW JERSEY**
 Asbury Park, WCAP
 Atlantic City, WPG
 Camden, WCAM
 Elizabeth, WJBS
 Hoboken, WMCA, WPCH
 Jersey City, WAAT, WKBO
 Newark, WAAM, WGCP,
 WNJ, WOR
 Paterson, WODA
 Plainfield, WEAH
 Red Bank, WJBI
 Secaucus, WOY
 Union City, WBMS
 Trenton, WOAX
- NEW MEXICO**
 Albuquerque, KGGM
 Raton, KGFL
 State College, KOB
- NEW YORK**
 Astoria, WGBS
 Auburn, WMBQ
 Bay Shore, WJNR
 Bellmore, WFAF
 Bronx, WHPP
 Brooklyn, WBBC, WLTH,
 WJBO, WSGH
 Buffalo, WBRB, WGR,
 WKBW, WKEN, WSVS
 Canton, WCAD
 Cazenovia, WMLC
 Coney Island, WCGU
 Endicott, WNEF
- NEW YORK (cont.)**
 Farmingdale, WLBH
 Freeport, WGBB
 Greenville, WCOH
 Ithaca, WLCI, WEAI
 Jamaica, WMRJ
 Jamestown, WOCL
 Long Beach, WCLB
 Long Island City, WLBX
 Martinsville, WPAK
 Mt. Beacon, WOKO
 New York, WBNY, WHN,
 WJZ, WKBO, WMCA,
 WMSG, WNYC, WPCH,
 WRNY, WABC, WOV,
 WCDA, WQAO, WHAP,
 WLWL
 Rochester, WHAM, WHEC,
 WNYO
 Rossville, WBBR
 Saranac Lake, WNBZ
 Schenectady, WGY
 Syracuse, WFBL, WSYR
 Troy, WHAZ
 Utica, WIBX
 Woodhaven, WEVD
 Woodside, WWRL
- NORTH CAROLINA**
 Asheville, WVNC
 Charlotte, WBT
 Gastonia, WRB
 Greensboro, WRRO
 Raleigh, WPTF
 Wilmington, WRBT
- NORTH DAKOTA**
 Bismarck, KFJR
 Devils Lake, KDLR
 Fargo, WDAX
 Grand Forks, KFJM
 Mandan, KGCU
- OHIO**
 Akron, WADC, WFJC
 Bellefontaine, WHBD
 Canton, WIIC
 Cambridge, WBEA
 Cincinnati, WAAD, WFBE,
 WKRC
 Cleveland, WEAR, WHK,
 WJAX, WTAM
 Columbus, WAU, WCAH,
 WEAQ, WMAN
 Dayton, WSMK
 Hamilton, WRK
 Mansfield, WLBY
 Mason, WSAI, WLW
 Middletown, WSRO
 Springfield, WCSO
 Steubenville, WBR
 Toledo, WSPD
 Youngstown, WKBN
- OKLAHOMA**
 Alva, KGFF
 Chickasha, KOCW
 Enid, KGCB
 Norman, WNAD
 Oklahoma City, KFJE, KFJR,
 KGCB, KGFJ, WKY
 Picher, KGGF
 Ponca City, WBBZ
 Tulsa, KVOO
- OREGON**
 Astoria, KFJI
 Corvallis, KQAO
 Eugene, KOFB
 Marshfield, KOOS
 Medford, KMED
 Portland, KEX, KOIN, KFEC,
 KFIF, KFIE, KGW,
 KTRB, KWBS, KWJJ,
 KXL
- PENNSYLVANIA**
 Allentown, WGBA, WSN
 Altoona, WFBG
 Carbondale, WNBW
 East Pittsburgh, KDKA
 Elkins Park, WJBG
 Erie, WEDH, WRAC
 Frankford, WPKD
 Grove City, WSAJ
 Harrisburg, WRAC, WPRC
 Johnstown, WHBP
 Kingstown, WABF
 Lancaster, WGAL, WKJC
 Le Moyne, WMBB
 Lewisburg, WJBU
 Oil City, WLBW
 Philadelphia, WABY, WCAU,
 WFL, WBBW, WIAD, WIP,
 WLIT, WNAT, WOO,
 WRAX, WPSW, WPAH,
 WELK
 Pittsburgh, KQV, WCAE,
 WJAS
 Reading, WRAW
 Scranton, WGBI, WQAN,
 State College, WPSC
 Wilkes-Barre, WBAX, WBRB
 Wilkesburg, WBMJ
 Willow Grove, WALK
 Washington, WNBQ
- PORTO RICO**
 San Juan, WKAQ
- RHODE ISLAND**
 Cranston, WDWI
 Newport, WMBB
 Pawtucket, WPAW
 Providence, WEAN, WJAR
- SOUTH CAROLINA**
 Charleston, WBBY
 Columbia, WRBW
- SOUTH DAKOTA**
 Brookings, KFJY, KGOR
 Dell Rapids, KGDA
 Oldham, KGDY
 Pierre, KGFJ
 Rapid City, WCAT
 Sioux Falls, KSOO
 Vermillion, KUSD
 Yankton, WYAX
- TENNESSEE**
 Chattanooga, WDDO
 Knoxville, WFBC, WNBJ,
 WNOX
 Lawrenceburg, WOAN
 Memphis, WGPC, WHBQ,
 WMBM, WMC
 Nashville, WBAW, WLAC,
 WSM
 Springfield, WSIN
 Union City, WOBT
 White Haven, WREC
- TEXAS**
 Amarillo, KGRS, WDAQ
 Austin, KUT
 Beaumont, KFDM
 Breckenridge, KFYO
 Brownsville, KWVG
 College Station, WTAU
 Dallas, KRLD, WFAA, WRR
 Dublin, KFPL
 El Paso, WDAH
 Forth Worth, KFJZ, KFQB,
 WBAP
 Galveston, KFJX, KFUL
 Georgetown, KGBT
 Goldsboro, KGBB
 Greenville, KFPM
 Harlingen, KRFB
 Houston, KPRC, KTUE
 Richmond, KGHX
 San Angelo, KGET
 San Antonio, KGCI, KGDR,
 KGRC, KTAP, KTSB,
 WQAI
 Waco, WJAD
 Wichita Falls, KGKO
- UTAH**
 Ogden, KFUR
 Salt Lake City, KDYL, KSL
- VERMONT**
 Burlington, WCAH
 Springfield, WNBX
- VIRGINIA**
 Arlington, NAA
 Chesterfield Hills, WTAZ
 Mt. Vernon Hills, WJSV
 Newport News, WGH
 Norfolk, WBBW, WTAR
 Petersburg, WLBG
 Portsmouth, WSEA
 Richmond, WRBL, WMBG,
 WRVA, WTAZ
 Roanoke, WDBJ, WRBX
- WASHINGTON**
 Aberdeen, KXRO
 Bellingham, KVOS
 Everett, KFBL
 Lacey, KGY
 Longview, KUJ
 Pullman, KWSC
 Seattle, KOL, KFOU, KPO,
 KJR, KP, KOMO, KPBC,
 KNBC, KTW, KVL, KXA
 Spokane, KFIO, KFPY, KGA,
 KHQ
 Tacoma, KMO, KVI
- WEST VIRGINIA**
 Clarksburg, WQBJ
 Charleston, WOBV
 Fairmont, WMMN
 Huntington, WSZA
 Martinsburg, WQZB
 Wheeling, WVVV
- WISCONSIN**
 Appleton, WAIZ
 Beloit, WEBW
 Brookfield, WTMJ
 Eau Claire, WTAQ
 Fond Du Lac, KFJZ
 Kenosha, WOLO
 La Crosse, WLBH
 Madison, WHA, WIBA
 Manitowish, WQMT
 Milwaukee, WGWB, WEAD,
 WISN
 Poyntette, WIBU
 Racine, WRJN
 Sheboygan, WHEB
 Stevens Point, WLBL
 Superior, WERC
 West De Pere, WHBY
- WYOMING**
 Laramie, KFBU

Let Me Start you in this ~ Amazing new Business Of your Own ~ Now!

\$5.00
DOWN STARTS
YOU

MAKE \$5,000 TO \$15,000 A YEAR in Your Own Home, Basement or Garage Charging and Repairing Batteries

Here's your great opportunity to get into a Big Pay field that's growing by leaps and bounds—charging and repairing batteries. A \$5 deposit brings all the tools and equipment to get started in a real business of your own that brings you \$5,000 to \$15,000 a year. Clip coupon below and get complete facts.



\$950 IN 5 WEEKS FOR TREGO

"I never dreamed money was so easy to make. Your charger has given me independence I never before enjoyed."

Pocket 90c Clear Profit on Every Battery

I have invented a new Service Station Charger which saves 40% to 60% in electric current, yet handles 50% to 70% more batteries than similar outfits. Millions and millions of batteries in daily use by auto owners everywhere. Amazing new principle of my Service Station Charger simply scoops up all the business in town for you. My Free Book tells you how to get started.

No Experience or Education Required

Why go along at \$25, or \$30 a week when the battery fields holds out an opportunity for you to make upwards of \$5,000 a year? Easy to get started with my charger. When the outfit arrives, you're all ready to begin business. Simply let the business roll in. Charger is automatic and requires no attention during operation. Profits go into your pocket without effort on your part. Free Book tells how.



\$425 IN 18 DAYS FOR WHALEN

"I am now making money easier than at my job. Thank you for the wonderful prosperity your charger has given me."

\$5.00 Is All You Need to Start

Clip coupon and get your Free copy of my book "Big Profits." Read how hundreds of other fellows like yourself have established themselves in their own business. See the description of my amazing Service Station Charger. Find out about my plan for establishing you in this Big Pay field for only \$5. Along with the charger goes my complete outfit of tools, supplies, testers, advertising—in fact everything that you need to do business—you can take in \$20 a day or more right from the start. Get your copy of this book quick.

Free Advertising, Tools, and Working Outfits

As an owner of my charger you get the benefit of my advertising. When you open up, customers come right to your door. No soliciting—no plugging for business. Everybody is more than anxious to give you their trade.

Operate in Full or Spare Time

At first you can still work on your regular job. Go to your job in the morning and your batteries will be fully charged when you come home. You can make more money in this way during your spare time than at your job. Free book explains just how to do it.



Address me Personally. C.F. Holmes, Chief Engineer, Independent Electric Works, Dept. 37, 5116 Ravenswood Ave., Chicago, Ill.



\$85 A WEEK FOR McDERMOTT

"You are the best company I ever dealt with. My own station is now bringing me in plenty of money, with practically no effort."

GET YOUR COPY OF BIG PROFITS

Over 100 Illustrations

Find out the facts for yourself without one cent of expense. Read what the other fellows are doing. Let me show you how easy it is to get started—with only \$5.00 and how quickly you can build up your own business netting you \$5,000 to \$15,000 a year. Clip and mail coupon now.

Address Me Personally

C. F. HOLMES, Chief Eng.
Independent Electric Works, Dept. 37
5116 Ravenswood Avenue
Chicago, Ill.

7 BIG FREE OUTFITS

for Quick Action

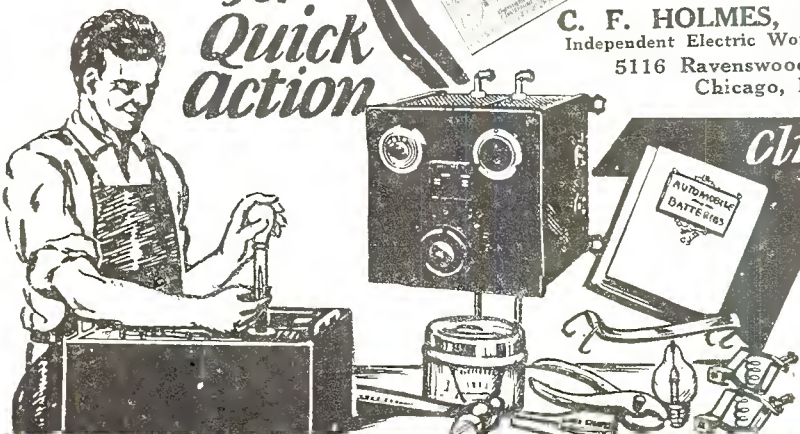

Clip Coupon Quick ~ ~

C. F. HOLMES
5116 Ravenswood Ave., Dept. 37
Chicago, Ill.

Rush me by return mail a copy of your Free Book "Big Profits."

Name.....
Address.....

If you are earning Less than \$90.00 a week mail Coupon

U. S. Broadcasting Stations by Frequencies

550 Kilocycles, 545.1 Meters:
WEAN, WGR, WEAQ, WKRC, KFUO, KSD, KFDY, KFYP, KFJM, KTAB

560 Kilocycles, 535.4 Meters:
WLIT, WFL, KFDM, WMBF, WNOX, WOI, KFEQ, KOAC, KLZ

570 Kilocycles, 526.0 Meters:
WNYC, WMCA, WSYR, WMAC, WSMK, WKBN, WWNC, KGKO, WHA, WNAX, WPCC, WIBO, KUOM, KXA, KMTR, KPLA

580 Kilocycles, 516.9 Meters—Canadian Shared:
WTAG, WKAQ, WOBW, WSAZ, KGFX, KSAC, WSUI

590 Kilocycles, 508.2 Meters:
WEEL, WEMC, WCAJ, WOW, KHQ

600 Kilocycles, 499.7 Meters—Canadian Shared:
WTIC, WCAO, WREC, WOAN, WEBW, KFSO, KFBW

610 Kilocycles, 491.5 Meters:
WFAN, WIP, WDAF, WOQ, KFRC

620 Kilocycles, 483.6 Meters:
WLBZ, WDBO, WDAE, WTMJ, KGW, KFAD

630 Kilocycles, 475.9 Meters—Canadian Shared:
WMAL, WOS, KFRU, WGBF

640 Kilocycles, 468.5 Meters:
WAIU, KFI

650 Kilocycles, 461.3 Meters:
WSM

660 Kilocycles, 454.3 Meters:
WEAF, WAAW

670 Kilocycles, 447.5 Meters:
WMAQ

680 Kilocycles, 440.9 Meters:
WPTF, KPO

690 Kilocycles, 434.5 Meters—Canadian Wave:

700 Kilocycles, 428.3 Meters:
WLW, KFVD

710 Kilocycles, 422.3 Meters:
WOR

720 Kilocycles, 416.4 Meters:
WGN, WLIB

730 Kilocycles, 410.7 Meters—Canadian Wave:

740 Kilocycles, 405.2 Meters:
WSB, KMMJ

750 Kilocycles, 399.8 Meters:
WJR, WCX

760 Kilocycles, 394.5 Meters:
WJZ, WEW

770 Kilocycles, 389.4 Meters:
KFAB, WBBM, WJBT

780 Kilocycles, 384.4 Meters—Canadian Shared:
WBSO, WSEA, WTAR, WPOR, WMC, KELW, KTM

790 Kilocycles, 379.5 Meters:
WGY, KGO

800 Kilocycles, 374.8 Meters:
WSAI, WBAP, KTHS

810 Kilocycles, 370.2 Meters:
WPCB, WCCO

820 Kilocycles, 365.6 Meters:
WHAS

830 Kilocycles, 361.2 Meters:
KOA, WHOH

840 Kilocycles, 356.9 Meters—Canadian Wave:

850 Kilocycles, 352.7 Meters:
KWKH, WWL, KFQZ

860 Kilocycles, 348.6 Meters:
WBOQ, WABC

870 Kilocycles, 344.6 Meters:
WLS, WENR, WBCN

880 Kilocycles, 340.7 Meters—Canadian Shared:
WQAN, WGBI, WCOC, KLX, KPOF, KFKA

890 Kilocycles, 336.9 Meters—Canadian Shared:
WJAR, WMMN, WMAZ, WGST, KGJF, WILL, KUSD, KFNF

900 Kilocycles, 331.1 Meters:
WFLB, WMAK, WKY, WFLA, WSUN, WLBL, KHJ, KSEI, KGBU

910 Kilocycles, 329.5 Meters—Canadian Wave:

920 Kilocycles, 325.9 Meters:
WWJ, KPRC, WAAF, KOMO

930 Kilocycles, 322.4 Meters—Canadian Shared:
WIBG, WDBJ, WBRC, KGBZ, KMA, KFWM, KFWI

940 Kilocycles, 319 Meters:
WCSH, KFIW, KOIN, KGU, KFEL, KFNF

950 Kilocycles, 315.6 Meters:
WRC, KMBC, KLDS, WHB, KFWB, KPSN, KGHL

960 Kilocycles, 312.3 Meters—Canadian Wave:

970 Kilocycles, 309.1 Meters:
WCFL, KJR

980 Kilocycles, 305.9 Meters:
KDKA

990 Kilocycles, 302.8 Meters:
WBZ, WBZA

1000 Kilocycles, 299.8 Meters:
WHO, WOC, KGFH

1010 Kilocycles, 296.9 Meters—Canadian Shared:
WQAO, WPAF, WHN, WRNY, KGGF, WNAD, WJBB, KQW

1020 Kilocycles, 293.9 Meters:
KYW, KFKX

1030 Kilocycles, 291.1 Meters—Canadian Wave:

1040 Kilocycles, 288.3 Meters:
WKEN, WKAR, WFAA, KRLD

1050 Kilocycles, 285.5 Meters:
WFBM, KNX

1060 Kilocycles, 282.8 Meters:
WBAL, WJAG, KWJJ

1070 Kilocycles, 280.2 Meters:
WAAT, WTAM, WEAR, WCAZ, WDWZ

1080 Kilocycles, 277.6 Meters:
WBT, WCBW, WMBI

1090 Kilocycles, 275.1 Meters:
KMOX, KFQA

1100 Kilocycles, 272.6 Meters:
WPG, WLWL, KJBS

1110 Kilocycles, 270.1 Meters:
WRVA, KSOO

1120 Kilocycles, 267.7 Meters—Canadian Shared:
WCOA, WTAW, KUT, WISN, WHAD, KFSG, KMIC, KRSC

1130 Kilocycles, 265.3 Meters:
WVOV, KFKB, KSL

1140 Kilocycles, 263.0 Meters:
WAPI, KVOO

1150 Kilocycles, 260.7 Meters:
WHAM, KGDM

1160 Kilocycles, 258.5 Meters:
WVVA, WOWO

1170 Kilocycles, 256.3 Meters:
WCAU, KTNT

1180 Kilocycles, 254.1 Meters:
WGBS, WJJD, KEX, KOB

1190 Kilocycles, 252.0 Meters:
WICC, WOAI

1200 Kilocycles, 249.9 Meters: Canadian Shared:

WABI, WCAK, WNBX, WEPS, WKBE, WIBX, WBBW, WFBE, WHBC, WLAP, WLBG, WNBQ, WPRC, WKJG, WNBW, WQBZ, WABZ, WJBW, WBBY, WBBZ, WFBC, WRBL, KGCU, WJBC, WJBL, WFAE, WRAF, WMT, KFJB, WCAT, KGDY, WMAY, KFWF, KFKZ, KGDE, KGFK, WCLO, WHBY, KFWC, KPCC, KXO, KMJ, KSMR, KWG, KGEK, KGEW, KFHA, KVOB, KGY

1210 Kilocycles, 247.8 Meters—Canadian Shared:

WJBI, WGBB, WINR, WCOH, WOCL, WLCI, WPAV, WDFW, WLSI, WMAN, WLBW, WEBE, WBAX, WJBU, WTAZ, WMBG, WSIX, WRBU, WJBY, WMBR, WRBO, WPCM, KFDX, KWEA, KDLR, KGGP, KFOR, WHBU, KFVS, WBOQ, WSBC, WCRW, WEDC, WCBQ, WTAZ, WHBF, WIBA, WOMET, KGDP, KFEY, KPQ, KPCB

1220 Kilocycles, 245.6 Meters:
WCAD, WCAE, WREN, KFKU

1230 Kilocycles, 243.8 Meters:
WNAC, WBIS, WPSC, WSBT, WCWK, WFBM, KYA, KFIO, KFQD

1240 Kilocycles, 241.8 Meters:
WGHF, KFQB, WJAD, WQAM, WIOD, WRBC

1250 Kilocycles, 239.9 Meters:
WGCP, WODA, WAAM, WLB, WGMS, WRHN, KFMX, WCAL, KFON, KEJK, KXL, KIDO

1260 Kilocycles, 238.0 Meters:
WLBW, WJAX, KWWG, KRGV, KOIL

1270 Kilocycles, 236.1 Meters:
WEAL, WASH, WOOD, WDSC, KWLC, KGCA, KTW, KOL, KFUM, WFBF

1280 Kilocycles, 234.2 Meters:
WCAM, WCAP, WOAX, WDOD, WRR, WDAY, WEBC

1290 Kilocycles, 232.4 Meters:
WNBZ, WJAS, KTSB, KFUL, KLCN, KDYL

1300 Kilocycles, 230.6 Meters:
WBBB, WHAP, WEVD, WHAZ, KFII, WLBW, KGEF, KTBI, KFJR, KTBR

1310 Kilocycles, 228.9 Meters:
WKAV, WEBR, WSMD, WNBH, WOL, WGH, WRK, WAGM, WMBH, WFDF, WNAT, WABY, WFKD, WHBF, WFBG, WRBW, WGBL, WSAJ, WBRE, WMBL, WKBC, WRBW, KGHG, WTHS, WRBI, WOBT, WNBZ, KRMD, KGGH, KFPML, WDAH, KGFJ, KFPL, KFNR, WKBS, WLBO, WEHS, WCLS, WKBB, WKBI, WHFC, KWCR, KFJY, KFGO, WBOV, WJAK, WLBC, WIBU, KFBK, KFCB, KFIU, KGEZ, KFUP, KFNJ

1320 Kilocycles, 227.1 Meters:
WADC, WSMB, KGIO, KGIO, KGHF, KGHB

1330 Kilocycles, 225.4 Meters:
WDRG, WCAC, WTAQ, KSCJ

1340 Kilocycles, 223.7 Meters:
WSPD, KFPW, KMO, KVI

1350 Kilocycles, 222.1 Meters:
WBNY, WMSG, WCDA, WKBQ, KWK

1360 Kilocycles, 220.4 Meters:
WBET, WMAF, WQBC, WJKS, WGES, KFBK, KGIR, KGB

1370 Kilocycles, 218.8 Meters:
WMOB, WSVS, WCBM, WEAM, WBLB, WHBD, WJBC, WIBM, WRAC, WELK, WJBO, WHBO, WRBT, KGFG, KGCB, KGCI, KGRC, KFJZ, KGKL, KFLX, WFBJ, KGDA, KZM, KRE, KGER, KFBL, KKP, KPEC, KWKC, KGBX, WRJN, KGA, KFUR, KOH, KVL, KFJI, KGFL, KGGM, WHDF, KOOS

1380 Kilocycles, 217.3 Meters:
WCSO, KQV, KSO, WKBH

1390 Kilocycles, 215.7 Meters:
WHK, KLRA, KUOA, KOW, KWSC, KPPY, WDGY, WHDI

1400 Kilocycles, 214.2 Meters:
WCGU, WSGH, WSDA, WLTH, WBBC, WBAA, WCMA, WKBZ

1410 Kilocycles, 212.6 Meters:
WDEL, WSKC, KGRS, WDAG, KFLV, WHBL

1420 Kilocycles, 211.1 Meters:
WLBH, WHPP, WMRJ, WLEX, WTBO, WSSH, WRSO, WBR, WAAD, WEDH, WMBG, WKBP, WOBZ, KGFF, KOCW, WKBT, KTAP, KTUE, KFYO, KICK, WIAS, KGCN, WLBZ, WMBH, KGFV, KFIZ, KFNY, KGFJ, KFQU, KGTT, KFND, KGHD, KGCN, KFIF, KMED, KORE, KFQW, KXRO, WIL, KGIW, KGXX

1430 Kilocycles, 209.7 Meters:
WBRL, WMBS, WCAH, WGCN, WNBZ, WBAK

1440 Kilocycles, 208.2 Meters:
WHEC, WABO, WOKO, WABF, WRAX, WNRG, WTAD, WMBD, KLS

1450 Kilocycles, 206.8 Meters:
WBMS, WNJ, WBS, WKBO, WSAR, WJAY, WFJC, KSB, WTFI

1460 Kilocycles, 205.4 Meters:
WJSV, KSTP

1470 Kilocycles, 204.0 Meters:
WKBW, KFJF, WRUF, KGA

1480 Kilocycles, 202.6 Meters:
WJAZ, WHT, WORD

1490 Kilocycles, 201.6 Meters:
WBAW, WLAC, WFBL

1500 Kilocycles, 199.9 Meters:
WMBZ, WLOE, WMES, WNBQ, WNBZ, WMBQ, WLBX, WCLB, WTBO, WWRL, WAFD, WKBZ, WMPG, WMBJ, WCRB, WSAK, WALK, WOO, WHBV, WPSW, WIBZ, KFHL, WRBJ, WMBM, KGKB, GDSR, KGHX, WKBV, KPJM, KWBS, KWTC, KFCR, KUJ

"How I Laughed Myself Into Success in Radio"

by Howard Clark

"I'm sitting on top of the world! My bank account is growing fatter every day . . . my home is all paid for . . . I've just ordered a new car . . . and my wife and I can at last enjoy life in real style. It sure feels great to be earning big money. And to think how it all came about!"

IT happened on a rainy Monday night. I was reading a magazine while Mary was clearing away the supper dishes. Suddenly a funny cartoon caught my eye . . . and I laughed out loud.

"Jim, you make me sick!" she cried. "How can you laugh while I'm nearly dying of weariness!"

"But Mary dear—"

"Don't dear me, you idiot!"

I was alarmed. "Great heavens, what's wrong?"

"Wrong?" she screamed, "here I drudge all day, do my own housework, wash all the clothes, take care of the baby, and worry about your meals. I never get a moment of freedom . . . and haven't a decent thing to wear even to church . . . yet you never seem to care!"

I was ashamed!

A feeling of shame swept over me. So that was why she seemed so "moody" the last few days! Like a good sport she had suffered in silence until she couldn't keep it in any longer. Poor kid!

For hours after Mary had gone to bed that night I kept staring into space. What a mess I had made of our lives . . . What a slave I had made of her.

Listlessly I kept thumbing the pages of the magazine . . . thinking . . . thinking. Was there no way out of it?

Then suddenly . . . as if by some kind act of Providence . . . I stopped before a story. It told of a fellow who had made quite a fortune in an uncrowded profession. Fascinated, I read on. It told of the brilliant opportunities in the radio industry . . . of the big incomes fellows like myself were earning . . . and of the ease with which expert radio training could be acquired. But what impressed me most was the



fact that success was practically assured by means of a new home-study laboratory method sponsored by three of America's great corporations.

With gigantic enterprises like these behind a school I needed no greater guarantee . . . so without a second's further hesitation I tore the coupon and mailed it.

A lucky event that changed my life

It sure was my lucky day, when the first lessons came in. I never dreamed that learning radio was so easy. I didn't know the first thing about it when I started. Yet before many months were over I was able to solve many of the problems which command big pay.

Each subject was explained in simple word and picture form. It carried me along like a novel. From magnetism and electricity the lessons took me step by step through trouble-finding and repairing—through ship and shore and broadcasting apparatus operation and construction—through photoradiograms, television and beam transmission.

I didn't have to give up my regular job. I stayed right at home and learned

during my spare time. I actually learned by doing. With the lessons I received a complete, expensive storehouse of apparatus with which I was able to build radio circuits and sets of almost every description. Yet it cost me absolutely nothing extra.

As a result of this practical, technical working out of big radio problems with a fine home-laboratory, I was able to earn good money even before I had completed my course! And it wasn't long before I was able to quit my regular work entirely . . . and branch out for myself in big paying radio jobs.

Today, I have more work than I can take care of. And I often make more money in a day than I used to earn in a week.

Read this thrilling Free Book

Howard Clark's story is typical of the success which scores of other men have achieved . . . through the "big-league" training given by the home-study course of the Radio Institute of America . . . the only school in America sponsored by RCA, General Electric and Westinghouse.

Radio needs you. Manufacturers, dealers, broadcasting stations, ships . . . all need trained radio experts. The pay is big. The opportunities are limitless . . . The work is thrilling! Find out all about it. The Institute has prepared an interesting, illustrated booklet telling you all you want to know about this vast industry and about the remarkable home-study course that can fit you for a brilliant radio career. Just mail the coupon below . . . the booklet is absolutely free. Radio Institute of America, 326 Broadway, New York.

Mail this coupon

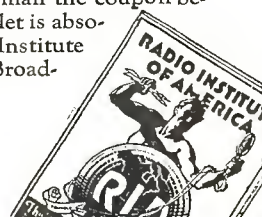

Radio Institute of America
Dept. CB-1, 326 Broadway, New York

Gentlemen: Please send me your big FREE 50-page book which tells about the great opportunities in Radio and about your famous laboratory-method of radio instruction at home.

Name.....
Address.....

CANADIAN STATIONS

Table of Canadian radio stations categorized by province: PRINCE EDWARD ISLAND, QUEBEC, SASKATCHEWAN, ALBERTA, BRITISH COLUMBIA, MANITOBA, NEW BRUNSWICK, NOVA SCOTIA, and ONTARIO. Columns include Call, Wave, Power, and Call.

SHORT WAVE PHONE AND TELEGRAPH STATIONS

Table of short wave phone and telegraph stations with columns for Call, Frequency (K.C.), Meters, Owner, and Apertures.

SHORT WAVE TELEVISION STATIONS

Table of short wave television stations with columns for Call, K.C., Meters, Owner, and Apertures.

FOREIGN BROADCAST STATIONS

(Much of the data here shown is supplied by the Bureau of Foreign and Domestic Commerce Division of the Department of Commerce)

Large table of foreign broadcast stations organized by country: ARGENTINA, AUSTRALIA, AUSTRIA, BELGIUM, BOLIVIA, BRAZIL, CHILE, CHINA, and CUBA. Columns include Call, Wave, and Call.

Call	Wave
2JF	Mariana 294
2JL	Mariana 294
5DW	Matanzas 270
6HS	Sagua la Grande 200
6KP	Saotei Spiritus 195
8HS	Santiago 200
8DY	Santiago 255
8FU	Santiago 150
8IR	Santiago 130
8IQ	Santiago 130
6XJ	Tuimenu 278
6KW	Tuimenu 340

CZECHOSLOVAKIA

OKR	Bratislava 300
OKB	Brum 441.2
	Kosice 263
OKP	Prague 384.9

DENMARK

D7RL	Copenhagen 84.25
D7MK	Copenhagen 32.05
	Copenhagen 337.4
	Kalundborg 1535
	Ryfaag 1170
	Soro 1153.8

ESTONIA

	Tallinn 408
	Tallinn 1200

FINLAND

	Rjorneborg 254.2
	Helsingfors 500
	Helsingfors 31.5
	Helsingfors 240
	Jacobstad 275.2
	Jyvaskyla 1575
	Lahitis 1575
	Lahitis 318
	Mikeli 566
	Tammerfors 400
	Uleaborg 250
	Viborg 240

FRANCE

2BD	Agen 297
	Agen 30.75
	Reziors 180
	Bordeaux 419
	Ecaamp 200
	Grenoble 416
	Juan les Pins 246
	Lihogues 285
	Lille 267.3
	Lyons 291
	Lyons 40.2
	Lyons 480
	Marseilles 300
	Monte de Marzan 390
	Montpelier 23.8
	Naney 15.5
	Nimes 240
	Nozent sur Seine 80
	Paris 1750
	Paris 308
	Paris 2650
	Paris 17.63
	Paris 458
	Paris 350
	Paris 340.9
	Paris 32
	Paris 61
	Paris 37
	Rennes 294
	Strasbourg 222.2
	Toulouse 260
	Toulouse 389.6

YR	Lyons 40.2
YN	Lyons 480
	Marseilles 300
	Monte de Marzan 390
	Montpelier 23.8
	Naney 15.5
	Nimes 240
FSAY	Nozent sur Seine 80
	Paris 1750
	Paris 308
	Paris 2650
	Paris 17.63
	Paris 458
	Paris 350
	Paris 340.9
	Paris 32
	Paris 61
	Paris 37
	Rennes 294
	Strasbourg 222.2
	Toulouse 260
	Toulouse 389.6

GERMANY

	Aix-la-Chapelle 400
	Augsburg 566
	Berlin 566
AFT	Berlin 1250
	Berlin 438.9
	Breslat 322.6
	Bremen 272.7
	Cologne 283
	Danzig 272.7
	Doheritz 67.65
AFK	Doheritz 37.65
AFK	Dortmund 283
	Dresden 275.2
	Eberfeld 268.8
	Freiburg 577
	Frankfurt 428.6
	Gleiwitz 320.7
	Hanover 297
	Hamburg 394.7
	Kaiserlautern 204.1
	Kassel 252.1
	Kiel 254.2
	Konigsberg 303
	Langenberg 468.8
	Leipzig 365.8
	Munchen 535.7
	Munich 235.7
	Munster 241.9
	Nauen 56.7
AGJ	Nauen 17.2
AGC	Nordfieh 183.9
	Nurenberg 241.9
	Scharbeck 230
	Stettin 236.2
	Stuttgart 379.7
	Zeesen 4000
AFB	Zeesen 2900
AFP	Zeesen 1250

GREAT BRITAIN

2BD	Aberdeen 500
2BE	Belfast 306.1
5FT	Birmingham 326.1
6FM	Birmingham 491.8
2LS	Birmingham 252.1
5WA	Cardiff 353
2NA	Catherham 32.5
6SW	Chelmsford 24
5GB	Daventry 491.8
5XX	Daventry 1604.3
2DF	Dundee 294.1
2EH	Edinburgh 458.5
5SC	Glasgow 465.4
6KI	Hull 294.1
2LS	Leeds-Bradford 277.8
6LV	Liverpool 297
2LO	London 361.4
2ZY	Manchester 384.6

Call	Wave
5NO	Newcastle 312.5
5NG	Nottingham 275.2
5PY	Plymouth 400
6FL	Sheffield 272.7
6ST	Stoke-on-Trent 294.1
5SX	Swansea 294.1

HAITI

HHK	Port au Prince 361.2
-----	----------------------------

HOLLAND

PCJJ	Bloemendaal 566
PCFF	Eindhoven 31.4
HDO	De Bilt 1100
	Hilversum 1060
	Huisen 340.9
	IJousen 1950
PCLL	Kootwij 18.4
	Scheveningen 1950

HUNGARY

MTI	Budapest 555.6
MT2	Budapest 1050

ICELAND

22SH	Akureyri 192
	Reykjavik 333.3

INDIA AND CEYLON

7BY	Bombay 357.1
2AX	Bombay 320
2FY	Bombay 387
7CA	Calcutta 370.4
YPR	Colombo 400
2GR	Madras 400
2HZ	Rangoon 350

IRISH FREE STATE

6CK	Cork 400
2RN	Dublin 319.1

ITALY

1MI	Milan 315.8
1NA	Naples 333.3
1RO	Rome 449
1LX	Rome 45

JAPAN

JHBB	Hirasio 37.5
JOPK	Hiroshima 353
JODK	Keijo 357
JOGK	Kumamoto 380
JOCK	Nagoya 360
JOBK	Osaka 385
JFAB	Taipah 39.5
JOAK	Tokyo 375
JOJK	Sapporo 361
JOHK	Sandai 390

JAVA

JFC	Batavia 220
ANH	Malabar 17
	Surabaya 140
ANE	Vandoeng 31.86
ANE	Vandoeng 15.93
	Vandoeng 310

JUGOSLAVIA

	Zagreb 275.2
--	--------------------

CHOSEN

JODK	Seoul 357
------	-----------------

KWANTUNG

JQAK	Dairen 395
------	------------------

LATVIA

KCX	Riga 526.3
-----	------------------

LITHUANIA

	Kaunas 2000
--	-------------------

MEXICO

CZF	Chihuahua 325
CYS	Ciudad Lerdo 250
OYA	Guadalajara 250
CZC	Jalapa 475
CYY	Merida 548.6
CYX	Mexico City 325
CFX	Mexico City 357
CYB	Mexico City 410
CFG	Mexico City 450
CZJ	Mexico City 470
CZA	Mexico City 507
CZM	Mexico City 600-500
XEI	Monterey 311
XEI	Morelia 300
CYP	Oaxaca 265
NEE	Puebla 312

NEW ZEALAND

1YA	Auckland 420
3AC	Christchurch 400
3YA	Christchurch 306
4YA	Dunedin 463
2ZF	Palmerston 280
2YA	Wellington 420
2YK	Wellington 295

NORWAY

	Aalesund 511
	Bergen 31.25
LGN	Bergen 30
	Bergen 370.4
	Fredrikstad 434.8
	Notodden 412
	Oslo 370.4
	Porsgrund 405
	Rjukan 447.8
	Stavanger 277.6
	Tromso 500
	Trondhjem 243.9

PERU

OAX	Lima 360
-----	----------------

PHILIPPINES

KZIB	Manila 260
KZKZ	Manila 270.1
KZRM	Manila 413

POLAND

	Cracow 422
	Kattowitz 422
	Posen 270.3
AXO	Warsaw 1111
	Wilna 435

PORTUGAL

PTAA	Lisbon 305
------	------------------

Call	Wave
PAJ18	Almeria 320
PAJ13	Barcelona 462
PAJ1	Barcelona 344.8
PAJ13	Barcelona 277.8
PAJ9	Bilbao 434.3
PAJ8	Cadiz 400
PAJ16	Cartagena 330
PAJ5	Las Palmas (Canary Islands) 250
PAJ5	Las Palmas (Canary Islands) 350
PAM	Madrid 37.7
PAJ7	Madrid 420
PAJ2	Madrid 420
PAJ25	Malaga 250
PAJ19	Oviedo 280.4
PAJ27	Salamanca 500
PAJ8	San Sebastian 297
PAJ17	Seville 434.8

STRAITS SETTLEMENTS

1SE	Singapore 330
-----	---------------------

SWEDEN

SASE	Boden 1190
SMYB	Boras 230.8
SMXF	Gavle 204.1
SASE	Goteborg 416.7
SMZK	Falun 315.8
SMTC	Estskuna 350
SMSB	Halmstad 215.8
SMYE	Halsjuborg 229
	Hamar 555.8
SMSL	Iduksvall 272.7
SMZD	Jonkopung 201.3
SMSW	Kalmer 254.2
	Karlsborg 52.2
SMSM	Karlskrona 196
SMXG	Karlstad 220.6
SMTG	Kiruna 238.1
SMTI	Kristinehamn 202.7
SMCW	Linkoping 500
SMXO	Malmberget 400
SASC	Malmo 260.9
SASG	Motala 1380
SAYV	Norrkopung 275.2
SMTI	Ornskoldsvik 286.2
SMZA	Ostersund 187.5
SASF	Ostersund 720
SMTS	Safle 252.1
SASA	Stockholm 454.5
SASD	Sundsval 545.6
SMXQ	Trollhattan 277.8
SMZJ	Udevalla 294.1
SMZP	Umea 229
SMRN	Uppsala 500
SMSO	Varborg 297

SWITZERLAND

HD3	Basle 1000
H9OC	Berne 32
HBA	Berne 411
HBI	Geneva 760
H82	Lansanne 850
H9ND	Zurich 85
H9XD	Zurich 32
H8Z	Zurich 500

TURKEY

	Angora 1806
	Stamboul 1200

UNION OF SOVIET SOCIALIST REPUBLICS

RA47	Armavir 720
RA56	Artemovsk 790
RA26	Astrakhan 700
RA45	Baku 750
RAS	Bogorodsk 750
RA80	Dneipropetrovsk 525
RA49	Erivan 1050
RA39	Gomel 925
RA57	Irkutsk 1100
RA7	Ivanovo-Vosnesensk 800
RA43	Khar'kov 472
RA45	Kiev 775
RA34	Kerensk 575
RA88	Krasnodar 513
RA42	Leningrad 1000
RA59	Leningrad 150
RA18	Minsk 860
RA1	Moscow 1450
RA2	Moscow 450
RA4	Moscow 450
RDV	Moscow 1450
RA67	Nalchik 1075
RA13	Nizhni-Novgorod 840
RA32	Novorossisk 1117
RA40	Odessa 975
RA25	Orenburg 640
RA64	Petrovavlovsk 350
RA40	Petrozavodsk 765
RA14	Rostov-on-Don 820
RA22	Samara 800
RA32	Saratov 420
RA9	Sevastopol 800
RA68	Smolensk 330
RA72	Smolensk 150
RA77	Stalino 730
RA20	Stavropol 550
RA15	Sverdlovsk 1050
RA27	Tashkent 715
RA11	Tbilis 870
RA21	Tomsk 300
RA44	Tver 690
RA51	Ulyanovsk 500
RA16	Vel' Ust'uk 650
RA17	Vladivostok 480
RA41	Volgata 875
RA12	Vorenezh 950

URUGUAY

CWOA	Montevideo 428.4
CWOF	Montevideo 300
CWOG	Montevideo 280
CWOH	Montevideo 300
CWOL	Montevideo 260
CWOM	Montevideo 272
CWOI	Montevideo 265.5
CWON	Montevideo 256.5
CWOO	Montevideo 294
CWOS	Montevideo 350
CWOT	Montevideo 380
CWOJ	Salta 272
CWOJ	Salta 250

VENEZUELA

KC	Meters	STATIONS	DIALS		KC	Meters	STATIONS	DIALS	
			1	2				1	2
1500	199.9				1020	293.9			
1490	201.2				1010	296.9			
1480	202.6				1000	299.8			
1470	204.0				990	302.8			
1460	205.4				980	305.9			
1450	206.8				970	309.1			
1440	208.2				960	312.3			
1430	209.7				950	315.6			
1420	211.1				940	319.0			
1410	212.6				930	322.4			
1400	214.2				920	325.9			
1390	215.7				910	329.5			
1380	217.3				900	333.1			
1370	218.8				890	336.9			
1360	220.4				880	340.7			
1350	222.1				870	344.6			
1340	223.7				860	348.6			
1330	225.4				850	352.7			
1320	227.1				840	356.9			
1310	228.9				830	361.2			
1300	230.6				820	365.6			
1290	232.4				810	370.2			
1280	234.2				800	374.8			
1270	236.1				790	379.5			
1260	238.0				780	384.4			
1250	239.9				770	389.4			
1240	241.8				760	394.5			
1230	243.8				750	399.8			
1220	245.8				740	405.2			
1210	247.8				730	410.7			
1200	249.9				720	416.4			
1190	252.0				710	422.3			
1180	254.1				700	428.3			
1170	256.3				690	434.5			
1160	258.5				680	440.9			
1150	260.7				670	447.5			
1140	263.0				660	454.3			
1130	265.3				650	461.3			
1120	267.7				640	468.5			
1110	270.1				630	475.9			
1100	272.6				620	483.6			
1090	275.1				610	491.5			
1080	277.6				600	499.7			
1070	280.2				590	508.2			
1060	282.8				580	516.9			
1050	285.5				570	526.0			
1040	288.3				560	535.4			
1030	291.1				550	545.1			

A. whispering campaign



will ruin the popularity of any set owner

if the set has "ADENOIDS"!

REMEMBER it isn't what they say to your face about your set—it's what they say behind your back. And how those hammers do get busy when they get a set with "adenoids" to talk about.

Preserve the good opinion of your friends—and get the enjoyment you deserve—perform that adenoid operation today—take out the inferior transformers and in their place put AmerTran tone-true radio products.

You can use AmerTran DeLuxe audio transformers—or push-pull for 171 tubes—or better yet the completely built Power Amplifier for two 210 type

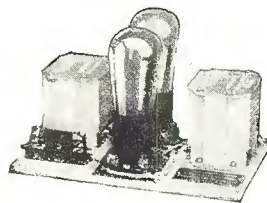

tubes and the AmerTran Hi-Power Box.

No matter what the change—if you switch to AmerTran you will improve the quality of your set.

Perform that adenoid operation today—turn the sneers to cheers! AmerTran Radio Products will do the job for you.

AmerTran Push-Pull Power Stage (illustrated here)—completely wired with input transformer and a choice of 4 output transformers depending on speaker and power tubes. Adaptable to 171 or 210 tubes, cones or dynamic type speakers. Price, East of Rockies—less tubes—\$36.00.

AMERTRAN

AMERICAN TRANSFORMER COMPANY, 95 Emmet St., Newark, N. J.

Transformer Manufacturers For More Than 29 Years

Tell 'Em You Saw It in the Citizens Radio Call Book Magazine and Scientific Digest

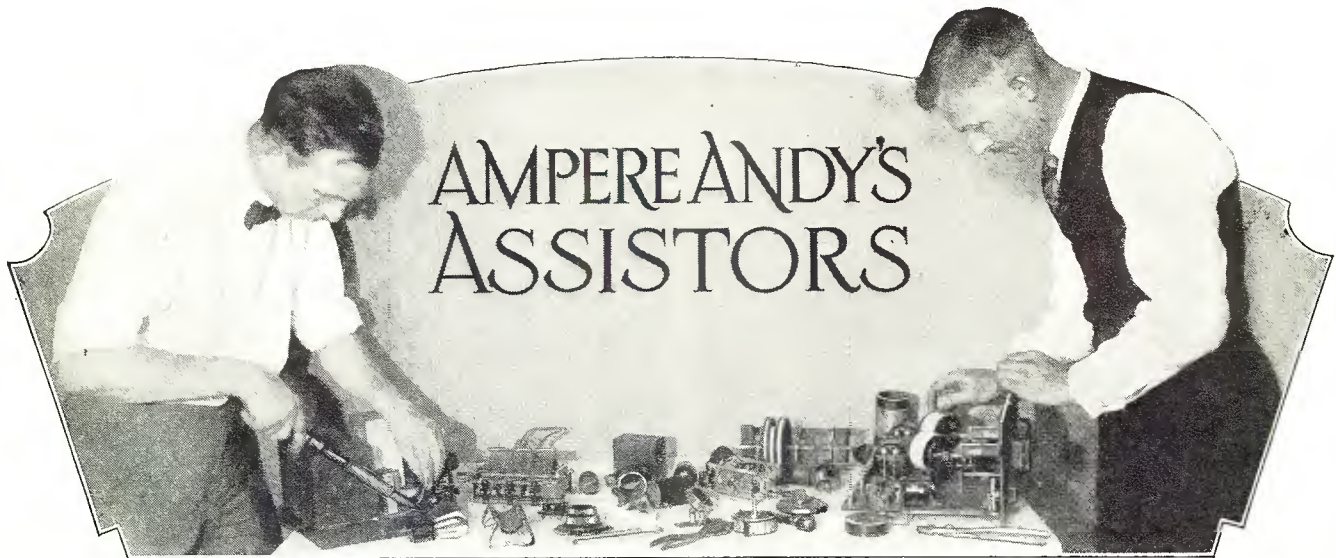

Pepping Up a Loop



Frequently superheterodyne owners complain that they do not secure a strong signal from their loop operated sets. One of the simplest and most economical methods of feeding greater signal voltage to the loop is by means of wrapping two or three turns of antenna lead-in around the loop and then either grounding or leaving ungrounded the free end. This procedure results in an inductive feed from the antenna to the loop and will give a much stronger signal, although if too many turns are put on there is a possibility of the loop dial being rather broad. As in everything else there is a happy medium which experimentation will disclose.

Home Made Coil Winder

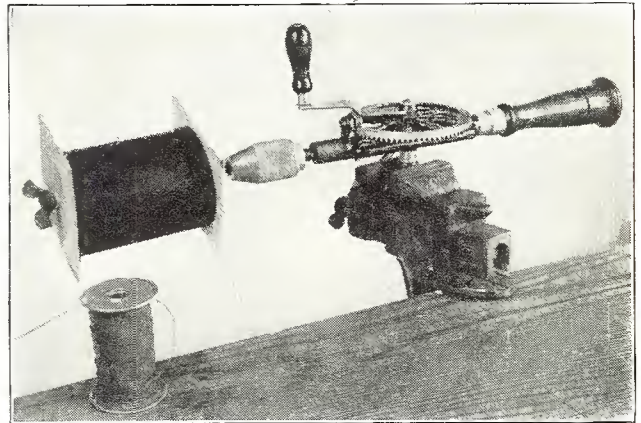

Lack of a lathe should not prevent a builder from winding any simple coil he desires, when the expedient illustrated in the photograph is possible. A twist drill is placed in the vise in the manner shown and a quarter-inch threaded rod put in the chuck. The coil is held between two end pieces on the threaded rod and a wing nut used at the extreme end to compress the two end forms tightly together. When the coil has been properly centered so that it does not wobble on rotation, the wire may be wound on the coil, using the left hand to maintain a slight tension on the wire and the right to turn the crank of the two" drill.

Novel AC Adapter

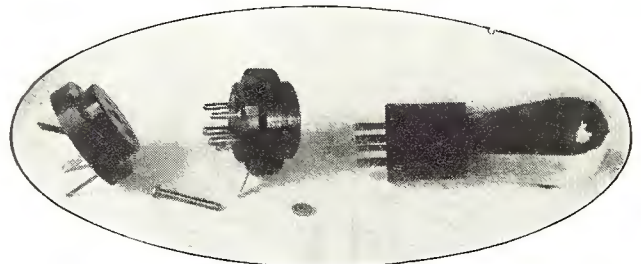

A simple home-made adapter may be readily constructed for converting a set now using d. c. tubes into one using the a. c. tubes. An old tube base is cut off and placed on the under side of a Tyrman socket. These two parts should be held together, by means of a bolt and nut. The grid and plate prongs of the socket shown in the center photograph are bent over to touch the grid and plate prongs of the tube base and soldered thereto. The two filament prongs on the tube base are left unconnected. The two terminals of the Tyrman socket representing the filament leads are bent outward and to these are connected the two wires from the filament transformer. The adapter is plugged into the regular four-prong socket in the receiver and the a. c. tube plugged in at the top of the adapter. This permits conversion of a d. c. set to an a. c. set without very much difficulty, and should one be dissatisfied he can always return to the old style operation.

Securing Odd Voltages

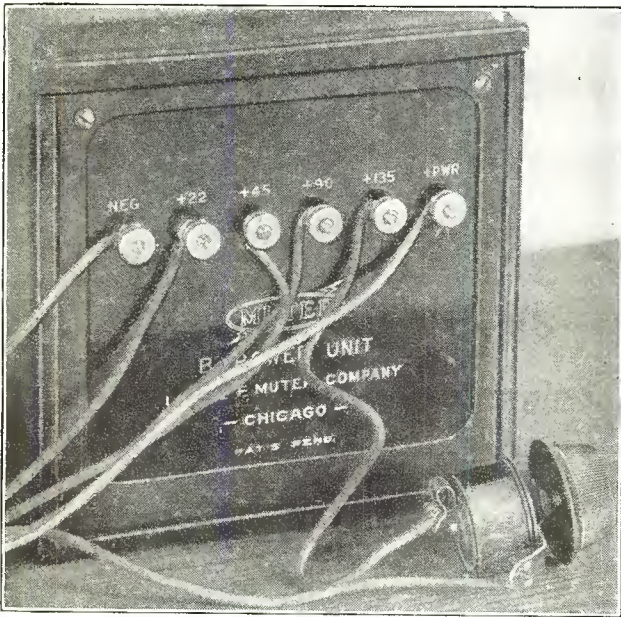

In many instances where the fan has a standard eliminator, he may desire to have a voltage value other than the one provided on his eliminator. Intermediate values of voltages over a moderate range may be secured by placing a Clarostat or other heavy duty variable resistance in series with the positive 135 volt terminal on the eliminator.

Getting Tighter Grip

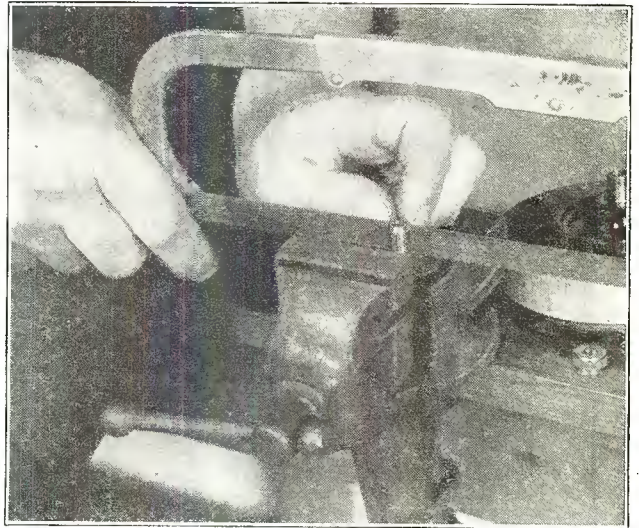

When tightening up the compression bushing on some types of drum dials, occasion may arise where there is not sufficient grip in the bushing to hold the dial tightly to the shaft. To remedy this, the bushing may be taken out and placed in a vise and a hack-saw run through the slot so as to clear it and possibly widen the slot. When the bushing is again put back into position, it will be found that with the nut it will be possible to get a tight grip on the shaft.



Square Cutouts Easy

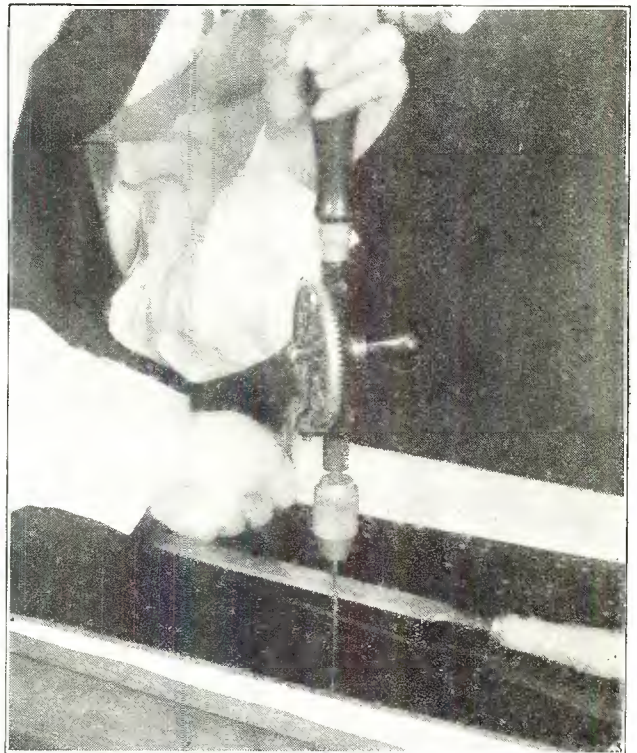

Many embryo set builders have been puzzled when confronted with the necessity of making a square cut-out in a sub-panel. Of course, if a hack saw is available the job is very easy, but not every builder has such apparatus. Therefore, the simplest method is to bore a line of holes along the marking for the cut-out, spacing these holes quite close together so that when all holes have been drilled it will be possible to use a file or a hack saw blade to cut through between hole-walls. A file may be used to smooth off the edges after the section has been knocked out.

Making Correct Loop

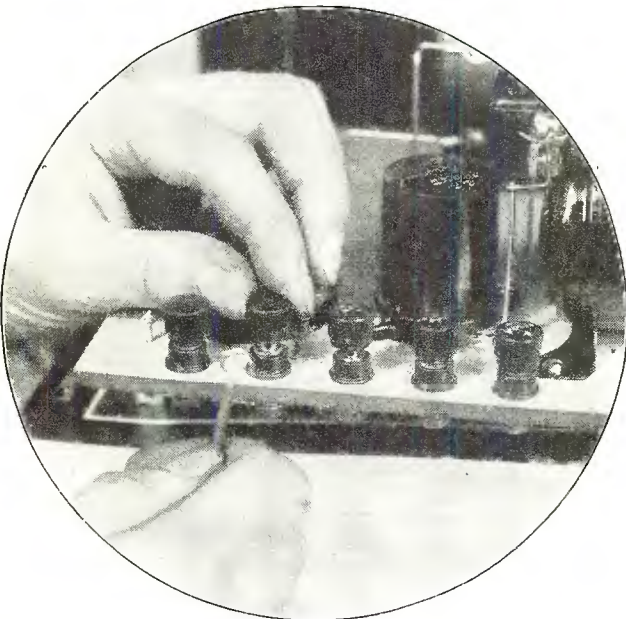

Despite all that has been written for years on the subject of how to make a loop go under a binding post, repair shops still find evidences that many builders do not know the proper way of making a wire loop go under any binding post. Since the rotation of the binding post knob is towards the right, it naturally follows that the curl of the loop should be in the same direction, so that maximum holding is secured. If the loop is run in the opposite direction, it is very difficult to secure a tight hold and there is always a possibility of the connection becoming loosened.

Simple Antenna Switch

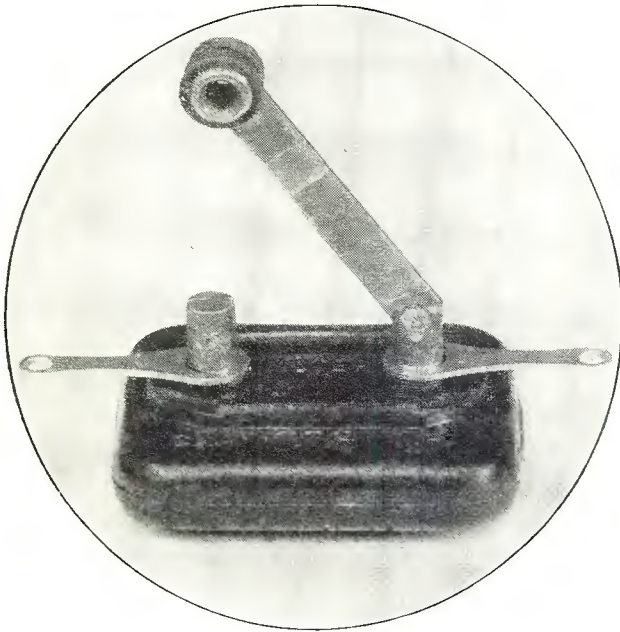

A very novel method of securing the equivalent of a long or short antenna is illustrated in the photograph herewith. The method consists simply of a shorting switch located across the terminals of the condenser shown in the photograph. The antenna wire is attached to the lug at the left, while the lug at the right goes to one end of the antenna coil. Thus when the switch is open, as shown herein, the condenser is in series with the antenna, giving the effect of an electrically shortened antenna. When the switch is closed, the electrical length of the antenna is greatest and naturally strongest signals ensue.

Reducing Tube Voltage



If you find your rheostat will not dim your tube sufficiently, a further drop in voltage may be secured by the simple expedient of placing a fixed resistance in series with the rheostat as shown in the accompanying photograph.



Soldering Tinsel Wire

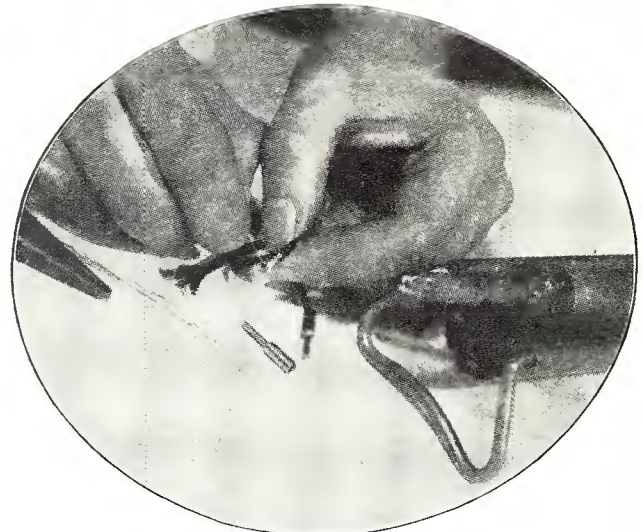

We have been taught for years that there is no such word as "can't" in the vocabulary of an ambitious individual. However, in the case of the radio art, we believe there are several, one of the most noteworthy being the fact that you can't solder tinsel wire directly. The simplest way of achieving the result is by wrapping the tinsel wire closely with a single strand of small copper wire for a distance of about $\frac{1}{2}$ inch or so, then quickly tinning the wrap. Then if tips are to be soldered on, the tip should be filled about one-half full of solder and held against an iron until the solder is hot, when the tinsel end with its protective covering is deftly plunged into the opening in the tip. The photograph shows the operator in the act of winding a single strand of flexible wire around the tinsel to prevent its burning through the application of the heat.

Keep Away from Heat

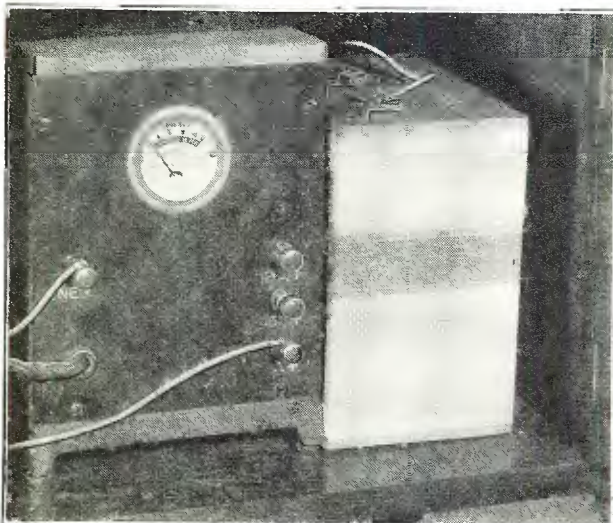

All manufacturers of dry cell batteries state in their literature and on the battery cartons the cells should be kept in a cool, dry place. In the photograph above a battery is shown next to a 5 ampere charger, which generates considerable heat and which heats up the battery. This is not a good plan and wherever possible the dry cell and any given heat producer should be separated by several inches.

"The Swedes' Magic IN RADIO"

THUS one owner characterizes the powerful Peerless Dynamic. She was not a radio expert—just a music-wise woman whose ear told her when her speaker brought in, with real fidelity, all the mellow harmonics—and elusive shadings of tone.

The single turn voice coil, the cone suspension, the single-turn transformer secondary—these exclusive Peerless features make the Peerless Dynamic the simplest and sturdiest dynamic ever built.

See the Peerless Trio—at any good radio dealer's. No matter which Peerless you buy you can depend upon it to "Make Any Radio Better!" United Reproducers Corporation, *Peerless Division*, Rochester, New York, *Export Department*, 130 West 42nd Street, New York, N. Y.

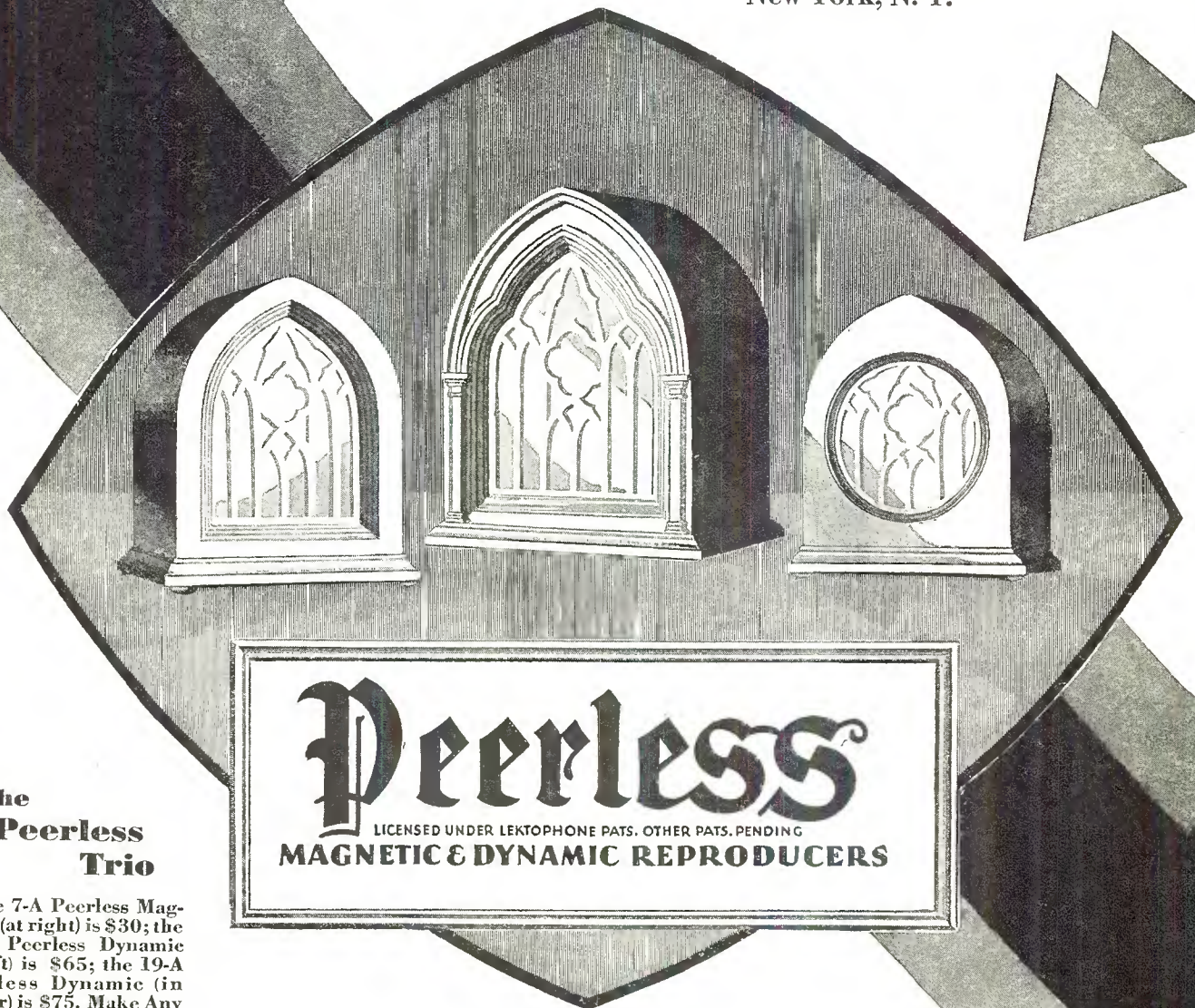

The Peerless Trio

The 7-A Peerless Magnetic (at right) is \$30; the 17-A Peerless Dynamic (at left) is \$65; the 19-A Peerless Dynamic (in center) is \$75. Make Any Radio Better.

UR-168

Tell 'Em You Saw It in the Citizens Radio Call Book Magazine and Scientific Digest



STOPS MAN-MADE STATIC

FILTERETTE No. 22

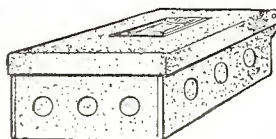

\$15⁰⁰

THERE is a FILTERETTE for every problem. FILTERETTES put an end to radio noises caused by electrical appliances for all time.

FILTERETTE No. 22

FOR STOPPING "MAN-MADE" STATIC AT ITS SOURCE

DESIGNED FOR ALL TYPES OF
MOTORS, GENERATORS, BLOWERS OR OTHER ELECTRICAL APPARATUS
USING 110 OR 220 VOLTS REGARDLESS OF HORSEPOWER

MOTOR, GENERATOR,
BLOWER OR OTHER
ELECTRICAL APPARATUS

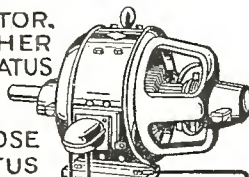

To be Filterette No. 22 will take out "static" caused by motors, oil burners, blowers, fans, ice machines or any noise disturbing electrical device.

Filterettes will do their designated job right or your money will be cheerfully refunded.

WHEN USED WITH THREE PHASE MOTOR THE TOBE FILTERETTE No. 23 IS RECOMMENDED OR TWO TOBE FILTERETTE No. 22

Write for "The Filterette," the new TOBE Monthly House Organ and study on interference

TOBE DEUTSCHMANN CO.

NEW YORK

Canton, Mass.

CHICAGO

Tell 'Em You Saw It in the Citizens Radio Call Book Magazine and Scientific Digest

We will make You Our Exclusive R-D Set-Builder

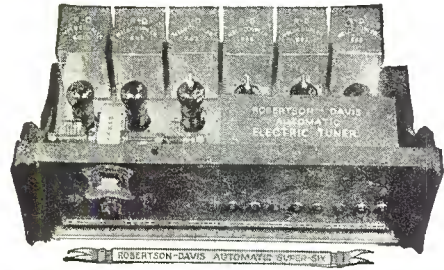

THE ROBERTSON-DAVIS AUTOMATIC SUPER-SIX RECEIVER

WHETHER you are building for your own amusement, or to sell for profit, you can't go wrong with the new Robertson-Davis Automatic Super-Six Receiver. All of the best features of the world's best and most expensive receivers are combined and provided to you in one, at the same price as that of an ordinary receiver. It is the design of the world's leading radio engineers, built and serviced by the world's leading custom set-builders. It is the receiver that has everything everybody wants in a radio set. Entirely A.C. operated—and 3 Stages A.C. Shield Grid Amplification.

No other custom-built set has the automatic feature. Supplied with or without the Automatic Electric Tuner, as desired. You have the automatic tuner, and a single illuminated drum-dial for tuning in stations of the greatest distance—they all come in at one spot on the dial or on one automatic tuner button. So here you have all that is new in radio because of the automatic feature, and all that is new in old-fashioned tuning because of the single drum-dial.

GOES TOGETHER IN 18 MINUTES

You get the receiver ready to assemble in a few minutes—it fits together like a set of toy building blocks. All instruments are fitted and housed in the sub-panel except the trimmer, condensers and volume control, which are mounted directly on the panel. No soldering or tinkering—all you need is a screw-driver. The entire receiver comes in a factory packed kit of wired, laboratory-tested parts complete. A complete set of Blue Prints and Instructions furnished with everything marked. You lose no time.

Due to the improved circuit and shielding throughout, static is at a minimum. There is no more hum with this receiver, though entirely A.C. operated, than with a receiver eliminator—operated on D.C. current. The unique shielding, specially constructed transformers, and peculiar way in which the R-D Automatic Super-Six circuit is arranged, all give it a selectivity that surpasses anything known in radio. Gives 10 K.C. separation, one spot reception, and perfect tone and volume on local or coast-to-coast stations through all forms of interference.

All of these points are proven nightly for the public in our Receiving Studios, which are located in the heart of the highly congested districts of Chicago. The public is invited. You can see for yourself!

The Only Custom-Built Radio Receiver Automatically Tuned

Press a button and your favorite station plays. Even a child of 3 can play it—the Automatic Electric Tuner does all the work. Any six stations can be selected for automatic playing, and these can be changed at will. Depressing any button automatically cuts out all the rest, and brings in only the station desired from those on the Automatic Tuner, or any other you wish to tune in with the drum-dial on the receiver. This is the receiver you will want to own, and the receiver you will want to build. Fill in and mail the coupon, and we will tell you all about it!

How Would You Like To Be the Only Representative of Custom-Built Automatic Radio Receivers?

There isn't another custom-built receiver in the world that has all the features of the R-D Automatic Super-Six. There isn't another automatically tuned receiver in the world that you can build and sell. No other set-builder in your district can offer the same service, if you take advantage of this opportunity. No other manufacturer can offer you the same profitable proposition.



Showing the R-D Automatic Super-Six in one of our exclusive consoles

WE SUPPLY EVERYTHING DIRECT TO OUR LICENSED SET-BUILDERS

Through our exclusive Franchised Set-Builders, we provide every part and accessory complete—everything guaranteed to give satisfaction;

- | | |
|--------------------------|------------------------------------|
| R-D Super-Six Receiver | A.C. Tubes for Set and Pack |
| Automatic Electric Tuner | Cabinets and Furniture |
| All-Electric Power Pack | Phonograph Pick-Ups and Turntables |
| Dynamic Speakers | Short-Wave Coils, Etc. |
| Phonograph Pick-Ups | |
| Television Coils, Etc. | |

All of this equipment is internationally known to be of the highest standard and best quality. It is only a question of following the simple instructions that come with the kits to secure the finest and most satisfying results you have ever obtained with a radio receiver.

YOU WILL BE ABSOLUTELY PROTECTED

You can make yourself our Exclusive Franchised and Licensed Set-Builder for your community, if you are now engaged in or wish to enter this profitable, fascinating field of work. We are looking for one good set-builder in each district, and we fully protect him! You will not find the Robertson-Davis Automatic Super-Six Receiver sold over the counter by so-called dealers who sell to the public at wholesale prices. No other dealer or set-builder can come in and supply the receiver after you promote the sale. You have no competition.

A FRANCHISE TO ALL WHO QUALIFY

We sell direct to you, wholesale. While you are starting, we give you all the help we can, and an option on your district. After your third set is built and sold, you are given the Exclusive Franchise for your district, authenticated by a large Certificate for framing and an authorization card. Circulars, Broadsides for mailing (imprinted with your name), Window Trims and other advertising and selling helps are supplied free to help you sell.

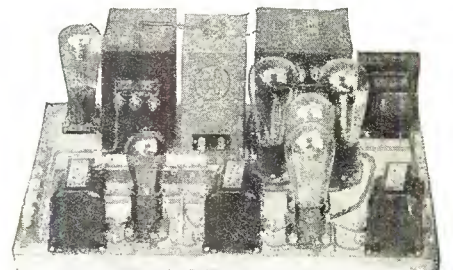

THE R-D AUDIO & A-B-C ALL-ELECTRIC POWER PACK

This is a special 210 Push-Pull Unit with voltage divider, for use with any type of speaker, horn or cone—magnetic or dynamic. Equipped to be used with phonograph pick-up, if desired. Takes care of all audio and power requirements for the R-D Automatic Super-Six Receiver when operated from 60 cycle A.C. 110 volt electric lighting socket.

The World at your fingertips
with ROBERTSON-DAVIS Automatic Radio

SET BUILDERS: RADIO FANS:

MAKE REAL MONEY WITH THIS QUICKLY ASSEMBLED, FOOL-PROOF RECEIVER. WRITE FOR BUILDER'S DEAL VOLUME. SEND COUPON FOR FREE LITERATURE.

Gentlemen:

Please send, without charge or obligation, complete literature on the R-D Automatic Super-Six Receiver, Automatic Electric Tuner, All-Electric Power Pack, and Guaranteed Accessories to use with them. (Set-Builder's Offer will be included, if indicated.)

ARE YOU NOW A SET-BUILDER? [If You Are, Enclose] YES NO

Name.....

Address.....

Town.....

29 RCB-1

Robertson-Davis Company, Inc.
361 W. Superior St.
Chicago, U. S. A.

Addition of 250 Power Tube Makes S-M 720 Even More Powerful

Screen Grid Six Now Arranged for Increased Output for Use at Lodge Halls and Dances

SINCE the appearance in the September issue of the Citizens Radio Call Book Magazine of an article describing the S-M 720 Screen Grid Six, a number of letters have come to our notice, describing feats of distance reception through local interference, using this extremely high gain receiver. Listeners in New York City report no difficulty in loud speaker reception of stations like KRLD, Dallas, Texas; KOIL, Council Bluffs, Iowa, and CHNS, Halifax, Nova Scotia. In Cincinnati a listener reports daytime reception of stations all over the Mississippi Valley and Great Lakes region, with good preservation of the excellent tone quality produced by the new Clough system audio transformers, which has made so many friends for this hook-up.

Want 250 Tube

Numerous requests have been received, however, for information as to how a set of this type may be equipped with a high power output tube such as the 250, and thus make it effective in

lodge halls, church assembly rooms and other meeting places, as well as for use in the home when unusual volume is desired for some occasion such as a dancing party. Provision was made by the designer of the 720 so that the super-power tube can very easily be installed, with a minimum change, in the set as wired for lower voltage power tubes—in fact, without any change whatever if so desired, in routing and wiring of existing parts. For readers who have not yet built the 720 Screen Grid Six, the description here given, of the set as it may be built originally with the 250 type tube, may result in adding one more interesting feature to a design already very attractive to the set builder.

Phonograph Amplification

Many owners of high grade radio receivers are now finding it very advantageous to provide wiring, through a jack, from the audio amplifier input to a magnetic phonograph pickup, so that the high quality amplifier built into the radio receiver can be used

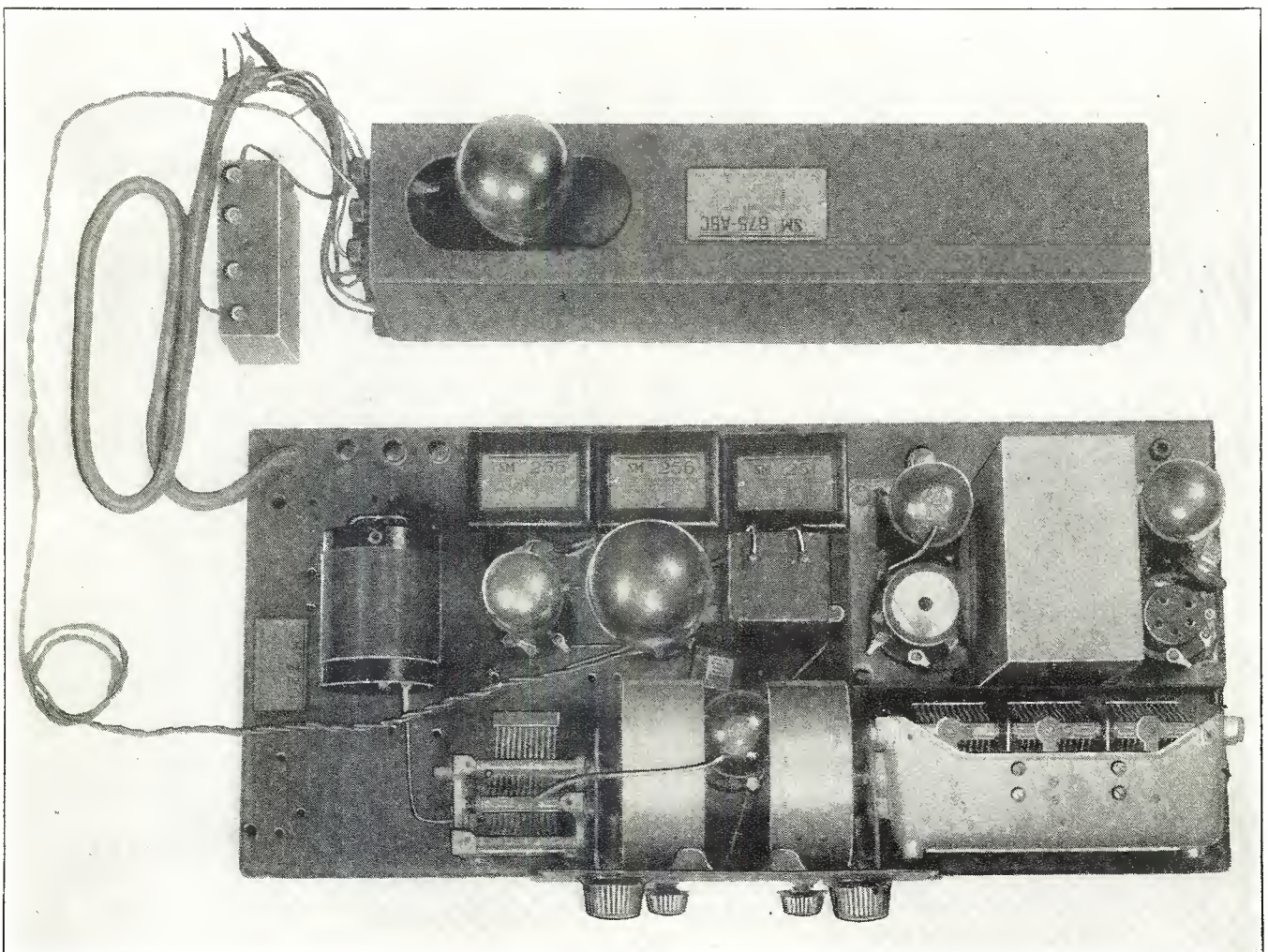

Fig. 1. This photograph shows the new arrangement of the Screen Grid Six used in conjunction with a 675 ABC power supply as described in the accompanying article

(This receiver tested and all illustrations made in our laboratory)

when playing phonograph records. This use of the radio set becomes still more attractive when the last audio stage is equipped with a 250 tube, for in this way a very inexpensive phonograph—or a simple turntable with electric motor mounted in the cabinet—can be made to deliver to the dynamic speaker volume usually equal to or even greater than that of the original studio performance, even in the case of a large band or orchestra; and with such an extremely high grade audio system as found in the Screen Grid Six, this sound reproduction may be expected to show a quality equal to the best that can be had from high priced electrical phonographs.

Power Needed on Low Notes

The great advantage in using high powered tubes like the 250 is more readily seen when it is remembered that the amount of energy necessary to produce a given effect upon the ear is several million times as much for a note of 50 cycles pitch as for a note at 1000 cycles. When using transformers of the type commonly found on ordinary ready made radio sets, it is not so necessary to have this additional power in the tube, because very little of the energy passing the detector at frequencies around 50 cycles can get through the audio system—these low bass notes being thus almost completely lost as far as any actual reproduction in the speaker is concerned (the ear often imagines them to be present even when they are not, so that even a cheap audio amplifier does not usually sound quite as bad as laboratory tests would indicate. But with audio coupling such as provided by the two Clough system transformers in the S-M 720, which actually do pass at practically their full natural strength, currents of frequencies as low as 50 cycles (a note just below the lowest one on a common E-flat bass tuba) it becomes very important, in order to utilize this broad range in the amplifier, to have a tube powerful enough to supply the required energy.

Use Output Filter

Owing to the high plate voltage which is necessary with the 250 type tube if its full power is to be secured, it is never safe to let the plate current flow directly through the loud speaker. That is, some kind of output transformer or other coupling device



Fig. 2. The completed receiver is here shown in an exquisite furniture setting

is always necessary. On the chassis of the Screen Grid Six, a suitable space has been left for mounting, beside the second stage audio transformer, an S-M 251 output transformer—this being an instrument of the same general type as the 255 and 256 Clough system audio transformers. The 251 transformer has four terminal lugs, but only two or three are used in any circuit—the selection of the proper terminals to be used, depending, however, on the type of power tube out of which the 251 transformer is to work. In this way, due allowance is made for differences in the impedance of common power tubes, so that none of the high quality of output possible with the 250 tube need be sacrificed on account of the output transformer having been designed to work optionally out of smaller power tubes.

How to Mount New Parts

Having mounted the 251 transformer as shown in the photograph, it should be connected as follows if the 250 tube is to be used: terminal 1 to the 450 volt post of the power supply, terminal 2 to the plate (P terminal on the socket) of the last audio tube. The insulated tip jack formerly connected to this P terminal on the tube socket should now be connected to the extra 1 mfd. condenser which is to be mounted as in the photograph directly in front of the output transformer. The other side of this high voltage condenser then goes to terminal 2.

The 250 type tube requires filament current at 7½ volts. Since this voltage is not available from storage batteries in common use, and since raw a. c. is not objectionable in the filament of the last tube "A" current for the 250 tube will be taken from a filament voltage coil on the power supply. If the adapter is used, so that filament wiring to the last audio socket need not be disturbed, the two leads from the adapter are simply run to the 7½ volt terminal on the power supply. A somewhat neater method, however, and one which is very easily carried out if all the leads present in the power cable to the set have been retained, is to utilize the yellow and yellow-white leads to carry filament current to the 250 tube. If this is to be done, the two wires, connecting the filament terminals of the power tube socket on the 720 chassis to the "A" power supply for the other tubes, are

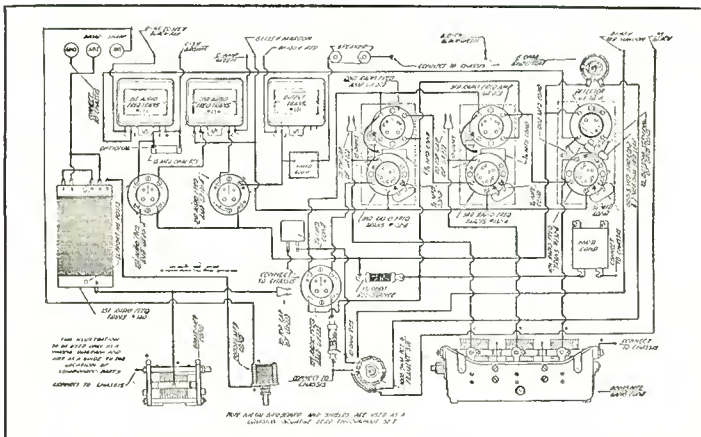

Fig. 3. This drawing represents the graphic method of making connections in wiring up the receiver

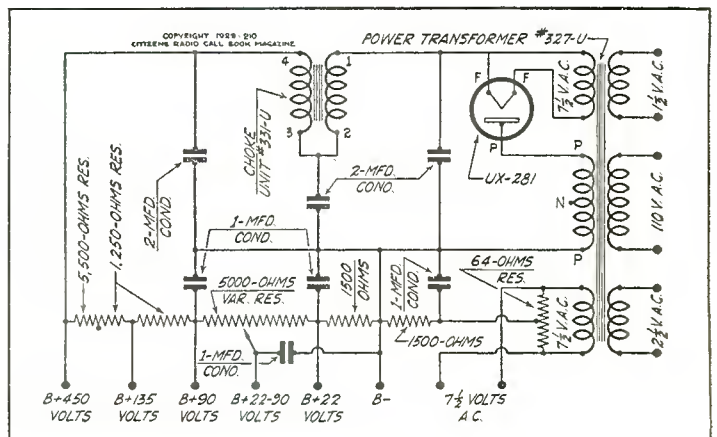

Fig. 4. The schematic circuit involved in the ABC supply is illustrated above

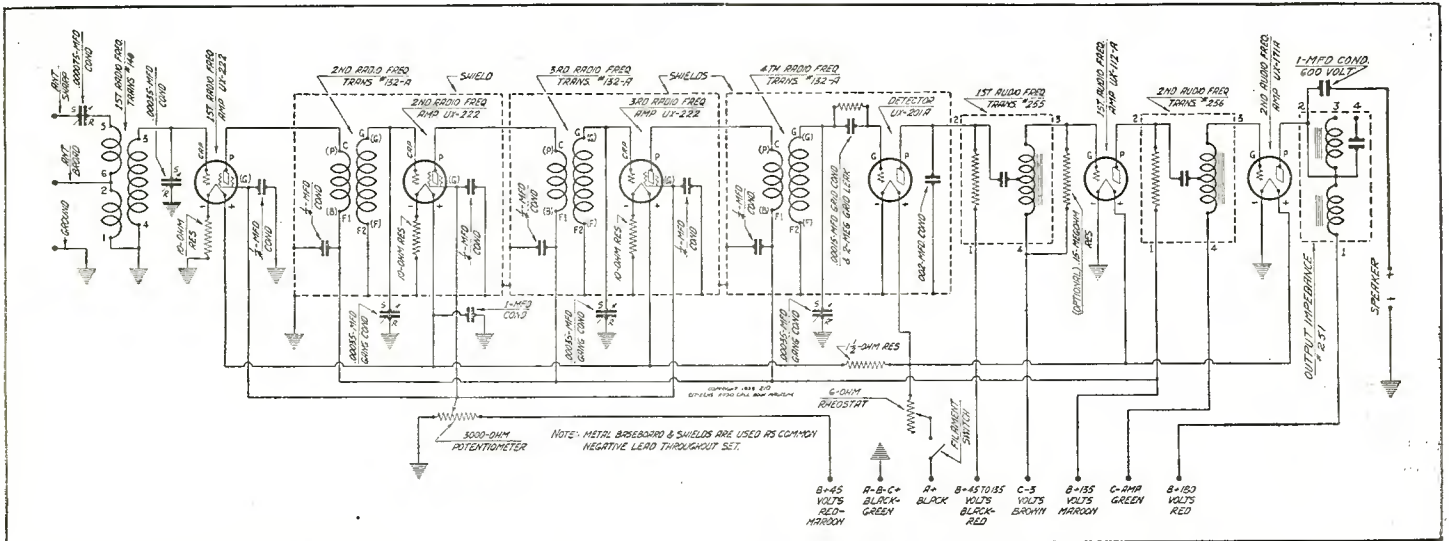

Fig. 5. This schematic diagram gives all of the electrical connections involved in the Screen Grid Six described in this article

disconnected from this last socket, and the yellow and yellow-white wires substituted. The outer ends of these wires are then connected to the $7\frac{1}{2}$ volt posts on the power supply, and the adapter is not used at all. This makes the installation no less neat and compact than where a smaller power tube is used.

Used with Power Supply

An S-M 675ABC power supply is ideal for furnishing to the super-power 720 the high B voltage required for the 250 tube, as well as the $7\frac{1}{2}$ volt "A" current required for its filament. Moreover, the internal connections of the 675ABC are such that the necessary C bias is furnished to the power tube without altering the connections of the receiver in any way for this purpose. This is accomplished by connecting the "C— power amplifier" lead from the receiver to the "B—" post on the 675ABC power supply, and connecting the other power leads just as is done on ordinary B supplies, or on the S-M 670 (which is recommended for the 720 set when used with 171A power tube). The 40 volt "C" battery commonly used with the 171A type of power tube is then not required, and a small 3 or $4\frac{1}{2}$ volt "C" battery, as shown in the photograph, is all that is required.

Hence, the super-power 720 Screen Grid Six is very nearly equal in simplicity of installation to the same set when used with power tubes of ordinary type, and the considerable improvement in tone quality and tremendously greater volume capacity amply justify the small added expense.

The schematic diagram shown in Fig. 5 will give all of the electrical details involved in the screen grid Six. The antenna stage has two input connections, one for sharp tuning and one for broad tuning. The grid of the input stage is tuned by the .00035 mfd condenser across the secondary section of the first radio frequency transformer 140. The second r. f. transformer, 132-A, which is of the plug-in type, and its associated 222 tubes are contained within one shield, while the third r. f. transformer 132-A and the third r. f. amplifier are contained in a second stage shield. The detector tube and its associated transformer are located in the third shield. The screen grids of the first, second and third tubes are connected together and potential applied to them through a 3000 ohm potentiometer located across the B-45 volt terminal and ground. This enables the operator to shift the potential applied to the screen grid and is used as volume control. A separate bias is applied to the grid of each shield grid tube by the drop across the 10 ohm resistance located between the negative filament of the tube and ground. The detector circuit has a 6 ohm rheostat in series with that filament, which is common with the positive line of the screen grid tubes, the latter through a $1\frac{1}{2}$ ohm fixed resistance. This 6 ohm rheostat also controls the first and second audio tubes. Each screen grid circuit, the positive filament circuit, and the B terminal of each r. f. trans-

former are bypassed to ground through the shield. The plate circuit of the detector is also bypassed with a .002 mfd condenser from plate to negative filament, which is common with the shield, all of which contributes materially to the stability of the receiver.

Official Parts List

Parts for the complete receiver as here described are:

- 1 Silver-Marshall 701 Universal chassis
- 1 Silver-Marshall 809 dual control escutcheon
- 1 Silver-Marshall 806-L vernier drum dial
- 1 Silver-Marshall 806-R vernier drum dial
- 1 Silver-Marshall 320-R .00035 mfd Universal condenser
- 1 Silver-Marshall 323 .00035 mfd 3-gang condenser
- 1 Silver-Marshall 342-B .000075 mfd midget condenser
- 3 Silver-Marshall 638 copper stage shields
- 1 Silver-Marshall 140 antenna coil
- 3 Silver-Marshall 132-A plug-in r. f. transformers
- 3 Silver-Marshall 512 5-prong sockets
- 5 Silver-Marshall 511 tube sockets
- 1 Silver-Marshall 255 first stage audio transformer
- 1 Silver-Marshall 256 second stage audio transformer
- 1 Silver-Marshall 708, 10 lead, 5 foot connection cable
- 1 Package Silver-Marshall 818 hook-up wire
- 1 Yaxley 3000 ohm junior potentiometer, No. 53000-P
- 1 Yaxley 500 switch attachment
- 1 Yaxley 420 insulated tip jacks
- 3 Carter RU-10 resistances
- 1 Carter AP-6 sub-base rheostat
- 1 Carter H- $1\frac{1}{2}$ resistor
- 1 Potter No. 1 mfd bypass condenser
- 6 Sprague or Polymet $\frac{1}{4}$ mfd midget bypass condensers
- 1 Polymet .00015 grid condenser with clips
- 1 Polymet .002 mfd bypass condenser
- 1 Polymet 2 megohm grid leak
- 1 Durham .15 megohm resistor with leads
- 1 Naald 581XS cushion tube socket
- 3 Moulded binding posts
- 1 Set hardware consisting of studs, screws, nuts, washers
- 3 222 type r. f. amplifier tubes
- 1 201-A type, or preferably 112-A type, detector tube
- 1 112-A type first stage a. f. amplifier tube
- 1 171-A type power output tube (if 250 not used)

Extra Parts Required If 250 Tube Is Used

- 1 Silver-Marshall 251 output transformer
- 1 Silver-Marshall 1 mfd condenser, 600 volts
- 1 Silver-Marshall 675ABC high voltage power supply

Remler A. C. Power Amplifier Using 250 Tube for High Quality

Output Circuit of Amplifier Has Tapped Coil for Use of Either Dynamic or Magnetic Speaker

DESCRIBED in this article is a new addition to the Remler line of radio apparatus designed for use in connection with Remler receivers, as well as receivers of other makes. Its output circuit is so constructed that either magnetic or dynamic speaker may be used, depending on the method of connection made in the output coil winding. The entire amplifier is designed for quality amplification throughout and will be welcomed by Remler enthusiasts who wish to increase their possibilities of quality reproduction.

Built on Chassis

Examination of the schematic circuit shown in Figure 2 will give an idea of the constituent parts and related circuits. The Remler power compact No. 950 is enclosed in a metal housing and is that portion of the set represented at the right rear in the photograph, Fig. 1. It comprises an alternating current primary with three taps, one for 105 volts, the second for 115 volts and the third for 125 volts. By this means some compensation may be allowed for a variation in line voltages at the location where the amplifier is being operated. The secondary of the power transformer has a high voltage winding, the extremities of which go to the plates of the two 281 rectifier tubes, while the center tap of this winding becomes the negative line of the amplifier. Across the $7\frac{1}{2}$ volt winding, which supplies the filaments of the two

rectifiers, is placed a 64 ohm center tapped resistance, the center of which becomes the high voltage line and leads to the input of the double filter choke system, this filter being bypassed at the input, the center and the output by 2 mfd condenser blocks. The filament circuit of the first audio amplifier, which uses a 227 tube, is energized by a $2\frac{1}{2}$ volt winding from the power transformer, a 64-ohm center-tapped resistance being placed across the heater terminals, the center of which goes to the common negative of the system. Grid bias for this first stage is supplied through the drop across a 2000 ohm variable resistance between the cathode of the 227 and the common negative line.

In the last power stage, where a 250 tube is employed, the bias for that grid circuit is obtained through the drop across a variable 2000 ohm resistance between the common negative and the center tap of the 64 ohm center-tapped resistance across the $7\frac{1}{2}$ volt filament winding. The plate circuit of the 250 tube takes the maximum high voltage.

Magnetic or Dynamic Speaker

When the power amplifier is to be operated in conjunction with a magnetic speaker, the terminals at the point marked "see note A" are bridged with a 2000 ohm resistance to make up for the lower value of the resistance network when the magnetic speaker is used. When the dynamic speaker is used, the resistance of the

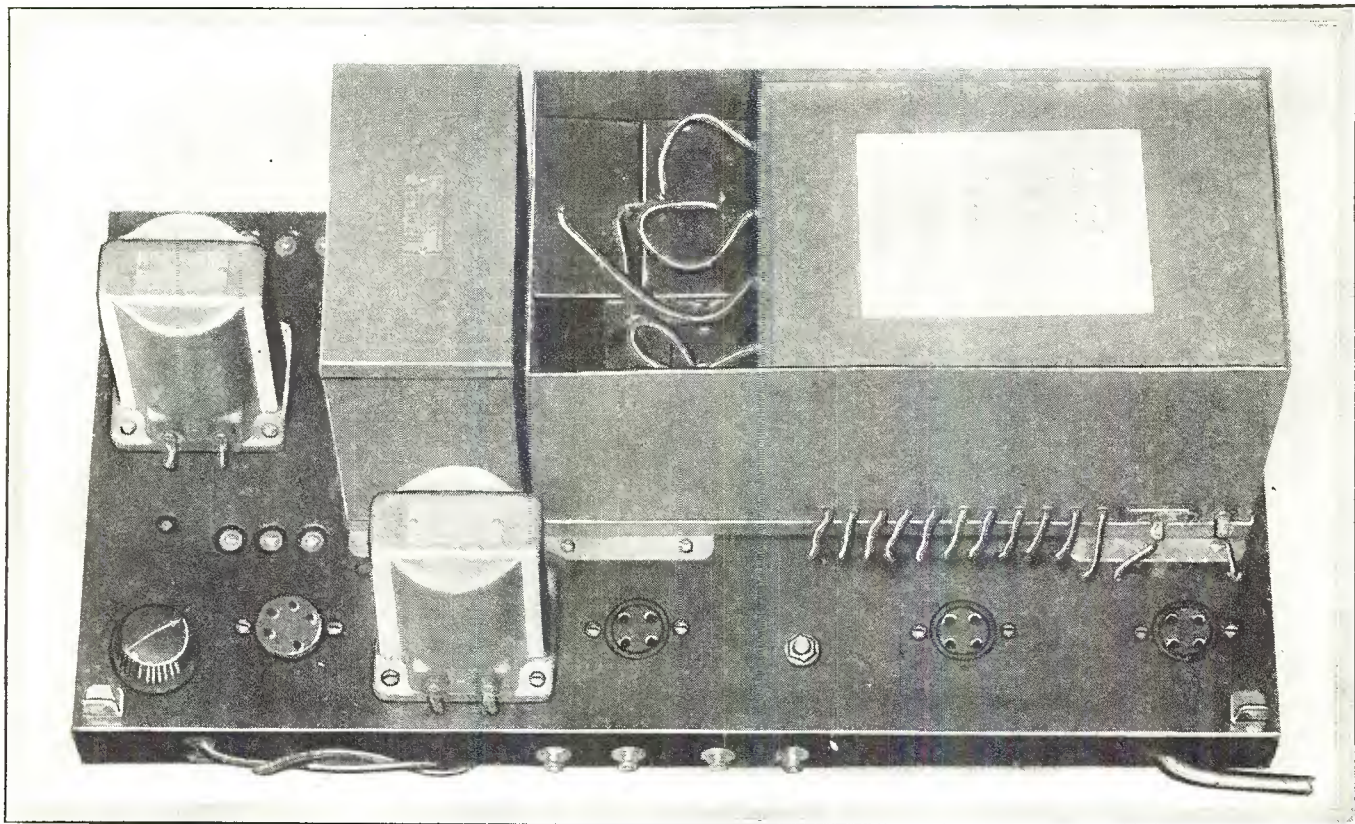

Fig. 1. This photograph shows the completed Remler power amplifier after all of the wiring has been put in. The power compact shown at the right rear has been almost fully wired, there only being two or three wires to run to the various condensers. The chassis upon which the amplifier rests is already pierced for the necessary units

(This amplifier tested and all illustrations made in our laboratory)

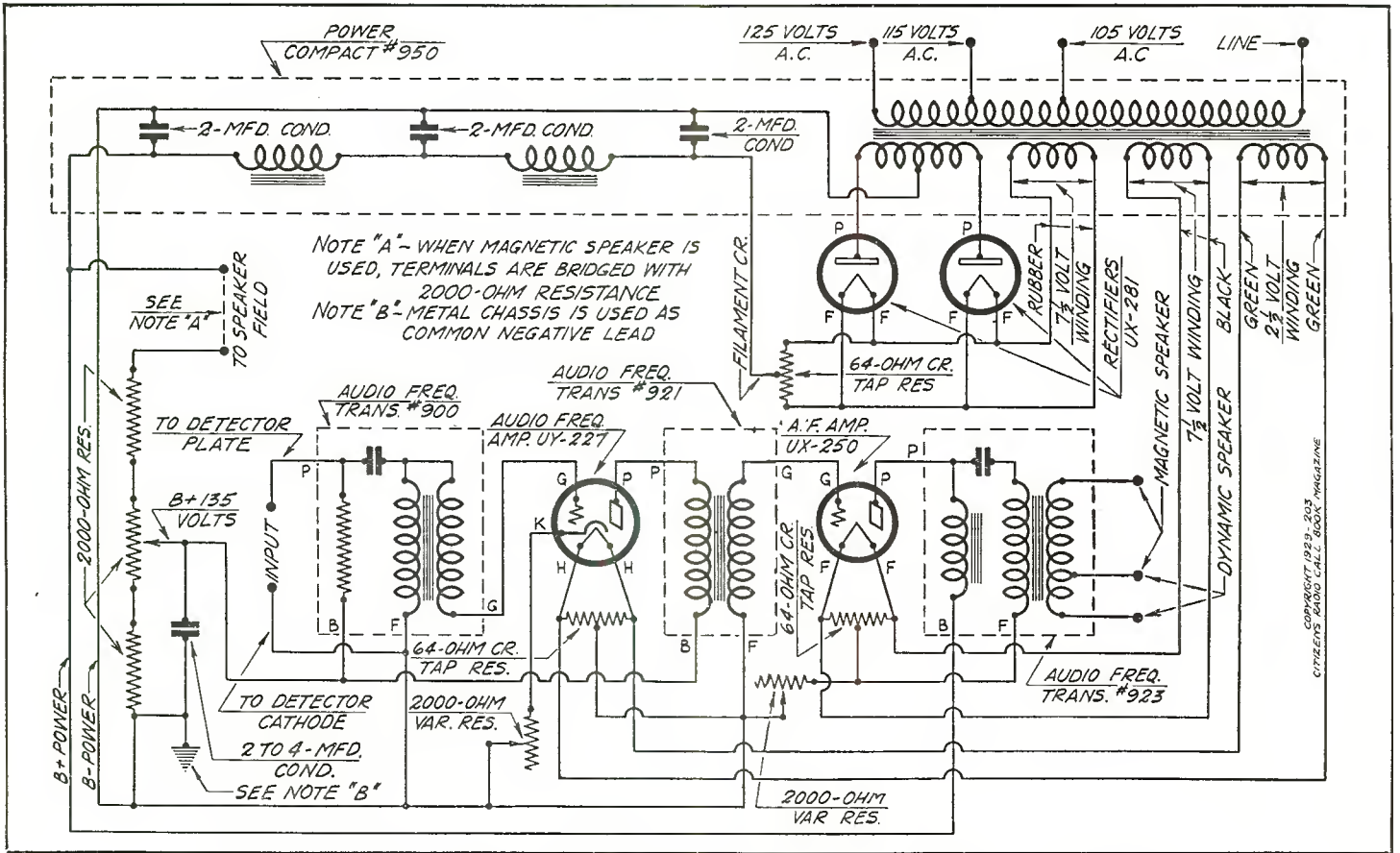

Fig. 2. The schematic circuit involved in the Remler power amplifier is shown above

field winding is 2000 ohms and as a consequence only the field winding goes across the speaker field terminals without any additional change.

Input to the amplifier is across the P and F terminals of the No. 900 audio frequency transformer. This transformer is of the resonated primary type previously described in this magazine in

connection with the "29" Remler receiver. The second audio is of the conventional two-winding type. A plate voltage of 135 volts is applied to the B terminal of the first audio unit, as well as the B terminal of the second, although the fixed resistance in (Continued on page 140)

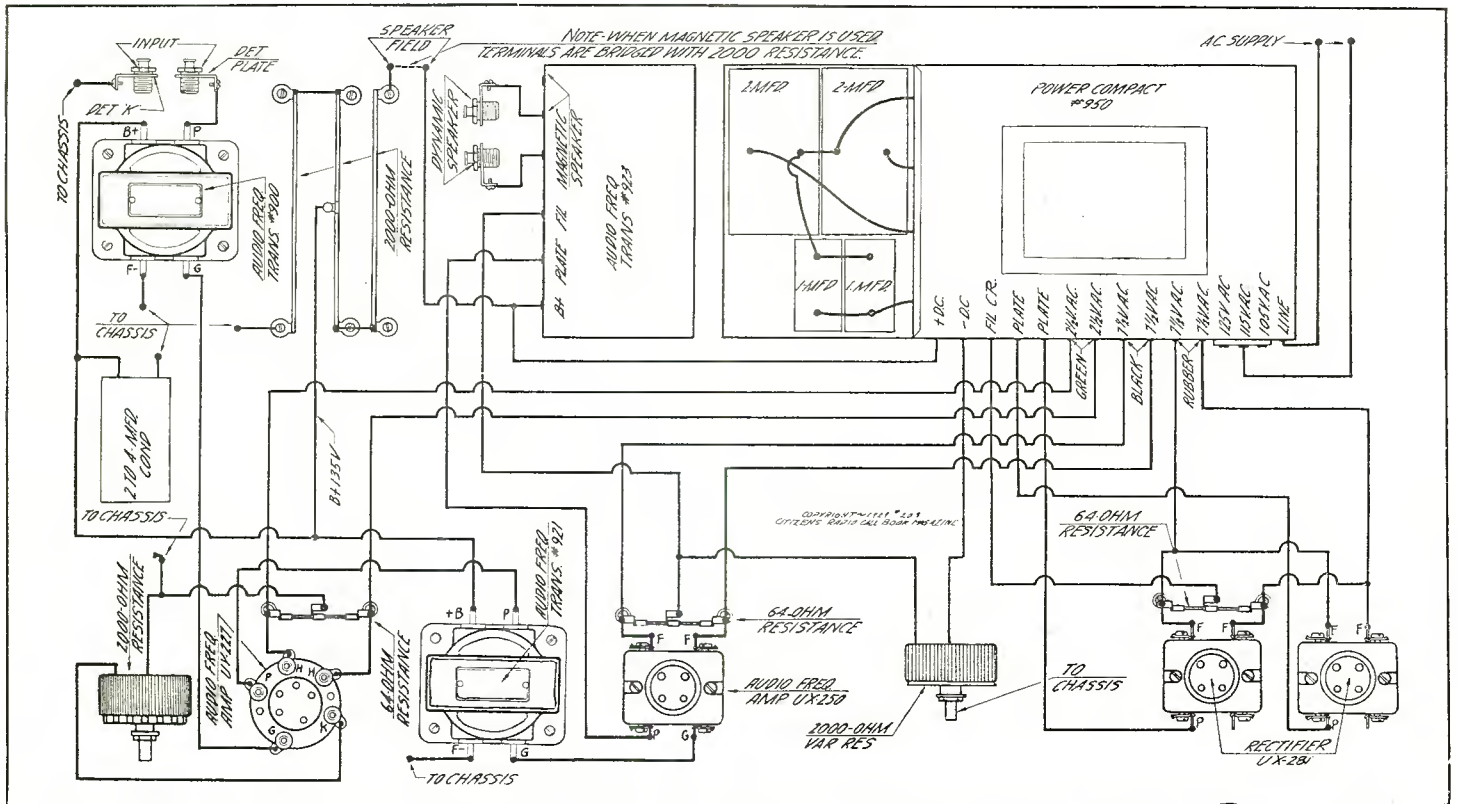

Fig. 3. This graphic diagram represents the manner in which connections should be made for wiring up the amplifier

Aero 21 Chronophase Has Its Own A, B and C Supplies in Set

Completely Alternating Current Operated This Model Uses Four 227 and One 171-A Tubes

PRODUCED by Aero to meet the demand of the public and professional set builders for a custom-built receiver which will compete in price and exceed in performance the factory receivers, the Chronophase 21 a. c. is described in the accompanying article.

This is one of the several models designed and merchandised this season by the Aero Products in order to give their customers and the public a wide line of receivers and parts from which to make selections.

Full A. C. Operated

Completely alternating current operated, the Aero 21 Chronophase contains a Radiart power unit, which supplies A, B and C voltages for the receiver. Four of the heater type tubes are used, the filament energy being derived from the low voltage secondary on the Radiart unit. The 5 volt secondary supplies filament current for the 171-A, which is used as a power tube, while the high voltage section of the unit is used in connection with a 280 rectifier tube and supplies plate voltages for all tubes as well as the C bias.

Construction of the receiver is considerably simplified by the fact the sub-panel and the front panel are already pierced, and in the case of the sub-panel the sockets are attached thereto. Holes are also punched for the audio transformers, coil sockets, etc., so that very little time need be expended in placing the parts on the

sub-panel and front panel. The wiring itself is also quite simple if the builder follows the diagram shown in the graphic illustration in Fig. 2, or if he is more experienced this wiring may be accomplished by consulting the schematic circuit in Fig. 5. In wiring up the power supply, Figs. 4, 6 and 7 should be consulted.

In the design of the Chronophase receiver, consideration was given to the most bothersome type of station interference which appeared to be that strong local station's signals had a tendency to spread as much as 100 kilocycles on each side of the transmitting frequency. Inasmuch as the Chronophase was being planned to secure distance, even though there was strong local interference, this particular condition was not allowable and it was decided that a signal strength of 1 per cent of the full value was permitted 50 kilocycles on each side of the normal frequency. With further experimental set-ups, entirely unshielded and with the coils separated by a distance of about 8 inches, it was found that this condition was secured by the use of two stages of radio frequency. These tests were performed at the Aero laboratories during actual reception conditions using a 100-foot aerial approximately 50 feet high. A general idea as to the placement of the coils, that is, the final placement, is shown in the photograph in Fig. 1.

Next came the question of audio frequency amplification. A transformer has been recently made available of the type hitherto

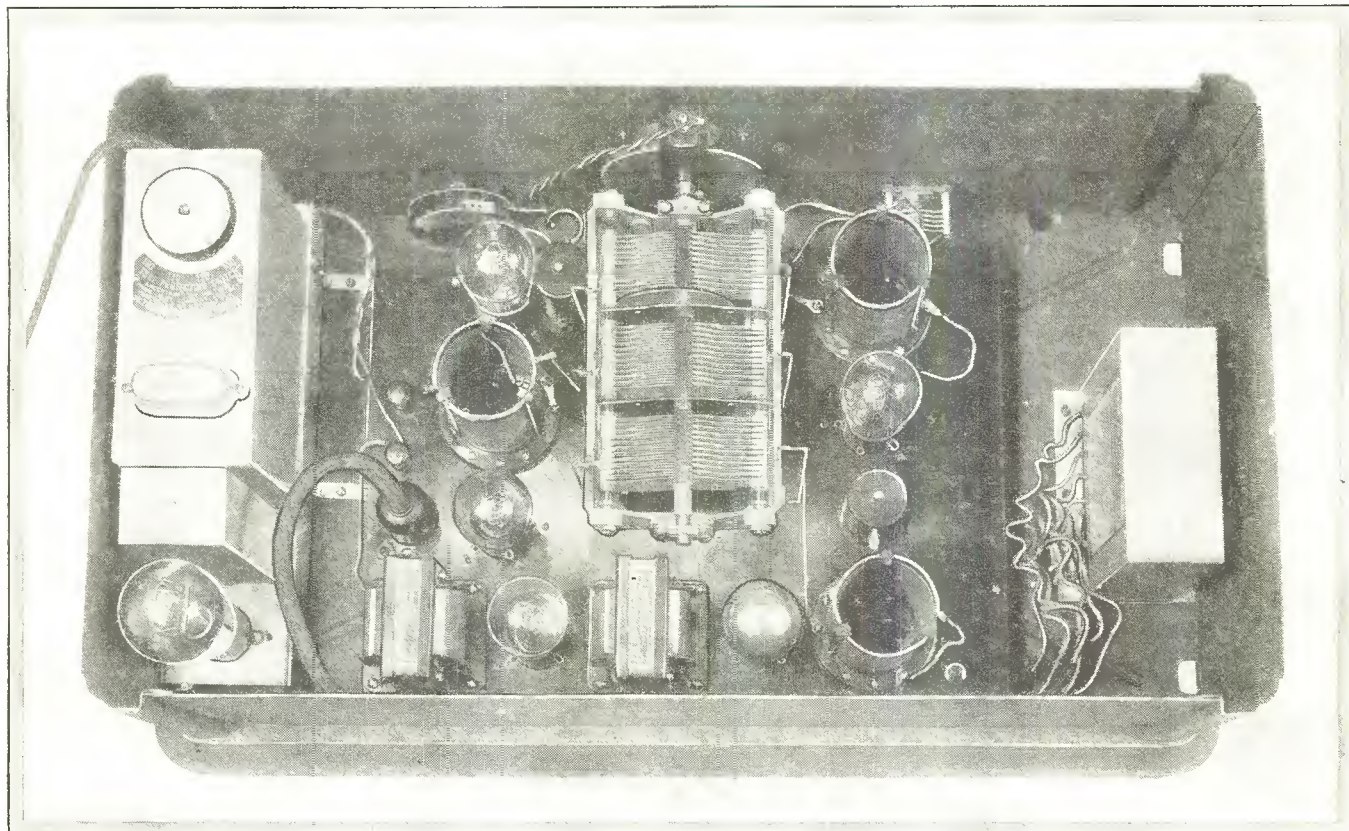

Fig. 1. This photograph shows the Chronophase 21 fully wired together with its A, B and C power supply, which is shown at the left of the photograph

(This receiver tested and all illustrations made in our laboratory)

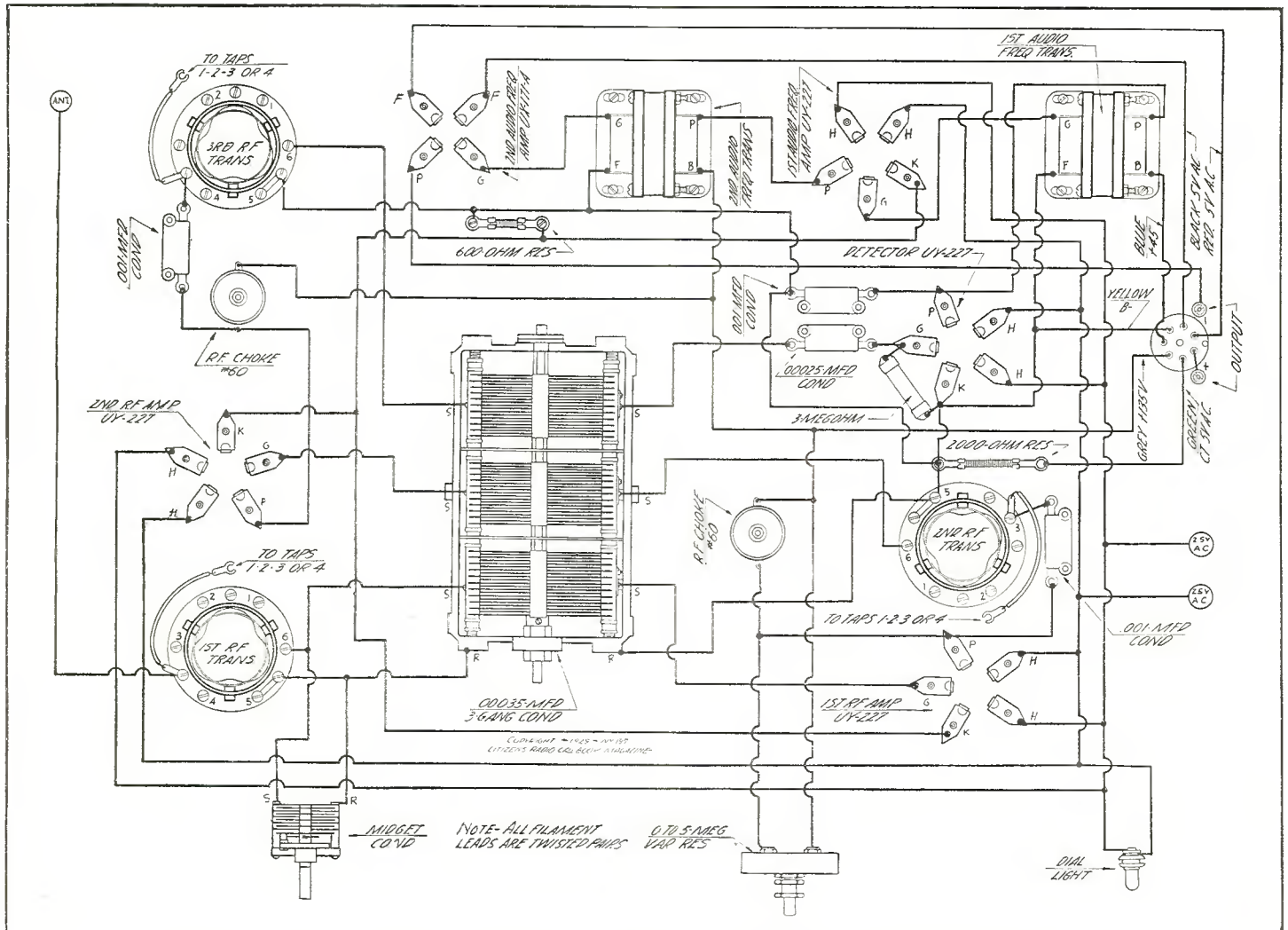

Fig. 2. For those who wish to save time in wiring, the graphic diagram shown above may be followed

used only in especially constructed amplifiers which are placed in telephone lines used in transmitting broadcast programs for long distances over wire. To the average man who has trouble building a three stage audio amplifier without getting violent distortion, it would seem almost inconceivable that some of the chain programs may pass through many times that number of amplifier stages before being transformed in a radio frequency carrier and put on the air. The fact that no quality can be lost through this long chain of amplifiers is indicative of their need for almost perfect characteristics in the transformer and a special type is developed for that purpose, with much flatter curve over the audible range than is ordinarily obtainable and continues the flat portion of this curve out beyond the audible range so that there will be no loss of overtones and harmonics, which although themselves inaudible will produce a decided effect upon the ear.

With these audio transformers available, both the audio and the radio frequency ends of the receiver are taken care of.

Short Leads Important

Next in importance comes the design or layout of the receiver in such a way that no serious losses would result from troubles in the layout construction. Assuming that the coils and condensers of the radio frequency amplifier are of the best quality obtainable, one of the most prolific sources of difficulty has been found to be in superfluous lengths of leads, particularly in the grid circuit where a maximum energy is desired and the impulses are most readily vulnerable. The plate leads are next in sensitivity to external influences. In order to keep both these leads as short as possible, the arrangement of parts indicated in the photograph in Fig. 1 was employed. It will be noticed that the stators of the condensers which must be in the grid circuit any-

way are used as grid leads, allowing the placing of each tube very close to the subsequent radio frequency transformer and permitting extremely short leads in both instances. A triple condenser with arrangements for compensating any slight differences in capacity is used to tune the r. f. stages. The means provided for synchronizing sections of the condenser proved to be insufficient to properly compensate for antenna variation, and since with some antennas adjustment will be required between the high and low frequency ends of the broadcast band, it was deemed advisable to put a midget condenser, used as a vernier for the first stage, on the front panel.

An inspection of the illustration accompanying this article will show there are practically no connections on the top of the sub-panel other than those running from the stators of the variable condensers to the No. 6 terminals of the coils. The coils are mounted by three machine screws and the .001 condenser between the plates of the tubes and the taps on the coils are connected to the mounting screws between terminals 3 and 4 on the underside of the panel. A piece of flexible wire is attached to the top of the same screw, the other end of which can then be connected to whichever terminal of the coil gives the desired results, as will be explained later.

Heavy Filament Leads

In constructing this a. c. model, it should be borne in mind that the filament leads to the heaters of the 227 tubes should be twisted and made of fairly heavy wire. Examination of the photograph shown in Fig. 1 will disclose that the power supply shown at the left is quite close to the Yaxley cable plug, so that these filament leads are very short. The Radiart power unit No. 55 has been designed both mechanically and electrically to fit the

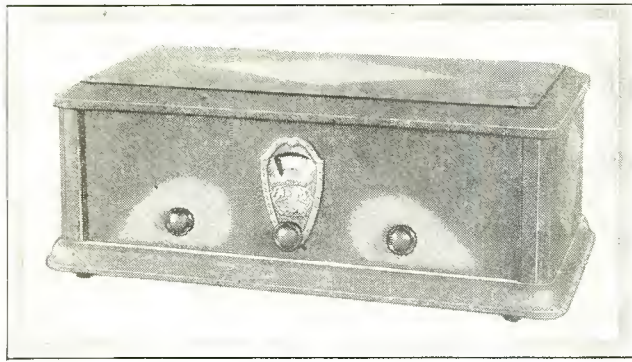

Fig. 3. An attractive metal cabinet is made by Aero in which their receivers may be placed

Chronophase 21 a. c. receiver only and may not be used with other receivers. It is a very compact unit consisting of a power transformer, choke coils, a container for the transformer, choke coils, resistance unit, sockets for the 280 rectifier tubes, a tube protecting voltage control switch, a protecting fuse, a detachable bakelite terminal board and a base for mounting the unit in the Aero metal cabinet. The overall size is 3 in. wide, 11 in. long and 7 in. high. Choke coils are designed to pass 60 milliamperes with less than 1/4 of 1 per cent ripple. On account of the type of transformers used in the Aero receiver, it is necessary that the power supply be perfectly filtered, which it is. A tube protecting voltage control switch is mounted on the top of the unit, which operates in connection with the tapped primary of the power transformer. This switch regulates the A, B and C voltages, insuring highly efficient regulation. There is a pointer on top by which changes may be made from 100, 110, 120 and 130 volts to take care of any line variations. The owner of the receiver must ascertain the exact voltage of the electric light line in his own home. He can do this either with the aid of a proper voltmeter, or he can ascertain the voltage from the electric light company supplying the power. The pointer should be set at the voltage obtainable on his line. A 1 ampere fuse covered in the specifications of the Underwriters laboratory is located on top of the power unit and connected to the primary circuit of the power transformer. In this position it is readily accessible. This fuse will blow and open the primary circuit of the high tension winding, should it become short circuited. It will also blow in case of any other short circuit effecting the power unit. The resistance network in the power supply is a unit mounted at one end and outside of the container of the transformer and choke coils. It is wound and tapped to supply the exact B voltages for the Aero 21 Chronophase. In the cord supplied with the unit is incorporated a cut-out switch, for turning the a. c. current on and off. This automatically stops and starts the entire receiver. All

of the leads from the power transformer choke coils are brought out from the bottom of the power unit container directly to a permanently mounted terminal board. By reason of this design there are only two solder joints which are not in plain view but easily accessible. This is a very desirable feature.

Connections Are Simple

With each power unit there is supplied an auxiliary removable bakelite terminal board which fits over the permanently mounted terminal board. On this auxiliary terminal board are mounted soldering lugs to which the leads from the receiver itself and

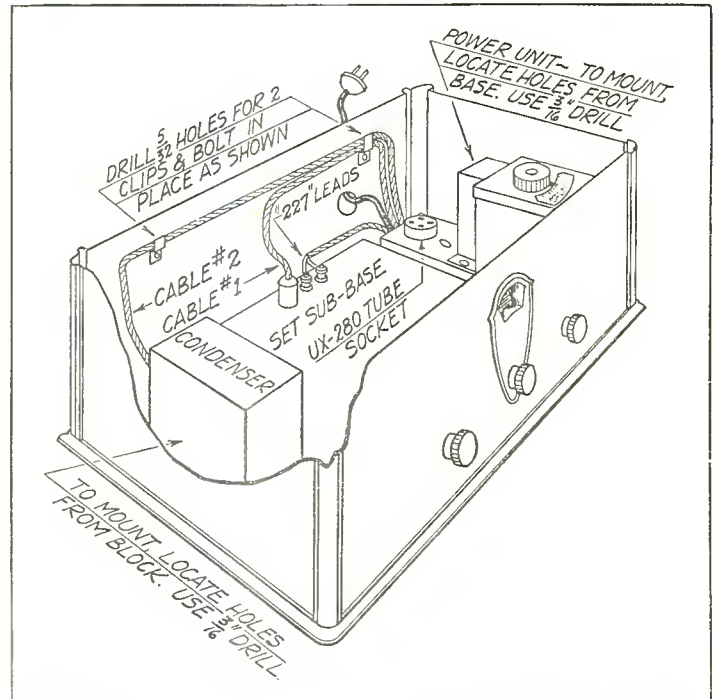

Fig. 4. The sketch shown above shows the relation of the power supply and the filter condenser block as placed in the receiver itself

from the condenser block and from the rectifier tube socket and from the resistance unit are soldered. The only additional apparatus side from the receiver and the power supply is the Aerovox BC-280 filter condenser block having a total capacity of 11 mfd. This filter block is shown at the right side of the photograph in Fig. 1.

Most of the connections to the power supply and to the condenser are made from two short cables, these being made by cut-

(Continued on page 134)

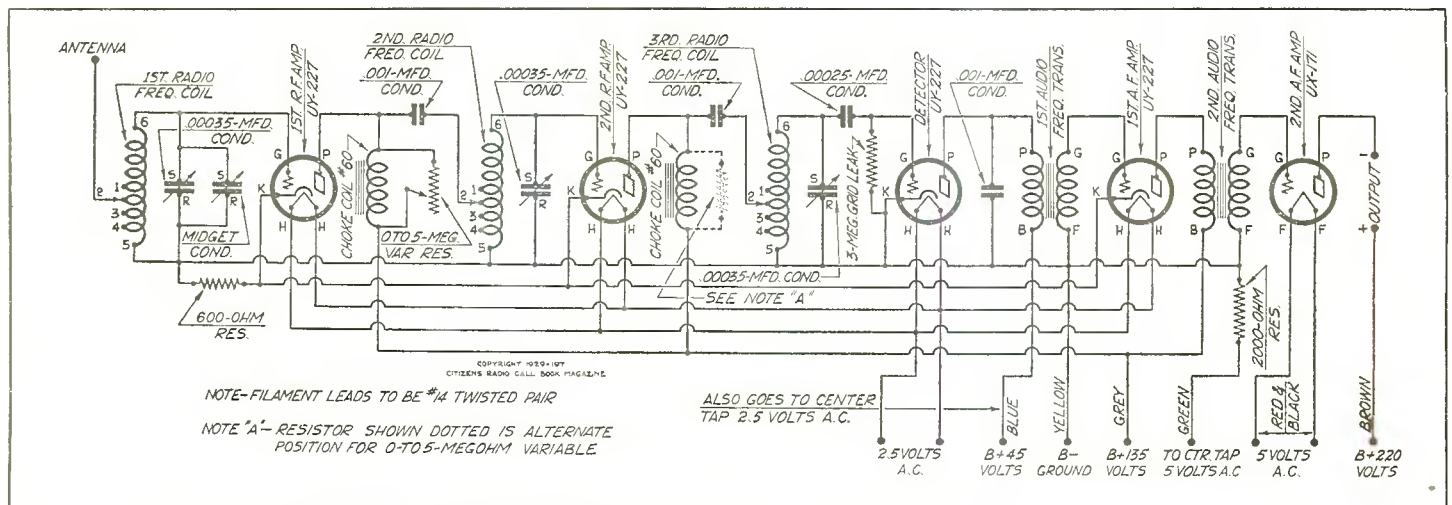

Fig. 5. The schematic circuit involved in the Aero 21 Chronophase is shown in the above diagram

Laboratory Amplifier Made for the Professional Set Builder

Sangamo Transformers Used in Push-Pull 171-A Design for Testing Radio-Phonograph Sets

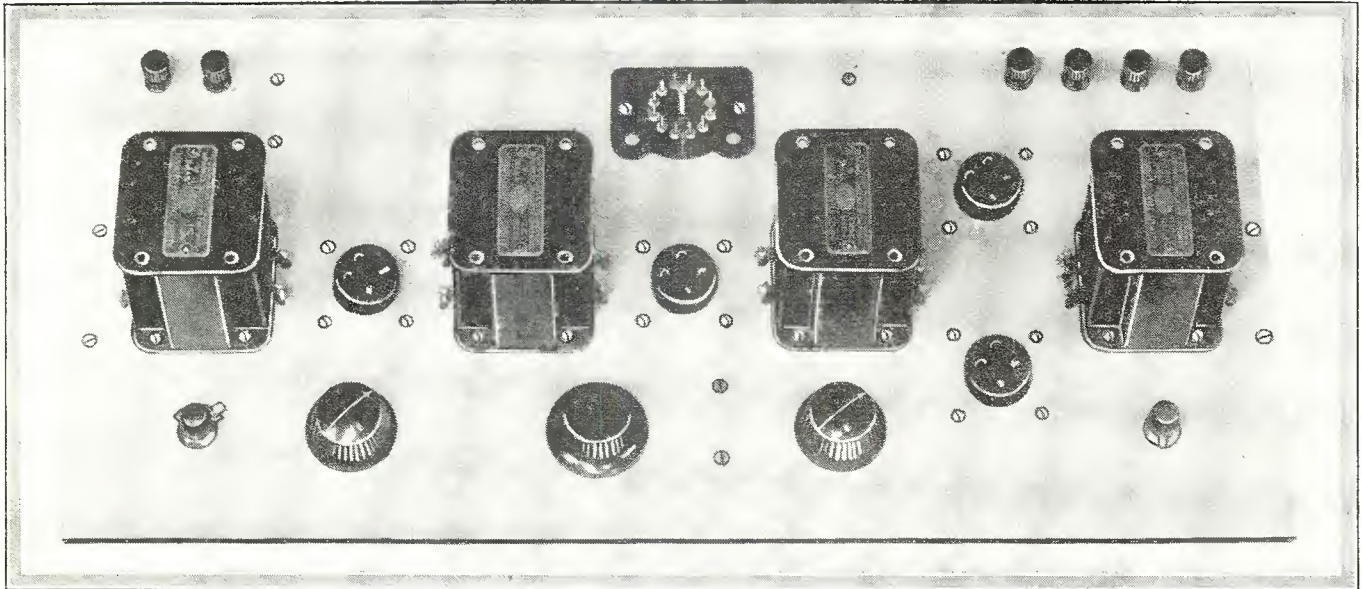

Fig. 1. The completed laboratory amplifier using Sangamo parts is shown in the photograph above

FREQUENTLY our technical department is called upon to provide a sketch or diagram of an amplifier using transformers of various makes now on the market. One of the recent requests was for a laboratory type amplifier which could be employed by professional set builders in their workshop as a means of testing the r. f. end of a receiver or using it in connection with a phonograph pick-up unit.

The design described in the accompanying article was developed in order to give as much flexibility as possible for operation of the amplifier and at the same time hold down its cost. Since a number of the set builders and other experimenters desired an amplifier which could be operated from storage batteries, if necessary, or with a small B eliminator, it was felt that the 201-A, 112-A or 171-A tube combination would probably be the most satisfactory.

Sangamo Transformers

As shown in the schematic diagram in Fig. 2, it will be seen that the amplifier consists of a Sangamo type A input transformer for use in connection either with a phonograph pick-up or with the detector circuit of a receiver. While at the time it might appear that two stages of transformer coupling followed by push-pull would give entirely too much volume, nevertheless it was felt that when the unit is used in connection with a phonograph pick-up it might be necessary to have the added stage and when required the volume could be cut down by means of the 200,000 ohm variable resistance placed across the secondary of the second audio transformer. If the set is to be operated with a radio receiver, then the volume control is turned to the "off" position so its presence in the circuit does not matter. Then the volume is controlled by the receiver itself.

In the schematic diagram, previously referred to, the input tube is a 201-A with a 20 ohm rheostat in series with the negative

terminal of that socket as well as the negative terminal of the socket for the 112-A, which is the second audio tube. By placing a rheostat in this position it is possible for the professional set builder or experimenter to use almost any type of tube in these two positions that he desires. A 20 ohm rheostat is also included in the negative filament circuit of the two 171-A tubes, so that there is some flexibility in this particular circuit as well.

Push-pull Circuit

The output of the 112-A stage is fed into the primary of the transformer type B, which is a push-pull input. Its secondary is of the center-tapped type, the center leading to a negative bias voltage of 40½ volts. The two extremities of the secondary go to the grid of the two 171-A's arranged in push-pull. Under certain conditions it might be advisable to use a .00025 mfd fixed condenser from the F terminal to one G terminal of the push-pull input circuit, although this may not be required in each installation. The plates of the 171-A tubes go to the P terminals of the Sangamo output transformer type C-171, while the center of this winding goes to the 180 volt terminal of the eliminator or battery. By means of a single pole double throw switch located at the extreme right in the schematic circuit, it is possible to switch the output of the amplifier from one speaker to another. This was designed in order to allow the operator or experimenter an opportunity of determining for himself the difference between two speakers of the magnetic type. While this arrangement is perfectly satisfactory for the magnetic type of speaker, nevertheless when it is used in connection with the dynamic kind, results will not be so satisfactory because the output of this amplifier is then feeding into another input transformer, or a step-down transformer, in the dynamic speaker itself. However, if just for test purposes, that is, for determining the difference between two dynamic speakers, the arrangement shown above might be considered satisfactory.

(This amplifier designed, tested and all illustrations made in our laboratory)

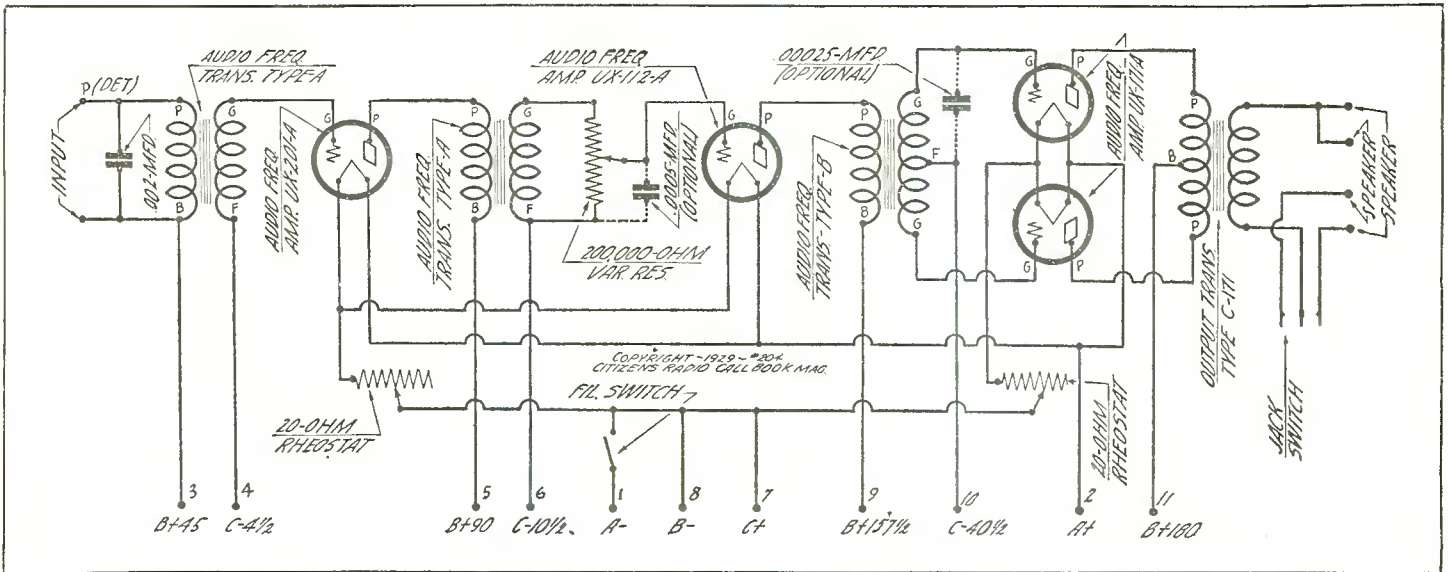

Fig. 2. This diagram represents the schematic circuit involved in the phonograph or radio amplifier used by the professional set builder for test purposes

If the amplifier is to be used as a permanent job on the operation of dynamic speakers, then the output transformer shown as C-171 should be removed and the H-171 substituted therefore, because the latter is designed for an impedance working into the dynamic speaker, whereas the C-171 is so designed to match the impedance of a cone type speaker. Since it is more likely that the set builder and experimenter will be testing the cone type of speaker, the C-171 will be found in more general use. If it is desired to use a dynamic speaker permanently with amplifier and the owner already has a C-171 output transformer in the amplifier, he may take the dynamic input terminals across the two extremities of the primary in the C-171 transformer. Of course, this will not permit shifting from one dynamic to another, but at least, if the job is to be a permanent one, it can be so arranged.

Sub-panel Mounting

The sub-panel on which the apparatus is mounted is a piece of ivory Formica 9x20x3/16 in. It is supported by means of two Silver-Marshall 540 brackets. Looking at the photograph in the 20 ohm rheostat next to it is the filament control for the 201-A and 112-A tubes, the center knob of the three is the 200,000 ohm variable resistance for a volume control, while the right knob is the 20 ohm filament rheostat in series with the negative terminal of the two 171-A tubes in push-pull. At the extreme right is a single pole double throw Carter jack switch for shifting from one cone speaker to another.

At the left in the rear are the two binding posts represented as the input terminals, while at the right rear are the four binding posts, two of these going to one cone speaker and two going to another cone speaker, if two speakers are to be tested. The Yaxley 12-contact cable plug is shown at the center in the rear. Looking at the photograph in Fig. 1, at the extreme left, is the Sangamo type A transformer, then another type A transformer, these two

being the first and second stages, then comes the type BX push-pull input and finally the type C-171 output transformer. Four Benjamin UX sockets of the floating type were employed.

By consulting the photograph shown in Fig. 3, the builder will acquaint himself with the manner in which the wiring is accomplished. This wiring may be done with flexible wire and after all leads have been run in properly, the entire job may be cabled with string or tape. The cabled lead idea results in much stabler operation of the amplifier, because the various leads do not have an opportunity for picking up any energy from high potential neighbors.

Official Parts List

Parts used in the construction of the radio phonograph amplifier using Sangamo transformers are shown below:

- 1 Sangamo .00025 mfd. fixed condenser
- 2 Sangamo .002 mfd. bypass condensers.
- 2 AF Sangamo 3-1 audio frequency transformers
- 1 BX Sangamo push-pull input transformer
- 1 C-171 Sangamo push-pull output transformer
- 1 1892 Frost 200,000 ohm 3-point variable resistance
- 2 1920 Frost 20 ohm rheostats
- 1 Formica ivory sub-panel 9x20x3/16 in.
- 1 Yaxley 12 contact cable plug
- 6 Eby binding posts
- 4 9044 Benjamin UX sockets
- 1 10 Yaxley line switch
- 1 D-22 Carter jack switch
- 2 540 Silver-Marshall brackets
- 1 CeCo or Sonatron 201-A tube
- 1 CeCo or Sonatron 112-A tube
- 2 CeCo or Sonatron 171-A tube
- 1 Pkg. Corwico Braidite hook-up wire

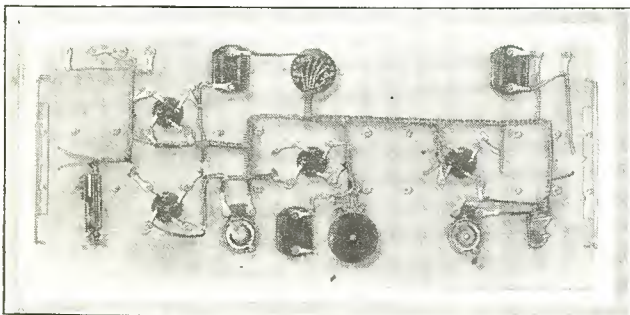

Fig. 3. All of the wiring on the bottom of the amplifier is run together in a cabled form, which gives it a neat appearance

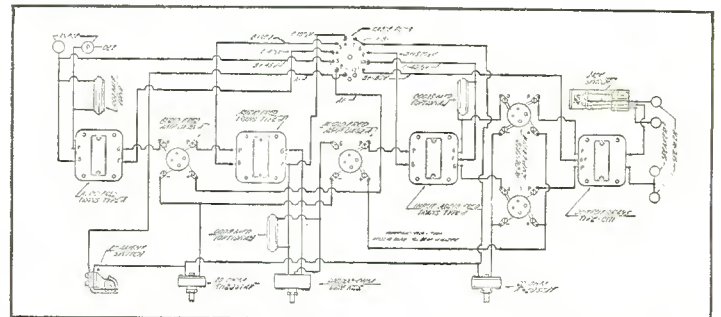

Fig. 4. The amplifier referred to in this article may be wired by following the above graphic diagram, although professional set builders will probably wire their jobs from the schematic shown in Fig. 2

Tyrman 72 Now Designed as Battery or Alternating Current Set

Production Change Made So All Models Fit in Standard Cabinet;
Power Supply Separate

SECOND in the line of receivers manufactured by the Tyrman Electric Corporation is the model 72 described in this article, which is a seven tube superheterodyne using screen tubes, and arranged either for alternating current operation or battery operation, as desired by the builder.

When assembled for alternating current operation, the receiver is a complete a. c. receiver in every sense, using a. c. shield grid tubes and the 227 type of detectors. Even if the model is assembled as a battery or eliminator operated model, it is a comparatively simple matter to convert it to socket operation by changing a few parts and the sockets for a. c. tubes and following a different wiring scheme.

In the model described in this issue, the wiring is shown as an alternating current operated superheterodyne. A power pack especially designed for the 72 is provided, which is plugged into the receiver by means of a connector cable. Where in the original model, it was desired to include the power supply on the rear of the sub-panel, nevertheless it was found in merchandising that this involved securing a cabinet of other than standard dimensions. As a consequence, in order to meet the demand of set builders, who wish to use the receiver in a standard cabinet, the power supply was taken from the chassis and is now supplied

in a separate unit, which is connected to the receiver itself by means of a cable. Thus the power supply may be on a lower shelf in a console.

Volume for Home

The power supply uses a 280-tube as a rectifier for the high voltage current and has a very high grade filter system, which filters the pulsating current so that it is the equivalent of battery operation. The power stage in this receiver is a 171-A, which gives ample volume for home purposes.

Looking at the schematic circuit shown in Fig. 3, it will be observed that the first detector is a 222 tube of the a. c. type, this being located at the extreme left in the diagram. The oscillator for the circuit is at the extreme right of the diagram, where a 227 heater type tube is employed. Mixing is accomplished by the pick-up in the oscillator coil feeding into the lower portion of the antenna coil, the tuning being across the two extremities of this inductance. Rectification in the first detector is by means of the .0001 mfd condenser and 3 megohm grid leak shown in the diagram. A 3000 ohm fixed resistance spanned by a $\frac{1}{4}$ mfd fixed condenser between the cathode of the a. c. 222 and the ground furnishes the necessary drop in that circuit.

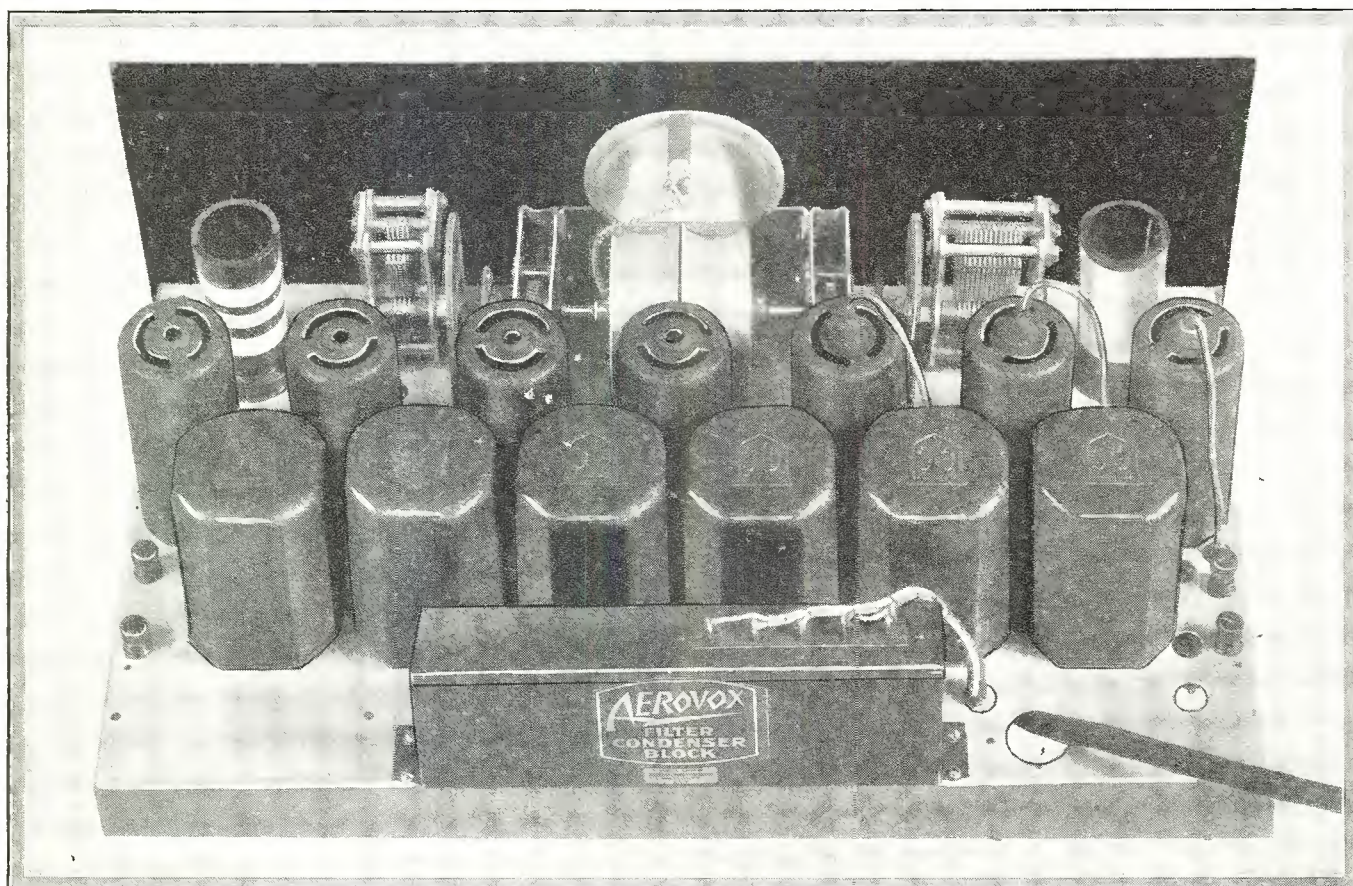

Fig. 1. This photograph shows a rear view of the Tyrman 72 for battery or a. c. operation. The power supply used in conjunction with the receiver is illustrated in the photograph shown in Fig. 4

(This receiver tested and all illustrations made in our laboratory)

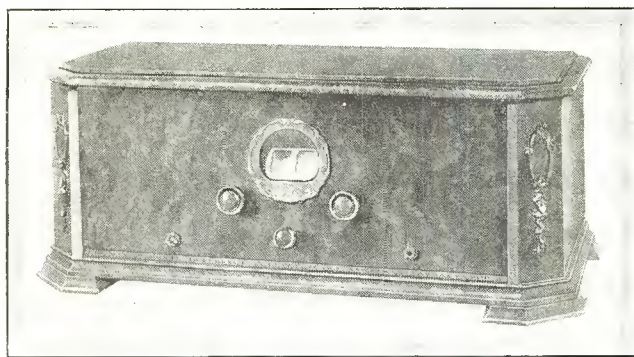

Fig. 2. This photograph illustrates the manner in which the Tyrman 72 is placed in a table size cabinet. It may also be used in a console if desired

Three stages of screen grid intermediate frequency amplification are provided, the 222 tubes being used and feeding into a second detector using a 227 tube. In the second detector, rectification is by means of the bias afforded the grid through the drop across the 3000 ohm fixed resistor between the cathode of the tube and ground. A 75,000 ohm variable resistance common with

be adjusted so that the minimum capacity is obtained. This is necessary in order that the oscillator condenser just covers the broadcast band without overlapping. All of the terminals of the various units which are to be grounded are automatically grounded because of the construction of the chassis and the insulating sub-panel.

In outward appearance, the 72 is a duplication of the model 80, which appeared in the last issue of this magazine. The front panel is metal with a burl walnut finish. It is equipped with a new Tyrman double drum drive which concave translucent window reflector permitting indirect illumination of the drum dial. The operation of the receiver is concentrated control with three knobs. Two are for selecting stations and one for volume. Sub-panel platform is of heavy gauge steel cadmium plated, formed and pierced to automatically accommodate the parts to be mounted on it.

All parts for the model are merchandised by Tyrman in a complete container.

Power Pack Separate

The power pack supplied with the Tyrman 72 is a very compact one and foolproof in operation, since there are no variable controls which the operator can work. Examination of the sch-

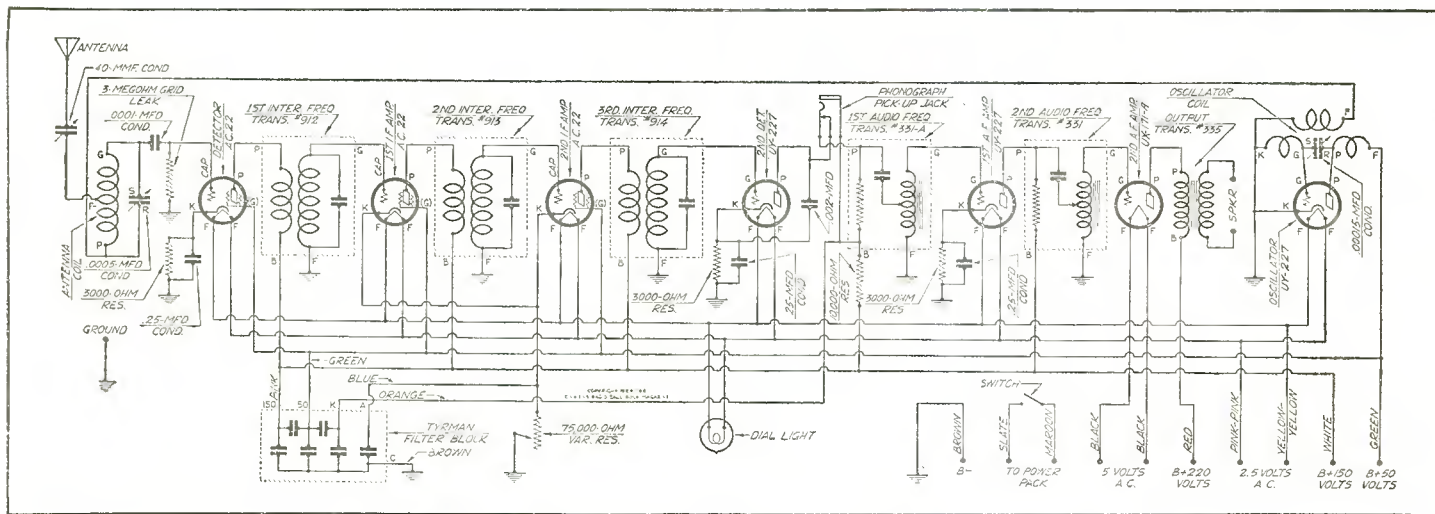

Fig. 3. The schematic circuit involved in the Tyrman 72 is illustrated above

the two cathodes of the first and second intermediate tubes and the ground afford a control of bias on the grids of these two tubes. This variable resistance is used as the volume control in the receiver. Shield grid voltages of a value of 50 volts are supplied to all of the type 222 a. c. tubes.

Phono Pickup Jacks

Located in the plate circuit of the second detector is the phonograph pick-up jack, by means of which energy from a phonograph pick-up unit can be applied directly across the plate side of the first audio unit and then obtains its amplification through the succeeding amplifiers and be reproduced through the loud speaker units used with the Tyrman 72. This phonograph pick-up jack is brought to the front panel and is shown at the right in the photograph, Fig. 2. The switch at the left in Fig. 2 is the 110 volt switch controlling the power supply, while the center knob is the variable resistor or the volume control. The left dial in this photograph controls the condenser across the antenna inductance, while the right dial governs the condensers across the oscillator inductance.

Plug In Coils

The antenna tuning coil is of the plug-in variety, which is also true of the oscillator coil. This makes for convenient changing when short wave reception is desired. Suitable coils can be obtained for short wave operation.

The condenser tuning the oscillator coil has a maximum capacity of .00015 and a semi-fixed variable plate which should always



Fig. 4. This photograph shows the power supply which is used separately with the Tyrman 72

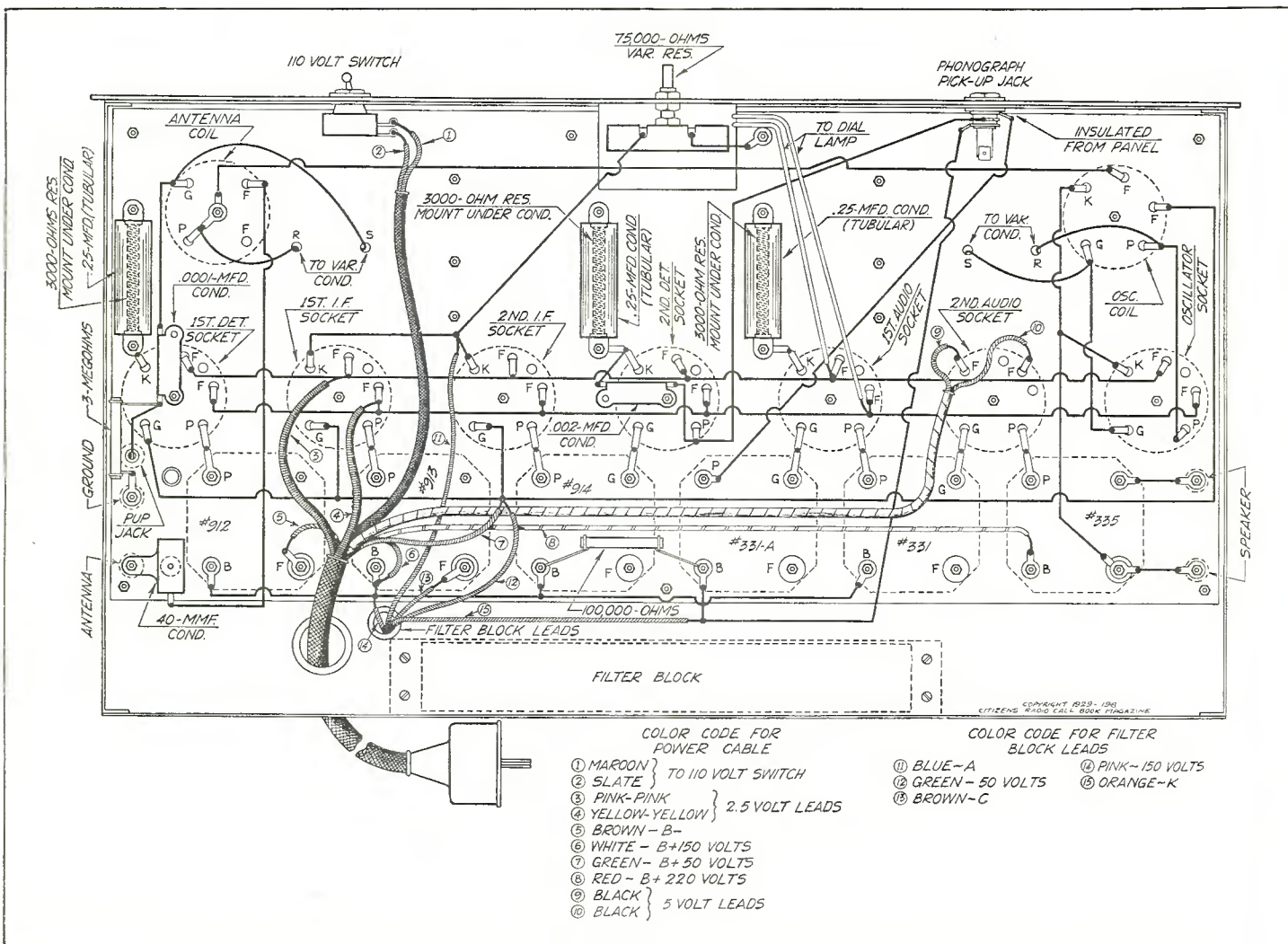

Fig. 5. Above is a drawing of the under side of the chassis, this graphic diagram being suitable for wiring up the receiver

matic in Fig. 6 will show that the power transformer consists of a 110 volt a. c. winding, with a switch in the primary for high or low voltage, this being placed there to compensate for a drop in the line at the home of the operator. By the same token, it can be used as a compensator in the event that the line voltage is high.

The high voltage winding which is one of the secondary goes to the two plates in the UX-280 rectifier, the center tap of this winding becoming the negative line of the system. The filament secondary which supplies current for the filament of the 280 is center tapped and this center tap becomes the positive high voltage, which is carried through the double choke unit, properly

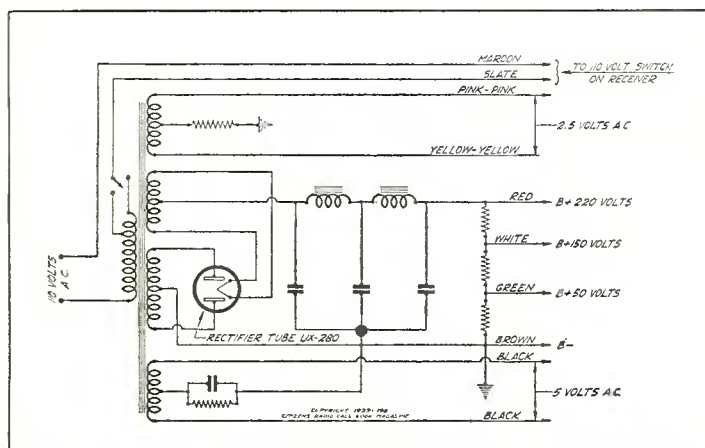

Fig. 6. The schematic of the power supply is illustrated above

bypassed with its required capacity. A 5 volt secondary is supplied for energizing the filaments of the 171-A tube, the center tap of this winding having a fixed resistance and a capacity across it leading to the common ground, this resistance furnishing the required C bias for that tube. The 2½ volt a. c. current for the filaments of the 22 tubes is supplied by a 2½ volt winding. The resistor protects the winding against shorts.

Maximum voltage obtained from the power unit will be 220 volts and the resistance network is made up so as to give additional voltages of 150, and 50. These values are fixed and may not be changed by the builder.

Examination of the photograph shown in Fig. 4 will disclose that connection is made to the receiver by means of a flexible cable having a plug head, this plug fitting into the receptacle shown at the top of the power supply in Fig. 4.

A 40 mmf condenser is located in series with the antenna lead and to the center tap of the antenna inductance. This condenser may be shifted around within its limits so as to increase or decrease the amount of pick-up being secured from the energy collecting system. This condenser is also helpful in cutting down the amount of energy picked up from local stations when the receiver was being operated adjacent to a broadcast station.

Parts contained in the Tyrman 72 A. C. kit, merchandised by the Tyrman Electric Corp, are as follows:

- 1 Front panel
- 1 Steel chassis
- 12 No. 14 bus bar wire
- 1 Cable
- 1 Intermediate kit

(Continued on page 132)

Amertran Parts in a High Quality Radio Phonograph Amplifier

Push-Pull Arrangement of 210 Tubes Suggested Because of Their Greater Undistorted Output

THE above caption, in a nutshell, expresses the desired specification of a unit required by a radio enthusiast. What sort of a circuit should it be? How many stages; and what are the resulting frequency and gain characteristics?

Such questions are of paramount importance, and must be answered before going ahead with this type of radio job. Assuming one has a good radio frequency amplifier developing ample selectivity, without undue cutting of the audio frequency side-bands, and with long distance signal reception of little or no importance it may be reasoned, therefore, all apparatus up to and including the detector should be used.

The latter remarks are generally overlooked, because the average set owner seems to invariably reach the decision that only a new set will fill his needs, whereas, in many cases installation of a highly audio amplifier alone generally develops tonal quality excelling that of most of the so-called mass production factory built sets.

Reasons for the Circuit

Analysis of the requirements revealed that the amplifier must be of the dual type, that is to say, it should be suitable for use with both the radio frequency circuits, or in conjunction with a high grade phonograph pick-up.

And if quality reproduction is of principal consideration, then certainly a push-pull stage becomes necessary since this stage must be capable of handling signals of large amplitude without fear from overloading, and it should be relatively free from frequency or signal shape distortion. It also appeared desirable to limit the plate voltage to a maximum of 180—such as would be developed by a power device incorporating a 280 type rectifier tube.

Such an output power stage unit would of course call for a push-pull stage using 171-A type tubes. But further analysis of the problem showed that the maximum instantaneous values of tube load current was such as to cause a relatively large drop in effective plate voltage that it was doubtful whether a push-pull 171 stage should be considered.

Another important feature generally overlooked where low-mu power tubes are resorted to is the fact that the lower a power tube amplification factor the smaller will be its sensitivity to weak (or distant) signals.

In view of these facts it was felt that since there is but a rather slight difference in building costs between a 171 and a 210 push-pull power amplifier, it was decided to construct the 210 type because undistorted power output is fully 100 per cent greater than for 171 types, plate voltage could be more easily maintained for best all around operation and a better response would be

realized when dealing with distant or low amplitude signals.

Some may say, "Well, if one is so critical, then why not go to a 250 push-pull stage?" And the answer, briefly, is that such an output is seldom made necessary for the average home; nor should one forget its low sensitivity, as previously pointed out.

Since the amplifier must also give quality reproduction from a phonograph pick-up it was thought best to make a little study as to proper means for coupling the pick-up to the first audio tube. Such devices are of relatively low impedance, and are not suitable for either direct connection across a tube input or if placed in series modern transformer primary windings.

However, the Amertran people were found to have developed an impedance balancing transformer or network which functions as an adjustable primary impedance for obtaining the best match for the pick-up proper; while its secondary windings possess correct impedance characteristics for working into standard audio frequency transformers. With such an efficient combination it only becomes necessary to use a simple little Yaxley jack switch for setting the amplifier input circuits so these may be connected to either the radio set or phone pick-up.

While ample loudspeaker volume was a requirement, still it was felt that a properly designed two stage amplifier should prove every bit as good as the average attempt at three stage types.

And for the latter reasons it was decided to use high quality audio transformers. The Amertran models adopted possess high primary winding inductance and impedance values. This feature, of course, is realized by use of high permeability alloy core materials. But through its use, like with Permal-

loy, one must be careful to keep the d. c. plate current circulating through this winding down to fairly low values (approximately 3 ma.) or preferably it should be eliminated altogether.

It was therefore decided to design the amplifier so that only the first or input Amertran unit would carry the d. c. plate circuit component of the detector tube, whereas plate current would be kept out entirely from the primary winding of the push-pull input transformer.

The latter scheme was accomplished by means of a type 103 Amerchoke—another apparently new device now available in the interest of high quality reproduction. Analysis of the circuit shows that in this stage the parallel feed plate supply system was adopted; in this way only the a. c. signal component circulates through the transformer primary winding.

A Few Other "Tricks"

Any capable engineer appreciates that one must be careful when

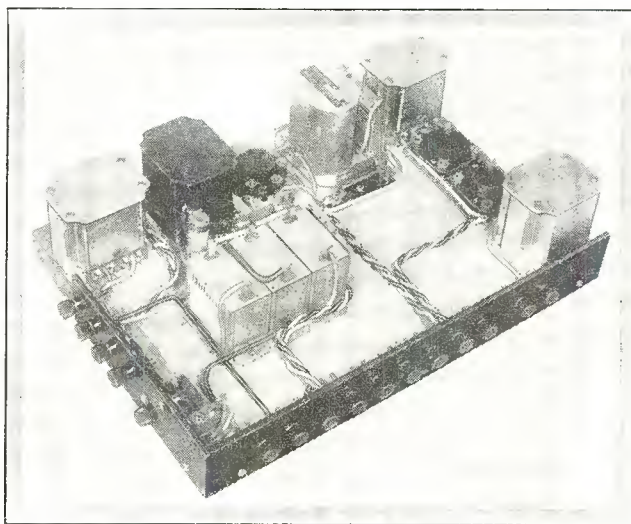

Fig. 1. This photograph shows the completed combination of radio and phonograph amplifier constructed with the Amertran parts

(This amplifier tested and all illustrations made in our laboratory)

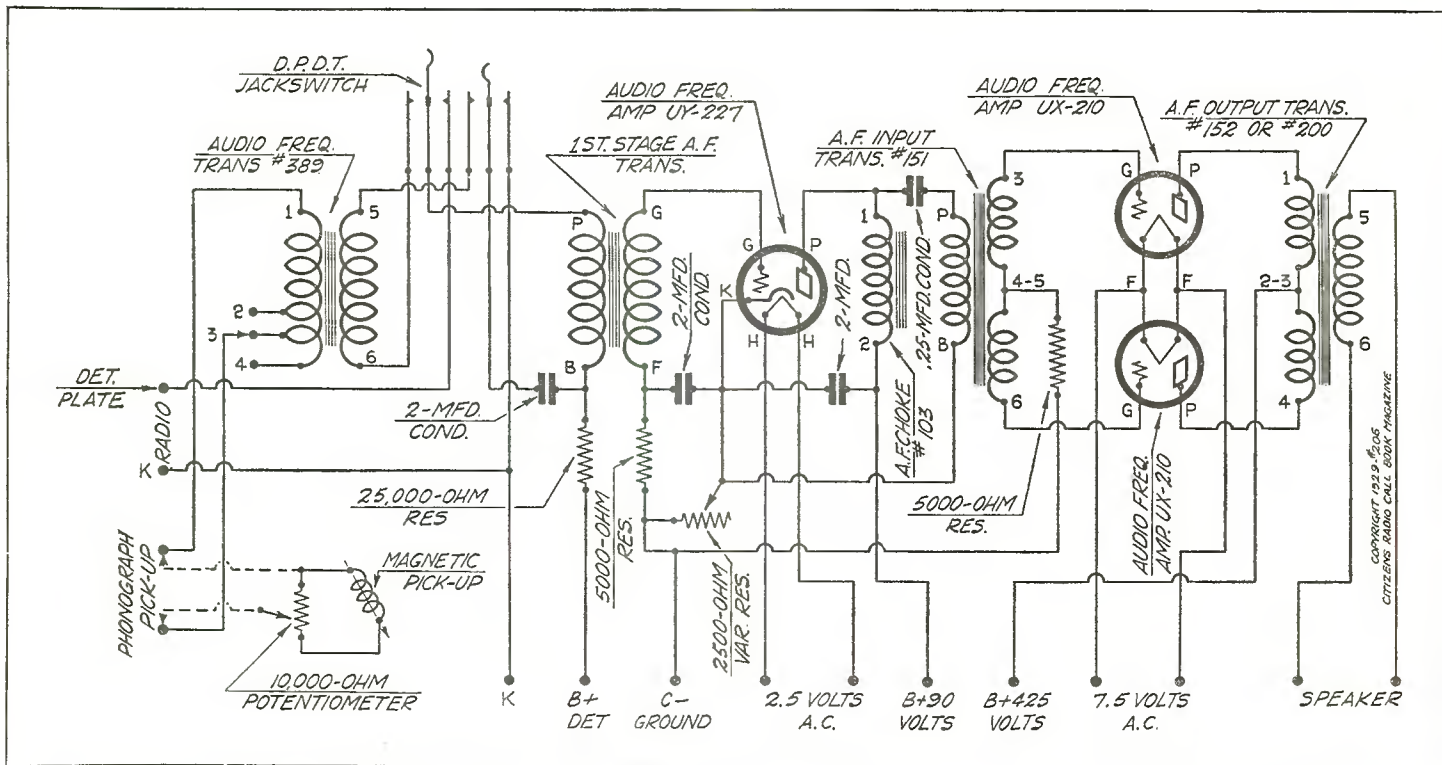

Fig. 2. In the above schematic diagram may be seen the electrical details of the combined amplifier. Parts required for the construction of the unit are shown in the list of parts accompanying this article

using high quality amplifier systems in conjunction with high voltage rectifier methods. Otherwise the common impedance path offered by the power unit may be of such order as to cause audio frequency oscillation or "motorboating," which, of course, will completely change the amplifier characteristics.

It will ordinarily be found that the detector stage proves a principal offender. And in the circuits under discussion the designer adopted a "trap circuit" scheme, as originally developed by R. Wise, whereby a simple resistance and shunt condenser is placed in series with the primary winding of the first audio.

Because the plate current of a 227 a. c. detector tube is somewhat high this resistor, of course, brings about a fairly large voltage drop. However, since a high voltage power unit was employed with the amplifier, this drop could be compensated for by using a detector "B" voltage of either 90 or 135. But in the event one may care to employ another method free from such voltage loss then it is apparent that a type 103 Amerchoke may be used in place of the resistor.

It also is important to use a suitable number of high quality long life by-pass condensers at certain points of the circuit. It is good practice to note that the leakage resistance be a minimum for the coupling condenser placed between the parallel feed choke and the 151 input push-pull transformer.

In order that the several circuits would operate with complete stability, metalized grid-leak resistors were placed in the grid circuits of both stages; perhaps the use of wire-wound resistors of the Superdavoohm type should prove an even better scheme.

The photograph reveals that practically all wiring (three colors used is of the twisted pair type. This method proves quite helpful to eliminate stray inductive pick-up of hum and background noises. All a. c. filament wiring going to either the 227 heater type tube or the 210's were kept rather well isolated from the other circuits, and this in a measure accounts for the somewhat open type of construction.

Now just a word with reference to the phone pick-up or equalizer transformer. This unit is equipped with a tapped primary so that this circuit can readily be adjusted for the best load impedance ratio for working out of any high grade magnetic pick-up such as the Stromberg-Carlson, Bosch, Phonovox, Victor, General Electric, etc. It will be necessary to make a simple test for determining best operation.

The foregoing reveals the engineering data developed by the designer—it tells the whole "why and wherefore" of the design. And should one be interested in a high quality combination radio and phonograph power amplifier, certainly it should meet with his approval.

The entire device was assembled on a small 10 by 14 inches drafting board. The photograph shows just where and how each part should be placed; if these designs are carried out, then perfect results may be assured, though, of course, certain changes depending upon individual requirements may suggest itself—for example, one may rather use a d. c. instead of an a. c. tube in the first audio stage.

At this point may be remarked that the power amplifier as built was constructed so that the output push-pull transformer should feed into some high grade electro-magnetic type loudspeaker; in this case a model No. 152 Amertran transformer was employed. However, should the builder desire the amplifier to operate into a dynamic type speaker, then it becomes necessary to use a type No. 200 Amertran output transformer.

Official Parts List

Parts used in the construction of the amplifier here described are:

- 1 AmerTran type 389 equalizer transformer
- 1 AmerTran DeLuxe first stage audio transformer
- 1 AmerTran 151 input transformer
- 1 AmerTran type 152 or 200 output transformer
- 1 AmerChoke type 103
- 1 Dubilier 907 $\frac{1}{4}$ mfd condenser
- 3 Dubilier 907 2 mfd condensers
- 1 Electrad type B 25,000 ohm wire wound resistor
- 1 Electrad type B 2,500 ohm wire wound resistor
- 1 Electrad Royalty potentiometer 10,000 ohms
- 2 Daven 5,000 ohm Super Davoohm or Glastor resistors
- 1 Yaxley double pole double throw jack switch
- 1 Benjamin UY socket
- 2 Benjamin UX sockets
- 15 Eby binding posts
- 1 Ceco or Sonatron 227 tube
- 2 Ceco or Sonatron 210 tubes
- 1 Package Belden hook-up wire

Receiver and ABC Supply Combined in "Hi-Q" 29 A. C. Junior

Three Stages of Resistance Coupled Audio Amplification Using Arcturus Heater Tubes

DIFFERING only a trifle in circuit arrangement and the number of tubes from the Master model described in the November issue of this magazine, the Hammarlund-Roberts Hi-Q 29 Junior a.c. model is presented in the article following for the benefit of those who wish a smaller set, yet one operating on the same principle as the bigger receiver.

The a. c. and battery operated Junior models were designed by Hammarlund particularly for those who want a good all-around receiver built at a moderate price. It is a true single control six tube set, using a screen grid antenna coupling tube, a screen grid tuned radio frequency stage, a detector and three stages of high quality audio amplification.

Resistance Amplification

Where in the Master model audio amplification is by means of transformer coupling, in the Junior model, to cut down expense for the builder, resistance coupled audio amplification is employed, with an output circuit using a 171-A power tube.

The screen grid coupling tube is used to isolate the antenna from the first tuned circuit, making possible satisfactory simultane-

ous control of both the detector and the tuned radio frequency stages, without necessitating any separate means for compensating for different types of antennas.

Coupling Tube Amplifies

The 201-A type of coupling tube as used in most factory-made, single control sets is satisfactory for isolation purposes, although it provides but little amplification. In the Junior, however, a screen grid tube is used as a coupling tube and high amplification obtained from this tube results in considerable increase in signal strength.

The radio frequency stage also uses a screen grid tube, resulting in a very high degree of amplification in this tuned stage. The coil used in the radio frequency amplifier incorporates primaries especially designed for screen grid use, being unusually small in diameter and consisting of a great number of turns of very fine wire. This design tends to equalize the amplification over the broadcast frequency range. The interstage radio frequency transformers have the further advantage of tapped primaries, making it possible to vary the operating characteristics

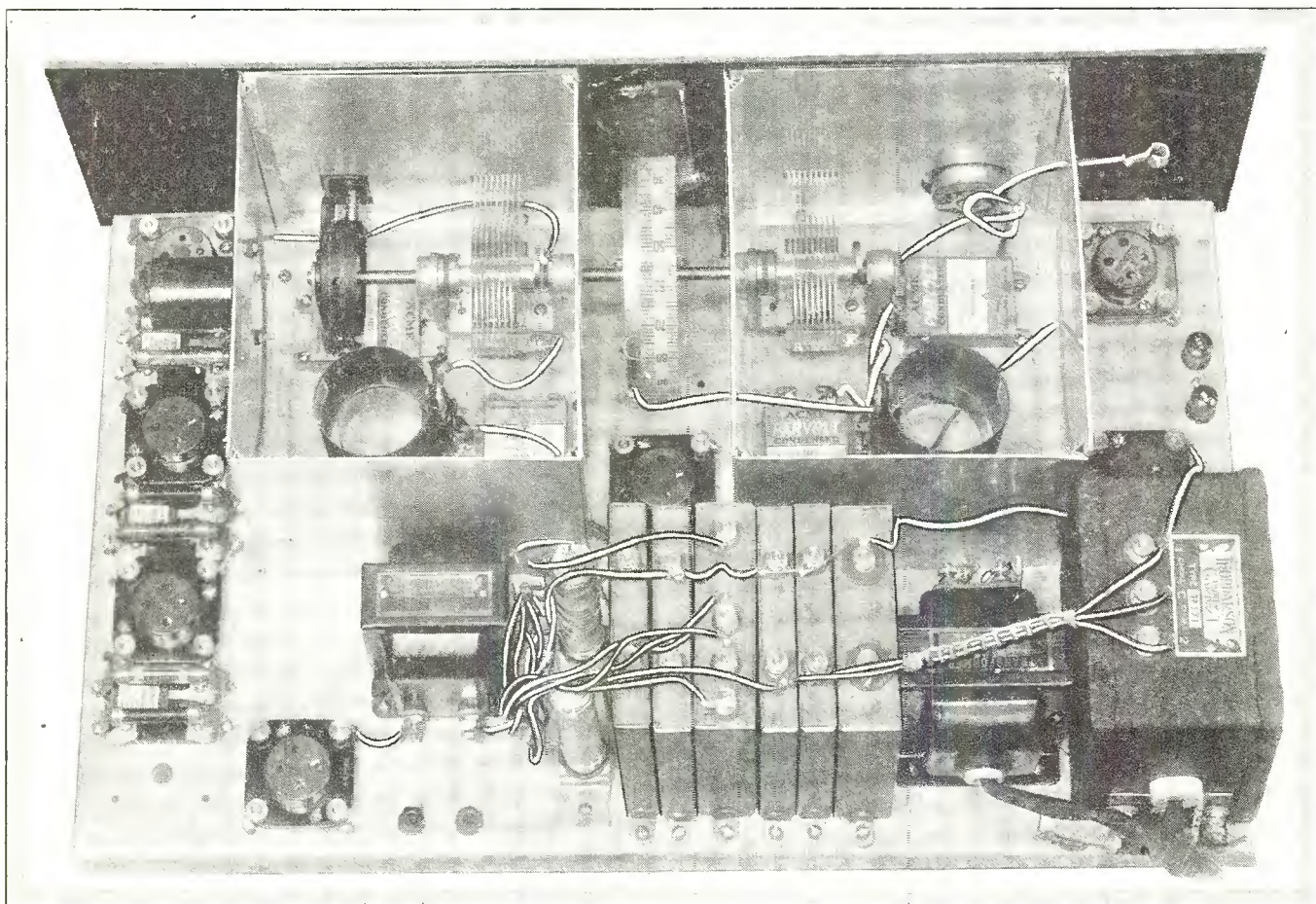

Fig. 1. This photograph shows a rear view of the completed receiver, the power supply is being located at the rear of the sub-panel

(This receiver tested and all illustrations made in our laboratory)

of the receiver to suit broadcasting conditions and their requirements for different classes of service.

Plate Rectification

The detector circuit is arranged for plate rectification, providing a high quality output for the audio frequency amplifier, which consists of three stages, resistance coupled. Technical advantages of resistance coupling are too well known to require further comment, and in addition the mechanical layout is especially suited to the requirements of Junior model. A Hi-mu tube is used in the first stage of the amplifier, another in the second and a 171-A in the output stage to furnish the amount of power required by the better class of speakers. In the a.c. model described in this article, the Arcturus tubes are employed, these being operated from a 15 volt transformer.

The tuning circuits are completely shielded in aluminum shields of special design to prevent electrostatic and inductive coupling between them. If the screen grid tubes are to be used at maximum efficiency any feed-back must be prevented. Separate stage shielding accomplishes the major part of this necessary isolation and in addition the shield grid terminals of the tubes are bypassed to prevent coupling between them. Also separate filters are used in the plate circuit of both shield grid tubes, these filters consisting of 5000 ohm resistors and .5 mfd bypass condensers.

Short Grid-Plate Leads

Shielding of the screen grid tubes has been handled in an unusual manner. Placing these tubes in the shield cans of the coils and tuning condenser would necessitate individual tube shields to isolate the tube element from the other apparatus. To avoid the use of these additional shields, the tubes are placed between the stage shields in such a position that the control grid and plate leads are very short and all coupling of the tube element to other parts of the circuit is prevented.

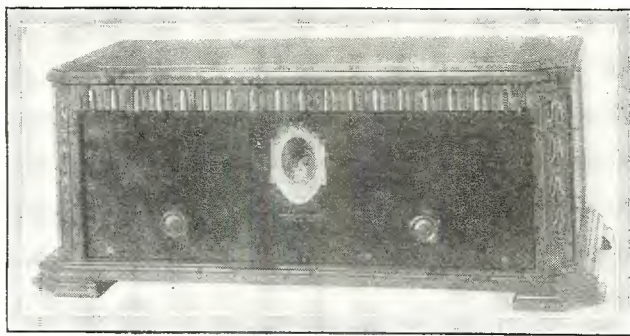

Fig. 2. In this photograph is shown the completed a. c. Junior mounted in a suitable cabinet

Control of volume is accomplished by the use of a 3000 ohm specially tapered potentiometer connected between the antenna and ground. The slider of this instrument is connected to the grid of the antenna coupling tube, thus allowing any desired part of the signal voltage to be passed on to the grid. This results in a smooth, continuous control of volume from a whisper to the full power output of the set. The special tapering of the resistance unit prevents criticalness at the lower volume setting.

In the complete a. c. operated model, described in this issue, the A, B and C power apparatus is mounted directly on the steel chassis, making the receiver an entirely self-contained unit ready to plug into the light socket. Arcturus uni-potential cathode heater type a. c. tubes are used because of the favorable characteristics of d. c. tubes and are reliable in long life due to the excellent mechanical features incorporated in their construction.

Uses Carbon Heater

Briefly, the Arcturus a. c. tube is an alternating current tube of the indirectly heated cathode type, employing a carbon heater, mounted in a standard four-prong base fitting the present sockets without additional wiring of any kind. A heater type of tube is a tube in which the filament is used to heat the cathode or electron emitter without emitting itself. In other words, that part of the tube which carries the hum producing alternating current forms no part of the receiving circuit, resulting in a reduction of hum to an infinitesimal minimum. Arcturus tubes are of the heater type, which aside from a highly desirable hum insurance, results in several mechanical conveniences which were taken into consideration by the designers of the receiver. These tubes, due to the similarity of heater design, operate from the same heater potential, drawing the same filament current, thereby necessitating only one secondary winding on the filament lighting transformer. Also the filament wiring to all tubes is identical, greatly

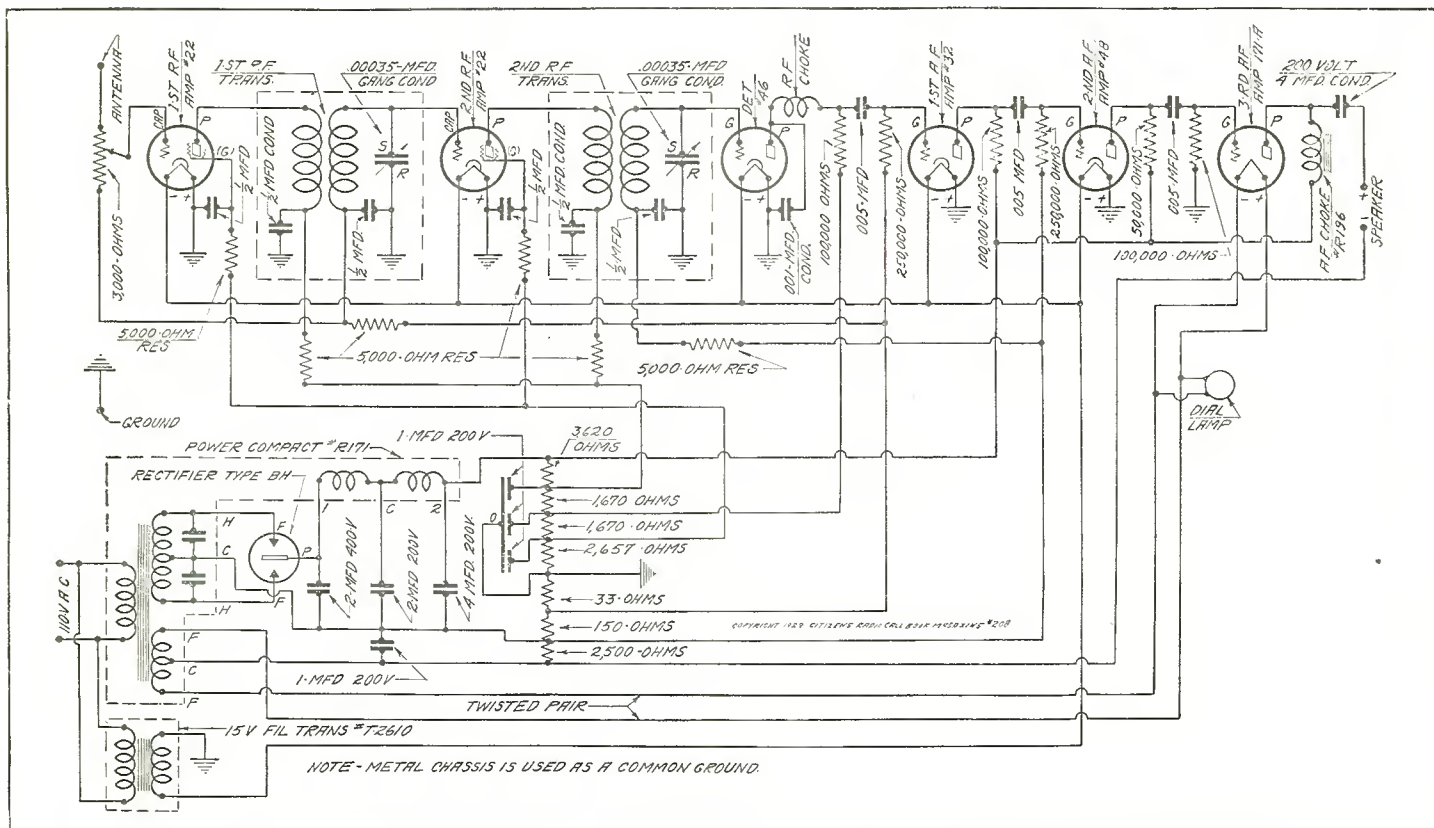

Fig. 3. The schematic of the combined receiver and power supply is shown in the above diagram

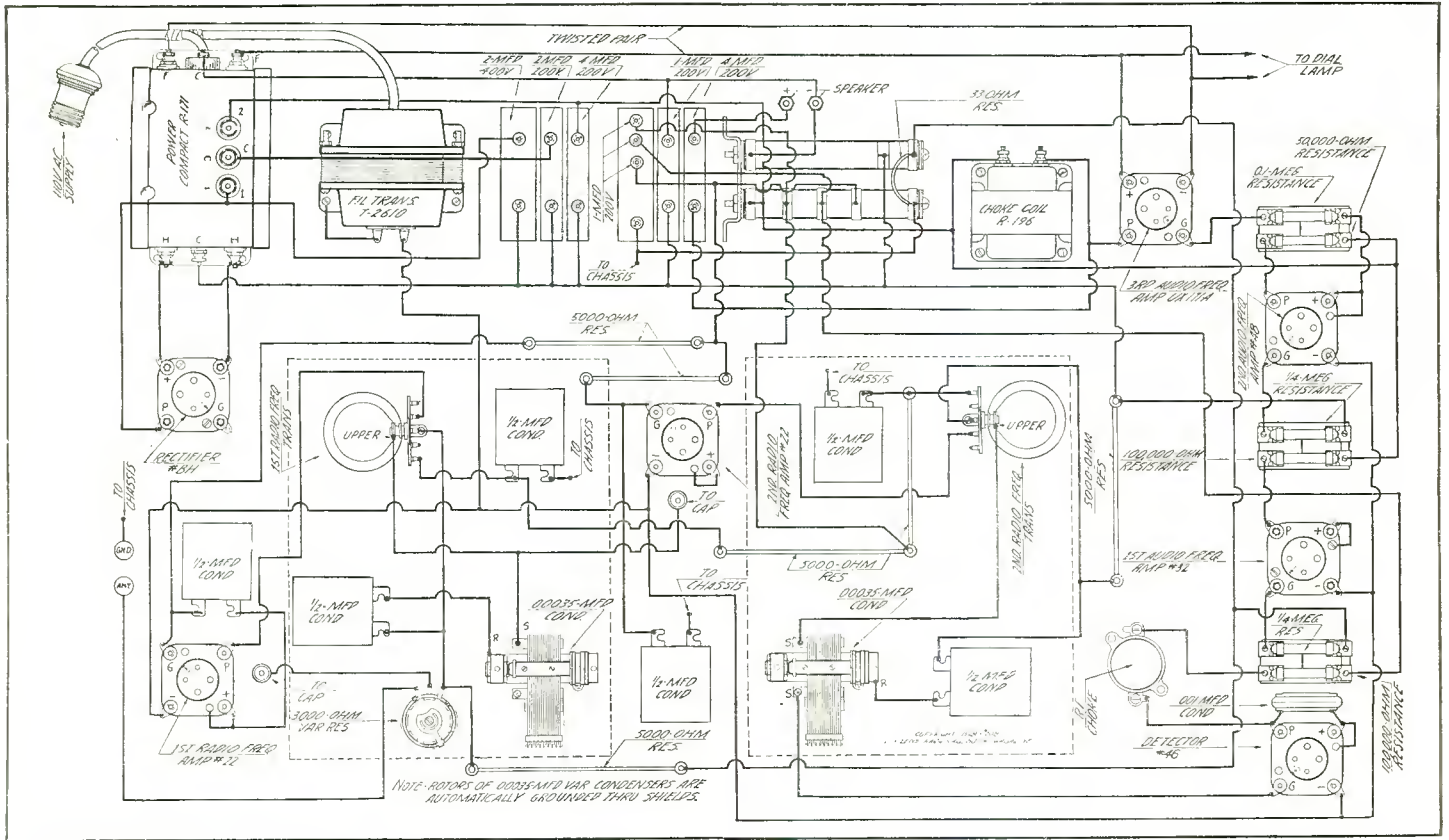

Fig. 4. Those not having a great deal of experience may wire up the receiver from the graphic illustration shown above

facilitating wiring. These tubes operate from the filament or heater potential at 15 volts and consume a current of .35 amperes. Due to this low heater current, these tubes are operated in multiple exactly as d. c. tubes are, and can be wired with the conventional hook-up wire. Extra heavy bus leads are not necessary.

In this model, there are two Arcturus No. 22 shield grid tubes, one No. 46 detector tube, one No. 32 Hi-mu amplifier tube, one No. 48 amplifier tube and a conventional 171-A power tube.

Testing the Set

When assembly and wiring are finished, a systematic course of testing should be followed by the builder to make sure that no errors have been made in the job. Checking may be done by referring either to the schematic or the graphic diagrams contained in this article.

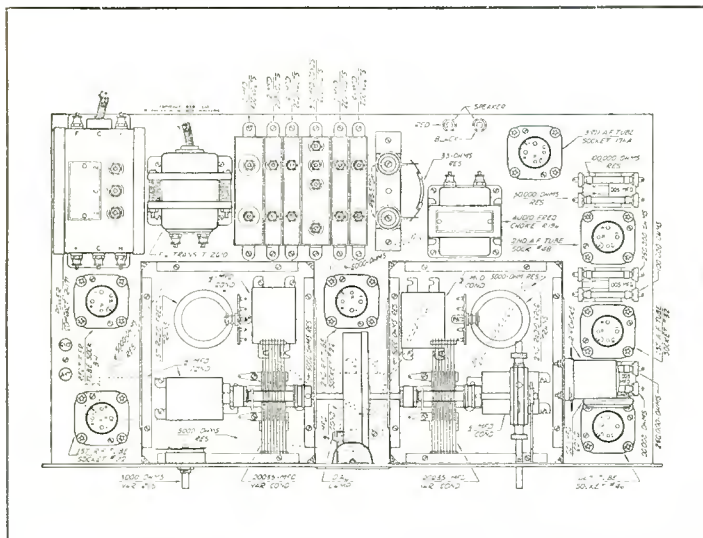

Fig. 5. Although the sub-panel for this receiver is already pierced, the parts should be laid out in accordance with the general idea shown above

The tubular bronze springs furnished in the foundation unit of the Junior model are in reality small padding or compensating condensers to equalize the tube capacities of the various stages. The design of these springs is such that when the specified lengths are slipped over the proper grid lead, compensation is effected under average conditions. Of course, vacuum tubes vary slightly in their characteristics. Also there will be slight variations in wiring. Therefore, where exact circuit-alignment is desired, a Hammarlund equalizer code No. EC35 may be substituted. This equalizer may be mounted directly on a tuning condenser by removing the unused stator soldering lug and using its screw to secure the equalized to the stator clamping bar. The bronze spring of the equalizer may be then connected to the lug on the condenser frame by a short wire. The equalizer may be adjusted with a screw-driver until precise alignment is obtained.

Features of Circuit

By referring to the schematic circuit shown in Fig. 3, good many details of the receiver's operation may be learned. In the antenna stage, the input stage is aperiodic, while the plate circuit is not tuned, this particular tube only acting as a buffer against the antenna. However, in the first radio frequency stage, the input circuit is tuned by one of the variable condensers, while the input circuit of the detector is tuned by another. These two condensers are joined together with a shaft connecting them to the drum dial located at the front of the receiver. On account of the first tube being a buffer one, it is possible to line up the r. f. and detector tuning condensers without reference to any changes in the constants of the antenna being operated. Thus, these two condensers should permit their circuit to be in exact resonance from the bottom to the top of the dial.

It will be noted that the screen grid of each 22 tube is bypassed directly to ground with a proper condenser and also that a fixed resistance is placed in series with each of the screen grids. There are also resistors in the plate circuit of the first and second screen grid tubes.

With reference to the photograph in Fig. 1, which gives a rear view of the receiver, it will disclose the fact that the set is

(Continued on page 126)

Victoreen Duplex Power Amplifier Is All-Electric Operated

Two Voltage Regulator Tubes Are Used and Separate C Bias Supply Is Provided in New Design

CONSISTING of two power amplifiers so arranged as to give the equivalent of push-pull amplification with fidelity, regardless of the input voltage, the Victoreen duplex amplifier is described in this article. It has been designed by the makers for the benefit of the professional set builder, dealer or any one interested in an amplifier that will take care of almost any condition of power handling.

Standard Victoreen Parts

Built up from standard parts, the duplex amplifier is alternating current operated throughout by the use of the heater type 227 tube and the larger power tubes, the 250 type. An inspection of the schematic circuit shown in Fig. 4 will give a general idea as to the electrical characteristics of the amplifier. It will be seen that the unit contains two audio amplifiers, each one consisting of three tubes, an input, first and second audio. Each stage employs straight transformer coupling. The impressed signal enters each amplifier system, in the same manner, but 180 degrees out of phase. The output of each of the two audio systems is in series. Because of the 180 degree phase relation between the two systems, they be said to be in push-pull to each other.

It will be noted that the amplifier employs two 874 voltage regulator tubes. The purpose of these tubes is to hold the plate voltage constant on the input and first audio tubes. In this manner an overload in the output stages cannot react throughout the audio system. By this method the useful undistorted output is thereby increased over the value normally obtained from a 250 tube.

Separate C Supply

In previous power amplifier systems, a resistor in the negative

B circuit has been employed to obtain a voltage drop for the C bias. Under those conditions, the C bias is dependent upon the plate current drawn by the amplifier. In the new design of amplifier made by Victoreen, a separate grid voltage supply is provided, the C voltage for the power tube being definitely determined regardless of change in plate current. Changes in line voltage are thus automatically corrected as the C supply primary and the power transformer primary both operate from the same line.

The power amplifier described in this article has been primarily designed for phonograph reproduction, in which a magnetic phonograph pick-up is used. The volume is either controlled by means of the volume control furnished with the pick-up or by a variable resistor placed across the pick-up. With some pick-ups fixed condensers are placed across the input to the amplifier, in order to prevent needle scratch. This is particularly true with pick-ups having a greater efficiency at the higher frequencies. With high grade pick-ups a very small value is needed, otherwise as high as .02 mfd may be required. This value is solely determined by opinion, as some individuals prefer more low notes than others. The exact method of connecting the magnetic pick-up to the input is shown in Fig. 2.

Voice Amplifier

In the event that the unit is to be used as a voice amplifier and a microphone provided for voice or music, it should be connected as shown in Fig. 3. The resistor resistance should be about the same as that of the microphone unit. In general a value of 25,000 ohms will suffice. The potentiometer is used as volume control. The microphone shown in the diagram is a single button type, which will serve for general purposes.

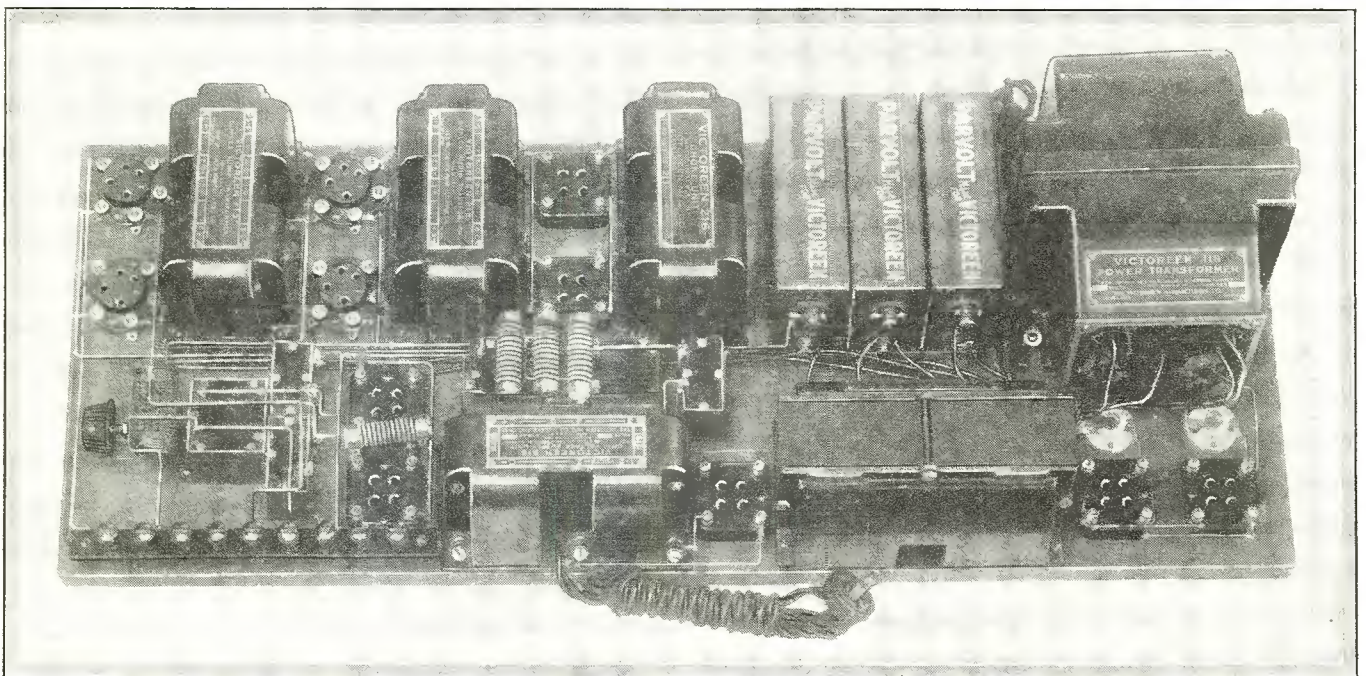
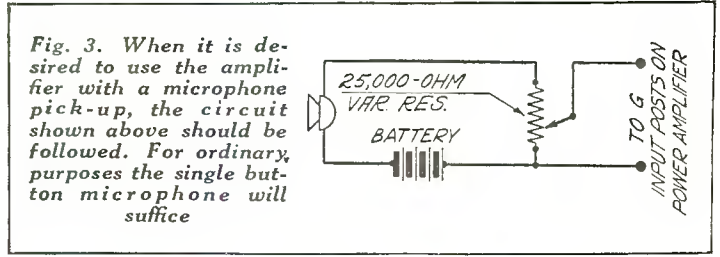
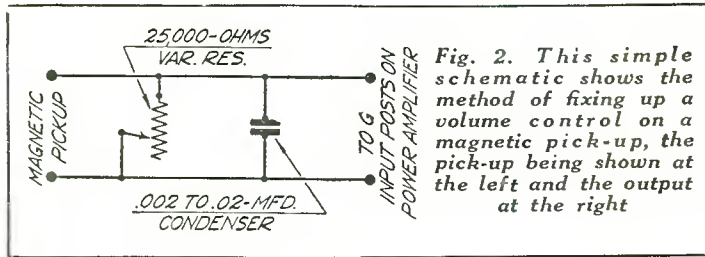

Fig. 1. In the photograph shown above may be seen the duplex power amplifier recently announced by Victoreen

(This amplifier tested and all illustrations made in our laboratory)



The duplex power amplifier will supply 45 and 90 volts to the radio frequency stages of almost any radio set. However, the detector system must be changed. Two detector tubes are placed in a receiver and their grids connected together. The reason for connecting the two detectors in parallel is to give a greater power output from the detector. The diagrams shown in Fig. 5 and Fig. 6 represent the methods of hooking up the power detector. While this method of connection is not especially desirable for distant reception, nevertheless when the amplifier is used for maximum power output on any given station, extremely satisfactory results are secured. In the event that the amplifier unit is to be used on 25 cycle current, a special 118 power transformer only is required. A separate C battery must be used, because the 516 unit cannot be furnished for 25 cycles.

In the diagram shown in Fig. 4, it will be observed that the filaments of the 227 tubes are left unconnected. This is not an oversight, but rather was done in order to eliminate a large number of lines necessary for connecting this tube to the 2½ volt secondary of No. 118 power transformers. The same thing applies to the filament connections of the 250 tube.

Safety Lamps Used

It will also be noted that two small 6 volt flashlight lamps are used in the plate circuit of the rectifier. These lamps are used as a protective measure in the event that one of the high voltage condensers should become shorted. In operation, should these lamps light up brilliantly and the signal cease, it is an indication that one of the condensers has probably blown. In normal practice, these lamps should operate at about one-half of their rated brilliancy. Our loud signals, should the lamps flicker or momentarily increase in brilliancy, it indicates that the amplifier is being forced beyond the rated ability of the 250 tube. Both tubes should operate at the same brilliancy. If not, the bulbs should be inter-

changed with each other. Should the brighter bulb now be dimmer, it indicated that the 281 rectifier tube, used with the dim bulb, is low in emission and should be replaced.

If trouble should develop, it will usually be found to be in either the tubes, resistances or condensers. A set tester will generally locate faulty tubes. Any tube which turns blue must not be used, this being particularly true of the 250. One of the main difficulties encountered with a 250 is its tendency to draw reverse grid current, even when slightly overheated, and thus drop in C voltage. This generally shows up after the amplifier has been in operation for several minutes, when the volume will begin to decrease and distortion occurs. At the same time the flash bulbs will gradually increase in brilliancy.

Another possible source of trouble may be the resistors. These should be handled with care before assembling and because of the extremely small wire with which they are wound, should be assembled very carefully. Should the 5000 ohm resistor become opened, the voltage regulator tube will not glow. Should either of the three resistors in the C supply become opened, the amplifier will have a tendency to motor-boat. This may be tested by short circuiting each of the three resistors separately. When the open resistor is shorted, the motor-boating will cease. It is important to connect the C supply primary and the power supply primary permanently together in order to be able to connect that grid voltage is always available.

More Than One Speaker

A large number of speakers may be operated in parallel or in series, depending upon their type and number, and the 216 choke unit is so designed that no direct current flows through the speaker. Where complete insulation is required from the high voltage, a 4 mfd 600 volt d. c. condenser should be placed in each
(Continued on page 146)

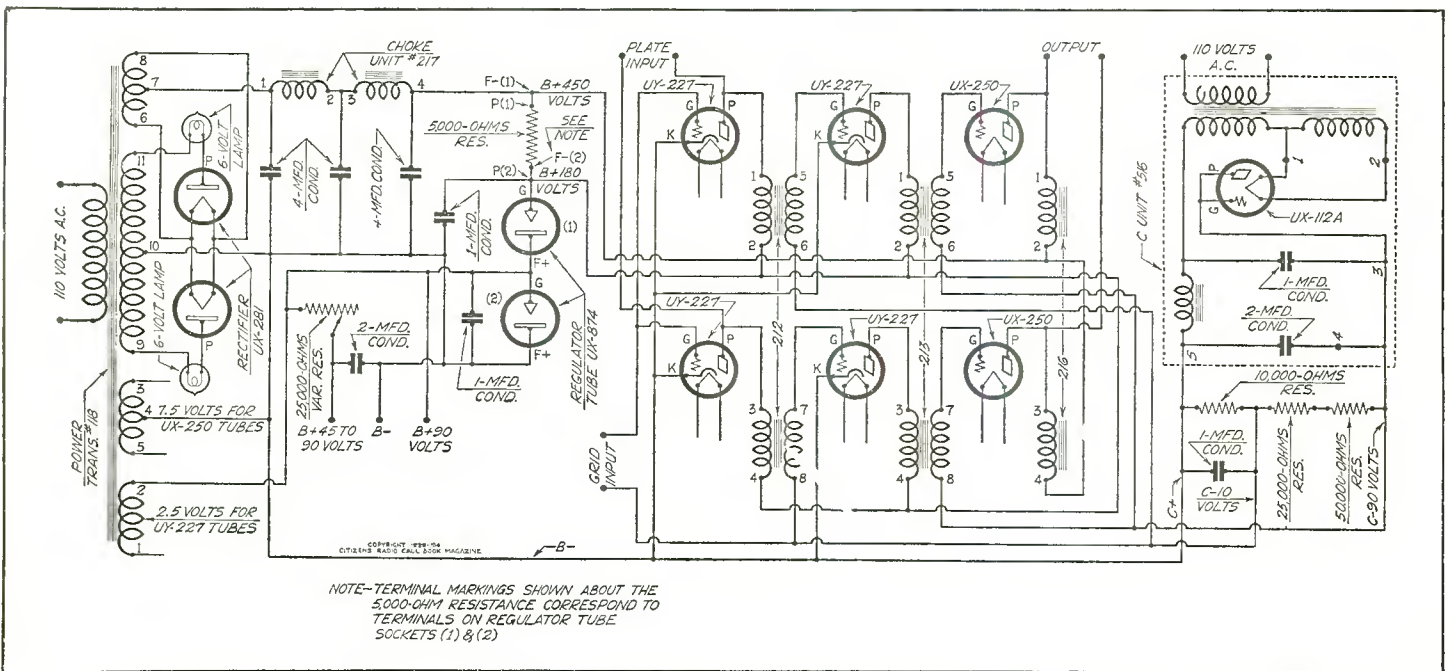

Fig. 4. The schematic circuit of the power amplifier itself and the separate C bias rectifier is shown herewith

Aero Low Wave Adapter for Custom or Factory A. C. Receiver

Radio Owners May Secure Full Enjoyment on Increased Broadcast Range of Their Own Set

THERE is hardly a day that passes in the technical department of this magazine but that some one of our readers possessing an alternating current operated set, either of the custom built type or of the factory built, has asked whether or not a short wave converter is available for use in connection with an alternating current set. While it is true that we have published many short wave converters, or adapters, nevertheless these previous articles have only dealt with the direct current operated sets.

Answering the demand for a converter which could be utilized with alternating current sets, regardless of whether of the custom built variety or factory made, the Aero Products organization has recently designed and announced a short wave converter employing a 227 a. c. tube. While this short wave converter was originally designed to fill out the Aero line, which includes a number of tuned radio frequency receivers for both d. c. and a. c. operation, nevertheless the converter may be used with any receiver regardless by whom made.

Increased Tuning Range

With the announcement of this alternating current operated short wave converter, professional set builders and listeners are now enabled to take full advantage of an increased broadcast range on their a. c. operated sets. While undoubtedly the d. c. type had a considerable vogue, with the extreme interest shown this year by the public in alternating current operated sets, the converter being described in this article should meet a hearty response.

An examination of the photograph shown in Fig. 1 will disclose the general layout of the parts involved. The coil shown at the back of the sub-panel is of the plug-in type and consists of a secondary and regenerative winding on the big form, and the primary on the small form, which is variable in inductive relation with respect to the secondary. This coil is known as the LWT-10 kit. The antenna coil portion remains in the circuit for all time after it is once plugged in, the secondary, however, being of different value for the various wavelength bands that are covered.

As shown in the schematic diagram, Fig. 4, wavelength tuning is across the secondary by means of the .00014 mfd variable condenser. Regeneration control is through a combination of fixed capacity and variable resistance, this control being located between the junction of the plate coil and the choke coil and the negative return of the circuit. This is but one of the numerous methods by means of which regeneration and oscillation can be controlled and was adopted because it involved a very small amount of additional apparatus and simplicity of control is thereby gained, together with economy. The choke coil No. 60 placed in

the B positive lead to the plate coil insures smooth operation regeneratively over the broadcast band covered.

Uses 227 Tube

Detection is by means of the .00015 mfd grid condenser spanned by a 10 megohm grid leak, the latter going from the grid of the tube to the cathode of the 227 tube. The cathode line, the bottom of the variable resistor, the rotor of the variable condenser and the filament terminal of the secondary inductance are all common and go to negative B line, which is carried to one of the prongs of a five-prong tube base. A sketch of the five-prong tube base is shown in the lower right section of Fig. 4 diagram, the view being taken from the top. This tube base is the one that is inserted in the detector socket of a receiver, when it is desired to operate the short wave converter in conjunction with a standard wavelength receiving set. The antenna coil is of the conventional type, one end going to the antenna and the other to the common cathode lead. The inductive relationship of the antenna coil may be varied from minimum to maximum in order to increase or decrease the amount of pick-up from the aerial. The inductive relation of this coil with respect to the secondary has, to some extent, an effect upon the regeneration and oscillation qualities of the receiver. The set will oscillate easiest when the coil is practically at right angles to the secondary, and will oscillate with increasing difficulty as the coil is brought up to closest possible

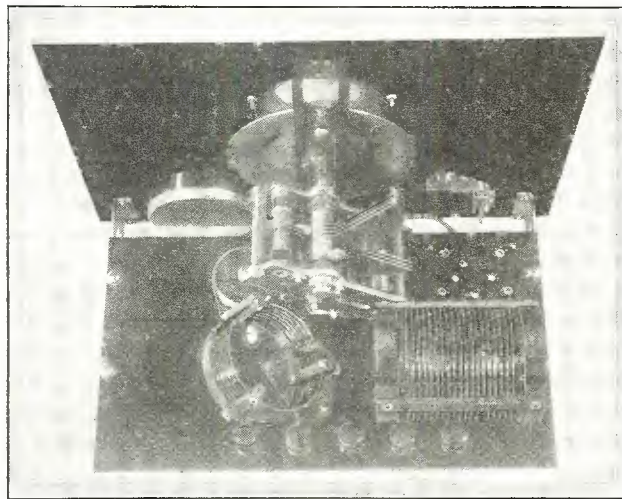

Fig. 1. Neat and compact is the new Aero a. c. short wave converter described in the accompanying article

coupling.

Subpanel Is Punched

One of the features of the short wave converter, which will be appreciated by the average builder, is the fact that the subpanel is already punched and the necessary coil socket holes, socket holes and other position for apparatus are punched at the factory, with the result that the amount of wiring required on the part of the builder is reduced to a minimum. The idea of punching the subpanel also contributes materially to preventing wrong connections being made by the builder.

In effect, the short wave converter is nothing more or less than a single tube short wave receiver with plate and filament leads brought out through a cable, which terminates in an ordinary tube base and can be inserted in either the first r. f. socket or the detector socket of the broadcast receiver. In the a. c. model of this converter, the 227 detector tube removed from the set may be used in the short wave converter. When using the converter with a superheterodyne, the converter plug should be inserted in the second detector socket.

(This converter tested and all illustrations made in our laboratory)

The wavelength range covered by the three coils included in the LWT-10 kit is as follows: The first coil has a range from 16.5 to 32 meters. The second coil has a range from 26.2 to 48.7 meters. The third coil runs from 46.7 to 89.5 meters. These three broadcast bands are sufficient to receive almost any of the short wave broadcast work being done now in the United States and abroad. Information covering short waves may be gained by referring to the broadcast list published in each issue of this magazine.

A little data on the putting together of the receiver might not be amiss at this point. When the unit is unpacked by the builder, he will find one unit completely wired containing the tube socket, binding posts, coil primary, interchangeable coil sockets, radio frequency choke, grid condenser, grid leak and plate blocking condenser. Packed loose in the box will be the switch, regeneration control resistance, tuning condenser and dial parts, as well as the front panel. First the dial should be mounted on the front panel, attaching the tuning condenser and then followed by mounting the switch and regeneration control. The front panel is now mounted on the subpanel. The necessary wires are then put in in accordance with the graphic diagram shown in Fig. 3, or the diagram accompanying the kit. A very convenient plug may be made by utilizing the base of a burned-out vacuum tube. Break the glass away from the base and remove the plate and grid structures, taking care to see that the wires running to the plate and filament contact on the bottom of the base are not broken off too short. The connecting cable should be soldered to these wires, making sure to connect the filament and plate

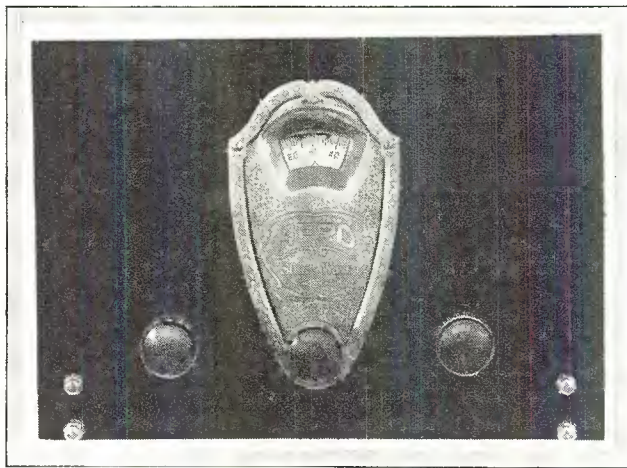

Fig. 2. A top view of the short wave converter may be seen above. The left-hand control is for the 110 volt off and on switch and the right-hand control is for regeneration

leads to the appropriate wires in the base. The filament pins on the plug which is to be inserted in the receiver are those prongs of the larger diameter. To determine which is the plate terminal, the simplest way is to place the tube base in the socket and notice which pin goes in the hole marked P on the socket. A small sketch of the tube base is shown in Fig. 4 and it may be readily wired by referring to that particular drawing. After the wires have been properly attached to the tube base, the base may be filled in with melted sealing wax.

Operating the Converter

To operate the converter, first remove the detector tube from its socket in the broadcast receiver.

In the case of the alternating current operated set, this is a 227 tube. This tube should then be inserted in the socket of the converter. Next insert the plug carrying the cable into the detector socket of the receiver. The aerial to be used should be connected to the binding post provided. The tubes of the radio frequency end of the broadcast receiver may be either turned off or removed, according to the facilities provided, as they serve no useful purpose when used with the converter.

There have been occasions when better reception is secured when the converter plug is put into the first radio frequency socket of the broadcast set. In this connection it acts as an autodyne receiver and oscillator. The incoming signal is heterodyned to the wavelength on which the broadcast receiver is set and then amplifies those frequencies passing through the detector and audio frequency amplifier in the usual manner. Controls on the broadcast set need not be changed. Regeneration is controlled by means of the variable resistance in the converter, while control of tuning is accomplished by varying the .00014 mfd variable condenser. This converter is tuned in identically the same manner as an ordinary three-circuit broadcast receiver.

These a.c. converters are designed to operate with a B voltage of 22½ to 45 volts applied to the plate of the detector tube. Some set manufacturers, however, apply 67 volts and sometimes more to the plate of this tube and where this is done, it is necessary to reduce this voltage by a variable resistor of 0 to 50,000 ohms, such

(Continued on page 140)

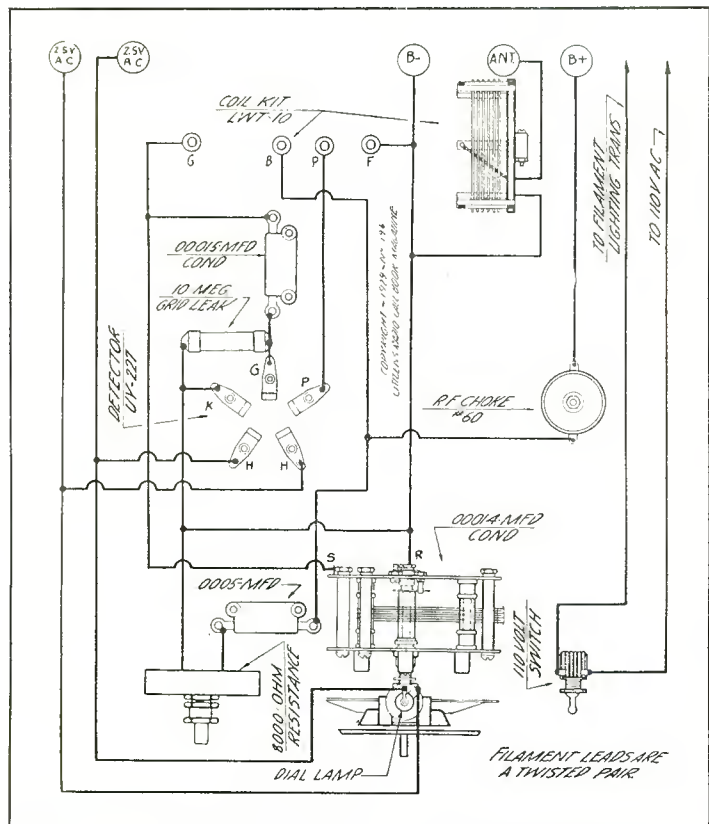

Fig. 3. Considerable speed may be made in wiring up the short wave converter by means of the graphic diagram shown in the illustration above

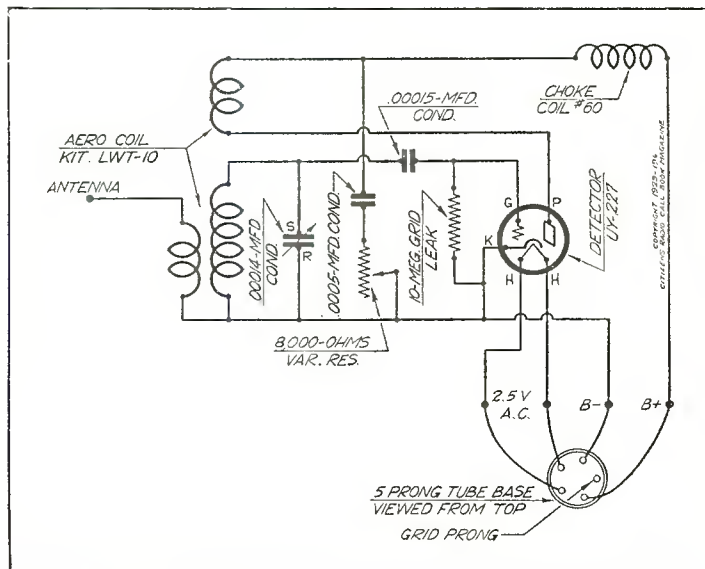

Fig. 4. After all there is not very much to the electrical circuit of the short wave converter, as will be shown by an inspection of the above schematic

One Dial Tuning and A. C. Screen Grid Tubes in H. F. L. Special 9

New Models for Alternating Current Operation with 250 Tube,
or D.C. Model with 171-A

A VAILABLE in two models, the new H. F. L. Special Nine just announced for the 1929 season has many interesting features which should appeal strongly to the professional set builder.

It is available in two forms, a straight d. c. operated model using a 171 A output tube and a straight a. c. model using heater type tubes throughout with a 250 as the power output tube. Both receivers have four screen grid intermediate frequency stages.

Inasmuch as both receivers are constructed on the same chassis, and since both operate in substantially the same fashion, we will describe the a. c. set, as space does not permit a description of both of them.

Complete In Kit

In line with the merchandising policy of H. F. L. both kits come complete, i.e., all of the parts are riveted down to the chassis and the intermediate frequency catacomb is completely assembled, wired and tested. It is, therefore, impossible for the purchaser of an a. c. kit to confuse his parts with those of a d. e. kit and vice versa.

Attention is directed to the fact the intermediate amplifier catacombs are of different construction in each case. The problems of amplifier design for a. c. and d. c. screen grid tubes vary greatly with the different kinds of tubes. An entirely different kind of amplifier is necessary in each case.

This amplifier is responsible for the selectivity and sensitivity of the H. F. L. Special Nine. It has one tuned intermediate frequency stage more than the well known Isotone. The appreciation in selectivity and sensitivity is considerable.

This catacomb fits along the back edge of the receiver chassis. The chassis itself measures 20½ inches long by 4¾ inches deep.

When the amplifier catacomb is bolted on to the rear of the chassis the depth of the entire receiver becomes 7½ inches. The front panel protrudes ¼ inch beyond the chassis face at each end and measures 21 inches long by 7 inches high.

Wiring is accomplished by simply running jumpers from the catacomb terminal strips to the proper positions on the tube sockets and so forth. Practically all of the by-pass condensers are wired right into the catacomb, so the actual wiring of the H. F. L. Special Nine is a very simple job, requiring not more than an hour at the most.

The catacomb is divided into seven compartments, one for each radio frequency circuit and its associate equipment. This method of construction allows an extremely high ratio frequency gain, and also permits the screen grid tubes to be operated without shielding. This is a highly desirable consideration in a. c. operation where the tubes become quite hot, and it also permits a substantial saving in the manufacturing cost of the receiver which is passed on to the purchaser.

One Spot Tuning

The intermediate frequency amplifier operates at a frequency which allows absolute one spot tuning, and each transformer in the amplifier can be peaked for exact resonance by adjusting the small condenser which is shunted across the secondary circuit. These small adjusting nuts can be seen between the tubes in the illustration.

It will be noted that each grid bias resistor is by-passed, and it may be well to state that these resistors are not of the standard recommended values, but of a special value which permits a very much larger gain per stage throughout the instrument. The first detector tube has a high bias which increases the selectivity of

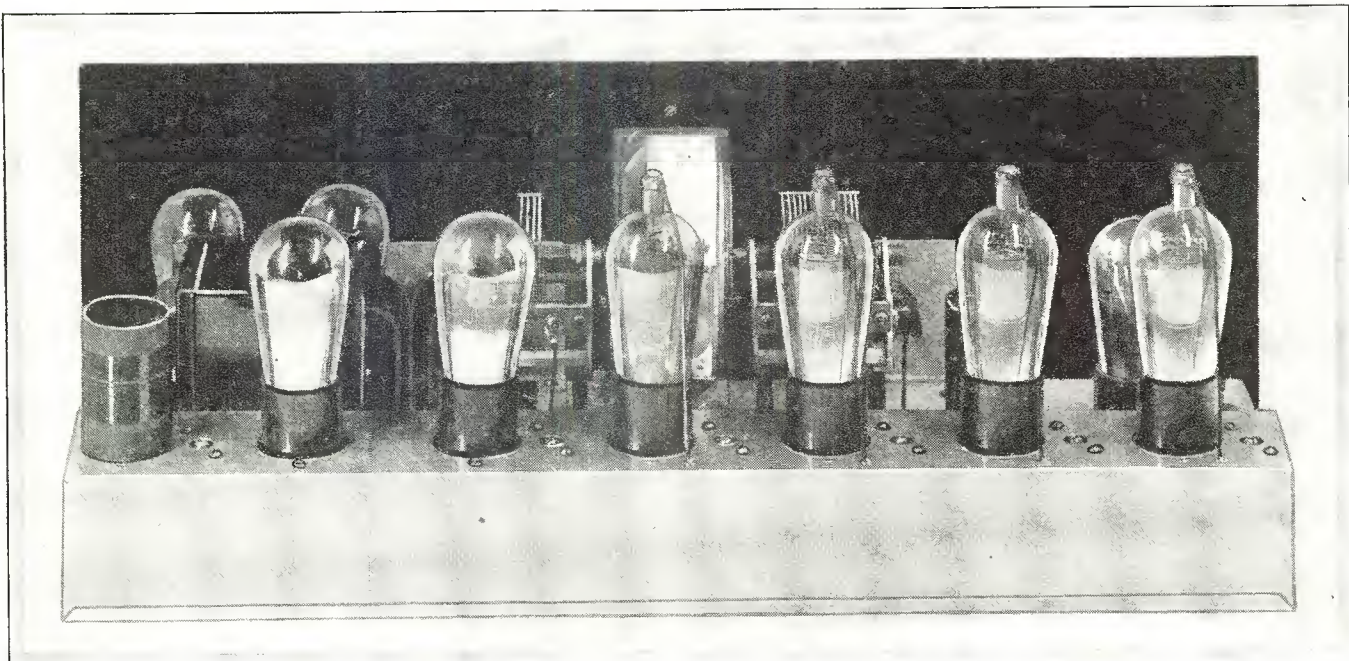

Fig. 1. In this photograph is shown the new HFL Special 9 described in the accompanying article

(This receiver tested and all illustrations made in our laboratory)

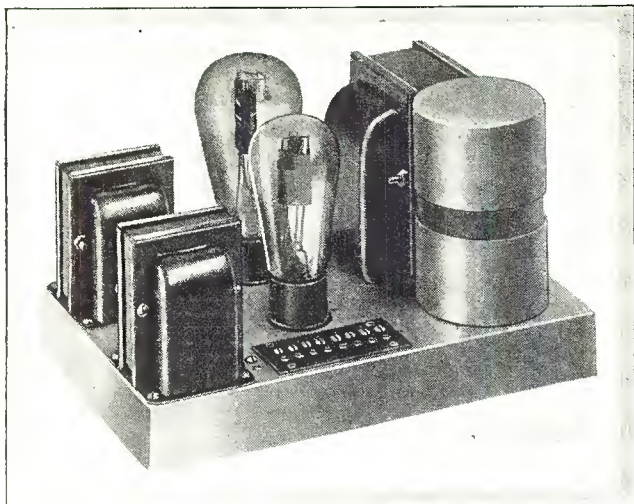

Fig. 2. Above is a photograph of the power supply for operating the alternating current model of the HFL Special 9

the antenna circuit, and the oscillator is also biased in order to do away with any tendency toward harmonics.

Inasmuch as the gain of the intermediate frequency amplifier is considerably more than could ever be utilized under the operating conditions, the tubes are operated at low heater temperature. The standard filament voltage for a tube of this type is 2.25 volts. The tubes in the H. F. L. Special Nine never receive more than 2.1 volts. This drops the current from the standard value of 1.75 amperes to 1.60 amperes. A. C. tubes cost money, and the set builder generally considers economical operation a factor.

The H. F. H. Special Nine is a one dial super. There are only three controls, the main tuning dial, a small compensating condenser for the antenna circuit (the left hand knob) and a volume control and switch which are attached to the right hand knob. In actual operation, it is easily possible to hear twenty consecutive stations without adjusting the antenna compensator, and for local reception the entire broadcast band may be covered with the main tuning control alone. Thus, the set is a true one dial receiver of the highest type. Plug in coils are being designed for the short wave broadcast bands, and these coils will be constructed with the one dial method in view.

The kit comes entirely assembled, including the front panel, which is of metal, having a very fine burled walnut finish. Custom set builders will welcome the news that H. F. L. has decided not to put their trade mark on this receiver, except in the form of a small decalcomania, which may be readily washed off with a little alcohol.

The A. C. Special Nine operates from an excellent 250 power amplifier. This compact unit measures 11 inches long, 7 inches deep and 7½ inches high with the 250 tube in the socket. It furnishes all B, C and heater voltages to the Special Nine. Attention is called to the fact that in the a. c. set the ninth tube or 250 operates in the power amplifier circuit, and that there are only eight tubes in use on the receiver chassis.

This efficient power amplifier will no doubt be welcomed by custom set builders, for it can be operated with any kind of a receiver, and it is designed so that it will furnish plenty of plate current with extra voltages up to 150 volts. Fourteen amperes of heater current at 2.25 volts can be taken from the unit, and it is wired so that one single 110 volt switch (on the receiver chassis) handles the power amplifier and its associate dynamic loud speaker, if one is used.

The power amplifier operates with a single 280 rectifier tube,

and, of course, the 250. A 210 may be used as the amplifier tube in place of the 250, inasmuch as the circuit is self balancing. Variable resistors are employed so that the set builder can move the clips and thus obtain whatever voltages he may require; 37 microfarads of condenser are employed in the filter circuit.

Inside or Outside Aerial

The H. F. L. Special Nine is designed so that it will operate with practically any outside or inside antenna. In addition to the variable compensating condenser which tunes the first grid circuit, there is a variable condenser of low capacity in series with the antenna circuit which allows the adjustment for any length of antenna. In an actual laboratory test, the Special Nine reproduced signals from station KWKH at Shreveport, La., with full loud speaker volume using a 30 inch length of bus bar for an antenna.

Loud speaker signals from station CZE at Mexico City were obtained at 9:30 p. m. Thursday, November 22, using a 20-foot inside antenna. Several interested parties witnessed this demonstration at that time when twenty-eight local stations were in operation in the district around Chicago, where the test was made. Station PWX at Havana, Cuba, which operates right behind station KWKH at Shreveport, La., was heard on several evenings whenever a lapse of a few seconds at KWKH permitted them to come through.

The audio transformers are specially designed for the receiver, and the impedances are figured for the particular jobs which they have to do. Low note reproduction is entirely dependent upon the size of the dynamic baffle board.

The output filter is an impedance and condenser arrangement which has been carefully figured so that it will match the general run of dynamic loud speakers with the minimum loss of power.

When the H. F. L. Special Nine is operated with a dynamic loud speaker which derives its field supply from a tube of the 280 type (such as the new one designed by Muter), the tone quality is well high perfect.

Phonograph operation is the one test which brings out the perfection of a good audio amplifier.

Attaching a pick-up to the Special Nine is a simple matter when a phono adapter such as the Pacent is used. This adapter simply slips over the pins of the second detector tube and the tube is replaced in its socket. The pick-up cord tips are then plugged into the two little tip jacks on the phono adapter, and the amplifier is ready for phonograph operation. The pick-up, of course, should be disconnected when the instrument is again used as a radio receiver.

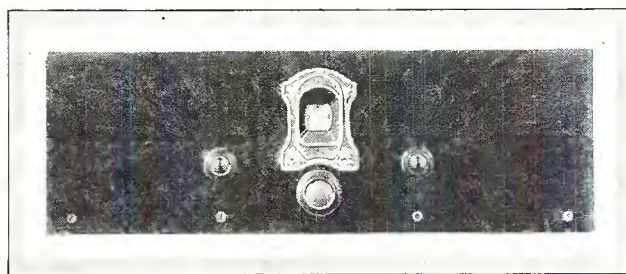

Fig. 3. In this photograph is seen a front view of the new receiver with its single control tuning dial at the center

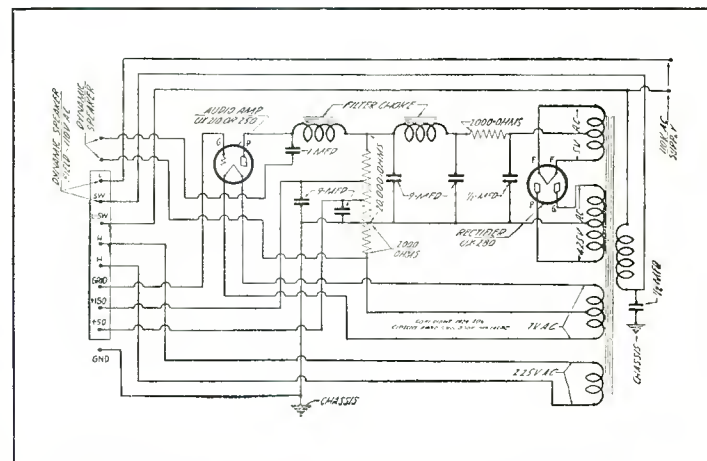

Fig. 4. The electrical connections in the power supply are shown in the schematic illustrated here

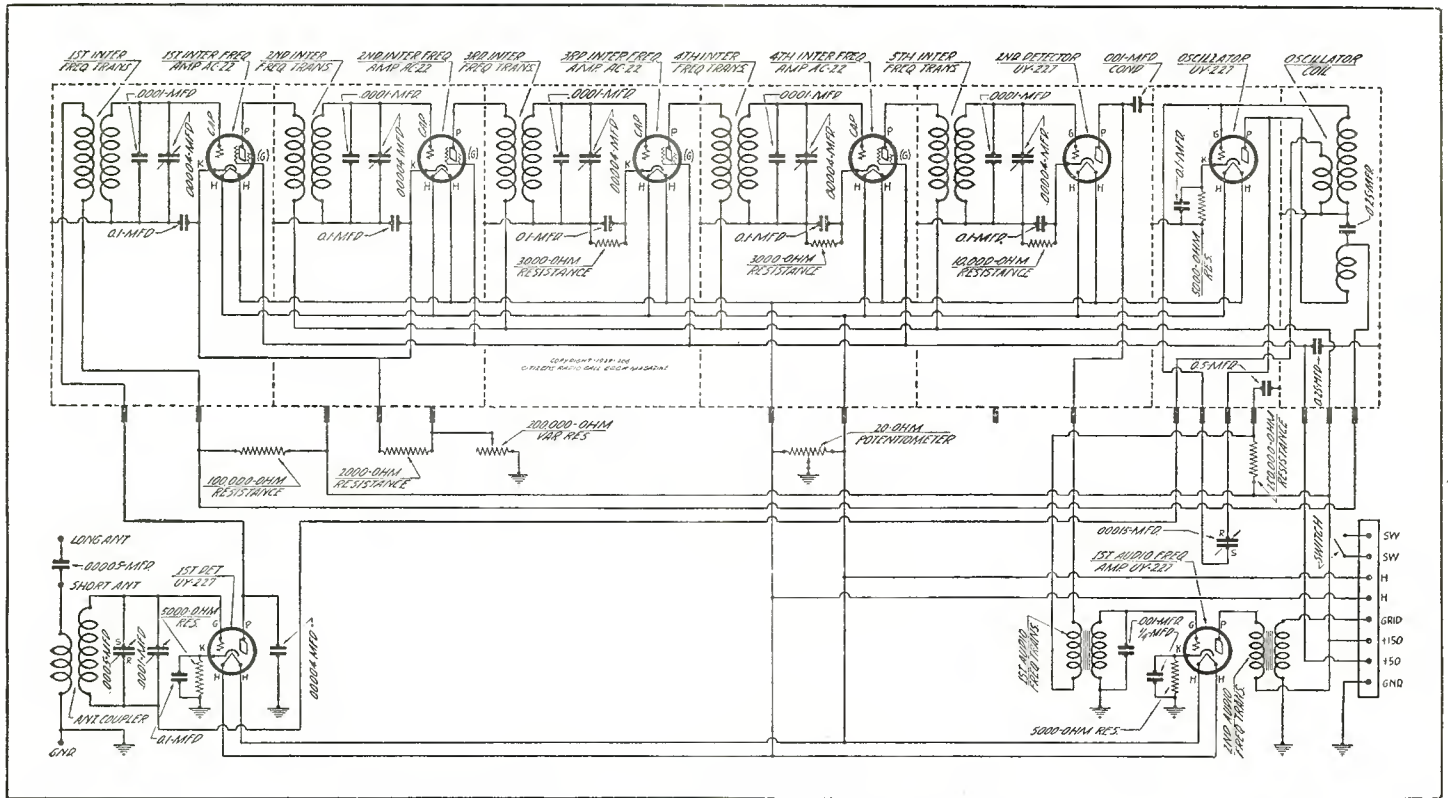

Fig. 5. All electrical details of the circuit employed in the new receiver are depicted in the above schematic

The photograph shown in Fig. 2 gives an idea as to the appearance of the power supply designed for operation with the HFL Special Nine. This unit comprises the two chokes shown at the left in the photograph, the 280 rectifier tube in the foreground with the 250 power amplifier tube in the rear. The high voltage transformer with its low voltage secondaries is at the right rear, while the tubular unit at the right front is the special bypass condenser. Resistors and other small parts are located underneath the chassis of the power supply.

An examination of the schematic diagram shown in Fig. 4 discloses a 2000 ohm fixed resistor, which is a departure from other power supply methods. This 2000 ohm resistor forms a portion of the input circuit to the filter and eliminates the necessity for having a double filter choke in that particular position. The resistance network across the output of the filter has a total of 20,000 ohms with voltages of 50 and 150 properly bypassed. The bias resistor has a value of 2000 ohms and is located between the center tap of the high voltage winding and the center tap of the 7½ volt secondary for operating the 250 or 210 power tube. The unit is self-balancing in that either a 250 or 210 may be used and the proper voltage may be assured for the grid bias. All of the voltage terminals and those for the dynamic speaker are brought out to a connection block, which is shown in the forefront of the photograph in Fig. 2.

Tubes required for operation are:

A. C. Operation

- 4 Ceco or Sonatron a. c. 22
- 4 Ceco or Sonatron 227
- 1 Ceco or Sonatron 250 (or 210)
- 1 Ceco or Sonatron 280 (rectifier)

D. C. Operation

- 4 Ceco or Sonatron 222
- 4 Ceco or Sonatron 201 A tubes
- 1 Seco or Sonatron 171 A

Parts in Kit

Although the H. F. L. sets come to the consumer entirely assembled, the a. c. parts list is being given for general information. The d. c. parts list is substantially the same with a few changes in the

resistor and condenser values.

- 1 H. F. L. special copper amplifier housing
- 1 H. F. L. special copper amplifier top
- 1 H. F. L. special copper amplifier bottom.
- 9 Special UY type sockets
- 1 Special UX type sockets
- 5 H. F. L. special r. f. transformers
- 7 Micamold .00003 mfd trimmer condensers
- 5 Micamold .0001 mfd fixed condensers
- 7 Sprague .1 mfd bypass condensers
- 3 Sprague .25 mfd bypass condensers
- 10 Love plastic resistors—various values
- 1 H. F. L. special No. 3 terminal strip
- 1 H. F. L. special No. 4 terminal strip
- 2 Muter .001 mfd fixed condensers
- 4 Carter screen grid clips
- 1 Special .5 mfd bypass condenser
- 1 Special 2-stage audio transformer unit
- 1 Frost special 200,000 ohm volume control and switch
- 1 Pilot .0001 mfd variable condenser
- 1 USL .00015 mfd variable condenser
- 1 USL .0005 mfd variable condenser
- 1 Special cord driven drum dial
- 1 H. F. L. special steel chassis, cadmium plated
- 1 H. F. L. special 7x21-inch steel front panel
- 3 Kurz-Kasch 1¼-inch bakelite knob
- 1 Yaxley 20 ohm hum balancer
- 2 H. F. L. special steel control supports, cadmium plated
- 1 H. F. L. special 110 volt supply cable
- 1 H. F. L. special plate supply cable
- 8 H. F. L. special condenser mounting studs
- 3 Eby bakelite binding posts
- 1 Westinghouse 2½ volt dial light
- 2 H. F. L. special steel chassis supports, cadmium plated
- 1 H. F. L. special No. 5 terminal strip
- 1 H. F. L. special plug-in antenna coil
- 1 H. F. L. special plug-in oscillator coil
- 1 H. F. L. special bakelite condenser drive shaft
- 1 Muter .0005 mfd fixed condenser
- Miscellaneous equipment consisting of eyelets, washers, lugs; nuts, bolts, wire, instructions, etc.

"Round the World Four" Uses Screen Grid for Distant Signals

Silver-Marshall Model May Be Made Up Either as Four Tube Set
or as Two Tube Adapter

COINCIDENT with publication in the November issue of an article covering the construction of the 731 "Round the World" Adapter, as made by Silver-Marshall, our blue print department has been literally swamped with requests for the four tube version of this same circuit, which in deference to our readers is being presented in the accompanying article.

Made in Two Models

When constructed as a four tube receiver, the unit is given the number of 730, whereas when built as a short wave adapter it bears the code number 731. The latter is the unit which was described in the November issue on pages 86 and 87. That particular model was used for some time by our technical staff in intercepting the short wave television signals from station 3XK, the Jenkins laboratories at Washington, D. C.

Basically there is very little difference between the two models, with the exception that the 730 has two audio transformers and the extra sockets, binding post, bypass condensers, etc., which the 731 does not have. However, the aluminum stage shield is punched for the four tube job, and when the adapter is built only the required number of units are located in it.

"The "Round the World Four" is illustrated photographically in Fig. 1, with another view of the inside of the unit being given in Fig. 2. The schematic circuit is in Fig. 3, while the graphic circuit shown in Fig. 4 is for the benefit of those who are fairly experienced at set construction.

Referring to the schematic diagram shown in Fig. 3, it will be observed that a screen grid tube is used as the first r. f. stage. The input circuit of the screen grid is aperiodically tuned by means of an r. f. choke, so that it is responsive to waves over quite a wide band. The plate circuit of the screen grid tube contains the secondary of the regenerative inductance and it is tuned by means of a .00014 mfd variable condenser connected through the .005 fixed condenser and located across the G and F-2 terminals of this inductance. An r. f. choke coil, type 275, is located between the F-2 terminal and the B-90 voltage terminal to prevent r. f. stray current from getting into the battery circuit. The detector uses either a 201-A or a 112-A tube, depending

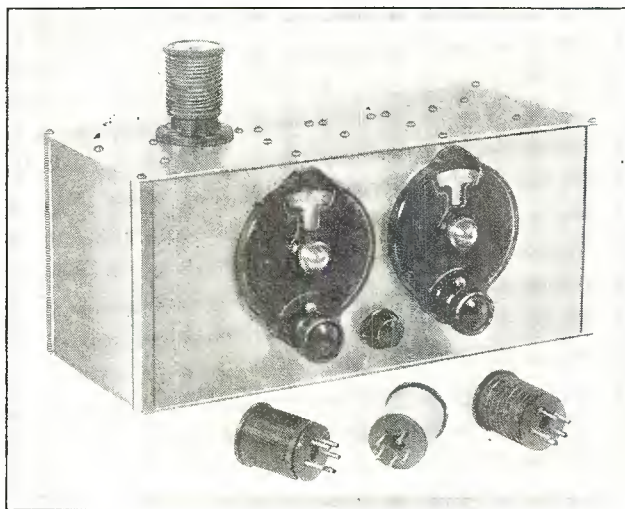

Fig. 1. In the photograph shown above is the completed four tube job, together with the four coils required for covering the short wave broadcast band

on the wishes of the operator. However, when using a 112-A tube, it will be found that the coils will not tune down as low as if the 201-A is employed. Detection is by means of a .00015 fixed condenser, with a 5 to 10 megohm grid leak, running from the grid to the negative filament of that tube. It will probably be necessary to try several values of grid leak to secure the one which gives best operation from all standpoints. It is also quite likely that a different grid leak will be required when used for short wave telegraph signals than when it is used on short wave phone broadcasts. Regeneration in the detector stage is accomplished by means of the .00035 mfd variable condenser between the junction of the plate coil and the r. f. choke and the negative filament line. The regenerative coil is that part of the winding shown at F-1 and P in the schematic circuit, Fig. 3. When the unit is used as a short wave adapter, the head phones are placed between the bottom terminal of the plate choke 277 and the 45 or higher plate voltage terminal. However, in this model the first audio transformer, which is a type 255, is located in this position. This transformer is of the Clough type, having a resonated primary as shown in the schematic. The secondary goes to the grid of the 112-A first audio tube. A 60,000 ohm fixed resistance is shown as an optional across the grid terminal of the 112-A and terminal 4 of the first audio transformer, this being the C 4½ bias connection.

Coupling of the first audio to the second audio is also by means of the Clough system, in this case a type 256 transformer being used. The output tube in this design is also a 112-A tube, with the speaker terminals being located between the plate of the last tube and the 135 volt terminal.

Filament control in the first and second audios is by means of a 2 ohm fixed resistance located in the positive leg of the tubes' filament. Filament control of the detector circuit is by means of a 20 ohm variable rheostat, which, if desired, may be used as a volume control, although the regenerative condenser will probably serve better in that capacity. The filament circuit of the 222 screen grid tube is fixed by means of the two 10 ohm resistances in each side of the filament circuit. Bias for the grid of the 222 tube is obtained by the drop across the 10 ohm resistance in the negative side of

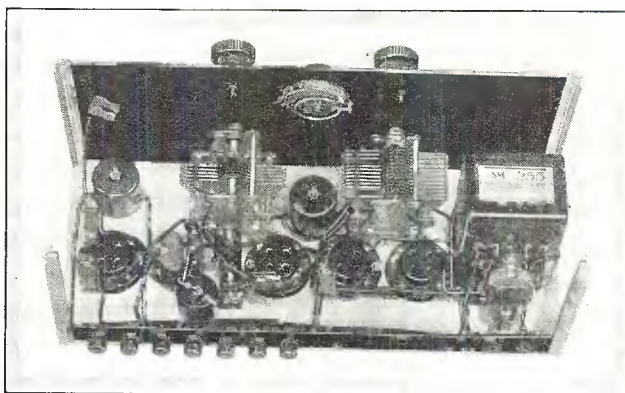

Fig. 2. This photograph shows the inside of the aluminum shield with all parts in place and properly wired. The photograph is taken upside down, with the bottom, back and two side shields removed

(This receiver tested and all illustrations made in our laboratory)

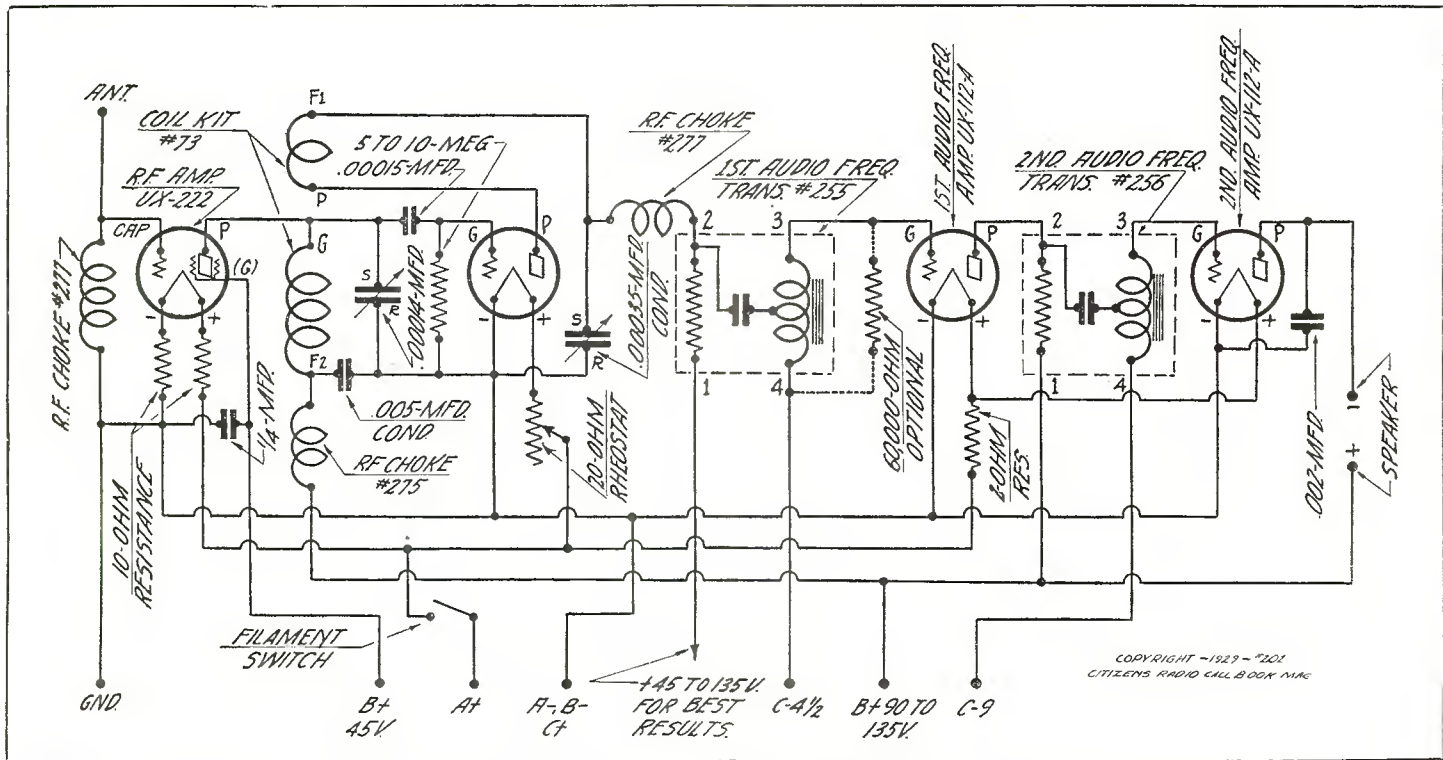

Fig. 3. The schematic circuit involved in the "Round the World Four" is shown in the diagram above

that circuit.

Operation Easy

In operation of the receiver, after all the batteries and other connections have been made, insert the 131-V coil, this being the one with the greatest number of enameled wire turns, turn the rheostat knob so that the arrow points straight up. If operated during the evening, station KDKA on 64 meters will be found somewhere between 20 and 25 degrees on the left dial. Turn the right dial, which is the regenerative one, up from zero until a dull plunk is heard in the speaker and then rotate the left dial about its setting until a sharp squeal is heard. Then adjust both the left and right dials until the squeal becomes music. The adjustment of both dials for best signal strength will be found quite critical and to facilitate tuning the dial reduction ratios may be increased by turning to the right the small nickel button just over each tuning dial knob, which will give the indicator dials a slow movement. Volume may be reduced by tuning down the right dial. A tuning chart which accompanies the 730 and 731 kits, will give an approximate idea of where the receiver is tuned at any dial setting. However, it is probably best for the operator to make up his own tuning chart in accordance with his own particular set.

Blank Forms Available

In addition to the ready made coils available, these being known as the type 131 P, U, V, W, X and Y, Silver-Marshall also are in position to furnish plain moulded bakelite forms, which may be used by the operator in winding his own coils. Each grid coil is started at the top of the form with the end connected to the pin G. Turns are wound in the smooth winding space and the winding ended at the bottom in pin F-2. The tickler or regenerative winding is wound in the slot starting at pin F-1 and ending at pin C. Both coils must be wound in the same direction for regenerative effect. If the regenerative coil is reversed, signals will hardly be heard.

The fifth prong on these coils is not used.

The wavelength range of the coils is as follows:

- 131-T 17.4 to 32 meters
- 131-U 31 to 58 meters
- 131-V 56 to 110 meters
- 131-W 105 to 204 meters

- 131-X 190 to 358 meters
- 131-Y 344 to 647 meters

Official Parts List

Parts required for the construction of the 730 "Round the World Four" are shown in the list below.

- 1 Silver-Marshall 732 "Round the World" Essential kit
- 1 Silver-Marshall 734 aluminum shielding cabinet with terminal strip
- 1 Silver-Marshall 255 first stage a.f. transformer
- 1 Silver-Marshall 256 second stage a.f. transformer
- 3 Silver-Marshall 511 tube sockets
- 1 Yaxley 20-ohm midget rheostat
- 1 Yaxley 500 switch attachment
- 2 Yaxley insulated tip jacks
- 1 Na-ald 481XS spring socket for detector
- 1 Polymet .00015 condenser
- 1 Polymet .002 condenser
- 1 Polymet .005 condenser

(Continued on page 134)

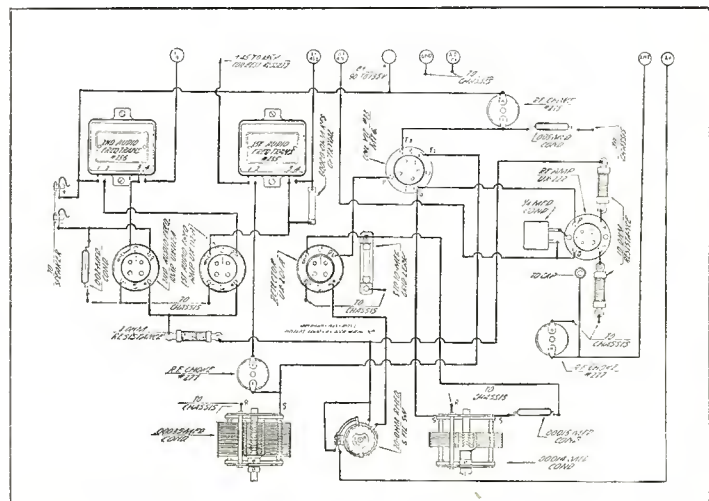

Fig. 4. Those who are not experienced set builders may readily construct the four tube receiver by means of the graphic diagram shown in this sketch

Vee Products Has Six Tube Receiver for Medium Priced Market

Recent Design Using A. C. 22 Tubes Has A, B and C Power Supply on Rear of Receiver Chassis

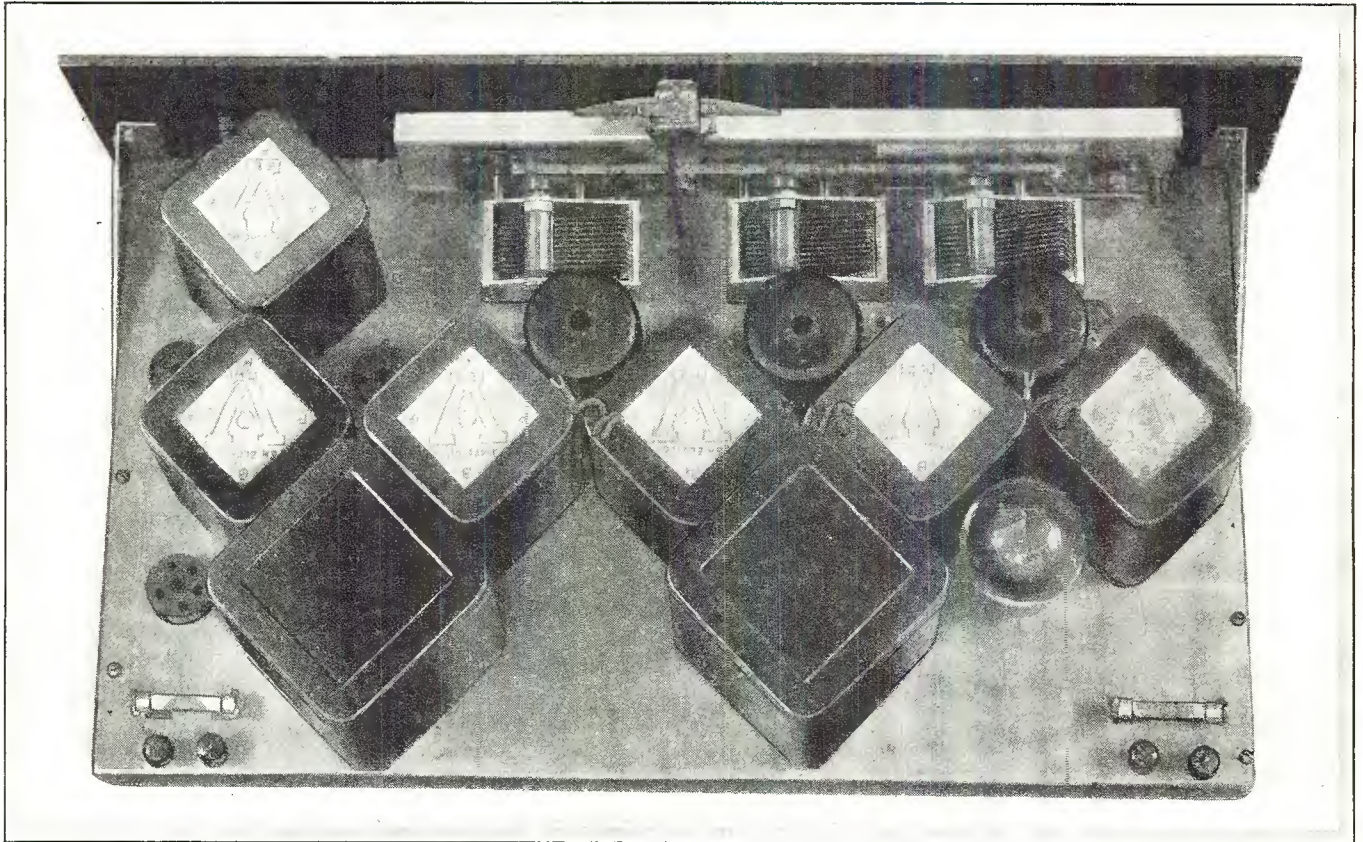

Fig. 1. In above photograph may be seen the rear view of the recently designed Vee Products six tube a. c. screen grid receiver. The five square copper containers in the center of the set are the radio frequency stages and the first audio. The two larger containers at the rear of the sub-panel contain the high voltage power supply and the filter condensers and choke

LOOP OPERATED, using three a. c. screen grid tubes, 227 detector and first audio and the last stage a 171, the receiver shown photographically in Fig. 1 is a recent design of C. J. Victorien and is being merchandised for the medium priced set market by the Vee Products of Chicago.

Operates From Loop

Heretofore practically the only receivers in which a loop was recommended for operation were the superheterodyne type, but in this instance the designers feel that quite satisfactory results may be secured by the employment of a loop in connection with this six tube receiver. Then again the presence of the loop in the circuit would permit taking advantage of some of the directional properties of a coil antenna, which might not be the case if the receiver were operated from a short length of aerial. This feature should be of some assistance to those who are so located that interference is caused by nearby stations.

Wiring Is Concealed

All of the wiring in the receiver is concealed, which contributes materially to the simplicity in wiring. A new type of rectifying tube, which automatically protects the power pack condenser from

overload while the heaters are warming up, is provided in this new design, the tube being supplied with the kit. Single control in the receiver is achieved by means of the patented Vee compensated control unit, which has a rack and pinion arrangement for governing two or more variable condensers from a single knob.

Units Sealed in Cans

Many of the details of the circuit will be apparent on an inspection of the schematic circuit shown in Fig. 3. The Vee loop recommended by the designer goes across the P and B terminals of the first radio frequency unit, 1-L. The inductance shown in the schematic inside of the dotted lines of the first r. f. unit acts as loading inductance and makes possible "center tapped" regeneration with only two wires, also the use of .00035 tuning condenser with .0005 loop. Tuning for this particular circuit is by means of a .00035 mfd variable condenser from the cap of the first tube to the other loop terminal. This stage may be made regenerative by manipulation of the .000035 mfd midget condenser from one of the loop terminals to the plate of the first r. f. stage. The second radio frequency unit known as the 1 r. f. coil is of a special type, the upper inductance being in the plate circuit, with a bypass condenser from its lower extremity to the common ground. The lower section of the

(This receiver tested and all illustrations made in our laboratory)

inductance acts somewhat as an r. f. choke. The plate circuit of the first radio frequency stage feeds capacitatively into the cap of the second r. f. amplifier, with a fixed resistance being placed from the cap terminal down to the common ground. The two inductances, the two condensers and the fixed resistance are contained within the can of the second unit. This particular stage is not tuned in this receiver. The succeeding stage, which is the third r. f. amplifier, is tuned by the second .00035 mfd condenser, which is ganged together with two others on the rack and pinion Vee control. The primary of the third r. f. unit, called 2 r. f., is the same as the preceding one, although the secondary is different, as will be shown by an examination of that section of the schematic. In series with the cap lead of the secondary, is a fixed resistance, for stabilizing purposes. The fourth r. f. unit, called 3 r. f., is also of a special type and its secondary is tuned by the third .00035 mfd variable condenser. In this stage a 227 detector is employed, and the detector is made regenerative by means of the .000035 mfd midget condenser between the F terminal of the 3 r. f. unit and the P terminal of the 227 tube. The first and second audio units are of special design, whose characteristics may be learned by referring to that portion of the schematic circuit.

Set Doubly Regenerative

It will, therefore, be seen that the receiver is doubly regenerative, in that the first r. f. amplifier may be made regenerative and the detector may be regenerative, both of these controls being in the form of midget condensers, one of which is brought out to the front panel, this being the detector regeneration.

The volume control employed in this receiver is a 400 ohm variable resistance between the common cathode terminals of the first and second r. f. and detector and the ground, this control serving to increase or decrease the bias placed on the caps of the

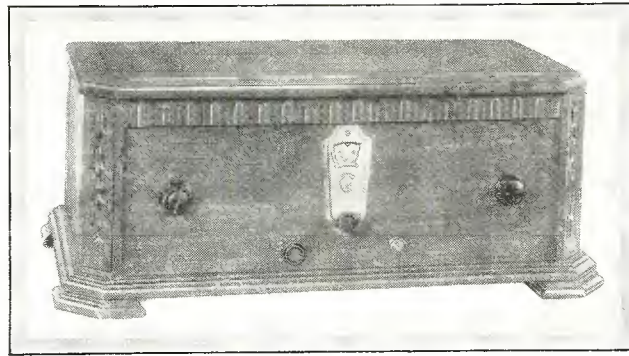

Fig. 2. This photograph shows the front view of the Vee Products receiver, which is a single control job, using a rack and pinion movement in the rear of the center dial in order to turn the three variable condensers across the first and second radio frequency and the detector stages

three a. c. screen grid tubes. There are only two filament voltages, these being the two .5 volt windings for the filaments of the a. e. 22 and the 227 tubes, and another winding of 5 volts a. c. for the filament of the 171 power tube in the last stage. A special 7.5 volt secondary is provided for the filament of the special rectifier shown at the lower portion of the schematic in Fig. 3.

Special Rectifier Tube

A, B and C voltages are supplied by the special rectifier circuit, which is made a part of the chassis, the high voltage transformer, choke and filter condensers being located in the two larger copper containers at the rear of the sub-panel in Fig. 1. The tube at the right rear is the rectifier which is plugged in the socket. The socket at the extreme left is the 227 first audio stage, while the power stage is at the left and nearest the panel.

Only One Voltage

The power unit will be seen to consist of a 110 volt a. c. primary, with a switch in one lead for turning the set on and off, a 2.5 volt winding for the a. c. screen grids and the 227, and a 5 volt winding for the 171 tube. Bias for the 171 grid is secured by the drop across the 1500 ohm fixed resistance between the 5 volt center tap and ground. One side of the 2.5 volt secondary is grounded. The high voltage secondary has one terminal going to the P terminal on the rectifier socket, while the other one goes to the mid-point between two fixed condensers, one condenser then leading to the G terminal of the rectifier and through the choke to the 200 volt line supply, while the other condenser leads through to ground, where it is joined by the main filter condenser between the 200 volt line and the ground. The cathode of the special rectifier tube is common with ground, while the filaments are energized from the 7½ volt secondary previously mentioned. Thus, the rectifier supplies only one main

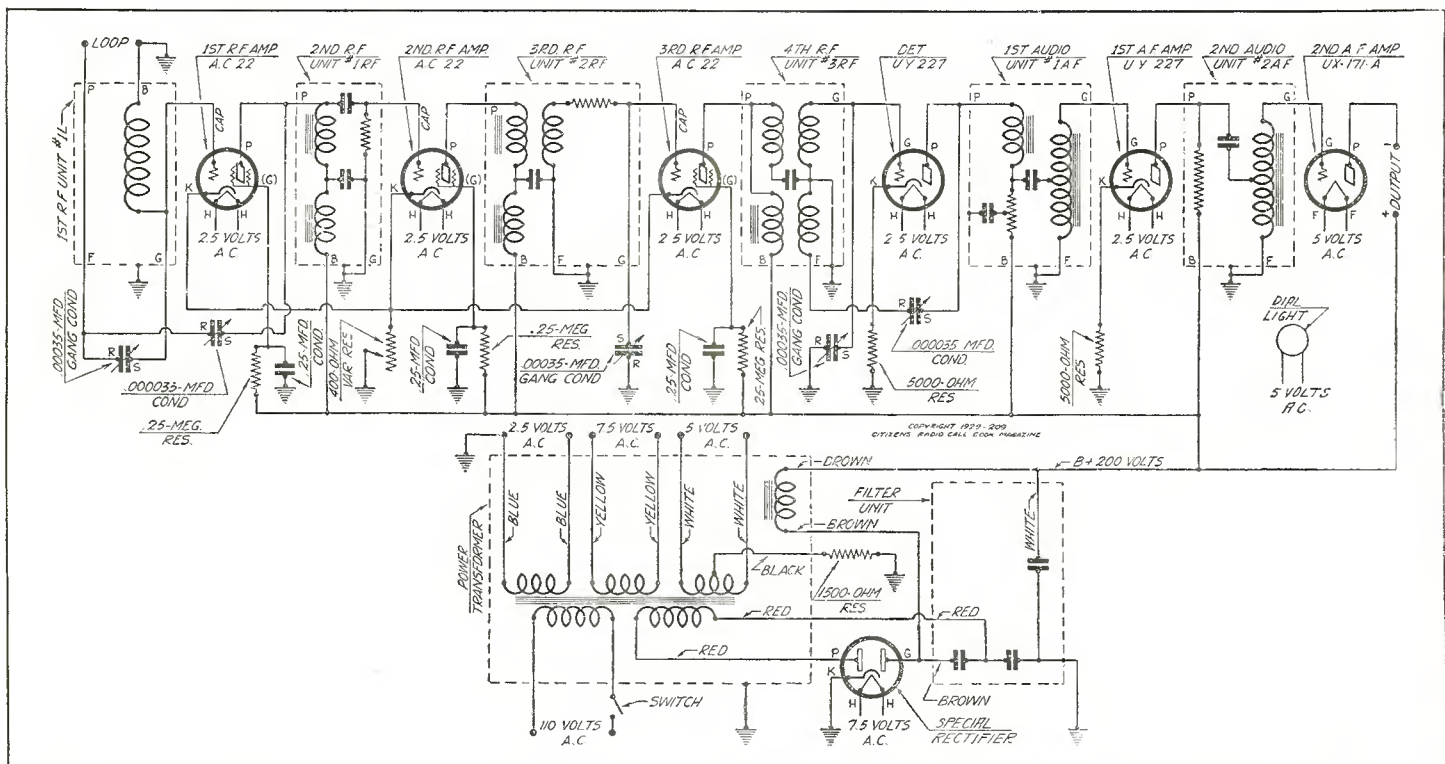

Fig. 3. In the schematic circuit above are shown the electrical details of the receiver described in the accompanying article, together with the diagram of the power supply, which is included on the chassis of the receiver

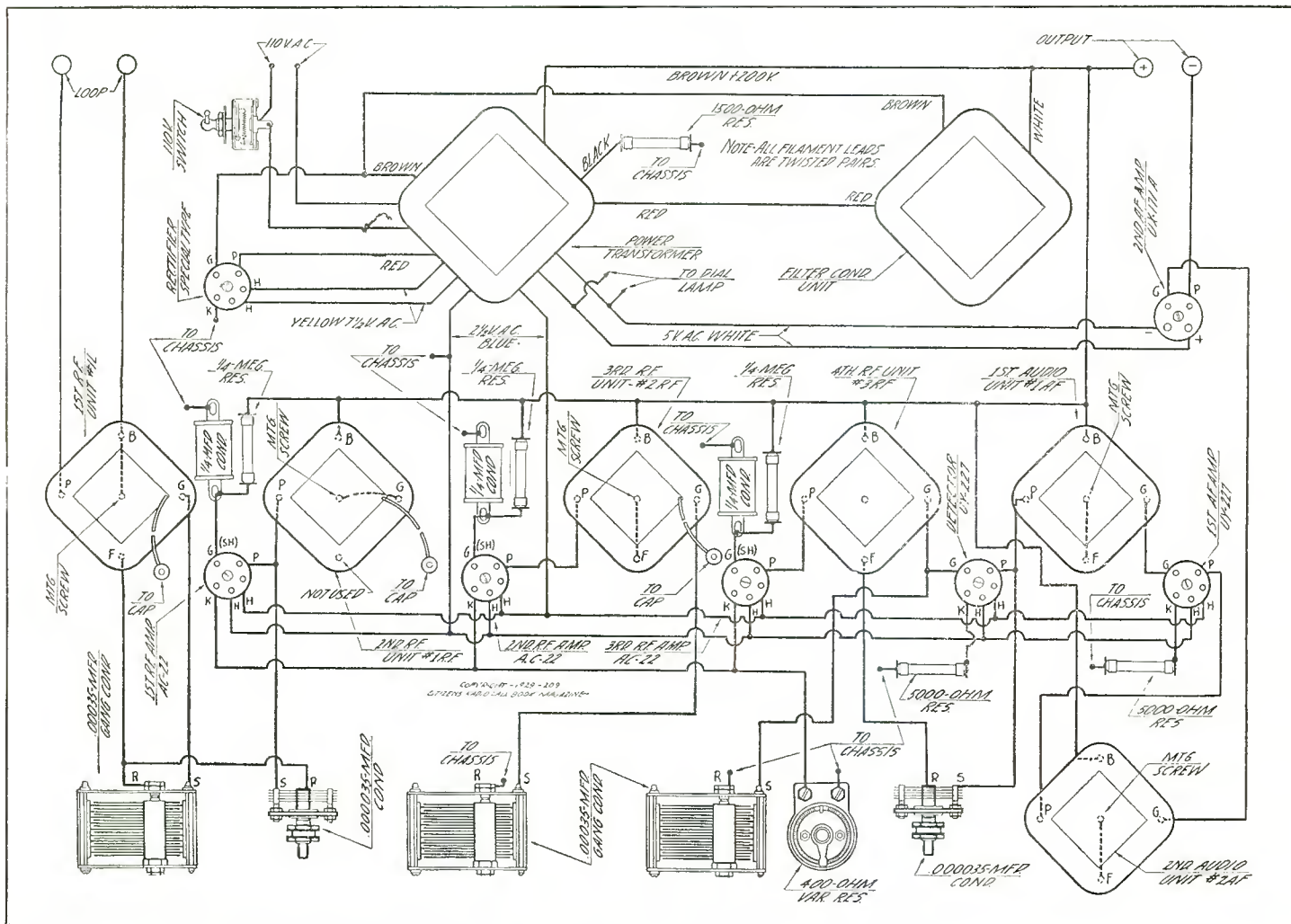

Fig. 4. In wiring up the receiver described in this article, this graphic diagram should be employed by the builder, since it will save him some time in making connections. If there is any doubt as to a connection, it would be a good idea to refer to the schematic circuit shown in Fig. 3 to check up

voltage, which is 200 volts, which potential is applied to all tubes through proper resistances in the first and second audio. A 1/4 megohm fixed resistance, properly bypassed to ground with its respective condenser, is placed in each of the screen grid leads of the three a. c. 122 tubes, so as to drop this voltage to the proper value for the operation of the screen grid.

The absence of a resistor network and other items required in a power unit supplying several voltages thus permits production economy, which is seen in the price of the completed job. The dial light is operated from 5 volts a. c., which is the same voltage used on the filament of the 171-A power tube. This power stage gives ample volume for home purposes, and a very nice tone quality.

Everything required for the construction of the receiver is included in the kit, the parts of which are shown in the succeeding paragraphs.

Official Parts List

Parts required for the construction of the receiver described in the above paragraph are shown in the accompanying list, and are supplied by the designer of the receiver:

- 1 Vee shield coil type 1-L
- 1 Vee shield coil type 1-RF
- 1 Vee shield coil type 2-RF
- 1 Vee shield coil type 3-RF
- 1 Vee shield coil type 1-AF
- 1 Vee shield coil type 2-AF

The above units are individually tested and adjusted at the factory.

- 1 Vee power unit
- 1 Vee special rectifying tube

- 1 Vee tuner unit
- 2 Midget variable condensers
- 2 R.F. chokes
- 1 Vee control unit
- 1 High resistance variable
- 3 Bypass condensers
- 6 UY sockets
- 1 UX socket
- 3 Tube shields
- 5 Fixed resistances, cartridge
- 5 Mountings
- 1 Metal sub-panel
- 1 Front panel
- 4 Binding posts
- 1 Roll special hook-up wire
- 1 Rosin core solder
- 1 Vee coil antenna

Power Supply Parts

Parts required for the power supply and amplifier when used with other circuits, as shown below:

- 1 Vee power unit
- 1 Vee special rectifier tube
- 1 Vee filter unit
- 2 mfd condensers
- 1 UY socket
- 1 UX socket
- 1 Resistance unit
- 1 Sub-panel
- 6 Binding posts
- Hook-up wire and solder

S-M Double Push-Pull Public Address Amplifier for Theatre Work

Used with Two Electric Turntables and a Dual "Fading" Device
It Permits "Cueing" Pictures

PROFESSIONAL set builders in the smaller towns of the country may at times find it profitable to install in the small theaters a means of entertainment to take the place of an existing form of entertainment which may be unsatisfactory.

Record Reproduction

In the accompanying article, we are describing briefly the dual push-pull auditorium amplifier made by Silver-Marshall, which may be used in conjunction with a double electric turntable for providing record reproduction during the course of a picture and for fading out one record and fading in another where it is desired to do any cue work.

Uses Double Turntable

Perhaps the simplest way of mounting up the two turntables is by the method shown in the photograph at the head of this article. A stand is built on the top of which are located the two electric turntables, with the balancer or fading device located between the two. Two electric pick-ups are employed, one for each turntable.

The amplifier is located in the bottom portion of the stand and the speakers are energized from the output of the dual push-pull amplifier. As many as four small dynamic speakers may be used, or one or two large auditorium dynamic speakers, if preferred. All speakers must, in every case, be connected to the same pair of lugs on the output choke (see Fig. 4); the question of which of the three pairs to use depends on the speakers themselves and must be settled by trial, the inner pair (5 & 3) being, in general, more likely to accentuate bass notes than the outer pairs. The speakers should be set in a cluster, at the best position found by test on the part of the professional set builder and the representative of the theater.

Has ABC Supply

The dual push-pull amplifier, whose schematic circuit is shown in Fig. 4, is complete in that it supplies A, B and C voltages for all tubes. Any professional set builder who has any radio experience at all can proceed with this work without encountering any difficulty. This is just another one of the means whereby set builders may be able to produce business that will prove profitable to them.

Official Parts List

Parts required for the construction of the dual push-pull amplifier described in the article above are shown in the list below:

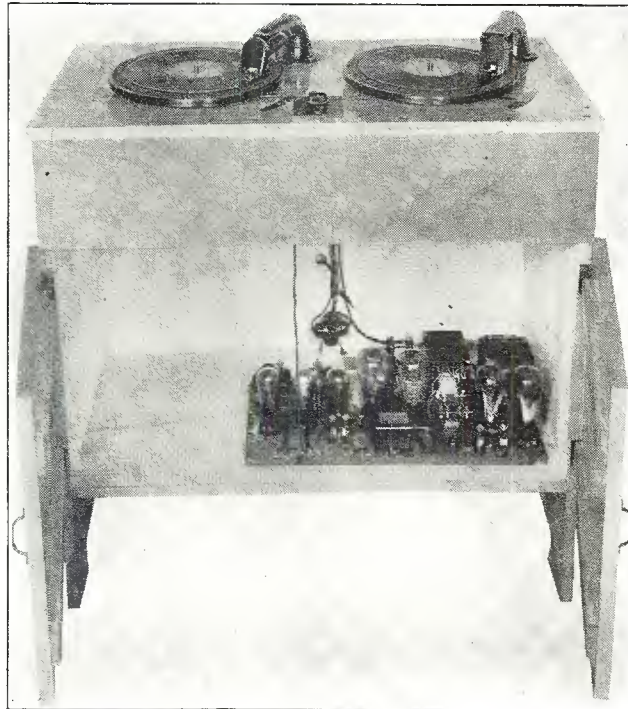

Fig. 1. This photograph shows the rear view of a stand on which has been mounted two electric phonograph turntables. The amplifier is located in the bottom of the stand. By means of the fading device shown at the center between the two tables, it is possible to shift from one record to another without any lapse in the program

- 1 Silver-Marshall 328 power transformer
- 1 Silver-Marshall 247 filament transformer
- 2 Silver-Marshall 255 first stage transformers
- 1 Silver-Marshall 257 push-pull input transformer
- 1 Silver-Marshall 227 push-pull interstage transformer
- 1 Silver-Marshall 248 Universal output choke (or type 228, if encased model is desired)
- 6 Silver-Marshall 511 tube sockets
- 1 Silver-Marshall 512 tube socket
- 2 Silver-Marshall 659 resistors
- 1 Potter 673 condenser bank
- 2 Ohmite 750 ohm resistors
- 1 Yaxley 2000 ohm grid resistor
- 2 Frost FT64 center tapped resistors
- 1 Carter AP15 balancing potentiometer
- 1 5 foot cord and plug
- 1 Silver-Marshall 818 hook-up wire (25 feet)
- 5 Fahnestock clips
- 1 Silver-Marshall wood chassis, 21 $\frac{7}{8}$ x 9 $\frac{1}{8}$ x $\frac{1}{2}$ inch
- 1 Set hardware as below
 - 4 8/32 threaded brass rods 3 $\frac{3}{8}$ inches long
 - 2 8/32x5 inch threaded brass rods
 - 12 8/32 nuts
 - 1 Steel strap 5x $\frac{1}{8}$ x3 inch
 - 38 $\frac{1}{2}$ inch No. 6 RH wood screws
 - 4 1 inch No. 6 RH wood screws

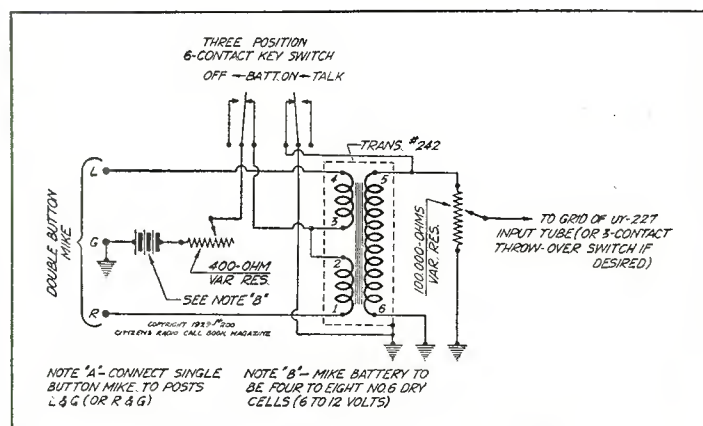

Fig. 2. The schematic circuit shown here shows the method of hooking in a double button microphone if this amplifier is to be used for voice work

(This amplifier tested and all illustrations made in our laboratory)

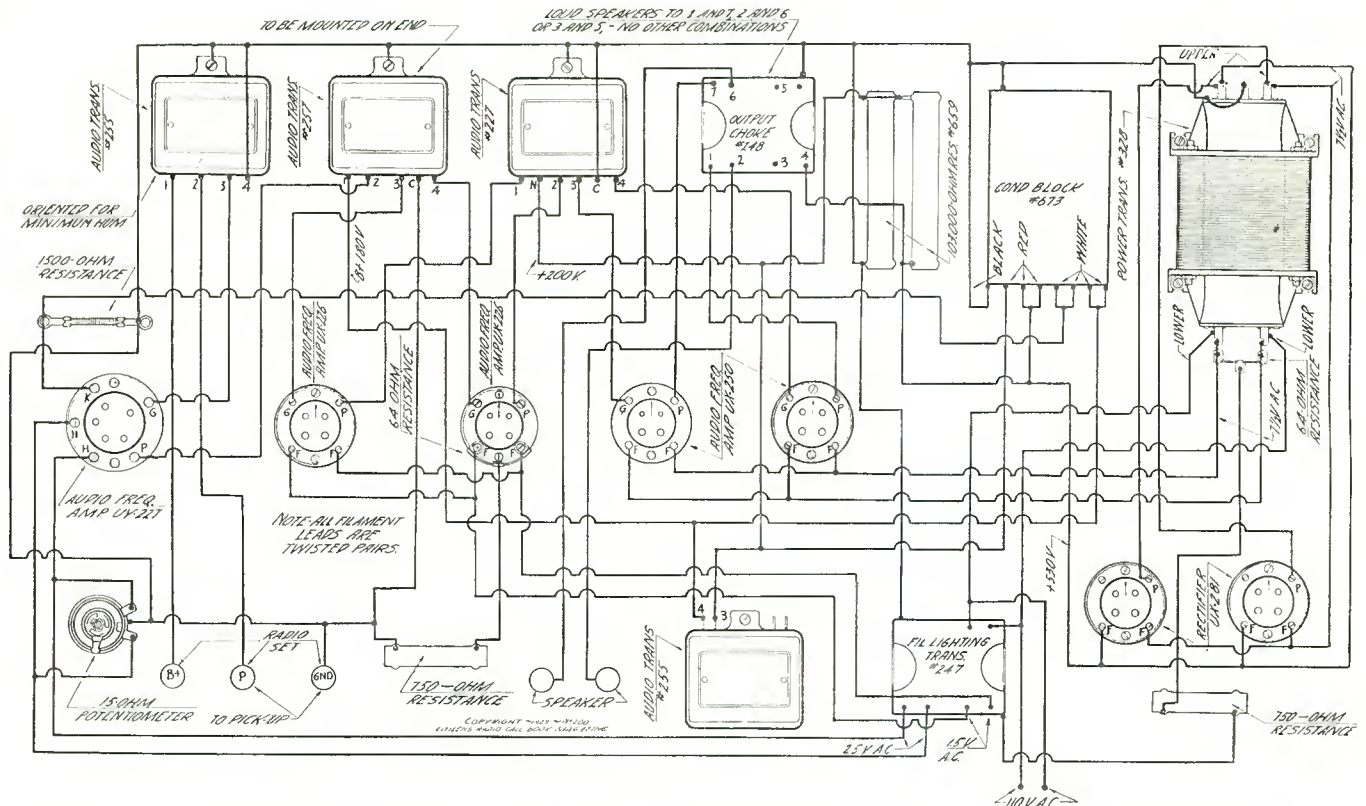

Fig. 3. This is a graphic illustration of a method by which connections may be made in wiring up the dual push-pull amplifier described in this article

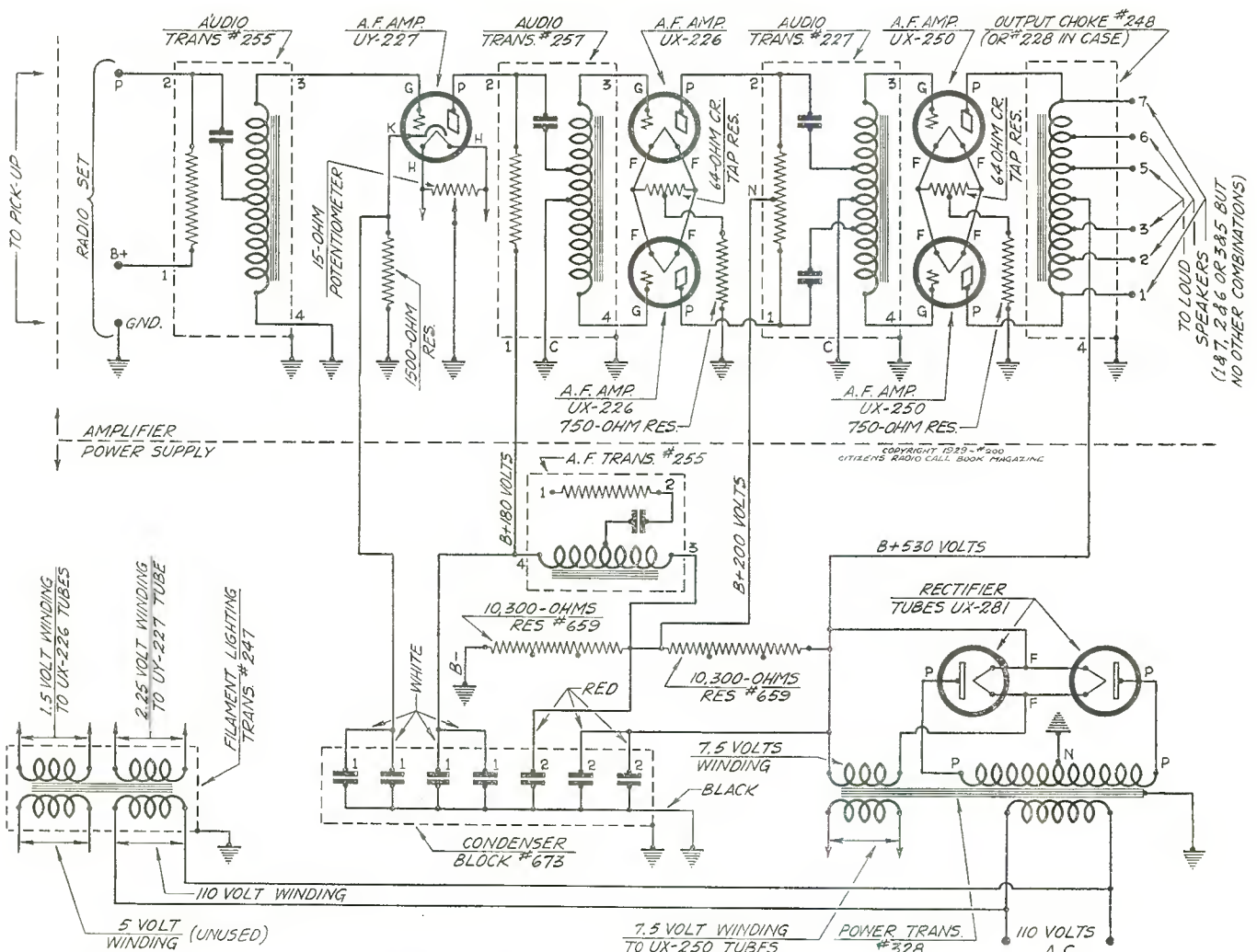

Fig. 4. This schematic diagram represents all of the connections in the dual push-pull amplifier

(Continued on page 120)

A. C. Shield Grid Magnaformer Design Announced for 1929 Season

Popular Super Is Now Made Completely Light Line Operated in
Answer to Fan Demand

THE new all-electric Magnaformer 29 a. c. shield grid receiver is the 1929 offering of the Radiart Laboratories and is the successor of the Magnaformer 9-8 described in previous issues of this magazine.

This new receiver is the result of eight months of effort to build a set superior to the Magnaformer 9-8. The new job is 100 per cent shielded and has a complete built-in power unit that is a part of the set itself. The entire set, including power unit and filter condenser, occupies a sub-panel measurement of $11\frac{1}{2} \times 23$ inches.

Two a. c. shield grid 22, five a. c. 227, two 281 rectifiers and one 250 power tube are used. Volume on distant stations is tremendous and the tone quality is practically the same beautiful result as that from local stations. Power is very simply controlled from the faintest whisper to extreme volume.

The new receiver is controlled from a single dial and has no harmonic repeats. A new Magnaformer coil developed by engineers of the Radiart Laboratories makes the screen grid tubes tune as sharply as the 227's and still retain the amplification factor and sensitivity peculiar to the shield grid tube.

Another feature of the new receiver is the plug-in oscillator coils, one for the long waves and one for short waves. All that is necessary to do to change from one band is to remove one coil

and plug in another. The set is designed for loop operation on account of the directional factor of the loop, but if one wants a short aerial, two antenna couplers are available, one for long waves and one for short waves. The set is particularly designed to operate with the new dynamic speakers.

Construction of the receiver is not difficult, because the entire layout has been so arranged that with the punched sub-panel and front panel, there is relatively little work to be done in assembly and mounting the various units in their respective positions. The photograph shown in Fig. 1 gives an idea as to the general layout of the receiver, while the schematic diagram shown in Fig. 2 gives the electrical circuit involved. The graphic diagram shown in Fig. 3 is not so much as a means of wiring but as a means of showing how simple the actual wiring is. However, for better results, it is suggested that the large sized graphic which accompanies the kit be employed, since it is much easier to read than the one shown in Fig. 3.

As shown in the schematic circuit in Fig. 2, it will be seen by readers that the circuit is designed for use with a loop. The reason it is desired to operate the set with a loop is because the input stage tuning may then be kept at a definite value, so that the single control idea may be carried out very successfully. Therefore a center tapped loop is used, the .0005 mfd Remler con-

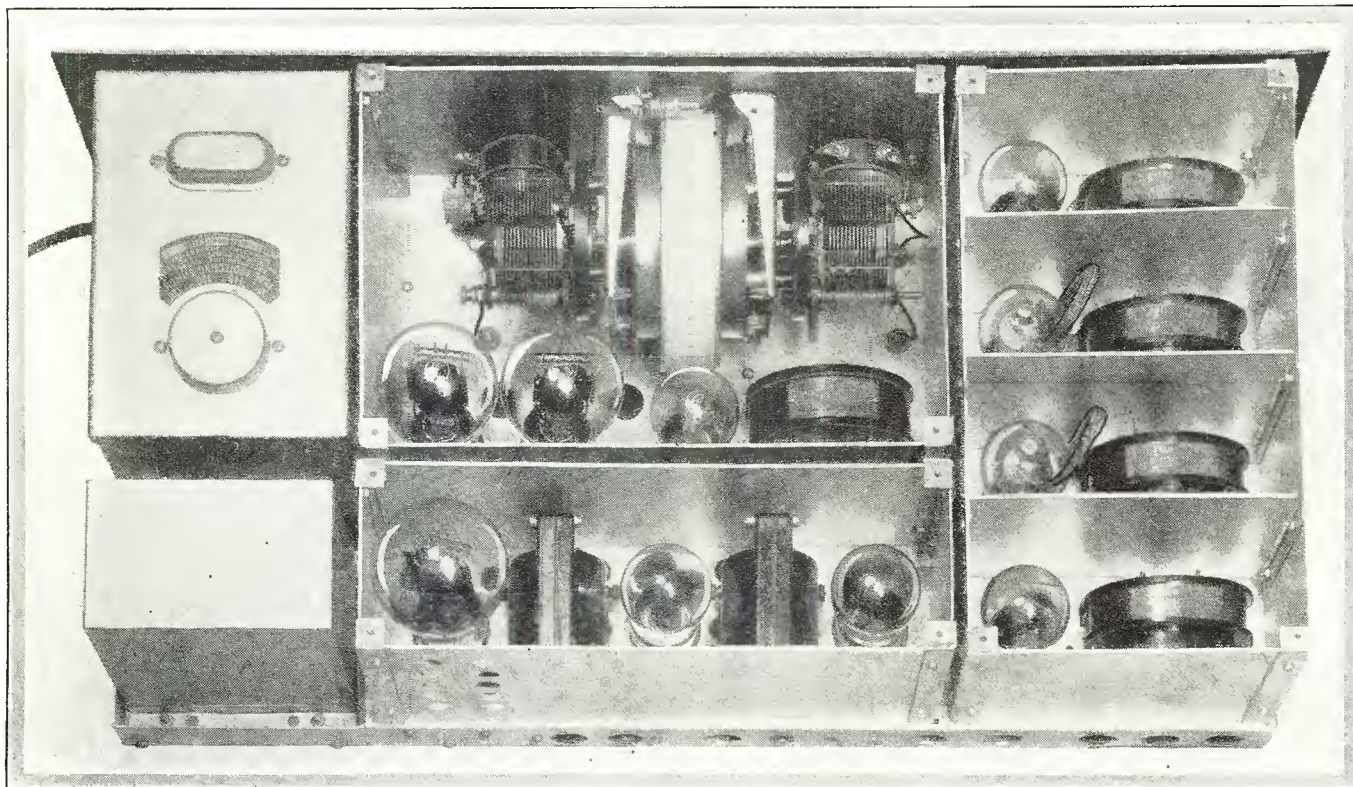

Fig. 1. This photograph shows the top and rear view of the a. c. shield grid Magnaformer as recently designed in answer to the demand of the fans. The A, B and C power supply is that portion of the set at the extreme left. The audio portion is in the center rear section, while the intermediate frequency stages are shown at the right. The receiver is a single control affair, with a balancing arrangement on the input end, so that the set may be tuned to absolute resonance, when desired

(This receiver tested and all illustrations made in our laboratory)

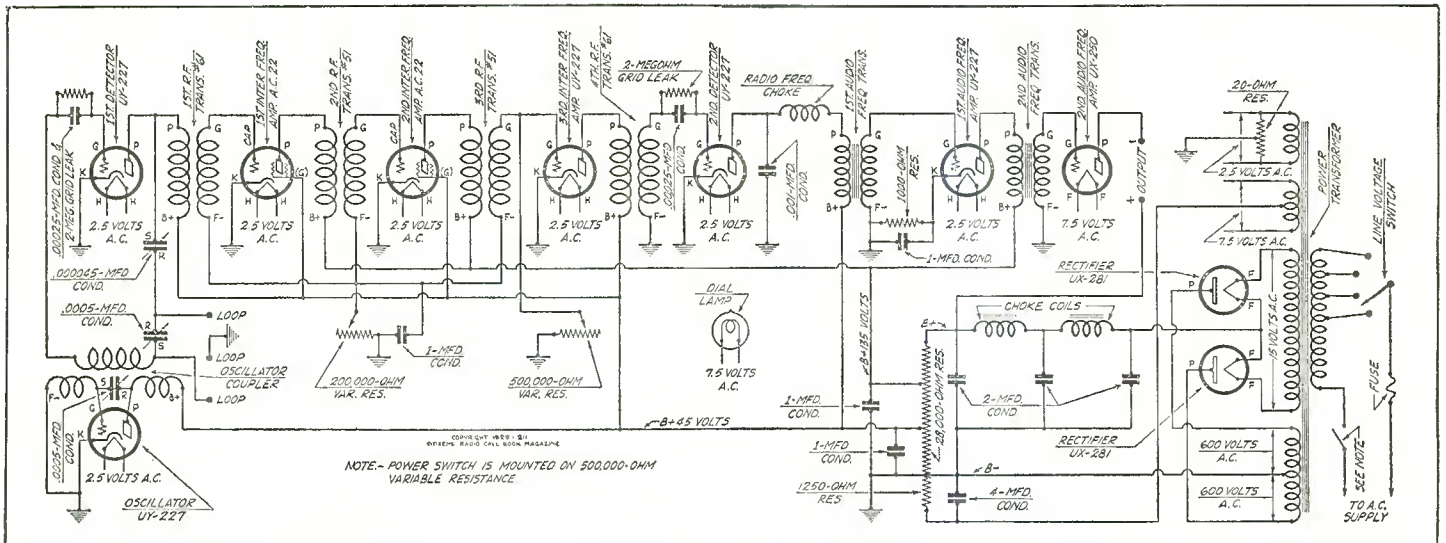

Fig. 2. The schematic circuit of the combined receiver and power amplifier is shown in the diagram above

denser being placed across the extremities of the loop, with a regeneration control of the first detector made possible by the employment of a .000045 mfd midget condenser between one loop terminal and the plate of the first detector, which is a 227 tube. Rectification in the first detector is by means of the .00025 mfd condenser and 2 megohm grid leak. The cathode of the 227 first detector is common with ground. By means of the .000045 mfd regenerative condenser, it is possible to make the first detector circuit quite sensitive to weak signals, although the condenser should not be turned too far, or instability will result due to a semi-regenerative first detector. On account of the location of this particular condenser, it will not be used as a tuning control, but will merely set at a definite value for best results and then left alone.

No Body Capacity

The oscillator in this new design uses a 227 tube, with its cathode common to ground. Tuning is across the grid and plate of the oscillator tube and because of the type of condenser used (Remler) no body capacity may be encountered. Plate voltage for the oscillator circuit is 45, which is also the value placed on the plates of the first detector, first intermediate screen grid, second intermediate screen grid, and the plate circuit of the third intermediate frequency amplifier. The second detector also operates with 45 volts on the plate of the 227. The plate of the first intermediate amplifier, the second intermediate amplifier and the plate of the first audio frequency transformer are supplied a potential of 135 volts, while the 250 tube used in the last stage is given 450 volts, which is the maximum output of the power supply included in the receiver chassis.

Sensitivity and Volume Control

There are two high resistance controls located on the front panel, one being a 200,000 ohm variable in series with the grid return of first, second and third intermediate frequency amplifier stages, where two a.c. 22 tubes and one 227 are used. This variable resistance is located between the grid return and the ground and is bypassed to a 1 mfd condenser. This control governs the input impedance of the two a.c. 22 tubes and the 227 and is used exclusively on distant stations. This control is located at the left of the receiver when facing the front panel. The control at the right is the one shown in the schematic diagram, Fig. 2, as being a special tapered 500,000 ohm variable resistance located directly from the grid of the third intermediate frequency tube, which is a 227, and ground.

Grid Biases Automatic

In the second detector, another .00025 mfd grid condenser and 2 megohm grid leak are used for rectification. The cathode of this 227 tube also goes to ground. A radio frequency choke in series with the plate circuit of the second detector and bypassed by a .001 mfd condenser to ground serves to prevent passage of any stray r.f. current into the primary of the first audio transformer. In the first audio amplifier, a 1000 ohm fixed resistance bypassed with a 1 mfd condenser is located between the F minus terminal of the transformer on the cathode of the tube and there serves as a means of placing the proper bias on the grid of that stage. The bias for the 250 power tube used in the last stage is obtained by the drop across a 1250 ohm fixed resistance, bypassed with a 4 mfd condenser between the common B negative line and the center tap of the 7½ volt a.c. winding for the filaments of the 250 tube.

By examining the schematic circuit shown in Fig. 2, it will also be possible to see the details of the power supply, which is included in the receiver. The primary of the power supply has a tapped arrangement whereby various voltages may be selected from which to operate the unit. For example: if the line voltage is 115, the power supply may be set for that value, or it may be set for any other value of line voltage within the limits of the unit itself. For that reason it is advisable to find out beforehand from the electric light company the exact voltage at the location where the receiver is to be operated, so that the power supply may be set for that value. A break is made in the 110 volt a.c. supply, so as to be controlled from the 500,000 ohm variable resistance, which has a switch contact arranged on it. Thus, when the 500,000 ohm variable resistance is turned all the way to the left, the set is cut off, while to turn on the set, the knob is turned to the right and volume controlled from that point to the extreme right hand travel of the knob. This eliminates the necessity for

(Continued on Page 122)

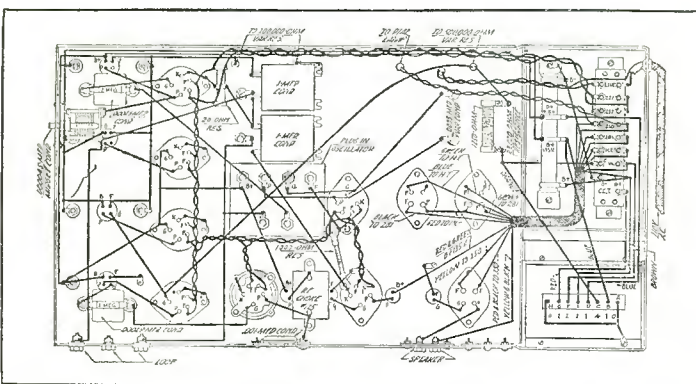

Fig. 3. This graphic diagram is merely shown to give an idea as to the simplicity of the wiring in the receiver itself. In actual wiring it would perhaps be better to follow the full sized graphic which accompanies the kit, since it is much easier to read a diagram of larger dimensions than the present one

Junior Radio Builder May Get Fun in Making This Simple Set

Many Young Fellows Might Like to Have Their Own Radio Receiver; Here's How It Is Built

AMERICAN boys are representative of the spirit of the times in that they keep abreast of improvements in any of the arts. The telephone, electric light, telegraph, automobile, radio and other factors which accelerate transportation or communication are being constantly seized upon by the younger generation as a means of better keeping in touch with progress in the world.

Boys' Personal Receiver

There is so much entertaining or instructive material broadcast by radio stations at the present time that many boys, who in the past might have been satisfied with some other form of entertainment, are now turning to radio as a means of appeasing their healthy appetites for the brighter things in life. In families where one radio set, generally a large one, is used in the living room for the entertainment of the elders, the boy or young man of the family might wish to have a private set of his own which could be operated in his room with a pair of head phones and by means of which he might seek out the program of his choice, rather than having to listen to those that the family desires. Then, too, there are many families in which the elders are not interested in radio, but the boy of the family because of training received during school hours is more than interested in the learning of the fundamentals of the radio art and perhaps learning to build small receivers, by means of which he can gain experience in set construction.

With the present efficient state of the art, when apparatus has been developed to a high degree of perfection and when prices of material have been brought down to a point where they are now within the reach of almost every individual, it is a simple enough matter to build a small receiver for personal entertainment purposes that will yield a maximum in entertainment or instruction, and at the same time not be a severe drain upon the pocketbook of the builder.

Built In Two Parts

In designing this small receiver shown in this article, it was the intention of the technicians in our laboratory to create a small set which might be started as a single stage of tuned radio frequency and a regenerative detector, and then later by the addition of two stages of audio, the receiver could be brought up to a point where it would entertain more than one individual. Thus, the receiver might be called a two-step affair. The first step is illustrated and described in this article, and the second step, which consists of the addition of the audio frequency amplifier stages, will be shown in the forthcoming issue of this magazine. For that reason, the baseboard shown in the photograph, Fig. 1, has been purposely made large, so that the parts for the entire receiver may be easily laid out on this baseboard, but in the present case only the first and second tubes are placed thereon. In the forthcoming issue, there will be two more tubes and two audio transformers on the baseboard. The radio frequency and

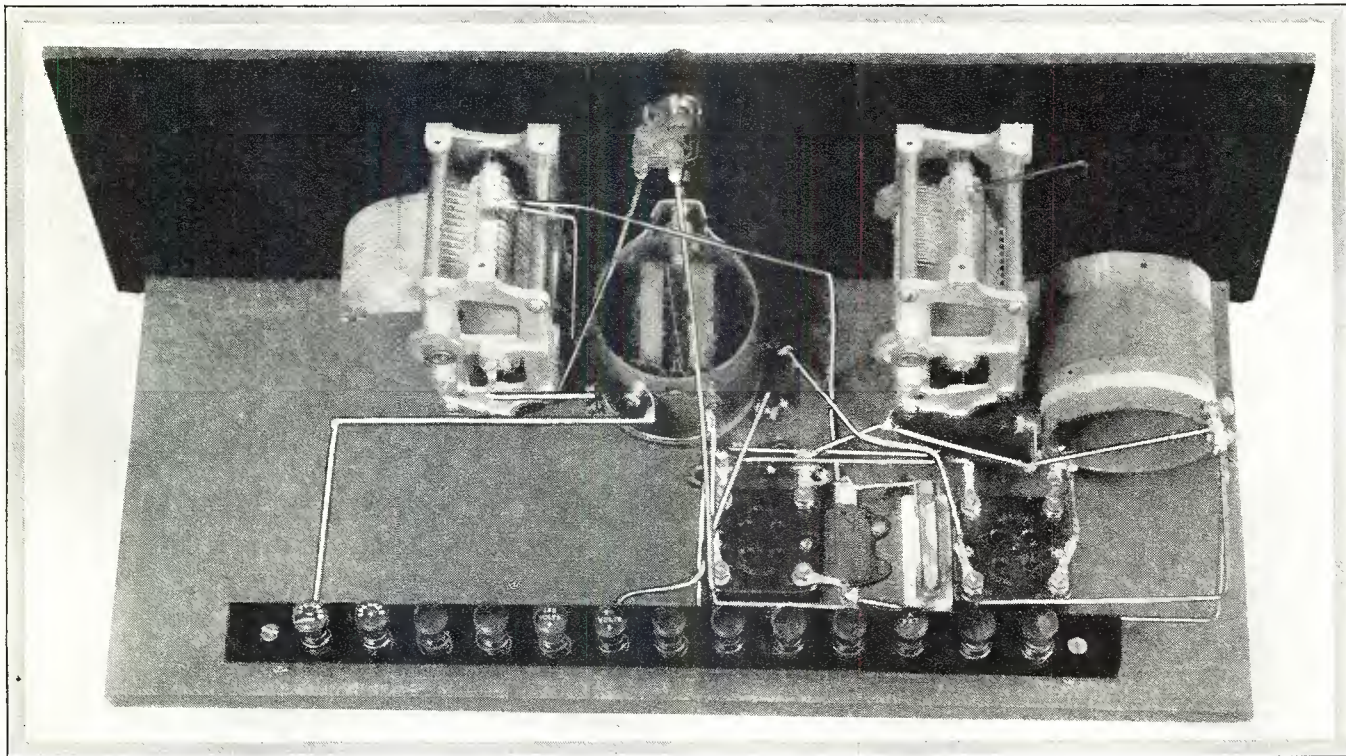

Fig. 1. The photograph above shows the simplicity of the small receiver containing one stage of radio and a regenerative detector. The baseboard is made large on purpose for the two stages of audio which are to follow in the next number of this magazine

(This receiver designed, tested and all illustrations made in our laboratory)

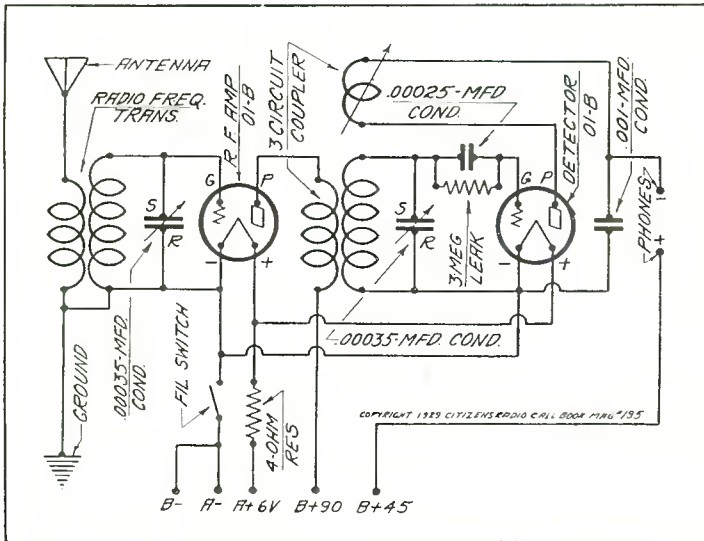

Fig. 2. The schematic circuit involved in the simple receiver is shown above and may be followed in wiring work by those who are accustomed to this type of a diagram. Inexperienced builders should construct their receiver from the graphic illustration shown in Fig. 4

detector stages will not be changed in the succeeding article, since this portion of the receiver is standard.

Therefore, in securing a front panel, for the receiver, a panel size is utilized which will cover both the first and second steps in the construction of the set without any necessity for throwing away any portion of it. The same thing applies to the binding post strip which is shown in the photograph, Fig. 1. All of the binding posts on this strip are not used in the present receiver, although when the second step is illustrated in the forthcoming issue, each one of the binding posts will terminate at a definite position and all be used.

As shown in the list of parts, which appears at the end of this article, the front panel will be seen to be a Formica 7x18x3/16 inch black panel. The baseboard is a wooden one 7x17x5/8 inch. By referring to the photograph shown in Fig. 3, it will be seen that the two condensers are placed on the front panel so as to be more or less centrally located, with the mounting of the regenerative coupler being located at the exact center. The filament switch is also located at the middle of the panel, but at the top. A better idea of this may be secured by looking at the photograph shown in Fig. 1. The only holes in the front panel beside the condenser, inductance and switch holes are for three holding screws, which go between the lower part of the front panel and the baseboard. These screws serve to hold the front panel and the baseboard together.

After the condensers, inductance and switch have been located, the front panel may be affixed to the baseboard and then the binding post strip should be constructed. This binding post strip is a piece of Formica 1x13x3/16 inch and has thirteen holes made in it for the same number of X-L binding posts. These are the bakelite top push post type. Soldering lugs should be placed under each binding post at the bottom of the strip before the screw is run up. Because of this, all of the binding posts may be affixed to the strip at one time and then the strip itself screwed down to the baseboard. When connections are made to the binding post strip, the connection itself is made to the soldering lug without having to disturb the post itself. The two sockets are screwed down to the baseboard. When doing this part of the work, it would be well to follow somewhat the idea shown in the

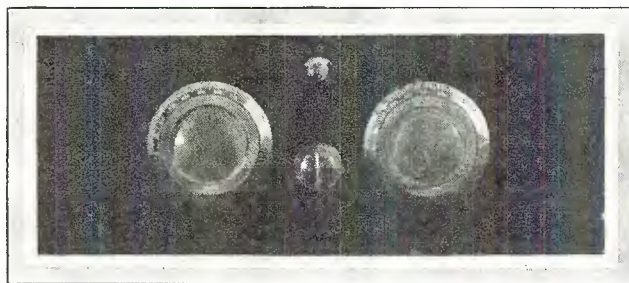

Fig. 3. There are two major controls and one refining control shown in the front of the simple receiver described herein. The left-hand dial governs the wavelength of the r. f. circuit, while the right dial covers the wavelength of the detector circuit. Regeneration is accomplished by rotating the variable plate coil, the knob of which is located at the center of the panel. The filament switch is placed at the top and in the center

graphic diagram, No. 4. The grid condenser and the mounting for the leak are located between the two sockets. These should be preferably placed as close to the grid of the second socket as possible. The .001 mfd bypass condenser, which in the schematic is shown as being across the bottom end of the regenerative winding and the negative filament, may be located on the baseboard in almost any position as long as it does not appear to the left of the socket located at the center in the photograph, Fig. 1. If by chance the condenser is put in that position, then when the two stages of audio are added, it is likely that the bypass condenser would be in the way.

How to Wire It

After all of the parts have been laid out on the baseboard and the builder is ready to wire, the graphic diagram shown in Fig. 4 should be very carefully studied. It will be noted that between the antenna binding post and one terminal of the radio frequency transformer a wire is run. Then another wire goes from the ground binding post to the second terminal of the radio frequency terminal of the secondary, the rotor of the tuning condenser at the left in Fig. 4, to one side of the .001 mfd to the negative terminal of both of the tube sockets, to the rotor of the second condenser shown at the right in Fig. 4, to one terminal of the middle inductance, which is the grid return of the secondary and then through the filament switch to the two binding posts represented as being B negative and A negative, these two binding posts being tied together with a jumper.

The grid terminal of the first tube goes to the last terminal of the radio frequency transformer and to the stator of the left-hand condenser shown in Fig. 4. Be sure to connect the stator of this condenser to the grid of the first tube because otherwise body capacity might result. The plate circuit of the first tube socket is connected to one of the terminals of the middle inductance, the other one being connected to the B plus 90 binding post on the strip. The grid circuit of the second tube is connected with a piece of wire

(Continued on Page 124)

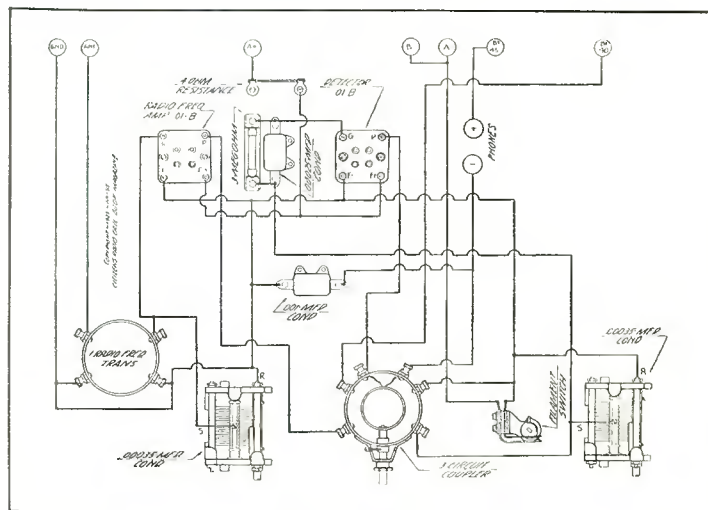

Fig. 4. Even a beginner in radio may wire up the small receiver described in this article, by following the simple directions shown in this graphic diagram. By consulting this diagram and the photograph shown in Fig. 1, it is easy to see how the set may be put together and wired. The forthcoming issue of this magazine will contain an article describing how the two stages of audio are placed in the receiver



With the PROFESSIONAL SET BUILDER

SINCE the publication in the September issue of this magazine, page 83, of an article concerning the construction of an ohmmeter, we have had several requests from our readers as to whether the range of this meter could be increased to include megohms.

This could not be done without considerable alteration and an extremely expensive operation at that. It was originally our desire to run another article covering construction of a megohmmeter for those who might have use for such an instrument. However, going over the subject with the technicians in the laboratory, it was discovered that one of the chief drawbacks of such instrument is the extreme cost of meter for use in such a circuit. This meter would cost around \$25.00 and the question occurred to the Editorial Department as to whether our set builders would care to go to that expense in building up such a test device.

We shall be glad to hear from our set builders as to whether they would be interested enough in building up such a device, if we give them the constructional data. Frankly, the use of such a device is quite limited in that it may be only used for the measurement of circuits involving a resistance of a million ohms or more. The ohmmeter shown in the September issue, however, has quite a number of uses in power supply work, audio transformers, resistances of most all types, and for general, all-around purposes, whereas the megohmmeter would have but limited use. However, if a sufficient number of professional set builders desire that we construct the apparatus, we shall be glad to do so in a forthcoming number, provided these set builders will give us their opinions on the subject.

Dynamic Input Transformers

INPUT transformers used for dynamic speakers are not the same as the type used for other speakers. Any of the magnetic type speakers used on a dynamic input speaker will sound distorted. While it is usually customary for the input transformers for dynamics to be included in the speaker housing, nevertheless there are cases where these input transformers are available on the open market and these should always be used only with a dynamic speaker.

Handy Work Bench Unit

IN our November issue, in this department, was described a handy unit for the work-bench suggested by O. H. Schmidt. At the time we were not able to secure a photograph of the unit in ques-

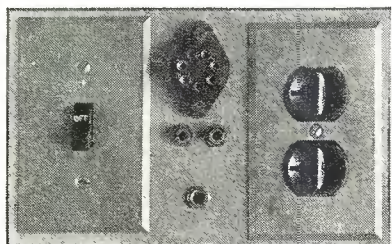

tion, but in this section of this issue we are showing the general idea photographically in the picture reproduced herewith.

Shifting Antenna Load

WHEN using double or triple section condensers and one section is across the grid circuit of the antenna stage, it is generally considered good practice to remove about five turns of wire from the grid coil and employ a .000025 mfd midget condenser on the front panel to bring the antenna stage in resonance with the succeeding one or two tuned stages.

This procedure is usually considered necessary in order to allow the operator to shift the antenna load to compensate for varying aerial lengths. Of course, when the antenna stage is tuned by a single condenser and the succeeding stages are tuned by a gang condenser, the method referred to previously is not required, since the single antenna stage will allow placing of that stage in exact resonance with succeeding ones.

Home Made Portable Tester

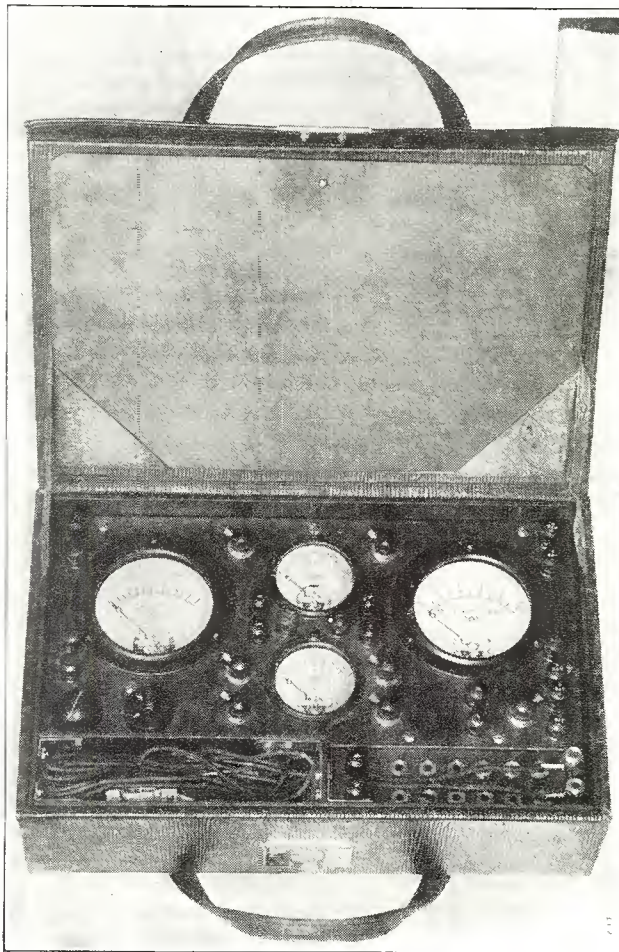

Fig. 3. An enterprising Chicago set builder named Lynn Sherk, 5901 Race Ave., finding the need for a portable set tester constructed one as shown in the photograph above. The vanity case in which the tester is housed was secured at a department store at a nominal cost

D. C. "A" Eliminator

THESE are many occasions where individuals residing in districts supplied with direct current may have been hard put to find an eliminator from which the filaments of their radio sets might be operated. This is particularly true since they do not desire to use a storage battery. In the accompanying

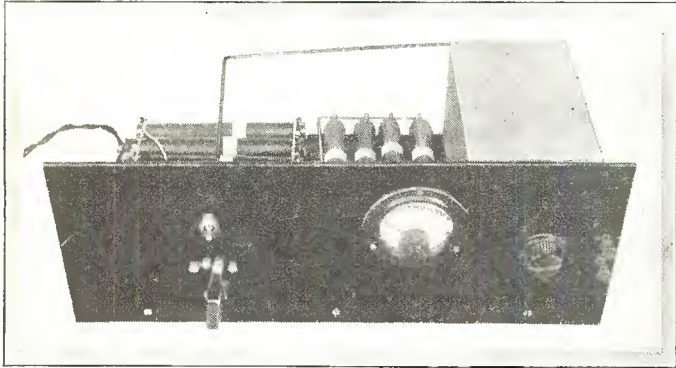

Fig. 1. This photograph shows the front and top views of the 110 volt line A eliminator recently designed in our laboratory for those who live in direct current districts. This switch on the front panel cuts in or out resistance sections for increasing or decreasing the current available. A voltmeter is supplied on the front panel in order to keep the operator advised of the voltage obtained at the time

article is described a simple A eliminator for 110 volt d. c. circuits. It is shown pictorially in Fig. 1 and schematically in Fig. 2.

The eliminator consists of a Tobe A filter, a Weston O-10 d. c. voltmeter, 16 fixed resistances made by Ohmite, a switch and four switch points, a power switch, and a three or six ohm rheostat which will handle 20 watts at 6 volts without heating.

In the resistance network there are 16 fixed resistances, each of these being 70 ohms apiece. They are in sets of four in parallel, and each four sets in turn are in series. Looking at the schematic circuit shown in Fig. 2, resistors R-4, 5, 12 and 13 should handle 100 watts. Resistors R-3, 6, 11 and 14 should also be able to handle 100 watts. Resistors R-2, 7, 10 and 15 should handle 75 watts, while resistors R-1, 8, 9 and 16 should be of the 50 watt capacity. In the original model which was built up in our laboratory, 25, 50 and 75 watts was the rating of the resistors, but on test it was determined that they got too warm and as a consequence the higher power rating was required.

On account of the heating, it is suggested that the entire unit

difficulty. With such an arrangement each of the four taps would overlap each other, which would give a control from 1½ to 3 amperes without any spaces between. The schematic shows that on the first tap 1.5 amperes is available, the second tap 2 amperes and the third tap 3 amperes. The d. c. voltmeter must be placed across the output of the filter after it has gone through the variable resistance, so that it gives an indication of what is actually being supplied the receiver. As a precautionary measure the power switch is the one which should be used to break the circuit, rather than the switch on the receiver because if the receiver switch is turned off the load disappears and the voltage across the meter will be high enough to burn out the meter. For that reason the power switch has been provided in this design.

Above all be certain that the ground binding post of the receiver does not go directly to ground but through a ½ or 1 mfd, as one side of the 110 volt line is grounded and the receiver being grounded too would cause a short circuit.

While the unit works quite satisfactorily in handling any special receiver, nevertheless it operates better when used for one definite value of current rather than a variable device. It is not as good a testing medium for receivers as a battery, due to the presence of commutator ripple which might be bothersome when actually testing receivers, and which at the same time might not be noticed on broadcast reception in the home.

Term TU Defined

WITH the frequent appearance of the word "transmission unit" in literature covering radio subjects, many of our professional set builders have been a little curious as to the exact meaning of the term transmission unit. Accordingly we are giving a brief statement as to the definition of the term and also the means by which it is derived.

A transmission unit (t u) is an expression symbolizing the power ratio of a circuit.

Used originally by the wire communication companies, the term t. u. is now universally used in the radio industry to denote gain or degree of amplification in amplifiers, the loss in any type transmission circuit, or for comparing the strength of two signals.

The input and output circuits of any circuit bear a definite relation to each other, this being known as the power ratio. This power ratio is expressed in transmission units by making use of the following relation:

$$N = 10 \log \frac{P_2}{P_1}$$

N is the number of transmission units, which is equal to ten times the logarithm (to the base ten) of the power ratio. In this relation, P₂ is the output measured in milliwatts and P₁ is the input measured in milliwatts.

In measuring any circuit where the output exceeds the input, the gain is shown as a gain in transmission unit, or where the input exceeds the output, the loss is represented as a loss in transmission units.

The use of the word "transmission unit" is particularly applicable to description of the gain to be secured from a public address system and it will be noted in a recent article covering Silver-Marshall's public address system what the word "transmission unit" is used quite frequently.

Novel Mounting Wrinkle

MOUNTING midget condensers in a tight place, or on a sub-panel, where there is very little room afforded, is quite a problem. One of our set builders observes that the Hammarlund midget is threaded at one end of the condenser stator post, so as to permit the condenser being mounted vertically on top of the sub-panel, if not sufficient room is afforded beneath. While it is not often that one must depend on this style of mounting, nevertheless it is well to know that this method of placing the condenser may be resorted to in a pinch.

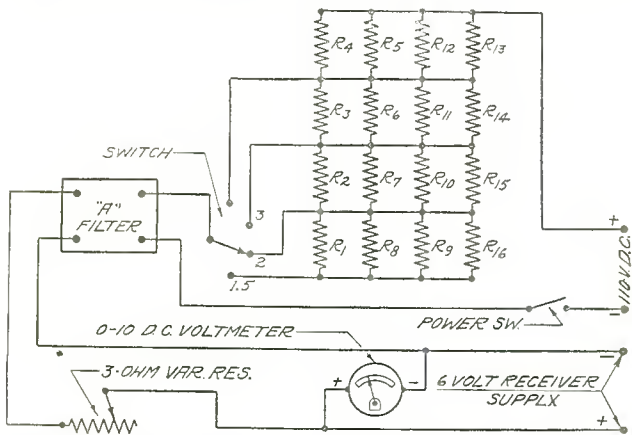

Fig. 2. The schematic circuit used in the d. c. A eliminator is shown in the above diagram. Resistance values from R-1 to R-16 are given in the text accompanying this description

be mounted on transit board, so as to lessen the fire danger. While a 3 ohm rheostat is shown in the schematic circuit, nevertheless it would probably be better to use a 6 ohm provided one can be found which will pass 20 watts at 6 volts without any

Causes of Oscillation

MANY professional set builders have on occasions been called upon to service a tuned radio frequency receiver in which one of the radio frequency stages is oscillating. Quite frequently the location of the cause of oscillation in a tuned radio frequency set may not be as easy as it appears, although if a little thought is given to the subject and considerable patience is expended, the cause will eventually be found and the remedy applied.

In the ensuing paragraph we are going to attempt to give as large a number of causes for oscillation as it is possible to mention briefly. There are four principal causes of oscillation in any r. f. amplifier circuit. These causes are:

1. Magnetic field coupling
2. Conductive coupling
3. Capacitative coupling
4. Magnetic loop

Under the classification of magnetic field coupling, there are three possible causes of trouble. The first is that the radio frequency inductances may be placed too close to each other. The second is that unshielded audio frequency transformers and the r. f. inductances may be too close to each other. The third is that the radio frequency coils may be located in an incorrect inductive relation or position.

Conductive coupling may give rise to two possible causes, the first of which is that in a. c. receivers the r. f. and a. f. filament supply is secured from the same filament secondary instead of an individual secondary being provided for the r. f. and another for the a. f. supply. The second possible cause is that insufficient bypass capacity is placed across the grid biasing resistance in an a. c. set.

In considering capacitative coupling, there are three possible causes of trouble, the first two of which are closely related. For example: the condenser and coil may be too close together, giving rise to an electrostatic coupling condition, which is after all a capacitative coupling. The same applies in the second case, where condensers may be located too close together. The third possible cause under capacitative coupling is that the grid and plate leads may be located too close to each other. As a rule a distance of $1\frac{1}{2}$ inches or 2 inches between these leads will prevent trouble, or at least the difference between them should be the distance that the grid and plate occupy on a socket. This is around 2 inches.

Under the heading of magnetic loop there are a number of possible sources of trouble. For example, the grid wires may be located in a field set up by the A negative and B positive wires. Or the grid wires may be located in a field set up by the A negative and A positive wires. Also plate wires in the field of A and B positive, or A negative and A positive will give trouble. Another possible cause of trouble is that coils may be located between the loops mentioned in the foregoing paragraph, or that condensers are likewise located between the loops previously mentioned.

In addition to the four general causes noted in the preceding paragraphs, there are a number of related causes which usually indicate that one of the four conditions mentioned above exists. However, it is a rather difficult task to draw a fine line of distinction between direct causes and indirect causes, so in the following list the causes given are related regardless of whether they are direct or indirect. These secondary causes are as follows:

- A. Too high plate voltage
- B. Too many turns in plate coils
- C. Filament voltage too high
- D. Insufficient antenna load
- E. Insufficient bypass condenser across the battery end of a plate coil
- F. Too low grid bias on tubes
- G. Poorly evacuated tubes

- H. Unbalanced section of gang condenser
- I. Unmatched coils used in tuning circuit
- J. Screen grid voltage too low
- K. Coupling between primary and secondary too close
- L. In neutralized sets, the neutralization of the set may be out, or unbalanced
- M. Poor or leaky shielding
- N. Shielding not grounded
- O. Poor or no ground connection

As previously stated, one of the prime requisites in searching for trouble in any circuit is patience. Even in the absence of a great degree of understanding of the circuit, nevertheless if the service man will persist in his search for the trouble, and make such search in an orderly manner, he will eventually locate the cause by a process of elimination. Usually it is best to start out with A, B, C circuits, then the coils, then the tubes, then the wiring, etc. Before all possibilities have been exhausted, the cause will undoubtedly be found.

Ask Us an Easy One

ASKING a question is the easiest thing in the world and the hardest thing in the world is to answer it, especially when the question is: "Which is the best set you have ever tried?"

Quite frequently our readers will write us seeking an answer to the question noted above. They are undoubtedly sincere in their desire to know which is the best set that has ever been tested in our laboratory. However, such a question is impossible to answer, simply because there is no definite standard of what constitutes the best. There is no best radio set any more than there is a best coffee, best chewing gum, best automobile or any other object. No two engineers or even individuals will agree on a single radio receiver. Obviously if everybody agreed on one thing, there would be only one set, but the very fact that there are hundreds is evidence that likes and dislikes are different with each individual.

Another question which is frequently asked is: "How does set A compare with set B?" This is another poser. No comparative test would be worth the paper it is written on unless the two receivers were tested within a second of each other under duplicate conditions regarding A, B and C supplies, tubes, antenna and ground, wavelengths of the station being listened to, duplicate speakers and all conditions of the test being exactly alike. Even assuming that such a test were made with receivers A and B and it was determined that receiver B was the best of the two, there is no indication that this receiver would, on actual working conditions with the purchaser, merit its selection as the best of the two.

It is, therefore, easy to see why no comparative test between two receivers could be made. The personal experience of every experimenter or set builder with a particular receiver is the best guide as to which set should receive his continued patronage.

Fig. 4. Here we see a service man diagnosing trouble in a radio set by means of a test outfit of the portable type, aptly called a little "box of tricks." The set tester illustrated in this photograph is one of the kind made by the Jewell Electrical Instrument Co. of Chicago

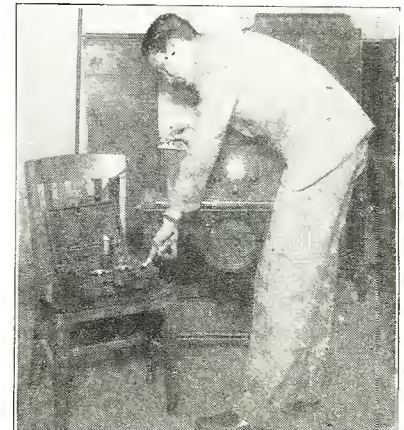

IN the simple schematic circuit shown herewith is a method whereby a 90 volt storage B battery may be charged from a 110 volt direct current source. All that is required is a 30 ohm rheostat with a rating of 10 watts, a switch and a 0-1.5 ammeter. These parts are arranged as shown in the schematic. Before the B battery is placed on charge, make sure that all of the resistance in the rheostat is in so that charging will be at a minimum rate.

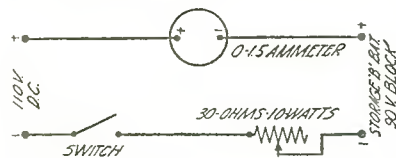

The method shown will enable one to charge B battery units from a 110 volt d. c. source. If it is desired to charge other than 90 volt blocks, that is, for example, a 45 volt block of

wet battery, it is necessary to double the resistance value shown in the schematic. Thus for 90 volt blocks the value is 30 ohms and for 45 volt blocks the value would be 60 ohms. Charging current will be greatest at the time that the battery is started on its charge and will be least at the time when the charge is completed. The charging rate at all times may be read directly from the ammeter, which is always in the circuit.

Status of Set Builder

ONE or two professional set builders have written in to this department to determine their legal status as regards the construction and sale of kit receivers.

Judging from conditions in the past and viewing the matter from the standpoint of the professional set builder, it does not appear that the custom builder of radio sets will ever be bothered, principally because of the fact that such a step would involve thousands of individual suits, each one of them expensive, and scattered all over the country. Then again there is the attitude taken that the manufacturer of the kit must bear the burden for their merchandising and sale.

So far we have not heard of any one ever being molested and until such an occasion does arise, it is probably the best policy to keep on working and not worry about the future.

UNDOUBTEDLY many of our readers have frequently come upon handy shop hints or kinks during the course of their experimentation. The columns of this department are always open to ideas and suggestions from our professional set builder readers who wish to give their fellow-craftsmen the benefit of such suggestions. We shall be glad to print such novel stunts, hints or ideas as our readers send in from time to time. After all this department is established for the benefit of the professional set builders and anything they do to improve their own work will help to improve that of the other professional set builders. Don't be bashful about sending in your suggestions and we will be glad to print as many as space and timeliness will allow.

Magic in Modern Servicing

OWNERS of radio receiving sets no doubt often wonder at the ease and apparently unerring manner in which radio service men can get at the exact seat of trouble or can tell just the right adjustment to make to put a balky receiving set back in tip top operating shape. Knowing of the multitude of ills which may overtake a radio set this thought certainly gives one reason for wonder and speculation.

A loose screw, an unsoldered connection, a bad condenser, a defective tube, a poor tube contact—these and a thousand other easily corrected faults hard to find, can easily be the cause of complete failure of the receiver, and still the modern service man locates the exact trouble in a few minutes after arriving on the scene. Of course the average service man is more or less technical but for the most part his success can be traced to the "little box of tricks" that he carries with him.

In the earlier days of radio it was different. The successful

service man not only had to be a good guesser but also had to know how to best take advantage of his guessing. A pair of pliers, a screw driver, a soldering iron and solder, a pair of phones, a voltmeter, a small flashlight battery and a dozen or more sundry articles were used by him to pry or entice the trouble to the surface. And even then it sometimes required several return calls before a set was completely serviced. But now it is different. One call not only serves to correct the trouble but brings to light impending failure of tubes or other weaknesses which may be developing. And again its the "little box of tricks" that does it.

Diagnosing Set Ills

The radio industry has often been likened to the automobile industry especially as to the methods of distribution and program of service after sale, but in the servicing of automobiles there never was a device available which could look into its vitals, and point out the trouble so definitely as is now available for servicing radio receivers.

We refer directly to the modern up to date radio servicing device or devices as the "little box of tricks" for in practically all cases that is the general appearance created by the equipment usually carried by the up-to-date, enterprising service man.

Of the several complete service sets on the market the more

TUBE NO. IN ORDER	TYPE OF TUBE	POSITION OF TUBE 1ST IF OCT. ETC.	TUBE OUT OF TESTER				TUBE IN TESTER				NORMAL PLATE M.A.	PLATE W & GRID TEST
			A VOLTS	B VOLTS	C VOLTS	D VOLTS	E VOLTS	F VOLTS	G VOLTS	H VOLTS		
1	201-A	1st R.F.	5.2	95	5.0	90	0	5.3	16.1			
2	201-A	2nd R.F.	5.2	95	5.0	93	0	5.2	10.8			
3	201-A	3rd R.F.	5.2	95	5.0	90	0	1.7	0			
4	201-A	Detector	5.6	75	5.0	75	0	4.5	0			
5	201-A	1st audio	5.4	0	5.0	0	41.0	5.0	7.5			
6	171	2nd audio	5.2	157	5.0	150						

RECOMMENDATIONS OR CHANGES MADE: New tube in socket #2. Repaired break to plate of 1st audio tube socket. Rechecked B-wiring on last tube.

By: Smith Radio Shop - A.R. West

In the photograph above is shown a sample of a typical chart furnished by the Jewell organization with each of the set testers. The charts are ordinarily provided in pad form. The form above, one of the many possible combinations, is the one given the set owner by the service man. It serves as a receipt for work done and tells what was corrected, as well as showing the time of last inspection

efficient are housed in a handy portable case of attractive appearance generally designed to add a professional atmosphere to the appearance of the service man. For the sake of brevity we will confine ourselves to a discussion of one of the testing sets which seems to be highly representative of these outfits, made by the Jewell Electrical Instrument Co. of Chicago.

The "little box of tricks" in question lends itself very effectively to the picture. It is of a size handy for carrying. The case is covered with a good grade of black leather and all in all its appearance lends dignity to the work for which it is used. Lifting the cover we find a panel generously covered with a multitude of parts including two instruments, a number of binding posts, and several switches in the form of simple push buttons. This combination, innocent enough in appearance, is still a wonder in efficiency, and performance. Every test requirement likely to be encountered in a radio set is provided for.

Buttons Tell Secrets

Starting with a plug and cord leading into the interior of the test set—this plug fits directly into a socket of the radio set under test and because of its construction leads thus directly to all the major circuits in any of which the trouble being sought may be located. For servicing a radio receiver this plug is inserted, in turn, into each of the tube sockets in the receiver and the tube

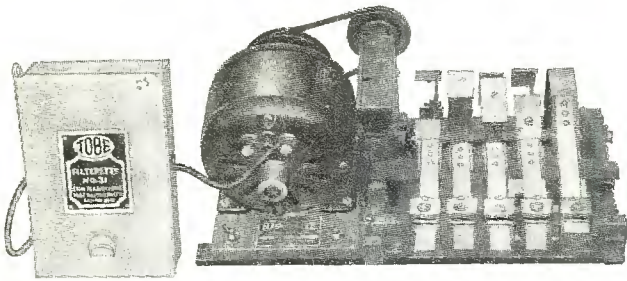

Fig. 6. In the bigger cities one of the greatest causes of interference, especially to those in the immediate neighborhood, is the electric sign flasher, which is illustrated in the photograph above. However, interference of this nature can be curbed by the proper use of the filter condenser circuit, such as the one made by Tobe and shown in the illustration

from the socket placed in the socket which is provided on the panel of the tester. And now for the tricks.

The innocent looking push buttons placed along each side of the tester are brought into play and because they are plainly marked as to their function cannot be readily overlooked unless intentional. They also serve as a hint to the service man as to the tests to be made, and if followed in their order will tell him exactly where to find the trouble. Now you are asking "What do they do?" They tell you facts as fast as the individual buttons can be pressed, which is faster than the instruments can be read. Actually they select a definite part of the radio receiving circuit to test and connect that circuit through one of the ranges in either of the two instruments. This of course is accomplished by the plug and cord which is inserted into one of the several sockets in a set. If the receiver under test is a. c. operated there are push buttons which when pressed tell at once the voltage received at the filament of the tube. As this voltage may normally range from one to fifteen volts three push buttons are needed to cover the three ranges, any one of which may be involved for this test, depending upon the voltage requirements of the tube filament. Another button tests for cathode voltage, strictly an a. c. test.

Should the radio be operated from batteries, filament voltage is obtained on another push button switch. In both types of sets a. c. or d. c. plate and grid voltages and plate milliamperes are obtained by push buttons common to both. In addition to tests for these factors a reliable tube test is incorporated in the form of a grid shift button and a small dry cell clipped into the case giving a uniform voltage for grid shift.

All these tests require multi-range instruments if only two are used as in this tester. A glance shows the direct current instrument as having six readings—7.5—75—300—and 600 volts all of high resistance, and 15 and 150 milliamperes. The a. c. instrument has four ranges—4—8 16 and 160 volts. The ranges of these two instruments are seen to be sufficient to cover all requirements of input and output of either a. c. or d. c. operated receiving sets. To make the service set even more useful all ranges are available at binding posts and test leads including a special pair of line voltage testing at the outlet are included. Four and five prong tube adapter for use in making the right connection in a tube socket in a set with the plug and cord and also for inserting the tube in the socket of the tester are also provided.

Briefly summarized this tester provides testing either a. c. or d. c. operated sets for filament, grid and plate voltages, line voltage, plates milliamperes, total B-eliminator, output in milliamperes, charging and discharge rates, tube conditions (a special grid shifting test being included) continuity tests of condensers, transformers or other circuits. In addition a special cathode test gives information of this important a. c. tube function. Has anything been overlooked? Is it any wonder that the service man using one of these test sets can put his fingers on the fault in a receiving set in short order?

Substantially Built

The internal construction and quality of workmanship in this test set need no special comments further than to suggest that a

single device covering so many functions so closely related to each other as found in this tester must need be of substantial character to avoid failure of inter-related parts.

Maybe servicing in the future will be automatic and all that is required to test a defective radio receiver will be to connect it to the descendant of one of these test sets, pull a lever and a printed card bearing the trade name, model number, quantity and year manufactured together with the exact location and nature of the trouble in the radio set will be ejected to a container at the lower left hand corner—then it surely will be—"a little box of tricks."

Filter Development

IN the onward sweep of radio the entire industry has been fighting to keep its production keyed up to a point where the market could be satisfactorily taken care of. Time for the careful consideration of many accompanying problems has been lacking.

Radio can be likened to the automobile, only it is a method of transporting mental objects by sound in the form of music and words. Like the automobile industry, the production of cars for years required everyone's attention. The roads were pretty bad in the earliest days; in fact, have only been good in the last few years. Good roads followed the demand for them caused by a huge riding market.

Man Made Static

Today we see radio sets in such numbers that the demand for better radio "roads" is starting to assume tremendous proportions. The ether is the radio road. The new allocations are the result of this demand for better radio "roads." But still there are millions of imperfections on these new roads which must be ironed out before smooth, satisfying radio transportation can be achieved. These imperfections may be entitled "interference" or "man-made static."

Regular static offers its problems but is being overcome to a great degree by cleared channels and increased power. Local interference or man-made static is, however, a horse of another color and its overcoming has for the most part been totally neglected.

With five million receivers in operation the listening public, well over its first thrill of just hearing music, has suddenly realized that many undesired noises are spoiling reception. Practically all of these are caused by local electrical machinery; such as, motors, vacuum cleaners, washing machines, refrigerators, oil burners, hair dryers, fans, sign flashers, and all other electrical apparatus.

It has been the privilege of the Tobe Deutchmann Company

Fig. 7. Here's a method of stopping man-made static at its source. It is known as the Tobe Filterette No. 22, designed for all types of motors, generators, blowers or other electrical apparatus using 110 or 220 volts, regardless of horse power

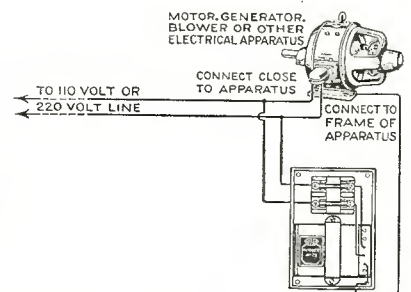

of Canton, Mass., to have foreseen the need of attacking this opponent of good radio reception and to have spent the last few years in preparing for this problem, at a time when no one thought it would amount to anything at all.

Coping with Interference

The result is that they are completely equipped to meet problems of radio interference with several perfected pieces of apparatus, known as "Filterettes," and an engineering staff capable of running down the causes and designing special apparatus for unusual situations.

No one who has not lived with this problem night and day for a while can appreciate the tremendous field of opportunity it

offers. Every power and light company is eagerly seeking co-operation as they want to sell electric current, and interfering machinery brings them constant complaints. Real estate operators cannot have satisfied tenants when the radio reception is spoiled by noises from oil burners, iceless refrigerators, ventilators and elevators.

As an important step in this new field of radio endeavor, the Tobe Deutschmann Company is starting a little paper, "The Filterette," dedicated to the annihilation of man-made static. It is planned as a help to every radio listener, retailer, real estate operator, service man, power company, and all others whom man-made static affects. They are offering a free advisory service on interference problems and will be glad to hear from any of our readers.

A Useful Panel Switch

WE are grateful for a recent contribution to the set builder's department from M. D. Vail, treasurer of the Vail-Ballou Press, Inc., Binghamton, New York, who writes: "Several of my friends who are set builders and radio experimenters have shown so much interest in my panel switching device and wiring arrangement that I feel that these might be of interest to others."

We feel sure that our professional set builders will be glad to have the ideas of Mr. Vail and will undoubtedly put them into practice in some of their own jobs. It is contributions of this nature which we most welcome, since it represents an actual interest on the part of the set builder in the department which this magazine has established for the individual. The article accompanying Mr. Vail's drawings is printed below:

MOST experimenters and set-builders have accumulated several extra rheostats. Certain kinds may be utilized for the construction of useful panel switches. Knobs to match the tuning and volume controls can be attached, and, if properly wired, these switches are a great convenience. Fig. 8 shows one of the common variety, of bakelite construction. First detach the connector strip F from C and move it to B. Then mount a third post at B. Solder a small piece of wire from H to C. We now have a potentiometer. With a file cut the wires at two convenient points such as E and D. With a pair of pliers remove the

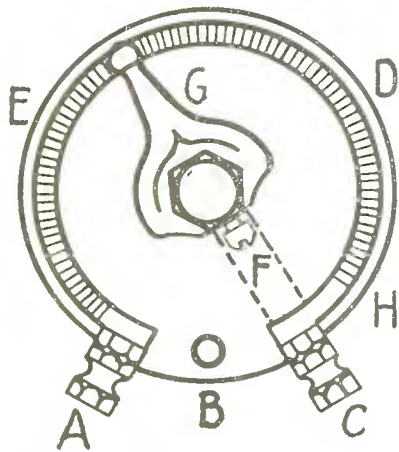

Fig. 8. This sketch shows the manner in which a useful panel switch may be made by means of a rheostat that may be laying around the workshop. This sketch and the idea shown in Fig. 9 on this page are furnished through the courtesy of M. D. Vail, Binghamton, New York

short loose pieces of wire. The two gaps at E and D should not be more than 1/16 to 1/8 inches wide so that the slider G can pass between two consecutive sections without completely losing contact with both. The potentiometer has now become a form of single-pole, double-throw switch.

Controlling Two Speakers

Connect the output from the set to A and C. Attach one speaker to the posts A and B and another to posts B and C. When the slider G is at any point between E and D both speakers are in series and in operation at the same time. When the slider is moved to either side, one of the speakers is short-

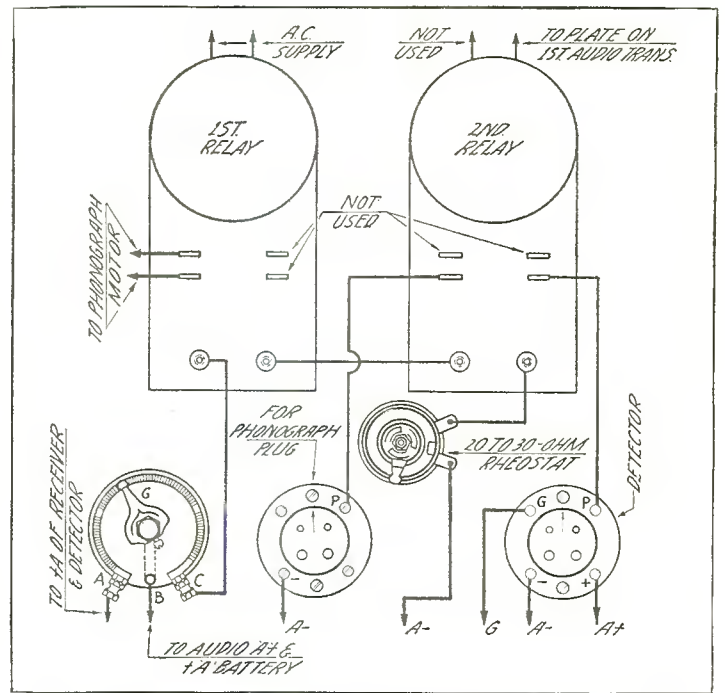

Fig. 9. In the above diagram is shown the method of shifting to and from the phonograph in connection with a radio set. The two relays shown in the diagram are of the type known as the Yaxley automatic power control. A full description of the method of operation is contained in this department

cuted. Thus we can have either or both of the speakers on by merely operating the knob.

Shifting to and from Phonograph

Construct another switch like that described above. It is best to run a light coating of solder between points E and A also D and C. The ordinary phonograph magnetic pickup has, besides the unit holding the needle, a plug which must be placed in the socket of the detector. One must also remove all the tubes from the stages preceding the detector. By means of one of these switches and two relay switches like the Yaxley automatic power controls, one can shift from radio to phonograph or back again by merely operating the knob on the panel. When the slider G is in the center position both instruments are shut off. First mount an extra socket at any point convenient to the detector.

(Continued on page 130)

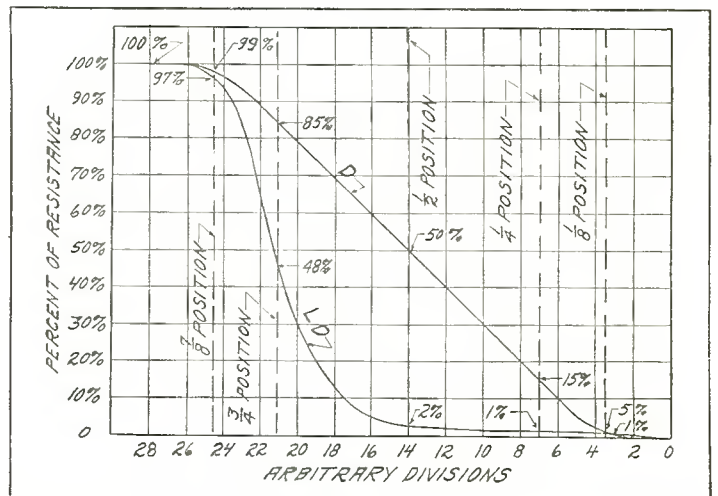

Fig. 10. In the graph shown above are two types of resistance controls, of the variable high resistance type. One is the D type and the other the LD type, and these refer to curve obtained on variable resistances of the type mentioned, made by Frost. Each one of the curves representing a type of resistance has a specific purpose as is explained in the text accompanying the diagram

Radio-Phonograph Lab. Amplifier

SERVING a dual purpose, in that it may be used for amplification of either radio or phonograph, the amplifier described in this article, which was recently designed in our laboratories, should be of benefit to any professional set builder or other experimenter who desires a standard amplifier into which may be fed the output of any receiver or phonograph pick-up unit.

Single or Double Audio

The output stage of the amplifier is arranged for push-pull amplification, using 171-A tubes, and by a switching arrangement either one stage of audio or two stages of audio preceding the push-pull section may be used. The transfer from a single to a double stage amplifier is accomplished by means of a four pole double throw switch shown in the schematic, Fig. 3. A double pole double throw switch is also provided for the use of a single speaker if desired, or if a comparative test of three speakers is to be made, throw the switch in one position and permit this sort of comparative test. This is also illustrated in the schematic circuit previously mentioned.

Another feature of the amplifier which makes it of interest to the professional set builder is the 0-25 millimeter placed on a plug which may be inserted into the first, second or third jack on the panel and will give you the milliampere reading of each stage of amplification. In the case of the jack No. 3, which is in series with the plate circuit of the push-pull stage, a 50 milliampere shunt is provided across the jack so that when the reading is taken the current shown should be multiplied by two. In the case of jack No. 1 and jack No. 2, the current readings are exactly as shown on the meter. Another possibility that is of interest in connection with jacks Nos. 1, 2 and 3 is the fact that instead of plugging in the milliammeter the experimenter or professional set builder can plug in a pair of headphones on each individual stage and adjust his C bias for maximum results according to the dictates of his ear.

The amplifier panel is designed so that a shallow box may be built, onto which the panel is placed. It was felt that this form of construction would be more logical than to have the panel setting up on edge, since the experimenter or builder is more than likely to have the amplifier on a work bench, in which event the panel lies flat and is more accessible for connecting A, B and C supplies and speaker terminal. Also the tubes would then be in an upright position, whereas if the panel were placed in an upright position the tubes would be placed horizontally, which is not quite so desirable on account of the possibility of sagging of filament or other elements.

A 6 ohm rheostat on the negative filament of the two straight audio stages is provided for volume control in that portion of the circuit, while a second 6 ohm rheostat in series with the filaments of the two 171 stages is also provided for altering the current on the filaments of the push-pulls.

In the event that the amplifier, when using two stages, should

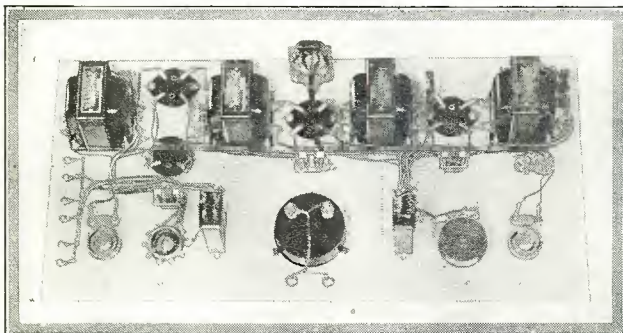

Fig. 1. This photograph shows a bottom view of the completed amplifier

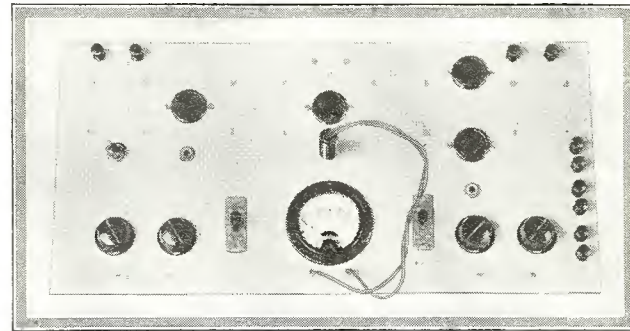

Fig. 2. Top view of the radio-phonograph combination is shown in the above picture

exhibit any tendency towards squealing or howling with a high pitched squeal, this may be curbed by placing a .005 mfd fixed condenser across terminals P and G of the second audio transformer. This method of connection gives a semi-impedance coupling, or furnishes a sufficient phase shift to prevent the stage from howling.

Official Parts List

Parts used in the construction of the laboratory amplifier are:

- 2 Carter .001 mfd fixed condensers
- 1 Carter .005 mfd fixed condenser
- 2 Thordarson R-300 audio transformers
- 1 Thordarson 2408 push-pull input transformer
- 1 Thordarson 2420 push-pull output transformer
- 1 Frost 895 500,000 ohm variable resistor
- 2 Frost 1906 6 ohm rheostats
- 1 Formica 10x21x $\frac{1}{8}$ inch Ivory panel
- 1 Frost 10-contact cable plug
- 10 Eby binding posts
- 4 Eby UX sockets
- 1 Yaxley No. 10 line switch
- 2 Federal 1427-W jack switches
- 2 Yaxley pin jacks
- 1 Carter inductance switch
- 1 Weston 302 0-25 millimeter

Granting that electrical and physical characteristics are identical, the following items made by the respectively named manufacturers may be used in the construction of an amplifier similar to the one described above.

Condensers, fixed: Acme, Aerovox, Dubilier, Muter, Potter, Sangamo, Tobe; Transformers, audio: AmerTran, Dongan, Jefferson, Sangamo, Silver-Marshall; Panels: Celeron; Binding Posts: X-L; Sockets: Benjamin, Frost; Switches and Jacks: Carter, Frost, Yaxley; Meters: Jewell; Tubes: Ceco, Sonatron; Resistances, variable: Carter, Centralab, Clarostat, Electrad, Yaxley; Cable Plugs: Yaxley.

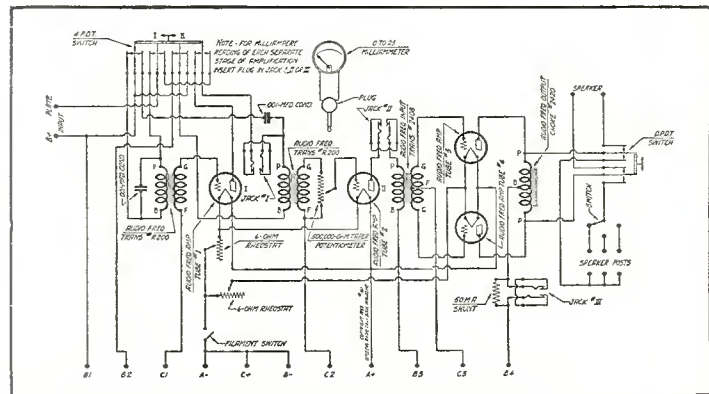

Fig. 3. The schematic circuit which may be followed by professional set builders in wiring up the amplifier is given above

(This amplifier designed, tested and all illustrations made in our laboratory)

Citizens Interference Locator for Finding Power Line Leaks

Self-Contained A and B Supply for Detector and One Stage Receiver; May Be Slung Over Shoulder

SO many requests have come in from professional set builders for a portable set by means of which power leaks may be located that the technical department has recently designed the interference locator described in the following article as a means of giving these professional set builders some unit which could be put to a practical use in the location of interference.

Many Power Leaks

Judging from the multitude of correspondence that passes over the editorial desk in connection with the location of interference, it would appear that most of this interference is confined to the rural sections and is of the power leak kind. Power leaks may be caused by several factors, the most common one being either a leaking or a defective insulator, or a broken insulator where the wire has fallen away from the pin on the cross arm and in the wind will swing back and forth against or near the metal brace holding up the wood cross arm. Then again there is the type of

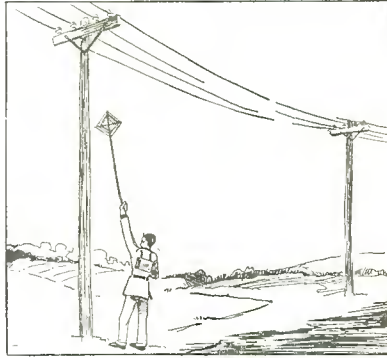

interference that is caused when tree limbs or branches or leaves are too close to a high power line. This type of interference is especially prevalent immediately following a storm or during the winter time when sleet gets on the branches and pulls them down close to a line.

When such leaks occur on a line, it is quite likely that the interference will be heard over a fairly wide area. There have been occasions when a leak of that sort will be heard over a fair sized town and it was only located after intensive search on the part of three or four individuals using portable sets and patrolling the line until they reached the position where the sound was the loudest in the head phones.

Then again there is the type of interference encountered in the fairly large towns, where there are street railways, this interference being apparently caused by the street railway, but in fact probably being caused by defective transformers, defective insulators, defective oil switches and other devices, as well as perhaps

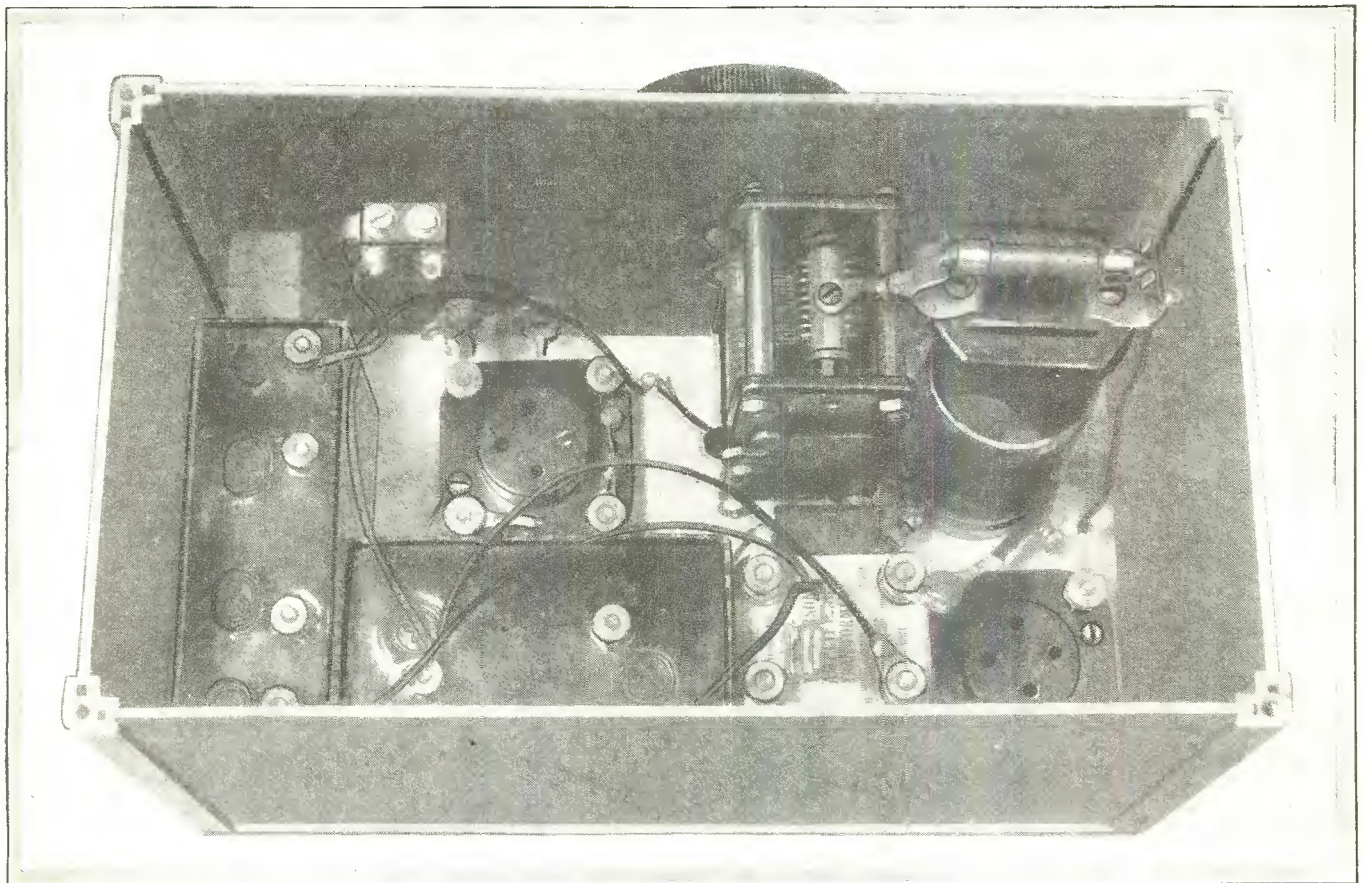

Fig. 1. This photograph discloses the compactness of the interference locator, which has its own A and B supply contained within the aluminum shield. Both the coil and the condenser are of small dimensions, so as to permit being placed inside. A high ratio audio transformer is employed to give good amplification without regard to quality

(This interference locator designed, tested and all illustrations made in our laboratory)

poor ground. While the interference locator described in this article is not intended to locate all types of interference, nevertheless the most pernicious type may be found by a judicious use of the interference locator.

As shown in the little pen and ink sketch at the heading of this article, the unit is small enough to be carried on the back or swung over the shoulder of the man who is patrolling a power line. By means of a short pole and a small spider web loop, the operator is able to probe in the vicinity of insulators and on account of the loop being connected to the grid circuit of the receiver itself, he can get quite a signal when in the proximity of the disturbing interference. In this connection, it might not be a bad idea to call attention of the users of such a device that in patrolling a line or probing for interference, they must not get too near to the line itself with the loop because if by some chance they happen to hit the line, disastrous consequences would undoubtedly result. For that reason, in the sketch, the human figure is shown holding a loop which does not reach up near the wires or the insulators.

On Broadcast Band

In the design of the interference locator, it was felt that since most of the interference which causes universal trouble is on the broadcast band, it would be best to confine the tuning range of the receiver to that particular band. However, it would be possible if one desired to use a plug-in coil and cover a number of wavelengths, but in this particular instance it was found that interference on other frequencies was not sufficiently bothersome to warrant using a plug-in coil and for that reason a single coil of a definite band coverage was employed.

In order to make the set portable, it was deemed expedient to include the A and B battery inside of the receiver can. A 4½ volt C battery lights the filaments of the two 199 tubes and will

give them sufficient current for operation over a period of between five and six hours.

Fits Carrying Case

This is practically the only expense involved in shooting trouble, but the possible expense is over-balanced by the portability of the unit and its lightness. If desired, a small carrying case may be made for the unit and it can be dropped over the operator's shoulder or swung over his back. Those desiring information as to the maker of a carrying case may secure such information by writing the editor of this magazine.

By a special arrangement with our technical department, the Vee Products of Chicago have arranged to make up, on order, a small spider web loop suitable as a probe for connecting to the grid

circuit of the interference locator and to be employed somewhat after the fashion shown in the sketch at the beginning of this article.

Referring to the schematic circuit shown in Fig. 4, it will be seen that the receiver itself consists of a non-regenerative detector, followed by one stage of audio amplification, the turn ratio in the audio transformer being high in order to give quite an amplification value without regard to distortion. There are cases when this would be necessary, since the operator must wear the head phones and must have at least a readable signal upon which to work.

Because the grid of the detector tube is the most sensitive part of the circuit, it is only logical that the antenna coil, or the probe, should be connected to the grid. Tuning is accomplished across the broadcast band by means of the .00035 mfd variable condenser. It will be found that the condenser will be set at a value where the interference is loudest and it need not be touched as long as that particular form of interference is being encountered. In some cases the interference will be found on the lower wave-

(Continued on page 142)

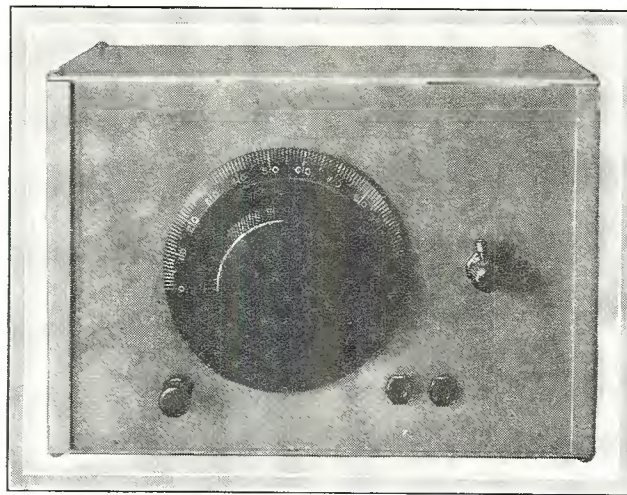

Fig. 2. In this photograph may be seen the front of the interference locator. The dial is for tuning. The switch is at the right. The binding at the left bottom is the grid terminal of the set and to which is attached the wire for probing, the phones going to the tip jacks at right lower part of the panel

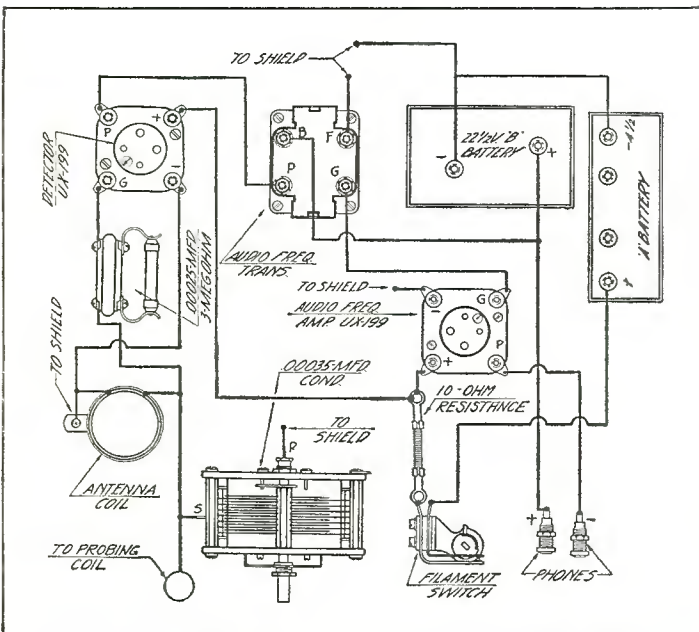

Fig. 3. All parts for the receiver may be laid out in accordance with the graphic diagram shown in the above illustration

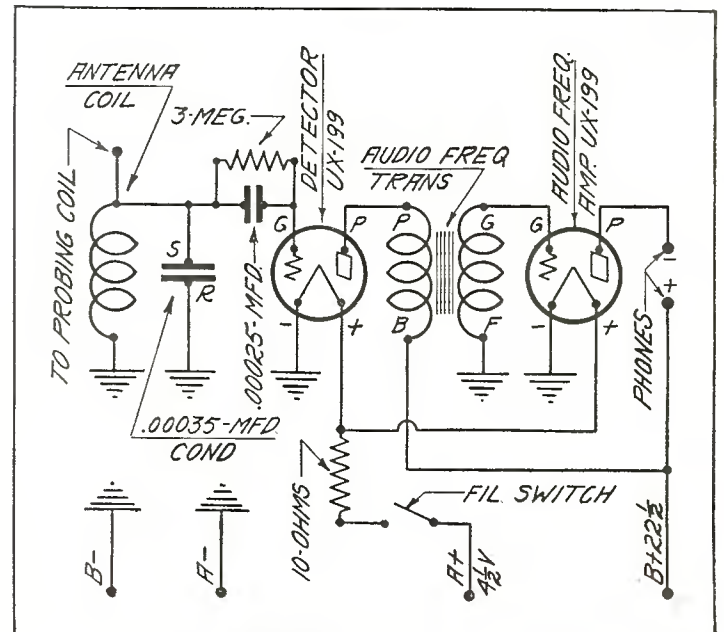
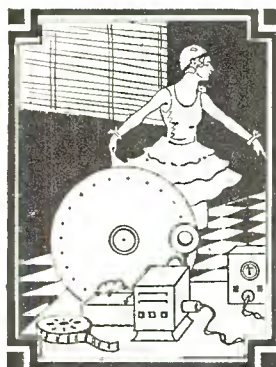

Fig. 4. Electrical details of the circuit may be learned by consulting the schematic printed above



PRACTICAL TELEVISION



BEFORE the end of next summer baseball games will be broadcast by television and will be seen as they happen, according to the latest prediction made by C. Francis Jenkins, pioneer experimenter in television and radio movies. He is now constructing a new form of receiver that will give many times as much light as those now in use, and which, using proper lenses, will permit the image to actually be projected on a screen.

In the new receiver, tiny incandescent lamps take the place of the neon light used at present. The usual telemovie method is to rotate rapidly a disc containing a spiral row of tiny holes in front of the glowing neon tube. The entire disc rotates fifteen times a second. As used in the old Jenkins apparatus there are 48 of these holes, and as the picture is square, it consists of 48 times 48, or 2304, separate units. It may be compared with a newspaper halftone picture, which is made up of small dots about the same size.

Unlike the halftone, however, in the radio movie receiver only one dot is seen at a time. On account of persistence of vision in the eye, one impression lasts until the same spot appears again a

tube. It will be so bright that a projection lens can be placed in front of it, and an enlarged picture projected upon a screen.

Mr. Jenkins also plans a transmitter upon the same principle. In this, a bank of small light-sensitive cells, which give off electric current when light shines on them, will be used in the same position as the incandescent lamps. A large camera lens will form an image of the subject upon them. Each cell will be connected to a condenser, so that electricity will be stored up in it, and every fifteenth of a second a commutator will come around and discharge it, thus controlling the radio transmitter.

Overloading Kino-Lamps

IN the desire to secure greater illumination not so much in television reception as in general experimentation, there is always danger of overloading the neon or kino-lamp. In the case of the standard or Raytheon kino-lamp, the current should be limited to 25 milliamperes for long life, which is obtained by operating on 235 volts with a 50,000 ohm adjustable current-limiting resistor in series.

Just what happens when a kino-lamp is overloaded? Answering this question, D. E. Replogle of the Raytheon engineering staff, states:

"Of course the illumination from an overloaded kino-lamp is enormously increased, but the life is correspondingly decreased. The neon gas is rapidly cleaned up or exhausted, as the result of overload, and other gases present in the metal and glass parts, are driven into the diminishing neon content, causing a change in color of the glow from the rich pink to a sickly lavender. The kino-lamp should be operated at 25 milliamperes or less. The life is cut in half if the current flow is raised 50 per cent, with still more rapid decrease of life beyond that overload.

"An overloaded kino-lamp soon loses its uniform glow, and the illumination on the plates becomes spotty. This is due to the boiling out of gases deeply imbedded in the plates, which would not be boiled out under normal operating conditions. Excessive overloading causes the plates to buckle from the heat generated. The glass beads may be cracked by the heat, causing leakage of current. Voltage breakdown takes place between closely spaced wires, due to the presence of other gases and water vapor.

"A kino-lamp that has been seriously overloaded is, of course, more or less permanently ruined and should be replaced by a new kino-lamp for any precision work such as television reception. Nevertheless, due to the care with which such a device is made in the first place, it is possible to restore the damaged lamp to some extent, at least for experimental application. The damaged kino-lamp should be operated at a current drain of 20 milliamperes for hours, following the same practice of the original aging of the tube at the factory. This procedure should restore a more or less uniform glow over the plates, although of reduced intensity and changed color. If alternating current is applied, both plates will be treated simultaneously. If direct current is applied, such as from a B-eliminator, only one plate will be treated at a time. A re-aged kino-lamp will usually be good enough for ordinary experimental use, so that it need not be a total loss.

"Nevertheless, an ounce of prevention is worth a ton of cure, when it comes to the operation of kino-lamps."

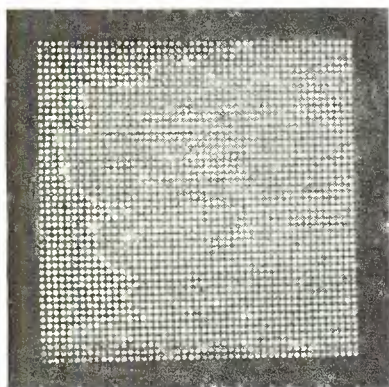

This photograph shows a radio movie receiver surface divided into 48 times 48 elementary areas, the phenomena being a substitution of persistence of elementary area light for persistence of vision. This receiver light source is projected on to a theater screen, giving ample illumination for theater radio movies

The substitution of light sensitive elements for the lamps of the receiver makes an excellent transmitter by which outdoor

scenes and sports may be broadcast directly from the field

fifteenth of a second later, so that the observer seems to see a continuous area of light as a background against which the dark figures appear.

Mr. Jenkins' latest idea is to get away from the persistence of vision in the eye, and to provide a light that will continue to glow for the full fifteenth of a second between successive pictures. This is accomplished by employing a bank of 2304 small incandescent lamps, like those used in flashlights. These are controlled by the radio receiving set. A revolving switch, or commutator, connects the lamps successively to the set. But unlike the neon light, the filament of the lamp continues to glow for an instant after the current is turned off, until it is again connected. Thus the background does not merely appear to be bright the whole time; it actually is bright. However, there is enough contrast between a lamp that has just been connected, and one that was connected a fifteenth of a second earlier, on a previous turn of the commutator, to give sufficient contrast between the subject and background, even in the case of a rapidly moving object. With the light advantage thus gained, and with the greater intrinsic brightness of the incandescent lamps, the image will be many thousands of times as bright as with any form of neon

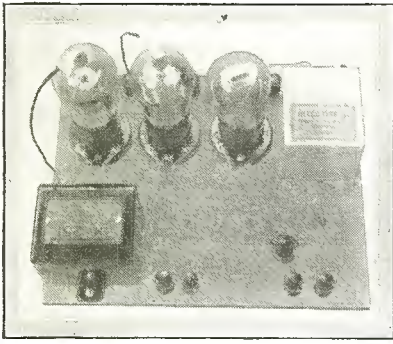

This photograph shows a top view of the resistance coupled amplifier described schematically in part in Fig. 4 on the succeeding page. An input transformer is shown in the photograph and was used in operation because it was felt that when using the amplifier with a regenerative set, better results might be expected than if the input network to the amplifier were a resistance affair. It will be noted in the schematic in Fig. 4

that the input circuit is left blank, so that any type of input may be used as desired

RESISTANCE coupled amplifiers in common use today, have two inherent disadvantages. In the first place, they require altogether too many B and C batteries; in the second place, they are unstable. It is true that reasonably stable amplifiers have been built, amplifiers with a maximum gain of 70 t. u. and a variation if less than 10 t. u. over a range extending from 30 to 6000 cycles. There are, however, many instances where an amplifier capable of handling direct and audio frequency voltages up to 10,000 and even 30,000 cycles is highly desirable.

According to a recent release of the International Resistance Co. such an amplifier has been designed in England and after much experimentation, its basic principles have been successfully applied to standard American vacuum tubes. Here in America have been developed two remarkably stable amplifiers. The first is capable of giving an excellent gain on direct voltages and audio frequency voltages up to 10,000 cycles, while the second gives the same result up to 30,000 cycles. The latter amplifier is being described in this article and is shown schematically in Fig. 1. In both amplifiers, the uniformity throughout the frequency ranges leaves little to be desired. In one model having three stages, the overall gain is approximately 60 t. u., with less than 10 t. u. variation between zero and 3000 cycles and 60 t. u. between 3000 and 6000 cycles. For use in a broadcast receiver, an amplifier of this type will provide excellent results for moderate power output, since the frequency band necessary for excellent reception extends from 30 to 6000 cycles. It has the added advantages of simplicity and low cost, but its particular field of application is found wherever it is necessary to amplify direct voltages or very low frequency alternating voltages.

Television Amplifier

The amplifier shown in Fig. 1 is not primarily intended for broadcast reception, although it may be employed for that purpose. It has a gain frequency characteristic, which is flat from below 30 cycles to above 15,000 cycles, decreasing only 7 t. u. at 30,000 cycles. This amplifier is especially well adapted to television experiments and to any purpose requiring amplification over the entire audio frequency band. The overall gain of this particular model is 54 t. u.

The circuit shown in Fig. 1 is quite novel. For one thing, it will be observed that no coupling condensers are used to link one stage to the next. This coupling is accomplished by means of resistors. The first two stages employ a standard screen grid tube, while the last stage calls for Western Electric type 101-D tube, although any power tube may be employed in the last stage with slight alteration. In the diagram shown herewith a 171 or 171-A tube has been employed. It will be noticed that the first two tubes are connected according to the screen grid or shield grid method. This decreases the effect of grid-plate capacity with its resultant drooping of the gain frequency characteristic at the higher frequencies. However, for its still flatter characteristic, the equalizer, shown in the output circuit of the last tube, has been inserted. This equalizer, consisting of a series circuit containing an inductance of approximately 750 MH and a resistance of 3500 ohms, is connected across the load. It acts as a high pass filter. The value of the resistance governs the amount of signal loss at the low frequencies.

In this photograph is shown a bottom view of the resistance amplifier unit, the resistors and their mountings being located underneath the sub-panel because of the fact that fairly high voltages are dealt with and it was not considered advisable to have these clipped on the top of the sub-panel, where they might become short circuited or might give the operator a shock.

If the proper values are placed in the clips at the beginning of the experiment, it is not likely that it will be necessary to change resistance values. However, if it should be necessary to change these values, the whole unit may be tipped up at one end and the resistance cartridges changed. In doing so it would be a good plan to break the high voltage line so that there is no possibility of a shock when changing resistors

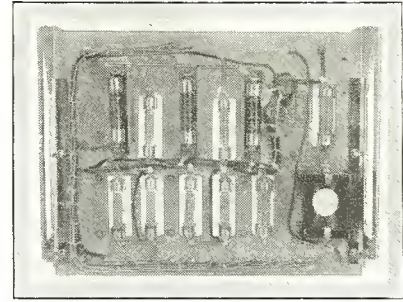

The values of the Durham resistors used in the amplifier are given in the schematic circuit. Battery voltages, A, B and C, are likewise noted in the drawing.

In this amplifier the plate and grid bias voltages are somewhat critical. Shielding of the amplifier, however, is entirely unnecessary. Although this amplifier requires a high voltage and is somewhat critical in its initial adjustment, its performance is so good that the International Resistance Co. staff has found no other to take its place where high and uniform amplification over the entire audio frequency band is required. Needless to say the resistors used in the construction of this amplifier must be the best obtainable. If the resistors are not accurate in resistance value, not stable or again incapable of carrying the necessary currents without deterioration, the amplifier cannot be expected to perform satisfactorily. Although the amplifier is essentially a precision device for radio enthusiasts and experimenters seeking precision amplification, nevertheless it is essentially inexpensive. This particular would be very good for television work where a wide response of frequency is desired.

The amplifier illustrated photographically on this page has recently been built in the laboratory of this magazine, incorporating the schematic circuit shown in Fig. 4 on the succeeding page.

The unit is made quite compact and simplified as much in construction as was possible considering the amount of parts involved in the unit. The amplifier is mounted on a Formica 7 in. x 10 in. x $\frac{1}{8}$ in. Ivory sub-panel and is elevated by means of two Benjamin brackets located at either side. The transformer used is one made by Silver-Marshall and known as their type 240, details of which transformer will be covered further along in this article. Three of the Silver-Marshall 511 UX sockets were employed for holding the two screen grid tubes and the 171-A.

These resistors are mounted in eight Amco grid leak mountings, and are the type made by Durham, there being two of the powerohm type and the remainder of the grid leak type. The powerohm type are called upon to handle a heavier current and for that reason the grid leak resistor type would not be suitable. Filament control is by means of the 1-A Amperite for the 171 tube and two 622 Amperites for the screen grid tubes. The Sanson 500 MH choke is employed instead of the 750 MH shown in the schematic. In actual practice, the 500 gives almost the same results as the 750, and the former is a standard size, whereas the 750 would have to be made up especially. The condenser shown in the output circuit of the schematic is a type 711 made by Tobe and is of 4 mfd capacity.

In using the receiver ahead of this amplifier on television signals, and employing C bias for detection in the detector stage, it was found that utilizing the Silver-Marshall 240 transformer, a fairly wide frequency response could be secured because with a C bias detector the plate circuit would have a very high impedance when no signal is being received but when a signal is being received, the impedance would drop to a low enough value to cause the transformer to function over a much wider range of frequencies. For experimental purposes, this transformer serves

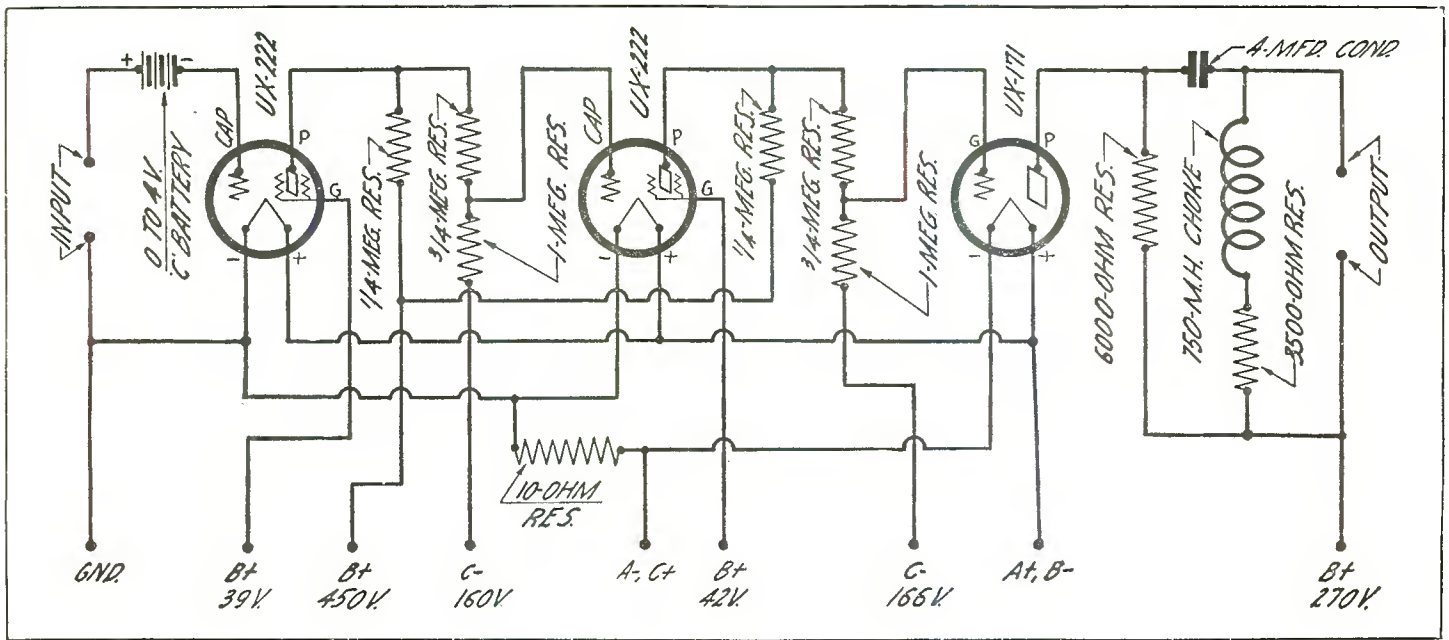

Figure 4

quite satisfactorily and with the present state of the art it is quite possible to secure very good television images through this particular transformer.

In the operation of the detector stage by the method referred to previously, it is quite likely that a bias voltage on the grid will have to run as high as 22 volts and that the plate voltage applied to the detector tube should be in the neighborhood of 180 volts. With this high C bias and high plate voltage on the detector, the impedance of the plate circuit is quite high when no signal is received and when a signal is coming through the impedance of the plate circuit is quite high when no signal is received and when a signal is coming through the impedance drops accordingly.

Parts required for the construction of this experimental television amplifier are shown below:

- 1 711 Tobe 4 mfd fixed condenser
- 1 240 Silver-Marshall audio transformer
- 1 500 Samson 500 MH choke
- 1 1-A Amperite
- 2 622 Amperite
- 1 Formica 7x10x3/8 in. sub-panel, Ivory
- 16 Eby binding posts
- 3 511 Silver-Marshall sockets
- 1 10 Yaxley line switch
- 2 Benjamin brackets
- 1 Durham 3500 ohm power ohm
- 1 Durham 6000 ohm power ohm
- 2 Durham 1 megohm grid leak
- 2 Durham .75 megohm grid leaks
- 2 Durham .25 megohm grid leaks
- 8 Amsco grid leak mountings
- 1 Pkg. Corwico Braidite hook-up wire
- 1 Ceco or Sonatron 171-A tube
- 2 Ceco or Sonatron 222 screen grid tubes

Television Reception Progressing

WHERE in the beginning only a few hundred individuals were listening in on television broadcasts, we are now informed by Mr. Jenkins that several thousand are listening in nightly to the 3XK broadcast. The majority of these listeners are securing excellent results, although there are sporadic cases where on account of skip distance or undue fading, the receivers are not able to maintain good detail. Just prior to the presidential election, the station 3XK was closed down about a week or ten days in order to permit reception of pre-election and

election bulletins. However, right after the election the station started up transmitting again and is still continuing.

With the recent announcement of the incorporation of the Jenkins Television Corp., with James W. Garside, president of DeForest, as president of the new organization, and Mr. Jenkins himself as vice president in charge of research, it is anticipated that much more interest will be aroused on the part of television experimenters.

We are now advised that work will start immediately on the completion of the 5000 watt transmitter for use on the wavelength authorized by the Federal Radio Commission for the Jenkins radio movies. With such a transmitter, this should insure that television experimenters scattered all over the country, should be able to maintain an exceptionally good signal strength from that station in Washington. With an ideal signal, something which every experimenter desires, it is only natural that more indi-



Photo by Wide World

The above photograph shows Philo T. Farnsworth, the inventor of a new type of television transmitter and receiver, which is said to do away with the usual scanning disc which is in use with other types of television apparatus. The image size is as large as the largest square which will fit in the white circle to which Farnsworth is pointing

viduals can be convinced of the interest that exists in the reception of radio movies from the Jenkins transmitter.

It is also understood that the new Jenkins organization contemplate going on the market with the Jenkins drum scanner, described in previous departments, and that the price is to be brought down to a value where almost any individual can afford such a device. As previously explained, the drum scanner does away with the necessity for a 18 or 24 in. scanning disc. By means of a magnifying glass, the image is brought up to a size of approximately 6 in. x 6 in. While this does not necessarily spell the death knell of the scanning disc, nevertheless for those who wish to play with television in the home and at the same time have a fairly civilized looking outfit, the new Jenkins scanner will undoubtedly have considerable appeal. On the other hand, there are many thousand experimenters who already have the regular scanning disc and who will continue to operate it as long as programs are sent utilizing that particular number of holes.

By this time the 48 hole scanning disc, or scanning method, regardless of whether it is a disc or not, is almost universally accepted. Some of this is due to the pioneer work done by the television committee of the R. M. A., who got together and decided that the R. M. A. should suggest a definite standard of apertures and 48 holes seems to be the most logical figure.

Increased Cell Sensitivity

WITH the newly created interest in television, as well as sound-reproducing films and other developments calling for the translation of light intensities into corresponding electrical intensities, the photo-electric cell has become an object of considerable interest. The former selenium cell, once considered ideal for the purpose, has not even been considered, because of its sluggish response and other handicaps. The older types of photo-electric cells have had to make way for far more efficient cells developed during the past year. And now, as another step in the development of light-sensitive devices, the sensitivity of the best of cells has been multiplied by three or four times through the efforts of a young genius.

A young engineer, working in the Raytheon Research Labora-

Alexanderson's 48-Hole Disc

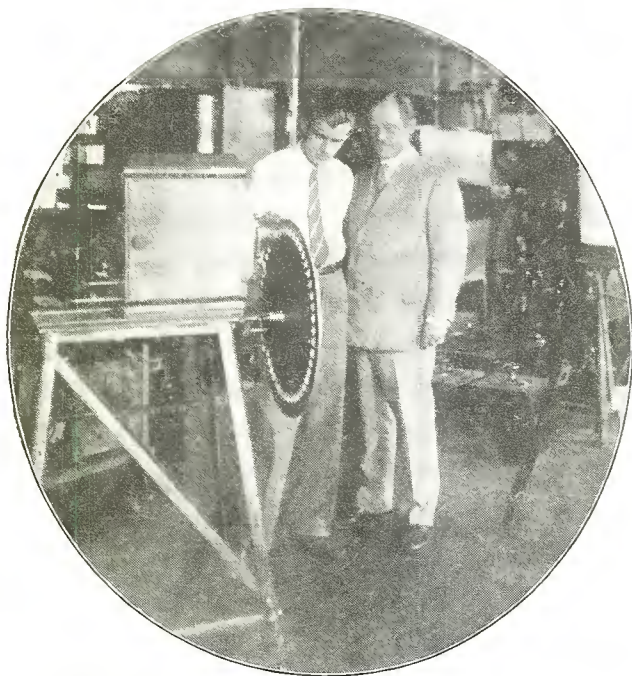

Photo Wide World

Dr. Ernest F. W. Alexanderson, of the General Electric Co. research laboratories, recently demonstrated his latest discovery in the television field, that of projecting the image on the screen. The television projector includes a disc with 48 lens and the picture or image is projected through a ground glass screen. The photograph shows Dr. Alexanderson and his assistant, R. D. Kell, in the laboratory of the General Electric Company at Schenectady, experimenting with the television screen.

Looking into Televator



Photo Wide World

The radio televator, still in its experimental stage, designed by two Chicagoans, M. L. Hayes and U. A. Sanabria, was exhibited to the public for the first time at the Second Annual Radio Trade Show at the Hotel Stevens in Chicago. The transmission of the pictures is done by converting light into electrical energy and back into light at the receiving point. This conversion is done with photo-electric cells, filled with inert gas and actuated by electric current. The photograph shows M. L. Hayes, television engineer, sitting in front of the televator transmitter during its demonstration. The photo-electric cells act as part of the projector

atories at Cambridge, Mass., has startled the radio and electrical world by increasing the sensitivity of the usual photo-electric cells by a factor of three or four. His new cells are more sensitive than any light-sensitive devices ever produced before, and even more sensitive than those employed for daylight pick-up of the television image in recent experiments.

It appears that this young engineer, whose modesty prevents the use of his name, in the course of his laboratory work hit upon a new combination of rare elements placed on the cathode of the photo-electric cell, causing a much greater electrical response. With every chemical known at his disposal, together with machinists ready to turn out any desirable metal parts, skilled glass-blowers ready to shape any kind of tube or stem, as well as various gases, vacuum pumps, bombardment equipment, sealing machinery and other facilities, this research worker has tried many combinations of chemicals, shapes, dimensions, mechanical combinations and so on. Many of his essays have been duds. A few have been good. One of his combinations, however, has proved so far superior to the best photo-electric cells heretofore known to the art, as to open up new possibilities for this new technique.

The new photo-electric cell developed by the Raytheon staff does not have the disadvantages of the potassium hydride cells, since it can withstand ionization without any detrimental effects. In the case of the small sized photo-cell, the cathode lead comes out through the top of the tube as in the usual screen-grid vacuum

(Continued on page 128)

The ABC of Radio

ONE of the first steps a novice should take in learning the fundamentals of radio is to become acquainted with the generally accepted symbols for the various apparatus. A clear understanding of all of the symbols will go a long way toward helping the beginner to master the rudiments of the art.

In sketch A are shown eleven figures, each representing a different piece of apparatus. In this particular sketch tubes of various sorts and types are shown symbolically. In Fig. 1 is given the symbol for an ordinary receiving or amplifying tube with direct current filament. The tube consists of three elements, the grid shown at G, a plate shown at P and the filament shown at F and F. This tube might be a 199, 201-A, 112-A, 171-A. It might also be a 210 or a 250. In the event it is a power tube operated from alternating current on the filament, the leads to the tube would be shown as twisted pair or at least marked a. c. 5 or 7½ volts. In all drawings appearing in this publication, the type of tube is specified alongside of the symbols so as to make it perfectly clear to the builder which particular tube is to be employed.

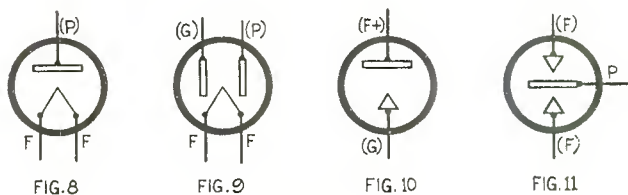
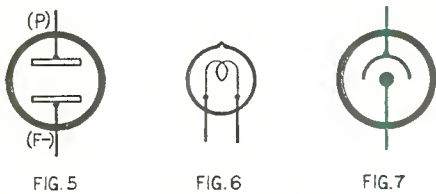
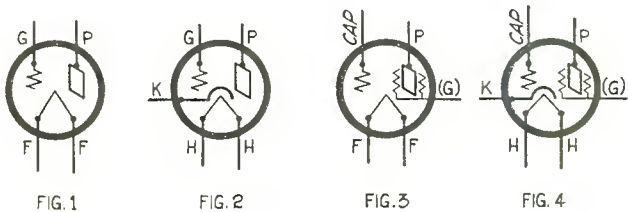

Sketch A

In Fig. 2 is shown a tube having heater elements for operation from an alternating current source. The heater elements are shown at H and H, while the terminal K is known as the cathode and is the termination of the grid return of the tube. The grid and plate elements are identical in this figure, the only departure from the previous figure being that the tube is operated by means of a heater energized from an alternating current source.

Fig. 3 shows the new screen grid, or shield grid tube. It is operated from direct current. It consists of the cap of the tube, which is the ordinary grid of tubes similar to Fig. 1 or Fig. 2. The normal G marking on the socket is not the grid, but instead is the screen grid upon which a positive potential is applied. The plate and the filament of this tube is the same as the preceding figures. The cap on the tube is a small metal one and this cor-

responds to the grid in the other types of tubes.

In Fig. 4 may be seen a screen grid tube using a. c. on the filament by means of the heater. This tube also has a cathode at K, similar to the cathode in Fig. 2. Cathodes are provided in this type of tube to permit a point of no potential to which a grid return from the tube may be made.

The symbol for a television lamp, or neon tube, is shown in Fig. 5. The two terminals of a four-prong socket which are used are the P and F minus terminals. These go to the plates of the television lamp.

Fig. 6 shows symbolically a dial light, which is quite simple. Fig. 7 shows the symbol used for a photo-electric cell, this device being used in television transmission.

A half wave rectifier is shown symbolically in Fig. 8. This would correspond to the 216-B type of rectifier tube which is now practically obsolete, its place having been taken by the 281. Three of the four terminals on a four-prong socket are utilized by this tube, these being the P terminals and the two F terminals. In the case of a full wave rectifier, such as the 280 shown in Fig. 9, all of the terminals on the socket are utilized, G and P representing the two plates of the rectifier, while the F and F represent the filament. A voltage regulator, or glow tube, similar to the 874, is shown symbolically in Fig. 10. The voltage regulator tube also only uses two of the terminals in a four-prong socket.

Where the full wave rectifier shown in Fig. 9 is of the type using a filament, the full wave rectifier shown in Fig. 11 is of the gaseous type such as the Raytheon BH and BA type. In those the two plates are represented by terminals F and F and the negative of the system represented by the terminal P.

The symbols referred to in sketch A comprise practically all of those required in the radio art at the present time as far as the home builder or professional set builder is concerned. The oldest of the symbols is that in Fig. 1, while the newest one is shown in Fig. 7, since a special symbol had to be made for a television photo-electric cell.

Resistance Symbols

Another series of symbols which also will be understood by the layman is shown in sketch B, which represents the resistance symbols. Fig. 1 is a simple fixed resistance. Fig. 2 is a variable resistance, such as a rheostat. At times it is necessary to show a variable resistance by the symbol shown in Fig. 3. Fig. 4 is a center tapped resistance which cannot be moved. Fig. 5 is resistance with a center tap and a number of other taps, which are movable. In Fig. 6 is shown the symbol of a potentiometer, this unit having three binding posts.

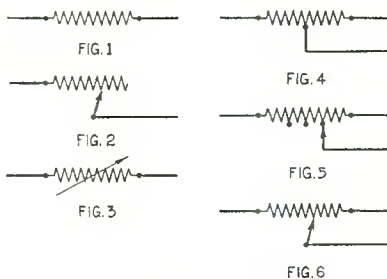

Sketch B

In the sketch shown as sketch C are many of the ordinary symbols used in radio work, which will also be of interest to the novice. The antenna is represented in Fig. 1, while the ground symbol is shown in Fig. 2. Fig. 3 shows where one wire passes over the other without any connection being made.

Fig. 5 represents a fixed condenser of any kind regardless of whether it is in the grid circuit of a detector, across a transformer or as a bypass in a power supply. Fig. 6 is a switching arrangement with five switch points and a movable arm. Fig. 7 shows a variable condenser regardless of whether it is continuously variable, as in a tuning condenser, or semi-variable, as in a neutralizing condenser. Fig. 8 represents a switch. Switches are generally used in the filament circuit of d. c. operated receivers or in the 110 volt line of alternating current operated receivers.

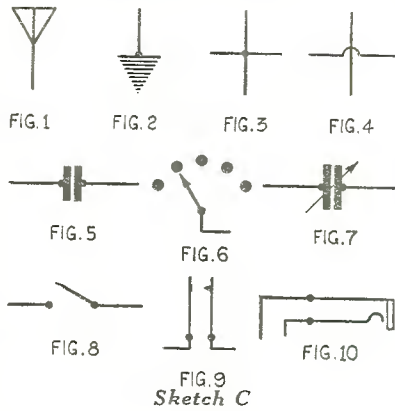

Sketch C

Fig. 9 represents a jack switch and is somewhat the same as that shown in Fig. 8, although different in construction. However, its uses are the same. Fig. 10 represents a phone jack, or any open circuit jack. There are many types of jacks, but in the present day there is generally only one type, which is used in the receivers found during this period.

Another series of symbols which are quite interesting to the novice may be found in sketch D. In Fig. 1 is shown a simple single winding coil. It may either be a plate coil, an r. f. choke, or any coil having only one winding and no iron located within its core. In the following figure, which is 2, is a single winding coil but having an iron core. This may be used as an audio frequency choke or as a radio frequency choke, but with a wide response band on account of the presence of the iron in the core. Fig. 3 is r. f. coil, similar to the kind used in an antenna circuit, where the top winding goes to the grid, the bottom to the filament and the off-center tap going to the antenna.

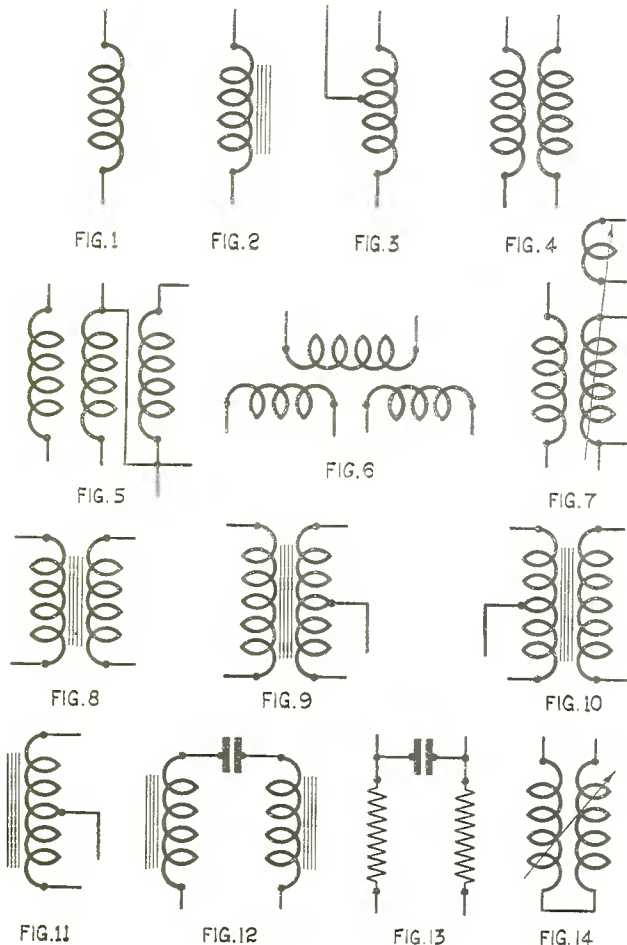

Sketch D

In Fig. 4 we have an r. f. transformer. It consists of two windings, a primary and a secondary. In most cases the primary has the smallest number turns of wire and the secondary the largest. It may be wound on any type of insulating material or it may be air spaced and self-supporting, due to the method of winding and impregnating the winding. It may also be an intermediate transformer in a superheterodyne. Regardless of the frequency at which the intermediate is peaked, it would be represented in the fashion shown in Fig. 4.

The coils shown in Fig. 5 comprise a primary and a secondary with a neutralizing winding. In years past this particular type of coil was quite popular, although since the introduction of the screen grid tube the necessity for neutralizing has been done away with and as a consequence most of the tuning coils are of the type shown in Fig. 4. In the case of the coils shown in Fig. 5, the one at the left is the primary, the one at the right is the secondary and the one in the center is the neutralizing coil. This neutralizing coil generally consists of a small number of turns wound in an opposite direction from those on the secondary.

Those who are interested in superheterodynes will recognize the oscillator coil from the one shown in Fig. 6. The top coil is the pick-up winding, the left-hand section of the coil is the grid circuit and the right-hand section is the plate circuit. Regardless of the form of connection used in the circuit, the oscillator coil will be represented in the form shown in Fig. 6.

Regenerative coils are always shown by one symbol and that is the one shown in Fig. 7. The coil at the left is the primary, the one immediately next to it at the right is the secondary, while the small winding at the top is the plate coil or regenerative winding. The long arrow going through the secondary and the plate coil indicates that the plate coil is movable or variable against the secondary, and allows regeneration control by means of varying the inductive relation of the plate coil to the secondary.

In Fig. 8 is a radio frequency or audio frequency coil. If used in a super, it is a broad response intermediate. If used in an audio stage, it is an audio transformer. When used in a super in the intermediate stages, this coil may be tuned either at the primary, left, or secondary, right, sides. Or it may be left untuned. The coil shown in Fig. 9 is a push-pull input audio transformer. The winding at the left is the primary, while the one at the right is the secondary. The two extremities of the coil go to the grids of the two tubes in push-pull and the center tap goes to the bias terminal.

While the coil in Fig. 9 might also be a push-pull input for an intermediate stage, nevertheless no manufacturer is making this type of coil. The mate to this circuit is shown in Fig. 10, which is a push-pull output coil. The winding at the left has at its two extremities the plate of the two tubes used in push-pull, while the center tap goes to the B battery terminal. The output circuit is the coil at the right and goes to the speaker, in the event that one is used in this position. This type of coil might also be used in intermediate frequency work, but so far no manufacturer is doing this type of winding. Hence, it can be considered as strictly an audio frequency output transformer of the push-pull type.

In Fig. 11 is shown an audio frequency choke having a center tap. The top end of this coil goes to the plate of the power tube and to one side of the speaker, while the bottom end of the coil goes to the other side of the speaker and the center tap goes to the B battery potential.

In the circuit shown in Fig. 12 may be found an impedance coupled form of audio amplification. The coil at the left is the plate circuit, the upper extremity going to the plate and the lower going to the B battery. The coil at the right has its upper extremity going to the grid and the bottom terminal going to the C bias or filament. Coupling from one circuit to the other is by means of the fixed condenser placed between the top of each of the coils.

Another form of audio frequency amplification is shown in Fig. 13, which is a resistance coupled job. Here the resistance shown at the left and the right takes the place of the impedances at the left and right shown in Fig. 12 and the coupling method between the plate of one tube and the grid of the next is the

same, that is, by means of the fixed condenser. In addition to this there are combinations of resistance and impedance, where the plate circuit of the unit will be a resistance and the grid circuit will be an impedance. While resistance coupling may be used in the intermediates, nevertheless it has not been found very satisfactory to date.

In Fig. 14, which is the last one of this particular series, is shown a variometer. This form of winding is quite old and is seldom seen except in laboratory apparatus or occasionally where a portion of a secondary will be wound in variometer form to allow for compensation, without the use of a variable capacity for trimming.

The symbols shown in four sketches, A, B, C and D, comprise practically all that is required for a clear understanding of set building. However, as new ones occur, we will include them in this department.

Transmission and Reception

SINCE the opening of this department we have had a number of requests from non-technical radio fans for a complete description of all that transpires in the transmission and reception of the voice or music. While this is necessarily a lengthy subject, nevertheless we feel that perhaps it may be summarized within a reasonable length, if not too much attention is paid to the technique, but mostly to the actual steps in the process of transmitting and receiving voice waves.

Perhaps the easiest way for the layman to get an idea of the necessary steps in this transmission phenomena is to consult the diagram shown in sketch G. Here it will be seen that transmission consists of six orderly steps and that reception consists of the same number of orderly steps but in the reverse direction. For example: the first step in transmission is the actual voice of the performer or the sound of the music. The next is the microphone, then the audio amplifier, then the modulator, then the oscillator and finally the aerial. In reception, the process is reversed. We start at the aerial, then follow the radio frequency, then the detector, then the audio amplifier, then the speaker and finally the voice heard. It will be noted by careful examination of the diagram that many of the functions are similar, but reversed in process. For example: the voice in transmission is the same as the voice in reception. The microphone in transmission is the same as the speaker in reception, but reversed. Audio amplification in both transmission and reception is the same. Modulation in transmission and detection in reception are like processes except opposite in function. In the case of the oscillator, it and the r. f. are similar except that they, too, are reversed in function. The aerial, of course, is used for both transmission and reception, and is the same.

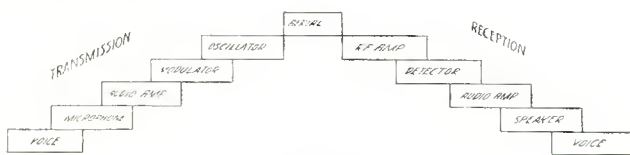

Sketch G

Sound Waves Start

We will now take the first step in the transmission and attempt to give as simple an explanation of it as possible. A performer in a broadcasting studio is giving a talk. The sound of the performer's voice on striking the air in the studio sets up a train of sound waves varying in amplitude in accordance with the range and intensity of the voice. These sound waves of their own accord could not be impressed on a transmitter without auxiliary or interpreting devices and here is where the microphone steps in. The microphone, similar to the one on your house telephone, but infinitely more satisfactory and more sensitive, consists of a diaphragm located equi-distant between two sets of carbon granules. The carbon granules and the diaphragm are connected together in a battery, or energizing source. When the sound waves

set up by the performer strike the diaphragm of the microphone, the diaphragm is set into vibration at the same frequency as the voice of the performer. This physical vibration compresses and decompresses the carbon granules in the microphone and alternately increases or decreases the resistance of the microphone circuit. This increase and decrease of the electrical resistance of the circuit is at the amplitude of the voice uttered by the performer. We have now changed from a physical condition into an electrical one. Where in the case of the human voice, the sound waves are considered a mechanical or physical function before they reach the microphone, after they have hit the microphone an electrical condition is created. This electrical condition, in the microphone circuit, sets up in the secondary of the microphone transformer an alternating current at audio frequency, or at the same frequency as the spoken voice. These alternating currents are not of themselves sufficiently strong to be impressed on the transmitter and as a result they must be passed through an audio amplifier to strengthen them.



Sketch H

By consulting the sketch shown in Figure H, it is seen that the grid circuit of any tube has present in it alternating current, while the plate circuit has two types of current present. The first is the direct current resulting from the plate battery, and the second is the alternating current component similar to but immensely stronger in amplitude than the comparatively weak current in the grid circuit. In passing to the next stage, the only thing that goes through is the alternating current component, which, when it reaches the grid circuit of the succeeding tube, is pure alternating current. Then when the process is carried further, the succeeding plate circuit contains both direct current and the alternating current component. In the case of the audio amplifier, the alternating voice currents are stepped up in intensity until they can be delivered to the modulator circuit, this last stage being the one where we lose sight of the audio frequency voice currents because they are being impressed onto the radio frequency carrier created by the oscillator. The voice currents are directly audible in the modulator, but after getting into the oscillator they are lost entirely because they are occurring at a frequency too great for the human ear to appreciate. The radio frequency or inaudible current (because it is beyond the range of human audibility) is now fed into the antenna, where by its frequency of polarity reversal it sets up in the surrounding atmosphere a train of electro-magnetic waves. This train of electric-magnetic waves travels in each and every direction of the compass. Some of these waves, traveling at a speed of 186,000 miles per second, strike a distant antenna and there the process of reception begins.

Mechanical to Electrical Change

In the transmitting end, we have seen that the voice started as a physical sound, was changed to an electrical one by the microphone, amplified by the audio amplifier, impressed into the radio frequency carrier by means of the modulator and forced out into the air by means of the oscillator and the antenna. In such a condition these waves are inaudible and it is now necessary to bring them back into audibility. At the receiving end the electro-magnetic waves strike the antenna and induce in the grid circuit of the radio frequency amplifier minute electrical currents, which are amplified by this stage. This electrical energy is then passed on to the detector stage, where rectification or demodulation takes place. Where in the transmitter the modulator is the one that impressed the audio frequency currents onto the oscillator, in the reception it is the detector which takes out of the radio frequency amplifier the audio frequency tones desired. A homely simile for the detector would be that of an automatic pea

sheller, which takes the peas out of the pod and throws away the pod. In this case, the peas are the audio frequency currents and the pod is the radio frequency current. After the detector has demodulated or converted the radio frequency energy into audio frequency energy, this alternating current component, at a relatively low frequency is now led into the audio amplifier where it is stepped up in strength in the same fashion that it was done in the transmission end from the microphone to the modulator. In the reception end, the same process holds true as far as the tube circuit is concerned, as was previously explained under the sketch H, where the grid circuit of the tube contains alternating current and where the plate circuit contains direct current and an alternating current component. The radio frequency currents having been thrown out of the detector circuit by means of the bypass condenser used for that purpose, the only thing that now goes into the audio stage is alternating current at the frequency of voice transmission. In this case, the a. c. voice current is strengthened and built up so that it may be impressed upon a sound producing device, the latter being the speaker. A speaker is in effect the reverse of a microphone, because where in a microphone the sound wave strikes the diaphragm and cause electrical energy, in the speaker electrical energy travels through the windings of the speaker and sets up a field around the diaphragm, causing the diaphragm to produce sound waves which are audible to the ear.

The foregoing briefly gives an idea as to the two processes in connection with transmission and reception. It will, therefore, be seen that the voice is the same at the receiving end as at the transmitting end because of fidelity of transmission processes. It will be further seen that the microphone and the speaker are similar devices with opposite purposes. The audio amplifier in either case performs the same function, while the modulator and the detector are like devices but with opposite functions. In the case of the oscillator, this device is a producer of radio frequency current, whereas in the r.f. amplifier at the receiving end this device is a receiver of modulated and unmodulated radio frequency current. In the case of the antenna in the transmitting scheme, it causes fluctuation in the surrounding atmosphere, thereby setting up electro-magnetic waves. The aerial at the receiving end, being located in the atmosphere, is acted upon by these electro-magnetic waves and thereby sets up an alternating current in the grid of the receiving tube.

Resonance

In order for the transmitted energy to be received, it is necessary that the receiving antenna be tuned to the same wavelength or frequency as the transmitting antenna. This is necessary because the transmitter is emitting its waves at a definite frequency and unless the receiver is tuned to exactly the same frequency, nothing occurs in the receiver. A simple analogy whereby this condition may be appreciated is the consideration of two G strings separated by a distance of about three or four inches. If one G string is plucked hard enough, it will set into vibration the neighboring G string. This will only occur providing both strings are tuned to the same pitch. In the event one of the strings is off pitch, or out of resonance with its neighbor, it will not vibrate when plucked. Thus the two G strings correspond to the antenna at the transmitter and that at the receiver.

Alternating Current Defined

SOME of our readers have stated that they do not understand how alternating current is obtained to actuate the speaker windings of a dynamic when pulsating current is found in the plate circuits of the amplifier stages.

This can best be understood by stating that alternating current may be produced by two methods. One is a reversal of polarity, and the second is amplitude of current change. The latter method is the one that explains how alternating current can be produced in a speaker winding when a plate circuit contains pulsating current. If alternating current were only produced by the first method, the dynamic, head phone, detector or other radio appliance would not be possible.

An interesting series of symbols for the different parts for radio sets is shown in the diagram below and is taken from one of the lesson sheets of the Junior Radio Guild, about which our readers were advised in our last issue. In addition to showing the technical representation of the item itself, there is also given a graphic view of the unit so that even if the builder was not acquainted with the technical name or symbol of the unit, he would recognize it by its physical characteristics. This is quite desirable when the embryo builder has not reached the point where he is able to read a simple schematic circuit.

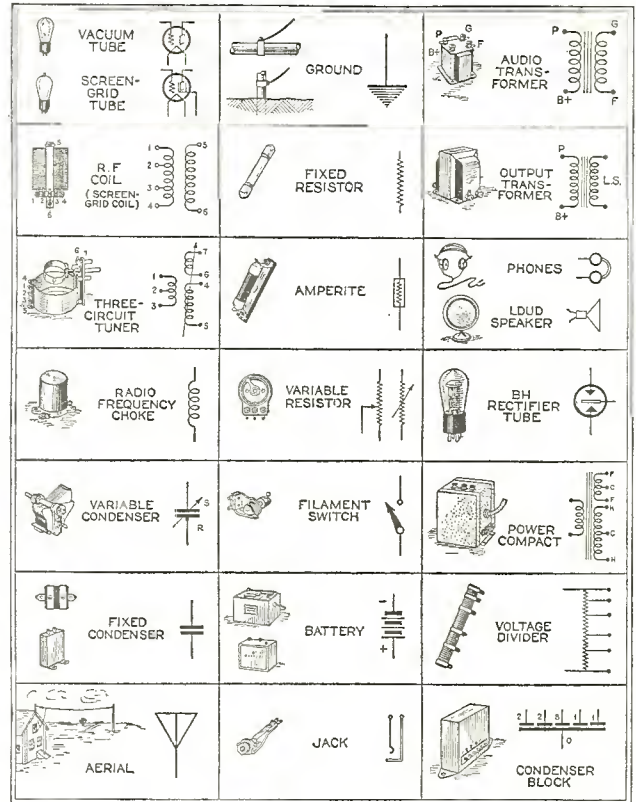

Therefore, there is no reason for any young boy or young man to refrain from building a set simply because he cannot read the schematic. If he will follow the graphic diagram shown, he will have no difficulty in recognizing the different units by their physical characteristics.

One of the interesting diagrams shown in the first lesson of the Junior Radio Guild is that illustrated in Fig. 4.

Quoting from the lesson sheet in particular, we find there are just a few pointers on the antenna ground system. "At the broadcasting station, the purpose of the antenna is to radiate the waves

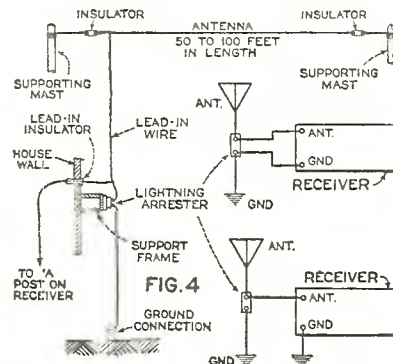

into space. At the receiving station, it is the job of the antenna to absorb a portion of this radiated energy and pass it along to the receiver coil and another tuning apparatus, so that of all the waves absorbed the desired one may be selected.

There are a number of considerations which must be given to

the construction and erection of the antenna if it is to be really efficient, that is, if it is to absorb a maximum of energy. First it should be erected as high as possible. The wire used for the antenna should be strong enough to be pulled tight, so that there will be no slack after it is put up. Antenna wire usually consists of seven strands of copper or bronze wire. Second, it should be located in an unobstructed place.

If it is placed close to other large metallic objects, such as a tin or copper roof, the received signals will be seriously weakened. Third, it should be erected in such a manner that it is free from

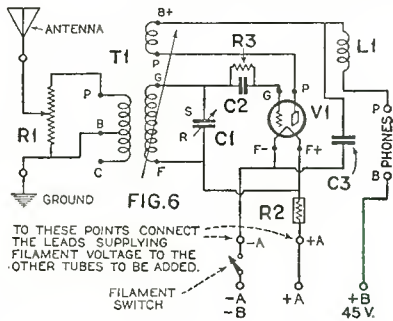

contact with other objects. At no point along the length of the antenna or its lead-in wire should it come in contact with cornices, supporting masts, sides of the house or any grounded object. If such contact does take place, not only the efficiency of the antenna receiving qualities will be reduced, but also a disturbing, scratchy noise will be heard in the receiver due to the constant making and breaking of the contact between the antenna and the other object.

The down-lead, otherwise termed the lead-in, should comply with fire underwriters' rules in that it should be connected to a lightning arrester at the where the lead is brought into the house. All of these points are made clear by referring to the sketch showing antenna construction and erection in Fig. 4. Several methods of connecting the lightning arrester are also shown.

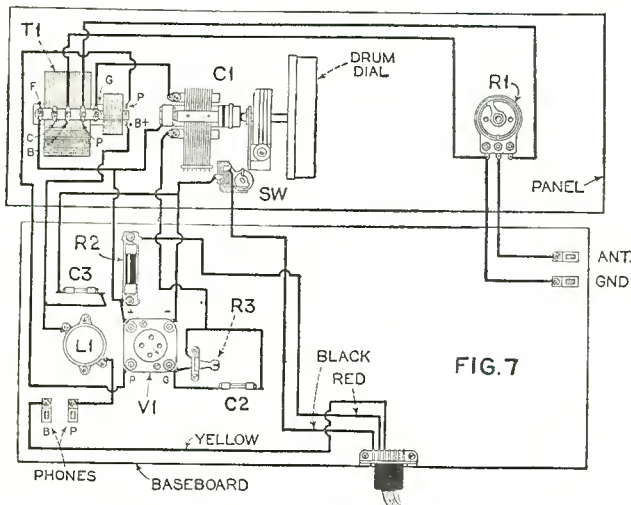

In the second lesson in the Junior Radio Guild course, from which we are excerpting certain portions, is a description of the construction of a single detector stage illustrated in Fig. 6 shown above. This is the simple schematic diagram of the receiver. In Fig. 7 is shown a graphic idea of how the receiver should be wired. The diagram in Fig. 7 indicates the back view of the front panel and the top view of the baseboard. The upper portion of the sketch represents the back of the front panel, while the lower portion represents the sub-panel. Thus, the operator is looking at the rear of the receiver.

This receiver is so designed that as a detector it will give excellent results on head phone operation for the builder and later on, if he so desires, it may be converted into a larger set. After the first portion of the receiver has been built, there will be no changes in that end of the circuit and the only addition will be

the employment of sufficient audio amplification to make signals audible on a speaker instead of having to listen in on a pair of head phones. However, for the beginner, the simple detector circuit is quite economical and later on he can add to the set as his purse and desires warrant.

Inasmuch as the panel of the receiver is already drilled, much of the work is reduced in the preparation of the receiver. The wiring may be accomplished by following the diagram shown in Fig. 7.

Parts required for the detector stage are shown in the list below.

- 1 Hammarlund Midline condenser .0005 mfd
- 1 Hammarlund TCT-23 coil
- 1 Hammarlund r. f. choke 85
- 1 Hammarlund drum dial type SDB-1
- 1 Electrad Tonatrol type A variable resistance
- 1 Electrad bypass condenser .001 mfd
- 1 Electrad grid condenser .00025 mfd
- 1 Durham grid leak 5 megohm
- 1 Benjamin Ux socket
- 1 Durham single resistor mounting
- 1 Amperite type 1-A
- 1 Yaxley midget battery switch No. 10
- 1 Yaxley cable connector, cable and plug type 660
- 1 Drilled front panel 7x21-in.

After the receiver has been completely wired, operation may be secured by following the procedure outlined below:

Insert the 5 megohm grid leak in the clips of the grid leak mounting. Connect the antenna and ground to the respective clips. Connect the phones to their clips. Connect the batteries to their respective wires. Only the A battery and the first 45 volt section of the B battery are used with the detector unit. If, when the condenser plates are entirely closed or meshed with each other, the dial does not read 100, then loosen the dial set screws and make the correction. Next turn on the filament switch, turn the regeneration control partly to the right and then slowly rotate the dial knob. At first the station will manifest itself by a shrill whistle. After the whistle has been tuned in to its loudest point, then slowly retard the regeneration control until the undistorted signal of the station is heard. At this point, it may be found necessary to slightly retune the setting of the dial to bring in the station with maximum loudness. Other stations may be tuned in in a like manner.

The editorial department of this magazine will be interested in hearing from readers as to their reactions on the type of material contained in the Junior Radio Guild and whether the readers find this material of service to them. If this material does prove of benefit to them, we will be glad to continue making excerpts from the lesson sheets, although, of course, the best idea is for the ones interested to take the course themselves.

Listeners' Commandments

NOW that DX or long-distance reception is becoming possible again with the clearing of the broadcast atmosphere by the Federal Radio Commission, it is well to formulate Ten Commandments for the DX fan. And here they are, as formulated by the Clarostat engineering staff:

1. Good reception begins with the interception of ample signal strength. Therefore, make sure of a good antenna and ground connection. Joints should be soldered, or at least taped. A suitable socket antenna plug will often prove more efficient than an antenna, particularly in poor radio localities. It may be employed as a "booster," in addition to the usual antenna.

2. Reception can do no better than the tubes employed. Tubes, contrary to general opinion, do not last forever. Even if they light, that is no indication of their goodness. When tubes have been in use more than a year, they should be replaced with fresh tubes. Only tubes of a reliable brand should be used. Cheap tubes are most expensive in the end.

3. Proper A, B and C voltages should be applied. In the case of batteries, this may be done by voltage taps. In the case of

(Continued on page 138)

Digest of Science



Oil-Electric Locomotive

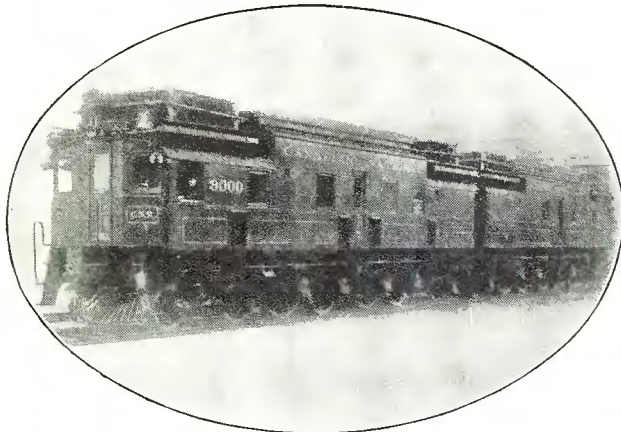

The brains of three countries, Canada, the United States and Britain, have been working to produce this Canadian National Railway oil-electric locomotive which, by utilizing an oil motor to generate electrical energy, develops speed and power at costs far below those of coal fired steam driven engines. The new locomotive, which has developed from the oil-electric car, originated by the Canadian National, is being placed in service on the main line between the Northern type now in use over the National system. The promise of its wide use in the hauling of heavy passenger and freight trains, in which it will effect an outstanding economy, is predicted by railroad engineers as certain to bring about a revolutionary change in transportation on the North American continent.

Easy Gear Shifting

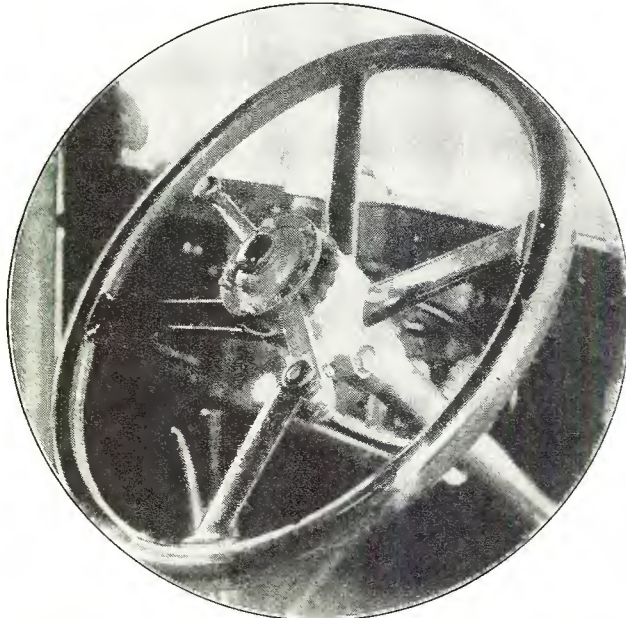

Motorists will welcome the self-changing, automatic gear shift which has been adopted by Armstrong-Sydney Motors, Ltd., of London. This innovation is simplicity itself in operation. Gear positions are clearly indicated on a quadrant on the steering wheel. These positions are reverse, neutral, low, medium, normal and high. When the driver wishes to start he turns the steering wheel pointer to low and presses the foot pedal and the car glides away. When going up a hill, the car automatically shifts from high to normal.

Spanish Easy for Parrots

Parrots learn the Spanish language easier than English or German, dealers in birds and other pets in the Southwest declare. Species of parrots from the tropics that are brought here when young are said to acquire the habit of saying the soft words of the Spanish language quicker than the rather harsh words common to the Teutonic languages. In the bird house at the Dallas municipal zoo a parrot speaks Spanish words picked

Bridge 5½ Miles Long

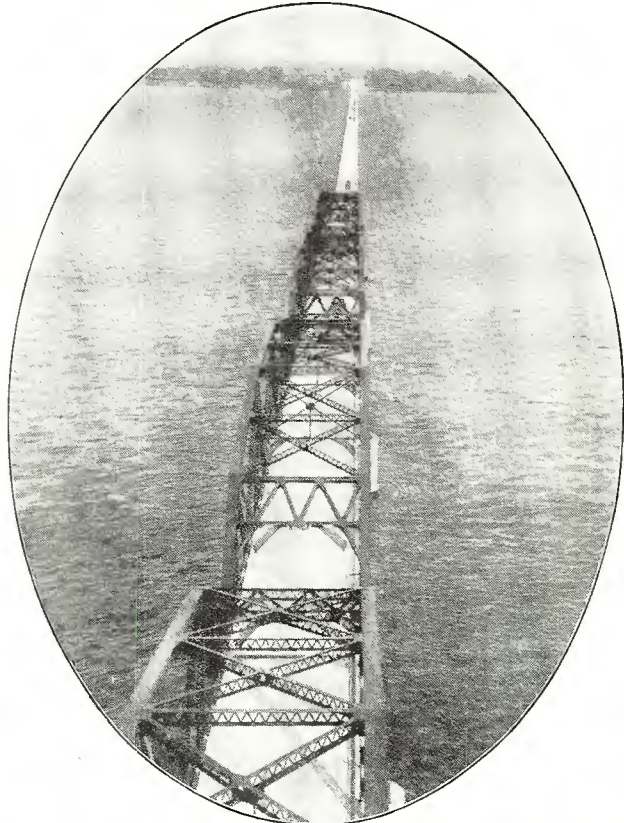

A view of the great Newport News-James River bridge leaping five and one-half miles across the James River, connecting the mainland with the Virginia peninsula, costing \$7,000,000, which was formally opened recently when President Coolidge pressed a button in Washington, D. C.

up from countless Mexican visitors and has never spoken a word in English. In El Paso a parrot learned words in Spanish and in Chinese but seldom spoke English.

Unmutilated Animal Grows New Foot

A triton, one of the lower vertebrates related to frogs and salamanders, has been induced to grow a new foot on an un-mutilated leg already provided with a foot. At a recent meeting of the Russian Academy of Sciences, Dr. N. N. Nassenow described his experiments.

It is nothing new for a triton to grow a new foot, or even a

whole new leg. Tritons seem to be able to regenerate very considerable parts of their anatomy, even including such complex organs as eyes. But hitherto they have done so only when through accident or surgical operation something was cut or bitten away.

In Dr. Nassenow's experiment no cutting took place. He merely put a bandage around the creature's leg, tight enough to put pressure on the tissues but not tight enough to injure them severely. Some time thereafter, a swelling was noted on the triton's leg, which subsequently grew out into a normally formed foot, alongside the one already normally present.

Dengue Fever Is Mosquito-Borne

Dengue fever, which has been running riot in Athens, and in fact has swept over the whole of Greece, is no respecter of persons, having finally attacked Prime Minister Venizelos himself. The total number of cases in the present epidemic has reached 80,000, according to reports received by the U. S. Public Health Service at Washington. This is an unusually large num-

X-Rays Blooming Rose

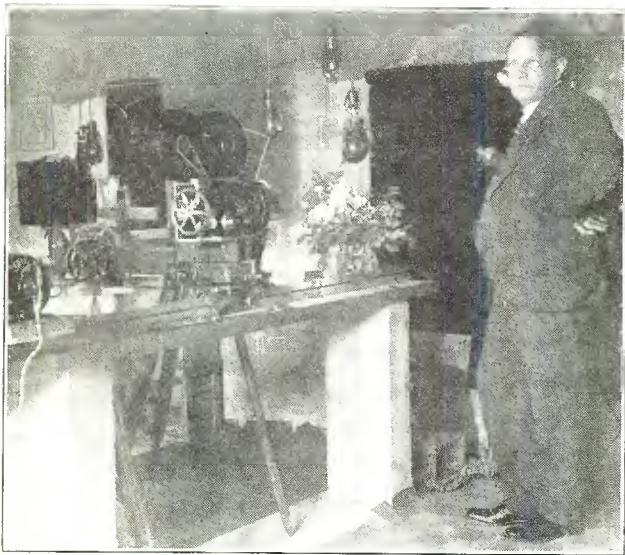

Arthur C. Pillsbury, California photo-botanist and x-ray motion picture expert, is shown in his laboratory with a machine he uses and the rose that he is now x-raying. This rose has been blooming four days and it is expected to take four more days before full bloom is reached. In addition to the study on roses, Mr. Pillsbury is x-raying and photographing the mending of a break in a rat's leg.

ber even for a warm country like Greece, where the disease occurs frequently.

Dengue fever, like yellow fever and malaria, is one of the so-called tropical diseases and is spread by the mosquito. In former times it was considered a mild form of yellow fever, but more recently it was found to be a distinct disease. It has a sudden onset, and the course of the disease is acute and short, usually seven days. The death rate is very low, the patients almost always recovering. The severe pains which characterize this fever earned it the name of "break-bone" fever.

Hypnotism Used to Capture Lizards

The capturing of lizards used to be a difficult, almost impossible, matter for Edwin D. McKee, connected with the educational forces at the Grand Canyon National Park in Arizona. Now, however, he reports it surprisingly easy, since he has learned to hypnotize them before attempting to catch them. This method, he states, applies particularly to the blue-bellied lizard, which is a particularly long and slender member of the lizard family.

The method employed is to keep one's eyes squarely and steadily focused on those of the desired animal. At the same time the hand is gradually advanced to a commanding position within a

Three-Bladed Propeller

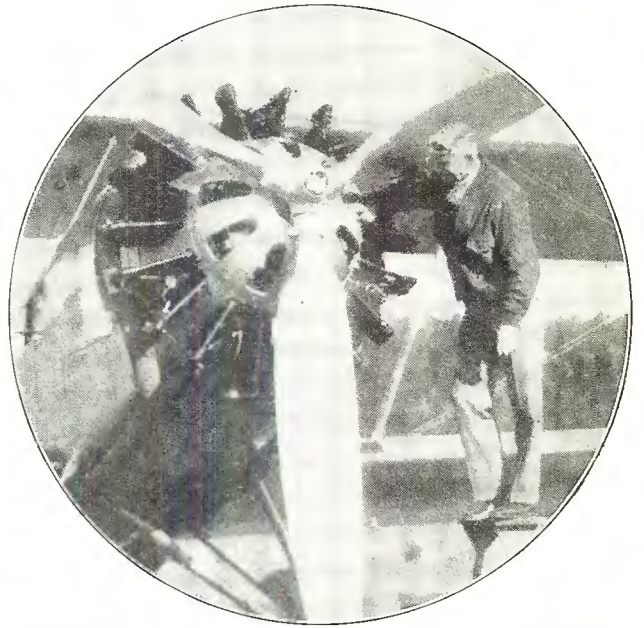

Erik Nelson, round the world flyer, now attached to the Boeing Air Plant of Seattle, is making experiments with a three-bladed propeller on the theory that the new arrangement will give the plane more lifting power and speed. Photo shows Nelson exhibiting the new propeller.

foot or less of the intended victim. Then with a quick downward dart of the hand the lizard is pinned to the rock, from which he may be transferred with ease.

Undersea Camera Gets Tide Data

A unique motion picture camera, recording automatically the velocity and direction of currents beneath the surface of the water, was used to advantage this past summer by the U. S. Coast and Geodetic Survey during what is stated to be the most comprehensive survey of tide and current conditions in Chesapeake Bay ever attempted.

While the device is so new that it has not yet been perfected fully, it has shown results that indicate it will be used as a regular part of standard current testing equipment. The camera is

Measures Value of Daylight

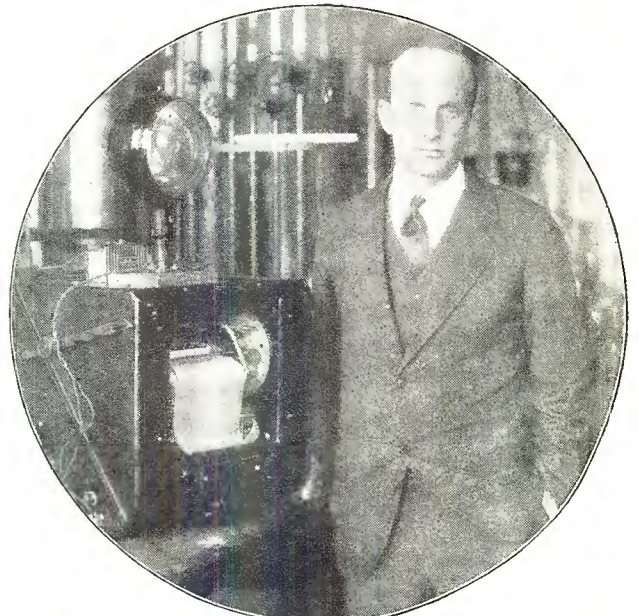

Dr. L. R. Koller, of the Research Laboratory of the General Electric Co., with his daylight integrator, a device that records the amount of daylight received over any desired period of time. The equipment consists mainly of a giant photo-electric cell, several times larger than the usual cell and two hundred times as sensitive

Folding Kitchen



An extremely serviceable adjunct to the modern one-room apartment is this fourfold screen, with all the requirements of a miniature kitchen enclosed. When not in use, it may be folded up and placed discreetly in one corner of the room. This idea is quite popular in London.

designed to take the place of a complete human observing unit composed of one boat, one officer and six men. It contains within it a compass and revolution dial of which pictures are made each half hour, and works continuously without attention for an entire week.

The purpose of the Survey's probe this summer was to bring aids to navigation, such as mariner's charts and current tables, absolutely up to date. From the data gathered this year and

High Speed Camera

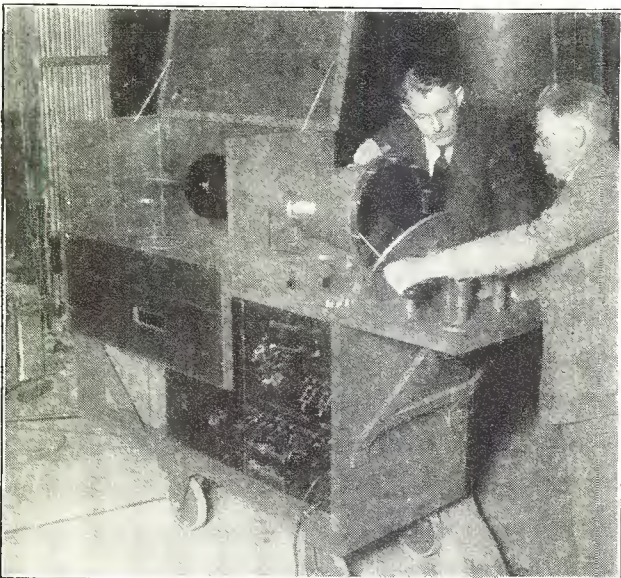

A colossal photograph machine capable of recording electrical phenomena occurring in a 100,000,000th part of a second is purchased by the California Institute of Technology at Pasadena. It will be used in the Institute high tension laboratories. The big camera is called a cold cathode ray oscillograph and will be used to study and record the antics of the electrical activities. It is the first machine of its type to be placed in an institution of learning. Professor Royal W. Sorensen, head of the electrical engineering department, explains the operation of the powerful oscillograph to Professor Chas. E. Lauritsen (left) of the Institute faculty.

last, current tables will be published from which at any future time the direction and velocity of currents at any place in the Bay may be ascertained. The information likewise will be valuable in enabling engineers of surrounding cities to make proper disposal of their sewage. They must know at precisely what point the ebb of the tide will be able to convey the sewage farther out to sea than the flood current is able to bring it back.

Fishing interests will be aided by the data since certain fish are known to bite better at certain tidal stages than at others.

Htaded by Lieut. George L. Anderson, the Survey engineers, four all told, conducted their investigations from four 65-foot launches. A unique feature was that 24 college boys, selected from leading universities in the east and mid-west, acted as special observers, their purpose being to gain technical experience to add to their engineering knowledge.

Will-o'-the-Wisp Studied by Germans

Two close-up observations of the will-o'-the-wisp, those weird and elusive flames that appear over marshy ground, have recently been put on record by German observers.

H. H. Sven, a German scientist, observed one night in November, 1927, near an iron mine in Bohemia upon a swampy tract of land, four small bluish phosphorescent flames. They were of the

New Type Movie Film



Karl Wahl, (right) and Roehrich, two Berlin engineers, who have succeeded in manufacturing a film destined to revolutionize present day methods and to reduce cost of material to a fraction of its present price. The distinctive features of the product are: it burns only with difficulty, and is free of argentine. Besides it is 50 per cent more pervious to light, thus causing a saving in electric current when projecting.

height of the candle-flame and a diameter of about an inch and were constantly hopping up and down. Near them appeared a flame of about three feet in height of a yellowish green color and diameter of about a foot. Their light was sufficient to read the face of a watch and to make notes, but the flames had no heat when touched. After the phenomenon had lasted 15 minutes they went out.

In the vicinity are several springs with radio-active water. Upon returning to the place in the day time Mr. Sven could find no trace of the source of the flames. He learned, however, that while will-o'-the-wisps appear to be independent of air temperature they are dependent upon air pressure; the higher the pressure the less the light.

Robin Breaks Ice to Take Bath

During a recent cold spell at the Grand Canyon a robin discovered the bird bath outside the chief ranger's house to be covered with ice. Many humans would have been discouraged and postponed the daily bath until the sun had a chance to get its work in. Not this immaculate robin, however, Undaunted by the icy coating of the bath he first broke the ice with his feet and then plunged in.

"Ultra-Violetted" Cereal Now Offered on the Market

A cereal food treated with ultra-violet light to give it the beneficial action of vitamin D, preventive of rickets, has now appeared on the market. This is the first commercial application of the discovery of the famous University of Wisconsin professor, Harry

Every Man His Own Cop



Pedestrians can now act as their own traffic officers with the invention of a new street crossing device by Ralph Dorsey, Los Angeles traffic signal engineer, which is now being tried out. Operated by a push-button, this work-it-yourself signal halts traffic with stop arm and red light for 15 seconds, giving the pedestrians time to cross the street, then it automatically reverts to the "clear" position. Twenty-five seconds must then elapse before another pedestrian can again halt traffic. Photo shows pupils from the Luther Burbank Junior High School in Los Angeles operating the new device.

Steenbock, that ordinary foods exposed to the action of ultra-violet rays, either from quartz lamps or from natural sunlight, will promote the formation of healthy bones and teeth in children and young animals, supplementing or sometimes even supplanting the cod liver oil which it is so hard to make children swallow.

New Aviation Test Duplicates Plane's Motion

A device that stimulates actual flying conditions and produces the psychological effect to the beginning airman of an airplane in motion has been developed at the Wright Field Experiment Flying Station at Dayton after almost a year's tests, it was revealed recently by Lieut. Albert I. Hegenberger.

As yet without a technical name but known temporarily as an "orientator" or apparatus designed to accustom the novice to the feel of the plane, the new invention is producing excellent results

New Plate Invented



A new plate, taking the place of the mat and the electrotpe, has made its appearance on the market, and all signs point to its revolutionizing the printing industry. The invention consists of a flexible plate, fabricated by a special process from a paper base so light that it can be whisked through the mails as first class matter, and yet withstand wear and tear and general knock-about handling to a degree that metal plates can not endure. The new paper plate is capable of being run off on either the flat bed or cylindrical presses, without mechanical make-ready. It is the invention of Fred C. Goldenbaum of New York. Photo shows three of the newly invented paper plates mounted on blocks ready for flat bed presses

and when further perfected may entirely take the place of the "Ruggles" orientor, the standard device of the same general nature that is in wide use today.

As a casual glance the "orientator" looks very much like the Ruggles apparatus since it is about the same size and is used in a like frame. However, it has certain marked and revolutionary differences, Lieut. Hegenberger explains. Whereas the former device is able to simulate the control apparatus of a plane and contains the actual cockpit, it has neither propeller nor engine. But the new "orientator" has all these things and is thus able to give all the plane's basic movements, such as an up and down lift, a left and right stability, the roar of the engine plus the attendant strong blast of air, and precisely the same loops and turns as are made by an actual plane in the air. In addition the "orientator" is equipped with a regulation acron or moveable flat foil that serves the ship from wobbling from side to side. The apparatus is electrically controlled and the bulk of it is covered with a fabric very similar to that of a plane.

Removes Metal from Body



Newest electrical marvels were exhibited at the recent annual electric show at the Grand Central Palace in New York. In this photograph Carmen Morales of the "Lucky Girl" cast is shown before the giant eye magnet which is capable of removing all sorts of metal from the human body. She is here demonstrating how a bit of metal is removed from the eye.

Measured Athletes' Speed at Olympics

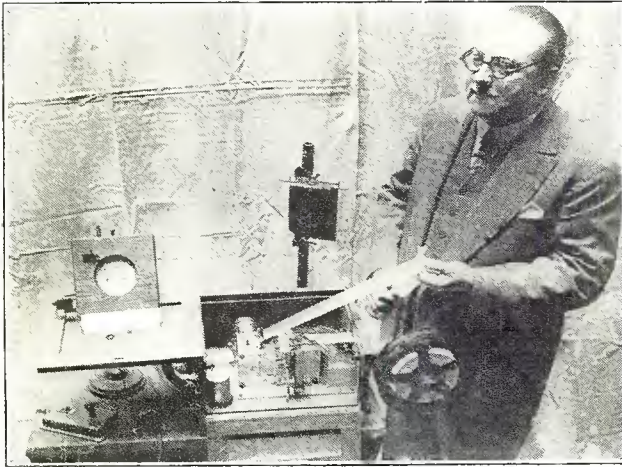

Wide World Photo

F. L. Loebner, inventor, with his newly perfected time measuring apparatus which records the speed of athletes and pictures the finish of a race at the same time. The new device was tried out at the Olympic games in Amsterdam

Radio "Echo" Tells Ship's Position

Methods of locating a ship's position by means of automatic radio signals sent out from shore stations upon the receipt of a sound signal through the water from the ship have now reached a high degree of perfection and dependability. This is the announcement made by Col. E. Lester Jones, director of the U. S. Coast and Geodetic Survey, in his annual report just made public.

Depth measurements are made by the survey's ships with the echo sounding device. A sound wave travels to the bottom, is reflected back and the time taken indicates the depth. In order properly to locate the position, however, it is necessary to know the position with respect to fixed points that can be identified on maps. With radio this can be done at night or in cloudy weather or at distances too far for the ordinary visual bearings.

"In radio acoustic sound ranging," said Col. Jones, "a sound is produced at the survey ship which travels through the water to

Tests Eyes Minutely

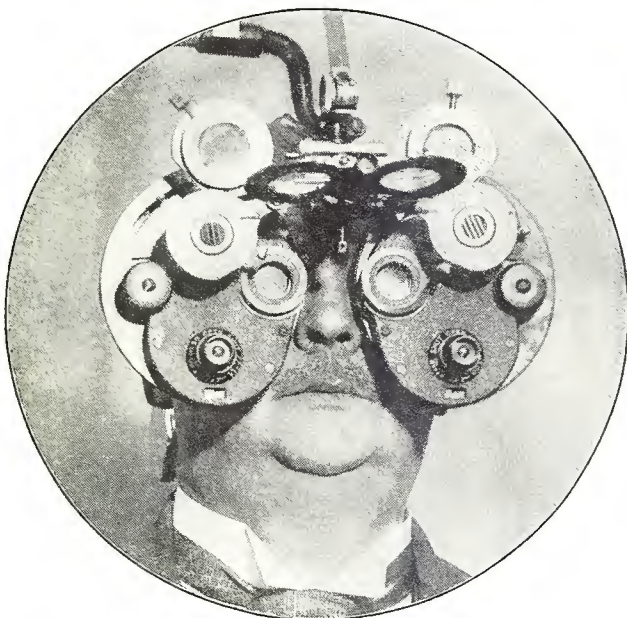

This remarkable instrument, which is in reality a battery of lenses no bigger than a cigar box, enables the optician to secure over one million combinations of lenses almost instantaneously. It is one of the various new instruments installed in the London Refraction Hospital which has been rebuilt at a cost of \$50,000. This instrument will reveal the fact that patient's eye deviates by as little as a quarter of a degree from its normal outlook.

two or more shore stations which automatically send wireless signals to the ship as soon as the sound arrives. This gives a measure of the distance of the ship from each station. Knowing the location of the two stations from previous surveying, the three sides of a triangle are known from which the ship's position can be computed."

Helium Leaks Through Glass

Glass, which about fits the average man's idea of something absolutely leak-proof unless it is cracked, isn't so tight after all. It will permit a slow leak of the valuable gas helium, even when

Waves Operate Turbines



Photo Wide World

An entire city can be furnished with electricity by this wave turbine pier, according to George E. Faucher, its inventor, who has just completed and is exhibiting his first model in Los Angeles. Built like a pier, 1,000 feet long, the "V" of the machine points oceanward and as the waves roll in they are split and operate two series of turbines on both sides of it. The turbines are made of steel and encased in air and watertight tanks that float. The force of the waves is caught in air and wings that send the turbines spinning, according to the inventor. Constant storing of electric energy thus developed will require the largest storage battery ever built. The turbines will float so high that high and low tide present no handicap.

the high-quality pyrex variety is used, according to results of an experiment by Prof. G. P. Baxter, Dr. H. W. Starkweather and Dr. R. B. Ellestad of Harvard University, which will be reported in the forthcoming issue of Science. The three experimenters sealed up 1044 milliliters—something over a quart—of helium in a pyrex glass globe and left it there for over a year, weighing it carefully at intervals. At the end of 366 days it had lost 10.7 milliliters, or over one per cent of its original content, by slow seepage through the glass.

Pulleys, Not Hearts, Raise Sap in Trees

Sap does not rise in trees, it gets pulled up. There are no hearts or other pumps, and the mysterious "root pressure" that used to be talked about is little more than a myth. And water, though "as weak as water" in large masses, is as strong as wire when confined within the walls of the tiny tubes that make up the sap-wood of trees.

These are elements in the picture of the inside of a plant's water-distributing system, worked out by Dr. D. T. MacDougal of the Desert Laboratory, Tucson, Ariz., who lectured recently before the Carnegie Institution of Washington. One of Dr. MacDougal's most recent discoveries is that the air confined in the deal vessels of a tree trunk forms a single connected system, just as the sap does. By applying pressure instruments to different

Test for Radium Poisoning



Photo Wide World

To prevent any repetition of the famous "radium poisoning" case in the East, employees of Los Angeles concerns making luminous dial-appliances are tested for any poisonous effects through the use of an ingenious apparatus devised by Capt. H. R. Zimmer, famous radium products technician. Capt. Zimmer is presiding in tests of all radium products employes which started recently at the Pacific Radium Appliance Company in Los Angeles. Miss Helen Pimmings is being tested while Bernice McGalliard makes notes. The new testing device is said to be the only apparatus in existence of its kind and operates by testing the radio-active reaction from a person's breath.

parts of the tree's anatomy, he discovered that changes of pressure in one part of the confined air were rapidly transmitted to all parts of the tree.

Electric Meter Keeps Tab on Planes' Gas

No longer will aviators have to guess at their fuel supply when the gasoline gauge freezes or breaks. A simple and strongly constructed electric meter, connected by wires to the bottom of the gas tank, may tell the gas supply in future planes. The new gauge is the invention of J. H. Payne, of the General Electric Company. By means of a diaphragm at the bottom of the tank with a pile of small pieces of carbon back of it the exact weight of the gasoline is measured. It will measure the amount of fuel in the tank to within an eighth of an inch, or about 1 per cent of the amount.

Measures Body Electricity



J. Vacher, a Berlin engineer, who has invented a device called "Jonisator," which he claims will show the amount of electricity in the human body. He proves this by fixing to one part of the body a zinc sheet, to another part of the body a copper sheet. Connecting the two to a sensitive galvanometer, the amount of electricity in the body may be determined

Mechanical Crew-Saving Lung

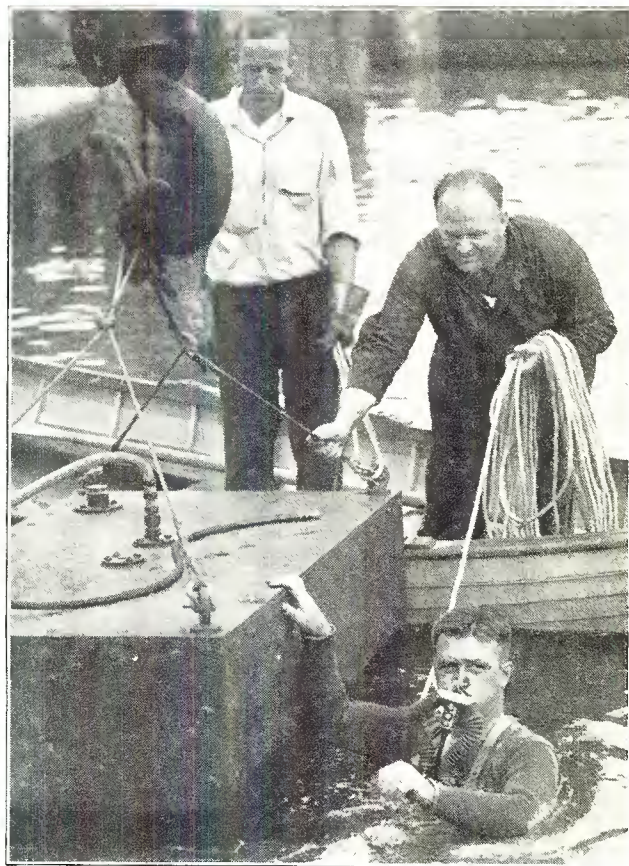
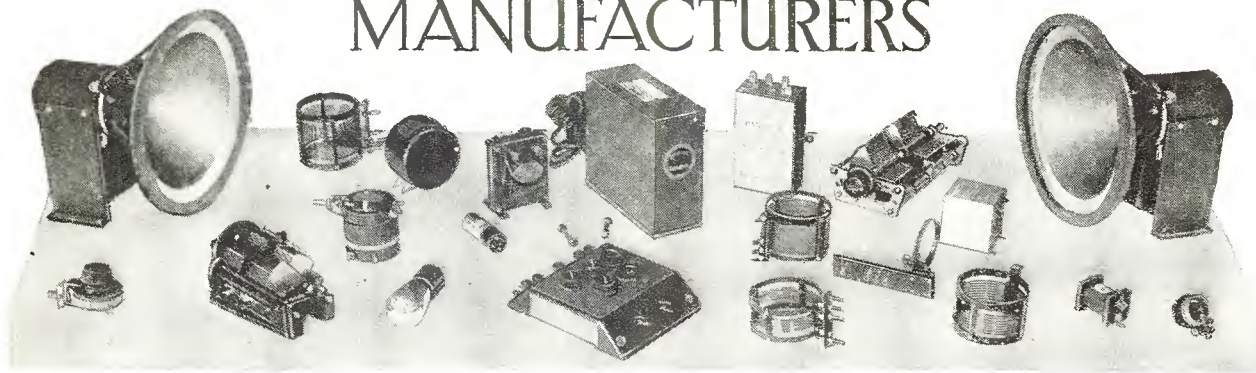

Photo Wide World

Lieutenant C. B. Momsen demonstrating the use of his new safety device, called "The Lung," which will enable the trapped crews of sunken submarines to leave the craft at will. Assisting him into the boat is Chief Gunner C. O. Tibbals of the Washington Navy Yard who assisted in developing "The Lung."

WITH THE ACCESSORY & PARTS MANUFACTURERS



Use Full Wave Rectifier Circuit As Exciter in Muter Dynamic

New Arrangement Permits Use of Proper Filter to Kill A.C. Hum;
Simplifies Replacement

Muter Dynamic Rectifier Circuit

EMPLYING a much more simpler and efficient rectifier circuit, the new Muter a. c. dynamic speaker announced for the 1929 season has been placed in production and by the time this magazine is on sale it will be available throughout the country. The Muter 1929 dynamic represents the last word in electrical reproducers, designed for universal use, and will give satisfactory results when used with either an ordinary radio set or a special power amplifier for phonograph work. It is entirely free from any inherent tone pitch and when used with a proper baffle, it will faithfully reproduce without distortion or alteration whatever sounds are fed into it through the amplifier system. A photograph of the new unit is shown in Fig. 1, while in Fig. 2 is a schematic and graphic combined sketch giving an idea as to the rectifier circuit together with the connections involved in the speaker.

Because of its mechanical and electrical construction, the Muter dynamic is able to reproduce to its full value low notes which would scarcely be audible on the reproducer of a magnetic type. However, this does not necessarily mean that the use of a Muter on any radio set will bring out bass notes with the desired volume. These notes must first come through the audio amplifier system with proper intensity. There are three different models of the 1929 Muter dynamic, varying in accordance with the method of exciting the electro-magnetic field. These three

units are supplied in a handsome walnut cabinet, as well as in the manufacturer's model, which is the unit form. The three units are alike in every respect, except the method of exciting the field, and when properly used will be identical in performance from the standpoint of volume and tone quality. Type No. 4310 for 110 volt a. c. is designed for field excitation on any 105 to 125 volt alternating current source of supply. It is the model recommended for general use wherever an alternating current supply in the above voltage range, such as the ordinary house lighting supply, is available for excitation. When the field is properly excited, this model will perform equally well on either a. c. or d. c. radio sets.

Because direct current is required to excite the magnetic field, it is necessary to provide some means of rectifying the 110 volt alternating current. In the 4310 Muter, the dry rectifier has been replaced with a 280 vacuum tube rectifier. This has enabled Muter to incorporate a special filter circuit not possible with the dry rectifier, eliminating the 60 cycle hum which has been an annoying factor in the operation of any 110 volt a. c. dynamic speaker previously. The tube is also a much more practical rectifier, inasmuch as it can be quickly, easily and cheaply replaced. The sketch shown in Fig. 2 is a schematic diagram of the 4310 unit, with its rectifier and filter circuit. This model is supplied with a 6 foot cord for input connections and a 10 foot lamp cord and plug for the field connection. A switch is provided in the cord; when the speaker is not in use, care should be taken to turn this switch to the off position, to prevent undue wear on rectifier tube.

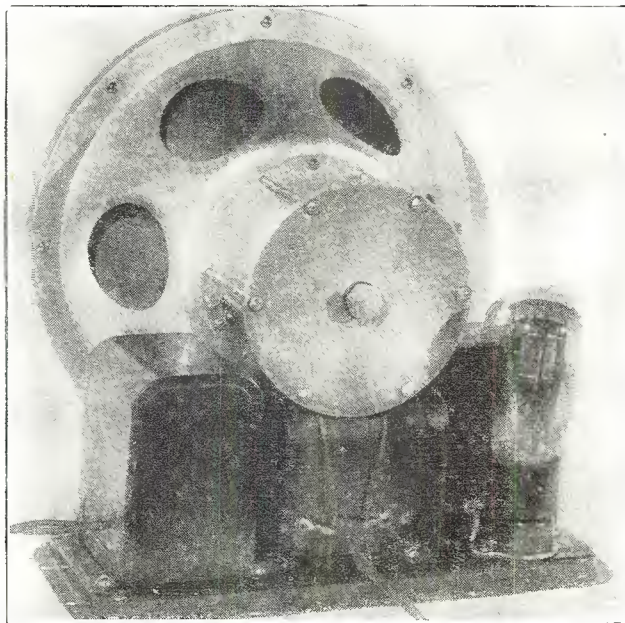

Fig. 1

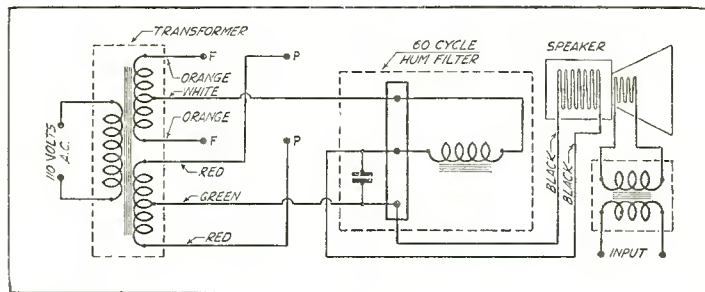

Fig. 2

When the speaker is used with an a. c. set, it is often possible to connect the field lead to the 110 volt line inside of the set in such a manner that the power switch on the set will control both set and speaker. If the user is not familiar with the proper method of accomplishing this, a competent service man or professional set builder should be consulted.

Another model of the Muter using the 280 rectifier tube is the 4410 unit, in this the back of the cabinet must be unscrewed in order to insert the tube in the place provided in the base of the unit. After the tube has been inserted and the speaker tested, the back should be replaced and care must be taken to insure that it is screwed down tight to prevent rattle. Rectifier tubes are not supplied with either the 4310 or 4410 models. Any 280 type full wave rectifier tube, such as the CX-380 or UX-280 may be used.

The direct current models are 4390 and 4490, the 4390 having a field resistance of 2300 ohms designed for excitation on 90 volts to 180 volts direct current. It may be used in cases where the lighting circuit is 110 volts d. c. and also in connection with radio sets and power or phonograph amplifiers that provide special field connections for dynamic type speakers. When used in connection with such devices, care must be taken to insure that the current passing through the speaker field is not less than 40 nor more than 80 milliamperes. The 4390 is especially adapted for use by amateurs and set builders in connection with power amplifiers, etc., where it is desired to excite the speaker field direct from the B supply system, thus avoiding the additional cost of a special rectifier for the speaker.

The 4490 dynamic consists of a 4390 unit in a handsome walnut cabinet. In this model a 6 foot phone cord is provided for input connections and two 8 foot wires for the field connection.

Battery operated types are the 4306 and the 4406, the 4306 unit being designed for field excitation on six or twelve volts d. c. The field may be excited either from a 6 volt battery or a 6 volt battery charger.

The 4306 unit is intended to be used in connection with battery operated sets in cases where the 110 volt house lighting current, either a. c. or d. c., is not available. The 4406 unit is a 4306 unit installed in a handsome walnut cabinet. This also has 6 foot phone cords for input connections and two 8 foot leads for the field connection.

From the professional set builders' standpoint, as well as that of a manufacturer embodying dynamics in the cabinets or consoles of receivers, it is quite likely that the 4310 unit will be very well received. The replacement problem of a rectifier in that model is quite simple, as contrasted to the replacement of other forms of rectifiers. This point alone should be of interest to a professional set builder, who is called upon to do frequent servicing in his locality. Another important feature is the fact that by the use of this rectifier circuit, it is possible to eliminate more a. c. hum than by any other method, and this should go a long way towards satisfying the critical buyers of dynamic speakers, who wish to have something that is entirely free from extraneous noises.

New Weston Set Tester

THE Weston Model 537 a.c.-d.c. radio set tester is a complete outfit, most ingeniously designed and fully adaptable to the testing requirements of every set made, whether operated by direct current from batteries or battery substitutes, or by alternating current from socket power.

It will measure the various currents and voltages employed anywhere in the set, including those at the tube sockets. All

tests can be made by using the regular voltages normally supplied to the set by its batteries or socket power without the necessity of changing connections. Nor is any auxiliary power required.

The set is provided with two instruments—an a. c. voltmeter and a d. c. volt-milliammeter. An ingenious system of switches and binding posts provides for automatically connecting the instruments to the circuits being tested. The a. c. voltmeter has three ranges—150-8-4 volts—the lower ranges being required for measuring the filament voltages of tubes, and the highest range is provided for measuring the line voltage. The d. c. volt-milliammeter has four voltage ranges—600, 300, 60 and 8 volts and two current ranges—150 and 30 milliamperes. All voltage ranges have a resistance of 1,000 ohms per volt. The set is furnished with the necessary socket adaptors and a complete instruction book.

It is made by Weston Electrical Instrument Corporation, Newark, N. J.

Webster Auto-Potentialator

AN interesting item being marketed this season by the Webster Company, 850 Blackhawk Street, Chicago, Ill., is known as their potentialator for a. c. voltage regulation.

The new Webster autopotentialator provides complete automatic regulation of a. c. current. It delivers to the a. c. set or the A and B eliminator absolutely even flow of alternating current of the exact voltage necessary for the most successful operation of any make of receiver. Entirely automatic, it contains no tubes or liquid, needs no complicated adjustment and affords protection from sudden line fluctuations that occur in a. c. lighting circuits.

It is sturdily built, small in size. It slips out of sight in the console or other place where the radio set is being operated. It measures 8¾x4½x5¼ inches.

Amperite Blue Book

BEGINNERS in radio and others who are not well versed in the art may find considerable information in the Amperite Blue Book of radio information, issued by the Radiall Co. of 52 Franklin Street, New York City. Matter that is especially interesting may be found on pages 8 and 9, where a current problem is described. Simple charts are shown to give an idea as to the operation of a tube with Amperites in the filament circuit.

There is also a chapter in the little booklet on voltage regulation for the a. c. tubes, wherein the new Amperite made for the 226 and 227 tubes is described and methods of installation are explained.

Interesting Magnavox Booklet

DESPITE the tremendous interest in the subject of dynamic speakers, and this year this type of speaker is proving even more popular than ever before, there is still a demand for a plainly written booklet covering the principle of the electro-dynamic speaker.

We believe the recent booklet issued by the Magnavox Co., 4250 Horton Street, Oakland, Calif., covers the subject very fully and should be of more than ordinary interest to those who have been wondering what actually goes in the dynamic speaker. There are some historical sketches which show the dynamic principle as pertaining to reproducer design, and also showing that this particular design was not new to the Magnavox interests as early as 1911, seventeen years ago. By careful perusal, even the layman can grasp the true meaning of the word dynamic. In this booklet there are a number of small sketches which give an idea as to the operation of a dynamic speaker.

Those interested in this subject may secure a copy of this interesting booklet by writing the Magnavox Co. at the address given above.

(Continued on page 114)

SM

The Synonym for Quality Audio Amplification—S-M

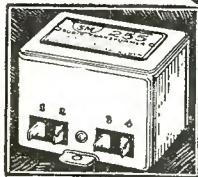

To the proven "finest audio transformers ever made" S-M now adds push-pull transformers of utterly unequalled performance!

The S-M 255 and 256 transformers at \$6.00 each, and the 225 and 226 units at \$9.00, each introduced the Clough audio system. Just how good they are is told by two things. Sold on the only "better or money-back" guarantee in the business, hardly a one has ever been returned, and more are sold today than any other supposedly high-quality transformers.

Now S-M offers push-pull transformers built on the Clough system—transformers unconditionally guaranteed finer than any and all competitive types. The Type 257 is a push-pull input type to operate between a magnetic record pickup or one 201A, 112A, 226 or 227 tube and two 112A, 226, 227, 171A, 210 or 250 power tubes. Its frequency characteristic is practically flat from 40 to 8,000 cycles in an A.C. or D.C. amplifier, yet its price is but \$7.00 in the popular 255 type case. Type 227 is a dual push-pull transformer to operate out of two 201A, 112A, 226, 227, or 171 tubes into two power tubes such as 112A, 226, 227, 171, 210, or 250 types. Its characteristic is flat from 40 to 8,000 cycles in A.C. or D.C. amplifiers. Price in new 255 type case 3 1/2" high, \$9.00. (Both 257 and 227 transformers show a desirable—and exclusive—slight accentuation of bass notes between 40 and 150 cycles.)

Type 258 push-pull output choke is intended to operate out of two 171A or 210 power tubes into any standard magnetic or dynamic speakers, and is provided with taps for exact impedance matching. Its frequency characteristic is flat, its core will not saturate from 171 or 210 plate currents, and its price in a 255 type case is only \$5.00.

Type 248 Universal output choke is for operation out of two 171 or 250 type tubes into any normal combination of standard magnetic or dynamic speakers. It is provided with impedance adjusting taps, and is designed to operate out of two 250 tubes with absolutely no danger of core saturation. It allows a flat frequency characteristic over the entire audio range, or bass note accentuation if desired. Upon the addition of a 1 mfd. condenser it may be operated with one 250 tube as an adjustable impedance tone filter. The 248 is the output device you have been waiting for, carefully designed to meet a demand filled by no other output device—yet its price is but \$7.00, in 240 type open mounting (or \$8.00 as type 248 in same size case as 227).

Look these new prices over—they tell you that nowhere else can you get the value in quality and price that S-M offers.

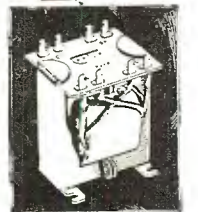
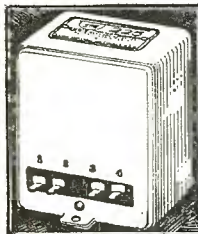

THE S-M reputation for high quality audio transformers is so well known that there isn't much to write about it. It is based on one basic fact—that S-M makes the finest audio transformers available, bar none. And not alone does S-M simply say this—S-M proves it by making public comparative tests against other standard transformers as no other manufacturer has ever dared to do. And no person has ever yet heard or made such a fair test and retained any other idea than that S-M makes the best a.f. transformers in America today.

Of course, you don't find S-M audio transformers in ready-made sets—and you don't find S-M tone quality in ready-made sets either. The reason is simple. Set manufacturers pay sixty cents, or maybe a dollar (for their several-hundred-dollar sets), for audio transformers, and no one, S-M included, can make quality audio transformers for sixty cents or a dollar. And then, again, S-M doesn't price a transformer to you at \$6.00 or \$8.00 and then turn around and sell it for a tiny fraction of that amount to some set manufacturer—no, a \$6.00 S-M transformer costs a manufacturer more than competitive \$8.00 and \$10.00 types—simply because there is more actual quality in S-M.

But on the other hand it happens not infrequently that still another set manufacturer's engineers will say "Yes, our tests show you've got the best tone, but our buyer simply won't let us pay the price." Another well-known Chicago manufacturer of expensive sets said that a few days ago. And the head of the testing laboratory of one of the country's few really large and great manufacturers said, unofficially, recently "We ran curves on your 225 and 226 transformers. The curves looked better on paper than those of any transformers we make, so we substituted a pair of S-M's in one of our amplifiers. We couldn't help but notice the improvement." And so it goes.

But where price doesn't count—take theatrical sound reproduction and group address work for instance—S-M sells the largest makers of theatrical phonographs; the U. S. Shipping Board selected S-M Unipac amplifiers when it needed such equipment. Users of other audio equipment come to S-M every day. Their story is: "We want better quality—hang the price." And S-M gives it to them.

That's about the story—if you want the superior tone quality for which the S-M name is synonymous today, you can't find it in ready-made sets where price is the governing factor. But you can find it in custom-built sets. And just how good S-M audios are—how far S-M is ahead in engineering—is well illustrated by the fact that the Clough audio system introduced by S-M last June was copied by competitive parts manufacturers as soon as it was out! Imitation, they say, is sincere flattery.

If you build professionally, write us about the Service Station franchises. Or if you don't build, yet want your radio to be custom-made, S-M will gladly refer your inquiry to an Authorized Silver-Marshall Service Station near you.

Are you receiving "The Radiobuilder" regularly? Every issue describes new and interesting radio developments. To all Authorized S-M Service Stations, it comes free of charge; to others a nominal charge is made. Use the coupon.

SILVER-MARSHALL, Inc.
836 West Jackson Blvd., Chicago, U. S. A.

Silver-Marshall, Inc.
836 W. Jackson Blvd., Chicago, U. S. A.

...Please send me, free, the complete S-M Catalog; also sample copy of The Radiobuilder.

For enclosed.....in stamps, send me the following:

... 50c Next 12 issues of The Radiobuilder

... \$1.00 Next 25 issues of The Radiobuilder

S-M DATA SHEETS as follows, at 2c each:

... No. 1. 670B, 670ABC Reservoir Power Units

... No. 2. 685 Public Address Unipac

... No. 3. 730, 731, 732 "Round-the-World" Short

Wave Sets

... No. 4. 223, 225, 226, 256, 251 Audio Trans-

formers

... No. 5. 720 Screen Grid Six Receiver

... No. 6. 740" Coast-to-Coast" Screen Grid Four

... No. 7. 675ABC High-Voltage Power Supply and

676 Dynamic Speaker Amplifier

... No. 8. Sargent-Rayment Seven

... No. 9. 678PD Phonograph Amplifier

.....Name

.....Address

Tell 'Em You Saw It in the Citizens Radio Call Book Magazine and Scientific Digest

SM

Japan, Australia and New York — from Los Angeles — in a Single Evening

Get this remarkable receiver from W. C. Braun Co.

YES, that's a mouthful—and it's an earful, too—the kind of earful that owners of the Sargent-Rayment Seven get a couple of times a week out on the West Coast. And if you don't know it, any radio set that can "do its stuff" in California—noted for the country's poorest reception conditions—is a radio set and a half.

But this is not intended to be the usual kind of radio advertisement in which an imaginative ad man tells you all he thinks some radio set will do—not at all. It's intended to tell you only what the Sargent-Rayment Seven has done, day in and day out, rain or shine. Then you can decide on facts, not fancies, if it is the set, or "just another set."

In Chicago, on sweltering summer nights, Sargent-Rayment 710's have tuned in over one hundred stations on a single evening. Night after night East Coast, West Coast, Gulf Coast and Canadian stations have come in on the speaker, not 5,000 watt super-power stations, but little 100-watters which ordinary sets never hear.

In New York City in August, in a steel building in the towering financial district, Frank McDonell, well-known engineer, tuned in stations no other radio set had ever brought in there before, even in winter! And Mr. McDonell, a cold, practical engineer, wrote that the 710 was "without question the finest receiving set of any type or description that we have ever demonstrated here in New York."

On the West Coast again, Kenneth G. Ormiston was so surprised at the results he obtained from a 710 that he did what he had never thought it worth while to do with any radio set before—have a try for the Japs and Australians, not from the usual hand-picked location, but right from the heart of Los Angeles City. And at 4:00 A.M. he got four Japs and 4QJ of Brisbane, Australia on the speaker! Today 710 after 710 brings them in several times a week; under the new allocations, these same California 710's bring in New York regularly, not for one, but for practically every owner.

Out in Colorado, a man hooking up a 710 short-circuited his antenna lead to the grounded metal set cabinet. Not a peep. Then he pulled off the cover, and accidentally touched his little finger to the second r.f. stage grid. In came East and West Coast stations, with only his body for an antenna. When he fixed the antenna connection, East Coast stations nearly tore the speaker to pieces!

And so it goes. One man gets stations no other set would ever bring in before—another hears JOAK, Japan from Chicago—another splits hairs and gets not 100, but over 150 stations in a single evening! And their letters—letter after letter telling of never-equalled results—are in the S-M files.

But one fact stands out above all else.

In direct comparative tests against the finest ready-made and custom-built sets on the market, the 710 has never failed to get more stations, with greater volume, finer tone and less interference, under identical operating conditions, than any and all other sets.

That's what S-M tells you. It's what Sargent and Rayment tell you. It's corroborated by what not one, but hundreds of letters written by men who have built and used enough sets before the 710 to "know their onions" say—and it's what we tell you, too.

If facts, not fancies, influence you—well, you've got a 710 right now. But if you haven't—well, when you finish your first evening's tuning, you, too, will say that the flightiest ad-writer's fancies couldn't begin to tell what this set will really do—right in your own home, not in some "hand-picked" location.

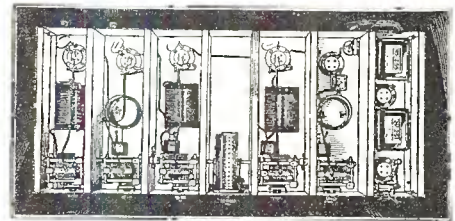
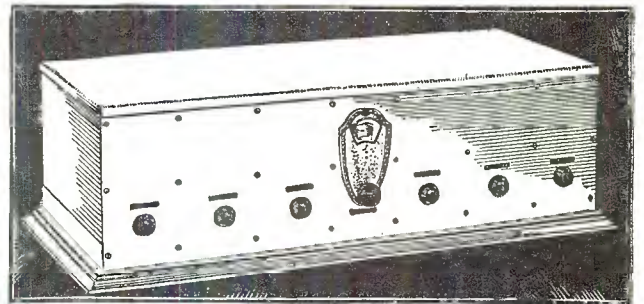

The Sargent-Rayment Seven is the first and only set to offer all the advantages of four stages of screen grid and tuned r.f. amplification, and the unsurpassed tone quality of the S-M Clough audio system—the first and only set to give one-dial control, yet at the same time individual stage trimmers that mean the last drop of sensitivity when you want it. And its seven tubes, with 171, 210, or 250 power tube, do a giant's job. Fine tone or hair-splitting selectivity, super-distance or local programs with thrilling quality—they are all at your finger-tips in the 710 Sargent-Rayment. The complete kit will be shipped from stock for \$130.00—or the fully factory-wired and guaranteed set for \$175.00. Both are complete with handsome satin aluminum shielding cabinet—and the key to radio results you've never had before.

OFFICIAL WHOLESALE DISTRIBUTORS FOR S-M PRODUCTS

As official wholesale distributors for the products of the Silver-Marshall laboratories, W. C. Braun Co., Wholesale Radio Headquarters, offers you this big line of radio merchandise with the assurance that your orders will be filled on the very day they are received. Our plant is located very close to the Silver-Marshall factories and we can give you service on your orders impossible to secure anywhere else. Order your favorite S-M parts, kits and supplies here. You'll save time and money.

In addition to the complete Silver-Marshall line, we offer you a complete line of everything in the radio field—sets, radio furniture, tubes, power units, portable receivers, dynamic and other speakers, parts and kits for all popular circuits advertised in the leading radio publications, short wave and television supplies, short wave transmitters, radiophones, public address systems, novelties, etc.

Special departments include auto tires and tubes, auto accessories, electrical goods, lighting fixtures, wiring material, household appliances, stoves, vacuum cleaners, washing machines, camping equipment, sporting goods, golf and baseball supplies, outing clothing and thousands of everyday necessities.

Our centralized location insures fast service to customers in all parts of the country.

Thousands of choice bargains are shown in the big 1929 Braun Catalog. If you haven't a copy, send for it at once. It is free—mail the handy coupon now.

W. C. BRAUN CO.,
590 W. Randolph St., Chicago

Dear Sirs: I am not receiving the W. C. Braun Co. Catalog regularly. Please put my name on your mailing list of set-builders and dealers, giving me the prices and information on S-M parts and other merchandise. My letterhead is attached.

.....Name
.....St. & No.
.....City.....State

W. C. BRAUN COMPANY

Pioneers in Radio

590 W. Randolph St.

CHICAGO
ILLINOIS

Tell 'Em You Saw It in the Citizens Radio Call Book Magazine and Scientific Digest

SM

Supposing We Told You Something That Isn't a Secret?

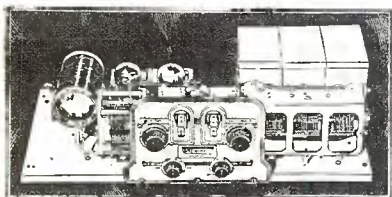
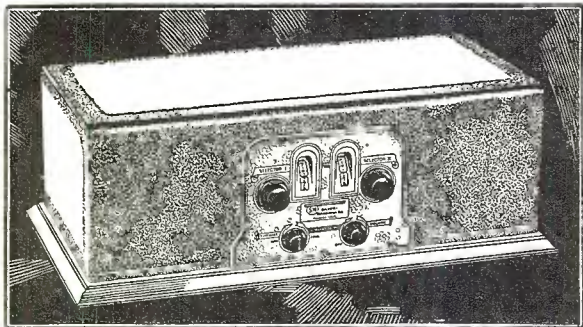

SUPPOSING you could look at our records—suppose we told you that the S-M 720 Screen Grid Six is the largest selling kit of the season—what would you say? Maybe you'd say it must be a good set. Then suppose you asked your friends, and you looked around, and you found out for a fact that more S-M 720 kits had been built this season than any other high quality kit—what then? Wouldn't you begin to believe that the 720 must be about the best value on the market?

And suppose, again, that right now you could hear this set, tune it for an hour or two—well, then you'd anxiously wait until the expressman brought you yours too.

The plain cold facts are simple. The Silver-Marshall 720 is a six tube t.r.f. set using three screen-grid r.f. tubes, a detector, and two stages of S-M Clough audio amplification. It's an all-metal, shielded assembly, just like the finest ready-made sets, with its own attractive two-tone brown metal shielding cabinet, its antique brass escutcheon plates with two dials, a volume knob, and a small selectivity knob. Yet this set with its three stages of screen-grid r.f. amplification, and its audio system that money can't buy in a ready-made set, costs you but \$72.50 for the S-M packed kit, or \$102.00 for an S-M custom-built wired receiver complete with cabinet.

We don't need to tell you that that's a "buy," if there ever was one—our sales prove it. Any way you look at it, 10 to 15 kilocycle selectivity, regular 2,000 mile enjoyable reception range, tone quality you simply can't find in ready-made sets at any price, is dirt cheap at \$72.50, and when Silver-Marshall backs the 720 as the season's biggest value—well, our sales prove it.

Now You Can Have a 250 Power Amplifier Right in Your Set

The S-M 675ABC Power Unit is what you've been waiting for. It comes with an adapter which you put in the last audio socket of your set—any set—and then you put a 210 or 250 super-power amplifier tube in this adapter. Presto!—the 675 supplies all ABC power to the new power tube (without a single change to the set) and replaces all B batteries or other B eliminators as well. (It will also supply A and C power to A.C. tubes).

Add a 675 to your set and you have all the advantages of the fine, full, sonorous tone the super-power tubes bring—tone you find only in

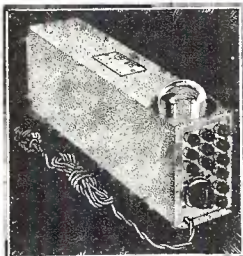

\$300.00 to \$500.00 factory-built sets—yet you can add it to your set for \$54.00 plus two tubes!

The 675ABC power supply is ready for same-day shipment at \$54.00 for the kit, or \$58.00 fully wired with adapter. It needs one CX381 rectifier tube at \$7.50 and one CX310 super-amplifier at \$9.00, or one CX350—the "daddy of them all" at \$12.00.

If you've got an S-M 720—well, a 720 Screen Grid Six and a 675ABC unit makes a tone combination that will simply make thrills run up and down your spine when you first listen to it.

We carry a full line of S-M Products: each of the kits, amplifiers, and power supplies listed in this section is a specialty with us, and can be shipped promptly from stock. The new edition of our catalog contains a splendid showing of the finest quality kits, parts, and accessories to be found anywhere. The coupon will bring it to you, free.

MAXIMUM DISCOUNTS TO DEALERS



WESTERN RADIO MFG. CO.
128 W. Lake St., Dept. SM-1
Chicago, Ill.

Please send at once your new FREE catalog, listing S-M parts and kits as well as many other highest-quality radio products.

.....Name

.....Address

.....Town and State

Western Radio Mfg. Co.

"The Big Friendly Radio House"

128 W. Lake Street

Chicago, Illinois

Tell 'Em You Saw It in the Citizens Radio Call Book Magazine and Scientific Digest

S-M

**This Is the Type of Kit that
GRAYMORE
Heartily Recommends
and Can Ship from Stock**

FROM Graymore of New York you can get immediate delivery of all S-M kits and parts from the *biggest stock outside the S-M factory*. That's what Graymore thinks of the S-M quality that makes for S-M popularity. And you'll agree with us once you've had a taste of that long sought, but seldom found, prompt service that Graymore gives on tested and approved S-M apparatus.

Take the 710 for example—a wire will bring you express shipment the same day. And once you put it together, you begin to find out what radio reception to the nth degree is. Right in our steel frame office building, in downtown New York, the 710 will bring in Texas, Florida, Chicago, Davenport, and Canada—and many stations that we've never been able to get on any other set. And tone—S-M audio transformers are the best guarantee we know for that. The 710 can be had just as promptly from Graymore custom-built by the S-M factory at



S-M 710 KIT includes the full set of satin-finished aluminum plates which build up into the handsome cabinet shown.

S-M 720 KIT includes pierced metal chassis, but not the cabinet. S-M 700 metal shielding cabinet is extra, but is included with the WIRED S-M 720 receiver.

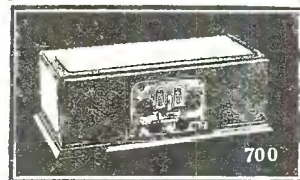

\$175.00 as the kit at \$130.00, complete with cabinet.

And the S-M 720 Screen Grid Six—we've sold hundreds right here in New York to fans who build not one, but build 720 after 720 for their enthusiastic friends who've heard this biggest kit value of the season. Three screen-grid r.f. stages, detector, and two Clough audio stages—no wonder the 720 makes friends for Graymore and S-M, and keeps us hard-pressed to maintain stock. But we can make same-day shipment of the 720 kit at \$72.50, of the 700 Shielding Cabinet at \$9.25, or of the S-M custom-built set with cabinet at \$102.00.

And besides a big stock of every popular S-M item, we've got plenty of the new 678PD 2-stage dynamic speaker A.C. amplifiers that are so popular for movie theatres and for rejuvenating older sets—good on distance, but out-of-date on tone. This big 250 amplifier is ready for you—the 678PD WIRED at \$73.00, the KIT at \$65.00.

Graymore Super ABC Power Units

Graymore engineers have developed two special ABC power units, and then, to insure the utmost in quality, contracted with Silver-Marshall to build them to Graymore designs.

The Graymore 250 Super ABC is a complete light-socket ABC power supply that converts any set at all (without change) to use a 210 or 250 tube. It supplies A, B, and C power to A.C. and power tubes. All you have to do to bring any set up to super-power performance and "250" tone is to add a Graymore 250 Super ABC. Thru its adapter—which adapts the last stage audio socket of your set to a 210 or 250 tube—the 250 Super B furnishes all ABC power to the power tube, and B power to any D.C. set, or ABC power to any A.C. tube set, of course. The 250 Super ABC is a wonderful buy, and Graymore is proud to offer it at \$34.50 net—

for prompt shipment from stock. One CX381 tube is needed at \$7.50, and one CX310 power amplifier tube at \$9.00, or one CX350 at \$12.00

And for 171 or 112 equipped sets Graymore has the 171 Super ABC—an ABC unit made by S-M to Graymore specifications. It supplies 1.5 volts, 2.25 volts and 5 volts A for A.C. and power tubes; and 45, 90, 135, and 180 volts B, plus the exclusive Graymore feature of a high power B+ post for 171 push-pull amplifiers. This post supplies full 220 volts—180 for B and 40 for C; yet with this special feature, fully hum-free and backed by the double-barrelled Graymore-S-M guarantee, the Graymore 171 Super ABC costs but \$16.50 net! It requires one CX380 tube at \$4.25 for operation.

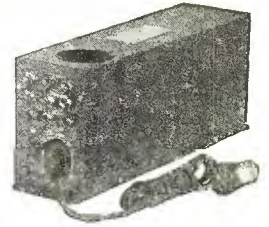
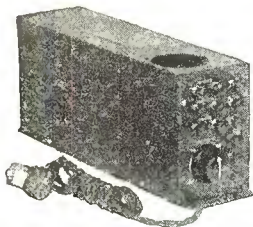

Headquarters for S-M Parts and Kits

WE are one of Silver-Marshall's largest jobbers, and can fill promptly your mail orders for S-M, as well as for other high quality merchandise. Send coupon for our new catalog. Best discounts to dealers.

Prompt shipments on all items of the S-M line, including the new 678PD Phonograph Amplifier, the 740 and 740AC "Coast-to-Coast" Fours, the 730 "Round-the-World" Short Wave Kits, Unipacs, and power supplies and transformers of all types, including the new Clough-system push-pull audios.

Graymore Radio Corporation

142 Liberty St.

New York, N. Y.

GRAYMORE RADIO CORP. CBI
142 Liberty St., New York, N. Y.

Please send your big new catalog of highest-quality radio parts and kits.

Name.....

Address.....

Town.....State.....

SM

Why Does JAPPE

Recommend All S-M Kits?

Why does H. Jappe Company get solidly behind these S-M Kits and recommend them 100% to every set-builder and listener in our territory? Simply because the most thorough-going tests—not of one or two samples, but of thousands of S-M Kits in the hands of hundreds of our customers—have demonstrated that, dollar for dollar, these values cannot be beaten.

Take for example the great Sargent-Rayment 710—aptly termed "The Boss of the Air." Everything the most fastidious listener might want—an ultra-sensitive and knife-edge tuning set, which can, nevertheless, be operated when desired as a real one-dial set—yet which gives tone quality that cannot be excelled, even in sets not designed for unusual selectivity. All this at a price of \$130.00 for the KIT, or \$175.00 WIRED—both prices including cabinet!

Or take the 720 Screen Grid Six—a beautiful compact receiver which, in the S-M 700 metal table cabinet, is a match in eye-value for any receiver now on the market. Yet its precision construction throughout, with three screen grid stages, r. f. coils of amazing accuracy, copper stage shields on a metal chassis—everything denotes that quality construction which is the necessary foundation for the universal good-will that the S-M 720 has created. And the prices—KIT, \$72.50; WIRED, \$102.00!

And for those who want top-notch tone quality, but do not require the extreme selectivity of the higher priced sets, there is the 740 "Coast-to-Coast Four"—for D. C. or for A. C. tubes—equal in every way to most ready-made six-tube sets.

In the short wave field, the S-M "Round-the-World" sets—available like all the above, fully WIRED or in KIT form—fill every need, and give real comfort in operation.

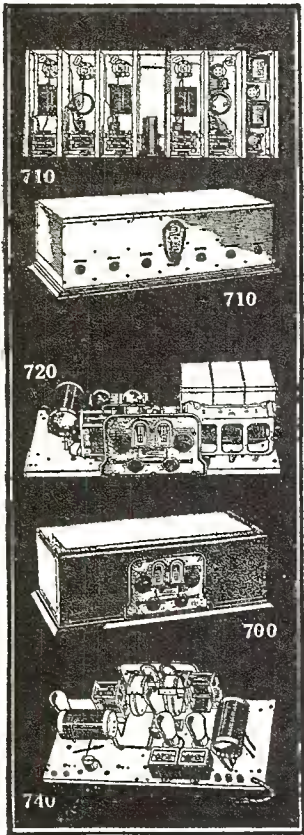

H. JAPPE COMPANY,
46 Cornhill, Boston, Mass.

Please send your literature and best discounts on all S-M parts, kits and power equipment, as well as all other standard radio supplies, as advertised in Citizens Radio Call Book for January.

Name.....

Address.....

DEALERS and SETBUILDERS: Send the coupon to the largest S-M New England Distributor for maximum discounts and literature—or send your order to be shipped C. O. D. at the very best trade discount.

H. JAPPE COMPANY

46 Cornhill

Boston, Mass.

Tell 'Em You Saw It in the Citizens Radio Call Book Magazine and Scientific Digest

SM

This— and from a Four-Tube Set!

The National Better Business Bureau warns against judging a radio set by the number of tubes it uses—and we thought of this when we saw two letters that recently came to the Silver-Marshall factory. One, from Coleman, Alberta, Canada, tells of picking-up WFLA (Clearwater, Fla.), WWL (New Orleans, La.), and KNX (Hollywood, Calif.); even with an antenna only 10 inches long, Salt Lake City and Denver are picked-up with good volume by this Canadian listener—all with the S-M "Coast-to-Coast" Four. The other letter, from Owensboro, Ky., says:

"I have tried the [here are named eight well-known makes of receivers], but this is the finest set I have ever tuned. It has selectivity; it has wonderful tone—it picked up more stations in the daytime than any set I have ever tuned."

Results are proving daily what the laboratory tests showed long ago—that the S-M 740 Four, equipped as it is with the S-M Clough Audio System, is a better set than most ready-made, 5's and 6's selling at twice the price!

740
for
D. C.
Tubes

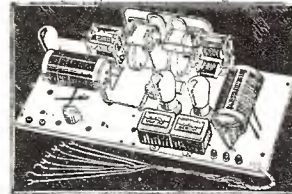

740AC
for
A. C.
Tubes

This receiver, available for either D.C. or A.C. tubes, uses the 4-tube r.f. amplifier, regenerative detector, and two-stage audio amplifier circuit—for many listeners the time-tested standard of receiver comparison. The screen-grid r.f. amplifier stage, together with the finest coils ever utilized in this circuit, provide 10 to 20 kc. selectivity.

With the ease and simplicity of building, and performance like that described above, we declare it as our firm conviction that more radio value cannot be had at a price around \$50.

S-M 740, for D.C. tubes, is \$51.00 for complete factory-packed KIT; S-M 700 cabinet (same as used on the 720 Six) is \$9.25 extra. S-M 740 WIRED complete in cabinet, \$75.00.

S-M 740AC, for A.C. tubes throughout, is \$53.00 for the complete KIT less cabinet, or \$78.00 WIRED in cabinet.

S-M Parts Always in Stock

We always have a large stock of S-M kits and parts, as well as other high quality apparatus. Send the coupon for our catalog. Discounts to dealers. Try us for quick service.

CLARK & TILSON

122 Chambers St.

New York, N. Y.

CLARK & TILSON,
122 Chambers St., New York, N. Y.

Please mail your catalog showing S-M parts and kits, and other high quality radio apparatus, as advertised in Citizens Call Book for January.

Name.....

Address.....

SM

Own A Short-Wave Set You Can Rely On

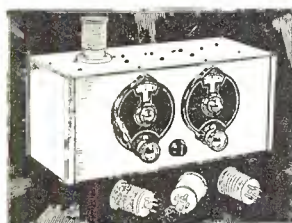

All sorts of excitement and adventure are to be found nowadays on the short-wave bands—"below 200." But if you use one of the hastily designed sets which give good reception on some wave lengths and not so good on others—you will miss a lot of fun.

S-M "Round-the-World"

Four sets cover the entire band from 17 to 200 meters—with 4 quick-action plug-in coils. The aluminum cabinet gives perfect shielding, and entire freedom from hand capacity effects. You can build up an S-M 730 in 3 hours time; you will have a really reliable short-wave set—and the cost will be no higher.

COMPLETE KIT

Everything necessary to build the complete four-tube r.f. regenerative (non-radiating) short-wave set, including aluminum cabinet and two S-M Clough audio transformers.

730 Complete Kit.....\$51.00 730 Set, Wired.....\$66.00

ADAPTER KIT

Complete with aluminum cabinet, less the two audio stages. Used with an adapter plug, it converts any broadcast receiver for short-wave use. Ideal for Television.

731 Adapter Kit.....\$36.00 731 Adapter, Wired.....\$46.00

ESSENTIAL KIT

Contains the two tuning and tickler condensers, four wound plug-in coils, coil socket, and three r.f. chokes, with full instructions for building a 1, 2, 3 or 4-tube set.

732 Essential Kit.....\$16.50

S-M 5-Prong Midget Plug-In Coils

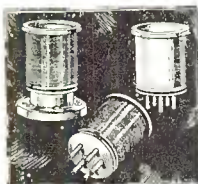

The new S-M coils for short and broadcast waves. Wound on forms of threaded moulded bakelite.

You can use your Round-the-World Four on broadcast bands with these new coils—131X for 190-350 meters, \$1.25; 131Y for 360-650 meters, \$1.50.

Unwound coil forms, 130P plain or 130T with 98 threads, 65c. each.

OUR BIG MAIL ORDER DEPARTMENT

specializes in quick service on all S-M parts and kits, and other high quality radio merchandise. Send the coupon below for our new catalog. Liberal discounts to dealers and setbuilders.

ROYAL-EASTERN ELECTRICAL SUPPLY COMPANY

EST. 1897

16-A West 22nd Street, New York, N. Y.

New York's Best Known Radio House

ROYAL-EASTERN ELECTRICAL SUPPLY CO., Dept. CB-1,
16-A West 22nd St., New York, N. Y.

Please send me free, your latest catalog of radio apparatus, containing full description of the complete S-M line, as well as other leading lines of receivers, accessories kits and parts.

Name.....

Address.....

SM

Volume to Fill Any House —the Last Word in Realism —from Any Phonograph

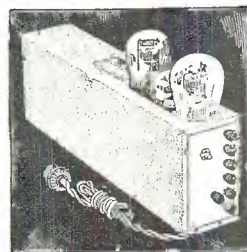

with ^[or] Radio

← this

and

← this

and this →

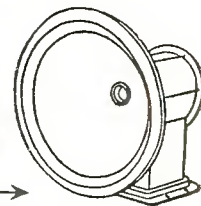
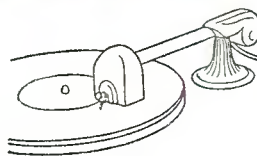

The new 2-stage S-M 678PD Phonograph Amplifier is priced so low that, while particularly adapted for dance halls and small theaters, it is ideal for the home also. Used with any 110 volt D.C. dynamic speaker, it takes input from any magnetic phonograph pickup, or from the detector tube of a broadcast or short-wave receiver, and, by means of its S-M Clough-system audio transformers, supplies to the speaker undistorted the full power output of its 250-type tube. All input power is taken from the 110 volt A.C. house-lighting mains. Price, wired, \$73.00; complete kit, \$65.00.

Or you can get 250-tube power right in your present set by inserting a 250 tube (with an adapter) in the last socket of the set, and using the S-M 675ABC Power Supply—which furnishes ABC power for the 250, and B power to the entire set (or full ABC power to A.C. tube sets). Price, 675ABC kit, \$54.00, or factory-wired, \$58.00.

PROMPT, COURTEOUS SERVICE ON ALL THE BIG S-M KITS

S-M No.	Name	Scr.-Gr. Tubes	KIT Price	WIRED Price
710	Sargent-Rayment Seven.....	4	\$130.00*	\$175.00*
720	Screen-Grid Six.....	3	72.50	102.00*
730	"Round-the-World" Four.....	1	51.00*	66.00*
731	"Round-the-World" Adapter.....	1	36.00*	46.00*
732	Short-Wave Essential Kit.....		16.50
740	"Coast-to-Coast" Four.....	1	51.00	75.00*
740AC	"Coast-to-Coast" Four.....	1	53.00	78.00*
675ABC	High-Voltage Power Unit.....		54.00*	58.00*
678PD	2-Stage Power Amplifier.....		65.00*	73.00*

*Price includes metal shielding cabinet or case.

WHOLESALE RADIO SERVICE CO.
6 Church Street, Dept. CB-1
New York, N. Y.

Please send your new FREE catalog, listing a full line of S-M kits and parts, as well as all other standard brands of radio products for the set-builder.

Name.....

Address.....

Town.....State.....

Mail the Coupon Now for Catalog and Best Trade Discounts

WHOLESALE RADIO SERVICE CO.

A SERVICE OF EXCELLENCE TO THE DEALER

6 Church St., New York, N. Y.

OFFICIAL NATIONAL WHOLESALE DISTRIBUTORS

S-M Kits That Get Results Like These

The three letters below all refer to the S-M720

Gentlemen:

I have had this kit in actual operation for over a month and am astounded with the results. Stations which my friends and myself had given up as "lost at sea" have come through like a ghost from the grave, and dance volume from a loud speaker from the Pacific coast is a reality instead of a will-o-the-wisp. And knife-edge selectivity. What a treat!

F. Jordan,
Galveston, Tex.

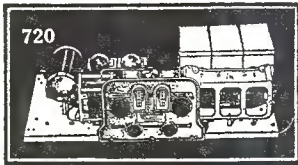

Gentlemen:

I have built one of your 720 Screen Grid Six Sets. I have never heard anything like it. It goes out and gets them, slices them apart, and brings them in with volume and quality that is almost unbelievable. Its pick-up is great. Stations "pop in" at practically every notch on the dials. There is no interference in this set. If they all operate like mine, there is neither a "cough" nor a squeal "in a carload."

Roy L. Porter, Cincinnati, Ohio.

Gentlemen:

On my set, which is a Silver-Marshall Screen Grid Six, I am using a loop, and it might be interesting to you to know that in testing with the loop for distance this last week I received (at Rochester, N. Y.) Los Angeles, Hot Springs, Arkansas; Davenport, Iowa; Jacksonville, Florida and Omaha, Nebraska.

Clayton R. Bragg,
Rochester, N. Y.

Get Tremendous 250 Tube Volume with Clear Tone Quality from Any Set

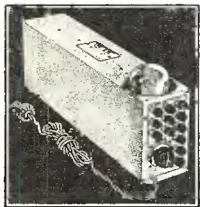

S-M 675ABC high-voltage power supply enables a 250-type supply power tube to be used—with an adapter in the last socket in the radio set. Not a wire in the set is to be molested. Used with A.C. tube sets, the S-M 675ABC furnishes all ABC power to the set. Used with S-M 720 Screen Grid Six, it preserves all the wonderful tone quality of this set, giving a combination that is, indeed, hard to beat at any price. And a 675 ABC is only \$54 for the KIT, or \$58 WIRED, complete with adapters.

As national distributors of S-M Products, we carry for your convenience a complete line including the Sargent-Rayment 710, High and Medium Voltage Power Supplies, and Audio Transformers. Any of these can be shipped at once, as well as any of the other new S-M kits. Our new catalog will be a revelation to you—use the coupon and get it now!

LIBERAL DISCOUNTS TO THE TRADE

Setbuilders Supply Co.

104 Romberg Building Chicago

SETBUILDERS SUPPLY CO.

104 Romberg Bldg., Chicago, Ill.

Send me at once, FREE, your big new 100 Page Wholesale Catalog listing S-M and other radio parts, cabinets, consoles, and accessories of highest quality.

NAME.....

ADDRESS.....

TOWN.....STATE.....

CALIFORNIA

SM HEADQUARTERS FOR SILVER-MARSHALL **SM**

OFFERS YOU ~
AN UNEQUALLED RAPID MAIL ORDER

SERVICE

WE FEATURE SILVER-MARSHALL PRODUCTS because our Patrons demand FIRST and LAST "QUALITY". The Distance Fan who seeks Exceptional Performance NEEDS QUALITY PARTS—SILVER-MARSHALL. The "FOR PROFIT" Builder of CUSTOM-BUILT SETS Plays Safe—with SILVER-MARSHALL MATERIALS—HIS TURN OVER.

IS FASTER!

HE KNOWS—The SILVER-MARSHALL "720" or SARGENT-RAYMENT Stays Sold. They OUTPERFORM other receivers of Twice Their Cost! FIGURING DOLLAR-FOR-DOLLAR against MILE-FOR-MILE of UNDISTORTED DISTANCE SILVER-MARSHALL PRICES ARE

LOWER

WE STRONGLY ADVOCATE THE PURCHASE OF SILVER-MARSHALL PARTS and KITS, and MAINTAIN THE MOST COMPLETE STOCKS ON THE PACIFIC COAST.

WRITE FOR OUR FREE ILLUSTRATED CATALOG OF ALL SILVER-MARSHALL PRODUCTS AND OTHER STANDARD LINES. WE GUARANTEE YOU BIGGEST DEALER DISCOUNTS — AND SAVE YOU MONEY ON LOWER

EXPRESS COSTS!

WE MAINTAIN A HIGHLY TRAINED TECHNICAL STAFF OF LICENSED RADIO OPERATORS TO SOLVE YOUR RADIO DIFFICULTIES. TAKE ADVANTAGE OF THIS FREE ADVISORY SERVICE. MAIL ORDERS FILLED SAME DAY AS RECEIVED!

RADIO

MANUFACTURERS SUPPLY CO.

WHOLESALE WHOLESALE
RADIOS PARTS
SPEAKERS SOUTH BROADWAY OR BROADWAY ACCESSORIES

LOS ANGELES, CALIFORNIA

SM

Top Notch Service

On S-M Products on the West Coast

We can supply promptly, from our stock in Oakland, California, all the big items of the S-M kits, power supplies, and power amplifiers. When you want a Sargent-Rayment Seven, or a Screen-Grid Six, or a "Round-the-World" short wave kit, or "Coast-to-Coast" Four—or if it's a 678PD Phonograph Amplifier, a 675 high voltage power supply, or any of the Unipac amplifiers—or, in fact, anything else in the entire line of S-M quality radio products—you will find it distinctly profitable to BUY IN THE WEST. Send your order or inquiry for best dealer discounts to either office.

ELECTRIC SUPPLY COMPANY

370 11th Street
Oakland, Calif.

250 New Chronicle Bldg.
San Francisco, Calif.

SM

100% SERVICE ON S-M IN NEW ENGLAND

Prompt delivery on all of the big new S-M Kits, Sets, Power Amplifiers, and Power Supplies. Best discounts to dealers. Authorized Silver-Marshall Service Station—we specialize in repairing and rebuilding all Silver-Marshall Equipment.

Radio Inspection Service Co.

193 Trumbull Street
HARTFORD, CONN.

SM

We Supply Any S-M Kits, Custom-Built Sets, Power Amplifiers, and High-Voltage Power Supplies

We ship from our complete stock in Philadelphia, within a few hours from receipt of order, any of the S-M products advertised in this section. Best dealer discounts.

Raymond Rosen & Co., Inc.

49 N. SEVENTH STREET
PHILADELPHIA, PA.

Read what BIG money these fellows have made in the RADIO BUSINESS

\$375 One Month Spare Time



"Recently I made \$375 in one month in my spare time installing, servicing, selling Radio sets. And, not so long ago, I earned enough in one week to pay for my course."
EARLE CUMMINGS,
 18 Webster St., Haverhill, Mass.

\$1597 In Five Months



"The N. R. I. is the best Radio school in the U. S. A. I have made \$1597 in five months. I shall always tell my friends that I owe my success to you."
HENRY J. NICKS, JR.,
 302 Safford Ave.,
 Tarpon Springs, Fla.

\$1164 Spare Time Profits



"Look at what I have made since I enrolled, \$1,164—money I would not have had otherwise. I am certainly glad I took up Radio with N. R. I. I am more than satisfied."
HENRY R. HEIKKINEN,
 123 W. Erie St., Chicago, Ill

Over \$1000 In Four Months



"My opinion of the N. R. I. course is that it is the best to be had at any price. When I enrolled I didn't know a condenser from a transformer, but from December to April I made well over \$1000 and I only worked in the mornings."
AL JOHNSON,
 1409 Shelby St., Sandusky, Ohio.

I will show you too how to start a spare time or full time Radio Business of Your Own without capital



Radio's amazing growth is making many big jobs. The world-wide use of receiving sets and the lack of trained men to sell, install and service them has opened many splendid chances for spare time and full time businesses.

Ever so often a new business is started in this country. We have seen how the growth of the automobile industry, electricity and others made men rich. Now Radio is doing the same thing. Its growth has already made many men rich and will make more wealthy in the future. Surely you are not going to pass up this wonderful chance for success.

More Trained Radio Men Needed

A famous Radio expert says there are four good jobs for every man trained to hold them. Radio has grown so fast that it simply has not got the number of trained men it needs. Every year there are hundreds of fine jobs among its many branches such as broadcasting stations, Radio factories, jobbers, dealers, on board ship, commercial land stations, and many others. Many of the six to ten million receiving sets now in use are only 25% to 40% efficient. This has made your big chance for a spare time or full time business of your own selling, installing, repairing sets.

So Many Opportunities You Can Make Extra Money While Learning

Many of our students make \$10, \$20, \$30 a week extra while learning. I'll show you the plans and ideas that have proved successful for them—show you

how to begin making extra money shortly after you enroll. **G. W. Page,** 1807-21st Ave., S., Nashville, Tenn., made \$935 in his spare time while taking my course.

I Give You Practical Radio Experience With My Course

My course is not just theory. My method gives you practical Radio experience—you learn the "how" and "why" of practically every type of Radio set made. This gives you confidence to tackle any Radio problems and shows up in your pay envelope too.

You can build 100 circuits with the Six Big Outfits of Radio parts I give you. The pictures here show only three of them. My book explains my method of giving practical training at home. **Get your copy!**

I Will Train You At Home In Your Spare Time

I bring my training to you. Hold your job. Give me only part of your spare time. You don't have to be a college or high school graduate. Many of my graduates now making big money in Radio didn't even finish the grades. Boys 14, 15 years old and men up to 60 have finished my course successfully.

You Must Be Satisfied

I will give you a written agreement the day you enroll to refund your money if you are not satisfied with the lessons and instruction service when you complete the course. You are the only judge. The resources of the N. R. I. Pioneer and Largest Home-Study Radio school in the world stand back of this agreement.

Get My Book

Find out what Radio offers you. My 64-page book, "Rich Rewards in Radio" points out the money making opportunities the growth of Radio has made for you. Clip the coupon. Send it to me. You won't be obligated in the least.

Address

J. E. Smith, Pres.
Dept. 9MD

National Radio Institute
Washington, D. C.

This Book points out what Radio offers You Get a copy!



This coupon is good for a FREE copy of my Valuable Book. Mail it NOW!

J. E. Smith,
 President,
 Dept. 9MD
 National Radio Institute, Washington, D. C.

Dear Mr. Smith: Send me your book. I want to know more about the opportunities in Radio and your practical method of teaching at home in spare time. This request does not obligate me to enroll and I understand no agent will call on me.

Name.....Age.....
 Address.....
 City.....State.....

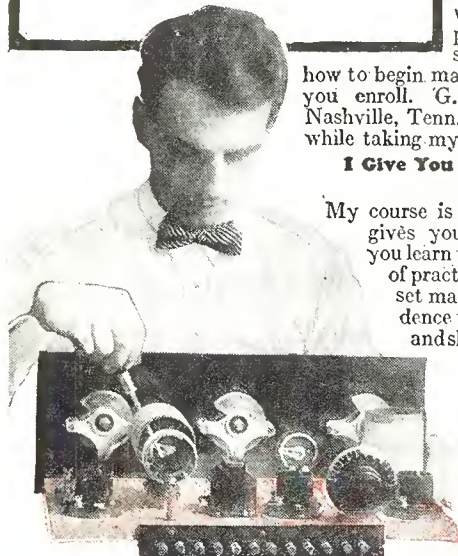

Radio "first aids"

No matter what your interest in radio may be, whether just an average listener-in or a dyed-in-the-wool experimenter, you *must* obtain better results if you use Clarostat "First Aids."



For your regular broadcast set—don't fail to use a Grid Leak Clarostat (\$1.50) for maximum sensitivity, as well as a Volume Control Clarostat for regulating plate voltage, oscillation and loudspeaker volume and tone.

For your radio power unit—apply a Duplex Clarostat (\$2.25) for better voltage regulation, for obtaining extra taps, for increasing or decreasing existing taps, and for obtaining C or grid bias voltages.

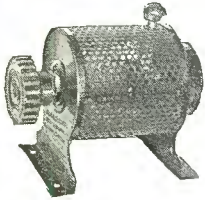

For television—use the standard scanning disk control—the Speed Control Clarostat (\$5.00) now employed by leading television broadcasters and experimenters.



For loud-speaker control—use the Table Type Clarostat (\$2.50), which can be connected in series or in shunt, nearby or at a distance, for regulating radio volume and tone to fit any occasion. No tools required.



For greater signal strength—try a Clarostat Antenna Plug (\$1.50), the different and improved device which makes an excellent antenna out of any socket or outlet.

WRITE for the Clarostat literature, which tells the story at length on how you can improve your radio results. Better still, send 25 cents in stamps or coin for "The Gateway to Better Radio"—88 diagrams, over 20,000 words, and a wealth of ideas. The best investment you ever made in radio!



CLAROSTAT MFG. CO., Inc.

Specialists in Variable Resistors

285 North Sixth Street Brooklyn, New York

CLAROSTAT
Reg. U. S. Pat. Off.

With the Parts and Accessory Manufacturers

(Continued from page 105)

Thordarson-Electrad Resistance Kit

TRUVOLT resistors are now being included in the Thordarson specifications for the R-171, R-280 and R-480 power compacts, according to a recent announcement made to the trade.

They are also being used in the Thordarson R-210 power amplifier kit, as well as the Thordarson 250 plug-in power amplifier and power supply, Thordarson 210 push-pull power amplifier No. 1, Thordarson 210 push-pull power amplifier No. 2, Thordarson 250 two-stage power amplifier and plate supply and the Thordarson heavy duty 250 power amplifier.

Truvolt resistor kit 1-T goes in the R-171, R-280 and R-480. Truvolt resistor kit 2-T goes in the R-210 power amplifier, while kit No. 3 goes in the five specified sets mentioned in the previous paragraph.

Electrad, Inc., 175 Varick St., New York City, now has a handy reference chart for manufacturers, representatives and dealers, giving the type numbers of the Electrad parts used and specified in the various popular power amplifier and power supply combinations. This chart also gives the various values of Truvolts, wire grid resistance, center tapped resistances, Royalty variables, Tonatrols and Electrad Rheostats and potentiometers. It also gives the different resistance values in the power supply systems specified by the various manufacturers.

Yahr-Lange Super Ball Antenna

RECENT changes in the design of the super ball antenna have been announced by Yahr-Lange, Inc. at Milwaukee, Wis. In the previous models, there were only three guy wires used, whereas in the new model there are four wires employed. These guy wires are 12 feet long. Another feature of the super ball antenna is the fact that a condenser has been located under the ball, as shown in the illustration accompanying this article. The manufacturers state that this condenser acts as a neutralizer for the entire antenna system and clarifies the tone.

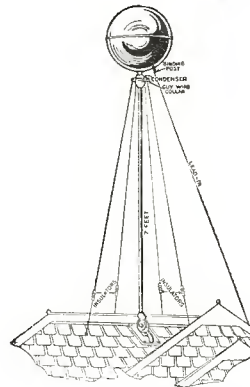

The model illustrated is for use on any type of building, and has an adjustable ball and socket at the base, by means of which it may be mounted vertically regardless of the slope of the roof.

The super ball aerial is all-directional and has a conductive surface of 346 sq. in. The four 12 foot guy wires gives this aerial an additional vertical pick-up. The super ball aerial complies with the standard of the national electric code and rulings of the National Board of Fire Underwriters.

Tell 'Em You Saw It in the Citizens Radio Call Book Magazine and Scientific Digest

No More "Call Backs" when you service with a **SUPREME**

A Real Money Maker for Dealers and Service Men

The Model 400A SUPREME is not only the most thorough and complete testing apparatus available, but the instrument comes in a handsome brass bound traveling case especially designed for use by the practical service man. This case is most complete and convenient in its appointments, providing adequate and easily accessible compartments for all tools, accessories and supplies. It also contains a special swinging tube shelf providing absolute protection and instant accessibility to tubes. Complete set of tools and materials, from electric soldering iron to screw-driver, is furnished, each located in its proper place in the case. All of this is accomplished by ingenious design without making the case bulky or cumbersome—the exterior measurements of the case being only 18 in. x 10½ in. x 7 in., and the weight approximately 23 lbs. complete.

Instrument lifts out of traveling case for store or laboratory use.

THREE WESTON METERS

Mounted in Bakelite cases.
1 Voltmeter, three scales of 0/10/100/600, 1000 ohms per volt.
1 Millimeter, of 125 mills and 2½ amps.
1 A.C. Voltmeter, three large scales of 0/3/15/150.

Use the Supreme in making installations and repairs. Balance the radio frequency tubes. Test all tubes at time of sale. Assures your customer maximum results, saves time and increases profits for you and creates good will that builds business. With the Supreme one man does the work of three and does it more accurately and easily, because it substitutes scientific analysis for guess work.

PRICES AND TERMS

Under our time payment plan the Model 400A SUPREME can be bought for \$38.50 cash and 10 trade acceptances (installment notes) for \$10 each, due monthly. Cash price, if preferred, is \$124.65. All prices are net and do not carry dealers' discounts.

Send No Money

The SUPREME must sell itself to you on sheer merit and performance. We are willing to place it in your hands for actual use in your service work, and allow you to be the sole judge of its value. Fill out and sign the following request for six-day trial.

Request for 6-Day Trial

Supreme Instruments Corporation Date.....
310 Supreme Building
Greenwood, Mississippi.

Please ship me one Model 400A SUPREME.
Upon delivery of the instrument I will deposit with the express agent either the cash price of \$124.65 OR \$38.50 cash and 10 trade acceptances (installment notes) for \$10.00 each, due monthly, at my option, subject to the following conditions:

It is agreed that the deposit made with the express agent shall be retained by him for six days. If, within that time, after testing the instrument I am not entirely satisfied, I have the privilege of returning the instrument to the express agent in good condition, with the seal unbroken (see note below) and all tools and parts intact. Upon such return and upon the prepayment of return express charges, the deposit I have made with the express agent will be promptly returned to me.

Signed.....

Firm Name.....

Address.....

City..... State.....

Please send three or more trade references, including at least one bank, with this coupon.

NOTE: The seal on the panel of the instrument covers the master screw in the assembly. It is never necessary to disturb this, and it does not in any way prevent or restrict the use of the instrument. Factory guarantee ceases with disturbance of seal.



The Sign of Efficient Radio Service

Radio Owners: Look for this emblem in your radio shop or on the button worn or card carried by your service man. It is your guarantee of dependable service.

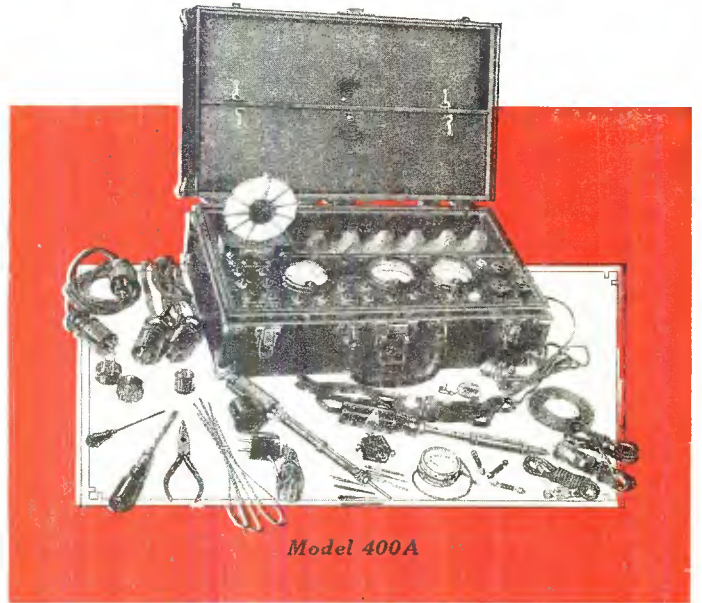

Model 400A

The Only Instrument on the Market That Will Make All These Tests

The SUPREME is the only service instrument that makes oscillation tests on all radio tubes—the true measure of the value of a tube.

The exact working conditions of any tube from 1½ to 15 volts, including screen grid, heater type, and rectifier tubes are shown by meter readings; the only instrument that shows output of rectifier tubes on meter.

The oscillation tests from alternating current are made possible by the exclusive self-contained SUPREME Power Plant. Every radio engineer and service man will appreciate this feature.

The SUPREME radiator sends out a modulated wave. Simply plug into A.C. line. No more wasting valuable time on broadcast stations; always at your service and finer adjustment assured. Condensers can be balanced or synchronized—not by the former tedious methods—but with both meter reading and audible click. Easy and much more accurate.

All continuity tests can be made from socket on either A.C. or D.C. sets, with independent cathode readings.

The SUPREME heavy duty rejuvenator provides scientific method of rejuvenation of any thoriated filament tube. Will reactivate up to 12 tubes at one time without removal from set. Push a plug—the SUPREME does the rest.

The SUPREME will give direct reading of amplifying power of tubes and will show actual working condition of all tubes. The SUPREME will play radios with open transformers and will give condenser, choke coil output and capacity output on radios not wired for that purpose.

Access is provided to all apparatus through pin-jacks. Will test condensers for breakdown. Contains various fixed condensers from .001 to 2 mfd., a 30 ohm rheostat, a 500,000 ohm variable resistance, and an audio transformer, for instant use and various combinations.

It will give plate and filament voltage readings with or without load; will test voltage and current of all radios, including those using tubes such as 210 and 250. It will give grid circuit readings up to 100 volts; will test output of trickle charges, or any output up to 2½ amps.

In fact, the SUPREME will give you everything that can be obtained with all other set testers and analyzers combined, and in addition will provide many other really important tests that cannot be obtained by any other means.

Tell 'Em You Saw It in the Citizens Radio Call Book Magazine and Scientific Digest

"Super Ball" Antenna

"The Antenna Is the Brains of Your Radio Set"

THE SUPER BALL AERIAL is all directional, gives any Radio Set selectivity, better volume and greater distance, due to low power loss—"bunched capacity" and the aluminum alloy construction. Receives all wave lengths—short or long—with exactly the same efficiency. Has a conductive surface of 346 sq. in. equal to that of 75 feet of wire aerial. The four 12 ft. guy wires give this aerial an additional vertical pick-up capacity as illustrated in diagram. The condenser under the ball acts as a neutralizer for the entire antenna system; it clarifies the tone.

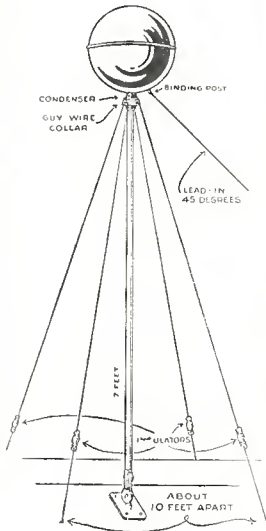

Price \$7.50

West of the Rockies \$8.00

The Super Ball can be placed within 10 feet of another aerial without interference. Count 'em on apartments and you know the owners who enjoy good reception. Easy to install and inexpensive and guaranteed by manufacturer, the Super Ball is awaiting its opportunity to improve your reception.

The Super Ball Aerial complies with the standard of the National Electric Code and the rulings of the National Board of Fire Underwriters.

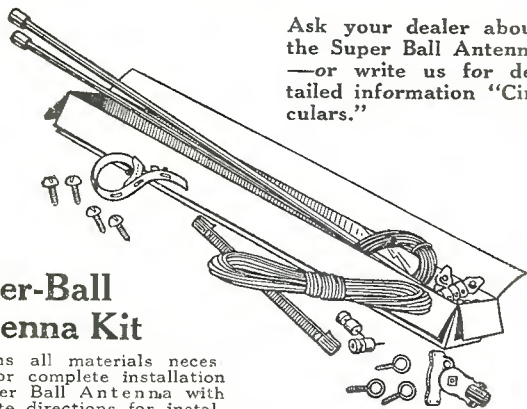

Ask your dealer about the Super Ball Antenna—or write us for detailed information "Circulars."

Super-Ball Antenna Kit

Contains all materials necessary for complete installation of Super Ball Antenna with complete directions for installation.

\$4

DEALERS: Be prepared to cash in on the ready sale of this finest of antennas. Order from your jobber and write us for liberal selling helps.

YAHR-LANGE

MILWAUKEE INCORPORATED WISCONSIN

Hammarlund Short Wave Manual

MUCH interesting information covering the subject of short waves is contained in the Hammarlund Short Wave Manual for 1929, which has recently been released and which is available at a nominal fee of 10c from the Hammarlund Mfg. Co., Inc., 424 W. 33rd St., New York City.

Many of the topics handled in this manual will be of more than ordinary interest to the short wave enthusiasts. For example: there is data on the reflection of short waves, exclusive field for short waves, short wave design trend, theory of the 222 tube, effect of grid plate capacity of the 222, limiting frequency for stable operation, tuned input circuits, standard antenna constants, single control for r. f. circuits, shielding the r. f. stage, common regeneration controls, dead spots due to poor chokes and many other interesting problems which the average set builder will encounter at some time in his work.

In addition there is material on television circuit requirements, a list of short wave call letters, a frequency wave length conversion chart, and many other interesting items of a real informative nature.

Holmes Battery Charger

A CHICAGO inventor, C. F. Holmes, recently developed a new machine for charging batteries which promises amazing new fields of profit for operators. This new service station charger, according to the inventor handles 50% to 70% more batteries than similar machines now on the

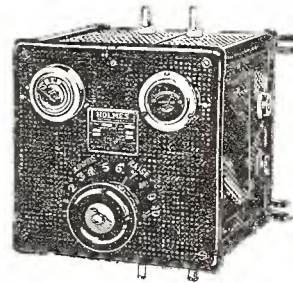

market, yet effects a saving in electric current equal to 40% to 60% due to special transformer construction and other original features of design. Readers interested in this branch of service should write to C. F. Holmes, 5116 Ravenswood Ave., Chicago, Ill. for a further description of his invention.

Clarostat Television Control

A NOVEL variable resistance which may be used in television control circuits has recently been announced by Clarostat Mfg. Co., Inc., 285 North 6th Street, Brooklyn, N. Y. The unit is illustrated below and is supplied with a ventilating housing.

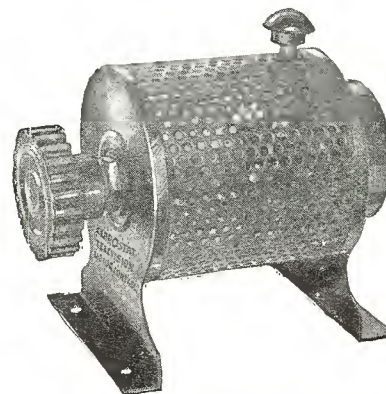

In addition to this, a push button is provided at the top, which shorts the resistance and enables the operator to kick his motor ahead at a greater speed in order to maintain synchronism.

Now—Radio's Two Biggest Advances Combined— Screen Grid and AC

LAST year's two big contributions to better radio were in tube design. AC heater-type tubes advanced radio reception immeasurably. Screen grid tubes improved it in volume and clarity. Now in the Vee Screen Grid Kit using AC Screen Grid tubes, these two big advantages are combined—the great amplification factor and inherent stability of the screen grid tube with the high emission possible only with the heater type tube.

Here are transformers which are not an adaptation—they are designed only for Screen grid tubes enabling you to get all the value from them. The Power Pack is greatly simplified, giving A, B and C voltages with a minimum of parts, as voltage regulation is inside the transformer cases.

The Vee Screen Grid receiver is a real unit control, lamp socket set having great volume with a purity and faithfulness of reproduction heretofore unknown—all this with only six tubes.

The Vee Shield-Coil Kit Includes

Transformers, both RF and AF, condensers, patented Vee unit control, chokes, powerpack including special tube, resistances, sockets, wire, panel and subpanel, layout and wiring instructions. Everything is included excepting tubes, cabinet and loud speaker. Better results than have been obtainable with 8 to 10 tubes. Loop operated. The last word in receivers.

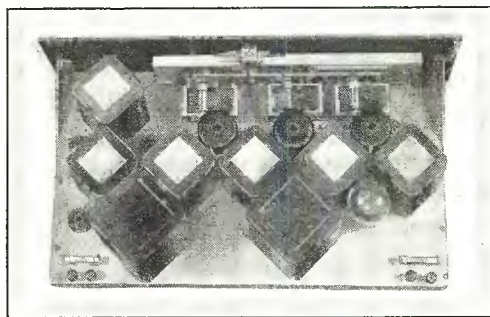

Compact—simple—automatically protected against overload of condensers. It is complete, including everything needed—rectifying tube, subpanel, resistance units, sockets, binding posts, wire and full directions.

If your dealer hasn't these new Vee Products, send orders direct. The coupon will bring you full data—send it today, checking the items in which you are interested.

The Vee Safety Power Pack

The Vee Power Pack is furnished separately for use with other circuits, giving all B voltages and filament and grid voltage for last audio stage (171).

We believe this to be the most efficient practicable Power Pack yet designed.

The VEE Coil Antenna



THE improved Vee Coil Antenna has a greater pick-up, keener directional ability, and a lower distributed capacity. Not only for loop sets, but can be used with a slight change with any tuned R. F. set of five tubes or more. Complete instructions packed with the loop.

*Remember the Vee Kit Is Complete Including Everything Needed—
Rectifying Tube, Subpanel, Resistance Units, Sockets,
Binding Posts, Wire and Full Directions*

VEE PRODUCTS

Division of
Story & Clark Piano Co.
173 North Michigan Avenue
Chicago, Illinois

VEE PRODUCTS

Division of Story & Clark Piano Co.
173 No. Michigan Ave., Chicago, Ill.

I am interested in the items checked below. Send full details at once.

Name.....

Address.....

City..... State.....

My dealer is.....

Address.....

Screen Grid Kit Essentials Power Pack VEE Loop

America's Leading Kit House

Official Service Station for the Leading Kit Manufacturers

The confidence of the leading kit manufacturers is evidenced by our being appointed "Official Service Station." You will obtain here the same conscientious and courteous service the manufacturer would give you himself. Our corps of trained and experienced radio men will serve you efficiently.

All Parts Are Carefully Matched
and Tested, Before Shipping, for
the Following Popular Circuits

SM

Official Service Station
for All
Silver-Marshall Kits

HAMMARLUND-ROBERTS HiQ 29

Aero Chronophase A. C. 21
Hammarlund-Roberts Jr. A. C.
Tyrman 72 Receiver and Power Pack
Aero A. C. Short Wave Adapter
Victoreen Push-pull Amplifier
Vee Products Screen Grid Receiver
Amer-Tran Power Amplifier
Remler Power Amplifier
Silver-Marshall Phonograph Amplifier
Silver-Marshall 730 Four Tube Receiver
HFL Special Nine A. C. Superheterodyne
Sangamo Amplifier

Set Builders and Dealers

Write or call on us for prices on any circuit appearing in any of the radio magazines. Our prices are lowest to professional set builders and dealers.

Mail Orders Filled Promptly Thirty Years Efficient Service Transmitting Equipment

We have a complete line of amateur transmitting and receiving equipment for short wave work. Write us for any amateur equipment.

Send for Our New Wholesale Catalog,
Just Off the Press

M & H
SPORTING GOODS
COMPANY
512 MARKET STREET
PHILADELPHIA, PA.

Peerless Dynamic Speakers

IN the illustration herewith is shown the Peerless dynamic speaker manufactured by the United Radio Corp., Rochester, N. Y. The model 19-A is encased in a beautiful carved wanut cabinet of classic Gothic design. This powerful, new 9 inch Peerless dynamic is in every essential the industry's standard of comparison for dynamic speakers. The 9 inch cone gives remarkable efficiency at all audible frequencies.

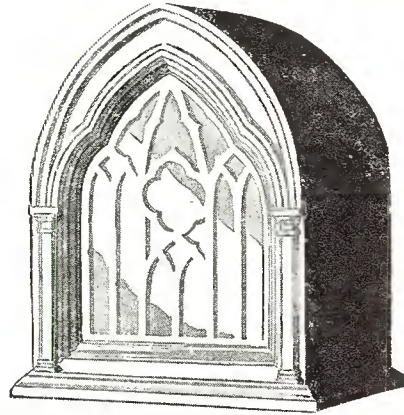

The model has an overall height of $16\frac{1}{8}$ inches, a depth of $10\frac{1}{8}$ inches and a width of $14\frac{1}{2}$ inches. Models are available for battery or socket power operation, direct or alternating current and in either 25 or 60 cycles.

Another model built like the 19-A but in a cabinet of lesser cost and with a 7 inch instead of a 9 inch cone, is known as the Peerless 17-A with an overall height of $14\frac{1}{2}$ inches, depth $9\frac{1}{4}$ inches and width $12\frac{1}{2}$ inches. It is also equipped for battery or socket power operation, direct or alternating current, 25 or 60 cycle.

In addition to the dynamic speakers, Peerless also manufactures the model 7-A, which is a magnetic cone speaker and is available in a beautiful Gothic cabinet of mahogany. Its overall height is $12\frac{1}{2}$ inches, depth 7 inches, width $11\frac{1}{2}$ inches. It is equipped for battery operation.

General Radio Filter-Wavemeter

DESIGNED primarily to reduce interference when listening in on broad tuning receiving sets, the General Radio type 247-W filter illustrated below has a value when used in sharp tuning sets where it may be operated as a wavemeter.

The 247-W filter has two forms of connection. The series connection for the filter is termed a rejector circuit inasmuch as it will reject any particular station within the range of the filter.

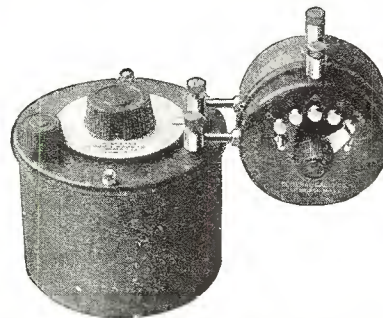

For example, this connection is used whenever an operator desires to eliminate a single interfering broadcasting stations.

When the filter is to be used as an acceptor, the parallel connection is employed and the unit will accept only one station within the filter range. In this condition it is used to reduce code interference or interference from a group of stations.

These filters are individually calibrated to a wavelength accuracy of 2%, and may also be used as a wavemeter for the measurement of a received signal or the measurement of the wavelength of the transmitter regardless of whether it is radio-phone, continuous wave or spark.

The unit is manufactured by the General Radio Co. of Cambridge, Mass.

Now...4 or 6 Volts with the Improved Knapp "A" POWER

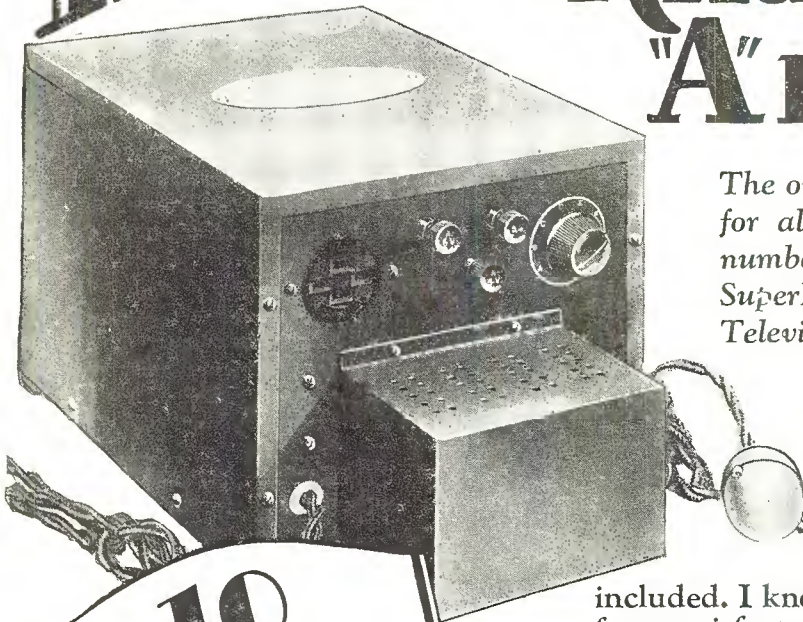

The only "A" Power suitable for all sets — irrespective of number of tubes — including SuperHets, Short Wave and Television receivers.

THE new Knapp "A" Power is designed for the most exacting service — super-hets, short wave and television receivers

included. I knew that if it would perform satisfactorily with these receivers that there could be no question as to its efficiency on ordinary broadcast signals. The three Elkon dry condensers, the improved choke coils and the special Elkon dry rectifier make the difference between ordinary and Knapp performance.

No Change in Price

Even with these wonderful and costly improvements, there has been no advance in price — due to the tremendous volume going thru my plant. Remember that the Knapp is the fastest selling "A" Power on the market.

KNAPP ELECTRIC, Inc.,
—Division of P. R. Mallory & Co., Inc.—
350 Madison Ave., New York City

10 Improvements

1. Two taps for 4 or 6 volt operation.
2. Larger filter system.
3. Three Elkon Dry Condensers instead of two.
4. Improved Choke Coils.
5. Pendant Switch Controlling "A" Power, "B" Eliminator and Set.
6. Dial for Regulating Voltage.
7. Celeron Front Panel.
8. Baked Finish.
9. Heavier Gage Metal Cover.
10. Die Cast Base Plate instead of wood.

See your dealer today

Go to your dealer today. Most of the good ones carry the Knapp in stock. Do not accept a substitute — because only in the Knapp will you get full satisfaction as typified by the famous Knapp "A" Power. If your dealer cannot supply you send the coupon.

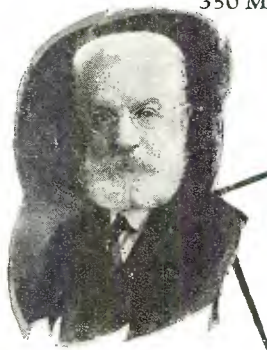

Mr. David W. Knapp, Pres.,
Knapp Electric, Inc., Dept. K-16
350 Madison Ave., N. Y. C.

Send me complete information on the Knapp "A" Power.

Carter Products

STANDARD MERCHANDISE

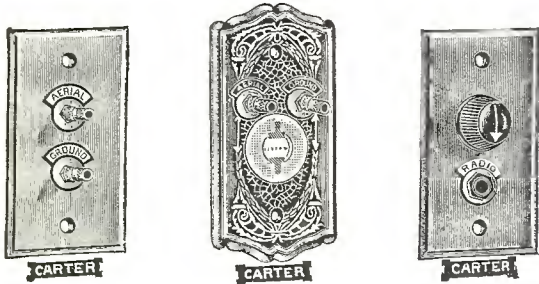

CARTER RADIO OUTLET PLATES

Carter plates are made in sixteen different styles and combinations to meet all usual installation requirements. Specified and used by modern architects and contractors. Write for our attractive booklet. It carries many practical suggestions on how to use these conveniences to advantage.



CARTER RADIO-PHONO ATTACHMENT

Makes it simple to reproduce phonograph records through your radio set. No wiring changes necessary. Supplied in two types (for four prong or five prong tubes).



CARTER CENTER-TAPPED RESISTORS

Used with the new 322-222 tubes. Guaranteed accurate within 3%. Terminals small, yet makes a good solder joint. Securely attached. A small, compact, rugged resistor. There is a Carter Resistor for every requirement.

CARTER TAPERED RHEOSTAT FOR VOLUME CONTROL

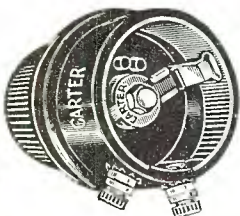

For use in A.C. circuits to control volume. The tapered resistance and the increasing of the spacing between the turns of wire at the narrow end—makes possible a close adjustment where the useful range of adjustment is crowded into a small arc, not affected by climatic conditions.

Any Dealer Can Supply



"The Majority's Choice"

Browning-Drake A. C. Kit

STRICTLY modern in every particular is the new Browning-Drake kit available for a. c. shield grid operation. It is shown in the illustration herewith.

The receiver is a single control affair without trimmer con-

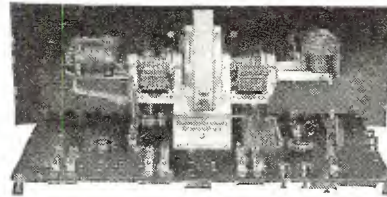

densers or antenna variometer. By the use of the a. c. shield grid tube, it is possible to operate the set from the electric light circuit in connection with a B eliminator or other power supply, although if desired it can be operated on B batteries as far as the plate circuit is concerned. The kit is made by the Browning-Drake Corp. at Cambridge, Mass.

Truvolt Voltage Divider

JUDGING from the comments of professional set builders, the Truvolt divider, announced sometime ago by Electrad, Inc., 175 Varick St., New York City, N. Y., is meeting with considerable success in its application in the construction of power amplifiers and power supplies, where it is desired to have the resistance network in small, compact units.

The Truvolt divider offers the radio engineer or builder of eliminators a compact wire wound resistance unit so arranged with five adjustable contacts that all required voltages may be obtained with any set or eliminator combination. The device removes the guess work and saves time and trouble in constructing an eliminator. By dividing the filter voltage into usable values, it eliminates the necessity of mathematical calculation. It does away with a great deal of wiring and the need of regulator tubes. The Truvolt divider is not only flexible to all receiver current conditions, but it is possible, because of its inherent design, to calibrate the adjustable contacts. By the use of tables or graphs, the divider may be adjusted to give desired voltages without using a high resistance voltmeter.

An interesting booklet giving information covering the divider may be secured on application to Electrad, Inc., whose address is given elsewhere in this article.

Silver-Marshall Public Address Amplifier for Theater Work

(Continued from page 75)

- 1 1/2x6/32 machine screw
- 1 6/32 nut
- 1 Silver-Marshall 340 condenser bracket
- 13 Soldering lugs

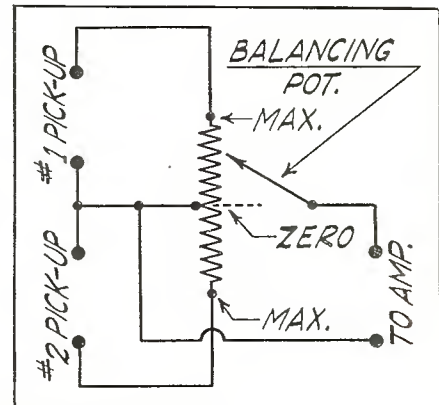

Fig. 5. In this schematic are shown the connections of the fading device used for shifting from one record to another

(Continued on page 150)

An Entirely New Speaker!

THE 1929 MUTER DYNAMIC

Radio has reached its present state of perfection by a series of improvements in mechanical and theoretical design of parts, accessories and circuits. The most recent of these has been the Dynamic speaker.

Now *MUTER* presents an *improved* Dynamic Speaker, one that embodies all the desirable features of the Dynamic type—without its drawbacks.

The 1929 *MUTER* Dynamic has—

No Hum

When connected to a set and operating, there is no perceptible line or surface noise whatever. A weak or distant signal can be received clear and distinct. The "live" noise of the ordinary Dynamic is entirely eliminated.

This is accomplished by the use of an *improved filter circuit with tube rectifier*, giving an alternating current suppression equal to that of the "B" supply in the radio set. This also has the advantage of allowing an instant interchange of rectifiers, which is impossible with speakers using the customary dry rectifier.

No Drumming Emphasis of Low Notes

The 1929 *MUTER* Dynamic is so designed that it neither loses nor over-emphasizes any part of the musical scale. It is equally as faithful in the higher notes as in the lower and has no objectional hollow drumming sound on low notes.

Tonal frequency charts show that its response is superior over a frequency range 50% wider than any other Dynamic.

Superior Mechanical Design and Construction

The 1929 *MUTER* Dynamic has been designed by a foremost group of acoustical and speaker engineers. The quality of material and workmanship has seldom been approached in the construction of a radio accessory. Every vital part is matched to the general assembly. The cone, magnet and field coil are built and tested as a single unit by a method that instantly detects any variation whatsoever. Every 1929 *MUTER* Dynamic is a *perfect* speaker.

See and hear this new Dynamic Speaker at your dealer before equipping your new set or replacing your old speaker. Its superiority is instantly recognizable.

If your dealer cannot supply you, send us his name and address, and purchase price, and we will ship direct, express prepaid.

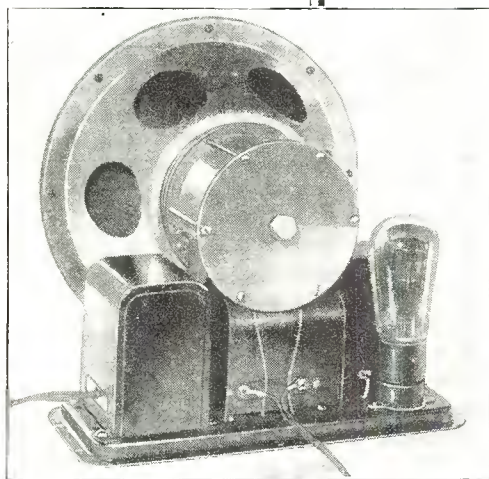

1929 *MUTER* Dynamic Speaker

Type No. 4310
(110 v. A.C.)

List Price \$39.50

Exclusive New Features of the 1929 *MUTER* Dynamic

Tube Rectifier . . . No Hum . . . No Surface Noise . . . Sensitivity to Weak or Distant Signals . . . Perfect Voice Reproduction . . . Matched Assembly and Testing . . . Lowest Current Consumption . . . Faithful Response Over 50% Wider Tonal Range . . . Adaptable to Any Set Instantly . . . Excellent for Phonograph Pick-Up . . . Unlimited Capacity for Undistorted Volume . . . Unqualified Guarantee by the Largest Manufacturer of Radio Accessories in the World.

LESLIE F. MUTER COMPANY

8440 South Chicago Avenue / / / Chicago

Use Jewell Meters for Set Building and Servicing

THE key to the most efficient results in set building and servicing is through the use of high grade meters. Jewell Meters for radio service cover every possible need. They have been developed and specialized for every particular service and represent the utmost in accuracy and reliability of performance. You can rely on Jewell Instruments.

Jewell 199 Set Analyzer



This remarkable Jewell Instrument tests both A. C. and D. C. sets in actual service, also tubes. It gives accurate data on each stage throughout the whole set, so that all the troubles are quickly and accurately located. Unquestionably the best radio service instrument on the market today.

Jewell 210 Tube Tester



This latest Jewell development is the first tube checker that gives direct reading of tube values—eliminates mental arithmetic. Tests all tubes from WD-12 to 210, also single and double wave rectifiers. Operates direct from A. C. service. Adjustable for line variations from 110 to 130 volts. Investigate this new tube tester.

Jewell Panel Instruments



Jewell Panel Instruments for the radio set builders and experimenters are made in an extremely wide variety of ranges, sizes, and ratings. There is a Jewell Instrument that exactly meets every requirement in broadcasting, testing, and experimental work. Ask your jobber's salesman or write us for complete information covering Jewell Instruments for radio service.

Jewell Electrical Instrument Company 1650 Walnut St., Chicago, Illinois

Manufacturers of high grade A. C. and D. C. instruments for every purpose from two-inch switchboard to large laboratory standard precision instruments



29 Years Making Good Instruments

A. C. Shield Grid Magnaformer Design Announced for 1929 Season

(Continued on Page 77)

having a pendant switch on the 110 volt line to start and stop the set.

Rectifier Circuit

The high voltage secondary in this unit is carried to the plate of each of the 281 rectifier tubes and the center tap of this transformer, which has 600 volts each side of it, goes to the common B negative line and ground of the system. Instead of using a conventional $7\frac{1}{2}$ volt winding for the filaments of rectifiers and placing these in parallel, the designers of the Magnaformer are using a 15 volt secondary with the two rectifier tubes in series across this winding. Then the center position between the filament circuit, as shown in the schematic, becomes the positive voltage line and goes in through the double choke coil, the input, center and output being bypassed by 2 mfd filter condensers as shown in the diagram. The value of the resistance network across the high and low voltage terminals of the rectifier is 28,000 ohms, there being a tap for 45 volts and another for 135.

The power supply of the whole is compact and rugged. It may be seen by referring to the left of the photograph shown in Fig. 1. Although the maximum voltage of 450 may seem rather high to use on the present 250 tubes, nevertheless arrangements are now being made for that particular tube to be produced as an interchangeable one with the 210, so that the maximum voltage rating of 450 volts will be proper. However, in view of the fact that the undistorted output of the 250 is much greater than any other tube, it is only logical that this tube should be employed for best results.

Official Parts List

Parts required for the construction of the receiver described in the article above are as follows:

- 2 Magnaformer r. f. No. 51 intermediate shield grid r. f. transformers
- 2 Magnaformer r. f. No. 61 intermediate r. f. transformers
- 1 Long wave C. U. No. 71 uncoupler oscillator
- 1 Radiart completely drilled aluminum sub-panel, $11\frac{1}{8} \times 23$ inch, with 10 mounted sockets
- 1 Radiart special finished and drilled metal front panel, 7×24 inch
- 1 Radiart No. 250 ABC power unit, including mounting base and resistant unit
- 1 Radiart 5 panel audit unit shield
- 1 Radiart 8 panel r. f. unit shield
- 1 Radiart 5 panel control unit shield
- 1 Radiart bakelite tip jack panel for speaker
- 1 Radiart bakelite regenerative .000045 condenser panel
- 1 Radiart bakelite plug-in oscillator panel
- 1 Radiart bakelite plug-in long wave oscillator C. U. No. 71 coil bottom panel
- Bolts, screws, bushings, solder lugs (Radiart), cables and hook-up wire (Radiart)
- 2 Shield grid clips and 2 shielded grid cable leads (Radiart)
- 1 Yaxley No. 820-C, 20 ohm center tapped resistance
- 1 Yaxley No. 71000, 1000 ohm resistance
- 7 Yaxley insulated tip jacks, 5 black No. 421 and 2 red No. 420
- 1 .000045 midget regenerative condenser with bracket
- 2 Ferranti a. f. No. 4 audio transformers
- 2 Remler No. 639, Universal S.L.W. .0005 variable condensers
- 1 Remler No. 110, single control Universal drum dial
- 1 Remler No. 112, single control equalizer
- 2 Remler No. 110-4BR knobs
- 1 Remler No. 750-12 knob
- 1 Remler No. 1103 escutcheon plate
- 1 Frost No. 1892, 200,000 ohm variable high resistance unit without switch

Tell 'Em You Saw It in the Citizens Radio Call Book Magazine and Scientific Digest

FREE!

YOU can enjoy the perfect reproduction and the unusual convenience of this Midget Cone Speaker *absolutely free*. Manufactured by one of the largest manufacturers in the country, this speaker has innumerable advantages in portability and perfect tone. Ideal for apartment use, or in different rooms of the house, the Midget Speaker is delighting thousands who are now using it.



From Elizabeth, N. J.:

"I received the Midget speaker today. It's great and I am well pleased."

Richard Ogden.

From Ocean Breeze, Cal., W. P. McGuide writes: "I received your Midget Speaker and sure was surprised by its performance. I play all distant stations just as good as any speaker I've had, and it performs dandy."

One of these speakers may be yours absolutely free, by just filling in the coupon below for one year's subscription to the Citizens Radio Call Book Magazine. Because the supply is limited, do not delay in sending in the coupon.

Mail It Today!

CITIZENS RADIO CALL BOOK MAGAZINE

508 So. Dearborn St., Chicago, Ill.

Here's my \$1.75 (Foreign \$2.00), for which please send me Citizens Radio Call Book Magazine for one year, beginning January March September November.

This subscription entitles me to a free Midget Loudspeaker.

NAME.....

ADDRESS.....

CITY..... STATE.....

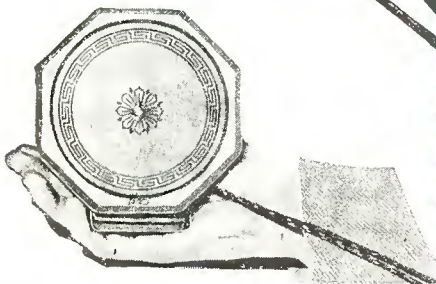

Tell 'Em You Saw It in the Citizens Radio Call Book Magazine and Scientific Digest

More Than Just Resistance

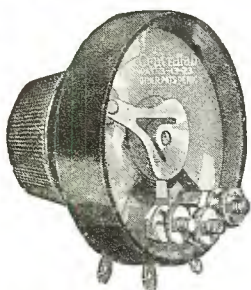

Radiohm — Potentiometer — Modulator. Rocking disc contact — smooth — noiseless — properly tapered. All resistances. List price.....\$2.00

The true value of a variable resistance in its application to radio voltage and volume control cannot be measured solely by a resistance value standard.

A stick of carbon or roll of resistance wire may have great resistance, but that does not make of either a suitable radio power control.

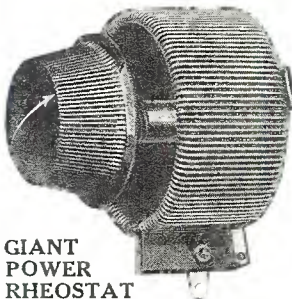

GIANT POWER RHEOSTAT

Tremendous current capacity. Rated at 70 watts, 375 degrees Fahrenheit. The ideal transformer primary line voltage control. List price.....\$1.75 to \$2.50 in three or four terminal units, slightly higher.

Centralab Volume and Voltage Controls not only possess the required resistance, but they are built mechanically and theoretically to serve their function with the ultimate in efficiency and satisfaction.

Send for booklet, "Volume and Voltage Controls—Their Use." It is free.



CENTRAL RADIO LABORATORIES

12 Keefe Avenue

Milwaukee, Wis.

BENJAMIN

TRADE MARK

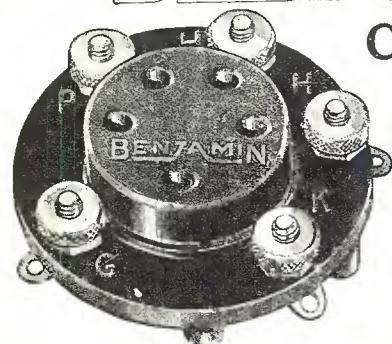

Cle-Ra-Tone Radio Sockets

Spring supported, shock absorbing. The tube holding element "floats" on perfectly balanced springs. Reduces microphonic disturbances, tends to

lengthen life of tube and lessens the possibility of short-circuiting closely spaced tube elements.

Y-Type, Green Top, for 5 Prong AC Tubes: For mounting on top of panel, \$1.00; for direct attachment to panel, 75c.

Red Top, for Standard UX Type Tubes: For mounting on top of panel, 75c; for direct attachment to panel, 50c.

Shelf Supporting Brackets

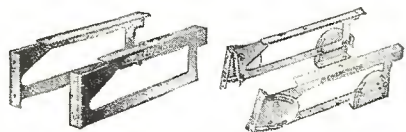

A decided advantage for the neat and substantial construction of the set. Used when panel and sub-panel are assembled to make one complete removable unit. The Adjustable Brackets permit panels to be mounted vertically or at any desired angle. No. 8629—Rigid—70c per pair No. 9029—Adjustable—\$1.25 per pair

At All Radio and Electrical Dealers and Jobbers

BENJAMIN ELECTRIC MFG. CO.

120-128 S. Sangamon St.

New York
247 W. 17th St.

Chicago

San Francisco
448 Bryant St.

- 1 Frost No. AC1885 Magnaformer Special 500,000 ohm tapered variable high resistance unit with approved a. c. snap switch and Remler No. 750-12 knob
- 1 Samson No. 125 r. f. choke
- 6 General Radio No. 274-J jacks for plug-in oscillator panel
- 6 General Radio No. 274-P plugs for L. W. uncoupler No. 71
- 1 Aerovox Special TH-862M, 12 mfd filter condenser
- 2 Aerovox No. 200-S, 1 mfd bypass condensers
- 2 Aerovox No. 1475, .00025 fixed grid condensers with mountings
- 1 Aerovox No. 1450, .001 fixed condenser
- 2 Aerovox No. 1082, 2 megohm grid leaks
- 1 Electrad B-12.5, 1250 ohm fixed resistance unit

Extra Equipment

- 1 Radiart short wave C. U. No. 72 uncoupler oscillator coil
- 1 Radiart bakelite plug-in S.W. oscillator No. 72 coil bottom panel
- 6 General Radio No. 274-P plugs for S.W. No. 72 uncoupler coil
- 1 Radiart long wave No. 82, antenna coupler
- 1 Radiart short wave No. 83, antenna coupler
- 1 Radiart bakelite plug-in antenna coupler panel
- 5 General Radio No. 274-J, jacks for plug-in antenna coupler panel
- 5 General Radio No. 274-P, plugs for long wave antenna coupler No. 82
- 5 General Radio No. 274-P, plugs for short wave antenna coupler No. 83
- 1 Radiart bakelite plug-in L.W. antenna coupler No. 82 bottom panel
- 1 Radiart bakelite plug-in S.W. antenna coupler No. 83 bottom panel

Junior Radio Builder May Get Fun in Making This Simple Set

(Continued on Page 79)

from the G terminal of the socket to a junction between the 3 megohm grid leak and the .00025 mfd condenser. This leak is in parallel to the condenser and after leaving this point the wire is carried to the stator of the second tuning condenser, which is at the right and to one terminal of the three-circuit coupler. The regenerative winding of the three-circuit coupler goes between the P terminal of the second socket and one side of the head phone binding post, the other side going to the B45 binding post on the terminal strip. In the second step of this receiver, the binding posts for the phones are eliminated and the primary of the first audio transformer takes this position, but this matter will not be discussed in the present article.

The radio frequency transformer is the one which has only two windings, a small number of turns being the primary and a large number being the secondary. In the case of the three-circuit coupler, there are three distinct windings, a small fixed winding being the primary, a large number of turns, fixed, being the secondary, and the small number of turns on a rotor being the regenerative coil. Reference to the schematic circuit shown in Fig. 2 will also help the builder in understanding some of the terms used in this description.

The receiver is designed to operate from the 01B type of tube. These tubes are the same, in effect, as the 201-A, except that the filament current is exactly half. Thus, the receiver might be operated as far as the filament circuit is concerned from four 1½ volt dry cells. The plate supply is obtained from two 45 volt blocks of B battery. These may be of the heavy duty type and will last a considerable length of time because the current drain of the set itself is rather small.

WRIGHT-DECOSTER DYNAMIC REPRODUCER

"The Speaker of the Year"

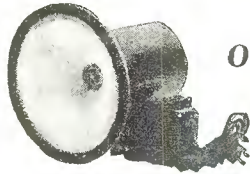

MODEL 107 CHASSIS

BELOW is a paragraph taken from a letter written by one of the largest, if not the largest amplifier manufacturer in the United States.

"In reference to the question of speakers breaking down, we would like to refer you to the Wright-De Coster Company of St. Paul, Minnesota, who manufacture the only dynamic speaker that we have seen which will operate properly with our largest types of amplifiers without breaking down".

Could Any Speaker Have a Higher Recommendation?

Descriptive Matter and Prices Gladly Mailed Upon Request

FACTORY REPRESENTATIVES

Electrical Sales Company
261 Franklin St., Boston, Mass.
Electrical Sales Company
9 South Clinton St., Chicago, Ill.
Mr. G. G. Willison
1913 Pacific Ave., Dallas, Tex.

Mr. Ben J. Aplin
30 Church St., New York, N. Y.
Browne-Hendricks Company
328 Union Mortgage, Cleveland, Ohio
A-K Sales Corporation
291 So. Elmwood Ave., Buffalo, N. Y.
Foreign Representative—Melchior, Armstrong, Dessau Company, 116 Broad St., New York, N. Y.

Palmer & Boyd
1202 Maryland Ave., Baltimore, Md.
Radio Sales Institute
2607-11 2nd Ave., Seattle, Wash.
Church Radio Construction Company
300 Eleventh St. S. W., Washington, D. C.

Carl A. Stone Company
407 E. Pico St., Los Angeles, Calif.
Mr. W. P. Brush
327 Tilden Sales Bldg., San Francisco, Calif.
Palmer & Boyd
327 N. 16th St., Philadelphia, Pa.
B. J. Fitzner Company
159 E. Elizabeth St., Detroit, Mich.

WRIGHT-DECOSTER, INC.

2233 University Avenue

St. Paul, Minn.

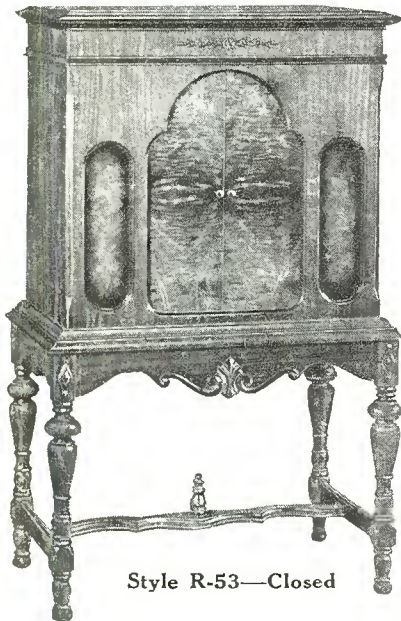

Style R-53—Closed

1929 EXCELLO Radio Consoles

For Beauty and Quality

STYLE R-53 Console is adaptable for radio only or Phonograph-Radio combinations. The Top is hinged and a motor board is provided making for the purchasers' convenience if they desire to make their own Phonograph installation.

Regular phonograph equipment consists of A.C. Motor, Electric pickup, Volume control, Phono-Radio switch, Radio adapter, automatic shut-off, etc.

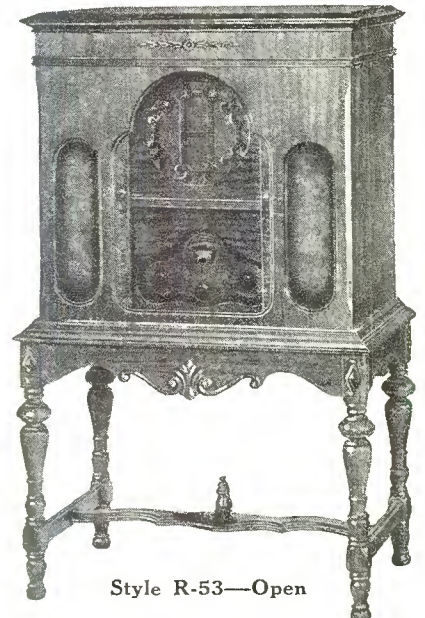

Style R-53—Open

A descriptive bulletin of this and other new 1929 styles sent free on request

EXCELLO PRODUCTS CORP.

4820-28 West 16th St.

Cicero, Illinois

Tell 'Em You Saw It in the Citizens Radio Call Book Magazine and Scientific Digest

X-L LINK New!

Is Your Set ENTIRELY AC?

The most favorable feature of the A.C. set is convenience: the fact that it requires no external batteries, power units, etc., deriving power straight from the light socket.

It still has the disadvantage, though, of requiring an antenna and ground with the accompanying inconveniences of a wire on the roof, lead-in and ground connection.

This also can now be eliminated! The X-L LINK furnishes antenna and ground to any set from the light socket, using the shielded light wires for antenna and ground. In addition, it provides line voltage regulation, double socket outlet and switch for Dynamic Speaker, complete fusing as a protection to all parts in the set and can be attached in a moment's time without wiring or complicated connections of any kind. Simply plug the LINK into the socket and the set into the LINK.

Manufactured and unqualifiedly guaranteed by the makers of the X-L Vario-Denser. If your dealer cannot supply you, it will be sent postpaid on receipt of price.

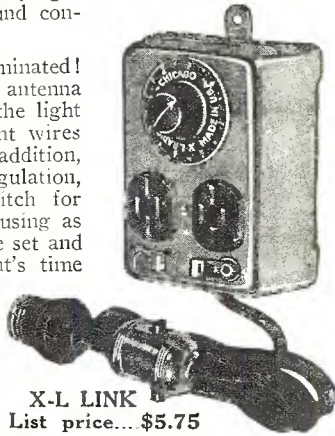

X-L LINK
List price... \$5.75

X-L RADIO LABORATORIES

Department G 1224 Belmont Ave., Chicago

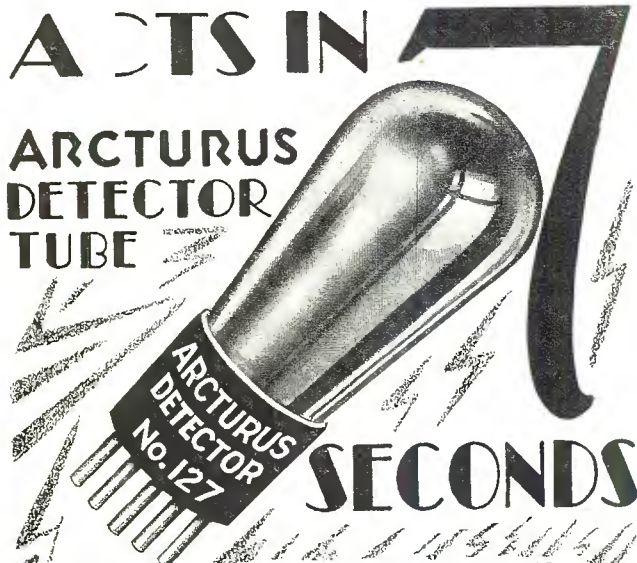

ARCTURUS DETECTOR TUBE

SECONDS

That is the speed you get with an Arcturus blue Detector Tube. Write today for interesting free booklet on these better, longer lasting tubes, colored blue for your protection. Arcturus Radio Company, Department C-1, 220 Elizabeth Avenue, Newark, N. J.

ARCTURUS A-C LONG LIFE TUBES

ARCTURUS RADIO CO.
NEWARK, N.J.

In the event that the builder is a little uncertain as to where the connections from the inductances go, we would suggest that he place the receiver before him in a position shown in Fig. 1. The inductance at the right is made fast to the baseboard by means of a small angle bracket. Looking at this inductance in the manner shown in the photograph, the first winding is a light colored one and has two terminals on it, these two terminals being located at the right in the picture, Fig. 1. One of these terminals, the lower one, goes to the antenna binding post on the strip, which is the first binding post at the extreme right. The second terminal of this primary winding, or the upper one, goes to the second binding post at the extreme right and has a jumper from the binding post on the coil down to the top binding post at the left of this coil when looking at it as shown in the photograph, Fig. 1. The bottom terminal on the left is the one that goes to the grid of the first tube and stator of the right-hand condenser, looking at the set as shown in Fig. 1.

Three Circuit Coupler

When looking at the set exactly as in Fig. 1, the second inductance, or the three-circuit coupler, may be easily figured out by the following method: The terminal at the bottom of the coil nearest the front panel at the right is the one that connects to the plate of the first tube socket. The next binding post on the right, the one nearest the builder, is the primary of the three-circuit coupler and goes to the B plus 90 binding post on the strip. At the left of the three-circuit coupler the terminal which is nearest the front panel is the one which goes to the stator of the condenser at the left and then to the grid condenser and grid leak in parallel and from there into the grid of the detector tube socket. The other binding post at this winding, which is at the left but towards the back of the set, connects with the negative terminal on the second socket and with the rotor of the left-hand condenser. The regenerative winding is the orange colored one on the rotor and the right-hand terminal of this winding goes to the plate terminal of the detector socket. The headphones are located between the left terminal of this regenerative winding and the extreme left post on the terminal strip, and the B+45 volt binding post. These are the only connections that might cause any trouble and the foregoing description is given so as to simplify the wiring of the coils as much as possible.

(A special graphic illustration of this set is available from our Blueprint Department for 10 cents.)

Official Parts List

Parts required for the construction of the first step in this receiver are shown in the following list:

- 2 Amsco .00035 mfd variable condensers
- 1 Frost .00025 mfd fixed grid condenser
- 1 Yaxley 4 ohm fixed resistance
- 1 Durham 3 megohm grid leak
- 1 Formica 7x18x3/16 inch black front panel
- 1 Wood baseboard 7x17x5/8 inch
- 1 Formica 1x13x3/16 inch terminal strip
- 13 X-L bakelite push posts
- 2 530 Frost UX sockets
- 1 10 Yaxley jack switch
- 1 Amsco grid leak mounting
- 1 Frost .001 mfd fixed condenser
- 1 Birnbach r. f. transformer for .00035 condenser
- 1 Birnbach three-circuit coupler for .00035 condenser
- 2 Kurz-Kaseh 4 inch plain dials

Receiver and ABC Supply Combined in "Hi-Q" 29 A. C. Junior

(Continued from page 61)

quite compact and symmetrically laid out. The a. e. leads to the 15 volt filament transformer and the 110 volt primary of the 171 compact may be tied together and a cutout, or a pendant

OUR DRAFTING ROOM

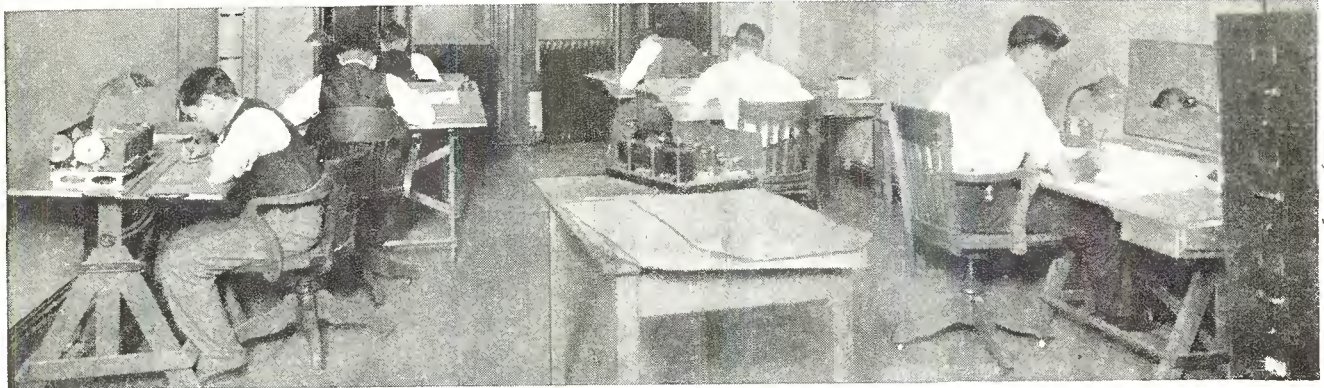

This staff of highly trained draftsmen is continually preparing the most accurate and complete full size blueprints of radio receivers and power packs obtainable. Blue prints are available on all circuits described in the CALL BOOK. Each set of prints is composed of all the necessary drawings prepared in such complete detail and accuracy as to enable an inexperienced builder to duplicate in every respect the receivers built in our laboratory, thus assuring positive success and the greatest satisfaction.

PLEASE ORDER BLUE PRINTS BY NUMBER AND NAME

No. 4	Browning-Drake 5 Tube Receiver using National Impedaformers	1.40	No. 100	Tyrman Super Ten for "A" Elimination (5 drawings)	1.50
No. 8	15 to 550 Meter Receiver	1.40	No. 107	Bremer-Tully A. C. Power Six	1.40
No. 12	Madison-Moore Super-heterodyne Receiver using 201-A Tubes	1.40	No. 115	Tyrman Amplimax "70" (Shielded Grid) 6 drawings	1.50
No. 13	Browning-Drake 5 Tube Receiver Using Acme Impedance Amplifier	1.40	No. 118	Karas A. C. Equamatic (5 drawings)	1.50
No. 14	Browning-Drake 4 Tube Receiver Using Audio Frequency Amplification	1.40	No. 120	Every-Man Four	1.40
No. 32	Scott "World's Record" Super Eight	1.40	No. 122	Phasatrol DeLuxe 7-Tube T.R.F. Receiver (5 drawings)	1.50
No. 37	Madison-Moore "One-Spot" Receiver	1.40	No. 123	World's Record Super Ten & Power Pack (6 drawings)	1.60
No. 44	Melo-Heald Super-heterodyne—11 Tube	1.40	No. 124	Hammarlund-Roberts Hi-Q Six	1.40
No. 47	The "Phasatrol Five" (5 drawings)	1.50	No. 125	Silver-Marshall Universal & Power Pack (7 drawings)	1.70
No. 48	The Citizens Super Eight	1.40	No. 126	St. James Twin Four	1.40
No. 55	30 K. C. Super-heterodyne Receiver	1.40	No. 129	Remler A. C. Super & Power Supply (9 drawings)	1.90
No. 56	Improved Browning-Drake	1.40	No. 137	Citizens-Birnbach A. C. 4-Tube Receiver (5 drawings)	1.50
No. 58	"World's Record" Super Nine	1.40	No. 138	Aero Radio-Phone Transmitter	1.40
No. 64	Aero Seven Tube T. R. F. Receiver (5 drawings)	1.50	No. 147	Custom-built Model Madison-Moore International One-Spot A. C.—Sub-panel Job (6 drawings)	1.60
No. 68	Improved Remler 45 K. C. Super-heterodyne Receiver (5 drawings)	1.50	No. 153	Citizens Shield Grid Short-Wave Receiver	1.50
No. 70	Improved Nine-in-Line (5 drawings)	1.50	No. 162	National Screen Grid Five (5 drawings)	1.50
No. 73	Magnaformer Super-heterodyne Receiver (5 drawings)	1.50	No. 163	Citizens Regenotriac (3 tube A. C.—5 drawings)	1.50
No. 76	Tyrman Ten (5 drawings)	1.50	No. 167	Scott World's Record SG Nine "Power Pack Operated" (4 drawings)	1.40
No. 79	Silver-Marshall High Amplification Super-heterodyne Receiver (5 drawings)	1.50	No. 172	Remler 1929—115 K. C. SG Super (3 drawings)	1.30
No. 81	1928 Infradyne	1.25	No. 173	Aero International Four (4 drawings)	1.40
No. 82	Thompson Super-heterodyne Receiver (5 drawings)	1.50	No. 179	Lincoln 8-80 One Spot Super—3 drawings	1.30
No. 85	Citizens Super Nine (5 drawings)	1.50	No. 181	Citizens Special R. F. Seven—5 drawings	1.50
No. 86	Thordarson Power Amplifier (5 drawings)	1.40	No. 184	Citizens Super using HFL I.F. Amplifier—5 drawings	1.50
No. 87	Improved Aero Dyne Six (5 drawings)	1.50	No. 188	Tyrman Imperial 80—3 drawings	1.30
No. 89	The New Victoreen Universal Super-heterodyne	1.40	No. 189	Hammarlund-Roberts "Hi-Q" 29 Master—3 drawings	1.30
No. 93	Knickerbocker Four (5 drawings)	1.50	No. 190	Victoreen 1929 A.C. Super—6 drawings	1.50
No. 98	Madison Moore International One Spot and Power Pack Baseboard Job (6 drawings)	1.50	*No. 198	Tyrman 72 A.C. Super	1.40
No. 99	Magnaformer 9-8 A. C. (5 drawings)	1.50	*No. 208	Hammarlund Roberts A.C. Junior	1.30

GRAPHIC WIRING DIAGRAMS

No. 20	Silver-Marshall Improved 7 Tube Super-heterodyne Receiver	\$0.60	No. 166	Silver-Marshall SG Six (no output choke)	.60
No. 65	National Browning-Drake with Power Amplifier	.60	No. 170	Silver-Marshall SG Super Nine	.60
No. 88	Two-Tube Browning-Drake with Power Supply	.60	No. 171	Thordarson Dealer's Amplifier	.60
No. 101	World's Record Economy Super 8	.60	No. 174	Sargent-Rayment Seven Receiver	.60
No. 108	Aero A. C. Seven T.R.F. Receiver	.60	No. 178	Silver-Marshall 731 Short Wave Adapter	.60
No. 119	A-B-C Eliminator for D. C. Receiver	.60	No. 182	Haldorson A.C. 56—T. R. F.	.60
No. 134	Nine-in-Line A. C. Operated	.60	No. 183	National Short Wave Receiver	.60
No. 136	Citizens Crystal Receiver	.60	No. 185	Silver-Marshall "Coast to Coast" Four	.60
No. 139	Silver-Marshall Shield Grid Super	.60	No. 186	Aero 7-29 No. 32 S. G. Receiver	.60
No. 140	Citizens Radio Frequency Amplifier	.60	No. 187	Citizens Special Short Wave Receiver	.60
No. 144	AmerIran Power Pack	.60	*No. 195	Junior 2 Tube Receiver	.10
No. 146	Citizens 115 K.C. Shield Grid Super	.60	*No. 196	Aero A.C. Short Wave Converter	.60
No. 150	Samson Push-Pull Amplifier & Power Supply	.60	*No. 197	Aero A.C. 21 Chronophase Receiver	.60
No. 154	Silver-Marshall 4-Tube Shield Grid Receiver	.60	*No. 200	Silver-Marshall Phonograph Amplifier	.60
No. 155	Thordarson Shield Grid Power Amplifier	.60	*No. 202	Silver-Marshall 730 Four Tube Receiver	.60
No. 160	Thordarson 210 Power Compact	.60	*No. 203	Remler A.C. Power Amplifier	.60
No. 164	Thordarson 250 Amplifier	.60	*No. 204	Sangamo Push-Pull Lab. Amplifier	.60
No. 165	Citizens SG Booster Stage	.60	*No. 209	Vee Products A.C. Shield Grid Receiver	.60
			*No. 210	Silver-Marshall 6 Tube Receiver (using output choke)	.60

SCHEMATIC WIRING DIAGRAMS

No. 160a	Thordarson 210 Power Compact	.50	No. 187a	Citizens Special Short Wave Receiver	.50
No. 164a	Thordarson 250 Power Supply and Amplifier	.50	No. 191a	Scott World's Record S. G. Nine "Battery Operated"	.50
No. 165a	Citizens SG Booster Stage	.50	*No. 194a	Victoreen Duplex Power Amplifier	.50
No. 166a	Silver-Marshall SG Six (no output choke)	.50	*No. 196a	Aero A.C. Short Wave Converter	.50
No. 168a	HFL Isotone	.50	*No. 197a	Aero A.C. 21 Chronophase Receiver	.50
No. 169a	Haldorson SG 5-6	.50	*No. 200a	Silver-Marshall Phonograph Amplifier	.50
No. 170a	Silver-Marshall SG Super Nine	.50	*No. 202a	Silver-Marshall 730 Four Tube Receiver	.50
No. 171a	Thordarson Dealer's Amplifier	.50	*No. 203a	Remler A.C. Power Amplifier	.50
No. 174a	Sargent-Rayment Seven Receiver	.50	*No. 204a	Sangamo Push-Pull Lab. Amplifier	.50
No. 178a	Silver-Marshall 731 Short Wave Adapter	.50	*No. 205a	AmerIran Power Amplifier	.50
No. 182a	Haldorson A.C. 56—T. R. F.	.50	*No. 206a	HFL Special Nine A.C. Super	.50
No. 183a	National Short Wave Receiver	.50	*No. 209a	Vee Products A.C. Shield Grid Receiver	.50
No. 185a	Silver-Marshall "Coast to Coast" Four	.50	*No. 210a	Silver-Marshall 6 Tube Receiver (using output choke)	.50
No. 186a	Aero 7-29 No. 32 S.G. Receiver	.50	*No. 211a	Magnaformer 1929 A.C. Super	.50

*Circuits described in present issue.

Any of the above blue prints will be sent postpaid by return mail upon receipt of the proper amount or they can be obtained from any of the Radio jobbers advertising in this publication. C. O. D. orders not accepted.

CITIZENS RADIO SERVICE BUREAU

508 So. Dearborn Street

7th Floor

Chicago, Illinois

Demand for T. C. A. PRODUCTS Necessitates Seven Times Greater Production

THE rapid growth of the Transformer Corporation of America proves once more that dependability is the thing that counts. In the Radio Industry perhaps more than any other, precision is the big factor in turning out products that will give faithful service.

T.C.A. products are being used as standard equipment by many of the country's largest builders of radio sets and radio accessories. They are continually specified by prominent designers and used by thousands of set builders. Wide reputation for efficiency and durability, due to refinements in construction and careful design, has resulted in a steadily increasing appreciation of T.C.A. Products. A new factory of seven times greater capacity is now under way to take care of the steadily mounting demand.

The Transformer Corporation manufactures a complete line of power transformers, audio transformers, audio output chokes, power packs, filament transformers, for A.C. conversion, and neon transformers.

Sales offices in all principal cities. Write and send all specifications to Chicago office. Manufacturers expecting to change or improve design for next year should submit specifications early. Catalog sent upon request.

We will announce new power packs and audio transformers for 1929 sets in the February issue of this publication.

~

**The Transformer Corporation
of America**
1428-1432 Orleans Street
Chicago



switch, may be inserted in the main 110 volt line so as to start and stop the receiver by that particular switch.

This particular model of the Hi-Q 29 a. c. Junior should be well received by the professional set builder who is frequently called upon to sell a custom built receiver in competition against some of the lower priced factory built sets. Since the receiver will fit the standard cabinets or consoles, it is possible to make up a furniture combination that will appeal to any set buyer.

Official Parts List

Parts required for the construction of the receiver described in the foregoing article are shown below:

- 1 Hammarlund Hi-Q 29 Junior foundation unit containing drilled and engraved panel, two complete aluminum shields, drilled steel chassis, shaft, coupling condenser, resistor mounts, binding post strip, fixed resistance unit, clips, wire, screws, nuts, washers, solder, all special hardware required to complete receiver.
- 1 Hammarlund ML-17 .00035 mfd Midline condenser
- 2 Hammlund SGT-17 shield grid r. f. transformers
- 1 Hammarlund RFC-85 radio frequency choke
- 1 Hammarlund SDW knob control drum dial, walnut
- 7 Benjamin Cle-Ra-Tone 9040 sockets
- 1 Sangamo .001 mfd fixed mica condenser
- 1 Carter PT3M tapered volume control 3000 ohm
- 6 Parvult .5 mid series 200 bypass condensers
- 1 Parvult 3 mfd series 200 bypass block
- 1 Parvult 1 mfd series 200 filter condenser
- 1 Parvult 2 mfd series 200 filter condenser
- 2 Parvult 4 mfd series 200 filter condenser
- 1 Parvult 2 mfd series 400 mfd filter series
- 2 Durham metalized resistors $\frac{1}{4}$ megohm
- 1 Durham metalized resistor 1/10 megohm
- 2 Durham powerohms, 1 watt, 100,000 ohms
- 1 Durham powerohms, 1 watt, 50,000 ohms
- 1 Thordarson R-171 power compact
- 1 Thordarson R-196 choke coil
- 1 Thordarson T-2610 filament transformer, 15 volts
- 1 Electrad Truvolt Hi-Q 29 type resistor
- 1 Pr. Yaxley No. 422 insulated tip jacks
- 2 Eby engraved binding posts.

Practical Television

(Continued from page 92)

tube, in reducing leakage current or "dark current" to an absolute minimum in this super-sensitive device.

The increased sensitivity of the latest foto-cell paves the way for important developments in television technique. In fact, it becomes possible to pick up images in broad daylight, with the image scanned by a powerful arc light beam, since the new cells arranged in a bank, are sufficiently sensitive to differentiate between daylight illumination and the superimposed arc beam. These super-sensitive foto-cells may also have a marked bearing on the reproduction of sound tracks on motion picture film, as well as in other non-radio applications.

Interesting Bulletin

CONSIDERABLE information of a helpful nature on the subject of television audio amplifiers is contained in engineering bulletin No. 4 recently issued by the engineering department of the International Resistance Co. at Philadelphia, Pa. The bulletin covers the subject of precision audio resistance amplifiers for television and laboratory experimenters. It gives schematic circuits and frequency characteristics which are quite interesting. Copies of this bulletin may be secured upon writing the International Resistance Co., 2006 Chestnut St., Philadelphia, Pa.

THE NEW 5000 HOUR ELKON METALLIC RECTIFIER FOR "B" ELIMINATORS

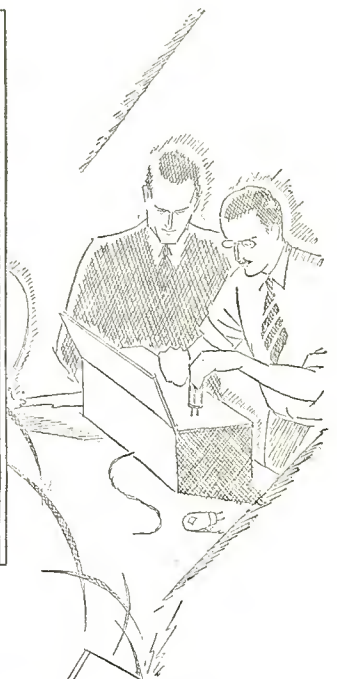
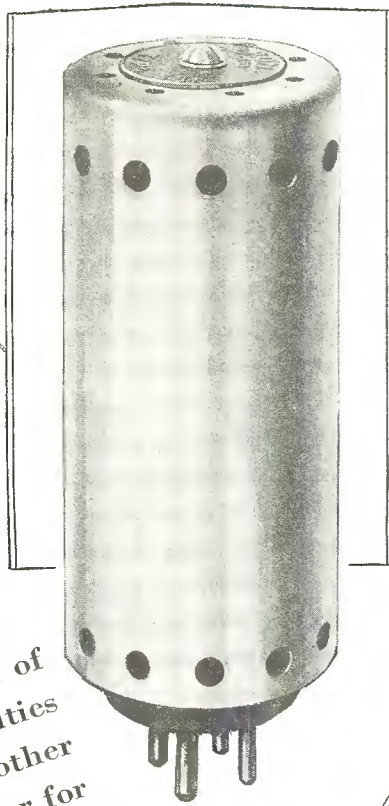

At last a dry high-voltage rectifier! All of the advantages of a tube—none of its frailties—much longer life—more efficient—smoother power—no noise—now as perfect a rectifier for the "B" end as the Elkon "A" Rectifier—stand the Elkon Rectifiers are Self-Healing—surges or accidental overloads are automatically taken care of—no permanent injury is done.

The Elkon EBH replaces BH type tubes in "B" Eliminators. Simply take out the fragile 1000 hour tube and plug in the husky Elkon EBH 5000 hour Rectifier. Same characteristics, but what an improvement.

Use the Elkon EBH Rectifier! Eliminate all uncertainty of life, of successful operation. Build your own new "B" Eliminator or convert the one you have to up-to-the-minute radio efficiency.

ASK ABOUT THE OTHER RECTIFIERS, TOO
M-16 for "A" Eliminators and 3 ampere chargers. V-1 for trickle chargers—and the authorized Balkite Replacement Rectifiers BAK and BJ.

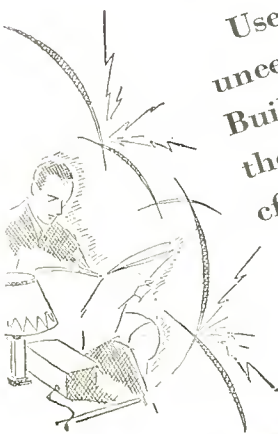

Radio Department
ELKON, Inc.
Division of P. R. Mallory & Co., Inc.
350 Madison Ave., N. Y. C.

ELKON, Inc., Dept. E-3
350 Madison Ave., N. Y. C.
Kindly send me complete information on Elkon Quality Radio Products.
Name.....
Address.....

EBY SOCKETS—

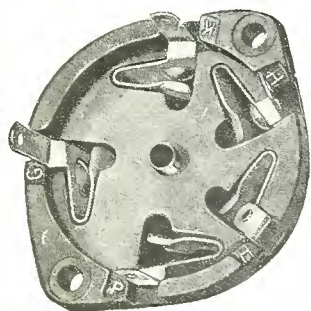

Bottom view without base,
showing contacts

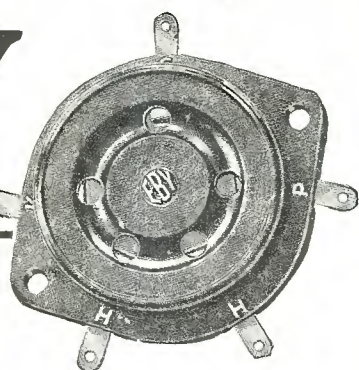

PERFECT CONTACT

Efficient in action and attractive in appearance. Can be mounted above or below any panel. A groove in the top guides the tube-prongs into the socket. The spring action of the phosphor bronze contact prongs can not be weakened—no matter how many times the tubes are inserted or withdrawn.

The H. H. EBY MFG. CO., Inc.

4710 Stenton Avenue

Philadelphia, Pa.

~ PUSH-PULL ~

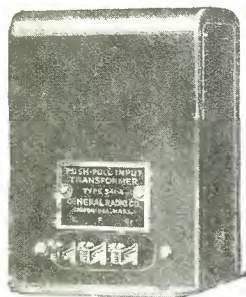

Type 541-A Transformer
Price \$15.00

The Type 541-A Push-Pull Input Transformer illustrated, possesses an unusually good frequency characteristic, due to its sandwich type of coil. The curve is flat from 100 to 10,000 cycles, dropping to about 75% of the maximum at 30 cycles.

Two types of push-pull output transformers are also available. The Type 541-B, designed for use with standard speakers, and the Type 541-C, for dynamic speakers. The primaries of both types are for use with power tubes having plate impedances of 2,000 to 6,000 ohms, and plate current not in excess of 55 milliamperes per tube.

*Bulletin No. 931, which fully describes
these transformers, will be sent
on request*

GENERAL RADIO CO

30 State Street, Cambridge, Mass.

274 Brannan Street, San Francisco, Calif.

With the Professional Setbuilder

(Continued from page 85)

The two relay switches can be hung on the back or ends of cabinets on the inside. The plug that comes with the phonograph pickup is placed in the extra socket permanently. One of the Yaxley relay switches starts and stops your turn-table motor. The other shifts the plate connection of first audio transformer to either the radio detector socket or the phonograph plug. The panel switch operates these two relay switches and shuts off the filament current in the unused tubes when phonograph is on. After the wiring is completed as shown in Fig. 9, set the rheostat in —A return of second relay so that the maximum resistance is in. They turn the panel switch to post C. Neither of the relays should come on. Slowly turn the rheostat till you hear the click of both of them. Leave this rheostat permanently in that position. If this precaution is not taken, you are likely to burn out the actuating coils in the relays. Some testing is necessary to determine which one of the wires at the top of the second relay is unused. This is easily done by connecting the end of one wire in series with a battery, a meter and post P on phonograph plug socket. The wire that gives no meter reading should have tape wrapped around it and remain idle. If you are now using a relay to operate a B-Eliminator, it should be wired in series between your A Battery and the post B of panel switch.

Controlling A. C. Supply

Construct a third switch with solder coating between EA and DC. Insert one quarter-inch bakelite shaft in place of two metal

Does Everything but Think

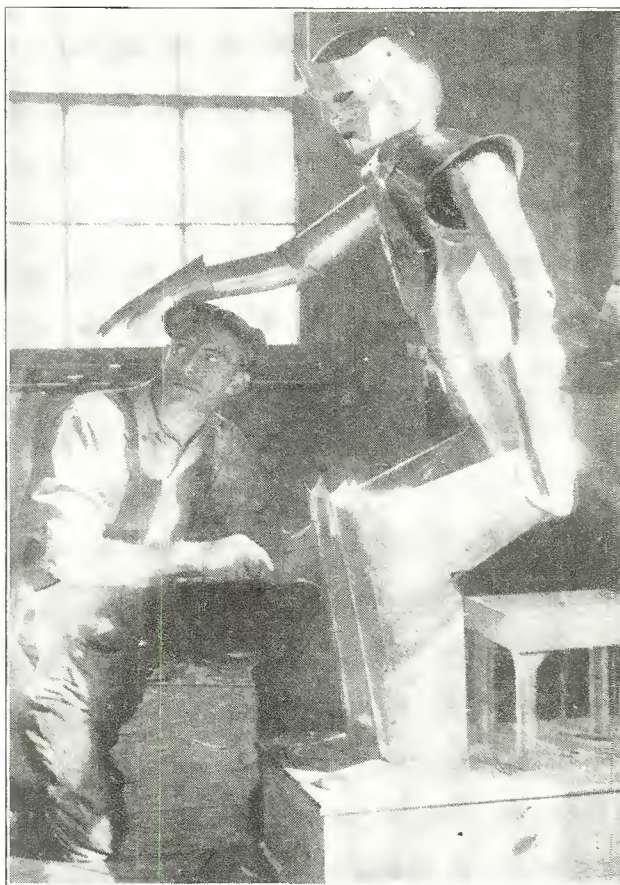
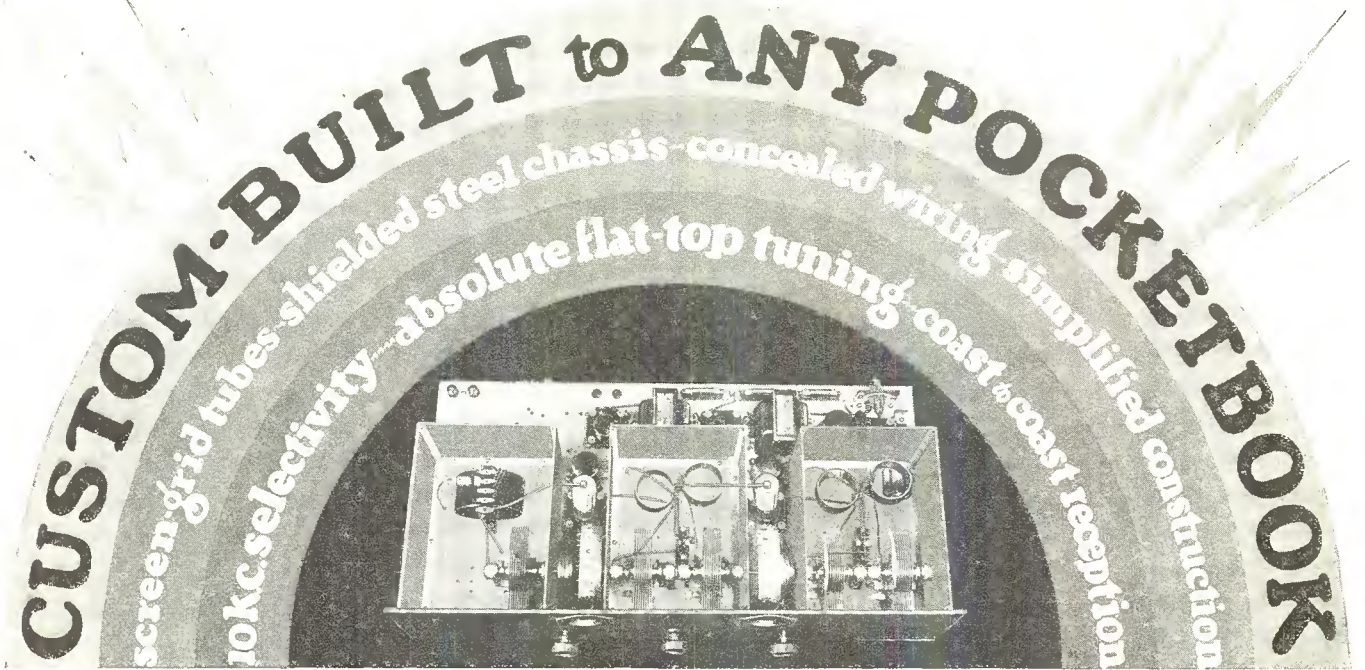

Photo Wide World

Capt. Richards, English inventor, is shown here working on his "Robot," which was later exhibited at the London Radio Show, causing much interest. The mechanical man is able to move his hands, sit down and stand up, and last but not least, to actually speak. There is really nothing but a radio loud speaker inside but the effect is uncanny, combined with the flashing of its eyes, which are electric light bulbs.



THE 4 GREATEST RECEIVERS IN Hi-Q HISTORY!

TO say that these four new Hi-Q Receivers are the greatest instruments ever produced in Hi-Q History is equivalent to saying that they are the most efficient, most selective, most sensitive and most beautifully toned radios in the world. A powerful, all-inclusive statement. But every professional RADIO-TRICIAN who has built one knows this statement is a fact.

For example, there is no receiver, to our knowledge, which employs the Band Pass Filter—an entirely new system used exclusively in the Master Hi-Q 29 models. This new development effects absolute flat-top *square cut-off* tuning for the first time in radio history. It assures positive 10 K. C. selectivity. Even in crowded areas it is impossible to tune in more than one program at a time. "Cross talk" cannot occur. Oscillation, buzzing, humming and background noises are totally eliminated. Stations don't simply "swish" in—they *snap* in, clear

and positive. Tone is practically identical with the original broadcast at the microphone!

There are FOUR Hi-Q Receivers for 1929—the Junior Hi-Q 29 at \$54.35; the Junior A. C. Hi-Q 29 at \$101.50; the Master Hi-Q 29 at \$99.50 and the Master A. C. Hi-Q 29 at \$151.50—four wonderful receivers which meet practically every range of pocketbook. All these instruments are the joint creation of America's ten leading parts manufacturers. All are stage-shielded,

built on steel chassis from the finest parts available in the industry.

If You Want Real Radio Value, Write for Our New 80-Page Book

The new 80-page Construction Manual is the biggest and most complete book of its kind ever published. Tells how to build all 4 new Hi-Q Receivers. Photos and diagrams illustrate every detail. Covers power amplifiers, tube and battery combinations, antennae, installation, short-wave adapters, house wiring and a wealth of other data on custom-built radio. Price 25c.

FOUR MODELS

A. C. or D. C.

Have One Built by Your Local RADIO-TRICIAN

Anyone can build the Hi-Q Receiver, quickly, easily, successfully AND AT BIG SAVINGS over factory-made sets of anything like similar efficiency. If you prefer to have it built for you, write for address of your local Radio-Trician. Over 6,000 of these Hi-Q experts in the country. One is near you. He will be glad to demonstrate the Hi-Q Receiver and build one for you at a very moderate fee.

HAMMARLUND-ROBERTS, Inc. 1182-C BROADWAY NEW YORK CITY

Associate Manufacturers



Tell 'Em You Saw It in the Citizens Radio Call Book Magazine and Scientific Digest

"You Can Forget the Condensers—If They Are DUBILIER'S"



**There
is
No Substitute for Quality!**

No amount of lurid claims by nimble-penned advertising writers will take the place of quality in the final analysis—the operation in your power supply.

Ever since the advent of Radio, Dubilier has been the manufacturers' standard—and the set builders' stand-by. Built in every Dubilier Condenser is a factor of safety which is your safeguard for years of service without failure.

The Dubilier Condenser illustrated here is specially designed for Thorndarson Power Packs. Type 574 for use with the Raytheon BH tubes or the Elkon Metallic EBH rectifier. Type 575 for use with 210 type tubes and 281 rectifier tubes. Type 1152 for use with 210 and 250 type tubes and 281 rectifier tubes. Type 1120 for use with 280 type rectifier tubes or the Elkon E-80 metallic rectifier.

Ask about the
Dubilier Light
Socket Aerial,
Price \$1.50.

Address Dept. 61 for free catalog.

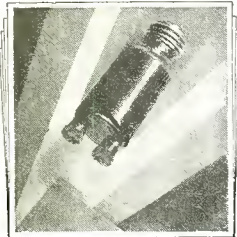

**Dubilier
CONDENSER CORP.**

10 E. 43rd Street, New York City

**POLK BINDING
POST**

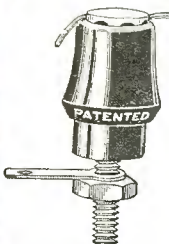

15 cts. each

J. L. POLK, 41 Belle Ave., Troy, N. Y.

SENSATION OF THE NATION

INSULATED

No holes to fish for—just press the sleeve and insert the wire in any position—quick action and holds tight—standard markings.

shafts in original rheostats so that both a. c. and d. c. current can be controlled by one knob. Drill two small holes in bakelite shaft through which insert very small nails which can be soldered to the two sliders. The two switches can be attached to brackets which are mounted to radio base board. We now have a double-pole, double-throw switch, made of the two switches constructed last. Mount an ordinary a. c. porcelain base-socket to your radio base board. Connect one side of socket-plug to both posts A and C of a. c. switch and connect other side of plug to post B of switch. Thus the a. c. current will come on when knob is turned either way.

By means of the combined panel switches described above, it is possible for you to turn either or both speakers on either your radio or phonograph amplifier. Many other useful applications of panel switch will suggest themselves to the experienced experimenter and set-builder.

Resistance Curves

PROPER methods of employing variable high resistances in direct current and a. c. circuits are always interesting and we feel sure that professional set builders will be glad to see the resistance curves shown in Fig. 10, which is supplied us by courtesy of the H. H. Frost Co. The graph represents two types of curves. With the development of the D curve unit, these variable resistances become a universal unit for oscillation or tone and volume control. Since all units are equipped with three terminals, they may be used as a potentiometer type of control, or if desired, by connecting the center terminal and one of the outside terminals, the unit can be used as a two-terminal resistance. The direction of rotation of the knob for increase or decrease of resistance would depend upon which outside terminal is connected. As will be seen in the graph accompanying the description, the D curve is practically a straight line, with the exception of the slight curve at either extremity of the line.

Thus, the D curve type of variable resistance may be used as an oscillation control in tuned r. f. circuits, where it is placed in series with the plate voltage to the radio frequency stages. It may also be used as a volume control in a transformer coupled audio circuit, where it is located across the secondary of the audio transformer, with the center arm going to the grid of the succeeding tube. It may also be used as a sensitivity control with the screen grid tubes, in this connection being located in series with the plate of the 222 tube.

In the LD curve which is shown in the accompanying graph, it will be observed that the resistance change from zero to fourteen arbitrary dial divisions is a very gradual one. Thus for 2 per cent of the range of the resistance unit, the curve is almost flat, then it mounts and increases fairly rapidly up to about 97 per cent of this range, then gradually up to the 100 per cent. This type of curve makes a unit extremely nice for use as a regeneration control in a regenerative circuit, where it is placed across the windings of the plate coil or tickler. By the same token, it is also quite useful as a volume control in an a. c. circuit, where it is placed between antenna and ground, with the center arm going to the grid of the first radio frequency stage.

A good deal of very interesting information contained in the recent Frost Radio 1928 catalog, which may be secured by writing H. H. Frost, Inc., at the main office, Elkhart, Indiana, or copies may be secured from this publication if the set builder will write us for them.

Tyrman 72 Now Designed as Battery or Alternating Current Set

(Continued from page 56)

- 1 Double drum
- 1 .00015 condenser
- 1 .0005 condenser
- 1 6 mfd filter block
- 6 5 prong socket and shields

Save \$2⁵⁰

Get two radio magazines for the price of one!

“Citizens Radio Call Book” and “RADIO” (San Francisco)—a full year subscription to both magazines for the price of a subscription to “RADIO” alone—\$2.50. This great money saving offer is repeated again by popular request.

Radio fans in various parts of the world have taken advantage of this saving. The opportunity is yours once more—if you act quickly. Let us send both of these well known magazines to your address for an entire year. If you are already a subscriber you can extend your subscription for another year and save money. These magazines regularly cost you \$5.00 if purchased from a news dealer over a period of a year. Save \$2.50 by subscribing NOW! This is the most liberal magazine subscription offer available. Get in on it before it is withdrawn. Clip the coupon—attach your check, money order or stamps for \$2.50—and get it in the mails today.

The Coupon Saves you \$2⁵⁰

—if you mail it now

CITIZENS RADIO SERVICE BUREAU
508 South Dearborn Street
Chicago, Ill.

Here is \$2.50. Send CITIZENS RADIO CALL BOOK
and RADIO, each for a full year to—

Name.....

Street and No.....

City and State.....

KABINETTENNA

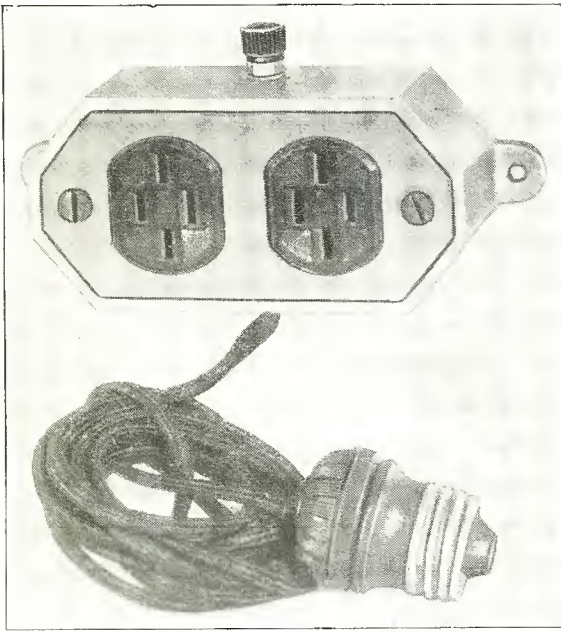

Radio's Greatest Forward Stride Since A. C. Reception

Combines Inside Aerial with Power Lines

YOU can eliminate unsightly wiring, double plugs, and cumbersome aeri-als,—eliminate all of these simply by installing the Kabinettenna. Kabinettenna requires no lightning arrester, reduces static and local interference; Kabinettenna is built on an entirely new and successful principle.

Prolonged tests have proved Kabinettenna the champion long distance performer of inside aeri-als, and users enthusiastically endorse the compact, efficient operation.

Money Back Guarantee

Backed by an iron-clad guarantee, Kabinettenna is positive assurance that you can get every voice from the skies. A trial will prove its superiority.

The diagram to the right shows how Kabinettenna is installed with the hook-up to the dynamic speaker, aerial and chassis.

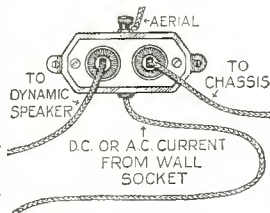

Priced at
\$4.50

A wonderful opportunity for profitable dealers' sales. Investigate now.

*Kabinettenna is the verdict of
Radio Experts*

YAHR-LANGE

MILWAUKEE

INCORPORATED

WISCONSIN

- 1 4 prong socket and shield
- 1 Hardware
- 1 Volume control
- 1 Set coils
- 1 3-31 audio coupler
- 1 3-31A audio transformer
- 1 3-35 audio output coupler
- 3 Yaxley 3000 ohm resistors
- 1 Amsco 100,000 resistor
- 1 Global 3 megohm grid leak
- 3 Brown & Caine ¼ mfd condensers
- 1 Eby antenna binding post, 1/32 in. extruded
- 1 Eby ground binding post, 1/32 in. extruded
- 2 Eby plain binding post, 1/32 in. extruded
- 1 2-A Jack, Carter with 2 insulating washers, 1 Br. washer, 1 hex. nut
- 1 Steinen, single pole, single throw Toggle switch
- 1 Aerovox .002 condenser, midget mica
- 1 Aerovox .001 condenser, midget mica
- 1 Shielded grid connector lead
- 1 Hammarlund equalizing condenser
- 1 Eby tip jack with two washers

"Round the World Four" Uses Screen Grid for Distant Signals

(Continued from page 70)

- 1 Polymet grid leak mounting
- 1 Polymet 5 megohm grid leak
- 1 Durham 60,000 ohm resistor
- 1 Sprague ¼ mfd condenser
- 2 Carter RU10, 10ohm resistors
- 1 Carter H2, 2 ohm resistor
- 8 binding posts consisting of 8/32 screw, nut and insulated top
- 2 National type B vernier dials
- 1 set hardware

Aero 21 Chronophase Has Its Own A, B and C Supplies in Set

(Continued from page 51)

ting in half the regular Yaxley cable. This 5 ft. Yaxley 7-strand connector cable and plug is supplied with the Aero kit. The cable is cut in two parts 20 in. from the base of the seven-point plug. Cable No. 1 is connected from the power supply to the set, while cable No. 2 goes from the power supply to the condenser. This is shown in the sketch illustrated in Fig. 6. Complete instructions for making the two cables are contained in the literature accompanying the Radiart power supply.

If it is desired to use the panel switch on the receiver, by means of which the receiver may be turned on and off instead of by the cut-out switch in the power supply cord, the two terminals on the bottom of the power supply shown connected together by means of a jumper should be opened and the panel switch should be connected to these two terminals. These terminals are shown in the diagram, Fig. 6, and are those which are indicated by the legend "see note." If the set is to be turned on and off by means of the cut-out switch in the power supply cord, then the jumper is left in the position shown in Fig. 6.

The designers state that using the particular receiver described in this article, on a 200-ft. antenna, sufficient selectivity was obtained to bring in WOC at Davenport, while WEBH and WBBM were both in full operation, although WEBH is located within about a mile where the set was tested. With the same adjustments exactly and during the same evening, the set brought in stations over 1,000 miles distant with loudspeaker volume. Over a short period of testing, stations on both coasts were received in the same location.

The need for careful adjustment of both taps and synchronizing studs on the multiple condenser cannot be too strongly empha-

THE NEW CORBETT CONSOLES

For Radio and Phonograph

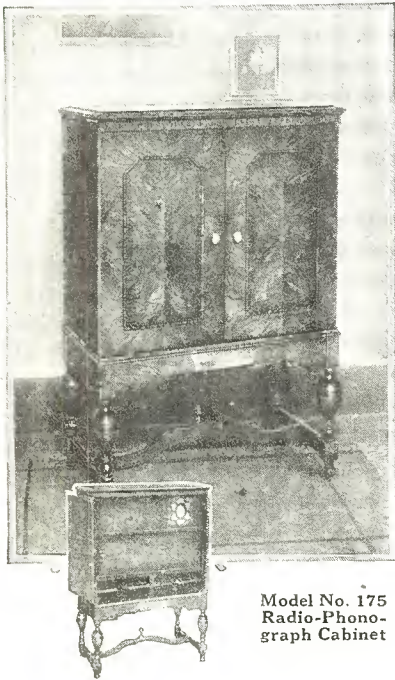

Model No. 175
Radio-Phono-
graph Cabinet

DISTINCTIVE designs, superior products and beautiful finish, have made Corbett Cabinets leaders in the trade. The name Corbett has meant quality Radio Furniture to the dealers since the early radio days. Corbett Radio Phonographs are specified for use with Tyrman and Hammarlund Roberts receivers.

The No. 300 and No. 175 are only two of the attractive models you will find in our 1929 Catalog—write for it today.

**CORBETT CABINET
MANUFACTURING CO.
ST. MARYS, PENNA.**

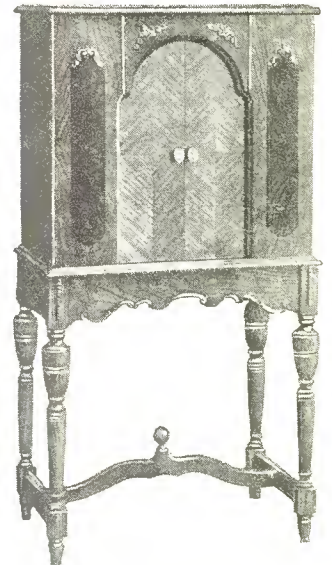

Model No. 300 Walnut Chest

Readrite

Universal Test Set

Complete Outfit, Shown One-Half Scale

Operates equally well on A. C. or D. C. circuits. Just the thing for service man or set owner. A trouble shooter and tube tester combined. Order one today. Literature for the asking.

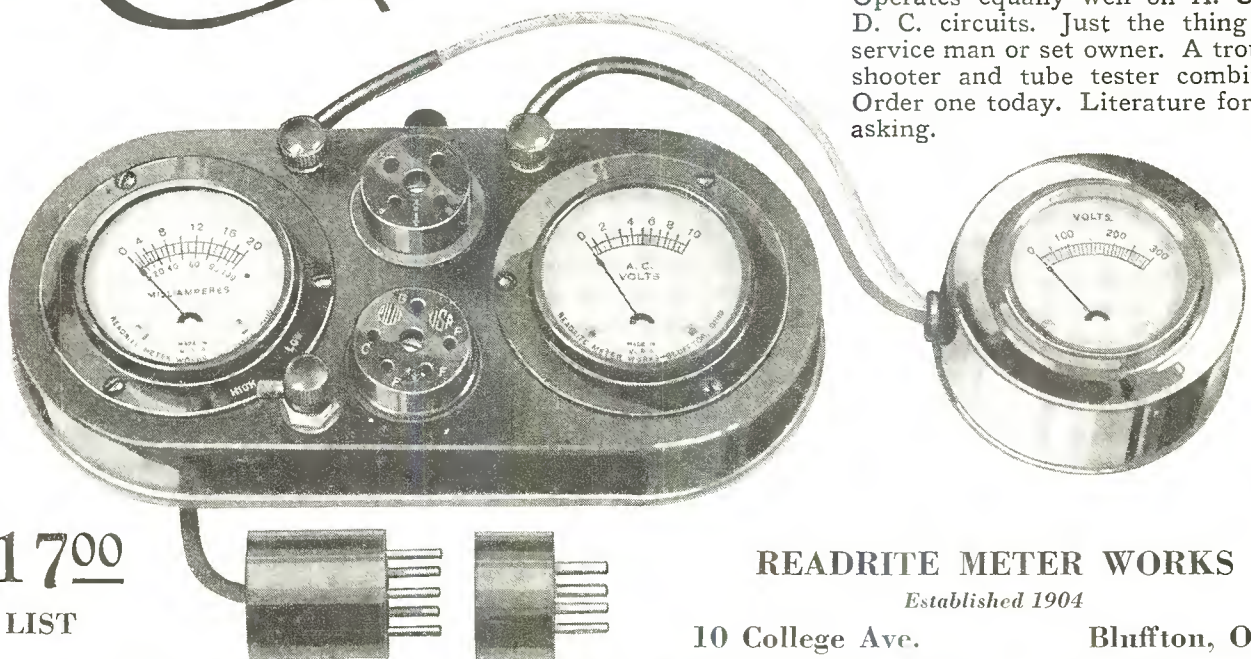

\$17⁰⁰
LIST

READRITE METER WORKS
Established 1904

10 College Ave.

Bluffton, Ohio

Tell 'Em You Saw It in the Citizens Radio Call Book Magazine and Scientific Digest

FOR EVERY RADIO

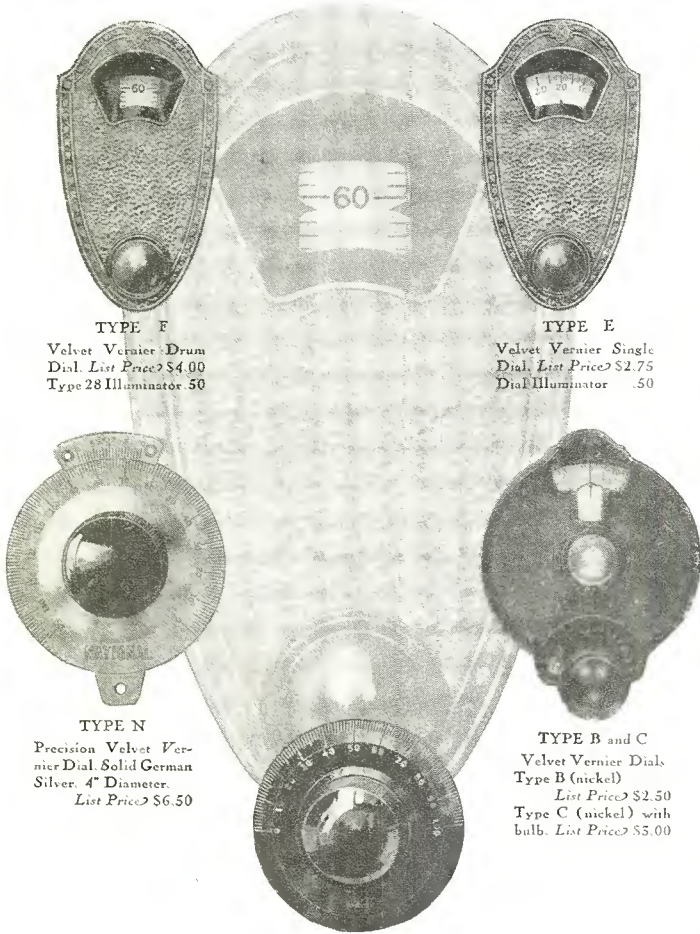

TYPE F
Velvet Vernier Drum
Dial. List Price \$4.00
Type 28 Illuminator .50

TYPE E
Velvet Vernier Single
Dial. List Price \$2.75
Dial Illuminator .50

TYPE N
Precision Velvet Vernier
Dial. Solid German
Silver. 4" Diameter.
List Price \$6.50

TYPE B and C
Velvet Vernier Dials
Type B (nickel)
List Price \$2.50
Type C (nickel) with
bulb. List Price \$5.00

TYPE A
The Original Velvet Vernier
Dial. 4" Diameter.
List Price \$2.50

There is a National Velvet Vernier Dial for broadcast sets, for shortwave receivers and for transmitters and every type of radio laboratory apparatus. National Velvet Vernier Dials are standard equipment of a large number of nationally known manufacturers and are specified and used by leading Radio Engineers and Constructors the country over.

NATIONAL VELVET VERNIER DIALS

NATIONAL THRILL BOX
Two Tube
Short Wave Set
Complete Parts
in factory-sealed
cartons, less tubes
\$36.00

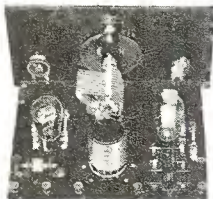

Metal Cabinet for
THRILL BOX
Blackmoire Finish
\$6.50

NATIONAL CO. INC.
MALDEN, MASS.
W. A. Ready, Pres.

NATIONAL THRILL BOX
Send for Bulletin 121-CR

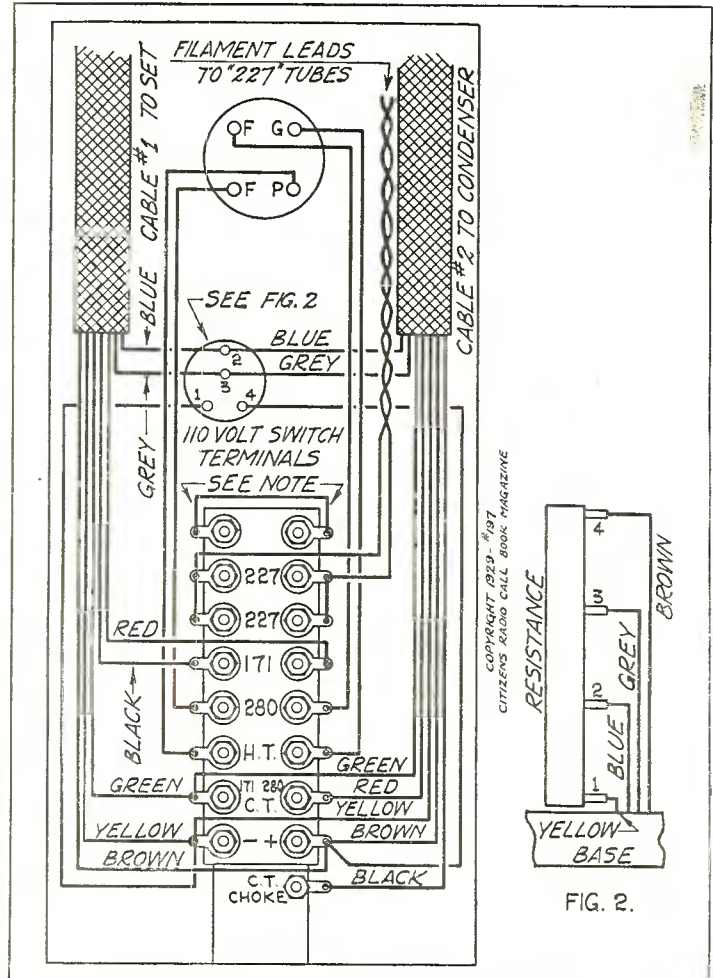
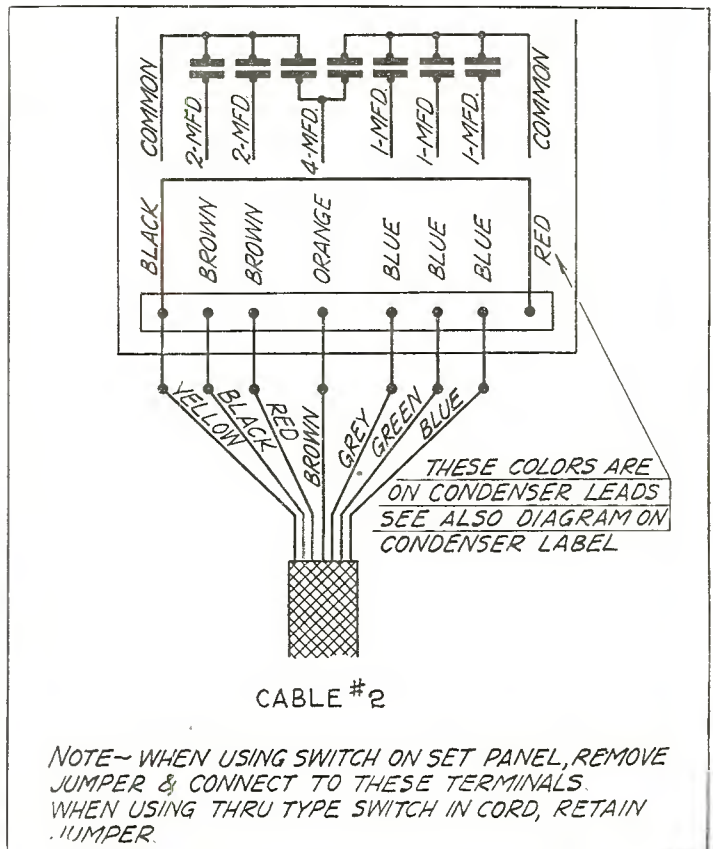

Fig. 6. This sketch shows the terminals on the bottom



NOTE— WHEN USING SWITCH ON SET PANEL, REMOVE JUMPER & CONNECT TO THESE TERMINALS. WHEN USING THRU TYPE SWITCH IN CORD, RETAIN JUMPER.

Fig. 7. This simple sketch shows proper connections

HARDER HALL

ON LAKE JACKSON



SEBRING FLORIDA

WITH beautiful Lake Jackson at its front door, Harder Hall is adjacent to the attractive city of Sebring on the "ridge" of Florida and far to the north of Miami and Palm Beach. Forty thousand acres of Lakes, aided by an altitude of 300 feet and natural drainage, completely protects this section from destructive cold weather. The average winter temperature is 65 degrees, assuring the most delightful climatic conditions, with frost practically unknown.

The Seaboard Air Line and the Atlantic Coast Line provide direct Pullman trains from Jacksonville and the North, and similar service to Tampa, St. Petersburg, Miami and Palm Beach. And for the motorist, hard surface roads radiate from Sebring to every section of the State, with Tampa only a short three hours drive.

The location of Harder Hall was carefully selected, and the appeal of the Sebring climate, with its lack of humidity is irresistible. Comparative accessibility to the centers of population; the beautiful location on Lake Jackson, with its natural white sand beach, and eleven miles of fascinating shore line; the general beauty of the Scenic Highlands; the pure water and invigorating air—all combine to make Harder Hall an ideal spot for your winter vacation.

If GOLF is your passion you will be perfectly at home. The best 18 hole Golf Course in Florida is within a stone's throw of the front door. The views of lake and countryside are fascinating. The near-by Kenilworth course has been the scene of several championship tournaments, and a number of other excellent courses are within a short distance.

Lake Jackson is a bewitching body of water and affords motor boating, rowing, canoeing, and bathing at their best. Fishing is very popular. There is baseball, football, basketball, and tennis for the more strenuous. Horseback riding finds much favor, thanks to miles of fascinating roads and trails in every direction.

The illustration above conveys but a suggestion of the simple beauty of Harder Hall, which is 630 feet long, with a tower 108 feet high. The furnishings throughout are comfortable and restful, with quiet and harmonious color schemes.

The American Plan prevails, with rates that are surprisingly moderate for the type of accommodations. The season is from December 14th to late April, and the management will welcome your inquiry for a copy of the illustrated folder of Harder Hall.

HARDER HALL SEBRING, FLORIDA

Charles N. Thompson, Managing Director
Roberta A. Hill, Associate Manager

FREE!!

with a year's subscrip- tion to the Citizens Radio Call Book Magazine

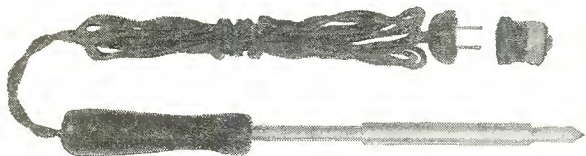

The Famous WARD needs no introduction. Heating Elements will not burn out; either A. C. or D. C., 110-115 volts draws 100 watts. Six feet of heater cord, standard 2-piece separable plug, ebony finish handle, brass plated barrel, $\frac{3}{8}$ -in. diamond-shaped tip, temperature 500 degrees maintained, handle remains cool. Handle insulated against possible short. A genuine high-grade electric iron. Lava rock core approved and listed as standard by Underwriters' Laboratories.

**A most useful household article.
Can be used to solder anything
that requires soldering**

Send in the coupon below and receive the iron absolutely free with a year's subscription to the Citizens Radio Call Book Magazine—for only \$1.75. Hurry—this offer is limited—mail coupon today.

**Iron Is Guaranteed by Manufacturer for
One Year—Hurry—This Offer
Is Limited**

Citizens Radio Call Book Magazine
508 So. Dearborn Street, Chicago, Ill.

Here's my \$1.75 (Foreign \$2.00), for which please send me a Ward Electric Soldering Iron free and enter my subscription for the Citizens Radio Call Book Magazine for one year starting with the

Jan. March Sept. Nov. issue.

Name.....

Address.....

City.....State.....

sized. If either adjustment is not correct, there will be a pronounced lack of selectivity and the receiver will probably bring in nothing but local stations.

The matter of balancing up the set is not at all difficult, but will primarily require quite a bit of time. In most cases, regardless of the type of tubes used, the set will be found to operate to the best advantage with the antenna on tap No. 2, the first radio frequency coil connected at tap No. 3, and the second radio frequency coil at No. 1 or No. 2. For a comparatively short antenna, it may be desirable to put the tap on the antenna coil on No. 3 or No. 4 and for maximum selectivity with a long antenna tap No. 1 should be used.

After connecting the tap, tune in a station which will give a fairly weak signal when the set is not oscillating. Turn up the stabilizer until the set oscillates. Then when the set is in oscillation adjust the stabilizer units on the two rear sections of the multiple until maximum volume is obtained, retuning to a weaker station if necessary, so that while adjusting the volume is always kept at a comparatively low value. When perfectly balanced, the set should go into oscillation with the stabilizer about one-third of the distance from minimum resistance and should go in and out of oscillation at the same point, that is, it should be unnecessary after the set breaks into oscillation to retard the control beyond the point where it went into oscillation.

Official Parts List

The following is the list of parts for the Aero 21 Chronophase a. c.:

- 1 Aero Chronophase foundation unit 21F for a. c.
- 1 Aero special 3-gang condenser .00035 mfd
- 1 Aero special Precise midget condenser
- 1 Aerovox moulded bakelite condenser .00025
- 3 Aerovox moulded condensers .001
- 1 No. 660 Yaxley cable connector
- 2 No. 422 Yaxley tip jacks
- 1 No. U-203 Aero coil kit
- 2 No. C-60 Aero Noskip choke coils
- 1 Type E National illuminated dial
- 3 Kurz-Kasch walnut knobs
- 2 Aero type AE-770 transformers
- 1 3 megohm Allen-Bradley grid leak
- 1 Aero special type AE-250 Centralab resistor
- 1 Aero bushing for dial shaft
- 1 Radiart No. 55 power unit
- 1 Aerovox BC-280 filter block

The ABC of Radio

(Continued from page 97)

radio power units, this may be done by employing efficient variable resistors, such as the clarostat, in obtaining precise voltages for all purposes.

4. The grid leak in the detector circuit should be adjusted for best results. While the 2 megohm value may be satisfactory for powerful local signals, this resistance value is too low for weak, DX signals. Either a collection of grid leaks of various values should be on hand, or a suitable variable grid leak such as the grid leak clarostat should be employed if you would enjoy DX results.

5. Regeneration is practically essential to real DX results. It can be secured in various ways, for practically every radio-frequency circuit has some form of stabilizer to prevent regeneration, and this can be altered when in search of DX, so as to permit of regeneration or approach to maximum sensitivity.

6. A sensitive loud-speaker should be employed, or, better still, a pair of head-phones, plugged into the first audio stage. Many loud-speakers today are relatively insensitive, because they are designed to operate on powerful local signals without blasting

7. It is well to change tubes around, so as to obtain the best tube for each function in the radio set. There is sufficient varia-

Quality
Long Life

Uniformity
Economy

Potter Condenser



By-Pass



**Potter Interference
Eliminator**

Code	Cap.	Working Voltage D.C.	Size	Price	Code	Cap.	Working Voltage D.C.	Size	Price	Code	Size	A. C. Supply Line Volts	Price
A-1	.1 Mfd.	160	7/8" x 3/4" x 1 1/8"	\$0.60	A-4	1. Mfd.	160	1 1/8" x 3/4" x 2"	\$0.90	103-03	1" x 2" x 4 3/8"	110	\$2.25
A-2	.25 "	160	"	.70	A-103	.5 "	200	"	.90	104-04	1 3/8" x 2 1/4" x 4 3/8"	110	3.00
A-3	.5 "	160	"	.75	A-104	1. "	200	"	1.25	105-05	1 3/4" x 2 1/4" x 4 3/8"	110	3.75
A-101	.1 "	200	"	.70	A-302	.25 "	400	"	1.00	303-03	1" x 2" x 4 3/8"	220	3.00
A-102	.25 "	200	"	.75	A-303	.5 "	400	"	1.25	304-04	1 3/8" x 2 1/4" x 4 3/8"	220	3.50
A-301	.1 "	400	"	.85	A-402	.25 "	500	"	1.25	305-05	2" x 2 1/4" x 4 3/8"	220	6.50
A-401	.1 "	500	"	1.00									

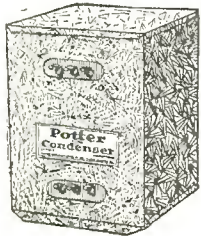

T-2900 Condenser Block for the single 250 type tube amplifier..... **\$20.00**

T-2098 Condenser Block for single 210 type tube amplifier..... **\$20.00**

T2950 Condenser for the push-pull 250 type tube amplifier..... **\$22.50**

T-280-171 Condenser Block for power pack with 280 type tube rectifier. **\$18.00**



The Potter Co.

North Chicago, Illinois
A National Organization at Your Service

Junior Rheostats



Small in size, but a master instrument. Ask your dealer to show you the exceedingly fine adjustment and velvet smooth action. Diameter, 1 1/8 inches.

- Up to 400 ohms.....\$0.75
- 1,000, 2,000 and 3,000 ohms..... 1.00
- Potentiometers.....extra .25
- Self-attaching, positive-acting switches for Junior Rheostats..... .40

Colored Phone Tip Jacks



Have distinctive colored caps, red for positive side of loud speaker and black for negative side.

Cap is of Bakelite. Take standard phone tips. Phone tips nest all the way in jack, making excellent spring contact. Lessens danger of shorts. For Bakelite or metal panels.

- No. 422—Insulated Colored Phone Tip Jacksper pair **\$0.25**

PHONE PLUGS

AUTOMATIC POWER RELAYS
AIR-COOLED RHEOSTATS

New Illustrated Catalog

YAXLEY MFG. CO.

YAXLEY

APPROVED RADIO PRODUCTS



Radio Convenience Outlets

Enjoy your radio programs in any room in the house. Put the batteries in any out-of-the-way place. Bring aerial and ground connections to most convenient

point. These outlets fit any standard switch box. Easily installed.

- No. 135—For Loud Speaker.....\$1.00
 - No. 136—For Aerial and Ground..... 1.00
 - No. 134—For Several Loud Speakers... 2.50
 - No. 132—12 Conductor—For Power Pack Connections..... 3.00
 - No. 137—7 Conductor—For Battery Connections 2.50
 - No. 138—For AC Connections..... 1.00
- Also furnished in two and three plate gang combinations

WITH BAKELITE PLATES

Now furnished with a rich satin Brown Bakelite plate, with beautiful markings to harmonize, at 25 cents extra for the single gang plates.

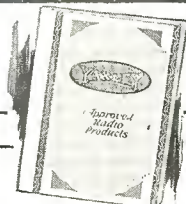

Resistance Units



Absolutely dependable. Run true to rating. Have convenient screw eye and soldering lug for easy mounting and wiring.

- Space wound, 1 to 60 ohms.....15c
- 100 to 400 ohms.....25c
- Tapped resistances, 6 to 64 ohms.....30c
- 100 and 400 ohms.....40c
- Grid resistances, 100 to 500 ohms.....25c
- 600 to 3000 ohms.....35c

Cable Connector Plug

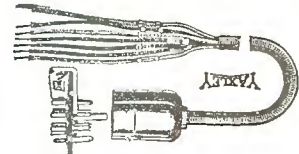

Complete as illustrated with 5-foot cable and cable markers. Mounting

plate mounts on base panel by means of bracket. Bakelite construction; positive spring contacts; no loosening of pins or springs in soldering. You cannot put the Cable Connector Plug together improperly. All terminals and cable ends plainly marked.

- No. 660—Complete\$3.00

CABLE MARKERS

PANEL LIGHTS

JACK SWITCHES

Mailed FREE on Request

Dept. C 9 So. Clinton St., Chicago

RADIO'S HALLMARK
OF QUALITY

DeJUR AMSCO

WORLD'S LARGEST
MANUFACTURER OF
HIGH GRADE RADIO PARTS

THE DeJur-Amsco line of quality radio parts is the most complete and diversified in the industry. Whenever you need anything, from the smallest part to the largest unit in a receiver, go to your dealer and ask him to show you the DeJur-Amsco line.

We are the world's largest and oldest manufacturers of high grade radio parts. Our long experience assures the highest quality and our larger output and most modern manufacturing facilities assure the lowest prices consistent with quality.

SOME DeJUR-AMSCO PRODUCTS

Rheostats	Molded Mica Condensers
Condensers	Phone Plugs
Resistors	Pin Jacks
Choke Coils	Grid Leaks
Speaker Filters	Resistor Mountings
R. F. Coils	Voltage Regulators
Three Circuit Tuners	Voltmeters
Sockets	

Write for Catalog

Write today for DeJur Catalog No. 28 illustrating, describing and pricing every item in the DeJur-Amsco line.

DeJUR-AMSCO CORPORATION

Broome and Lafayette Sts., New York City

DE JUR AMSCO "BATHTUB" CONDENSERS

These new type Bath-tub Condensers are the most perfect units made for single-control tuning. They are available in double, triple and quadruple combinations in all capacities.

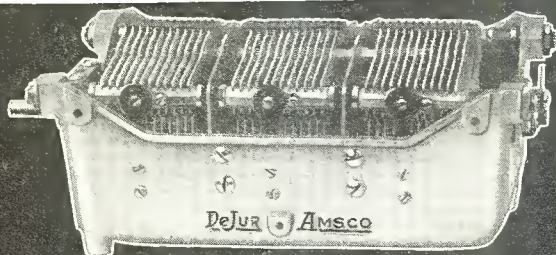

DE JUR AMSCO
"BATHTUB" CONDENSER

tion in most tubes to make some better for one purpose than for another.

8. If troubled by excessive background noises or microphonic interference, the cause is generally traced to the detector tube, which should be changed.

9. By-pass condensers of 1 or 2 mfd., connected between minus B and the various plus B terminals of the radio set, will improve sensitivity and tone quality of weak signals.

10. And in the final analysis, DX is largely a matter of patience and skill, for some fellows can hear Hong Kong on a crystal detector while others can't cover 500 miles with an eight-tuber.

Remler Power Amplifier Using 250 Tube

(Continued from page 48)

series with the primary of the first transformer is of such value as to cut down the voltage applied to the plate of the detector tube. In the output circuit of the power tube, the maximum voltage is applied, this output transformer being also of the resonated type. In the diagram, the speaker coil of this 923 audio

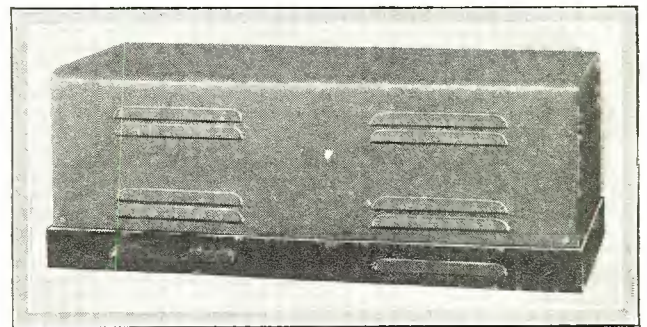

Fig. 4. In this photograph is shown the amplifier after the cover has been placed on it. The louvers shown in the front of the cover are for ventilation

frequency transformer has two taps, one set of taps being for the dynamic speaker input and another set being for the magnetic.

The metal chassis of the amplifier is used as a common negative lead throughout the set. Because of this fact, considerable of the wiring may be simplified and much time may be saved.

Official Parts List

This amplifier is merchandised in a kit built around Remler and Frost parts. In the list of parts shown may be found all of the necessary units required for the construction of this amplifier.

- 1 Remler 950 power transformer
- 1 Remler 900 first stage audio transformer
- 1 Remler 921 second stage audio transformer
- 1 Remler 923 output transformer
- 1 Remler 952 foundation kit
- 1 Frost 300 resistance kit
- 3 Frost 1405 2 mfd filter condensers
- 2 Frost 1104 1 mfd bypass condensers

Aero Low Wave Adapter for Custom or Factory A. C. Receiver

(Continued from page 65)

as a clarostat or adjustostat, and, if desired, the filament switch shown on the panel may be omitted and this resistor mounted in its place. If this is done, connect together the two leads that now are shown running to the filament switch, for the filament lighting can be controlled by the insertion and removal of the tube base plug, which is inserted in the detector socket of the broadcast receiver. To then connect up the variable resistor, run a lead from one side of it to the tube base prong marked B plug in the diagram, Fig. 4. Then run a lead from the other side of this resistor to one side of the choke coil No. 60, the opposite end of the choke being connected to the tickler coil as illustrated in Figs. 3 and 4



The BELLEVUE STRATFORD PHILADELPHIA

The choice of discriminating Philadelphians and particular travelers.

Famous for its courteous service and homelike environment.

Centrally Located
BROAD at WALNUT

J. M. ROBINSON, Manager
Affiliated Hotels

WALDORF-ASTORIA New York NEW WILLARD Washington D.C.

MAGNAVOX "Dynamic" SPEAKERS



"And ev'ry voice is heard repeating
The merry burthen of glad song."—CARMEN.

Before Buying any "A" Eliminator

Get my authorized Discount Card and complete description of the finest "A" Power Kit ever offered.

DAVID W. KNAPP, Pres.

Knapp Electric, Inc.

Division of P. H. Mallory & Co., Inc.

Borden Bldg., Madison Ave., N. Y. City

The Aristocrat

Beautiful butt burl walnut cabinet finished in two tones.

For A-Battery Operation...\$60
AC Operation...\$70

"FIRST SPEAKER
FIRST DYNAMIC"

LICENSED APPARATUS
DYNAMIC
THE MARK OF THE GENUINE

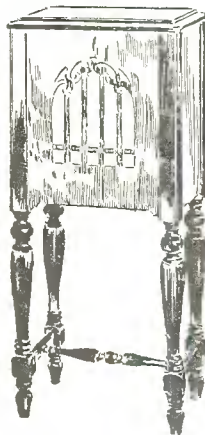

A startling illusion . . .

studio realism in the home. Only a dynamic speaker can so faithfully reproduce the full, rich beauty of the original . . . in volume . . . undistorted. Magnavox created the dynamic. makes only dynamics, supplies leading set makers.

THE MAGNAVOX COMPANY

Oakland, California Chicago, Illinois

284



HFL SPECIAL NINE DEMONSTRATION
every day 1PM until 10 PM.
LAKESIDE RADIO CO.
2808 SHERIDAN ROAD
Wholesale Prices

HEADQUARTERS

For Set Builders and Dealers

We are the Wisconsin distributors for Silver-Marshall Kits Tyrman Kits Scott Screen Grid Nine Robertson-Davis Thordarson and other popular merchandise. We can furnish you within ten hours the parts for the above circuits and others as specified in the CITIZENS RADIO CALL BOOK. Mail orders filled promptly.

RADIO PARTS CO.
311 State St. Milwaukee, Wis.

Acme Parvott	Amertran
Aero	Benjamin
Bodine	Browning-Drake
Carter	Centralab
Daven	Eby
Electrad	Elkon
Hammarlund	
Jensen	
Knapp	Lynch
Madison-Moore	National Co., Inc.
	Newcomb Hawley
Raytheon	
Samson	Pacent
Sangamo	
Scott	
Silver-Marshall	
Sylvania	
Thordarson	
Tobe	
Tyrman	
Victoreen	
Ward-Leonard	
Weston	Yaxley

FREE to You

1929 RADIO BOOK

New hook-ups. This book shows how to make Short Wave Receivers and Short Wave Adapters. How to use the new screen grid tube in D. C. and A. C. circuits.

How to Build Power Amplifiers and ABC Eliminators. Up to the minute information on all new radio developments. Set Builders, Fans, Dealers, send for it today!



Write for it!

KARAS ELECTRIC COMPANY
4026-A N. Rockwell St. Chicago, Ill.

Please send me your Free Book.

Name.....

Address.....

City..... State..... 4026-L1

Metallized

**USE
DURHAMS
as
Grid Leaks
Detector Tap
Resistors
Voltage
Dividers
Resistance
Coupling
Battery
Eliminators
TELEVISION**

Wherever Non-Capacitative Non-Inductive Pure Path of Resistance is a Vital Factor!

~ whether in factory-made or custom-built radio receivers, whether in battery eliminator circuits, whether in power amplifiers or in television circuits ~ DURHAM Resistors, Powerohms and Grid Suppressors are the first choice of men who seek first quality results. DURHAM Powerohms are recommended for use in the sensitive resistance-coupled amplifiers in the photo-electric cell circuit of Television apparatus. They are specified in the popular Cooley Rayo-Photo Equipment. They are used by the U. S. Government and by such experienced organizations as General Electric, Western Electric, Westinghouse, Stewart-Warner, Bell Laboratories, and practically every important radio service station and experimental laboratory in the country. Made in all ranges for every practical equipment. Follow the lead of the leaders in radio and tie-up to DURHAMS ~ radio's leading resistance units.

DURHAM

METALLIZED

RESISTORS and POWEROHMS

International Resistance Co., 2006 Chestnut St., Philadelphia

Parts required for the construction of this receiver are shown in the following list.

- 1 Aero base unit 12BW or 14BW
- 1 LWT-10 Aero coil kit
- 1 Type E National dial, illuminated
- 3 Black Kurz-Kasch knobs
- 5 Eby binding posts
- 1 Centralab type AE-8 variable resistor
- 1 Carter a. c. switch 110-A
- 1 F-1 split brass bushing.

Citizens Interference Eliminator for Finding Power Leaks

(Continued from page 88)

lengths and in other cases on the higher wavelengths. The coil is an ordinary Birnbach r. f. transformer made for use in connection with a .00035 mfd variable condenser. The audio transformer is one of the small Thordarson, with a ratio of six to one. On account of an aluminum shield being used, it is possible to make a good many of the circuit returns to the shield for a common ground and this saves considerable time in wiring. Connections for the head phones are brought out to two tip jacks on the panel. When the set is in operation, the operator will have the head phones on his head while patrolling from pole to pole in order to locate the interference, this process of location being assured by an increase or decrease in the strength of the signal as he walks nearer or away from the source of interference.

Electrically, the circuit is very simple and its construction is quite easy. Even the layman may build up the unit from the diagram shown in Fig. 3, while the experienced set builder will be immediately able to hook up the circuit from that shown in Fig. 4.

Types of Interference

In some of the larger cities, the power companies are equipped with a portable receiver located in a car which they use for chasing down power leaks or other sources of interference along their lines. However, there are many cases in which either the broadcast listener or the professional set builder in a neighborhood is called upon to convince the service company that interference exists. In all our experience with power companies, we have found that they have been quite co-operative, and always willing and desirous of locating any source of trouble on their own line, not only because of the fact that this helps the broadcast listeners in their own neighborhood, but also any form of interference which persists for any length of time will undoubtedly manifest itself in a break or a short and naturally it is to the advantage of the service company to know of these conditions in advance and thus prevent their occurring.

In one case in northern Ohio it was found that interference was being created over an area of a mile or so in each direction and one enterprising set builder finally tracked down the interference and found it to be caused by a pole transformer, which was defective. While it is true that the interference was carried over the particular area covered by that particular pole transformer, nevertheless the set builder found that greater signal was secured as he neared the transformer itself.

In another case under our observation a small town had an interference which blanketed practically all of the broadcast reception. Numerous tests were made at the power house and along the line to determine the cause of interference but no success was encountered. Finally one individual with a portable set located the trouble in one of the oil switches. This switch had been giving trouble recently, but repairs had been made and apparently the switch was not causing the trouble. However, two days after the source of trouble was located and before any definite action could be taken on it, the switch burned out.

Another interesting case of interference was that created by a wire which had broken off from one of the insulators on the cross arm and the wire swung in the wind to within about four

Faithful Radio Servants ELECTRAD RADIO CONTROLS

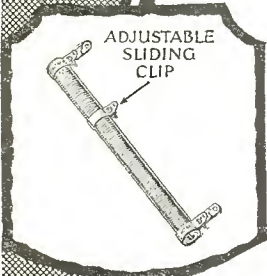

Because a radio receiver or eliminator can give no greater satisfaction than the quality of its vital parts, Electrad resistances are an unqualified choice of professional set builders, experimenters and well-informed radio fans.

They are the guardians of your radio—protecting it against fluctuating voltages, controlling volume smoothly, eliminating oscillations—assuring the highest order of performance for whatever radio function they are used.

Electrad specializes in a complete line of such resistance controls for all radio purposes, including Television. They are obtainable at your dealer's.

TRUVOLT All-Wire RESISTANCES

Reg. U. S. Pat. Off.—Pats. Pending

Admittedly superior for control of voltages in B-Eliminators. Their air-cooled design and unique construction make for unusual accuracy and permit the carrying of much greater current loads without breakdown.

Truvolt Variables simplify B-Eliminator construction by eliminating difficult calculation and making all adjustments easy. Truvolt Fixed are adjustable to different set values by the use of sliding clip taps—an exclusive Truvolt feature!

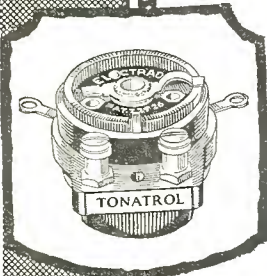

TONATROL

Trade-Mark

A Complete Line of
Volume Controls

Exclusively Licensed by Technidyne Corporation Under U. S. Patent Nos. 1593658, 1034103, 1034104

Tonatrols control volume perfectly, adapting reception to personal tastes. Made for all circuits—battery or A. C. In standard types, or with filament or power switch attached. \$1.50 to \$3.00.

Mail Coupon for FREE Circulars and Full Information

----- CUT HERE -----

ELECTRAD, Inc.
Dept. E-1, 175 Varick Street, New York
Please send me descriptive circulars on the following products and put me on your mailing list for similar literature.

.....General Circular;Tonatrol Volume Controls;Phasatrols;Royalty Variable Resistors;“Electrad Control Manual”

(Enclose 10c for mailing);“What B Eliminator Shall I Build?” (Enclose 10c for mailing.)

I am particularly interested in.....

Name.....

Address.....

ELECTRAD Inc.

or five inches of a metal brace holding up the cross arm. When the wire reached a distance of four inches from this metal brace, there was a loud crackling noise heard, which was heard over practically the whole city. Then when the wire swung in the opposite direction, the noise ceased. However, with the wind, this interference was kept up for nights and days at a time, until finally it was located by patrolling the poles carrying one of the high tension lines. This particular form of interference was very difficult to find, because it was not continuous in nature but rather interrupted, and on days when there was no wind, no interference occurred. The interference only occurred on windy days and gave rise immediately to the idea that something must be swinging close to a power line. However, it was only by following the line with a portable set and wearing a pair of head phones that the inspector was able to find the cause of the trouble.

Service Companies Co-operate

It would seem the best policy on the part of professional set builders or others who have a need for such a device to take up with their local power company the question of locating interference and secure as much co-operation from them as possible. With the hundreds of types of interference that can be caused in the electrical circuits of the nation, it is only natural that the power companies must be fairly certain that the trouble is on their own lines before they will take any action. For example: if the violet ray machine is being operated in a house, it is hardly logical to expect the power company to eliminate a type of interference such as that. By the same token, if trouble arises in the street car rail bonding, it is not logical to go to the local power company and expect them to tear down lines and renew apparatus merely to eliminate an interference which they are not causing. For that reason, with the location of interference it is wise to be very sure of the source before any report is made. In many cases it is advisable to have the advice and help of some of the local power house people after the trouble has been found, in

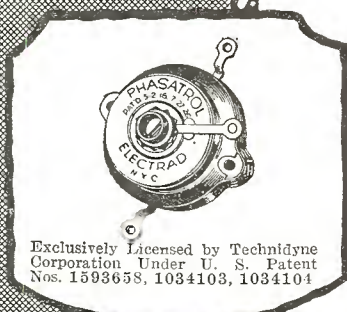

Exclusively Licensed by Technidyne Corporation Under U. S. Patent Nos. 1593658, 1034103, 1034104

Stop Those Oscillations!

PHASATROL

Reg. U. S. Pat. Off.

A True Balancing Device for Radio Frequency Amplifiers
Licensed by Rider Radio Corporation

Phasatrol is an unusually efficient device for controlling radio frequency oscillations and thus eliminating the disturbances to reception which they cause. Adapted to any type of receiver using R. F. Amplification. A wonderful improvement for the new A. C. circuits where the elimination of oscillation is often a serious problem. Price \$2.75 each.

Dept. E-1
175 Varick Street, New York

Electrad specializes in a full line of resistance controls for all radio purposes including Television. Dealers everywhere sell them.

ELECTRAD Inc.

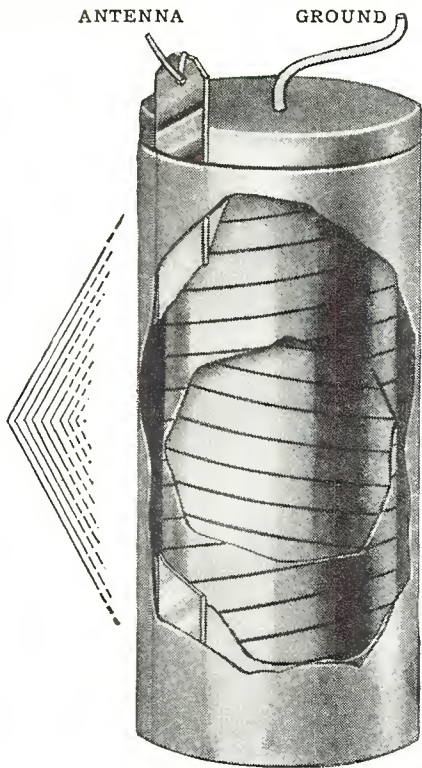

NEW

ANTENNA and GROUND Combined in one convenient Unit

A wonderful thing has happened in radio! Convenience never before dreamed of! Clearer, sweeter-toned reception! Radio pleasure with less interruption! These things are brought to you by the amazing, tested, approved, EARTH-ANTENNA.

Many set owners have come to realize the importance of using a dependable antenna, also the value of perfect grounding in getting good reception. Now science has gone a step further; it says that the LOCATION of the antenna is an equally important factor in getting best results. Because the radio wave goes right into the earth—where obviously there is less atmospheric disturbance and interference—it is claimed the logical place for the antenna should be the EARTH, not the air. This important conclusion allowed Radio Engineers to work out the EARTHANTENNA.

REDUCES STATIC

Gets Clearer, Sweeter Tone

Have you ever listened to reception that almost took your breath away with its faultless reproduction, its pure melodious tone? And then gone home and compared its haunting beauty to YOUR receiver's often unsatisfactory, static-ridden performance? Probably nine out of ten set owners who formerly thought they were getting "pretty good" reception have had this experience.

They accepted the shrieks, whistles, knocking and howls due to atmospheric conditions—the weak, faulty results of sagging, broken or soot-laden aerial wires—the interference of other aerials or power line noises—the fading often caused by corrosion or imperfect contact in an unscientific ground—all as necessary evils.

Progressive radio refused to stop there. The new Scientific successful EARTHANTENNA is designed to give you clearer, better, more dependable reception—and it costs no more than the old inefficient aerial—in fact less than many.

EARTHANTENNA is so easy to install that soon people will wonder how they ever put up with the old, dangerous, slow methods. You simply dig a small hole only two feet below the surface of the ground, drop the EARTHANTENNA into it and attach the lead-in wires to your set. Now you are ready to listen to earth-clarified, sweeter toned ground wave reception. You never need to touch the EARTH-ANTENNA again.

Shielded Antenna Gets Better Reception

The antenna is insulated or "shielded" against electro-static disturbances as are the most advanced, expensive receivers and their various parts. Science declares that the earth itself "shorts" the electro static capacity before it reaches the Antenna. This acts as another shield. The ground element is constructed of copper, undisputed as the most effective material for obtaining a perfect ground connection. This section of the unit is separated from the antenna by the insulation which shields the Antenna. So in the EARTHANTENNA you have a scientific ground and an antenna of modern shielded construction combined in one compact unit. You can test it yourself right now, at our risk. Hear the wonderful results!

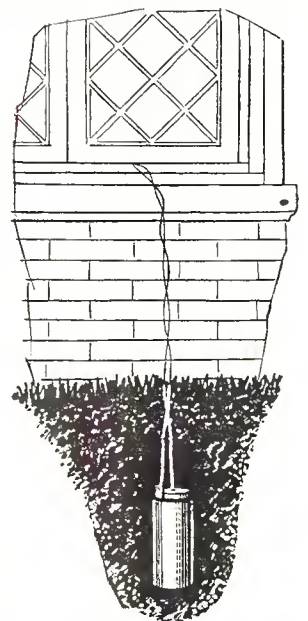

Test EARTHANTENNA at OUR Risk

Let EARTHANTENNA prove its own value without your risking one cent. Don't remove your old aerial and ground until you've compared the old and modern methods and hear the vast improvement with the new. If possible pick a time when static is bad. Then if you are not convinced that EARTHANTENNA is the greatest discovery you've ever found for your radio—if you are not enthused over the improvement—you don't pay us a cent. The thrilling details of this important development—illustrated—will be sent immediately on receipt of this coupon. Mail it NOW!

THE MODERN ANTENNA COMPANY

Dept. 502-A.E., St. Clair Bldg., cor. St. Clair and Erie Sts.
CHICAGO, ILLINOIS



THE MODERN ANTENNA CO., Dept. 502-A.E.
St. Clair Bldg., cor. St. Clair and Erie Sts.
Chicago, Ill.

Rush literature on EARTHANTENNA and Free Trial Offer. No obligation.

Name.....

Address.....

City..... State.....

Tell 'Em You Saw It in the Citizens Radio Call Book Magazine and Scientific Digest

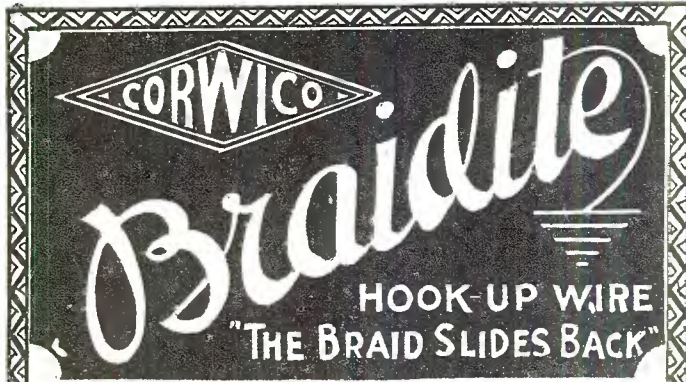

HERE are the features that make Corwico Braidite Hook-Up Wire the first choice of amateurs as well as professionals.

Braidite can be easily twisted for filament leads, making it excellent for all A-C work. It holds its shape permanently after bending. You cannot scorch or burn Braidite with a soldering iron. Being a sleeve insulated hook-up wire, Braidite is safe to work with, yet it is as convenient as bare wire. Braidite cuts wiring time in half. The insulation can be easily shoved back far enough for both solder and post connections, sliding back into place after the connection is made. Braidite thus provides a neat, clean and effective insulation for all exposed areas. It is the fastest and easiest working hook-up wire made. Use Braidite in the next set you build. Write today for a

Free Sample

Send us the name and address of your dealer and we will send you a sample package of Braidite FREE. Include 10c for postage.

Red, Green, Yellow, Blue and Black

List prices as follows:
25 feet stranded Braidite.....35c
25 feet solid Braidite.....30c



At All Dealers

If yours cannot supply you, order direct



ANTENNA WIRES

Stranded, Braided, Solid, Plain, Tinned, Enameled

COMPLETE ANTENNA KITS

From \$1.75 to \$4.50

HOOK-UP WIRES

"Braidite," "Flexibus," Colored Rubber

A-C ADAPTER HARNESES

Type R for RCA type tubes.....\$8.00
Type A for ARCTURUS type tubes..... 5.00

CORNISH WIRE Co

30 Church Street New York City

order to make sure that that is the actual cause of the interference.

The small loop referred to previously and which Vee Products is prepared to make on order is in conformity with specifications drawn up by our laboratory and consists of two lengths of wood which are joined together either by a ferrule or by a screw, the top length carrying a small spider web loop. The loop is in effect merely a coil of wire and only one end of it is used, that being the end that goes down to the receiver itself. The two wood sticks are 5 feet in length and the loop is about 8 inches across. Thus, a man is able to reach up a distance of approximately 15 or 16 feet into the air, and still not high enough to touch any of the lines. Attention could again be called to the danger of touching any power lines with such a probing coil.

We shall be glad to hear from professional set builders and others who have occasion to use such a device and would like to know of the results they experience.

Official Parts List

Parts required for building the interference locator are:

- 1 518 Amsco .00035 mfd variable condenser
- 1 Sangamo .00025 mfd grid condenser and clips
- 1 Birnback r. f. transformer for .00035 mfd condenser
- 1 Thordarson audio transformer, 6-1 radito
- 1 810 Yaxley 10 ohm fixed resistance
- 1 Durham 3 megohm grid leak
- 1 Eby binding post
- 2 9040 Benjamin UX sockets
- 1 Kurz-Kash 4 inch knob
- 1 Yaxley No. 10 switch
- 2 422 Yaxley pin jacks
- 1 Aluminum Co. of America stage shield
- 1 Package Corwico Braidite hook-up wire
- 2 Ceco or Sonatron 199 type tubes
- 1 Vee Products special probing coil

Victoreen Duplex Power Amplifier Is All-Electric Operated

(Continued from page 63)

output lead. This may be done without impairing the quality.

Another point which might be observed by the service man or professional set builder is that if the amplifier exhibits a tendency to squeal as the volume control is opened, it indicates that a

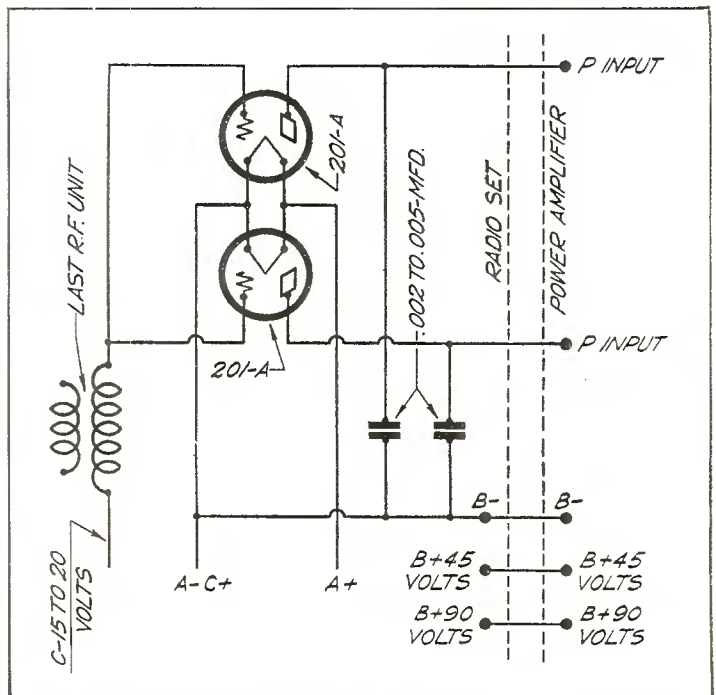
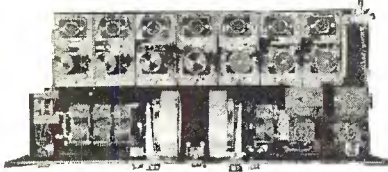

Fig. 5. In this schematic diagram is shown the method of securing power detection using direct current tubes

a REMLER KIT



BEST 115 SUPER

The best 115 Kilocycle Super-heterodyne differs from the Remler 29 in that it incorporates two stages of shield-grid radio frequency amplification instead of one and two stages of impedance-coupled shield-grid intermediate amplifier functioning at 115 Kc. as against three stages of transformer-coupled intermediate in the "29." The sensitivity of the "29" and the "115" are approximately the same, although the selectivity of the "115" is slightly greater due to the use of two stages of radio frequency amplification. The "115" cannot be surpassed for selectivity and is highly recommended for use in cities where broadcast congestion is very bad. It will bring in distant stations under conditions which make the successful use of any other set impossible.

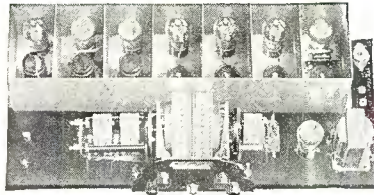

REMLER 29

incorporates a stage of shield-grid radio frequency amplification, oscillator, first and second detectors in the first of which regeneration is used, three stages of transformer-coupled shield-grid intermediate amplification functioning at 115 Kc., and an audio amplifier. It is to be built up on a pressed steel chassis which is drilled for Remler Audio Transformers. Remler Audio Transformers provide reproduction far superior to that which can be had from any other units. Either one or two stages of audio amplification can be built into the receiver proper. It is particularly recommended for use in cities where the usual broadcast congestion exists.

for every LOCATION

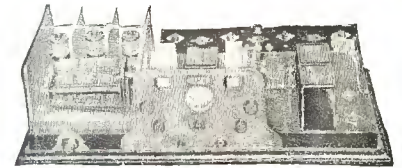

1928 INFRADYNE

incorporates one feature which commands it to everyone. While it is a ten-tube set, a switch is provided so that a five-tube, single-dial tuned radio frequency set is immediately available for local reception. This single-dial feature makes it the ideal set for all members of the family. The complete infradyne is immediately available whenever the extra selectivity and sensitiveness necessary for distant reception are necessary.

The Infradyne is intended for antenna operation and may be operated from a "B" eliminator if desired. A storage battery is recommended as a filament supply.

REMLER DIVISION of

Gray & Danielson Mfg. Company

260 First St., San Francisco

Chicago

New York

HOW TO IMPROVE YOUR RADIO SET OR TESTER

WITH NA-ALD PRODUCTS



No. 502—\$5.00

Here are fourteen NA-ALD products each designed to help you get more out of your radio set.

The NA-ALD Electric Pickup at only five dollars represents remarkable value. It connects to any phonograph large or small and reproduces the music from the records through the radio set and loud speaker. Richer quality and greater volume can be obtained through electrical reproduction. The NA-ALD Pickup is sold on a money back guarantee. Order one—use it for three days and if not satisfied return it and your money will be refunded.

The ten NA-ALD Adapters shown are a small part of the family of sixty different Adapters we make. There is a NA-ALD Adapter for every purpose. If you don't see the one you want—ask for it. No. 933 connects A.C. sets to power amplifiers. It will connect a Radiola 60 to the Victor Electro. No. 954 tests 5 prong tubes in D.C. testers. No. 429 puts UV-199 tubes in UX-201-A or UX sockets. No. 999 puts UX tubes in UV-199 sockets. No. 421-X puts UX tubes in WD-11 sockets—such as in Radiola III and III-A sets. No. 934 prevents squealing or oscillation in unbalanced sets. No. 947 connects Radiola 16, 17 and 18 and other sets to Victor



No. 429—75c



No. 999—\$1.00



No. 421X—75c

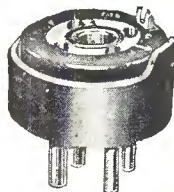

No. 934—\$1.25



No. 947—\$1.50



No. 949—60c



No. 427—50c

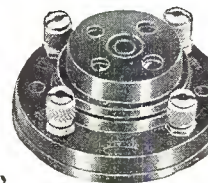

No. 481-XS—65c

Electrolas. No. 949 fits A.C. or D.C. 4 or 5 prong tubes and connects Electric Pickups to sets. Also is ideal for attaching volume controls to sets. No. 945 permits tests in A.C. sets with D.C. testers. No. 419-X puts UX-199 tubes in UX-201-A sockets to make battery sets portable.

Three of the family of fourteen NA-ALD Sockets are shown. No. 481-XS Spring Socket (patented) is recommended for sensitive detector and screen grid tubes. No. 428 compact Socket with one piece contacts and deep, colored locator ring is ideal for power packs and eliminators. It is used in the Skyscraper and Everyman 5 circuits. No. 427 is for five-prong A.C. tubes.

Your dealer should have these products in stock. If he hasn't—send direct. Insist on NA-ALD. Use the coupon below for free catalog and booklets.

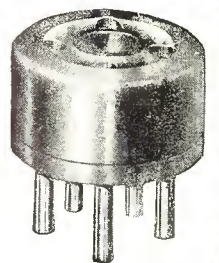

No. 945—\$1.00



No. 419X—35c



No. 428—25c

At All Good Dealers or Write Direct

ALDEN MANUFACTURING CO.
Brockton, Mass. Dept. CCB5
Please send me the Booklets marked.
 THE SOCKET STORY.
 COMPLETE NA-ALD CATALOG.

Name.....
Street.....
City.....State.....

ALDEN MANUFACTURING CO., Brockton, Mass.

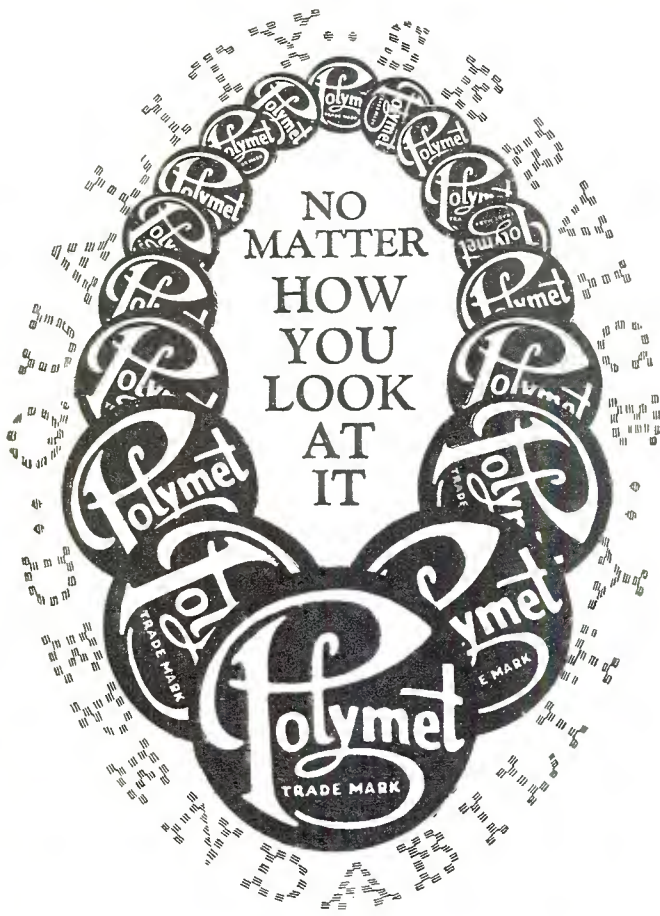

**QUALITY
SERVICE
DEPENDABILITY**
*are closely
WOVEN
around*
POLYMET



*Polymet
Block
Condenser
Built to
Specification*



*Polymet
Filter
Condenser*

POLYMET MANUFACTURING CORP.
609 Broadway New York City

**POLYMET
PRODUCTS**

Tell 'Em You Saw It in the Citizens Radio Call Book Magazine and Scientific Digest

ground is required. Wherever possible, it is recommended that a ground connection be used from the B minus post to a waterpipe or other good ground.

In the operation of the amplifier from a phonograph pick-up, the pick-up leads from the phonograph itself should be no longer than necessary and the condenser across these leads should be located close to or in the power amplifier. A .02 mfd condenser will give less needle scratch and more low notes than a .002 mfd condenser, although the higher condenser may be detrimental in some cases.

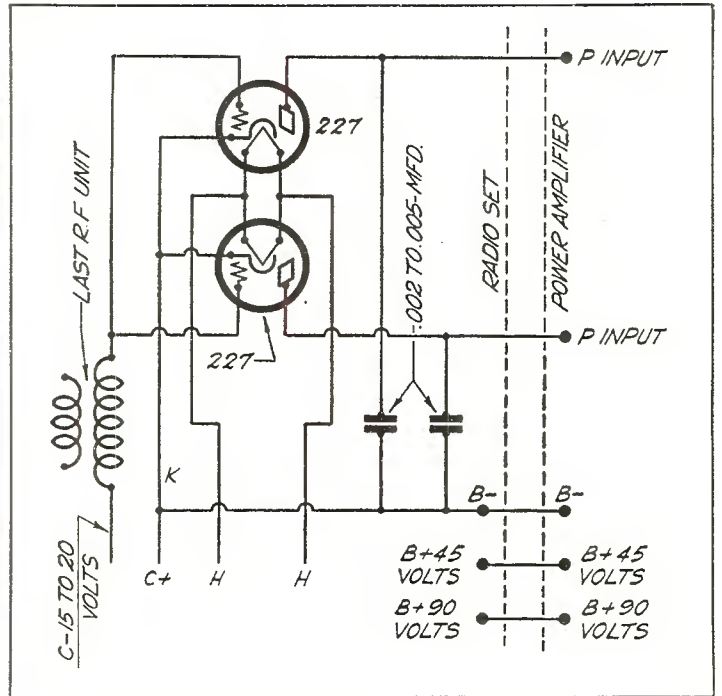

Fig. 6. In this diagram may be seen the duplex power detector system for alternating current tubes

In the wiring of the amplifier, it is suggested that all leads be covered with Empire tubing, spaghetti, to prevent short circuit, or if the job is done with flexible wire, it should be seen that a generous amount of rubber covering is available on the wire. In operation, the amplifier should have ventilation, if it enclosed, as otherwise there is a possibility of damaging the condensers through their proximity to heat source.

Official Parts List

Parts required for the construction of the Victoreen duplex power amplifier are shown in the accompanying list.

- 1 118 Victoreen power transformer
- 1 212 Victoreen duplex audio transformer
- 1 213 Victoreen duplex audio transformer
- 1 216 Victoreen choke unit
- 1 217 Victoreen choke unit
- 1 516 Victoreen C unit
- 3 Parvolt 4 mfd 600 volt d. c. condensers
- 2 Parvolt 1 mfd bypass condensers
- 1 Parvolt 2 mfd bypass condenser
- 4 Benjamin 5-prong sockets
- 7 Benjamin 4-prong sockets
- 1 Truvolt 25,000 ohm variable resistor
- 1 Daven 5,000 ohm superohm
- 1 Daven 10,000 ohm superohm
- 1 Daven 25,000 ohm superohm
- 1 Daven 50,000 ohm superohm
- 2 5 Eby binding posts
- 2 Miniature sockets
- 1 Package Belden hookup wire
- 1 Wood baseboard 10x28x $\frac{3}{8}$ -in.
- 1 Formica binding post strip $\frac{1}{2}$ x $\frac{1}{8}$ x8 $\frac{1}{2}$ -in.

The MIK-1--only AC-operated amplifier of its kind

This amplifier should be used to supply current to, and amplify output of, any standard two-button carbon microphone. It has the same high quality microphone input transformer we supply to a great many of this country's better broadcast stations. This amplifier has an overall gain of approximately 40 t. u. The MIK-1 is built to meet AIEE standards and the requirements of the National Board of Fire Underwriters. Overall dimensions, 15¼x11½x7½". Net weight, 25 lbs.

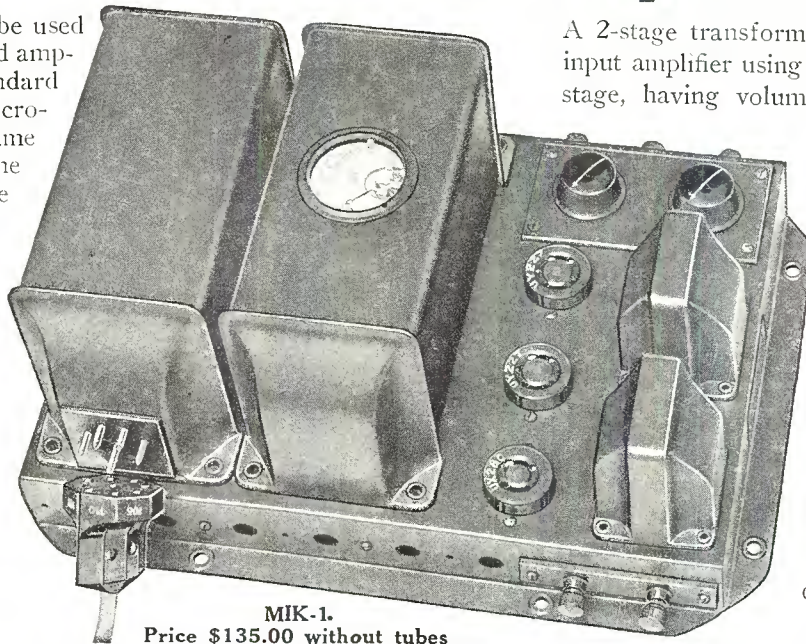

MIK-1.
Price \$135.00 without tubes

A 2-stage transformer-coupled microphone input amplifier using a UY-227 tube in each stage, having volume control, microphone rheostat and switch-controlled milliammeter for quickly determining microphone button currents.

Utilizes UX-280 tube in full wave rectifier system. Compensates for 105 to 120 volt line voltage. Its output terminals connect direct to input terminals of any of our PAM amplifiers.

For conventions, open air assemblies, political gatherings, fairs, race tracks, athletic contests, banquets, receptions, paging systems in hotels, clubs, theatres, railroad stations, etc.

Send for folder CRCB 4 showing this and other PAM amplifiers which are also a "Sound Investment"

Main Office: Canton, Mass.
Manufacturers Since 1882

Samson Electric Co.

Factories at Canton and Watertown, Mass.

Long Distance Reception!

Amazing Performance with Halldorson Shield-Grid 56

Powerful locals such as exist in congested broadcast areas like New York and Chicago are no bar to the Halldorson Shield-Grid 56. "Better than a super" is the favorite expression of fans who have witnessed its marvelous performance. It slips right out through the locals to bring in DX from astonishing distances, and at a volume often indistinguishable from nearby stations. Why bother with an expensive multi-tube set when you can get everything you wish with this six-tube shield-grid marvel?

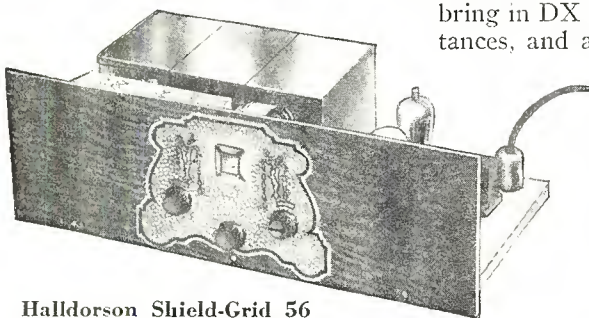

Halldorson Shield-Grid 56

The A.C. 56 is a receiver of similar design for A.C. operation using 226 and 227 tubes.

Halldorson Radio Products

Complete details on this and other Halldorson kits and parts sent upon request.

Shield-Grid Audio

Not content to confine the use of the highly efficient shield-grid tube to the r. f. end of the receiver, the designers of the Halldorson Shield-Grid 56 have extended its use to the first audio. This exclusive feature gives the S. G. 56 circuit a tremendous advantage in picking up signals that otherwise may never be heard except on ear phones. Followed by two 171 tubes in push-pull circuit the power and tone quality is amazing. Never before have such astonishing results been witnessed in a six tube set.

Single Dial Control. When to these advanced features of design you have added the simplicity of one dial illuminated control, copper stage shields, phonograph pickup switch, all metal crystal finished chassis, connecting cable with colored leads, and bronzed escutcheon plate, you have in the S. G. 56 a kit worth more than others at twice the price.

Amazingly Low Price

Compare the Halldorson Shield Grid 56 with any other kit on the market. Never before has such value been offered. Halldorson Shield Grid 56, list price,

\$59.85

THE HALLDORSON COMPANY
4745 N. Western Ave., Chicago, Ill.
Please send me all data on your S.G. 56 receiver and place my name on your mailing list.

Name.....

Address.....

Raytheon

Tubes for Television



Foto-Cell

A television sending tube in hard-vacuum or gas-filled types.

As in tubes for radio, again leadership is accorded Raytheon in tubes for television. The tubes illustrated here are standard sending and receiving equipment.

We welcome correspondence from all having either a scientific or a commercial interest in television.

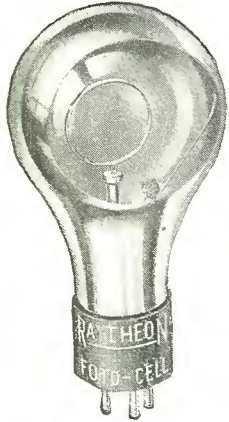

Kino-Lamp

The television receiving tube adapted to all systems.

Price, \$7.50

RAYTHEON MANUFACTURING CO.

CAMBRIDGE, MASS.

BIRNBACH EXTENSION CORD "It's moisture-proof"

*Enables You to Place Speaker Where
It Will Give Best Reception*

YOUR radio receiver must be placed where it will harmonize with the other furnishings of the room and where antenna and ground wires can be easily brought in. With the Birnbach Extension Cord, you can properly place your receiver and put the loud speaker in front of a tapestry, window, behind a screen, in a corner or wherever it gives the best acoustical reception. In addition to this advantage, Birnbach Extension Cords enable you to carry your loud speaker into any room in the house, thus making radio reception available in any room without moving the radio set.

The New Birnbach Extension Cords are available in four attractive colors, Old Gold, Maroon and White in the silk; and Brown, in moisture-proof. These colors will harmonize with any color scheme of home decoration. A thorough insulation of rubber over the strands of copper wires in the Birnbach Moisture-Proof Extension Cord, prevents leakage from one conductor to another, and eliminates the frequent cause of a scratchy noise in the speaker.

Your dealer has these sizes in stock, 10,
20, 30, 40, 50 and 100 foot
lengths, or write us

BIRNBACH RADIO CO.

254 West 31st Street

NEW YORK, N. Y.

(Continued from page 120)

The New Eby 220 Power Amplifier

THE illustration shown herewith is that of the new number 220 power audio amplifier being manufactured by the H. H. Eby Mfg. Co., 4710 Stenton Ave., Philadelphia, Pa.

This power unit, operated from the 110 volt a. c. mains consists of two stages of transformer coupling, and utilizes a stage of perfectly balanced 226 and a stage of push-pull 171s. The power supply for the unit is obtained from a 280 full wave rectifier.

The unit has been designed along most modern lines and in

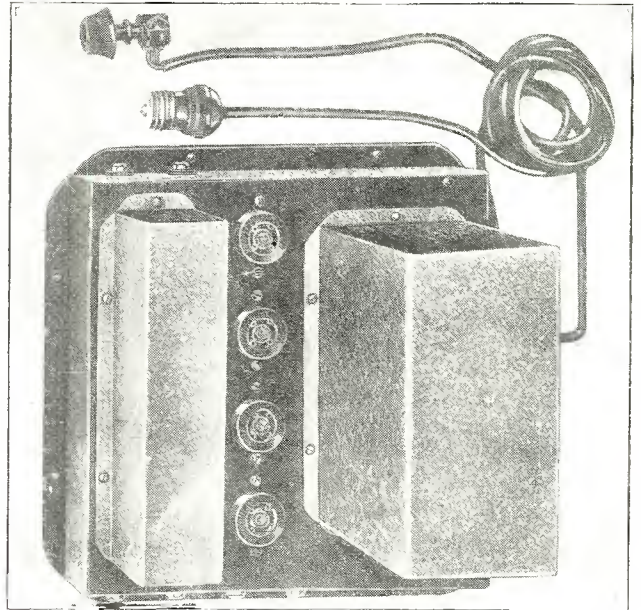

accordance with the transmitting characteristics of the majority of high calibre broadcasting stations. As such, it is possessed of a flat frequency operating characteristic between 60 and 5000 cycles. The complete unit has an undistorted power output of approximately 1500 milliwatts, the equivalent of 1.5 watts.

Particular care has been exercised to obtain correct filament balance and perfect filtering in the B eliminator. As a result, the 226 stage is perfectly balanced and the total hum is so small as to be inaudible 1 foot distant from the speaker connected to the power amplifier. The design of the audio coupling units differs from the conventional, and satisfactory response is obtained at 25 cycles.

Ferranti Announces Meter Line

FERRANTI, Inc., wish to announce the introduction of a new line of radio meters now available for distribution.

Three types are available, a portable of 1,000 ohms per volt with 3-scale ranges of 10/50/250 volts and a second 3-range 200 ohms per volt portable with voltage scales of 7.5/150 and milliamper scale of 15 mills.

The latter instrument is equipped with a switch for changing from one range to others, and a fuse which protects the meter from being burned out in case a high voltage lead is connected to the milliamper scale by mistake.

The third type consists of a flush pattern milliammeter which is available in ranges of 100 and 200 milliamperes. All of these meters are of the D'Arsonvol moving coil type. The moving

Wholesale Prices

Here you will find a new up-to-date stock of kits, parts, accessories and sets—everything you want in radio. Write for Catalog "C-2," quoting special dealers' wholesale prices.

Allied Radio CORPORATION
711 W. LAKE STREET, CHICAGO

BE COMFORTABLE IN LOS ANGELES

El Cortez Apartments

Close In ~ Excellent Transportation

Two Rooms—Bath—Kitchenette Apartments
New, Modern and Completely Furnished
with Hotel Service

Weekly \$25 ~ Monthly \$75

516 West 31st St., at Figueroa
Los Angeles, Cal.

SM AUTHORIZED "SERVICE STATION"

We are completely equipped to SERVICE and repair all SILVER-MARSHALL PRODUCTS.

RADIO SERVICE LABORATORIES

(Harrison 2870)

508 South Dearborn St.

Chicago, Ill.



Whatever Your Connection with Radio

Whatever you need for instruments—whether as set builders, amateur transmitter or service and repair man—the name "WESTON" on any meter you select is the highest guarantee of long life and dependable service with the lowest possible cost of instrument upkeep. Listed herewith are but a few timely models. The complete radio line is fully described in Circular J, mailed upon request.

A. C. and D. C. Portable Models



The compact little instrument held in the hand above is a new 3-range A. C. voltmeter—for testing the supply and tube voltages of A. C. receivers. 150—8 and 4 volt ranges. Mottled red and black bakelite case. Made also in double voltage ranges. Prices, \$13.50 to \$18.00. Also D. C. voltmeter with black bakelite case—1000 ohms per volt—\$28.00.

A. C. and D. C. Set Tester

Model 537

A dealer's or radio serviceman's complete testing outfit. Weight, only 6½ lbs. No additional tools, instruments or equipment necessary. Simple, automatic method of making connections. Meter equipment:—Two 3¼" diam. high grade Weston models. (1) 3-range A. C. voltmeter—150/8/4 volts. (2) D. C. volt-milliammeter with four voltage ranges—600/300/60/8 volts (1000 ohms per volt resistance) and two current ranges—150/30 milliamperes. Price, \$100.00.

A. C., D. C. and Thermo-Couple Types

For panel mounting

Two complete lines—2" and 3¼" diam. sizes, uniform in appearance. Remarkably precise as to electrical characteristics and of highest quality in workmanship and construction. From \$7.00 up.

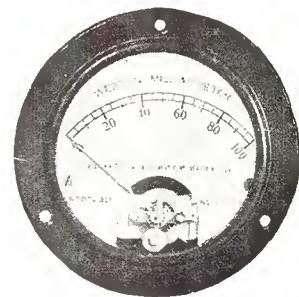

WESTON ELECTRICAL INSTRUMENT CORPORATION

574 Frelinghuysen Ave.
Newark New Jersey

WESTON RADIO INSTRUMENTS

Tell 'Em You Saw It in the Citizens Radio Call Book Magazine and Scientific Digest

\$6.50 FREE \$6.50

Introduction Offer

To introduce the MACK LABORATORY BOOSTER we are supplying the necessary SHIELDED GRID TUBE FREE. The BOOSTER is furnished completely assembled and wired in a standard Aluminum Co. of America shielded box ready to operate.

INCREASES
VOLUME,
BETTER
SELECTIVITY,
MORE
DISTANCE

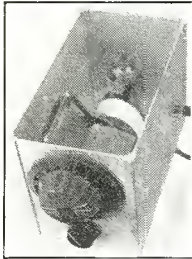

View with cover removed

EASILY
APPLIED,
NO CHANGES
NECESSARY,
NOTHING
ELSE TO BUY

\$16.95
Complete

\$16.95
Complete

Each BOOSTER complete with Tube and Battery Cable, ready to operate and guaranteed to improve the reception of your receiver.

MACK LABORATORIES

Superior and Cass Streets
Chicago, Ill.

Send for WESTERN RADIO

New 1929 Catalog

DEALERS AND SET BUILDERS
The NEW 1929 Catalog is crammed full of the FINEST, NEWEST, Nationally known A.C. sets, consoles, cabinets, dynamic speakers, kits, eliminators and accessories at LOWEST PRICES. Largest stock of radio parts. Prompt delivery. Write for our FREE catalog.

Western Radio Mfg. Co., Dept. C-3, 128 W. Lake St., Chicago



"The Big Friendly Radio House"

WE specialize in constructing and repairing all types of A and B power units.

RADIO SERVICE LAB'S 508 S. Dearborn St. CHICAGO, ILL.

SET BUILDERS

write for
Discount Card

Enabling you to purchase the new and Improved Knapp "A" Power Kit at big discount—Write for full particulars.

DAVID W. KNAPP, Pres.
Knapp Electric, Inc.

Division of P. R. Mallory & Co. Inc.
Borden Bldg., Madison Ave., N. Y. City

element has highly polished steel pivots running in sapphire bearings and girder type pointer of very light and strong construction with knife edge to facilitate accurate reading.

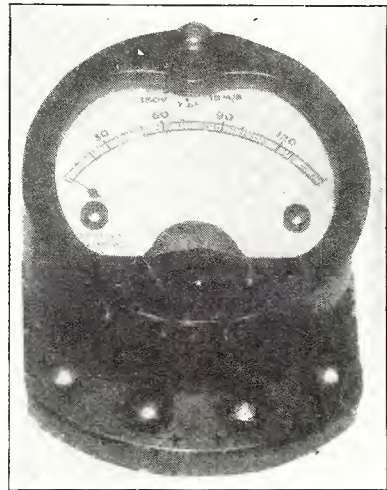

All of these instruments are of highest quality, accuracy and finish. Manufactured by Ferranti, Inc., 130 W. 42nd St., New York, N. Y.

Weighs Paper In Motion

RADIO by-products are increasing in number from day to day. The latest one brought to our attention is called the Verigraph, which is an instrument that accomplishes a difficult feat and a commercially important one, since it weighs moving webs of materials without touching them. It does this by electrical means reliably and with extreme and permanent accuracy. It adapts radio principles to an important industrial service that has never hitherto been performed, the continuous weighing of sheeted products during their manufacture. The principle is new and the working-out very ingenious, but the

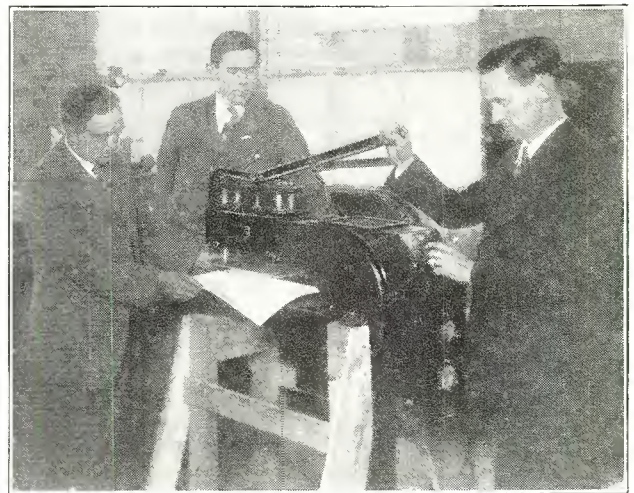

instrument is simple and robust and it can be used as an indicator, which can easily be read by the workman. Either the weight of the moving web or its deviation, up or down, from the standard sample, may be indicated on the large dial where ever it is wanted, or it may be reported on a chart, or both.

The inventor of the device is Albert Allen, who is shown in the photograph herewith. The unit is made by the Atlantic Precision Co., 80 Federal St., Boston, Mass., who also make a moisture control instrument embodying radio principles.

**Radio's
greatest
value!**

SUPERPHONIC



**7 TUBES
SINGLE DIAL**

Superphonic 7 is a world beater! An exceptionally high grade receiver that is amazing the Radio World. Latest 7 tube tuned radio frequency circuit, using 4 radio frequency amplifiers, detector and 2 stages of audio. Power tube can be used in last audio stage. Extremely selective, marvelous sensitivity. Single drum dial control. Straight line wave length condensers permit accurate, equally spaced tuning over entire wave band. All sockets spring cushioned to eliminate microphonic noises. Bakelite subpanel (8 1/4" deep) insures minimum dielectric losses. Clear and realistic reception guaranteed. An exceptionally beautiful, walnut finish, metal front panel 7"x18". Complete chassis. No extra parts to buy. All parts mounted ready to wire. No special tools needed. All hook-up wire and colored battery cable included. Value \$60.00; our price **\$16.95.** **TESTED AND APPROVED**

Severe laboratory tests have proved the remarkable efficiency of this set. Owners everywhere are sending us letters praising its wonderful receptive qualities.

SIMPLE WIRING DIRECTIONS
Very easy to wire this set with the instruction we furnish. Just connect a few wires. All you have to do is follow numbers. Simple as adding 2 and 2. Can be wired in a few minutes by anyone. No radio knowledge needed. Make money by wiring these sets in your spare time and selling them to your friends.

SEND NO MONEY
Just write your name and address on a post card and ask us to send you this wonderful outfit. We ship right away. Upon arrival pay only **\$16.95** plus a small delivery charge. (Foreign countries send **\$19.50** with order. We pay shipping charges)

RADIO EQUIPMENT COMPANY
549 S. Wells St., Dept. 30-E Chicago, Ill.

**Only
\$16.95**

**COAST
& COAST
RECEPTION**

Over 100,000

Townsend "B" Power Units Now in Use --they must be good!

They ARE good! Besides full tone, clarity and volume, you get the thrill of startlingly clear long-distance reception. Never in radio history has anything given such sensational results for such a low price. **UNSURPASSED QUALITY** built in with money saved by unified production methods and low merchandising costs. New thousands of set owners learning amazing value of this Unit.

Utmost economy and convenience. Plug into light socket and forget it. Delivers up to 100 volts on any set on D.C. or A.C.—any cycle. **YOU TAKE NO RISK.** Sold on real **GUARANTEE**—it *must* satisfy or money paid us will be returned.

Complete
\$6.45
\$1.00 Down
Balance C.O.D.

SEND ONLY \$1.00 Fill in coupon and send with only \$1.00. Prove this marvelous value to yourself. Use it ten days. Then if it fails to do everything we say, return it and money paid us will be refunded. Make a **REAL** receiver of your set.

APPROVED

and passed by the rigid laboratory tests of "Popular Radio" and "Radio News."

*From
This Month's Mail*

Your Eliminator has been in use for two years at an average of 6 hours a day and it is still going strong. Three friends have also purchased one and are equally pleased.
Clifton E. Palmer, Highland Park, Mich.
Walter P. Renisch, So. Pasadena, Calif.
Your Eliminator far superior to "B" batteries. Attached to my 5-tube Radiodyne it is as good as any All Electric set I have yet heard.
Leo Pfeffer, Alton, Ill.
Have had your Eliminator in use for over a year and it has proven very satisfactory.
Irving J. Scherer, Detroit, Mich.
Have been using your Eliminator for almost a year and it is giving fine service.
G. D. Murray, Roanoke, Va.
Your Eliminator has given excellent and satisfactory results. Also increased volume and improved tone.
E. J. Luken, Louisville, Ky.
I have used your Eliminator for a year and am very well satisfied with it and have recommended it to many in this city.
Donald J. Scott, Lansing, Mich.

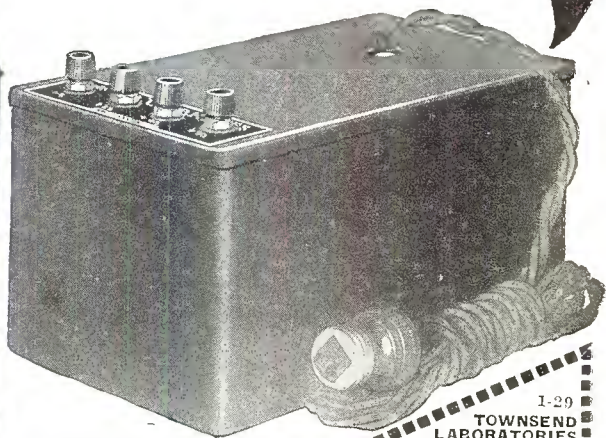

**Attach only
\$1.00
to this
coupon**

1-29
**TOWNSEND
LABORATORIES**
Dept. 26
713 Townsend St.,
Chicago, Ill.

Gentlemen: Attached find \$1.00. Kindly send at once Townsend "B" Socket Power Unit. C.O.D. \$5.85, plus postage, on guaranteed 10-day Free Trial.

Name.....
Address.....
City..... State.....

RADIO KROBLAK TELEVISION

WIRE WOUND RESISTANCES



For all eliminators, power amplifiers, electric sets and Television. For service stations we carry a complete line of resistances for all standard make receivers. Use Mountford Plunger Type Variable Grid Leaks. Ask your dealer or write for circular.

C. E. MOUNTFORD, 30 Sullivan St., New York

SMALL AD-LOWEST PRICES

DEALERS! Our common sense merchandising and economical methods of selling enables us to quote lowest possible prices on nationally known Radio Sets, Kits and Parts. This small ad is an example of our economy. Instead of spending money extravagantly for large magazine space we save this expense and pass it along to you in the form of Lower Prices. Send for our wholesale Radio Catalog. Use your letterhead when requesting this book.

NEW ENGLAND MILLS COMPANY
853 WASHINGTON BOULEVARD CHICAGO, ILLINOIS

Wholesale Prices

Tremendous stock and sales volume, with rapid turn-over to the thousands of radio dealers we serve enables us to make you worthwhile savings at lowest wholesale prices. Write for latest, new illustrated Catalog "C-2."

Allied Radio
CORPORATION
711 W. LAKE STREET, CHICAGO

Lowest Wholesale Prices!

Set Builders and Dealers!

Let the largest Radio Mail Order House in the East serve you!

You'll get better service and better merchandise at the lowest wholesale prices obtainable anywhere.

NEW 1929 BUYING GUIDE

Your copy is ready for you. It lists all the latest Radio Parts, Accessories, Sets and Kits. Catalog K also lists Electrical Supplies, Household Appliances, Golf and Tennis Equipment, Cameras, Traveling Bags, etc. Send for your copy now. It's free.

Allen-Rogers-Madison

35 WEST 31ST. NEW YORK, N. Y.

WRITE TODAY

Send for large, new, illustrated Catalog "C-2," showing the latest of everything in radio at wholesale prices.

Allied Radio CORPORATION

711 W. LAKE STREET, CHICAGO

FROST

FROST MICROPHONES

Built of finest quality materials so as to deliver 100% satisfaction. Solid back, carbon button type. Have unusually sensitive microphones which reproduce all audible frequencies with great fidelity and trueness of tone. Supplied complete with superior quality tinsel cords.

- No. 155 Hand Microphone..\$6.00
- No. 159 Desk Microphone.. 8.75
- No. 157 Pony Arm Microphone for wall or panel mounting 4.50

FROST JAC-BOX

For connecting two or more pairs of phones or for comparing loud speakers. Has 18 inch attaching cord and plug. \$2.50.

FROST VOLUME CONTROLS

Provide absolutely stepless, jumpless control of oscillation, tone or volume, made possible by exclusive roller contact arm and smooth, continuously variable adjustment. Non-inductive. Polished Bakelite shell and dust cover. 2000 to 500,000 ohms. \$2.00 and \$2.25.

Mail Coupon for Catalog



FROST FONES

Extremely sensitive, light in weight, very easy to adjust and a way comfortable.

- No. 174 2000 ohms. aluminum . \$3.00
- No. 175 3000 ohms. aluminum . \$3.50
- No. 172 3200 ohms. gen. bakelite. \$6.00



HERBERT H. FROST, Inc.
160 N. La Salle St., Chicago
Send me by return mail your catalog of Frost Parts.

Name.....
Street Address.....
City.....
State.....

HERBERT H. FROST, INC.
ELKHART, INDIANA

Chicago San Francisco

RADIO

Tell 'Em You Saw It in the Citizens Radio Call Book Magazine and Scientific Digest

Makes Record Dive

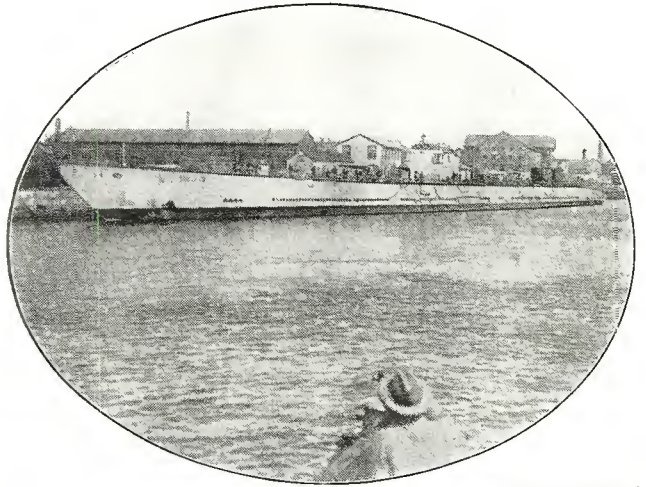

Photo Wide World

A view of the U. S. Submarine V-4, largest in the navy, which established what is believed to be a record for submarine diving in the United States when it reached a depth of 318 feet during a five-hour test off the Isles of Shoals

Measuring Atomic Layers Step to Better "Talkies"

Layers of metallic rubidium, only one atom deep, so thin that several million would be required to equal the thickness of the paper this is printed on, have been measured at the Bell Telephone Laboratories. Thin films of rubidium, a metal similar to the sodium of common salt, are important because of their use in photoelectric cells.

As the magic lamp of modern physics, the photoelectric cell, transmuter of light variations into sound, is the very heart of the revolutions in industry that have been plotted in the physics laboratories. Talking motion pictures, radiovision, television, telephoned photographs would all be impossible without the photoelectric cell.

In the course of researches on how to make the photoelectric cell most efficient, A. L. Johnsrud measured the thin films. When the thin film of metal inside the glass cell was very thin it operated better than when thicker. Rubidium can be made into thin films more easily than its relative metals, because at rather low temperatures and without loss of time it can be made to evaporate and the vapor deposited, in a vacuum, to form such a film.

A large photoelectric cell was made and so arranged that rubidium could gradually be deposited on the glass, or else, after a thick deposit had been made, it could gradually be removed. While the film was thus getting thicker or thinner, the photoelectric response, the current given off when light fell on it, could be measured. Since the maximum response was obtained at the same point, whether the film was growing thicker or thinner, it was necessary exactly to record the film's depth.

Ordinary measuring methods proved inadequate and polarized light was used. Polarized light differs from ordinary light because, by passage through a special kind of prism, it is made to vibrate in a single direction. Ordinary light waves vibrate up and down, right and left, and in every conceivable direction, but that of polarized light is confined to a single plane.

When polarized light passes through any film, such as the one of rubidium, the direction in which it vibrates is twisted. The thicker the film, the more it is twisted. By means of another prism similar to that which polarizes the light the extent of the twisting, and also the thickness of the film, is measured. The most current was obtained when the film was but one atom thick.

(Continued on page 158)



IN THIS ISSUE

Short Wave Superheterodyne
 Radio Picture Reception
 Overcoming Volume Control Difficulties
 Helps For The Radio Trouble-Finder

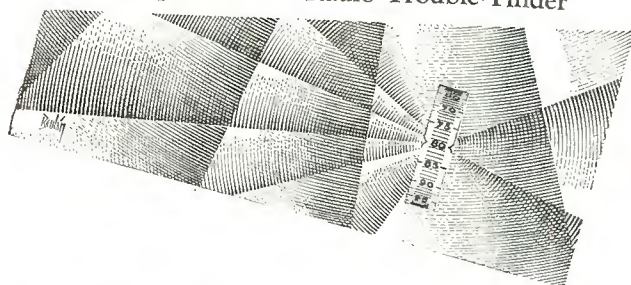

The "Debunker" of Radio

FOR 12 years "RADIO" has told why—AND HOW—radio equipment works.

Its accuracy and conservative policy have earned its reputation as the "debunker" of radio. Readers know that it is reliable if it is published in "RADIO."

Reader confidence applies to the advertising as well as to the editorial pages because the publishers guarantee every advertisement as "Money Back" if not satisfied.

"RADIO"

Established 1917

20 East 42nd St. - - - - - New York City, N. Y.
 307 No. Michigan Ave. - - - - - Chicago
 86 St. Botolph St. - - - - - Boston, Mass.
 Pacific Building - - - - - San Francisco

SPECIAL OFFER

For only one dollar you can have the next six issues of "RADIO" sent right to your home. Six copies if purchased from a newsdealer would cost you \$1.50. You save fifty cents by subscribing now for six months. Mail your dollar bill, check, money order or stamps to Pacific Radio Publishing Co., Inc., 428 Pacific Building, San Francisco, Calif.

FREE!

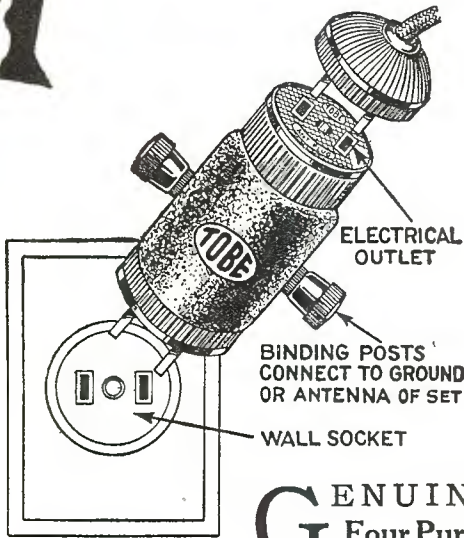

GENUINE Tobe Four Purpose Light Socket Aerial

FREE with one year's subscription to Citizens Radio Call Book—Radio's Greatest Magazine.

The Tobe Socket Aerial solves many aerial problems and does many things—just put plug in your electric light socket and hook your radio set to one side, your ground to the other and you still have your electric outlet.

Static minimized—construction of plug prevents excessive pickup of static—increased selectivity—improves tone quality. Tuning is sharpened—your set will tune much more sharply when you use a Tobe Aerial, than when you use an outside aerial. **Each aerial guaranteed for two years, unconditionally.** Full instructions showing many combinations accompany each aerial.

Send This Coupon Today!

CITIZENS RADIO CALL BOOK MAGAZINE
508 So. Dearborn Street, Chicago, Ill.

Here is my \$1.75 (Foreign \$2.00) for which please send me a Tobe Four Purpose Light Socket Aerial FREE and enter my subscription for the Citizens Radio Call Book Magazine for one year starting with the

January March September November issue

Name.....

Address.....

City.....State.....



Build Your Power Amplifier Around UX 250 Tube and Dongan Transformers, Chokes and Condensers



No. 7568

Immediate delivery of all items listed. Send check or money order.

- No. 7568—Transformer for full wave rectification using 2 UX281 tubes to supply B and C power to receiver and power for 2 UX250 tubes\$13.50
- No. 8529—Transformer similar to No. 7568 with addition of 2 low voltage windings, one for 226 tubes and the other for 227 tubes so that you can build a power amplifier for either radio receiver or phonograph pick-up.....\$16.50
- No. 6551—Double Choke, for use with above transformers.....\$15.00
- D-600—Power Amplifier Condenser Pack contains 2-2.4 Mfd. 1000 volt condenser units.....\$16.50
- D-307—A Condenser Pack, containing 4-2-1-1 Mfd. 400 volt condenser units, used in connection with D-600.....\$10.00
- No. 1177—Straight Power Amplifier Output Transformer.....\$12.00
- No. 1176—Same as No. 1177 but of Push Pull type.....\$12.00

Dongan Electric Manufacturing Company
McDougall at Franklin Street
Detroit, Mich.

TRANSFORMERS of MERIT for FIFTEEN YEARS

At Last! JEEMS SUPER TROUBLE SHOOTER

*The Easy Method for Locating Trouble
in Your Superheterodyne*

THIS handy chart, comprising 16 symptoms, 130 possible causes, is highly recommended by professional set builders as a valuable asset in the work shop.

Accurate, Sure, Complete, Practical

By Mail, 50c

Roberts Radio Service

Caxton Building

Chicago, Illinois

Tell 'Em You Saw It in the Citizens Radio Call Book Magazine and Scientific Digest

Radio's Most Complete Testing Outfit

Converts Service Calls into Sure Profits!

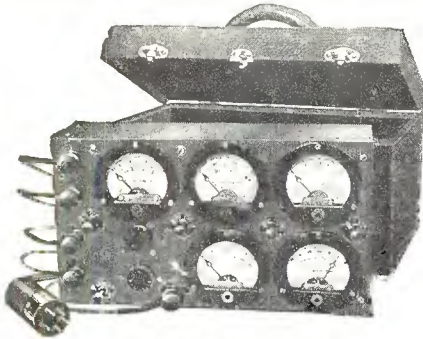

THIS Hickok Set and Tube Tester meets every requirement of service dealers who demand accurate, complete testing equipment to safeguard their interests and increase their products. Within this single unit is incorporated the necessary apparatus for making any and every test on all types of AC and DC Sets and Tubes; it consists of five meters:

HICKOK
"SEES ALL—TELLS ALL"
RADIO SET TESTER
For Every AC and DC Set and Tube

Plate Voltmeter—AC Filament Voltmeter—DC Filament Voltmeter—Plate Milliammeter—Grid Voltmeter. Resistance per volt, 1333½ ohms.

Two sets of cables are furnished for UV and UX or UY tubes; also attachments for all dome type tubes. A beautiful, scientifically designed testing unit containing five meters at practically the same price you would pay for two meter testers. No buttons to push—no multi-scale meters to read.

Write for latest Service Manual No. 25, containing valuable Service Data on proper testing methods. Free upon request.

The Hickok Electrical Instrument Company
Cleveland, Ohio

We are Headquarters for ALL Parts for Building

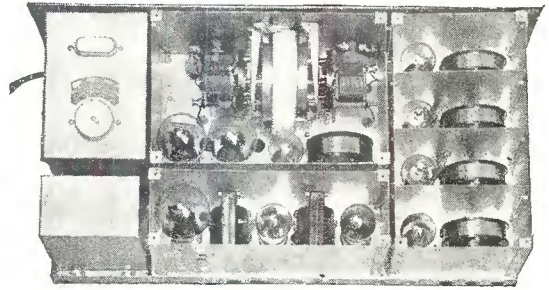

The New Magnaformer AC-29

A Super Powerful 10 Tube Completely Shielded All Electric AC Shield Grid Single Dial, No Harmonic Super, with Self-Contained A, B & C Power Supply, and Four Hundred and Fifty Volt 250 Tube Output for Dynamic Speaker.

This set is a sensational performer. It has tremendous power, making it just as easy to tune in distance as it is to tune in locals. The Tone Quality of this set is Perfect even at full volume. Easy to assemble and easy to tune. Just the set to build for well-to-do, particular customers at a good big profit. Build up a demonstrator at once. You will book orders fast.

Send at once for complete information about the New Magnaformer AC-29, full list of parts, complete radio catalogue and Radioticians and Dealer's Special Discount Sheet.

We Are Wholesale Distributors of All High Grade Radio Apparatus We Specialize on Parts for

- | | |
|------------------------|-------------------------------------|
| New Magnaformer AC-29 | Remler No. 29—115 K.C. |
| Magnaformer 9-8 | National Browning-Drake Units |
| Victoreen DC and AC | Silver-Marshall Apparatus |
| Tyrman 80, 60 and 72 | Kuprox Apparatus |
| Scott Screen Grid Nine | Hammarlund and Aero Short Wave Kits |

NELSON ELECTRIC COMPANY

508 South Dearborn St. Chicago, Illinois
Complete Immediate Deliveries—No Substitutions—"We Ship Faster"

Send for WESTERN RADIO

new 1929 Catalog

DEALERS AND SET BUILDERS
The NEW 1929 Catalog is crammed full of the **BINEST, NINEWEST**, Nationally known A.C. sets, consoles, cabinets, dynamic speakers, kits, eliminators and accessories at **LOWEST PRICES**. Largest stock of radio parts. Prompt delivery. Write for our **FREE** catalog.



Western Radio Mfg. Co., Dept. C-3, 128 W. Lake St., Chicago
The Big Friendly Radio House

REAL SPECIAL OFFER!

UNI-RECTRON POWER AMPLIFIERS (Ideal for Use with Dynamic Speakers)

As the Uni-Rectron stands it is a super power amplifier, which can be used in connection with any radio set and loud speaker. Binding posts are provided for input to the Uni-Rectron and output to the speaker. Requires no batteries for its operation. It obtains its power from the 110 Volt, 60 Cycle alternating current lighting circuit of your house.

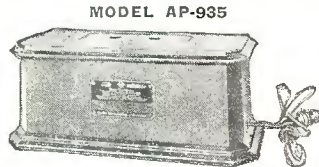

MODEL AP-935
LIST PRICE \$38.50 (without tubes)

Special \$19.75 EA.

The UX-210 super power amplifying tube and the UX-216B or 281 rectifying tubes are used with this amplifier, which cannot overload. From the faintest whisper to the loudest crash of sound—R. C. A. Uni-Rectron amplifies each note at its true value. High and low notes are all treated alike. The volume and quality delivered will be a revelation.

All Units Are Brand New and Packed in Original Factory Cartons
American Sales Co., 19-21 Warren St., New York City



RESISTOVOLT

AUTOMATIC VOLTAGE CONTROLLER

TRADE MARK REGISTERED U. S. PAT. OFF.

Antennavolt

COMBINATION RESISTOVOLT AND LIGHT SOCKET ANTENNA

Gives the benefits of a light socket antenna without tying up the socket for set current PLUS giving RESISTOVOLT VOLTAGE CONTROLLING PROTECTION!



\$2.25

Automatically checks all line voltage in excess of 110 volts, protecting your tubes from slow burn-out or line surges. Protects tubes and set wiring in case of short circuit by acting as a fuse. Barnishes line noises caused by the use of electric appliances, switches, etc., in the home. This new De Luxe model is completely Air-cooled regardless of overload. All metal, entirely automatic, unconditionally guaranteed.

\$1.75

Your dealer can supply, if not remit cost to manufacturer:

INSULINE CORP. of AMERICA
78-80 Cortlandt Street New York City, N. Y.

Television

Complete Kits

- Model B-1—Without amplifier or Television Tube\$37.50
- Model 45—Same as B-1 with improved motor\$45.00
- Model 52—Same as 45 with four stage amplifier\$52.00
- Model 65—Same as 52 with Television Tube\$65.00
- Model A-1—Model 65 completely built up on metal stand\$100.00

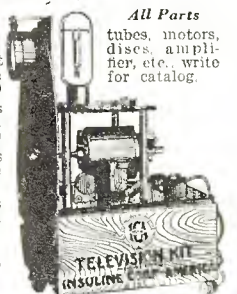

All Parts tubes, motors, discs, amplifier, etc. write for catalog.

Send for WESTERN RADIO
New
1929 Catalog

DEALERS AND SET BUILDERS
 The NEW 1929 Catalog is crammed full of the FINEST, NEWEST, Nationally known A.C. sets, consoles, cabinets, dynamic speakers, kits, eliminators and accessories at LOWEST PRICES. Largest stock of radio parts. Prompt delivery. Write for our FREE catalog.
 Western Radio Mfg. Co., Dept. C-3, 128 W. Lake St., Chicago

FREE 

The Big Friendly Radio House

(Continued on page 154)

Cathode Rays Promised As Laboratory Tool

The wonder-working cathode rays, first obtained in large quantities in the open air two years ago by Dr. W. D. Coolidge, of the General Electric Company's research laboratory, are now at the disposal of any well equipped research institution. The effects of the rays on all sorts of living and mineral matter can now be studied.

This is possible with a new form of the tube, simpler than an X-ray tube, and hardly more complicated than an electric light bulb, which has been perfected by Dr. C. M. Slack, of the Research Department of the Westinghouse Lamp Company.

Cathode rays were first studied as they were produced inside glass tubes made by the English scientist, Sir William Crookes. Then, in 1894, a German, Prof. P. Lenard, first succeeded in getting them in feeble quantities in the air. Dr. Coolidge, in 1926, invented a tube in which they were obtained in large quantities in the open air.

The rays consist of speeding electrons, the "atoms" of an electric current, and of which the atoms of matter are supposed to be built. In the Coolidge cathode ray tube they are produced by a glowing electric light filament, and given their great velocity by the application of an electric potential of several hundred thousand volts. This is sufficient to drive them through a thin nickel window at the end of the tube, where they cause the air to glow, as well as other curious effects.

Dr. Slack's improved tube dispenses with the nickel window and uses a bubble of glass, but so strong is it that the pressure of the air on the outside is not sufficient to break it, and destroy the essential vacuum within. Some of these windows are only one-fifth thousandth of an inch thick and an inch in diameter.

They are made by drawing in a bubble of molten glass on the end of the glass tube, and then allowing it to freeze. Thus it automatically assumes the shape so that the air pressure afterwards is the same as that during its formation, and it will stand surprisingly high pressures. The glass is so thin, that the electrons, or cathode rays, can sneak through the spaces between the glass atoms, even though these spaces are not large enough for the air atoms to squeeze through.

HOTEL FORT SHELBY

Lafayette and First, Detroit

New 22-Story Addition

equipped with every advanced feature of accommodation, including **SERVIDORS**

WHETHER your choice be one of the very comfortable rooms at \$3, \$4 or \$5, or one of the especially large rooms or suites in the new addition, with an entrancing view of city, river and Canadian shore, you will enjoy a special sense of value in Hotel Fort Shelby.

Convenient to all downtown and to all transportation. Shopping, theatrical, financial and wholesale districts within five minutes' walk. Garage in connection. Cars delivered without service charge. *Brochure on request*



Look for Large Green Sign on Roof

Boat Jumps Through Loop



Photo Wide World

This remarkable scene of a spectacular jump made by Floyd Pierce in Commodore O. K. Hunsacker's "Oh Kay" outboard motorboat at Lake Elsinore, near Los Angeles, was snapped during the try-outs for the jumping contest that will be an added feature of the National Mid-winter Outboard Championship races held at the lake recently

Get Distance

Amazing Discovery For Any Radio

\$2 brings this

SATISFACTION GUARANTEED

Why confine your radio programs to a few local stations when the expansive concerts, dance music and lectures of hundreds of big cities are ready for you? With every order for our treatise, "The Distance Getter," we include FREE our wonderful new Distance Transformer. Tune your set according to our special instructions, and presto—note the distant stations full and clear!

MAIL COUPON TODAY

HAZLETON LABORATORIES
 4554 Malden St., Dept. X, Chicago, Ill.
 Send me Distance Getter, postpaid. Enclosed find \$2.00 (M.O., stamps or check.)
 Send C.O.D., plus small postage added.
 Also send 100-page Radio Catalogue Free.

Name.....
 Address.....
 City..... State.....

Your money instantly refunded if you are not satisfied. The attachment furnished free with the "Distance Getter" alone is worth the price. "Results beyond all expectations. Cuts thru local stations like a knife."—writes Galloway of Chicago, Ill. "Send three more for my friends. I bet Denver and Calif. easily," says Homes, Palos, Ill.



Scientists Need X-Ray Protection

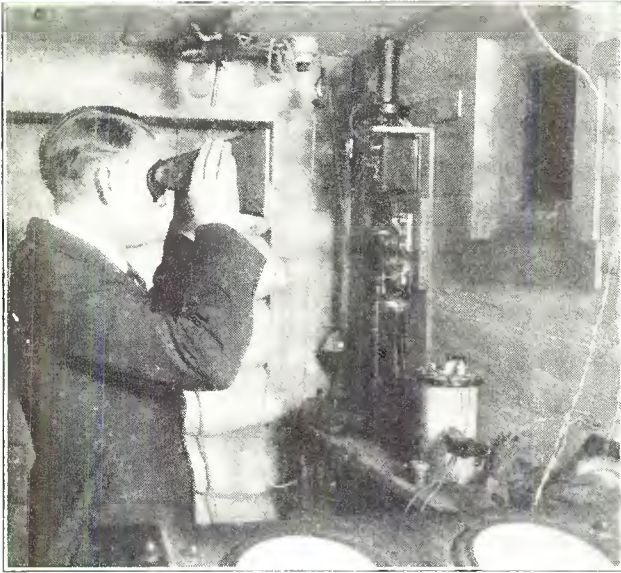

Photo Wide World

Wartime emplacements with a concrete wall and sandbags are built around the world's largest x-ray tube at the California Institute of Technology in Pasadena, Calif., to protect scientists from rays emanating from the fifteen foot tube. Operating under the impulse of 1,000,000 volts of electricity, the giant ray throws off stray rays that would be harmful to the operator and scientists during the experiments now being conducted with it. The wall and the sandbags are designed to absorb these

Two Magnets Contain Secret of Gravity Defier

Magnetic force is the defier of gravitation in the so-called gravity eliminator that London daily papers report has been invented by a young Englishman. This appears probable from the reports reaching here.

Making metal float in the air is a laboratory trick with a firm scientific basis. Upon the desk of R. L. Sanford, chief of the magnetic section of the U. S. Bureau of Standards in Washington there is a small metal bar that stays up in the air all the time. Similar demonstration devices were used recently by an electrical manufacturing company as souvenirs at a scientific meeting.

The law that every high school physics student learns, "Like poles of a magnet repel," makes this metal float in the air in apparent defiance to gravity. Below the floating steel bar there is another metal bar, a twin in size, shape and treatment. Each is made of a special magnet steel, containing about 35 per cent cobalt. The peculiar quality of this steel is that it can be more strongly magnetized than ordinary iron or steel.

When the bars of this steel with their magnetic ends pointing the same way are placed together, they are repelled with such force that they spring apart. Light vertical guides are necessary to prevent the upper magnet swinging around bringing together unlike poles, which attract each other. With this precaution, the steel will stay afloat for days. The lower magnet is hidden by the wood of the base so that the phenomenon seems mysterious.

Ordinary magnets can not be used to perform this trick as one of them will soon lose its strength under the influence of the other. Nor can electromagnets be used for the same reason.

The sphere of influence of a magnet is very limited, the force diminishing according to the square of the distance. There is therefore no possibility of this magnetic phenomenon being used on a large scale, as for instance to hold an airplane aloft. But electrical machines in daily use make magnetism serve man in a multitude of ways.

Tune In on the Short Waves

Get distance—escape static on the long wave broadcast band. See Call Book for short wave stations. SUBMARINER wave band includes all powerful stations that broadcast programs on short waves—thousands of SUBMARINERS now in use—short waves are the new adventure—a new thrill awaits you.

Short Waves Popular

The SUBMARINER has taken the country by storm. Nothing made like it. Many users have been getting London, England; many get Holland, even in summer. Short waves are great distance carriers with less static.

Best of All

Your present radio receiver, whether battery operated or all electric, will bring in short wave broadcasting when used with

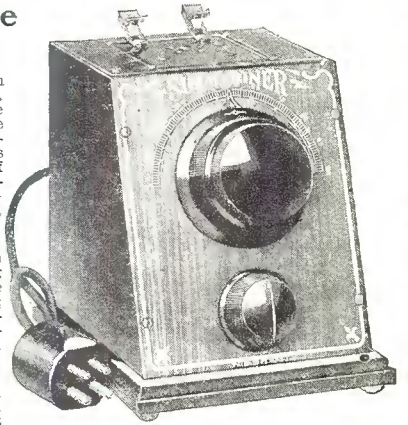

THE SUBMARINER

It is easy to connect a SUBMARINER. Simply remove a tube from receiving set and place in SUBMARINER socket; then insert SUBMARINER plug in place of tube. Attach regular aerial and ground to clips on SUBMARINER. That's all. No changes in wiring of set necessary. No additional tubes, or batteries required. If set operates a loud speaker, it will do so with SUBMARINER. We guarantee that the SUBMARINER will operate within the wave band covered equal to any short wave receiving system known, when attached to your receiver. Completely shielded metal cabinet. Fine tuning dial, ratio of 32 to 1. Get the short wave musical programs and other activities, including television signals. Never before has so much in radio been offered for so little money! Order a SUBMARINER now!

FOUR MODELS

20 to 65 meter range—for battery operated radios, \$15.00. For all electric radios, \$17.50. 10 to 160 meter range—for battery operated radios, \$22.50. For all electric radios, \$25.50. 10 to 160 meter range models have three interchangeable coils. A fourth coil, 160 to 340 meter range, will be supplied as extra equipment when specified—price \$2.00.

If your dealer does not carry, order direct from factory. Sent anywhere in the U. S. post paid upon receipt of price. Canada and Foreign, 60c additional. Money order only. Also sent C.O.D. plus postage in U. S. if \$1.00 accompanies order to insure carrying charges. In ordering be sure to name set and tubes used, such as UV199, UX199, 201A, UX226 or UY227. See dealer or order direct today.

J-M-P MANUFACTURING CO., Inc.

3445 Fond du Lac Ave.

Milwaukee, Wis., U. S. A.

Use a REESONATOR

TRADE MARK

for Volume, Distance, Sharp Tuning

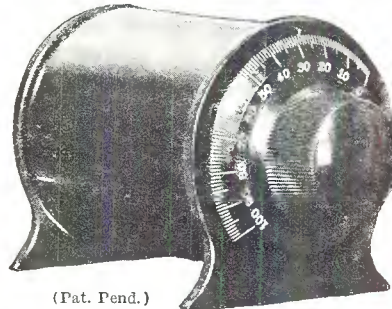

(Pat. Pend.)

Not a wave trap

\$4.75 COMPLETE

and similar radios. When ordering state type of machine on which the REESONATOR is to be used. Equivalent to two extra tubes on your machine. The mahogany brown color.

The REESONATOR is an instrument designed to balance the antenna and to tune the coupling tube, which increases the volume and selectivity of your machine. It will enable you to play with dance volume, stations which are barely audible or sometimes entirely inaudible without it. It will also decrease battery consumption 30%, as you do not have to apply as much power to obtain the desired results. It does not require tuning for every station you receive; only when additional selectivity, power or distance is required. It is attached externally to the machine, and can be attached by anyone, without tools, in a minute. REESONATOR as illustrated, is especially designed for Single Dial Attraction Kent Models, 30, 32, 35, 37 and 38, Crosley Bandbox, Showbox and Jewelbox. All Rayfan Single Dial Models; also Dayton, Apex.

Gentlemen: We wish to inform you that the REESONATOR we purchased from you some time ago, is meeting with our highest expectations. We have found it of much value in aiding reception, increasing volume, clearness of tone, and enabling us to get stations which we otherwise could not hear.

Gentlemen: Last month I bought one of your REESONATORS and I find it to be just as you said. Now I have no trouble in bringing in far stations, and it cuts through interference good. It makes a big improvement in my set.

What Some of Our Users Say

Yours truly, N. N. Fisher, Janesville, Wis.

(Signed) Charles Moreau, Albany, N. Y.

We Guarantee Satisfaction Try one for three days at our risk. If not thoroughly satisfied your money will be cheerfully refunded.

F & H RADIO LABORATORIES

Dept. 105, Fargo, N. D.

Ref.: Fargo National Bank
Dun's or Bradstreet's
Dealers' and Jobbers'
Inquiries Solicited

SEND COUPON NOW
F. & H. RADIO LABORATORIES

Dept. 105 Fargo, North Dakota

I enclose check or money order for \$4.75 for which send me a Reesonator postpaid.

Send Reesonator (C. O. D.)

Send Dealers' Proposition.

Please send literature.

Send Name of Jobber.

Name.....

Address.....State.....



NEW YORK'S NEWEST HOTEL
THE PICCADILLY
 227 West 45th Street
 at Broadway
 New York

ADJACENT TO EVERY ACTIVITY
 600 BRIGHT SUNLIT ROOMS,
 EACH WITH BATH, ELECTRIC
 FAN, ICE WATER

SINGLE ROOM ^{with} BATH \$3.00
 DOUBLE ROOM ^{with} BATH \$4.00

EXCEPTIONAL RESTAURANT ^{and} LUNCHEONETTE
 WIRE AT OUR EXPENSE FOR RESERVATIONS
 F. D. SOFIELD - MANAGING DIRECTOR

SET BUILDERS

Write us for new illustrated Catalog "C-2" containing all the new and popular kits in radio. Our tremendous stock enables us to give you immediate service on all radio supplies at wholesale prices.

Allied Radio CORPORATION
 711 W. LAKE STREET, CHICAGO

Write for this Discount Card NOW!



It will enable you to purchase the New and Improved
KNAPP "A" POWER KIT
at a liberal discount

The new Knapp "A" is the finest and most complete kit ever offered. It is the only "A" Power adaptable to Short Wave—Super Heterodyne and Television reception.
 Take advantage of the wonderful offer today—write

David W. Knapp, Pres.
Knapp Electric, Inc.
 Division of P. R. Mallory & Co., Inc.
 Borden Bldg., Madison Ave., N. Y. City

Interweaves Paper Margins

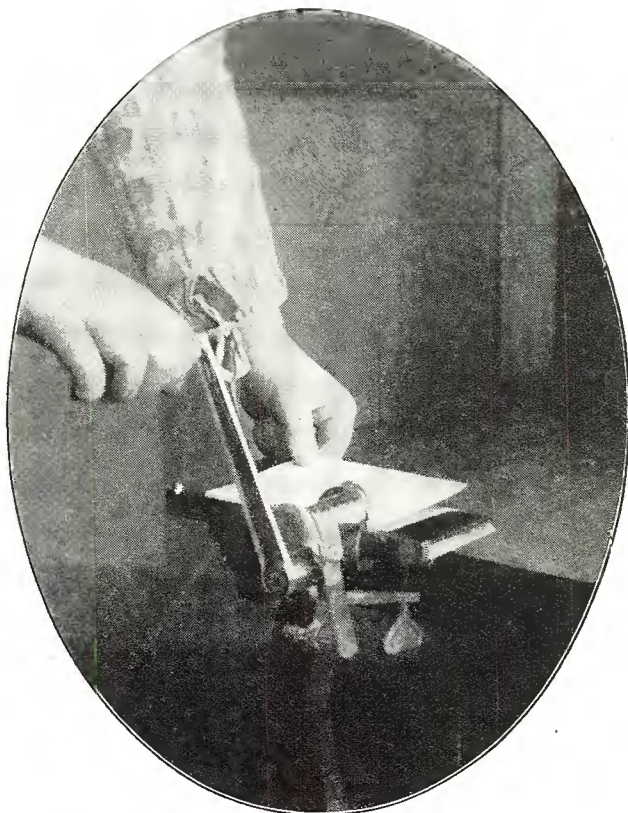

Photo Wide World

Everyone knows the awkwardness of trying to read a prospectus or other series of typewritten pages when attached with either a pin or ordinary paper clip. This little apparatus, the "Clusor," by a simple system of attaching the paper margins to each other and interweaving them, creates a book-like form, handy to read and quite securely fixed so that there will be no loss of papers from removing and mislaying them.

Bombs of Gas Fall Into Sun

Bombs of gas, traveling at great speed may fall into the sun, but not solid meteors. This is the surprising announcement made at the meeting of the National Academy of Sciences by Prof. Henry Norris Russell, astronomer of Princeton University.

Previously, astronomers assumed that solid meteorites could fall into the sun. Prof. Russell pointed out that the great heat of the sun would change them completely to gas as soon as they approached, unless they are more than two or three feet in diameter. However, the mass of gas would itself continue towards the sun with the same speed as if the meteor were solid.

Dr. Harlow Shapley of Harvard, has estimated that 1,000,000,000 meters strike the earth daily, and the Dutch astronomer, J. C. Kapteyn, has computed the total quantity of matter in a given volume of the universe. This has allowed Prof. Russell to calculate that the average mass of a meteorite is about 2 milligrams, or about one-fourteen thousandth of an ounce, which would make them microscopic in size. He suggested that the meteors we observe from the earth may be members of the solar system, and that they might be larger, but he thinks that few of these would hit the sun.

Because this amount of meteoric matter is so small, not more than about 60 tons a second would fall into the sun, a very small amount, considering the sun's great size. On this account, he said, the gas generated by the meteors would not be enough to account for some of the strange dark bands observed in spectrum photographs of the stars, which are suns, like ours, but much farther away.

Tell 'Em You Saw It in the Citizens Radio Call Book Magazine and Scientific Digest

Distinctive Radio Cabinets by Aston

*For those who are pleased with
only the finest*

THE name **Aston** is now recognized as the hallmark of supreme excellence in cabinet craftsmanship. For in **Aston Cabinets** are combined a basic soundness of construction and a beauty of design that have inevitably brought the highest recognition. The cabinets here illustrated are a fitting piece to occupy the most handsomely appointed room. No. 223 and No. 218 are only two of the attractive cabinets you will find in our new catalog—write for it today.



No. 223—Open No. 223—Closed

One of our latest Aston Radio Cabinets, of 100% Burl Walnut front, together with the Satinwood overlay topping the doors. As the doors are opened, they reveal the richness of the set panel 13" wide for dials and the French polychromed speaker grille with a dash of color.



No. 218—Closed No. 218—Open

A staunchly built Aston Radio Cabinet, of select five ply Walnut. Doors of beautifully figured matched Walnut which fold back against the sides. Carved legs joined with a pleasingly designed stretcher.

DEALERS and SET-BUILDERS

Write for our new 1929 catalog. It will give you full details about these beautiful cabinets, as well as description of many other pleasing **ASTON** models. Our attractive discounts will interest you.

ASTON

CABINET MANUFACTURERS

1223-1229 West Lake Street
Chicago, Illinois



*Distinctive Originality
in Design of
High Grade Radio Cabinets*



If you are in this vicinity **COME IN** and see our new, complete display

Send for WESTERN RADIO
New
1929 Catalog

DEALERS AND SET BUILDERS
 The NEW 1929 Catalog is crammed full of the FINEST, NEWEST, Nationally known A.C. sets, consoles, cabinets, dynamic speakers, kits, eliminators and accessories at **LOWEST PRICES**. Largest stock of radio parts. Prompt delivery. Write for our **FREE** catalog.

Western Radio Mfg. Co., Dept. C-3, 128 W. Lake St., Chicago

The Big Friendly Radio House



LIFE-TIME DX AERIAL No. 30 Length 30 ft.

Non-corrosive—30 ft. length—volume of 150 feet aerial with selectivity of 30 foot antenna. Assembled—ready to string up—all connections soldered or riveted.

Guaranteed Double Volume and Sharper Tuning

Rings are heavy gauge solid zinc. Permits using a powerful aerial in 30 ft. space. Duplicates in design and material. The aerials used by largest Broadcasting Stations. Sharpens tuning of any set, because of short length, but has enormous pick up because 150 ft. of enameled 12 ga. wire is used. Insures more uniform reception. Non-corrosive feature insures long life and 100% efficiency at all times. "Truly a Life Time DX Aerial." List. **\$10.00**

No. 60—Length 60 ft. Price \$12.50

"Big Boy" size. Best for European tests. (Same description as above, except that 300 ft. of wire is used making this the most efficient and powerful aerial ever made.)

Manufactured by
THOROLA RADIO PRODUCTS 110 E. 21st St. Chicago, Illinois

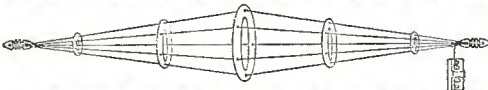

Lowest Wholesale Prices!

Set Builders and Dealers!

Let the largest Radio Mail Order House in the East serve you!

You'll get better service and better merchandise at the lowest wholesale prices obtainable anywhere.

NEW 1929 BUYING GUIDE

Your copy is ready for you. It lists all the latest Radio Parts, Accessories, Sets and Kits. Catalog K also lists Electrical Supplies, Household Appliances, Golf and Tennis Equipment, Cameras, Traveling Bags, etc. Send for your copy now. It's free.

Allen-Rogers-Madison
 35 WEST 31st ST. NEW YORK, N.Y.

Before Buying
Any "A" Eliminators

Write me about the discount card which enables you to purchase the new and improved **Knapp "A" Power Kit** at a liberal discount.

The most complete "A" Power Kit ever offered—Address for details of plan—
 David W. Knapp, Pres.
Knapp Electric, Inc.
 Borden Bldg., Madison Ave., N. Y. City

Zeppelin's Commander Began As Psychologist

Dr. Hugo Eckener, commander of the Graf Zeppelin, obtained his doctor's degree in a field quite removed from aviation, it was recently revealed by Dr. Lightner Witmer, director of the Psychological Laboratory and Clinic at the University of Pennsylvania. Dr. Eckener was a student in psychology at the University of Leipzig, under the famous Prof. Wilhelm Wundt, at the same time as Dr. Witmer. In 1892 Dr. Eckener received his degree, but he remained at the university and when Dr. Witmer received his degree a year later, it was for a piece of research for which Dr. Eckener had acted as subject.

Failure in obtaining a position in psychology led Dr. Eckener into the work for which he is now internationally famous. No jobs were open, even though he wrote Dr. Witmer later to see if there was an opening in America. As an alternative, he got into newspaper work. In the early days of Count Zeppelin's experiments, he wrote a scathing article condemning the whole lighter-than-air proposition. Zeppelin protested that Eckener knew nothing about it, but invited him to visit his works and learn more. As the result of this visit the air-ship builder and the erstwhile psychologist became close friends, and eventually Eckener became Zeppelin's assistant.

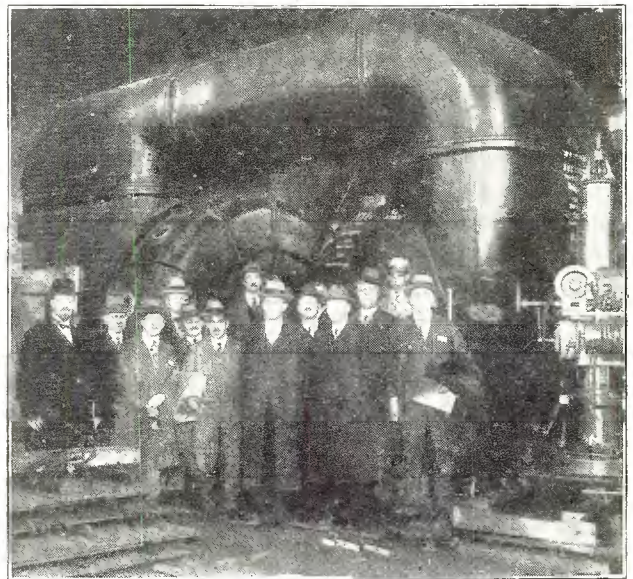

Photo Wide World

Members of the American Society of Mechanical Engineers, at their convention in New York recently, made a tour of inspection of the new 210,000 horsepower turbo-generators in the Hell Gate station of the United Electric Light & Power Company. They are among the largest in the world and will be placed in operation shortly. Photo shows engineers inspecting one of the new turbo-generators at the station. In the group are Professors Fessenden and Keller, of the University of Michigan

Big Tree Bark Resembles Asbestos

The bark of a California Big Tree is, on large specimens, as much as three feet thick and is almost as resistant to fire as asbestos. A sample of the bark twelve inches square was placed in a lumber mill furnace, surrounded with dry pine and fir wood and burned for eight hours. When taken from the furnace the Big Tree bark was merely charred on the outside.

This resistance to fire is one reason for the longevity of the California Big Tree, which is known to attain an age of four thousand years and may reach six thousand or more. A mature specimen, twenty feet or more in diameter, sustained scores of forest fires in the days before the national parks and forests were protected.

Other conifers of the western mountains, notably the sugar pine, yellow pine, red and white fir, also possess thick fire-resisting bark. But the *Sequoia gigantea* is the Shadrach, Meshach and Abednego of the forest world.

The
Tallest Hotel
in the World

Forty-Six
Stories High

Nearest in the
City to Offices,
Theatres,
Stores and
Railroad
Stations



The New Morrison, when completed, will be the world's largest and tallest hotel—46 stories high, with 3,400 rooms.

Chicago's
MORRISON HOTEL

Corner Madison and Clark Streets
1944 Rooms \$2.50 Up

—all outside, with bath, running ice water, telephone, bed-head lamp, and Servidor. A housekeeper is stationed on each floor. All guests enjoy the privileges of the hotel's garage.

Wire or Write for Reservations

This Catalog Will
Save You Time and Money

Write today for our large illustrated new Catalog "C-2," showing how this organization of men with years of experience, can give you personal service.

⚡ Allied Radio
CORPORATION
711 W. LAKE STREET, CHICAGO

DID YOU KNOW? That you can make one of the best "A" eliminators with your bulb, liquid or metal rectifier charger by using a Dry "A" Filter at a cost of..... **\$10.80**

We also distribute most of the nationally advertised lines of radio merchandise. *Write us your needs.*

RELIABLE SUPPLY CO. 19 BROAD STREET
PROVIDENCE, R. I.

Ohmite

Vitreous Enameled Resistances

ALL SIZES—ALL TYPES

OHMITE MFG. CO., 634 N. Albany Ave., Chicago, Ill.
Pacific Coast Office: 905 Mission St., San Francisco, Calif.

RADIO—a fast-growing money-making field

Get into it NOW!

WITH amazing rapidity, radio has developed from a scientific toy to a tremendous industry. Men still young hold responsible executive positions or head companies of their own. They have grown with the industry. They share its prosperity.

And radio, like the men who serve it, is still young. It is expanding, advancing always. Already, it has made television an actuality. It gives promise of almost unlimited future development.

Get into radio now, while opportunity offers. Learn to install sets—to service them. Build a business of your own and be independent. Or, if you prefer, enter the industry as a designer, engineer, operator, salesman.

All you need is training, and there is no better way for you to secure it than the Radio Course of the International Correspondence Schools. Endorsed by radio experts and manufacturers, this course is complete and thorough. Moreover, it is regularly revised to keep abreast of changing conditions.

Scores of I. C. S. radio graduates hold good positions in factories, laboratories and stores. J. B. McCune, of Donora, Penna., has established a flourishing business for himself. Quincy J. Workman, of Scranton, Penna., has "nearly doubled his salary" as manager of the Radio Department of a large store. I. C. S. training won for John M. Paynter of Charleston, S. C., a position as Radio Operator and Ship's Electrician. Men in many phases of the field report the same success.

If you are at all interested in things electrical and scientific, if you would like to enter a modern money-making industry, mail the coupon below for full information about the I. C. S. Radio Course. It will show you what you really can accomplish. There is no obligation, of course.

Mail the Coupon for Free Booklet

INTERNATIONAL CORRESPONDENCE SCHOOLS
Box 8316-D, Scranton, Penna.

Without cost or obligation, please tell me how I can qualify for the position or in the subject, before which I have marked an X:

RADIO

- | | |
|---|--|
| <input type="checkbox"/> Electrical Engineering | <input type="checkbox"/> Architect |
| <input type="checkbox"/> Electric Lighting | <input type="checkbox"/> Architects' Blueprints |
| <input type="checkbox"/> Mechanical Engineer | <input type="checkbox"/> Contractor and Builder |
| <input type="checkbox"/> Mechanical Draftsman | <input type="checkbox"/> Architectural Draftsman |
| <input type="checkbox"/> Machine Shop Practice | <input type="checkbox"/> Concrete Builder |
| <input type="checkbox"/> Railroad Positions | <input type="checkbox"/> Structural Engineer |
| <input type="checkbox"/> Gas Engine Operating | <input type="checkbox"/> Chemistry |
| <input type="checkbox"/> Civil Engineering | <input type="checkbox"/> Automobile Work |
| <input type="checkbox"/> Surveying and Mapping | <input type="checkbox"/> Airplane Engines |
| <input type="checkbox"/> Metallurgy <input type="checkbox"/> Mining | <input type="checkbox"/> Navigation |
| <input type="checkbox"/> Steam Engineering | <input type="checkbox"/> Agriculture and Poultry |
| <input type="checkbox"/> Pharmacy | <input type="checkbox"/> Mathematics |

BUSINESS TRAINING COURSES

- | | |
|--|---|
| <input type="checkbox"/> Industrial Management | <input type="checkbox"/> Advertising |
| <input type="checkbox"/> Personnel Management | <input type="checkbox"/> Business Correspondence |
| <input type="checkbox"/> Traffic Management | <input type="checkbox"/> Show Card Lettering |
| <input type="checkbox"/> Accountancy (including C.P.A.) | <input type="checkbox"/> Stenography and Typing |
| <input type="checkbox"/> Cost Accounting | <input type="checkbox"/> English |
| <input type="checkbox"/> Bookkeeping | <input type="checkbox"/> Civil Service |
| <input type="checkbox"/> Secretarial Work | <input type="checkbox"/> Railway Mail Clerk |
| <input type="checkbox"/> Spanish <input type="checkbox"/> French | <input type="checkbox"/> Common School Subjects |
| <input type="checkbox"/> Salesmanship | <input type="checkbox"/> High School Subjects |
| | <input type="checkbox"/> Illustrating <input type="checkbox"/> Cartooning |

Name _____

Address _____

Tell 'Em You Saw It in the Citizens Radio Call Book Magazine and Scientific Digest

WARD

Electric Soldering Irons

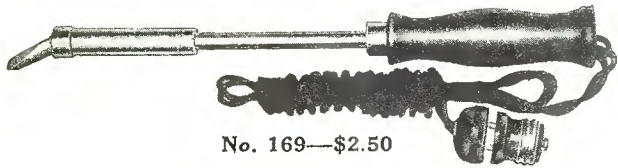

No. 169—\$2.50

A complete line of soldering irons, designed for radio work—or wherever a soldering tool is required.

No. 169—has standard Ward Heating Element, 6 feet of Flexible Heater Cord, Highly Nickeled Parts— $\frac{3}{8}$ in. Diamond Tip (screw driver tip optional). Point swivels to 45° angle, permitting difficult soldering operations. Exclusive patent.

*If your local dealer cannot supply you—
write us direct*

Heavy Irons for Manufacturers

**Jobbers, Dealers—Write for
Special Discount**

WARD MFG. COMPANY

941 Wellington Avenue

Chicago, Illinois

50,000 FEET OF RADIO

50,000 square feet of floor space in a large, modern building devoted exclusively to radio. Tremendous stock of latest kits, parts, accessories and sets in improved designs and styles. Write for Catalog "C-2." Wholesale Prices.

Allied Radio
CORPORATION

711 W. LAKE STREET, CHICAGO

TOBACCO HABIT BANISHED

**Quick
Sure
Lasting
Results**

Tobacco Redeemer banishes the habit completely, almost before you know it. Absolutely scientific, thoroughly reliable treatment. No matter how long or in what form used, you will have no craving for tobacco after you take this pleasant, inexpensive treatment. This we positively guarantee. Money returned without question if not satisfied. Write for free booklet and proof of what Tobacco Redeemer has done for men addicted to tobacco habit. Send postcard or letter today.

NEWELL PHARMACAL COMPANY
Dept. 864 Clayton Station St. Louis, Mo.

More "A" Power For Less Money!

With the Set Builders discount card you can purchase a

KNAPP "A" POWER KIT at a liberal discount.

Write me today for full details telling about this new money-saving plan for set builders.

DAVID W. KNAPP, Pres.
Knapp Electric, Inc.

Division of P. R. Mallory & Co., Inc.
Borden Bldg., Madison Ave., N. Y. City

Radio Altitude Meters May Permit Plane Landing in Fog

Airplanes may soon be able to land safely in a fog without the pilot seeing the landing field at all. This is one of the possibilities of a radio altitude meter for airplanes developed by Dr. E. F. W. Alexanderson, of the General Electric Company, and described by him to the National Academy of Sciences.

The radio altitude gauge does the same thing for an airplane that the sonic depth finder does for a ship, he announced. With the aid of the latter, the captain can make a constant record of the depth of the water beneath him. He can not only avoid shallow water, but he can actually plot the contour of the ocean bottom and identify it with the contours given on his charts. It operates by sending a sound wave from an oscillator on the bottom of the ship. The wave travels to the bottom, is reflected upwards, and the difference between the time the sound is made and the time the echo returns permits an exact measurement of the depth.

Radio waves may be made to do the same thing for the airplane that the sound waves do for the ship, said Dr. Alexanderson, but since they travel at the speed of light and far faster than the sound waves through water, their use requires quite a different technique. The waves are sent out from a transmitter on the plane, part travel downwards to the ground, there they are reflected, and with the proper receiver they may be picked up again in the airplane. The time is too short to notice the difference, however, and indirect methods must be used.

Television "War Paint"



Photo Wide World

For the first time in history a complete drama was transmitted by television, picture and voice being simultaneously broadcast on separate radio channels from the laboratories of the General Electric Co. at Schenectady, N. Y. Dr. E. F. W. Alexanderson, consulting engineer of the company, staged the performance for the purpose of demonstrating the great strides made in this new science within the past few years. The photograph shows Izotta Jewel as she appeared before the television transmitter. Note the heavy make-up required for the performance.

Tell 'Em You Saw It in the Citizens Radio Call Book Magazine and Scientific Digest

Farm Industry Book Printed on Cornstalk Paper

Paper made from cornstalks will be used in the printing of a book on farm products in industry soon to be issued. The author, Dr. George M. Rommel, agricultural expert, investigated the problem of waste materials in agriculture. As a demonstration of the use of one of the most plentiful of farm by-products he conceived the idea of printing his book on a new paper made from cornstalks which are usually wasted.

Boys Study Television

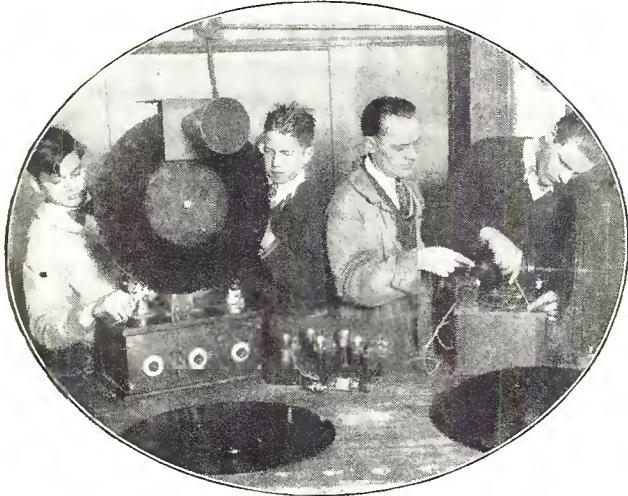

Photo Wide World

The radio class at Lane Technical High School of Chicago are studying the theory and building of television apparatus. Several television receivers are under construction and the students expect to produce great results with this latest radio innovation. Photo shows the Lane Technical High School students assembling a television set.

Russians Have Native Source for Camphor

A native source for camphor, important in both medicine and manufacturing, has been discovered in a species of wormwood that grows on the sandy steppes of the government of Astrakhan. An oil extracted from this plant has been subjected to experiments at the Saratow experiment station and was found to yield a quality of camphor. The crystals differ in their physical properties from those of camphor obtained from camphor trees, but chemically they are identical with it.

Biggest American Built Steamer

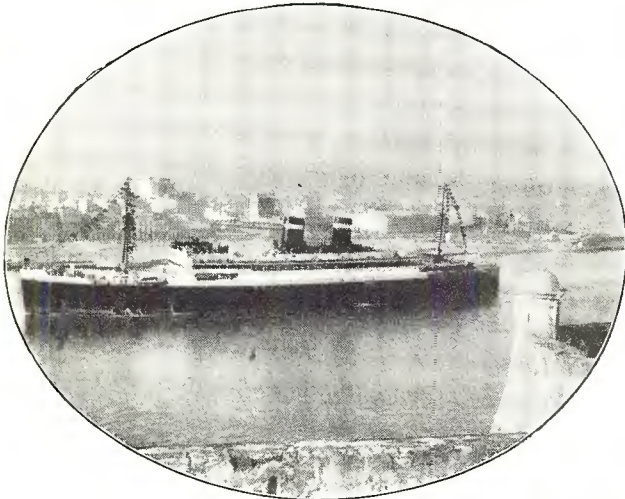

Photo Wide World

The S. S. Virginia, the largest American built steamer, passing historic Morro Castle at entrance to Havana, on her maiden voyage to Cuba.

A Small Part with a BIG JOB

AMPERITES take little space, but they control the very life blood of your receiver by automatically regulating the tube filaments.

It pays to use AMPERITE—the only self-adjusting resistance for "A" current. Maintains filament temperature at proper voltage despite variations in supply. Essential with eliminators. Entirely unlike fixed resistors. Instantly interchangeable. Banishes hand-rheostats. Beautifies panel layout. Saves wiring. A type for every tube—battery or A. C. \$1.10 with mounting (in U.S. A.), at all dealers.

Radiall Company
50 FRANKLIN ST., NEW YORK

FREE

"Amperite Blue Book" of new circuits and how-to-build data. Write Dept. CR1.



AMPERITE
REG. U.S. PAT. OFF.
The "SELF-ADJUSTING" Rheostat

The ALVON ~ ~

Custom-Built Radio

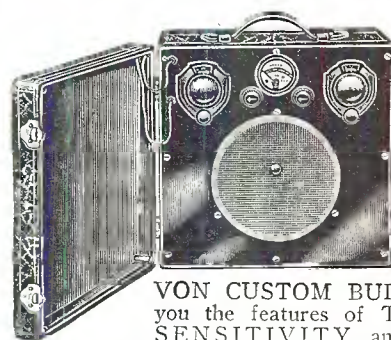

Just the thing for your vacation! With a weight slightly under 30 lbs., fully equipped, dimensions of 13 3/4" high, 14 1/4" wide and 8 7/8" deep, the AL-

VON CUSTOM BUILT PORTABLE offers you the features of TONE, SELECTIVITY, SENSITIVITY and CRAFTSMANSHIP, unsurpassed by any commercial receiver on the market.

Agents desired at once. Write today for special proposition and descriptive literature

ALVON RADIO LABORATORIES
716 West Madison St. Chicago, Illinois



ENGLAND every day AUSTRALIA on Thursdays HOLLAND on Fridays

"It may be of interest to you to know . . . that 5SW (Chelmsford, England) has been received every afternoon . . . since March 19th. . . . PCJJ at Eindhoven, Holland, comes in every Friday from 7 p. m. to 11 p. m. . . . 2NM at Caterham, England, on Sundays,

Wednesdays and Fridays. . . . PCLL at Kootjwijk, Holland, about three days a week. Listened to 2FC at Sydney, Australia, from 6:30 a. m. to 7 a. m. Thursday morning." . . .

—Extract from letter received

Aero Gets Everything in the Air

The above is an unsolicited letter received by us from a satisfied user of a short wave set built around Aero Coils. With two stages of audio, *loud speaker reception* was obtained about three days a week.

While such results as this cannot be expected from every receiver, it is a fact that with a given amount of power, a broadcasting station can be heard at far greater distances when transmitting on short waves than in the usual broadcast band, and this fact has been responsible for the tremendously increasing interest in short wave reception by radio fans. Static is much less objectionable on the short waves and their use has made possible, for the first time, summer reception in many parts of the country where the seasonable decrease in signal strength and increase in atmospheric dis-

turbances has heretofore rendered the summer use of a radio receiver very unsatisfactory.

Most of the short wave receivers which have been made available to the public up to the present time have been designed primarily for the reception of continuous wave code signals, and have been more or less unsatisfactory for the reception of musical programs, and we believe that Aero short wave receivers are the first ever placed before the general public which have been designed primarily for the reception of *broadcast programs on short waves*. Aero International Kit shown above will give you real thrills. Price of Kit No. 8, complete, \$55.30. For sale by jobbers and dealers.

AERO PRODUCTS, Inc.
4611 E. Ravenswood Ave., Dept. 1019, Chicago, Ill.

Send me your Big Aero Green Book, 25c, giving the latest information on What's New in Radio, Short Wave, etc.

Name.....

Address.....

City.....State.....

(1019)

Mail This Coupon Now for Big Green Book

AERO PRODUCTS
INCORPORATED

Dept. 1019
4611 E. Ravenswood Ave. Chicago, Ill.

Tell 'Em You Saw It in the Citizens Radio Call Book Magazine and Scientific Digest

OFFICIAL WHOLESALE DISTRIBUTORS— Send Your Orders to W. C. BRAUN CO.

SHORT WAVE RECEIVERS

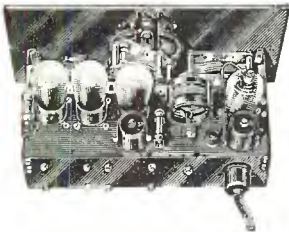

INTERNATIONAL Short Wave Receiver

This is the first short wave receiver designed exclusively for the reception of broadcast on low waves. Broadcast reception on short waves is remarkably clear and free from static. Programs come in from greater distances with the utmost simplicity of control. Complete kit includes everything necessary to assemble the set.
Aero Kit No. 8—Price.....\$75.30

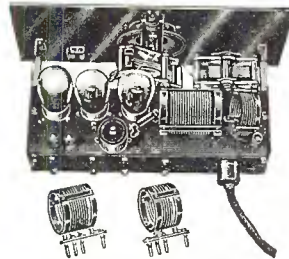

STANDARD Short Wave Receiver

This three-tube short wave receiver utilizes a circuit which has been proven by years of excellent results in the hands of amateur operators. The audio transformers are of the same type as are used in broadcasting stations, assuring excellent tone quality even when receiving programs from a great distance.
Aero Kit No. 10 for A. C. Tubes.
Price.....\$49.95
Aero Kit No. 11 for D. C. Tubes.
Price.....\$49.95



STANDARD Short Wave Converter

You can receive short wave programs on your present set by utilizing this short wave converter. Kit is complete. The base panel has all parts entirely assembled on it, wired and tested. It is only necessary to connect four or five wires to use this converter.
Aero Kit No. 12 for D. C. Tubes.
Price.....\$32.00
Aero Kit No. 14 for A. C. Tubes.
Price.....\$32.00



Short Wave Transmitters

For either the man who wishes to build his first low-power transmitter or for the dazed-in-the-wool amateur who wants to purchase all the parts for a high-powered installation from one source. Aero Radiophone Transmitters are available in complete, easy-to-assemble kits. Prices on application.

for AERO PRODUCTS

The Aero-5-tube Chronophase Receiver and all of the famous Aero Short-Wave and Broadcast Receiver and Transmitter Kits, parts and supplies are carried in stock at Wholesale Radio Headquarters, W. C. Braun Co., Chicago, Ill., who are official distributors for the complete Aero line.

Dealers and setbuilders are urged to send their orders here, where they will be carefully and promptly filled and shipped.

Nowhere in the country will you find such a huge assortment of everything needed by the radio setbuilder and dealer—including complete kits of all circuits, parts, supplies, accessories and complete factory-built sets, both A. C. and D. C.

If you have not received the big 264-page Braun's Big Radio Buyers' Guide, be sure to send for it today. Write on your letterhead and free copy will be mailed to you at once.



W. C. BRAUN CO.
Pioneers in Radio
553 W. Randolph St.
CHICAGO
ILLINOIS

BROADCAST RECEIVERS

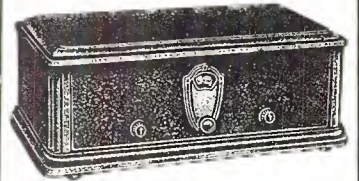

AERO-SEVEN TWENTY-NINE

The Aero "7-29" is a 7-tube set, employing three stages of "Chronophase" radio frequency amplification, and one semi-apertiodic stage. Extreme selectivity and great sensitivity assure the user of distance and "pop" while the improved audio amplifier gives truly surprising tone quality. A 71 power tube is employed in all models. In the A.C. Model, six 27 tubes are utilized, and in the D.C. type, six 01-A type tubes. The shield grid model uses four shield grid tubes, two 01-A's and one 171. All kits, \$97.85 list with cabinet.

AERO-DYNE

The Aero-Dyne is a 6-tube receiver of supreme excellence. Three stages of "Chronophase" radio frequency amplification, will utilize any type of tube, whether it be shield grid, A.C. or D.C., to the maximum advantage. Uses the new special broadcasting line audio amplifier and is the most sensitive and selective receiver which can be built for anything like the money. Transcontinental reception can be properly expected from the Aero-Dyne under favorable conditions. This Kit includes the large cabinet illustrated. A.C. set uses 5 227 tubes with 171 power amplifier. D.C. uses either shield grid or 201-A tubes and 171 power amplifier. All kits, \$93.50 list with cabinet.

"METROPOLITAN"

The Aero "Metropolitan" is a four-tube receiver especially designed to secure the maximum possible gain from the already popular radio frequency regenerative circuit. Special coil kits allow the use of shield grid tubes or standard tubes with the inter-electrode capacity of the tube neutralized as in the popular Roberts and Chicago Daily News circuits. A novel and extremely efficient method of controlled regeneration is employed which also operates to stabilize the R. F. Amplifier automatically, compensating for any slight changes introduced by careless wiring and at the same time gives greater selectivity as the sensitivity of the receiver is increased. All kits, \$58.00 list with cabinet.

"CHRONOPHASE"

The Aero "Chronophase" Receiver is a 5-tube set, embodying two stages of tuned radio frequency, utilizing the "Chronophase" circuit for either shield grid, A.C. or D.C. tubes. This receiver is recommended as the best low priced all purpose receiver on the market. Selectivity is sufficient to separate powerful locals without difficulty and reception reports of 2,000 miles are not unusual. We have seen no 7-tube set that can approach it. List price, all kits, \$74.50 with cabinet.

"TRIO"

The Aero "Trio" is a simple three-circuit regenerative receiver of time-proven ability. It is recommended especially for use in locations one hundred miles or more distant from high-powered broadcasting stations where the selectivity given by "Chronophase" system is not required. Practically all the long distant reception records have been made on receivers of this type. All kits \$42.00 list with cabinet.

"Metropolitan"



The Aero "Metropolitan" is a four-tube receiver especially designed to secure the maximum possible gain from the already popular radio frequency regenerative circuit. Special coil kits allow the use of shield grid tubes or of 01-A tubes with the inter-electrode capacity of the tube neutralized as in the popular Roberts and Chicago Daily News circuits. A novel and extremely efficient method of controlled regeneration is employed which also operates to stabilize the R.F. amplifier, automatically compensating for any slight changes introduced by careless wiring, and at the same time gives greater selectivity as the sensitivity of the receiver is increased. The audio amplifier is the same broadcasting station type employed in the more expensive Aero Kits and will assure the user of the finest tone quality. The receiver is built in the small cabinet illustrated. This receiver is, we believe, the most sensitive four-tube receiver available to the builder and surpasses most six-tube receivers.

- Aero Complete Kit No. 26 for Shield Grid Tubes. Price...\$58.00
- Aero Complete Kit No. 27 for A. C. Tubes. Price.....\$58.00
- Aero Complete Kit No. 28 for D. C. Tubes. Price.....\$58.00
- Aero Complete Kit No. 26-P for Shield Grid Tubes. Price...\$53.00
- Aero Complete Kit No. 27-P for A. C. Tubes. Price.....\$53.00
- Aero Complete Kit No. 28-P for D. C. Tubes. Price.....\$53.00

Chronophase

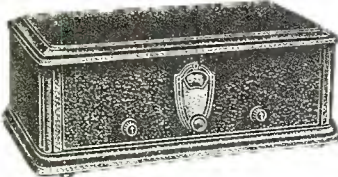

The Aero "Chronophase" Receiver is a five-tube set embodying two stages of tuned radio frequency utilizing the "Chronophase" circuit for either shield grid, A.C. or D.C. tubes, and the new Aero broadcasting type audio amplifier. Uses a 171 power tube. This receiver is recommended as the best low priced all-purpose receiver on the market. Selectivity is sufficient to separate powerful locals without difficulty and reception reports of two thousand miles are not unusual. It is designed for use in the smaller of the two cabinets illustrated, making a handsome addition to the most well-appointed living room. A.C. set uses four 227 tubes. Very simple to connect.

- Aero Complete Kit No. 20 for Shield Grid Tubes. Price...\$74.50
- Aero Complete Kit No. 21 for A. C. Tubes. Price.....\$74.50
- Aero Complete Kit No. 22 for D. C. Tubes. Price.....\$74.50
- NOTE: For those wishing to build the set in a console or table, the same kit is supplied except that a handsome walnut finished Westinghouse-Micarta 7x18" drilled and engraved panel is supplied in place of the cabinet.
- Aero Complete Kit No. 20-P for Shield Grid Tubes. Price...\$68.55
- Aero Complete Kit No. 21-P for A. C. Tubes. Price.....\$68.55
- Aero Complete Kit No. 22-P for D. C. Tubes. Price.....\$68.55

Wholesale Headquarters

for

AERO KITS

THE Aero 4-tube Metropolitan, the sensation of the season in Custom-Built Radio, is selling its head off. Dealers and set-builders the country over realize that this economical, all-purpose radio circuit is the final word in quality radio reception. Wholesale Radio Service Co. endorses this circuit of circuits and offers to its customers, dealers and set-builders, an unusual service in filling complete orders with same-day delivery assured.

The various Aero broadcast and short-wave receivers, transmitters and parts are kept in stock by us. Send us your orders for these fast selling items as well as any of the standard radio circuits, parts and supplies on the market. We carry everything you need. Send the coupon now for complete illustrated catalog and wholesale price list.

WHOLESALE RADIO SERVICE COMPANY

A Service of Excellence to the Dealer
6 Church Street, Dept. AR-2 New York City
 Mail This Coupon Now

WHOLESALE RADIO SERVICE CO.
 6 Church Street, Dept. AR-2
 New York, N. Y.

Please send your new FREE catalog, listing a full line of Aero kits and parts, as well as all other standard brands of radio products for the dealer and setbuilder.

Name.....
 Address.....
 Town..... State.....

**AERO-SEVEN
 Twenty-Nine**

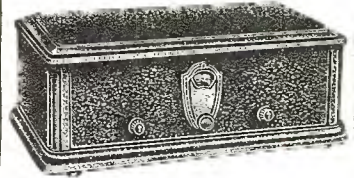

The Aero Seven-Twenty-Nine is a seven-tube Deluxe model employing three stages of "Chronophase" radio frequency amplification and one semi-periodic stage. Extreme selectivity and great sensitivity assure the user of distance and "pep," while the improved audio amplifier gives truly surprising tone quality. A 71 power tube is employed in all models. In the A.C. model, six 27 tubes are utilized and in the D.C. type six 01-A type tubes. The shield grid model uses four shield grid tubes, two 01-A's and one 171. The semi-tuned antenna stage reduces static pickup considerably. This receiver uses the large size cabinet and is the most satisfactory set in every way which can be purchased.

- Aero Complete Kit No. 32 for Shield Grid Tubes. Price...\$97.85
- Aero Complete Kit No. 33 for A. C. Tubes. Price.....\$97.85
- Aero Complete Kit No. 34 for D. C. Tubes. Price.....\$97.85
- NOTE: For those wishing to build the set in a console or table, the same kit is supplied except that a handsome walnut finish Westinghouse-Micarta 7x18" drilled and engraved panel is supplied in place of the cabinet.
- Aero Complete Kit No. 32-P for Shield Grid Tubes. Price...\$87.85
- Aero Complete Kit No. 33-P for A. C. Tubes. Price.....\$87.85
- Aero Complete Kit No. 34-P for D. C. Tubes. Price.....\$87.85

AERO-DYNE

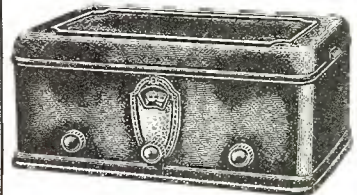

The Aero-Dyne is a six-tube receiver of supreme excellence. Three stages of "Chronophase" radio frequency amplification will utilize any type of tube, whether it be shield grid, A.C., or D.C. to the maximum advantage. Uses the new special broadcasting line audio amplifier and is the most sensitive and selective receiver which can be built for anything like the money. Trans-continental reception can be properly expected from the Aero-Dyne under favorable conditions. This kit includes the large cabinet illustrated. A.C. set uses five 227 tubes with 171 power amplifier. D.C. set uses either shield grid or 201-A tubes and 171 power amplifier.

- Aero Complete Kit No. 23 for Shield Grid Tubes. Price...\$93.50
- Aero Complete Kit No. 24 for A. C. Tubes. Price.....\$93.50
- Aero Complete Kit No. 25 for D. C. Tubes. Price.....\$93.50
- NOTE: For those wishing to build the set in a console or table, the same kit is supplied except that a handsome walnut finish Westinghouse-Micarta 7x18" drilled and engraved panel is supplied in place of the cabinet.
- Aero Complete Kit No. 23-P for Shield Grid Tubes. Price...\$83.50
- Aero Complete Kit No. 24-P for A. C. Tubes. Price.....\$83.50
- Aero Complete Kit No. 25-P for D. C. Tubes. Price.....\$83.50

AERO KITS

In Stock
For Prompt Shipment



Standard Short Wave Converter



International Converter

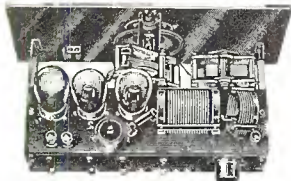

Short Wave Receiver



International Short Wave

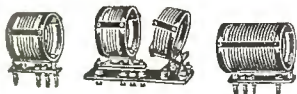

Short Wave Coils

THE famous Aero line of parts and kits is here, ready for your call. Along with it are the products of the country's foremost manufacturers of parts, kits, accessories and receivers, all combining to place at your disposal one of the most tremendous stocks of radio ever gathered under one roof.

WHOLESALE PRICES

In our large general catalog, we quote net wholesale prices, placing before the set builders of the country, lowest dealer's prices, enabling you to realize a handsome profit on every purchase. A.C. and D.C. sets, priced as low as \$32.95. A wonderful array of consoles and accessories. Practically all of the nationally advertised lines in parts and kits at prices that actually defy competition.

The Allied organization is trained to service. Real team work—a competent personnel and our tremendous stocks of merchandise—all combine to make possible the Allied reputation for promptness in shipping.

FREE CATALOG

The large, new 1929 Allied catalog is free. We want every dealer, set builder and radio enthusiast to have a copy. Check Allied prices—service—quality—and you will agree with us that dollar for dollar you get greater values—and better merchandise. Write for catalog now!



U203 Kit of Coils

Allied Radio Corporation
711 W. LAKE ST. Dept. C-2 CHICAGO

AERO KITS

CHRONOPHASE

ONE of the many AERO KITS that we are featuring—the new Aero “Chronophase” Five-tube Receiver for either shield grid, AC or DC Tubes, Recommended as one of the best low priced receivers on the market.



For complete information regarding these wonderful New Aero Kits and other Nationally Known Parts and Kits, write for our free big new 1929 Catalog today.

Complete Line of Aero Kits Carried in Stock—Quick Delivery

WESTERN RADIO MFG. CO.
“The Big Friendly Radio House”
Department C-4 128 W. Lake St. Chicago, Ill.

BIG DISCOUNTS
to Dealers &
Set-Builders

WRITE OR ASK!

Jammed with Big Bargains

Our 1929 Catalog lists all the new standard and nationally famous sets and parts. Our enormous buying power gives you rock bottom wholesale prices. Write for it now!

World's Largest Radio Store

If it's in radio we have it! Complete parts for all the latest circuits as described in this issue of the Call Book. 24-hour service guaranteed on mail orders.

FREE

Beautifully Illustrated

Chicago Salvage Stock Store

Wholesale Department CB3
509 South State Street Chicago, Ill.

OFFICIAL NATIONAL WHOLESALE DISTRIBUTORS

AERO KITS

24-HOUR SERVICE

"CHRONOPHASE"

5 TUBE KIT

For the man who wants to build a receiver that will separate locals almost regardless of how congested the ether may be and will at the same time have sufficient sensitivity to reach out for distant stations, we recommend the "CHRONOPHASE."



This receiver contains two stages of tuned radio frequency, one detector and two stages of audio frequency using the new Aero audio system. The two radio frequency stages will utilize either shield grid, 227 or 201-A tubes to their maximum efficiency and the AC model will utilize either the 171, 210 or 250 power tubes, depending upon power supply available.

Prices are very low,—for example "CHRONOPHASE" 5 tube kit complete without cabinet has a retail list of \$68.55. Your Wholesale Price is \$40.31. Kit for shield grid tubes is No. 2R-3685; for AC tubes is No. 2R-3686; and for DC tubes is No. 2R-3687. Your order for any of these models will be filled within 24 hours from the time it is received.

Aero Short Wave Converter

World wide reception on the short waves has aroused the interest of thousands of new Radio fans. Get started by using the simple Aero Standard Short Wave Converter which can be attached to any "broadcast" radio receiver. It can be assembled in a few minutes and can be plugged into the detector and sometimes the first R.F. socket utilizing the same tube which has been removed. Factory sealed kit, complete with instructions. Kit for DC tubes is No. 2R-3666 and for AC tubes is No. 2R-3667. The price is unusually low especially when you consider the thrill you'll get of listening in on foreign programs. The retail list is \$32.00 and your special wholesale price is \$18.82.

Free Wholesale Catalog

Our big wholesale catalog which is **FREE** to you contains 100 pages of selected values "boiled down" from the vast offerings of an enormous market. You will applaud our choice. Kits, parts,

sets, accessories, cabinets, electrical appliances,—the best the market affords. Absolutely **FREE**. Send for your copy today.

Setbuilders Supply Co.

105 Romberg Bldg. Chicago, Ill.

SETBUILDERS SUPPLY CO.
105 Romberg Bldg., Chicago, Ill.

Gentlemen: Send me without obligation on my part your *Free* Wholesale catalog showing the Aero line and other radio parts, accessories, kits, consoles and cabinets of finest quality.

Name.....

Address.....

City..... State.....

AERO KITS

California Headquarters

for

AERO KITS and PARTS

Same Day Shipment
Complete Stocks

WE are California headquarters for the new Aero 4-tube Metropolitan and all other Aero parts and kits. Our complete stocks on this popular line, as well as all others of reputable manufacture enable us to make **same day shipment** on all mail orders. For **quick delivery**, send your orders to us. You will profit by our speedy service.

DEALERS AND SETBUILDERS: Write for our literature and prices on all high grade radio products. Best discounts to the trade.

RADIO SUPPLY COMPANY

912 South Broadway

LOS ANGELES, CALIFORNIA

A, B and C Power Supply for Aero 5 Tube A.C. Kit

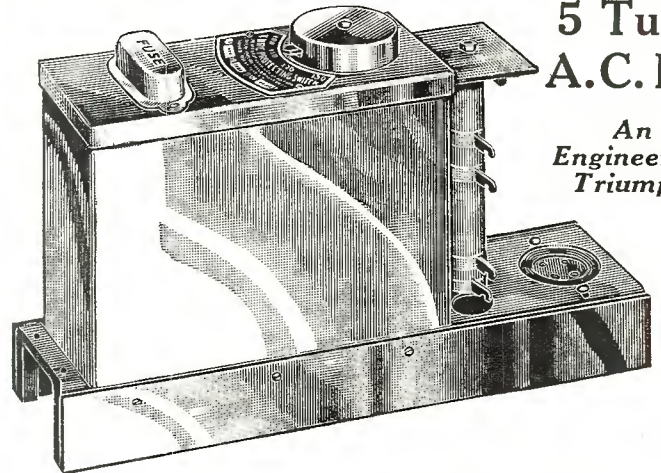

An
Engineering
Triumph

Fits Inside Aero Metal Cabinet

Size ONLY 3x7x11"

Price ONLY \$34 Each

EXACTLY supplies all filament voltages for the No. 280 Rectifier Tube, the No. 227 A.C. Tubes and the No. 171 Power Tube. Also supplies the absolutely correct B voltages for all of the tubes. Also EXACTLY supplies the very important C bias voltage for the No. 171 power tube, insuring the full power and truly beautiful tone quality of which this tube is capable when A, B and C voltages are all absolutely EXACTLY as specified by the tube manufacturers.

These Power Units are special jobs. They are built for the exact and specific requirements of the Aero 5 Tube No. 21

Chronophase A.C. Receiver Kit. They are the result of many months of the combined efforts of Aero Engineers working in co-operation with Radiart Laboratories Engineers.

Order Radiart Power Unit No. 55 for the 5 Tube Kit. Order Aero Metal Cabinet No. 250 for the 5 Tube Kit. Order Aerorox Filter Condenser Block No. BC-280 for the 5 Tube Kit.

Radiart Power Units for Aero A.C. Kits can be obtained from all distributors of Aero Kits. If your dealer is temporarily out of them they will be shipped direct on receipt of price. Address

RADIART LABORATORIES, 1002 Ass'n Bldg., Chicago, Ill.

GENUINE Nathaniel **BALDWIN** Regular \$9.00 Famous Type C **HEADPHONES**



OUR PRICE \$5.50 ORDER NOW

We offer several thousand genuine Nathaniel Baldwin PERFECT type C headphones fresh from the factory in original sealed cartons at a fraction of their cost. Never before sold for less than \$9. Price while they last only \$5.50. Satisfaction guaranteed or money refunded.

Baldwin Headphones

hold all long distance records, you simply cannot get distance stations by any other means. An operator at San Francisco picked up a code message from Bagdad, Turkey—half way around the globe, a world's record. Whether you are a professional operator, set builder, or R.C.L. these are the headphones you need.

PREMIER ELECTRIC CO.
150 Nassau St. New York

Shanco **Battery Clip**
GRIP-TITE POWERFUL TENSION



THE Shanco Clip design assures free and uninterrupted flow of electrical current. There are no springs to heat up, burn or drop out. Made of powerful tension, tempered spring steel solidly riveted together. All parts electro-plated before assembly (not galvanized or tinned), acid-resisting. The jaws open wide and are easily applied. The Griptite bulldog teeth "stay put" and bite right through corroded bars and terminals. The teeth are so arranged that the clip cannot fall over and "short" the battery.

There are 4 sizes for every battery need: 5 Ampere, 15 Ampere, 50 Ampere, 300 Ampere.

Write for our literature and prices

Shanklin Manufacturing Company
Dept. 63, Springfield, Illinois

Television Outfit \$4.98



TELEVISION'S newest developments require thorough knowledge of chemistry. **Chemrad Radio Chemical Outfit** shows you how. Chuck full of new ideas. Teaches radio chemistry, the alluring, thrilling, new science. Complete outfit includes chemicals, metals, apparatus, instructions to carry on chemical and radio experiments, television, etc. Send \$4.98 money order, or sent C. O. D. Satisfaction guaranteed. **Chemical Radio Company, 4730 J. Drexel Blvd., Chicago.**

GET MY DISCOUNT CARD!
Before buying a **KNAPP "A" POWER KIT**
Absolutely dry—Magically silent—the finest "A" Power adaptable to Short Wave, Super-Heterodyne and Television reception.

WITH THE 10 NEW IMPROVEMENTS
Write me today for details of this money saving plan and get your discount card. Address

DAVID W. KNAPP, Pres.
Knapp Electric, Inc.
Division of E. R. Mallory & Co., Inc.
Borden Bldg., Madison Ave., N. Y. City

I Will Train You at Home to Fill a Big-Pay Radio Job



Here's Proof

\$375 One Month In Spare Time



"Recently I made \$375 in one month in time installing, servicing, selling Radio Sets."

Earle Cummings
18 Webster St.
Haverhill, Mass.

\$450 a Month



"I work in what I believe to be the largest and best-equipped Radio shop in the Southwest and also operate KGFI. I am averaging \$450 a month."

Frank M. Jones
922 Guadalupe St.
San Angelo, Tex.

If you are earning a penny less than \$50 a week, send for my book of information on the opportunities in Radio. It's FREE. Clip the coupon NOW. A flood of gold is pouring into Radio, creating hundreds of big pay jobs. Why go along at \$25, \$30 or \$45 a week when the good jobs in Radio pay \$50, \$75 and up to \$250 a week? "Rich Rewards in Radio" gives full information on these big jobs and explains how you can quickly learn Radio through my easy, practical home-study training.

Salaries of \$50 to \$250 a Week Not Unusual

The amazing growth of Radio has astounded the world. In a few short years three hundred thousand jobs have been created. And the biggest growth is still to come. That's why salaries of \$50 to \$250 a week are not unusual. Radio simply hasn't got nearly the number of thoroughly trained men it needs.

You Can Learn Quickly and Easily In Spare Time

Hundreds of N. R. I. trained men are today making big money—holding down big jobs—in the Radio field. You, too, should get into Radio. You can stay home, hold your job, and learn in your spare time. Lack of high school education or Radio experience are no drawbacks.

Many Earn \$15, \$20, \$30 Weekly On the Side While Learning

I teach you to begin making money shortly after you enroll. My new practical method makes this possible. I give you **SIX BIG OUTFITS** of Radio parts and teach you to build practically every type of receiving set known. M. E. Sullivan, 412 73rd St., Brooklyn, N. Y., writes, "I made \$720 while studying." G. W. Page, 1807 21st Ave., S., Nashville, Tenn. "I picked up \$935 in my spare time while studying."

I give you 6 big outfits of Radio parts. With them you can build 100 Radio set circuits. Here are 3.

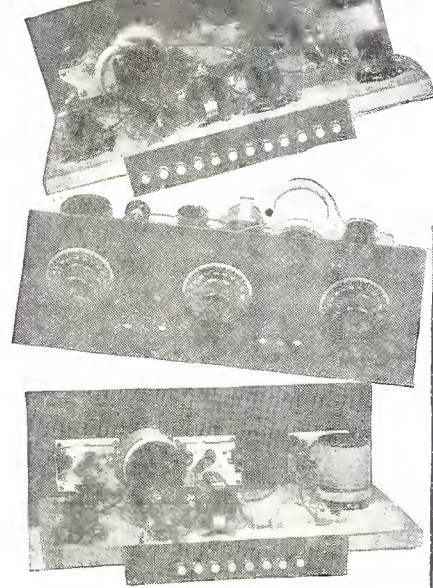

Your Money Back If Not Satisfied

My course fits you for all lines—manufacturing, selling, servicing sets, in business for yourself, operating on board ship or in a broadcasting station—and many others. I back up my training with a signed agreement to refund every penny of your money if, after completion, you are not satisfied with the lessons and instructions I give you.

Act NOW—64-Page Book Is Free

Send for this big book of Radio information. It has put hundreds of fellows on the road to bigger pay and success. Get it. See what Radio offers you, and how my Employment Department helps you get into Radio after you graduate. Clip or tear out the coupon and mail it **RIGHT NOW.**

J. E. Smith, President
Dept. 9MDD
NATIONAL RADIO INSTITUTE
Washington, D. C.

FREE



Mail this coupon NOW

J. E. SMITH, President
Dept. 9MDD, National Radio Institute
Washington, D. C.

Dear Mr. Smith: Send me your Free book "Rich Rewards in Radio," giving information on the big-money opportunities in Radio and your practical method of teaching with six Radio Outfits. I understand this places me under no obligation.

Name.....Age.....
Address.....
City.....State.....

Guaranteed

BY THE LARGEST AND MOST UP-

This highly efficient organization with trained service men, together with a completely equipped laboratory, is at your disposal for repairing, testing and advice on all types radio receivers, battery eliminators and power units. Our experience in this field has helped all our clients to enjoy better and continuous radio reception. All laboratory instruments used in testing and repairing are modern and up to date, insuring rapid and accurate location of trouble involved in your receiver.

Remember

the confidence of many leading manufacturers has been placed in this laboratory. The Radio Service Laboratories will give to you the same conscientious service that the manufacturer himself would give you.

Any receiver or power device repaired by us is positively guaranteed to perform in the manner claimed by the manufacturer.



Because the largest staff of trained service repairmen and engineers are at your service, you can be assured at all times of the most careful and competent work. This is proven by the large numbers of sets shipped to us for service from every state in the U. S., Canada, Alaska and Mexico.

We Specialize

on all receivers illustrated in the Citizens Radio Call Book. If you have constructed any of these receivers and are not obtaining satisfactory results, let us give an estimate for putting the set in first class condition. Each receiver repaired by us is given a thorough inspection of each individual part.

BEST operation of any receiver is only secured when all voltages are up to their rated value. Many a set giving poor results is due to lower plate voltages. Occasionally this may be caused by defective resistances or poor or leaky condensers.

Our trained staff is fully equipped to service your power supply and restore it to its proper condition. Have your work done now so that you may obtain the maximum efficiency of your receiver. We are also prepared to construct any type of power device.

RADIO SERVICE

508 South Dearborn Street

Telephone

Radio Service

TO-DATE SERVICE STATION IN AMERICA

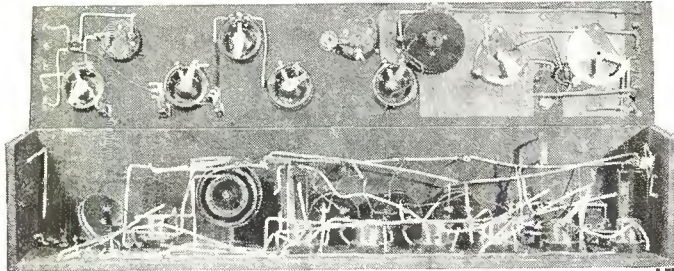

The way it came in

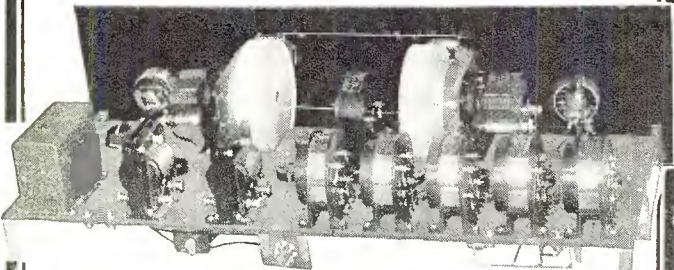

The way we returned it

WE will repair, test or design any type of receiver you may desire. Being specialists in this field we are in an excellent position to rebuild your present receiver and bring it up to date.

It is more practical and wise to bring your problems here than to some irresponsible radio man who is unfamiliar with the merchandise you wish serviced. This is an era of specialized effort and our charges are no more than you would pay for inferior workmanship.



(All receivers serviced in this laboratory are given a final test in a completely shielded room where the internal noises are absolutely eliminated.) This insures noise-free reception, which is necessary for satisfactory performance. In addition, complete equipment is available for properly testing all types of power units.

If you are unable to personally deliver the receiver or unit you wish to have repaired, securely pack it in a strong box with plenty of cushioning material such as excelsior, and ship it to us via American Railway Express, prepaid. It is not necessary to ship the cabinet or accessories.

In order that you may safely ship your receiver to us for repairs, we can supply you with a strong fabricated carton, including the required amount of packing, sealing tape, wrapping paper and rope at a cost of \$1.00. This carton conforms to the construction requirements of Consolidated Freight Classification, a resistance of 200 pounds per square inch and a gross weight limit of 65 pounds.

LABORATORIES, Inc.

Harrison 2870

Chicago, Illinois

Index to Advertisers

A			H			R		
Aero Products, Inc.....	166		Haldorson Co., The.....	149		Radiall Company	165	
Aerovox Wireless Corp.....	4		Hammarlund Mfg. Co.....	143		Radiart Laboratories	2-170	
Alden Mfg. Co.....	147		Hammarlund-Roberts, Inc.	131		Radio Association of America.....	25	
Allen-Rogers-Madison Co.	154-162		Harder Hall	137		Radio Equipment Co.....	153	
Allied Radio Corp.....	13-151- 153-154-160-163-164-169		Hazelton Laboratories	158		Radio Inspection Service Co.....	112	
Alvon Radio Laboratories.....	165		Hickock Electrical Instrument Co.....	157		Radio Institute of America.....	33	
American Sales Co.....	157		High Frequency Laboratories.....	23		Radio Manufacturers Supply Co.....	112	
American Transformer Co.....	37		Howard Radio Co.....	Second Cover		Radio Parts Co.....	141	
Arcturus Radio Co.....	126					Radio Service Laboratories, Inc.....	151-152-172-173	
Aston Cabinet Manufacturers.....	161		I			Radio Supply Co.....	170	
B			Independent Electric Works.....	31		Raytheon Mfg. Co.....	150	
Barawik Co., The.....	176		Insuline Corp. of America.....	157		Readrite Meter Works.....	135	
Bellevue-Stratford Hotel	141		International Correspondence Schools.....	163		Reliable Supply Co.....	163	
Benjamin Electric Mfg. Co.....	124		International Resistance Co.....	142		Roberts Radio Service.....	156	
Birnback Radio Co.....	150		J			Robertson-Davis Co., Inc.....	43	
Braun Co., W. C.....	1-5-107-167		J. M. P. Mfg. Co., Inc.....	159		Rosen, Raymond & Co., Inc.....	112	
C			Jappe Company, H.....	110		Royal-Eastern Electrical Supply Co.....	111	
Carter Radio Co.....	120		Jewell Electrical Instrument Co.....	122		S		
CeCo Mfg. Co.....	11		K			Samson Electric Co.....	149	
Central Radio Laboratories.....	124		Karas Electric Co.....	141		Sangamo Electric Co.....	17	
Chemical Radio Co.....	171		Knapp Electric Corp.....	119-141- 152-160-162-164-171		Set Builders Supply Co.....	112-170	
Chicago Salvage Stock Store.....	169		L			Shanklin Mfg. Co.....	171	
Citizens Radio Service Bureau (Blue Prints)	127		Lakeside Radio Co.....	141		Shieldplate Tube Corp.....	29	
Clark & Tilson.....	110		Lincoln Radio Corp.....	15		Silver-Marshall, Inc.	106	
Clarostat Mfg. Co., Inc.....	114		M			Sonatron Tube Co.....	Fourth Cover	
Corbett Cabinet Mfg. Co.....	135		M & H Sporting Goods Co.....	118		Supreme Instruments Corp.....	115	
Cornish Wire Co.....	146		Mack Laboratories	152		T		
D			Magnavox Co., The.....	141		Thorola Radio Products.....	162-Third Cover	
DeJur-Amsco Corp.....	140		Midwest Radio Corp.....	21		Thordarson Electric Mfg. Co.....	7	
Deutschmann Co., Tobe.....	42		Mississippi Valley Radio Co.....	143		Townsend Laboratories	153	
Dongan Electric Mfg. Co.....	156		Modern Antenna Co.....	145		Transformer Corp. of America.....	128	
Dubilier Condenser Corp.....	132		Morrison Hotel	163		Tyrman Electric Corp.....	27-29	
E			Mountford, C. E.....	153		U		
Eby Mfg. Co., H. H.....	130		Muter Co., Leslie F.....	121		United Reproducers Corp.....	41	
El Cortez Apartments.....	151		N			V		
Electrad, Inc.	9-144		National Co., Inc.....	136		Vee Products	117	
Electric Supply Co.....	112		National Radio Institute.....	113-171		W		
Elkon, Inc.	129		Nelson Electric Co.....	157		Walker Co., The, Geo. W.....	19	
Excello Products Corp.....	125		New England Mills Co.....	153		Ward Mfg. Co.....	164	
F			Newell Pharmacal Co.....	164		Western Radio Mfg. Co.....	108-152-157-158-162-169	
F & H Radio Laboratories.....	159		O			Weston Electric Instrument Corp.....	151	
Ferranti, Inc.	3		Ohmite Mfg. Co.....	163		Wholesale Radio Service Co.....	111-168	
Formica Insulation Co.....	143		P			Wright-DeCoster, Inc.	125	
Fort Shelby Hotel.....	158		Pacific Radio Publishing Co., Inc.....	155		X		
Frost, Inc., Herbert H.....	154		Pierson Co., The.....	175		X. L. Radio Laboratories.....	126	
G			Piccadilly Hotel, The.....	160		Y		
General Radio Co.....	130		Polk, J. L.....	132		Yahr-Lange, Inc.	116-134	
Gray & Danielson Mfg. Co.....	3-147		Polymet Mfg. Co.....	148		Yaxley Mfg. Co.....	139	
Graymore Radio Corp.....	109		Potter Mfg. Company.....	139				
			Premier Electric Co.....	171				

Pierson Phono-Radio



PIERSON
PHONO-RADIO
The Orleans

ABOVE is illustrated, the GREATEST VALUE IN PHONO-RADIOS on the market. Think of it:—THE ORLEANS sells at List, with Magnetic Speaker, completely equipped for \$185.00, or with Dynamic at \$215.00. The equipment consists of A.C. Induction Type Electric Motor, Cobalt Magnet, Electric Pickup, Statuary Bronze Tone Arm, Two-Way H & H Phono-Radio Switch, Volume Control, Radio Adapter, etc.

THE ORLEANS will house such sets as Radiola 18, or 60—Graybar, Brunswick, Federal and in fact any set, with wonderful results.

Special—

Atwater-Kent, Crosley, Steinite and sets having center Tuning Control, can use the *Miracle Phono-Radio*, listing at \$156.00 complete, with Dynamic Speaker.

“Be First with Pierson”

**THE PIERSON
COMPANY**

ROCKFORD, ILL.

The “MIRACLE” Radio Cabinet

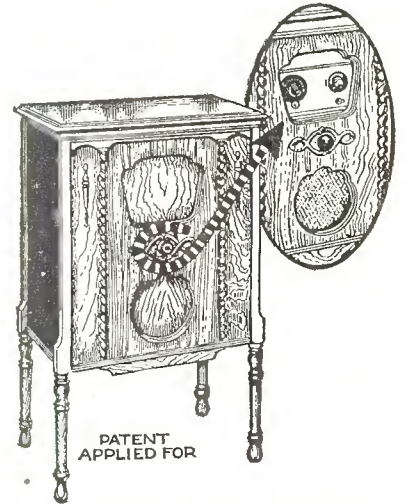

*“When You See the
Revolving Door
You’ll Know—
It’s the MIRACLE”*

DEALERS

Advance information is now available on the MIRACLE CABINET. WRITE FOR IT TODAY!

Custom-Radio Builders, ATTENTION

PIERSON protects your profits. You have a complete line to select from and no mail order house can sell your customers.

Write today for application for Dealer’s Pass Card, which will admit you to any of our Wholesale Display Rooms.

THE PIERSON CO.
830 Cedar Street
Rockford Illinois

Barawik - the Old Reliable

RADIO SERVICE

NEW WRINKLES FOR SPRING AND SUMMER

THE Barawik Radio Guide points the way to a new and unique service to radio fans. Plenty of profitable business and entertainment for the Spring and Summer months, with new portable radio sets, portable phonographs, short wave, television, camping and outing equipment, golfing supplies, tennis and other sporting goods. Hundreds of items of new merchandise—auto tires, tubes and accessories—and just the things you need most for everyday use in the home, office, shop, store and factory.

Get the *Barawik Radio Guide* if you already haven't one. It shows you have to save tremendous sums on everything you buy in these lines.

Amateur and Short Wave Equipment

BARAWIK is the pioneer in supplying kits and parts for short wave receivers and transmitters. We are headquarters for all the popular short wave circuits such as: Hammarlund, Aero, Karas, Cardwell, R.E.L., Thordarson, Acme, National, etc., as well as the individual parts used in the assembly of all makes of short wave receivers and transmitters.

Television

Television is still in its infancy and far from perfect, but we are keeping abreast of all events in this new field and will be able to supply fans with the various necessary parts to keep up experiments as new developments come out. During vacation many fans will want to experiment with television. Barawik will help you to get the most reliable merchandise for this purpose.

You Save More Money Here

Ask any of the quarter million Barawik customers why they trade here, and they'll tell you that, *quality considered*, our prices can't be beat. That's something to think about! Quality comes first—good, new, fresh, reliable merchandise, but the price always means a tremendous saving, nevertheless. Get our catalog and prove this to yourself. Don't spend a nickel until you see our offerings first.

BARAWIK CO., 31 Canal Sta., Chicago

Please send me the big free Barawik Radio Guide, Catalog and Radio Cyclopeda at once, showing the many new bargains you offer.

Your Name.....

Address.....

City.....State.....



Deal with a Reliable House

At Barawik's you can secure the proved, reliable merchandise of the world's leading radio manufacturers—everything from complete sets to the smallest individual parts so necessary to the set builder. You can depend upon the reliability of Barawik goods. You can depend upon Barawik's ability to deliver the kind of service that means time saved in waiting. You can depend upon Barawik's honesty, ability and willingness to serve you—and last, but far from least, you know that Barawik's big discounts assure you of the lowest prices always—prices that mean huge savings to you in everything you buy.

Send Coupon for Free Book

You need Barawik's Big Guide as you never needed it before. Just mail the coupon and the big, profusely illustrated Radio Catalog, Guide and Cyclopeda will be sent to you free. Be sure to write for this new big edition today.

12-HOUR SERVICE

The Barawik Co.

31 Canal Station
CHICAGO, ILL., U. S. A.

We want IMMEDIATELY

Thorola TUBE 5000 Dealers

The demand for Thorola Tubes compels us to get wider distribution *immediately*. We must add at least 5000 dealers quickly! To get them—and to make the Thorola line everywhere available to the Thorola buying public—we make this *amazing* offer to dealers who will *act at once*.

WE OFFER FREE
With Each \$100 (Net) Order
of Thorola Tubes

THIS MARVELOUS TONED

Thorola DYNAMIC SPEAKER

The finest type of dynamic speaker available today—made by Thorola, for ten years nationally famous in the loud speaker field. This offer has no strings attached to it. We make it to get *immediate* wider distribution of the world's finest *one-year guaranteed* tubes—and to assure adequate

representation of the complete Thorola line of tubes and loud speakers.

Take advantage of this offer, Mr. Dealer! Of necessity, it is limited as to time. Thorola offers you a generous 50% off list tube prices. In addition, you get absolutely FREE this nationally famous Thorola Dynamic. We ask you only to demonstrate to your trade the wonderful new reproduction afforded by this magnificent toned speaker.

YOURS! This THOROLA DYNAMIC

This magnificent-toned Thorola Dynamic Speaker actually "breathes." Catches and reproduces with life-like realism every note from the highest violin treble to the lowest boom of the kettle drum. Ten inch-cone, 25% larger than usual, gives greater volume and efficiency. Mounted in beautifully designed solid walnut cabinet, 15 inches wide, 13 3/4 inches high, 8 1/2 inches deep. Furnished for both 110 volt AC (with built-in rectifier) or 6 volt DC. Specify type you want sent with order.



Jobs, Dealers and Manufacturers' Representatives are invited to write or wire us immediately for full particulars regarding a very desirable proposition.

THOROLA RADIO PRODUCTS
110 East 21st Street
Chicago, Illinois

Please ship at once my order for Thorola **Guaranteed** Tubes totaling \$..... (less 50% discount). Find my itemized order attached. If my order amounts to \$100 or more **NET**, I understand that I will receive absolutely **FREE** one Thorola Dynamic Speaker.

Name.....
Firm.....
Address.....



The Thorola line offers a *guaranteed* tube for every requirement; also matched sets of AC tubes.

50% off

LIST PRICES

All Standard Types

No sliding scale discounts
—50% from current list price is your discount on any quantity.

DC TUBES

Type	List
201-A	\$1.50
V-199	2.25
X-199	2.25
X-11	2.50
X-12	2.50
X-120	2.50
X-222	6.50

AC TUBES

226	2.25
227	4.00
AC-171	4.00
280	4.25
222-AC	7.50

POWER TUBES

X-171	2.75
X-112	2.75
112-A	2.75
171-A	2.75
200-A	4.00
281	7.50
250	11.50
210	9.00

MATCHED SETS OF AC TUBES

No. 6 AC KIT	
1-AC-227	List Price
1-AC-171	\$22.25
4-AC-226	
1-280 (Rectifier)	

No. 7 AC KIT	
1-AC-227	List Price
1-AC-171	\$24.50
5-AC-226	
1-280 (Rectifier)	

No. 8 PUSH PULL KIT	
1-AC-227	List Price
2-AC-171	\$26.25
4-AC-226	
1-280 (Rectifier)	

Thorola Tubes - the World's Finest Guaranteed Line

For ten years Thorola has stood for the best in the field of *fine* radio. This name on radio tubes is absolute assurance of rigid quality standards, long life and dependable performance. Every Thorola Tube is scientifically engineered, laboratory tested and backed by a gilt-edged, full year's unconditional guarantee which is made good directly at the factory if any tube proves defective.

DEALERS! Order your requirements from list opposite—50% off list prices. *Get your order in immediately!* Upon receipt of your \$100 (net) order for Thorola tubes, we will ship at once with your order a FREE demonstrator Solid Walnut Thorola Dynamic Speaker. Don't pass up this opportunity—the *season's most sensational dealer offer!* We can afford to make it only because we must have immediate representation everywhere. *Wire your order today.* Or fill in the coupon below and mail at once. Act *immediately*, before the supply of Thorola Dynamic Speakers set aside for this special purpose is exhausted.

THOROLA RADIO PRODUCTS
General Offices: 110 East 21st St., Chicago

Thorola

Guaranteed TUBES "World's Finest Tube Line"



Bombarded with Energy

... for longer life and super-performance! Sonatron radio tubes come to you brimming with energy ... Life! Zest! Sparkling tone for your set! Many added hours of dependable service because of the Sonatron bombarding process. A vivid, colorful flash of light ... and another Sonatron radio tube has been given that abundant energy which Sonatron standards demand.



Of the many interesting processes to which Sonatron tubes are subjected, none is more interesting or more important than "bombarding."

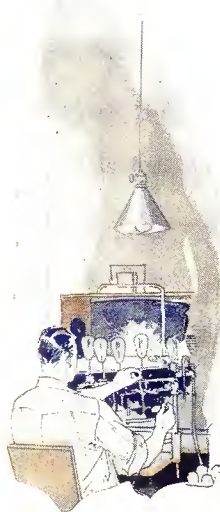

In this process, the elements of each Sonatron tube are literally "bombarded" with energy for the operation of the tube throughout its life. In Sonatron tubes, this process is, in part, the secret of the longer life and super-performance with which the Sonatron label has become associated.

The thoroughness of the "bombardment," the length of time in which this operation is performed—these have a vital bearing on the qualities of the tube. As in every operation in the Sonatron factory, there is no skimping here, no compromise with time or cost. Every Sonatron tube is a rich storehouse of energy and vitality for your receiver. Set owners who have equipped with Sonatrons are enthusiastic over their tone and performance throughout a longer life.

Go to your Sonatron dealer for your next set of tubes. Write us for a free copy of the 1929 edition of "How to take care of your Radio Tubes."



SONATRON

THE WORLD'S LARGEST RADIO TUBE LINE

SONATRON TUBE COMPANY

16 Hudson Street, New York City 108 West Lake Street, Chicago, Ill.
88 Eighth Avenue, Newark, N. J. Cable Address: SONATRON-NEWARK