

TK APRIL.
7800 1919
E54 20 CTS.
v.6
no. 2 12

ELECTRICAL

OVER
175
ILLUST.

EXPERIMENTER

SCIENCE AND INVENTION

REG. U.S. PAT. OFF.

A NEW INVENTION -
NOT X-RAYS

?

SEE PAGE 860



BE A CERTIFICATED ELECTRICIAN



A Real Position Like This—For You

The country needs thousands of trained, Certificated Electricians to fill good positions—and at big pay. It's all a matter of knowing how, and I will teach you by up-to-date, modern instruction. You can learn at home, without interfering with your regular work, by my highly successful method of *Home Instruction in Practical Electricity*.

Prepare NOW and be ready in a few months to earn your \$46 to \$100 A WEEK

Send for this Book

My book, "HOW TO BECOME AN EXPERT ELECTRICIAN," has started thousands of young men on the way to splendid success. A new edition of this has just been printed. I want every young man interested in Electricity to have a copy, and will send you one, ABSOLUTELY FREE and PREPAID. Write me today.

How I Train My Students

As Chief Engineer of the Chicago Engineering Works I know exactly the kind of training a man needs to enable him to get and hold good positions, and to earn big pay. I have trained hundreds of men who are holding splendid electrical jobs.

I give each of my students personal attention and a complete and thorough training. I give him a SPLENDID ELECTRICAL OUTFIT FREE, and much of the training is done by actual work. When my students graduate and receive their Certificate, they are ready for a real position. But *still more*, at any time you wish you can come to our splendidly equipped Electrical Shops for special training. No other school can give you this.

A Real Opportunity for YOU

Wishing is never going to make your dreams come true. You've got to *study—to learn*. A man is worth possibly \$2 or \$3 a day from his neck down—and no more; but there is *no limit* to what he can be worth from his neck up.

A *trained mind* is what gets the big pay. It is this training that you need, and I can train you in a few months. Are you ambitious to make a real success—then send me the coupon—today.

Electrical Outfit FREE

To every student who answers this ad I am giving a Splendid Electrical Outfit of standard size Electrical Tools, Instruments, Materials, etc., *absolutely free*. Furthermore, to every Electrical Student I give a truly *valuable* surprise that I cannot explain here.

Free Employment Service

I am continually receiving requests from employers to send them trained Electrical men. I assist my students to secure good positions. I keep in touch with them for years, helping and advising them in every possible way.

Write Now—Don't Delay

Delay never got you anything. Action is what counts. Get started—and get started now. Write me, or send me the coupon, right NOW.

L. L. COOKE, Chief Engineer
CHICAGO ENGINEERING WORKS

441 Cass Street

Dept 24

Chicago, Ill.

USE THIS "FREE OUTFIT" COUPON
CHIEF ENG. COOKE, Chicago, Ill.
Dept. 24, 441 Cass St., Chicago, Ill.
Send at once, fully prepaid and entirely free—complete particulars of your great offer for this month.
Name.....
Address.....
City.....
State.....

YOU CAN DO IT

The Burgess BLUE BOOK

for all Practical Men and Electrical Students

(See review of this book by Editor in December issue of your Electrical Experimenter page 568)

I have prepared a pocket-size note book especially for the practical man and those who are taking up the study of electricity. It contains drawings and diagrams of electrical machinery and connections, over two hundred formulas for calculations, and problems worked out showing how the formulas are used. This data is taken from my personal note book, which was made while on different kinds of work, and I am sure it will be found of value to anyone engaged in the electrical business.

The drawings of connections for electrical apparatus include Motor Starters and Starting Boxes, Overload and Underload Release Boxes, Reversible Types, Elevator Controllers, Tank Controllers, Starters for Printing Press Motors, Automatic Controllers, Variable Field Type, Controllers for Mine Locomotives, Street Car Controllers, Connections for Reversing Switches, Motor and Dynamo Rules and Rules for Speed Regulation. Also, Connections for Induction Motors and Starters, Delta and Star Connections and Connections for Auto Transformers, and Transformers for Lighting and Power Purposes. The drawings also show all kinds of lighting circuits, including special controls where Three and Four Way Switches are used.

The work on Calculations consists of Simple Electrical Mathematics, Electrical Units, Electrical Connections,

Calculating Unknown Resistance, Calculation of Current in Branches of Parallel Circuits, Law to Figure Weight of Wire, Wire Gauge Rules, Ohm's Law, Watt's Law, Information regarding Wire used for Electrical Purposes, Wire Calculations, Wiring Calculations, Illumination Calculations, Shunt Instruments and How to Calculate Resistance of Shunts, Power Calculations, Efficiency Calculations, Measuring Unknown Resistances, Dynamo and Dynamo Troubles, Motors and Motor Troubles, and Calculating Size of Pulleys.

Also Alternating Current Calculations in finding Impedance, Reactance, Inductance, Frequency, Alternations, Speed of Alternators and Motors, Number of Poles in Alternators or Motors, Conductance, Susceptance, Admittance, Angle of Lag and Power Factor, and formulas for use with Line Transformers.

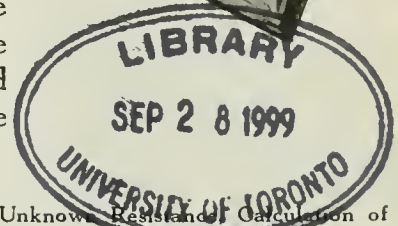
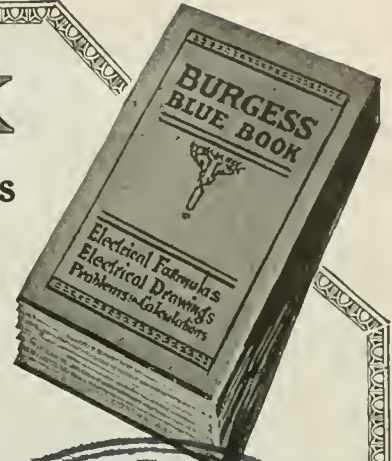

WHAT PRACTICAL MEN SAY ABOUT THE "BURGESS BLUE BOOK"

Received your "Blue Book" and must say it is the best book I ever saw. I showed it to a friend of mine and he refused to give it back to me but he paid me a dollar and told me to get another. Rather than be without this book I am sending Money Order for three of them so I can show them to two more of my friends and have one left for myself. Wishing you would mail them at once. I am
Yours very truly,

JOSEPH BRAITH, Electrician,
Madison, Wisconsin.

Your "Blue Book" received and it is just the book I have been looking for. Please mail me three more by return mail for which I am enclosing Money Order. Respectfully,
V. E. JOHNSON, Western Union Tel. Co.,
Marion, Ohio.

Have received the copy of the "Burgess Blue Book" and am very well pleased with the easily found formulas and data contained in it. I am enclosing Money Order for four additional copies.
Very truly yours,

THURE C. ANDERSON,
Ridgeway, Penn.

I am enclosing three dollars for which please send me three copies of the "Burgess Blue Book". I showed the copy I got last week to some friends and three of them asked me to get them one.
Very truly yours,

CHAS. H. DAVIS,
Los Angeles, Cal.

I received your "Blue Book" and after I looked over it I see that it is a very useful book. After I showed it to some fellows they wanted a copy also and I am enclosing Money Order for which please send me three at once. Yours very truly,

R. S. SWANSON,
St. Paul, Minn.

I received the three books I sent for and the next day I sold them. The fellows think they are well worth the price. Please send me three more for which I am enclosing Money Order.
Yours very truly,

R. S. SWANSON,
St. Paul, Minn.

AN OPPORTUNITY FOR YOU TO MAKE SOME MONEY

To help get the "Burgess Blue Book" to the men who need it the most, we have established a resale discount to which those who have purchased a book from us are entitled. The "Burgess Blue Book" is not sold through the regular book dealers so we offer the regular book dealers' discount to men who will take orders and send them in to us. In this way the "Blue Book" is only sold by those who know its value and we feel that this arrangement is much more satisfactory to the purchaser, than if he bought it through the regular book-selling channels. The book practically sells on sight, as a man engaged in practical work realizes when he sees it, that it contains information which is extremely useful and which is difficult to obtain in any other way.

The Burgess BLUE BOOK Will Be Shipped, Postpaid, on Receipt of \$1.00

Send dollar bill, money order or check. I guarantee satisfaction or will return your money if you decide not to keep the book after using it for five days

BURGESS ENGINEERING CO., YORKE BURGESS, Consulting Engineer
747 East 42nd Street Chicago, Illinois

Electrical Experimenter

233 FULTON STREET, NEW YORK

Published by Experimenter Publishing Company, Inc. (H. Gernsback, President; S. Gernsback, Treasurer;) 233 Fulton Street, New York

Vol. VI. Whole No. 72

APRIL, 1919

No. 12

GRAND OPERA IN YOUR HOME.....By H. Gernsback	855	THE OPINION OF RADIO EXPERTS ON RADIO WAVE TRANSMISSION.....	873
NEW YORK TO CHICAGO VIA THE AIR IN 12 HOURS.....	856	THE HOW AND WHY OF RADIO APPARATUS—HOW TO MAKE A DIRECT-READING WAVE METER AND DECREMENTER.....By H. Winfield Secor	874
GUIDING AIRSHIPS WITH THE "RADIO BARRAGE".....By Dr. Lee de Forest	857	GERMAN RADIO APPARATUS USED AT METZ.....A TIMELY REINFORCEMENT—A COPPER-PLATED STOMACH	876
HOW ELECTRICITY SERVES WORLD'S LARGEST HOTELS.....By H. Winfield Secor	858	THE ALKALINE STORAGE BATTERY.....By J. F. Springer	878
SEEING THRU YOU WITHOUT X-RAYS.....By C. Battell Loomis	860	EXPERIMENTAL MECHANICS—THEORY OF TWIST DRILLS	879
CATCHING DIAMOND THIEVES WITH THE X-RAY.....	862	By Samuel D. Cohen	
GREAT BRITAIN'S NEW MONITOR-SUBMARINE WITH 12-INCH GUN.....	862	PRACTICAL CHEMICAL EXPERIMENTS—BUTTER AND BUTTER SUBSTITUTES.....By Albert W. Wilsdon	880
MY INVENTIONS. By Nikola Tesla. No. 3. "My Discovery of the Rotating Magnetic Field".....	864	HOW-TO-MAKE-IT DEPARTMENT—PRIZE CONTEST.....	881
THE MOON'S ROTATION.....By Nikola Tesla	866	WRINKLES, RECIPES AND FORMULAS..Edited by S. Gernsback	882
EXPERIMENTAL PHYSICS—SCIENCE IN THE WAR.....By John J. Furia, A.B., M.A., (Columbia University)	867	LATEST PATENTS DIGEST.....	883
POPULAR ASTRONOMY. THE PLANET EARTH—AS OTHERS SEE US.....By Isabel M. Lewis, of the U. S. Naval Observatory	868	WITH THE AMATEURS—PRIZE PHOTO CONTEST.....	884
RADIOPHONY TO AIRPLANES A GREAT SUCCESS.....	870	SCIENCE IN SLANG—NO. 2—JAZZ STOKES ON WIRELESS DOPE.....By Emerson Easterling	885
DO RADIO WAVES TRAVEL ABOVE THE EARTH OR THRU IT?.....By Dr. Lee de Forest	872	"THE ORACLE"—QUESTION AND ANSWER BOX.....	886

EDITORIAL

Interplanetary Messages



FEW weeks ago Marconi startled the world by stating that he had often received strong wireless signals which seemed to come from beyond the earth. In a recent interview published in the *New York Evening Post* Nikola Tesla, too, reminds us that he had made known to the world years ago the fact that extra-planetary signals were recorded in his Colorado Laboratory. That was in 1899, before the world dreamt of wireless.

Even today announcements such as the above are made light of by editorial writers and others of limited scientific perception. For the earth-bound layman still persists that intelligence can only exist on Earth. Such childish reasoning shows what sort of "intelligence" blossoms on this planet. It never occurs to these reviewers to question why Nature in her Wisdom should have singled out the little speck called Earth, on which to plant beings endowed with reason. Why should there be such an exception? Life in some form or other is certain of being found on myriads of worlds throout the Universe. And if one world dies, all life does not die with it. Svante Arrhenius shows us how life-bearing spores are carried by the pressure of light thru interstellar space, notwithstanding the absolute zero which prevails there.

In our planetary system, conditions for life, such as we know it, probably only exists on two planets: Mars and Venus. Life on the latter being more or less doubtful, due to its heavy water-laden atmosphere, there remains Mars, a body much older in evolution than the earth. Conditions on Mars we know by direct observation as well as deduction are favorable for life, and we may be certain that it exists there. And if we once grant this, we must also grant that it must have existed for hundreds of thousands of years prior to that on Earth; consequently Martian civilization must be thousands of years ahead of ours.

From this we must deduce again that the Martians probably signaled to us ages ago, when prehistoric man still roamed the forests. But why go so far back? Suppose the Martians had sent us radio messages only

thirty years ago. We could never have received them, for we then had no means of recording them. Detectors and audions were undreamt of.

In all this warped logic, we presuppose wireless signals. But why should a civilization so far ahead of ours use—to them—obsolete radio waves, which, like as not, can never hope to bridge 35 million miles! If the Martians are signaling to us, you may be certain that they use an entirely different means than Radio. To be sure, it may turn out to be one of the many wave forms of the ether, but we can only make a poor guess at it today. Meanwhile Martian signals probably fly about our heads day and night, as they may have for thousands of years, but we are still deaf and blind to them. The Martian Wave Detector still remains uninvented. At that the Martians probably have used many methods on us. It is not even impossible that they may have used reflected sun rays. Bell and Tainter in 1880 demonstrated a "wireless" telephone—the Photophone—by making use of a vibrating light ray falling upon a selenium cell. Speech was transmitted over many miles this way. With necessary refinements such a system might bridge interplanetary space.

As to one planet understanding the other, that is of course child's play. Still, many humorous editorial writers have misgivings on that score. They are afraid that on Mars $2 + 2$ might equal, perhaps, 5 or 3, so how could we get together, they ask.

A simple example might serve as an illustration. Suppose an American and a Frenchman, neither knowing the other's language, were connected by a long telegraph line. Both are ignorant of the code. But both have enough sense to tap the key. Suppose both have the desire to enter into communication, what will they do? Tap out dots from one to ten, of course. Thus etc. It will not take them many months, if they keep at it, to work out a sort of "international" language by means of dots. And the higher their intelligence, the quicker will they understand each other.

That is the basis of interplanetary communication.

H. GERNSBACK.

The ELECTRICAL EXPERIMENTER is published on the 15th of each month at 233 Fulton Street, New York. There are 12 numbers per year. Subscription price is \$2.00 a year in U. S. and possessions. Canada and foreign countries, \$2.50 a year. U. S. coin as well as U. S. stamps accepted (no foreign coins or stamps). Single copies, 20 cents each. A sample copy will be sent gratis on request. Checks and money orders should be drawn to order of EXPERIMENTER PUBLISHING CO., INC. If you change your address notify us promptly, in order that copies are not misdirected or lost. A green wrapper indicates expiration. No copies sent after expiration.

All communications and contributions to this journal should be addressed to: Editor, ELECTRICAL EXPERIMENTER, 233 Fulton Street, New York. Unaccepted contribu-

tions cannot be returned unless full postage has been included. ALL accepted contributions are paid for on publication. A special rate is paid for novel experiments; good photographs accompanying them are highly desirable.

ELECTRICAL EXPERIMENTER. Monthly. Entered as second-class matter at the New York Post Office under Act of Congress of March 3, 1879. Title registered U. S. Patent Office. Copyright, 1919, by E. P. Co., Inc., New York. The Contents of this magazine are copyrighted and must not be reproduced without giving full credit to the publication.

The ELECTRICAL EXPERIMENTER is for sale at all newsstands in the United States and Canada; also at Brentano's, 37 Avenue de l'Opera, Paris. Member of the Audit Bureau of Circulation.

Remarkable **FREE** Charts OFFER

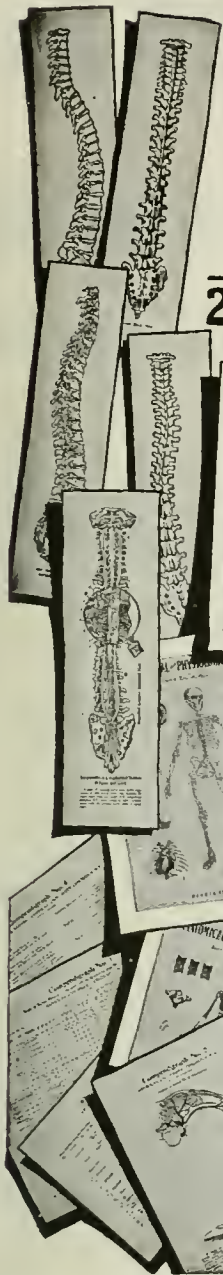

- 8** Anatomical and Physiological Charts (with Bound Manual Key) Handsomely Lithographed in Lifelike Colors.
- 4** Original Compeodigraphs.
- 5** Illustrative Spinal Columns.
- 5** Colored Nerve, Pain Area and Coccausio Charts.
- 22** Magnificent Charts—Value \$31.50—All Absolutely FREE.

We want ambitious men and women to have these remarkable Charts which are a visual demonstration of Chiropractic, the new science of Drugless Healing. This offer is now made to show the opportunities now open to Chiropractors. We also explain how we give a practical training by mail in this dignified, paying profession. If your desire is to enter an uncrowded field—if you want to achieve financial independence and social standing, at least investigate. Your request on the coupon below is all that is necessary.

Drugless Healing

The 72-page book and other literature we send on request shows the immense possibilities for Chiropractors of both sexes. The public is awakening to the fact that drugging to cure disease is in many instances, a fallacy. They are ready to welcome the practitioner who relieves and heals without nauseous dosing. The Charts show how the science of Chiropractic is applied. They reveal facts about the human body, instructive to the layman. You should obtain them without fail.

\$3000 to \$5000 a Year

Many Doctors of Chiropractic earn \$5,000 a year and more; some upwards of \$10,000. Dr. M. D. Moore of Ky., reports an income of \$9,000 a year. Dr. L. H. Roche, New Jersey, \$5,500; Dr. Hanna of Florida, over \$5,000 yearly. What others are doing you should be able to do. A diploma gives you the same opportunity—is evidence that you are master of a profession of dignity, prestige and influence.

Our Lessons Teach You

how to make Spinal Adjustments for speedy relief of

- | | |
|---------------------|-------------------|
| Headache | Neuralgia |
| Indigestion | Neuritis |
| Lumbago | Catarrh |
| Epilepsy | Fevers |
| Pleurisy | Jaundice |
| Constipation | Dyspepsia |
| Rheumatism | Paralysis |
| Asthma | Etc., Etc. |

Be a Chiropractor Learn At Home

By the American University system of instruction, you can become a Doctor of Chiropractic by studying in spare time at home or in class at the University. You do not require special talent or advanced education. A common school education and the ambition to succeed are all that is necessary. You will be trained under the direction of Chiropractic specialists who will teach you thoroughly the principles and practice of the profession. You will graduate with the degree of Doctor of Chiropractic.

Mail the Coupon

Any intelligent man or woman can readily master by our method—also information on how you can get these 22 instructive Charts. Send coupon for this free offer.

This coupon will bring full information about this new, interesting and profitable calling which any intelligent man or woman can readily master by our method—also information on how you can get these 22 instructive Charts. Send coupon for this free offer.

AMERICAN UNIVERSITY

Manierre Bldg., Dept 456

Chicago, Illinois

Free Charts

AMERICAN UNIVERSITY
Manierre Bldg., Dept. 456 Chicago

Gentlemen: Without cost or obligation, send me by mail, your new illustrated, 72-page book and your Free Charts Offer.

Name

Address

City

PRACTICAL

As experts Know it SENT FREE FOR INSPECTION



ONLY

\$16

for a complete
Electrical
Education—

Payable \$2
Per month

Learn electricity as you would in actual PRACTICE—in accordance with the methods employed by the highest paid electrical experts in America. The New McGraw-Hill Library of Practical Electricity contains the actual working facts which you need in order to succeed in the electrical field. Terrell Croft, formerly with the Westinghouse Company, makes the conquest easy for you.

A New Standard in Electrical Literature

The New Library of Practical Electricity by Terrell Croft marks a new era in electrical literature.

The great field of electrical engineering, with its limitless possibilities of earning power, is brought to you in a form that makes success easy. The Library is a creation—an achievement that is without parallel in technical literature, because it sticks to actual practice throughout its 3,000 pages.

8 Volumes
Flexibly bound
Pocket size
3000 pages
2100 illustrations
Everything
you must know
about electri-
city at the
finger's end

A letter that means something to YOU—

McGraw-Hill Book Company, Inc.
239 West 39th Street, New York, N.Y.

Gentlemen: In an attempt to express myself about CROFT'S NEW LIBRARY OF PRACTICAL ELECTRICITY, I have never seen, and do not believe there was ever printed in the English language, a more comprehensive set of books. It is a library that is just as valuable to the novice as to the expert, because it is all practice.

Respectfully,

GUY H. PEIFER,
Chief, Doplax Silk Corporation,
Hazleton, Pa.



Learn
electricity
as you
would
in actual
practice—
get Croft's
Library
NOW



ELECTRICITY

Records of actual Work NOT ONE PENNY IN ADVANCE

You have always wanted a compact set of books containing the solution to all your electrical problems. You have wondered if it were possible for any author to place himself in your shoes, and explain the very problems that face you every day. You have picked up books that covered the other fellow's problems, but not yours. These books seemed to touch on everything except the matters that pertained to your own work.

These books were not complete. They were probably out of date. They were probably not practical.

You have said yourself and heard others say, "I want books that fit into my work. The man who writes those books must understand my work, and know what he is talking about. I like to go into theory and the higher spheres of electricity occasionally, but not while I am on the job. Then I want plain facts, plainly stated. I want books that have anticipated my problems and figured them out for me."

Your wants have been anticipated and met in the new Croft Library. It is a seven-year undertaking recently completed by a man whose experience covers the whole field of electrical practice.

Examination will show why Croft's Library is now the accepted standard. Why it is used by the highest authority as well as the lowest beginner. Examination will show how it is revolutionizing the methods of teaching the practical side of electricity.

Examination is absolutely free. Merely return the coupon below.

Now is the time to master Electricity—Now is the time to prepare for a high salary

Old books won't do. Amateurish books won't do. Books compiled by "desk authors" or men with no practical experience will not serve your purpose.

Practical books are easiest mastered. Practical books, written by practical men, teach you accurately and rapidly. There is nothing in the Croft Library which you cannot understand. Terrell Croft tells you the secrets of success in electricity in plain words, figures and illustrations. Nothing is left to the imagination. There is no guesswork. There is no theory or higher mathematics.

Send now for these eight volumes. No matter how many books on electricity you possess, you are unfair to yourself unless you take advantage of this free examination privilege. No matter whether you are beginner or expert, these books will show you the clear road to success. Inspection will prove this.

READ THIS—

McGraw-Hill Book Company, Inc.,
239 West 39th St., New York.

Gentlemen:

I am enclosing money order for \$2.00, which I believe is my last payment on Library of Practical Electricity. I wish to say just a word about the books. I want to go on record with the statement that they are absolutely the best set of books ever published for the man on the job. To have these books and get familiar with them makes one want to meet and talk with Mr. Croft. As a rule books which claim to be self educational are very incomplete and well padded with tables, etc., which one may find at any time in catalogues, but I will say Mr. Croft has certainly gotten away from this. A man who cannot read these books understandingly is hopeless. There never was a correspondence course even with the aid of personal letters, that could give a man real knowledge as these books do. I am Chief Electrician at a State Institution here and have use for these books every day. I fear no job because I know that if I cannot solve the problem, I've a friend at home in Mr. Croft's books, who will come to my aid.

Yours truly,

E. E. CONYER,
Anna, Ill.



Meet Terrell Croft

Be guided in your study of electricity by an experienced Electrical Engineer of high professional standing. Terrell Croft, author of 7 of these volumes, climbed from the ranks to Electrical Engineer with the Westinghouse Company. He gained his knowledge with his sleeves rolled up and has met your problems in advance. He tells in plain, understandable language how to proceed by the best and most practical methods.

Not one cent in advance—Just the coupon

Examine this new Library for ten full days without expense. Find out for yourself why it is now taking the lead in electrical book sales in America. Use the books as you see fit for ten days. Look at the hundreds of illustrations that clear up all the mysteries in electrical practice. Stick a couple of the volumes in your pockets, and refer to them during the day. Figure out in an instant the problems that have heretofore taken hours.

Then send us \$2 per month for eight months, or return the set entirely at our expense. You risk nothing by returning the attached coupon.

McGraw-Hill
Book Co., Inc.
239 W. 39th St.,
NEW YORK

Gentlemen: Please send me the Library of Practical Electricity (shipping charges prepaid) for 10 days' free examination. If satisfactory, I will send \$2 in ten days and \$2 per month until \$16 has been paid. If not wanted I will write you for return shipping instructions.

ACT NOW

McGraw-Hill Book Co., Inc.

239 West 39th Street, New York, N. Y.
Publishers of Books for Engineers Since 1876

FREE EXAMINATION COUPON

Name.....

Home Address.....

City and State.....

Name of Employer.....

His Address.....

Your Position..... Ex. Apr. '19

You benefit by mentioning the "Electrical Experimenter" when writing to advertisers.



Master Electricity By Actual Practice

The only way you can become an expert is by doing the very work under competent instructors, which you will be called upon to do later on. In other words, *learn by doing*. That is the method of the New York Electrical School.

Five minutes of actual practice properly directed is worth more to a man than years and years of book study. Indeed, Actual Practice is the only training of value, and graduates of New York Electrical School have proved themselves to be the only men that are fully qualified to satisfy EVERY demand of the Electrical Profession.

The Oldest and Only Institution of the Kind in America

At this "Learn by Doing" School a man acquires the art of Electrical Drafting; the best business method and experience in Electrical Contracting, together with the skill to install, operate and maintain all systems for producing, transmitting and using electricity. A school for Old and Young. Individual instruction.

Over 5,000 Graduates are Successful Men in the Electrical World

No previous knowledge of electricity, mechanics or mathematics is necessary to take this electrical course. You can begin the course now and by steady application prepare yourself in a short time. You will be taught by practical electrical experts with actual apparatus, under actual conditions.

Let us explain this course to you in person. If you can't call, send now for 64-page book—it's FREE to you

New York Electrical School
29 West 17th Street, New York

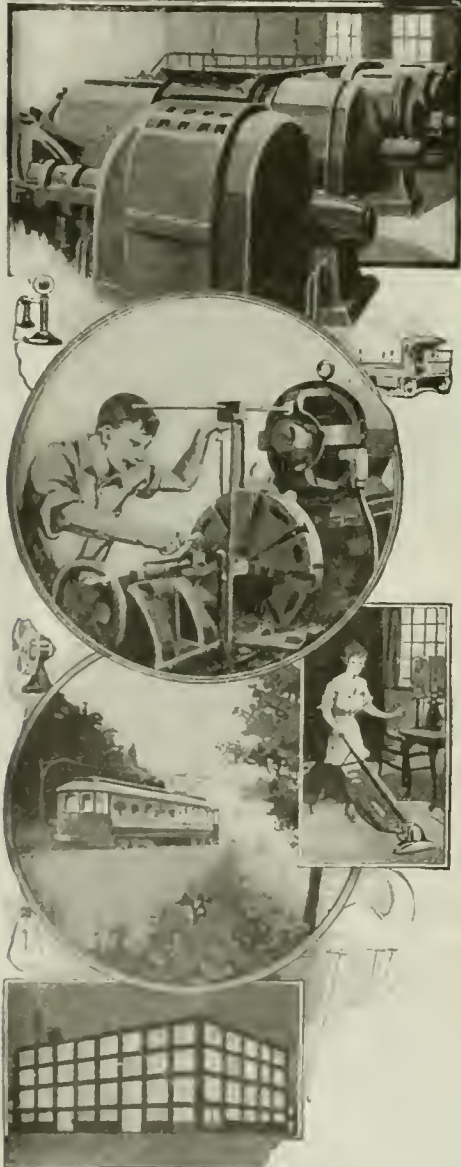

New York Electrical School
29 W. 17th St., New York, N. Y.

Please send FREE and without obligation to me your 64-page book.

..... (NAME)

..... (ADDRESS)



Grand Opera in Your Home

By H. GERNSBACK

MANY thousands of people musically inclined are deprived of hearing our great operatic stars mainly on account of the high price of admission, also because of the limited seating capacity of even our largest opera houses. Take for instance a

limited income prefer such seats and, therefore, the gallery is usually made up entirely of really music-loving Italians.

Suppose that all you had to do was to step to the telephone at 8.30 in the evening, no matter if you lived in New York or anywhere else in the country, and immediately

one great technical difficulty at that time which only during the past two years has been overcome.

While it is a comparatively simple thing to place sensitive microphones about the stage and on the other end of the line connect a loud speaking telephone in order to



Copyright, 1919, by E. P. Co.

Due to the invention of the Audion, it is now feasible from a technical standpoint to connect to one stage as many as fifty thousand telephone subscribers, all of which can listen simultaneously to our great opera stars. The invention of the loud talking telephone also has made it possible for the entire family to hear the music as pictured above.

“star” performance at the Metropolitan Opera House, New York City. It is necessary to secure tickets weeks ahead if one wishes a good seat in the house, otherwise it is often impossible to make a reservation at all.

While seats may be bought at low prices “up in heaven”, only our Italian friends of

had the whole room filled with Caruso’s voice. Would this not appeal to you, providing of course that you were musically inclined? All this is now possible, and, we believe, will shortly come about. While of course the idea itself is nothing new—it having been tried thirty years ago to transmit music in this manner,—there was

listen to the transmitted music, it is quite a different problem to connect say *twenty or forty thousand* subscribers’ lines to these microphones and then reproduce the music at the end of *all* these thousands of circuits. The reason is that heretofore we had no satisfactory instrument whereby the

(Continued on page 924)

New York to Chicago Via the Air in Twelve Hours

"AIRLINE TICKET for Chicago, Please." "Yes, sir; five hundred and twenty dollars, Please. The next 'liner' leaves in half an hour for Chicago and way stations," replied the ticket agent of the *Trans-Continental Airline Company* on a bright

It is proposed to form a company with four dirigibles and two main terminals, one at New York, the other at Chicago. The dirigibles are to be of the Zeppelin type, with rigid housing and multiple compartment structure. The U. S. War Department's wonderful new discovery, Helium

Balance and altitude will be adjusted by expansion or compression of the gas.

The crew will consist of the captain, navigator, chief and two assistant engineers, wireless operators, steward, cook, waiter and maid.

In regard to the landing places, which

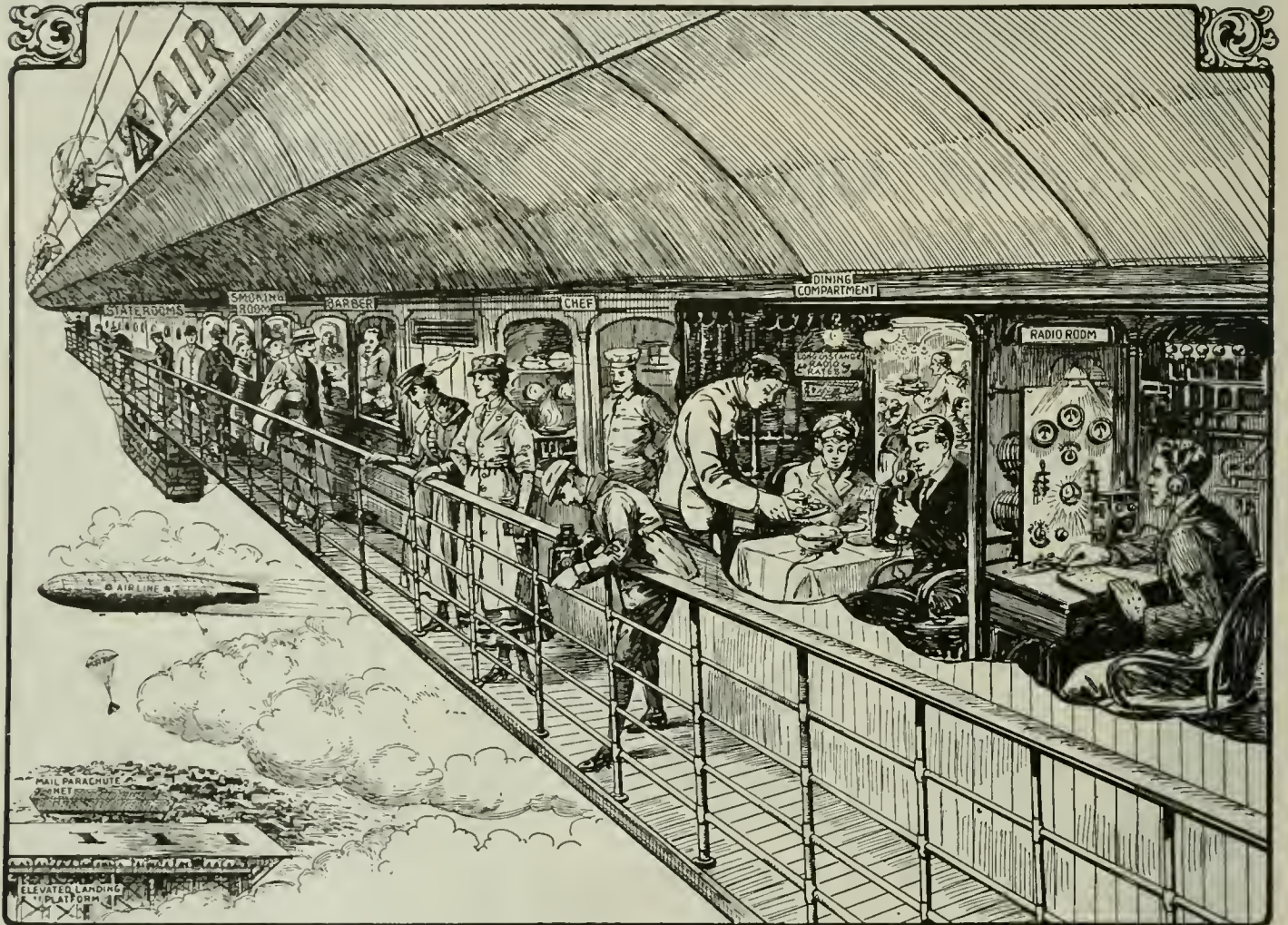

Regular Air Line Passenger and Freight Transportation Between the Larger Cities, Particularly New York and Chicago, Promises to Become an Accomplished Fact This Spring. A Company Has Already Been Formed to Develop and Promote This Project. All the Usual Conveniences Will Be Available to Passengers, Besides Wireless Communication, Mail Service, Sleeping Quarters and Aerial Promenade, Not to Mention the Most Wonderful Scenery ever Presented to Alpine Tourists, for These Giant Airships Will Fly Right over the Mountains.

June morning in the year 1919. At least that is a fair sample of the conversation you may find quite common in a few months or so, if the plans of one of the largest aerial transportation organizations materialize in any such manner as their originators predict. Complete arrangements for the construction and operation of a line of passenger carrying dirigibles between New York and Chicago at an initial charge of sixty-five cents a mile for each passenger have been made by J. M. McElroy, chief engineer of the Sturtevant Aeroplane Company, of Boston, in collaboration with Noble Foss, one of the officials of the corporation and a son of former Governor Foss, of Massachusetts.

Announcement of the big undertaking was made recently by the Massachusetts Aircraft Association, which held its annual aeronautical exposition at Madison Square Garden and the Sixty-ninth Regiment Armory from March 1 to 15, inclusive, in co-operation with the War and Navy Departments.

gas, will be used, thus removing the danger of fire. The airship will be 425 feet in length and forty-five feet in diameter. Its engines will have a horsepower of 1,200. The bag will have a capacity of 650,000 cubic feet of gas, providing a gross lifting power of twenty tons at sea level. This would mean a practical net lift of ten tons.

It is estimated by Mr. McElroy that a speed of seventy miles an hour can be maintained and that the trip from New York to Chicago could be made in comfort in less than twelve hours.

"The cost per mile, roughly speaking," says Mr. McElroy, "would approach sixty-five cents per passenger, or \$520 for the entire trip in either direction. There is no doubt but that after the line is run for some time, it will be possible to cut down the rate considerably."

Each dirigible will have accommodations for twenty-five passengers. The power plant will consist of two engines, side by side, driving thru gears a central shaft mounting a variable pitch air screw.

with dirigibles is a great problem, Mr. McElroy says:

"It is reasonable to believe that hill walled landing zones could be located, or natural depressions in the earth could be enlarged to offer breakairs to permit the air liner to come down safely. The terminals at either end of the New York-Chicago route could be floating piers secured at one end, so as to swing with the wind to permit easy housing of the ship."

With regard to the possibility of trans-Atlantic flight, Mr. McElroy says:

"When we have put the New York-Chicago route into successful operation then it is time to throw a line across the pond and do a real job."

Apropos of transcontinental aerial transportation we find much food for thought in a speech recently made by Allan R. Hawley, president of the Aero Club of America, before the National Rivers and Harbors Congress, at Washington, D. C., on

(Continued on page 915)

Guiding Airships With the "Radio Barrage"

Invisible Walls of the Ether

By DR. LEE de FOREST

JUST at this time, when our army and navy officials, and many airplane builders, are taking steps for the commercial development of the airplane and dirigible, along industrial and governmental lines, is it not practicable, as well as advisable for radio inventors and engineers, as well as others concerned, to give thought to those essential safety devices which come within the scope of radio-communication and control?

I venture to say that if there was any one device used in the European war which contributed to the success of the Allies in their supremacy of the air, it was radio-communication, both telephone and telegraph. By means of it the fighters in the air were at all times able to talk and sig-

pilots in case of fog, cloud or other interferences. Will it not be necessary, for example, to establish a regular "traffic squad of the air," for those cities in the principal lines of communication? The use of the human voice in sounding a warning, without wires, is already an accomplished fact; at Point Judith Light, where the *Radiophore*, at regular intervals, calls out to the ship operator: "Point Judith Light," and then in a weaker voice: "You are getting closer—Keep off."

By means of a number of wireless stations placed around any given city, why cannot we do likewise in the matter of our radio traffic squad of the air? So that when a pilot comes within range, he would receive a message such as the following:

"Buffalo Office—Turn West by South, and

with extraordinarily tall buildings with consequent air pockets.

By arrangement of antenna or reflectors not unlike those used behind large searchlights, a beam, or narrow zone of wireless waves, invisible to the eye of course, could be set up. This would necessitate the use of very short wave lengths, of only a few meters, far shorter than the wave lengths used today in radio-communication. This feature would also have the advantage that these short wave lengths would not interfere at all with existing radio-communication. All this short wave vertical radiation would be controlled by the automatically repeating phonograph, similar to the *Radiophore* arrangement at Point Judith Light.

The pilot of the airplane, his 'phone

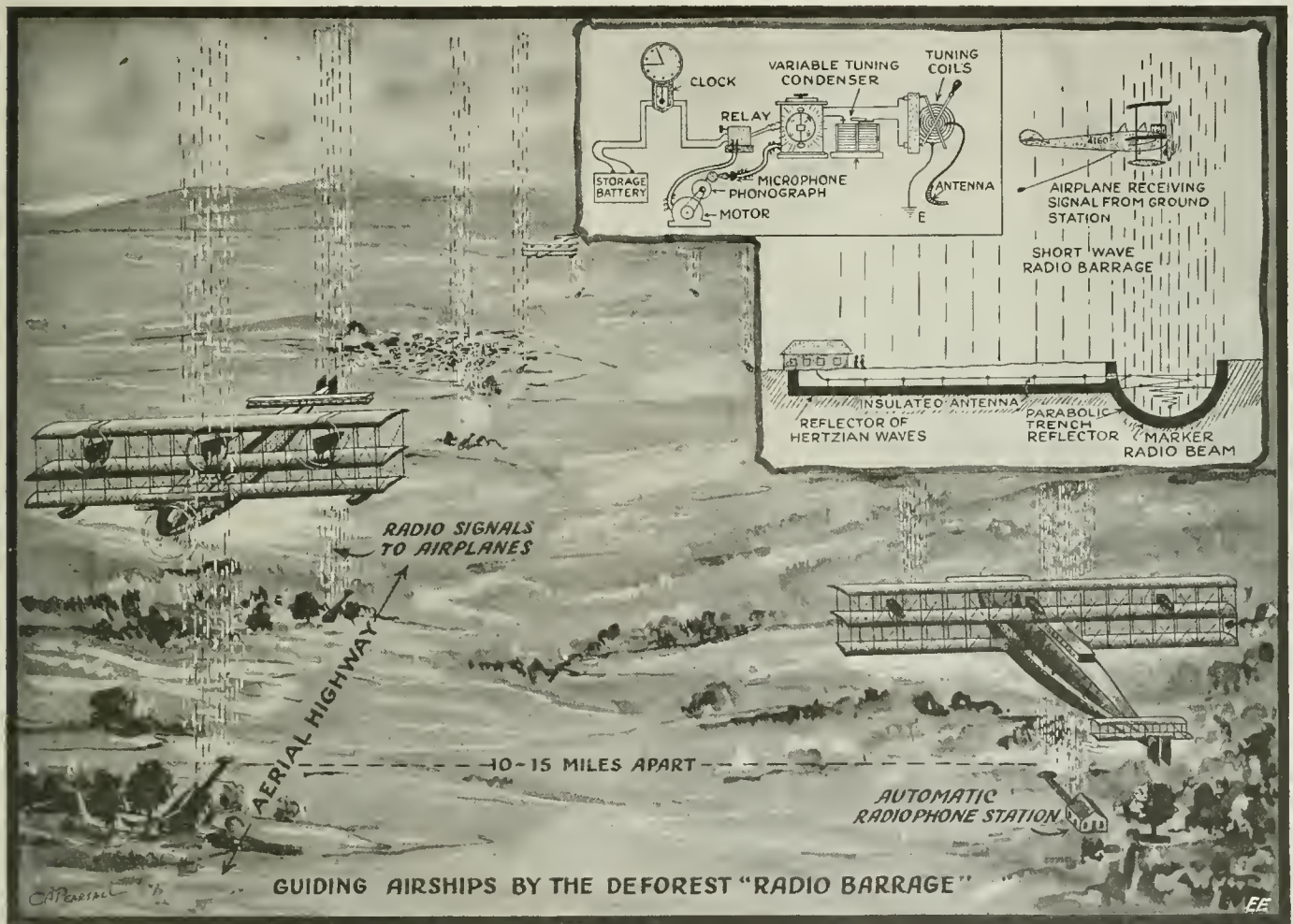

Copyright-1919-by E. P. Co.

The Airships of Tomorrow Will be Guided by Wireless Telephone Signals, Possibly Arranged in "Barrages" or Walls, as Here Illustrated. This is the Only Feasible Way of Signaling Location and Weather Data to Aerial Craft in Stormy and Especially Foggy Weather. Prof. Walter I. Schlichter, of Columbia University, Has Also Recently Advocated the Use of Powerful Wireless Signaling Stations for Guiding Trans-Atlantic Seaplanes in Their Proposed Trips Across the Ocean.

nal with their commanding officers at headquarters, and after a personal examination of the various kinds of apparatus used by the different countries, all of which pay high tribute to American genius, I feel I am fully justified in predicting an even greater use of radio control and communication for peace purposes.

One of the first questions to be taken up, it seems to me, when we have reached the point of regular passenger and freight traffic by air, is that of proper warning to

Pick up Cleveland," or again such warnings as, for example, it will be necessary to inform the pilot of weather changes: "Weather Warning—Your are nearing a storm area—Cyclone Ahead," etc., etc.

There should be, no doubt, a continual "radio barrage," or zone of automatic warnings thru which airplanes must pass in approaching regions where air traffic is dense; namely, around landing stations, and especially so near steep mountain ranges and peaks, or cities like New York,

clamped to his head in the helmet, would hear these safety signals as he flies thru these invisible walls of etheric warning, in ample time to govern his course accordingly.

With the mastery of the air for governmental, and for commercial purposes, already at hand, certainly the question of radio control, and of traffic regulation, is of prime importance, worthy of the immediate interest, and of the best thought in the radio world.

How Electricity Serves World's Largest Hotels

Do you know that the two largest hotels in the world have just opened in New York City, each one with over 2,000 guest rooms and a bath in every room? One of these hotels has, among other startling new features, an electric automobile elevator, which carries the guests' motor cars up to the grand ball room floor, so that milady and her escort do not have to pass thru any chilling winds when arriving at the hotel. These hotels are veritable cities in themselves, and either of them has more telephones than the entire nation of Greece. One hotel has the largest electric laundry in the world, not to mention the gigantic dining rooms, ball rooms, kitchens, swimming pools, children's open-air playgrounds, and a whole regiment of employees.

By H. WINFIELD SECOR

THE two largest hotels in the world recently opened in New York City, one, the "Hotel Pennsylvania," opposite the Pennsylvania Railroad Terminal at 33rd Street and 7th Avenue, and the other, the "Hotel Commodore," located adjacent to the Grand Central Terminal, and built directly over both the Queensboro and Lexington Avenue subways. There are so many hundreds of innovations and conveniences which have been developed and applied to these—the last word in Hoteldom—that one can hardly judge of the undoubted value of all of these important and elaborate appointments without having actually visited such an establishment in person. Take, for example, the gigantic proportions of the Hotel Pennsylvania with its 2,200 rooms and bath. This hotel can accommodate 3,500 registered guests with rooms, not to mention several dozen additional small-town populations, which it can easily entertain in the grand ball room and its six well appointed restaurants, also numerous private banquet rooms and private dining rooms, not forgetting the roof garden, which is one of the most beautiful and perhaps the largest in the world. Besides a capacity of 3,500 guests with rooms, 3,000 additional guests may be entertained in the several restaurants including the roof garden, or the total capacity of 6,500 guests, which is a respectable little city all by itself.

If you haven't already visited one of these magnificent and beautifully appointed 20th century hotels, you will probably wish to know what conveniences are provided for the guest, and with that very object in mind, the writer paid a special visit to these establishments and enjoyed an afternoon off from the editorial rub-dub, amid the flowering palms and the aroma of one dollar Havana perfectos arising from the "lounges" reclining luxuriously on the thousand dollar leather settees, which grace the main lobby. This wonderful lobby is furnished in handsome imported marble and is lighted by reflected beams passing thru a richly designed leaded glass ceiling. Both the Hotel Pennsylvania as well as the Hotel Commodore have the same transit facilities, i.e., both have subway as well as railroad service, the one the Pennsylvania Railroad, and the other New York Central Lines. There are underground passageways in either case leading from the railroad terminals directly into the hotels, and special elevators for this service to carry the guests to the floor of the main lobby or vestibule. If one arrives by subway from up or downtown New York, he finds the same conveniences awaiting him, and is whisked from the subterranean passageway to the splendor of the main lobby by elevator, which is operated by young women nattily attired in spic and span uniforms. There is even a woman "elevator starter"—and speaking of elevators, the Hotel Pennsylvania boasts of a total of 27. In the following description of the hotel features, as the writer found them, the Hotel Pennsylvania is inferred, except where otherwise mentioned.

On arriving on the floor of the main lobby, which is certainly a magnificent piece of architecture, one finds that the principal

and most important conveniences of the hotel are at once available. Among other appointments immediately accessible and available from the lobby are the main Dining Room, the Palm Room, used for afternoon teas, etc., the men's café, the men's bar, the grill room, and in the basement the most attractive barber shop imaginable, resplendent in handsome tile and marble with leather lounges, and adjacent to these the handsomest array of lady manicurists ever seen this side of Paris. While dining in the grill room, you may, if you wish, have a one-step or two with your guest on the highly polished dancing floor in the center of the room, while the Original Dixy Jazz Band turns loose the jazziest jazz you ever shook a foot to. Considering for the moment that some rainy afternoon you might happen to pop in at the "Pennsylvania" from the water-proof subway, and that you might find at arriving in the royally appointed lobby that your capital was limited to the large sum of 15c, due perhaps to the efficient activities of an unknown pickpocket on your ride up to the hotel, you can still enjoy yourself ostentatiously by repairing to the basement floor, where there is a "Quick Lunch Restaurant," which will accommodate several hundred guests, who may for one reason or another wish to enjoy a 15c or 25c meal. That is what you call real service, and both of these hotels are out for service with a capital "S," first, last and always. Later, when you are assigned to the guests' floors and see the layout of the rooms, you will find that these hotels undoubtedly count on a heavy, transient traffic, the suites in most cases consisting of from one to three rooms and a bath.

The lower part of the hotel is well shown in the accompanying illustration, and of course there are many rooms and conveniences not shown for obvious reasons, owing to their location on other parts of the mezzanine floors, et cetera, which cannot be brought out in the limited size of our illustration. The mezzanine floors, just above the main or street floors, contain the private offices, and also there are sleeping and living quarters on these floors for the employees. On the first mezzanine floor there are exhibition rooms for business purposes, and on the second and third mezzanines dining rooms for the employees. On the third mezzanine we find the "Grand Ball Room," which is most beautifully decorated in pleasing colors which do not jar or irritate the eye as do some of these large public rooms in similar establishments. The general decorative scheme thruout the hotel, it may be said, is one of good taste and extremely homelike. The service is carefully worked out to give this feeling at every turn.

The largest private telephone exchange extant, with capacity for 3,340 extensions, 260 trunk lines and 23 operators is connected to the various rooms and other parts of the hotel, and this is located on the second mezzanine floor.

In the telephone exchange are also located a large battery of "Telautographs"—the electric machines that write—and both of these recently opened hotels have been

very lavish in their telautograph equipment. The Hotel Pennsylvania has at present some 200 telautographs, and more will undoubtedly be added later as demands require them. The telautograph equipment at this hostelry has been very carefully worked out by skilled engineers, and it undoubtedly is one of the best that the writer has ever seen put into operation. More will be said with reference to the telautograph system anon, and for the present it will be of interest to the reader to note what happens when a guest is to be paged. In most hotels, at least in the smaller hotels, a guest is not paged except in the main lobby and dining room, but at the "Pennsylvania", when an outside party or a guest calls up the telephone exchange, and the operator writes down the name of the person who is wanted, the following operations ensue: the telephone operator,—(and they are all good looking, take it from your Uncle Dudley, for he had the good luck to actually visit this "holy of holies", past the door of which no man may enter, excepting that he has a pass signed by the powers that be in the telephone world),—proceeds to write the name on the transmitting platen of her telautograph, there being a telautograph for each of the 23 telephone operators, and simultaneously the written name appears in the main dining room, grill, bar, roof garden and the office, as well as at the bell captain's office in the main lobby, so that when the name is called out by one of the bellhops in your vicinity, you can rest assured that the same name is being called simultaneously in about ten other parts of the building. This of course, serves two purposes; it promotes speed in locating the guest, which is sometimes a very important factor, and also owing to the multiplicity of the system, it renders trebly certain the locating of the desired party, which would not be the case under ordinary conditions.

The total amount of electric power, not to mention the steam used for heating, is truly enormous in a building of this size, which covers a whole city block, and while talking to the chief engineer of the building, it was ascertained that the total light and power load for the hotel would require as much as 1400 K.W. or about 1900 horsepower. Electricity is used in a general way for many purposes and important operations conducive to the efficient operation of the hotel, which the average guest never sees or even dreams of. For instance, how do you suppose the ventilation of such a large hotel as this is taken care of? The chief engineer answers this question by taking you down to the sub-basement two stories underground, where you see one of the largest electric motor-driven blower rooms in the world, covering a quarter of a square city block. Here dozen of powerful electric motors rated at anywhere from 25 to 50 horse-power each, drive gigantic blowers or fans, each of which is connected up with certain air ducts leading to various parts of the building. Thru these ducts, air is pumped which promotes the proper circulation thru the hallways, and the rooms of the building. Neither of these monster hotels has a large power plant of its

(Continued on page 915)

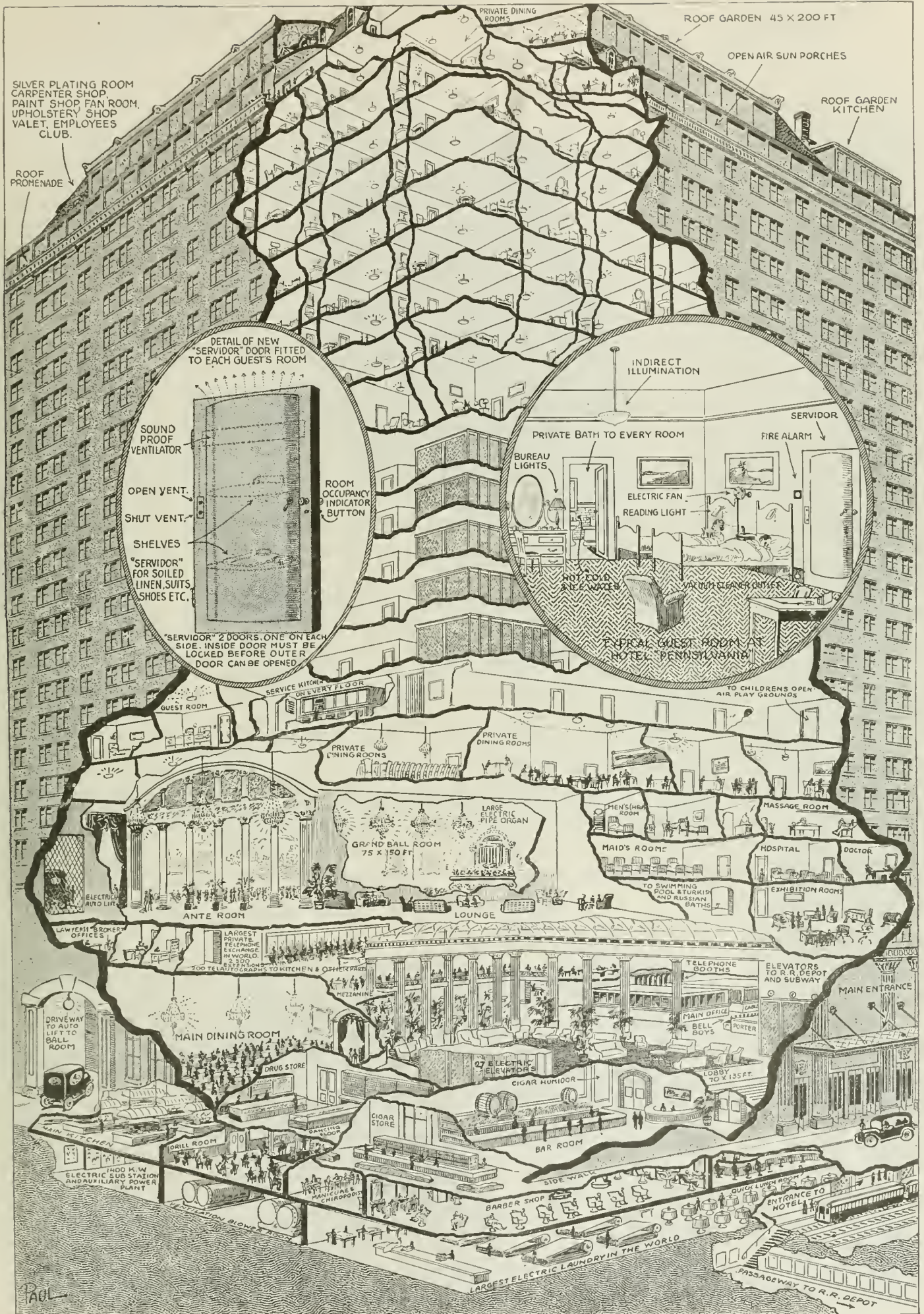

FULL STORY OF THIS LATEST NEW YORK HOTEL—A VERITABLE CITY IN ITSELF—ON OPPOSITE PAGE.

Seeing Thru You Without X-Rays

The New Shadow Photography

By BATELL LOOMIS

WHAT of the infra-red ray in photography? Is its penetrative power the equivalent of the ultra-violet, or actuating principle of the X-ray? Has Dr. Paull S. Hunter, former State Secretary of Health for Colorado, and hailing from the city of Denver, stumbled on something he didn't know and doesn't know yet, in looking for something he had guest? That is a question it may take time and development to answer, but which the writer is content only to raise by way of introduction to a story which has its element of humor because tho it relates a serious discovery, worth thousands of dollars to society at large, the discovery will not realize its discoverer one penny. In which it is not unlike many other important scientific discoveries.

One night Dr. Hunter was waiting for a car. He held a flashlight in his hand, and covering the ray, was attracted by the marked red glow of his flesh. He noted the dim shadows of the bones in his fingers. "Hm," said he, "the red rays come thru. If the rays were more vivid, the shadow of the bones would be sharper. I can intensify them and I'll bet I can photograph that."

The idea took hold. The doctor was a user of the X-ray, but he found it easier in ordinary practise to bring a patient to the ray than to take the weighty apparatus with its cells and coils to the patient. What a boon to the country doctor it would be if he could make a fracture diagnosis with an ordinary camera! The X-ray is of value only to the rich and the very poor who receive free treatment. The middle class must pay more than it can afford or go without.

So Dr. Hunter seized the first opportunity to lay his hand on a naked panchromatic photo plate and expose it to the electric light for a moment. He secured a picture of his bones with his first try. It was not very sharp, but it was a good beginning. He reasoned it out: "It wants only a concentrated light from a point to cast a clearer shadow. This ray must go thru a camera which protects the plate from random rays and I have a good bone picture," he argued.

Accordingly he employed his mechanical knack to construct a black box with an opening at one end large enough to receive his hand or foot. See illustration of the apparatus used by Dr. Hunter, herewith. He made it collapsible so it would fit in a physician's grip. He fitted an iris diafram in the top of his box and fastened a plate-holder on the bottom with a developing box beneath that, into which the plate might fall the instant of its exposure, for speedy developing. He then se-



Hold Your Hand Before a Flashlight in the Dark—You Can See the Bone Outlines Dimly. This Is the Basis of the New X-Ray-less Bone Photography Here Described.

cured a Wratten F or extreme red ray filter and placed it above his lenseless shutter and diafram. He placed his hand over the

holder, and squeezed his bulb for a half second exposure. The result was the excellent bone picture shown herewith.

This picture was taken entirely with a filtered light—the light that passes most easily of all visible light, thru blood. The discoverer has made nothing new except his camera, which is not essential to success. He has merely combined a stock Eastman panchromatic photo plate brushed with eosin solution to intensify its sensitiveness, with an F ray filter and a fine point of light to do simply what Röntgen earned his fame for doing in a more round-about and costly way. He has made a discovery which he prophesies every school-boy will at once begin to play with, and every doctor to use in his business.

And he has given his discovery freely to the world. He does not intend to secure patents either on his combination of materials or on his novel folding camera, which may be made in any size and open at both ends to fit different portions of the limbs. Whether the rays will penetrate the trunk for abdominal and intercostal examinations he does not know from practise, altho from theory he contends they might be made to do so by improved technique, such as a more intense ray of light and a more sensitive plate.

Further Dr. Hunter has to say: "My claim is not with a box fitted out in this manner and a box of panchromatic plates a physician can tell whether a broken arm is set right before leaving the house, and that it will undoubtedly be used all over the country for that purpose.

"The machine can be improved by using a roll of film if the manufacturers would make it, and so do away with glass plates; the developing tank at the bottom would be adapted to films. The whole outfit is, moreover, made to fold up flat and occupy very little space.

If you are old enough, you will probably remember the time when the X-ray was first announced. We all thought it one of the most marvelous inventions ever conceived by the human mind, and so it was indeed. But now Dr. Paull S. Hunter announces a strikingly simple way to perform the same experiment which Dr. Röntgen performed in a very difficult, round-about way. Where Prof. Röntgen used a complicated electrical apparatus in order to take shadowgraphs of the human body, Dr. Hunter uses nothing but plain light rays. There is no doubt in our minds that if sufficiently powerful light rays are used in connection with a heat filter in order that the patient does not sustain burns, it should become possible in the near future for physicians to actually see every bone in the human body. Not only this, but we predict that by using certain color rays, it should be possible to bring out every organ in the human body as well, such as heart, liver, blood vessels, etc., which are now very difficult of observation by the X-ray.

Our front cover shows what is already possible today if you will drape the human body in such a way as to cut off all the direct glare, and then by exposing strong electric arc-lights from behind, it becomes possible to see the bones of the body clearly. Dr. Hunter, who is an American physician, deserves great credit for bringing about this extraordinary result, as simple as it is efficient. The accompanying article explains the system and methods fully.

EDITOR.

plate, tied a black cloth at the open end about his elbow, turned on the electric light, removed the slide from the plate-

to films. The whole outfit is, moreover, made to fold up flat and occupy very little space.

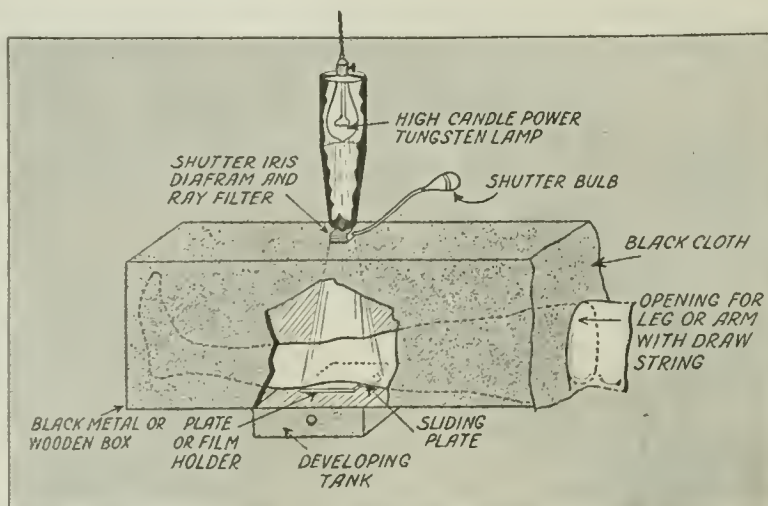

Diagram of the Actual Bone-Photography Apparatus Used by Dr. Hunter in Successfully Photographing the Bones of the Limbs.

"These pictures could also be made with a camera using a powerful arc lamp to throw the rays thru the human body, and if plates could be made sensitive enough, pictures of the heart's action could be made on celluloid rolls, giving moving pictures of the heart action and other organs of the body. So far I have only used it for extremity work and it has proved very satisfactory; in fact, the first pictures are as good if not better than the first ones made by the X-ray.

"I give the idea to the world with the hope that someone will further develop its usefulness and by improved design and more sensitive plates be able to make pictures as well with this \$2.00 outfit as with a \$1,000 X-ray machine."

The front cover picture, showing the bone structure of a woman, gives us a clear idea of how the full figure would appear, using of course, a sufficiently strong light source, such as an arc lamp. A frisket or template would be cut out to just fit the outer contour of the body, thus giving the maximum X-raying power available in any case. The fleshy portions of the body would appear red just as our artist has shown them, in contradistinction to the usual X-ray image observed in a fluoroscope, where the outline of the flesh is just discernible. It would seem that this new direct light system of bone photography would be much less harmful to the patient, as the X-rays exert a detrimental effect when applied in reasonably large dosages, and in some cases cause growths and burns which are incurable.

WAR ACHIEVEMENTS OF U. S. SIGNAL CORPS.

When the American forces came to France "communication" was one of the first efforts to which American ingenuity and invention was directed and the Signal Corps, under which communications fall, met it as have the organizations of the American Expeditionary Force. Existing French telegraph and telephone systems were overburdened. There was little left for Uncle Sam and Brig. Gen. E. Russell, chief signal officer, and his staff of experts tackled the job.

What they have done in construction is shown in the following statistics: The Signal Corps has built approximately 1,750 miles of poles on which it has strung 4,175 miles of wire. In addition about 2,000 miles of American wire has been strung on existing systems for our use, and it has leased and operates more than 3,000 miles of French wire. Exchange lines to the extent of 12,750 miles have been

built, and to operate these lines it has 244 stations, and 102 telegraph offices.

The long-distance telegraph and tele-

and material from the United States, with the single exception of poles, most of which were obtained in France.



Actual Bone Picture of the Hand Taken by the Inventor of the New System of X-Ray-less Bone Photography—Dr. Paul S. Hunter, with a Strong Electric Light, a Red Ray Filter and a Photographic Plate.

THE JOHN FRITZ MEDAL FOR GENERAL GOETHALS.

The John Fritz Medal Board of Award, composed of representatives of the National Societies of Civil, Mining, Mechanical and Electrical Engineers, held their annual meeting for 1919 at the Engineers' Club, January 17, and awarded their gold medal to George W. Goethals, the builder of the Panama Canal.

The medal has previously been awarded to Lord Kelvin, George Westinghouse, Alexander Graham Bell, Thomas A. Edison, Charles T. Porter, Alfred Noble, Sir William Henry White, Robert W. Hunt, John Edson Sweet, James Douglas, Elihu Thomson, Henry M. Howe and J. Waldo Smith.

Col. John J. Carty, now in France, has been Chairman of the Board, but in his absence Ambrose Swasey, of Cleveland, presided.

George H. Pegram has been elected Chairman for 1919 and W. F. M. Goss, Treasurer, in place of Prof. F. R. Hutton, who died during the year.

NEW MARCONI INVENTION EXPLAINED.

A joint meeting of the Institute of Radio Engineers and the New York Electrical Society was held on Wednesday evening, March 5, at the Engineering Societies Building, at which Roy A. Weagant, chief engineer of the Marconi Wireless Telegraph Company of America, read a paper on "Reception thru Strays and Interference."

The recent announcement of Mr. Weagant's discoveries and inventions in connection with wireless telegraphy created wide sensation.

THE AERIAL PASSENGER LEFT BEHIND.

WE all know of the taxicab clattering down the street at breakneck speed with the belated passenger making a bee-line for the dock and just arriving in time to see the gang plank pulled in and missing the Liverpool steamer. But the American business man, nothing daunted, by such a trivial occurrence promptly chartered a fast harbor boat and races the steamer down the bay, overtakes it and is hoisted up to the deck in time for lunch.

A few years from now humanity probably will not have changed much, and we will still have with us the late passenger, only this time he will not race down to the dock but up a 30- or 40-story elevator trying to catch the Trans-Atlantic Flier, but just in time to see the big bird "take the air."

Will the American business man of 1925 bewail his lot and return dejectedly to his home? Not if he can help it! He will signal a passing taxiplane which will come down on the huge platform which a few minutes ago harbored the great Trans-Atlantic flier.

Twenty minutes later, the fast little *air-flier* will have overtaken the big air monster and after depositing the belated passenger on the upper deck of the European bound flier,—not to forget the violent language of our businessman who thinks he has been overcharged by the modern bandit of the air,—he will go to his deck chair and begin perusing the latest edition of the *ELECTRICAL EXPERIMENTER*.

While the taxiplane might land directly on the big European-bound flyer, such a

method might be more or less fraught with danger. Mr. H. Gernsback suggests that the transfer of the passenger might be accomplished much easier, as shown in our illustration. The taxiplane would fly about twenty feet above the deck of the big flyer, in the same direction of course, and also at the same speed as that of the large machine. The passenger could then descend from a rope ladder and drop to the deck with ease, as well as without danger.

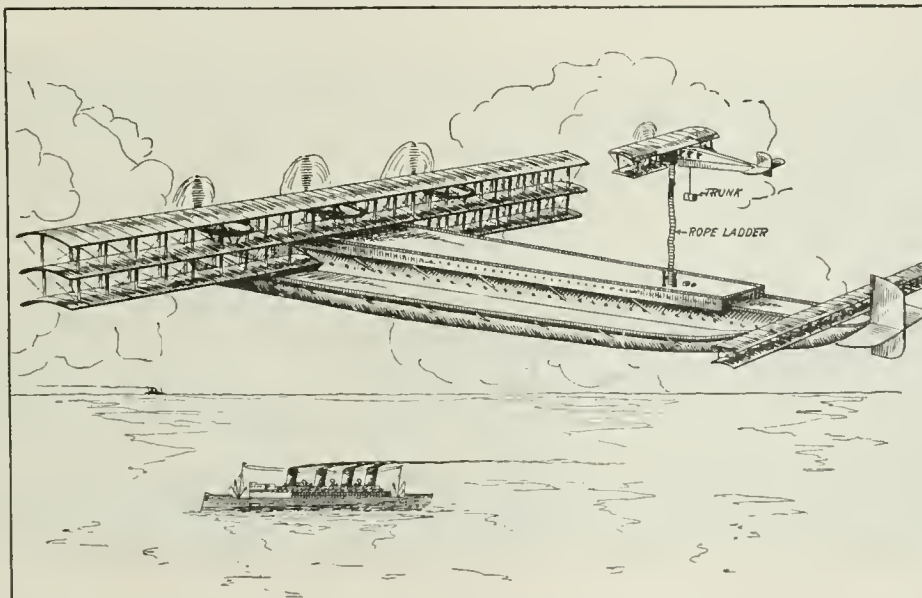

The Giant Airplanes of To-morrow May Slip Away from London or New York and Leave You Behind. Then What Would You do? Easy—Board a "Taxiplane" and Chase the "Sky-hound" Down the Bay.

YOU CAN WHITTLE THIS IRON.

It is well known that rapid cooling of hot metals hardens them. That the opposite is true has recently been demonstrated in striking fashion by the General Electric Co. One of their scientists annealed American ingot iron surrounded by hydrogen gas for three hours at a temperature above 1,600° F. The product was very little harder than the softest copper, and could be whittled with a jack knife.

One of the largest electric plants in the world is being planned to supply power for nearly all the mines at Johannesburg, South Africa.

Locating Stolen Diamonds by X-Rays

Possibly you will remember having read from time to time of the remarkable tricks resorted to by the native diamond miners in the great Kimberly diamond region in South Africa and other parts of the world. So great has the temptation often become

body in a few seconds. This system of detecting the presence of a diamond, no matter whether it is buried in the flesh, resting in a throat cavity, or even in the stomach—an almost unbelievable practise resorted to in several instances on record—the X-ray

stance, and it has certain fluorescent properties which render the facility of its detection all the more possible under an examination by X-ray, as it has a tendency to fluoresce or glow slightly when under the influence of X-rays, which phenomenon is readily detected on a sensitive flourscope or X-ray screen.

The X-ray machine here shown is connected to a battery of four powerful X-ray tubes of the latest Coolidge type, as otherwise if the tube had to be moved up and down behind the subject, considerable time would be lost in performing this operation, and where several hundred subjects have to be examined in a very short space of time, it can readily be imagined that such a device as here shown is imperative.

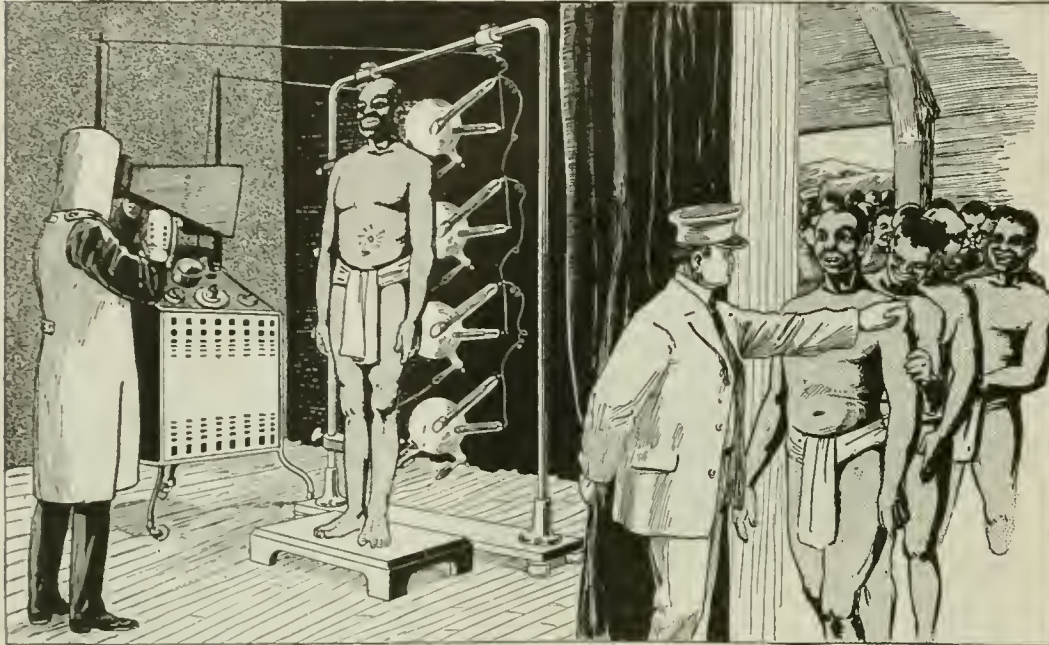

The Tricks Resorted to by the Native Diamond Miners in Kimberly, South Africa, and Other Mines, Pass All Human Belief and Imagination at Times. Cases Have Been Known Where the Lucky Finder of a Particularly Fine Specimen Even Swallowed the Stone, Intending Presumably to Regain the Diamond Later. In Some Instances Diamonds Have Been Secreted in Self-Inflicted Wounds or Incisions in the Leg. But the X-Ray Spoiled All These Clever Ruses as Soon as It Was Adopted for Examining the Miners Every Day, Before They left the Mines. The Eye of the X-Ray Sees All.

to steal diamonds, especially when an extra large one may have been suddenly unearthed, that these natives have been known to resort to the most unbelievable tactics in order to carry the diamonds out of the mine and to withstand inspection even when stripped, as practically all of them are, before they leave the mine at the end of the day's labor.

One of the successful schemes which has been worked out by the superintendent of a large South African diamond mine is shown in the accompanying illustration, and it involves the use of a powerful X-ray machine having several X-ray bulbs excited simultaneously. As each miner passes before the X-ray bulbs, the examiner looks thru his flourscope and rapidly swings it up and down, so as to take in the entire

examination quickly indicates the presence of the diamond.

Of course, the logical question that arises is—How can the X-ray detect the presence of a diamond inside of the body; especially when it may be temporarily lodged by the clever thief in proximity to large or fairly large bone structures, which would seem to preclude any possibility of detecting the precious stone? However, a perusal of a table showing the various transparencies of different materials under the X-ray will give the solution to the problem. It has been found that the diamond has a different transparency than any ordinary materials, including the bone and flesh of the body, which might happen to be in proximity to it at the time of such an X-ray examination. Also the diamond is a most peculiar sub-

face warship. One photo shows a British "K" class, two funnel submarine "steaming" on the surface at sea. This is the largest class submarine produced by any nation and is 340 feet in length. It out-classes any U-boat built by Germany. Great Britain has a whole fleet of these sea terrors. Storage batteries and motors are used while running submerged.

The other photo shows a new British monitor submarine with a 12-inch gun, capable of giving battle to most any class of armed ship under favorable conditions. So far as known this is the first photograph to be received in this country showing Great Britain's combination of the U-boat and coast defense vessel. The 12-inch gun is the largest that was ever mounted on a submarine.

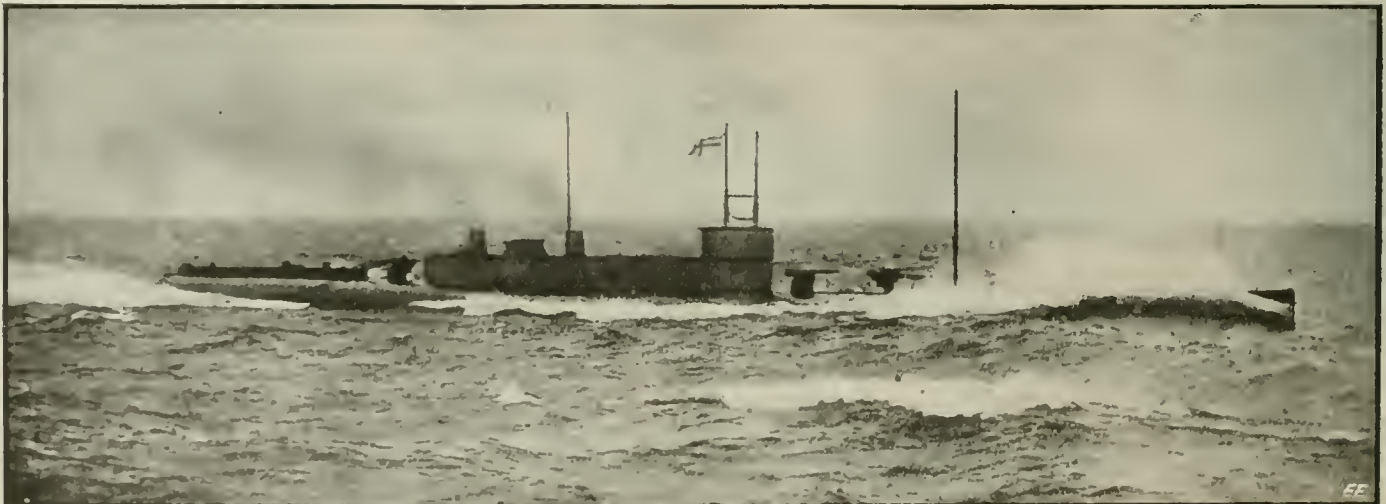

The Latest British Style in Submarines. It Is Capable of a Speed of 24 Knots on the Surface, When Propelled by Its Steam Power Plant. The Two Smoke Stacks Fold Down When the Submarine Submerges, and It Is Then Propelled by Storage Batteries Previously Charged While Running Awash. This Giant Craft Is 340 Feet in Length, and Is Armed with Three 4-Inch Guns, Two Forward and One Aft, as the Photo Shows. The Displacement of This Boat When Submerged Is 2,700 Tons and the Speed 10 Knots.

GERMAN RADIO FOR HOLLAND STATION.

Details of the giant wireless telegraph station to be erected in Holland by German interests for the purpose of facilitating communication between Holland and her East Indian possessions, according to a contract recently concluded between the Dutch Government and the Telefunken Company of Berlin, are found in a recent issue of Commerce Reports.

Paul L. Edwards, Commercial Attaché at The Hague, reports that the receiving station of the new plant, which is expected to cost about \$2,000,000, will be at Boxmeer, in the Province of North Brabant, and the sending station will be located on a hill at Kootwijk, Province of Gelderland, near Apeldoorn, some thirty-five miles from the receiving station. The sending station will consist of six steel towers, each 200 meters (about 688 feet) in height. The Radio-Nieuws says that the Kootwijk sending station will have the same range as the German station at Nauen. The installation will be able easily to transmit to and receive from a station of like dimensions and capacity which is shortly to be built at Bandoeng, Java. The distance between the Kootwijk and the Bandoeng station is about 6,830 miles.

It is understood that an engineer representing the Telefunken Company is in Java with a view of supervising the construction of the station at Bandoeng. De Nieuwe Courant stated some time ago that all of the apparatus and raw material for the construction of the Bandoeng station were in Berlin ready for shipment at the first opportunity.

INSTRUMENT DISCOVERS COMING STORMS AT SEA.

A barocyclonometer, which locates the center of typhoons and other storms, and also indicates when they are due, and from what direction, has been invented by Father Jose Algue, director of the Manila Weather Bureau, and, according to Capt. A. W. Nelson, of the Pacific mail steamship Ecuador, is being used in safeguarding from storms numerous vessels plying in Chinese and Japanese waters.

Stereoscopic Movies

The accompanying illustration shows a possible later-day development of the present moving picture, which, altho it has been greatly perfected in the past few years, leaves considerable detail yet to be worked out. No matter how clear or flickerless a motion picture may be when viewed on the

then undoubtedly it will be necessary for the theater proprietor to provide or make readily accessible, by means of slot machines arranged on the back of the theater chairs, etc., a special small size stereoscope similar in appearance to a pair of opera glasses, thru which the duplicate moving images on

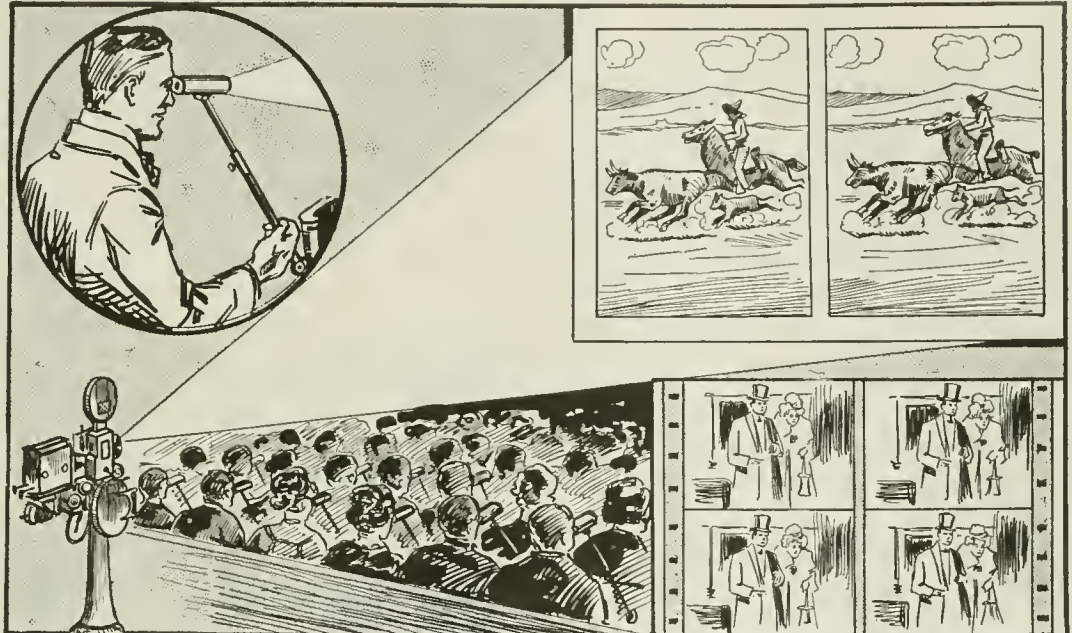

Of All the "Movie" Inventions That Have Past Our Way, We Have Yet to See Exploited, at Least Commercially, the "Stereoscopic Movie." If You Have Ever Used a Parlor Stereoscope Then You Will Appreciate What a Wonderful Improvement This Idea Would Make in the "Movie" Show, for Then the Figures Would Actually Stand Out in Relief. A Special "Stereoscope" Would Be Placed on Every Seat. Try This Experiment—Hold a Small White Card Vertically Between the Two Similar Views Here Shown, Move the Page Up and Down Until the Images Appear in Relief.

screen as projected by modern moving picture machines, it would still be one hundred per cent more perfect to our vision, if it could be thrown on the screen in duplicate

The names of the manufacturers of new devices and appliances in which readers are interested will be furnished free of charge by addressing our TECHNICAL INFORMATION BUREAU.

or stereoscopic fashion in a similar manner to the parlor stereoscopes which we have all seen and used. Of course, if we ever do get to the stage of stereoscopic movies,

the screen could be properly viewed and focust. These would of course be fitted with proper lenses for the purpose.

It might seem off-hand that this latter refinement would be unnecessary, but it is really one of the great marvels of science that causes us to see the images stand out, as it were, from the picture, when we look thru a stereoscope at the photographs or other views mounted in duplicate. The stereoscope operates on a very simple and yet peculiar physiological arrangement, based on the inter-action of the optical powers of the two eyes when they are focust on two properly made and similar images.

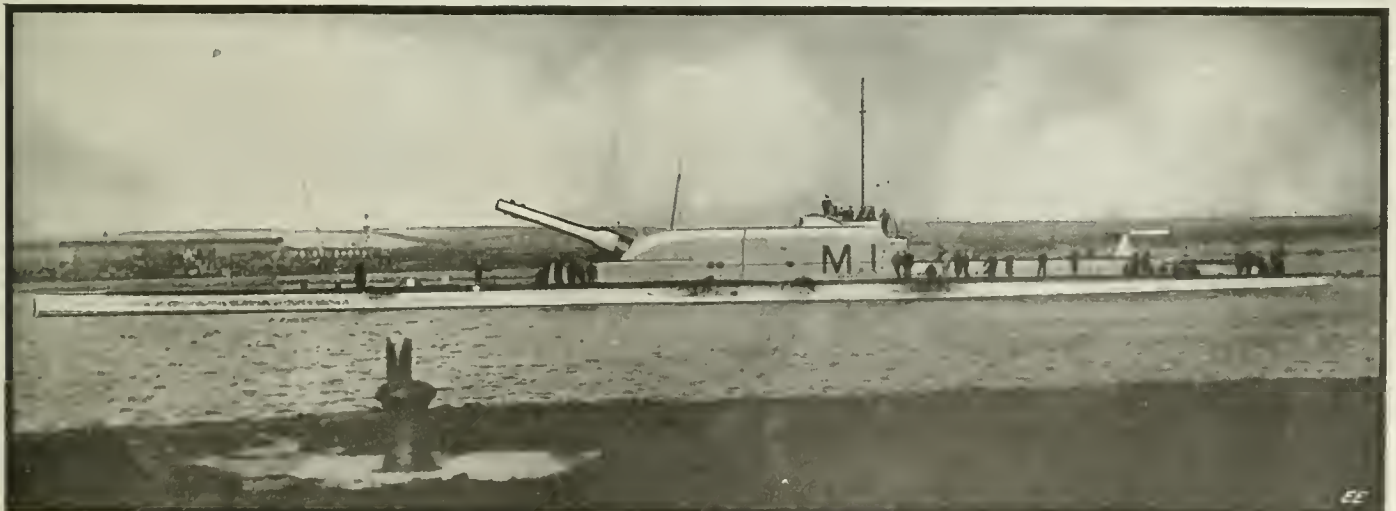

Here's the New British "Monitor-Submarine." It Sports a Dangerous Looking 12-Inch, 50-Ton Gun, Which Can be Traversed 6 Degrees. It Was Built for Bombarding the Forts at the Dardanelles Straits. This is the Famous "M-1," a 1,700-Ton Subsea Craft That Would Make Any Light Cruiser or Similar Warship, Not to Mention a Dozen or So Armed Merchantmen, Scratch as They Never Scratched Before. She Carries, Besides the 12-Inch Gun, Two Torpedo Tubes and an Anti-aircraft Gun, and Several Other Surprises Which Helnie Never Even Dreamed About.

My Inventions

By Nikola Tesla

III. MY LATER ENDEAVORS

The Discovery of the Rotating Magnetic Field

AT the age of ten I entered the Real Gymnasium which was a new and fairly well equipped institution. In the department of physics were various models of classical scientific apparatus, electrical and mechanical. The demonstrations and experiments performed from time to time

by the instructors fascinated me and were undoubtedly a powerful incentive to invention. I was also passionately fond of mathematical studies and often won the professor's praise for rapid calculation. This was due to my acquired facility of visualizing the figures and performing the operations, not in the usual intuitive manner, but as in actual life. Up to a certain degree of complexity it was absolutely the same to me whether I wrote the symbols on the board or conjured them before my mental vision. But free-hand drawing, to which many hours of the course were devoted, was an annoyance I could not endure. This was rather remarkable as most of the members of the family excelled in it. Perhaps my aversion was simply due to the predilection I found in undisturbed thought. Had it not been for a few exceptionally stupid boys, who could not do anything at all, my record would have been the worst. It was a serious handicap as under the then existing educational regime, drawing being obligatory, this deficiency threatened to spoil my whole career and my father had considerable trouble in railroading me from one class to another.

In the second year at that institution I became obsessed with the idea of producing continuous motion thru steady air pressure. The pump incident, of which I have told, had set afire my youthful imagination and impressed me with the boundless possibilities of a vacuum. I grew frantic in my desire to harness this inexhaustible energy but for a long time I was groping in the dark. Finally, however, my endeavors crystallized in an invention which was to enable me to achieve what no other mortal ever attempted. Imagine a cylinder freely rotatable on two bearings and partly surrounded by a rectangular trough which fits it perfectly. The open side of

the trough is closed by a partition so that the cylindrical segment within the enclosure divides the latter into two compartments entirely separated from each other by air-tight sliding joints. One of these compartments being sealed and once for all exhausted, the other remaining open, a perpetual rotation of the cylinder

would result, at least, I thought so. A wooden model was constructed and fitted with infinite care and when I applied the pump on one side and actually observed that there was a tendency to turning, I was delirious with joy. Mechanical flight was the one thing I wanted to accomplish altho still under the discouraging recollection of a bad fall I sustained by jumping with an umbrella from the top of a building. Every day I used to transport myself thru the air to distant regions but could not understand just how I managed to do it. Now I had something concrete—a flying machine with nothing more than a rotating shaft, flapping wings, and—a vacuum of unlimited power! From that time on I made my daily aerial excursions in a vehicle of comfort and luxury as might have befitted King Solomon. It took years before I understood that the atmospheric pressure acted at right angles to the surface of the cylinder and that the slight rotary effort I observed was due to a leak. Tho this knowledge came gradually it gave me a painful shock.

I had hardly completed my course at the Real Gymnasium when I was prostrated with a dangerous illness or rather, a score of them, and my condition became so desperate that I was given up by physicians. During this period I was permitted to read constantly, obtaining books from the Public Library which had been neglected and entrusted to me for classification of the works and preparation of the catalogues. One day I was handed a few volumes of new literature unlike anything I had ever read before and so captivating as to make me utterly forget my hopeless state. They were the earlier works of Mark Twain and to them might have been due the miraculous recovery which followed. Twenty-five years later, when I met Mr. Clements and we formed a friendship between us, I told



Nikola Tesla at 60. A Very Recent Portrait of the Great Inventor. An Excellent Likeness.

him of the experience and was amazed to see that great man of laughter burst into tears.

My studies were continued at the higher Real Gymnasium in Carlstadt, Croatia, where one of my aunts resided. She was a distinguished lady, the wife of a Colonel who was an old war-horse having participated in many battles. I never can forget the three years I past at their home. No fortress in time of war was under a more rigid discipline. I was fed like a canary bird. All the meals were of the highest quality and deliciously prepared but short in quantity by a thousand percent. The slices of ham cut by my aunt were like tissue paper. When the Colonel would put something substantial on my plate she would snatch it away and say excitedly to him: "Be careful, Niko is very delicate." I had a voracious appetite and suffered like Tantalus. But I lived in an atmosphere of refinement and artistic taste quite unusual for those times and conditions. The land was low and marshy and malaria fever never left me while there despite of the enormous amounts of quinin I consumed. Occasionally the river would rise and drive an army of rats into the buildings, devouring everything even to the bundles of the fierce paprika. These pests were to me a welcome diversion. I thinned their ranks by all sorts of means, which won me the unenviable distinction of rat-catcher in the community. At last, however, my course was completed, the misery ended, and I obtained the certificate of maturity which brought me to the cross-roads.

During all those years my parents never wavered in their resolve to make me embrace the clergy, the mere thought of which filled me with dread. I had become intensely interested in electricity under the stimulating influence of my Professor of Physics, who was an ingenious man and often demonstrated the principles by apparatus of his own invention. Among these I recall a device in the shape of a freely rotatable bulb, with tinfoil coatings, which was made to spin rapidly when connected to a static machine. It is impossible for me to convey an adequate idea of the intensity of feeling I experienced in witnessing his exhibitions of these mysterious phenomena. Every impression produced a thousand echoes in my mind. I wanted to know more of this wonderful force; I longed for experiment and investigation and resigned myself to the inevitable with aching heart.

Just as I was making ready for the long journey home I received word that my father wished me to go on a shooting expedition. It was a strange request as he had been always strenuously opposed to this kind of sport. But

a few days later I learned that the cholera was raging in that district and, taking advantage of an opportunity, I returned to Gospic in disregard of my parents' wishes. It is incredible how absolutely ignorant people were as to the causes of this scourge which visited the country in intervals of from fifteen to twenty years. They thought that the deadly agents were transmitted thru the air and filled it with pungent odors and smoke. In the meantime they drank the infected water and died in heaps. I contracted the awful disease on the very day of my arrival and altho surviving the crisis, I was confined to bed for nine months with scarcely any ability to move. My energy was completely exhausted and for

the second time I found myself at death's door. In one of the sinking spells which was thought to be the last, my father rushed into the room. I still see his pallid face as he tried to cheer me in tones belying his assurance. "Perhaps," I said, "I may get well if you will let me study engineering." "You will go to the best technical in-

stitution in the world." he solemnly replied, and I knew that he meant it. A heavy weight was lifted from my mind but the relief would have come too late had it not been for a marvelous cure brought about thru a bitter decoction of a peculiar bean. I came to life like another Lazarus to the utter amazement of everybody. My father insisted that I spend a year in healthful physical outdoor exercises to which I reluctantly consented. For most of this term I roamed in the mountains, loaded with a hunter's outfit and a bundle of books, and this contact with nature made me stronger in body as well as in mind. I thought and planned, and conceived many ideas almost as a rule delusive. The vision was clear enough but the knowledge of principles was very limited. In one of my

inventions I proposed to convey letters and packages across the seas, thru a submarine tube, in spherical containers of sufficient strength to resist the hydraulic pressure. The pumping plant, intended to force the water thru the tube, was accurately figured and designed and all other particulars carefully worked out. Only one trifling detail, of no consequence, was lightly dismissed. I assumed an arbitrary velocity of the water and, what is more, took pleasure in making it high, thus arriving at a stupendous performance supported by faultless calculations. Subsequent reflections, however, on the resistance of pipes to fluid flow determined me to make this invention public property.

Another one of my projects was to construct a ring around the equator which would, of course, float freely and could be arrested in its spinning motion by reactionary forces, thus enabling

(Continued on page 905)

This installment, no doubt the most interesting of the three published so far, reveals many extraordinary occurrences and experiences in the world's greatest inventor's life—experiences such as do not fall to the lot of ordinary mortals. And Tesla, the many sided, aside of inventing, knows the rare art of painting word-pictures. He does so here in a masterly fashion. He tells us how he finally conceived the induction motor—perhaps his greatest discovery—the invention which changed the face of the globe, the invention which made possible the street car, the subway, the electric train, power transmission, the harnessing of water falls and countless others. But let Tesla tell you himself how it all came about. It is a classic worth reading.

EDITOR.

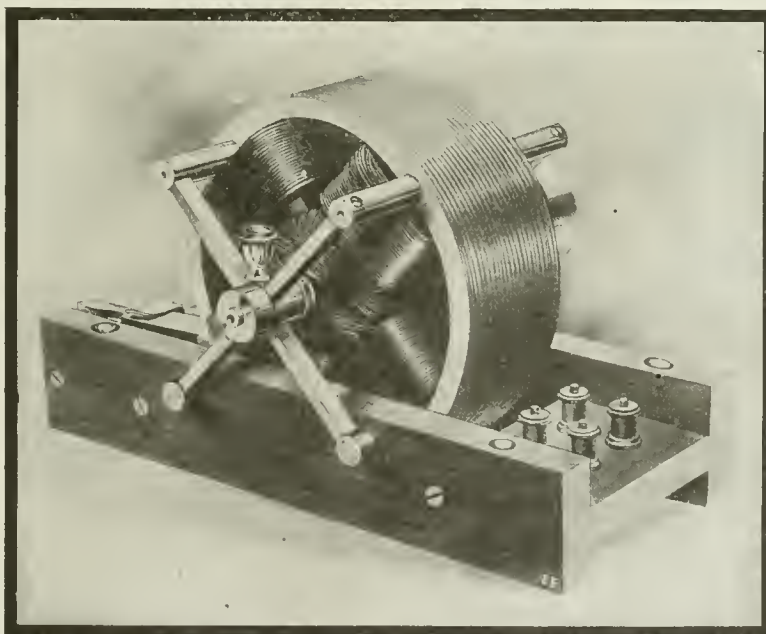

Tesla's First Induction Motor. This Historic Model is One of the Two First Presented Before the American Institute of Electrical Engineers.

WHAT IS THE INDUCTION MOTOR?

The induction motor operates on alternating current. It has no commutator like a direct current motor, nor slip rings like an alternating current motor. Contrary to the two types just cited the "field" current is not steady, but the current itself rotates constantly pulling around with it—by induction—the only moving part of the motor—the rotor or armature. Having no armature nor slip rings, the induction motor never sparks. It consequently knows no "brush" trouble. It needs no attention because of its ruggedness. Only the bearings wear out. Its efficiency too is higher. On account of all this the induction motor is used in a prepondering proportion in street cars, electric trains, factories, etc.

The Moon's Rotation

By NIKOLA TESLA

SINCE the appearance of my article entitled the "Famous Scientific Illusions" in your February issue, I have received a number of letters criticizing the views I express regarding the moon's "axial rotation." These have been partly answered by my statement to the *New York Tribune* of February 23, which allow me to quote:

In your issue of February 2, Mr. Charles E. Manierre, commenting upon my article in the *Electrical Experimenter* for February which appeared in the *Tribune* of January 26, suggests that I give a definition of axial rotation.

I intended to be explicit on this point as may be judged from the following quotation: "The unflinching test of the spinning of a mass is, however, the existence of *energy of motion*. The moon is not posed of such *vis viva*." By this I meant that "axial rotation" is not simply "rotation upon an axis nonchalantly defined in dictionaries, but is a circular motion in the true physical sense—that is, one in which half the product of the mass with the square of velocity is a definite and positive quantity. The moon is a nearly spherical body, of a radius of about 1,087.5 miles, from which I calculate its volume to be approximately 5,300,216,300 cubic miles. Since its mean density is 3.27, one cubic foot of material composing it weighs close on 205 lbs. Accordingly, the total weight of the satellite is about 79,969,000,000,000,000,000, and its mass 2,483,500,000,000,000,000 terrestrial short tons. Assuming that the moon does physically rotate upon its axis, it performs one revolution in 27 days, 7 hours, 43 minutes and 11 seconds, or 2,360,591 seconds. If, in conformity with mathematical principles, we imagine the entire mass concentrated at a distance from the center equal to two-fifths of the radius, then the calculated rotational velocity is 3.04 feet per second, at which the globe would contain 11,474,000,000,000,000,000 short foot tons of energy sufficient to run 1,000,000,000 horsepower for a period of 1,323 years. Now, I say, that there is not enough of that energy in the moon to run a delicate watch.

In astronomical treatises usually the argument is advanced that "if the lunar globe did not turn upon its axis it would expose all parts to terrestrial view. As only a little over one-half is visible it *must* rotate." But this inference is erroneous, for it only admits of one alternative. There are an infinite number of axis besides its own in each of which the moon might turn and still exhibit the same peculiarity.

I have stated in my article that the moon rotates about an axis passing thru the center of the earth, which is not strictly true, but it does not vitiate the

conclusions I have drawn. It is well known, of course, that the two bodies revolve around a common center of gravity, which is at a distance of a little over 2,899 miles from the earth's center.

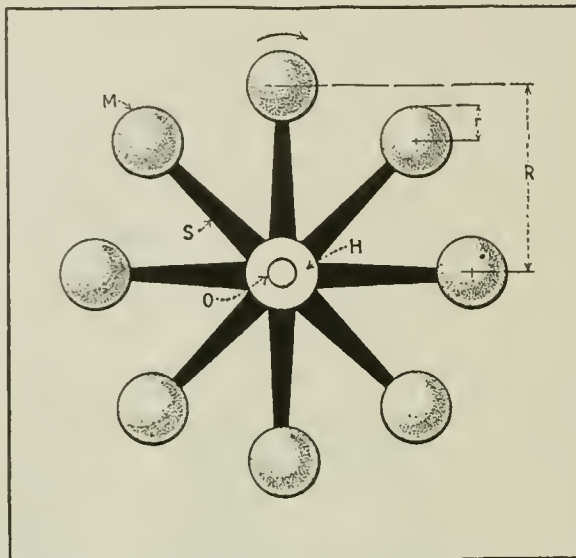

If You Still Think That the Moon Rotates on Its Axis, Look at This Diagram and Follow Closely the Successive Positions Taken by One of the Balls M While It Is Rotated by a Spoke of the Wheel. Substitute Gravity for the Spoke and the Analogy Solves the Moon Rotation Riddle.

Another mistake in books on astronomy is made in considering this motion equivalent to that of a weight whirled on a string or in a sling. In the first place there is an essential difference between these two devices the involving the same mechanical principle. If a metal ball, attached to a string, is whirled around and the latter breaks, an axial rotation of the missile results which is definitely related in magnitude

slung. In this case a *much more rapid* rotation is imparted to it in the *opposite sense*. There is no true analogy to these in the motion of the moon. *If the gravitational string, as it were, would snap, the satellite would go off in a tangent without the slightest swerving or rotation, for there is no moment about the axis and, consequently, no tendency whatever to spinning motion.*

Mr. Manierre is mistaken in his surmise as to what would happen if the earth were suddenly eliminated. Let us suppose that this would occur at the instant when the moon is in *opposition*. Then it would continue on its elliptical path around the sun, presenting to it steadily the face which was always exposed to the earth. If, on the other hand, the latter would disappear at the moment of *conjunction*, the moon would gradually swing around thru 180° and, after a number of oscillations, revolve, again with the same face to the sun. In either case there would be no periodic changes but eternal day and night, respectively, on the sides turned towards, and away from, the luminary.

Some of the arguments advanced by the correspondents are ingenious and not a few comical. None, however, are valid.

One of the writers imagines the earth in the center of a circular orbital plate, having fixedly attached to its peripherical portion a disk-shaped moon, in frictional or geared engagement with another disk of the same diameter and freely rotatable on a pivot projecting from an arm entirely independent of the planetary system. The arm being held continuously parallel to itself, the pivoted disk, of course, is made to turn on its axis as the orbital plate is rotated. This is a well-known drive, and the rotation of the pivoted disk is as palpable a fact as that of the orbital plate. But, the moon in this

model only revolves about the center of the system *without the slightest angular displacement* on its own axis. The same is true of a cart-wheel to which this writer refers. So long as it advances on the earth's surface it turns on the axle in the true physical sense; when one of its spokes is always kept in a perpendicular position the wheel still *revolves* about the earth's center, *but axial rotation has ceased*. Those who think that it then still exists are laboring under an illusion.

An obvious fallacy is involved in the following abstract reasoning. The orbital plate is assumed to gradually shrink, so that finally the

WE believe the accompanying illustration and its explanation will dispel all doubts as to whether the moon rotates on its axis or not. Each of the balls, as M, depicts a different position of, and rotates exactly like, the moon keeping always the same face turned towards the center O, representing the earth.

But as you study this diagram, can you conceive that any of the balls turn on their axis? Plainly this is rendered physically impossible by the spokes. But if you are still unconvinced, Mr. Tesla's experimental proof will surely satisfy you. A body rotating on its axis must contain rotational energy. Now it is a fact, as Mr. Tesla shows, that no such energy is imparted to the ball as, for instance, to a projectile discharged from a gun. It is therefore evident that the moon, in which the gravitational attraction is substituted for a spoke, cannot rotate on its axis or, in other words, contain rotational energy. If the earth's attraction would suddenly cease and cause it to fly off in a tangent, the moon would have no other energy except that of translatory movement, and it would not spin like the ball.—Editor.

and direction to the motion preceding. By way of illustration—if the ball is whirled on the string clockwise ten times per second, then when it flies off, it will rotate on its axis ten times per second, likewise in the direction of a clock. Quite different are the conditions when the ball is thrown from a

centers of the earth and the satellite coincide when the latter revolves simultaneously about its own and the earth's axis. We may reduce the earth to a mathematical point and the distance between the two planets to the radius of the moon without affecting the system in principle, but a further diminution of the distance is mani- (Cont. on p. 892)

Experimental Physics

By JOHN J. FURIA, A. B., M. A., (Columbia University)

LESSON TWENTY (Conclusion)

PHYSICS AND THE WORLD WAR.

As a fitting conclusion to this series of articles, let us consider to what extent Physics helped to beat the Huns. The bulk of the wonderful work done by all branches of science has as yet not been



Wireless Telegraphy — It Often Proved the Only Reliable Communication in Battle.

disclosed by the general public; but the following material disclosed by Professor Ames, of Johns Hopkins University, in his address at the University of Virginia, by Dr. Hale in his address before the New York Engineering Societies, by Professor Millikan, of the University of Chicago, in his address at the Philadelphia meeting of the American Institute of Electrical Engineers, and by Major-General Squier in his address at the New York meeting of the A. I. E. E., is more than sufficient to make it evident to us that Science in general and Physics in particular, deserves a lion's share of the glory accruing from the victory of the Allies.

The American public at the beginning of the war held its scientific men in insignificant regard, and was very much surprised to learn of the high degree of mobilization of Germany's scientific men for war work. The "fool professor" was destined to come before the public eye. On our entering the war our wizard inventors with their efficient press agents won the war for us over night by their epoch-making inventions. Days went by, but our epoch-making inventions did not appear, and gradually the usual murder and divorce cases appeared in the papers again, displacing the names and ideas of our wondrous newspaper wizards. An Inventions Board received some 1,600 inventions from our inventors and found about half a dozen of them were worth considering. Magnets of tremendous size were proposed, which when placed in the bottom of the sea would attract all shells, etc., and thus stop the war.



Machine Guns — Another Weapon of Science, Worked Havoc to Both Sides Night and Day.



Giant Bombing Planes Were Threatening to Wipe Out Berlin When the Armistice Was Signed.

Others proposed magnets of various forms, which on trailing along beneath an airplane would drag up any submerged invisible submarine. Another proposed generating a wind so strong that it would push away any approaching

airplane, balloon, etc. Thus airplane raids were eliminated, submarine attacks were ended, and the war was over. These fool inventions were coming in so fast that the Board in self-defence determined not to consider any inventions sent in by these wonder-workers unless a "working model" accompanied the papers. It was evident that the road to a successful termination of the war lay in bringing together men possessing scientific knowledge, and equipt with scientific methods. In ordinary peace times the college professor is at a disadvantage—he is usually ignorant of, or not interested in commercial development, and does

IN THE "MAY" EXPERIMENTER

The Editors have in preparation some exceptionally interesting articles for the May number of the ELECTRICAL EXPERIMENTER, among which are the following:

The Latest in Aerial Railways. "My Inventions"—No. 4, by Dr. Nikola Tesla.

Electricity and Dynamite—How they help the farmer irrigate land, divert streams, loosen hard soil, and clear land of stumps and stones.

Recording Our Thoughts Electrically, by H. Gernsback.

New York to New Jersey Via Wagon and Auto Tunnel—A Gigantic Engineering Problem.

The Latest Electrical News from France, by Jacques Boyer, Paris Correspondent of the "E. E."

Springtime Fashions in Electric Fans—Several dozen new wrinkles with these useful devices that will interest the whole family.

X-Raying Our Teeth—How disease and mental ailments have been actually traced to ordinarily invisible infections of the teeth. Written by the Medical Director of a Prominent State Hospital.

How to Build a Professional Medical Induction Coil Outfit, by H. Winfield Secor.

Some Interesting Facts Concerning the Electron, by L. R. Jewett.

How to Build an Efficient Open-core Step-up Transformer, by William Holladay.

Choke Coils—How to compute their dimensions with data on actual coils, by Prof. F. E. Austin, Instructor of Electrical Engineering, Dartmouth College.

"Science in Slang"—Installment No. 3, by Emerson Easterling.

not come in contact with the technical trades. However, his researches in pure science are eventually commercialized and become of vast technical importance. In bringing together eminent scientists, presenting them with problems, showing them the conditions, having them perform their researches under the best of conditions and immediately making use of the fruit of their toil—this proved the way to victory. In Washington, London, Paris and Rome, some of the foremost of the Allied scientists were gathered. Among the Physicists we have Millikan, Ames, Mendenhall, Gale, Wood, Duff, Hubbard and others, all in uniform and commissioned as officers in the U. S. Army or Navy. Major-General G. O. Squier, the Chief Signal Officer of our army, is a Physicist of considerable repu-

tation, having received his degree of Ph.D. in Physics at Johns Hopkins University. The rest of our Physicists served in civilian capacities.

Let us now see how our war needs affected scientific research. It is a well-known property of charcoal that it has a high absorbing power for many gases. When the Huns brought forth their little surprise of "poisonous gas," the gas mask was immediately evolved. Research developed that a special treatment of charcoal, made in certain sizes from special kinds of wood had an increased absorbing power. The Physicist knew that charcoal had this absorbing power, and when the problem of increasing this power to make the combating of gas warfare more efficient was proposed, the problem was solved. Airplane engines have been manufactured for many years, but never before has the necessity arisen for high speed quantity production. The problem arose and was solved, the Liberty engine was designed, developing 400 horse-power and weighing only 800 pounds; about 2,000 per month were manu-

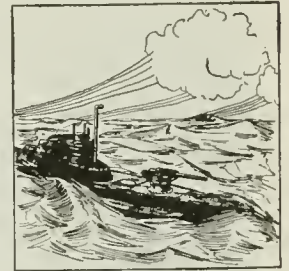

The Submarine—A Terror of the Seas, with a Range of 4,000 Miles.



Tanks by the Thousand Frequently Turned the Tide of Battle for the Allies.

factured. The resistance offered by the wings of different sections, the stability of the airplane, the character of the covering surfaces, etc., have all been investigated in detail. The instruments of navigation and of signaling are perhaps every bit as important as the airplane itself. Instruments for indicating speed, direction, height, distance travelled, etc., have all required extended and careful research by the Physicist. In all airplane work, whether in observations or in making attacks, it is necessary for the men in the machines and the men on the ground to be in constant communication. The wireless telephone is the obvious solution. Wireless telephony has no doubt made more progress in one month of war than in one year of peace. The modifications and improvements made in wireless telephony apparatus in America's physical laboratories by her scientists (most of which have as yet not been disclosed to the public) are positively epoch-making. Our improvements have made it possible (Con. on page 926)

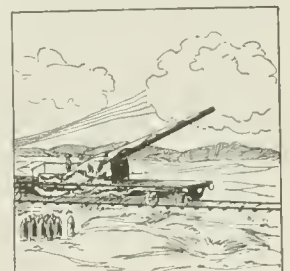

Portable Long Range Guns Routed the Enemy and Levelled His Cities as Well as Fortifications.

Popular Astronomy

The Planet Earth
as Others See Us

By ISABEL M. LEWIS
OF THE U. S. NAVAL OBSERVATORY



Copyright, 1919, by E. P. Co.

The Earth As It Appears to an Observer Stationed At the Moon, One of the Most Wonderful and Awe-Inspiring Objects of the Heavens. On the Moon, the Earth Appears Sixteen Times Larger Than the Moon Appears to Us On the Earth. The Sun Shown At the Right Illuminates Only Part of the Earth, Which Therefore Appears In Crescent Form. It Is, However, Not In Total Darkness for Some of the Light Is Reflected By the Moon Onto the Earth and Back to the Moon, Hence the Darkened Portion Is Not Entirely Dark, But the Continents Can Be Faintly Seen. There Being No Atmosphere On the Moon, the Sky Appears Dead Black In Day Time. The Sun Will Be Seen With Its Corona and Streamers Somewhat as Shown in This Illustration.

WERE it possible for us to view the heavens from the planet Mars we might see in the hours just following sunset or preceding dawn a most beautiful star of first magnitude rivaling and at times surpassing the great star Sirius in brilliancy, closely attended by a small companion star considerably less brilliant. The smaller body is evidently a satellite of the brighter one, as its position relative to the larger body changes in such a way as to show it is revolving around it. It appears now to the east, now to the west of the chief star. At their widest separations the two form a very distinct double star, unique in the heavens of the Martians. As the little star travels from one side to the other of the bright star it usually goes above or below it the occasionally it passes directly in front of or behind the brighter body and at such times only one star is then visible to our Martian observers.

This lustrous double star, the morning or evening star of the Martians, is our planet Earth and its satellite the moon.

Were we observing our planet from Mars it would be quite beyond our powers of

imagination to conceive that this tiny point of light, glowing by the reflected light of the sun, has been for ages upon ages the abode of species and forms of life of well nigh infinite variety that have existed under widely different conditions of temperature and pressure not only on the surface of the planet but in the depths of the seas that cover three-fourths of its surface.

We can imagine conservative scientists of Mars frowning at the flights of fancy of the Martians in regard to the nature of the inhabitants of this other world in space. Yet in their wildest speculations the Martians could hardly exaggerate the wonders of our planet Earth or the strength of the conflicting forces for good and evil to be found upon it.

Let us consider for a moment how our planet Earth and its satellite would appear were we able to examine it telescopically from Mars. Most of the difficulties that beset us here on earth in our attempts to observe Venus telescopically would be experienced in attempting to view the planet Earth from Mars. A reference to Fig. 1, which shows the relative positions of the three planets, will make this clear. The

earth's orbit lies between Mars' orbit and the sun, just as the orbit of Venus lies between us and the sun. As we will see later, Venus has a decided advantage over Mars for observations of the planet Earth. On Venus and on our own planet, Mars can be seen in opposition to the sun that is on the Meridian at midnight, with its disk fully illuminated like the full moon. To Mars, on the contrary, all the inner planets, Mercury, Venus and Earth, appear as half or crescent moons telescopically when they are in the best position for observation and they never appear with fully illuminated disks.

When the earth is nearest to Mars, in position E_2 , see Fig. 1, it is invisible to the Martians, just as Venus is invisible to us in the corresponding position, owing to the fact that it is then *in line with the sun* and lost in the glare of its light. This position is known as the planet's inferior conjunction with the sun. Just before and after the earth is in this position it would show a very thin crescent if viewed telescopically from Mars.

In the position E_2 the earth is once more in line with the sun and Mars in what is

known as superior conjunction, and is again invisible. Just before and after it is in this position its disk is like a gibbons moon almost entirely illuminated, but it is unfavorably situated for observations from Mars because it is so near the sun and on the far side of its orbit from Mars. In position E_1 and E_2 the earth is at its greatest distance from the sun, spoken of as its greatest eastern and western elongations, as seen from Mars. It is then a half-moon in the telescope, is at its highest elevation above the horizon and is evening or morning star to the Martians, according as it is east or west of the sun. We might expect that it would now be in its most favorable position for observation, but this is not so.

Looking at Fig. 1 we see that as the earth passes from the position E_2 toward inferior conjunction with the sun at E_3 , its distance from Mars *decreases* and therefore the apparent size of its disk *increases*. The *form* of the illuminated portion now changes from half moon to crescent but the *total area* of the illuminated portion increases up to a certain point. When the area of the illuminated portion of the planet has its greatest value the brightness of the planet is at a maximum. The exact time when this will occur can be worked out mathematically. The best observations of the earth seen from Mars would be obtained when the planet is in this position and the corresponding one lying between inferior conjunction and western elongation. (See positions E' and E'' in Fig. 1.) We can therefore imagine the Martians observing our planet at its best in the morning or evening twilight. The brilliancy of the earth in Martian skies at this time usually surpasses that of all other planets. Mercury and Venus, tho also evening and morning stars to the Martians, appear considerably less brilliant than they do to us. The earth appears to the Martians much as Venus does to the earth, tho less brilliant, owing to the fact that Venus comes nearer to the earth than the earth does to Mars. The only planet that may rival the earth at the time of its maximum brightness is the giant planet Jupiter, which appears at times brighter to the Martians than does our own planet.

In their telescopic observations of the earth the Martians would experience the same difficulty that we experience in our observations of Venus. When the planet is in its most favorable positions for observation the greater part of its disk is darkened, owing to the fact that the phase is the same as that of the crescent moon.

The Martians, however, would not be handicapped by a dense cloud-laden atmosphere such as surrounds Venus and makes it so difficult for us to observe. As the earth's diameter is twice that of Mars, our surface markings would appear considerably more extensive to the Martians than the markings on Mars appear to us, tho drifting clouds and snow storms on our

planet would frequently hide temporarily some of the markings on our planetary disk.

We can imagine the Martians puzzling over our seas and continents and largest islands and lakes, our polar snow caps and tropical vegetation showing in green and grey-green splashes, our reddish-tinted deserts, our mountains and our great level plains just as we puzzle over the canal-system and the desert and marshy tracts on the planet Mars.

The fact that our planet rotates on its axis in twenty-four hours and has marked seasonal changes could be as readily determined from the distance of Mars as the seasonal changes and rotation of Mars on its axis have been determined by us. We can imagine the interest that our large satellite would arouse and the speculations that would be made concerning its indistinct surface markings. In one respect the Martians would have an advantage over



Fig. 4. The Earth As Seen from Mars. At the Time of Its Greatest Brilliancy the Earth Appears As a Crescent to the Martians. To Better Understand This See Figs. 2 and 5. To the Martians the Planet Earth Can Never Be Viewed As a Full Disc—Only In Crescent Form. When Entirely Illuminated By the Sun, It Is Lost In Its Rays and Is Therefore Invisible to the Martians

planet appears to any other planet as magnificent as the Earth-Moon system does to Venus at the time of nearest approach. The brilliancy of the earth seen from Venus at this time is twice that of Venus as it appears to us at its best. As the earth's disk is then fully illuminated the inhabitants of Venus would have a great advantage over the inhabitants of Mars in their study of the surface markings of our planet. Objects on the earth's surface fifty miles in diameter could be made out easily by the inhabitants of Venus with the assistance of such telescopes as we employ for the observations of the planets. When Mars is most favorably situated for observation from the earth the diameter of its disk is between fifteen and twenty-five seconds of arc, according to its distance from the earth at the time of opposition. When the earth is most favorably situated for observations from Venus the diameter of its disk is sixty-three seconds of arc and that of the moon is seventeen seconds of arc. So even the disk of our moon appears at certain times as large seen from Venus as the disk of Mars seen from the earth. The markings on the earth itself seen from Venus stand out more distinctly at opposition than the markings on Mars do to us at the most favorable opposition of Mars as we are nearer to Venus than to Mars.

It is when we take our station on our own little satellite, however, that we behold our planet earth as the ancients wished to consider it—the most wonderful and awe-inspiring object in the heavens. To the inhabitants of the moon, were there such, the earth's disk would appear four times greater in diameter and sixteen times greater in area than the moon's disk appears to us. Since the moon, in its revolutions around the planet Earth, always keeps the same face toward it, the position of the earth, for any one point of observation on the moon, remains immovable in the heavens, and it goes thru the various phases of its illumination by the sun in the reverse order to that followed by the moon. When the moon appears to us to pass from new to full the earth appears to the moon to pass from full to new and vice versa.

The rotation of the earth on its axis is plainly visible from the moon even to the naked eye. A distinctive marking will appear at the western edge of the earth's disk, say the Black Sea or Central America. It will be carried gradually eastward by the rotation of the planet and will finally disappear twelve hours later at the eastern edge.

Oceans and continents and polar caps appear in their general outlines and contrasting shades, visible easily to the naked (Continued on page 911)



The Planet Earth and Its Satellite the Moon As It Appears Among the Stars When In Opposition to the Sun, Viewed from the Planet Venus

us in their observations of the moon. They would be able to examine one side of the moon that we have never seen. The side of the moon that is never turned toward the earth would be visible frequently to the Martians.

Let us now consider how our planet would appear if we were stationed on the planet Venus, assuming that it is possible at times to see the beauties of the starry heavens thru occasional rifts in dense clouds that apparently shut the surface of this interesting planet almost completely away from the universe beyond.

Seen telescopically at the time of its opposition to the sun, the planet Earth and its satellite the moon would be for the inhabitants of Venus the most beautiful and interesting object in the heavens. No



Fig. 6. The Earth and the Moon As Seen from Planet Venus Thru the Telescope At the Time of Its Opposition to the Sun

Radiophony to Airplanes a Great Success

A CONSIDERABLE time before the United States entered the world war the Bell Telephone system supplied the American Navy with a wireless telephone outfit designed for communication between an airplane and a sta-

"All this sounds very simple, but it would take volumes to describe the innumerable experiments and heart-breaking failures before the first real successes. So far as the radio part of the equipment was concerned we had an answer in a short time. We had

densers and other apparatus that comprise the transmitting and receiving elements. Working this apparatus under ordinary conditions on the ground, and in a swift-moving and tremendously noisy airplane, were two entirely different propositions. The noise of the engine and rushing air was such that it was impossible to hear one's own voice, to say nothing of the weak signals of the telephone receiver," stated Edward B. Craft, Assistant Chief Engineer of the Western Electric Co.

One of the first problems was to design a head set which would exclude these noises, and at the same time permit of the reception of the telephone talk. A form of aviator's helmet was devised with telephone receivers inserted to fit the ears of the pilot or observer. See accompanying illustration of the helmet with 'phones complete. Cushions and pads were provided for adjusting the receivers to the ears and the helmet fitted close to the face so as to prevent as far as possible, the sound being heard either thru the ear passage or thru the bony structure of the head, which acts as a sort of a sounding board. A helmet, such as that illustrated, was finally developed and was found to solve this portion of the problem. The earpiece finally adopted was made of sponge rubber (made so by blowing air thru it while molten), reinforced by tinfoil, and the receivers themselves embedded therein. These were mounted in a thick leather helmet, to be clamped over the flier's head and ears. It effectually muffles bone transmission also, besides permitting the use of oxygen or gas masks.

Everyone knows how sensitive the ordinary telephone transmitter is to extraneous noises, and it does not require a wide stretch of the imagination to picture how this would act alongside the exhaust of a 200 horsepower gasoline engine. A brilliant line of experimentation finally resulted in a form of a telephone transmitter or microphone, which possess the remarkable quality of being insensitive to engine and



U. S. Army Airplane Pilot and Observer Equipt with Wireless Telephone Sets for Transmitting as well as Receiving Speech. These Sets Are Provided with a Change-over Switch Which Permits the Instruments to Be Utilized as a Regular Telephone Between the Two Birdmen.

tion on land or on a ship. From that time on until this country entered the world-conflict, the Western Electric Company, as a part of its general study, conducted the work of perfecting light, compact wireless telephone sets, which would be available on small vessels and on airplanes. The first successful wireless test between an airplane and the ground after our entry into the war was made with one of the sets designed and completely built by this enterprising engineering organization prior to our entry into the war. The test was made on Langley Field.

On May 22, 1917, Gen. George O. Squier, Chief Signal Officer of the United States Army, sent for Dr. F. B. Jewett, chief engineer of the Western Electric Company, to confer with him with reference to the matter of equipping airplanes with wireless telephone apparatus. At this conference, which was held in Washington, besides Gen. Squier and Dr. Jewett, there were present E. D. Craft, one of Dr. Jewett's principal assistants; Capt., now Col. C. C. Culver, of the Signal Corps, and Col. Rees, of the British Army Air Service. The possibility of providing airplanes with wireless telephone service was discust, and the reports of the development work being done by the Western Electric Company made by Dr. Jewett were so promising that he was ordered in writing by Gen. Squier to proceed with the development of the system, and to actually equip planes with it.

The Bell system engineers had progress so far at that time that they were able on July 1, 1917, five weeks after the first conference, in a test at Langley Field, to actually demonstrate the working of the wireless telephone between an airplane and the ground. This test also showed that it was practical to operate the system between two or more airplanes in the air.

developed some very successful forms of vacuum tubes and it was a simple matter to assemble them with the necessary coils, con-



Testing the Radiophone Between New York and Washington. A Photograph of U. S. Naval Operators Communicating with the U. S. Navy Department at Washington, D. C., from the Bankers Club in New York, Thru the Radio Telephone. Many of the Country's Leading Bankers Were Present to Witness the Demonstration. Afterward Tests Were Made from this Station to Airplanes and Dirigibles Flying over New York City, Various Orders Having Been Successfully Sent to the 'Planes.

wind noises, and at the same time very responsive to the tones of the voice. With these two elements in hand, the problem was apparently solved. The fact remains, however, that three solid months of the hardest kind of work was necessary to iron out all the kinks and get the thing in shape so that it might be considered a practicable device for the everyday use of other than experts, as Mr. Craft points out. The microphone perfected for this work has no mouthpiece, but instead a flat cap having three tiny openings about 1/16 inch in diameter. The voice waves pass thru these onto the diafram easily, but the engine noises swirl round it in other directions and do not enter in sufficient volume to be heard at all.

A typical performance of the radiophone between 'planes and ground will prove of interest. Here is the way it worked at one of the first official army tests at the flying field at Dayton, Ohio, December, 1917, as related by Mr. Craft.

"The 'planes left the ground and after what seemed to be an interminable length of time, we got the first sounds in the receiver, which indicated that they were ready

In our next issue will appear an important article by Nikola Tesla entitled

"TRUE WIRELESS"

In this article Dr. Tesla will make known his views of the propagation of the wireless waves.

ing at various speeds, and the specifications stated this to be from forty to one hundred and sixty miles per hour, the latter figure representing the speed when the machine was diving. The little dynamo, therefore, had to deliver a constant voltage with a speed varying from 4,000 to 14,000 R.P.M.

The microphone and receivers used for radiophoning from 'plane to 'plane or 'plane to earth are arranged by means of a switch so that the pilot and observer can converse over the telephone circuit between the pilot and his mechanic with ease, and by throwing a switch can connect themselves with the radio apparatus and talk with the men in another 'plane three or four miles away, or to the ground.

The primary object was to make it possible for the commander of an air squadron to control the movement of his men in the air, the same as a squad leader of infantry does on the ground. For this purpose extra long range is not required, and the distance over which they can talk is purposely limited to two or three miles, so that the enemy cannot overhear, except when actually engaged in combat, and then nobody cares.

The Navy also makes use of these sets in their sea-planes, and here the range is somewhat greater, up to twenty miles in some cases. The Navy has also made use of a modified form of this set in their 110-foot submarine chasers. The chasers hunt submarines in packs, and by means of the radio telephone, their commanders keep in constant touch with each other, thereby greatly increasing the effectiveness of their operation.

Finally, with the formal demonstration completed, pressure was immediately applied to produce the necessary quantity of sets with their multitude of auxiliary and subsidiary parts. From January 1, 1918, to the early summer of that year the Western Electric Company established factories and trained thousands of operatives so that when the armistice was signed the necessary transmitting and receiving tubes for radio telephone sets were being produced at a rate in excess of a million and a half good tubes per year. Improvement in vacuum pumps has resulted in a wonderfully high degree of exhaustion being attained—about one-billionth of an atmosphere.

Altogether thousands of radio telephone sets of different types have been manufactured and delivered to the Army and Navy since the early part of 1918. In spite of the fact that prior to July, 1917, no commercial types of this apparatus were in existence, and some of the fundamental problems had not yet been solved, the resources of this great telephone engineering organization were sufficient to establish

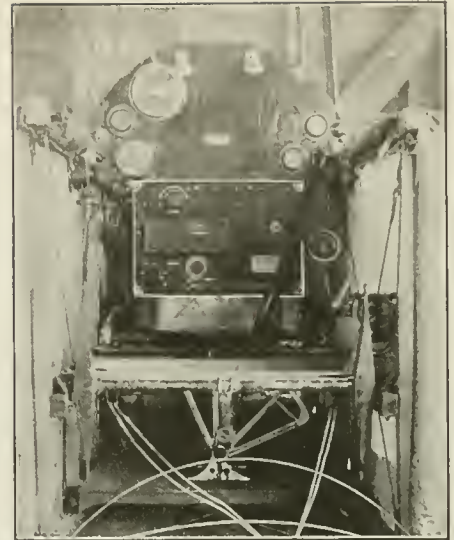

The Wireless Telephone Apparatus (Outlined in White Square) Installed in Cock-pit of Airplane. It Takes up But Little Room and Has Such a Small Weight as to Be Insignificant, Compared to the Lifting Power of the Plane.

on a commercial basis, within this short space of time, practically speaking, an entirely new art!—Photos Courtesy W. E. Co.

HOW AIRPLANES FIND THEMSELVES BY RADIO.

In his recent lecture before the American Institute of Electrical Engineers at New York Major-Gen. G. O. Squier, in connection with his description of the war's developments in radio apparatus, spoke as follows concerning the problem of aerial navigation:

"One of the principal problems of airplane navigation has been the evolution of a suitable compass, particularly for night bombing work. Magnetic and gyroscopic compasses have limitations at present which make impossible reliable air navigation by dead reckoning.

(Continued on page 926)

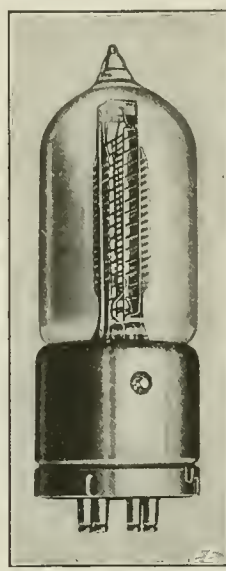
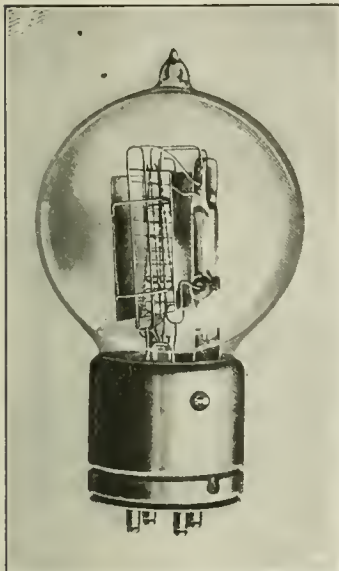

The Vacuum Tubes Which Do the Work in Radiophoning to and from Airplanes and the Ground. At the Left—the Transmitting Tube; at Right—the Receiving Tube. America Was Turning Out These Bulbs by Thousands Every Day When the Armistice Was Signed, so Rapid Had the Standardization and Production Progress.

to perform. The spectators were only mildly interested, and some seemed to be a bit bored. Suddenly out of the horn of the loud speaker came the words, "Hello, ground station. This is 'plane No. 1 speaking. Do you get me all right?" The bored expression immediately faded, and looks of amazement came over their faces. Soon we got the same signal from No. 2, and the show was on. Under command from the ground the 'planes were maneuvered all over that part of the country. They were sent on scouting expeditions and reported what they saw as they traveled thru the air. Continuous conversation was carried on, even when the 'planes were out of sight, and finally upon command they came flying back out of space and landed as directed."

Electric current must be supplied to operate the wireless set on the 'plane, as we well know, this current being used to heat the filaments of the vacuum tubes and to operate the transmitter. But the 'planes were already loaded down with all the gear they could carry, and the use of heavy storage batteries was out of the question. The airplane engineers would allow nothing to be connected to their engines, so there was nothing left but to supply a separate radio dynamo, and drive it by a wind propeller, taking its power from the rushing air. Airplanes are in the habit of fly-

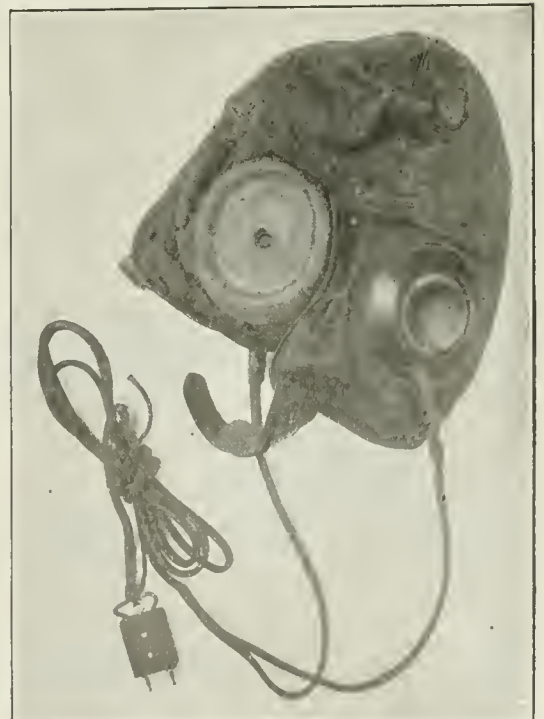

Aviator's Radiophone Helmet Fitted with Special Sound-proof Pads and Having the Two Receivers Mounted Tightly Therein. The Receivers Are Moulded in Sponge Rubber. The Helmet is Made of Leather.

Do Radio Waves Travel Above the Earth or Thru It?

By DR. LEE de FOREST

(Written exclusively for the Electrical Experimenter)

THE article on "Radio Around the World" is very interesting. From my own rather extended experience and based also on the calculations and results obtained by most of the serious workers in this field, I think there can be no doubt but that the *etheric wave* component is by far the more important one. Understand, however, that these are not ordinary space waves, but *are grounded waves gliding over the surface of the earth*, thus following the contour of the earth. See Fig. 1. The depth of the wave in the ground or sea water has been shown by actual measurements, as well as by theoretical calculations, to be ordinarily and until recently only a few feet; sufficient, however, to explain the interesting results obtained with an horizontal antenna lying close to the surface of the earth, or even in trenches a few inches below the surface and extending, of course, in the general direction of wave propagation.

Unquestionably the molten interior of the earth would conduct low frequency oscillations with comparatively little loss, but it is obviously impossible to make connection to this molten interior, ordinarily. If one cared to experiment with two volcanoes at a comparatively short distance apart, making each crater the terminus of a line connecting with the terminals of an A. C. generator, and at some distant spot of the earth's surface between two neighboring volcanoes another parallel wire, in which a tuning and detecting device was located, very interesting results might be obtained. See Fig. 2.

However, if such a combination could be found there would probably exist not the slightest excuse for sending telegrams between stations thus situated. Unfortunately, or fortunately, we cannot locate our volcanoes as we would subway tubes.

If, as you suggest, a powerful wireless station could be operated at a sufficient distance from the earth's surface, and completely isolated therefrom, remarkable distances of transmission thru the ether might be achieved. However the energy obtainable at the moon from a

THE editors sent a copy of the article published in the December issue of the ELECTRICAL EXPERIMENTER entitled "Radio Around the World," and also the editorial in that issue by Mr. H. Gernsback, covering several interesting and more or less doubtful theories concerning the propagation of these electric waves over a distance of 12,000 miles, i.e. between Carnarvon, Wales, England and Sydney, Australia, to Dr. Lee de Forest, the prominent American radio engineer and scientist. The editors asked Dr. de Forest the following questions:

First: What is your opinion concerning the etheric wave transmission above the surface of the earth, i.e., free space wave propagation? Do you believe that the etheric wave wireless transmission is better beyond the computed fifty mile atmospheric envelope surrounding the earth, and how far into interstellar space do you believe these signals might be carried? Imagine for the moment that an airship fitted with sensitive wireless receiving instruments could have traveled away from the earth for any desired distance? Do you think these waves would be felt on the moon, approximately 238,000 miles distant, considering of course that suitable receiving instruments were available at that point?

Second: What is your opinion concerning the ground wave transmission, i.e., do you believe, with the geologists and others, that the earth presumably being a molten mass in the interior, might be a better conductor than the soil and rock crust surrounding it, and that this gaseous interior of the earth might therefore prove a better conductor than the soil and rock strata, and thus that the ground radio wave may have traveled directly thru the earth or a distance of nearly eight thousand miles—corresponding to the diametrical axis—or do you believe it much more likely that these ground waves followed around the curvature of the earth in the manner explained by Prof. J. Zebeck and other investigators, each ground wave gliding over the surface of the earth?

Third: Is it your opinion at the present day that the pure etheric space wave, gliding over the earth in accordance with the generally accepted theories concerning radio transmission, is the predominating wave, both as to electrical energy involved and amplitude, compared to the ground wave; or is the ground wave superior in its energy component and amplitude? These conditions are shown in one of the following diagrams, Fig. 1, and we would request your opinion on the relative extent above and below the surface of the earth, of the space wave and the ground wave respectively.

given output of energy transmitted near the earth's surface can be calculated, by inverse square law. It will be found that a tre-

is great need for interesting data on the phenomena of transmission from airplanes and whoever will collect and publish such data will be conferring a great service to the Radio Art.

Concerning your question as to whether the wireless waves travel or glide along the surface of the earth in the manner which I have described above, each wave having a grounded foot or base generating a short distance into the earth, I might mention a very interesting phenomenon which we have encountered in installing wireless stations in mountainous or mining country in the western part of the United States. Figs. 4 and 5 illustrate this phenomenon. Fig. 4 shows a case which often happened in the early commercial days of radio-telegraphy, where a mine owner or other party wished to install a station in a valley or cañon, which happened to have sharply rising cliffs on either side. Apparently the composite etheric and ground waves became so stretched out or attenuated in their effort to leap across this valley, that the station was only able to intercept either very weak signals or no signals at all. Therefore it was found advisable in-

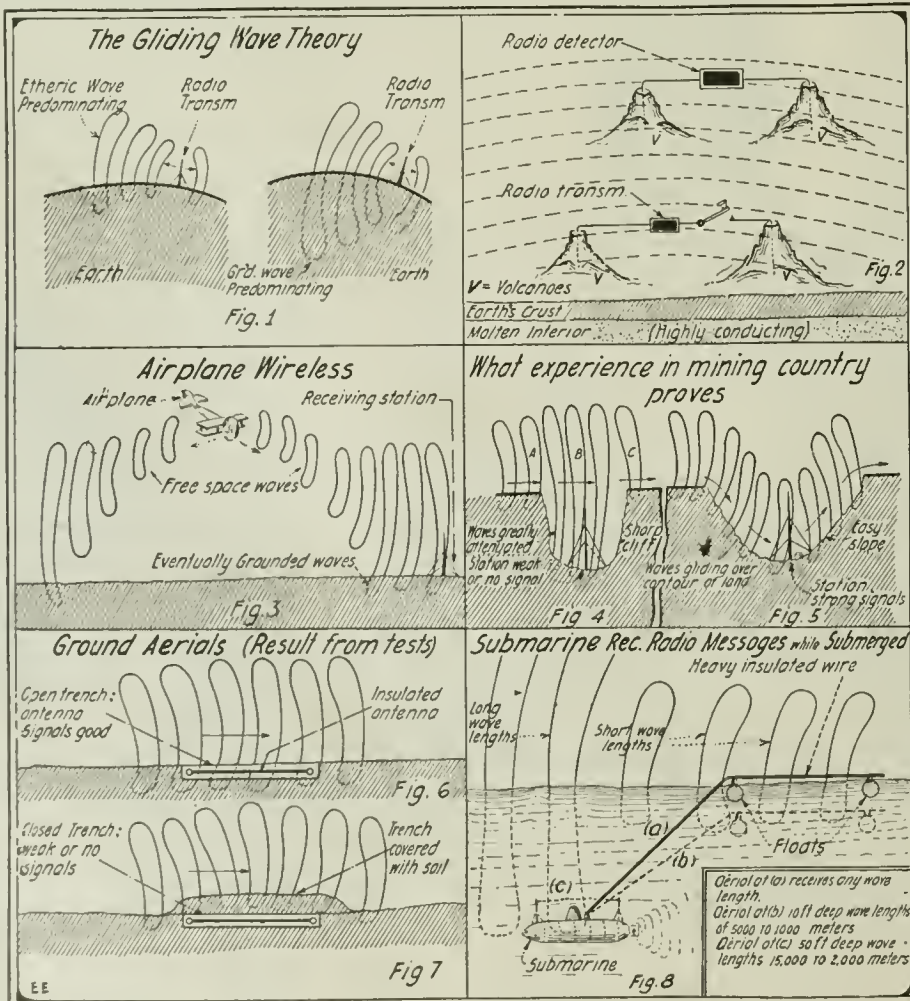

Various Phases of Gliding Wave Wireless Transmission Used in Discussion Here Given. In General, the Etheric Space Wave Glides along the Surface of the Earth, Accompanied by Its Grounded or Foot Wave.

(Cont. on page 919)

Aërial or Ground Radio—Which?

The Opinions of Two Leading Wireless Experts

Do Radio Waves Travel Above the Earth or Thru It?—by Dr. L. W. Austin, Radio Expert, U. S. Naval Radio Laboratory.

REPLYING to your queries of recent date, I am very glad that you have asked these questions and will answer them to the best of my ability.

Q-1. I see no reason to doubt the validity of the old theory of wireless transmission which supposes a wave in ether (and under certain circumstances in the upper layers of the earth, provided they are sufficiently bad conductors), the lower ends of the electric lines being grounded on the conducting surface. The space wave under most circumstances certainly carries the greater part of the energy, except where the wave front is bent very far forward. This theory, it seems to me, is sufficiently proven by quantitative observations on received radio current which at moderate distances always agree within a few per cent with the theory that the antenna produces a field corresponding to a Hertz oscillator of twice its length.

Q-2. I believe that the currents in the earth are only incidental to the presence of the ether waves.

Q-3. In the case of transmission between airplanes and the earth, the phenomenon is similar. In sending from a 'plane, the wave must start as a *pure ether wave* which spreads downward and grounds

Here Are the Questions the Editors Submitted

Q. 1. Do you believe that wireless transmission is effected by complex ether waves having a grounded foot, these waves gliding over the surface of the earth from the antenna, and if so:

(a) Do you think that the etheric space wave above the ground is the predominating one in energy component and amplitude?—or
(b) Do you believe that the ground wave component is the predominating one in energy component and amplitude?

Q. 2. Do you believe that underground wireless transmission is effected by means of ground impulses or currents radiating thru the earth from the base of the antenna, and that the etheric space wave radiation from the antenna is merely an incidental and separate phenomenon, which dissipates itself at a comparatively short distance of a few hundred miles or so?

Q. 3. Do you not believe in this general direction of thought on the matter, that it is the etheric space wave radiation from the antenna that accounts entirely for airplane radio transmission; either 'plane to 'plane, 'plane to earth, or earth to 'plane communication?

Q. 4. How do you account for the results obtained with the Rogers underground and undersea radio transmission and reception? Do you believe that this is accomplished by the grounded components or "feet" of the gliding etheric space waves in conformity with the usual theory accepted theretofore by the Hertzian wave school, or do you think that it is due to ground impulses or high frequency oscillating currents propagated thru the conducting shell of the earth?

Q. 5.—Do you think that, all things considered, and in the light of present day radio developments, such as the Rogers underground and undersea system, that radio transmission would take place with higher efficiency in free interplanetary space, or do you believe that our wireless signals produced at stations on the earth are retained within the atmospheric envelope of the earth due to reflection from the "Heaviside" ionization layer?

Q. 6. It has been hinted at by several naval radio experts and others that it has recently been found that the penetration of the ground wave component in radio transmission increases with increase in wave length, and this phenomenon they are inclined to believe accounts for the results obtained with the underground system. Do you believe this to be a fact?

itself, and then spreads out longitudinally (with a more or less bent wave front) very much like the wave from a grounded antenna.

Q-4. In antennas close to the ground or buried in the ground which, by the way, behave exactly alike except for a slight difference in static-signal ratio, the reception is accomplished by picking up the earth currents produced by the wave. These, of

course, become relatively more powerful at greater distances from the sending station, owing to the usual bending forward of the wave front. The sending from earth or buried antennas is probably accomplished as follows:

In the first place, *ground currents* are formed which produce an electric field in the ether above the earth's surface. This field in spreading out and upward gradually rights itself and travels off very much like the field from an antenna, except that it is *directive*.

Q-5. I do not believe that it is probable that any wireless radiation passes thru the Heaviside layer. (Ed. Note: This would seem to eliminate the "Mars" radio story which has been going the rounds of the daily press.)

Q-6. Experiments indicate that *long waves* can be detected at *greater depths* than short ones, as would be expected from the ordinary skin effect phenomenon of alternating currents.

I am very sorry I have to disagree with Mr. Tesla in this matter, for I consider him the father of wireless telegraphy. His lectures in the early '90s contain full descriptions of a wireless system superior to anything which we actually had in practise before 1910, except for the lack of a proper detector.

How I Believe Radio Wave Transmission Is Accomplished

By F. H. KROGER

Chief Engineer, International Radio Telegraph Co., Formerly Chief Engineer, National Electric Signaling Co.

IN response to the request of the Editors of the ELECTRICAL EXPERIMENTER, I give below my replies to the questions here submitted:

Q-1. Practically all the energy delivered by the radio transmitter is radiated in the form of waves *gliding on the earth's surface*. Any energy which may be found to exist in the earth's surface is supplied by the waves sent out from the antenna. The poorer the conductivity of this surface, the more energy is taken from the wave, and consequently the less there is available at the receiving station.

Q-2. There must exist in the earth's surface, currents at the feet of the waves referred to in question number one. Means for detecting these currents will give a method of receiving messages. These currents, however, represent only a small per cent of the energy of the traveling wave. It is quite generally agreed that the wave above the surface cannot exist without the current in the surface and vice versa.

Q-3. Yes.

Q-4. Currents due to the gliding wave.

Q-5. The "Heaviside" ionization layer must be a boundary to the waves. One of the explanations of the marvelous work done in the North during the winter is the fact that the ionized layer of the Aurora,

coming close to the earth, provides a boundary to the waves which prevents the usual attenuation.

Q-6. The ground losses are higher with longer wave-lengths for poorly conducting earth, in the vicinity of the antenna, which indicates that a greater volume of the earth is affected by the currents. This greater penetration would also hold for the gliding wave. Ground tests made some years ago indicated that the ability to receive signals did not depend upon the quality of the ground nor the wave-length: therefore Mr. Rogers' system probably does not depend upon a penetration due particularly to long wave-lengths, but upon a penetration which is sufficient for his purposes, given by any wave-length.

EXAMINATIONS FOR AMATEUR FIRST GRADE RADIO OPERATOR'S LICENSE AT NEW YORK.

Examinations for amateur first grade radio operator's license are being given at Room 603, Custom House, Bowling Green, New York City, every day after 9 a. m., announces Charles D. Guthrie, Radio Inspector of that district.

Attention is called to the fact that applicants for amateur first grade radio oper-

ator's license must qualify in the transmission and reception of Continental Morse code at the rate of *ten words per minute* instead of five as heretofore.

Papers covering these examinations will be rated by the examining officer as soon after the examination as possible *but no licenses will be issued until amateur stations are permitted to operate.*

PLEASE NOTE: By taking this examination authority is NOT granted to open your station. It will be necessary after the stations are authorized to open, to furnish on form 762, Applicant's Description of Apparatus, the particulars required and await the issuance of station license as well as the operator's license before operating the station and form 762 cannot be filled in and filed until the station has been made ready for operation as it is important that the exact dimensions of the antenna and the amount of power to be used be stated in this application.

You are hereby cautioned that it is unlawful to operate an unlicensed station, and all amateur licenses (operator's and station) issued prior to the war are now void.

When authority is granted to issue amateur licenses, new station numbers and call letters will be given.

CHAS. D. GUTHRIE,
Radio Inspector.

The How and Why of Radio Apparatus

By H. WINFIELD SECOR

No. 11. How to Make and Use a Direct-Reading Wave Meter and Decremeter.

From time to time we will describe one particular instrument used in either the radio transmitting or receiving set, explaining just how it works, and why. We have received so many requests from new readers asking for such explanations that we have decided to publish this matter in serial form. In the course of several issues all of the principal transmitting and receiving apparatus will have been covered. The subject for the eleventh paper is HOW TO MAKE AND USE A DIRECT-READING WAVE METER AND DECREMENTER.

THE present time seems an opportune one for the radio student and the radio amateur to prepare for the forthcoming opening of experimental radio opportunities, and we believe that no better use can be made of the spare time than to construct and study the use of the wave meter and decremeter. The accompanying text and illustrations show how to build a home-made wave meter which will give very satisfactory service. The dimensions given for the various parts of the instruments are taken from an experimental one which was carefully calibrated for the writer.

We will first take up the construction of the wave meter and will afterward consider the calibration curves to be used with it, and also the determination of decrement.

Perhaps the first part of the instrument that will come to hand as the student sets about the building of it, is the inductance, or rather the inductances. These coils are also referred to as the exploring coils or exploring inductances. They are used to pick up sufficient energy from a radio transmitter or receiving set, so as to cause oscillations to be set up in the wave meter circuit, which will be of sufficient strength to give a positive indication of resonance or non-resonance of the circuit, and thus to determine the exact period at which the current being measured is oscillating.

The illustration, Fig. 1, gives the details of construction for the three inductances used with this wavemeter. The wooden forms on which the coils are wound are best turned on the lathe from some fine grained hard wood such as mahogany or maple. The physical dimensions of the forms are given in the drawing and the

length A, of each of the three coils varies with the number of turns on each, the table in the figure providing these values for the different coils. The winding in each case consists of one layer of No. 20 B. & S. gage

coils to the wave meter cabinet is shown at Fig. 1, and consists of two lugs made of 1/16 inch brass and having slots at the lower ends of each. This enables the operator to slip the coils on and off the binding posts quickly. The inner and outer leads from the winding of the inductance should be carried thru diagonally drilled holes in the wooden form, as is indicated by the dotted lines, and they should be soldered to the two brass lugs, which are screwed to the form by means of small flat-head brass wood screws. The wooden form may be varnished or shellacked before winding, but the winding itself should not receive any coating of shellac or varnish, as this changes the distributed capacity of the coil. Do not use any iron in building these inductances.

The next item claiming our attention is the variable condenser, and we might say a great deal concerning this part of the apparatus, and then again we might just as well say very little. Experience dictates that this comes out about as follows: in the first place many radio experimenters would rather obtain on the open market a small

rotary type variable condenser having the proper capacity for use in this particular wave meter, and this should be .00086 microfarad. Of course any condenser having this capacity within a small fraction one way or the other may be used, but if the student wishes to have a good accurate wave meter, and intends to eventually have it calibrated or checked against a standard wave meter, then he will do well to select a good sturdy and reliable make of rotary condenser. Some of the points to be watched in the design of such a condenser are that it should not have the rotary and fixt plates too closely spaced, or else it will frequently give trouble by short-circuiting; the rotary plates should be accurately locked on the rotary shaft either by having their hubs molded on the shaft or else they should be mounted on a square shaft so as not to turn, or again they can be keyed on the shaft. For the purpose of a wave meter there should also be practically no up and down movement or play in the vertical shaft supporting the rotary plates. For all practical purposes, the capacity of a rotary variable condenser (see Fig. 2), is determined by the usual capacity formula using a K value of 1, which is that for air.

Many radio amateurs and experimenters

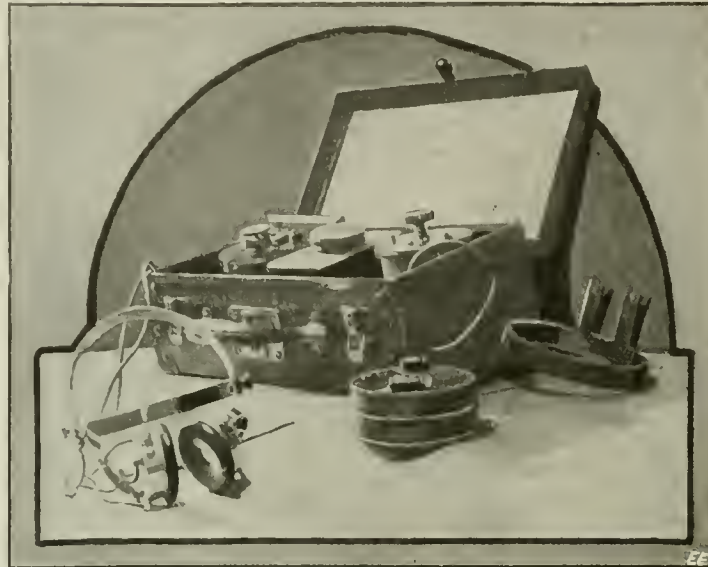

Photograph of Author's Wave Meter Fitted with Calibrated Condenser and Inductance Coils of the Dimensions Given in the Present Article.

enameled magnet wire. These inductances have been accurately calibrated by comparison with a standard wave meter at the Radio Standardization Laboratory of the College of the City of New York, thru the courtesy of Dr. Alfred N. Goldsmith, Di-

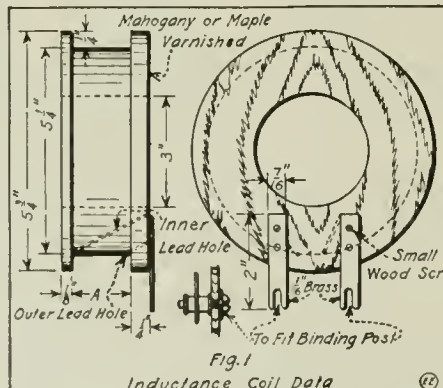

Details of Inductance Coils, Three of Which Are Used to Give the Wave Meter a Desirable Range.

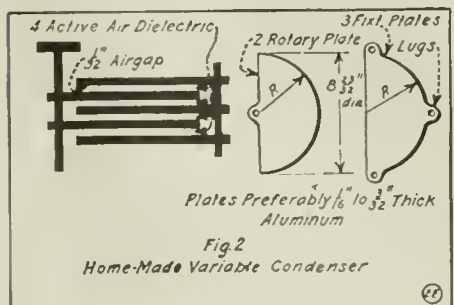

Dimensions of Home-made Variable Condenser of the Required Capacity for Wave Meter Here Described.

rector, and the specifications for building these coils must be rigidly adhered to. Where the accuracy of the instrument within a few per cent below or above the calibrated values is not imperative, No. 20 gage magnet wire, covered with a single winding of silk may be used; but due to the peculiar qualities of enameled magnet wire and the number of turns per inch of winding, etc., it will be seen that the specifications here given should be carefully followed to obtain the inductance values in centimeters here given. The three coils, numbers 1, 2 and 3, have inductances of 36,000, 126,000 and 259,000 centimeters respectively.

The manner of attaching the inductance

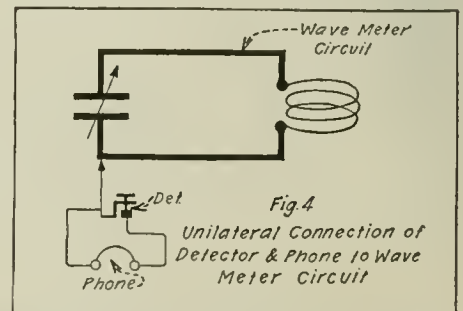

Usual Hook-up of Detector and 'Phones in Unilateral Fashion, Where There is Sufficient Energy to Actuate Detector Properly.

will undoubtedly wish to construct their own variable condenser having this required capacity, and the physical dimensions of such a variable condenser are given in Fig. 2. As will be seen, this particular design comprises three stationary and two rotary aluminum or brass plates. These plates should preferably have a thickness of 1/16 to 3/32 inch so as to be perfectly flat and retain their shape, and thus maintain the accuracy of the condenser when once assembled. The four active air dielectric spaces between the plates should be exactly 1/32 inch. The diameter of the rotary plate, as Fig. 2 indicates, should be 8-23/32 inches, and by cutting the lugs on the stationary plates as well as on the rotary plate in the manner indicated, will permit of the accurate interleaving of the rotary and fixed plates so as to give the proper capacity.

Thus we see that the two principal parts of any wave meter are—an accurately cali-

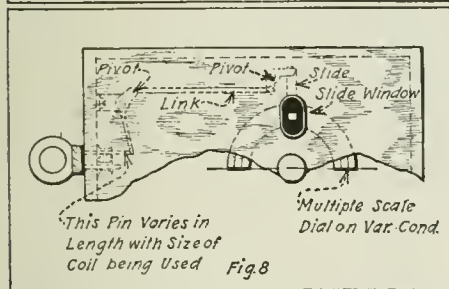
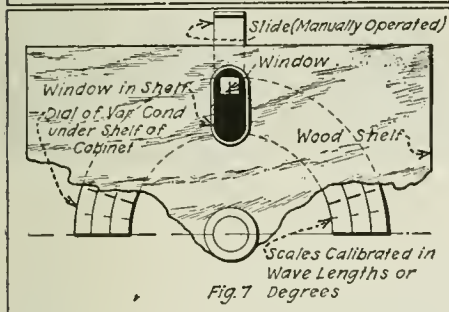
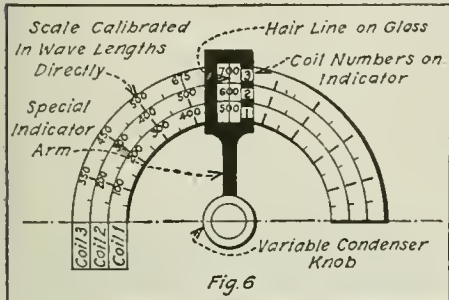

Three Schemes for Improving the Wave Meter Dial and Indicator so as to Make It "Direct Reading." Fig. 8 Shows an Automatic Dial Arrangement Which Causes the Correct Reading to Appear, no Matter Which of the Three Coils Is in Use.

brated precision variable condenser and an accurately calibrated inductance. In practically all cases this inductance and capacity of known values are connected together in parallel or shunt as shown at Fig. 3-A. Referring to Figs. 3-A and 3-B, the lead wires joining the inductance or exploring coil to the variable condenser are composed of two pieces of No. 16 flexible lamp cord, each 6 inches long. A 3-inch length of copper strip joins the two pairs of binding posts. Fig. 3 shows one set of binding posts being used for the inductance coil and the other set intended for the connection of a hot wire milliamperemeter or thermo-couple and galvanometer. Ordinarily this latter pair of binding posts are fitted with a piece of copper strip about 1/16 inch thick forming a jumper.

It is well in all cases to fit a safety spark gap across the terminals of the variable condenser as shown at Fig. 3-B, as when the wave meter is used in close proximity

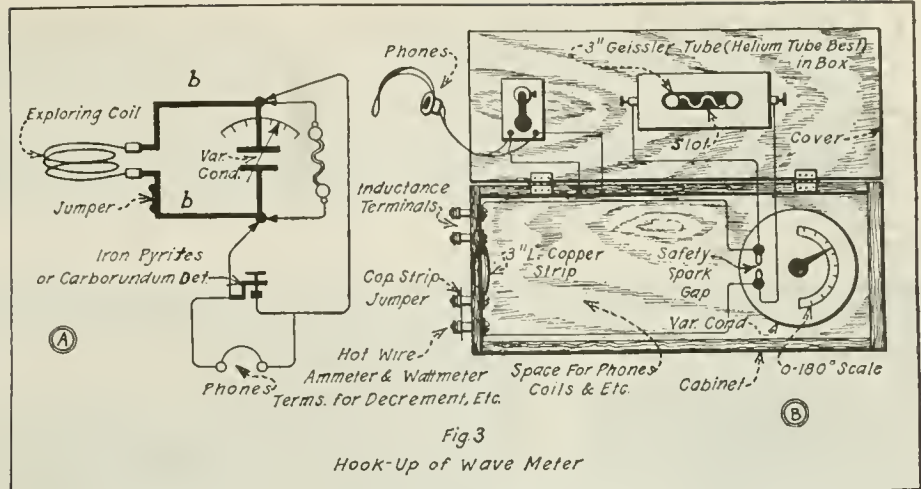

Arrangement of Wave Meter in Cabinet, Including Condenser, Inductance, Geissler Tube, 'Phone (1,000 or 75 ohm), Etc. The Diagram Shows Geissler Tube and Detector and 'Phone Indicator Circuit, Either of Which Can Be Used.

to radio transmitting sets, there is very often a sufficiently heavy current induced in the wave meter circuit to cause a puncture of the insulation of the inductance coil or a short-circuiting of the variable condenser, especially if the latter happens to have closely spaced plates.

For indicating the maximum resonance when measuring the wave length of a transmitting set, where the induced current in the wave meter is of course quite strong in any case, a very good indicator, as proven by practise and experience, is an ordinary 3-inch Geissler tube, or better yet a small helium gas tube. It is best when using either a Geissler or helium tube as an indicator of maximum resonance, to place the tube in a small box mounted on the lid of the wave meter, the box being blackened inside and provided with a slot in the front so that the degree of glow in the tube may be easily seen. It is also common practise to connect a hot wire milliamperemeter in series with the inductance and condenser of the wave meter by removing the jumper on the series binding post terminals and connecting the meter to this; in this case the maximum resonance, and therefore the wave length at which the circuit under test is oscillating, is indicated by turning the condenser handle until the needle of the hot wire meter reaches a maximum reading. Some operators prefer to use the well-known detector and telephone receiver method of determining the maximum resonance point in the wave meter circuit as the diagrams at Fig. 3 show. The detector and wireless 'phones are connected (in series or in multiple) across the variable condenser for the purpose. This arrangement is extremely sensitive, and is the one invariably used in measuring the wave

length of received signals. The Geissler tube or other apparatus is, of course disconnected from the wave meter circuit, if the detector and 'phone method is to be used. With respect to the detector used on the wave meter, it may be said that either carborundum or iron pyrites proves best, as either may be subjected to a very strong current without harm.

Figures 4 and 5 show two more circuits used with the wave meter. Fig. 4 shows a detector and telephone receiver circuit, connected to the main oscillating circuit of the wave meter by a unilateral or one-wire connection. This method is highly recommended in many text books treating on the wave meter and its uses, and at the present time it is used on many of the best commercial wave meters. This connection of the detecting circuit possesses the advantage that it cannot have any detuning or offsetting effect on the oscillating circuit as is the case where it is placed in shunt to the capacity and inductance composing this circuit, and it is very efficient for the purpose in hand, as with this connection the detector and 'phone receive just a sufficient amount of energy to operate

(Continued on page 921)

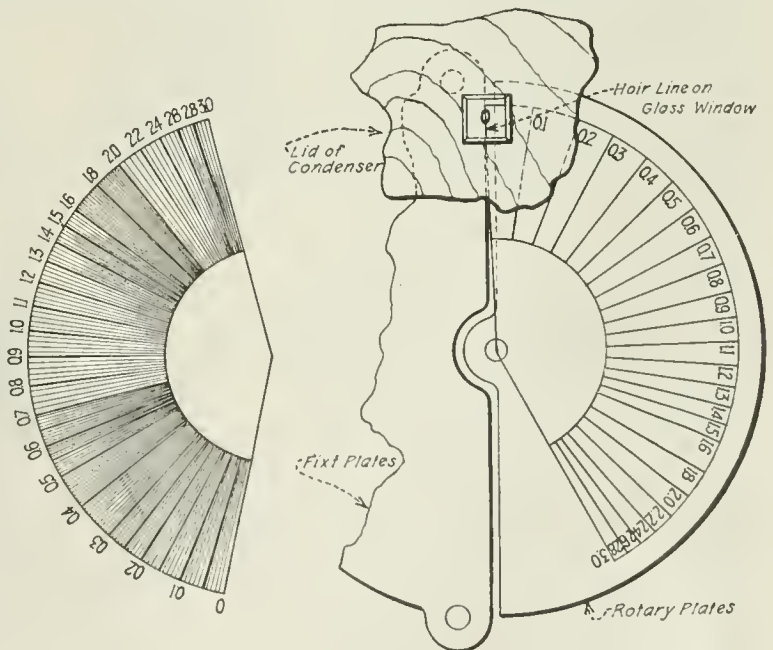

Position of Paper Scale on Rotary Plate of Condenser

To Make a "Direct Reading Decrement" of Your Wave Meter, Cut Out the Paper Scale at the Left and Mount It on the Variable Condenser Shaft or on the Top Rotary Plate in the Manner Here Shown. The Decrement Is Read thru the Window When Resonance Is Indicated.

German Radio Apparatus Used at Metz

THE accompanying illustrations show the interesting radio apparatus and antenna mast used at the famous German military base at Metz. These photographs were taken by the French Army when they entered Metz after the signing of the armistice. The photo-

which are placed in a group at the lower center of the front panel.

Among other things, we find it interesting to note the very neat arrangement of the interior wiring of the cabinet, the various connections being run symmetrically in straight lines, evenly spaced and held rigidly

MORE BUNQUE.

By J. A. Weaver.

I often wonder how Noah made the arc light.

And it sure does get my goat why insulators wear petticoats.

And of what possible use is a vacuum

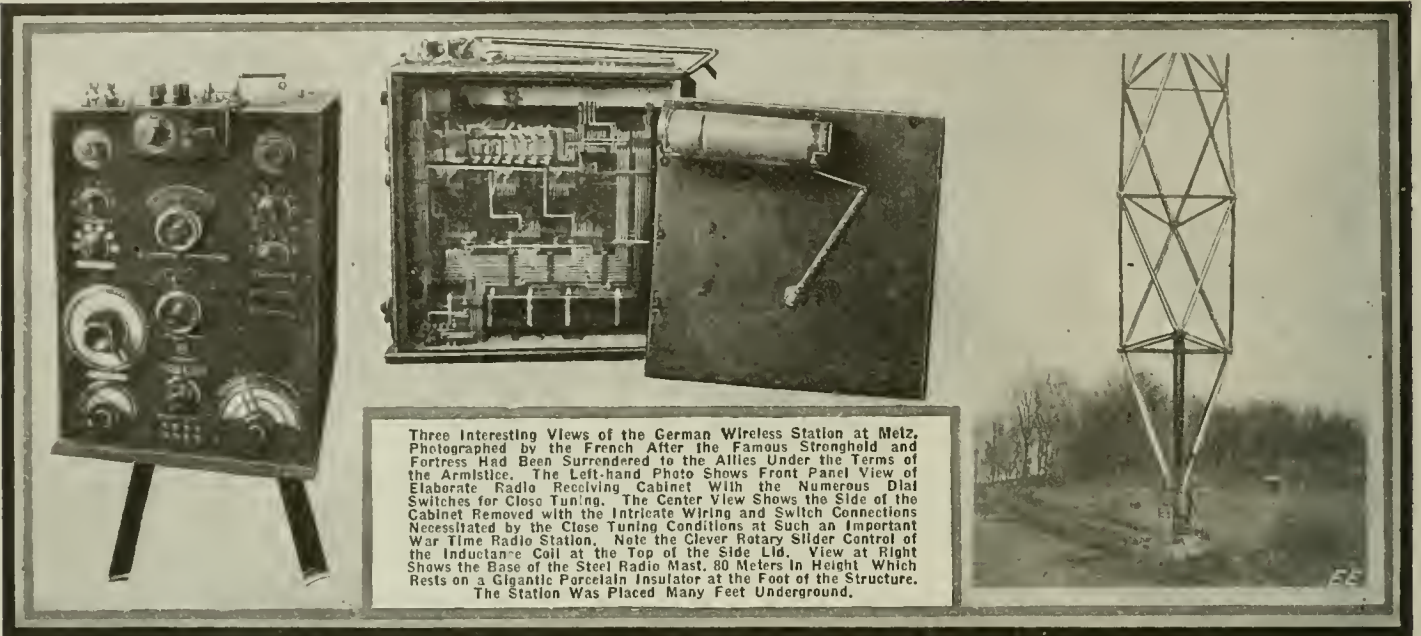

Three Interesting Views of the German Wireless Station at Metz, Photographed by the French After the Famous Stronghold and Fortress Had Been Surrendered to the Allies Under the Terms of the Armistice. The Left-hand Photo Shows Front Panel View of Elaborate Radio Receiving Cabinet With the Numerous Dial Switches for Close Tuning. The Center View Shows the Side of the Cabinet Removed with the Intricate Wiring and Switch Connections Necessitated by the Close Tuning Conditions at Such an Important War Time Radio Station. Note the Clever Rotary Slider Control of the Inductance Coil at the Top of the Side Lid. View at Right Shows the Base of the Steel Radio Mast, 80 Meters in Height Which Rests on a Gigantic Porcelain Insulator at the Foot of the Structure. The Station Was Placed Many Feet Underground.

graph of the aerial mast is interesting as it shows a very novel construction whereby a strongly braced tower structure is formed of steel tubes or pipes, provided with flattened ends thru which bolts are past. The base of this radio mast, measuring 80 meters in height, is tapered to a point at the bottom, as the photograph shows, and rests on a large porcelain insulator. Suitable guys and pins were used in arranging this insulating base support, so that the foot of the mast could not slip or break away if for any reason the insulator should break. The mast was well-guyed with steel cables running in different directions, and the antenna was supported in umbrella fashion from the top of the mast. As the photograph discloses, a high steel fence enclosed the grounds connected with the station to preserve secrecy, and also to prevent any one coming in contact with the highly charged aerial conductors.

The remaining two photographs show respectively front and side views of the receiving apparatus used at Metz. One of the first interesting things we note in connection with the design of the apparatus, and plainly visible in the side view is the rotary control of the inductance slider. This is accomplished by a lever secured to a rotary knob, the free end of which is joined by means of a link member to the slider of the inductance in the manner shown, so that as the handle is turned in rotary fashion, the slider will move back and forth along the coil. The detectors, of which there are several in duplicate, are observed at the top of the instrument, while an elaborate multiplicity of control handles with graduated inductance pointers, are provided for changing the wave length of the primary and secondary receiving circuits, as well as the coupling between the coils of these circuits, and also the capacity values used.

The telephone receivers, several sets of which may be used when desired, are connected with the receiving set cabinet by means of flexible cords and jacks, eight of

in place by means of insulating cleats. In the side view of the apparatus, which shows the interior, one may perceive the neatly wound inductance coil at the bottom of the cabinet, and as will be seen, it is square in form with a number of inductances placed along the form on which it is wound. This set is designed so as to be suitable for receiving either spark or arc signals. No



Wireless Terms Illustrated—"Beat Receiver"
—Courtesy The Oscillator.

vacuum bulb detectors or oscillators are shown, but we know that they were used in many of the German sets, the bulb employed being that devised by Lieben and Riez.

cleaner, being as a vacuum is always clean? And whether undamped waves oscillate or vibrate?

And whether it would be murder to kilowatt?

And whether you can measure water with a wavemeter?

And how a bus-line can run from place to place without moving?

And whether it would be nice to be a miner in the mines of Asia-Minor?

And if a condenser is over charged by a conductor would it cause a disturbance on the trolley line?

And where does the dago when nite approaches?

And how to tell when onion plants armature?

And what is the price of a drink at the bus bar?

And why some boobs persist in saying a.c. current and d.c. current instead of a.c. and d.c.?

And whether there are any seeds in a transformer core.

CHAIN OF RADIO STATIONS.

The establishment of a chain of radio stations, approximately 30 miles apart along the Atlantic Coast, was announced at the headquarters of the 1st Naval District recently. The statement intimated that by this arrangement incoming vessels, when 150 or 200 miles off coast, could determine their position easily by communicating with shore stations, regardless of weather conditions. Along the 250 miles of coast included within the 1st District eight stations are already in operation.

COAST GUARD STATIONS TO HAVE WIRELESS.

In the near future radio stations will be installed at the coast guard stations at the Isles of Shoals, at Station No. 2 at Cross Island, Buck's Harbor, Me., and Station No. 8 at Damiscove Island, Boothbay Harbor, Me. A number of radio operators will be sent to these stations.



A Timely Reinforcement A Copper Plated Stomach

By THOMAS REED

THERE'S a lot in being forehanded. Mother was that way. Every Saturday we used to have salt fish for dinner, so she wouldn't be bothered with getting up anything to eat on baking-day. That sounds like a paradox, but it wasn't, it was a shame, for the "baking" was very appetizing and savory, while the fish was—well, not so savory.

Now, when you wanted salt fish on Saturday, you had to begin way back in the week somewhere. Tuesday was a good day because there wasn't much of anything to do (on top of the regular chores) except the ironing, and you had a chance to think. Follow me carefully—you know how long it is from Tuesday before Saturday comes around? Well, mother used to plan ahead all the time, foreseeing she was going to be heated and tired, and all fust up with cooking formulas, and would need an accommodating viand for dinner that she could slap down most anywhere without hurting it, and tell us children to go to it and forget the whole business. On Tuesday she commenced *deodorizing* the fish.

You see, while the fish abode with the grocer, it was always picking up scents like coffee and spices and matches and kerosene, from the clerk's habit of wiping his hands on it in passing, and the hostler would chuck a horse-blanket on it often enough to give it a quaint stable tang. But what you'd call the basic flavor was imparted by "Tabby"—the store cat. The pile of codfish was the place where the cat slept and took her bath (the kind of dry-cleansing a cat calls a bath); also her refuge from stray dogs—or ambush, according to whether she could lick the dog or not. The result was you couldn't say the cat smelt fishy, or the fish catty, but they smelt about alike! It was a blend, like this fancy-named toilet-water you have to have pronounced for you, *eau de something* or other.

If you just wanted the fish for a smelling fish, you didn't have to do anything to it, it was all right as it was. But when you wanted to use it for an eating fish, you had to go to work and separate the fish part from the odor part, or as much of it as you could. It wasn't difficult or laborious at all, but it took time, and that's why you had to be forehanded. You put this fish into a good stout pan—a pan that wasn't particular whom it associated with—and covered it with common ordinary water. The water didn't stay that way very long. In a few hours it was most *uncommon* water, yelling to heaven and casting into the air bunches of assorted perfumes, like Spring-

time tripping o'er the lea and scattering flowers—I mean the operation was the same, not the raw material.

When one dose of water had suffered about enough you poured it off and renewed it, and so on. If you tended right to your business thru Tuesday and Wednesday and Thursday and Friday and Saturday morning, then by Saturday noon there was your fish—transformed into a regular eating fish—at least those who had to eat it could: That's how you had to plan meals in those days—no frittering away your time at *tea-dongsongs* till the last minute, and

From that moment nothing was thought of but comebacks to hand to Germany in return for her favors of the past 40 years, with the accent on the last 4—which was righto, and success to the job; but in the rush of business, a very important point was overlooked by everybody—but ME. I'll tell you what I mean.

You know how thick and fast the celebrations came, along there in November? They made a record for thickness and fastness that won't be beaten till "Bill" gets back from Hell. There was the "Fake Peace Celebration" on Thursday, and the "Real One" on Monday, and the "Regular One" on Tuesday. I don't know how it was with you, but by Wednesday I had food for thought—and it was the only kind of food I was able to sit up and take any notice of.

The thought, being fed, was mainly to the effect, how nice it would have been if I'd had one of those *copper-lined stomachs* that are always being talked about and never realized. I don't know as I ever appreciated before how reliable copper is. Viewing the ruin of my faithful Gastric Cavity thru handling the few easy objects I'd sent down to it, I envied the old copper boiler at home—how it used to digest 3 or 4 bushels of the family wash, or boil up a barrel of soft soap, or a tub or two of whitewash—stunts really exacting, you know—and get away with it year after year.

Ah me, as the fellow says. With a tummy built on the lines of that boiler, one could celebrate Peace till the cows came home with their 16-cent milk, and then tackle a New Year's Eve and a couple of "wakes" on the side, instead of rueing the day—whatever that is—as I was doing.

But the real horror of the situation was this; here were a million or two of soldiers and sailors due to come home and go thru this celebration-thing multiplied to the hundredth-power. The big cities were going to stuff 'em, then the smaller branch cities, and the railroad towns, and the home towns—the strain all the time increasing as the burg grew smaller—till finally they'd fetch up at "Home" itself, the one with the Big "H", with Mother roasting chickens and frying flapjacks and baking pies in a wild effort to make up a year's deficiencies in army rations all at one meal. All that, and only an ordinary membranous stomach to stand it! Was there any time to lose? No. The copper stomach, so long postponed, had to be invented *tout de suite* if it was going to be ready for the occasion.

Well, here it is, all ready and waiting, (Continued on page 927)

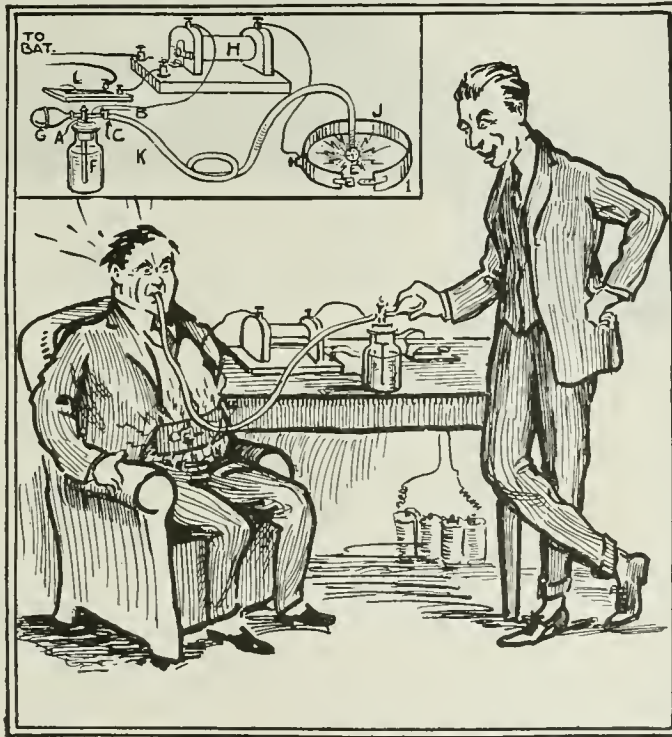

To Copper Plate Human Stomachs So as To Digest the Present Post-War Foods, Thomas Reed Here Shows Us How To Set About Rigging Up the Necessary Apparatus. When You Once Receive This Treatment You Will Be Able to Swallow Nails, Old Milk Cans, Sections of Steam Boilers, Bricks, et Cetera, and Then the Undertaker Will Nail You Up.

tossing on a preserved pig's foot for supper.

Examples like this gave me the same habit of being forehanded. I'm always looking ahead and spying out some situation that's liable to be dangerous or disagreeable, and providing against it. It's a lucky thing I am, as it happens, and you'll say so, too, when I tell you.

Perhaps you remember we had a "war", or something like that, recently. Well, just when we were thinking it was going to last forever, we began to hear noises from the Other Side that sounded like "By gorry we've got 'em licked!" "They're quitting!" "The war is over!" "Honk-honk!" "Wow!" and other expressions of quiet satisfaction.

The Alkaline Storage Battery

By J. F. SPRINGER

STORAGE batteries are of two principal kinds—(1) the lead-acid battery, and (2) the alkaline battery. Our attention is now directed upon the latter. There is but one alkaline cell

of prominence on the market—the Edison battery. Each cell is a complete self-contained unit and may be used alone or in conjunction with other cells. A typical cell will have a voltage of about 1.2 average discharge potential; the maximum discharge potential is about 1.45 volts at the start. The charge and discharge characteristics are given in the accompanying graph, Fig. 1. While charging the cell voltage may rise as high as 1.85 volts. The amperage will vary with the size of the cell. By connecting a battery of cells in series, it is possible to run the voltage up to any desired point; see Fig. 2-A. A usual voltage for rather short circuits—under 300 feet—is 30-32 volts. Accordingly, about 30 cells are required. The battery used as a unit will have a voltage equal to the sum of the voltages of the individual cells. The amperage will remain the same as with the single cell. It is necessary, therefore, to choose a size of cell that will give the amperage required for the service or else use more than one battery, connecting the batteries—not the cells—in parallel, see Fig. 2-B. For a 110-volt system, a large number of cells will be needed. In making such calculations, it will be best to rate the alkaline cell at just about 1 volt. Thus, for 110-volt service use 110 cells, connected in series.

In purchasing a battery, it will be necessary to decide on the voltage to be used. There are probably more household and similar devices on the market that are designed for the 110-volt system than for any other. At the same time, there is a considerable range of such devices which are adapted to, and available for use on 30-32 volt circuits.

The alkaline cell has a tight-fitting cover. As in all batteries there will be generated a

certain amount of gas; this escapes thru a special valve. The cell is well suited to rough usage, partly because of the tight cover and partly because the container is of sheet steel and not of glass or hard rubber. The liquid is of an alkaline character. It

be preferred, if conditions make slowness conveniently possible. Whether the battery is charged slowly or rapidly, evenness of charging is always to be adopted.

Direct current only is usable in charging. If alternating current

is the only source of energy available it will be necessary to convert it into direct current and to use the latter with the battery. There are several methods which may be employed. First, there is the motor-generator. The alternating current is used to operate a motor. The motor drives the generator and produces the direct current for charging. A mercury arc rectifier is another device for converting the alternating current into direct. This device is often more economical and convenient if only a small current is to be handled.

Of course, direct current may be generated at once. The equipment necessary will be (1) an engine or some equivalent means of operating the generator, and (2) a generator, and (3) a switchboard. It

would probably be cheaper to use the current direct from the generator to operate the lights, etc., and to dispense with the storage battery, if the current were required in a steady, even stream. But current is not ordinarily required thus in a home or on board a boat.

(Continued on page 931)



A Typical Alkaline Storage Battery Installation On Ship-Board, the Battery Operating the Wireless Telegraph Equipment In Emergency. The Control and Charging Switch-Board Appear At the Left of the "Battery Room." All Radio Operators Should Thoroughly Understand Storage Batteries, Both the Lead and Alkaline Types. The Smaller Cut Shows the Non-Leaking Gas Vent Fitted On the Alkaline Cell. This Cell Has a Mean Potential of 1.2 Volts.

loses but little of its water as time goes on. In order to determine whether the strength is normal, a hydrometer may be used. The electrolyte consists of potassium hydrate (21 per cent solution) to which has been added a small amount of lithium hydrate. The specific gravity of the alkaline cell does not change during charge or discharge. The normal specific gravity will be 1.210, but this may drop at times to as low as 1.160 without affecting the cell. A brand new alkaline battery will not develop its full capacity at once. After a number of chargings it will settle down to a standard performance. This settlement into a standard condition is understood to be due to the improvement in the conditions of the negative plate consequent upon regular charging and recharging. This process of self-forming continues over a period of from one to three months.

The care of an alkaline battery will ordinarily be simple. The density of the liquid may be watched and corrected, if necessary. This will usually mean the addition of a little water to bring the hydrometer reading down to 1.210. Regularity of handling will probably give better results in an alkaline battery than any other one thing. This is especially true in connection with the charging.

A battery may be charged slowly or rapidly or at a medium rate. That is, it may be done normally in 7 hours, or rapidly in 1 or 2 hours, or at a moderate rate in 4 or 5 hours. Slow, regular charging at the normal rate is to

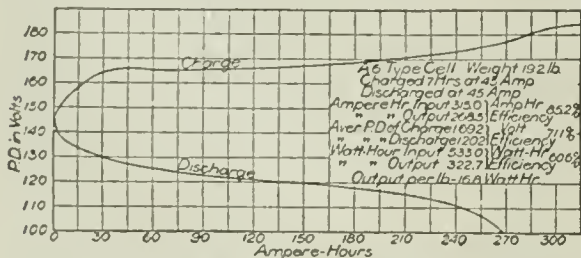

Typical Characteristic Curves for Charge and Discharge of Edison Type Alkaline Storage Battery. The Average Discharge Potential Is Seen to Be 1.2 Volts. Fig. 1.

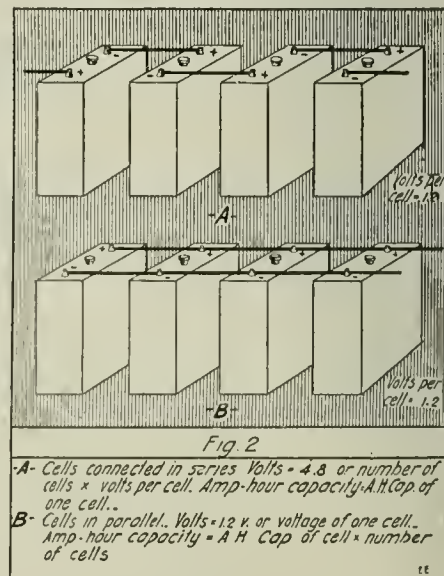

Fig. 2
A- Cells connected in series. Volts = 4.8 or number of cells x volts per cell. Amp-hour capacity = A.H. Cap. of one cell.
B- Cells in parallel. Volts = 1.2 x or voltage of one cell. Amp-hour capacity = A.H. Cap. of cell x number of cells

Diagram Showing Voltage and Amperage With Series and Parallel Connections of Battery Cells.

Experimental Mechanics

BY SAMUEL D. COHEN

LESSON XI

THE THEORY OF TWIST DRILLS.

THE student who has been following the past lessons in "Experimental Mechanics" may now find himself confronted by a more or less difficult task in properly utilizing a very important tool, namely—*twist drills*, and

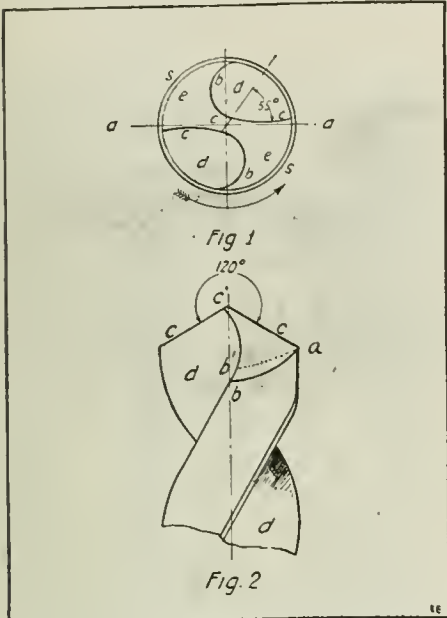

In the Present Article the Author Discusses the Theory of Twist Drills, the Shape of the Grooves, the Pitch of the Cutting Edges, Et Cetera. The Lips C-C May Be Considered as the Cutting Edges of Two Chisels, Which Turn about the Axis of the Drill.

the writer gives below a brief resumé of the subject of twist drills and their grinding. Because it is very essential to follow understandingly the subject of twist drills, a short mathematical treatise of simple nature will be given in order to more readily facilitate the understanding of the subject.

The twist drills stand in use so far above flat drills that they are now an indispensable tool in every workshop for metal working. They may be manufactured by milling or forging two spiral grooves out of a cylindrical bar, or by twisting a bar of the desired cross-section, so that the lines originally running parallel to the axis become spiral lines. The first method of manufacturing is today still the most common one. When we take a spiral drill and turn it with the top towards us, we shall see it as shown in Fig. 1. *dd* are the spiral grooves, *cc* both cutting edges, so the drill will have to turn in the direction of the arrow. *ee* is the solid part of drill; the top of the drill nearest to us is the edge *c'*, which unites the two edges *cc*, making an angle of about 55 degrees with each of them. The cylindrical surface of the drill at *ss*, only exists for the part *aa*, for, to prevent unnecessary

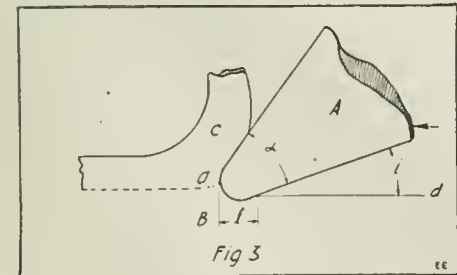

Further Illustrating the Similarity of a Chisel Cutting into a Piece of Metal to the Two Cutting Edges of a Twist Drill.

friction against the walls of the hole, the rest of the surface is brought to a somewhat smaller diameter. Sometimes the surface *s*, is gradually backed off, beginning at the edge without a distinctly perceptible step, as in Fig. 1. The profile of the grooves *dd*, is chosen so that the intersection with the top plane *b*, gives as far as possible a right angle line *C*. The shape of the line *b* is of lesser importance provided that the groove *d* is wide enough to allow the chips to pass easily. The dimension of the weakest point of the drill where the edge *c'* is found, is fixt by the demand of strength in the drill. The edge *c'*, which cuts very badly, should be as short as possible. Ordinarily, it is taken 1-10th of the diameter at the point of the drill and gradually increases to the upper end, for reasons of strength.

When looking at the drill sideways we now see it as shown in Fig. 2; *cc* are the sectants which form together an angle of about 120 degrees, *c'* the connection, *dd* the grooves, the pitch of which amounts to 5 to 8 times the diameter of the drill. We consider *cc* as being the cutting edges of two chisels, which, turning around the axis must cut chips from the metal. The form and the position of these chisels in regard to the metal will have to answer the same requirements as every other cutting chisel, which are these: In Fig. 3 *A* represents a cross-section of the chisel, *B* the piece of work from which the chip *C* is cut by moving *A* in the direction of the arrow.

To prevent the chisel breaking its cutting edge—the angle α —obtained by grinding, and therefore called the *grinding angle*, must be sufficiently strong. For cutting mild steel and iron α is made upon an average of about 55 degrees; with very good steel the angle can be some degrees smaller; with a poorer grade steel it must be some degrees larger. The loosening of the chip from the metal is not done at the lowest point of the chisel, but at *a*, being the point most advanced. The metal is pushed down at a length *l*, Fig. 3, and there-

Don't Miss the Next Lesson— "Grinding Twist Drills."

It will discuss the various factors involved in properly grinding twist drills, both by hand and machine or jig. A real practical article which every amateur machinist will want to read.

after returns to its level *a-d*. The smaller the angle *i*, which may be enlarged or diminished by the position of the chisel, the longer *l* will be, and the greater will be the resistance of the metal being pushed down. Experience tells us how large the angle *i* must be; it varies between 4 degrees to 8 degrees for lathe and planer tools. We shall see how great it must be made for twist drills. In no case may it be smaller than 4 degrees, or the chisel will refuse to cut.

Referring to Fig. 4, the point *a*, of the cutting edge *c*, situated on the cylindrical surface of, the chisel, we find the grinding angle α , appointed by the tangent to the spiral and by the tangent to the line *ab*, sectant of the cylindrical surface of the drill, and the ground top *B*. So the size of this angle is determined with regard to the strength of the edge and practically amounts to about 55 degrees. Then follows the angle *i* in Fig. 3; where to find it. While turning around on its axis the drill advances into the metal. So each point describes a spiral line with the pitch equal to

the feed of the drill for one revolution. These spiral lines, however, are of unequal diameter. Point *a*, in Fig. 4, on the circumference of the drill is given in Fig. 5, as if moving on the spiral line *a'a*. The diameter of the drill being $D = 1$ in. and the feed 1-50th in.; the inclination of the spiral line is found by:

$$\tan \beta = \frac{\text{feed}}{\text{circumference}} = \frac{1}{50 \times \pi} = 0.00637$$

$\beta = 0^\circ 22'$

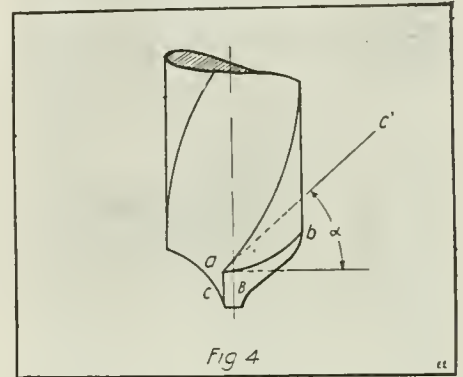

Discussion of the Angle and Clearance of the Cutting Edge of a Twist Drill.

Point *a*, in Fig. 4, at a distance of 1-20th in. from the drill axis, describes the spiral line *c'c* with the same pitch *h*, Fig. 5, as *a'a*; the angle of inclination γ however, is quite a different one; for the case of 1-20th in. it is:

$$\tan \gamma = \frac{1}{50 \times \pi \times 1/10} = 0.0637$$

$\gamma = 3^\circ 39'$

In Fig. 5 the value *h* of the feed has been given immoderately large for the sake of clearness, and the angle γ has consequently been drawn much larger than it is in reality.

The spiral lines, *a'a* and *c'c*; are the lines in regard to which the angle *i*, in Fig. 3, has to be measured. They agree with the line *a-d*, in that figure. From this it follows that for point *a* of the drill the setting angle *i* is measured in regard to the line, inclining already $0^\circ 22'$, and therefore must be so much greater than usually. For point *c* this difference becomes $3^\circ 39'$. The setting angle becomes a changeable value, increasing towards the center of the drill. In giving it everywhere the same value for simplicity's sake, that is to say the largest cutting cross-section desired in the center, the edge would become too weak at the circumference.

With the above facts in mind the writer will give a complete practical discourse on how to handle twist drills, grinding, et cetera, in the next installment.

(To be continued)

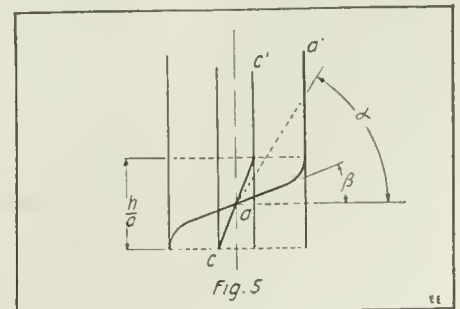

Diagram Used in Explaining the Value of the Angles of Grinding of Twist Drills.

Practical Chemical Experiments

Butter and Butter Substitutes

By ALBERT W. WILSDON

BUTTER is obtained by skimming the milk and putting it thru the process of churning, the globules coalesce and the solid fat separates more or less thoroly from the other constituents of the milk. As found on the market, butter is rarely found to contain more than 80 to 85 per cent fat; the rest

ice-water, thus chilling it rapidly. It can then be salted and packed like ordinary butter. Two marked advantages which this material has over butter are: (1) It is much cheaper, and (2) owing to the absence of buttermilk and butter fats it has much better keeping qualities. Its flavor ranks well with second-class butter.

"Renovated" or "Process" butter is in general prepared as follows: Old, rancid, and unsalable butter is melted in a large vat surrounded by a hot water jacket at a temperature of about 45 deg. C. The curd and brine are then drawn off at the bottom, the scum being taken off at the top. Air is blown thru the mass, to remove the disagreeable odor, and after mixing with some milk, the mass is churned and then run into ice cold water to make it granular in structure. It is then ripened, worked to free it from buttermilk and salted. It is required by law in some states that this product be marked "Renovated Butter."

SIMPLE TEST FOR BUTTER

Experiment No. 1. See Fig. 1.

Heat about 3 grams of the sample in a large iron spoon over a low Bunsen flame, stirring constantly. Genuine butter will boil quietly, with the production of considerable froth or foam, which may, on removal

removed from the flame; in the case of genuine butter these particles are *small* and *finely divided*, but in the case of oleomargarin the curd will gather in large masses.

MILK TEST FOR BUTTER

Experiment No. 2. See Fig. 2.

To make a "milk test" for butter, place



Fig. 1. Apparatus Used in Making Test for Butter and Oleomargarin or Renovated Butter.

being principally water, with some proteids and lactose from buttermilk still remaining in it, and more or less salt or saltpeter, to flavor and preserve it. It quite frequently is colored with some harmless vegetable compound.

Oleomargarin is usually prepared from the fat contained in the intestinal folds of beef cattle. It is carefully stripped from the fresh carcass, washed, chilled and hashed exceedingly fine. It is then rendered in water-jacketed kettles at a temperature of about 50 deg. C. The scum which separates out at the top is drawn off and the scraps settle at the bottom. The liquid fat is then run into vats and there permitted to stand for a day or two at about 27 deg. C., at which temperature butter is just liquid. The semi-liquid mass is then wrapt up in cloths and there permitted to stand for a day or two at about 27 deg. C., at which temperature butter is just liquid. The semi-liquid mass is then wrapt up in cloths and there permitted to stand for a day or two at about 27 deg. C., at which temperature butter is just liquid.

The semi-liquid mass is then wrapt up in cloths and there permitted to stand for a day or two at about 27 deg. C., at which temperature butter is just liquid. The semi-liquid mass is then wrapt up in cloths and there permitted to stand for a day or two at about 27 deg. C., at which temperature butter is just liquid. The semi-liquid mass is then wrapt up in cloths and there permitted to stand for a day or two at about 27 deg. C., at which temperature butter is just liquid.

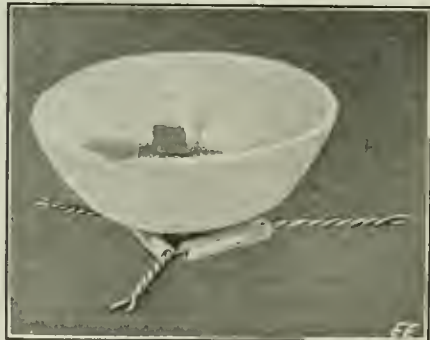

Fig. 3. Test for Coal Tar Coloring in Butter Which Can Be Made by Anyone in a Few Minutes' Time.

from the flame, boil up over the side of the spoon. Renovated butter or oleomar-

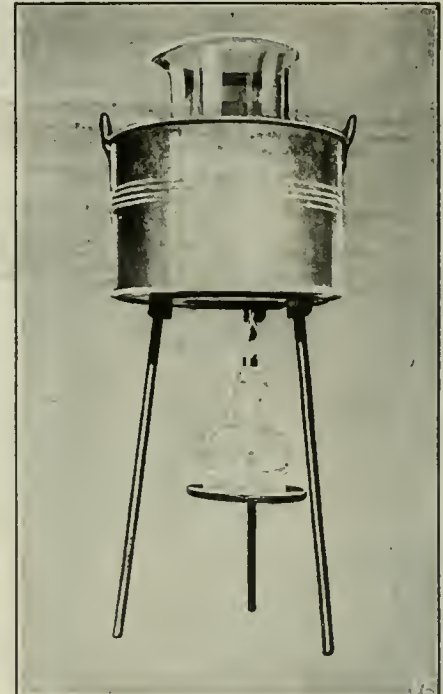

Fig. 2. Set-up of Simple Apparatus Utilized in Making the "Milk Test" for Butter.

about 60 cc. of sweet milk in a wide-mouthed bottle, which is set in a vessel of boiling water. When the milk is thoroly heated, a spoonful of the butter is added and the mixture stirred until the fat has melted. The bottle is then placed in a dish of ice-water, and the stirring continued until the fat solidifies. If the sample is butter, either fresh or renovated, it will be solidified in a granular condition and distributed thru the milk in *small particles*. If, on the other hand, the sample consists of oleomargarin, it solidifies practically in *one piece*, so that it may be lifted by the stirrer from the milk.

By the two tests just described, the first of which distinguishes fresh butter from process butter or renovated butter and oleomargarin; and the second of which distinguishes oleomargarin from either fresh butter or renovated butter, the nature of the sample examined may be determined.

Every house-wife should know how to test butter and oleomargarin and the important differences between them. That is one object of the present paper. The author trusts it proves of value.

BEGINNING with this issue, "EXPERIMENTAL CHEMISTRY", as will be noted, has been changed to "PRACTICAL CHEMICAL EXPERIMENTS." For several years past, Mr. Albert W. Wilsdon, who will continue the new department, has become familiar to our readers thru his chemistry articles. There has, however, been an urgent demand from our readers for articles on everyday chemistry, practical experiments, etc. We are, therefore, beginning with this issue a series of practical chemistry, free from technicalities. We think the change will be welcomed by our friends.

In the same department we are also inaugurating a Question and Answer Department, and every reader is invited to ask any question on chemical phases which may occur to him. Such questions will be answered every month hereafter in these columns. When sending questions, they should be address to "Editor, Chemistry Department."—Editor.

gargin will sputter and act like hot fat containing water, but will not foam. Examine also the curdy particles when the sample is



This department will award the following monthly prizes: First Prize, \$3.00; Second Prize, \$2.00; Third Prize, \$1.00. The purpose of this department is to stimulate experimenters towards accomplishing new things with old apparatus or old material, and for the most useful, practical and original idea submitted to the Editors of this department, a monthly series of prizes will be awarded. For the best idea submitted a prize of \$3.00 is awarded; for the second best idea a \$2.00 prize, and for the third best prize of \$1.00. The article need not be very elaborate, and rough sketches are sufficient. We will make the mechanical drawings. Use only one side of sheet. Make sketches on separate sheets.

FIRST PRIZE, \$3.00

A SIMPLE WHIMSHURST INFLUENCE MACHINE.
By Melville Fisk.

THE static machine described herein is made of simple materials, is easy to construct and the work does not

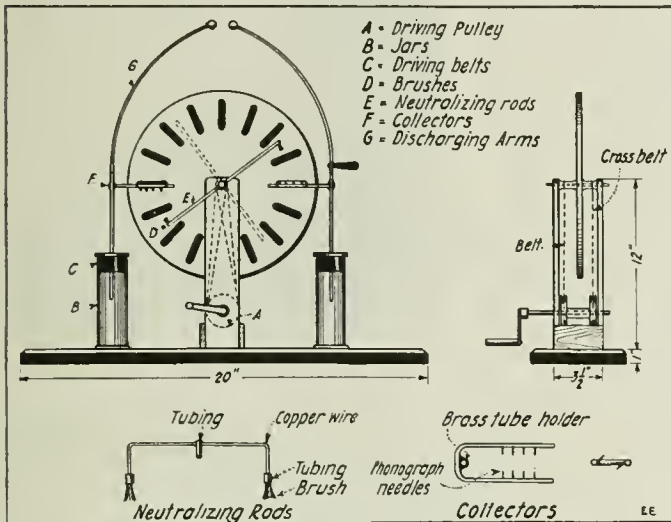

A Home-made Static Machine Constructed from Phonograph Disc Records.

require the use of special tools. A similar machine built by the writer produces a violent and steady spark discharge about an inch or more in length, without the use of Leyden jars.

The plates are two twelve-inch phonograph records of the disk type. Select two which have one side blank. The tin foil sectors are cemented to the smooth side. It is not necessary to varnish the plates. The bosses that keep the plates parallel on the shaft are small cotton spools, that have a hole in them the size of the one in the record. Fit the spools up with brass tube bearing and fasten to the plates with glue. A thin cloth or paper washer inserted between the boss and plate will help the glue to hold. Rubber tire cement will hold better if at hand. The shaft on which the plates revolve extends out $\frac{3}{4}$ of an inch on either side of the wooden standards; it is held stationary by a cotter pin inserted in a hole bored down thru the top of the standard. Glue a cardboard washer $1\frac{1}{2}$ inches in diameter to the inside of one of the plates. The base and standard are made of wood in the manner illustrated.

Make the double driving pulley from a large spool such as wire is sold on. Fasten it to the shaft by drilling thru the shank and shaft and inserting a cotter pin or screw. Be sure and make the grooves in the pulleys deep enough to hold the belts securely. Rubber bands tied together make very good driving belts. Tie them with strong linen thread and leave a half inch of slack between each band. As the plates are to revolve in opposite directions, cross one belt.

The neutralizing rods are made from $\frac{3}{8}$

SECOND PRIZE \$2.00

BLINKING LIGHTS TELL YOUR FORTUNE.

A glance at the illustration will show that while the magnet side of the relay is open, the small battery motor is running, revolving the drum. A gear may be used if a slower speed is necessary. When the push button is prest, the armature of the relay is attracted, breaking the motor circuit and making connection on the other side of the relay which goes to the one set of brushes on one side of the drum. The armature is itself connected to one side of the battery for the motor, and to one side of the current supply for the lamps. On the other side of the drum are the brushes connecting to the different rings on the drum. These brushes also connect with the various lamps which are again connected to the other side of the current supply for the lamps. As the button is prest, the motor stops and the circuit thru one of the lamps is made, the particular lamp depending upon the position of the drum when the motor stops. In front of each lamp is a pane of glass on the back of which is pasted the fortune telling matter. The front of the glass may be painted with a thin white paint.

Contributed by
WILLIAM F. HAASE, JR.

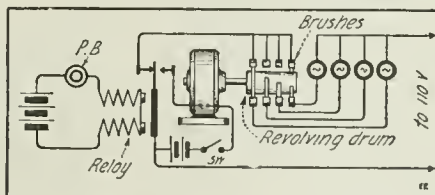

An Interesting Electric Fortune-Teller, Which Will Provide Hours of Amusement.

inch copper wire bent to shape. They are pivoted on the protruding ends of the shaft by a short piece of tubing soldered to the center. Press the tubing slightly together at the open end to make it grip firmly. The brushes are made from very fine copper strands secured from wire such as is used in receiver cords (gilt tinsel). Cut about twelve strands two inches long; tie a knot in the center, and fold over so that all ends are together. The brushes are then split into the small tubes soldered onto the ends of the rods and are fastened by squeezing the end of the tube together.

Make the collectors as per sketch, using heavy copper wire. The points are long phonograph needles, fastened to the arms

THIRD PRIZE, \$1.00

PORTABLE BATTERY HAND LAMP FOR THE HOME.

The articles for the construction of this lamp can be purchased at a small sum, if you haven't them at home. Flexible lamp wire is the best for the wiring of this light.

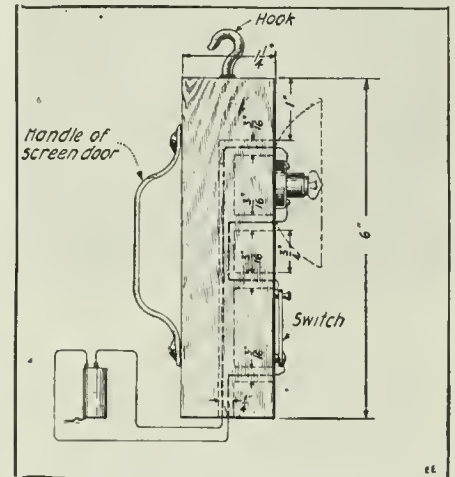

You Have Often Wanted a Portable Battery Hand Lamp—Here's How to Make One at Practically No Cost.

About ten feet of wire is needed, when a large dry cell is used which cannot be carried around. For a pocket (flashlight) battery only a few feet is necessary. By means of the hook the lamp can be hung anywhere or in any corner on a nail, etc. A $1\frac{1}{2}$ volt tungsten lamp is right for a single dry cell. A reflector adds greatly to the efficiency of the light.

Contributed by **RAYMOND WAGNER.**

by drilling and then soldering. The needles should be slanted slightly in the direction in which the plate rotates. The supports are brass tubing, soldered on.

The discharging arms are of brass rod of a size that will fit in the collector supporting tubes. Make a small dent in each tube so that the rods do not slip all of the way thru. Fit balls to the ends of the rods by boring, then pegging and soldering.

The jars are used as supports only. Varnish them inside and out and fit with stoppers, bored to hold the collector tubes. A simple stopper is made by cutting a large wire spool in half and then winding paper around the shank to make a fit with the jar. Before using soak the stopper in melted paraffin. Further insulation can be obtained by placing pieces of a broken record under the jars. Glue the jars to the base.

In operation the neutralizing rods should be at right angles to each other, the best angle, however, can easily be found by trial. The brushes should touch the plates lightly—no pressure is necessary. The collector points should be about $\frac{1}{4}$ inch away from plates. Be sure that they are all the same distance away or else some will not contribute to the collecting. The distance between the plates should be about $\frac{1}{8}$ to $\frac{1}{4}$ inch.



EDITED BY S. GERNSBACK

A Simply Constructed Gas Generator

By IVAN CRAWFORD

AMONG the automatic gas generators on the market there are few within reach of the average experimenter. To meet this condition, Prof. C. D. Dilts has recently developed a generator which may be easily and cheaply constructed. In experi-



This illustration shows the different parts composing the "Gas Generator" here described.

menting with qualitative analysis a constant supply of hydrogen sulfide is essential. This generator, being self-regulating, will furnish a constant flow of hydrogen sulfide, carbon dioxide, or hydrogen. The principle of operation is the same as that of the well-known Kipp generator, namely that when the gas formed is not allowed to escape the solid material is automatically raised out of the liquid, but when the pressure is relieved the solid substance is lowered into the liquid, and the generator begins to function. As will be seen in the drawing, the four parts are: first, a glass jar or container; second, a bottle of slightly smaller diameter, with the bottom removed, and fitted with a stopcock in the top; third, a lead basket for holding the solid material; and fourth, a small wash bottle.

The glass jar may be easily made by cutting off the top of a large bottle. There

are many methods which may be employed in removing the bell of the bottle, but by far the best and surest is the one described below.

Several long strips of newspaper, about an inch wide, should be soaked in water and wound about the bottle in two bands at the place where it is desired to break the bottle. About a quarter of an inch should be left between the two bands. The bottle should then be slowly revolved with the hands, allowing a blow-pipe flame to play upon the exposed part between the bands. When this portion is heated sufficiently the application of a drop of water will cause the glass to be evenly broken. The edges should then be smoothed on a soft grindstone. The bottom of the smaller bottle is removed in the same manner.

The sheet lead for the basket may be procured at any plumbing shop. It may be

easily bent to the required shape, leaving small holes in the bottom to allow the acid to enter. The basket is suspended by means of a closed piece of glass tubing, bent to form a hook, which runs thru the two-hole stopper. The delivery tube from the bottle



Completely Assembled Gas Generator and Wash Bottle.

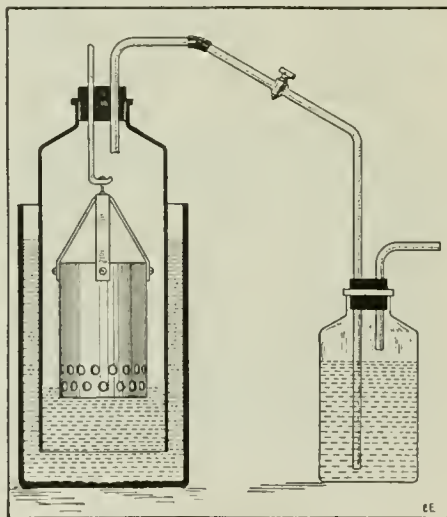

Sectional View of Gas Generator.

may be fitted either with a glass stop-cock or with rubber tubing and metal pinch-cock. Altho not absolutely necessary, a wash bottle is a desirable addition to the generator, as it not only steadies the flow but cleans and purifies the gas.

The apparatus should now be assembled as is illustrated in the drawing and photograph. The solid material, such as iron sulfid (when H₂S is desired) is placed in the lead basket and the dilute acid in the glass jar. When the smaller bottle is placed in the jar the acid, reacting with the iron sulfid, engenders a flow of H₂S which forces the acid out of the basket if the stop-cock is closed. When the stop-cock is opened, the gas escapes and allows the acid to touch the iron sulfid, again causing the formation of H₂S. Thus gas is always easily procurable without waste of material.

TESTED CHEMICAL LABORATORY STUNTS.

1. *Spoons That Will Melt in Hot Water.*—Fuse together in a crucible 8 parts of bismuth, 5 of lead, and 3 of tin. These metals will combine and form an alloy, of which spoons can be easily made which possess the remarkable property of melting in hot water, coffee or tea.

2. *A Self-dancing Egg.*—Take a thin glass tube about 3 inches long and fill it with mercury then seal both ends with good hard wax. Next have an egg boiled and then break a small piece of the shell from the smaller end and thrust the tube with the mercury in, lay it on a table and it will not cease tumbling until the egg is cool. The same can be done by taking a small bladder putting a little mercury inside and blowing it up, then warm the bladder, it will skip about as long as the heat remains.

3. *To Give a Piece of Charcoal a Coat of Silver.*—Lay a crystal of silver nitrat upon a piece of burning charcoal; the metallic salt will catch fire and will emit sparks of various colors. The silver is reduced, and, in the end, produces upon the charcoal a

very brilliant and beautiful appearance.

4. *In Water But Not Wet.*—Powder the surface of a large or small vessel of water with some lycopodium, which may be obtained at any drug store; you may then challenge any one to drop a coin into the water, and that you will get it without wetting your hand. The lycopodium adheres to the hand and prevents its contact with the water.

5. *Artificial petrifications* (turning into stone).—In a retort place a small quantity of pounded fluor-spar and sand, and pour upon it some sulfuric acid; fluosilicic acid gas will be disengaged, holding silex in solution. The subjects you wish to petrify must be moistened with water and placed in a vessel connected with the neck of the retort, the silex will be precipitated upon them like a frost and will have a beautiful appearance. It will wear for years. Note—Do not breathe in this gas.

6. *An Experiment With Sugar.*—Take about 5 or 6 pieces of lump sugar and place them in a cup; next pour about 3 tea spoons full of boiling water upon them, and then add some sulfuric acid. It is truly a won-

derful spectacle, and more instructive than reading, to see the sugar turn black, then boil, and now, rising out of the cup in a black color. It is now charcoal.

7. *To Melt Steel.*—Heat a piece of steel to redness in a fire, then hold it with a pair of pincers. In the other hand take a stick of brimstone or roll sulfur and touch the piece of steel with it. Immediately after their contact the steel will melt and drop like melted butter.

8. *Explosion Without Heat.*—Take a crystal or two of nitrat of copper and bruise them; then moisten them with water and roll them up in a piece of tin-foil, and in a minute the foil will begin to smoke and soon after will take fire and explode. Unless the crystals of copper are moistened, no heat will be produced.

9. *To Melt Lead in Paper.*—Wrap up a very smooth piece of lead in a piece of paper, then hold it over the flame of a taper; the lead will be melted without burning the paper providing there are no wrinkles in the paper and that it is in contact with the lead everywhere.

Contributed by EUGENE MCGOWAN.

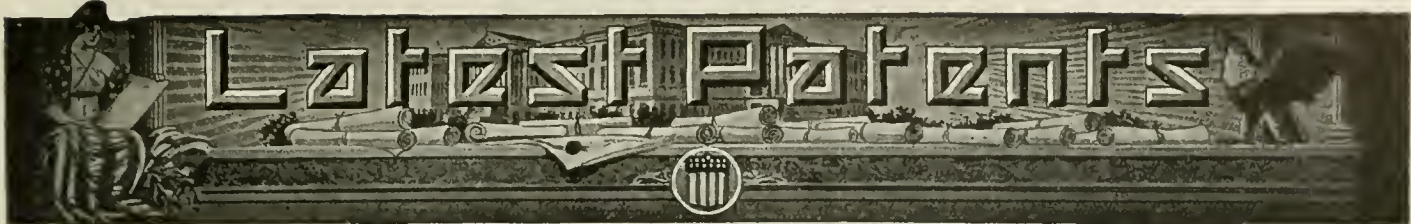

Electric Engraving Apparatus
(1,289,000; issued to Andrew M. Robinson)

An electric engraving apparatus employing a source of electric current forming an arc to produce the engraving. It consists of an ap-

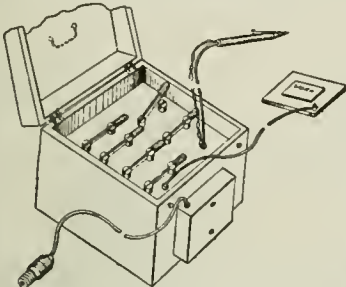

paratus employed with graduating tools, etc., for marking metal parts of machines, etc. A further object in the invention provides an auxiliary electric current or circuit connected to the pencil, and means in the pencil for controlling the make and break of the auxiliary circuit, to open and close the main circuit so as to prevent arcing when it is raised from the work. This apparatus eliminates this objectionable feature. The case contains a transformer, also a number of switches, by which the character of the current may be varied at will.

Current Modulator
(1,288,117; issued to Francesco Morano)

The chief object of this invention is a metallic microphone for high currents, which microphone is constituted by one or more metallic

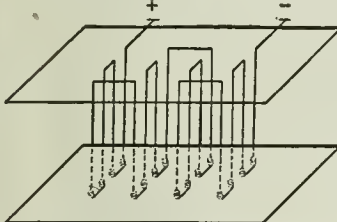

gripping contacts, which gripping contact is formed of two contact elements, so arranged that one of them grips the other. The vibrating element is firmly mounted by the diaphragm, while the other element is supported by such means that the pressure of the contact which is formed by both elements accurately affects it. In consequence, the electrical resistance of the contact itself may be capable of varying in rigid conformity with the vibrations of the diaphragm according to the amplitude of said vibrations.

Apparatus for Locating Sunken Bodies
(1,287,907; issued to Patrick B. Delany)

Sunken ships and bodies, by the use of this invention, may be found very readily. It is an electrically operated device, used with some form of communicating device, such as a telephone receiver, and acts upon the principle of the circuit



being closed, and having normally a certain definite resistance, i.e., the inventor does not use coils conductively or otherwise for the detection. The bare electrode is lowered by means of an insulated wire thru the water, and depends upon actual

contact with some metallic body for its location. The circuit is formed thru a pair of sensitive head receivers, the bare electrode, the water and the electrode, and normally is of high resistance.

Recording Telephone
(1,290,621; issued to John F. Malhaner)

A new form of recording telephone, more or less on the style of the dictating telephone. A device in convenient size and weight for use on office desks, etc. It is so constructed that it may be used for receiving direct dictation over the phonograph, and also may be used to receive telephone messages from the ordinary telephone receiver, and in this manner to record the same on a phonograph record. Particular attention is attached to a new form of reed diaphragm constructed of the same width from end to end; approximately at its center is mounted a square soft iron disc held in place by clips, which on its underside has a holder for supporting the sapphire point of the phonograph.

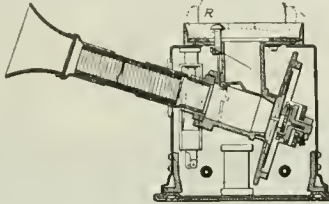

Advertising Lamp and Radiometer
(1,290,749; issued to Edward J. Hunt)

The device consists of a motor operating on the principle of the radiometer, in which the moving motor elements are caused to rotate upon their axes by the action of light. The device is primarily intended to be inserted within the enclosure of any ordinary incandescent lamp bulb and combined with the filament support in a manner permitting the use of the usual lamp filament, so that the light issuing therefrom shall cause the rotation of the several motor vanes. The motor element consists of a series of vanes, preferably four or more, which are silvered upon one side and blackened upon the other side with carbon or lamp black.

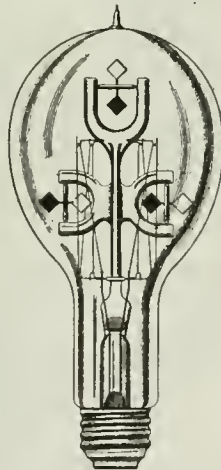

Radium-Applicator
(1,288,048; issued to George Kunkle)

A radium applicator adapted for the use of radium and other radioactive salts. The applicator is properly calibrated in advance and so arranged that the physician using it can accurately measure and administer by any of the approved

methods the correct dosage at any moment by a simple adjustment of its parts. This instrument automatically and evenly irradiates surfaces of widely variable areas, as, for instance, areas of from one mil-

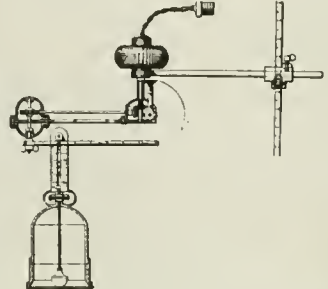

limeter to thirty-two centimeters in diameter.

Secondary Or Storage Battery
(1,285,660; issued to Bruce Ford)

A new type and form of storage battery, its principal object being to minimize leakage between cells and still have a multiple voltage battery of sufficient strength to withstand the stresses and wear acting on such a battery. The structure may be described as a number of plates having a central portion, one face provided with a negative formation and the other face having a positive formation, with a rim projecting beyond both formations so as to fit and be prest into soft rubber tubing, which will make it non-leakable. The spaces between are filled with an electrolyte, which may be any plain liquid, or else held soaked in blotting paper or some other gelatinous formation.

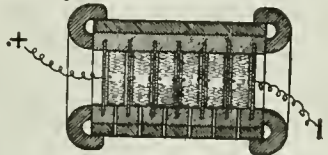

Method of Telephonic Transmission Without Return-Wire
(1,287,180; issued to C. Bardeloni)

A new method of transmitting speech without a return wire. It is sometimes necessary to use a single wire for telephonic transmission without earthing its end. A condition like this might exist in connection with an observation balloon where the stringing of the separate telephone cable would not be feasible. Under these conditions the circuit does not close by conductivity, but remains as an open circuit, the return being formed by one or more metal conductor squares, electrostatically and electromagnetically connected between each other. This invention has the object of effecting telephonic transmission by the variations of the electrostatic and electromagnetic conditions, without any metallic conductors, or the earth, connecting the extremities of the system.

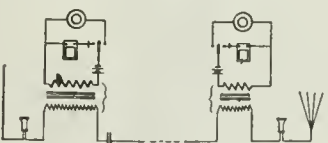

Compass-Gyroscope
(1,289,813; issued to Emil Klahn)

The invention consists primarily in mounting the gyroscope so that at all times it is unaffected by gravity, and in utilizing this potential function of the gyroscope to regulate the position of the controlled member, when a disturbing force is acting on

the gyroscope. Its application is mainly a non-magnetic compass, when such disturbing or directive force results from the rotation of the earth, and for movements and changes in the course of a vessel carrying the compass, and apparent rotation of the compass card or controlled member taking place and serving as a measure of the change in course. The gyroscope is a means to partly suppress freedom of rotation about its vertical axis and a frame within which said gyroscope is pivotally mounted. A resilient means is connected with the frame adapted to work on the gyroscope, when the control member or compass card is in connection with said frame.

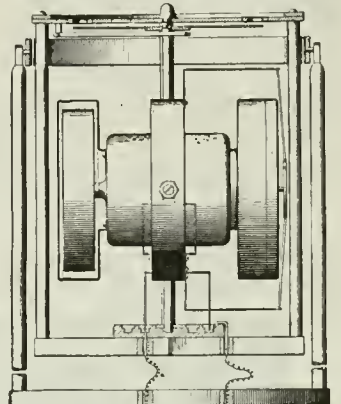

Thermostat
(1,287,188; issued to Heinrich Beck)

A new design of thermostat, which to a certain extent eliminates many of the troublesome factors of the old style instrument. This type of thermostat is one which employs but one movable contact, the other being fixed, altho adjustable, and the two thermostat elements generally control the single movable contact, in response to a variation in temperature. But only one is subject to the action of radiant heat, and acts directly upon the carrier, and thereby acts directly upon the movable contact. The heat ray

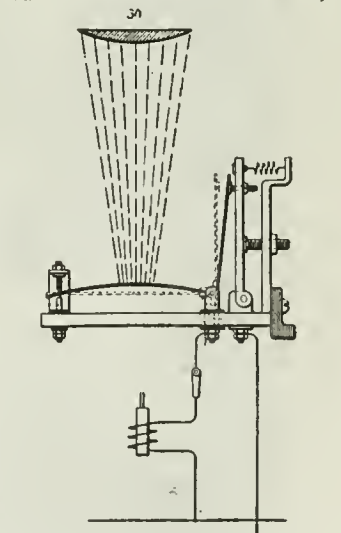

may be concentrated on the thermostatic element by means of a condensing lens. When the element is at a normal room temperature it is straight, but when the radiant heat strikes the thermostatic element, then it curves slightly upward, moves a crank upon the carrier, which presses the fixed contact, thereby closing the circuit.



Our Amateur Laboratory Contest is open to all readers, whether subscribers or not. The photos are judged for best arrangement and efficiency of the apparatus. To increase the interest of this department we make it a rule not to publish photos of apparatus unaccompanied by that of the owner. Dark photos preferred to light-toned ones. We pay \$3.00 prize each month for the best photo. Address the Editor, "With the Amateurs" Dept.

"Amateur Electrical Laboratory" Contest

THIS MONTH'S \$3.00 PRIZE WINNER — RAYMOND L. CASSELL

HEREWITH I present three pictures of my Electrical Laboratory. In this "Lab" you can find anything from a binding post to a six hundred thousand volt Tesla coil. I have constructed two high potential transformers and one welding transformer with an output of three volts and five hundred amperes. Practically everything in this "Lab" was built by me. There are several motors, both A. C. and D. C., dynamos, about a dozen spark coils, transformers, storage batteries, small steam engine, rectifiers, Tesla coil (Oudin type), switches of all kinds, telegraph instruments, condenser, volt and ammeters, et cetera. I can get a twelve to fourteen inch spark from the Oudin coil. If the spark is not drawn off, it will brush discharge to a length of ten inches, crackling and waving like a thing alive. I perform some very interesting experiments with the coil. I also have a small storage battery set with a separate switch-board for charge and discharge. I have a search-light (arc), which will throw a beam about two miles. I operate this on a 110 volt circuit with a transformer built for the purpose. I am now building a 330 watt D. C. dynamo. I experiment with about everything going and a lot more.—Raymond L. Cassell, Roanoke, Va.

HONORABLE MENTION (1 year's subscription to the "ELECTRICAL EXPERIMENTER")—J. H. ENGLAND

HEREWITH are photographs of my Laboratory. In one of the photographs may be seen my "Wireless Table," which contains all the different instruments used for both sending and receiving. The transmitting set consists of a $\frac{3}{4}$ K. W. step-up transformer, condensers, spark gap, key, ammeter, et cetera. There is also a 1 inch spark coil for sending short distances. For receiving I have used successfully (before the war) a tuning coil for short distances and a loose coupler for long distances, in connection with a silicon detector, 2,000 ohm Brandes' phones, loading coil, variable and fix condensers. To the left may be seen my switch-board, which is home-made. It contains a number of different switches, a buzzer, a lamp resistance, and a pilot lamp. To the left of the switch-board there are several shelves on which are different electrical books, such as "Hawkin's Electrical Guides," Houston's "Electricity in Everyday Life," and many others. There are various other instruments on this table, such as telegraph key and sounder, electric fan, Solderall torch, and an interrupter. Another photograph shows the chemical and photographic table. This table consists of a complete developing and printing set. To the left will be seen the printing box, which is home-made. The frame is an Auto Mask Printing Frame and is secured to the box by means of small hooks, so as to permit it to be removed easily. Inside there is a red and a white light. To the right there are a large number of chemicals, such as nitric acid, bromin, sodium, et cetera. This part of my "Lab." comes in handy when I need a picture of some electrical experiment. This laboratory is the result of but one year and a half of earnest work and study.—J. H. England, 509 George, Greenwood, Miss.



Science in Slang

Jazz Stokes on Wireless Dope

By EMERSON EASTERLING

"I SAW a while back in a paper that Tesla and Marconi were expressing their ideas on interplanetary wireless communication. It don't look very reasonable to me that it could be done in the way that they proposed it, but I don't say that the feat is impossible," remarked Jazz Stokes the other night.
"How does a wireless wire?" asked Bender.

loco, bunque, and then some. The same ginks today however sing a different tune and admit that in 1900 THEY were fast asleep and deader than an Egyptian mummy, with heads as solid.

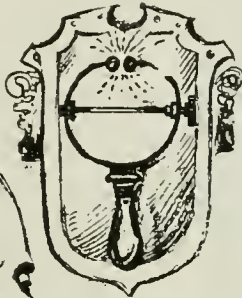

Heiney Hertz — Who While Monkeying Around Spark Coils and a Micrometer Spark Gap, Fell over the Hertzian Wave.

"It don't wire, that is why they call it wireless," returned Jazz.

"Well," I put in, "of course, Punk and I know all there is to know about wireless; but for Bender's sake I wish you would tell us a little about wireless."

"You are probably familiar with the African tum-tums and the Indian signal fires," he began. "They were the original form of wireless.

"A scientist by the name of Hertz, Herr Heinrich Hertz, got to monkeying around with spark coils and developing the micrometer spark gap or resonator. This apparatus worked on the principle that electro-magnetic waves radiate from a point of discharge. The twinkling spark between the gap was due to induced current, being virtually a secondary coil of one turn. Well, this set Heiney to deducing, and he deduced the present Hertzian theory of wireless wave radiation.

"While Heinrich, never having caught up with the second syllable of his first name, died a poor man, Nick Tesla hadn't been napping either. The whole wireless dope to this bird was an unsealed book as early as 1893, when Marconi still slid down the banister in his knickers. Thus we see Nikola two-stepping it nonchalantly to the Pat. Office, where he grabs the first REAL wireless patent along in 1900. The old boy had it all down in black on white, aerial, ground, spark gap, *et al*—the real, honest to goodness dope. This earned him the title of "Papa of the Wireless." But in those days there were no detectors and few experimenters to boot. So the then wisecrackers sniffed at Nick's Patents, tapt their foreheads significantly and made known that this wireless stuff was all

"Then along comes Kid Marconi and devils around with oscillators, sending waves thru buildings and other masses until he gets to work and builds a real wireless telegraphing station. By sticking his aerials up so as to clear the buildings and other masses he finds that he can send and receive for miles instead of blocks. In 1901, on the twelfth day of December, he shoots a 'can-you-get-it' across the Atlantic—and they got it. Soon all the first class vessels were equipt with radio men and added antennae to their rigging, so that they could let the world know that all was off with them by their C. Q. D. and S. O. S. yelps, instead of leaving floating spars upon the briny deep for some brig to sight later.

"Marconi went on improving his apparatus and handled the financial end so that besides being a first rate experimenter and Italian gentleman of standing, he don't have to eat macaroni with a pencil.

"The world wallows along, and the patent offices pile up the documents in the wireless department, when an ardent bird, Dr. Lee de Forest, waltzes on the stage of industry to the tune of 'N' EVERYTHING' and shows us *something*. You might mistake it for an incandescent bulb, but it is as much like a light globe as a Victrola is like a centre table. We call it the Audion Amplifier, and with it in your receiving set you are able to make a squeal a scream. The wireless nuts first found that it was a scream when the ionizing sunlight failed to close the Hula-hula island and 'Frisco communication in the wee sma' hours of the morning, after the hour that the other detectors went bad on 'em.

"For Bender's sake I will give you 'Kicks'* the line up on a simple wireless station. First the transmitting apparatus

obtains its juice from batteries or other sources. Is that plain? Yes, well next there is a spark coil that steps the voltage up to a dangerous stage and a spark gap that lets the high tension current break down across the air space. This discharge sets up an oscillating current of high frequency. To increase the efficiency there are condensers inserted in the circuit—these store

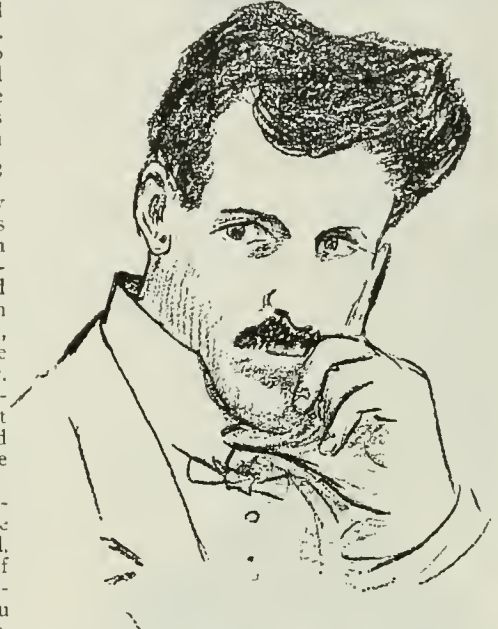

Doc "Nick" Tesla—Papa of the Wireless, Who Grabbed the First REAL Wireless Patent in 1900

up and discharge the juice like a nigger squirting prune juice thru his teeth, only very much faster."

Taking a pen and pad from his pocket, Jazz proceeded. "It is like this—see the K is the key; C, coil; c', condenser; A, aerial; G, ground; and B is for the source of juice. Then the receiving station is like this—A, aerial; D, detector; R, receiver.

There is added more stuff to sensitize the layout, but they would only look like a telephone central station wiring diagram here on paper, and besides, there are more different kinds than there are ways for a young boy to go wrong.

"In Guglielmo Marconi's original contraption the Signor used a *coherer*, where we use a detector or audion now. The coherer works by being welded by the incoming waves, the electrical resistance being less when the filings in the coherer are welded. The current is so regulated that when the wave waltzes in and unites the nickel and silver filings, the sounder that is connected in the circuit bangs down with a faint tap. The coherer is tapt by a de-coherer, jarring the nickel and silver filings loose for the next dot or dash—*ad infinitum*.

"The detector rectifies the oscillating current, making it fit to vibrate the diafram on the receiver that the 'Radiobug' has glued to his ear.

"The audion is an incandescent hulk with a parallel grid and plate, working on the theory that current will flow



Kid Marconi Who Devilled Around Oscillators and Who Shot "Can-You-Get-It" Across the Atlantic.

*That word is Kick and not Hick. Kick is a San Francisco slang word—it means almost anything, originating from a kick in booze and now applying to almost anything, good, bad, and indifferent.

(Continued on page 911)

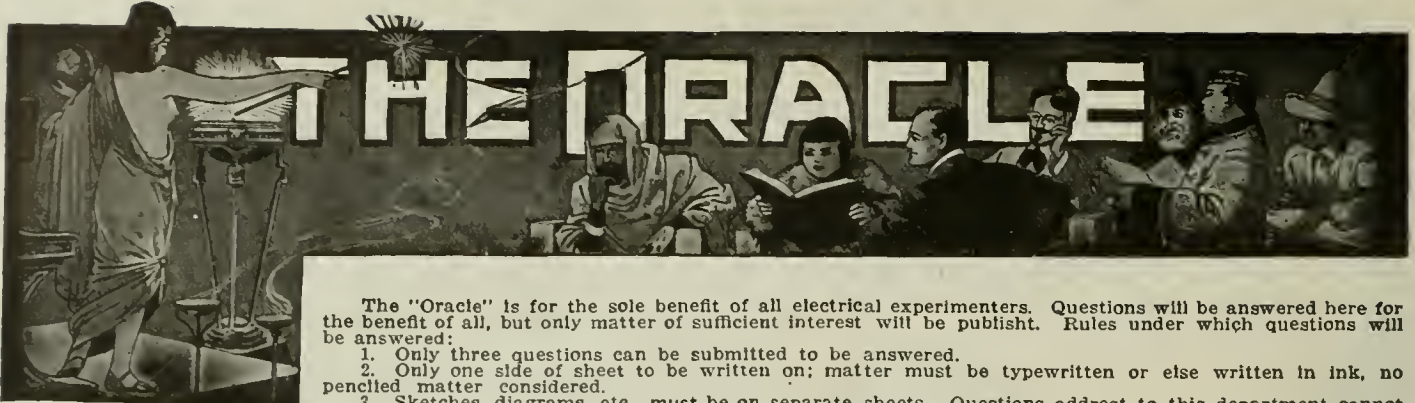

The "Oracle" is for the sole benefit of all electrical experimenters. Questions will be answered here for the benefit of all, but only matter of sufficient interest will be published. Rules under which questions will be answered:

1. Only three questions can be submitted to be answered.
2. Only one side of sheet to be written on; matter must be typewritten or else written in ink, no pencilled matter considered.
3. Sketches, diagrams, etc., must be on separate sheets. Questions address to this department cannot be answered by mail free of charge.

4. If a quick answer is desired by mail, a nominal charge of 25 cents is made for each question. If the questions entail considerable research work or intricate calculations a special rate will be charged. Correspondents will be informed as to the fee before such questions are answered.

500 K. W. DYNAMO DEVELOPS BURNT SPOTS ON COMMUTATOR.

(990) Geo. W. B., Chicago, Ill., inquires of the "Oracle":

Q. 1. What causes commutator bars to burn, blacken and roughen up in the following manner? There are about 4 bars under a set of brushes and every set of 4 bars spaced equally between centers of field poles will blacken. Description of machine: D. C. 500 K. W. rope drive, 8 poles, compound wound, 220 volts. Even airgap all around, commutator undercut, commutator true, field coils equal strength, no reversed coils, no overload, machine runs alone most of the time; sometimes in parallel with a 150 K. W. Brushes have a per-

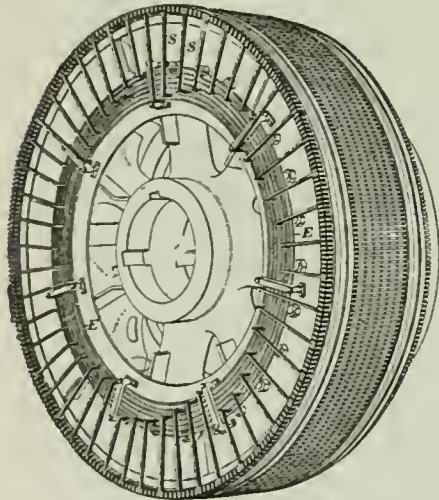

A Large Dynamo Armature Develops Burnt Spots on the Commutator at Equally Spaced Points, Corresponding to the Pole Pitch. One of the Remedies Suggested Is That the Armature Be Equipped with Balancing or Current Equalizing Rings, as Here Illustrated, which Shows Them Applied to a Parallel-Wound D. C. Dynamo Armature. These Rings Help to Equalize Any Heavy Cross Currents in the Armature which Might Produce Such Troubles.

fect gloss, practically no sparking. Four hundred segments to the commutator, all tight. Sanding commutator stops the trouble for 2 to 6 months. What causes it?

A. 1. We were particularly interested in the phenomenon you describe where the 500 K. W. D. C. dynamo, which altho apparently in perfect shape and maintenance, develops burnt spots all around the commutator at points corresponding to the spacing of the brush studs.

The Editor of the Oracle, while serving as engineer in a large power house some years ago, had similar trouble, and it practically defied solution by any of the experts who attempted to remedy it. Also in this case, it is clearly recollected that the machine, of about the size you mention, was in very fine running condition, and every-

thing seemed to be in favor of its perfect operation. But still these spots developed just as you state. After some thought on the matter it would seem from later experiences, that some of the following troubles might be the cause of these burnt spots appearing on the commutator:

ODD PHOTOS WANTED AT \$1.00 EACH!!!

Now is the time to make your Kodak pay for itself in a real practical way. We are after interesting photographs of out-of-the-ordinary electrical, radio and scientific subjects and are willing to pay \$1.00 cash for every one we can use. Please bear in mind that for half-tone reproduction in a magazine, a photograph should be particularly sharp and clear. Of course, if a subject happens to interest us particularly well, we can have the photo retouched. For the general run of subjects, however, it does not pay to go to such expense. Therefore, please take pains to properly focus and expose your pictures. It often happens that a really mediocre subject well photographed wins approval over an excellent subject poorly photographed. And don't send us plate or film "negatives"; send unmounted or mounted "prints", preferably a light and dark one.

As to what to photograph: Well, that's hard for us to say. We leave that up to you, and every reader now has the opportunity to become a reporter of the latest things in the realm of Electricity, Radio and Science. But, please remember—it's the "odd, novel or practical stunts" that we are interested in. Every photo submitted should be accompanied by a brief description of 100 to 150 words. Give the "facts"—don't worry about the style. We'll attend to that. Enclose stamps if photos are to be returned and place a piece of cardboard in the envelope with them to prevent mutilation. Look around your town and see what you can find that's interesting.

Address photos to—Editor "Odd Photos", ELECTRICAL EXPERIMENTER, 233 Fulton Street, New York City.

1. From experience with several smaller machines, especially motors on elevator service, it would seem that field discharge currents, which are often of very high instantaneous e.m.f. value, would be liable to cause this burning. The remedy, or rather safeguard, against such trouble from this source would be to provide a field break switch fitted with an extra contact, so that

when the switch is open half-way it makes connection, so that the field can discharge thru a resistance. This resistance in some cases has been formed of a lamp bank, and if you try this, you will be surprised to see how brightly the lamps flash up whenever the field switch is open, i.e., when the dynamo is being shut down and after the main D. C. bus-bar switch has been opened. The field magnet, of course, possesses very high self induction, and when the field switch is opened, a very high self-induced current occurs in the field windings, tending to prolong the magnetization, and causing therefore, a very heavy current of high e.m.f. to occur when the switch is suddenly opened. Practically all dynamos above 50 K.W. capacity are and should be provided with proper protective field discharge resistance and field break switches of the type described.

2. It seems that insufficient brush tension would also cause this trouble, not perhaps while the machine is rotating at its normal speed and load, but due to a tendency which the brushes in such a case might have to jump when the machine was started.

3. Another possible but hardly probable source of this burning might be traced to hard commutator bars. High mica would also cause the trouble, but as you state, in your particular case the mica has been undercut.

4. Trouble is often experienced in power-station work where two or more dynamos are run in parallel, and especially if there is any weakness in the design of the equalizing circuit between the two or more machines, which may cause heavy cross currents to pass between the two machines. As you will readily conceive, such a current which might be caused by a partial unbalancing of the load between the two machines, might cause a momentary and in fact a fairly high e.m.f. transitory current to pass thru the brush and commutator system of one of the machines, and such a current would tend to have the effect of producing the burnt commutator.

5. Another trouble which would seem to point very strongly as a frequent source of this trouble, and one also that is very often overlooked entirely, is the unequal distribution of the armature current in such a large machine as this. The Editor recollects a case at one of the southern universities a few years ago, where no end of trouble was experienced in the operation of a large D. C. generator unit, due to this very reason, i.e., the unequal distribution of the current thru the armature windings. This defect in design, for that, of course, is what it is, causes a number of current paths to be set up periodically around the armature, and comparatively heavy currents will start flowing around these paths, their area being that enclosed between the axial lines of the two field poles in most instances. In the case in question, this was finally solved by the proper designing and installation of

(Continued on page 888)

The Opportunities In Draftsmanship

By CHAS. W. MOREY
President Chicago Technical College



During the twenty-five years in which I have had exceptional opportunities to observe the progress of technical work of every character, I have never known of such opportunities as exist today for competent draftsmen.

Very naturally the war had a great effect in producing the present conditions. Men were called from the drafting room to the trenches, leaving great gaps in our industrial organization which have not yet been filled.

And now when the war is over, we find many men not returning to their old jobs. We see business pushing harder than ever for markets. We hear of great building operations to be undertaken. We see a vast area of Europe devastated beyond description, to be rebuilt and very largely I believe with American material and with the help of American technical experts.

When it is considered that the draftsman must be employed on every detail that goes into the manufacture of structural work of every kind, machinery, ships, railroads, buildings, etc., the vast field for men in this profession can be somewhat appreciated.

The problem before thousands of ambitious young men is not whether to become draftsmen or not, but how and where to learn most quickly and thoroughly.

Formerly it was necessary to attend a resident school, which often meant giving up a position and spending time as well as money. It also often meant, if a man wanted to graduate, taking studies not really bearing upon technical training. Some got their training in drafting rooms of factories, architects' offices, or other places where they started out as boys and slowly worked their way up.

It has remained, however, for correspondence instruction to give every man a chance to become an expert in any branch of draftsmanship without leaving any job he may have and as quickly as his industry will let him pass from one lesson to another.

The Chicago Technical College by its method of training has prepared and is now preparing men everywhere to study in spare time at home and then to step into high-paying positions.

By this method no time is wasted on unnecessary branches. The student gets exactly the training he will use in practical work and in every case he has the direct personal instruction of specialists in the branch he has selected.

Before he decides about enrolling, any man can easily find out just how well qualified he may be to follow Draftsmanship. A test lesson is sent free to show the plan of instruction and to give the prospective student a chance to "size himself up."

We are ready to help ambitious men to get into this great profession with the least expense of time and money. We here know what the opportunities are. The calls we have to furnish good draftsmen to every kind of an organization prove every day that the job is always ready for the man who can fill it. If young men throughout the country could only realize what a future there is in Draftsmanship, many a one now wondering what his future is to be would come to a quick decision.

I hope that every reader of the Electrical Experimenter who is now doubtful about the calling he is to follow will write for information on one of our Drafting courses. If in doubt about which branch to take up, a letter sent to me personally will bring suggestions based on my own experience and that of our staff.

Make a Bigger Income Learn Draftsmanship

Great demand for draftsmen now. Still greater demand in prospect. War over, building is to be resumed and manufacturing to expand to meet home and foreign needs—which means plenty of good positions for draftsmen. Take up this paying profession. The Chicago "Tech" method is the quickest, easiest way to become a draftsman in spare time while you hold your present position. That proved before you pay a penny. (See free lesson offer below.) Send coupon. Learn how to earn

\$25 to \$100 a Week or More

at interesting work with opportunities to rise to superintendent, manager, or other executive positions. Let the Chicago "Tech" engineers train you. At least get the free lesson and information.

Drawing Outfit (No Extra Charge)

Every student of the Chicago "Tech" Home Study Course

in Draftsmanship receives this drawing outfit—set of instruments in case, drawing board, T-square, triangles, scale, curve, drawing paper, pencils, etc., or a cash credit in case he already has an outfit. You use them while learning—then take them right into your practical work.

Come To the College or TRAIN at HOME

Wherever you are you can have this Chicago "Tech" training. Complete instruction by mail. Exercises, lessons, personal direction of our experts right in your own home if you cannot come to the college for a resident course. Send the coupon and get the facts.

Auto and Gas Engine Course

All about automobile mechanism—its construction, operation and REPAIR—taught by mail. You train directly under the Chicago "Tech" automobile experts. Splendid opportunities open now.

Learn All This in Spare Time

All about the Principles of the Automobile.

All about Gasoline Engines.

All about Power Plants and Transmissions.

All about Carburetors and Fuel Supply Systems.

All about Lubrication and Cooling.

All about Batteries.

All about Magneto Ignition.

All about Starting and Lighting Systems.

Know How To Fix Troubles

Most complete instruction in auto repair work. Equips you for high pay or to start a business. Big demand for trained repair men.

Write Send the coupon and get catalog and all information now.

Easy Payments

The fees for Chicago "Tech" courses are very moderate—and you can pay on easy terms. And also—you can obtain in a few months what it would take several years to acquire by ordinary methods. You can get an early start. You are soon ready to take a paying position and to quickly get back the cost of your course.

FREE TEST LESSON

Other institutions ask you to pay first—and then to find out later how well qualified you are for this profession. We send the free lesson first and place you under no obligation at all. Discover your qualifications before you pay anything. And see for yourself just what Chicago "Tech" offers you in training which will bring a ready market for your services and open opportunities which are closed to the untrained man. The coupon will bring all the facts about the course, the small fee, and the easy terms.

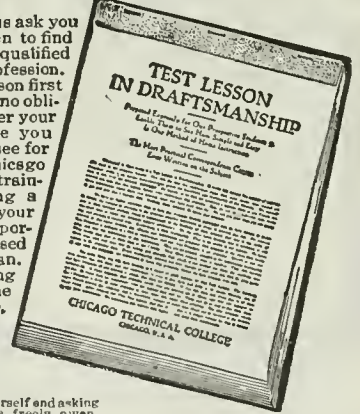

Mark with X the branch you are interested in—or if in doubt about which course to take, write interesting facts about yourself and asking our advice which will be freely given. Mail either the coupon or the letter today.

CHICAGO TECHNICAL COLLEGE, 445 Chicago "Tech" Building, Chicago

Without obligation upon me, send your Catalog on subject indicated below. Also FREE Lesson if inquiry is on Drafting or Plan Reading. Mark X opposite work in which you are especially interested.

- Architectural Drafting
- Machine Drafting
- Electrical Drafting
- Structural Drafting
- Sheet Metal Drafting
- Builders' Course
- Plan-Reading—Buildings
- Plan-Reading—Shop Men
- Estimating
- Surveying
- Map Drafting
- Autos and Gas Engines

Name.....

Address.....

City..... State.....

College or Home Study? State which.....

Preserve Your Phonograph Records!

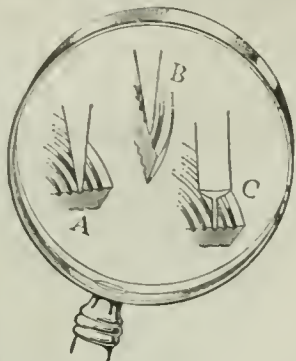

- A—Ordinary Steel Needle, new.
- B—As the ordinary needle wears down, owing to its taper form, it can no longer fit the record groove perfectly and has a tendency to wear the record.
- C—Sonora Needle having parallel sides ALWAYS fits record groove exactly and lengthens the record life.

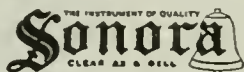

Semi-Permanent Silvered NEEDLES
 Replace steel needles!
 They play 60 to 100 times without wearing out

Use Sonora Needles for mellow tone, greater economy, convenience and for longer record life.

Loud—Medium—Soft

30c per card of 5

Sample Needle FREE! Write for it.
Sonora Phonograph Sales Company, Inc.

GEORGE E. BRIGHTSON, President

Executive Offices:

279 Broadway, Dept. G, New York

Use Sonora Needles on all makes of steel needle records

CAUTION! Beware of similarly constructed needles of inferior quality

Humanize Your Talking Machine

with the Ellis "Music Master" Reproducer. It is adapted for all makes of machines using disc records and entirely overcomes those harsh, rasping, scratching, metallic sounds, disagreeable nasal tones and other annoying "faults". Brings out all the hidden harmonies, musical shading and tone coloring and makes your old phonograph sound like an entirely different instrument. Guaranteed for five years, but improves with age and will last a lifetime. Write for circular "E".

J. H. ELLIS, P. O. Box 88
 Milwaukee, Wisconsin

CLEARTONE PHONOGRAPHS

\$4.00 to \$200.00 Retail

Needles \$450 per thousand in lots of 500,000
 Motors \$1.35 to \$14.75 each. Tone Arms and Reproducers \$1.30 to \$5.75 per set. Main Springs 20c to 90c each. Records, Needles, Sapphire Points and Parts at reasonable prices.

Write for our 84 page catalogue, the only one of its kind in America, illustrating 33 different styles of Talking Machines and over 500 different Photographic Parts.

LUCKY 13 PHONOGRAPH COMPANY
 Export Dept. 46B E. 12th St., N. Y., U.S.A.



THE ORACLE.

(Continued from page 886)

current equalizing rings placed on the back of the armature, as shown in the accompanying illustration.

Many different windings have been proposed and used successfully, but the majority of direct-current armatures are wound with either the single-parallel ring winding, the single-parallel drum winding, or the single-series drum winding. The single-parallel drum winding is probably more used than any other, and, on large multipolar machines, any unbalanced condition in the magnetic circuits is likely to cause the current to divide unequally among the several paths thru the armature. For example, if the air gap on one side of the armature becomes slightly shorter than that on the opposite side, which may easily occur due to wear of the bearings, the flux in the short air gap will become unduly dense, thus causing the generation of higher e.m.f. in the armature conductors on that side than in those on the other side, and the path that develops the highest e.m.f. takes the greatest share of the current. In some cases this unbalanced condition may not be bad enough to cause trouble other than some slight sparking, but in extreme cases, the e.m.f. of one path or of the paths on one side of the armature may become so excessive as to reverse the current in some of the other paths, making part of the armature act as a generator and part of it as a motor at the same time. This condition is usually accompanied by severe vibration of the whole machine, due to excessive mechanical strains, with more or less violent sparking or flashing at the brushes, and the machine is said to be "bucking." On account of the effects of armature reactions, bucking is somewhat more liable to occur in motors than in generators. The bad effects due to unbalancing can be eliminated by providing the armature with equalizer rings as shown. By means of equally spaced leads these rings connect points of equal potential in the winding and allow an equalization of current between the various paths in the armature.

Sometimes erratic line disturbances, motor flare-backs, defective motor control apparatus, will cause the effect you describe.

We would recommend that you look up some of the better class books on D. C. machinery operation and design, particularly those by Hobart and Parshall, which you can procure at your local library.

BALLAST COIL FOR ALTERNATING CURRENT ARC-LAMP.

(991) Henry Tustin, Ocean Grove, N. J., writes:

Q. 1. I am having trouble in operating an experimental arc-lamp on 110 volts. What can you suggest?

A. 1. Regarding the operation of arc lamp at 110 volts house lighting current, you do not state what kind of current you have, whether alternating or direct. For one thing, this factor would determine whether your experiment would be a success or not, for the reason that if you are trying to operate the arc on alternating current, then you will find invariably that it will not operate well using a simple resistance coil or rheostat in series with it.

For alternating current operation the proper ballast is always composed of an adjustable impedance or choke coil made up of an iron wire or laminated sheet iron core on which several layers of magnet wire are wound. Where an ordinary 1,200 C. P. arc, such as used in ordinary store lighting, etc., is employed and taking about 5 amperes on a 110-volt circuit, the impedance coil may be composed of an iron core about 4" x 2", as shown in the diagram, and on one leg of which is wound about six layers of No. 14 D. C. C. magnet

wire, taking off taps from the third, fourth, fifth and six layers.

We very strongly surmise from the symptoms you give in your letter concern-

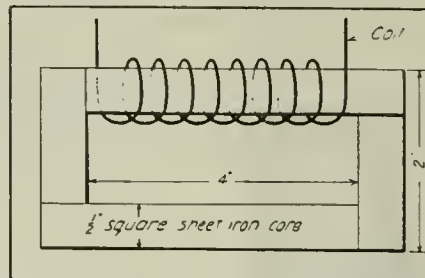

How Choke or "Ballast" Coil Is Made for Use in an A. C. Arc Lamp Circuit. This Takes the Place of the Resistance Coil in a D. C. Arc Lamp.

ing the failure of the arc to operate, that this is the trouble, as on A. C. circuits resistance will give a very poor break spark, and for this purpose there is required an inductance of the order described above.

HOMOPOLAR DYNAMO.

(992) O. S. M., U. S. N. R. F., writes: Q. 1. Giving a sketch of a commutator-less D. C. dynamo which he has invented and believes to be entirely new.

A. 1. We have looked over your drawings and description of what you term a direct current commutator-less dynamo, and while you appear to have something new in the peculiar design of the pole-shoes of the field magnet and the arrangement of the armature inductors, the whole principle of this type of dynamo has been known for the last forty years or more.

In other words what you have shown is simply the well-known "homopolar" dynamo, also called the "unipolar" dynamo. Faraday's first disk type dynamo belonged to this class. All machines of this type have the disadvantage of producing a very low electromotive force or voltage and are not usually practical, altho a few machines of this type have been used, where a very heavy current at a potential of a few volts was desired. You will find all the information you may desire in this direction by referring to the following works:

"Elementary Lessons in Electricity and Magnetism," by Silvanus Thompson, page 498. Also you would do well to refer to Professor Thompson's complete treatise, "Dynamo Electric Machinery," and a most thoro work covering the complete design and calculation of the electrical as well as the magnetic circuits of the "homopolar" dynamo is given in Prof. Alfred E. Wiener's excellent book, entitled "Continuous Current Dynamo Electric Machinery Design." These books are available thru our "Book Department."

The outline of the action of the machine you show is in accordance with the opinion of this machine given by Prof. Silvanus Thompson, in which he says in part:

"There is a class of dynamo-electric machine, differing entirely from any of the commutating types, in which a coil or other movable conductor slides around one pole of the magnet and cuts the magnetic lines in a continuous manner without any reversals in the direction of the induced currents. Such machines, sometimes called 'homopolar' or 'unipolar', have a very low electromotive force or voltage. Faraday's disk machine belonged to this class."

The stream that has been supplying the ancient city of Damascus with water for forty centuries has been harnessed to provide electricity to light the city and operate a railway.

According to an Italian scientist's figures, a square mile of the earth's surface in six hours of sunshine receives heat equivalent to the combustion of more than 2,600 tons of coal.

LANGUAGES QUICKLY LEARNED ON ALL PHONOGRAPHS

"Like learning a tune—and as easy." Our Disc Records repeat the correct accent and pronunciation until you know it. Family and friends enjoy language study by the **LANGUAGE-PHONE METHOD** And Rosenthal's Practical Linguistery

War has created unlimited opportunities for those who know languages. Prepare now to better your position or increase your business. Used and recommended by educators in leading colleges. Write for booklet and Free Trial Offer.

THE LANGUAGE PHONE METHOD
 931 Putnam Building 2 W 45th St., N. Y.

SPANISH, FRENCH, ITALIAN, ETC.

You can be a Graduate ELECTRICAL ENGINEER

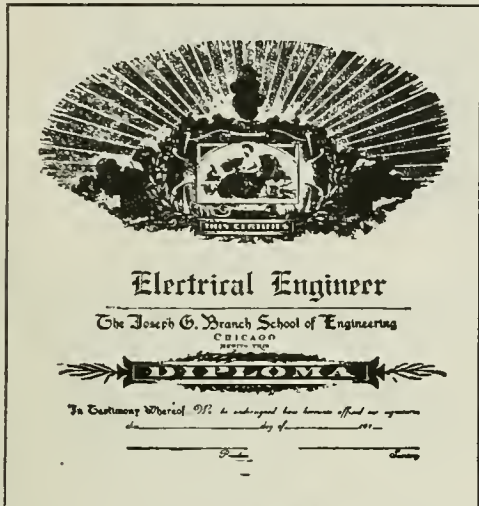

YOUR DIPLOMA

Our method of teaching saves you time and money in becoming a graduate, practical, Electrical Engineer—at Big Pay.

There is a large and constantly increasing demand for Graduate Electrical Engineers. Our Diploma is accepted as evidence of a competent, trained electrician. Hundreds of our Graduates are now big, successful Electrical Engineers. They will tell you what we have done for them. We can do the same for you—in your *spare time at home*. Read how these results are accomplished:

Your object in taking a correspondence course is to *Increase your Earning Power*. To learn exactly what you need and not waste your time and efforts on superfluous matter, is the shortest means to that end. The *Joseph G. Branch School of Engineering* specializes in equipping you with the *practical and usable* knowledge that enables you to qualify as an Electrical Engineer in the shortest time, yet our course is practical and complete. *This we definitely guarantee.*

You Get Intensive, Selected, Personal Instruction

Our courses are simple, practical and easily understood. Everything is made clear. You do not become involved in difficult technical matter of no practical value, and which is so discouraging to the student, but you go straight into the principles of the subject and the application of these principles. Every one of our students gets *personal* instruction, so that his progress is steady and sure. *You can't fail* with this course if you will simply follow our very clear directions. One of our students says: "Your course is strong for the Engineer. It gives him the vital working knowledge of the subject which makes him a competent Electrical Engineer in a very short time and at a very moderate cost." Many Electricians earn

\$2,500 to \$7,500 a Year

The course in Electrical Engineering covers the installation and operation of all kinds of modern electrical machinery and appliances, including power plant work, viz.: Practical Electricity, Alternating Currents, the Electric Motor, Practical Mathematics and Electrical Wiring. Under Practical Electricity both direct and alternating currents, high potential and high frequency currents are covered.

You get *everything* that will make you a proficient,

practical Electrical Engineer—without the loss of time spent on endless theory and difficult technical work of other methods. This has been made possible by the thirty years of practical experience of Mr. J. G. Branch, B.S., M.E., in the engineering field. This is now presented to you in compact, usable and easily learnable form. There is no course which will put you on a big salary basis in so short a time.

SEND FOR COMPLETE CATALOG, TESTIMONIALS AND LIST OF POSITIONS SECURED

Complete, Practical Correspondence Courses in

- | | |
|---------------------------------|-------------------------------|
| <i>Electrical Engineering</i> | <i>Power Plant Accounting</i> |
| <i>Stationary Engineering</i> | <i>Practical Chemistry</i> |
| <i>Mechanical Refrigeration</i> | <i>Practical Mathematics</i> |
| <i>Drafting</i> | <i>Ingenieria Electrica</i> |
| <i>Drawing and Designing</i> | (Spanish course) |
| <i>Power Engineering</i> | <i>Marine Engineering</i> |

We trained over 1,000 men for Government Marine Service
THESE BOOKS FREE!

With the Electrical Engineering course you get, FREE, these splendid text books—all *Standard Works*. These books alone are worth more than the price of the course. Each book by a recognized authority:

- | | |
|------------------------------|------------------------------|
| <i>Practical Electricity</i> | <i>The Electric Motor</i> |
| <i>Alternating Currents</i> | <i>Simplified</i> |
| <i>Electric Wiring</i> | <i>Practical Mathematics</i> |

You need this Electrical Library. Here is your chance to get it *free*.

Due to Mr. Branch's long experience in and close contact with the engineering field the courses embrace such questions as are usually asked by the various Boards of Examining Engineers throughout the country. Our graduates will testify to the ease with which they were able to pass these examinations, and the cooperation received from us in helping them get positions.

A Diploma from the Branch School of Engineering is a sure step to a better position and a larger salary. You can soon have your Diploma—without interfering with your present work.

SPECIAL OFFER

The price of the course is extremely low and just now we are making a Special Limited Offer to those who reply to this advertisement. This remarkable offer reduces the cost of the complete course to a very low figure. You will be astonished to find how little this tremendously valuable training will cost you. Mail coupon at once for full particulars and Special Terms. Jos. G. Branch School of Engineering, Dept. 14, 542 Dearborn Street, Chicago.

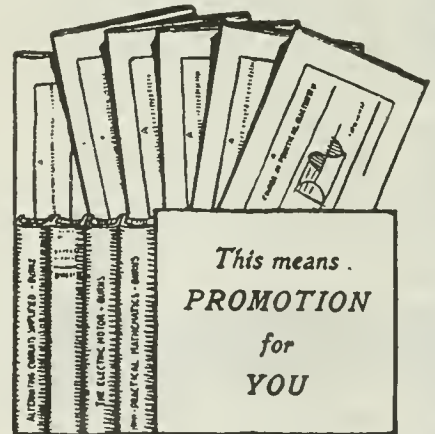

USE THIS COUPON

Jos. G. Branch School of Engineering
Dept. 14, 542 Dearborn St., Chicago

Without obligation you may send me information about your Special Offer on your course checked below:

- | | | |
|--------------------------|------------------------|-----------------------|
| Electrical Engineering | Drawing and Designing | Practical Mathematics |
| Stationary Engineering | Power Engineering | Ingenieria Electrica |
| Mechanical Refrigeration | Power Plant Accounting | (Spanish course) |
| Drafting | Practical Chemistry | Marine Engineering |

Name

Address

City State

Present Position.....

BOOK REVIEW

A VEST-POCKET DICTIONARY OF TECHNICAL TERMS USED IN WIRELESS. Flexible cloth covers, 168 pages, indexed alphabetically, size, 3 3/4 x 2 1/2 inches, price \$0.75. Publish by the Wireless Press, Ltd., London, England.

A very useful compendium of the principal wireless terms which should prove useful to all radio operators and students of the art. The various technical terms are arranged alphabetically, and the subject matter given seems to cover most of the more important terms used in radio engineering and operating. Some of the definitions are rather terse, and it seems that they could have been easily amplified without increasing the size of the book very much. For instance, we find the term "billi-condenser," and the definition of the term succinctly says—"consists of a metallic tube made to slide over an insulating tube having a metallic lining." This definition does not mean very much to any radio man, and really it is nothing but a trade definition, while as a matter of fact most of the regular text-books on wireless telegraphy describe this condenser as one having a definite electrostatic capacity of one billi-farad. This little work forms a handy, low-priced compilation of wireless terms which may prove of considerable use to radio students and others interested generally in this line of work.

HAND-BOOK OF CHEMISTRY AND PHYSICS—A READY REFERENCE POCKET-BOOK OF CHEMICAL AND PHYSICAL DATA, by Charles D. Hodgman, B.S., and Melville F. Coolbaugh, M.A. Flexible leather covers, 478 pages, size 7 x 4 3/4 inches, price \$2.00. Publish by The Chemical Rubber Company, Cleveland, Ohio.

This work is something out of the ordinary and places in the hands of chemistry students and chemists in general a most excellent collection of tables and formulas worked out, which would require many hours of search thru books on chemistry and physics in order to determine these quantities. There is a large number of tables giving the complete equations for various organic compounds; physical constants of the elements; physical data of organic compounds; qualitative analysis procedure; flame and bead testing; various solutions of salts and other reagents; solubility charts, including a table giving the solubility of organic salts in water; a large number of tables giving gravimetric factors and their logarithms; tables of nitric and sulfuric acids, as well as ammonium hydroxid and potassium hydroxid, giving the proportion by weight and the corresponding specific gravities for these various chemicals in solution; tables of sound and heat velocity and conduction; the various properties of saturated steam; co-efficients of thermal expansion; voltage and composition of voltaic cells; sparking potential or dielectric strength, wave length of principal lines of various elements, for spectroscopic and other work; tables giving index of refraction for gases in solution as well as metals and glass, radio-active tables, etc., etc.

This is a practical hand-book which every student of chemistry and physics should not be without. It contains an excellent glossary of technical terms with many chemical equations worked out and completed, also a large number of various physical formulas in mechanics, etc. There is given a considerable number of very useful and practical laboratory recipes, such as those for silvering glass, making of pole test paper, making cross-hairs for telescopes, etc.; various forms of photographic developing solutions for both plates and printing papers, etc. A very complete bibliography is appended at the close of the book, giving a valuable titled list of several hundred works on chemistry and physics. The volume is well indexed.

MILITARY AND NAVAL RECOGNITION BOOK, by Lieut. J. W. Bunkley, U. S. Navy. Cloth bound, 224 pages, 51 full page plates, 18 being in color, size 5 x 7 inches, price \$1.00. Publish by D. Van Nostrand Company, New York City.

This work proved of great value during the war and is one of the best ever published on the subject of military and naval organizations thruout the world, giving as it does not only the different insignia of rank in the various organizations of the principal countries of the world, but the customs of the service as well, such as etiquette of enlisted men and officers, etc. This book has been endorsed by the Secretary of the Navy. The treatment starts with the organization of the army bureaus and corps, the composition of the army and its various depart-

ments, how the staff is composed, and the divisions into the various arms of the service, such as cavalry, field artillery, coast artillery, infantry and engineers. Then we learn about the various coast artillery districts thruout the United States, the various ranks held in the army, and the duties of the officers holding these ranks, army etiquette and customs including salutes and courtesies in conversation, when and when not to address a lieutenant by his title; how to address a colonel, et cetera.

The succeeding chapters take up the composition of the navy and the organization of the naval force ashore, including an explanation at last, on page 41, of the duties of the Bureau of Steam Engineering, and how it comes about that the "Bureau of Steam Engineering" has to do with the installation of Radio Equipment on ships of the navy and on shore—a nice little poser that has been asked many times thru our "Oracle Department," and of the editors personally every time we meet a "Radio-bug."

Then follow interesting chapters on naval etiquette and customs, including what to do when the officer of the deck passes you, when to stand up, and when to sit down when a naval officer enters a cabin, and when an army officer enters a tent or barracks; what to say and how to say it, why a "gob" or his high superior officer must walk down Broadway in the pouring rain without an umbrella, and also you will find it prescribed in the rules and regulations on naval etiquette, that it is unbecoming an officer in uniform to carry a package of any kind. But at the close of the hum-drum of red tape, which tells you how you shall place your feet, and when you shall take off your hat, also when you can use your handkerchief, and which proves mighty interesting reading to us poor land-lubbers, we come to the most interesting announcement that—"it is customary for a committee of officers, to make the round of calls on New Year's Day on all ships in the same port," and further—"when in Washington, it is customary to call on the Secretary of the Navy and other high officials on New Year's Day, and you shall appear in your full dress uniform," rain or shine, and leave your umbrella at home.

Other chapters treat of the U. S. Marine Corps, the coast guard and the light house service. We then come to the sections dealing with the strength and organization of foreign armies and navies with the insignia of rank printed in colors.

The volume is one of the best works of this kind ever published, and Lieut. Bunkley should be complimented on the excellent and very interesting style in which he has compiled the work.

ELEMENTARY NAVAL ORDNANCE AND GUNNERY, by Lieut. H. C. Ramsey. Limp leather cover, size, 4 1/4 x 7 1/4 inches, illustrated and numerous drawing plates. Publish by Little, Brown & Company, Boston, Mass., 1918, Price \$3.00 net.

One of the most valuable works published during the war as a ready aid to the new students in the Naval Gunnery Schools and also as a guide to instructors and those trying for commissions. It has been prepared in a simple, easy and direct manner so that all classes of readers may readily acquire a correct and thoro knowledge of the fundamentals and general principles of the art of modern naval gunnery.

Most of the material has been gathered from lectures delivered at the Ensign School at Harvard University, and a number of interesting questions asked by students have been incorporated in the work with full answers.

A few titles of some of the more important chapters follow:—Naval Guns, Manufacture of Naval Guns, Gun Mounts, Breech and Firing Mechanisms, Electrical Firing Mechanisms, Turrets, Gunpowder, Projectiles, Magazines, Inspections and Tests, Spotting, Sighting, Fire Control, The Battery in Action, Care of Turrets, Automatic Machine Rifles, Battle Drills, The Gunnery Officer of a Ship, Infantry.

The chapter on Infantry has been included in order that those new to the service may understand some of the newer positions as practised in this branch of the service.

There is no doubt but that this book will fill a very distinct want amongst those who are studying this subject, besides serving to give the layman a real glimpse into what a tremendous part Gunnery plays in every battle engagement whether on land or sea. Lieut. Ramsey is to be complimented upon the excellent style in which he has covered the work in hand. The illustrations are particularly fine and show at a glance just how the breech mechanisms of the great naval cannon work as well as the small arms, including automatic rifles, machine guns, etc. Every kind of projectile is fully explained with sectional drawings, how the powder is placed and computed, calculating the range from a moving war-vessel with the compensations made for wind, speed of target, temperature of powder charge, etc., etc. A most interesting, authentic and valuable work.

Speak QUICK

SAVE.

ANY UNDER MANUFACTURER'S PRICE!

Genuine, visible writing Underwoods—rebuilt to our factory, with Back Spacer, Tabulator, Lateral Guide, Stencil Attachment, 2-color Ribbon, Waterproof Cover and Special Touch Rewriting Guide Book sent on 10 Days' Free Trial. Write.

Over 100,000 Underwoods Sold to U. S. Govt.

That makes rebuilt Underwoods scarce. So—**write quick for yours.** Guaranteed for 5 years. You can rent, buy on easy terms, secure cash discount or easily earn one through agency plan; no canvassing. Ask for Offer No. 154

TYPEWRITER EMPORIUM
34-36 Lake St.
CHICAGO, ILL.

RENT OR BUY

How to Get a Good Job

You have the requirements necessary to hold a good job—but do you know how to get one? This book, entitled "Getting a Good Job," will tell you how. Based on the practices followed by big, successful employers, it tells what to do and say—how to make applications by letter—how to get personal interviews—what kind of job to choose—references, how to use them—answering advertisements—in all—135 things you should know. It costs a dollar and may be worth thousands to you.

MONEY BACK

Send a dollar bill, stamps or money order with your name and address. We will send the book at once. Use it five days and return it if you don't think it worth the dollar. Your money back if you don't keep it.

5 Days Trial

American Technical Society
Dept. C.104, Chicago

Send To-day for the "Electrical Worker's Friend"

An electrical book of 66 motor drawings with complete instructions for rewinding and reconnecting A.C. motors. Special at \$3.50

Or write for full particulars of this valuable book.

J. SMITH & SON
1524 LOWRIE ST., N.S., PITTSBURGH, PA.

GET ON THE STAGE VAUDEVILLE

I tell you how. Fascinating profession for either sex. Big salaries. Experience unnecessary. Splendid engagements always waiting. Opportunity for travel. Theatrical agents and authorities endorse my methods. Thirty years' experience as manager and performer. Illustrate book "All About Vaudeville" sent FREE.

Frederick La Delle, Sta. 49, Jackson, Mich.

POPULARITY FOLLOWS THE UKULELE

If you play quaint, dreamy Hawaiian music or latest songs the like of you will be wanted everywhere. We teach by mail 20 simple lessons, give you free a genuine Hawaiian Ukulele, music, everything no extras. Ask us to send the story of Hawaiian music. You will love it. No obligation—absolutely free.

The Hawaiian Institute of Music
1400 Broadway, Suite 1104, New York

Pour Red, White and Blue from a Glass of Water

You can mystify your friends with puzzling chemical tricks; write secret letters with invisible ink; make your own magic writing paper, and your own blue ink or ink powder. Write with water and have it turn blue. You can pour seemingly plain water into three glasses and have it turn red in one, white in another and blue in the third. Send twenty-five cents in stamps and get your outfit by mail, postpaid. If you send right away, we will enter your name to receive a copy of "The Chemcraft Chemist." It's an "Chemcraft" interesting magazine for boys.

Regular "CHEM-CRAFT" Outfit, 25c.
file # 11 60, \$3.00 and \$5.00.

THE PORTER CHEMICAL CO., 25c.
Arcade Building Hagerstown, Md. Postpaid

ZIP-ZIP Patented Sept. 3rd, 1918

The Greatest 50 Ct. Article on the Market. Shipped right from the factory the same day we receive your order. The Zip is made of beautiful metal; never breaks or wears out; scientifically made and best workmanship. The rubbers are elastic and lasting, with plenty of grip and firm. Zip, complete, only 50c prepaid. Be sure the name Zip-Zip and our address appear on the article you buy. Order from us or any Sporting Goods Store in your city and stamps, Coin or Money Order.

AUTOMATIC RUBBER CO.
COLUMBIA, S. C.



Free Proof that I Can Raise Your Pay

No matter how much you are earning now, I can show you how to increase it. I have even taken failures and shown them how to make \$100—\$200, and in once case as high as \$2,000 weekly. I am willing to prove this entirely at my risk and expense.

LET'S have a little chat about getting ahead—you and I. My name is Pelton. Lots of people call me "The Man Who Makes Men Rich." I don't deny it. I've done it for thousands of people—lifted them up from poverty to riches.

I'm no genius—far from it. I'm just a plain, everyday, unassuming sort of man. I know what poverty is. I've looked black despair in the eye—had failure stalk me around and hoodoo everything I did. I've known the bitterest kind of want.

But to-day all is different. I have money and all of the things that money will buy. I am rich also in the things that money won't buy—health, happiness and friendship. Few people have more of the blessings of the world than I.

IT was a simple thing that jumped me up from poverty to riches. As I've said, I'm no genius. But I had the good fortune to know a genius. One day this man told me a "secret." It had to do with getting ahead and growing rich. He had used it himself with remarkable results. He said that every wealthy man knew this "secret,"—that is why he was rich.

I used the "secret." It surely had a good test. At that time I was flat broke. Worse than that, for I was several thousand dollars in the hole. I had about given up hope when I put the "secret" to work.

At first I couldn't believe my sudden change in fortune. Money actually flowed in on me. I was thrilled with a new sense of power. Things I couldn't do before became as easy for me to do as opening a door. My business boomed and continued to leap ahead at a rate that startled me. Prosperity became my partner. Since that day I've never known what

it is to want for money, friendship, happiness, health or any of the good things of life.

That "secret" surely made me rich in every sense of the word.

MY sudden rise to riches naturally surprised others. One by one people came to me and asked me how I did it. I told them. And it worked for them as well as it did for me.

Some of the things this "secret" has done for people are astounding. I would hardly believe them if I hadn't seen them with my own eyes. Adding ten, twenty, thirty or forty dollars a week to a man's income is a mere nothing. That's merely playing at it. In one case I took a rank failure and in a few weeks had him earning as high as \$2,000.00 a week. Listen to this:

A young man in the East had an article for which there was a nation-wide demand. For twelve years he "puttered round" with it, barely eking out a living. Today this young man is worth \$200,000. He is building a \$25,000 home—and paying cash for it. He has three automobiles. His children go to private schools. He goes hunting, fishing, traveling whenever the mood strikes him. His income is over a thousand dollars a week.

In a little town in New York lives a man who two years ago was pitied by all who knew him. From the time he was 14 he had worked and slaved—and at sixty he was looked upon as a failure. Without work—in debt to his charitable friends, with an invalid son to support, the outlook was pitchy black.

Then he learned the "secret." In two weeks he was in business for himself. In three months his plant was working night and day to fill orders. During 1916 the profits were \$20,000. During 1917 the profits ran close to \$40,000. And this genial 64-year-old man is enjoying the pleasures and comforts he little dreamed would ever be his.

I COULD tell you thousands of similar instances. But there's no need to do this, as I'm willing to tell you the "secret" itself. Then you can put it to work and see what it will do for you.

A Few Examples

Personal Experiences

Among over 550,000 users of "Power of Will" are such men as Judge Ben B. Lindsey; Supreme Court Justice Parker; Wu Ting Fang, Ex. U. S. Chinese Ambassador; Assistant Postmaster General Britt; Lieut. Gov. McKevie of Nebraska; General Manager Christeson of Wells-Fargo Express Co.; E. St. Elmo Lewis, former Vice-Pres. Art Metal Construction Co.; Gov. Ferris of Michigan, and many others of equal prominence.

\$300 Profit from One Day's Reading

"The result from one day's study netted me \$300 cash. I think it a great book and would not be without it for ten times the cost."—A. W. Wilke, Faulkton, So. Dakota.

Worth \$15,000 and More

"The book has been worth more than \$15,000 to me."—Oscar E. Sheppard, 1117 E. Locust St., Decatur, Ill.

Would Be Worth \$100,000

"If I had only had it when I was 20 years old, I would be worth \$100,000 today. It is worth a hundred times the price."—S. W. Taylor, The Santa Fe Ry., Milans, Tex.

Salary Jumped from \$150 to \$800

"Since I read Power of Will my salary has jumped from \$150 to \$800 a month."—J. F. Gibson, San Diego, Cal.

From \$100 to \$3,000 a Month

"One of our boys who read Power of Will before he came over here jumped from \$100 a month to \$3,000 the first month, and won a \$250 prize for the best salesmanship in the State."—Private Leslie A. Still, A. E. F. France.

I don't claim I can make you rich over night. Maybe I can—maybe I can't. Sometimes I have failures—everyone has. But I do claim that I can help 90 out of every 100 people if they will let me.

The point of it all, my friend, is that you are using only about one-tenth of that wonderful brain of yours. That's why you haven't won greater success. Throw the unused nine-tenths of your brain into action and you'll be amazed at the almost instantaneous results.

The Will is the motive power of the brain. Without a highly trained, inflexible will, a man has about as much chance of attaining success in life as a railway engine has of crossing the continent without steam. The biggest ideas have no value without will-power to "put them over." Yet the will, altho heretofore entirely neglected, can be trained into wonderful power like the brain or memory and by the very same method—intelligent exercise and use.

If you held your arm in a sling for two years, it would become powerless to lift a feather from lack of use. The same is true of the Will—it becomes useless from lack of practice. Because we don't use our Wills—because we continually bow to circumstance—we become unable to assert ourselves. What our wills need is practice.

Develop your will-power and money will flow in on you. Rich opportunities will open up for you. Driving energy you never dreamed you had will manifest itself. You will thrill with a new power—a power that nothing can resist. You'll have an influence over people that you never thought possible. Success—in whatever form you want it—will come as easy as failure came before. And those are only a few of the things the "secret" will do for you. The "secret" is fully explained in the wonderful book "Power of Will."

How You Can Prove This at My Expense

I KNOW you'll think that I've claimed a lot. Perhaps you think there must be a catch somewhere. But here is my offer. You can easily make thousands—you can't lose a penny.

Send no money—no, not a cent. Merely clip the coupon and mail it to me. By return mail you'll receive not a pamphlet, but the whole "secret" told in this wonderful book, "POWER OF WILL."

Keep it five days. Look it over in your home. Apply some of its simple teachings. If it doesn't show you how you can increase your income many times over—just as it has for thousands of others—mail the book back. You will be out nothing.

But if you do feel that "POWER OF WILL" will do for you what it has done for over a quarter of a million others—if you feel as they do that it's the next greatest book to the Bible—send me only three dollars and you and I'll be square.

If you pass this offer by, I'll be out only the small profit on a three-dollar sale. But you—you may easily be out the difference between what you're making now and an income several times as great. So you see you've a lot—a whole lot—more to lose than I.

Mail the coupon or write a letter now—you may never read this offer again.

PELTON PUBLISHING COMPANY
30-H WILCOX BLOCK MERIDEN, CONN.

Pelton Publishing Company
30-H Wilcox Block, Meriden, Conn.

You may send me "Power of Will" at your risk. I agree to remit \$3.00 or return the book to you in five days.

Name

Address

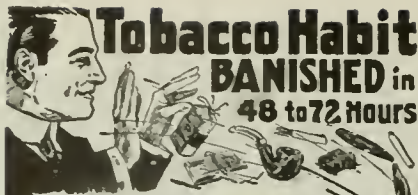

Tobacco Habit BANISHED in 48 to 72 Hours

No craving for tobacco in any form when you begin taking Tobacco Redeemer. Don't try to quit the tobacco habit unaided. It's a losing fight against heavy odds and means a serious shock to the nervous system. Let the tobacco habit quit YOU. It will quit you, if you will just take Tobacco Redeemer, according to directions for two or three days. It is a most marvelously quick and thoroughly reliable remedy for the tobacco habit.

Not a Substitute

Tobacco Redeemer contains no habit-forming drugs of any kind. It is in no sense a substitute for tobacco. After finishing the treatment you have absolutely no desire to use tobacco again or to continue the use of the remedy. It makes not a particle of difference how long you have been using tobacco, how much you use or in what form you use it—whether you smoke cigars, cigarettes, pipe, chew plug or fine cut or use snuff. Tobacco Redeemer will positively banish every trace of desire in from 48 to 72 hours. This we absolutely guarantee in every case or money refunded.

Write today for our free booklet showing the deadly effect of tobacco upon the human system and positive proof that Tobacco Redeemer will quickly free you of the habit.

Newell Pharmacal Company, Dept. 521, St. Louis, Mo.

BOYS! FREE FELT PENNANT

Write For New AUTO-WHEEL BOOKLET, and

Send us the names of three coaster wagon dealers, mentioning which handle the AUTO-WHEEL, and we'll send you a beautiful Felt Pennant FREE and tell you all about the wonderful Auto-Wheel Coaster and the patented Auto-Wheel Convertible Roadster.

Wouldn't YOU Like to Organize a Coaster Club? It's great fun. Every member receives a cap and the Captain a special cap. When you write, be sure to ask for full information and the new Auto-Wheel Booklet. It's brimful of information you should have.

The Buffalo Sled Co. Dept. 163 N. Tonawanda, N. Y.

In Canada: Preston, Ont.

Get an



Auto-Wheel

BOYS BUILD THIS CAR

This ditty little car driven by gasoline motor, can be built by any boy. Parts are furnished by us and are very cheap. Send 25 cents for building plans and price list of parts showing how to build this lads' car.

SYPHER MFG. CO. 156 Warren Street TOLEDO, OHIO.



BUSH CAR—FREE

This Five Passenger 37 H. P. car, 116 in. whl. base. All bearings Timken, Delco Ign., Dyneto Ste. and Ltg. Write at once for my great Free Offer and describe catalog. Agents wanted to drive and demonstrate. Territory open. Prompt shipments. Big money. Cars guaranteed or money back. 1918 cars ready. Address: J. H. Bush, president, Dept. 615 BUSH MOTOR CO., Bush Temple, Chicago, Illinois

The Moon's Rotation

(Continued from page 866)

festly absurd and of no bearing on the question under consideration.

In all the communications I have received, tho different in the manner of presentation, the successive changes of position in space are mistaken for axial rotation. So, for instance, a positive refutation of my arguments is found in the observation that the moon exposes all sides to other planets! It revolves, to be sure, but none of the evidences is a proof that it turns on its axis. Even the well-known experiment with the Foucault pendulum, altho exhibiting similar phenomena as on our globe, would merely demonstrate a motion of the satellite about some axis. The view I have advanced is NOT BASED ON A THEORY but on facts demonstrable by experiment. It is not a matter of definition as some would have it. A MASS REVOLVING ON ITS AXIS MUST BE POSEST OF MOMENTUM. If it has none, there is no axial rotation, all appearances to the contrary notwithstanding.

A few simple reflections based on well established mechanical principles will make this clear. Consider first the case of two equal weights w and w_1 , in Fig. 1, whirled about the center O on a string s as shown. Assuming the latter to break at a both weights will fly off on tangents to their circles of gyration, and, being animated with different velocities, they will rotate around their common center of gravity o . If the weights are whirled n times per second then the speed of the outer and the inner one will be, respectively, $V = 2(R+r)n$ and $V_1 = 2\pi(R-r)n$, and the difference $V - V_1 = 4\pi rn$, will be the length of the circular path of the outer weight. Inasmuch, however, as there will be equalization of the speeds until the mean

consumed in the supposed axial rotation, which is, consequently, wholly illusionary. Something even more interesting may, however, be stated. As I have shown before, a ball flying off will rotate at the rate of the wheel and in the same direction. But this whirling motion, unlike that of a projectile, neither adds to, nor detracts from, the energy of the translatory movement which is exactly equal to the work consumed in giving to the mass the observed velocity.

From the foregoing it will be seen that in order to make one physical revolution on its axis the moon should have twice its present angular velocity, and then it would contain a quantity of stored energy as given in my above letter to the *New York Tribune*, on the assumption that the radius of gyration is $2/5$ that of figure. This, of course, is uncertain, as the distribution of density in the interior is unknown. But from the character of motion of the satellite it may be concluded with certitude that it is devoid of momentum about its axis. If it be bisected by a plane tangential to the

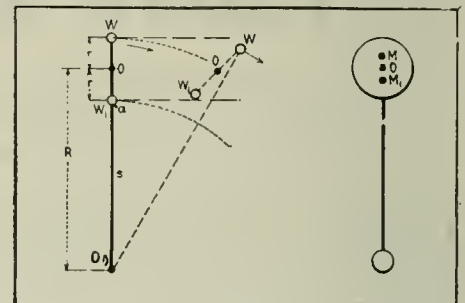

Diagram illustrating the Rotation of Weights Thrown Off By Centrifugal Force.

value is attained, we shall have $\frac{V - V_1}{2} = 2\pi rn = 2\pi rN$, N being the number of revolutions per second of the weights around their center of gravity. Evidently then, the weights continue to rotate at the original rate and in the same direction. I know this to be a fact from actual experiments. It also follows that a ball, as that shown in the figure, will behave in a similar manner for the two half-spherical masses can be concentrated at their centers of gravity and m and m_1 , respectively, which will be at a distance from o equal to $\frac{3}{8}r$.

This being understood, imagine a number of balls M carried by as many spokes S radiating from a hub H , as illustrated in Fig. 2, and let this system be rotated n times per second around center O on frictionless bearings. A certain amount of work will be required to bring the structure to this speed, and it will be found that it equals exactly half the product of the masses with the square of the tangential velocity. Now if it be true that the moon rotates in reality on its axis *this must also hold good for EACH of the balls as it performs the same kind of movement*. Therefore, in imparting to the system a given velocity, energy must have been used up in the axial rotation of the balls. Let M be the mass of one of these and R the radius of gyration, then the rotational energy will be $E = \frac{1}{2}M(2\pi Rn)^2$. Since for one complete turn of the wheel every ball makes one revolution on its axis, according to the prevailing theory, the energy of axial rotation of each ball will be $e = \frac{1}{2}M(2\pi rn)^2$, r_1 being the radius of gyration about the axis and equal to $0.6325r$. We can use as large balls as we like, and so make e a considerable percentage of E and yet, it is positively established by experiment that each of the rotating balls contain only the energy E , no power whatever being

orbit, the masses of the two halves are inversely as the distances of their centers of gravity from the earth's center and, therefore, if the latter were to disappear suddenly, no axial rotation, as in the case of a weight thrown off, would ensue.

WHAT IS MAN?

A man weighing 150 pounds will contain approximately 3,500 cubic feet of gas,—oxygen, hydrogen and nitrogen in his constitution, which at eighty cents per thousand cubic feet would be worth \$2.80 for illuminating purposes. He also contains all the necessary fats to make a 15-pound candle, and thus, together with his 3,500 cubic feet of gases, he possesses considerable illuminating possibilities. His system contains 22 pounds and ten ounces of carbon, or enough to make 780 dozen, or 9,360 lead pencils. There are about fifty grains of iron in his blood and the rest of the body would supply enough of this metal to make one spike large enough to hold his weight. A healthy man contains 54 ounces of phosphorus. This deadly poison would make 800,000 matches, or enough poison to kill five hundred persons. This, with two ounces of lime, make the stiff bones and brains. No difference how *sour* a man looks, he contains about 60 lumps of sugar of the ordinary cubical dimensions, and to make the seasoning complete, there are 20 *spoonfuls of salt*. If a man were distilled into water, he would make about 38 quarts, or more than half his entire weight. He also contains a great deal of starch, chlorid of potash, magnesium, sulfur, and hydrochloric acid in his wonderful human system.

Break the shells of 1,000 eggs into a huge pan or basin, and you have the contents to make a man from his toe-nails to the most delicate tissues of his brain. And this is the scientific answer to the question, "What is Man?"

"I have watched the progress of the International Correspondence Schools almost from the very beginning. To me their rapid growth is easily understood, because I realize the practical value that is back of them and know something too of the success attained by many ambitious men throughout the country who have taken their courses.
 "May your splendid institution continue to so grow and flourish that the world will come to appreciate the actual worth of the I. C. S. trained man."
 —THOMAS A. EDISON.



"I am familiar with the textbooks and method of instruction used by the International Correspondence Schools in their Courses in Electrical Engineering, and I also know of a number of young men who have taken these Courses with great benefit. I believe that any young man who is interested in electricity but who cannot find an opportunity to go through an engineering college, if he will apply himself to one of these courses will find it a practical and economical way to acquire a knowledge of the profession second only to that acquired by devoting all the time for years to this study, in a regular college course."
 —DR. CHARLES P. STEINMETZ.

What Would Their Advice Be Worth to You?

Suppose you have a knack for things electrical—that you realize what a wonderful opportunity for earnings and advancement the field of Electricity offers. What, then, would it be worth to *you* to have Edison and Steinmetz, the two foremost figures in the electrical world, tell you of a thorough, practical plan by which you can acquire, right at home, the training you need for success?

Well, *here* is their advice, based on years of familiarity with the instruction given by the International Correspondence Schools and on personal knowledge of I. C. S. trained men in their employ:

"I know of the success attained by men who have taken your Courses," says Edison. "It is a practical and economical way to acquire a knowledge of the profession," says Dr. Steinmetz. Read their full statements above.

For 27 years the I. C. S. have been training men at home in their spare time for success in Electricity and 280 other subjects. It is training over 100,000 men and women right now. It is ready and anxious to prepare you for advancement in Electrical Engineering or any special branch of it—or in any other line that appeals to you.

Pick the position you want in the work you like best, then put it up to us to prove how we can help you. Here is all we ask—without cost, without obligation, mark and mail this coupon.

TEAR OUT HERE
INTERNATIONAL CORRESPONDENCE SCHOOLS
 BOX 6184, SCRANTON, PA.

Explain, without obligating me, how I can qualify for the position, or in the subject, before which I mark X.

- | | |
|--|--|
| <input type="checkbox"/> ELECTRICAL ENGINEER | <input type="checkbox"/> CHEMICAL ENGINEER |
| <input type="checkbox"/> Electrician | <input type="checkbox"/> SALESMANSHIP |
| <input type="checkbox"/> Electric Wiring | <input type="checkbox"/> ADVERTISING MAN |
| <input type="checkbox"/> Electric Lighting | <input type="checkbox"/> Show Card Writer |
| <input type="checkbox"/> Electric Car Running | <input type="checkbox"/> Outdoor Sign Painter |
| <input type="checkbox"/> Heavy Electric Traction | <input type="checkbox"/> RAILROADER |
| <input type="checkbox"/> Electrical Draftsman | <input type="checkbox"/> ILLUSTRATOR |
| <input type="checkbox"/> Electric Machine Designer | <input type="checkbox"/> DESIGNER |
| <input type="checkbox"/> Telegraph Expert | <input type="checkbox"/> BOOKKEEPER |
| <input type="checkbox"/> Practical Telephony | <input type="checkbox"/> Stenographer and Typist |
| <input type="checkbox"/> MECHANICAL ENGINEER | <input type="checkbox"/> Cert. Public Accountant |
| <input type="checkbox"/> Mechanical Draftsman | <input type="checkbox"/> Traffic Management |
| <input type="checkbox"/> Toolmaker | <input type="checkbox"/> Commercial Law |
| <input type="checkbox"/> Machine Shop Practice | <input type="checkbox"/> GOOD ENGLISH |
| <input type="checkbox"/> Gas Engineer | <input type="checkbox"/> Common School Subjects |
| <input type="checkbox"/> CIVIL ENGINEER | <input type="checkbox"/> CIVIL SERVICE |
| <input type="checkbox"/> Surveying and Mapping | <input type="checkbox"/> Railway Mail Clerk |
| <input type="checkbox"/> MINE FOREMAN OR ENGINEER | <input type="checkbox"/> STATIONARY ENGINEER |
| <input type="checkbox"/> ARCHITECT | <input type="checkbox"/> Textile Overseer or Supt. |
| <input type="checkbox"/> Architectural Draftsman | <input type="checkbox"/> AGRICULTURE |
| <input type="checkbox"/> PLUMBING AND HEATING | <input type="checkbox"/> Navigator |
| <input type="checkbox"/> Sheet Metal Worker | <input type="checkbox"/> Poultry Raising |
| <input type="checkbox"/> Ship Draftsman | <input type="checkbox"/> AUTOMOBILES |

- | |
|----------------------------------|
| <input type="checkbox"/> Spanish |
| <input type="checkbox"/> French |
| <input type="checkbox"/> Italian |

Name _____
 Present Occupation _____
 Street and No. _____
 City _____ State _____

Canadians may send this coupon to International Correspondence Schools, Montreal, Canada

Commercial Telegraph Apparatus Bargains

- Standard twenty ohm Telegraph Sounders at \$200 each
- Standard Telegraph Keys at 125 each
- 110 Volt A.C. Dynamos 175 1/2 each
- Three Bar..... 225 each
- Four Bar..... 275 each
- Five Bar..... 275 each

For other bargains see page 935

Skinderviken Telephone Equipment Co.

Abbreviated Address

STECO-2118-2136 N. Clark St. CHICAGO

FACTORY-TO-RIDER SAVES YOU MONEY



Buy direct and save \$10 to \$20 on a bicycle. **RANGER BICYCLES** now come in 44 styles, colors and sizes. Greatly improved; prices reduced. Other reliable models also. **WE DELIVER FREE** to you on approval and 30 days trial and riding test. Our big **FREE** catalog shows everything new in bicycles and sundries. Write for it. **TIRES**, lamps, wheels, parts and supplies at half usual prices. Do not buy a bicycle, tires, or sundries until you get our wonderful new offers, low prices and liberal terms. A postal brings everything. **MEAD CYCLE COMPANY** Dept. D-107, Chicago

Build Your Own PHONOGRAPH,

It's Easy With Our Help
A few hours interesting work saves many dollars and gives you a machine exactly to suit your ideals. We furnish motors, tone arms, case material, blue prints and full instructions. Plays any record. You can make fine profit building phonographs for your friends.

Write Today for Our Free Blue Print Offer. Agents wanted for our ready built Choraleons.

Choraleon Phonograph Co. 704 Manger Bldg., Elkhart, Ind.

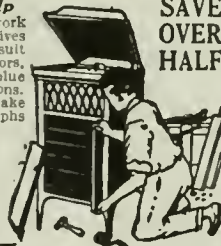

SAVE OVER HALF

House Lighting Plants

\$225 to \$2100

Write for Catalog, giving name of your electrical dealer. Agents Wanted.

Dynamos, Motors
All sizes. Battery Chargers and Motor Generator Sets, \$25 to \$120. Hydro-Electric Generators.

SPECIAL — Holtzer-Cabot 110-V. A.C. Hand Generators, while they last, only \$5. Order from this ad.

WATSON ELECTRIC CO., Dept. 14, Ges Bldg., Chicago.

BIG BUNCH OF FUN 10c

1 New Airship Game with Airships, 1 Chess and Checker Board and men, 1 Chinese Dip-se-lu-la, 1 Set Dominoes, 12 Other Games, 19 Lessons in Magic, 12 Money Making Secrets, Wireless Code, 18 Pictures Pretty Girls, 3 Puzzles, & New Ford Joke Book. All for 10c with large Catalogue.

Dept. 72

American Toy Co., Lowell, Mass., U. S. A.



Printing Cheap

Cards, circulars, labels, book, paper. Press \$6. Larger \$20 Job press \$50 up. Save money. Print for others, big profit. All easy, rules sent. Write factory for press catalog, TYPE, cards, paper. **THE PRESS CO.** D-47 Meriden, Conn.

HOW BOY SCOUTS CAN GAIN "WIRELESS MERIT" BADGE.

The committee on badges, awards and scout requirements of national headquarters has just established a "wireless merit" badge which no doubt will become quite popular as soon as there is an opportunity for scouts to perfect themselves in the details. The requirements are as follows:

Be able to receive and send correctly not less than 10 words a minute.

Know the correct form for sending a message.

Be able to tell in own words the principal laws regarding radio communication.

Know at least 10 of the radiogram abbreviations (Q signals).

Be able to name two types of detectors and explain how they work.

Name five minerals used in detectors in the order of their sensitiveness.

Draw a diagram of a simple transmitting set, showing how the following instruments are connected: Source of power (dynamo or storage battery), transformer, condenser, spark gap, helix, key, and explain their function.

Draw a simple diagram showing how to connect the following instrnments: Tuning coil or loose coupler, condensers, fixt or variable, detector, phones and ground. Tell the use of the above apparatus.

Draw a diagram of three different types of aerials and tell their advantages or faults.

Know how to properly ground a radio

set and know what precautions to take during a thunderstorm.

Demonstrate how to rescue a person in contact with a live wire, and have a knowledge of the method of resuscitation of a person insensible from shock.

Write a brief essay on the development of wireless telegraphy.

ELECTRIC DRIVE FOR U. S. WARSHIPS.

America's capital fighting ships of the future will be superior to those of other nations because of their electrically driven machinery, Secretary Daniels told the House Naval Committee recently, in disclosing remarkable results attained by the new dreadnought New Mexico, equip with the electric drive which is to be a feature of all the big ships authorized since 1916.

The New Mexico's turbo-electric machinery was designed to develop 26,500 horse-power at full speed and to give the ship a speed of twenty-one knots.

"It actually developed more than 31,000 horse-power," Mr. Daniels said, "and maintained for four hours a speed of twenty-one and one-quarter knots, and this when running at a displacement 1,000 tons greater than its design called for.

The secretary said fuel economy at cruising speed had been one of the things sought in substituting electric drive for the ordinary turbine equipment.

Practical Chemical Experiments

(Continued from page 880)

TO TEST FOR COAL TAR COLORING.

Experiment No. 3. See Fig. 3.

To test for coal tar colors in butter, a small sample is mixed on a porcelain plate with Fuller's earth, and if coal tars are present, there will be a red mass, while if absent the color will be only light yellow or brown.

Experiment No. 4.

Put a little butter in a test-tube, and a little oleomargarin into another. To each add one inch or so of alcoholic potash solution, and warm each in the steam of the water bath. Distinguish the one from the other by smell. Add a little sulfuric acid (dilute) to each and smell again. Notice that "oleo" test tube will only smell of alcohol, but that the other will smell, besides, of butyric ether.

Radium Substitute.

We are all quite familiar with the uses of Radium in medicine and as an ingredient in luminous paint, both of which have been brought to the general public's attention within the past few years.

Luminous paint in particular offers a field whereby a substitute for Radium may be judiciously utilized. This paint played an important rôle in the war which has just terminated, having been used more particularly on the dials of instruments used on airplanes, so that they could be read at night. It has also been used for electric push buttons, door numbers, etc. The paint is permanently luminous in the dark and contains from 0.1 to 0.25 milligrams radium element to one gram of zinc sulfid. A luminous watch face usually contains from ten to twenty cents worth of radium on it.

An excellent substitute for radium for certain purposes is Meso-thorium. This is a radio-active element found in Monazite sand and other thorium minerals. When first extracted it is not satisfactory for luminous paint, and consequently must be "ripened" for several months, or even a year before it can be used. During this time the alpha radiation, which is required for luminous paint, becomes sufficiently

strong. On the other hand the beta and gamma radiation of Meso-thorium grows rapidly and it can be used for medicinal purposes within a few days after preparation.

Radium, we are told, has a long life, half of it decaying in approximately 1800 years. Meso-thorium on the other hand possesses a short life, 5 or 6 years being its useful life for luminous purposes. For luminous paint to be used on objects which themselves have a short life, it is an excellent substitute for radium and will conserve the element radium for medicinal purposes only.

Static Electricity and Gasoline.

Static electricity, superinduced by the passage of gasoline thru chamois skin during the filtration process, was declared to be full of great danger. When this idea became prevalent, a well known automobile concern undertook a series of rigid experiments to learn what prospects there were of real danger. Their investigations resulted in their finding that the static electricity scare from the use of chamois skin was without foundation. They claim to have secured authentic data from which it was proved that a static electric charge cannot be developed with the temperature above freezing (32 deg. F.), while at zero (0 deg. F.) the conditions for producing the spark are most favorable.

Two Trade Secrets.

There are two trade secrets at least that the world at large may never know, but which it is well worth the while of inventors to study. One is the Chinese method of making the bright and brilliant color known as Vermilion, or Chinese red; and the other is a Turkish secret—the inlaying of the hardest steel with gold or silver. Among the Chinese and Turks these two secrets are guarded well. Apprentices, before they are taken for either trade, are compelled to swear an ironclad oath to reveal nothing of what passes in the workshop. They must also belong to families of high standing, must pay a large sum of money as a guaran-

(Continued on page 911)

Learn Electricity



In the Great Shops of
COYNE

IN 3 1/2 MONTHS

Thousands of Electrical experts are needed to help rebuild the world. Come to Chicago to the great shops of Coyne and let us train you quickly by our sure, practical way, backed by twenty years of success. Hundreds of our graduates have become experts in less than four months. *You* can do the same. *Now* is your big opportunity. Come—no previous education necessary.

Earn \$125 to \$300 a Month

In the Electrical business. Come here where you will be trained in these great \$100,000 shops. Experts show you everything and you learn right on the actual apparatus. You work on everything from the simple bell to the mighty motors, generators, electric locomotives, dynamos, switchboards, power plants, everything to make you a master electrician. We have thousands of successful graduates. Just as soon as you have finished we assist you to a good position. We now have more positions than we can fill. Think of it.

Become an Expert in 3 1/2 Months

No need of taking from 1 to 4 years to become an expert, we have proved this in thousands of cases. The Coyne method of practical training eliminates all books, useless theory and other non-essentials and trains you in just what you need to know to become an expert.

Earn Your Way

Don't tell yourself you haven't got the money to come to Coyne. If you have ambition and the nerve of a real man, that's all you need. Dozens of our students every year work in their spare time and earn their living expenses. Dozens of others work in the day time, earn all their expense and attend our evening school. Our employment department will help you without charge.

BENNETT W. COOKE, Director

COYNE TRADE AND ENGINEERING SCHOOLS

Dept. 24 39-51 E. Illinois Street, Chicago, Ill.

Day or Evening Courses

Don't worry about the money. Anyone with ambition can learn here. Our tuition is low with small easy payments if desired. All tools and equipment is furnished free. Our students live in comfortable homes in the best section in Chicago—on the lake—just a few minutes' walk from our school.

Electricity, Drafting Motion Picture Operating Plumbing

We teach all these trades and professions quickly and in such a thorough, practical way that when finished you are ready to step right into a position of responsibility and big pay.

Send Today for Big Free Book

Write today, *now*, for the book. It tells what Coyne graduates have done. What you can do. Fill in the coupon, check the trade you are most interested in or send a postal card, do it *now*.

Learn Drafting

The country is crying for skilled draftsmen in all lines. Thousands of positions open with princely salaries. We have been able to place every graduate in a good position. One firm asked for all our men. Now is the time to get into this big field. Experts train you under practical working conditions, no books and theory go here. Check drafting on the coupon below and mail it *at once* for full particulars.

COYNE TRADE AND ENGINEERING SCHOOLS
Bennett W. Cooke, Director
Dept. 24, 39-51 E. Illinois St.
Chicago, Ill.

Please send at once your big Free Book—I am interested in
 Electricity Drafting Plumbing
 Motion Picture Operating
 (Check trade interested in)

**MAIL COUPON FOR FREE BOOK
NOW!**

Name.....
Address.....



DO Your Own PLUMBING AND HEATING at low cost

Send for our big instructive 256 page well-bound Handy-Man Book Catalog. Every Home Owner, Contractor, Electrician, Farmer, Factory Manager, etc., needs it. Shows over 10,000 Fixtures and Supplies in plumbing and heating at wholesale. Shows how to save skilled labor, hard work and unnecessary material by

OUR NEW Cut-to-fit-Method

This wonderful book helps you select, and install the proper Plumbing, Water Supply System, Hot Air, Water or Steam Plant. Besides being our Whole Sale Catalog it has many practical plans, diagrams, sketches, elevations, etc., showing how to do the work in the new, cut-to-fit way. Any handy man with a few tools can easily do his own installing with the aid of this

Big Handy-Man Book

We have spared no effort and have gone to a great expense to compile this valuable book. With economy still a national necessity, it would be unpatriotic to send this expensive book broadcast to non-interested parties. Therefore, we request a temporary deposit for each copy of 25c which we refund on first order or we send our Bargain Bulletin Free. Address Today

HARDIN-LAVIN COMPANY
40 Years At
4510-20 Cottage Grove Ave., Chicago
\$500,000 plants behind our guarantee

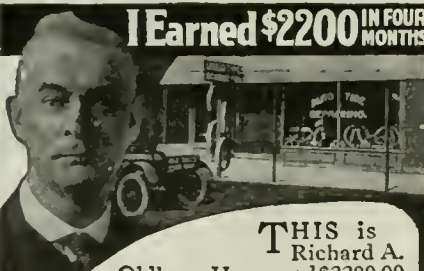

I Earned \$2200 IN FOUR MONTHS

THIS is Richard A. Oldham. He earned \$2200.00 in four months with a Haywood Tire Repairing outfit. For 20 years he was telegraph operator on the Illinois Central Railway. He is now 58 years old. He answered my advertisement—quit his job—bought a plant and opened a business. He just wrote me "I have made more in eight months than 2 1/2 years as operator." There are now 500 stations where tire repairing is neglected.

I Must Have 500 Men To Fill These Positions

I have a Big interesting Book to send you. It tells all about tires—gives inside figures and profit. Send for it! What Oldham and others are doing you can do. \$250.00 to \$4,000.00 per year in conservative. Like Mr. Oldham—One machine will start you. Then open a shop. You can see business all around you. Put out a Haywood Sign and business will come to you. Now get started. Send for the Big Book and start making money.

M. HAYWOOD, Pres.

Haywood Tire & Equipment Co.
1209 Capitol Ave. Indianapolis, Ind.



CONSULT US When in need of definite and reliable data concerning trade formulae or industrial processes. When you desire to either duplicate or improve upon a product or process now in use, we can help you, as we are ever on the alert and closely following the development of the industrial art in all its branches. The formulae listed below will serve briefly to show the field we cover: 1—Preparing Solidified Alcohol. 2—Producing Liquid Toilet Soap. 3—Process for Electro-galvanizing Iron. 4—Ink for Typewriter Ribbons (all standard colors). 5—Process for Sensitizing paper which gives excellent prints from line drawings and plain tracings; it supplies copies in white lines on a brown ground. 6—Alloy for Soldering Aluminum. The standard price for each formula issued by this bureau is Thirty-five cents. Letters of inquiry welcomed. Informative literature sent upon request. Industrial Methods Bureau, 320 Fifth Avenue, New York, N. Y.

INTRODUCING

Mr. R. W. DeMott

For eight months past Mr. R. W. DeMott has been advertising manager of your magazine.

You have noticed the rapid growth of "E. E." during that time. One big reason for this astounding growth and betterment of your magazine is due directly to Mr. DeMott and his "ads."

If you have the welfare of your magazine at heart, read Mr. DeMott's message. It means money to you.

The Publishers.

Advertising Talks

You, as a reader of the ELECTRICAL EXPERIMENTER, are vitally interested in every department of the magazine. There are some very strong reasons why you should be doubly interested in the advertising.

The publishers are constantly striving and planning to improve the quality of the magazine offered you each month. But it is your magazine and it is up to you as to how big it shall grow. There are a great many things that you ought to know about advertising, and how this powerful force affects you personally.

Progressive and responsible firms all over the country announce what they have to offer you through the advertising pages of the ELECTRICAL EXPERIMENTER. Not only will you help your magazine by showing an interest in its advertisers, but you will benefit yourself to an even greater degree. I will take up these points one by one each month, and hope that every reader will follow this column and offer any suggestions or ask any questions that may come to his mind regarding advertising and its relation to a big magazine.

If you have any suggestions to make regarding the advertisements that appear, if there is any information you would like regarding advertising in general, write me personally and your questions will be taken up in due course through this column.

For the next few months I will tell you about "E. E." advertising and its relation to you. Each month I will give you one reason more why the advertisements should be of vital interest to everyone of us.

You have watched the EXPERIMENTER grow from a little sixteen-page magazine to its present size. You have watched the class of articles improve, its staff of authorities who contribute each month get bigger and better, finally resulting in the wonderful announcement made in our January issue that the publishers had secured for you the services of the world's greatest inventor, Nikola Tesla, to give you exclusive feature articles in every issue for the next two years at least.

One of the principal factors in this rapid growth has been its advertising.

Next month I will show you how, by reading and answering the advertisements, you will help to still further build up and increase the size of the EXPERIMENTER.

R. W. DeMott

Advertising Manager.

AN OZONE WATER PURIFIER FOR THE HOME.

For use in homes, offices, drug stores, restaurants, hospitals and institutions, a Milwaukee concern has designed a convenient size of Ozone Water Purifier constructed as shown in the accompanying illustration. It is pointed out that in the ozonizing process employed, ozone is produced by means of an electric current and mixed thoroly with the water as drawn from the faucet, so that all water used comes into actual contact with ozone. The extra oxygen atoms of the ozone combine with organic matter of the germs in the water and burn them up. The carbon dioxide formed by this chemical action passes out into the air leaving a trace of the same effect produced in carbonated beverages, which adds to the palatability of the ozonized water. It is claimed that all tastes and odors are removed by this process while mineral elements essential to health remain, for they do not oxidize.

There are a great many cities whose water supplies are chlorinated and it is claimed that the use of this ozone water purifier will eliminate the odor and taste of chlorin from the water the same as it



New Design of Ozone Water Purifier for the Home, Office and Factory. The Ozonizer Connects With Any Lamp Receptacle. The Purifier Has a Capacity of Over 2,000 Gallons Per Day.

eliminates other objectionable odors and tastes.

As an amelioration of filtered water, or as a substitute for filtered or distilled water, it is claimed the process of ozonization stands by itself; it has no equal in efficiency; the removal of disease germs is absolute; the water resulting from such process is as perfect as one can wish, being bright and sparkling. Each of the water purifiers has a purifying capacity of over 2,000 gallons a day, and, therefore, any user is entirely independent of the condition of the water at the municipal plant in his city.

THE MAKING OF A MATCH.

Thorpe gives the following proportions for match head and for striking surface:

Head composition: Potassium chlorat, 5 parts; potassium bichromat, 2 parts; glass powder, 3 parts; gum, 2 parts. Rubbing surface: Antimony trisulfid, 5 parts; red phosphorus, 3 parts; manganese dioxid, 1 1/2 parts; glue, 4 parts.

Tungsten is now used as an electric battery element.

Electrical goods of American manufacture are extensively sold in Porto Rico.

WHAT IS A "KILOWATT" AND "KILOWATT-HOUR".

By Frank Szabo.

THERE seems to be quite a wrong conception of the terms *kilowatt* and *kilowatt-hour*. Quite frequently one hears expressions such as "10 kilowatts per hour", but such an expression does not mean anything.

What is a kilowatt? Kilowatt is a term for power or rate of work. According to Kent and other authorities, one kilowatt is equivalent to the evaporation of 3.52 lbs. of water *per hour* from and at 212 deg. F., or 3,415 heat-units *per hour*. In this definition, *per hour* is a necessary part of it, without which the definition is incomplete.

If it takes approximately 3 lbs. of burning coal to evaporate 3.52 lbs. of water from and at 212 deg. F., then one kilowatt represents the consumption of 3 lbs. of coal *per hour*, and not simply the consumption of 3 lbs. of coal. If we extend the evaporation of 3.52 lbs. of water from and at 212 deg. F. by a consumption of 3 lbs. of coal uniformly over a period of two hours, we do not have the equivalent of one kilowatt, but one-half, or 1/2 kilowatt, because during one hour only one-half of 3.52 lbs. = 1.76 lbs. of water have been evaporated with a consumption of one-half of 3 lbs. = 1.5 lbs. coal. Also, if we did the above performance in 30 minutes, or one-half hour, we would not have the equivalent of one kilowatt, but two kilowatts, because at the same rate we would, during one hour, evaporate 2 x 3.52 lbs. = 7.04 lbs. of water with a consumption of 2 x 3 = 6 lbs. of coal. Hence, *one kilowatt represents the consumption of 3 lbs. of coal per hour*.

Of course the quantity of 3 lbs. of coal in the above explanation is not fixed; it may take slightly more or less than 3 lbs. per hour for one kilowatt, depending on the heat value of the coal and the efficiency of the steam and current generating units, but 3 lbs. is a fair average figure.

What is a kilowatt-hour? According to Kent, it is the evaporation of 3.52 lbs. of water from and at 212 deg. F., or 3,415 heat units. In this definition, *per hour* is left out because no matter how fast or how slow the water evaporates, the actual work done in evaporating 3.52 lbs. of water from and at 212 deg. F. is equivalent to *one kilowatt-hour*. In other words, one kilowatt-hour is the equivalent of the rate of one kilowatt for a period of one hour. The rate of 1/2 kilowatt for a period of 2 hours is also equivalent to one kilowatt-hour. Hence:

$$\text{Kilowatts} = \frac{\text{Kilowatt-hours}}{\text{No. of hours}}$$

and kilowatt-hours = kilowatts x No. of hours.

Referring to the operation of electric cars, we cannot correctly say they require *four kilowatts per car mile*; we must say *four kilowatt-hours per car mile*, because the speed of the train has to be considered. Suppose we introduce a watt-meter and a watt-hour-meter into the circuit. The watt meter will indicate the *rate* of power consumed in kilowatts, whereas the watt-hour-meter sums up all the kilowatt-hours consumed during the run. At uniform speed of the car the watt-meter pointer will remain approximately steady in one position, but the watt-hour-meter will continue increasing the reading at a constant rate. If the watt-hour-meter at the end of ten miles' run at constant speed shows a reading of 40 kilowatt-hours, and it took one hour to make the run of ten miles, then the watt-meter showed a constant reading of 40 kilowatts. But if the run of 10 miles is made in say one-half hour, the reading of the watt-hour-meter will be approximately the same—40 kilowatt-hours (neglecting the difference in efficiency of the unit at different loads)—but the watt-meter

(Continued on page 700)



ELECTRICITY

Taught By A Practical Man and in Your Home!

I am teaching electricity and electrical drafting to many men, young and old, and trust you will become sufficiently interested after reading this advertisement, that you will send for my catalog which tells what I am endeavoring to do and also places before you the simple way in which the instruction work is handled. The catalog is written in a very plain manner, much in the same style as my lessons are written,

and tells you exactly what you get and what the course can do for you. My catalog, as well as my advertisements, is written in a very careful, conservative manner so there is no possibility of you expecting something you will not get.

The Purpose of the Course of Study

I have been designing courses in electrical instruction and teaching electricity, off and on during the past 17 years, and during that time I have had an unusual opportunity to make a special study of the teaching business, from the standpoint of a practical man. This course of my own is designed with a view of reaching those who do not have a lot of time and money to devote to study work, and to give them as thorough a knowledge as possible of electricity, in the shortest possible time. The instruction is given like you were working on various jobs and I was the boss telling you what to do and how to do it, and giving the explanation necessary for the understanding of the theory covered by the subject under discussion. There are many conditions which seldom occur in the every day run of electrical experience, and these conditions I lay particular stress on. This part of the instruction makes the course particularly attractive and valuable to those already engaged in active electrical work.

It Is Up To You

The instruction work is laid out and given in a way easily understood. It is not a cut and dried book plan, but the lessons are prepared especially for the purpose for which they are used and additional instruction is given to the individual student, with a view of meeting his particular needs. I have the information to give and I believe the ability to impart it to others, a fact which is in a way proven by other institutions which have made use of my services in the design and perfecting of instruction courses. To understand this work, IT IS UP TO YOU to stick with me and I will surely stick with you till you understand any part of the work you have gone over.

Practical Men Take My Course and Recommend it to Others

Sixty percent of my students are actively engaged in electrical work and find the instruction I give well suited to their needs. Several of these men have had their fellow workers take the course also and they are taking the instruction together, making a class-room proposition of it and the results are in every way satisfactory to all concerned. One of these classes was started by a Chief Electrician, one of my students in Glen White, W. Va., who now has practically all the men under him taking my course. I believe the fact that these men who understand electrical work approve of my course to this extent is one of the strongest endorsements I could get.

FIFTY FIFTY

I work absolutely on a 50-50 basis with my students. You pay me the comparatively low price I ask, and I give you the instruction and other help as is stated in my catalog. No student is permitted to pay cash for his entire course on starting, the course being paid for in small monthly payments as you go along. Students have the privilege of discontinuing the work if they should find that it was not just what they were after, and their payments stop at the same time. This is my way of doing business and I would not want your money when I was not giving you the instruction.

Apparatus, Instruments, Material, Etc.

Certain electrical apparatus, instruments, material, charts, drafting implements, etc., as detailed in the catalog, are included in the course and are a part of the regular instruction for which there is no extra charge as it is covered by the regular monthly payments.

FILL OUT COUPON FOR ONE OF MY CATALOGS WHICH GIVES FULL INFORMATION.

BURGESS
Electrical School
745 E. 42d St., Chicago, Ill.

YORKE BURGESS,
BURGESS ELECTRICAL SCHOOL,
745 East 42nd Street, Chicago, Illinois.

Gentlemen:—
Send me catalog describing your course in Electricity and Drafting.

NAME.....
ADDRESS.....
CITY.....
STATE.....

LEARN WIRELESS IN TEN WEEKS Right In Your Own Home

The Age of Wireless Is Here

The experimental stage has passed. Wireless now equals in importance telegraphy, and telephony. It has assumed its place among the great commercial industries of the earth. So rapid has been the development and growth of wireless in recent years that there has been left in its wake a tremendous shortage of operators. Actually thousands upon thousands will be needed for permanent "peace time" positions offering wonderful opportunities for advancement:

No Previous Experience Necessary

You do not need any previous training or experience in order to become a successful Wireless Expert. By our practical ten weeks' Home Study Course you can quickly qualify for a good position at big pay. Many of our students have secured positions before completing the course.

Get Your Instruction From the Nation's Capital

Our Course Is Endorsed by Officials of the U. S. Government

The National Radio Institute, headed by authorities who have been closely allied with government training of students, has perfected an easily mastered course in wireless telegraphy whereby students are taught completely in ten weeks, either here in Washington at our large residence school or at home, by mail. Many of our students are ready to take up actual wireless work in much less time. The course is founded on actual practice, hence the rapid progress of the student.

Earn Up to \$200 Per Month

In the short period of ten weeks we can make of you a wireless operator, a man with a profession, independent, and not subject to the rise and fall of wages in the labor market. Salaries are as high as \$200 per month. We give you this training at home, by mail, in your spare time. It is not necessary for you to lose any time from your work to take the course. Then when you have received your diploma we help find you a good position.

Free Instruments to Every Student

In addition to text books, lessons and personal instruction, we send you a Home Practice Set consisting of a standard sending key and buzzer, and a Universal automatic wireless transmitting and receiving set. These instruments are free to every student. No other school can offer you what we do.

Pay As You Go Along With Your Lessons

Our plans of payment bring a wireless education within the reach of anyone who desires to learn. A small payment down and small payments twice a month enable you to earn the cost of your tuition while actually learning to be a wireless operator.



Reproduced from the Washington Times, January 31, 1919—

SAYS RADIO WILL SOON SCRAP WIRES

"Scrap. That's all the telegraph and telephone poles, wire and instruments will amount to in a year if the program now being made in a wireless communication continues."

Congressman Steenerson of Minnesota, rank-office Republican member of the House Post-Office Committee, made this prediction today. Wireless communication will have become so general by the end of the year 1919, Steenerson said that few persons will give much concern about whether the Government or private interests control the country's telegraph and telephone lines.

Limitation of Government control of these lines until the end of the present calendar year will have been forgotten, Steenerson added, if wireless telegraphic and telephonic communication is to continue along the present general lines.

DECLINES TO COMMENT

Steenerson declined to comment upon the report that most of the telegraph and telephone companies would be glad to turn over their properties—which they now estimate to be worth about a billion dollars—to the Government, if they would be permitted to invest their capital in wireless communication.

"Such telegraph and telegraph property will not be worth half as much as it is quoted at today, after wireless communication has demonstrated its usefulness and value," Steenerson continued.

This shows what big men think of the future of Wireless

Wireless News Notes

The U. S. Shipping Board has recently announced an increase of nearly 30% in the pay of Merchant Marine Wireless Operators.

Nicola Tesla, world famous inventor, has recently perfected his Wireless Light, one of the wonders of the age.

Another new invention has been perfected whereby wireless messages may now be sent underground.

Due to the recent perfecting of the Wireless Telephone, we expect to soon be able to communicate with our Home Study students by wireless.

Mail This Coupon Today

Valuable Wireless Book FREE

Our booklet, "WIRELESS, the Opportunity of Today," gives you complete information in regard to our course, the quick and easy methods by which you can master wireless, and other important facts you should know. It is free. Just mail the coupon. No obligation whatever on your part.

NATIONAL RADIO INSTITUTE,
Dept. 70, Washington, D. C.

Send me, free of charge, your booklet, "Wireless, the Opportunity of the Age," with full particulars regarding your famous 10 weeks' Home Study Course, and your Special Free Instruments Offer.

Name

Address

Town State

TRANSMISSION OF LIGHT THRU WATER.

The comparative transmission of light thru varying depths of water is a problem that science until recently knew but little

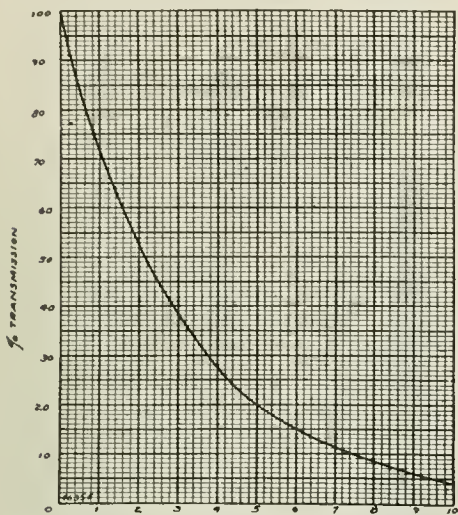

TEST MADE IN CITY WATER OF SCHENECTADY, N.Y.

Showing Decrease In Transmission of Light Thru Water for Different Depths. A Problem Which All Submarine Inventors Are Interested In.

about. Now, thanks to Mr. S. L. E. Rose, of the General Electric Company's illuminating engineering laboratories, who describes his findings in the *General Electric Review*. Photometric readings were taken every six inches thruout the available range of 5½ feet of water in the cylindrical tank in which the tests were conducted. The water used was Schenectady city water, which is clear artesian well water. Sea water would transmit much less light owing to the apparent blue or greenish tint it possesses which tints bespeak a fairly considerable amount of suspended matter and consequently increased opacity.

The accompanying graphic curve shows vividly the relative transmission of light from a Mazda lamp, fitted with waterproof connections. A table of constants is given in the article, together with a formula for computing the illumination intensity for different depths of water when the initial intensity is known. The present graph shows, however, just how rapidly the illumination falls off in water for any given initial illumination. The particularly interesting feature of the results from a practical standpoint is the very considerable cut-off of light produced by a substance apparently so transparent, amounting for a single foot (0.05 m.) of water to 27.5 per cent. On this basis the trans-

mission through 50 ft. (15.2 m.) of water would be only about one part in 10,000,000 of the incident light.

The rapid decrease in the transmission factor with increased light travel in water coincides with the well-known facts that, for a so-called transparent medium, the ocean permits the penetration of daylight to but a surprisingly short distance below its surface and that fish native to the depths are blind or carry their own illuminants.

HAMMOND RADIO CONTROLLED BOAT SUCCESSFUL.

Army and navy experts have reported the device of John Hays Hammond, Jr., for radio control of surface craft to be sent laden with explosives against enemy ships, a success, and predict similar results with submerged craft.

Secretary Baker wrote the House appropriation committee recently that the joint army and navy board was "convinced of the practicability of the control" of the surface craft, and added that there had also been demonstrations of the possibility of the control to a craft, completely submerged, except for an air in-take pipe.

Before finally deciding on the purchase of the patents for \$750,000 the board desires further experiment with the submerged craft.

Construction of the submerged craft, which will be about 80 feet long by 7 feet in diameter, will take two years, according to Mr. Hammond, who told the committee, he had spent ten years and \$400,000 on his invention.

"The board considered the ability of the enemy to interfere with the control of the vessel by radio energy. Mr. Hammond's claims are that no interference can be had with the craft outside a radius of 100 to 150 yards from the source of the energy; that is, from the radio plant of a battleship, for example."

Major-General F. W. Coe said he had run the craft "all around vessels coming into the harbor at will." Mr. Hammond said an aviator after four hours' training on control, was able from a height of 9,000 feet and a distance of six or seven miles to exercise absolute control over the high-speed boat.

ELECTRIC SNOW MELTER FOR TRACK SWITCHES.

The electric snow melting device for track switches here illustrated is purely and simply an electric heater enclosed in a 3½ inch wrought iron pipe, 20 inches long. These heaters are placed between the ties, just under the rail. They are wired from a circuit as the amount and character of the supply current makes necessary, and a switch is placed in this wiring at some

convenient point clear of the track. The current can be turned on as the snow storm starts by an employee as easily as an electric light. The heat generated does the rest.

The temperature in the heater rises about 100 degrees Centigrade in the first half hour and by the end of an hour is about 135 degrees Centigrade above the outside temperature. This heat is not enough to set fire to anything but is sufficient to melt the snow.



EARN \$35 TO \$100 PER WEEK

As a Mechanical Draftsman

Thousands of Men Wanted

You can learn Mechanical Drawing at home in your spare time through our practical Home Study Course and qualify for Big Pay. We have placed hundreds of our students in good paying positions. Government departments and private concerns are continually calling upon us for our graduates.

Become a Chief Draftsman

and get to the very top in this well-established and rapidly growing profession. The training given by the Columbia School of Drafting will give you just the knowledge you need to make good as a Chief Draftsman. No previous training is necessary. You can begin our course now and make rapid progress from the start under the Personal Instruction of the President of the School, Mr. Clafin, by mail. His carefully prepared lessons and personal letters of advice make each step easy and interesting.

Draftsmen Now Getting \$35 to \$100 a Week

with big chances for better pay as the demand grows. All big engineering, construction and manufacturing projects must first go through the drafting room before the workmen can commence. All such enterprises depend upon large numbers of draftsmen. Salaries are advancing steadily.

Drawing Outfit Free with Our Course

As soon as you enroll you will be sent our drawing outfit for your own use throughout the course. This entire outfit will be yours to keep. You are not obliged to return it after completing the course.

Not Only a Correspondence School

The Columbia School of Drafting is probably the largest residence school in the country specializing in the training of professional Draftsmen. Our Home Study Courses are an extension of the same instruction as given locally.

Illustrated Catalog FREE

Simply fill in the coupon below, return it to us and we will send you free a copy of our illustrated catalog which tells all about our practical Home Study Course and how you may secure our instructions at once on easy terms so as to quickly qualify for one of the big positions open.

Send This Coupon Today.

COLUMBIA SCHOOL OF DRAFTING
Dept. 982, 14th and T Sts., Washington, D. C.

Without obligation to me, please send me your Illustrated Catalog and tell how I may secure your practical training in Drafting and your help in securing a position as Draftsman.

Name

Address

City..... State.....

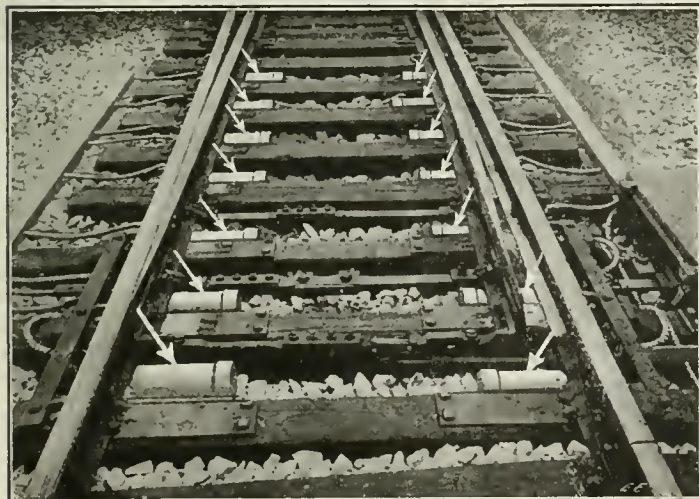

New Electric Snow Melter for Railroad Track Switches. Heating Coils Indicated By Arrows.

110-V. TRANSFORMERS

8 Volt Secondary



Consumes so little current will not move ordinary meter.

\$1.00

Postpaid

No. 10 gives 3 currents — 8, 12 and 18 volts secondary. Ideal for experimental work. A standard transformer, guaranteed. Complete with plug, \$2.00 postpaid. Order from this ad.

NATIONAL TRANSFORMER CO.,
Dept. 13, 3124 No. California Ave., Chicago

ELECTRICAL ENGINEERING

training again open to civilians. Over 3000 men trained for electrical industries in experience of more than a quarter of a century. For men of ambition and limited time. Condensed course in Electrical Engineering enables graduates to secure good positions and promotions. Theoretical and Practical Electricity, Mathematics, Steam and Gas Engines, Mechanical Drawing. Students construct dynamos, install wiring and test electrical machinery. Course with diploma complete. Thoroughly equipped fireproof dormitories, dining hall, laboratories, shops. Write for catalog. 27th year opens October 1, 1919.

BLISS ELECTRICAL SCHOOL
260 Takoma Avenue, Washington, D. C.

WHAT IS A "KILOWATT" AND "KILOWATT-HOUR?"

(Continued from page 897)

will give a constant reading of 80 kilowatts; in other words, for a speed twice as great the watt-meter will show a constant reading twice as high, whereas the watt-hour-meter reading will be the same for the same distance traveled.

Applying the formula to this example for a speed of 10 miles per hour and a power consumption of 40 kilowatt-hours, we get

$$\text{Kilowatts} = \frac{40}{1} = 40$$

Making the same run in one-half hour we get

$$\text{Kilowatts} = \frac{40}{\frac{1}{2}} = 80$$

Dividing the total power consumed by one car in kilowatt-hours by the distance in miles, we get the power consumption in kilowatt-hours per car mile.

Applying the above terms to electric light, a 40-watt electric light is one that consumes electric power at the rate of 40 watts or 40 watt-hours per hour. A circuit having, say, twenty 40-watt lights in parallel will then consume electric power at the rate of $20 \times 40 = 800$ watts or 800 watt-hours per hour, or 40 watt-hours per lamp-hour. If

an electric power station charges you ten cents per kilowatt-hour you can burn one 40-watt lamp 1,000 — = 25 hours, or twenty 40-watt lamps 40 1,000 = 1 1/4 hours, for ten cents, since 20×40 both conditions represent one kilowatt-hour.

SOMETHING NEW IN LAMP GUARDS.

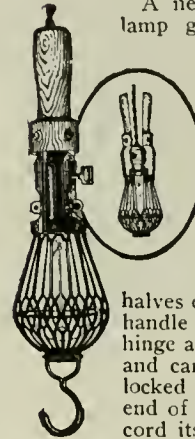

A new departure in portable lamp guards is shown in the illustration of a split handle which can be quickly attached to a special expanded steel lamp guard supplied by the same concern.

This portable successfully fills a demand for a substantial handle guard which does not need to be wired. The

halves of the guard including the handle itself, open from the hinge at the bottom of the guard and can instantly be closed and locked around the socket at the end of any extension cord. The cord itself runs thru grooves in the handle.

The convenience of this new product will be appreciated by the motorist in his garage as well as in every factory, mill or warehouse, because it permits light to be safely carried to dark corners, in stock bins, engine pits, etc. Fire danger is avoided and lamp users will readily see the advantage and economy, as the modest cost of the guard is quickly repaid thru prevention of lamp breakage.

ANOTHER "USELESS" PATENT.

A Chicago woman has patented a shoe with an electric battery in the heel to supply a mild current to a wearer's ankle as a tonic. Another "useless patent!"

THE PHOTOELECTRIC SENSITIVITY OF VARIOUS SUBSTANCES.

SOME time ago an examination was made of various substances to determine their electrical sensitivity to light; and in view of the fact that some of the results obtained are at variance with the measurements made by Case, it seems desirable to publish a summary of these observations, which were made at the Bureau of Standards.

Two of the herein described substances were examined for change in electrical conductivity caused by the action of light upon them, and all of them were examined for photoelectric activity when they were charged to a negative potential in an evacuated bulb and exposed to light, reports Messrs. Coblentz and Emerson in the *Journal of the Washington Academy of Sciences*.

When the substances were examined for an increase in electrical conductivity, a potential of 2 to 6 volts was connected thru a resistance of zero to 1,000,000 ohms into a circuit containing a d'Arsonval galvanometer and the substance under investigation. In most cases the substances were slightly conducting when not exposed to light, so that the dark current had to be annulled by joining a counter e.m.f. thru a resistance of 10,000 ohms to the terminals of the galvanometer. This counter e.m.f. was obtained by shunting across a resistance of 100 ohms which was in series with a cell of 2 volts and a variable resistance of zero to 70,000 ohms.

The source of light, when not otherwise

MAGNETIC RECTIFIER

Patented April 18, 1916



COLD WEATHER WON'T BOTHER YOUR STARTER

If you keep your battery charged up with an

F-F BATTERY BOOSTER

CONNECT to any lamp socket without removing battery from car or breaking any electrical connections. Changes alternating to direct charging current, and will completely fill your battery over night.

The Private Garage types cost only \$24.00 and come complete with long cord and plug to fit any lamp socket, ammeter, which tells what current is flowing into the battery and charging wires fitted with clips, to snap on the battery terminals.

Thousands in use giving satisfaction. Write today for Bulletin No. 12, or send us your order. Money back if you want it.

The France Manufacturing Company
Cleveland, Ohio

The House of Taylor



HOTEL MARTINIQUE

BROADWAY, 33D STREET, NEW YORK
One Block from Pennsylvania Station.

Equally Convenient for Amusements, Shopping or Business

157 Pleaaant Rooms, with Private Bath, \$2.50 PER DAY.

257 Excellent Rooms, with Private Bath, facing street, southern expoaurc, \$3.00 PER DAY.

Also Attractive Rooms from \$1.50.
The Restaurant Prices Are Most Moderate.

400 Baths
600 Rooms

CORE WIRE

We have been fortunate in securing thru auction several tons of guaranteed pure, double annealed Norway Iron Core Wire and are selling this wire to "Experimenter" readers

AT PRE-WAR PRICES 20cts LB.

This wire is just the thing for spark coils, transformers, etc., and it is, of course, a very much more superior product than the usual iron wire. We absolutely guarantee the quality.

If you ever thought of building a spark coil, transformer, or similar apparatus, now is the chance to get the right material for it. As far as we know this is the only lot of iron Norway Core Wire in the hands of any dealer at the present time, and none can be gotten until after the war.

We have only two sizes left:

26 INCHES Thickness about No. 21 B and S 36 INCHES

If either of these sizes should be too long we advise cutting the wire down yourself by means of shears. It will pay you to do so as real Norway Iron Wire, sold by a few dealers last year, brought from 40c to 50c a pound. American core wire now sells for from 30c upwards per pound.

As long as the supply lasts we offer this wire as described above to our customers at the very low price of 20c a pound. Order at once.

ELECTRO IMPORTING CO., 231 Fulton St., N. Y. C.

specified, was a 16-c.p. carbon incandescent lamp, placed at a distance of 10 cm. from the substance under investigation. One disappointing feature of this investigation is that no substance was found which is comparable in sensitivity with the *potassium photoelectric cell* and with the *selenium cell*. *Collium*. This metal was solid, thus differing from the impure material, which is a liquid.

The results obtained proved disappointing, this metal being quite insensitive to light. When the cell was exposed to daylight the photoelectric current produced a deflection of only 4 to 5 mm., whereas similarly exposing a *potassium photoelectric cell* the photoelectric current was sufficient to give a deflection beyond the range of the scale.

Silver Sulfide. The sample examined was a thin flexible strip, 6 by 10 mm. in area. In one test the silver sulfide formed the negative electrode of a photoelectric cell (evacuated glass bulb about 5 cm. diameter with a ring of platinum wire for the anode). It was connected thru an iron-clad Thompson galvanometer to a battery of 340 volts. When exposed to daylight a deflection of perhaps 1 to 2 mm. was observed, but no deflection resulted from exposure to the standard carbon lamp.

Selenium. A crystal of selenium, prepared by Dr. F. C. Brown and having a receiving surface of less than one sq. mm., when exposed to the standard lamp gave a deflection of more than 50 cm., which shows its *great sensitivity* as compared with other substances.

The mounting of the selenium crystal consisted of metal electrodes between which the crystal was held by compression. When operated as a photophone, by connecting the selenium crystal with an Audion amplifier, a loud musical note was obtained.

Tellurium. This metal is said to change in resistance when exposed to light. The present tests were made upon a mirror of tellurium deposited upon a glass plate by cathode disintegration. Suitable terminals were attached to a sample about 4 by 50 mm. *No change in conductivity* was observed when it was exposed to light.

Boleite. The sample of boleite [3Pb Cl (OH) .Cu Cl (OH) + Ag Cl], from Boleo, Mexico, examined was a single rectangular crystal 3 by 3 by 1.5 mm. It was held by compression between copper electrodes. *No change in conductivity* was observed when the crystal was exposed to daylight or to the standard incandescent lamp.

Stibnite. The size of one sample examined was 4 by 7 by 0.5 mm. Terminals were attached to it by heating a copper wire to incandescence in a gas flame and bringing it in contact with the plate of stibnite.

The standard carbon lamp caused a deflection of 5 cm. Stibnite may be considered as sensitive as *boulangerite*, to be mentioned presently, but the deflection drifted, due to the decrease in resistance with time already noticed by other observers.

Boulangerite. The specimen of houlangerite (3PbS. Sb₂ S₃, Irkutsk, Siberia), investigated was obtained from the Smithsonian collection. Several samples were examined. In one sample, 4 by 7 by 0.8 mm., the electrodes consisted of copper wires melted into the material as just described. The radiation from the standard lamp gave a deflection of 10 to 20 cm.

Another sample, 1 by 1.2 by 2 mm., held by compression between two heavy electrodes of copper, when exposed to the standard incandescent lamp produced a deflection of 2 to 3 cm., which is comparable with the preceding when one considers the size of the exposed surfaces.

Altho this substance seems fairly sensitive, it did not appear to be sufficiently so to justify an investigation of its spectral sensitivity with a view of using this mineral as a selective radiometer.

Jamesonite. (2PbS.Sb₂S₃; Smithsonian



Telegraph and Telephone Books Sent to Experimentors for a Whole Week FREE

Absolutely free to use for seven days—no strings of any kind to this offer. Every reader of *Electrical Experimenter* can have a set of these great, instructive and intensely interesting books telling everything that the greatest experts in the business know about telephony and telegraphy. The coupon brings all four volumes right to your door. If they don't please you in every way, we stand the expense of shipping them back. See the list of things the books explain and our *free trial* offer below.

Will Make You An Expert

This Library of Telephony and Telegraphy will fit you to hold the biggest kind of job in this interesting and well-paying field. The 4 big books with 1,728 pages and 2,000 pictures, plates, diagrams, etc., bound in genuine leather, regular library style, explain everything you need to know.

Part of What They Contain Electric Telegraph—Wireless Telegraphy—Elements of Electricity—Line Construction—Engineering and Maintenance—Electrical Measurements—Switchboards—Automatic Systems—Power Plants and Buildings—Special Service Features—Telegraph and Railway Work—Substation Equipment—Party Line Systems—Generators—Train Dispatching—Storage Batteries—Coils—Tests. Altogether a thousand different subjects are covered in detail.

Consulting SERVICE FREE With every set of the *Cyclopedia of Telephony and Telegraphy* we will give without any charge whatever a one year membership in the American Technical Society enabling you to consult our engineers and experts on any telephone, telegraph or wireless problem you want solved for one year. This membership usually sells for \$12.00. It is yours free with the books.

DON'T SEND MONEY

Don't send one cent with your free trial request. The coupon is all you need to get the books. Just fill out all three lines and mail it to us. We will ship the books to either your home

or shop by express collect and you can use them as if they were your own for a whole week. Then if you want to send them back do it. It's all right with us and we will pay the expense of shipping them back ourselves. If you want to keep the books send us only \$2.00. You can send the balance of our special \$12.80 price the same way—\$2.00 each month.

We reserve the right to withdraw this price at any time. In fact we cannot maintain it after the present edition is sold. Act now while the low price holds good.

AMERICAN TECHNICAL SOCIETY
Dept. X-3384
Chicago, U. S. A.

This Coupon is all You NEED

Send it Now

American Technical Society,
Dept. X-3384
Chicago, Ill.,
U. S. A.

Please send me the four-volume set of "Telephony and Telegraphy" for seven days' examination, shipping charges collect. If I decide to buy, I will send \$2.00 within seven days and balance at \$2.00 a month until \$12.80 has been paid. Then you will send me a receipt showing that the set of books and the Consulting Membership are mine, and fully paid for. If I want to get along without the books, I will return them at your expense after seven days.

Name.....
Address.....
Reference.....

FREE TO THE RUPTURED

DON'T WEAR A TRUSS

FREE TRIAL

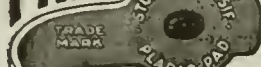

IT'S THE NON-SLIPPING YET, NON-RIGID PAD AND WHAT IS WITHIN IT, THAT COUNTS.

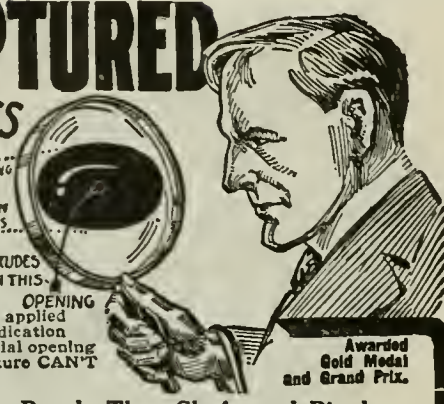

Awarded Gold Medal and Grand Prix.

PLAPAO EXCLUDES Inner surface made self-adhesive purposely to prevent slipping and to keep constantly applied the absorbent-astringent medication called PLAPAO. Close the hernial opening as nature intended so the Rupture CAN'T come down.

Do Away With Steel and Rubber Bands That Chafe and Pinch

You know by your own experience that the truss is a mere makeshift—a false prop against a collapsing wall—and that it is undermining your health. Why, then, continue to wear it? **STUART'S PLAPAO-PADS** are entirely different—being medicine applicators made self-adhesive purposely to prevent slipping and to hold the distended muscles securely in place. No straps, buckles or springs attached. No "digging in" or grinding pressure. **Soft as Velvet—Flexible—Easy to Apply—Inexpensive.** Continuous day and night treatment at home. No delay from work. Hundreds of people, old and young, have gone before an officer qualified to acknowledge oaths, and swore that the **PLAPAO-PADS** cured their Ruptures—some of them most aggravated cases—and of long standing.

Send Today For FREE PLAPAO--No Charge for it--Now or Ever

Simply write your name and address below. Send this advertisement for absolutely FREE TRIAL PLAPAO and 48-page Book on Rupture. No charge for it—now or ever. Nothing to be returned. "Be wise today 'tis madness to defer." Address, **PLAPAO CO., Black 844, St. Louis, Mo.**

Name..... Address.....

The Breakers

Atlantic City's Newest Fire-Proof Hotel

Ocean Front. Unusually attractive during the Autumn and Winter seasons.

American and European Plans

Luxurious lobbies, spacious verandas and sun parlors overlooking the ocean. Charming afternoon musicales and evening concerts. A palatial residence for those seeking rest and recreation. Sea water baths. Fireproof garage. Illustrated booklet sent on request.



"THERE'S MONEY IN IT"

LEARN TELEGRAPHY AT HOME

MORSE AND WIRELESS

TEACH YOURSELF

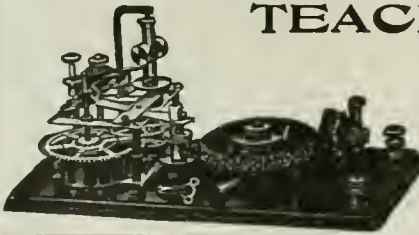

In half the usual time, at trifling cost, with the wonderful Automatic Transmitter, **THE OMNIGRAPH**, Sends unlimited Morse or Continental messages, at any speed, just as an expert operator would.

Adopted by U. S. Gov't. 4 styles. Catalogue free.

OMNIGRAPH MFG. CO.
39L Cortlandt St. New York

1-50 H. P. Motor \$4.00 complete as shown

If you are in need of a small motor for experimental purposes, this is your chance to get one at a very low price. Wound for 110 volt A. C. or D. C. Built exactly the same as a large motor; twenty-two section commutator, laminated field and armature construction, drum wound armature.

We have only a limited quantity to offer at this price which means that you must act quick if you wish to secure one at this low price.

BODINE ELECTRIC COMPANY

2254 WEST OHIO STREET CHICAGO, ILLINOIS

GREEN AUTOMATIC MACHINE

ADD TO YOUR INCOME WITH LITTLE EFFORT \$5 to \$10 A DAY MADE EASY WITH

New Improved Green Automatic Machine

Sharpens, Hones and Straps all kinds of safety razor blades, in one operation, from four to six blades per minute. For both Quality and Quantity, this machine is in a class by itself. There is nothing like it on the market. Let us send you our free booklet explaining everything including the "AMERICAN" Key Cutter—cuts square, angular or round slots.

AMERICAN SHARPENING MACHINE CO. (Inc.), Dept E E, 184 W. Washington St., CHICAGO



"AMERICAN" Key Cutter

collection, from Cornwall, England.) The sample examined (size 2 by 7 by 1 mm.) had the copper wire terminals attached by fusing the incandescent wire into the material. The standard lamp gave a deflection of only 1 to 2 cm., which seems to indicate that this material is not so light-sensitive as is boulangerite.

Mixtures of galena and stibnite in various proportions were melted in a crucible and poured upon a plate of metal. Several samples, 5 by 10 by 0.5 mm., were examined, but none of them gave any indication of light-sensitiveness (change in resistance) when exposed to daylight or to the standard incandescent lamp.

Bismuthinite. Bismuthinite, Bi₂S₃, was obtained from the Smithsonian collection from Jefferson County, Montana. This is the most interesting substance examined, in view of the diverse results obtained and the explanation offered therefor.

The sample of bismuthinite examined consisted of a non-homogeneous mass of acicular crystals, which was easily crushed into numerous fine needle-like crystals. The first sample examined was a small mass of crystals (size 1 by 1 by 0.7 mm.) held by compression between two heavy electrodes of copper. When the crystal was exposed to the standard carbon lamp *no change in conductivity* could be detected with certainty.

A second sample, 3 by 6 by 1 mm., had the copper wire terminals attached by fusion, as already described. The e.m.f.'s applied were the same as for the preceding sample. When exposed to the standard lamp no change in conductivity was observed. These results being contradictory to those published by Case, who used a three stage Audion amplifier to detect the change in conductivity of the crystals, the foregoing experiments were repeated in the manner described by him. For this purpose the light from an acetylene flame shining thru a slit 2 by 10 mm. was focused upon the crystal by means of a triple achromatic lens, 6 cm. in diameter and 18 cm. focal length. The light was interrupted by means of a sector disk having 15 openings and operated by means of an electric motor, the speed of which could be varied. The usual speed gave 240 interruptions per second. The crystal was connected to a three stage Audion amplifier and telephone receiver. A crystal of selenium or a selenium cell produced a loud note, but the samples of boulangerite and jamesonite, which by previous tests were light-sensitive, did not give a musical sound in the telephone.

The sample of bismuthinite with electrodes sealed on produced no audible note when exposed to light.

At least a dozen samples of bismuthinite held by compression between heavy copper electrodes were examined in connection with the amplifier. Of this number only two samples appeared to be light-sensitive. One sample produced only a faint sound in the telephone receiver. The second sample produced a loud note in the telephone. The sound was the loudest when the crystal was exposed along the line of contact with the copper electrode. Covering the crystal with red glass did not reduce the loudness of the note very much, indicating that the effect is due to heating of the material. Unfortunately, this crystal was crushed while under investigation. Prolonged tests on other samples gave negative results as regards the production of sound.

In view of the fact that the tests made with a sensitive galvanometer failed to show an increase in conductivity when bismuthinite was exposed to light, it appears that the change in conductivity which was observed when a certain specimen was exposed to intermittent flashes of light (photophone or, ratiier, radiophone) is

the result of a *thermal change* within the crystal, or perhaps a change in the *contact resistance* at the electrodes. In this connection the following experiments on thin strips of metals are of interest.

Platinum and Gold. In conclusion it is of interest to record the results obtained when using thin blackened strips of platinum and of gold-leaf as radiophones, by connecting them thru a battery to an amplifier.

These blackened strips were warmed intermittently by exposing them thru a rotating sectored disk to the acetylene flame, as already described.

When a sensitive platinum bolometer receiver was used as a radiophone, the sound produced in the telephone was not very audible. This no doubt was due to the great heat capacity of the material which prevented the rapid alternations in resistance and hence in electric current, from being of sufficient magnitude to affect the telephone receiver.

Using a lightly smoked strip (6 by 2.5 mm.) of gold-leaf, the ends of which were clamped between thin (0.02 mm.) strips of tin, the sound produced in the telephone receiver was as loud as was observed in the photophone made of selenium.

This device was mounted in a glass bulb which could be evacuated. As was to be expected, there was no marked difference in the intensity of the sound produced when operated in air and in a vacuum.

In the gold-leaf radiophone as used, the limit of audibility was attained for a light (radiant power) intensity of 4.8×10^{-5} watts. Using a larger receiver and amplifier and a larger current (which was 0.2 amp. in the present tests) thru the receiver, the sensitivity could be greatly increased.

MENTAL TELEPATHY—A SIMPLE CONCEPTION OF PSYCHICAL ACTIVITY.

By Dr. Charles H. Merlitz

IN the September issue of the *ELECTRICAL EXPERIMENTER* there appeared an extremely interesting article by Dr. A. Abrams on *Thought Transference and Other Phenomena*. Altho he gave many interesting experiments he did not show the relationship of this theory to the modern physical theories. It is the author's intention in the present article to present an explanation for this remarkable phenomena.

We know very little in regard to the functioning of the human mind. We have practically no insight into the mechanism of thought and memory. We do know, however, that the brain in functioning requires nourishment. Thus it follows that any operation of the brain is accompanied by the absorption of a certain amount of energy. However, *contrary* to ordinary laws, in storing a thought and in subsequently recalling it, *energy is absorbed*. These two processes are the opposite of each other, and it would naturally be supposed that in remembering energy would be dissipated.

To commit a thought to memory we repeat it several times, each successive repetition requires the expenditure of a certain amount of energy. Thus we may say that the energy expended after a number of repetitions equals:

$$1^2 + 1^2 + 1^2 + 1^2 + \dots + 1^2 = n \text{ times}$$

Now when we remember it the process is the reverse, which gives us $(-1)^2$ which would equal 1^2 , which means the *addition of energy*. Thus the act of remembering a fact more firmly implants it in the mind.

We may easily assume that there is a certain practical limit to the amount of effect that can be produced. This limit might be called the *saturation* of the brain. It would be reasonable to suppose from this that for each repetition or act of remembering the amount of energy stored is less than that of the preceding one, decreasing in geo-

VIOLET RAYS

for Health Strength and Beauty

You can **TREAT YOURSELF** at home with the wonderful Violet Ray, most effective health-restoring agent known to science. At practically no cost, the great benefits of famous Violet Ray Treatment heretofore only procurable at big expense from physicians and beauty specialists, now secured in your own home. Look over the list of treatments on the coupon below. Send for particulars.

RENULIFE VIOLET RAY High Frequency Generators

How Violet Ray Benefits

Electricity from your light socket is transformed into health and beauty-giving Violet Ray—powerfully effective, yet gentle, soothing, perfectly safe. Voltage is raised from lighting current, giving tremendous penetrative force. The irresistible revitalizing powers of Renulife Violet Ray are carried at once to every nerve cell of body. Blood is enriched and purified by a flood of oxygen, functions restored to normal—extra supply of fresh blood quickly brought

to area treated, removing congestion and supplying nourishment; combines the benefits of electricity, vibration, exercise, stimulation and oxidation.

Painless Electricity

Science has modified electricity that the weakest may stand its force without fear or pain. Violet Ray high frequency has no comparison with old, crude, electrical batteries and shocking current. Every jar and shock is removed. The effects are marvelously rapid. Relief can be given in one or more treatments. Often permanent improvement is accomplished in that time,



USE AT HOME

Offered on Liberal TRIAL PLAN Learn the Wonderful Benefits by Actual Use.

To keep or restore your good looks and gain vitality, throw away medicine bottles—take this sensible scientific means. Every day's delay makes relief more difficult. Send for Booklet "Health via Violet Ray."

Lowest Priced—Most Effective Violet Ray for Home Use

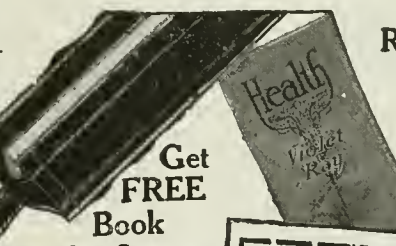

Get FREE Book Tear Out Coupon

Renulife Electric Co.
535 Marquette Bldg., Detroit, Mich.

Canadian Renulife Electric Co.
Ford City, Ontario

Opportunities for live sales representatives

COUPON FOR BOOK and Special Information

RENULIFE ELECTRIC CO., 535 Marquette Bldg., Detroit
Please send without obligation, your book "Health," explaining Violet Ray treatments with Renulife Generators; also give full particulars as to its application for ailments checked below.

- TREATS SUCCESSFULLY**
- .. Abscesses
 - .. Anemia
 - .. Asthma
 - .. Arteriosclerosis
 - .. Baldness
 - .. Blackheads
 - .. Brain Fog
 - .. Bronchitis
 - .. Bunions
 - .. Bruises
 - .. Catarrh
 - .. Colds
 - .. Chills
 - .. Chills
 - .. Dandruff
 - .. Deafness and Ear Diseases
 - .. Eczema
 - .. Enlarged Prostate
 - .. Facial Neuralgia
 - .. Falling Hair
 - .. Femata Complaints
 - .. Gout
 - .. Hemorrhoids
 - .. Hay Fever
 - .. Infantile Paralysis
 - .. Insomnia
 - .. Lameness
 - .. Locomotor Ataxia
 - .. Lumbago
 - .. Nervous Affections
 - .. Neuralgia
 - .. Neuritis
 - .. Obesity
 - .. Pain in Abdomen and chest
 - .. Paralysis
 - .. Piles
 - .. Pimples
 - .. Pyorrhea
 - .. Rheumatism
 - .. Scars
 - .. Scalds
 - .. Skin Diseases
 - .. Sore Throat and Throat Diseases
 - .. Sprains
 - .. Toothache
 - .. Weak Eyes
 - .. Wrinkles
 - .. Warts and Moles

Name

Address



Men Wanted for Airplane INDUSTRY

Wonderful opportunities—great scope for advancement—and big pay—await you in the airplane industry. This does not mean actual flying, but in any and all of the various branches of the industry. It is the coming profession—the future means of transportation. U. S. Mail is already being carried by airplanes. Factories are springing up every where and trained men are in big demand.

Openings in Many Branches

You can get into this profession while it is still in its infancy as a mechanic, engineer, repairman, instructor, inspector, builder, contractor, salesman or professional aviator. The minute you understand the science and mechanics of aviation you can step into a high-salaried position.

We Guarantee Our Training



We absolutely and unreservedly guarantee that our Home Training Course will enable you to qualify for a good position as soon as you graduate. The Course itself has been written by noted aeronautical engineers, and covers the entire fundamentals of practical aeronautics. Every lesson is written and illustrated so clearly that you cannot fail to understand it. But see for yourself. Take ten lessons. Then if you are not satisfied you are not out one cent. We guarantee satisfaction.

Prepare Now for a Big Future

Only by specialized instruction can you expect to succeed in aviation or in any line of business. Training alone will fit you for a big job—and NOW is the time to begin. Check and mail the coupon for Big Free Bulletin and Money-Back Guarantee.

AMERICAN SCHOOL OF CORRESPONDENCE

Dept. F-7444 CHICAGO, U. S. A.



TRAINING THE KEY TO SUCCESS

Please send Free Bulletin and explain how I can qualify for the position checked.

- ...High School Graduate
- ...Electrical Engineer
- ...Elec. Light & Power Supt.
- ...Hydroelectric Engineer
- ...Telephons Engineer
- ...Telegraph Engineer
- ...Wireless Operator
- ...Architect
- ...Building Contractor
- ...Civil Engineer
- ...Structural Engineer
- ...Mechanical Engineer
- ...Shop Superintendent
- ...Steam Engineer
- ...Draftsman and Designer
- ...Lawyer
- ...Business Manager
- ...Certified Pub. Accountant
- ...Accountant and Auditor
- ...Bookkeeper
- ...Stenographer
- ...Fire Insurance Expert
- ...Sanitary Engineer
- ...Master Plumber
- ...Heating & Vent. Engineer
- ...Automobile Engineer
- ...Automobile Repairman
- ...Airplane Mechanic
- ...General Education Course
- ...Common School Branches

Name.....

Address.....

SAVE 25% to 60% on slightly used GRAFLEX-KODAKS

Cameras and Lenses of every description. Equal to new. Save money. Write now for Free Bargain Book and Catalog listing hundreds of money-saving bargains in slightly used and new cameras and supplies. All goods sold on 10 days' Free Trial. Moneyback if not satisfied. You take no chances dealing with us. We have been in the photographic business over 16 years. Write now.

CENTRAL CAMERA CO., Dept. 174, 174 S. Wabash Ave., Chicago

Feldman's "Geysir" Electric Water Heater

Instantaneous Hot Water

FELDMAN MFG. CO. 1500 Times Bldg. New York City

Be an Artist

Comics, Cartoons Commercial, Newspaper and Magazine Illustrating, Pastel, Crayon portraits, Posters and Fashions. Earn Big Money. Taught by Mail or Local Classes. Write for illustrated booklet, terms and list of successful pupils.

ASSOCIATED ART STUDIOS, 13A Flatiron Bldg., N. Y.

metrical progression. Each repetition, however, is accompanied by the absorption of a certain amount of energy. Thus it follows that for each succeeding repetition there is a certain amount of surplus energy to be accounted for. It is this surplus energy that gives us an explanation for the process known as Mental Telepathy. Our question then resolves itself into the manner of transference or transmission of this energy.

Sir William Crookes has suggested that the transmission of this energy is effected by means of other waves of smaller magnitude and greater frequency than those which constitute X-rays. These rays also possess the property of neither being reflected or refracted. Prof. Flournoy suggested that these waves are undulations starting from the nervous centers in the brain. The greatest objection to this theory of telepathy is that the intensity of the received impulses is not inversely proportional to the square of the distance, no perceptible diminution in the impulses being produced by distance. In actual experiments the intensity sometimes even increased with the distance. The explanation of this curious phenomena is extremely simple, however. Pocock has suggested that the sensibility and capacity of the brain for the reception of these transmitted impulses is extremely small, so small in fact that the receiver is saturated even at the greatest distance over which telepathy has been observed. The excess energy passes on—unable to produce any effect upon the already saturated brain. This explains why the intensity is not diminished by distance.

We may postulate then that Mental Telepathy is a case of radiant energy. These radiations emanating from the brain when the mind is concentrated, are therefore very penetrating and traverse great distances without perceptible decrease in intensity.

The reasoning which I have heretofore pursued has been from the purely theoretical standpoint. The fact that the brain actually radiates energy has been demonstrated by several scientists. Charpentier showed that the human body emits what he has called "N-rays." He found that the phosphorescence of certain substances is increased when they are brought into the vicinity of contracting muscles or one of the nervous centers of the cerebral cortex. He demonstrated this by the use of a simple piece of apparatus. A lead tube about two inches long covered at one end by a piece of paper or silk treated with phosphorescent calcium sulfate was employed. By placing this tube near nervous centers a marked increase in phosphorescence was observed. Di Brazza showed that when a phosphorescent, platino-cyanid of barium screen faintly illuminated by a distant X-ray tube was placed near certain portions of the head, that when the subject concentrated his will the luminosity of the screen was varied in relation to the subjects *psychical activity*. From this he concluded that the brain was the seat of active radiations. When the subject's attention is not concentrated no variation in the luminosity is noticeable. Di Brazza found that the activity was greatest around the temples, the eyes and behind the ears. This experiment may be repeated by exercising great care. It must be remembered, however, that the variations in luminosity are extremely small.

There have been many experimenters in this branch of science, many of whom have recorded remarkable instances of telepathy or action at a distance, as it is sometimes called. Professor Henry Sidgwick has collected a great number of instances in which hallucinations directly preceded death, and which he attributed to mental telepathy. Wessermann has recorded a singularly in-

The ANDERSON Steam Vulcanizers

We manufacture them—we own and teach you the Anderson Method of Vulcanizing—90% profit. And still you guarantee your work to outlast balance of the tire and collect full customary price.

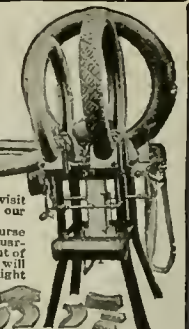

Ask us for literature and location of nearest Anderson State School. We urge you visit that city where you can see all other makes and learn their method, then visit the Anderson school there and learn our Method.

Go prepared to take 5 to 10 days' course of the ANDERSON METHOD. We guarantee to make a first-class vulcanizer out of you or refund your money. Our course will cost you \$20 in either the day or night classes and any time thereafter you buy and pay for a vulcanizer, your \$20 will be refunded in cash. \$235 and 5 to 10 days in Any Anderson State School of Vulcanizing will start you in the most profitable business. The Anderson Steam Vulcanizer Co., 23 Williams Bldg., Indianapolis, Indiana, U. S. A. Please print your name. We receive many we can't make out.

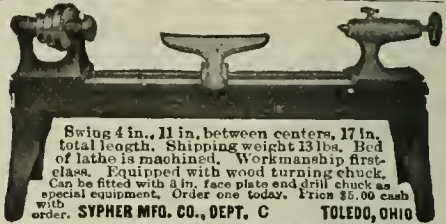

Swing 4 in., 11 in. between centers, 17 in. total length. Shipping weight 13 lbs. Bed of lathe is machined. Workmanship first-class. Equipped with wood turning chuck. Can be fitted with 1/2 in. face plate and drill chuck as special equipment. Order one today. Price \$5.00 cash order. SYPHER MFG. CO., DEPT. C TOLEDO, OHIO



THE NEW MIDGET SLIDE RULE has many exclusive features. It will add and subtract fractions and give decimal equivalents. It will also multiply, divide, add and subtract, solve problems involving any root or power (excepting 1) and will give Logarithms and the Sines, Tangents, Cosines and Cotangents of all angles. Made of metal. Size 3 1/4 inches. Send for free circulars. Price with complete instructions \$1.00 Your money back if you are not satisfied.

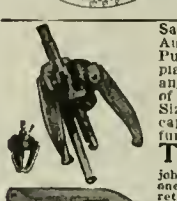

GILSON SLIDE RULE CO., Niles, Mich. Says the Master Mechanic. The Grab Automatic Grip Puller is a One-Man Puller—Quick-acting, strong and simple in the extreme. May be locked in any desired position. A combination of two or three arms. Heavy Duty Size capacity 1" to 1 1/2"—Junior size capacity 1/2" to 7/8". Two sets of jaws furnished with each size.

Ten Days' Trial If your jobber does not have them we will send you one. Try it ten days. If not satisfactory, return to us and we will refund your money. We also mail the GREB BIRMINGHAM THE GREB CO., 230 State Street, BOSTON

Electricians

Get up-to-date in HOUSE WIRING! Save TIME, MONEY, LABOR and MATERIAL by using our 98 GENUINE BLUE PRINT DRAWINGS, containing all the latest diagrams and connections known in house wiring—every diagram and connection up-to-the-minute as used by first class electricians for wiring BELLS, BURGOLAR ALARMS, LIGHTS, ANNUNCIATORS, FIRE ALARMS and ELECTRIC GAS LIGHTING. These drawings are bound in the form of a flexible book (8 1/2 x 12) for convenience in using on the job. Send for them, and if they don't make you more efficient as a wireman and save you many times their cost as a contractor, return them and money will be refunded—you can't afford to be without them. ONE DOLLAR postpaid. Send for circulars on other sets of drawings.

PATENT SPECIALTY COMPANY P. O. Box No. 583 San Francisco, Cal.

Battery Charging Pays

\$100 to \$200 Every Month extra profits to garage men. You can get these profits—easily, quickly. No electrical knowledge required. Full particulars on request. \$15 sent with this ad puts you in Seven-Battery Charger in your garage. Balance in 9 monthly payments of \$20 each. Ten days' free trial. Absolute money-back guarantee. Don't delay and lose profits. Order now. Hobart Bros. Co. Box 4E, Troy, Ohio



PHONOGRAPH

PARTS FOR ANY STYLE MACHINE Build your own cabinets We show you how. Circulars and instructions 10c. Motors, Reproducers, etc. sold Electro Mechanical Parts Co. Dept. E 160 No. Wells St., Chicago, Ill.

A STEFFEY MOTOR

on your wheel will convert it into a practical and successful high grade motorcycle that will cost you less to operate than the more expensive machines. Write at once and secure lowest factory prices. Excellent opportunity for agents. Send stamp. STEFFEY MFG. CO., Dept. E. 5025 Brown St., Phila. Pa.

Army Auction Bargains

- Tents \$4.25 up
 - Leggings .18 up
 - Saddles 4.65 up
 - Uniforms 1.50 up
 - Teaharness 26.85
 - C. W. revolvers \$2.65 up
 - Army 7 shot carbine 2.95 up
 - Army Haveracks .15 up
 - Knapsacks .75 up
 - Army Gun slings .30 up
 - Colts Army Revolver cal. 45 at \$8.45.
 - \$5 extra Army Goods. Large illustrated cyclo-pedia reference catalog—428 pages—issue 1917, mailed 50 cents. New Circular 6 cents.
- FRANCIS BARNERMAN & SONS 501 Broadway, New York

interesting incident. He wished to make the apparition of a young lady appear to a lieutenant living several miles away. At the time of the experiment a visitor happened to be with the lieutenant, who is said to have seen the apparition also. Many instances are recorded in which persons were hypnotized at some distance. All of these phenomena can be easily explained by the *brain wave* theory.

Besides the transference of thought, both sympathy and affection may be the outgrowth of these radiations from the brain. Whether our capacity for the reception of these impulses is increasing with the evolution of man, cannot be ascertained directly. It would seem probable, however, that with our increase in education and civilization that a conscious use of this *thought language* may be found. Who knows but that the man of the future may find a practical application for this radiation from the brain, and a higher and more delicately made creature may result who would effect mutual understanding by means of this marvelous and as yet but little understood *psychical activity*.

MY INVENTIONS

(Continued from page 865)

travel at a rate of about one thousand miles an hour, impracticable by rail. The reader will smile. The plan was difficult of execution, I will admit, but not nearly so bad as that of a well-known New York professor, who wanted to pump the air from the torrid to the temperate zones, entirely forgetful of the fact that the Lord had provided a gigantic machine for this very purpose.

Still another scheme, far more important and attractive, was to derive power from the rotational energy of terrestrial bodies. I had discovered that objects on the earth's surface, owing to the diurnal rotation of the globe, are carried by the same alternately in and against the direction of translatory movement. From this results a great change in momentum which could be utilized in the simplest imaginable manner to furnish motive effort in any habitable region of the world. I cannot find words to describe my disappointment when later I realized that I was in the predicament of Archimedes, who vainly sought for a fixt point in the universe.

At the termination of my vacation I was sent to the Polytechnic School in Gratz, Styria, which my father had chosen as one of the oldest and best reputed institutions. That was the moment I had eagerly awaited and I began my studies under good auspices and firmly resolved to succeed. My previous training was above the average, due to my father's teaching and opportunities afforded. I had acquired the knowledge of a number of languages and waded thru the books of several libraries, picking up information more or less useful. Then again, for the first time, I could choose my subjects as I liked, and free-hand drawing was to bother me no more. I had made up my mind to give my parents a surprise, and during the whole first year I regularly started my work at three o'clock in the morning and continued until eleven at night, no Sundays or holidays excepted. As most of my fellow-students took things easily, naturally enough I eclipsed all records. In the course of that year I past thru nine exams and the professors thought I deserved more than the highest qualifications. Armed with their flattering certificates, I went home for a short rest, expecting a triumph, and was mortified when my father made light of these hard-won honors. That almost killed my ambition; but later, after he had died, I was pained to find a package of letters which

(Continued on page 907)



Volume II Volume I
180 pages 184 pages

both bound in red Atho-leather, gold title, good paper, handy size, 4½" x 7".

You Will Want Both Books

These handy reference books are of exceptional value to you, whether you are an apprentice or a highly skilled mechanic. Both books are edited by men prominent in the machinery field—men who know exactly what is most helpful to the beginner as well as the experienced man.

Volume II for Practical Machinists
Sequel to Volume I

180 pages of important technical data, tables relating to machine speeds, power transmission, drilling, turning and milling, materials, etc.

Volume I for Machinists' Apprentices
Now in 4th Edition

184 pages of material that shows "how to do it." Essential to the beginner, valuable to the experienced machinist. It deals with the layout and precise measurement of work.

Ask Your Hardware Dealer to show them to you, or write direct—50c. each
Catalog No. 21LE of Starrett Tools on request



THE L. S. STARRETT COMPANY
The World's Greatest Toolmakers. Manufacturers of Hack Saws Unexcelled
ATHOL, MASS.

NEW YORK

LONDON

CHICAGO

42-900

MAKE MONEY
REPAIRING TIRES

The high cost and limited supply of tires makes it necessary for motorists to conserve their tires and get maximum mileage. Present conditions offer tire repair men a big opportunity to make money. Experienced help not necessary.

With this Shaler Electric Vulcanizer you can make money easy. It heats from city electric light current—has automatic heat control—no danger of fire or explosions.

Will mend any style or size of tire—both casing and inner tube. Handles 12 casings and 200 tubes a day. Anybody can operate it, and turn out perfect work. Price \$65.00 complete—subject to Trade Discount.

Write at once for catalog of our complete line of Shaler Vulcanizers, Steam or Electric for Repair Shops and quick selling models for motorists.

C. A. SHALER CO., 2203 Fourth St., Waupun, Wis.

SHALER
Electric
Shop Vulcanizer

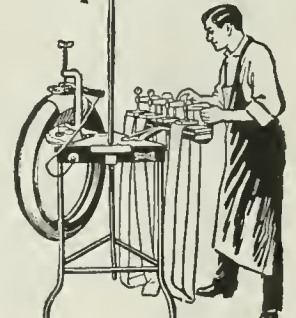

What 15¢ will bring You from the Nation's Capital

Washington, the home of the Pathfinder, is the nerve center of civilization; history is being made at this world capital. The Pathfinder's illustrated weekly review gives you a clear, impartial and correct diagnosis of public affairs during these strenuous, epoch-making days.

The little matter of 15¢ in stamps or coin will bring you the Pathfinder 13 weeks on trial. The Pathfinder is an illustrated weekly, published at the Nation's center, for the Nation; a paper that prints all the news of the world and tells the truth and only the truth; now in its 26th year. This paper fills the bill without emptying the purse; it costs but \$1 a year. If you want to keep posted on what is going on in the world, at the least expense of time or money, this is your means. If you want a paper in your home clearly, fairly, briefly—here it is. Send 15¢ to show that you might like such a paper, and we will send the Pathfinder on probation 13 weeks. The 15¢ does not repay us, but we are glad to invest in new friends. The Pathfinder, Box 576, Washington, D. C.

\$5.

EXPERIMENTERS!

A Sample of What You Can Do With This Outfit

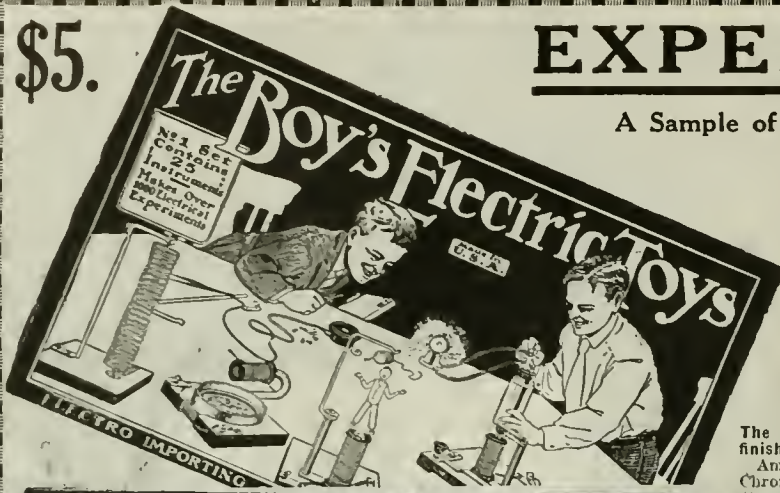

This illustration, made from an actual photograph, shows only a very few instruments that can be made with the Boy's Electric Toys: Electric Pendulum, Electric Telegraph, Current Generator, Electric Dancing Spiral, Galvanometer, Space device, not permit us to show the hundreds of experiments that can be performed with this wonderful outfit.

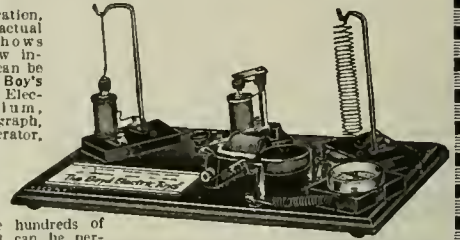

The outfit contains 114 separate pieces of material and 24 pieces of finished articles ready to use at once.

Among the finished material the following parts are included: Chromic salts for battery, lamp socket, bottle of mercury, core wire (two different lengths), a bottle of iron filings, three spools of wire, carbons, a quantity of machine screws, flexible cord, two wood bases, glass plate, paraffine paper, binding posts, screw-driver, etc., etc. The instruction book is so clear that anyone can make the apparatus without trouble, and besides a section of the instruction book is taken up with the fundamentals of electricity to acquaint the layman with all important facts in electricity in a simple manner.

We guarantee satisfaction.

The size over all of the outfit is 14x9x2 3/4. Shipping weight, 8 lbs. No. EX2002 "The Boy's Electric Toys," outfit as described. **\$5.00**
IMMEDIATE SHIPMENTS



No. EX2002

THE BOY'S ELECTRIC TOYS contains enough material to make and complete over twenty-five different electrical apparatus without any other tools, except a screw-driver furnished with the outfit. The box contains the following complete instruments and apparatus which are already assembled:

Student's chromic plume battery, compass-galvanometer, solenoid, telephone receiver, electric lamp. Enough various parts, wire, etc., are furnished to make the following apparatus:

Electromagnet, electric cannon, magnetic pictures, dancing spiral, electric hammer, galvanometer, voltmeter, hook for telephone receiver, condenser, sensitive microphone, short distance wireless telephone, test storage battery, shocking coil, complete telegraph set, electric riveting machine, electric buzzer, dancing fishes, singing telephone, mysterious dancing man, electric jumping jack, magnetic geometric figures, rheostat, erratic pendulum, electric butterfly, thermo electric motor, visual telegraph, etc., etc.

This does not by any means exhaust the list, but a great many more apparatus can be built actually and effectually.

With the instruction book which we furnish, one hundred experiments that can be made with this outfit are listed, nearly all of these being illustrated with superb illustrations. No other materials, goods or supplies are necessary to perform any of the one hundred experiments or to make any of the 25 apparatus. Everything can be constructed and accomplished by means of this outfit, two hands, and a screw-driver.

(Continued in next column)

"The Lives! Catalog in America"

Our big, new electrical encyclopedia No. 19 is waiting for you. Positively the most complete wireless and electrical catalog in print today. 228 Big Pages, 600 Illustrations, 500 Instruments and apparatus, etc. Big "Treatise on Wireless Telegraphy." 20 FREE coupons for our 160-page FREE Wireless Course in 20 lessons. FREE Encyclopedia No. 19 measures 7x5 1/4". Weight 1/2 lb. Beautiful stiff covers.

ELECTRO IMPORTING COMPANY
231 Fulton St., New York City

I enclose herewith 6 cents in stamps or coin for which please send me your latest Encyclopedia Catalog No. 20 as described.

NAME

ADDRESS

STATE E. E. 4-19



FREE

The "Electro" Radiotone HIGH FREQUENCY SILENT TEST BUZZER

This instrument gives a wonderful high pitched MUSICAL NOTE in the receivers, impossible to obtain with the ordinary test buzzer. The RADIOTONE is built along entirely new lines; it is NOT an ordinary buzzer, reconstructed in some manner. The RADIOTONE has a single fine steel reed vibrating at a remarkably high speed, adjusted to its most efficient frequency at the factory. Hard silver contacts are used to make the instrument last practically forever.



Yes, the RADIOTONE is SILENT. In fact, it is so silent that you must place your ear on top of it to hear its beautiful musical note.

You will be astounded at the wonderfully clear, 500 cycle note, sounding sharply in your receivers. To learn the codes there is absolutely nothing like it. With the radiotone, a key and one dry cell and ANY telephone, a fine learner's set is had. Two or more such sets in series will afford no end of pleasure for intercommunication work. Shipping Weight 1 lb. Radiotone as described.....each **\$9.00**

IMMEDIATE SHIPMENTS

The "Electro" Telegraph

is not a toy, but a practical, honestly built telegraph outfit, which not only sounds but works like the big commercial instruments. By studying the code for 30 days you can become a first-class telegraph operator. Such operators are in big demand now. Outfit consists of TWO complete telegraph instruments each measuring 3 1/2 x 2 1/2 x 2 1/4". All metal parts are highly nickel plated, including key lever. Note hard rubber knob, Telegraph Code Chart, telegraph blanks and connecting wire comes with set, but no batteries. Outfit works on 2 dry cells (one cell for each instrument). The "Electro" is the ONLY outfit that works both ways, each station can call; no switches, no extras. Nothing to get out of order. Guaranteed to please you or money back. Price Complete as illustrated (TWO INSTRUMENTS).... **\$1.25**



Shipping Weight, 2 lbs. IMMEDIATE SHIPMENTS

The "Electro" Codophone (Patents Pending)

\$1.50

What this remarkable instrument is and does.

The "Electro" Codophone is positively the only instrument made that will imitate a 500 cycle note exactly as heard in a Wireless receiver. The



long-talking receiver equipped with a horn, talks so loud that you can hear the sound all over the room, even if there is a lot of other noise.

THAT'S NOT ALL. By loosening or tightening the receiver cap, a tone from the lowest, softest quality, up to the loudest and highest screaming sound can be had in a few seconds.

FOR INTERCOMMUNICATION. Using two dry cells for each instrument, two Codophones when connected with one wire and return ground, can be used for intercommunication between two houses one-half mile apart.

One outfit alone replaces the old-fashioned learner's telegraph set, consisting of key and sounder.

The "Electro" Codophone is a handsome, well made instrument, fool proof, and built for hard work. Contacts are of hard silver 1/8 inch in diameter, that will outlast the instrument.

There is also a neat code chart and full directions enabling any intelligent young man or girl to learn the codes within 30 days, practising one-half hour a day.

Sizes: 6 3/4 x 3 x 2 1/4". Shipping weight, 2 lbs. The "Electro" Codophone as described, complete..... **\$1.50**

ELECTRO IMPORTING CO., 231 Fulton Street NEW YORK

MY INVENTIONS.

(Continued from page 905)

the professors had written him to the effect that unless he took me away from the Institution I would be killed thru overwork. Thereafter I devoted myself chiefly to physics, mechanics and mathematical studies, spending the hours of leisure in the libraries. I had a veritable mania for finishing whatever I began, which often got me into difficulties. On one occasion I started to read the works of Voltaire when I learned, to my dismay, that there were close on one hundred large volumes in small print which that monster had written while drinking seventy-two cups of black coffee per diem. It had to be done, but when I laid aside the last book I was very glad, and said, "Never more!"

My first year's showing had won me the appreciation and friendship of several professors. Among these were Prof. Rogner, who was teaching arithmetical subjects and geometry; Prof. Poeschl, who held the chair of theoretical and experimental physics, and Dr. Allé, who taught integral calculus and specialized in differential equations. This scientist was the most brilliant lecturer to whom I ever listened. He took a special interest in my progress and would frequently remain for an hour or two in the lecture room, giving me problems to solve, in which I delighted. To him I explained a flying machine I had conceived, not an illusionary invention, but one based on sound, scientific principles, which has become realizable thru my turbine and will soon be given to the world. Both Professors Rogner and Poeschl were curious men. The former had peculiar ways of expressing himself and whenever he did so there was a riot, followed by a long and embarrassing pause. Prof. Poeschl was a methodical and thoroly grounded German. He had enormous feet and hands like the paws of a bear, but all of his experiments were skillfully performed with clock-like precision and without a miss.

It was in the second year of my studies that we received a Gramme dynamo from Paris, having the horseshoe form of a laminated field magnet, and a wire-wound armature with a commutator. It was connected up and various effects of the currents were shown. While Prof. Poeschl was making demonstrations, running the machine as a motor, the brushes gave trouble, sparking badly, and I observed that it might be possible to operate a motor without these appliances. But he declared that it could not be done and did me the honor of delivering a lecture on the subject, at the conclusion of which he remarked: "Mr. Tesla may accomplish great things, but he certainly never will do this. It would be equivalent to converting a steadily pulling force, like that of gravity, into a rotary effort. It is a perpetual motion scheme, an impossible idea." But instinct is something which transcends knowledge. We have, undoubtedly, certain finer fibers that enable us to perceive truths when logical deduction, or any other willful effort of the brain, is futile. For a time I wavered, impressed by the professor's authority, but soon became convinced I was right and undertook the task with all the fire and boundless confidence of youth.

I started by first picturing in my mind a direct-current machine, running it and following the changing flow of the currents in the armature. Then I would imagine an alternator and investigate the processes taking place in a similar manner. Next I would visualize systems comprising motors and generators and operate them in various ways. The images I saw were to me perfectly real and tangible. All my remaining term in Gratz was past in intense but fruitless efforts of this kind, and I almost came to the conclusion that the problem was insolvable. In 1880 I went to Prague, Bohemia, carrying out my father's wish to

complete my education at the University there. It was in that city that I made a decided advance, which consisted in detaching the commutator from the machine and studying the phenomena in this new aspect, but still without result. In the year following there was a sudden change in my views of life. I realized that my parents had been making too great sacrifices on my account and resolved to relieve them of the burden. The wave of the American telephone had just reached the European continent and the system was to be installed in Budapest, Hungary. It appeared an ideal opportunity, all the more as a friend of our family was at the head of the enterprise. It was here that I suffered the complete breakdown of the nerves to which I have referred. What I experienced during the period of that illness surpasses all belief. My sight and hearing were always extraordinary. I could clearly discern objects in the distance when others saw no trace of them. Several times in my boyhood I saved the houses of our neighbors from fire by hearing the faint crackling sounds which did not disturb their sleep, and calling for help.

In 1899, when I was past forty and carrying on my experiments in Colorado, I could hear very distinctly thunderclaps at a distance of 550 miles. The limit of audition for my young assistants was scarcely more than 150 miles. My ear was thus over thirteen times more sensitive. Yet at that time I was, so to speak, stone deaf in comparison with the acuteness of my hearing while under the nervous strain. In Budapest I could hear the ticking of a watch with three rooms between me and the time-piece. A fly alighting on a table in the room would cause a dull thud in my ear. A carriage passing at a distance of a few miles fairly shook my whole body. The whistle of a locomotive twenty or thirty miles away made the bench or chair on which I sat vibrate so strongly that the pain was unbearable. The ground under my feet trembled continuously. I had to support my bed on rubber cushions to get any rest at all. The roaring noises from near and far often produced the effect of spoken words which would have frightened me had I not been able to resolve them into their accidental components. The sun's rays, when periodically intercepted, would cause blows of such force on my brain that they would stun me. I had to summon all my will power to pass under a bridge or other structure as I experienced a crushing pressure on the skull. In the dark I had the sense of a bat and could detect the presence of an object at a distance of twelve feet by a peculiar creepy sensation on the forehead. My pulse varied from a few to two hundred and sixty beats and all the tissues of the body with twitches and tremors which was perhaps the hardest to bear. A renowned physician who gave me daily large doses of Bromid of Potassium pronounced my malady unique and incurable. It is my eternal regret that I was not under the observation of experts in physiology and psychology at that time. I clung desperately to life, but never expected to recover. Can anyone believe that so hopeless a physical wreck could ever be transformed into a man of astonishing strength and tenacity, able to work thirty-eight years almost without a day's interruption, and find himself still strong and fresh in body and mind? Such is my case. A powerful desire to live and to continue the work, and the assistance of a devoted friend and athlete accomplished the wonder. My health returned and with it the vigor of mind. In attacking the problem again I almost regretted that the struggle was soon to end. I had so much energy to spare. When I undertook the task it was not with a resolve such as men often make. With me it was a sacred vow, a question of life and death. I knew that I would perish if I failed. Now I felt that the battle

(Continued on page 909)



HIGH SCHOOL COURSE IN TWO YEARS

Are you one of the 98% who didn't finish High School? If so you are badly handicapped. Without this training you are barred from a successful business career, from the leading professions, from well-paid civil service jobs, from teaching and college entrance, in fact from all worthwhile positions.

GET THIS TRAINING NOW! You don't want to be handicapped nor do you have to. Let the American School give you the training you missed. Our High School Course covers every subject taught in a resident school. It will broaden your knowledge, make you keen, alert and capable and fit you to earn a higher salary. You can complete the entire course in two years.

TAKE 10 LESSONS AT OUR EXPENSE

Test this Course at our expense. Take ten full examinations, then if you don't feel satisfied you are not out one cent. Training alone will make you master of your work, able to think and act for yourself, and competent enough to secure and hold the position you want. Whether you lack High School training or specialized instruction NOW is the time to get it.

BIG DEMAND FOR SKILLED WORKERS

The demand was never greater for skilled workers in every trade and profession. The pay was never higher—the opportunities never greater. Train and get into the game for all it is worth. We guarantee satisfaction. You do not risk one cent. Check and mail Coupon NOW. We will promptly send you full details and Free Bulletin.

AMERICAN SCHOOL OF CORRESPONDENCE

Dept. H-7444 Chicago, Illinois

TRAINING THE KEY TO SUCCESS

Tell me how I can fit myself for the position marked X:

- High School Graduate
- Electrical Engineer
- Telephone Engineer
- Architect
- Draftsman
- Building Contractor
- Structural Engineer
- Mechanical Engineer
- Civil Engineer
- Steam Engineer
- Shop Superintendent
- Lawyer
- Business Manager
- Auditor
- Certified Public Accountant
- Stenographer
- Bookkeeper
- Fire Insurance Adjuster
- Sanitary Engineer
- Automobile Engineer

Name

Address

GO INTO MOVING PICTURE BUSINESS

Small Capital Starts You on our easy payment plan. Begin now and get your share. We sell everything. Write today.

Our Catalog FREE. Show you how to earn \$25 to \$50 per day

Atlas Moving Picture Co.
Dept. 49 338 S. Dearborn St., Chicago

HYDRAULIC ANALOG OF TESLA TWO PHASE INDUCTION MOTOR

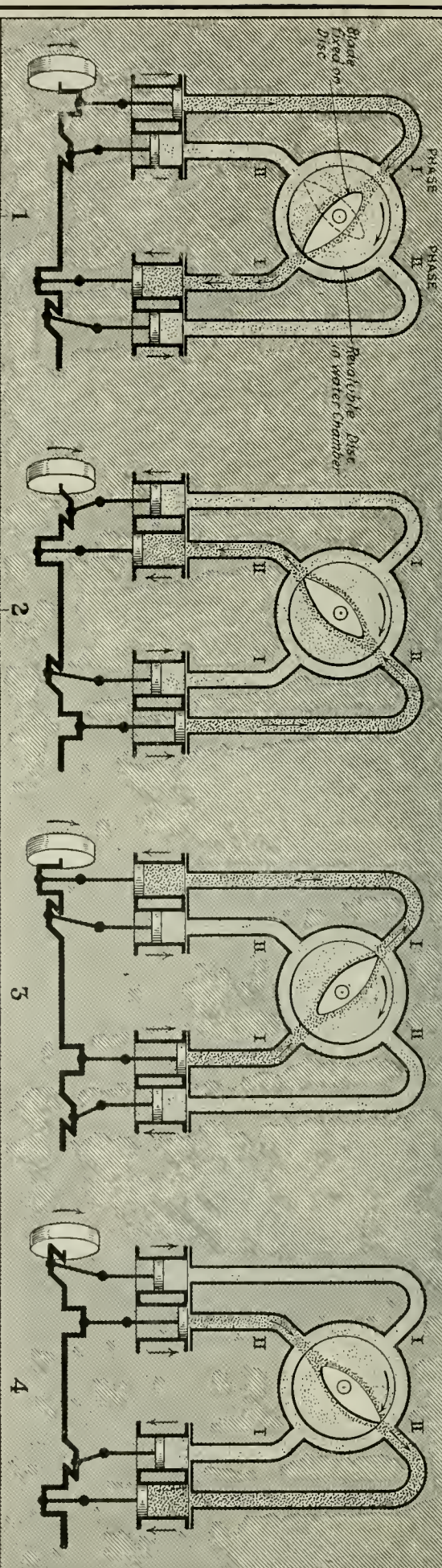

CURVES SHOWING CYCLE OF OPERATIONS

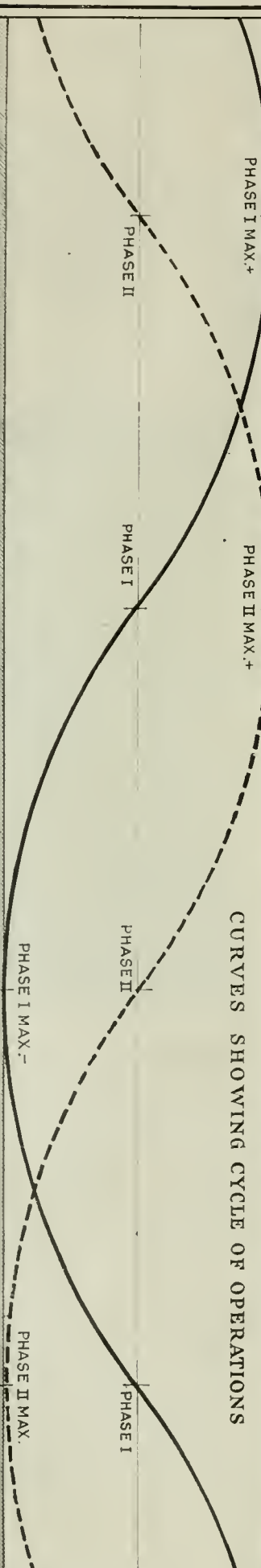

ELECTRIC INDUCTION MOTOR



Induced magnetic poles set up in rotor winding and core.

NOTE: Reversal of Stator Poles and how the rotor is pulled around by the constantly changing stator field.

Rotation of Magnetic Field in an Induction Motor

The Purpose of This Analog is to Portray, As Faithfully As Possible, the Phenomena of Tesla's Rotating Magnetic Field So As to Make Them Easily Understandable to the Average Reader. The Two Alternating Fluxes Are Represented By Streams of Water Having the Same Relation As to Phase, Amplitude and Direction. The Magnetic Polarity of the Rotor is Imitated By the Employment of a Body So Shaped As to Behave, With Respect to the Streams, Exactly As the Rotor With Respect to the Poles. Moreover, the Corresponding Rotating and Stationary Parts Are Given a Similar Appearance and Are Disposed in Like Manner. To Make the Analog Complete, It May Further Be Assumed That the Liquid is Compressible So That There Will Be a Phase Displacement Between Pressure and Flow As That Existing Between Electro-Motive Force and Current.

MY INVENTIONS.

(Continued from page 907)

was won. Back in the deep recesses of the brain was the solution, but I could not yet give it outward expression. One afternoon, which is ever present in my recollection, I was enjoying a walk with my friend in the City Park and reciting poetry. At that age I knew entire books by heart, word for word. One of these was Goethe's "Faust." The sun was just setting and reminded me of the glorious passage:

*"Sie rückt und weicht, der Tag ist überlebt,
Dort eilt sie hin und fördert neues Leben.
Oh, dass kein Flügel mich vom Boden hebt
Ihr nach und immer nach zu streben!"**

* * * * *
*Ein schöner Traum indessen sie entweicht,
Ach, zu des Geistes Flügeln wird so leicht
Kein körperlicher Flügel sich gesellen!"†*
As I uttered these inspiring words the idea came like a flash of lightning and in an instant the truth was revealed. I drew with a stick on the sand the diagrams shown six years later in my address before the American Institute of Electrical Engineers, and my companion understood them perfectly. The images I saw were wonderfully sharp and clear and had the solidity of metal and stone, so much so that I told him: "See my motor here; watch me reverse it." I cannot begin to describe my emotions. Pygmalion seeing his statue come to life could not have been more deeply moved. A thousand secrets of nature which I might have stumbled upon accidentally I would have given for that one which I had wrested from her against all odds and at the peril of my existence.

* "The glow retreats, done is the day of toil;
It yonder hastes, new fields of life exploring;
Ah, that no wing can lift me from the soil,
Upon its track to follow, follow soaring!"

† A glorious dream! though now the glories fade.
Alas! the wings that lift the mind no aid
Of wings to lift the body can bequeath me."

TESLA ON HIGH FREQUENCY GENERATORS.

Editor, ELECTRICAL EXPERIMENTER:

It is to be regretted that a letter addressed to me by Mr. J. Harris Rogers, in your care, was published in the march number of the ELECTRICAL EXPERIMENTER, altho the concurrence of our views in some wireless features might have made this desirable to so wide-awake and enterprising a periodical as yours.

Mr. Rogers seems to be a very appreciative gentleman and nothing would be farther from my thoughts than to detract anything from his merit, but in a separate contribution, which I expect to prepare for your next issue, I shall express myself on this subject without prejudice and in the interest of truth. However, the article by your Mr. H. Winfield Secor on "America's Greatest War Invention—The Rogers Underground Wireless" contains a reference to "a novel and original high frequency generator" of Mr. Rogers' invention. May I not—to use the President's elegant expression—call attention to the fact that this device was described by me years ago, as will be evident from the following excerpt of a communication which appeared in the *Electrical Review* of March 15, 1899. In speaking of circuit controllers, I said: "I may mention here, based on a different principle, which is incomparably more effective, more efficient, and also simpler on the whole. It comprises a fine stream of conducting fluid which is made to issue, with any desired speed, from an orifice connected with one pole of a generator, thru the primary of the induction coil, against the other terminal of the generator placed at a small distance. This device gives discharges of a remarkable suddenness, and the frequency may be

(Continued on page 914)

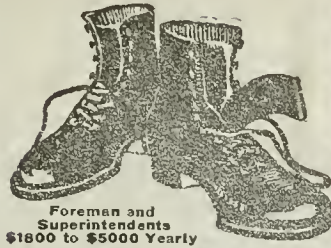

Foreman and Superintendents \$1800 to \$5000 Yearly



Office Manager or Auditor \$1800 to \$5000 Yearly

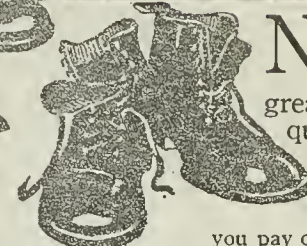

Engineers (all kinds) \$2000 to \$5000 Yearly

Learn to Fill Bigger Shoes

NO matter what kind of work you are doing now, a set of these great home study books will quickly fit you for a bigger and better paying job. We will send any set you select for one week's FREE examination, and if you want to keep them you pay only the special reduced price—at the rate of 50 cents a week. This is your opportunity to make more money—grasp it NOW. Use these books and a little spare time and LEARN TO FILL BIGGER SHOES.

Carpentry and Contracting

Five volumes, 2138 pages and more than 400 illustrations. Prepares for Contractor, Building Superintendent and Carpenter Foreman. Regular price, \$25.00. Special price, \$17.50.

Civil Engineering

Nine volumes, 3900 pages and 3000 illustrations, plates and diagrams. Prepares for Civil or Structural Engineer, Transmittan, Estimator, Designer or Chief Draftsman. Regular price, \$45.00. Special price, \$29.50.

Telephony and Telegraphy

Four volumes, 1728 pages and 2000 illustrations, plates and diagrams. Prepares for Telephone Engineer, Wire Chief, Exchange Manager, Trouble Man or Telegrapher. Regular price, \$20.00. Special price, \$12.50.

Steam and Gas Engineering

Seven volumes, 3300 pages and 800 illustrations, plates, diagrams, etc. Prepares for Stationary, Marine or Locomotive Engineer or Fireman. Regular price, \$35.00. Special price, \$21.50.

Law and Practice

(with Reading Course in 25 bound pamphlets). Thirteen volumes, 6000 pages and 24 illustrations. Prepares for all Bar Examinations. A wonderful aid to business men. Regular price, \$72.00. Special price, \$39.50.

Practical Accounting

Four volumes, 1540 pages and 800 illustrations, plates and diagrams. C. P. A. questions and practical problems. Prepares for Accountant, Bookkeeper or Cost Clerk. Regular price, \$20.00. Special price, \$12.50.

Pay Raisers

These books are written by well known authorities—the top-notchers in each line. They will help you make more money. You can't fail to understand them, because they are written in plain, everyday language. Thousands of photographs, diagrams, charts, etc., help to make difficult points as simple as A-B-C.

See our Free Examination—no money down offer below



Ask Our Experts

With these books goes free of all charge a \$12.00 Consulting Membership in the American Technical Society. If any question puzzles you—write us. Our corps of experts and engineers will solve any problem. Ask all the questions you want for a whole year. This service is absolutely FREE.

Automobile Engineering

Five volumes, 2400 pages and 2000 illustrations. Prepares for Garage Foreman, Automobile Mechanic or Chauffeur. Invaluable to car owners. Regular price, \$25.00. Special price, \$17.50.

Machine Shop Practice

Six volumes, 2300 pages and 2500 illustrations. Prepares for Machine Shop Superintendent or Foreman, Foundryman, Pattern Maker, Tool Designer or Tool Maker. Regular price, \$30.00. Special price, \$19.50.

Sanitary, Heating and Ventilating Engineering

Four volumes, 1454 pages and more than 1400 illustrations, etc. Prepares for Sanitary Engineer, Heating and Ventilating Engineer, Master Plumber or Plumber. Regular price, \$20.00. Special price, \$13.50.

Mechanical and Architectural Drawing

Four volumes, 1578 pages and more than one thousand illustrations. Prepares for Architectural or Mechanical Draftsman. Regular price, \$20.00. Special price, only \$13.50.

Electrical Engineering

Seven volumes, 3000 pages and 2500 illustrations, plates and diagrams. Prepares for Electrical Engineer, Power Plant Superintendent, Substation Operator or Electrician. Regular price, \$35.00. Special price, \$19.50.

Accountancy and Business Management

Ten volumes, 3650 pages and 1937 illustrations, forms, etc. Prepares for Certified Public Accountant, Auditor, Office Manager, Accountant, Credit Man or Bookkeeper. Regular price, \$50.00. Special price, \$24.50.

DON'T SEND ANY MONEY!

Write the name of the books you want on the coupon and mail it today. We will send the books at once, express collect, and you can use them just as if they were your own for a whole week. If you decide you don't want to keep them, send them back at our expense. If you like the books, as thousands of other

men have after examination, just send us \$2.00. You can send the balance of the special reduced price the same way—\$2.00 each month (50 cents a week).

Start right now and learn to fill bigger shoes. There will be a better job looking for you if you do. Be ready to meet it when it comes. *Send the coupon now.*

American Technical Society, Dept. T3384, Chicago, Ill.

American Technical Society, Dept. T3384, Chicago, Illinois

Please send me set of _____ for 7 days' examination, shipping charges collect. I will examine the books thoroughly and, if satisfied, will send \$2 within 7 days and \$2 each month until I have paid the special price of _____. If I decide not to keep the books, I will return them by express at your expense. Title not to pass to me until the set is fully paid for.

Name _____

Address _____

Reference _____



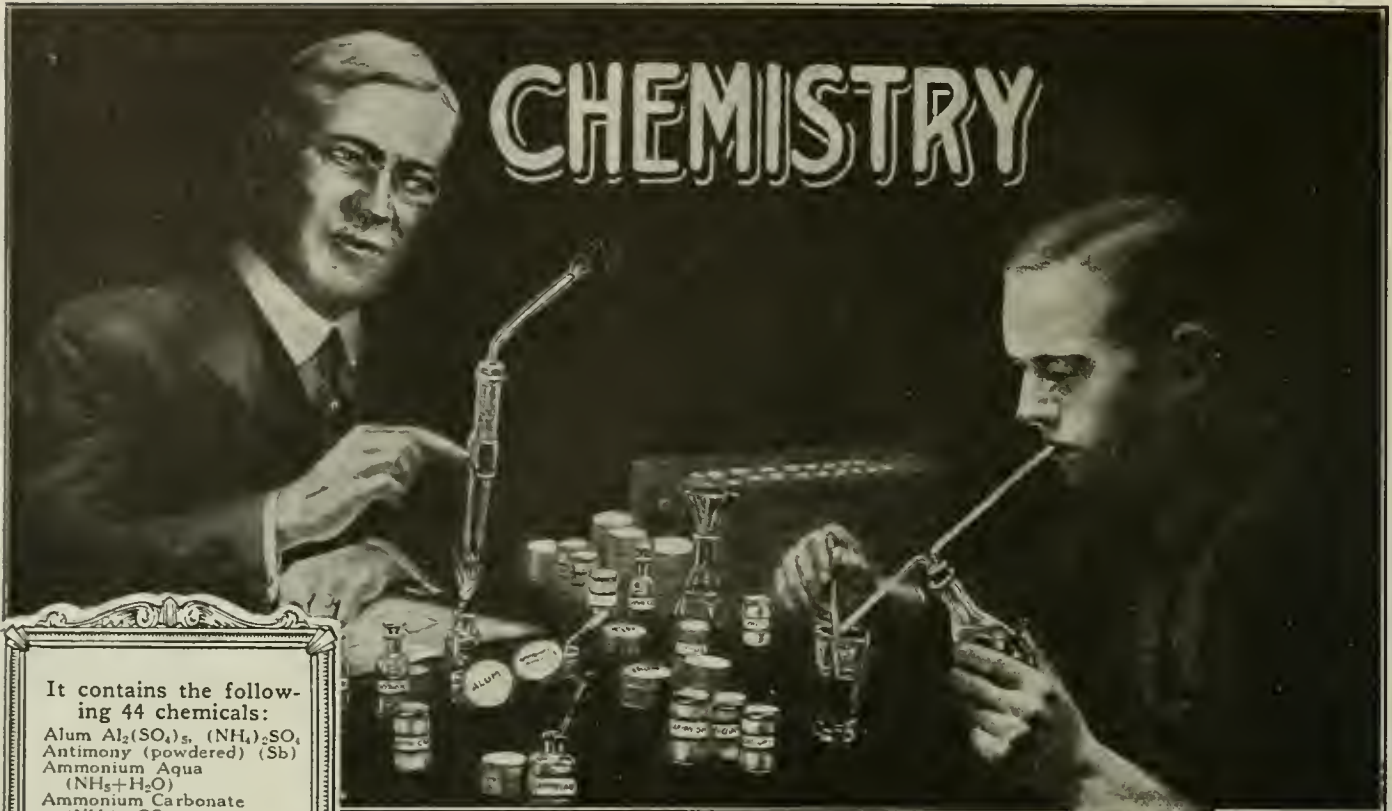

"The Joy of Father and Boy."

It contains the following 44 chemicals:

Alum $Al_2(SO_4)_3$, $(NH_4)_2SO_4$
 Antimony (powdered) (Sb)
 Ammonium Aqua
 (NH_3+H_2O)
 Ammonium Carbonate
 $(NH_4)_2CO_3$
 Ammonium Chloride (NH_4Cl)
 Ammonium Sulphate
 $(NH_4)_2SO_4$
 Barium Chloride $(BaCl_2)$
 Boric Acid (H_3BO_3)
 Brimstone (Sulphur) (S)
 Calcium Chloride $(CaCl_2)$
 Calcium Oxide (CaO)
 Calcium Sulphate
 $(CaSO_4 \cdot 2H_2O)$
 Charcoal (Carbon) (C)
 Chloride of Zinc $(ZnCl_2)$
 Copper Sulphate $(CuSO_4)$
 Ferrous Sulphate $(FeSO_4)$
 Ferrous Sulphide (FeS)
 Glycerol (Glycerine)
 $C_2H_5(OH)_2$
 Hydrochloric Acid (HCl)
 Iodine (I)
 Iron Chloride $(FeCl_2)$
 Iron Oxide (Fe_2O_3)
 Lead Acetate Pb $(C_2H_3O_2)_2$
 Litmus Paper
 Magnesium Carbonate
 $(MgCO_3)$
 Manganese Dioxide (MnO_2)
 Mercury (Quicksilver) (Hg)
 Nickel Chloride $(NiCl_2)$
 Oxalic Acid $(H_2C_2O_4)$
 Sodium Bicarbonate
 $(NaHCO_3)$
 Sodium Borate $(NaBO_2)$
 Sodium Carbonate (Na_2CO_3)
 Sodium Chloride (NaCl)
 Sodium Nitrate $(NaNO_3)$
 Sodium Phosphate
 (Na_2HPO_4)
 Sodium Sulphate (Na_2SO_4)
 Sodium Sulphite (Na_2SO_3)
 Stannous Chloride $(SnCl_2)$
 Sulphate of Nickel $(NiSO_4)$
 Sulphate of Zinc $(ZnSO_4)$
 Sulphuric Acid (H_2SO_4)
 Tin (Granulated) (Sn)
 Zinc (Metal) (Zn)
 Zinc Carbonate $(ZnCO_3)$

The following apparatus are furnished:

One Standard Washbottle
 One Alcohol Lamp
 One Conical Glass Measure
 One Erlenmeyer Flask
 One Glass Funnel
 One Delivery Tube
 Six Assorted Test-Tubes
 One Test-Tube Holder
 Ten Sheets of Filter Paper
 One Glass Dropper
 One Spoon Measure
 Glass Tubing
 One book containing Treatise on Elementary Chemistry and 100 Chemical Experiments to be performed with this outfit.

"ELECTRO"

Chemical Laboratory

We present herewith to our friends our new E. I. Co. Chemical Laboratory which contains real chemicals and apparatus to perform real chemical experiments. This outfit is not a toy, put up merely to amuse, but a practical laboratory set, with all the chemicals, apparatus and reagents necessary to perform real work and to teach the beginner all the secrets of inorganic chemistry. With this outfit we give free a book containing a Treatise in Elementary Chemistry, useful data and recipes, and 100 instructive and amusing experiments.

DESCRIPTION OF THE OUTFIT:

The outfit consists of forty-four (44) Chemicals all C. P. (chemical pure) put up in appropriate wooden boxes, glass bottles, and hermetically closed jars. The acids are put up in glass bottles, with ground-in glass stoppers and there is a sufficient quantity of chemicals supplied (mostly one to two ounces) enough to make dozens of experiments with each. See list of Chemicals herewith.

The apparatus furnished are all of the best obtainable make and of standard laboratory size and shape. A list of the 17 pieces of apparatus furnished with this outfit is printed also herewith.

The Instruction book is a real Chemistry Course for the Beginner. Some of the Contents are: Division of Matter; This is a Treatise on Elementary Chemistry and deals with the theory of the Elements, Molecules and Atoms, etc. Chemical Nomenclature. This explains in simple language the derivation of the chemical names of the Elements and their compounds. There is a chapter on Laboratory Operations; Glass Working; First Aid; Fire Extinguishers; Experimenters' Aphorisms, etc.

A good part of the book is devoted to Weights and Measures. The Metric System, the English system and the U. S. System are fully explained.

The following tables are furnished; Symbols and Atomic weights of the Elements; Measures of Weights, Volume, Capacity and Length; Per Cent solutions; Conversion of Measure expressed in parts; Poisons and their antidotes; Technical and common name of chemical substances; Formulas for Cleaning various substances, etc., etc.

Among the 100 Experiments are:

How to make chemical tricks; How to make invisible and magic inks; How to test flour; How to test soil; How to Make Chlorine Gas and smoke (German War Gas); How to bleach cloth and flowers. How to produce Oxygen and Hydrogen; How to make chemical colors; How to test Acids and Alkalies and hundreds of interesting hints and formulas.

The price is still \$5.00

Shipping Weight 10 lbs.

(Can be shipped by Express only.) Send your order today to:



THE ELECTRO IMPORTING CO., Mfrs.
 231 FULTON STREET NEW YORK CITY



See our full page Ad, on page 906 for Free Cyclopedia

You benefit by mentioning the "Electrical Experimenter" when writing to advertisers.

PRACTICAL CHEMICAL EXPERIMENTS.

(Continued from page 894)

tee, and must furnish certificates of good character and honesty. These secrets have been handed down faithfully from one generation to another for hundreds of years.

QUESTIONS AND ANSWERS IN CHEMISTRY.

Standard Soap Solution.

Q. 1. Roy Munsell, Henryetta, Okla., wants to know the method of preparing the Standard Soap Solution as mentioned in the lesson on water testing of the "Experimental Chemistry" lessons.

A. A strong solution of this soap is first prepared by rubbing together in a mortar, 75 grams of the so-called "lead plaster" (which consists practically of lead oleate), which may be obtained from your druggist, and 20 grams of dry potassium carbonate. When the two are thoroughly mixed a small quantity of methylated alcohol is added, and the mixture worked to the consistency of a thin smooth cream. More spirit is then added, and the contents of the mortar rinsed, using more of the spirits for this purpose. This is then collected in a bottle and the mixture placed aside to settle. The clear liquid is decanted off thru a filter, and the sediment finally washed upon the filter with more spirit. The volume of the liquid may now be made up to 200 or 250 cc., by adding a mixture of equal volumes of spirit and water.

Solvay Process.

Q. 2. C. H. Hathaway, of Peoria, Ill., desires information regarding the Solvay Process.

A. Sodium Chlorid, commonly known as table salt, is the source from which the sodium alkalis are derived. The starting point of this process is therefore salt—in the form of a good strong salt brine. If you open a bottle of ordinary smelling salts and inhale the vapor, you will immediately recognize the second fundamental of the process in the form of Ammonia, similar to the gas which is contained in the common household ammonia. The third and last fundamental is ordinary carbonic acid gas, the same as is used to make soda water fizz. For the purpose of this process it is obtained from limestone, by heating the stone to a high temperature. Thus we see that Salt, Ammonia and Carbonic acid gas are the three fundamentals upon which the process is based.

The salt brine is saturated with ammonia gas and carbonic acid gas is then blown into this solution of ammonia in the brine.

The process does not take place in one step, but the final products are Sal-ammoniac and crude bicarbonate of soda. The crude bicarbonate of soda separates out as a white powder and the sal-ammoniac remains dissolved. The Ammonia takes the place of the sodium in the salt, and the sodium combines with water and carbonic acid to form the well-known baking soda (Sodium Bicarbonate).

This is separated from the liquids by filtration. It is then necessary to prepare this for a commercial product by heating it in a furnace where it loses all its water and carbonic acid gas. The product is now known as sodium carbonate, or soda ash, the finished product of the Solvay process, and the starting point for other forms of sodium alkalis. (The liquid coming from the filtration process contains the sal-ammoniac, and this is distilled with lime to re-

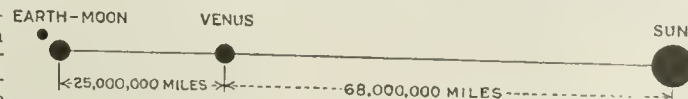

Fig. 7—Relative Position of Earth, Venus and Sun at Time of Observation at Opposition.

Mercury Vapor

Q. 3. Gordon Jones, Jr., Cordele, Ga., wants to know how Mercury Vapor is obtained.

A. Under a pressure of 760 mm., mercury boils at 357.25 degrees C., giving off a colorless vapor. Mercury gives off vapor even at ordinary temperatures, and a gold leaf suspended over mercury in a stoppered bottle, gradually becomes white upon the surface, owing to its amalgamation with the mercurial vapor. This vapor is poisonous, giving rise to salivation, such as loosening of the teeth, etc.

Buttermilk in Butter.

Q. 4. Theodore Coughlin, Rochester, N. Y., wants to know why buttermilk is objectionable in butter.

A. Buttermilk is very objectionable as it begins to decompose almost immediately, and sets up fermentation, in the butter itself. See article at head of this month's "Chemistry Department."

BACK NUMBERS CONTAINING "EXPERIMENTAL CHEMISTRY SERIES.

The "Experimental Chemistry" series, by Albert W. Wilsdon, started in the June, 1916 issue of the ELECTRICAL EXPERIMENTER and has run continuously since that date. Prices on the back numbers containing these respective lessons, many of which have been of the greatest value to High School as well as Correspondence School and University Scholars, as has been proven by many letters which we have received from readers of all classes, will be furnished upon receipt of stamped and address envelope. If you wish a first-class and clearly explained treatise on Experimental Chemistry, procure all of the lessons and bind them together. Many valuable and original tables and formulas are included in these lessons which the author has found of particular value in his commercial experience as a chemist.

SCIENCE IN SLANG.

(Continued from page 885)

one way only where the electrodes are of unequal temperature. With the audion, music has even been transmitted with charming effect, and over many miles. With a clever man at the adjusters, a long dash can be construed into a melody. An A flat can be made to sound like a Z sharp; in other words, you would be unable to hear it. As yet they have not got it down so pat that they can run the sound waves into the visual strata and make 'You Made Me What I Am To-day, Now Aren't You Satisfied?' evolve into a likeness of Bill Hohenzollern, or "They Are Wearing Them Higher in Hawaii" into an X-ray.

"Tesla, De Forest and Marconi do not hold the whole stage in the wireless field. Prof. Fessenden has bushels of patents in the Pat. office on the stuff, and there are a lot of other guys who have earned the price of a meal from some little thing that makes

(Continued on page 918)

POPULAR ASTRONOMY.

(Continued from page 869)

eye. The play of auroral lights around the poles is plainly visible and the earth's atmosphere reflects a rim of light to the moon at the time of *new Earth*. Owing to the lack of atmosphere on the moon, there is no diffusion of light and the earth therefore stands out in sharp contrast to a sky of inky blackness in which the solar corona

(Continued on page 912)



"I Can Succeed!"

"What other men have done with the help of the International Correspondence Schools, I can do. If the I. C. S. have raised the salaries of other men, they can raise mine. If they have helped others to advance, they can help me. To me, I. C. S. means 'I CAN SUCCEED.'"

Make up your mind right now that not another day shall pass until you have made your start toward success.

For 27 years men in offices, stores, shops, factories, mines, railroads, and in the Army and Navy have been winning promotion and increased salaries through the I. C. S. More than 100,000 men and women are getting ready *right now* with I. C. S. help for the bigger jobs ahead.

No matter where you live, the I. C. S. will come to you. No matter what your handicaps, or how small your means, we have a plan to meet your circumstances. No matter what career you may choose, some one of the 280 I. C. S. Courses will surely suit your needs.

When everything has been made easy for you—when one hour a day spent with the I. C. S. in the quiet of your own home will bring you a bigger income, more comforts, more pleasures, all that success means—can you let another single price-less hour of spare time go to waste? Make your start right now! This is all we ask: Without cost, without obligating yourself in any way, put it up to us to prove how we can help you. Just mark and mail this coupon.

TEAR OUT HERE
INTERNATIONAL CORRESPONDENCE SCHOOLS
BOX 6183, SCRANTON, PA.

Explain, without obligating me, how I can qualify for the position, or in the subject, before which I mark X.

- | | |
|---|---|
| <input type="checkbox"/> ELECTRIC ENGINEER | <input type="checkbox"/> SALESMANSHIP |
| <input type="checkbox"/> Electric Lighting and Wks. | <input type="checkbox"/> ADVERTISING |
| <input type="checkbox"/> Electric Wiring | <input type="checkbox"/> Window Trimmer |
| <input type="checkbox"/> Telegraph Engineer | <input type="checkbox"/> Show Card Writer |
| <input type="checkbox"/> Telephone Work | <input type="checkbox"/> Sign Painter |
| <input type="checkbox"/> MECHANICAL ENGINEER | <input type="checkbox"/> Railroad Trainman |
| <input type="checkbox"/> Mechanical Draftsman | <input type="checkbox"/> ILLUSTRATING |
| <input type="checkbox"/> Machine Shop Practice | <input type="checkbox"/> Cartooning |
| <input type="checkbox"/> Toolmaker | <input type="checkbox"/> BOOKKEEPING |
| <input type="checkbox"/> Gas Engine Operating | <input type="checkbox"/> Stenographer and Typist |
| <input type="checkbox"/> CIVIL ENGINEER | <input type="checkbox"/> Cert. Pub. Accountant |
| <input type="checkbox"/> Surveying and Mapping | <input type="checkbox"/> TRAFFIC MANAGER |
| <input type="checkbox"/> MINE FOREMAN or ENG'R | <input type="checkbox"/> Railway Accountant |
| <input type="checkbox"/> STATIONARY ENGINEER | <input type="checkbox"/> Commercial Law |
| <input type="checkbox"/> Marine Engineer | <input type="checkbox"/> GOOD ENGLISH |
| <input type="checkbox"/> Ship Draftsman | <input type="checkbox"/> Teacher |
| <input type="checkbox"/> ARCHITECT | <input type="checkbox"/> Common School Subjects |
| <input type="checkbox"/> Contractor and Builder | <input type="checkbox"/> Mathematics |
| <input type="checkbox"/> Architectural Draftsman | <input type="checkbox"/> CIVIL SERVICE |
| <input type="checkbox"/> Concrete Builder | <input type="checkbox"/> Railway Mail Clerk |
| <input type="checkbox"/> Structural Engineer | <input type="checkbox"/> AUTOMOBILE OPERATING |
| <input type="checkbox"/> PLUMBING AND HEATING | <input type="checkbox"/> Auto Repairing |
| <input type="checkbox"/> Sheet Metal Worker | <input type="checkbox"/> Navigation <input type="checkbox"/> Spanish |
| <input type="checkbox"/> Textile Overseer or Supt. | <input type="checkbox"/> AGRICULTURE <input type="checkbox"/> French |
| <input type="checkbox"/> CHEMIST | <input type="checkbox"/> Poultry Raising <input type="checkbox"/> Italian |

Name _____
Present Occupation _____
Street and No. _____

City _____ State _____

IT PAYS TO READ "E. E." ADVERTISEMENTS

You benefit by mentioning the "Electrical Experimenter" when writing to advertisers.

PATENTS

Hand Books on Patents, Trade Marks, etc., sent free. Our 70 years of experience, efficient service, and fair dealing assure fullest value and protection to the inventor. Patents procured through us receive free notice in Scientific American.

MUNN & CO., 618 Woolworth Bldg., N. Y.
Washington Office, 625 F St., Washington, D. C.

Patents Promptly Procured

Send sketch or model for actual search of U. S. Patents. Highest references. Personal service. Moderate fees. Write for Free Patent Book.

GEORGE P. KIMMEL, Patent Lawyer
99-S Loan & Trust Bldg., Washington, D. C.

PATENTS

Inventors Invited to Write for Information and Particulars

Highest References. Best Results. Promptness Assured.

WATSON E. COLEMAN
Patent Lawyer
624 F Street N. W., Washington, D. C.

\$50 for ONE DRAWING PAID

Illustrators—Cartoonists—Commercial Artists make big money. Learn NOW at home in spare time by our new instruction method. Handsome booklet free explains everything. Write for it today. Get our Special Free Outfit offer.

Washington School of Art, Inc.
1405 H St., N. W., Washington, D. C.

SPECIAL KON-VER-TER SLIDE RULE

"Hamilton" Improved Slide Rule instantly adds, subtracts, divides, multiplies, converts fractions or decimals of an inch or both. Gives sines, co-sines, versed sines, co-versed sines, tangents, cotangents, secants, co-secants of angles. Square root, cube root, roots to the fifth powers, logarithms, circumferences, arcs and diameters of circles. Most complete slide rule of its kind ever made. This rule is five and four tenths inches in diameter. Instructions with each rule.

PLAIN UTILITY RULES \$1.00 SPECIAL DE LUXE, white celluloid \$2.50 Postpaid. Agents and dealers wanted.

J. C. HAMILTON & CO., 7 Water St., Dept. R., Boston, Mass.

MUSIC TAUGHT FREE

You can read music like this quickly in your home. Write today for our booklet. It tells how to learn to play Piano, Organ, Violin, Mandolin, Guitar, Banjo, etc. Beginner or advanced pupils.

American School of Music 57 Lakeside Bldg., Chicago

NEW SCIENTIFIC WONDER "X-RAY" CURIO

PRICE 12 C. SILVER ONLY—BIG FUN BOYS

You apparently see thru clothes, wood, stone, any object. See bones in flesh. A Magic Trick Novelty given FREE with each X-Ray. MARVEL MFG. CO., Dept. 52, New Haven, Conn.

MARKO STORAGE BATTERIES ARE GOOD—TRY ONE

Paul M. Marko & Co., Inc.
1402-1412 Atlantic Ave.
Brooklyn, N. Y.

EARN MONEY

Stamping Names on Key Tags. \$50 Either set. Spare time. Some make \$250. Send 25c for tag with your name on and instructions. Returned if required. Epx. Key Tag Co., Cohoes, N. Y.

TYPEWRITERS

\$10 AND UP. ALL MAKES. SAVE \$25 TO \$50 on rebuilt at the factory by the well-known "Young Process." Sold for low cash—installment or rented. Rental applies on purchase price. Write for full details and guarantee. Free trial. YOUNG TYPEWRITER CO., Dept. 817, Chicago

STAMPS

50 diff. Belgium (large bl-color), China, Jamaica, Portugal, Venezuela, etc., 10c; 100 diff. nice packet, 20c; 1,000 well mixed, 40c; 100 var. U. S., 50c; 1,000 hinges, 10c; Agts. wanted, 50%. List free. I buy stamps. L. B. Dover, Overland, Mo.

and the stars appear even in the lunar day. To one equipt with an opera glass on the moon many of the wonders and beauties of our planet would be revealed: the shadows of our lofty mountain peaks would be seen falling across the adjacent plains and passing rain or snow storms would temporarily veil certain portions. Were our most powerful telescopes placed on the moon we could easily distinguish small islands and lakes and cities, as well. All objects five miles or so in diameter would be well within the reach of our great telescopes and we can imagine that the lunar inhabitants would spend a considerable portion of their time in attempting to solve the nature of many mysterious markings that come and go over the face of their nearest neighbor. It is indeed a pity that the opportunity to study a living planet at close range is granted to a world devoid of all forms of life while the great telescopes of our own planet sweep searchingly over a barren mass of lifeless rocks presenting no signs of growth or decay, a desolate and uninhabitable waste.

We have considered how our planet appears from the two other planets that are most likely to be the abode of life, Venus and Mars, and how it would appear if seen from our satellite the moon.

It will not take us long to consider how we would appear from the major planets—Jupiter, Saturn, Uranus and Neptune. The greatest possible distance the earth could depart from the sun viewed from Jupiter would be a little less than twelve degrees. Mercury, as we know, is not an easy planet to observe, yet it departs at times nearly thirty degrees from the sun. Moreover it is so near to the earth that when it is seen

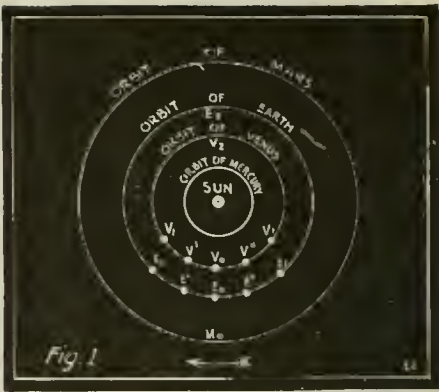

Fig 1. Diagram Showing Relative Positions of Mars and the Three Inner Planets, Earth, Venus, and Mercury, the Three Morning and Evening Stars of Mars. Assuming Mars to Be in the Position M₀ the Planets Are Best Seen When on the Near Side of Their Orbits, Positions E, E', E'' and E₃ for Earth and V, V', V'' and V₃ for Venus. At E₁ and E₂ Earth is Invisible from Mars, Being in Inferior and Superior Conjunction with the Sun Respectively. At E₁ and E₂ It is at its Eastern and Western Elongations Respectively and at E' and E'' It is at the Greatest Brilliance. When Venus is at its Greatest Brilliance V' and V'' and the Earth is in the Far Part of Its Orbit. Beyond E₁ and E₂ Venus Appears Brighter to the Martians Than Our Own Planet, but When the Earth is Near E' and E'' It Surpasses Venus in Brightness Because It is Then Considerably Nearer to Mars.

Experiments in Boston have shown that electric trucks deliver coal at a saving of 3.2 cents per ton mile from the expense of horse delivery and seven cents per ton mile cheaper than gasoline trucks.

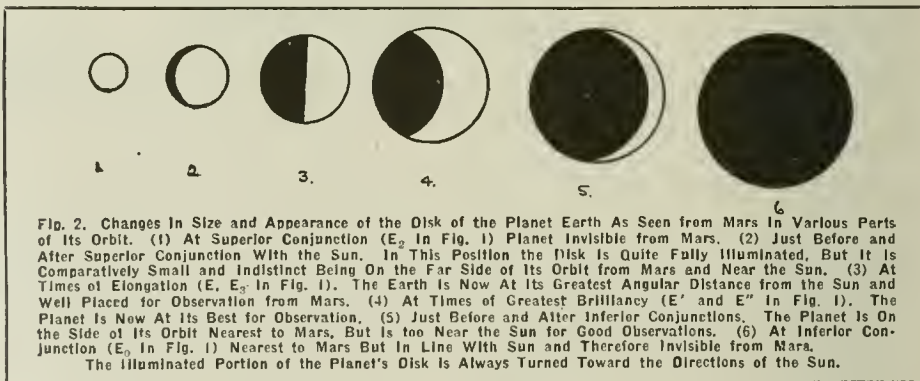

Fig 2. Changes in Size and Appearance of the Disk of the Planet Earth As Seen from Mars in Various Parts of Its Orbit. (1) At Superior Conjunction (E₂ in Fig. 1) Planet Invisible from Mars. (2) Just Before and After Superior Conjunction With the Sun. In This Position the Disk is Quite Fully Illuminated, But It is Comparatively Small and Indistinct Being on the Far Side of Its Orbit from Mars and Near the Sun. (3) At Times of Elongation (E, E₃ in Fig. 1). The Earth is Now at its Greatest Angular Distance from the Sun and Well Placed for Observation from Mars. (4) At Times of Greatest Brilliance (E' and E'') in Fig. 1). The Planet is Now at Its Best for Observation. (5) Just Before and After Inferior Conjunctions. The Planet is on the Side of Its Orbit Nearest to Mars, But is too Near the Sun for Good Observations. (6) At Inferior Conjunction (E₁ in Fig. 1) Nearest to Mars But in Line With Sun and Therefore Invisible from Mars. The Illuminated Portion of the Planet's Disk is Always Turned Toward the Directions of the Sun.

near its elongations it appears as a bright first magnitude star. Our planet earth on the other hand is so distant from Jupiter that it would be just barely visible to the naked eye if seen against a black sky. When we consider that it never gets more than twelve degrees from the sun under the most favorable circumstances as viewed from Jupiter and must therefore always be searched for in the light of the sun's rays we see the hopelessness of expecting to see our planet earth from the distance of Jupiter without telescopic aid and were it possible to set up our telescopes at the distance of Jupiter we would find that our little planet earth was not only a most elusive little body but also quite uninteresting when found. It would appear only as a very small half moon with a suspicion of a few dark shadings here and there. As we travel outward from Jupiter to the planets Saturn, Uranus and Neptune our interest in the little planet decreases rapidly. It appears to shrink more and more in size in the telescope until at the distance of Neptune it has become so tiny and so near to the sun that it is hardly worth a search in the telescope.

(The next Installment will appear in the May number.)

Ultra-violet rays are being blamed for the fading specimens in European museums, and a search is being made for a glass for cases that will cut off the rays and at the same time be colorless and inexpensive.

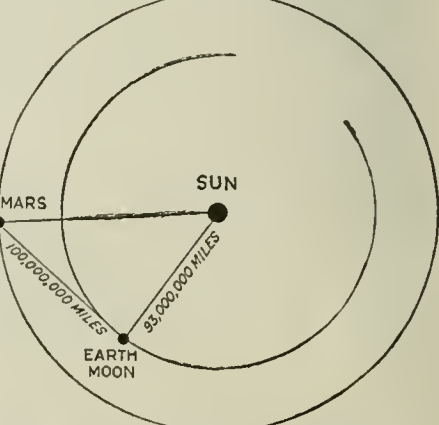
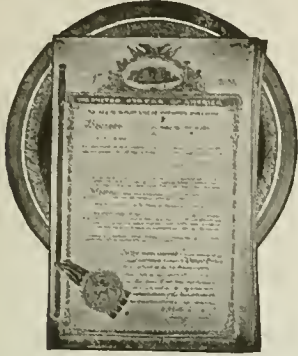

Fig 5. Relative Positions of Mars, Sun and Earth—Moon at the Time When the Earth Can Be Best Observed from Mars. The Earth as Well as the Moon in This Position Shows in the Form of a Crescent. (See Fig. 4.)

PATENT ADVICE



Edited by H. GERNSBACK

In this Department we publish such matter as is of interest to inventors and particularly to those who are in doubt as to certain Patent Phases. Regular inquiries address to "Patent Advice" cannot be answered by mail free of charge. Such inquiries are published here for the benefit of all readers. If the idea is thought to be of importance, we make it a rule not to divulge all details, in order to protect the inventor as far as it is possible to do so.

Should advice be desired by mail a nominal charge of \$1.00 is made for each question. Sketches and descriptions must be clear and explicit. Only one side of sheet should be written on.

NOTICE TO CORRESPONDENTS

Questions on Patent Advice are answered in this department every month, and naturally each department must take its turn. We have received so many letters during the past months that it is absolutely impossible for us to answer them all in the "Experimenter." Thus, for instance, the answers appearing in this issue are of letters going back as far as July, 1918. We would therefore urge our correspondents to bear this in mind, and if an answer is wanted quickly, correspondents should make themselves acquainted with the rules printed above.

Angle Finder.

(305) Geo. E. Zeigler, Urbana, Ohio, submits a device which he calls an *angle-finder*. It is an instrument to show on a scale directly the degree of any angle. Such an instrument could be used in connection with drafting work, building, construction, etc. Our advice is asked.

A. In the instrument described, use is made of a spirit tube with the usual air bubble, and by displacing the apparatus, the angle can be read off in a certain manner. This device itself is not new, and a similar one has been used on autos to read the percentage of the grade, and we do not think it would be possible for this reason to obtain a patent.

Submarine Shell.

(306) J. R. Pell, Jr., Parkersburg, W. Va., has submitted an idea on a submarine shell which only explodes fifteen feet under water. Diagram submitted shows the electrical connections which are acted upon chiefly by salt water, making a contact as soon as the shell comes within about 15-ft. under the water. Our advice is asked.

A. There is nothing fundamentally new shown in this device, and there are much better ones made which have been used freely in the war.

Electric Depth Bomb.

(307) Geo. W. Curtis, Detroit, Mich., has invented a depth bomb. In this particular bomb, when it is dropped, salt water enters thru the water inlets, and being conductive, completes a circuit between certain contacts. These contacts may be regulated by a water regulator in such a way, making it possible to explode a bomb at any depth.

A. Nothing new is shown in this idea, and we doubt very much if a patent can be obtained upon it. There are many patents on electrical depth bombs of this kind.

Flue Cleaner.

(308) Wm. H. Roberts, Chandler, Ind., has invented a device which he terms a "flue cleaner." In short, the idea consists of a fan arranged in the chimney in such a manner that the soot is cleaned out automatically, so that the latter will not clog the air passages of the flues. Various means are shown to carry out the idea.

A. While highly ingenious, we doubt if the device will work. Soot will be precipitated along the walls, fan or no fan, to our mind, and we do not think that the problem can be solved satisfactorily in this manner.

Steam Boat Brake.

(309) Otto I. Kirby, St. Vincent, B. W. I., submits an idea of a brake for steamers or boats. The idea in short is to have large steel vanes folded up against the body of a ship in normal position. If the boat is to be stopt, the vanes automatically open up at right angles to the boat, and the ship, thereby exposing an additional surface to the water, consequently must slow down.

A. This idea is a good one but unfortunately it has been described before, and to our mind no patent can be obtained upon it today. We do not think the device works out in practise.

Grass Cutter.

(310) John C. Reno, Spring Brook, Wis., has an idea of an arrangement to clean out grass that grows over the sidewalk. The device is to be made of sheet steel and by having a triangular nose, in our correspondent's opinion, such a tool would clean out the grass very readily in the corners between roadway and curb.

A. While no doubt this device would work satisfactorily on the ordinary concrete sidewalk, there would certainly be trouble if the road was compromised of cobblestones for instance. Otherwise, we find no trouble with the device, and think that a patent can be obtained upon it.

Fire Truck Device.

(311) M. Dunbar, Lorain, Ohio, writes: "I wish your advice about a patent on an electrical device that will immediately start the engine of a fire truck. My idea is, as soon as the alarm rings it closes the circuit which starts off the engine of the fire truck. Please advise if this idea is patentable."

A. Providing such a device can be made rugged enough, so that it conforms with the Fire Department's exacting requirements, we believe that such a device should prove of considerable benefit, altho most of the Fire Departments now have devices whereby the fire under the engines is started within a few seconds after the alarm has sounded.

U.S. PATENTS



SEND FOR THIS FORM

Don't Lose Your Rights

Before disclosing your invention to anyone send for blank form "Evidence of Conception" to be signed and witnessed. A sample form together with printed instructions will show you just how to work up your evidence and establish your rights before filing application for patent. As registered patent attorneys we represent hundreds of inventors all over the U. S. and Canada in the advancement of inventions. Our schedule of fees will be found reasonable. The form "Evidence of Conception" sample, instructions relating to obtaining of patent and schedule of fees sent upon request. Ask for them,—a post card will do.



255 OURAY BLDG., WASHINGTON, D. C.



U.S. PATENTS

Our facilities for securing patents enable us to give prompt and reliable service at reasonable rates. Inventors are invited to write to us regarding questions appertaining to securing patent protection. All matters receive prompt attention. Send sketch for preliminary examination.

Books free on request

A. M. BUCK & CO.

Patent Attorneys

205 Second National Bank Bldg., Washington, D. C.



RAISE BELGIAN HARES FOR HUGE PROFITS

easily and pleasantly made We furnish stock and pay you \$6.00 a pair and express charges for all you raise. Contract and book "Fortunes in Hares", by mail Free.

NATIONAL FOOD & FUR ASSOCIATION Dept. 116 MILWAUKEE, WISC.

PATENTS TRADE-MARKS AND COPYRIGHTS

Before disclosing an invention, the inventor should write for our blank form "EVIDENCE ON CONCEPTION." This should be signed and witnessed and if returned to us together with model or sketch and description of the invention we will give our opinion as to its patentable nature.

Our illustrated Guide Book, HOW TO OBTAIN A PATENT, sent Free on request. Contains full instructions regarding Patents, Trade-Marks, Foreign Patents, Our Methods, Terms and 100 Mechanical Movements illustrated and described. Articles on Patent Practice and Procedure, and Law Points for inventors.

An actual search of United States patents made in all cases before preparing application for patent

Electrical Cases a Specialty Highest References Prompt Attention Reasonable Terms

FREE COUPON!

VICTOR J. EVANS & CO., Patent Attorneys

New York Offices: 1001 to 1007 Woolworth Bldg. Pittsburgh Offices: 514 Empire Bldg. Philadelphia Offices: 135 S. Broad St. Main Offices: 779 Ninth Street, N. W., Washington, D. C.

Name Address

PATENTS

TO THE MAN WITH AN IDEA

I offer a comprehensive, experienced, efficient service for his prompt, legal protection and the development of his proposition.

Send sketch, or model and description, for advice as to cost, search through prior United States patents, etc. Preliminary advice gladly furnished without charge.

My experience and familiarity with various arts frequently enable me to accurately advise clients as to probable patentability before they go to any expense.

Booklet of valuable information and form for properly disclosing your idea, free on request. Write today.

RICHARD B. OWEN, Patent Lawyer
164 Owen Building, Washington, D. C.
2276-8 Woolworth Bldg., New York City

PATENTS

INVENTORS: Send us sketches or a model of your invention and a description of the device for advice in regard to the best way of obtaining patent protection. Our practical experience covers a period of twenty years. Our hand-book on patents is sent free on request. All communications strictly confidential. Write us today.

TALBERT & TALBERT

Patent Lawyers

4287 Talbert Bldg. Washington, D. C.

PATENTS

LACEY & LACEY

Attorneys-at-Law—Patent Practice Exclusively
Solicitors of

U. S. and Foreign Patents
Trade-Marks, Copyrights

639 F Street, N. W., Washington, D. C.

Write Us for Our Free Inventors' Book
PATENT-SENSE

ESTABLISHED 1869

Competent Patent Service

By a Former Examining Official
of the U. S. Patent Office

NORMAN T. WHITAKER

Lawyer and Engineer

480 Whitaker Bldg. Washington, D. C.

Branch Office, 87 Nassau St., New York City.

INQUIRIES INVITED

DRAFTING

Inventions and Ideas Developed!

Mechanical, Electrical, Patent Office and
Engineering Drawings of Every Description.

COMPETENT DRAFTSMEN AT YOUR SERVICE

A. G. HAGSTROM

116 Nassau St. New York City
Telephone Beekman 4559

Acetylene Bunsen Burner.

(312) Richard E. Mathes, Excelsior, Minn., writes: "I have devised a scheme whereby an acetylene gas plant for bunsen burners and gas in a small chemical laboratory may be installed at very low cost. This is meant especially for the amateur who does not have gas in his home. Is this practical? Could I sell a patent for it? If so, what would it be worth? Could I use an ordinary bunsen burner as part of the patent without infringement?"

A. We see nothing fundamentally new about this idea, as burners of this kind have been used for years, and such a device is well known in the art. We are quite positive that a patent could not be obtained upon it.

Double Lock.

(313) Chas. H. Morgan, Newton, Iowa, sends in an idea on a Double Hasp Lock which can be operated from both sides of the door. He wants to know if this device can be patented.

A. We see nothing fundamentally new in this, and furthermore doubt the utility of the device. We also doubt if a patent can be obtained on it.

Envelope.

(314) José Mata, San Francisco, Cal., submits a sample of an envelope. He wishes us to give him our advice if such an envelope could be patented and if it is feasible. As will be noted, a string with a knot at each end is glued into the envelope when made.

A. This is a good idea but it is not new. Similar devices have been on the market for a long time, and some years ago very many magazines used a string of this kind to open up the mailing wrapper, simply by having a thread incorporated into the magazine wrapper. This thread was pulled in a similar fashion as the string of our correspondent's envelope. We are positive no patent can be obtained on this device.

Automatic Fuse Replacer.

(315) Wm. Sambur, New York City, says: "I would like to know if an automatic fuse replacer which instantly inserts new fuses after extracting burnt out fuses would be patentable. This device could be manufactured at a cost of \$3.00. Would this be a good selling article? I await anxiously the next issue of the ELECTRICAL EXPERIMENTER for my answer."

A. Without having the necessary details, it is impossible for us to give advice. Correspondents should bear in mind that merely by giving vague indications, it is extremely dangerous for us to give advice as well as for correspondents to accept it.

Smoke Stack.

(316) Walter A. Buckheim, Boulder, Colo., asks us: "Please let me know thru your magazine if the following idea is patentable. It is desired to construct a chimney or factory smoke stack with rifles or vanes which will impart a rotary motion to the escaping gases. In forced draft plants the gases can be given a rotary motion by mechanical means. In this way a miniature whirlwind will be created which will hold the gases in a narrow column and carry them to a great height, where especially, if they are poisonous, they will be out of everyone's way. The gases will in effect pass thru a chimney made of air."

A. This is a clever idea, but it has one great fault, namely, it won't work. No matter what arrangement were used and even if you were to expend 10,000 H. P. to push the gases out of the smoke stack, if a moderately strong wind was blowing the gases would positively be forced sideways, and if the wind was blowing earthward, the gases in this case would be blown earthward too. You cannot hope to raise a gaseous column into the air and prevent its swaying sideways by any known means. For this reason smelters and chemical industries having to do with poisonous gases build their chimneys as high as possible. There are some cases known where a chimney has actually been laid up the side of a moderate mountain in order to let the gases escape at the top as far away from human habitation as possible.

Radio Break-In System.

(317) C. E. Mitchell, Miami, Fla., submits for our advice the following idea: "I have a break-in system for use in wireless telegraphy that does away with anchor gaps and other troublesome apparatus used in break-in systems. It consists of the ordinary heavy wireless key, with an attachment at the rear, working something similar to a compound lever. When the key is raised the antenna is connected to the receiver, the detector unshorted, and circuit to power transformer opened. In this manner the receiver is always in a receptive condition at the instant the key is raised. The idea provides for an extension in length to the ordinary wireless key and may be installed in any circuit with ease and does not hamper the pressure adjustment of the key. This means of break-in will prevent considerable interference and loss of time.

A. This is not at all a new idea and the Patent Office is full of break-in systems of this kind. A great many similar ones have been described in the past volumes of the ELECTRICAL EXPERIMENTER. Many of these systems are very good, as is our correspondent's, and many are actually in use, particularly amateurs seem to like them.

NEW PULL SOCKET HAS CURRENT TAP.

In many cases it is desirable to connect an electrical appliance to a single-lamp wall bracket or ceiling fixture without interfering with the lamp. A very convenient way for doing this has been provided by means of the new pull socket current tap illustrated. It is a combination pull socket and plug receptacle built into a single compact body. It is also supplied with a $\frac{1}{8}$ ", $\frac{1}{4}$ ", $\frac{3}{8}$ " or pendant cap. The pull chain controls the current to the lamp socket proper, whereas the terminals of the receptacle in the side of the body are continuously in circuit.

An advantage that this type of socket gives is that it eliminates the annoyance of the long cord running from side-wall outlets. By means of the new fitting, current can be supplied directly below the fixture



to operate various table appliances or other portable devices such as are in general use, without sacrificing the use of light from the lamp itself. It thus eliminates the annoyance of groping about in the dark while trying to plug into the socket.

AERONAUTICAL EXPOSITION AT NEW YORK.

Army Day at the Aeronautical Exposition in Madison Square Garden and the 69th Regiment Armory, New York City, brought several thousand uniformed spectators at the afternoon and evening sessions. Secretary of War Newton D. Baker was to have been the guest of honor, but at the last minute he notified the officials of the exposition that he had been summoned by the President for a conference. Major General Thomas Barry, Commandant of the Department of the East, accompanied by members of his staff, represented the Secretary of War.

At the wireless telephone exhibit in the 69th Regiment Armory, Lieutenant J. F. Adams entertained the spectators by reading news from a daily newspaper to ships in the harbor and places on land equipped with apparatus. The spectators, by means of a sounding horn, were able to hear the answers he received.

Brigadier General Guy Livingston, who represented the British Air Ministry in this country, was an interested spectator at the afternoon session. He said that he believed the Atlantic would be crossed by airplane or dirigible within the next two or three months.

TESLA ON HIGH FREQUENCY GENERATORS.

(Continued from page 909)

brought within reasonable limits, almost to anything desired. I have used this device for a long time in connection with ordinary coils and in a form of my own coil with results greatly superior in every respect to those obtainable with the form of your letter, make a few statements referring to such make-and-break devices in general, and various forms based on this new principle."

I may add that a great many forms of this apparatus were constructed and employed by me for a long time, proving very convenient and useful. Water does not give particularly good results, being incapable of causing very abrupt changes, but electrolytes have the property of diminishing enormously in resistance when they are heated and the effects are much more intense. Salts of lithium are especially efficient.

NIKOLA TESLA.

New York, February 20, 1919.

HEL-MET THE KAISER



Send one to your boy in camp; all the boys will want them. Anyone against the Kaiser or Germany should wear this. Same size as picture. Handsome metal, black letters. Will wear for years. Men and women wear them - causes laughter wherever seen.

Price 10 Cents

Voice Thrower 10c



Learn to throw your voice into a TRUNK, under the bed, out in the hall or anywhere. Lots of FUN fooling the Teacher, Janitor, Policeman, Parents, Neighbors, or Friends.

THE VENTRILO

is a little instrument that fits into the mouth out of sight. BOYS or GIRLS can use it. NEVER FAILS! A 32-page book on Ventriloquism sent with the VENTRILO for TEN CENTS.

NEW FORD JOKE BOOK 1919

All the latest jokes on the Ford auto. Hundreds of them, and all good ones. Spring a new one on your neighbors. Large book with colored cover by mail, 10c.



Devil Resigns to the Kaiser



Everyone who reads this book is wild over it. Contains the following:—The Kaiser's Dream, A Letter from the Devil to the Kaiser, Kaiser's Prayer, How Satan Resigns to the King of Devils, The Kaiser, etc. Many other stories, jokes, etc., about the German Emperor. Book mailed 10 cents, postage 2 cents extra.

ROGEN X-RAY

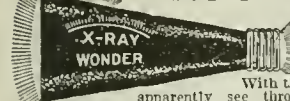

Price 10 Cents

HERE, BOYS, is just what you want. With this instrument you can apparently see through clothes, see the bones in your fingers. Think of the fun you can have with it. Sample, by mail, TEN CENTS.

SKULL RING



Here is a handsome, up-to-date Ring, representing a Skull and Cross-bone. Has stones in the eyes and looks something frightful. Women won't like it, but for men or boys it is a great novelty. Sample, by mail, 15c.

Gee! What a Wad!



This is STAGE MONEY

Looks like the GENUINE STUFF. Some Green backs and some Yellow backs. Create a BIG sensation among your friends. The girls will all be after you when they see the wad. BIG roll of 15 pieces by mail, 10 cents.

Boys Own Toy Maker and Nine Other Books for 10c



Tells how to make a Telephone, Magic Lantern, Kites, Sail Boat, Stills, Electric Telegraph, Pop Gun, Red Fire, Galvanic Battery and many other things. This book, with nine other interesting books, mailed for 10c.

ENCHANTED BARREL



The Most Wonderful Pocket Trick Made CHANGE A CENT INTO A DIME

Ask your friend to drop a dime in the barrel. When he takes it out, Behold! It is a CENT. You make 9 cents every time you fool them. Never fails. They cannot get on to it. Sample barrel, with directions, only 10c

Any three of the above articles for 25c or only six for 50c

Royal Novelty Co. 250 EAST AVENUE SOUTH NORWALK, CONN.

Get This Car

And the AGENCY in YOUR Territory

Drive a new 1919 Birch SUPER-FOUR and make good money selling Birch cars to your friends and neighbors. They are fully guaranteed. Promote shipments. Write quick for full information. Deot. 325 81E. Madison St. CHICAGO - ILLINOIS

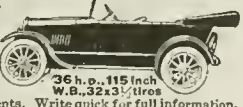

LEARN WATCH REPAIRING



You can learn by our modern and original system of instruction every part of the Watch Repairing Trade at home as good or better than at a shop. You can earn money while learning and secure a well paying position or start in business after completing our course of instruction. Good watch repairers are always in demand and earn from \$20 to \$35 per week. For particulars apply to the

Milwaukee School of Watchmaking 166 Mason St., Milwaukee, Wis.

NEW YORK TO CHICAGO VIA THE AIR IN 12 HOURS.

(Continued from page 856)

This important subject. Mr. Hawley said: "Aerial transportation is here and here to stay," said the president of the Aero Club, speaking along general lines. Aerial transportation bears the same relation to land and water transportation that the wireless bears to the regular mail and telegraph. It is unlimited by obstacles on land and water; curves are eliminated, and there are no grades to climb after reaching your flying level.

"It has been estimated that aerial express could be carried profitably at a charge of \$2 a pound for packages of a given size between New York and Chicago. A twin-motored plane can make the New York-Chicago trip without stopping, carrying a thousand pounds of express matter.

"The postoffice has been operating an aerial mail between New York and Washington daily since May 15, 1918, and has cut down the time of transit to two hours. Only small planes are used, which are more expensive than the large ones, when operated on the ton-a-mile basis. Yet the cost has been cut down to 40 cents a mile. It is cheaper than taxicab rates.

"British dirigible balloons, some of which are capable of carrying sixty tons of useful load at a speed of sixty miles an hour, may soon ply between Great Britain and the United States, carrying passengers, mail and express."

HOW ELECTRICITY SERVES WORLD'S LARGEST HOTEL.

(Continued from page 858)

own, as they obtain the required electric power and steam for heating and other purposes, from the railroad companies near the respective railroad terminals of which they are located. The Hotel Pennsylvania has a high tension transformer vault in the sub-basement as well as a large switchboard for controlling the power and light supply to the various parts of the building, and there is an auxiliary 500 K.W. steam-driven generating unit installed in the power plant.

My guide suggested that we next visit a typical "guest floor", and so we took an express elevator to the ninth floor, there being nineteen floors in all. On each floor there is a lady floor clerk, who has charge of everything on that particular floor, and is responsible for all the service in that particular part of the hotel. Obtaining keys for several of the rooms, we set out to look them over, and as the writer had heard of the far-famed "servidor", long before he had even thought of visiting the hotel, he asked the guide to explain this first of all. The "servidor", as its name implies, is a scheme for rendering service between the guest and the hotel attachés without introducing the objectionable personal touch, which is all right in the public rooms of the hotel, but rarely ever on the guest room floors, excepting when a waiter may have to bring in a table to serve a meal or something of that sort. The accompanying illustration includes a detail drawing of the servidor, which at the same time is also the "door" of the room, and "believe me, Xantippe", that door is one of the greatest masterpieces in all Hoteldom, and thereby hangs a tale, to wit:—In the first place the servi-"door" is made of steel, and finished in a perfect imitation of hard wood such as mahogany, or in some cases walnut, and so cleverly camouflaged that you cannot perceive the difference, unless you knock your head against it. The guide demonstrated all of the features of this most marvelous door at the request of the writer. This door swells out on both sides, giving a depth of ten inches between the inner and outer curved panels, which extend the full height of the door. These hinged steel panels are provided with an interlock, so that the outside or hall door in the



STRONGFORT The Perfect Man

Don't Be Handicapped

You will always stagger under the worst kind of a handicap, if you remain a puny, weak, ailing, skinny, miserable apology for a man. Big men, in the terrific competition of business life today, must be virile, strong, full of health and life and jump and ginger. Weaklings haven't the ghost of a show, in any position; they never can advance, their jobs may be taken from them any day and given to some man the boss knows is going to forge ahead.

ARE YOU HANGING ON TO YOUR JOB?

If you are just managing to stagger through your work each day, with constipation, indigestion, biliousness, lack of energy or frizzled nerves taking all the pep out of you, that job of yours will get away some day before you know it. Three million or so husky, hearty, healthy men will soon be back from the camps and the fighting lines in France, looking for jobs, and they're the kind of boys employers want!

MAKE YOUR JOB HANG ON TO YOU!

That's the only way to rid yourself of the constant fear of being fired. Build yourself up into a MAN, capable of doing all your work and more; show your employer that you are full of vim and vitality; that your body can stand any strain and that your brain is clear and keen, full of new ideas for the business. Make him feel that, and nobody could FIRE your job away—the only way you'll lose it will be to take another higher up.

STRONGFORTISM WILL ENABLE YOU TO DO IT!

Strongfortism will show YOU, as it has shown thousands of other men on the ragged edge of being fired, how to make yourself too valuable for any employer to lose sight of. No matter how deep a hole of dismal despair you may be in just now, no matter if you feel that you have burned out the last spark of vitality in you by dissipation or early excesses—Strongfortism can make you over, BUILD YOU UP, strengthen every vital organ in you and make you fine and fit again.

No druggist's dope or patent bottled humbugs in the Strongfort way—just living life as Nature meant it to be lived and getting the greatest enjoyment out of it. Send for my FREE BOOK "Promotion and Conservation of Health, Strength and Mental Energy." It will show YOU how thousands of other discouraged men have made themselves whole and well and strong again.

LIONEL STRONGFORT

Physical and Health Specialist

854 Park Building Newark, N. J.

BOYS Build and Fly Your Own Training Plane



Train yourself in Aviation. Be an Amateur Aviator with an Aeroplane of your own. Learn how Aeroplanes are built; learn the principles of construction, operation and control. We sell IDEAL Accurate Scale Drawings, and Building and Flying Instructions which show you how to build a perfect Model Aeroplane, 3 ft. size, that will rise from the ground by its own power and fly like a big one. Send now for the Drawings and Instructions for the one you want to build.

- Drawings and Instructions for Curtiss Military Trecator 25c
- Bleriot Monoplane EACH
- Naub Monoplane EACH
- Taube Monoplane Set of Seven
- Curtiss Flying Boat \$1.50
- Wright Biplane \$1.50
- Cecil Peoli Racer cost paid

Ideal Model Aeroplane Catalog 5c—None Free

Tells about Model Aeroplanes, Racing Aeroplanes, Flying Toys, and parts and supplies to build them with. 48 pages. Sent only upon receipt of 5 cents.

IDEAL AEROPLANE & SUPPLY COMPANY

76-82 West Broadway New York City

Learn Watchwork, Jewelrywork and Engraving

Optics and instrument repair. A fine trade commanding a good salary, and your services are always in demand. Address HOROLOGICAL, Dept. E., Bradley Institute, Peoria, Ill., for latest catalog.

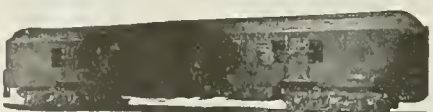

Wanted—Railway Mail Clerks

\$1100 to \$2000 Year

FRANKLIN INSTITUTE Dept. D-101, Rochester, N. Y.

Common Education Sufficient Sure Pay Life Job. Pull Un-necessary.

Sirs: Send me, without charge, (1) Sample Railway Mail Clerk Examination questions; (2) schedule showing places of all U. S. Government coming examinations; (3) list of other government jobs now open, and (4) free book describing them.

NAME..... ADDRESS.....

MY NEW BOOK

"Muscular Development"

will tell you how to get a wonderful muscular development like mine, perfect health, abundance of vitality and great strength as I have.



The results of my system are shown on my own person and that is recommendation enough. To give every one the opportunity to profit by what I have learned, I will mail my book, for a limited time only, on receipt of

10c Stamps or Coin

This wonderful book will help you. It is profusely illustrated and contains pictures of many of the world's strongest men whom I have trained. Send for it to-day. Right now, while it is on your mind.

EARLE E. LIEDEKMAN
Who's not look as healthy and be as strong as I am?
EARLE LIEDEKMAN, Dept. 207, 203 Broadway, N. Y.

Not Toys But Real Apparatus

the same as used by all operating companies. You had better send us your order immediately to insure prompt delivery, as this equipment will not last long at these prices.

- 110 Volt Hand Generators... 3 bars, each \$3.00
 - 4 bars, each 4.00
 - 5 or 6 bars, each 5.00
 - Telephone transmitters with arms, each... 7.00
 - Good ringers complete with bells, each... .50
 - Telephone receivers, each... .75
 - Condensers, 1/2 to 2 M.F., each... .50
 - Induction coils, each... .50
 - Relays, each... 1.50
 - Repeating coils, each... 2.00
 - Real complete C.B. wall type telephone... 4.50
 - Slightly used dry cells, per dozen... 1.25
- Please send money-order or cash with your order

ELECTRICAL SPECIALTY COMPANY
Dept. E, 128 So. 11th St., Philadelphia, Pa.
Dept. E, 48-50 So. Front St., Columbus, Ohio

MATYSEK The Way to STRENGTH

Take the SHORTEST, SUREST path to superb physical development.

BE EFFICIENT

SUCCESS! The achievement of that which we desire. ARE YOU SATISFIED?

EXTRA! JOIN! TODAY!

Matysek Physique Exercise SUPERIOR DEVELOPMENT CONTEST 76 Prizes

Everybody has a chance—Lean, Normal, Fat, Strong. For Booklets of further information write NOW. Entries close April 10th. You will not regret your enrollment. Enclose 6c in stamps for mailing.

PROF. MATYSEK
Rooms 2--4, 629 N. Lakewood Ave., Baltimore, Md.

SHUT YOUR MOUTH! Breathe Through your Nose as Nature Intended



Avoid dangerous mouth breathing which courts deadly infection of lungs and throat thru improper breathing.



annoyance a "Breathe-Rite" made of gold wire and aluminum pads, endorsed by physicians.

The air is full of virulent germs, mouth breathers inhale them and are in constant peril. Wear without

Best Supply Houses Have Them. Booklet Free. Price \$2.00
BREATHE-RITE CO., Dept. 1, Ann Arbor, Mich.

Telegraph Pictures BY ELECTRICITY

A complete set of two machines of this marvelous equipment for only \$19.50. Instructive, mystifying and useful. This picture of President Wilson was telegraphed by these machines. Will transmit pictures, maps, drawings and hand writing. Picture telegraphing is the coming science. Write today.

J. LEISHMAN CO. Dept. T Ogden, Utah

ENINGER WILL SAVE

\$40 BIG MONEY SAVINGS FOR YOU

Used and rebuilt motorcycles, single and twins, \$25 to \$100. Used bicycles, \$5.00; tricycles, \$10.00. All machines guaranteed in good working order. New bicycles and motorcycles at Factory prices. You save dealers' profits. Motorcycle and automobile tires too, \$3.00. Complete line of parts and supplies.

Send for catalog
Eninger Cycle Co., Rochester, N.Y.

YOU 25 TO 50 DOLLARS

door cannot be opened by a servant until the inner door is shut and locked. What you can't get via the servidor—ain't! There are two shelves in the servidor which might accommodate a special order of ice cream soda or near-beer from the tap-room, but mostly, so my guide explained, the servidor is intended for clothes intended to be prest over night, or at any time by the hotel valet, and for soiled linen.

The *modus operandi* of the servidor follows:—Suppose you, the guest, have a suit of clothes which you wish prest, and have just arrived at the hotel, and wish to retire at once. You call the telephone operator via your room telephone, and inform her that you have a suit of clothes which you desire prest by the house valet. She does the rest. You go to bed and forget about it. Next morning you awake and open the inner door of the servi-"door", and "pressed-O"! there is your suit as spick and span as ever before, and perhaps if you are lucky, you might find a couple of five dollar silk shirts and a nice roll of clean collars in your servidor, but how could you be expected to be able to tell to whom they belong out of 3,500 guests! Ennerhow, as Abie Kabibble might say, the guests at this hotel are all rich anyway. At least they look it! X? But this is only the start of the tale of the servidor, for you can press one of two buttons on the inside of the door, and open or close a sound-proof ventilator. Also there is another very elaborate and clever mechanical conception incorporated in the knob and lock of the door—this takes the form of a small pin about the size of a lead pencil, placed just under the knob on the hall side of the door. If one of the attachés (in everyday English, the chambermaid), tries to enter the room while it is occupied, she will ascertain this fact without having to rattle the knob about fifteen dozen times, and chuck you into a French fit, wondering if one of the Bolshevik gentlemen is calling on you with a bomb. She simply presses her finger on the projecting pin, just under the knob. If the pin resists the pressure of the finger, then the room is occupied; if not, it is unoccupied. Simple, yes, but someone spent a lot of time to "dope" this out.

The conveniences to be found in the guests' rooms, no matter whether large or small, are all similar, and designed to give the utmost comfort and homelike atmosphere. The basin in each bath room is fitted with three spigots, the two outer ones giving hot and cold water, while the center spigot yields *ice water*, cooled in the hotel's large private refrigerating plant driven by electricity, located in the basement. The rooms as well as all of the halls are cleaned by vacuum cleaners, thus doing away with all dust, besides keeping the carpets and draperies thoroly clean and germ-proof.

The double rooms do have the cutest little "twin beds" you ever laid eyes on. Each one is fitted with a handsome brass reading lamp attached to the head of the bed, and provided with a silk shade and chain pull socket. Yes, you can read in bed if you want to at one of these palatial hotels. Between the beds or alongside of the single beds, there is a telephone and night lamp table, which also comes in conveniently to hold the immortal "ice water" pitcher. In some of the suites of rooms inspected, the furnishings are very attractive, including large pedestal style dresser lamps with silk shades, on the bureau for milady, and all in all the guests can really feel at home, just as much as if they were in their own residence. We should not forget the electric curling iron heater and the electric fan. Perhaps if you feel so disposed, you would like to have something piping hot made in the chafing dish. If so, one of the maids will bring you an electric chafing dish, which can be easily connected to a special electric floor outlet provided for just such a purpose.

A-K TABLETS

FOR
**Grippe
Cold
in the
Head**

**Headaches
Neuralgias
Spanish Influenza
Women's Aches and Ills
Rheumatic and Sciatic Pains**

Ask Your Druggist for A-K Tablets
(If he cannot supply you, write us)

Small Size **10c** Dozen Size **25c**



See Monogram **A-K** on the Genuine
The Antikamoia Remedy Company, St. Louis, Mo.
Write for Free Samples



The Electric Safety razor makes shaving a pleasure. Blade vibrating 7,200 times a minute cuts the beard smoothly and without slightest pull or irritation—feels like a gentle massage. Can be used with or without electric current.

All users of the **Lek-Tro-Shav** speak well of it

A barber says—"Have shaved for years and have never used any shaving device near its equal."
A home user says—"The most pleasing shave I've ever had in my life. Shaves my face closer than I used to shave, but there is no after irritation or till effects as I usually get from another razor."
No. 1 Made for use from Light Socket.
No. 2 Made for use from Dry Battery.

Write for illustrated circular describing Lek-Tro-Shav Safety Razor fully.
VIBRATING ELECTRIC RAZOR CO.
Dept. 122, Omaha, Nebr.

EASIEST SHORTHAND

Learn in Sevenings home study; then acquire speed with E. I. Shorthand. Amazingly simple, easy. Approved by experts. Write dictation, messages, etc. Rapidly as spoken, after brief pleasant practice. Favorite method for personal use; make notes at lectures, meetings; keep confidential diary. Big help in any profession or business; aid in your career. Used in Army, Navy, courts, commercial schools; by public and private stenographers, teachers. Slight cost. **E. I. Shorthand** for busy people, including YOU. **PROOF LESSONS** Guaranteed and free with testimonials. **Write for Free Catalog.** Address: **KING INSTITUTE, EL 300, Station F, NEW YORK CITY**

Combination 'A. C. and D. C. Eight Inch DESK FAN

detachable plug and 8 ft. of cord. Will operate on A.C. or D.C. current, 100 to 125 volts, 30 to 60 cycles; weight 10 lbs.; black enamel finish; height 1 1/2 in. A real fan—not a toy. Price \$6.50. Agents wanted.

THE TEWNO CO.
150 Chambers St., New York

PHOTO CRAFT
THE NEW PHOTOGRAPHIC JOURNAL
Devoted to the Art of Picture Taking and Nature Work with the Camera.
Four Competitions with Valuable Cash Prizes Leading to a Fifth.
Send 10c for three months' trial subscription.
Photo Craft Magazine, Ann Arbor, Mich.

STUDENTS ART MAGAZINE
Publishes cash art assignments, lessons and articles on Cartooning, Designing, Illustrating, Lettering and Chalk-Talking. Critiques amateurs' work. Full of interesting and helpful information for artists and art students. Satisfactory or money refunded, 10 cents a copy, \$1 a year. Send \$1 NOW, stamps or bill.
STUDENTS ART MAGAZINE, Dept. 441, Kalamazoo, Mich

The "Room Service", as it is called in all modern hotels, and which covers the serving of meals in rooms, is very carefully worked out, in the "Pennsylvania" and the "Commodore". At the "Pennsylvania" the system works out in this fashion: Suppose for a moment you are the guest, and that you decide to have breakfast served in your room. You call up the telephonic operator and give her your order. She writes it down on her memorandum pad, and as soon as you have finished, she writes it on her telautograph transmitting platen. Then two important things immediately happen—two telautographs reproduce in writing your exact order for the meal, from coffee to cigars, one telautograph announcing your order in the "room service" kitchen in the basement,—while the second telautograph connected to the same circuit, but situated on your room floor, reproduces the order in writing before the "floor clerk" on your floor, and this is the first notice that she receives that you have ordered a meal. The system works out very beautifully in this way, and gives the greatest expedition possible to rapid service. Each floor has its own service pantry, which contains all ordinary things such as bread and butter, and which are supplied from this pantry. In this room there are also automatic high-speed electric dumbwaiters communicating with the "room service" kitchen in the basement, and as soon as any broiled meat, such as chops, steaks, etc., are prepared in the main kitchen, they are whisked skyward via the automatic dumbwaiter to your floor. As soon as the dumbwaiter reaches the floor, a buzzer starts signaling the fact, buzzing continuously until the door is opened; the victuals are removed and the door closed, after which the dumbwaiter is dispatched kitchenward. By means of a flexible cord and plug and a set of jacks, one for each of the 19 floors, the kitchen service dumbwaiters may be dispatched roof-ward and caused to stop at any floor automatically, simply by inserting the plug in the jack corresponding to that particular floor. When the meal is ready, one of the room service waiters stationed on your floor serves the meal in your room, and invariably of course, a table has to be provided for this purpose. Eventually, we presume, the servidor idea will be extended and amplified, so as to permit the serving of meals, altho this is questionable for the reasons already stated.

Returning toward the lower regions of the hotel, my guide piloted me down a long hallway on one of the lower floors, and we inspected the children's open-air playground, arranged in one of the large courts of which there are several, and ended up this part of our inspection trip, by looking over the large ladies' and gentlemen's "plunge", provided with large deep pools, and every convenience imaginable. The "plunge rooms" in general are provided with steam rooms, hot rooms, massage and silent rooms, drying and rubbing rooms, etc., while the women's plunge apartment contains specially fitted dressing and rest rooms, as well as a manicure and hair-dressing parlor and chiropodist.

Just as we were leaving the plunge rooms, we were surprised by seeing two nurses passing down the hall just ahead of us. Upon inquiry we found that the hotel management had not even overlooked such a possibility, and one to be conjured with when such a large number of guests are considered. Not only was it surprising that the hotel should include a "hospital," but it also developed that there is a physician always present. Thus the guests have always available hospital and medical attention for any emergency. Of course, for any protracted illness, the patient would have to be transferred to one of the regular city hospitals. One does not even have to leave

the building in order to get a prescription filled, as there is a large and complete drug store on the street floor, which is accessible from the interior.

In various parts of the hotel, where the architects have found room for them, one suddenly bumps into unsuspected scenes of activity. On some of the lower floors, as well as in spare rooms on the roof, one finds carpenter shops, painters and decorators shops, an up-to-date upholstery shop, yes, even a silver-plating room (for taking care of the vast amount of silverware used in the dining rooms), employees' club rooms, plumbers shop, etc., etc.

A few words may be said here concerning the elaborate kitchen equipment at these hotels, and it is indeed a great revelation to see how cleverly the engineers who designed these departments have worked out their problems. For example, all the soiled dishes from any of the dining rooms are practically never touched by human hands, after once being removed from the dining tables. They are placed in metal carriers resembling large drip pans as soon as they pass the dining room service door. Here they are placed on continuous moving platforms, which travel along at a constantly changing angle, so as to utilize the power of gravity, and eventually the dishes reach the dish-washing department, which is quite an establishment all by itself. The dishes are washed by plunging them into large tanks filled with steam and boiling water. Every germ is thoroly killed as soon as he hits the tanks, and the dishes are then rinsed in other tanks filled with boiling water, which is so hot that the dishes are dried as soon as they emerge from the tank, due to the rapid evaporation of the water vapor remaining on them. The clean dishes are then whisked away on another continuous moving platform, which takes them back to their respective kitchens. The scenes in these great kitchens are ones that you will not readily forget, once having visited this important department of the great hotel organization. Here we see dozens of French chefs preparing the various meats and cooking them. It would be a great revelation to any housewife to see how rapidly the cooking is accomplished. Steam, gas and electricity are used in the various ranges and stoves used for cooking the various foods, and there is a special kitchen fitted with all electric ranges and stoves, which is called the "home cooking kitchen". This kitchen is one of the features of the "Pennsylvania" and is in charge of an expert dietician. Any guest who has gastronomic trouble or for other reasons may desire to have a piece of pie "like Mother used to make" with its full quota of calories and other toothsome units, can have just what his stomach craves. When the writer visited the kitchen, it was near dinner time, and the chefs were busy cooking squabs by the hundreds in the gigantic ranges, chops by the same number, and steaks by the dozen, not to mention French-fried potatoes by the bushel. Other activities of the Culinary Department include ice-cream making, pastry and candy making, etc., etc. One of the most wonderful sights in this important section of any hotel, and particularly in this giant of all hostleries, is the storage room, where wagon-loads of vegetables are kept, not to mention several auto-truck loads of meats and fish. Large, thoroly ventilated refrigerators, kept cold by the ammonia compressor plant operated by the hotel, maintain a constant degree of cold in them.

Of course, there are the usual wine cellars, one of which extends the whole block, not to mention large rooms filled with snow white linen, shining silver and glassware and crockery, enough to stock an average department store.

You benefit by mentioning the "Electrical Experimenter" when writing to advertisers.

414 PAGES
145 ILLUSTRATIONS

I.C.S.
ELECTRICAL ENGINEER'S
HANDBOOK **\$1**

ELECTRICITY!

HERE'S just the book on Electricity that you need to answer your many questions—to solve your knotty problems, to teach you new kinks, to be your memory for tables, rules, formulas and other Electrical and Mechanical facts that some people try to carry in their heads—and fail.

With this "Little Giant" I. C. S. Electrical Engineer's Handbook in your pocket, toolchest on your work bench, drawing table or desk, an hour or a day need not be lost "digging up" some forgotten rule, some unfamiliar fact; you'll just turn to the very complete index and get it "in a jiffy." Just a few of the subjects treated are:

Electricity and Magnetism; Electrical Symbols; Batteries; Circuits; Magnets; Direct and Alternating Currents; Dynamos and Motors; Belts; Shafting; Electroplating; Electrical Measurements; Meters; Arc and Incandescent Lamps; Mercury Arc Rectifiers; Transformers; Insulation; Electric Cars; Single and Multiple-Unit Control; Transmission; Rail Welding; Tables of Wires—Sizes, Capacities, etc.—Mathematical Rules; Formulas, Symbols; Tables of Constants, Equivalents, Roots, Powers, Reciprocals, Areas, Weights and Measures; Chemistry; Properties of Metals; Principles of Mechanics; First Aid, etc.

The Electrical Engineer's Handbook is one of 22 I. C. S. Handbooks covering 22 Technical, Scientific and Commercial subjects. (See titles in coupon below.) They have the contents of a full-size book condensed into pocket-size ready to go with you anywhere and be at your instant command. Substantially bound in cloth, red edges, goldleaf stamping, printed from new, clear, readable type on good quality book paper and illustrated wherever a picture will help.

No Risk Money-Back Offer!

The price of the famous I. C. S. Handbooks, of which more than 2,000,000 have been sold and are in practical everyday use, is \$1 per copy. So confident are we that you will find them exactly what you need for ready reference in your work, that we stand ready to promptly and cheerfully refund your money if for any reason you are not fully satisfied with their value. Simply send a letter or the coupon below, enclosing \$1 for each book wanted. If at any time within 10 days you wish to return the books, your money will be refunded.

INTERNATIONAL CORRESPONDENCE SCHOOLS
Box 6185 Scranton, Pa.

TEAR OUT HERE
INTERNATIONAL CORRESPONDENCE SCHOOLS
Box 6185, SCRANTON, PA.

I enclose \$_____ for which send me postpaid the Handbooks marked X, at \$1.00 each. I may return any or all and get my money back within ten days from receipt:

- | | |
|--|---|
| <input type="checkbox"/> Electrical Engineer's | <input type="checkbox"/> Advertiser's |
| <input type="checkbox"/> Telegraph and Teleg. Engineer's | <input type="checkbox"/> Business Man's |
| <input type="checkbox"/> Mechanic's | <input type="checkbox"/> Bookkeeper's |
| <input type="checkbox"/> Steam Engineer's | <input type="checkbox"/> Steno. and Correspondent's |
| <input type="checkbox"/> Westinghouse Air Brake | <input type="checkbox"/> Salesman's |
| <input type="checkbox"/> Civil Engineer's | <input type="checkbox"/> Window Trimmer's |
| <input type="checkbox"/> Coal Miner's | <input type="checkbox"/> Cotton Textile Worker's |
| <input type="checkbox"/> Concrete Engineer's | <input type="checkbox"/> Farmer's |
| <input type="checkbox"/> Building Trades | <input type="checkbox"/> Poultryman's |
| <input type="checkbox"/> Plumber's and Fitter's | <input type="checkbox"/> Mariner's |
| <input type="checkbox"/> Chemist's | <input type="checkbox"/> Automobiles |

Name _____
Street and No. _____
City _____ State _____

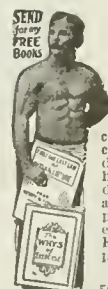

Do You Want to Know
HOW TO DEVELOP

Vitality, Energy, Endurance,
Nerve Strength, Muscular
Strength, Perfect Physique?

MY FREE BOOKS, "The Physic of Exercise" and "The First and Last Law of Physical Culture," tell you if you are weak or underdeveloped, how to grow strong; if strong, how to grow stronger. They explain how to develop the lungs and muscle, the strong heart and vigorous digestion—in short, how to improve health and strength internally as well as externally. SEND TODAY—NOW—for these FREE BOOKS. Enclose 4c in stamps to cover postage.

PROF. H. W. TITUS

56-58 Cooper Sq. Dept. 602. New York City

MAKE \$5 TO \$10 PER DAY EASY,
SELLING A WONDERFUL NEW INVENTION.

The Q. S. Target Pistol shoots shot 100 feet; wooden arrows. 20 to 30 feet with surprising power and accuracy. Send 10c (coin) for sample, terms, etc. Our Q. S. Special, 25c for the older boy and grown people. 3c extra for postage and packing single orders.

The Q. S. Novelty Pistol Co., Delanson, N. Y.

Mesco Telegraph Practice Set

For Learning Telegraph Codes

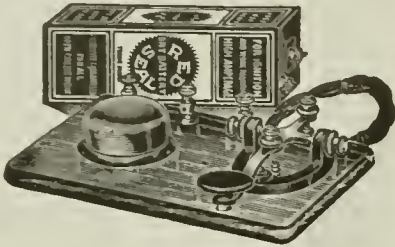

The Practice Set comprises a regular telegraph key, without circuit breaker, a special high pitch buzzer, one cell Red Seal Dry Battery, and four feet of green silk covered flexible cord.

The key and buzzer are mounted on a highly finished wood base, and three nickel plated binding posts are so connected that the set may be used for five different purposes. List No. Price

342 Telegraph Practice Set, with Battery and Cord. \$3.24
Weights 4 lbs. packed.
Price does not include postage.

MESCO Combination Practice Set for learning the Morse and Continental Visual and Audible Codes

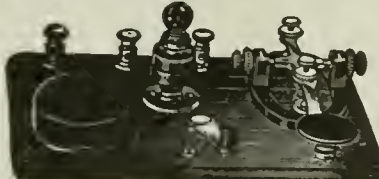

This outfit is the only reliable instrument which will enable students to become proficient operators in the U. S. Naval Service, because it is equipped with a buzzer and miniature lamp enabling the user to master both the visual and audible signals quickly.

List No. 52—Practice Set with Red Seal Battery and Cord. \$4.05
Weights 4 lbs. packed. Price does not include postage.

Send for the New Edition of Our Catalog W28

It is pocket size, contains 264 pages, with over 1,000 illustrations, and describes in plain, clear language all about Bells, Push Buttons, Batteries, Telephone and Telegraph Material, Electric Toys, Burglar and Fire Alarm Contrivances, Electric Call Bells, Electric Alarm Clocks, Medical Batteries, Motor Boat Horns, Electrically Heated Apparatus, Battery Connectors, Switches, Battery Gauges, Wireless Telegraph Instruments, Ignition Supplies, etc.

Send for the Catalog Now

Manhattan Electrical Supply Co., Inc.

NEW YORK: 17 Park Place
CHICAGO: 114 S. Wells St.
ST. LOUIS: 1106 Pine St.
San Francisco Office: 604 Mission St.

WANTED IMMEDIATELY

Civilian wireless operators are in great demand owing to the expansion of our Merchant Marine. Pay has increased to \$110 per month and all expenses.

Write for booklet giving full particulars about The Best Radio School in New York City

East Side **Y. M. C. A.**
Branch 86th St. and Lexington Ave.
Lenox 6051 New York

WIRELESS BOOKS

Send for NOW and Save a Dollar
PRACTICAL WIRELESS TELEGRAPHY By E. E. Bucher
and THE WIRELESS AGE for one year, \$2.75. Regular price, \$3.75.
WIRELESS PRESS, INC., 33 ELM ST., NEW YORK.

SCIENCE IN SLANG.

(Continued from page 911)

the wireless more of a success, but who have not had the public notified that they pulled a good one.

"Old Doc, Fleming got a good one in the form of a 'valve,' which is a lot like the audion. It was a close second in the patent office and only lost first place by much wrinkles and perspiration on the part of a wise old judge who weighed the proposition like a pair of assayer's scales.

"Then suddenly just when we kiss the dear old war good-bye, in drops old man Jimmy Rogers. He steps up on the platform, puts up his hand and says, says he: 'Sh, boys, before you put up your aerial zing-magics, see me! Nix on those aerial wires!' We say: 'Thehellusay. Whazze-matter with our good old aerial?'

"'Not much,' says Jimmy, 'except that aerials are all wrong. Besides you don't need 'em. Just you take a hundred feet of rubber covered auto cable and bury it three feet underground into a trench, savvy? Hook the loose end to what was once your aerial connection and, presto, in come the messages louder'n a goat on a tin roof. And you receive twice as far as before, AND the old girl static, who used to tease the life out of you, is gone for good, along with the war. Simple, if you know how!'

"I guess that is about all for to-day—now for tomorrow. We may be able to carry around in our pockets a 'phone that will enable us to talk to our colored friend in Africa—when we are in Siberia or Sing-Sing. The present wireless is a great success—so was the Roman chariot, but the Handley-Page aircraft has it over the old go-cart in more ways than altitude.

"Where are we in the art of cultivation? We thought that we had it down like a scenario until Luther Burbank showed us that cactus did not have to have their stickers and the little posies that we wear on our coat lapels could aspire to the rainbow. Way back in the old ignorant days, when a gink thought that it was no worse to marry his sister and raise a colony than we consider a divorce or Wall Street play, there lived an old bird who observed that a little hoeing and so forth would not hurt a wheat stalk and that other growths were helped thereby. I don't remember the guy's name—it was so long ago—but it seems he was an Egyptian. I would not say for sure though.

"Now look how long ago it was when we got out of the boyhood stage in the electrical game—there are a string of years ahead of us yet—perhaps some electrical Burbanks will show up. Don't get it in your head I am slighting Edison, Tesla, Steinmetz, Marconi, De Forest, Fessenden, and others who now have the WATT under the microscope and wearing their glasses at that. What would Caesar have done had he possessed a machine gun or a telephone—what would Edison do with the observations and discoveries of the years to come? Men, we are moving! Moving as men have never moved before!"

PREPARED TO DELUGE GERMANS WITH GAS.

Statements that America next spring would have smothered the German front with undreamed of quantities of poison gases, that Edgewood Arsenal thru gas production would have brought about the capture of Metz, that America alone would have had ten tons of mustard gas to Germany's one, and that our chemists had surprises of which German scientists never dreamed—all these facts were recently disclosed by the War Department.

Colonel Bradley Dewey, who was in charge of gas defense production, said that a mask had been evolved which required no nose clip and no piece in the mouth. A man could wear it indefinitely and could sleep in it.

FREE

To Every Experimenter Reader

COMBINATION OFFER

Send at once for this interesting and valuable collection. Send only four cents in stamps to cover postage. There is no further charge.

N-S Co. Catalogue C-3

War edition. Thousands of experimenters the world over already have this edition. Don't miss getting it now. Lists wireless goods, electrical and experimental supplies, educational toys, unique novelties. Also contains much useful information. Free on request.

Latest price revision supplement

Applying to Catalogue C-3. Contains latest last minute price changes so that you will know exactly what each item in the catalogue is going to cost you without troublesome and delaying correspondence. Free on request.

Code Chart

Very neat and practical. Presents all three telegraph codes. Pocket size so that you conveniently can carry it with you while learning. Free on request.

Chemistry Supplement A1

Presents a very fine list of pure chemicals and approved apparatus for the experimenter. Our "one price-for-all-chemicals" plan will please you, we know. Makes ordering simple and utmost value assured. Complying with the request of hundreds of our experimenter friends we have established a chemistry department. Stocks are of the freshest, assuring good results. You should have our list. Sent free on request.

Chemical Experiments

Describes a series of the best classical experiments in chemistry. Clear, concise directions. Very instructive for the beginner. Compiled by an expert chemist. Free on request.

Litmus Paper

Free sample of our best quality chemists alkali and acid test papers. Used in every laboratory. Generous sample litmus paper free on request.

All the above free for the asking

Send 4c in stamps to cover postage. No obligation. Only 1 set sent to any one address. Just write "Send Free Combination offer" and enclose postage.

The Newman-Stern®

Formerly **The Electro-Set Co.**

1874-76 E. 6th St. Cleveland, O.

Super-Sensitive Microphone ONLY \$7.50



This instrument is offered at an extremely low price. It is excellent for building your own amplifier. Can also be used in many experiments where a sensitive microphone is required.

Detectograph, \$15

This detecting instrument of marvelous sensitivity can be used for detecting secret conversations. Outfit consists of Sensitive Transmitter, 25-ft. Black Cord, Receiver, Headband, Case and Battery.



Send for One Today and Convince Yourself.

Detectograph \$15

THE \$15 MICROPHONE DEAF-PHONE



is a super-sensitive instrument which has been developed to meet the demands for a practical and efficient hearing device at an extremely low price. It is equal to any \$35 instrument made and superior to most of them. The outfit consists of One Super-Sensitive Transmitter with cord connector; One Super-Sensitive Ear Piece with small black cord; One Black Single Headband; Black Case and Two Batteries. WRITE TODAY FOR FREE BOOKLET

G. BOISSONNAULT CO.
26 CORTLANDT STREET NEW YORK
Makers of Super-Sensitive Microphone Apparatus

WIRELESS TELEGRAPHY

Our 14 weeks course prepares you for MERCHANT MARINE paying \$110 per month and expenses. RADIO INSPECTORS receive \$1,200 to \$3,500 per year. Our instructors are licensed by U. S. government; school fully equipped and largest of its kind in America. Tuition small and payable weekly. We guarantee to qualify you. Board and room in Washington at reasonable rates while taking the course. Particulars on request. SERVICE RADIO SCHOOL, 902 Pa. Ave. N. W., Washington, D. C.

DO RADIO WAVES TRAVEL ABOVE THE EARTH OR THRU IT?

(Continued from page 872)

stalling later stations under such conditions, to examine very carefully the topography or rise and fall of the country over which this radio system was to operate. Fig. 5 shows a more ideal condition for the operation of a radio station in a valley, and one which has proven to be entirely successful in practise. Here the surface waves have a chance to follow the contour of the ground, as shown, and the antenna in consequence receives a full quota of energy from the waves as they pass across it. It is conceivable in the case illustrated at Fig. 4 that the etheric space-wave component at B, may become totally a space wave without a grounded foot, and this would account all the more readily for the station in this case not receiving any signals.

Some very interesting experiments were made some years ago on the relative efficiency of *ground antennae* and which were reported in the journal "Jahrbuch Für Drahtlose Telegraphie und Telefonie", and the essence of these tests is illustrated diagrammatically at Figs. 6 and 7. The investigator, Kiebetz, working with such antennae, utilized one form composed of insulated conductors placed in an open trench, as shown in Fig. 6, and later he covered the trench over with boards and piled soil on top of it. The more soil he placed on top of the trench, the weaker the signals became, until finally *none were received at all*. This showed apparently that if wireless signals were to be received by an ordinary ground antenna, it must be placed in close proximity to the earth's surface, as I have already described in the opening part of this article, or else in a more or less shallow trench, the top of which is open and not covered with any conductive substance or material. The diagrams, Figs. 6 and 7, show how the gliding composite waves, with their ground components, cut across the antenna wires in the open trench, while in the closed trench, the ground waves or "feet" glide over the raised contour of the soil as shown, and how the ground components, reaching but a short distance below the surface as previously explained, do not cut across the buried aerial conductors, and therefore no currents are generated in them, as the tests prove.

One way in which a submarine may pick up wireless messages is shown at Fig. 8. Here the composite radio waves glide over the water with their ground components, as shown by the dotted lines. Now, if the submarine trails a heavily insulated wire, as shown, the upper end of which is supported on two or more floats, then it naturally becomes possible for this wire to pick up energy from the radio waves travelling in the direction of the wire, and signals will be received. As mentioned above, it is also possible, that by having the floats partly weighted so as to keep the antenna wires a short distance below the surface of the water, that wireless messages can then still be picked up, due to the partial penetration of the grounded components of the waves into the water, in a readily apparent manner. It is very doubtful if the submarine will be able to pick up any radio messages, if it lies at any considerable depth in the water, say below 50 feet, with the antenna wire trailing along behind it, as the penetration of the wave base has been shown to be usually but a few feet below the surface, especially over salt water. It must be clearly understood, however, that experiment as well as theory both show that the penetration into moist earth or water increases with increasing wave length. Hence it is that of late, as the wave lengths



Brandes "Superior" Head Set, complete with head band, \$6. A professional set within the means of every amateur. 2000 ohms.

BRANDES

on a
Wireless Headset
means
SENSITIVENESS

And sensitiveness means more than an ability to receive weak signals. It means being able to bring out a clear, unblurred sound, easily distinguishable in spite of static disturbances.

The sharp, readable tone obtained by Brandes receivers is due to long and careful experiment—and to the fact that both diaphragms are matched for tone and pitch.

TRY A BRANDES HEADSET--AT OUR RISK

Test Brandes receivers against any other make. If you do not find the Brandes superior in clearness, sensitiveness, and range, your money will be returned without question.

Order a Brandes Headset today—or send 4c for Booklet "E" with complete description of Brandes receivers.

C. BRANDES, INC.
Wireless Receiver Specialists

ROOM 814

32 UNION SQUARE

NEW YORK

Complete line of Brandes receivers for those in Western States and Pacific Coast. Catalogue "E" on request.

Balboa Building

FORD KING

San Francisco, Cal.

Radio Amateurs!

BUY PARTS AND MAKE YOUR OWN SETS

Large Stock of High-Grade Radio Materials Left on Our Hands Because of Cancelled Government Contracts

BARGAIN PRICES

WRITE FOR COMPLETE PRICE LIST

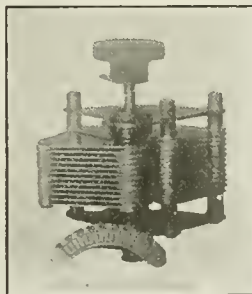

SMALL

Variable Air Condenser
90°, aluminum plates, rigid construction, capacity .0005 mf. Can be used one in primary and one in secondary for varying capacity. A high grade, assembled condenser at a lower price than most cheap ones. Complete with knob, scale and pointer, ready to mount on panel. . . . Each \$4.00

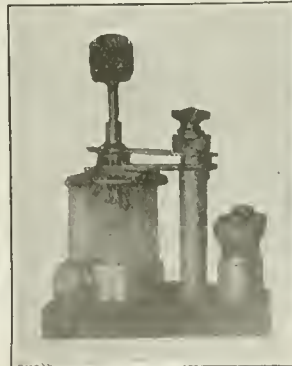

Galena Crystal Detector Units
complete. Crystal mounted inside weather proof cage. Knob and contact spring mounted on micarta base with binding posts. Close regulation, wide range of adjustment, variable pressure. Each \$1.80
Crystal detectors licensed under patents of the Wireless Specialty Apparatus Company of Boston



Split Head Band

Best grade light weight nickel-plated adjustable ear pieces—will fit any head phone.

50c each

DE FOREST RADIO TEL. & TEL. CO.
1391 SEDGWICK AVENUE - - - - NEW YORK CITY

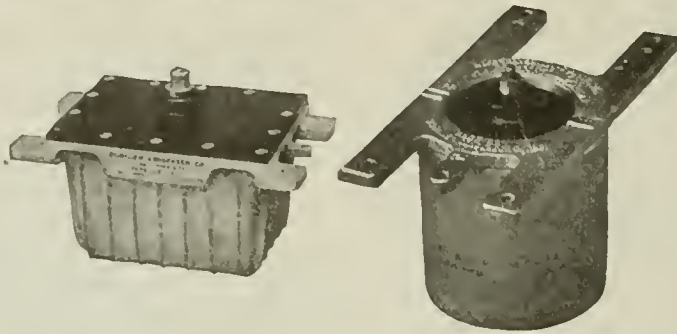

TWO TYPES OF MICA TRANSMITTING CONDENSERS SUITABLE FOR MODERN AMATEUR APPARATUS. 21000 VOLTS. .004 MFD.

Make Your Wireless Apparatus Send Further Last Longer and Work Better

The wireless amateur and experimenter is once more busy constructing apparatus for use the moment that orders go forward allowing amateur stations to open.

The kind of apparatus you used before the war doubtless answered your purpose nicely, but just consider the tremendous advancement made in the art during the past two years and you will appreciate your modern apparatus must contain several new types of equipment to bring it up to date.

DUBILIER MICA CONDENSERS

proved their real worth in the Navy, the Signal Corps, and as a part of the equipment of the fighting Airplanes both here and abroad since 1916.

You can now purchase a genuine DUBILIER MICA CONDENSER for your new set for any voltage and capacity. They replace Leyden Jars with greater efficiency and without brush discharge and with negligible losses. They are compact and indestructible.

Made in any capacity and up to 1,000,000 volts. Special condensers supplied for experimental work.

Used in practically every Government installation.
DUBILIER MICA CONDENSERS are now ready for your use.

	Type A	Navy Type
.002—21000 volts.....	\$11.00	\$18.00
.004—21000 volts.....	20.00	35.00

DUBILIER CONDENSER CO., Inc., 217 Centre St., New York
For Great Britain, Address DUBILIER CONDENSER COMPANY, Ltd.,
1 & 3 Stephen St., London, W. I., England

Boys! You Can Make Your Own Electrical Apparatus with the aid of these wonderful books

Home-made Electrical Apparatus

By A. M. Powell



Three wonderful big books, cluck full of just the sort of information you have been looking for and at a price within reach of your pocket book. Each volume is printed on heavy paper, contains 75 pages and over 60 illustrations, complete working drawings for making every sort of electrical apparatus. Written so you can understand them. The price is only 25 cents per copy—practically the cost of publication. See partial table of contents below and order now. The supply is limited.

Vol. I Contains working drawings and directions for making all sorts of Static Machines, Static Apparatus, Home-made Batteries, Storage Cells, Transformers, Rectifiers, etc.

Vol. II contains working drawings and directions for all sorts of Voltmeters, Ammeters, Galvanometers, Switches, Rheostats, Telegraph Keys, Sounders, Telephones, Shocking Coils, Spark Coils, Experiments, etc., etc.

Vol. III contains working drawings and directions for making all sorts of Dynamos, Motors, Electric Engines, Miniature Lighting Plants, Wireless Telegraph Apparatus, Tesla Coils, Wireless Telephone, Electroplating, Experiments, etc., etc.

Any of these wonderful books will be sent to you postpaid for 25 cents.

COLE & MORGAN, Inc., Publishers and Booksellers
P. O. Box 473, City Hall Sta., New York City

of the larger stations have been increased, these horizontal receiving antennae can be sunk deeper and deeper before effective screening is observed. Hence the periodic "rediscovery" of the astonishing efficiency of the horizontal receiving directive antenna.

So far as I have heard the first use of the horizontal receiving antennae was at Block Island in July, 1903, where we connected the receiver direct to a telephone line running across the island from the wireless station towards the Point Judith (R. I.) transmitter. Fine loud signals were thus received.

In 1905 I used a bare copper wire lying directly on the ground at New Haven, and then determined within a few degrees the direction of the transmitting station, by swinging this wire around a circle, the center of which was the receiving instrument and ground stake. The signals were loud when the wire lay in the plane of the station, in either direction to or from the station—practically the same for both. But when at right angles to this plane of propagation nothing at all was received.

But to return to your editorial, "Wireless Around the World", it is highly unfortunate that the esteemed advertising propensities of the Marconi interests should have made capital over this performance of their station in the year 1918, when similar performances had been on numerous occasions a matter of record for at least two years prior to that date.

I give below a news clipping sent to me back in 1916 by a wireless operator at Awarua, New Zealand, which is self-explanatory. I have received many communications from this section which, unfortunately, I have not felt authorized to publish, recounting similar "anti-podal" radio-transmission.

"In connection with Commander Cresswell's statement regarding the reception at various Australian wireless stations of messages sent out by Nauen and other places in Germany, it is stated that similar messages are received nightly at several of the New Zealand radio stations, especially Awarua, which is probably the best equipt in the Dominion. The distance from Nauen to Awarua is about 12,000 miles, which, if it does not constitute an absolute record, is very near it. The secret of these remarkable results which in less troublous times (referring to the World War) would excite world-wide interest, lies in the De Forest ultra-audion receiver—one of the most remarkable and simple pieces of apparatus invented since Marconi's first experiments. Dr. de Forest is an American, who lives at New York. His "ultra-audion" has the power not only of receiving the far-flung waves, but can also be used as a wireless transmitter for the voice—a field as yet practically unexplored."

In fairness to facts wherever an epoch-making feat of this sort is accomplished, whether in science or in any field of discovery, I am sure you will agree that it is highly important that due credit should be given to the first performance and not to a repetition which happens to be generously advertised years thereafter.

Perhaps your article lays unwarranted stress on the improvements which the Alexanderson alternator today enjoys over the arc transmitter. After witnessing what the big arc transmitters are doing in Europe, as well as in the United States, together with their simplicity and ruggedness and the facility with which any wave length can be instantly obtained, it is doubtful in my opinion whether the alternator will soon supplant the big arcs; at least, except in stations where one wave length only is required.

Get your wireless stations

In Readiness Now.

Be prepared and avoid delay.

DUCK'S big 300 page Wireless and Electric Catalog is now, as it always has been, the largest and most complete and dependable Wireless Catalog published. Mailed for 12c in stamps or coin. Not sent otherwise.

Everything in wireless worth while is listed in this catalog. The experienced amateur will tell you to see our catalog before buying. You are thereby insured against an unwise purchase. It is the Beacon Light to guide you right in the selection of your wireless apparatus. No bigger or better values are obtainable elsewhere.

If you have our catalog No. 11, you have our latest catalog. Do not write for another. Send for a revised price list. It is yours for the asking.

THE WILLIAM B. DUCK CO., 230-232 Superior St., Toledo, Ohio

MURDOCK Radio Receivers



Noted for their extreme sensitiveness and un-failing dependability. At the very reasonable prices, they are the best receiver value in the world. Buy now for present and future needs.

Other Apparatus of Equal Merit Available for Experimenters, Schools, and Colleges.

Ask for Bulletin No. 18.

WM. J. MURDOCK CO.
55 Carter St.
Chelsea, Mass.

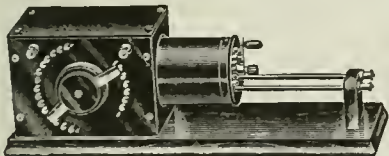

The Arnold Navy Model Loose Coupler IS MY SPECIALTY BUT

I also make short wave regenerative receivers, Varlometers and apparatus to order, and carry the finest line of accessories on the market.

J. F. ARNOLD
2082 Lexington Ave., near 125th St., N. Y.

BOOKS!!!

of every kind. English Translations (word for word):—"CAESAR" (1st 8 books), "CICERO" or "VIRGIL", \$2.00 each, postpaid. "Sexual Disasters", \$2.00 each, pp. All kinds of sex books, and the latest fiction. Tell us your needs. Monongahela Novelty Co., Box 299, Monongahela, Pa.

ELECTRICITY IN FAR-AWAY BOMBAY.

The great success with which the introduction of electric power from the generating station on the Ghats is being developed in Bombay is revealed by the report of the Tata Hydro-Electric Power Supply Company. The energy now being supplied to motors in Bombay amounts to 48,000 horsepower. Thirty-six mills are receiving power, and only the difficulties arising from the war prevented development being more rapid.

THE HOW AND WHY OF RADIO APPARATUS.

(Continued from page 875)

them in the proper manner for giving a good indication. At this point, it is well to mention that no matter which form of detector is used in conjunction with the wave meter, that the wave meter itself must be kept at a sufficient distance from the exciting circuit, no matter what its form or make-up, so that there shall be just sufficient current picked up by the wave meter oscillating circuit to give a good clear indication in the detecting or indicating device. If the wave meter is held too close to the exciting circuit, then several wave lengths or harmonics of various wave lengths may be heard, and an incorrect reading obtained.

For many purposes it is desirable and necessary to excite the wave meter so that it will radiate a wave length of known value, such as in various radio measurements, etc. Fig. 5 shows a standard method of exciting the wave meter. Here we have a high note or other form of buzzer connected with a few cells of dry battery, and a key or switch. This circuit is shunted across the variable condenser of the wave meter as the diagram indicates. This arrangement will cause oscillations to be set up in the oscillatory circuit of the wave meter, and an auxiliary inductance can be placed near the wave meter inductance so as to link the two inductively, and thus transfer the energy electro-magnetically from the wave meter circuit to the auxiliary circuit, and which energy shall have a wave length and frequency of known value.

At this juncture, the matter of arranging the wave meter cabinet, and especially the variable condenser and its scales, etc., should be considered. In this connection we may refer to Figs. 6, 7 and 8, wherein several important and simplified methods of arranging the variable condenser scales, especially direct reading scales, are given. Fig. 6 shows a method used by the writer for several years with good satisfaction. In the scheme the variable condenser scale is specially made up on heavy bristol board or celluloid, (or else hard rubber with the graduations scratched in with a scribe and then filled with Chinese white), and instead of having simply the angular spaces marked off in degrees, and then having to refer to a calibration chart in the usual way, the corresponding wave length values for the coil are read off from the calibration chart (see Fig. 9) and marked off on the scale as shown in Fig. 6. Then as the indicator attached to the variable condenser knob is moved over the scale, and by noting which inductance coil is in use at the moment, the corresponding wave length may be read off directly as soon as the maximum resonance point is indicated by the detecting circuit. The indicator, Fig 6, comprises a piece of heavy sheet brass, soldered or otherwise secured to the shaft of the variable condenser, and the outer end of the arm is cut to the form shown, with the two side edges bent over to retain a piece of ordinary glass. With a glass cutter, a straight line is scratched across the center of the glass, and this may be darkened

Draftsmen Earn \$35 to \$100 Weekly

You can get this big pay. All you need is the new 1919 edition of the Cyclo-pedia of Drawing and a little of your spare time. The cost is only 7 cents a day. You learn at home and pay this small amount while learning. See the FREE EXAMINATION offer below.

Architectural and Mechanical Drawing

4 big volumes each 5 1/2 x 8 1/2 in., bound in genuine American Morocco and trimmed in gold. 1578 pages and over 1000 illustrations, plates, diagrams and blue prints.

The only books that thoroughly cover Mechanical, Structural and Architectural Drawing in a non-technical way. You don't have to know anything about the subject to understand them. They begin at the beginning and tell you everything about Blue Print Reading—Mechanical Drawing—Machine Design—Machine Drawing; Structural Drafting; Architectural Drawing and Lettering—Shades and Shadows—Perspective Drawing—Freehand Drawing—Pen and Ink Rendering—Typographical Drafting—Drawing Instruments and their Uses and hundreds of other things connected with the work.

Use One Week FREE

You can use these books for a whole week free without sending a cent. Just send the coupon below and all 4 volumes will come to you at once by express collect. Use them as if they were your own—go through them thoroughly and send them back at our expense if you don't want to keep them. If you do keep the books send us only \$2.00. You can send the balance of our special introductory price—only \$13.80 the same way—\$3.00 each month.

Remember you don't take any chances. The risk is all ours and the benefits will all be yours. SEND THE COUPON TODAY.

American Technical Society
Dept. D-3384 CHICAGO, ILL.

CYCLO-PEDIA OF DRAWING VOL. I VOL. II VOL. III VOL. IV

American Technical Society
Dept. D-3384 CHICAGO, ILL.

Please send me the 4-volume Cyclo-pedia of Drawing for 7 days' Free Examination, shipping charges collect. I will send you \$2.00 in 7 days and \$2.00 each month until the special price of \$13.80 is paid, and you will send me a receipt showing the books are mine. If I decide not to buy I will return the books in 7 days.

Name.....
Address.....
References.....

TELEGRAPHY AND RADIO

DAY AND EVENING CLASSES
SEND FOR PROSPECTUS
IN SUBJECT INTERESTED
EASTERN RADIO INSTITUTE
899-B Boylston St. Boston, Mass.

Wireless Individual instruction continues under the general supervision of E. E. Bucher, Instructing Engineer, Marconi Wireless Telegraph Co.
Y. M. C. A. TELEGRAPH SCHOOL
Marcy Ave., near Broadway, Brooklyn, N. Y.

READ THE CLASSIFIED ADS. ON PAGES 932-934

Amateurs — Manufacturers
WIRELESS PARTS
Knobs — Bases — Insulation



This fine Base in composition hollowed to hold small condenser, 4 1/4" x 2" x 1/2". Postpaid 30c

Base 3 1/4" x 2" x 1/2" Postpaid 32c

Knob, 1 1/4 x 1/2 with 8-32 threaded bushing and extra inserts to hold contact securely. Postpaid 20c

Manufacturers send for discount in quantity.

A. H. CORWIN & CO.
 5 Kirk Place Newark, N. J.

HOW TO Become a WIRELESS OPERATOR



A practical book—boiled down to the real facts and giving all the information you need to become a Wireless Operator. No tiresome mathematics or useless data to wade through. 28c pages of interesting instruction and 196 pictures and diagrams that make difficult things as simple as A. B. C.

Money Back If You Want It
 Send \$1.75 and 10c extra for mailing (stamps or money order) with your name and address. The book will come at once postpaid. Use it 6 days and send it back if you want to. Your money returned if you don't keep it.

5 Days Trial

AMERICAN TECHNICAL SOCIETY
 Dept. W.104 CHICAGO, ILL.

"The Livest Catalog in America"

Our big, new electrical cyclopedia No. 20 is waiting for you. Positively the most complete Wireless and electrical catalog in print today. 180 Big Pages, 500 Illustrations, 300 Instruments and apparatus, etc. Big "Treatise on Wireless Telegraphy." 20 FREE coupons for our 160-page FREE Wireless

WIRELESS

Course in 20 lessons. FREE Cyclopedic No. 20 measures 7x5 1/2". Weight 1/2 lb. Beautiful stiff covers.

Send 6 cents in stamps or coin for which we will send our latest Cyclopedic Catalog No. 20 as described.

ELECTRO IMPORTING COMPANY
 231 Fulton St., New York City

SELENIUM CELLS

Guaranteed 99% pure selenium

Made by people who know their business, for the most difficult work, requiring very sensitive, quick acting cells. Standard cells, \$3 each. Special cells to order.

THE SELENIUM LABORATORIES.
 New York Offices, 56 West 45th St.

MATHEMATICS MADE EASY

The Arcascope—the Combination Triangle with a Brain—will multiply, divide, figure percentage and proportion, solve all problems in trigonometry and geometry, draw symmetrical figures, plot arcs, etc. Superior to any slide rule. Simple to operate. Also includes a TRANSPARENT TRIANGLE, PROTRACTOR and THREE RULES. Used at Columbia University, West Point, U. S. Aeronautic Schools, etc. Only 85 cents Postpaid. Order today before you forget.

Dept. S. **L. J. LEISHMAN CO.,** Ogden, Utah

SMALL ENGINES

Perfected Gasoline Engines—1/2, 1 and 1 1/2 h. p.—for Farm and Shop use. Price, \$27.50 and up. Also, **WASHING MACHINES**

We ship on trial. Send for Booklet and Special Offer **SIEVERKROPP ENGINE CO.**
 1401—19th St., Racine, Wis.

STARTER for FORD CARS

if necessary with a little black pigment. A piece of fine wire can also be drawn across the glass and soldered in place.

Fig. 7 illustrates a clever arrangement which also provides a direct-reading wave meter, and here the calibrated dial corresponding in its lay-out to that shown at Fig. 6, is secured to the variable condenser shaft below the shelf of the cabinet. A small oblong window is cut thru the cabinet shelf as shown, and a brass slide is placed under

calibration graphs is as follows: Consider that a maximum resonance point is indicated by the detecting instrument connected to the wave meter circuit, when the condenser needle stands at 105 degrees, with the 24 turn inductance in use. Glancing upward from the 105 degrees marked at the base of the chart, and noting the point where this line intersects the curve for the 24 turn helix, we find that the equivalent wave length for air dielectric in the con-

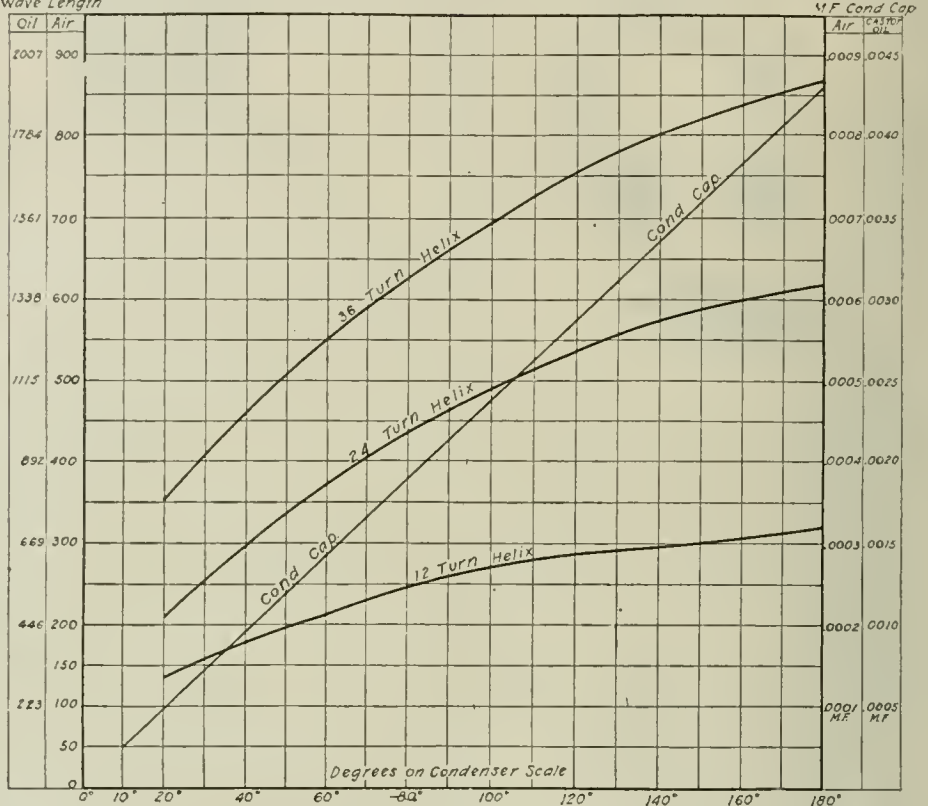

Calibration Curves for Wave Meter and Variable Condenser Here Described. To Read Any Wave Length Value from These Graphs, Note the Condenser Reading at Which Resonance is Indicated. Then Determine the W. L. Value Corresponding to the Intersection of the Vertical and Horizontal Lines with the Proper Inductance Graph, Fig. 9.

neath this shelf so as to be readily operated by hand, in such a way that the small window cut in the slide can be slid into any one of three positions, depending upon which scale and which inductance is being used at the moment. Fig. 8 shows an automatic arrangement, which is easily made by the radio student and whereby each of the three inductances is fitted with pin contacts, one of the pins in either case being made of a different length for each of the three coils. As each inductance is placed in the cabinet thru the spring contacts shown, the longer lug will actuate a lever system connected to the window slide shown at Fig. 7, and thus automatically move the slide to the proper position to read the corresponding wave lengths for that coil.

The calibration curves for the wave meter here described are given at Fig. 9. These values can be transposed to a special variable condenser scale if desired, of course. The variable condenser calibration curve is given as well as the wave length graph for each of the three inductances. As is well known, the capacity of a condenser may be increased by adding a liquid dielectric, such as castor oil, which has a coefficient K value of 5; or in other words, if the variable condenser is filled with castor oil, its capacity will be increased five times over that of air. The capacities for the condenser filled with castor oil (as well as air dielectric) are given at Fig. 9 on the right. Also in this way the student will have a greatly increased wave length range on the wave meter for any given coil, when the condenser is filled with castor oil, as the second column of wave length figures on the left indicates. The manner of using the

denser is 500 meters, and for castor oil in the condenser 1115 meters.

Direct-Reading Decimeter—The chart shown at Fig. 10 is described in a recent book entitled "Radio Instruments and Measurements," Circular No. 74, issued by the United States Bureau of Standards, and a copy of which can be obtained from the Government Printing Office, Washington, D. C., at small cost. This chart makes a direct-reading decimeter out of any wave meter. Fig. 10 shows how the chart may be attached to the upper rotary plate of the variable condenser; its zero graduation being set to coincide with an indicator mark or hair line thru a window in the top of the condenser case, when the rotary plates are all the way out from the fixed plates. Also it should be seen that the hair line in the window coincides with the straight edge of the semi-circular fixed plates. Full description of this arrangement is given in the work above referred to, as well as all the usual methods of measuring decrement.

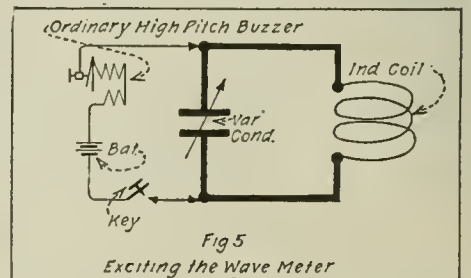

Hook-up for Exciting the Wave Meter so That It Will Emit Waves of Known Length.

Health In A Glass Tube

The interesting story of a man "too busy to bother" who appreciated perfect health, energy and vitality only after he lost it—and how he won it back in a startling way

By FRANK HARTLE

YOU probably know dozens of people like my friend John Brainard. Strong, robust, a human dynamo for work, a real bulldog for stamina, and a very likable fellow in spite of his entire lack of sympathy for sickness and sick people. He regarded sickness as a mild sort of crime and had such faith in his own excellent health that he had about as much sympathy for sick people as, according to Mark Twain, David had for Goliath. If you happened to mention that you didn't feel extra well Brainard would say, as courteously as was absolutely necessary, "T'bad, very sorry"—and you could almost see the entire matter sail out of his other ear. Sickness and suffering were foreign to John Brainard and he couldn't understand it in other people, that was all.

But as Josh Billings once said, "Health is like munny. We never have a true idee uv its value until we lose it." And quite suddenly John Brainard realized what ill-health is. Too much overwork, inconsiderate hours, immoderate meals, and general inattention to his health finally "told on him." One day I went to his apartments and found him in bed with a severe attack of sciatica, but fuming with rage in spite of the intense pain. "Why should I have this?—I've been as healthy as a horse all my life. Why should I be sick?—hang it, I won't be sick," and he jerked himself to a sitting posture only to fall back in pain upon the pillow.

For a week John Brainard lay in bed in intense agony. Those of you who have suffered from acute sciatica or rheumatism know what it is. The doctor came and went, but Tuesday and Friday when I called, John only said, with a weak attempt at his former cheerfulness, "Nothing doing, Frank. They haven't pushed the right health button yet. Who was that fellow anyway who said something about 'a man too busy to take care of his health is like a mechanic too busy to take care of his tools.'"

Next day while at lunch with George Conrad, our mutual friend, I mentioned about John's still being so very ill. "Listen, Frank, old boy," he said, "I don't want to be presumptuous or anything like that and I certainly believe that the Doc will fix John up fine, but there's a treatment which entirely cured my wife of chronic neuralgia, and now it's bringing total cure to my cousin, another sciatic sufferer. I think if John would give it a trial it might help him some." Ten minutes further conversation with Conrad convinced me and I went right over to John's home to "spring it."

"John," I said quietly, as I tip-toed into his bedroom, "I've got the very thing. Conrad has given me some real facts about what electric violet rays are doing for people and I think—"

"Oh," he interrupted, "I don't know. I don't imagine it can help me."

"Of course you don't know. And you never will until you try. Now don't talk foolish, Johnny, old scout. Won't you even believe your friends? This violet ray treatment has proved what it is."

And then I went on to tell him all I had learned about violet ray treatment—how it had been invented by the great Tesla in 1890, how it was being used with wonderful success by eminent physicians all over the world, how he

could use it on himself and it wouldn't shock him like electricity in other forms, how it would surely at least help his own sciatica when it had cured other folks' sciatica, neuralgia, hay fever, asthma, neuritis and dozens of other diseases, and finally I told him how it would bring back to him his old "pep," vigor, and "knock-'em-dead" vitality. Then John rolled over and said, "All right, if it brings me out of this blamed bed a well man I'll swear by it for life. Cart in the dynamo, or whatever it is."

"Its nothing of

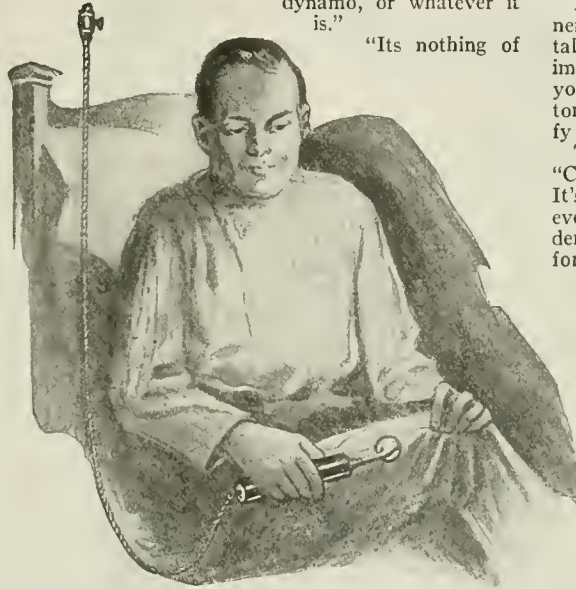

"When I ran that glass tube over my 'hide,'" said John, "it felt just like a local anaesthetic on a wild tooth."

the sort," I insisted. "It's a handy little tube-shaped thing that attaches to that electric socket right over your head. And you can apply it yourself right to your 'hide' without feeling a bit of a shock."

Three days later I had gotten a violet ray instrument from Chicago and John used it on his legs and thighs. "Say," he cried, after the first treatment, "I thought electricity always shocked a fellow. Why, when I ran that glass tube over me and the violet rays flashed around, it just felt like a local anaesthetic on a wild tooth. If this keeps up—oh, boy!"

John Brainard got up for good three days ago for the first time in over two weeks. Five days' treatment with the violet rays put him on his feet.

"Where is your 'rheumatiz,' John," I remarked yesterday.

"Dunno, Frank, I can't find it anywhere. It just 'violet-rayed' itself away, I guess," he said, pointing to the instrument in the bathroom.

"I see you keep it attached."

"Yes, you see my wife discovered that the best beauty specialists in town used it, and she—well, my wife's a woman you know."

* * * * *

Violet rays have brought good results in almost every disease and Violetta, being the most advanced instrument produced and selling many thousands ahead of all others, is certain to bring you the health-giving results you have always wished. But we do not want you to take our word for it. Judge for yourself—try it for ten days in your home before you decide one way or the other.

Now, through the Violetta, you can have in your own home, the wonderful violet-ray treatments exactly as given by eminent physicians and beauty specialists throughout the country. Now you can rid yourself of Chilblains, Colds, Corns, Constipation, Dandruff, Deafness, Eczema, Eye Diseases, Hay Fever, Headache, Goitre, Insomnia, Lumbago, Nervousness, Neuritis, Obesity, Paralysis, Piles, Pimples, Pyorrhea, Rheumatism, Skin Diseases, Sore Throat, and many other ailments.

Multiply your bodily health—vitalize your nerves—double or treble your energy and vitality. Sleep better, increase your strength, improve your appetite and digestion. Soothe your nerves, reduce or increase your flesh, tone and strengthen the entire system, beautify your complexion. All with the Violetta.

Trixie Friganza, the famous actress, says, "Cheerfully will I add my praise for Violetta. It's the best 'pain chaser' and 'soother' I've ever had the good fortune to find. It's wonderful. It cured my brother of neuritis. As for myself, I use it for facial treatments and general massage. I cannot say too much for it." Frank Borzone, of Seattle, Washington, says: "I purchased the Violetta for my wife who was suffering from an acute attack of sciatica. From the very first treatment it induced peaceful rest and she is entirely well now." Scores of letters like these are received each day.

The Violetta is not a vibrator. It is not a machine that contracts the muscles—it does not shock—it does not pound the muscles—it is absolutely painless.

Eminent physicians from all over the country apply the Violetta with wonderful results. Dr. Bert H. Rice, of Vinton, Iowa, says: "I have good results with the Violetta. Almost instant relief in Facial Neuralgia." Dr. Daniels, Lisbon, North Dakota, says: "Have used the Violetta in such cases as Goitre, Bronchitis, Pleurisy, Neuritis, Neuralgia and Lumbago, and find it very beneficial. In fact, I would not be without it in my office." Dr. G. B. Duncan, Kewanee, Ill., says, "The Violetta is the finest thing I ever used to relieve congestion in any part of the body; and to relieve pain. Treatments are so pleasant that all of my patients like it."

Write today for a very interesting little booklet explaining fully about the Violetta and how you can try it for ten days before you decide. Read some of the amazing results produced in almost every disease. Read how the Violetta can be attached to any electric socket and also used where there is no electric light. Read how this little instrument, shaped somewhat like a thermos bottle with a glass tube and bulb at the end, pours electric energy and vigor into every muscle, fibre, cell, and pore of your body, read how you do not have to obligate yourself in any way until the Violetta has proven its value in your particular case.

Write for this interesting booklet now. Fill out the coupon printed below for your further convenience, and mail at once. Address, Bleadon-Dun Company, Dept 2C, 11 So. Desplaines St., Chicago, Ill.

BLEADON-DUN CO.,
Dept. 2C, 11 So. Desplaines St., Chicago.

Please send me your free booklet about the Violetta and ten days' trial offer.

Name.....

Address.....

.....



CUT YOUR OWN HAIR

If you can COMB your hair, you can CUT your own hair with this marvelous invention. You can cut your hair any length you desire, short or long, and finish the job as nicely as any barber in one-fourth the time before your own mirror, with the

UTILITY Hair Cutter

You can keep your hair well trimmed for a lifetime with this marvelous invention for actually less than any good barber would charge you for a single hair cut. Very easy to manipulate. Use it just like a comb, pushing it through the hair, downward, in the direction the hair lays. It is impossible to leave any "nicks" or "cat steps" in your hair, as there is a special Guard that guides the cutter blade evenly over the scalp.

Cut Children's Hair

at home and save time, trouble and expense of taking them to the barber shop. It works so easily and the job is done so quickly that the children enjoy having their hair cut. The adjustment feature, whereby the blade can be set to cut the hair to any desired length—short, medium, or long—makes it possible to do as perfect work as the barber, not to mention the tremendous saving.

As a Safety Razor You can use the Utility Trimmer as an ordinary Safety Razor, and it will give you as good a shave as the most expensive Razor you can buy. You can shave the face or neck, or finish around the temples.

EASY TO HONE AND STROP BLADES
No trouble at all to keep the blades sharp. Just reverse the blade in the holder and proceed in strop as with an ordinary razor. Extra Blades are always obtainable and cost only 5 cents each, or 50 cents the dozen.

USEFUL FOR MANY OTHER PURPOSES
There are many other uses for the Utility Cutter that will suggest themselves to you. Ladies use it for removing hair from under the arms and elsewhere. It is perfectly safe, and cannot cut the skin. One customer wrote us that he found it just the thing for cutting corns, while housewives and dressmakers say there is nothing better for ripping seams and making buttonholes.

AGENTS AND DEALERS GET OUR PROPOSITION
This is one of the rare occasions when you are able to connect up with a really "Sell on Sight" article. Something that every man and woman will buy on sight, because it actually saves them money. Agents are coming money. Why not you? Handsome package, weighs but a trifle. Write at once for terms on the Trimmers and extra Blades.

JOHNSON SMITH & COMPANY
Dept. RK2 3224 N. Halsted Street CHICAGO



FOR CUTTING THE HAIR LESS THAN PRICE OF ONE HAIR CUT



NOTHING BETTER FOR SHAVING THE NECK



FOR TRIMMING THE CHILDRENS HAIR



YOU CAN USE IT AS A SAFETY RAZOR



WOMEN USE IT FOR REMOVING SUPERFLUOUS HAIR

SEC'Y DANIELS TALKED BY RADIO TO PRESIDENT WILSON AT SEA.

Secretary Daniels transmitted a telephonic greeting to President Wilson at sea by naval radio on February 22. From his desk at the Navy Department the Secretary's voice was carried to the transport George Washington, nearly 800 miles off the Atlantic coast.

The long-distance radio telephone equipment had been set up when Mr. Daniels reached his office. With Rear-Admiral Griffin, Chief of the Bureau of Steam Engineering, and Commander Hooper, the radio expert of the bureau, supervising the experiment, the Secretary's regular desk telephone instrument was connected up thru the telegraph wires to the transmitting station at the seacoast, where his voice was projected by radio waves to the aërials of the George Washington.

The Secretary said a great welcome waited the President in Boston and again in Washington when he reached the Capitol.

Mr. Daniels repeated his sentences several times to make sure that he was understood.

"Good-bye," the Secretary said into the instrument. "I will see you Tuesday. Good-bye."

GRAND OPERA IN YOUR HOME.

(Continued from page 855)

microphone circuit could be loaded simultaneously with such an immense number of lines which practically constitutes a short circuit, and while the thing is possible in a limited way by means of induction coils, not more than two or three hundred subscribers could be linked up by such means. Therefore, the system heretofore was a failure.

The invention of the Audion, however, has changed this and by using audions to "boost" the circuits, it is now possible to connect a practically unlimited number of lines to one microphone transmitter and reproduce the music clearly in 50,000 homes at the same time.

The writer who interviewed high telephone officials was informed that the plan was entirely feasible and there was only one objection, which is not of a technical nature but rather a commercial consideration. Thus, the telephone engineers did not think it good business to tie up say twenty thousand to fifty thousand lines simultaneously for several hours at a time on account of the congestion that would probably ensue, but this is really only a small consideration and not of much importance if the enormous revenue that the companies will derive from this scheme is taken into consideration. While the subscribers now pay only between two and five dollars a month for service on an average, the telephone company could easily double this revenue for at least 20 per cent of all of their subscribers by installing the operatic service.

Today the man who owns a phonograph thinks nothing of spending between three to five dollars a month for records which are "dead". If he knew he could hear Caruso, Galli Curci or any of the other stars tonight in one of his favorite operas, he certainly would not object to spending 50 cents or even a dollar for the privilege, and at that he would think he was getting it cheap because he, with his entire family, would hear the music in his own home, without having to travel to and from the opera. Of course, if the system eventually comes into vogue, the opera alone will not be the only source of amusement to be drawn up by a telephone subscriber. Any of the musical shows or comedies, farces, etc., could all be heard over the telephone, altho admittedly not to such an enjoyable extent as grand opera, where it is the music that counts most.

Just to Get Acquainted we will mail you 4 issues of

THE PHOTO-PLAY WORLD

The one by which all others are governed - for \$1.00

The Photo-Play World contains only the best pictures—Stories and Articles. Has a Staff of America's Foremost Writers.

Subscribe Now
35c a Copy \$3.50 a Year

THE PHOTO-PLAY WORLD
Bulletin Bldg. Dept. E. E. Philadelphia, Pa.

HANDY BINDER for the Electrical Experimenter

Holds and preserves 12 issues, each of which can be inserted or removed at will, without tools. Will keep your magazines perfectly for all time or just preserve them like new till you bind them permanently. Made of heavy material, extra strongly reinforced at the back and covered with handsome green cloth, suitably lettered in gold.

65c

Add postage for 2 lbs.
Experimenter Pub. Co., Inc. Book Department 233 Fulton St., N. Y.

How to Get Rid of Moles



A simple, safe home treatment—15 years' success in my practice. Moles (also BIG growths) Dry Up.

Ask for Free Booklet of Full Particulars

WM. DAVIS, M. D.
4140 State Street Perth Amboy, N. J.

You can be quickly cured, if you

STAMMER

Send 10 cents coin or stamps for 70-page book on Stammering and Stuttering, "Its Cause and Cure." It tells how I cured myself after stammering for 20 years.

Benjamin N. Boque, 753 Boque Building, Indianapolis

It will pay you to read the advertisements each month

You benefit by mentioning the "Electrical Experimenter" when writing to advertisers.

As for the technical aspect, we now have very good sensitive microphones, which placed about the stage and orchestra transmit the sounds strongly and faithfully. The microphones are then connected thru the audion switchboard, similiar to the one shown in the lower center of our illustration, which is the identical audion switchboard now used in multiplex telephony where five conversations are held over the same wire. From here the circuit runs thru the telephone exchange shown in the upper center of the picture, whence the circuit enters the subscriber's home as shown at the left of our drawing.

Here we have a novelty suggested by the writer. In transmitting music over the telephone heretofore, it was not possible for more than one member of the family to listen to the music as there was only one telephone receiver. By means of modern loud talking telephones, however, it now becomes possible to lift off the telephone from the hook and place it over a sensitive transmitter, as here illustrated. The weak sounds picked up by this transmitter are strongly amplified and projected from the horn in great volume. Thus, it becomes possible for any one in the room to hear the music clearly and almost as loud as we do sitting in one of the further rows in the opera, where the hearing is not always good, as is well known.

As for the subscriber's amplifier as shown in our illustration, this may be made of the ordinary loud talking variety, having a simple hyper-sensitive microphone connected to a loud talking telephone, or otherwise it may be a microphone connected to an audion amplifier. The latter probably is the better of the two systems.

The amplifying cabinet can be hung near the telephone, in case of a wall set, or otherwise it can be of a different shape for table use if the telephone is of the portable type. The amplifier could be sold outright to the subscriber or otherwise rented to subscribers by the telephone companies.

We feel confident that a plan similar to the one outlined here will soon come into general use, as there is a positive demand, particularly in America, for good music and which demand as yet has not been satisfied.

But like all other large interests, the telephone companies are slow moving organizations and do not make innovations unless they know that a large part of the public actually wants them. Therefore, if you are in favor of this plan, we think it would be a good idea to write the headquarters of the telephone company, advising them what you think of this plan. If, however, you were to write to your local telephone company, not much impression would be made. If, on the other hand, you address your letter to the American Telegraph and Telephone Co., No. 12 Dey St., New York City, then there is a chance that a national movement would perhaps result from such letters. Local telephone companies cannot make a change in their present system as they are governed by the policy which originates at the New York headquarters. Perhaps your letter will help to bring the Opera into your home.

TELEPHONE GIRLS' WORK IN FRANCE.

It is difficult for us to realize the scope of the work that has been done and is still being accomplished by the telephone operators in France. To serve the needs of an army of two million men, and to connect that army up with the French by telephone was a matter that required no small amount of organization and planning on the part of the Signal Corps, says the *Telephone Review*. The distribution of the girls in the Signal Corps service asked for careful study and met with unqualified success.



Learn Public Speaking

10 LESSONS FREE

Write — quick — for particulars of this extraordinary offer; an opportunity you will never forget if you take advantage of it. Ten lessons in effective public speaking absolutely FREE to those who act promptly, to introduce our course in localities where it is not already known.

We teach you by mail to become a powerful and convincing speaker—to influence and dominate the decisions of one man or an audience of a thousand. We have trained hundreds and helped them to increase their earnings and their popularity. Learn, in your spare time at home, how to overcome "stage-fright" and conquer fear of others; how to enlarge your vocabulary; how to develop self-confidence and the qualities of leadership; how to RULE others by the power of your speech alone; how to train your memory. Our

WHAT THE COURSE TEACHES YOU.

- How to talk before your club or lodge;
- How to address board meetings;
- How to propose and respond to toasts;
- How to make a political speech;
- How to tell entertaining stories;
- How to make after-dinner speeches;
- How to converse interestingly;
- How to write better letters;
- How to sell more goods;
- How to train your memory;
- How to enlarge your vocabulary;
- How to develop self-confidence;
- How to acquire a winning personality;
- How to strengthen your will power and ambition;
- How to become a clear, accurate thinker;
- How to develop your power of concentration;
- How to be the master of any situation.

New Easy Method

perfected and taught only by Prof. R. E. Pattison Kline, former Dean of the Public Speaking Department of the Columbia College of Expression, can be learned in 15 minutes a day. Prof. Kline is one of the foremost authorities in the country on public speaking and mental development. Do not let this chance escape you.

Offer Limited

Send This Free Coupon Now

This Special Offer of TEN LESSONS FREE is made strictly for advertising purposes and will be withdrawn without notice. Write now, before it expires, and receive full particulars with enrollment blank by return mail. No obligations of any kind. Just tear off and mail this free coupon—or a postal will do.

FREE LESSONS COUPON

North American Institute,
7444 Manhattan Bldg., Chicago

I am interested in your course in Effective Public Speaking and your offer of ten lessons free. Please send full particulars. It is understood that this request places me under no obligation of any kind.

Learn Telegraphy-Wireless

Right In Your Own Home, in your spare time

Remarkable opportunities are offered experienced wireless operators and telegraphers. The demand is greater than the supply—steady positions at increased pay and rapid advancement are assured.



Combination Wireless-Telegraphy Outfit



will soon make you an accomplished operator. Teaches Light and Sound Signals, both Radio and Morse. Outfit consists of exceptionally fine Telegraph Key, Buzzer, 3 Binding Posts, Lamp, Lamp Socket and Control Switch—all mounted on a highly finished base. Two outfits can be operated at considerable distance apart for sending and receiving practice.

\$3.00

This Same Outfit Without Lamp **\$2.50**

Order to-day. Or your dealer can secure it for you. Descriptive circular and catalog of celebrated Knapp Motors and Electrical Specialties from 10c up mailed free on request.

Knapp Electric & Novelty Co.
523 West 51st Street New York City

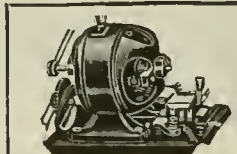

KNAPP LEADER
Radiates real power-plant efficiency. Two Speeds and Reverse.
Price, Complete, \$3.50

HOW AIRPLANES FIND THEMSELVES BY RADIO.

(Continued from page 871)

"The use of directional effects of loops or coils for receiving radio signals has resulted in the development of a radio compass for airplanes which gives positive information to the aerial navigator and enables him either to locate his position by triangulation with respect to two beacon land stations or to fly at any given angle with respect to a certain beacon station.

"The apparatus consists of two principal parts—the antenna coils and the tuning and amplifying apparatus. The antenna coils are mounted in the fuselage of the Handley Page airplane, with suitable means for rotating in azimuth. The amplifier is extremely sensitive, consisting of a detector and six-stage amplifier. A novel feature of the amplifier is the use of iron-core transformers for frequencies of 100,000 cycles.

"The direction of the beacon land radio station is determined by maximum strength of signals, in a highly ingenious manner developed originally by the British. The precision of the directional effect is remarkable. In fact, the radio direction finder may well be called a radio eye."

EXPERIMENTAL PHYSICS.

(Continued from page 867)

to send and take messages in spite of the enemy's interference by sending out impulses of similar wave length and other distributing influences. The problem of using a non-inflammable gas for inflating balloons and dirigibles has been solved under the direction of a Physicist and a Chemist, both "fool professors".

The submarine has probably attracted as much of the attention of the scientific men as all other war inventions combined, both as to its detection and its destruction. The detection of the submarine is a definite physical problem, and it is estimated that about one-fourth of the Physicists of the Allies have devoted a considerable portion of their time to solve this problem alone. The problem had been attacked from three standpoints, light, sound, magnetism and electricity, three branches which almost comprise the entire subject of Physics. The destruction of submarines has been successfully accomplished by the use of the depth bomb.

In long range artillery work, temperature, moisture, and wind are to be carefully determined; this is done by physical apparatus. Wind direction and barometric pressure information is essential in a gas attack. This information is furnished by physical apparatus. Anti-aircraft gunnery is largely indebted to physical research and calculations for its effectiveness. The speed of the airplane must be ascertained, its direction of motion, its height above the ground, the speed of the attacking shell, and its path.

The airplane camera would be almost useless were it not for our knowledge of the branch of Physics known as *spectroscopy*. Pictures can be taken which the eye cannot see because of fog, cloud, haze or distance. By the use of the proper filters, the enemies guns camouflaged so as to be indiscernible to the eye, are photographed and their positions located. The sound method of locating guns is very important. Three sounds are heard from a shell sent by the enemy. First we hear the hissing noise of the shell whizzing thru the air. Shortly afterward the boom of the gun is heard. (Since sound travels at about 1,100 feet per second and the shell's speed is greater than that). Finally we hear the sound of the exploding shell. If the time when the first of these three sounds is heard is recorded at several observing stations, from the speed of sound, and the difference in time recorded at these stations, the position of the

1/4 H.P., 110 volts, A.C. 60 cycle, single phase, 1750 R.P.M.

MOTORS



We have 1000 NEW WASHING MACHINE MOTORS. These are of standard manufacture and carry the regular factory guarantee. Shipped in original boxes. Complete as cut.

Bought from Bankruptcy Stock

Suitable for operating Coffee Grinders, Cream Separators, Bottle Washers, Air Compressors, Small Lathes, Etc.

Mail \$3.00 cash or Money Order. We will send C.O.D. subject to full examination.
MONEY BACK GUARANTEE

\$18.50 EACH

Special Quantity Prices Regular Value \$34

MANUFACTURERS' DISTRIBUTOR

CHAS. H. JOHNSTON - West End - Pittsburgh, Pa.

SAVINGS in Small Motors and Generators Write for Catalogue

YOU HAVE A BEAUTIFUL FACE

BUT YOUR NOSE?



BEFORE



AFTER



IN THIS DAY AND AGE attention to your appearance is an absolute necessity if you expect to make the most out of life. Not only should you wish to appear as attractive as possible, for your own self-satisfaction, which is alone well worth your efforts, but you will find the world in general judging you greatly, if not wholly, by your "looks," therefore it pays to "look your best" at all times.

Write today for free booklet, which tells you how to correct ill-shaped noses without cost if not satisfactory

M. TRILETY, Face Specialist

1162 Ackerman Bldg., Binghamton, N. Y.

TYPEWRITER SENSATION

PROMPT SHIPMENT.

\$4.00 per month buys a beautifully reconstructed, latest model visible typewriter, with back spacer, decimal tabulator, two-color ribbon, etc. Every late style feature and modern operating device. Sent on approval. Catalogue and special prices free.

Harry A. Smith, 738, 218 N. Wells St., Chicago, Ill.



gun firing the shell can be calculated in a few minutes.

The Bureau of Standards, at Washington, a great national Physics institution, has certainly done its share in the war. Vacuum tubes were studied in detail, from the stand-points of sending, receiving, and amplifying wireless messages, and many important improvements were evolved. High frequency oscillographic equipment was developed. The characteristics of airplane bombs were studied, resulting in new methods of computing trajectories. New types of machine gun sights were invented. Instruments for recording the speed, altitude, direction, etc., of the airplane were perfected. Special ignition apparatus for the Liberty engine was invented. A carbureter was developed which gives a correct mixture by the simple motion of a single throttle whether the airplane is on the ground or up 3,000 feet. A fabric 25 per cent. lighter but stronger than linen, extra light but strong alloys, and non-corrosive alloys were invented. These are among the best of its accomplishments which have been made known.

Now that the war is over we shall daily hear of new, marvelous and quite astounding inventions, that have been evolved and perfected. The "fool professor" has now come before the public eye and is regarded with just and long deserved admiration and respect by it. Some, like Professor Millikan, have had exciting military times, such as quieting a "buck private" under the influence of liquor, being fed delightful sandwiches by fair white hands of Red Cross and other workers, etc., while others have suffered an existence under the S. A. T. C., and those more fortunate have spent their time in France near the front; all however have done their share nobly. In closing let us bear in mind that all that has been said of Physics and the Physicist applies equally well to the other sciences and scientists.

(Conclusion)

EGGS PRODUCED BY ELECTRICITY.

The production of eggs by electricity may seem like an idea evolved in a mad-house, but it has been made a paying proposition at the Montana State College. By electric lighting of poultry pens, Professor W. F. Schoppe, poultryman of the state college, has created a sort of "daylight saving plan" for hens, whereby egg production has been increased more than twofold at a time when eggs were highest in price. In experiments covering the month of November last, Professor Schoppe showed a net gain of 28 cents per hen in value of eggs produced in ten lighted pens.

The experiment was tried on two pens of Leghorn hens, 160 in each pen. One pen was lighted with four 60-watt lamps, the other was left unlighted. The lights were turned on in one pen at 6 a. m. and switched off at 8.30 p. m. From the time the lights went on until they were dimmed at night, the hens in the lighted pen scratched away with all the energy of early spring or summer, showing a greater interest in the business of egg producing than ever.

The 160 hens in the unlighted pen produced during the month 443 eggs. The same number of hens in the lighted pen produced 1,306 eggs, a gain of 72 dozen. Hens in the lighted pen consumed little more food than their less active neighbors. The net gain was 28 cents per hen in egg production for the "electric" hens.

"I cannot say yet," said Professor Schoppe, "what effect this forced production will have on the hatching quality of eggs and upon the vitality of birds, as those are problems that will require further investigation."

(See our May, 1918 issue for full details of the automatic electric lighting in hen-houses.—EDITOR.)

**A TIMELY REINFORCEMENT.
A Copper Plated Stomach.**

(Continued from page 877)

thanks to mother and the salt fish—and the cat.

You have to begin by discarding the whole idea of sheet copper. It would be all right, and any plumber could make up a good tummy in half a day—even including going back to the shop for his tools—but for the fitting of it, or inserting, or whatever you'd call it. That's a sticker; it's what's kept the invention back all these years.

But why not plate the copper on from the inside? Sure! There it was, right off the bat!

Fig. 1 shows the invention—patents pending—all worked out—perfectly simple. You procure an atomizer, A, and attach to it a long fine rubber tube, B. This tube is surrounded by a spiral wire, C, and both are covered by high-tension insulation, K.

At the further end, both the tube and the spiral wire are connected with the perforated metallic hollow sphere, E. The atomizer-bottle, F, is filled with a solution of sulfate of copper, and the spiral wire is connected with one pole of the spark-coil secondary, H. Around the patient's waist is then buckled the belt I, containing a strip of wire netting J, connected with the other pole of the spark-coil.

All being ready, the patient "swallows" the perforated ball, E, with enough of the tube to maintain communication with the outer world. The ball is then resting nice and cozy within the tummy. Mark the patient closely; a really delightful surprise is about to be handed to him? X! Pressure on the bulb, G, projects a spray of copper sulfate from the perforations of the sphere, E, while at the same time a touch of the key, L, causes a shower of sparks to be thrown from the ball toward the metallic belt without. The sparks pass easily thru the patient's tissues, but not so the sulfate. This is decomposed by the electric current, and metallic copper is deposited on the gastric lining, forming a dense and highly polished surface, ready to tackle any food product short of Bangor red-eye and Irish confetti—brick-bats.

Perhaps you wondered why, before the operation, the patient took a few magnesia tablets, together with a peppermint "life-saver". This was to take care of the other product of the reaction, sulfuric acid—otherwise the patient might as well be fed to death as the way he is. The magnesia neutralizes the acid, producing a pleasant effervescence, which, being flavored by the peppermint, becomes the exact equivalent of an ice-cream "sody" fresh from the fountain.

So behold! at the end of the operation, when the patient finishes his cigarette and lets go the nurse's hand, there he is,—equipt with a perfectly-fitting copper stomach, enclosing a temperance-drink as a hint to guide him in the selection of future contents for it—like a new tin bank for little Willie, with a dime in it.

No, no, put aside that medal. Really I—well, if you must, you must. But I refuse to patent the idea in Germany. Absolutely. It's going to be dedicated to the free use of all free and civilized countries. "That's me all over—liberal, Mabel."

Note—The editor tried "Tom's" latest stunt. After he was dismissed from the hospital, and was at last equipt with his copper "insides", he felt pretty weak! So he promptly swallowed a few pounds of zinc dust with his next meal. The copper tummy, the gastric juice—(an excellent electrolyte)—plus the zinc dust, makes a really excellent battery. It strengthened and revived the editor at once. It works so well that he has given up all food in preference to zinc dust. A slight change in diet is had with magnesium dust—it tastes better, and gives a much higher voltage. Iron filings were tried, but they made the editor "rusty"!

BOYS



Learn Drafting

Employers everywhere are looking for skilled draftsmen. They are offering good salaries to start with splendid chances for advancement.

Drafting offers exceptional opportunities to a young man because drafting itself not only commands good pay, but it is the first step toward success in Mechanical or Structural Engineering or Architecture. And drafting is just the kind of work a boy likes to do. There is an easy delightful way in which you can learn right at home in spare time. For 27 years the International Correspondence Schools have been giving boys just the training they need for success in Drafting and more than 200 other subjects. Thousands of boys have stepped into good positions through I. C. S. help, but never were opportunities so great as now.

Let the I. C. S. help you. Choose the work you like best in the coupon, then mark and mail it. This doesn't obligate you in the least and will bring you information that may start you on a successful career. This is your chance. Don't let it slip by. Mark and mail this coupon now.

TEAR OUT HERE
**INTERNATIONAL CORRESPONDENCE SCHOOLS
BOX 6182, SCRANTON, PA.**

Explain, without obligating me, how I can qualify for the position, or in the subject, before which I mark X.

- | | |
|---|--|
| <input type="checkbox"/> MECHANICAL DRAFTING | <input type="checkbox"/> SALESMANSHIP |
| <input type="checkbox"/> STRUCTURAL DRAFTING | <input type="checkbox"/> ADVERTISING |
| <input type="checkbox"/> SHIP DRAFTING | <input type="checkbox"/> Show Card Writer |
| <input type="checkbox"/> ELECTRICAL DRAFTING | <input type="checkbox"/> Sign Painter |
| <input type="checkbox"/> ARCHITECTURAL DRAFTING | <input type="checkbox"/> ILLUSTRATING |
| <input type="checkbox"/> SHEET METAL DRAFTING | <input type="checkbox"/> Cartooning |
| <input type="checkbox"/> BOILER MAKER DRAFTING | <input type="checkbox"/> BOOKKEEPER |
| <input type="checkbox"/> BRIDGE DRAFTING | <input type="checkbox"/> Stenographer and Typist |
| <input type="checkbox"/> MACHINE DESIGN | <input type="checkbox"/> Cert. Public Accountant |
| <input type="checkbox"/> ELECTRICAL ENGINEER | <input type="checkbox"/> TRAFFIC MANAGER |
| <input type="checkbox"/> Electric Lighting and Railways | <input type="checkbox"/> Railway Accountant |
| <input type="checkbox"/> Electric Wiring | <input type="checkbox"/> GOOD ENGLISH |
| <input type="checkbox"/> Telephone Engineer | <input type="checkbox"/> Teacher |
| <input type="checkbox"/> Telephone Work | <input type="checkbox"/> Common School Subjects |
| <input type="checkbox"/> MECHANICAL ENGINEER | <input type="checkbox"/> MATHEMATICS |
| <input type="checkbox"/> Machine Shop Practice | <input type="checkbox"/> CIVIL SERVICE |
| <input type="checkbox"/> Gas Engine Operating | <input type="checkbox"/> Railway Mail Clerk |
| <input type="checkbox"/> CIVIL ENGINEER | <input type="checkbox"/> AUTOMOBILE OPERATOR |
| <input type="checkbox"/> Surveying and Mapping | <input type="checkbox"/> Auto Repairing |
| <input type="checkbox"/> STATIONARY ENGINEER | <input type="checkbox"/> PLUMBING AND HEATING |
| <input type="checkbox"/> Marine Engineer | <input type="checkbox"/> Textile Overseer or Supt. |
| <input type="checkbox"/> ARCHITECT | <input type="checkbox"/> CHEMIST |
| <input type="checkbox"/> Contractor and Builder | <input type="checkbox"/> Navigation |
| <input type="checkbox"/> Concrete Builder | <input type="checkbox"/> AGRICULTURE |
| <input type="checkbox"/> Structural Engineer | <input type="checkbox"/> Poultry Raising |
| | <input type="checkbox"/> Spanish |
| | <input type="checkbox"/> French |
| | <input type="checkbox"/> Italian |

Name _____
Present Occupation _____
Street and No. _____
City _____ State _____

Let Me train You in AVIATION



Capt. G. F. Campbell, formerly Third Ace of the Royal Flying Corps, that will interest you. Address: CAPT. GEO. F. CAMPBELL, Chief Instructor, National Aero Institute, 538 S. Dearborn St., Dept. 7441, Chicago

My advice to you is to start right now to take my **HOME COURSE IN AVIATION**

and prepare to fill one of the big jobs later. Wonderful opportunities. Trained men in big demand. Prepare now for big future. Lessons are easy to understand. Write TODAY for my FREE BOOK, "The Science of Aviation," and I will send it and write you a personal letter that will interest you. Address: CAPT. GEO. F. CAMPBELL, Chief Instructor, National Aero Institute, 538 S. Dearborn St., Dept. 7441, Chicago

INSYDE TYRES Inner Armor
for Auto Tires. Double mileage, prevent blow-outs and punctures. Easily applied in any tire. Thousands sold. Details free. Agents wanted. Amer. Accessories Co., Dept. 83, Cincinnati

JOHNSON SMITH & CO.'S
Annual Condensed
PRICE LIST
OF FINEST FLOWER,
GARDEN & VEGETABLE
All prices postpaid to any
address in the world.
Japanese Nest Egg Gourd
Calabash or Pipe Gourds

Produces fruit
 in a few
 weeks. The
 color of the
 fruit is
 green, yellow,
 orange, red,
 and white.
 Will
 keep for
 several
 months.
 A
 very
 desirable
 gift
 for
 any
 occasion.
 Price
 10c
 per
 dozen.
 Postpaid.

Butterfly's Own Bush
 This is a
 beautiful
 bush which
 attracts all
 the most
 beautiful
 butterflies.
 It is
 very
 hardy
 and
 bears
 fruit
 all
 year
 long.
 Price
 10c
 per
 dozen.
 Postpaid.

DEVIL'S CLAW
 An
 annual
 plant,
 bearing
 beautiful
 flowers
 in
 large
 quantities.
 It is
 very
 hardy
 and
 bears
 fruit
 all
 year
 long.
 Price
 10c
 per
 dozen.
 Postpaid.

Shoo Fly Plant
 A very
 remarkable
 plant,
 bearing
 beautiful
 flowers
 in
 large
 quantities.
 It is
 very
 hardy
 and
 bears
 fruit
 all
 year
 long.
 Price
 10c
 per
 dozen.
 Postpaid.

TREE OF HEAVEN
 A beautiful
 annual
 plant,
 bearing
 beautiful
 flowers
 in
 large
 quantities.
 It is
 very
 hardy
 and
 bears
 fruit
 all
 year
 long.
 Price
 10c
 per
 dozen.
 Postpaid.

PORTULACA
 A very
 remarkable
 plant,
 bearing
 beautiful
 flowers
 in
 large
 quantities.
 It is
 very
 hardy
 and
 bears
 fruit
 all
 year
 long.
 Price
 10c
 per
 dozen.
 Postpaid.

CATCHFLY PLANT
 A very
 remarkable
 plant,
 bearing
 beautiful
 flowers
 in
 large
 quantities.
 It is
 very
 hardy
 and
 bears
 fruit
 all
 year
 long.
 Price
 10c
 per
 dozen.
 Postpaid.

Japanese Nest Egg Gourd
 Calabash or Pipe Gourds

GROUND ALMONDS
 Assisted
 growth,
 early
 bearing,
 and
 large
 crop.
 Price
 10c
 per
 dozen.
 Postpaid.

Perfume Plant
 Blooms
 only
 at
 night,
 and
 the
 fragrance
 is
 very
 strong.
 Price
 10c
 per
 dozen.
 Postpaid.

Chinese Fragrant Tree Fern
 Just
 introduced,
 and
 very
 desirable.
 Price
 10c
 per
 dozen.
 Postpaid.

Tom Thumb Calliopsis
 Very
 early,
 and
 bears
 fruit
 in
 large
 quantities.
 Price
 10c
 per
 dozen.
 Postpaid.

Early Blooming Mammoth Carnations
 A
 wonderful
 variety,
 bearing
 large
 flowers
 in
 large
 quantities.
 Price
 10c
 per
 dozen.
 Postpaid.

BRUSSELS SPROUTS
 A
 very
 desirable
 variety,
 bearing
 fruit
 in
 large
 quantities.
 Price
 10c
 per
 dozen.
 Postpaid.

BALLOON VINE
 A
 very
 desirable
 variety,
 bearing
 fruit
 in
 large
 quantities.
 Price
 10c
 per
 dozen.
 Postpaid.

Giant Climbing Nasturtiums
 A
 very
 desirable
 variety,
 bearing
 fruit
 in
 large
 quantities.
 Price
 10c
 per
 dozen.
 Postpaid.

Umbrella Palm
 A
 very
 desirable
 variety,
 bearing
 fruit
 in
 large
 quantities.
 Price
 10c
 per
 dozen.
 Postpaid.

Japanese Nest Egg Gourd
 Calabash or Pipe Gourds

VINE PEACH
 One
 of
 the
 best
 of
 all
 vines,
 bearing
 fruit
 in
 large
 quantities.
 Price
 10c
 per
 dozen.
 Postpaid.

Japanese Ivy
 A
 very
 desirable
 variety,
 bearing
 fruit
 in
 large
 quantities.
 Price
 10c
 per
 dozen.
 Postpaid.

Matchless Dwarf Giant Tomato
 A
 very
 desirable
 variety,
 bearing
 fruit
 in
 large
 quantities.
 Price
 10c
 per
 dozen.
 Postpaid.

Red Cluster Pepper
 A
 very
 desirable
 variety,
 bearing
 fruit
 in
 large
 quantities.
 Price
 10c
 per
 dozen.
 Postpaid.

The Giant Spider Plant
 A
 very
 desirable
 variety,
 bearing
 fruit
 in
 large
 quantities.
 Price
 10c
 per
 dozen.
 Postpaid.

Mixed Squash Seeds
 A
 very
 desirable
 variety,
 bearing
 fruit
 in
 large
 quantities.
 Price
 10c
 per
 dozen.
 Postpaid.

White Velvet Okra
 A
 very
 desirable
 variety,
 bearing
 fruit
 in
 large
 quantities.
 Price
 10c
 per
 dozen.
 Postpaid.

New Garden Huckleberry
 A
 very
 desirable
 variety,
 bearing
 fruit
 in
 large
 quantities.
 Price
 10c
 per
 dozen.
 Postpaid.

APPLE PIE MELON
 A
 very
 desirable
 variety,
 bearing
 fruit
 in
 large
 quantities.
 Price
 10c
 per
 dozen.
 Postpaid.

Japanese Nest Egg Gourd
 Calabash or Pipe Gourds

Banana Musk Melon
 A
 very
 desirable
 variety,
 bearing
 fruit
 in
 large
 quantities.
 Price
 10c
 per
 dozen.
 Postpaid.

Giant Asparagus
 A
 very
 desirable
 variety,
 bearing
 fruit
 in
 large
 quantities.
 Price
 10c
 per
 dozen.
 Postpaid.

Chicago Pickling Cucumber
 A
 very
 desirable
 variety,
 bearing
 fruit
 in
 large
 quantities.
 Price
 10c
 per
 dozen.
 Postpaid.

Chinese Giant Pepper
 A
 very
 desirable
 variety,
 bearing
 fruit
 in
 large
 quantities.
 Price
 10c
 per
 dozen.
 Postpaid.

Garden Lemon
 A
 very
 desirable
 variety,
 bearing
 fruit
 in
 large
 quantities.
 Price
 10c
 per
 dozen.
 Postpaid.

Musk Melon
 A
 very
 desirable
 variety,
 bearing
 fruit
 in
 large
 quantities.
 Price
 10c
 per
 dozen.
 Postpaid.

Dusty Miller
 A
 very
 desirable
 variety,
 bearing
 fruit
 in
 large
 quantities.
 Price
 10c
 per
 dozen.
 Postpaid.

Snake Cucumber
 A
 very
 desirable
 variety,
 bearing
 fruit
 in
 large
 quantities.
 Price
 10c
 per
 dozen.
 Postpaid.

VEGETABLE SEEDS
 A
 very
 desirable
 variety,
 bearing
 fruit
 in
 large
 quantities.
 Price
 10c
 per
 dozen.
 Postpaid.

Japanese Nest Egg Gourd
 Calabash or Pipe Gourds

Japanese Pop Corn
 A
 very
 desirable
 variety,
 bearing
 fruit
 in
 large
 quantities.
 Price
 10c
 per
 dozen.
 Postpaid.

LUCULASSUMERSPINACH
 A
 very
 desirable
 variety,
 bearing
 fruit
 in
 large
 quantities.
 Price
 10c
 per
 dozen.
 Postpaid.

Early Chantenay Carrots
 A
 very
 desirable
 variety,
 bearing
 fruit
 in
 large
 quantities.
 Price
 10c
 per
 dozen.
 Postpaid.

Giant Pascal Celery
 A
 very
 desirable
 variety,
 bearing
 fruit
 in
 large
 quantities.
 Price
 10c
 per
 dozen.
 Postpaid.

Jerusalem Cherry
 A
 very
 desirable
 variety,
 bearing
 fruit
 in
 large
 quantities.
 Price
 10c
 per
 dozen.
 Postpaid.

Flower Seeds
 A
 very
 desirable
 variety,
 bearing
 fruit
 in
 large
 quantities.
 Price
 10c
 per
 dozen.
 Postpaid.

Flower Seeds
 A
 very
 desirable
 variety,
 bearing
 fruit
 in
 large
 quantities.
 Price
 10c
 per
 dozen.
 Postpaid.

Flower Seeds
 A
 very
 desirable
 variety,
 bearing
 fruit
 in
 large
 quantities.
 Price
 10c
 per
 dozen.
 Postpaid.

Flower Seeds
 A
 very
 desirable
 variety,
 bearing
 fruit
 in
 large
 quantities.
 Price
 10c
 per
 dozen.
 Postpaid.

Japanese Nest Egg Gourd
 Calabash or Pipe Gourds

JOHNSON SMITH & CO., Dept. E5, 3224 N. Halsted Street, CHICAGO

Bush Musk Melon
A melon, grown in small garden. The fruit is small, but very tasty. It is a very early variety, and is colored light green. It is a very early variety, and is colored light green. It is a very early variety, and is colored light green.



MIGNONETTE
Mignonette is a French plant, that typically describes this variety. It is a very early variety, and is colored light green. It is a very early variety, and is colored light green.

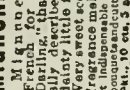

APPLE BALSAM
This is a very early variety, and is colored light green. It is a very early variety, and is colored light green. It is a very early variety, and is colored light green.



WIND FLOWER
Beautiful Irish flower, producing an abundance of large, single, semi-double flowers. It is a very early variety, and is colored light green. It is a very early variety, and is colored light green.



Japanese Morning Glory
A very early variety, and is colored light green. It is a very early variety, and is colored light green. It is a very early variety, and is colored light green.

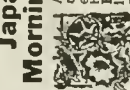

Chinese Cabbage
Novelty from China, and a good one for the garden. It is a very early variety, and is colored light green. It is a very early variety, and is colored light green.



Ever Blooming Hollyhock
Flowers in the garden, and is a very early variety, and is colored light green. It is a very early variety, and is colored light green.

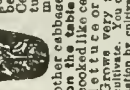

The Great Wonderberry
A beautiful berry, and is a very early variety, and is colored light green. It is a very early variety, and is colored light green.

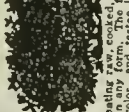

SUNBEAM GLADIOLUS
A beautiful flower, and is a very early variety, and is colored light green. It is a very early variety, and is colored light green.



CACTUS FROM SEED
A beautiful cactus, and is a very early variety, and is colored light green. It is a very early variety, and is colored light green.



PANSY-VIOLETS
A beautiful pansy, and is a very early variety, and is colored light green. It is a very early variety, and is colored light green.



Allegheny Vine or Mountain Fringe
A beautiful vine, and is a very early variety, and is colored light green. It is a very early variety, and is colored light green.

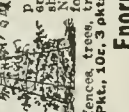

Enormous Prize-Medal Cabbage
A beautiful cabbage, and is a very early variety, and is colored light green. It is a very early variety, and is colored light green.



Butterfly Flower
A beautiful butterfly flower, and is a very early variety, and is colored light green. It is a very early variety, and is colored light green.



LOVE IN A MIST
A beautiful flower, and is a very early variety, and is colored light green. It is a very early variety, and is colored light green.



Chinese Wistaria
A beautiful wistaria, and is a very early variety, and is colored light green. It is a very early variety, and is colored light green.



LANTANA
A beautiful lantana, and is a very early variety, and is colored light green. It is a very early variety, and is colored light green.



Black Eyed Susan
A beautiful Black Eyed Susan, and is a very early variety, and is colored light green. It is a very early variety, and is colored light green.

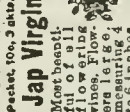

Jap Virgin's Bower
A beautiful Jap Virgin's Bower, and is a very early variety, and is colored light green. It is a very early variety, and is colored light green.



Asparagus Sprengeri
A beautiful Asparagus Sprengeri, and is a very early variety, and is colored light green. It is a very early variety, and is colored light green.

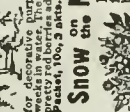

Snow on the Mountain
A beautiful Snow on the Mountain, and is a very early variety, and is colored light green. It is a very early variety, and is colored light green.



TEXAN PRIDE PILOX
A beautiful Texan Pride Pilox, and is a very early variety, and is colored light green. It is a very early variety, and is colored light green.



White Gem Feverfew
A beautiful White Gem Feverfew, and is a very early variety, and is colored light green. It is a very early variety, and is colored light green.



SCARLET SAGE
A beautiful Scarlet Sage, and is a very early variety, and is colored light green. It is a very early variety, and is colored light green.



Bachelor's Button
A beautiful Bachelor's Button, and is a very early variety, and is colored light green. It is a very early variety, and is colored light green.

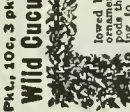

Wild Gucumber Vine
A beautiful Wild Gucumber Vine, and is a very early variety, and is colored light green. It is a very early variety, and is colored light green.



Gorgeous Giant Pansies
A beautiful Gorgeous Giant Pansies, and is a very early variety, and is colored light green. It is a very early variety, and is colored light green.



Fire on the Mountain
A beautiful Fire on the Mountain, and is a very early variety, and is colored light green. It is a very early variety, and is colored light green.



Mammoth Peanuts
A beautiful Mammoth Peanuts, and is a very early variety, and is colored light green. It is a very early variety, and is colored light green.



DAHLIA
A beautiful Dahlia, and is a very early variety, and is colored light green. It is a very early variety, and is colored light green.



SNAP DRAGON
A beautiful Snap Dragon, and is a very early variety, and is colored light green. It is a very early variety, and is colored light green.



Periwinkle or Old Maid Flower
A beautiful Periwinkle or Old Maid Flower, and is a very early variety, and is colored light green. It is a very early variety, and is colored light green.

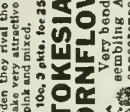

STOKESIA, or CORNFLOWER
A beautiful Stokesia, or Cornflower, and is a very early variety, and is colored light green. It is a very early variety, and is colored light green.



African Daisy
A beautiful African Daisy, and is a very early variety, and is colored light green. It is a very early variety, and is colored light green.

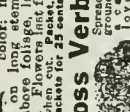

Moss Verbena
A beautiful Moss Verbena, and is a very early variety, and is colored light green. It is a very early variety, and is colored light green.

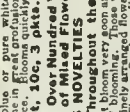

Monster Mixed Petunias
A beautiful Monster Mixed Petunias, and is a very early variety, and is colored light green. It is a very early variety, and is colored light green.

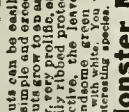

LARKSPUR
A beautiful Larkspur, and is a very early variety, and is colored light green. It is a very early variety, and is colored light green.

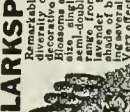

California Poppy
A beautiful California Poppy, and is a very early variety, and is colored light green. It is a very early variety, and is colored light green.



COLEUS
A beautiful Coleus, and is a very early variety, and is colored light green. It is a very early variety, and is colored light green.



Angel's Trumpet
A beautiful Angel's Trumpet, and is a very early variety, and is colored light green. It is a very early variety, and is colored light green.

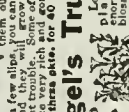

"Tiger" Flower
A beautiful "Tiger" Flower, and is a very early variety, and is colored light green. It is a very early variety, and is colored light green.



SURPRISE FLOWER GARDEN
A beautiful Surprise Flower Garden, and is a very early variety, and is colored light green. It is a very early variety, and is colored light green.

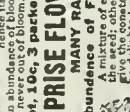

JAPANESE ROSE BUSHES
A beautiful Japanese Rose Bushes, and is a very early variety, and is colored light green. It is a very early variety, and is colored light green.

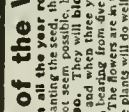

SCARLET FLAX
A beautiful Scarlet Flax, and is a very early variety, and is colored light green. It is a very early variety, and is colored light green.

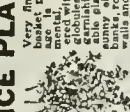

ICE PLANT
A beautiful Ice Plant, and is a very early variety, and is colored light green. It is a very early variety, and is colored light green.

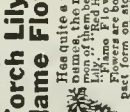

Torch Lily or Flame Flower
A beautiful Torch Lily or Flame Flower, and is a very early variety, and is colored light green. It is a very early variety, and is colored light green.



MIXED GERANIUMS
A beautiful Mixed Geraniums, and is a very early variety, and is colored light green. It is a very early variety, and is colored light green.

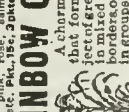

RAINBOW CORN
A beautiful Rainbow Corn, and is a very early variety, and is colored light green. It is a very early variety, and is colored light green.

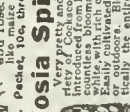

Celosia Spicata
A beautiful Celosia Spicata, and is a very early variety, and is colored light green. It is a very early variety, and is colored light green.



THE FIREFLY PLANT
A beautiful Firefly Plant, and is a very early variety, and is colored light green. It is a very early variety, and is colored light green.

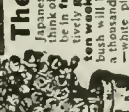

PAMPAS GRASS
A beautiful Pampas Grass, and is a very early variety, and is colored light green. It is a very early variety, and is colored light green.

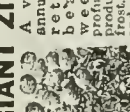

GIGANT PLANT
A beautiful Gigant Plant, and is a very early variety, and is colored light green. It is a very early variety, and is colored light green.



NICOTIANA
A beautiful Nicotiana, and is a very early variety, and is colored light green. It is a very early variety, and is colored light green.



Giant Empress Cockscomb
A beautiful Giant Empress Cockscomb, and is a very early variety, and is colored light green. It is a very early variety, and is colored light green.



THE REMARKABLE
A beautiful The Remarkable, and is a very early variety, and is colored light green. It is a very early variety, and is colored light green.



JOHNSON SMITH & CO., Dept. E.5, 3224 N. Halsted St., CHICAGO (OVER)

JOHNSON SMITH & CO., Dept. E.5, 3224 N. Halsted St., CHICAGO (OVER)

JOHNSON SMITH & CO., Dept. E.5, 3224 N. Halsted St., CHICAGO (OVER)

GREATEST TOY SENSATION OF THE DAY! FIGHTING DREADNAUGHT

Here is a model of Uncle Sam's fighting moosters. Eight big guns, each of which flashes at correct intervals...

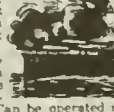

TOOTH-ACHE STOP

Signs the Pain, Stops the Tooth Squeals a bite in both of tooth; the Ache Stays in either...

"SAFETY IS" PINS

A clever safety pin. A National Safety Pin. A National Safety Pin...

INKLESS PEN

WRITES WITH WATER. Makes its own ink. Writes as fast as a fountain pen...

SIMPLEX TYPEWRITER

ONLY \$2.50. Cheap But Good. Can Use It. We Guarantee the Writing.

SOURT RING

You may have a lot of fun with this Sourting Ring. It is made of a special material...

Sneezing Place

Place a very small amount of Sneezing Place on the tip of your nose...

NEW BOOK OF ROPE SPLICING

USEFUL KNOTS, HITCHES, SPLICES, ETC. A most practical handbook giving complete and simple direction...

LUMINOUS PAINT

Make Your Watches, Clocks, Etc., Visible by Night. The very latest discovery in the scientific world...

MUSICAL KAZOO MAGIC FLUTE

With the Musical Kazoo you can, without any special practice or labor, play a wide variety of music...

All the Latest Surprising and Joke Novelties

Uncle Sam's Fighting Moosters, Tooth-Ache Stop, Safety Pins, Inkless Pen, Simplex Typewriter, Sourting Ring, Sneezing Place, Rope Splicing, Luminous Paint, Musical Kazoo Magic Flute...

Boys, you can have Movies at your own home with this latest model MOVING PICTURE MACHINE

Use Standard Films same as the larger machines. Very easily managed. Simply turn the handle. Good Variety of Films always obtainable

PRICE Complete \$2.50 Postpaid anywhere in the U.S. on 100 Feet Film

Extra Films, 15c each postpaid. THIS IS A GENUINE MOVING PICTURE MACHINE and the motion pictures are clear, sharp and distinct.

The screen up to three or four feet in area. The light is produced by a safety carbide generator, such as is used on the largest automobiles. This throws a dazzling white light on the screen.

JOHNSON SMITH & CO. Dept. E 6 3224 N. HALSTED ST., CHICAGO

ANARCHIST BOMBS

Consists of a little glass vial containing in liquid form a chemical which will produce a most horrible odor. One dropped in a room full of people will cause mere consternation...

INVISIBLE INK

The most confidential messages can be written with this ink. The writing is invisible until treated with a special solution.

MULTIPLYING BILLIARD BALLS

This trick is a favorite as a surprise. The balls are multiplied by a special device, creating a magical effect.

THE "LITTLE GIANT" TYPEWRITER

A First Class Writing Machine For \$1.25. A perfect little typewriter, compact and efficient, ideal for travel and home use.

SERPENT'S EGGS MYSTIC SKELETON

Each box contains 12 Eggs, which are no larger than a grain of dust. When lit with a match, they glow and create a mystic light.

CIGARETTE ROLLER

Very easy and handy. Makes cigarettes in a few minutes. Perfect for travel and home use.

MIDGET ILLUSTRATED BIBLE

The Smallest Bible in the World. A complete Bible in a tiny format, perfect for carrying in a pocket.

THE CONJURER'S CASKET

Apparatus and Directions for a Number of Mysterious Tricks. Enough for an Entire Evening's Entertainment. ANYONE CAN DO THEM 50c

THE NEWEST Novelty Aerial Balloon

Flies anywhere in 10 or 20 minutes. This is the VERY LATEST novelty in the world. Perfect for parties and entertainment.

LOADED CIGARETTES

Just Like Ordinary Cigarettes, but Much Better. A box containing ten apparently ordinary cigarettes, each containing a surprise.

Potmend Stops a Leak in 1 minute

The finest repeller for ironware, brassware, enamelware, etc. Good for kettles, pots, pans, boilers, and all kinds of ironware.

"The Baby" Double Action Revolver

A HANDSOME AND MOST EFFECTIVE WEAPON \$5.50



The new Baby Double Action Hammerless Revolver has been produced to meet the ever increasing demand for a revolver that would combine ample size and light weight with the essential features of Efficiency and Practicality.

THE EXPO WATCH CAMERA

The most wonderful and ingenious camera made. It is but little larger than a watch, which it closely resembles.

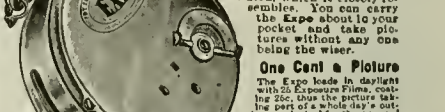

One Can't a Picture. The Expo takes in daylight with 25 Exposure Films, coating each with a special process...

QUICK AS A FLASH

Endorsed by amateurs and professionals the world over. Thoroughly practical in the pocket, it is a most desirable and important addition to any camera collection.

"YOUNG AMERICA"

Double Action Revolver. .22 and .32 CALIBRE. A GOOD POCKET GUN.

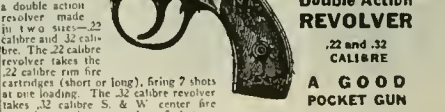

The "YOUNG AMERICA" is a double action revolver made in the United States. It is a most desirable and important addition to any camera collection.

New Vamping Card

No Teacher Needed. Bureau of Music System. Persons having neglected their Musical Education need not despair...

The Hamilton Breech-Loading Rifle

A LONG RANGE. WILL KILL UP TO 200 Yards. SMALL BORE. Accuracy of Counting Inaugures Great Penetration.

FIGHTING ROOSTERS

A full-blooded pair of fighting game cocks for sale. Perfect for entertainment and as a novelty.

LOADED CIGARETTES

Just Like Ordinary Cigarettes, but Much Better. A box containing ten apparently ordinary cigarettes, each containing a surprise.

Potmend Stops a Leak in 1 minute

The finest repeller for ironware, brassware, enamelware, etc. Good for kettles, pots, pans, boilers, and all kinds of ironware.

Potmend Stops a Leak in 1 minute

The finest repeller for ironware, brassware, enamelware, etc. Good for kettles, pots, pans, boilers, and all kinds of ironware.

JOHNSON SMITH & CO., Dept. E 6 3224 N. Halsted St., Chicago

The Alkaline Storage Battery

(Continued from page 878)

Consequently the engine would have to be operated at various rates and at all times. This is uneconomical. By using a storage battery one may arrange to run the engine at its most economical (full load) rate and thus effect a saving to offset more or less completely any loss of current resulting from the use of a storage battery between the generator and the lights. Further, the storage battery tends to improve the character (the steadiness) of the light. With a small installation where the current passes directly from the dynamo to the wires supplying current to the lights, the latter are apt to manifest undesirable fluctuations in brilliancy because of irregularities in the running of the engine. By using a storage battery, one is able to use this fluctuating current in charging and then to get an even current from the battery.

A shunt-wound dynamo is the thing to use—else, when the voltage of the battery rises too high, it may "back up" and operate the dynamo (series type) as a motor, causing considerable damage. If a compound dynamo is already installed, or if it is desired to use such a machine for charging storage batteries, it can be done simply by disconnecting the series windings on the field coils, thus converting the machine into a shunt dynamo.

The dynamo which is used to charge a battery should always have an excess voltage capacity. Thus, if we are going to use a battery of 30-32 volts rating, it is good practise to employ a 45-volt dynamo for charging. In fact, we may largely consult convenience when charging a battery, provided we use a high voltage rather than a low one. A 110-volt dynamo may be employed, at times, for charging a 30-32-volt battery, thru a suitable resistance; tho perhaps it will not be the best thing to do.

The alkaline battery with which we are concerned is made up in a variety of sizes, of which that known as "A" is quite popular for electric automobiles and trucks. A numeral used along with the letter indicates the number of positive plates used in the cell. These numbers furnish a rough gauge by means of which the comparative capacities of this type of cell may be determined. The reason underlying this is that amperage is determined by the total area of plate surface exposed to the action of the electrolyte. An A4 cell will have about half the capacity of an A8 cell, etc.

Charging.

The *positive terminal* of the battery is connected with the *positive line* of the supply current; and the *negative terminal* with the *negative line*. The positive pole of this type of cell is indicated by a *red bushing* and also by a + mark stamped in the metal of the container. A black bushing is used for the negative pole. A further means of determining the positive and negative poles is by means of the *form* of the little containers in the plates. The round tubes belong to the positive plates, and the flat pockets to the negative plates. If substantial heating is noticed at or near a cell pole during the charging operation, it is to be taken as indicative of an imperfect connection. If, however, all the connections are tight, then disconnect and determine whether there is dirt present and whether the metallic contacts are flat and rigidly clamped.

If there is any doubt as to which is the positive wire of the dynamo and which is the negative wire, the following simple test is recommended:—Connect one wire of the generator with some form of resistance. The free end of the unconnected wire of the resistance and the free end of the un-

connected wire from the generator may now be brought close together in a cup of salt water. In a moment one wire-end will begin to turn bright. Bubbles will form at this wire. This is the *negative* one. The other is, naturally, the *positive* wire.

Normal Amount of Electrolyte.

The proper amount of electrolyte is such that plates will be $\frac{1}{2}$ inch below the surface. During the charging operation the attendant evolution of gas will be likely to create a transient level. Tests for the level are to be made after the charging is all completed and the liquid has settled down. As it may not be easy to see conditions inside the cell, a good way to determine the depth of liquid over the plate tops is to use a piece of straight glass tubing with a bore of, say $\frac{3}{16}$ inch or more. Introduce one end of the tube, holding it vertical, until the bottom of the tube is on top of a plate. Then close the top of the tube with the forefinger and withdraw the whole. At the bottom will be found a column of electrolyte whose height will be the depth of liquid over the plate top. When the right amount of electrolyte is in the container, this column will measure $\frac{1}{2}$ inch. Simply a glass tube is required. No rubber cap or tube is needed in addition and the tube of an ordinary fountain-pen filler may be used. The rubber bulb is removed and the larger end of the tube is inserted into the electrolyte. The operation of charging, as already intimated, involves the production of gas. Some, at least, of this gas comes from the decomposition of water in the electrolyte into its constituent gases. These gases will naturally be lost, and the result will be a slight reduction in the total volume of the electrolyte in the container. Consequently, a very proper time to examine for height of solution is *subsequent to charging*. The remedy for this loss and any other loss due to withdrawal of water (as, for example, by natural evaporation) is the addition of pure water.

Adding Water.

When water is to be added to the contained electrolyte to bring the surface to the required height or to correct a solution that has become too strong, a special appliance—the "electric filling outfit"—may advantageously be employed. Only *distilled water* is to be used, whatever the method of introducing it. Of course, do not add water during charging, for the reason that the level can not be exactly determined at that time, as already explained. The addition of water will not, ordinarily, be required every time the battery is used. Usually, once or twice a week will be sufficient, unless the operation of the battery is very considerable. Other things being equal, water will be necessary oftener when the *constant current* method of charging is used instead of the *tapering current* method.

Two Methods of Charging.

To charge by what is known as the *constant current* method the rheostat is set a few amperes higher than the current it is proposed to deliver. The amperage will fall off as the charging goes on, but by readjusting the rheostat every 30 minutes or so to a point somewhat higher than the average desired, a fairly even flow may be maintained. To charge by what is known as the *tapering current* method, the rheostat is set a considerable amount above the desired average, say 50 per cent, and the current delivered without further adjustment. At the end it is proper that the current should be considerably below the average. An advantage of this method is the relief from attention during the charge.

LISTEN

TO ME!



Be A CERTIFICATED ELECTRICIAN

THIS IS YOUR CHANCE OF A LIFE TIME

I am Chief Engineer of the great Chicago Engineering Works. I am in close official touch with the electrical world. I know how badly we need trained electricians who can take charge of important work as experts. Right now there is such a need for executive electricians that I am making a special effort to help meet the demand. I am publishing this special announcement to secure a certain number of ambitious men whom I will personally train by mail for the wonderful opportunities that are open.

I WILL MAKE YOU a Trained Electrician

I don't care how young or old you are, just as long as you can read and write and have a spark of ambition. I don't care where you live or what you do. I don't care if you don't know a blessed thing about electricity. Just give me a little of your spare time for a short period and I'll show you the quick way to success in electricity. You can qualify to earn \$36 to \$100 a week with opportunities for greater earnings.

I Train You by Mail!

Your spare time will do. No interference with your regular duties. I understand just what you must know and I have devised a wonderful way of instructing by mail. I positively guarantee your satisfaction.

Free Wonderful Electrical Outfit

Absolutely free. Not a penny cost to you now or later. To those who act at once I will give a wonderful set of Electrical Equipment with my compliments. Write me at once. I have only a limited number of sets to be given free. Drop me a post card or letter.

Write! You will have to act quick to get in on this opportunity. Write me today for full particulars. Drop me a post card. **Write Now.**

CHIEF ENGINEER COOKE,
Chicago Engineering Works,
Dept. 524

441 Cass Street, Chicago, Illinois

Opportunity Ad-lets

YOU will find many remarkable opportunities and real bargains in these columns. It will pay you to read and investigate the offerings made every month by reliable firms, dealers and amateurs from all over the country. No matter what you may be seeking, whether supplies, automobile accessories, the opportunity to make money, or anything else, you will find listed here the best and most attractive specials of the month.

Advertisements in this section seven cents a word for each insertion. No advertisement for less than 50c accepted. Name and address must be included at the above rate. Cash should accompany all classified advertisements unless placed by an accredited advertising agency. Ten per cent discount for 6 issues, 20 per cent discount for 12 issues. Objectionable or misleading advertisements not accepted. Advertisements for the May issue must reach us not later than March 22.

The Circulation of the Experimenter is over 100,000 and climbing every month

EXPERIMENTER PUBLISHING CO., INC., 233 Fulton Street, New York, N. Y.

Automobile Accessories.

More Power, Less Fuel, No Carbon. No mystery, plain facts, results guaranteed. Write for booklet S. O. No-Leak-O Piston Ring Co., Baltimore, Md.

Fords Start Easy in Cold Weather with our new 1019 carburetors. 34 miles per gallon. Use cheapest gasoline or half kerosene. Increased power. Styles for any motor. Very slow on high. Attach it yourself. Big profits to agents. Money back guarantee. Thirty days' trial. Air-Friction Carburetor Co., 270 Madison, Dayton, Ohio.

Repair parts for all make cars, also engines. Carburetors, magnetos, bucket seats for racing cars. We also carry a large stock of slightly used tires and tubes at very lowest prices. Write for list. Haviland Supply Co., 2306 Seventh Ave., New York City.

Ford Car Repair Book sent free. This valuable, complete, well illustrated, book explains in a simple way the Causes and Cures of Overheating; Repairing Ford Timer; Curing Piston Ring Troubles; Carburetor Adjustment and Repairs; Connecting Rods; Transmission Troubles; Care and Repair of Rear Axle; Stopping Axle Grease Leaks; also covers practically every other phase of Ford Car repairing. Another feature is a chart showing exactly how much to pay for work done by repair men. Send 25c coin for three month's trial subscription and get the valuable repair book free. Ford Owners' Magazine, 417 Montgomery Bldg., Milwaukee, Wisconsin.

Simplex Belt Power Transmitter for Fords, \$12.50. Write for circular. Frank R. Weisgerber, Salina, Kans.

Agents Wanted.

Easy, Pleasant Work for mechanics, shop men, clerks, during spare hours, will add many dollars to their salaries. Also want persons who can give full time. Big wages assured. Novelty Cutlery Co., 308 Bar St., Canton, Ohio.

310 Daily refinishing chandeliers, brass beds, automobiles by new method, without capital or experience. Free particulars and proofs. Write today. Gunmetal Co., Ave. D, Decatur, Ill.

Insyde Tyres, inner armor for automobile tires, double mileage and prevent punctures and blow-outs. Quickly applied. Costs little. Demand tremendous. Profits unlimited. Details free. American Automobile Accessories Co., Dept. 54, Cincinnati, O.

American Inkless Pen—new invention. Everybody wants it. Sells \$1. Agent's sample 60c. Agents, District Managers wanted. Attractive proposition. Buckeye Distributing Co., 1822 Noble Rd., E. Cleveland, O.

Agents! Get busy sell Wax O Polish direct to car owners. Resists dust and mud. Makes the car look new and glossy. Requires no rubbing, dries instantly. Good profits given to agents. Send for sample now. Price postpaid \$1.00. Wax O Polish Co., 119 No. 1st St., Albuquerque, New Mexico.

Agents—Exciting fun flying a Yankee Aeroplane, flies like a real machine. Sample and money making plan, 25c. Yankee Mfg. Co., Milwaukee, Wis.

Make your own toothpowder and retail it. Great profits, receipt 25c. Mason's, Petaluma, Cal.

Agents—New invention puzzles world; wonderful chemical cloth; one rub over rain, snow blurred auto windshield, street car or engine window, presto! glass stays clear 24 hours; can't blur; agents making \$120 weekly. Security Mfg. Co., Dept. 106, Toledo, Ohio.

Telegraphy.

Telegraphy, Wire and Wireless, and Railway Accounting taught thoroughly. Unprecedented demand for both sexes. Big Salaries. Oldest and Largest School—Est. 45 years. Catalog free. Dodges Institute, Seventh St., Valparaiso, Ind.

Postcards.

Everything in Postcards. Live-wire list free. Worth-while samples 25c. Mention subjects preferred. Mutual Supply Co., Bradford, Pa.

Help Wanted.

Nikola Tesla Correctly Chose his life work. I can help you to choose as intelligently as he chose. Complete character reading showing what natural abilities you possess. Tried and true method based on photos and handwriting. No magic guesses. Particulars free. Lowell P. Hoyt, Presque Isle, Me.

U. S. Government Positions. Men—women. \$80 to \$135 month. Paid vacations. Short hours. Pleasant work. Common education sufficient. Write immediately for list positions now open. Franklin Institute, Dept. D26, Rochester, N. Y.

Raise White Mice, big profits let me start you. Ray Boyle, Watertown, S. Dak.

Make Die-Castings. Sketch, Sample, Booklet, and Proposition, 12c. Byrd & Blair, Box 227 F, Erie, Pa.

Motion Pictures.

Motion Picture Film for home machines 200 feet \$2.00, parcel post prepaid. Charles Gunby, 145 West 45th Street, New York.

For Sale Cheap, Motion Picture Films. Send 10c for sample and list. William Halstead, 88 Mamaroneck Ave., White Plains, N. Y.

February 24, 1919.

Mr. R. W. DeMott,
Advertising Manager,
THE ELECTRICAL EXPERIMENTER,
233 Fulton Street,
New York City, New York.

Dear Sir:

We take great pleasure in stating that our advertising in your classified department has been very successful.

To tell the truth, we have received more returns and at a lower cost than any medium that we are using.

Sincerely yours,

NATIONAL AERO INSTITUTE,
(Signed) John A. Tenney,
President.

Exchange Ads.

For Sale—Two loose coupler receiving sets, commercial type, best construction, and phones. Splendid condition. Low price. Unusual opportunity for amateur station. Call Saturday evening, 354 Convent Ave., near West 145th Street, New York City.

For Sale—Train, Camera, and other small stuff. Mahan Smith, Jefferson City, Mo.

For Sale—Telephone generators, \$1.50; Battery telephone, 75c; Electrolytic interrupter, \$2.00; \$35.00 Chemistry Laboratory, \$25.00; Brandes Superiors, \$4.25; Telephone transmitter, 50c; Audion, \$3.00; Double Barreled shot-gun, 12 gage, \$7.00; 17 jewel Waltham, silver case, \$9.00; etc. Want—Typewriter. Welton, 708 Marion, Mattoon, Ill.

\$300.00 Tent, 40 x 80, cheap, \$30.00 takes it. 4-20 ft. center poles 9 ft. wall. Also twin cylinder motorcycle engine with magneto \$10.00. V. G. Gustafson, 1492 N. Hickory St., Joliet, Ill.

Exchange—Thorough Bred Shetland Pony for 8 inch spark coil or \$125.00. Deb. Cummins, Wilmet, S. D.

Write immediately for large list of electrical and chemical apparatus. Mr. Keogh, 328 Lorel, Chicago.

For Sale—Electrical Apparatus. Send stamp for list. Alfred Embovitz, Washington Depot, Conn.

Brand new 15 dial Omniograph with 15 extra dials, \$15. Write J. F. Maurer, Jr., 682 Broadway, West New York, N. J.

Sell—Loose Coupler, \$4.00; Detector, 30c. List of Wireless apparatus 3c. Kenneth Tooker, Coshocton, O.

Will Sell or Trade a Fuller Johnson, overhauled, gasoline engine, 1 1/2 H.P. Fred Sheel, 174 Martin Street, Milwaukee, Wis.

For Sale—One 50 amps.—110-125 volts—2 wire—D. C.—Duncan Integrating Wattmeter in first class condition. J. Paternoster, 511 West 160th St., N. Y. C., Phone 9651 Audubon.

Exchange Ads.—Continued.

For Sale—Blueprints of motor windings, see add under Blueprints, etc., this issue. Charles L. Chittenden, 811 W. 18th St., Kansas City, Mo.

Wanted—Mignon Receiving Cabinet RLC 5 or RLC 6. Cash. J. H. Newton, Suffolk, Va.

For Sale—1, 2, 3, 8, 9 Hawkin's Guides, cheap. Joseph Saltry, 319 Oak St., Scranton, Pa.

Wanted—Omniograph and Records. State price and condition. J. A. Burgess, Provost, Va.

Sale—High tension magneto \$5. Austin Randall, Bradford, Me.

For Sale—Small Climax talking machine and 20 records in A1 condition for \$10.00. Also Telescope, Magazines, Electrical Apparatus. Emil Feldman, Manning, Iowa.

Sell—Omniograph No. 2 Jr. Make me an offer. Myrl Priest, St. James, Minn.

For Sale—National Automatic Telegraph Transmitter with 25 records in continental code, practically new, \$12.50. Leonard Ulstrup, Freewater, Ore.

For Sale—Complete sending and receiving set. Absolutely new. K. Jennings, Newton, Mass.

Wanted—Bound Volumes, 3 and 4 of Electrical Experimenter. Printing Outfit or Wireless Receiving Set. Everett Fritzberg, 727 Washington St., Northeast, Minneapolis, Minn.

For Sale—1 H.P. D. C. Electric motor; 1 motorcycle engine; also other things. George Conlio, 851 Columbus Ave., New York City, N. Y.

Sell—Complete Chemical Outfit, Wireless and Electrical Goods. Charles McLaughlin, Cadiz, Ohio.

For Sale—1/2 K.W. Open Core Transformer, unmounted, cost \$6.50, \$2.50; 1/4 K.W. Closed Core Transformer, \$7.50, \$4; Pancake Oscillation Transformer, \$3.75, \$2; Jove Detector, 70c; 2500 meter Loose Coupler, \$8, \$4; .22 II. & R. 7 shot revolver, \$8.50, \$5; .22 Automatic Rifle, \$17.00, \$8.50; 3000 meter home made Loose Coupler, \$5; all in fine condition. Guns' bores are perfect. Henry Cole, M-2 Box 380, Indianapolis, Ind.

Will Swap—No. 2 Folding Autographic Brownie and fishing rod and reel for wireless apparatus. Max Feldner, 1444 W. 13th St., Chicago, Ill.

Wanted—Parts type 400-500 Edison Primary Batteries. Michael Boland, Forest Avenue, Englewood, N. J.

2 K.W. Wireless Outfit. Full particulars by mail. Best offer or exchange for marine engine. W. Monroe Whaley, Maple Road, Linthicum Heights, Md.

For Sale—New 5 record Omniograph, buzzer, key, 20 records, \$15.00. Margaret Ewing, Norwichtown, Conn.

For Sale—Hytone Rotary Gap 1/2 K.W. Transformer, Pancake Type Oscillation Transformer. Unusually fine glass plate condenser NAA Coupler. All new, low price. V. Van Zandt, 1663 Winfield St., Los Angeles.

Sell—Good Remington Typewriter, \$30. C. Gillespie, 72 Woodward, Buffalo, N. Y.

For Sale—Noupareil printing press, number 22; eight fonts type and ornaments \$25. Donald Peglow, LaPorte, Ind.

For Sale—Curtiss Biplane, 3 ft. Model \$10.00. Miami bicycle \$12.00. Post card projector electric, \$4.00. Edw. Webb, New London, O.

Electrical Photographic and Chemical Apparatus, motors, fans, switches, spark plugs. Advise what you want or have for sale. H. C. Hancock, Bogota, N. J.

Exchange—\$8.00 Omniograph and dials for variable condensers or motor. W. T. Gravelly, Dauville, Va.

Sell—Twelve complete wrestling lessons, \$5.00. Harry Schulte, 2460 Buchanan St., Baltimore, Md.

For Sale—No. 5 (No. S) Omniograph worth \$7 perfect condition. **Wanted**—perfect Thordarsen 1 K.W. sending transformer, state price. Wallace Heckman, Windermere Rd., Auburndale, Mass.

Wanted—Telegraph Apparatus. Write Gowan, 343 George, Peterboro, Can.

For Sale—Audion Bulb, Tuner, Condenser and double receiving phones. Cahn, 182 Pulaski St., Brooklyn, N. Y.

For Men.

Shave Yourself? Send ten cents to Meentzen, Beaumont, Texas, for blood stopping styptic pencil.

Business Opportunities.

Victory—Mechanical Toy Soldier window attraction. 30 inches high. Salutes, turns head, points with finger, etc., as set. Well made, nicely dressed officers, privates, Uncle Sam, etc. Electrically operated. Does some stunt every half minute or oftener as set and will salute soldier and pay no attention to other if desired. Representative wanted in each city and town. Write for prices. The John M. Biggs Co., Box 324, Chattanooga, Tenn.

Dollars Yearly in Your Back Yard. No ginseng, mushroom dope. New ideas. Investigate. Particulars free. Metz, 313 East 89, New York.

Build up an Income in Oil—Others are doing it—Why not you? Today is the opportunity. Join our easy monthly payment plan NOW—it may mean hundreds in profits. Write for information. National Oil Drilling Co., Dept. K, Houston, Texas.

Incorporate your business under the common law. No organization tax; no franchise tax; no federal corporation tax; certificates not taxable; stockholders exempt from company debts; do business anywhere; directors reside where you wish; lowest cost organization possible. Common Law Organization Co., 4 Randolph, Detroit, Mich.

Patents For Sale: To buy or sell patents address Patent News-H, Washington, D. C. Only inventor's newspaper published.

Start a profitable business manufacturing "Puffed Crisp." Delicious confection. Whirlwind money-maker. Machine, instructions complete \$6.50. Samples 10 cents. Bestever Products Co., 2526—E4, Polk St., Chicago.

We will start you in the cleaning and dyeing business, little capital needed, big profits. Write for booklet, Ben-Vonde System, Dept. H, Charlotte, N. C.

Why Sell Perfumes and Toilet Goods for others! make your own; get all the profits. Particulars, Laboratory Box 1316—X— Memphis, Tenn.

Hurry: Our First Issue. Plans and specifications for building National Advertising Weather Service. Sales talk picture of finished machine, etc. Profit \$150.00 for manufacturer. Protected territory. Descriptive literature, terms and picture 25 cents. None free. National Sales Co., Box 421, Lima, Ohio.

If interested in profitable money making plan send quarter. Coffey, 104 Main St., Flushing, L. I.

"Quick-Action Advertising—How it is Building Business for the Progressive Advertisers of America"; A little story of RESULTS, told by the advertisers themselves—not the publisher. You will be interested in reading this little booklet, which we have prepared for prospective advertisers, a copy of which will be gladly mailed to you upon request. It tells you how to talk business with 1,000,000 intelligent, interested and responsive Americans every month—men who know what they want and who have the money to buy it. Write for particulars and rates today. Douglas Wakefield Cutlee, 225 West 39th Street, New York.

Enter a New Business. Earn \$3,000 to \$6,000 yearly in professional fees making and fitting a foot specialty, openings everywhere with all the trade you can attend to; easily learned by anyone at home in a few weeks, at small expense; no further capital required; no goods to buy, job hunting, soliciting or agency. Address Stephenson Laboratory, 18 Back Bay, Boston.

Make Die-Castings. Sketch, Sample, Booklet, and Proposition, 12c. R. Byrd, Box 227, Erie, Pa.

\$30.00 a week evenings. I made it with a small mail order business; continued my regular job daytime. Free Booklet tells how, 2 cents postage. Albert W. Scott, Cohoes, N. Y.

Gold and Silver Plating without costly electrical apparatus. Wonderful example of scientific achievement. Unparalleled opportunity to establish yourself in dignified lucrative business. Experience and capital unnecessary. Complete detailed instructions in both processes. One Dollar. Electrolux Plating Co., 1646 Echo Park Ave., Los Angeles.

Branch Manager Wanted for old established Chicago Concern. We furnish full stock of goods, advertising matter, and equip store completely, in good location, all at our expense and pay you \$40.00 a week salary, in addition to liberal share of the profits your store earns. Work can be started in spare time. No investment or previous experience necessary to secure this position. If you are a hustler and want an opportunity to make \$5,000 to \$15,000 a year we want you and will pay you well from the start. Send me your application today. S. Levy, Mgr., Department 784 Como Bldg., Chicago, Ill.

Experimenters: Would you like to earn \$100.00 a month in your spare time at home. Send 25 cents (Coin) for instructions. Lloyd Stultz, Middletown, Maryland.

Business Opportunities—Continued.

Make Big Money opening safes and setting combinations. Wayne Strong, P. O. Box 1430, Los Angeles, Cal.

Men, get into the wonderful tailoring agency business, big profits taking orders and your own clothes free. We furnish fine sample outfit and everything free. No experience needed; Write today! Banner Tailoring Co., Dept. 186, Chicago.

Attention manufacturers—What have you to offer for Mail Order House? Must be easy mailing. Can use large quantities. Address, Guarantee Sales Co., 468 E. 17th St., Cleveland, Ohio.

Miscellaneous.

Luminous Paint makes watches, clocks, anything visible at night, 25c bottle. Luminous Paint Co., 2426-X Polk St., Chicago.

Your Opportunity—Used correspondence courses bought and sold. Dollars saved. Write now. Enclose stamp. MacMichael Educational Bureau, Dept. 44, Victor, N. Y.

Japanese Incense produces fragrant odour. Sample 10c. Box Yama, Postal Box, 281 Sta. C., Los Angeles, Cal.

Be Healthy! Know the surest way to success. Read "Sincere Words," 1919 wonder. 20c postpaid. Success, 1943 Patten St., Philadelphia, Pa.

Cats crave catnip. Send 10c for a "catnip mouse" (a lifelike cloth mouse, stuffed with catnip). More fun than a "barrel of monkeys," and your "kitty" will like it. Address: Percy Ewing, Decatur, Ill.

You Can Be a Winner. Gain Power and Individuality and become what you wish to be, through our system of Self-Development. Practical, positive benefits. Send 10c and birth-date for interesting Personality Sketch and first lesson in Efficiency. Thomson-Heywood Co., Dept. 350, Chronicle Bldg., San Francisco, Cal.

Catch Fish. Descriptive folder containing valuable information mailed for stamp. George Julian, Albany Building, Boston.

Blacksmith, Listen! Prepare for big wages in Navy and Arsenal with Toy's Modern Methods doing hard jobs easy. Forging and making solid welds, hardening and tempering to a standard, with colored tempering charts. All for one dollar. Sample free. W. M. Toy, Sidney, Ohio.

Wanted—Small Gasoline and Steam Engines. Cash paid for 1 to 4 cylinder light weight Motors. 1/4 to 10 H.P. Johnston, West End, Pittsburgh, Pa.

Snow Plow. Removes snow from sidewalks, etc. Easy to raise or lower. Thoroughly tested. Can also be used as toy. A. H. Talley, Benson, Ill.

"Opportunity Adlets" bring quick results. Our 100,000 circulation, net. Other firms are making money—so can you. For proof address Classified Department, Electrical Experimenter, 233 Fulton St., New York City.

Wireless.

Amateur Radio will be Prohibited in Five Years unless amateurs organize for beneficial protection! Will amateurs be organized body able to protect themselves from this impending calamity? Write us for absolutely latest particulars concerning this latest question. Future amateur radio depends on you—the loyal amateur! Only a slacker will hesitate. You write immediately! American Institute of Radio Engineering. Omaha.

Complete receiving sets \$8.50, \$9.50 and up. Instruments, parts, minerals. Circular for stamp. Inquiries invited. Jenkins, 923 Purchase Street, New Bedford, Mass.

Mineral Detectors are not one hundred per cent efficient without a sterling silver catwhisker. Better than gold, 15c each. Gooding and Layton, 1604 Broome Street, Wilmington, Delaware.

DeForest Ship's Set Complete. Loose coupler, detector stand, reversing switch, variable condenser, etc., all mounted on hard rubber base and mahogany cabinet—very fine. Price \$30. W. M. Ronan, 172 Front St., New York.

Better stock up now on switches and switch points for that new set. Circular describing the most perfect on the market sent free. Eureka Secondary Co., 6939 S. May St., Chicago, Ill.

Learn Wireless Telegraphy at Home Cheap—Through home course outlined which will not exceed \$5.00 including the entire outfit. Don't waste time and money learning elsewhere. Use your spare time for this purpose. I tell you how to obtain this complete course and answer all questions free thereafter. Complete instructions and details, \$1.00. Investigate. Satisfaction guaranteed. E. Jones, 818 Roosevelt, New Orleans, La.

Switch Points, Binding Posts, Switch levers, and small parts, send 2c for catalogue describing these and other goods. A. W. Bowman & Co., 23 Church St., (Harvard Square), Cambridge, Mass.

Amateurs, Complete Set of Blue Prints and Instructions for construction of (RA6) Regenerative Receiver, amplification 100, range 180-580 meters. Easy to construct. Just revised. Price \$1.50 postpaid. Radio Research Laboratories, 2148 Fifth Avenue, Troy, New York.

Formulas.

500 Formulas, resilvering mirrors, renewing dry batteries, luminous paints, mechanics' soap, 25c, lists 2c. "Bestovall," 331-E Belleplaine, Chicago.

Chemicals.

Chemical Analysis honestly and correctly done by Leland E. Tenney, Chemist, Colton, N. Y.

If you are in need of Chemicals you will be wise if you send your orders here. We handle the Chemicals that are most rare and most difficult to obtain. Send 5c for sample price list. Ziegler Experimental Laboratory, 47 Judson Street, Rochester, N. Y.

Electrical Supplies & Appliances.

Motor Winders: See ad under blueprints, etc., this issue. Charles L. Chittenden, 811 W. 18 St., Kansas City, Mo.

One Service Station Storage Battery Generator; High tension magnetos; S. D. Motor starter; D. C. Motors 110 v.; Motorcycle engines and parts. Telephone parts of all kinds, belt, pulleys, spark coils, 2 cylinder Thor Engine carburetor and magneto complete. Going to sell dirt cheap while they last. P. A. Paul, Lewisburg, Ohio.

For Sale: 250 Penlites exact representation of fountain pens complete with 2 cell guaranteed battery only 65c each, postage 4c extra. Extra batteries 20c. Also 50 2-cell fiber tubular flashlights 90c, and 15 3-cell flashlights \$1.05. Postage 7c extra on either. J. A. McLardie, 424 Edgewater, Dayton, Ohio.

\$2.00 75-ohm double pole watch case receivers—NEW—permanent magnet type, fine for wireless, prepaid, \$1.25. Electro Sales Co., 1844 Cleveland Ave., Chicago, Ill.

Electrical Tattooing Machine and Supplies—Catalogue Stamp, Prof. Temke, Exp., 1019 Vine St., Cincinnati, Ohio.

Recharge 25 Dry Cells for Five Cents. Directions 10c. Gilbert, 28 Chestnut, Binghamton, N.Y.

All sizes of refillable fuses. Send 25c for sample plug fuse and 10 refills. State Amperage. Knoll and Palmer, 7076 Jenkins Arcade, Pittsburgh, Pa.

For Sale—Electrolytic rectifiers, glass jars, Knapp motor, 19, 21, 23, 25 and 35 D. C. magnet wire, 24 and 31 S. C. German silver wire, transformer iron, switchboard complete, miniature sockets, battery binding posts, spark gap, electric heater. J. L. Lange, 9 Roosevelt Ave., Jersey City, N. J.

For Sale—Electrical apparatus all kinds. List for purple stamp. Wm. Doty, 207 John St., Portland, Oregon.

Personal.

Are you self conscious—embarrassed in company—lacking in self control? These troubles overcome. C. E. Veritas, 1400 Broadway, New York.

Letter Specialists.

Letters That Land Orders and Money Orders—written for \$4.00; three for \$10.00. Guaranteed. Criterion Service, Dept. 3, West New York, New Jersey.

Real Estate for Sale.

Is This Your Idea of Florida? A little piece of land near the water, a boat, a garden, some strawberry plants, and perhaps a few chickens; a vine-covered cottage, pleasant neighbors; fish and oysters in abundance, plenty of quail and game—a simple, natural, wholesome life in the open the year round—Home, Health and Contentment. All this is within your reach at modest outlay in this beautiful land of sunshine and roses. We are on the Gulf and a navigable river; also on the Dixie Highway. Here we have the freedom, comfort and economy of country life, yet are only two hours by motor bus from big cities and resort centers like Tampa and St. Petersburg. Our community is new, but is one of the fastest growing in the State. Prices have not gone sky-high and living expenses are moderate. 100 Northern families already here. They like it—perhaps you will. May we send complete information? Board of Trade, Box 298, New Port Richey, Fla.

Motorcycles.

Motorcycles from \$25 up—New and second-hand. Easy terms, large list to choose from, all makes. Send 4c stamps for Bulletin "A." Peerless Motorcycle Co., Watertown, Mass.

Song Poems Wanted.

Write the Words for a Song. We write music and guarantee publisher's acceptance. Submit poems on war, love, or any subject. Chester Music Co., 538 S. Dearborn St., Suite 265, Chicago.

Continued on page 934

Patent Attorneys.

Inventions Patented. Trade-marks Registered, Labels, Prints and Publications Copyrighted, reasonable fees; correspondence solicited; detailed information free; booklets, Jaynes & Jaynes, 702 Kellogg, Washington, D. C.

Patents Procured—Trade Marks Registered—A comprehensive, experienced, prompt service for the protection and development of your ideas. Preliminary advice gladly furnished without charge. Booklet of information and form for disclosing idea free on request. Richard B. Owen, 130 Owen Bldg., Washington, D. C., or 278-T Woolworth Bldg., New York.

M. F. Miller, Ouray Building, Washington, D. C. Patent Attorney, Mechanical and Electrical Expert. Best quality of work and results. Moderate charges. Advice free.

Millions spent annually for ideas! Hundreds now wanted! Patent yours and profit! Write today for free books—tell how to protect yourself, how to invent, ideas wanted, how we help you sell, etc. American Industries, Inc., 212 Patent Dept., Washington, D. C.

John M. McLachlen, Atty. at Law, Patents, Trade Marks, Copyrights, 410 McLachlen Bldg., Washington, D. C.

Patents—My fee payable in monthly installments. Send sketch for advice. Booklet free. Frank Fuller, Washington, D. C.

Patent Your Own Inventions. Save attorney's fees; we prepare applications; furnish full instructions and give satisfaction. Free information. Carl Larsen Co., Park Row Building, New York City.

Patent Attorney, Electrical Engineer, Mechanical Expert; Thorough Personal Service. Frank Ledermann, 21 Park Row, New York.

Patents. My fee payable in installments. Full particulars return mail. John Patten Duffie, Patent Attorney, Washington, D. C.

For Inventors.

We Have A Proposition that will probably interest you. Inquiries invited. The Wakefield Engineering Co., 922C—F St., N. W., Washington, D. C.

600 Mechanical Movements, also illustrations and explanations of 50 perpetual motions. My book, *Inventors' Universal Educator*, 4th edition, tells how to procure and sell a patent for your new invention. Government and other costs. Covers the matter from A to Z. 140 pages elegantly bound. Contains noted Court decisions on Patent cases. Mechanical Movements greatly assist inventors—suggest new ideas that might prove of great aid in perfecting inventions. Tells how to select an attorney. Has valuable information regarding Patent Sharks, Selling Agents and Brokers. Price \$1. Postage free. Fred G. Dietrich, 603 Ouray Building, Washington, D. C.

Inventors. Protect your idea before exposing it. Advice free. Inventor's Patent Service, Park Row Building, New York City.

Inventions Commercialized. Cash or royalty. Adam Fisher Mfg. Co., 205 St. Louis, Mo.

Inventors join National Institute of Inventors, World Building, New York City; membership society 1,000 strong; will help protect, develop, finance and market your invention. Absolutely no charge. Write for booklet.

Patents for Sale.

Patent—Cork float oil gauge for Ford cars. Price right. L. A. Randall, Conimicut, R. I.

News Correspondents.

Earn \$25 Weekly, spare time, writing for newspapers, magazines. Experience unnecessary; details free. Press Syndicate, 566 St. Louis, Mo.

Scenery for Hire.

Collapsible Scenery for all Plays. Amelia Grain, Philadelphia, Pennsylvania.

Cameras, Supplies—Photo Developing.

Send us your next film for developing and printing. No charge unless you are satisfied with our work. The Photolo Co., 36 Garrison Road, Clarendon, Virginia.

Mail Us 15c with any size film for development and 6 velvet prints. Or send 6 negatives any size and 15c for 6 prints, 8 x 10" mounted enlargements 35c. Prompt, perfect service. Roanoke Photo Finishing Co., 255 Bell Ave., Roanoke, Va.

Camera bargain list free. Durso, Dept. 41, 25 Mulberry, N. Y. City.

Clean, Neat, Perfect Kodak Finishing at the lowest prices. Work returned the same day received. Send film for sample print and copy of Catalog on Developing, Printing, Enlarging and Hand Coloring, also copy for Photo Craft Magazine which will help you make better pictures. Photo Craft Co., Box 60, Ann Arbor, Mich.

Books.

What Every Draftsman Should Know. Very useful booklet. Price 12c postpaid. Wack Booklet Co., 1943 Patten St., Philadelphia, Pa.

Dear Reader—If Occult, New-Thought and Scientific books appeal to you, send for my catalog, it's free. I have books on Personal Magnetism, Concentration, Spiritualism, Clairvoyance, Seer-ship, Will, Mind, Hypnotism, Mesmerism, Character Reading, Healing, Mysticism, Success, Salesmanship, Mechanics, Entertainment, etc. A. W. Martens, J-49, Burlington, Iowa.

World-Romantic System, Masterkey to All Languages. Six Textbooks, \$1.44. French Chart, 37c; Spanish, 37c; Aviation Dictionary, \$1.50. French-English Aviation Dictionary, 61c. Languages, 143 West 47th, New York.

Books on Sex—Catalogue free. United Sales Co., Springfield, Ill.

Books for Real Live People. Lists free. J. E. Sheridan, 417 E. 151st, New York.

20,000 Formulas, Recipes and Trade Secrets in double-column, 530-page book, only \$1. Postpaid. Clifford Camp Co., 32 Prospect St., Claremont, N. H.

To Get Better Pictures: Read the Amateur Photographer's Weekly; illustrated; weekly prize competitions; print criticisms; many unique features; \$1.50 per year; three months' trial subscription 25c. Abel Publishing Company, 401 Caxton Bldg., Cleveland, Ohio.

Old E. E. Back Numbers: We have some valuable old E. E. back numbers on hand as follows: 1915—Jan., March, April, May, June, July, Aug., Sept., Oct., Nov., Dec., price each 35c. 1916—Jan., Feb., March, May, June, Sept., Dec., price each 35c. 1917—Jan., April, May, Aug., Nov., Dec., each 35c. 1918—Jan., Mar., 35c; 1918—May, June, July, Aug., Sept., Oct., Nov., Dec., each 20c. 1919—Jan., Feb., Mar., 20c. We can fill orders at once upon receipt of your remittance, and if you have not these numbers already, now is your chance to get them, as they probably will be snapped up very quickly. Experimenter Publishing Co., 233 Fulton St., New York City.

Sexual Knowledge—By Dr. Faulkner. Plain facts about sex matters. Over 100 pages valuable information for men and women, married or single. Price 25c, in plain wrapper. United Sales Co., Springfield, Ill.

Leading Magical Magazine. You'll like it! All magicians do! Why? The value is there. Sample 10c; three months, 25c; year \$1.00. The Eagle Magician, Dept. E, Minneapolis, Minn.

"Nature Book" facts every married and engaged person should know. 35c. Central Company, 599 Ninth Avenue, New York.

Blue Prints.

Blue Prints: 1/2 H.P. Gas Engine 30c, 1/4 H.P. Steam Engine 50c, 1/4 H.P. Boiler and Engine 70c, all 3 \$1.00. Circulars for stamp. Universal Gas Motor Co., 364 Monadnock, Chicago.

Blue Prints of Motor windings. 108 A.C. connections, 132 D.C. armature windings, complete 240 diagrams \$5.00 cash. Send 25c for 12 samples or write for particulars. Charles L. Chittenden, 811 West 18th Street, Kansas City, Mo.

Make volt and ammeters. Simple practical instruction and blue print 25c. D. R. Hansell, 238 N. Carlisle Street, Philadelphia, Pa.

Health.

Enjoy Vigorous Health. My new book "Muscular Development" tells how. Send for it today—10c. Earle Liederman, Dept. A, 203 Broadway, New York.

Tobacco or Snuff Habit Cured or no pay; \$1.00 if cured. Remedy sent on trial. Superba Co., SA, Baltimore, Md.

Pyorrhea—H. E. Kelty, D. D. S., M. D., pyorrhea specialist for 15 years, has developed a successful home treatment for pyorrhea. Purifying, healing, preventative. Full month's treatment and booklet \$1.00. Circular free. Dr. H. E. Kelty, 106 Gladwin Ave., Leonia, N. J.

Cigarette, pipe or chewing habit conquered. Nature's method. Guaranteed. Write for free brochure. Edw. J. Woods, TA-300, Station F, New York.

Stammering.

St-Stu-t-t-tering and Stammering cured at home. Instructive booklet free. Walter McDonnell, 105 Potomac Bank Building, Washington, D. C.

For the Hair.

I was Bald. Obtained hair growth by an Indian's ointment containing genuine bear oil and rare plant juices. Many others have good hair-growing results. Will send box, postpaid, with recipe, 10c. John Hart Brittain, 150 E 32nd St., BA-300. New York.

Tricks, Puzzles and Games.

Tricks, Puzzles, Jokes, Toys, Games, Novelties, Doll and Cane Racks, Plays, Wigs, Stage Supplies, Escapes and Illusions. Large 1917 catalog free. Oakes Magical Co., Dept. 549, Oshkosh, Wis.

1000 Stage Tricks with 500 illustrations. Catalogue 10c, small catalogue free. Hornmann Magic Co., Sta. 6, 170 Eighth Avenue, New York.

Black Art Hindoo Experiments, 1919 Edition, 25c. Invisible Ink. Free Trick. Catalogue each order. Linhorst Magic X Shop, St. Louis.

Ventriloquism taught almost anyone at home. Small cost. Send today 3c stamp for particulars and proof. O. A. Smith, Room R-605, 801 Bigelow Street, Peoria, Ill.

100 Kinds Wire and Steel Puzzles. Catalog and leader 10c postpaid. Western Puzzle Works, St. Paul, Minn.

Phonographs, Needles and Supplies

Build Your Own Phonographs and manufacture them for profit. Drawing instructions, Parts, Price List, Blue Prints, etc., complete, sent free upon request. Write today. Associated Phonograph Co., Dept. E-1, Cincinnati, Ohio.

Build Your Phonograph. "Perfection" high-quality spring and electric Motors, Tone Arms, Reproducers. Wonderful results. Big saving. New catalog and building instructions mailed for ten cents. Indiana Phonograph Supply Co., Indianapolis, Indiana.

Phonograph Owners: Test our wonderful, new Ring Point needles. Buy at wholesale prices and make money selling to your friends who hear how they improve tone. Scientific method, important discovery, very interesting. Single needle plays 100 records. Send 25c for samples and special offer. K. Kenyon Company, 31 Union Square, New York.

Wonderful \$75 Phonograph. 42 inches high, 12-records album, needles, \$45. Stamp. 631 Newhall, Milwaukee, Wis.

Motors, Engines and Dynamos.

Small Motors and Generators: 1000 New Motors and Generators from Bankruptcy Stock, 1/2 H. P. A. C., \$18.50 each; 1/2 H. P., \$30.00. Battery Charging Sets—Robbins & Myers new outfits, all sizes, \$30.00 each and up. Charging, Lighting and Moving Picture Arc Generators, \$10.00 each and up. Motors for all phases of current. Immediate delivery. Less than 1/2 regular prices. Write for late bulletin. Johnston, West End, Pittsburgh, Penna.

For Sale—The following 60 cycles, single-phase motors, 1800 r.p.m., new. 24-1/2-110 volts, 3/2 h.p., 220 volts, 2 3/4 h.p. 220 volts, 2-1 h.p. 220 volts, 1-1/2 h.p. 220 volts, 2-2 h.p. 220 volts. Electric Machinery Equipment Co., 714 W. Van Buren St., Chicago.

Wanted for Cash—Marine, rowboat, stationary, automobile, motorcycle engines or bicycle attachment motors. State condition, price, etc. Write, A. J. Temps, 305 Broadway, New York City.

Printing.

100 Bond Noteheads, 4 lines and 100 envelopes, prepaid, \$1.00. Southwestern, 1413-H Berendo, Los Angeles.

100 Engraved Style Visiting Cards 50c; 100 Emblem Cards 70c. H. Gregory, Warwick, N. Y.

Stamps and Coins.

500 Finely Mixed United States or Foreign Stamps, 12c. Philatelic Star, Madison, N. Y.

California Gold, Quarter size, 27c; Half-dollar size, 53c; Dollar size, \$1.10; Large cent, 1820, and catalogue, 10c. Norman Shultz, Kings City, Mo.

Stamps—61 all different free. Postage, 3c. Mention paper. Quaker Stamp Co., Toledo, Ohio.

Free—Packet Valuable Stamps to applicants 50% approvals. Benj. Forbes, 160 Devilliers, Pittsburgh, Pa.

Free packet of stamps to approval applicants. Laskaris, Union City, Pa.

Stamps 100 different, 8c; 200, 23c. Approvals. Michaels, 5600 Prairie, Chicago.

Acme Stamp Co.—Send stamp for pocket list. 494 12th St., Brooklyn, N. Y.

For Advertisers.

"Quick-Action Advertising—How it is Building Business for the Progressive Advertisers of America"; A little story of results told by the advertisers themselves—not the publisher. You will be interested in reading this little booklet which we have prepared for prospective advertisers, a copy of which will be gladly mailed to you upon request. It tells you how to talk business with 1,000,000 intelligent, interested and responsive Americans every month—men who know what they want and who have the money to buy it. Write for particulars and rates today. Douglas Wakefield Cutlee, 225 West 39th St., New York.

SKINDERVIKEN TRANSMITTER BUTTON

\$1⁰⁰
ppd.

YOU can easily make a highly sensitive detectophone by using a Skinderviken Transmitter Button to collect the sound waves.

You can build your own outfit without buying expensive equipment. Think of the fun you would have with such an instrument! It's very simple, too, and inexpensive.

You can install an outfit in your home and hear the conversation being held all over the house. You can connect up different rooms of a hotel. *Our outfit was used by secret service operatives during the War. It is being used on the stage. So much for its commercial adaptations! You can procure apparatus of the same type.*

One of the main advantages of the Skinderviken Transmitter Button lies in its ultra-sensitiveness. You can place it in any position you like. It is the greatest invention in micro-phones and has won recommendations from men of high standing in the scientific world. It is being used all over the world. You can mount it most anywhere. In figures 3, 4 and 5 are shown some unusual and practical methods. Card board boxes, stove pipes, stiff calendars and hundreds of other places will suggest themselves to you. The buttons cannot be seen by any one in the room as they are so small and light. Only a small brass nut is exposed to the view.



Fig. 4

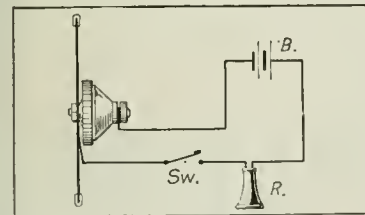

Fig. 1
Transmitter Button mounted on Diaphragm. Simplest circuit.

Full directions for connecting up the button for use as a detectophone are given in booklet No. 4 which is sent with each button. Figures 1 and 2 of this advertisement, two of the many illustrations in booklet No. 4, show the circuit connections of the detectophone.

The only instruments needed to complete a detectophone outfit, in addition to a Skinderviken Transmitter Button are a receiver, battery, and, if desired, an induction coil.



Actual size.



Fig. 3



Fig. 6

BARGAINS

These prices are very low

All equipment is GUARANTEED. The apparatus is the same as sold by us to large telephone companies. 110 volt telephone generators.

3 bar	\$1.75	Weight 6½ lbs.
4 bar	2.25	" 8 lbs.
5 bar	2.75	" 10 lbs.
Ringers 80 ohm...	.35	" 1 lb.
" 1000 ohm...	.75	" 1 lb.
Silk cords, 6 ft. 3 cond.	.20	" 3 oz.
" " 6 ft. 4 cond.	.20	" 3 oz.
" " 3 ft. 2 cond.	.10	" 1 oz.

Transmitters complete with
Steco transmitter button.....\$1.50 12 oz.
Induction coils35 6 oz.

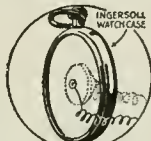

Fig. 5



Fig. 8

The same circuit connections apply to all experiments, regardless of how the transmitter button is mounted.

The Skinderviken Transmitter Button operates on one or two dry cells. It often happens that two cells produce too much current and the sounds are deafening. We recommend either one fresh cell or two worn out cells.

We have the utmost faith in our transmitter button. We guarantee satisfactory service or we will refund the purchase price. Boys — Young and old — send in a dollar bill RIGHT NOW! You can't lose. If you're not satisfied, you receive your dollar back. Isn't that fair?

Send a 3c stamp for a copy of Booklet No. 4.

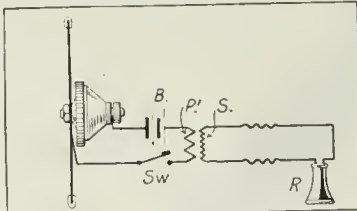

Fig. 2

Transmitter Button mounted the same but with Induction Coil.

AMONG electrical experimenters the button has created a sensation. It is not uncommon to receive unsolicited letters like these: "I received transmitter button today and I wish to inform you that it works great and is the best I have ever seen or heard of for the price. I will certainly recommend it to my friends. I wish to thank you for your good service."

\$1⁰⁰
ppd.

"I have been using one of your transmitter buttons, and it has proved to be worth more than its value in my experimenting." "I received one (Transmitter Button) some time ago, and they are just O. K. for experimental work and it certainly lives up to all you say for it and then some."

Mr. H. Gernsback, editor of this



Fig. 7

magazine, who is the dean of electrical experimenters, said: "In writer's opinion, obtained by actual elaborate tests, your Transmitter Button is probably most efficient device of its kind on market today, due to its simplicity and other outstanding features. Should have a great future."

Figures 6, 7 and 8 suggest some very interesting experiments. That of reproducing music at a point far removed from the phonograph is very popular with experimenters. The Skinderviken Transmitter Button is mounted in a very small hole in the under side of the sound arm. (Note: This hole will not injure the quality of the music.) When the phonograph is being played, the sounds produced are transformed by the Skinderviken Transmitter Button into a varying electrical current. The receiver, which is located in another room, reproduces the music at that point.

Figures 7 and 8 illustrate the methods of transmitting sound by means of the vibrations in a body while speaking. Speech will be reproduced by the receiver just the same as if the experimenter had spoken into a transmitter. In these experiments the Skinderviken Transmitter Button is mounted on a small iron disc.

USE THIS COUPON

STECO, 2134 North Clark St., Chicago, Illinois.
Gentlemen:—Please enter an order for

- Skinderviken transmitter buttons.....@ \$1.00 prepaid
- 110 volt generators.....bars.....@ Wt.....lbs.
- Ringers.....ohms@ Wt.....lbs.
- Cords.....conductor.....ft.@ Wt.....lbs.
- Induction coils@ .35 Wt.....lbs.
- Transmitters with T. Button.....@ 1.50 Wt.....lbs.

(Use Pencil) Enclose sufficient postage for mailing.

E. E. 4-19

Ship to.....
.....
.....
Send Booklet No. 4. []

FREE TO YOU!

Read this Remarkable Offer!



OFFER No. 1
Wireless Course
The most comprehensive Wireless Course ever printed. Contains 160 pages, 350 illustrations. Size of book 6 3/4"x10". Very fine flexible cloth cover.
• **FREE** with a year's subscription.
Add 5c for postage

OFFER No. 2
Experimental Electricity Course
This masterpiece contains 160 pages, 400 illustrations. Size of book 5"x9". Printed on extra thin paper, so book can be slipped into pocket. Handsome flexible cloth cover.
FREE with a year's subscription. Add 5c postage

OFFER No. 3
How to Make Wireless Sending Apparatus
By 20 Radio Experts
How to Make Wireless Receiving Apparatus
By 20 Radio Constructors
These books are by far the most successful wireless books on the market. Size of each book 5"x7", well bound on good book paper. Covers in two colors. We really cannot praise these books too highly. Each book contains 100 pages and from 88 to 90 illustrations. **BOTH** books **FREE** with a year's subscription. Add 5c for postage

This is a very limited offer. It may be withdrawn at any time, due to the tremendous cost of paper, which IS JUST DOUBLE WHAT IT WAS ONE YEAR AGO. We have only a limited supply of these fine books on hand; after they are gone we cannot reprint the books until conditions become normal again. **Now is your chance.**

The publishers of this journal have earned an enviable reputation of giving more than 100 cents' worth for each dollar spent with them. Profit by this liberal opportunity **NOW**; it may never be made again.

HERE'S THE OFFER

Subscribe to the **ELECTRICAL EXPERIMENTER** for one year, at the regular subscription price of \$2.00 per year (Canada, foreign and N. Y. C. \$2.50) and we will send you either books shown in one of the above offers. If you subscribe for two years, two offers will be given, etc.

If you are a subscriber at present take advantage of this wonderful opportunity anyway. If you do, we will extend your present subscription.

This Offer Limited.

Act Now.

EXPERIMENTER PUB. CO.
223 FULTON STREET
NEW YORK CITY

FILL IN
TEAR OUT
AND MAIL

Gentlemen:
Please enter my subscription to the **ELECTRICAL EXPERIMENTER** for the term of year, for which I enclose herewith \$..... You will also send me at once **FREE** your book,..... as per offer No.....

.....
Name.....
Address.....

You benefit by mentioning the "Electrical Experimenter" when writing to advertisers.



Every Electrical Man Wants These Books and we ship them for your inspection **FREE**

Flexible
Covers
—
Handy
Pocket-
Size
Volumes



10
Volumes
3500
Pages
4700
Pictures
\$1 Per
Volume
\$1 Per
Month

Just what you need to know to succeed in ELECTRICITY

EVERY electrician, every engineer, every mechanic should know about these wonderfully helpful instructive books, which give in plain words a complete working knowledge of electrical engineering in all its phases.

You run into some new electrical problem almost every day. The information you need to help you in your every day work is in

HAWKINS ELECTRICAL GUIDES

These books place electricity at your finger ends. They cover every imaginable subject, principle, theory, problem, trouble, and way of doing things electrically. Every subject is indexed so that you can turn right to it. They are a study course and a reference guide in one, written in plain every day language—no wasted words—only what you need to know—chock full of up-to-the-minute electrical knowledge. The guides are a complete course in electrical engineering. They will help you in every detail of the day's electrical work. You can't ask an electrical question that Hawkins Guides can't answer.

Pocket-Size Flexible Covers

The books are small enough to slip into your coat pocket—handsomely bound in flexible black covers. You can carry each volume with you until you have mastered its contents. 3,500 pages of actual information and 4,700 illustrations. Once you see these books and put them into actual use you will never again want to be without them. Try it at our expense.

SEND NO MONEY

It will cost you nothing to receive these books—to look them over—ask them all the questions you can think of—use them in your work—study them—pick up some information that will increase your earning ability. We will ship you the entire set of 10 volumes entirely FREE. This is a sign of our confidence in the guides. Pure gold does not object to being tested. Keep them for seven days and if you do not decide that you can't get along without them, return them to us and owe us nothing.

When you decide to keep them you only have to pay \$1.00 down and remit the balance of \$9.00 on the easy payment of \$1.00 a month till paid for. Use this coupon to get the books. It will pay you many times over.

THEO. AUDEL & CO.
72 Fifth Ave. New York, N. Y.

SEND NO MONEY—USE THE COUPON

READ THIS PARTIAL LIST OF CONTENTS

No. 1 Contains 343 pages, 388 illustrations. Electrical signs and symbols—static and current electricity—primary cells—conductors and insulators—resistance and conductivity—magnetism—induction coils—dynamo principles—classes of dynamos—armatures—windings—commutation—brushes, etc.

No. 2 Contains 348 pages, 394 illustrations. Motor principles—armature reaction—motor starting—calculations—brake horsepower—selection and installation of dynamo and motors—galvanometers—standard cells—current measurement—resistance measurement—voltmeters—wattmeters—watt hour meters—operation of dynamos—operation of motors, etc.

No. 3 Contains 300 pages, 423 illustrations. Distribution systems—wires and wire calculations—inside, outside and underground wiring—sign flashers—lightning protection—recifiers—storage battery systems, etc.

No. 4 Contains 270 pages, 379 illustrations. Alternating current principles—alternating current diagrams—the power factor—alternator principles—alternator construction—windings, etc.

No. 5 Contains 320 pages, 614 illustrations. A. C. Motors synchronous and induction motor principles—A. C. commutator motors—induction motors, transformers: losses, construction, connections, tests—converters—rectifiers, etc.

No. 6 Contains 298 pages, 472 illustrations. Alternating current systems—switching devices—circuit breakers—relays—lightning protector apparatus—regulating devices—synchronous condensers—indicating devices—meters—power factor indicators—wave form measurement—switch boards, etc.

No. 7 Contains 316 pages, 379 illustrations. Alternating current, wiring power stations—turbines: management, selection, location, erection, testing, running, care and repair—telephones, etc.

No. 8 Contains 332 pages, 436 illustrations. Telegraph—simultaneous telegraphy and telephony—wireless—electric bells—electric lighting—photometry, etc.

No. 9 Contains 322 pages, 627 illustrations. Electric railways—electric locomotives—car lighting—trolley car operation—miscellaneous applications—motion pictures—gas engine ignition—automobile self-starters and lighting systems, electric vehicles, etc.

No. 10 Contains 513 pages, 599 illustrations. Elevators—cranes—pumps—air compressors—electric heating—electric welding—soldering and brazing—industrial electrolysis—electro plating—electro-therapeutic—X-rays, etc.

Also a complete 126-page ready reference index of the complete library. This index has been planned to render easily accessible all the vast information contained in the 10 electrical guides.

There are over 13,500 cross references. You find what you want to know instantly.

THEO. AUDEL & CO.
72 Fifth Avenue
New York, N. Y.

Please submit me for examination Hawkins Electrical Guides (price \$1 each). Ship at once, prepaid, the 10 numbers. If satisfactory I agree to send you \$1 within seven days and to further mail you \$1 each month until paid.

Signature

Occupation

Business Address

Residence

Reference E. E. Apr.

What Electrical Men Say Helped Him Make Good

"It is only right for me to recommend highly the Hawkins Guides, for they have been of the greatest assistance to me in placing me in my present position as Superintendent of Construction Department of one of Ohio's largest Electrical Companies. I would like to see every man have a set of Hawkins Guides."

Geo. Knecht, Columbus, Ohio.

In the Naval Electrical Dept.

"The Hawkins Guides are great help to me in the Naval Electrical Department, which they cover very thoroughly."

C. J. Cornell,
U. S. Receiving Ship, Brooklyn, N. Y.

Superintendent

"I am now superintendent of the Dunnville Hydro-Electric Systems, and Hawkins Guides were a great help to me in holding down a responsible position."

W. E. Swartz, Dunnville, Ontario.

Wireless Operators

"I have worked wireless for ten years—but I wish I had these books years ago, as they have saved me a great deal of trouble."

H. Marshall,
Steamer M. & B. No. 2,
Walkerville, Ont.

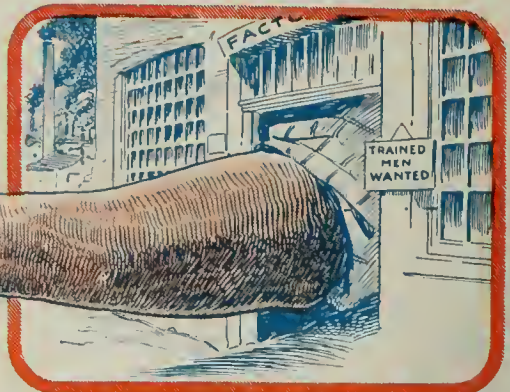

Coming! A World Era of Opportunity for Trained Electrical School Graduates!



One of the Lecture Rooms.



Motor Generator Testing Department.



Drafting Department.

Do you realize that this country, and practically all of the civilized world as well, is today facing a period of unparalleled demand for electrical engineers and trained electrical school graduates? Has it occurred to you that thousands upon thousands of engineers and electrical men are going to be needed soon, both here and abroad, to rebuild Europe's industries and restore her war-shattered commercial life? Have you heard what President Wilson says about after-the-war engineering? "It is of first consequence to the country that there be an adequate supply of engineers for the period of reconstruction which must follow the war."—Woodrow Wilson.

Prepare Now for This Extraordinary Opportunity—Learn the Electrical Profession as it Is Taught in America's Most Practical Electrical Institute.

Whether you take up Electrical Engineering, Expert Electrical Technique, or one of the Electrical Trades, your course in this school will be a complete, practical training for a definite kind of position. Under this institution's combined shop, drafting-room and recitation-room curriculum—with our high grade faculty of practical engineers, with our large splendidly-equipped shops and laboratories in which students learn to know electrical apparatus by actual, daily contact—an "S. O. E." Diploma has become a known badge of merit in the electrical industry.

Earn While You Learn

Mail this coupon for full details of this school's splendid part-time employment plan, which enables students, to earn living expenses while pursuing studies.

WHY NOT CLIP THIS COUPON RIGHT NOW?

-----TEAR OUT HERE-----

SCHOOL OF ENGINEERING OF MILWAUKEE

83-373 Broadway, Milwaukee, Wis.

Tell me all about your "Earn-While-You-Learn" plan, and your

- Electrical Engineering Course—3 years
- Electrical Technician Course 1½ to 3 yrs.
- 1-year General Electrical Course
- Six Months Trade Courses
- Students' Reserve Officers' Training Corps

Name.....

Address.....

City.....State.....

Age.....Education

B. S. Degree in 3 Years—Electrical Technician Diploma 1½ to 3 Years—Six Months' and One-Year Electrical Trade Courses.

Recognized "Bachelor of Science" degree given graduates of the Electrical Engineering Department, under laws of Wisconsin, in 3 years. Electrical Technician diploma given in 1½ to 3 years, according to whether student is only Grammar School graduate, or has some High School credits. (Diploma qualifies student for expert technical positions, such as Government Technician, Electro-Mechanical Draftsman, Power Plant Superintendent, Technical Salesman of Electro-Motive Power Installations, etc.) 1-year and 6-months' Trade Courses qualify students as Draftsmen, Linemen, Metermen, Motor Repairmen, Wiremen, Telephone Trouble and Repairmen, Armature Winders.

Two Reserve Officers' Training Corps Units Just Authorized in This School by United States Government.

The War Department has just authorized Junior and Senior R.O.T.C. units in this school. Students joining one of these units will be issued free uniforms and given a free six weeks' summer training camp trip each year. Members of Junior or Signal Corps Unit will receive free instruction in Wireless Telegraphy. And after a period of 2 years' enrollment, all R.O.T.C. students recommended for same will receive a Government allowance of \$12.00 per month. Requires 3 hours' military training per week. Membership cancelled on leaving school. Mail coupon for full particulars. New Term every 3 months.

SCHOOL OF ENGINEERING OF MILWAUKEE

You benefit by mentioning the "Electrical Experimenter" when writing to advertisers.