

R
700
54
5
1-12

OCTOBER, 1917

NOTICE TO READER—When you finish reading this magazine place a 1-cent stamp on this notice, hand same to any postal employee and it will be placed in the hands of our soldiers or sailors at the front.
NO WRAPPING—NO ADDRESS
A. S. BURLESON, Postmaster General.

15 CENTS

The Electrical Experimenter

POPULAR ELECTRICAL NEWS ILLUSTRATED

FIRING ELECTRIC BOMBS

SEE PAGE 370



☆ LARGEST CIRCULATION OF ANY ELECTRICAL PUBLICATION

MEN WANTED AS CERTIFICATED ELECTRICIANS

This is the Electrical Age, and this wonderful new profession is calling you. The demand for expert Electricians is greater every year and the salaries higher. Electricity is truly the greatest motive power in the world, to-day, and now is the time to enter this profession.

YOU CAN DO THIS



AFTER HOME STUDY \$36⁰⁰ TO \$100⁰⁰ A WEEK

You can earn \$36 to \$100 a week and more as an Expert Electrician. If you have a common school education I can train you in a few months at home. Big lighting and power companies, municipalities, and manufacturers are always seeking trained men to handle their Electrical problems.

I Guarantee Satisfaction

Every student receives our Sealed Guarantee Bond, which guarantees to return every penny of his money if he is not entirely satisfied. No other school has made this wonderful offer, but I know the success I have brought to hundreds of my students, and I know what I can do for any ambitious young man who will give me a little of his spare time each day.

FREE ELECTRICAL OUTFIT

MAIL THIS COUPON

Dept. 11
CHIEF ENGINEER, Chicago Engineering Works,
439 Cass St., Chicago, Illinois.

Without obligation on my part kindly send me completely prepaid, particulars of your complete Practical Home Study Course in Electricity.

Name

Address

Town State

For the next 30 days I am giving each student an Outfit of Electrical Testing Instruments, Tools, Electrical materials, and Motor absolutely Free. My instruction is by practical methods and this outfit is used in working out the lessons. Practical training with the theory makes perfect. I am Chief Engineer of the Chicago Engineering Works, and I can give you the training that will land the big jobs and hold them.

If you are in real earnest I want to send you my new Book—"How to Become an Electrical Expert." It's free. No matter how many other schools you write to I want you to have my book. It's different because it's practical—Write today.

CHIEF ENGINEER COOKE

CHICAGO ENGINEERING WORKS
Dept. 41 :: 439 CASS STREET, CHICAGO, ILL.

What's back of YOU?

SOONER or later you will be standing in front of the mahogany desk. The big man reclining in his office chair will gaze earnestly at you while his keen gray eyes "take you in."

When this big moment comes, can you make good? Will you "come through"? Will you be just another one of the million "little fish" trying hard to land a small job at \$15.00 a week, or will you be one of the men that DO things, at a salary running into four figures?

Suppose the man behind the desk bombards you with questions, such as these: "Can you wire a switchboard? Can you lay out a 500 light power installation on the drafting board? Can you rewind a 10 H. P. Direct Current dynamo armature? Can you plan and install a private telephone installation and 75 phones in a new factory?"

Will you withstand such a bombardment?

No, Sir. Not if you have no actual experience in back of you?

WHAT'S BACK OF YOU? Just a little personal dabbling in your attic at home, a few books and some magazines? Or have you actually done these things yourself with your own hands, in a place where such things are done every day? The keen eyed man behind the desk will know in less than a minute. You cannot bluff him. HE knows. He wants an expert, not a dabbler. It's experience that counts today. It's experience that brings the big coin.

Learn by Doing

The only way you can become an expert is by doing the very work under competent instructors, which you will be called upon to do later on. In other words, *learn by doing*. That is the method of the New York Electrical School.

Our concentrated work with actual apparatus under actual conditions will put you abreast of men with from 5 to 10 years' experience in the electrical field. 4,500 of our students have gone forth into electrical success.

LEARN BY DOING. This method makes you an expert, able to command a high salary. All instruction is individual. You go ahead as fast as you can learn. Good students complete the course in seven months. Send today for FREE 64-page book.

Use the handy coupon below and send it today. You will never regret it.

School open to visitors from 9 A. M. to 9 P. M.

"Yes, Sir, It's Experts We Want - - - When Can You Start?"

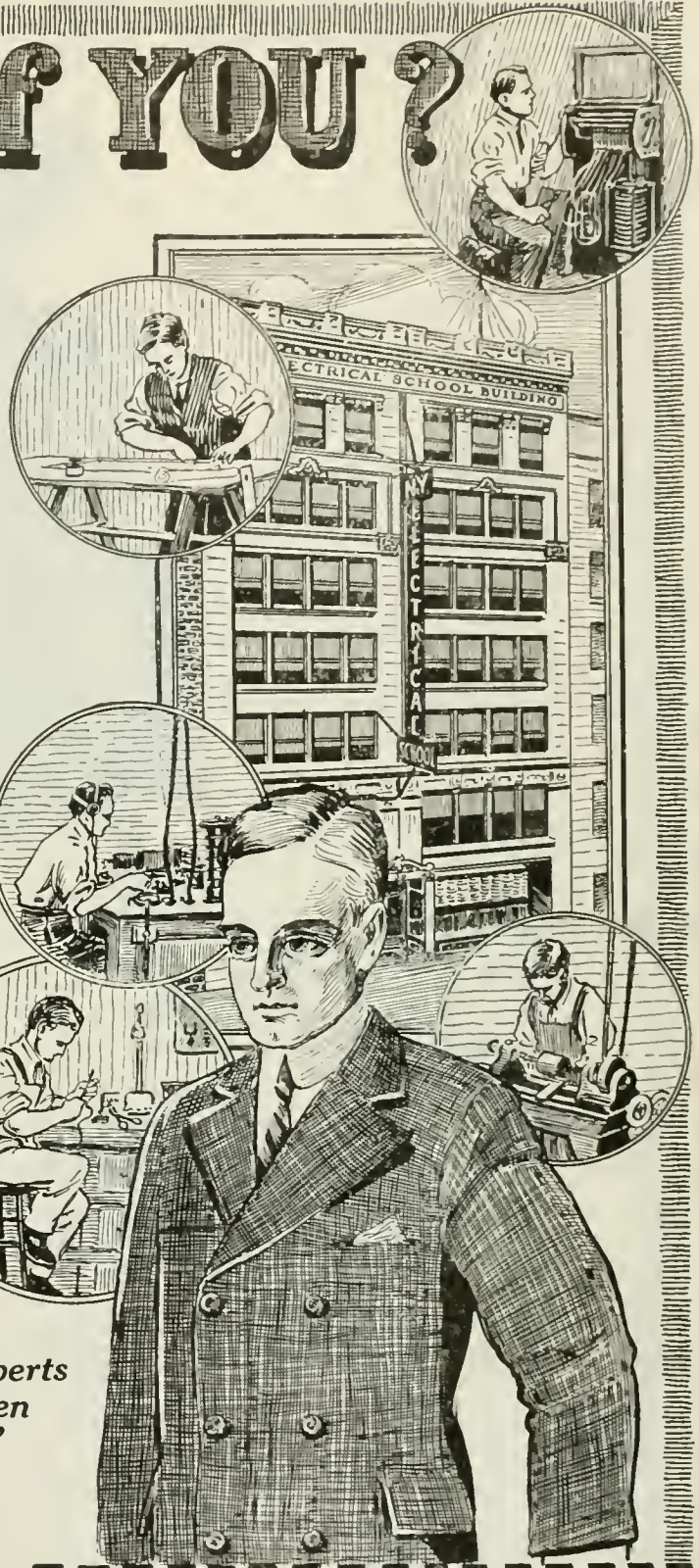

NEW YORK ELECTRICAL SCHOOL

29 W. 17th St., New York, N. Y.

Please send FREE and without obligation to me your 64-page book.

NAME

ADDRESS



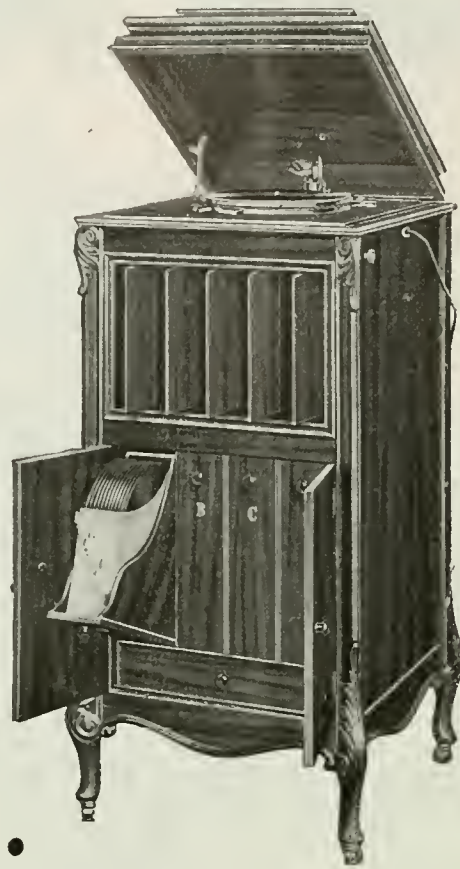

Columbia Electric
Grafonola 225 E
Price \$225.



Cabinet of mahogany, satin wanut, or quartered oak in all finishes, measuring 49¾ inches high on castors, and 22½ x 24 inches. All exposed metal parts heavily plated in 18 karat gold. Drop-tray record cradles to hold 60 records.

Electric

Columbia Grafonolas at \$125, \$135, \$175, and \$225

THE Columbia Electric Grafonola 125 E is equipped with an electric motor that is a marvel of accuracy and precision. It operates perfectly on any standard current, whether direct or alternating, and can be attached to any socket—Price \$125. Same model equipped with Columbia Individual Record Ejector—Price \$135.

The Columbia Electric Grafonola 175 E is designed to give satisfaction under any and all conditions. It provides the highest possible tone-quality and every refinement of mechanism, form and finish to correspond. Price \$175.

With its electrical and mechanical improvements, the Columbia Electric Grafonola 225 E is an instrument embodying the most perfect reproducing qualities and refinement and one that will be as well a harmonious part of the best appointed music rooms. The motor, a marvel of silence and smoothness, holds the tone absolutely *true*. Price \$225.

The Electrical Experimenter

233 FULTON STREET, NEW YORK

Publish by Experimenter Publishing Company, Inc. (H. Gernsback, President; S. Gernsback, Treasurer;) 233 Fulton Street, New York

Vol. V Whole No. 54

OCTOBER, 1917

No. 6

FIRING ELECTRIC BOMBS.....	Front Cover
From a painting by George Wall	
HOW LORD NORTHCLIFFE HEARD TWO OCEANS AT THE	
SAME TIME.....	365
ELECTRIC "ZIG-ZAGGER" AIDS SHIPS TO FOIL U-BOATS....	367
"ZIG-ZAG"—A NEW THRILLER FOR THE SEASHORE.....	
By George Holmes.....	369
FIRING BOMBS BY ELECTRICITY.....	By H. Gernsback 370
"BURNELL R. FORD" SCIENTIST—ELECTRICAL WIZARD"....	371
FREE ELECTRICITY FROM THE WIND.....	
By H. Winfield Secor, E.E.....	372
NEW ELECTRO-THERAPEUTIC APPARATUS.....	
By H. Rosenthal.....	373
BRANDING ORANGES BY ELECTRICITY.....	By Harold J. Wood 375
UNIQUE REVOLVING DANCING FLOOR.....	376
ARE THERE CURRENTS ABOUT A MAGNET?—PART II.....	
By F. F. Mace.....	380
NEW PORTABLE ELECTRIC LAMP FOR MINERS.....	
By F. T. Forster.....	382
THE EFFECT OF ULTRA-VIOLET RAYS ON MILK AND OTHER	
ASPECTS.....	By Dr. Humbert Bizzoni 383
SOME ELECTRICAL PROPERTIES OF SILVER SULFIDE.....	
By George W. Vinal.....	385
EXPERIMENTAL PHYSICS—LESSON 8—LIGHT.....	
By John J. Furia, A.B., M.A.....	386

RADIO-CONTROLLED TORPEDO DEvised BY CALIFORNIA	
GENIUS.....	By C. W. Geiger 387
THE AMATEUR'S OPPORTUNITY.....	By the Editor 389
A RADIO-CONTROLLED MODEL BOAT.....	
By H. C. Van Benthuysen and Max T. Black.....	390
MEASUREMENTS OF RADIO ANTENNA ON SHIPBOARD AND	
SOME INTERESTING COMPARISONS.....	
By F. A. Hart.....	391
HOW TO BUILD A UNIQUE VARIABLE CONDENSER.....	
By R. C. Clark, 3rd.....	393
MAKING AN ELECTRIC CLOCK—PART II.....	
By Thomas Reed.....	395
BUILDING A GOOD CARBON COMPRESSION RHEOSTAT.....	
By Albert H. Beiler.....	397
TRIALS OF A TROUBLESHOOTER.....	By Thomas W. Benson 399
CHEMICAL ACTION OF STORAGE BATTERIES—PART I.....	
By Albert W. Wilsdon.....	401
"HOW-TO-MAKE-IT DEPT." (PRIZE CONTEST).....	402
WRINKLES, FORMULAE AND RECIPES. Edited by S. Gernsback	404
"WITH THE AMATEURS" (PRIZE LABORATORY CONTEST)....	406
"THAT PERPETUAL MOTION"—ANNOUNCEMENT OF PRIZE	
WINNERS.....	407
LATEST PATENTS DIGEST.....	408
PHONEY PATENT CONTEST.....	409
"QUESTION BOX".....	410

Sub-Sea Microphones



WHEN reviewing the various methods which are in use, or which have been proposed to combat the submarine, we invariably are led back to the *microphone*. Indeed our officials are coming to recognize the microphone more and more each day, and just now at least, it seems to be in a fair way towards ultimate success.

Of course, we must admit, the difficulties encountered are enormous, and the ideal microphone for sub-sea work as yet does not exist.

In order to guide workers in this field we will enumerate several points, not well understood by the man, who has never worked with sensitive microphones under water. The information which we publish in the interest of all, and which has not appeared in print before has been secured from experts who have actually worked on the problem for months.

To begin with, a microphone working on dry land is a totally different instrument from the one working under water. Thus it will not do, for instance, to take any sensitive microphone and after waterproofing it, simply sink it into the ocean. A microphone as a rule has a sensitive vibrating diaphragm. Imagine sinking it fifty feet below water where the pressure is some 21 lbs. per square inch—the diaphragm would of course cave in. For that reason microphones as a rule are not actually sunk in the water, but are fastened against the inner steel shell of the ships. This naturally is a poor way, as much of the instrument's valuable sensitiveness is lost thereby. However, means have already been found to actually keep the diaphragm in physical contact with the ocean. Nevertheless improvements are wanting.

If an ordinary super-sensitive microphone is mounted on a ship without special attachments it will be found to be worse than useless. To begin with, the noise of the ship's engine, the walking about of the crew, the noise of the waves pounding against the ship, all make it impossible to hear anything else in the 'phones.

If on the other hand we sink the microphone clear of the ship, only supported by cables, our troubles are far from ended. The first thing we find is that we

must sink the sensitive microphone at the very least 35 feet below the ocean level. Failure to do so will bring a constant dull pounding into the ears of the man at the 'phones, due to the noise created by the everbreaking and rolling ocean waves above. Even at 35 feet below, trouble awaits us. If the microphone remained perfectly stationary it would be a fine thing, but if suspended from a moving vessel, the rush of the water against the microphone casing produces a lot of unwelcome noise, hard to get rid of.

Most of these troubles are slowly being mastered, but far too slowly. What is needed are many more investigators who are willing to actually perform experiments under water. Land experience with microphones is valueless.

To cite a few more points. The average microphone works well only if in one position. Incline its face 45° and it will cease operating almost entirely. This of course is due to the shifting carbon grains. Make-shifts, *i. e.*, suspending the instrument in gimbal-rings like a compass, will not always do under water; what is wanted, is a sensitive microphone which is not influenced when turned upside down.

It has also been found, and this is an important point to remember, that using a "sea-diafram" which in turn vibrates a layer of air, the latter acting on the microphone diaphragm, will not work at all.

Another very interesting point is that when mounting microphones on each side of a vessel, the *loudness* of the incoming sound is equal in both telephone receivers, *i. e.*, if a submarine is on the starboard side of the ship, it will be heard just as loud from the port side. But, the difference can be readily detected and very accurately too, by the *phase difference* as heard in the 'phones. In other words, the sound will be heard a fraction of a second earlier in one ear than in the other. Small as this difference is, even a green operator will detect it at once.

Finally, the motors of a submarine do not give a clear note of a certain frequency in the listener's 'phones. Rather we hear a dull rumbling noise, loud, but without any definite pitch.

H. GERNsBACK.

THE ELECTRICAL EXPERIMENTER is published on the 15th of each month at 233 Fulton Street, New York. There are 12 numbers per year. Subscription price is \$1.50 a year in U. S. and possessions. Canada and foreign countries, \$2.00 a year. U. S. coin as well as U. S. stamps accepted (no foreign coins or stamps). Single copies, 15 cents each. A sample copy will be sent gratis on request. Checks and money orders should be drawn to order of THE EXPERIMENTER PUBLISHING CO., INC. If you change your address notify us promptly. In order that copies are not misrouted or lost. A green wrapper indicates expiration. No copies sent after expiration.

All communications and contributions to this journal should be addressed to: Editor, THE ELECTRICAL EXPERIMENTER, 233 Fulton Street, New York. Unaccepted con-

tributions cannot be returned unless full postage has been included. ALL accepted contributions are paid for on publication. A special rate is paid for novel experiments; good photographs accompanying them are highly desirable.

THE ELECTRICAL EXPERIMENTER Monthly. Entered as second-class matter at the New York Post Office, under Act of Congress of March 3, 1879. Title registered U. S. Patent Office. Copyright, 1917, by E. P. Co., Inc., New York. The contents of this magazine are copyrighted and must not be reproduced without giving full credit to the publication.

THE ELECTRICAL EXPERIMENTER is for sale at all newsstands in the United States and Canada; also at Brentano's 37 Avenue de l'Opera, Paris.

OUR COUNTRY WANTS MORE CHEMISTS

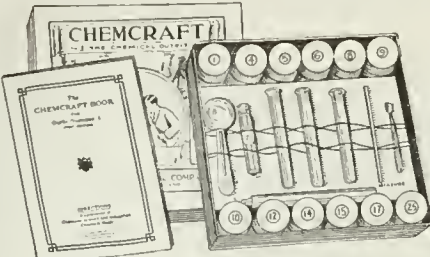

CHEMCRRAFT No. 1 Price Delivered \$1.25

West of the Mississippi and Canada \$1.50

This is a dandy set at a very reasonable price. With it you can work lots of wonderful experiments each one of which can be repeated many times. There are 14 different Chemicals, test tubes, glass tube, measures, etc., together with the No. 1 Chemcraft book which gives complete directions, explains all the experiments in a clear, interesting manner, and tells many wonderful and interesting things about Chemistry.

With Chemcraft No. 1 you can make fire ink and fuses; you can bleach colors, test water, prepare chlorine, manufacture ammonia, gun powder, colored fires, black and colored inks; you can prepare magic inks and papers, change water into wine and wine into water, pour ink and milk from same vessel and do no end of other wonderful things.



CHEMCRRAFT No. 2
Price Delivered \$2.50
West of the Mississippi and Canada \$3.00

Chemcraft No. 2 is much larger than the No. 1 set. It contains 32 different Chemicals and a liberal assortment of Apparatus and equipment. There are many rare and valuable Chemicals included in this outfit which represents the biggest value ever put on market for such a low price. The instruction book which comes with this set gives directions for working nearly a hundred wonderful experiments and after you have used the set for a little while you will be able to devise countless additional experiments of your own.

Every purchaser of Chemcraft No. 2 receives a Chemcraft service card, and is entitled to a free subscription to the Chemcraft Chemist. This is the biggest kind of a help in carrying on your experimenting and no one should overlook this offer.

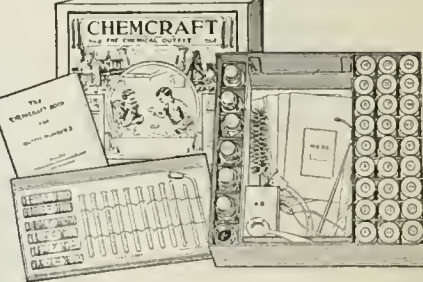
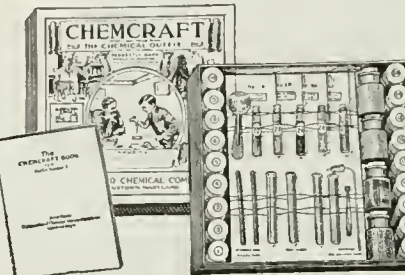

CHEMCRRAFT No. 3
Price Delivered \$5.00

West of the Mississippi and Canada \$6.00

The No. 3 Chemcraft is the biggest and most complete Chemical set on the market. This set contains 48 different Chemicals all of which are carefully chosen because of their many interesting reactions. A large assortment of valuable apparatus is included, among which is a blowpipe, alcohol lamp, 8 test tubes, test tube holder, test tube brush, measures, measuring spoon, gas delivery tube and stopper, glass tube, stirring rod, and other miscellaneous equipment.

The Chemcraft book for outfit No. 3 is complete in every detail. It contains 230 experiments and gives the user a complete course in Chemistry in addition to furnishing all kinds of fun.

Every owner of the No. 3 Chemcraft set is also entitled to Chemcraft service and a free subscription to the Chemcraft Chemist.

Your local dealer probably has the Chemcraft outfits in stock. In case he hasn't, however, we will supply you direct upon receipt of price. Prompt delivery guaranteed.

WILL YOU TAKE ADVANTAGE OF THIS OPPORTUNITY TO LEARN ABOUT THE WONDERS OF CHEMISTRY? CHEMCRRAFT IS JUST WHAT YOU NEED TO START YOUR CHEMICAL LABORATORY. YOU WILL LEARN THOUSANDS OF VALUABLE AND INTERESTING THINGS, BESIDES HAVING ALL KINDS OF FUN.

CHEMICALS AND CHEMICAL APPARATUS

Do you have a chemical laboratory? No experimenter should be without one. A knowledge of Chemistry will always be of greatest value to you and there is nothing more interesting than chemical experiments.

We are specially equipped to meet the requirements of the experimenter for chemical supplies. Let us know your wants. Our catalog lists nearly 200 chemicals, all kinds of apparatus, many books on chemistry, and gives valuable tables and other information. Sent to any address upon receipt of 10c in U. S. stamps or coin.

THE PORTER CHEMICAL CO. Dept. B. Hagerstown, Md.

At Last!

Electromagnetic waves of any length from an incandescent lamp.



TYPE OJ3—\$400.00 COMPLETE

Oscillation Telegraph, capable of transmitting the voice 15 miles, or telegraphic messages 40 miles. Larger transmitters for greater ranges.



TYPE "S"—\$60.00
De Forest "Oscillation"
(Oscillating-Audion)

Generator of absolutely undamped oscillations of any frequency. Permits Radio Telephone speech surpassing in clearness that over any wire. For Laboratory and Research Work has a field utterly unfilled. Patents issued and pending.

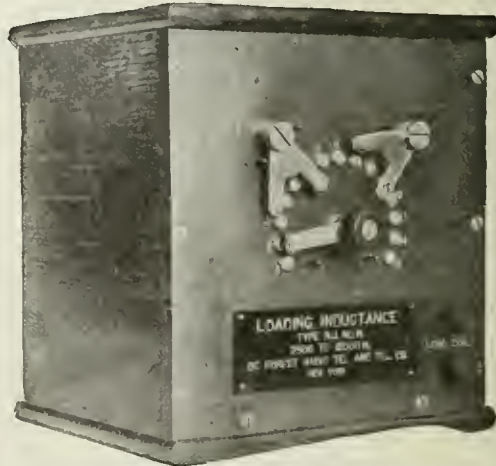

TYPE RJ11—2500—12000 METERS, \$35.00
THE DE FOREST LOADING INDUCTANCE

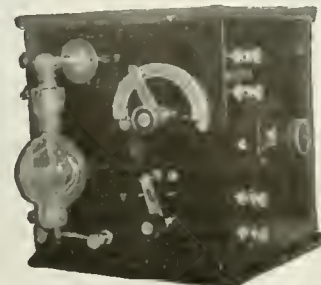

TYPE EJ2—PRICE, \$32.00
NEW AUDION AMPLIFIER FOR INCREASING STRENGTH OF RECEIVED SIGNALS 25 TIMES.
It is not a detector in any form.



TYPE VC4—PRICE \$20.00
VARIABLE CONDENSER

This Condenser is similar to our commercial type but is enclosed in an oak cabinet. It has 35 semi-circular aluminum plates. The maximum capacity is approximately .0025 M. F.

MANUFACTURED BY
DE FOREST RADIO TELEPHONE AND TELEGRAPH COMPANY
NEW YORK CITY

Office and Factory
1391 SEDGWICK AVE.

Cable Address:
RADIOTEL, N. Y.



THE ELECTRICAL EXPERIMENTER

H. GERNSBACK EDITOR
H. W. SECOR ASSOCIATE EDITOR

Vol. V. Whole No. 54

October, 1917

Number 6

How Lord Northcliffe Heard Two Oceans at the Same Time

A REMARKABLE demonstration of the wonderful telephone network which extends over the entire United States was recently made for the benefit of Lord Northcliffe and his party on the occasion of their

had for the occasion been extended to a telephone transmitter on the shore of the Pacific at the Golden Gate. Another telephone was connected to a line extending to a transmitter on the shore of the Atlantic. Thus by placing his ear to one receiver

per wire. There are 870 pounds of copper wire in each circuit mile and 2,960 tons in the entire line. The line crosses thirteen States and passes thru Salt Lake City, Denver, Omaha, Chicago, and Buffalo, with a branch that runs thru Pittsburgh, Wash-

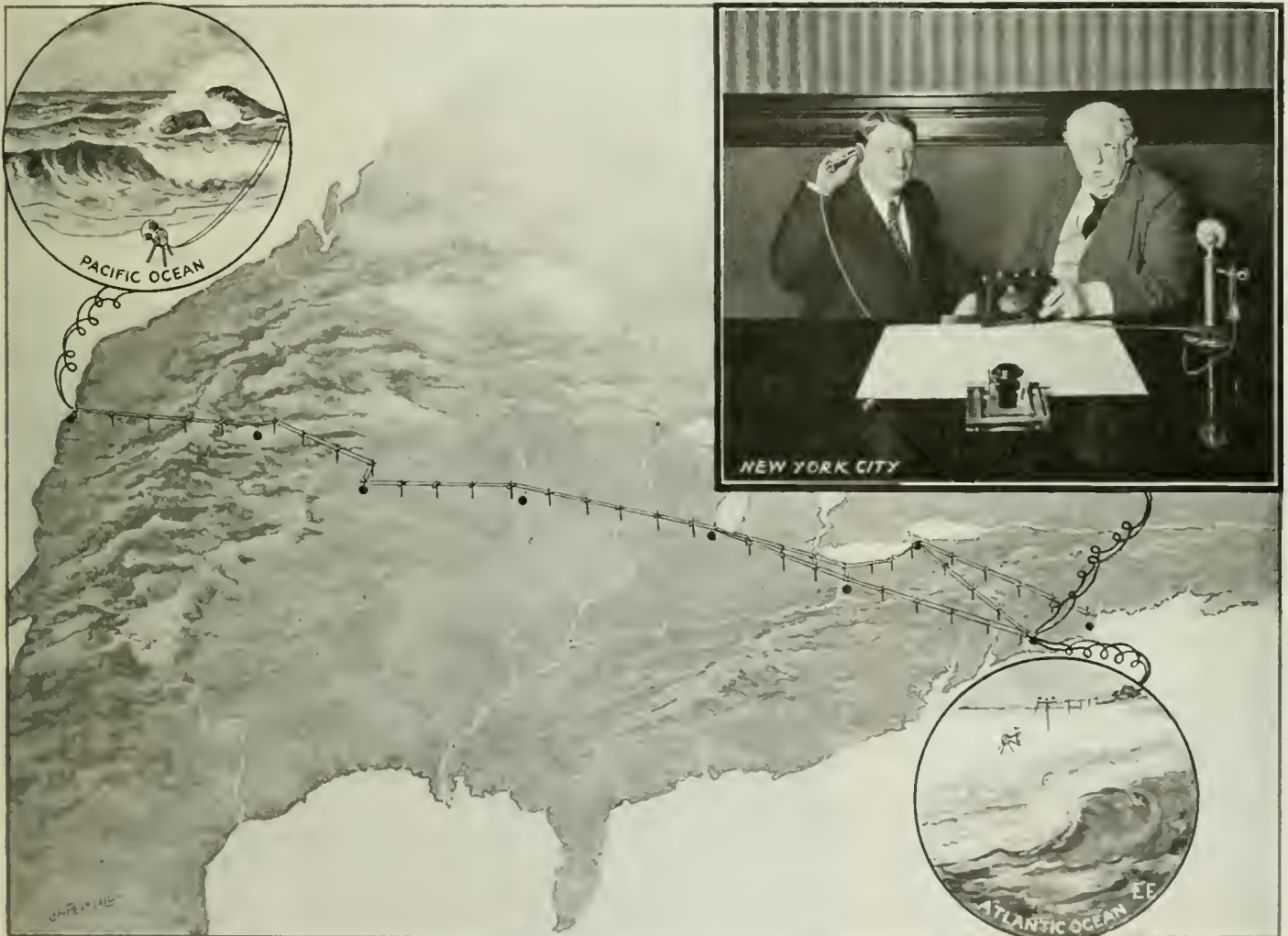

Lord Northcliffe, During His Recent Visit to the Offices of Theodore N. Vail, in New York City, Had the Pleasure of Listening to the Atlantic and the Pacific Oceans Simultaneously, Over the Trans-continental Telephone Line, 3,400 Miles in Length.

visit to the offices of Theodore N. Vail, President of the American Telephone & Telegraph Company, in New York City.

A point of historical interest was the listening by the distinguished visitor to the roar of the Atlantic and Pacific oceans simultaneously. A telephone instrument was connected to the trans-continental line reaching to San Francisco where the line

and then to the other, Lord Northcliffe was able to hear first one ocean and then the other, and by placing a receiver to either ear he was able to hear *both oceans simultaneously*.

In this remarkable telephone line there are two physical and one phantom circuits and in each physical circuit there are two wires and 6,800 miles of hard drawn cop-

ington and Philadelphia. In the main line there are 130,000 poles.

The power that sends the human voice out over the telephone is scarcely greater than that of a breath, yet it can be picked up by a delicate instrument, conserved over a distance of 3,400 miles, and reproduced perfectly and instantly across the continent.

NOW COMES THE ELECTRO-MAGNETIC RAPID-FIRE AERO GUN.

The accompanying photo shows the latest thing in aeroplane guns from France. It is operated by an electro-magnet thus giving the aviator-marksman instant con-

electric cooking apparatus includes novel designed soup kettles and boiling vessels, varying from fifty liters capacity to four hundred liters. These kettles shown in the accompanying photograph have insulating shells for retaining the heat, as well as

ovens require a current of eight kilowatts and measure three thousand four hundred millimeters long, one meter wide and one thousand two hundred and fifty millimeters high. The electric broilers are mounted on three tables and measure four hundred mm. by six hundred mm., with a depth of sixty-five mm., each requiring seven kilowatts. The capacity of these broilers is two hundred outlets per hour, while the total capacity of this kitchen is three hundred portions for each noon-day meal.

The electric coffee vessels have a capacity of five hundred liters and vary in size from seventy-five liters, capable of serving three hundred cups of coffee, to one hundred fifty liters having a capacity of seven hundred cups of coffee per hour. The smaller coffee pots of seventy-five liters require twelve kilowatts, while the larger ones use eighteen kilowatts. The hot water is supplied from electrically heated vessels at three temperatures automatically controlled to forty degrees Celsius, sixty degrees Celsius and one hundred degrees Celsius. The electric water heating boilers vary in size from 1.5 cubic meters to 6.5 cubic meters and the kitchen is equipped with a great variety of other cooking utensils.

The electric dishwashing apparatus is most complete, with electrically operated pumps for circulating the water thru the dishwashing machine, electric conveyors and electric drying oven. It will be seen that the kitchen is well ventilated with electric fans mounted in the wall and window casings conveying the fumes from cooking outside the building.

The cost of electric cooking in this installation is said to be extremely low, not exceeding 2.15 pfennig (1/2 cent) per capita per day, including the total current consumption for all purposes, while for cooking alone the cost does not exceed 1.53 pfennig (1/3 cent) per capita per day.

PARIS RESIDENT RECEIVES INCOME BY RADIO.

Mrs. Elizabeth K. Baker, of Paris, a daughter of Commodore Norman W. Kitt-

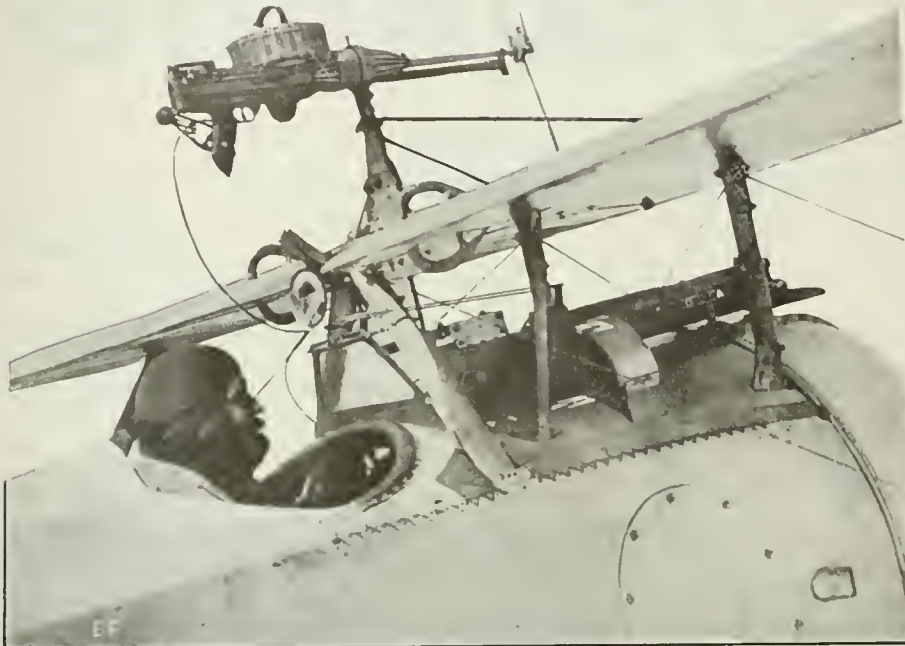

Photo from Underwood & Underwood

The Machine Gun In This French Aeroplane Is Fired by Means of An Electro-Magnet Controlled From the Aviator's Seat. Great Rapidity of Fire Is Thus Obtainable, As Well As Increased Accuracy.

trol of the gun, no matter at what angle it may be mounted.

The little French Nieuport "scout" plane is a great fighting machine and is equipped with an electric rapid fire gun which is worked from the pilot seat by a special switch. The machine is furnished with all the latest apparatus evolved from three years of intensive air fighting.

With the Nieuport, French airmen have repeatedly shown the German birdmen that there is not room for two brands of fighting men in the air and the Germans have acquired the knack of being "dropt."

THE GREATEST ELECTRIC KITCHEN IN THE WORLD.

By Frank C. Perkins.

THE electrical connections and the general design of the electric cooking, roasting and baking equipment of the largest electric kitchen in the world, in operation at Siemensstadt near Berlin, Germany, may be noted in the accompanying illustration. This remarkable electric kitchen has a capacity for serving three thousand persons in four groups of from seven to eight hundred workmen in each group between the hours of 12 noon and 2 P. M., one-half hour being allowed for each group. The electric cooking installation was decided upon after a careful study of the use of gas, coal and steam cooking in the various plants of the Siemens Schukert Werke, in other cities and other suburbs of Berlin, where the office forces as well as the workmen have been served with meals for a number of years during the noon hour.

This new electric kitchen is the most thoroly equip kitchen cooking installment in the world, as well as the largest, being provided with a modern cold storage and refrigerating plant operated by electric compressors, electrically driven kitchen utensils of every description, including coffee grinders, knife sharpeners and meat slicers, and vegetable cutters, as well as electric potato paring and slicing machines. The

a clever system of utilizing oil, electrically heated, between the casings, similar to the system of double boilers ordinarily using water for cereal cooking.

It may be stated that these oil-heated vessels have the electric heating element in the bottom arranged with two and three sets of windings providing for twelve kilowatts, twenty-four kilowatts and thirty-six kilowatts as desired. The roasting and bak-

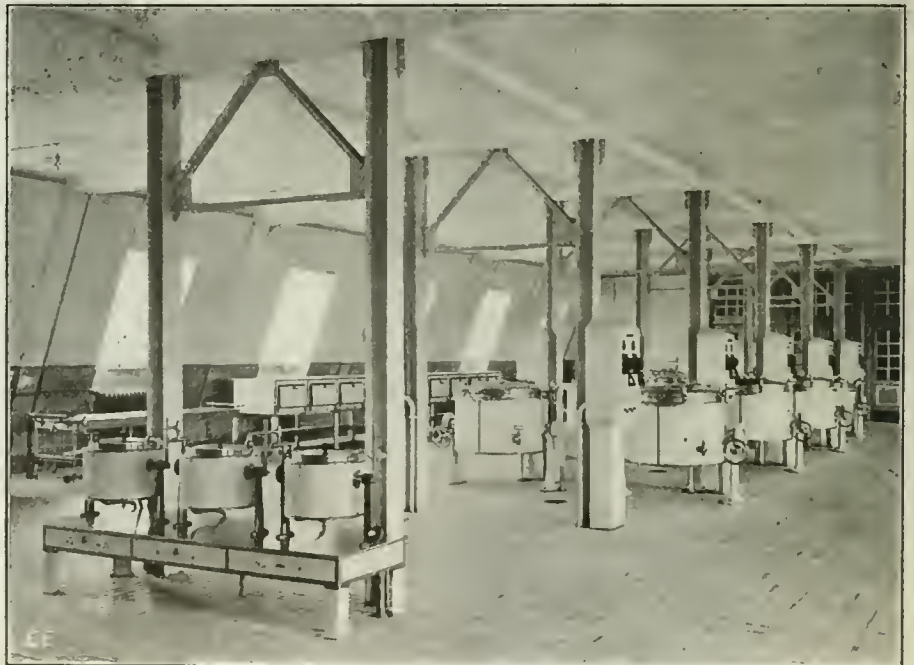

Remarkable Electric Kitchen in Operation at Siemensstadt, Germany, With a Capacity of 3,000 Persons. The Food Is Prepared by Electrical Machines Besides Being Cooked by This Agency.

ing equipment are of special interest, and may be noted in the background in the accompanying photographs. The baking

son, is receiving the income from a \$175,000 trust fund by wireless because of the war situation.

Electric "Zig-zagger" Aids Ships to Foil U-Boats

ACTUAL experience in the latest game—"dodging the submarines"—has proved the efficacy of putting a ship over a zig-zag course once a hostile U-boat has been encountered. It has been recommended by marine experts that cargo vessels, whether armed or unarmed, pursue a zig-zag course or better still, a progressive series of such

a rapid-fire gun of from three- to six-inch caliber, the U-boat, once it has come within the effective range of the gun, must stay below. The U-boat commander prefers to get within one thousand yards of a ship before he attacks, and, if he can make it, he will get within five to seven hundred yards. The preferred position for attack is about two points forward of the beam.

were based; his maneuver for getting into firing position goes for nothing, and he has to try again. Unless he is satisfied that his guns can greatly outrange the enemy, the U-boat commander does not dare to use his surface speed, and below the surface he has not sufficient speed to overhail the merchant ship. One or two misjudgments of this kind will lose so much

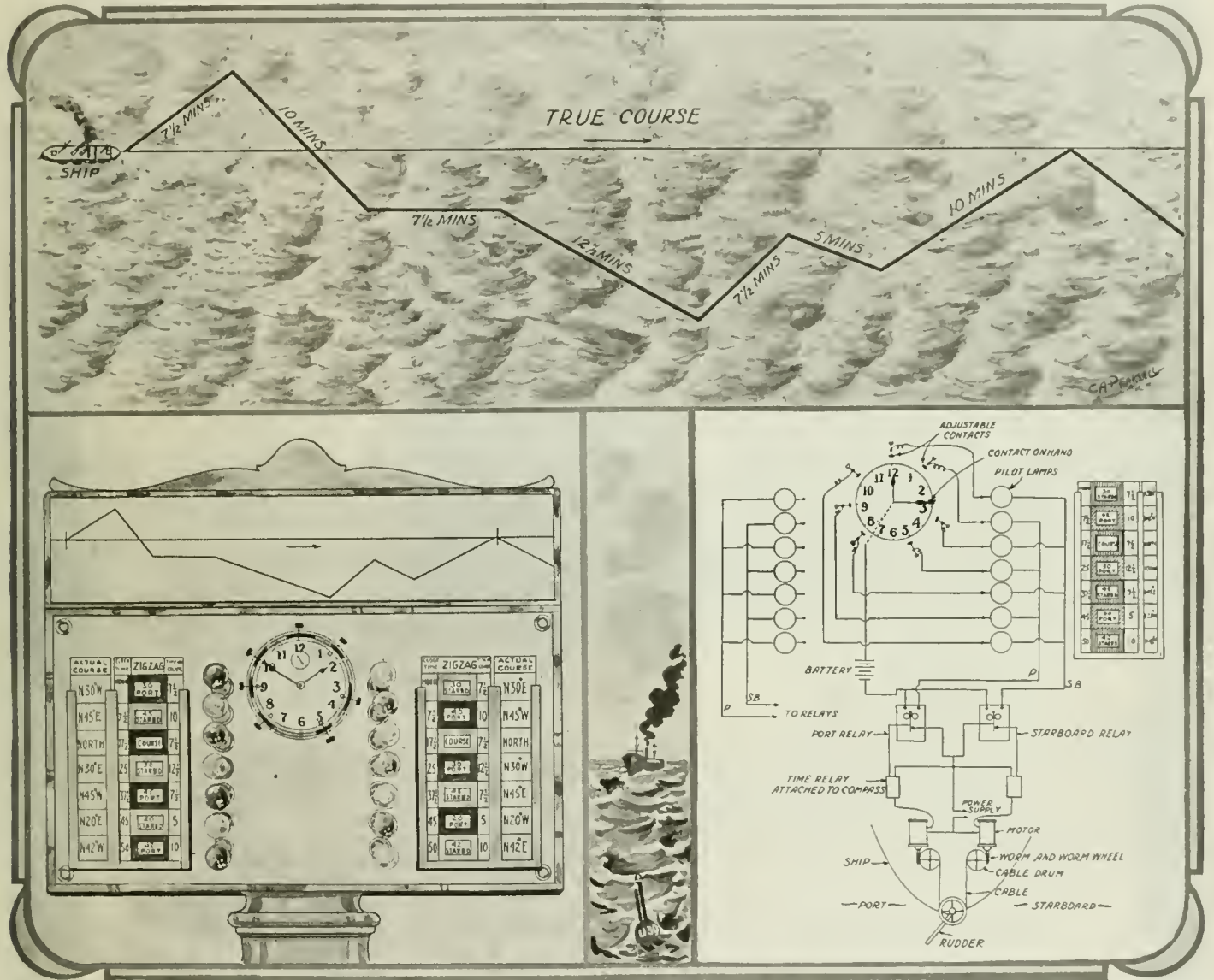

Instead of Relying Entirely on the Human Factor in "Zig-Zagging" the Course of a Ship Attacked by a Submarine, the Automatic Electrical "Course Zig-Zagger" Here Shown Is Proposed. Electric Motors Swing the Rudder to Port or Starboard As the Case May Be, These Course Changes Being Made Automatically by a Special Electric Clock Switch.

courses. But the captain of such craft is not over fond of following such a procedure ordinarily and would much rather take a chance on "beating it" along a straight course. Also, he is apt to argue, "why should I follow a zig-zag course, which is several miles longer than a straight one, and allow the submersible time to catch up to me?" Again, zig-zagging is rather a nuisance anyway, and liable to get the ship's "log" all out of sorts; unless such courses are accurately sailed there is a chance that the ship's true position will be misjudged.

When all is said and done, however, zig-zagging has a protective value which it did not have before merchant ships were armed. Now that the tramp is apt to carry

On sighting an approaching ship, the submarine heads to intercept her course, submerges, and then takes an occasional look at her, bringing its periscope above water for a few seconds only. The U-boat commander estimates the speed and course of the ship; submerges, and lays his own course by compass while below, so as to bring his boat within torpedo range at a point, preferably forward of the beam.

Now consider that while the submarine is below, the merchant ship changes her course, say thru an angle of 45 degrees, the former, on coming up for a few seconds' look at the ship, finds that, instead of converging to meet him, the merchant ship is sailing in a direction entirely different from that on which his calculations

time, that the ship will have a good chance to pass him and steam beyond torpedo range; indeed, it will soon have gained a lead which the U-boat cannot overcome, except by coming up and using his surface speed.

So we come back once more to the zig-zag course problem. Not only is more distance covered, but the navigating officer may forget to make the change of course from one leg to the next at the proper time, and so throw the whole zig-zag into such confusion that the ship will not know where she is with regard to her true course. To circumnavigate this, and with a view to making the running of the zig-zag course popular with ship captains, (Continued on page 414)

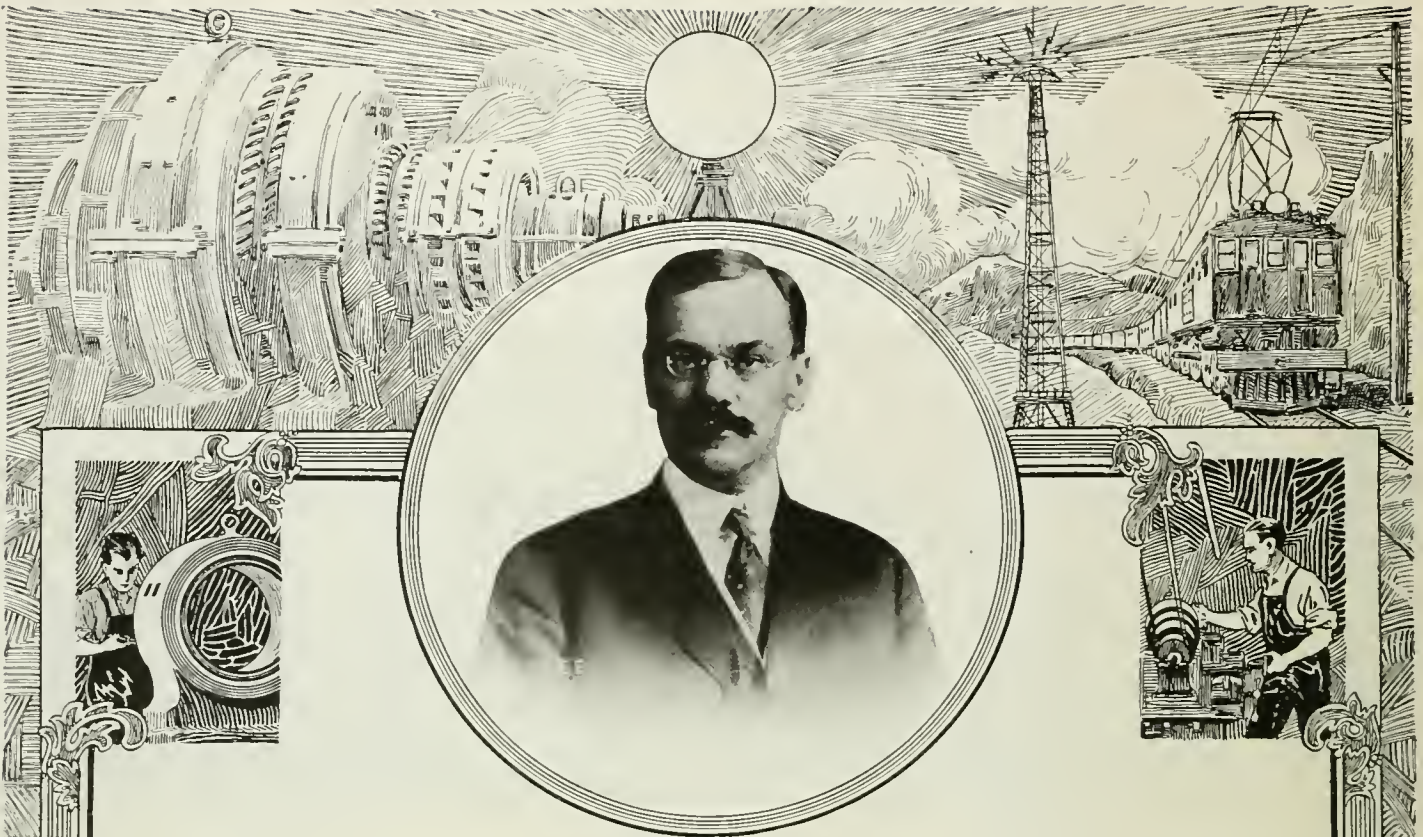

The Training of the Young Man in Industry

By E. M. Herr, President of the Westinghouse Electric & Mfg. Co.

Written exclusively for the "Electrical Experimente."

SUCCESS in the electrical industry is attained just as is success in any other industry, primarily by the development of general character and trustworthiness followed by mastery of the details of the particular branch of the industry in which the young man is engaged.

The men who do great deeds are those who have been again and again tried in stress and strain of hardships and difficulties, perhaps in an entirely inconspicuous way, but who have worked thru, never shirking, and have willingly taken up greater and greater burdens as they came to their hands, being most concerned not with the immediate rewards to be gained but with the feeling that progress was being made in the work entrusted to them and that they had succeeded in their immediate task with the result that their character, knowledge, training and, more important still, their courage and tenacity were strengthened for overcoming still greater difficulties and bearing more and larger responsibilities.

Great knowledge and learning will not alone suffice for attainment of success in the industrial world, for if they would, we would see the great scholars bearing the greatest responsibilities. History shows us that its greatest men were generally not men possess of unusual learning, or, if they were, other great qualities of mind and character were present to an even more remarkable extent.

Experience and a broad contact with affairs is not all that is required, for many men of widest experience and who have been in touch with world-wide affairs are ineffective and frequently unable to assume great responsibilities depending on their own efforts and initiative.

Much good effort is often wasted and many a valuable man fails to make good because, to use

the old familiar phrase, he is "a round peg in a square hole"—by persevering, possibly, in a most admirable manner, in a position for which he is unfit; whereas, were he placed in a position to which his talents were better suited, his entire source of energy would be devoted to an attainment of a high degree of perfection.

The gradual assumption of more and more difficult work with its attendant troubles, and the successful solution of them by his own efforts all tend to the development of the successful man.

A young man should perform his daily task for the satisfaction of its accomplishment rather than the expectation of an immediate reward. A reward, and a rich one, will surely come to him who can and does excel his fellow in doing things, no matter how burdensome or onerous, provided they are worthy, and especially if such excellence is in work or methods more difficult than is usually encountered. The reward may not come when expected—it may even be delayed until the worker feels great discouragement and can see no prospect of the recognition and reward he has justly earned.

Experience, however, shows that reward for unusual and successful efforts must come and if deferred, as it often is by uncontrollable circumstances, it will ultimately be paid with interest well compounded.

The Westinghouse Electric & Manufacturing Co. employs at the present time approximately 25,000 people. The capital stock is \$75,000,000. The gross sales for last year were approximately \$90,000,000 and will be considerably in excess of that this year. The plants occupy approximately 100 acres of floor space. The company controls several thousand patents.

WHERE ELECTRICITY CAN BE USED ON THE FARM.

Farmers are constantly hearing of the advantages of electricity on the farm, what it will do for them and its wide application. Some of this has been rather vague and *The Society for Electrical Development* has prepared a list of some 104 applications appended here.

Of course, every farm will not find it economical to install all the equipment listed, but every farm will find profitable use for some of it. Many of the applications can be handled best by a community of interests, for instance, electric threshing and harvesting machinery, hulling machinery, oil concentrating plants, hay balers, etc. High priced machinery used only for short periods during the year is applicable to this community treatment.

- | | |
|---------------------------------------|-----------------------------------|
| Oat Crushers | Cider Presses |
| Alfalfa Mills | Spraying Machines |
| Horse Groomers | Wood Splitters |
| Horse Clippers | Auto Trucks |
| Hay Cutters | Incubators |
| Clover Cutters | Hoovers |
| Corn Shellers | Telephones |
| Ensilage Cutters | Electric Bells |
| Corn Crackers | Ice Cutters |
| Branding Irons | Fire Alarms |
| Currying Machines | Electric Vehicles |
| Feed Grinders | Electro Cultures |
| Failing Machines | Water Supply |
| Livestock Food Warmers | Pumping |
| Sheep Shears | Water Sterilizers |
| Threshers | Fruit Presses |
| Grain Graders | Blasting Magnetos |
| Root Cutters | Lighting |
| Bone Grinders | Interior Telephones |
| Hay Hoists | Vulcanizers |
| Clover Hullers | Pocket Flash Lights |
| Rice Threshers | Ice Breakers |
| Pea and Bean Hullers | Grindstones |
| Gas-Electric Harvesters | Emery Wheels |
| Hay Balers | Woodsaws |
| Portable Motors for Running Threshers | Forge Blowers |
| Fanning Mills | Drop Hammers |
| Grain Elevators | Soldering Irons |
| Huskers and Shredders | Glue Pots |
| Grain Drying Machines | Cord Wood Saws |
| Binder Motors | Egg Testers |
| Wheat and Corn Grinders | Burglar Alarms |
| Milking Machines | Be'll Ringing Transformers |
| Sterilizing Milk | Devices for Killing Insects |
| Refrigeration | Machine Tools |
| Churns | Molasses Heaters |
| Cream Separators | Vacuum Cleaners |
| Butter Workers | Portable Lamps to Attract Insects |
| Butter Cutting-Printing | Toasters |
| Milk Cooling and Circulating Pumps | Hot Plates |
| Milk Clarifiers | Grills |
| Cream Ripeners | Percolators (Coffee) |
| Milk Mixers | Irons |
| Butter Tampers | Ranges |
| Milk Shakers | Toilette Articles |
| Curd Grinders | Water Heaters |
| Cassin Grinders | Fans |
| Pasteurizers | Egg Boilers |
| Bottle Cleaners | Heating Pads |
| Bottle Fillers | Dish Washers |
| Concrete Mixers | Washing Machines |
| Cider Mills | Curling Irons |

"Zig-Zag"—A New Thriller for the Sea Shore

By GEORGE HOLMES

WE ALL enjoy going to the seashore, when the summer comes around each year, and all look for thrills, be they young or old, grown-ups as well as kiddies, it's bound to get us all—this beat-it-from-the-city spirit—to get out in the great outdoors and let loose!

The attraction recently invented by an

and begins its descent from the top of the tower with a zig-zag motion, from which the attraction derives its name.

The cars after leaving the top descend by gravity, traveling over a series of inclined rails which are arranged one pair above the other in a vertical zig-zag line in such a manner, that the traveling seats are brought to a stop at the lower ends of



The Latest Electrically Operated Thriller for Pleasure Resorts is Known as the "Zig-Zag." The Passengers Are Hauled to the Top of the Tower by a Motor-driven Cable. They Then Start Their Zig-Zag Downward Journey by Gravity.

Eastern man, Mr. Hartman, called the "Zig-Zag," will soon be seen by the crowds at pleasure resorts.

The main part of the device is a large steel tower about a hundred feet high, an object of beauty and awe, especially at night, when hundreds of lamps shall blaze forth over the entire structure. At the top of the tower there will be a large ball of revolving lamps and searchlights to enhance the scene.

The passengers are seated in a small car which is drawn by an endless sprocket chain to the top of the tower. When the car reaches the top it is automatically released

each pair of parallel running rails, drop a certain predetermined distance upon the next lower pair of rails and then travel along such rails in the opposite direction downward, until they reach in a zig-zag line the lowest pair of rails. A further swinging movement is obtained at the sudden temporary stops by the living force of the traveling suspended seats.

A close inspection of the illustration will give the reader a good conception of how the mechanism works.

Mr. Hartman does not state how the passenger's "inside mechanism" works during the trip, but we presume people will like it.

X-RAYING RING NEBULAE.

At the last meeting of the British Astronomical Association at Sion College an application of X-rays to obtain by analogy a test of a theory of the structure of "ring" nebulae was shown by Mr. W. H. Steavenson. His idea was that the "ring" appearance did not necessarily imply the shape of a ring, but could be produced by a hollow globular form, the suggestion being that the absence of light in the interior of the "ring" is due to the thinness of the shell, which appears much thicker, and, consequently, brighter, just outside the central portion. X-ray photographs of rubber tubes showed a very similar appearance, rubber globes of sufficient thickness not being available.

DATE OF ISSUE.—As many of our readers have recently become unduly agitated as to when they could obtain THE ELECTRICAL EXPERIMENTER, we wish to state that the newsstands have the journal on sale between the fifteenth and the eighteenth of the month in the eastern part of the United States and about the twentieth of the month west of the Mississippi River. Our subscribers should be in possession of their copies at these dates. Kindly bear in mind, however, that publications are not handled with the same dispatch by the Post Office as a letter. For this reason delays are frequent, therefore kindly be patient and do not send us complaints as to non-arrival of your copy before the twenty-fifth of the month.

Firing Bombs by Electricity

By H. Gernsback

MODERN bombs as used in trench warfare are divided in two classes, namely: the "time-fuse" bomb, and the "contact" bomb. The former, which at the beginning of the war was a rather crude affair, has now been greatly improved upon, and as a rule will go off five seconds after its release. This type has a kind of trigger which is pressed against the body of the

"if you hold it too long, you jeopardize your own chances of being able to throw it at all."

As mentioned, this refers to the old timers, lit by a match or a cigarette, and does not hold true for the modern type, timed to go off in five seconds.

But the trouble with the modern type is that it is impossible to make it go off the moment it enters the enemy's trench; it

ically. We have a bomb weighing from five pounds upward, to be thrown in the enemy's trench precisely as any other bomb. It can be thrown by means of catapult or other suitable means. The construction of the bomb is shown in Fig. 1. It has a hollow center which contains in a shell a reel, upon which is wound a thin flexible electric cable. This reel runs free on ball bearings so as to give a minimum of friction. It

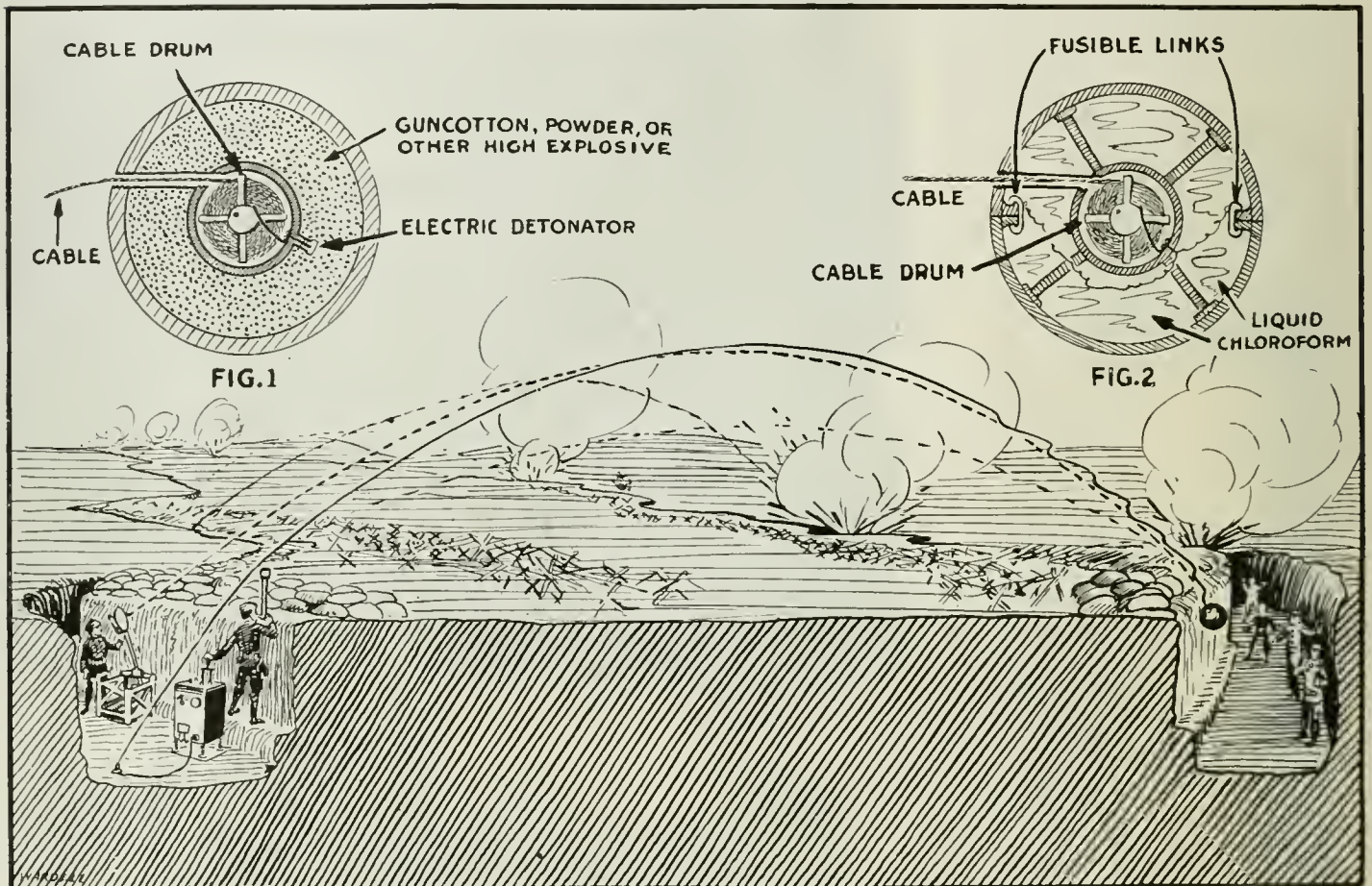

Why Take Chances With Time-fused Bombs When This Newly Devised Electric Bomb Is Sure to Explode at Exactly the Time Desired. When the Bomb, Filled With Explosive or Chloroform, Reaches the Desired Point, a Switch Is Closed and the Missile Is Detonated. They Are Thrown With a Catapult in the Manner Illustrated.

bomb; thus when the latter is released it will take the trigger just five seconds to ignite and consequently explode the bomb.

The second bomb, as its name implies, goes off the moment it strikes a hard body, showering destruction all about it. For trench warfare, bombs are highly effective, and if the enemy's trenches are "bombed" in a systematic manner, the men as a rule become very much demoralized.

Bombs vary in size from the small hand bomb, the size of a baseball and containing from six to ten ounces of high explosive, to the large cylinder-shaped affair containing as much as thirty pounds of Trinitro-Toluol. The latter kind of course cannot be thrown by hand on account of their weight, but are projected thru the air either by a modern spring operated catapult or by a mortar-type "Minenwerfer," first brought out by the Germans.

The chief trouble with the old time fuse type, to quote Captain Ian Hay Beith, is that if the bomb is thrown too soon "the other fellow has plenty of time to pick it up, and throw it back to the sender," incidentally killing him. On the other hand,

either explodes a few seconds too soon or a few seconds too late. In the former case the bomb does not do much harm, but merely sprinkles the trench with steel fragments. In the latter case the men in the trenches find time to run for cover; *i. e.*, dodging the bomb. In both cases not very much harm is done. It is on record that it takes almost *thirty bombs to kill one man!* This certainly is low efficiency. Also not all bombs go off, this being particularly the case with contact bombs; if the latter hit a soft body, such as straw or mud, they often fail to explode. Hence the great waste and low efficiency of the present bombs.

With a view to rectifying several of these defects, as well as gaining certain new important improvements, the electrically fired bomb is suggested. At first blush the idea of putting a "string" on a bomb seems foolish, awkward, as well as troublesome. But if we study the idea, it will be found that the new improvements probably greatly overbalance the imaginary defects, if such there are.

Our front cover illustrates the idea graf-

will thus be seen that as the bomb proceeds in its flight thru the air, the thin electric wire is played out, without in any way retarding or impeding the flight of the bomb. Naturally, the reel must contain a sufficient wire supply to reach from our own to the enemy's trench.

The space between the shell containing the wire reel and the bomb body proper is packed with the usual high explosive. The ends of the wire cable inside of the bomb are inserted into the explosive; the latter can therefore be set off by means of a fine platinum wire electrically heated to incandescence or by any other well-known firing method.

The electric cable being of rubber insulated stranded wire can be quite thin, there being almost no strain whatsoever on the wire cable. This will be understood after a second's reflection, for mechanically the bomb has nothing to do with the cable. The wire reel having ball bearings simply unwinds as the bomb moves on, therefore there can be no strain beyond the *weight*

(Continued on page 416)

“BURNELL R. FORD— SCIENTIST ELECTRICAL WIZARD”

THUS do our friends, the theatrical managers, announce the electrical star of theaterdom—he of the flashing sparks and mastodonic Tesla coils. Mr. Ford is one of the most successful scientific lecturers in the country and is now on a Chautauqua tour.

“The late Elbert Hubbard described electricity as ‘the juice.’ Since Benjamin Franklin brought it from the sky with a kite, no better, or more scientific definition has been made. Yet the remarkable misunderstanding of the nature and properties



mouth (by using a spoon for example) and also to employ a sufficiently high-frequency Tesla current. Such a current, oscillating at say 100,000 cycles per second, will exert no muscular effects and simply passes over the skin of the lecturer.

The interesting effect shown in the center top photograph, is attained by cutting out a cardboard figure and covering it with tinfoil. This may be laid on a photographic plate and charged for a second with a high-frequency electrode. If desired a larger figure may be cut out of

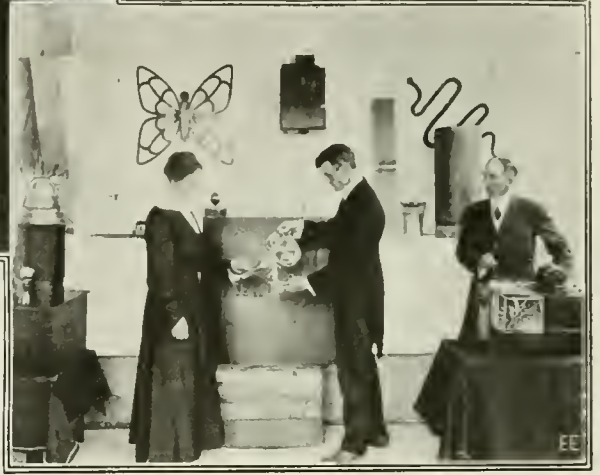

The Electric “Boogieman” Is Made By Cutting Out a Cardboard Figure of the Desired Shape. When Coated With Tinfoil and Charged by One Terminal of An Oudin Coil This Is What You See.

Here Is Shown a Remarkable Demonstration of Electrical Welding Thru Two Human Bodies. Stiff Iron Wires Are Forever Welded, the Current Flowing From the Lecturer to An Assistant. Capable of the Simplest Explanation, This Experiment Is Nevertheless An Awe-Inspiring One.

The Photograph Shows the Lighting of An Ordinary Candle by Means of a Stream of Water. In Connection With This Experiment, the Lecturer Becomes a Human Dynamo, Lighting Arc Lights by Holding the Carbons In His Hands and Handling 3,000,000 Volts of Electricity.

of electricity seems to be general and permanent. In the entire realm of popular education no one thing can be of more importance than to educate the people on what, to them, are the mysteries of electricity. To do this in a scientific, yet plain and thoroly entertaining way, is no small accomplishment. The management, after much search and many discouragements, has found, in the person of Burnell R. Ford,

such a man.”—so reads our program. One of the startling experiments performed by the lecturer is that of welding by current, which is made to pass thru the human body. Stiff iron wires are solidly welded as shown above, the heavy current flowing from the lecturer’s mouth to that of his assistant. The essential thing to be watched in making this experiment is to have metal contact with the

thin wood and coated with tinfoil. When this is exhibited against a dead-black background and properly excited by connection to a powerful Oudin or Tesla high-frequency coil the effect on the audience is truly remarkable. The foil-covered figure should be charged, preferably from the live terminal of an Oudin coil.

The right top view shows a mystify-
(Continued on page 422)



At Left:—Lighting Indian Clubs by High-Frequency Currents Past Thru the Body.

Above:—The Lecturer Lights Up a Bank of Lamps to Full Brilliancy, the Current Flowing Thru His Body.

At Right:—Lighting a Candle by a Spark From the Tongue—A Mystifying Electrical Stunt.

Free Electricity from the Wind

By H. WINFIELD SECOR

WIND pressure as a natural source of power has been in practical use for driving grist mills and pumps for the last six hundred years. The efficiency and utility of the wind-motor has increased along with the development of modern manufacture until the all-steel wind-motor of to-day is a highly efficient machine, giving more power for every dollar of capital invested than either steam, gas, or waterfall. The great drawback to the development and general use of wind power has been the intermittent character of the power. Attempts have been made in the past to generate electricity with wind power and store the electricity for lighting purposes. Theoretically, this combination should be perfect, but many difficulties have been experienced by those who have tried to put this combination into practise. The low speed of the wind-wheels made it difficult to get a satisfactory transmission of power from the wind-wheel to the dynamo. To operate at high efficiency the wind wheel had to run slow and the dynamo at high speed, thus introducing a dangerous element in the way of high speed gearing.

In the new type wind motor plant here illustrated this difficulty is claimed to have been overcome. A special slow-speed dynamo has been designed to couple direct on to the driving axles of the wind-wheels, and a strong gear of simple design connects them together.

The inventor, Mr. M. A. Mulrony, of

Australia, has designed two sizes of rural lighting outfits of this type, and which for

work together, like two horses, in pulling along their common load—the dynamo. When the two wind-wheels start turning, the dynamo, which is direct geared to the differential, starts generating electricity, and as soon as the electric pressure of the dynamo rises higher than that of the storage battery an electric valve trips, and the electricity begins to

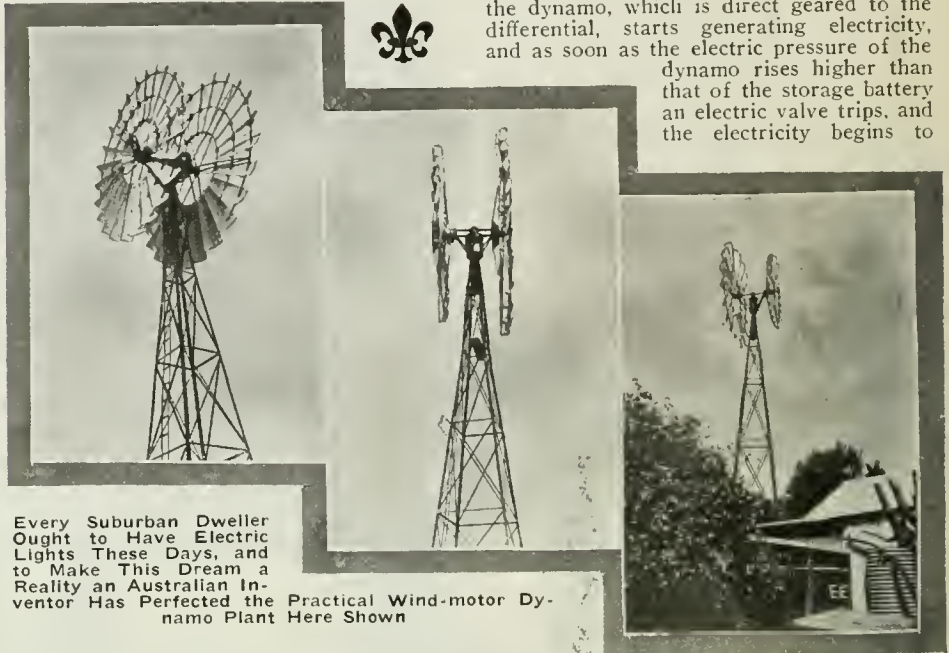

Every Suburban Dweller Ought to Have Electric Lights These Days, and to Make This Dream a Reality an Australian Inventor Has Perfected the Practical Wind-motor Dynamo Plant Here Shown

purposes of comparison we shall term as follows:

The small plant with a capacity for lighting fifteen 16-candle power lights for a period of four hours per day, and a storage capacity to operate fifteen 16-candle power lights for six days without any wind at all.

The large plant has the same specification as the small plant except that it has a capacity to light twenty-five 16-candle power lights per day.

The electricity may be used to operate electric fans, electric vacuum cleaners, sewing machine motors, electric pumps, electric toasters, and small electric irons. The inventor has adopted twenty-five volts as standard pressure. The storage battery consists of 14 cells connected in series. This insures easy charging from the dynamo, as there is practically no resistance in the circuit.

The wind-motor has two wind-wheels as will be observed, one being a little larger than the other. The smaller wheel of the two always faces to the wind, and maintains its position in front of the larger or back wheel. The wind first presses against the vanes of the smaller wheel, and starts this wheel turning in the direction of the hands of a clock. The whole force of the wind, however, is not exhausted on the wheel, but a part of the wind pressure passes thru to the back wheel, and again is turned into rotary motion. The back wheel also turns in the same direction as the hands of a clock. The two wheels are on separated axles, but are coupled together by a differential gearing in similar fashion to the back axle of a motor car. This differential allows each wheel to rotate practically as if it had no connection with the other, and in this way brings about an excellent equalizing effect and a balance of power. The two wheels

pour into the storage battery, and continues to do so until the wind pressure fails. When this happens the electric valve immediately trips and disconnects the wire carrying the current, thus preventing the electricity from escaping back thru the dynamo. The above operation can be likened to an ordinary windmill driving a pump, and pumping water from a well into a tank. When the wind fails the valve in the pump closes, and prevents the water from the tank running back into the well.

The operation of this plant is claimed to be absolutely automatic, and a hand is not needed near it for six months at a time. In high winds and low winds alike, all adjustments as to wind direction, speed, turning out of the wind, etc., are made automatically. The application of the gyroscopic principle ensures that the mechanical operation is automatic.

The dynamo is a special and original design, and forms the supporting base for the wind-motor unit. The armature is of peculiar shape, being much longer for its diameter than usual. This feature gives the dynamo its remarkable characteristic of generating electricity at exceptionally slow speed. (Continued on page 422)

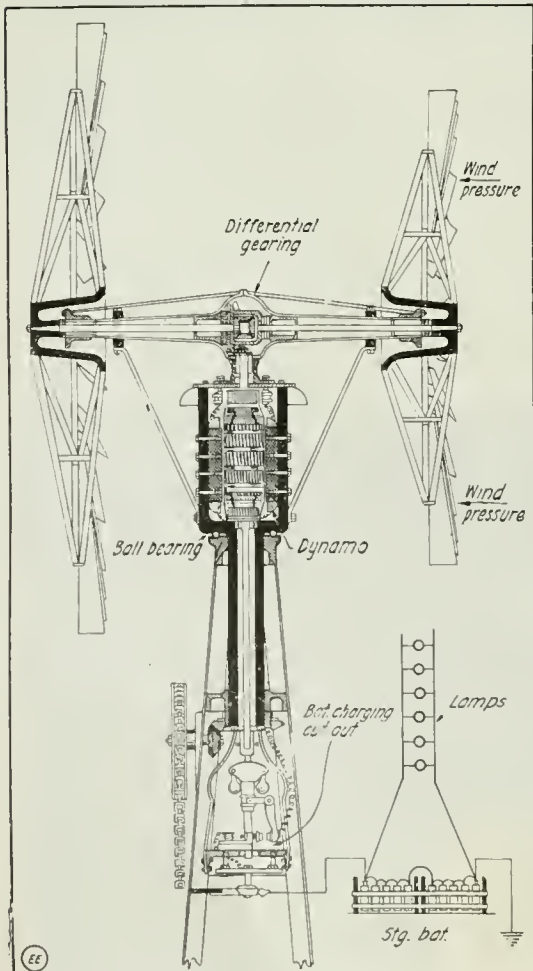

Sectional View of Newly Perfected Wind-Motor and Dynamo Unit. The Storage Battery Keeps the Voltage Even. The Plant Stands Any Wind Pressure.

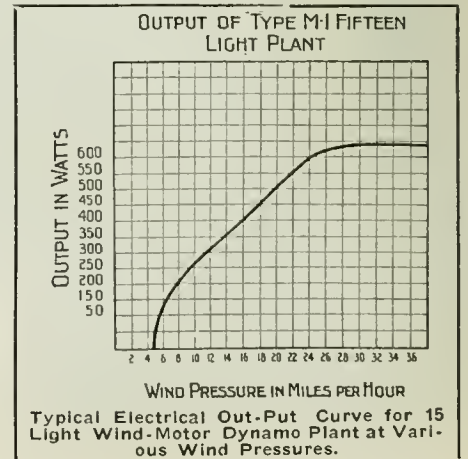

New Electro-Therapeutic Apparatus

By H. ROSENTHAL

X-Ray

AT the convention of the American Medical Association held at the Hotel Astor in June at New York City, the exhibit of electric apparatus showed many interesting new developments, particularly those to be used

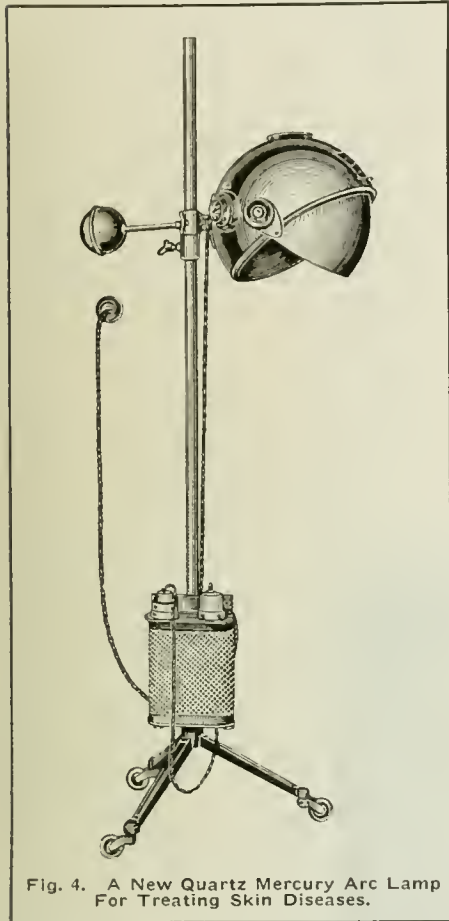

Fig. 4. A New Quartz Mercury Arc Lamp For Treating Skin Diseases.

in connection with hospitals and field hospitals at the front.

One very ingenious X-ray equipment consisted of a portable table for laying the patient upon to be X-rayed; the outfit also included a small gasoline engine generating set, a closed core transformer, this transformer being used in connection with a regulating device to operate a new type of X-ray tube. This tube, about four inches in diameter (see illustration, Fig. 1), had an anode terminal of solid tungsten metal

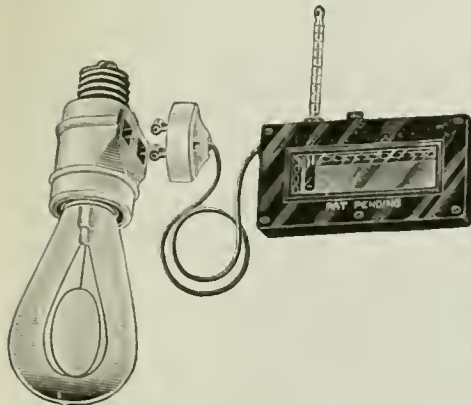

Fig. 7. This Miniature Electric Incubator for Microscope Stages Enables the Physician to Study "Live" Bacteria Organisms.

supported on a rod of molybdenum and a cathode consisting of a tungsten spiral, which was heated electrically from a low voltage circuit from the primary of the transformer. The X-ray tube suppresses any current in the direction that does not make the hot filament cathode. It therefore is capable of rectifying its own current. In order to make the conditions stable a large set of air cooled ventilating vanes are made part of the anode of the tube.

The gasoline engine unit which operates the transformer is so designed with an electrically controlled solenoid that it can be placed some distance from a base hospital or tent, thus eliminating the unpleasant noise. The entire equipment is so arranged as to be portable for immediate transportation.

X-Ray Accessories

Some of the newer developments in the accessories to be used in connection with X-ray work include the Hydrex tube, Fig. 2. This tube operates on the principle of having an auxiliary chamber filled with hydrogen and sealed from the top by a mechanically operated mercury valve. This valve is opened by drawing the mercury past two porous blocks, thereby leaving a passage for a certain amount of hydrogen to enter the tube. To open the valve a

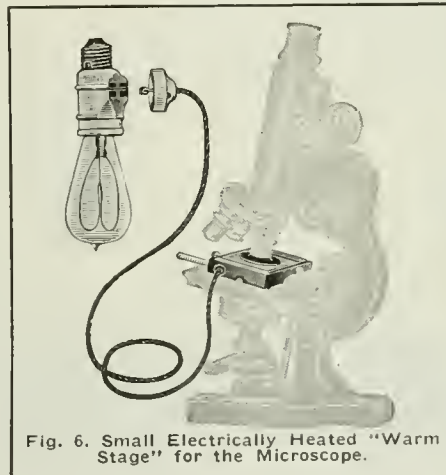

Fig. 6. Small Electrically Heated "Warm Stage" for the Microscope.

small suction pump is provided and is clamped directly on to the glass bowl, or any other convenient place, so the rubber tube can be attached to the hydrogen chamber. To lower the vacuum the plunger is pulled out to its full length and released immediately. To raise the vacuum all that is necessary is to disconnect the anode and connect it to cathode and run a weak current thru the tube.

Very elaborate tables of new development were shown for laying the patient upon and so equipt as to be used either for examination with a fluoroscope or to be used directly in taking X-ray plates.

One type of table was so nicely counter-balanced that very little effort was needed to obtain almost any position an operator would wish. It was also arranged with a small motor, foot controlled, which would raise the table or lower it in an angular position, according to the will of the operator.

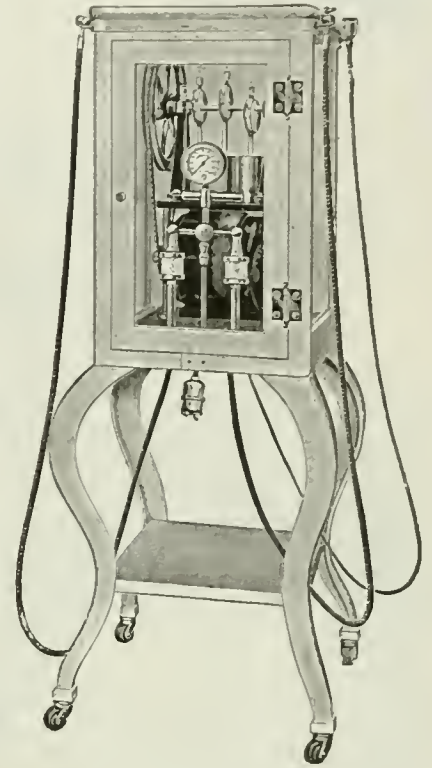
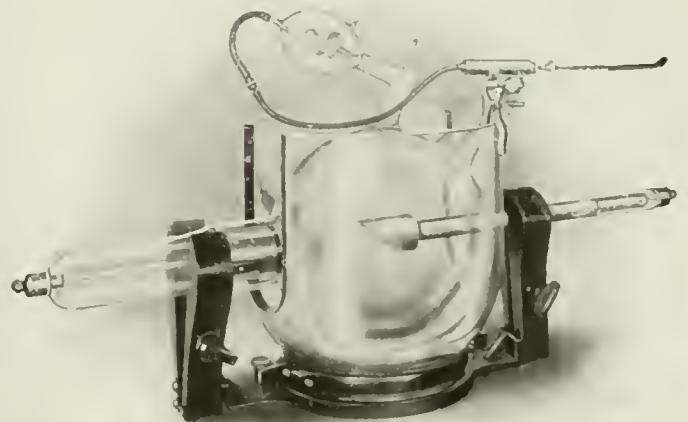

Fig. 5. A Recent Type of Anesthetizing Apparatus, Driven by a Small Electric Motor.

Another type of table was fitted with accessories necessary for making charts of the heart and lungs, these charts or tracings being made directly by examining the patient with a fluoroscope and by means of an automatic device.

A duplicate of the X-ray equipment supplied to the N. Y. Bellevue Hospital was also shown, being the largest X-ray plant in the United States.

(Continued on page 421)



Hydrogen Thru a Mercury Valve. Vacuum Is Adjustable. Hydrogen Thru a Mercury Valve Vacuum Is Adjustable.

ELECTRIC FAN EXCELLENT FOR DRYING FRUIT.

Cheap living and plenty of it; wide variety; wholesome, clean, nourishing food; prepared quickly with little labor and trouble in your own home—by your own hands!

An electric fan and a kitchen knife are

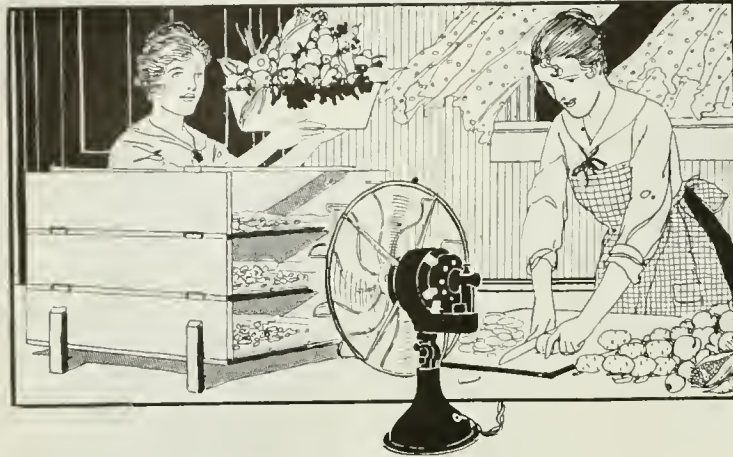

A New Use for the Electric Fan In Drying Fruit. Another Way in Which to Help Win the War.

the only "tools" necessary. Drying can be done in home-made box trays, a table top, sheet, strings (apples, pears, etc.), and dozens of other ways. Just like grandmother did, only quicker, cleaner and better tasting!

The U. S. Department of Agriculture says (Bulletin No. 841): "The fan method has a marked advantage in that the product keeps cool, owing to evaporation while it is being dried, thus tending to retain the color and eliminate spoilage."

Almost all the vegetables and fruits can be treated and stored away—even the most juicy, like tomatoes. And besides—this new way of drying eliminates the biggest part of the work. It does away with a lot of canning—and that's good, for jars and containers are very scarce and mighty high in price.

All summer long, at odd times, the housewife can pick up choice bargains at the markets, prepare them in a few minutes, and the drying goes on while she attends to something else. By cold weather time she can have her home stocked up like a siege fort—for the longest, hardest kind of a cold, long winter.

A THOUSAND AUTOMATIC TELEPHONES ORDERED FOR AUSTRALIA.

Orders aggregating 1,000 lines of automatic central office equipment and 1,000 telephones equip with the dial, have just been placed to be used as additions to the automatic exchanges in Australia. This is the second such order placed since the beginning of 1917, the first one, for 1,800 lines, being received in February.

The progress of the automatic in Australia has been most rapid. Only five years ago there was a single 1,100-line exchange in operation, at Geelong. Today there are nearly a score of exchanges and a total of practically 35,000 lines of automatic equipment in service throught the commonwealth. No "central" is required and thus misunderstandings are eliminated.

U. S. TO SPEND \$4,000,000 FOR NITRAT PLANT.

Secretary Baker has announced that a plant for the production of nitrats from atmospheric nitrogen would be constructed

immediately at a cost of about \$4,000,000 and that water power would not be used.

Informally officials explained that the announcement did not mean that the idea of building a water-power nitrat plant had been permanently abandoned, although it would not be pressed at present. Several

years would be required to build the enormous plant required for the utilization of water power, and for that reason it was determined that for urgent war purposes it would be necessary to adopt one of other processes of producing nitrats.

HOW TROLLEY MOTORMEN LEARN THEIR DUTIES.

By the time an applicant for the position of motorman or conductor on the Brooklyn Rapid Transit System has past thru their school for employees he has had it brought home to him that a man must have at least the qualifications of good character, a clean

rate detail of the mechanical equipment from which the men receive their instruction, are most impressive; and the entire array of massive and handsome exhibits, while attracting and holding the interest, might seem to defy the layman's understanding.

Here spread out before you are the vitals of the trolley car, dissected and labeled. (See accompanying illustrations.) No detail is left in darkness or obscurity. All is revealed. Even the little boy who for years has yearned to crawl under a car to see what it looks like inside would be satisfied. For in very truth he would see one turned upside down, and working just the same in spite of the awkwardness of this position, as a turtle sometimes keeps on working when you turn it over on its back. Be he schoolboy or grown man, any visitor would enjoy a trip around the motormen's room with one of Instructor Duffy's classes.

Emphasis is laid on the regular inspection of his car which a motorman is required to make before going on the road, special attention being called to the life guard, by which about ninety per cent. of persons knocked down by the front of a car have been saved.

Every part of the equipment is in its standard location, many of them bearing metal signs to accustom the men to calling things by their right names. Fare collection, door operation, buzzer signals, thermostat control of heaters, use of switches, replacement of fuses, etc., are also demonstrated. The use of the electric automatic track switch is taught in connection with the center entrance car, switch levers, semaphores and lights all working just as they would in actual service.

Step by step the men in the schoolroom become familiar with the elaborate mechanism that passes into their keeping when hand and controller meet. The "demonstration board," which shows the course of the current and the operation of the control from trolley wire to rail, is a toy which could not fail to fascinate any human being between the ages of six and sixty. When this board has been explained to him the student has a remarkably clear idea of how the electric current operates and how it is controlled.—Photos courtesy B. R. T. Monthly.

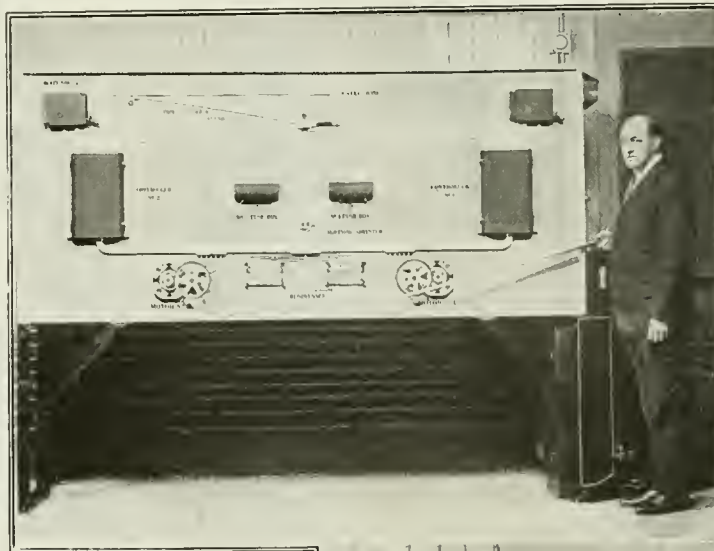

record, good health and a presentable appearance before he is even given a trial.

This frame of mind receives a new impulse when the student enters the B. R. T. Surface School Room, for here he finds himself in a place where there is manifestly much to learn—more, perhaps, the average applicant might feel at first glance, than he could ever hope to learn. The intricacy and elabo-

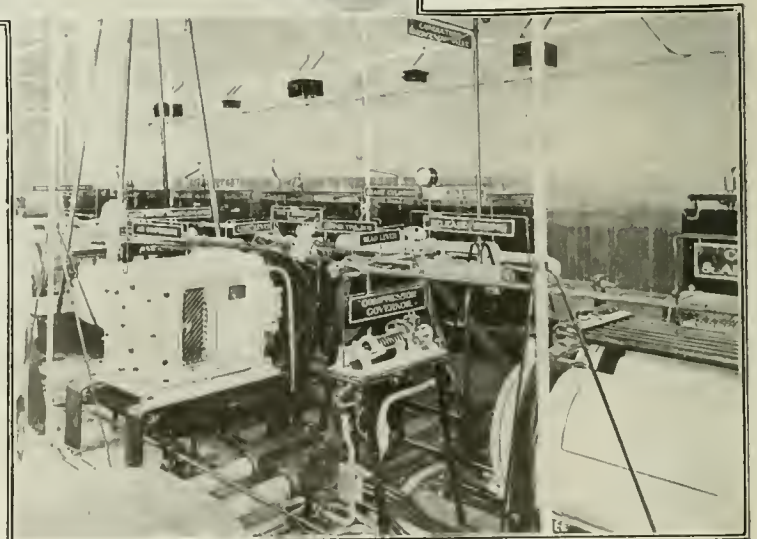

Two Views of the Brooklyn Rapid Transit Company's School for Motormen. Every Part of a Trolley Car Is Dissected and Demonstrated in Working Condition.

WOMEN AND ELECTRICITY.

When a woman is sulky and will not speak..... *Exciter.*
 If she gets too excited..... *Controller.*
 If she talks too long..... *Interrupter.*
 If her way of thinking is not yours..... *Converter.*
 If she is willing to come half way..... *Meter.*
 If she will come all the way..... *Receiver.*
 If she wants to go further... *Conductor.*
 If she would go still further *Dispatcher.*
 If she wants to be an angel... *Transformer.*
 If you think she is unfaithful *Detector.*
 If she is unfaithful..... *Lever.*
 If she proves your fears are wrong..... *Compensator.*
 If she goes up in the air... *Condenser.*
 If she wants chocolates... *Feeder.*
 If she sings wrong..... *Tuner.*
 If she is in the country..... *Telegrapher.*
 If she is a poor cook..... *Discharger.*
 If her dress unhooks..... *Connector.*
 If she eats too much..... *Reducer.*
 If she is wrong..... *Rectifier.*
 If she is cold to you..... *Heater.*
 If she gossips too much... *Regulator.*
 If she fumes and spitters... *Insulator.*
 If she becomes upset..... *Reverser.*

TELEGRAPHER LIFTS OVER 20 TONS PER NIGHT.

J. H. Johnson, an Associated Press operator in Boston, while working at Manchester, N. H., a year ago, devised an ingenious method of determining the amount of work performed by him in one night,

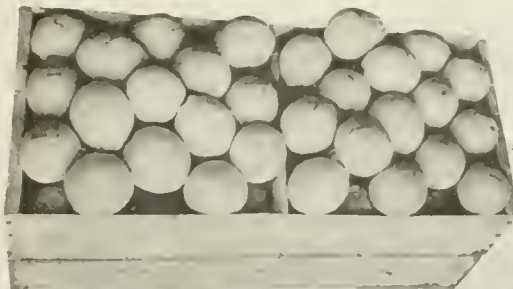

BRANDING ORANGES BY ELECTRICITY.

By Harold J. Wood.

ONE of the newest wrinkles under the sun is the idea of branding oranges, lemons and apples to protect them from the unscrupulous methods of fruit-

The Fruit Growers Have Solved the Problem of Indelibly Marking Their Brands by Means of An Electrically Heated Revolving Die. It Brands Two Carloads of Oranges Per Day.

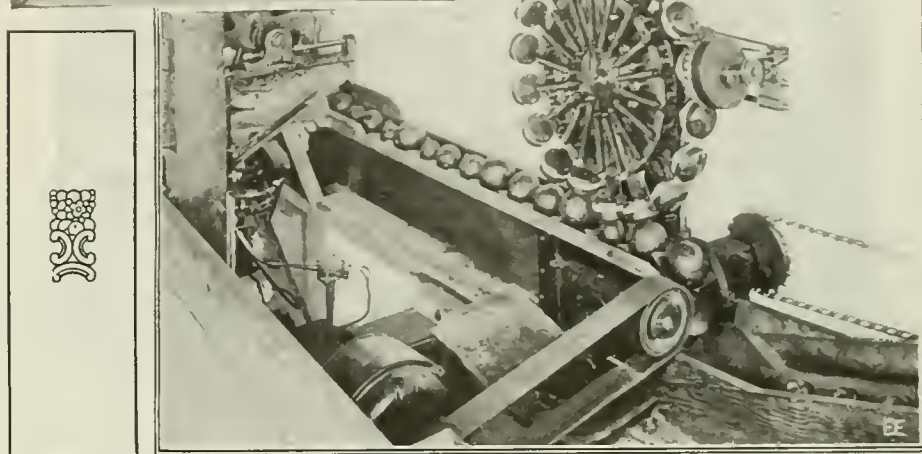

AUTO SCHOOL HAS ELECTRIC DYNAMOMETER.

One of the leading auto schools of the west has installed in its testing laboratory the modern electric dynamometer here illustrated. The students are thus enabled to make very accurate tests on any type of gasoline engine with regard to the horsepower output and other characteristics. The electric dynamometer represents the highest form of prime mover testing device available to-day. The dynamo unit is movably swung in substantial pedestal bearings as shown, the turning effort of the engine connected to it for test being indicated on suitable scales and electrical indicating instruments.

Aeroplane engines are now tested by a similar apparatus. No guess work enters the tests as carried out with the dynamometer, the results being accurate to within a fraction of a per cent. There will be a very large demand for engine drivers and experts this Fall.

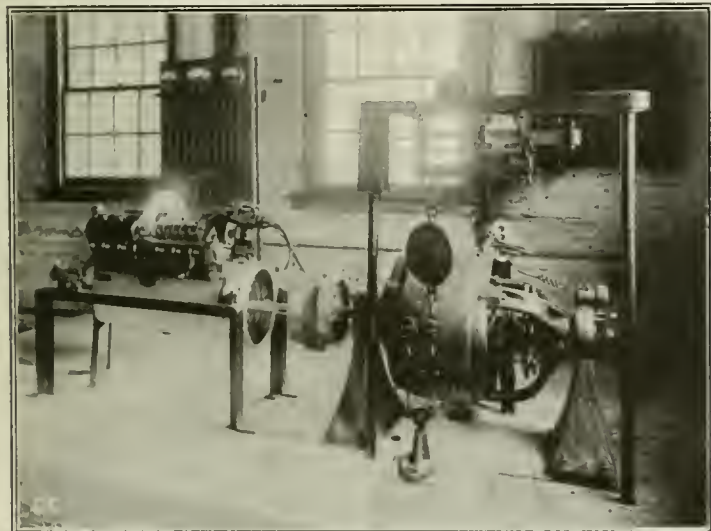

Photo Courtesy of Michigan State Auto School.

The Electric Dynamometer In Use for Testing Horse-power of Gasoline Engine In the Laboratory of Progressive Western Auto School.

express in mechanical terms says *Telegraph and Telephone Age*. By rigging up a postal scale in a special manner he found it required a pressure of ten ounces on the typewriter keys to print each letter, and in the course of a night, with an average report of 14,000 words, allowing five letters to a word, the total pressure exerted would lift 700,000 ounces, or 21¼ tons.

This computation was the result of a discussion which arose in the office of the Manchester paper as to which man on the paper worked the hardest.

The award was made to another man, but Mr. Johnson, not being satisfied with it, made the investigation of his own account, with the result that he was declared to be the hardest worker in the office. And yet they do say truck drivers are the only men that do real work!

WIRELESS PLOT IN ARGENTINA.

A secret wireless station has been discovered on the coast of the territory of Chubut by the Argentine Navy Department.

The authorities believe the station was to be used in communicating with suspicious vessels.

stand men in many parts of the country. L. Ahlberg, an Alaskan, has invented a machine which brands fruit by electricity. The California Fruit Growers Exchange has bought an option on the exclusive rights for the use of the machine in connection with shipments of "Sunkist" citrus fruits to all parts of the United States, Canada, England and Australia.

The machine can be used in branding any fruit that has a waxy skin. It will brand oranges, lemons, apples, pears, watermelons and cucumbers. The device consists of a big wheel with 18 spokes in it. At the end of each spoke is a shoe in which there is a die which stamps the name of the fruit into its cheek. As the wheel revolves, a small nipple at the top drops a little ink upon each die, and a felt wheel distributes it. An automatic device turns on the electricity or shuts it off whenever the temperature of the die rises above or drops below a certain point. The dies are prest down upon the fruits as they are carried along beneath the wheel on an endless belt of metal saucers, and each die makes its hot imprint into the cheek of the fruit.

The heat of the die melts the wax in the skin of the fruit, causing it to flow into the imprint of the die and fill up any breaks which might be made in the skin, at the same time taking up the ink from the face of the die.

Citrus growers in Southern California, where the machine has been operated in packing houses on an experimental basis for twenty months, declare that it gives absolute satisfaction. It is capable of branding two carloads of oranges or lemons per day.

AMONG the hundreds of new devices and appliances published monthly in *The Electrical Experimenter*, there are several, as a rule, which interest you. Full information on these subjects, as well as the name of the manufacturer, will be gladly furnished to you, free of charge, by addressing our Technical Information Bureau

Unique Revolving Dancing Floor

Do you like to dance? Well, here's a new one in gay New York that has the old-fashioned "barn dance" of our grand-dads beat forty ways.

gages this rack. The shaft is connected thru numerous reduction gears and attached to a 1/4 horse-power electric motor which slowly revolves the floor; not faster

CHROMIUM STEEL PERMANENT MAGNETS.

An investigation into the suitability of chromium steel for permanent magnets has recently been carried out in Germany and reported upon to the Physikalische-Technische Reichsanstalt. Figures are given for five bars of chromium steel, these being compared with five bars made of tungsten steel, the product of remanence and coercive force being taken as a criterion of quality. The remanence of the chrome steel bars was further tested under 20 hours' heating at 100°C., six heatings up to 100°C. and 20 falls from a height of 2 1/2 metres on to a wooden block. It is concluded that carefully prepared chromium steel is a suitable substitute for tungsten steel.



A New York Restaurant Has Provided a Real Novelty for Its Patrons in a Revolving Dancing Floor. An Electric Motor in the Basement Turns It Slowly While the Diners Enjoy the Novel Sensation.

When you are in town don't fail to take a trip to Murray's, one of the city's show places and cabarets, where between courses you may dance, dine and wine with your partner upon a floor that slowly revolves 'neath your feet, giving a pleasing and novel sensation as you whirl to the strains of the Jazz Band.

In the center of the revolving floor is a circle of beautifully colored glass, under which are myriads of lights and as one whirls around, flickering shadows are cast upon the dancers.

The writer, who did not know about the revolving floor feature, one day last month visited this restaurant and took a seat at one of the tables placed at the circumference of the revolving floor. At another table two feet away, but on *terra firma*, he noticed an acquaintance. A few pleasantries were exchanged, whereupon the writer buried his face in the voluminous bill-of-fare. It took several minutes to decipher the French dishes *et al*, after which he addressed a few more words to his acquaintance, not taking the precaution to look at him first. "Sir, how dare you!" spoke up an angry looking female, at the spot where the acquaintance was supposed to sit, but alas, sat no more! You see the floor had revolved smoothly and silently some six feet, and the writer's acquaintance was now that far behind! It took the writer a few seconds to realize what had happened, and the expression on his face while apologizing to the insulted damsel, must have been anything but intelligent.

Now to let the reader in on how all this is done—Presto. The floor is on a pivot under which are numerous wheels carefully set and oiled so as not to make any sound when the floor is moving. Along the outer edge of the floor (which is really a large disc twenty-five feet in diameter) is a toothed rack carefully concealed under the flooring. A pinion on a shaft that passes thru the floor to the basement en-

than one complete revolution every half hour. By referring to the sectional diagram

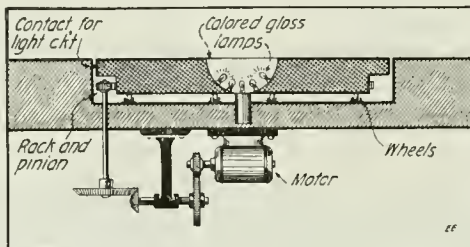

How Electric Motor Rotates Novel Dancing Floor.

a good idea of the mechanism may be obtained.

A gasoline engine driven dynamo that is entirely automatic in its action is attracting attention in England.

ELECTRICITY FROM THE WIND.

The electrical engineering department of the State Agricultural College of Manhattan, Ks., is at present engaged in conducting a series of experiments with a view to improving the prevailing methods of generating electricity from windmill power. In the present test the generator is mounted on the head of the mill and geared directly to the source of power, instead of being belted to the mill at its base, as is usually the practise. The main need at present seems to be a mill that requires a lower wind velocity to start those now available since the latter are idle for long periods at a stretch, and therefore necessitate the employment of large storage batteries.

NOVEL MEDICAL COIL IS CONTAINED IN HANDLES.

The accompanying illustration shows one of the latest electro-medical coils which is extremely compact as will be evident. The small induction coil, as well as the dry battery and regulating attachment, are all built into the tubular electrode handles which are connected together by a flexible conductor.

To use the apparatus the patient has but to hold the two electrodes in the hands and by pressing a small sliding switch on one of the electrodes, the current is turned on. The strength of the current may be intensified by means of a sliding tube projecting from one of the handles. If it is desired to apply the current by means of a dampened sponge electrode, then this device is inserted in a socket on one of the handles, and the current may then be switched on to the sponge instead of to the handle shell by depressing a switch button provided for the purpose. The com-

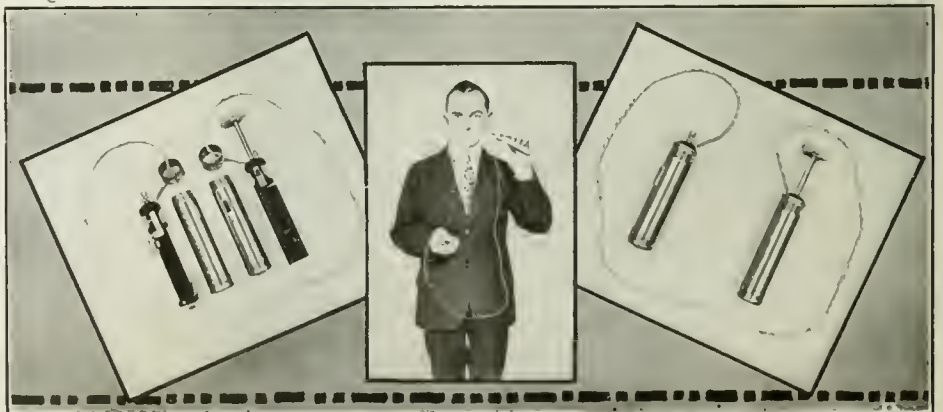

This Latest Idea in Compact Electro-Medical Coils Comprises a Small Induction Coil, Switches and Battery, Which Are All Contained Within the Two Electrode Handles.

The United States Bureau of Standards has developed a delicate thermo-electric test for the purity of platinum.

plete outfit is very neat in appearance, and a new dry battery can be replaced in a few seconds.

SCRUBBING BY ELECTRICITY.

The applications of electricity for relieving both man and woman of tedious work and drudgery are gradually being extended. One of the most irksome duties connected with the keeping tidy of large buildings and institutions, is the scrubbing of floors. Not only is this a laborious and disagreeable task, but it takes a great deal of time to go over a large surface of flooring with scrub brush or even with a mop.

The solution of this problem is the electrically driven floor scrubbing machine. A device of this character which has been tried out and found very satisfactory is illustrated herewith. The machine is entirely self-contained and, considering its large capacity, is quite compact. Its dimensions are 28 inches long, 20 inches wide, 16 inches high. The weight of the outfit is 100 pounds. The entire machine is made of metal except the revolving brush.

The upper portion of the machine consists of a tank for holding clean water. The machine wets, sweeps, scrubs and dries the floor at a single operation. It requires only a single attendant who merely pushes the machine forward and guides it. He controls the amount of water distributed on the floor by means of the handle. This water is immediately swept up by the cylindrical brush which is 16 inches wide and has a circumference of 23 inches. This brush is driven by a one-fourth horsepower motor thru a silent chain and sprocket so that the brush revolves at about 600 revolutions per minute. The brush does the actual scrubbing and carries all of the dirt and soiled water over an apron into a separate receiving pan so the scrubbing is always done with clean water from the upper tank. An upright is attached to the machine which carries a cord reel at the top to permit of taking in and letting out the cord by means of which it is connected to any ordinary lighting outlet.



A 1/4 H.P. Electric Scrubbing Machine for Use in Large Buildings and Halls. It Reels Up or Unreels Its Electric Supply Cable as It Goes Along.

This machine has an extraordinary capacity. It has been found that if the attendant pushes the outfit forward at a

rate of one mile per hour, it will scrub an area of nearly 7,000 square feet per hour. This is about ten times as much floor area as an experienced janitor can scrub clean in the same length of time. Not only has this machine exceptional capacity, but it leaves the floor much cleaner and more evenly scrubbed than can be done by hand.

Naturally the greatest field for a machine of this type is in cleaning corridors, halls and large rooms in public buildings, office buildings, etc. In such places the janitor work is usually done at night. Because the machine cleans the floors so rapidly, it results also in considerable saving in current used for lighting the premises during cleaning.

LET THE ELECTRIC LIGHTED KEY-HOLE FIND THE WAY.

The annoyance of groping about blindly for the keyhole on cold (or "large sized" evenings) nights will become a thing of the past if the invention illustrated here comes into general use. The device is that of an Ohio man. By pushing a button on the

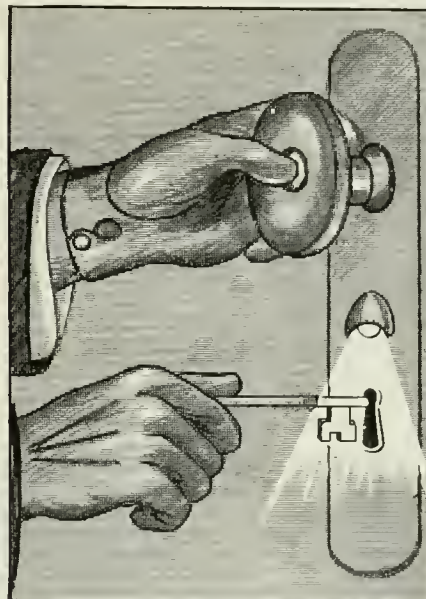

Blank — Blank — Where in — Is That Keyhole?! Push the Button in This Electric Knob Device and the Keyhole Becomes Instantly Illuminated.

door knob a small electric light just above the keyhole is flashed on and finding the keyhole then is an easy task.

ELECTRIC DRIVE FOR BATTLESHIPS "COLORADO" AND "WASHINGTON."

Contracts totaling approximately \$2,000,000 have been placed recently with the Westinghouse Electric & Mfg. Company, by the New York Shipbuilding Company, for furnishing the necessary electrical equipments for the propulsion of the new Superdreadnaughts "Colorado" and "Washington."

The equipments to be furnished are practically duplicates of that contracted for by the Navy Department for the U. S. S. "Tennessee," now building at the New York Navy Yard. The four propellers, as in the case of the "Tennessee," instead of being mechanically connected to driving engines or turbines, are to be driven by individual motors. The current for the motors will be furnished by two turbine generators.

A NOVEL ELECTRIC CIGAR LIGHTER.

The accompanying illustration shows a new type of electric cigar lighter for use in

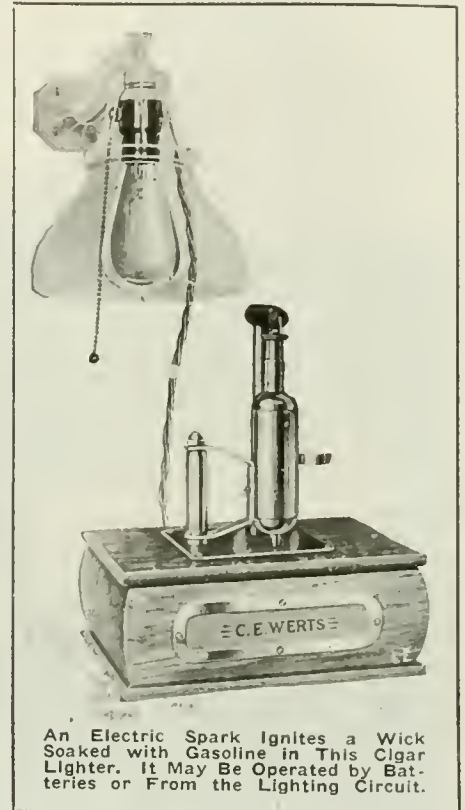

An Electric Spark Ignites a Wick Soaked with Gasoline in This Cigar Lighter. It May Be Operated by Batteries or From the Lighting Circuit.

cigar stores, or for private use. This device can be operated either from a lighting circuit or from batteries placed within the box supporting the lighter. This lighter insures a continuous stream of sparks which flow to the wick until it takes fire. The amount of electrical energy consumed for this purpose is very small. The only operating expense is the cost of 1 gallon of gasoline for feeding the wick. For this purpose 1 gallon of gasoline will last a full year. When used with batteries, a special control lever allows the device to use current only when the lighter is in actual use. This feature reduces the current consumption to a minimum. In case of wear or injury, any part of the lighter can be readily replaced at moderate cost.

In addition to the main generating equipments and propelling motors, the contracts include auxiliaries for the main turbine generators and smaller auxiliary turbine generators for supplying light and power thruout the ships. A multitude of electric motors will also be utilized for doing nearly all the work on board from raising the anchor to steering.

60,000 COPIES "E.E."

are now sold every month on the principal news-stands in the U. S. and Canada; and over 5,000 readers are disappointed every month because the news-dealer says: "Sold out!" How often did it happen to you? Why not order a copy from the news-dealer NOW? It costs you nothing to do so, and your copy will be waiting for you next month.

The greatest 15c worth in the U. S.

Intercommunicating telephones, electric lights, call bells, and a complete fire alarm system are installed in modern farm buildings on the estate of a wealthy Long Islander.

AN ELECTRICAL BROACH WRAPPER FOR DENTISTS.

For over fifty years, the treatment of root canals has been a nightmare to careful and conscientious dentists. Recent scientific investigation shows that the danger from the sort of treatment still in vogue among 99 per cent of operators, and the distress and mortality resultant from carelessness, improper methods, crude and inefficient instruments, are little short of appalling and certainly deplorable. To make root-canal operations a success the canal must be ade-

quately enlarged to permit thoro cleansing, which means that every vestige of dead nerve and bacteria, which is liable to be present, must be removed and the canal be perfectly filled, the most difficult part of the entire operation being the removal of debris under aseptic conditions.



Dr. Funk and His Newly Invented Electrical Broach Wrapper for Dentists which Bids Fair to Save Many Lives Annually by the Antiseptic Conditions It Brings About. It Ensures a Perfectly Clean Broach for Every Patient.

The only method by which root canals can be cleansed is purely mechanical and consists of wrapping cotton on steel needles, which have a fork or notch on the end. The notch is very important, otherwise the cotton would slip up on the shank of the needle and the cleansing cotton would not reach the base of the root, thereby leaving it uncleansed so that putrefaction would sooner or later take place, subsequently forming an abscess, which is liable to cause distressing, if not fatal disease, such as rheumatism, heart trouble, neuritis, blindness, insanity, and a host of other constitutional ills.

The old method of wrapping treating cotton on dental needles was accomplished by twisting it on the needle with the fingers; this is an uncleanly and dangerous procedure, the cotton being contaminated with dead cuticle, perspiration, and any germs that may have been present on the fingers of the operator.

Assuming there are 40,000 dentists in the United States, six patients per dentist per day, 240,000; three hundred days per year, 72,000,000 sittings; five applications per sitting, 360,000,000, to be conservative, divide this by two, 180,000,000. If one cares to be ultra-conservative, halve it again, 90,000,000 and re-halve it if you please,

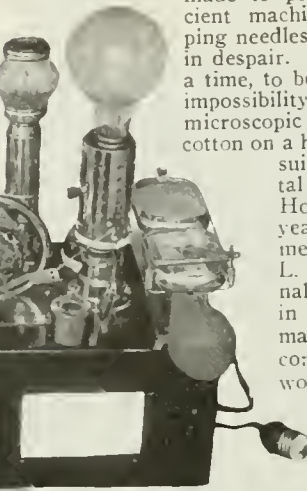

leaving 45,000,000 chances of infection due to digital contamination. This should still be sufficient reason to strive for safer and better methods. Many attempts were made to produce an efficient machine for wrapping needles, and given up in despair. It seemed, for a time, to be a mechanical impossibility to distribute microscopic threads of cotton on a hair-like needle suitable for dental purposes. However, after years of experimenting, Dr. L. L. Funk has finally succeeded in perfecting a machine that accomplishes the work in a most perfect, satisfactory and sanitary manner: the cotton at no time coming in contact with the fingers of the operator. The machine is self sterilizing and there can be no chance of infection due to faulty mechanism, since materials do not come in contact with germs during the process of wrapping, sterilizing would seem unnecessary; however, on the principle of safety first, last, and always, the machine is provided with five sterilizers, practically every method known to science, to be used in conjunction with the wrapper. The machine is simple to operate. A child ten years of age with ordinary intelligence can wrap broaches more quickly and perfectly than it can possibly be done by hand.

In view of the awful carnage now rampant thruout the world, and from a humanitarian standpoint I desire to offer what service I can, consistently, to the United States Government, by donating these Broach Wrappers to be used in Government Infirmaries, says Dr. Funk, with the hope of at least preserving one life for every life destroyed in battle.

A MOTOR THAT RUNS UNDER WATER.

The accompanying photograph shows a sturdy 3½ horsepower electric motor running under water. This motor was first put under water in September, 1909, at a Machinery Exhibition in Cleveland, where



A 3½ H.P. Electric Motor Running Under Water.

it attracted such great attention that it was decided upon as a sort of trade mark for the manufacturers.

The motor has repeatedly been used in installations where it is subject to condi-

tions fully as severe as this. One salt works in Cleveland has had a number of these motors in operation for over ten years, and the wet salt has caked into the windings, until they are scarcely visible; still there has been no motor failure in all this time. It takes a particularly husky and well-built motor to withstand any such treatment as this.

A MOTOR-DRIVEN COMMUTATOR RECTIFIER.

The rectifier shown in the accompanying illustration is designed for the charging of small storage batteries, such as used with automobile ignition, lighting and starting sets. The single-circuit type is a

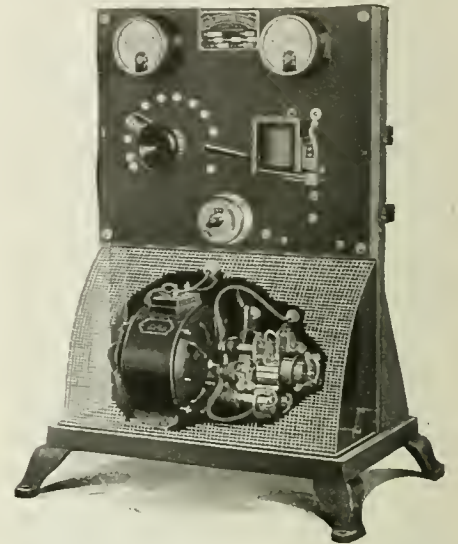

One of the Jobs We All Hate to Tackle Is Charging Storage Batteries. In This Simple Automatic Device a Motor Drives a Commutator in Such a Way that the Alternate + and - A. C. Pulses Are All Rectified or Converted Into Direct Current.

self-contained charging plant that will charge from one to five batteries (or up to a total of fifteen cells). By keeping the rectifier running twenty-four hours a day and taking out each battery as soon as fully charged, on an average, a total of thirteen 3-cell batteries, it is claimed, can be given a full charge in twenty-four hours, allowing for the average amount of residual charge. The rotating commutator principle is employed. Current from the alternating-current supply is brought to two terminals at the back of the switch-board. From these terminals the current passes thru the line switch to a special induction-type motor. On the extended shaft of this motor are two collector rings and beyond them a commutator. The synchronous motor is of such design that no further attention need be given in starting than to simply close the line switch, at which time the motor will start readily and fall into synchronism, remaining so, it is said, even at a great reduction in voltage.

EFFECT OF ELECTRICITY ON CROPS.

Important experiments on the application of electricity to agriculture are being made, under government grant, at Huntington, in Hereford, England. As is well known, high-tension discharge accelerates the growth of plants, and may lead to a considerable increase in the yield of crops from a given area. Associated with these experiments are Prof. T. H. Blackman, Mr. W. Duddell and Mr. I. Jorgensen, a Danish expert. Mr. W. J. Kerr, city electrical engineer of Hereford, is also concerned with the movement.

THE RECORD-LITE ILLUMINATES THE VICTROLA NEEDLE.

The miniature electric light for phonographs here shown is a neat, ornamental

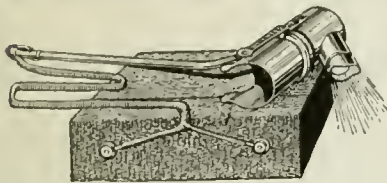
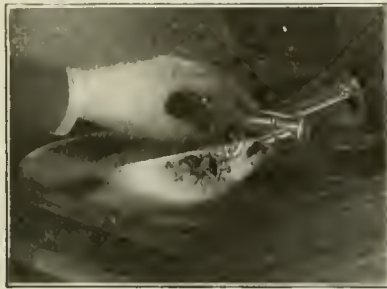

Have You Scratched Victrola Records Now and Then While Trying to Adjust the Needle? The Record-Lite Was Designed to Oblviate This Difficulty. It Works on Batteries.

attachment, that comes complete and ready for use. The installation is simplicity itself—the light is slipped over the end of a taper tube or tone arm, until it snaps into position and is ruggedly and permanently fastened. The battery box is set in the left-hand rear corner of the machine, or may be concealed inside the machine.

The operation is equally as simple. The second finger of the left hand rests naturally on the contact spring when operating the machine and the light illuminates the record, where the needle rests. As soon as the hand is removed, the light automatically goes out. The equipment includes a three-cell dry battery, and a four-volt flashlight battery lamp.

ELECTRIC BINOCULAR MAGNIFIERS.

By Thos. W. Benson.

The binocular magnifier has been designed to enable medical men, zoologists, geologists, botanists, art metal workers, watch-makers, and others called upon to examine small objects with a low magnification, to do so conveniently and with both eyes simultaneously.

Binocular vision in such a device has always been desirable in order to gain perception of depth, but optical means here-



This Binocular Magnifier Is Fitted with a Small Electric Battery Lamp for Illuminating Dark Cavities.

before available proved insufficient to provide it. Binocular vision correctly applied not only results in better definition, but allows the operator to observe the object in relief, giving practically a natural perspective.

This condition is fulfilled in the binocular magnifier illustrated herewith by arranging two rhombohedric prisms so as to reduce the distance between the two fields of view and thus place them within comparatively small convergent angles.

The magnifying lens system is arranged so that any desired magnification can be obtained by inserting the proper lenses. The maximum magnification recommended is three diameters, which allows of a large range of working distance.

The eye-piece caps are made of ebonite shaped to fit snugly over the edges of the orbit, the entire instrument being held in place by an adjustable elastic or special fiber head-band fitting around the head. Apertures are provided in the eye-pieces for ventilation and to prevent moisture collecting on the lens surface.

To facilitate the examination of cavities and dark uneven specimens, etc., an illuminating appliance can be fitted to the head-band. This consists of a small incandescent lamp operating on dry cells, as shown.

NEW OSCILLATING ELECTRIC WASHER A TIME-SAVER.

The oscillator principle followed in designing the new electric washing machine here shown utilizes both suction and compression force of air within its vacuum chamber. When in use the dasher oscillates in up and down motion something like a child's teeter-totter. It is available in either electric motor drive or gasoline engine drive.

As the dasher raises out of the water the vacuum chambers fill with air—when it goes down into the water the force of

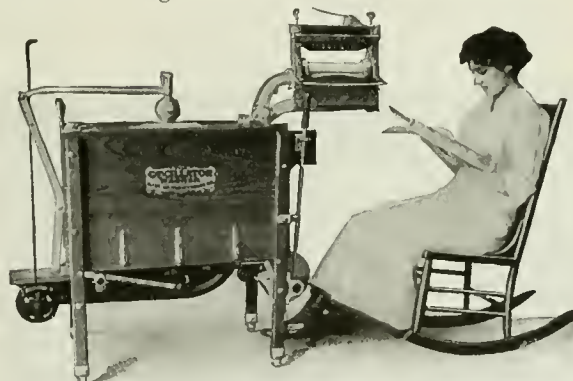

Electricity Has Reduced Wash-day Labors to Child's Play, Thanks to the Motor Which Not Only Rubs the Clothes But Wrings Them as Well.

the air compression drives the hot suds thru the clothes—then on its upward swing the air suction draws the suds back thru the clothes. All the washing is therefore done thru the use of air pressure and suction. This eliminates all rubbing, swishing around on pegs and other mechanical action that wears and tears clothes.

The machine is said to wash anything that can be washed with soap and water, cleaner and quicker than by any other method. The most delicate fabrics being washed without perceptible wear. All gearing is enclosed for the protection of the operator.

Included as part of the regular equipment is a swinging wringer—also a special folding bench. Also there is provided quick wringer release, safety hand control, safety foot control—the complete outfit wrings and washes at the same time.

ELECTRICALLY OPERATED AND LIGHTED ALARM CLOCK.

A great convenience in a bedroom is to have a reliable alarm clock to arouse the sleeper in ample time for the day's duties.



Automatic Electric Alarm Clock with Nite-Lite Attachment for Illuminating Dial.

Such a clock, electrically operated and with a special electric-light attachment, has now been made by a New York concern. As shown in the illustration, this is a handsome clock which adds to the appearance of any dresser or other bedroom furniture. The clock is electrically wound. In the bottom of the clock case is a dry cell which furnishes current for operating the clock, for ringing the alarm and for lighting the lamp shown just below the dial. This lamp is controlled by a push-button connected to a cord of considerable length, the button being placed near the bed so that by pressing it the dial is illuminated and the time observed at any period of the night without getting out of bed or other discomfort.

A NEW SOLDER-LESS WIRE CLAMP.

Wire-clamp connectors for circuits, fixtures and grounding purposes which are designed to connect four wires or less of different sizes without the use of heat are now being offered. To connect the wires the screws of the device are loosened slightly and each wire is inserted in one of the four loops and securely connected by tightening the screws. A knurled surface is provided on the nut threaded on each screw so it will grip the wire and not

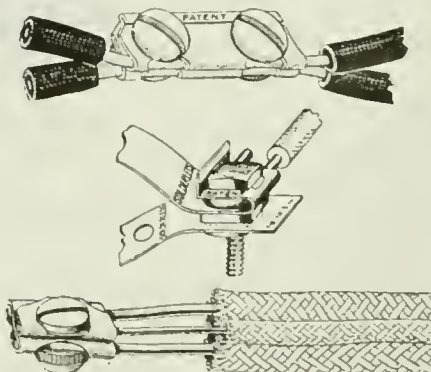

A Clever Wire Clamp Which Requires No Solder. Particularly Useful to Electrical Experimenters for Making Various Circuit Changes Quickly.

turn when the screw is drawn up. These connectors are also made for grounding work. They are very useful for electrical experimenters for making connections in the laboratory and among instruments.

Are There Currents About A Magnet?

By F. F. MACE, Superintendent of Public Schools, Dallas, Texas

IN a previous article in regard to *Magneto-graphs* it was demonstrated beyond controversy that there is actual motion, that there are actual currents, about a magnet, even a *permanent* magnet, and that this motion, these cur-

torsion of the thread does not become too great. With a powerful magnet the rotation may be even continued to the breaking point of the thread. But the revolution is always counter-clock-wise over the *North* pole and clockwise over the *South* pole.

B, C, and D may be made to revolve in the same manner and the direction is *always the same*. "E" in the same figure is a helix *without* an iron core. The same result may be obtained with this as with the electro-magnet F.

If A, B, C, and D are suspended as before and a permanent bar magnet is brought underneath and rapidly thrust up and down, they will rotate as before; that is, counter-clock-wise over the *North* pole and clockwise over the *South* pole.

Here then, if it had not already been proven by the effect of the magnet upon a photographic plate, is proof that there is *motion*—that there are *currents*—about the poles of a magnet and that these currents are the same about an electro-mag-

net, and currents capable of penetrating substances and affecting photographic plates, will doubt that, here is motion—currents—and that *these currents are rotary*. Lines of stress, or any other assumption can not account for this motion of the objects. Even a child recognizes the effect of currents in the moving straws and determines the direction of the currents by the path of the straws.

Nor would an assumption that this motion of the objects is produced by an attempt of the partially magnetized iron to set itself tangent to the lines of force about the magnet appear to be tenable. In Fig. 1, A may be made with strips of soft iron or it may be made with steel magnets. The magnets may be arranged in pairs with their poles in the same direction, or they may be arranged in pairs with their poles neutralizing each other. In any arrangement the result is the same, and the direction of rotation is the same. If "D" is used instead of "A," the magnet will temporarily impart to the lower end of the wire a magnetism *opposite* to that of the pole of the magnet. The tendency then is for the lower end of the wire to be strongly attracted to the magnet and to point to the center of the pole, but instead of this it swings in ever-widening circles about the pole of the magnet, the point of the wire becoming further and further from the magnet. Then we may go further. A loose "snarl" of soft iron wire may be suspended in the place of the other objects. The result is the same. Yet it would take quite a stretch of imagination and a decided determination to adhere to "it has been so written," to assume magnetic poles for a snarl of wire or that there would be any tendency to set itself tangent to the lines of force. Go even further. Suspend an iron ring in the same manner. Assume that it becomes magnetized or that it does not become magnetized. If it becomes magnetized the poles correspond to a continuation of the line made by the thread. But in any case the ring revolves as do the other objects.

It has been customary to "map the lines of force about a magnet" by sprinkling iron filings on a sheet of glass or cardboard placed over a magnet and then tapping the glass or cardboard. Now it is a well known fact that powder or iron filings may be made to arrange themselves in lines on glass or other substance by tapping or by stroking with a fiddle bow, etc.

The character and direction of these lines will be determined to a great extent by the nature of the disturbance. The same is true when we tap the glass over the magnet only that here we have a resultant of forces. Tapping the glass just right will produce

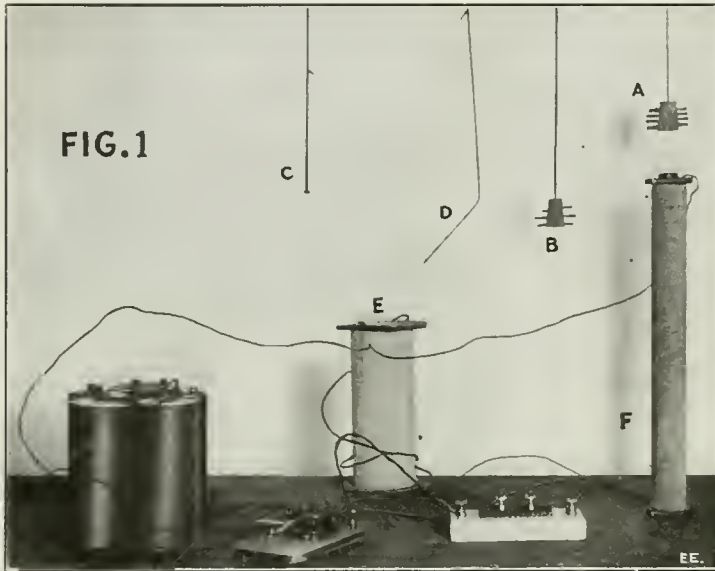

FIG. 1.—Apparatus Used by the Author for Demonstrating that Rotary Motion Is Created in Suspended Magnetic Objects When the Current in a Magnet Coil Below Them Is Suitably Interrupted.

rents, are of sufficient potentiality to affect a photographic plate and to penetrate wood, thin sheets of metal, and other substances. In the present discussion further proofs of these facts will be added and the direction and the character of these currents will be given. (See May, 1917, issue.)

In order to follow the subject in a perfectly logical manner I should begin with an experiment in regard to currents surrounding a charged wire, which experiment will be given later, but that this demonstration may be at once striking and convincing I shall first set out other experiments the conclusions from which are too obvious to be overlooked or denied.

In Figure 1, at "A" is shown a cork thru which are thrust straight, flat pieces of iron or steel. "B" is the same except that round iron wire is used in the place of the flat strips. "C" is an iron wire bent at right angles to its axis when hanging. "D" is an iron wire bent at an obtuse angle to its axis when suspended. When A is suspended by a thread of unspun silk or a hair over the electro-magnet "F" and the current passing thru the coil of the magnet is alternately made and broken by means of a key, A will revolve rapidly. If the direction of the current is such as to make the upper pole a *North* pole the rotation will be counter-clock-wise. If by means of a pole reverser the upper pole is made a *South* pole the revolutions will be clock-wise. This rotation may be checked and reversed at any point by reversing the current so as to reverse the poles: the only precaution necessary being to hold the current for an instant at the point of reversal so that the rotation is stopt. The revolutions may be continued to any length in one direction provided the

net upon a photographic plate, is proof that there is *motion*—that there are *currents*—about the poles of a magnet and that these currents are the same about an electro-mag-

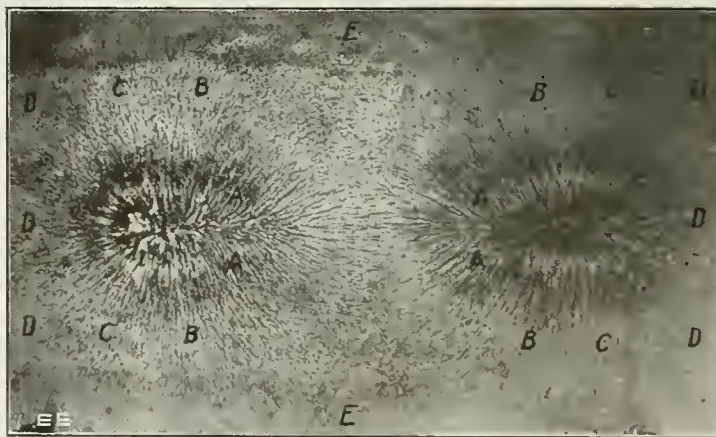

FIG. 2.—Showing the Lines of Force—or Rather a Map of the "Currents" About a Powerful Magnet. Taken by Means of Iron Filings Sprinkled on a Sheet of Glass Under Which the Magnet Is Placed. Then the Current Thru the Coil Was Made and Broken.

net and a permanent magnet. Moreover, it is plainly indicated that these currents not only move toward the magnet but that they also rotate in their forward progress counter-clock-wise over the *North* pole and clockwise over the *South* pole. A moment's consideration will show that these currents thus form a continuous spiral about the magnet and that this spiral conforms to the direction of the current about an electro-magnet and in the permanent magnet. No one capable of logical thinking, even if it had not already been

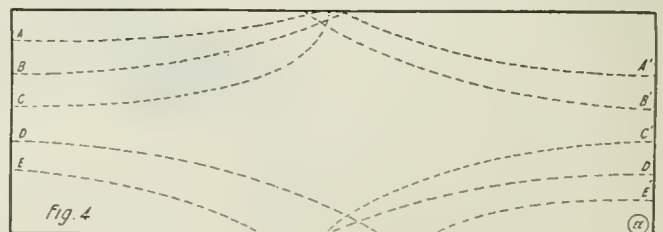

FIG. 4.—Various Paths Taken by an Iron Ball Over a Plane Surface, Such as a Card, Placed Inside a Solenoid.

the conventional lines about a magnet; tho it requires a great stretch of imagination to see the closed curves passing from one pole to another. Aside from this, different tapping, even when the magnet is used, will produce different results. A half score of "fields of force" can be produced in this manner. So easy is this of demonstration by anyone that it is not worth while to reproduce any of these fields here. But Fig. 2 shows a map of the lines of force—or more properly a *map of the currents*—about a magnet produced without jarring or touching the plate in any manner. In this experiment the electro-magnet "F" in Fig. 1, an electro-magnet thirty-eight centimeters in length, was used. This magnet was placed under a sheet of glass on which iron filings were sprinkled and the lines shown in the figure were produced by making and breaking the current in the coil about the magnet. These lines begin to form as soon as the circuit is closed. A little examination will show that the old "conventional" lines were erroneous and that the theories and conventions founded upon them were still more so. *Note carefully the direction and continuity of these lines.* In no place are they continuous from the North pole to the South pole of the field. At A, A, A, A, the lines actually make a sharp reverse curve and from curving inward toward the magnet show a tendency parallel to the magnet and more in the direction of the poles. At B, B, B, B, the lines are only slightly curved. At C, C, C, C, no curve can be detected. At D, D, D, D, there can be no question in regard to their being straight lines and that under no circumstances would they meet the lines from the other pole. Even at the center of the field, these lines do not form absolutely closed curves. At E, E, they show a tendency to meet each other, the lines from the opposite poles, at an angle. With some lines the angle is quite apparent. Here, then, is proof that the lines of force—currents—do not move in closed curves from the North pole to the South pole. That these are *currents* and not lines of tension will be further emphasized by the next experiment.

Place the electro-magnet under a tank of water (I used a glass bottomed tank placed over a magnetic field already produced by the magnet) and in the water place a small piece of iron attached to a cork. When the cork is placed over a point on the line E, E, and the circuit of the magnet is closed, the cork will remain almost if not quite stationary, or will even exhibit a slight tendency to drift away from the magnet. If placed a few millimeters to the right or left of this line, it at once moves in the direction of the nearest magnetic

pole following closely the direction of the line over which it is placed. Note carefully that the cork follows the curves shown in Fig. 2. If a magnetic needle is substituted for the iron the action is the same except that the needle is attracted or repelled along the lines according to its polarity. A magnetic needle placed over one pole so as to be repelled will often move to the center of the field and there stop. If a large bar magnet is substituted for the electro-magnet underneath the water the result is the same. Here, then, is proof of two facts: first, that there is *actually motion* about the magnet, *currents*, and that these currents do not move from one pole to another but that the currents originate near the center of the field (that is, those not entering from the directions of the ends of the poles) and move toward both poles. Also that in the center of the field between the two poles of the magnet is a point of neutrality or of actual repulsion, a point where the currents are outward.

If further proof is needed that there is an outward flow of currents from the center of the magnet it is furnished by the photographic plate. Fig. 3, is such a plate, taken underneath the "U" bend of a U-shaped magnet. "A" shows the position of the plate, the objects, and the magnet. "B" shows the result, the plate being taken under the same conditions as those described for the other *Magneto-graphs* (See first paper in May issue.) Now a current flowing upward would affect the photographic plate but would not produce an image of the objects, for the reason that it would be flowing toward them and would pass thru the plate before reaching them. In order to penetrate the objects and thus

and to one side. Place a piece of iron at both ends and when the circuit is closed

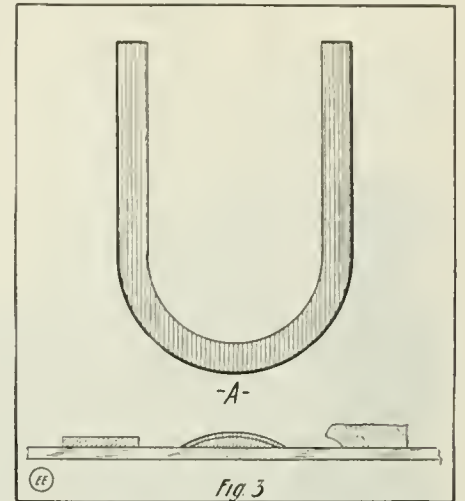

Demonstrating that There is an Outward Flow of Currents from the Center of a Magnet. To Make a "Magnetograph" Several Objects Are Placed on a Photograph Plate Beneath the "U"-Bend, and Left in the Dark for Several Weeks.



Fig. 3-B.—"Magnetograph" Obtained by Above Arrangement.

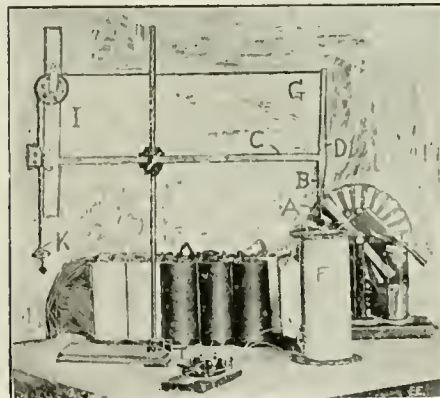

Fig. 5.—Apparatus for Measuring the Strength of the "Interior Current" of a Solenoid.

make their impression on the plate it must be passing downward; that is, must be flowing outward from the bend of the U magnet. The plate speaks for itself.

So far only the *exterior currents* of a magnet have been examined. The *interior currents* show equally interesting results. Place the solenoid "E" in Fig. 1, on its side and place a plane of cardboard inside on a line with the diameter. Place a small piece of iron on the end of the cardboard plane and as soon as the circuit is closed the iron will spring to the center of the coil

they will meet in the center of the coil, but it should be noted that one alone will move to the center. This shows that there are currents moving inside of the solenoid and that the attraction of the solenoid is not at the poles but at the center and toward the sides. This is also proven by the photographic plate for photographic plates exposed inside a helix bearing a current give results similar to the *magneto-graphs* already shown.

Again, place inside the solenoid "E" the cardboard plane as before and cover it with a soft but not rough paper. If an iron ball is placed on the cardboard at "A", Fig. 4, and the circuit is closed the ball is drawn inward and to one side. If the same is repeated by placing balls in succession at "B", "C", "D" and "E", and at "A", "B," "C," "D" and "E" the result is the same. The balls must be placed on the card one at a time and the circuit closed and opened again before another is put on. If several balls are placed on the card at the same time and the circuit closed, their tendency is to cluster together. If these balls are coated with oil and lamp black they will leave a faint trace of their several paths. Fig. 4 is the reproduction of an actual tracing made on cardboard in this manner.

The existence and strength of these currents is emphasized by another experiment. The solenoid here shown is twenty centimeters in length. Fig. 5 shows apparatus for measuring the strength of the *interior current* of this solenoid. "A" is a small piece of iron of known weight which is fastened to the wooden arm "B". "B" is pivoted to the crossbar arm "C", at "D", and so arranged by means of a set screw as to be lowered or raised inside the sole-

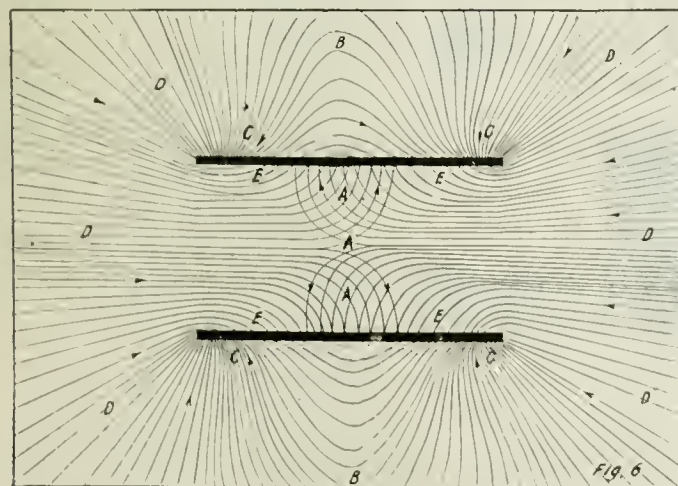

Fig. 6.—Map of the Interior Lines or "Currents" of a Solenoid as Plotted by the Author.

(Continued on page 417)

New Portable Electric Lamp For Miners

By F. T. FORSTER

Pittsfield Works, General Electric Company

WITH the advent of coal mining it was discovered that open flames in mines were sometimes dangerous, owing to the fact that explosive mixtures of methane gas frequently occurred. This led to a series of investigations to produce a lamp that would primarily prevent explosions and secondly detect the dangerous gas.



The Latest Safety Electric Lamp for Miners.

The electric incandescent lamp naturally obviates the objections found in the open-flame type miner's lamp. While the electric lamp will not detect gas, this can easily be accomplished by employing a few Davy lamps for this purpose. Special electric gas detectors are now being developed and it will probably only be a matter of a few months before thoroly reliable devices of this type will be on the market.

A glowing lamp filament has been proved by the Bureau of Mines to be dangerous. It is therefore necessary to supply each device with a safety switch that will break, or otherwise discontinue, the current thru the filament when the bulb is broken.

Tests with light and heavy blows in the directions most likely to cause failure are applied to each device and it must not fail on any test in order to pass, for obviously one failure in a mine might mean death to many miners and much damage to property.

Batteries must be proved by test to possess a capacity sufficient to burn the lamp through an entire shift of 8 to 10 hours with a margin of safety.

The first requisite of a mine lamp is to give light for the miner to find his way thru the various unlighted passageways to his work and then to enable him to perform that work in an efficient manner during the entire shift. It is therefore quite necessary that the light should decrease as little as possible in brilliancy during the time the miner is "inside." This is accomplished by using an ironclad storage battery very even. Except for the sudden small decrease in voltage which takes place in the first few minutes on a freshly charged battery, the change over 9 hours is only 6 per cent, or less than 1 per cent per hour.

The distribution of light is exceptionally good. A porcelain reflector of irregular shape is used, thereby eliminating those sharp changes in brilliancy that are characteristic of polished metal reflectors.

The cap shell is fitted with hooks for mounting the lamp on the miner's cap at such an inclination forward as to throw the beam of light directly upon the work which the miner is doing.

In this type of miners' lamp, the safety feature consists of two flexible contacts which hold an elliptical-shaped bulb hav-

ing a contact at either end with the filament extending thru the lamp between its two contacts. The illustration shows this safety device lamp mounting for holding the bulb. Any blow which will break the bulb in any manner will force the lamp out of the contacts.

Much depends upon the battery, of course. If it does not supply current to light the lamp for the full working time the miner will have to stop work sooner than otherwise, thus decreasing the output of coal for the mine owner and causing a loss of pay to the miner. It may also be difficult for him to find his way out of the mine if he does not have assistance from someone who has a lamp. With the ironclad battery, a reliable source of power is assured. The lead battery plates are very rugged and have established a reputation in mine locomotives and heavy trucks for their ability to withstand heavy duty conditions and severe shaking. The plates are contained in a strong, well-designed, semi-hard rubber jar that will stand an unusual amount of abuse. By making the metal containing case of proper design for the conditions under which the equipments are to operate, no trouble has been experienced from cracked or broken jars. The cover is fastened to the jar by a double caillary seal, which is acid-tight.

The filling and venting scheme is very simple and effective. To fill the battery the vent plug is removed, which gives free access to the cell space, and the level of the electrolyte is brought to within a small distance below the edge of the plug opening. The vent plug is very effective in preventing spilling of the electrolyte and is securely sealed in place by a quarter-turn of the plug, which draws it down against a rubber basket in a suitable seated surface on the jar to prevent any leakage of acid. The electrolyte, which is the usual battery acid (sulfuric), is corrosive in its action on metals and will damage all kinds of cloth except pure wool, yet on account of the degree of perfection which has been obtained in making a strong non-breakable jar, a perfectly seated vent plug, and a non-spilling vent no acid can escape.

SECRET WIRELESS RAZED.

Costa Rican Government authorities have dismantled a powerful wireless station at Heredia that is supposed to have been used by Germans. It was found on the property

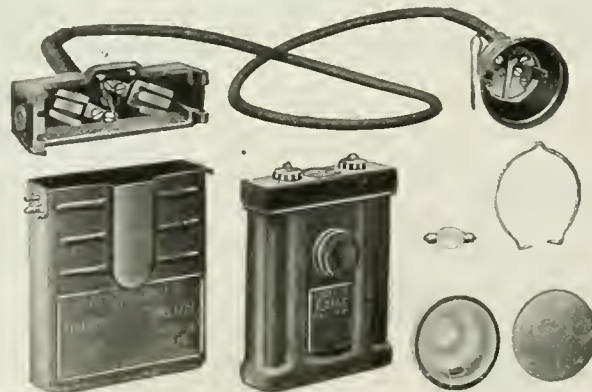

New Electric Miner's Lamp Disassembled.

of the former Governor of Heredia Province, Dr. Marcos Rodriguez, an intimate friend of the deposed President, Alfredo Gonzales, and of the latter's adviser, J. Kumpel.

ELECTRIC CLOCK DRIVEN BY EARTH CURRENTS.

This clock, unlike an ordinary time-piece, is not actuated by either weights or springs. The motive force is a current of electricity obtained from a pair of plates buried in old Mother Earth, and which are connected with the clock by wires.

The current is applied by means of an electro-magnet direct to the pendulum, so that the pendulum drives the clock, instead of the clock driving the pendulum, as is the case where weights or springs are used.

The current is reversed at each swing of the pendulum by an automatic switch, and this switch is so adjusted as to prevent the pendulum being moved in either direction beyond a given point. It is the application of this principle which secures correct time and overcomes any slight variation in the strength of current, and it is this which makes the *Earth-Driven Clock* a distinct advance upon electric clocks as previously made.

An interesting report has been given on this clock by Professor Silvanus P. Thompson, F.R.S., the world-renowned electrical expert, who has minutely examined the clock. The following are extracts from his report:—

"Having had the opportunity—both to see the earth-driven clock at work, and to examine the specifications of patent on this invention, I beg to report as follows:

"The pendulum is both the governing part and the driving part of the clock. I made various simple tests on the clock with a milli-ampere meter attached to the circuit. If I purposely gave the pendulum, by hand, a large impulse so that it swung too far, at once the automatic action of the contact device became evident, and after a few swings the current returned to its normal value, and the pendulum to its normal swing.

"It is, as will appear from the above description, entirely automatic and self-contained.

"I see no reason to doubt that with an earth battery properly laid, it will continue to go for years without stopping.

"I have used earth batteries many years ago, and know them to be extremely constant if they are properly laid down in the earth once for all."

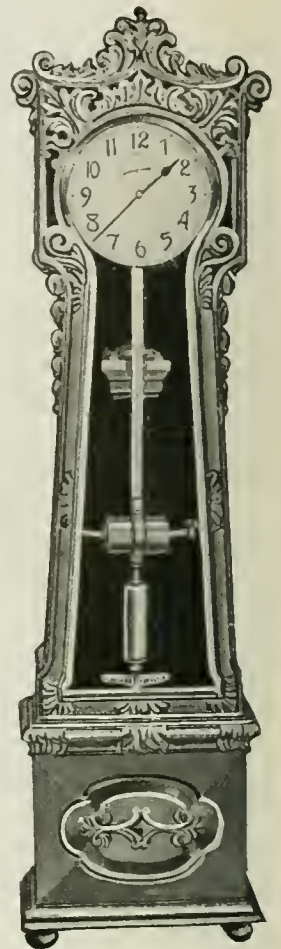

The Electric Clock We Have All Dreamed of. It operates on Electric Current from the Earth. No Battery Required.

MILK SHAKES BY MOTOR IN 10 SECONDS.

Several new and excellent features are embodied in the new motor-driven mixer



The Day of the Hand-Made Milk Shake is Past, Thanks to the Always-Ready Electric Motor.

here illustrated. The entire base and column is finished in white porcelain enamel. It can be easily kept clean and dispensers will appreciate this sanitary feature.

The motor which drives the mixing spindle is stationary on the head of the column, only the mixing spindle moving up and down. The spindle is light and the mixer is very easily operated. The current is automatically turned on when the spindle engages with the driving disk on the motor and is shut off instantly when the spindle is raised. This does away with the splashing of the contents outside of the container as is experienced with other types of mixers.

Another advantage of this mixer is that the spindle raises to a height of 7½ inches, enabling the largest container or mixing glass to be set under the spindle without tipping the container.

ELECTRICITY CLEANS ERASERS RIGHT IN SCHOOL-ROOM.

With the machine here shown erasers are cleaned right in the school-room or in the corridor. No need to throw them into a basket and take them outside or into the basement. A small girl can operate the device and get the erasers thoroly clean.

Turning the switch sets a rapidly revolving brush in motion. This loosens the dust and the suction developed by the motor extracts all of the dust from the surface and crevices of the felt. The dust

is drawn into a section of the base. The air created by the strong suction is filtered before it comes out of the exhaust. This is one way of solving the black-board and chalk problem, but it's a wonder to us

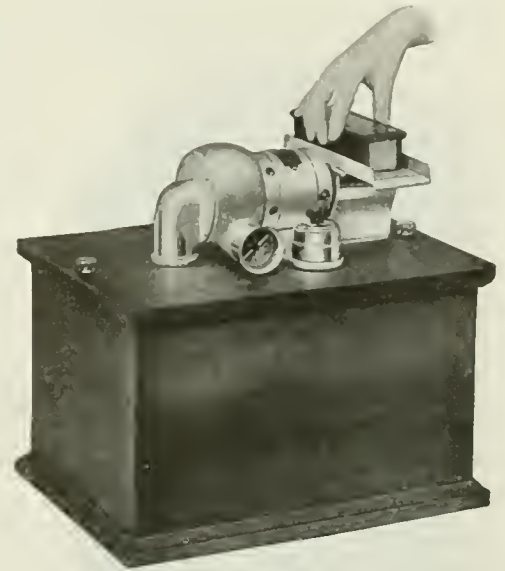

Electricity Now Cleans the Germ-Laden Black-Board Eraser in a Thoro and Sanitary Manner.

that some genius has not perfected a more cleanly and scientific school-room appurtenance than the "black-board eraser."

The Effect of Ultra Violet Rays on Milk and Other Aspects

By DR. HUMBERT BIZZONI

THE actions presented by the ultra violet rays on animal substances, or to state better, the changes produced on infinitesimal life by the ultra violet rays, are such as to leave much doubt and supposition as to their qualities as a friend of man. Still their chemical, physical and biological actions are not as yet known well enough that we might say *à priori* that they are *detrimental* or *beneficial*. The transformations produced by these rays are evident and show their existence, but just how this action forms or develops is yet to be explained, and it would be hazardous to state a fact on a subject which can be clast only in the same category with the undiscovered merits of the X-Ray.

In 1912, Holland had averred that the ultra violet rays were an enormous microbicide on animal substances, and they immediately adopted the ultra violet rays to sterilize their milk by passing it from one container to another in a thin film or stream upon which was projected the ultra violet ray. This was supposed to have the action of sterilization and preservation. The fact of sterilization existed, but while certain microbes were destroyed in this manner, especially those which are injurious to human life, it did not prevent the milk from turning sour; on the contrary the development of the germs under the action of the ultra violet rays was so great, that they seemed to find themselves in a most favorable environment, which was clearly seen under microscopic inspection. In fact, upon projecting an ultra violet ray on a vessel containing milk, it would be seen that the section upon which this ray touched becomes a veritable tumultuous life of multiplication of germs. This clearly indicated that while the microbicide

idea of the ultra violet rays exists, its application is on a different principle.

It has always been commonly believed that milk curdles owing to the change of temperature and that by using ice this difficulty would be overcome, but this precaution does not take away the primal cause which, while it remains latent under the unfavorable environment of perhaps zero degree, develops immediately upon being brought in contact with light and a more productive environment, namely, the moment that the ultra violet rays come in contact with the infinitesimal life their development begins, and while it is true that some microbes are destroyed by the ultra violet rays, it has been found that the inferior organisms generally develop more rapidly under the influence of these rays.

The milk of the Bulgarians, well known all over the world for its superior nutritive quality, is made by exposing it to the sun, the rapid development of the germs under the action of the ultra violet rays being such that when it becomes dry they are in highly concentrated form.

The difficulty of transporting milk from one city to another is well known, and I had occasion of demonstrating my beliefs on the action of the ultra violet rays by an experiment at which were present the representative commissioners of milk of Mülhausen, Alsace. It was midsummer (July) and we took milk directly from the cow, without it having had any exposure to the light, and placed it in two cans, one of which had been previously protected against the sun's ultra violet rays; the other canteen was left as it had been. The canteens were then placed on an uncovered freight car without any ice or other protection against the sun and shipt to Colmar, a trip of about four hours. Upon

arriving at our destination the cans were then examined; the milk in the can not protected had already turned sour, while the milk in the other can was as sweet and fresh as tho it had been hardly drawn. The fact that the ultra violet rays could not penetrate the protective covering of the canteen prevented any action on the milk.

To substantiate my theory, Dr. Stahel of the Internationale Cellulose Ester Gesellschaft of Sydowsaue had also asked for a patent of a product which was precisely against the action of the ultra violet rays, preventing the decomposition of diverse animal substances influenced by these rays, following several discoveries made from various observations of the action of the ultra violet rays.

The cerebral substances are decomposed by the ultra violet rays, causing sunstroke, and not by heat as generally believed, and to substantiate this statement it is not thought remarkable that we never hear of cases of so-called heat prostration among the workers in foundries, glass and pottery factories, etc., where an excessive heat temperature equal to mid-summer in the torrid zone is continually preserved, and where the man goes back and forth to and from his labor year after year unaffected. Yet this same man may be taken with a sunstroke in a moment's time upon exposure to the sun, when its rays are sufficiently powerful to react on the body.

In 1913 I had submitted an experiment for the protection of men and horses against the effects of the ultra violet rays by the application of a protective coating against these rays placed in the inside of hats and horse bonnets. Upon the success of the same the French Government used

(Continued on page 421)

A NEW PORTABLE ELECTRIC FIRE DETECTOR.

The new electric fire detector is a thermometer constructed of a steel tube for a mercury receptacle, to which is attached the lower contact screw, also the regulating screw by which the detector is set to any given degree from zero up to as high as

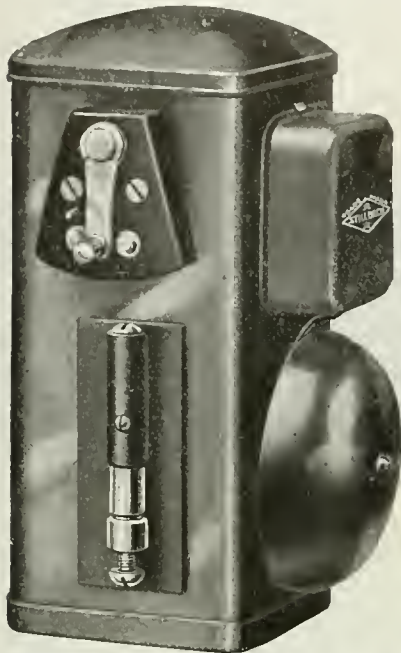

An Electric Fire Detector Which Can Be Left at Any Point Desired, Such as in the Kitchen, and as Soon as Blaze Occurs the Alarm Bell Rings. It Utilizes a Fine Mercury Column, Which Expands When Heated, Thus Closing the Bell Circuit. It Will Also Announce a Drop in Temperature.

conditions require. A fiber tube carries the upper contact screw. This fire detector and alarm may be termed almost "super-human," never failing to give an alarm of fire when in its incipency and which can be extinguished with a pail of water or small portable fire extinguisher and before it has gotten beyond individual control. The detector will not give a false alarm when properly set, it is claimed. The portable outfit shown is for use in kitchens or other localities.

The possibilities of this detector are unlimited, giving a positive alarm of fire at the opportune time; the absolute automatic control and closing of fire-doors and shutters; the announcement of rising temperatures in refrigeration plants and the absolute control of open-head sprinkler systems.

As a valuable equipment for the prevention of disastrous fires, the detector gives an alarm long before the automatic sprinkler will operate; thus not only preventing fire loss, but eliminating the water damage to a very large degree. For warehouses and holds of ships where cotton is stored, an alarm is given when the cotton first begins to smoulder. This also applies to uncured hay and rubbish.

The apparatus is peculiarly adapted for the regulation of temperature in refrigeration plants, being regulated to announce the rise in temperatures on an annunciator in the chief engineer's office, which obviates the necessity of continually making the rounds to read the thermometers.

The detectors can be set to show a rise of a fraction of a degree and a warning of this change given as above described. The detectors for protection in hotels, theaters, homes, apartment houses, office buildings and buildings of like character are set to operate at say 110° and are furnished

with ornamental guard of nickel-plated non-corrosive metal, which makes a neat, attractive outfit, but these can be more elaborately decorated to architect's specifications.

Each detector will under ordinary conditions cover an area of 250 square feet of floor space. In a room say 12 by 15 feet, one detector would be sufficient, but if fastened to side walls, two would be required.

RADIO EXPERTS NEEDED FOR NEW MERCHANT MARINE

There is a very great need in the navy just now for radio operators, according to the Buffalo office of the Naval Reserve. These operators are to be used on the giant merchant marine that is shortly to be put in service. The men in this service are well paid. There are several classes in this service so that the beginner has a chance for enlistment.

DON'T MISS THE NOVEMBER "E.E."

We have a great variety of electrical, scientific and radio articles in preparation for the "November" number. You can rest assured that you will find a big 15 cents worth of reading matter in that issue. If you are interested in war-time inventions in this field, you must not miss reading the up-to-date and authoritative articles on these topics, a host of which we publish every month. Here are a few of the "November" features:

- "The Use of the Telephone and Telegraph in Battle."
- "Action at a Distance as Exhibited in Selenium Crystals," by Prof. F. C. Brown, Ph. D.
- "The Marvels of Radio-activity," Part III, by Jerome S. Marcus, B. Sc.
- "Forcing the Growth of Plants with High-frequency Currents."
- "Historic Electrical Apparatus," by H. Winfield Secor.
- A new electrical story, by C. M. Adams.
- "A New Military Application of Electricity," by H. Gernsback.
- "Are There Electric Currents About a Magnet?" Part III, by F. F. Mace.
- "Science and the War"—In the "Movies," They Do It.
- "Experimental Physics—Lesson 9," by John J. Furia, A.B., M.A.
- "Chemical Action of Storage Batteries," Part II, by Albert W. Wildon.
- "How to Make an Electrically Played Mandolin," by McClure Albright.
- "The Construction of a Wheatstone Bridge," by Thomas W. Benson.

Class A is for amateur operators who can send and receive the Continental code at least ten words a minute and can write legibly. Class B is for first-grade commercial or amateur operators, receiving and sending twenty words a minute. Third-class electricians rating are in this class. Class C men must have commercial licenses and must have served at least one year as operator aboard ship and must send and receive at least twenty-seven words a minute in Morse and Continental. They get ratings of electricians, second class. Class E is for men who have worked on ocean-going boats as operators for at least four years and who can repair any break of apparatus. The rating is that of chief electrician. The pay ranges from \$33 a month for third-class men to \$65 a month for

chief electrician. Board, lodging and clothing allowances are given in addition to the regular salary.

GETS 30,000 VOLTS; LIVES.

Altho 30,000 volts of electricity past thru the body of Neil Hansen of Trenton, N. J., recently, he will live.

Hansen was cleaning a generator in the distributing station of the Public Service Corporation when he received the full force of the current. His left thumb was burned off, his hands and arms were burned and the top of his head was blistered.

For a time he lay as tho dead. After he was revived he could not remember his name.

PUSH-BUTTON DYNAMO REPLACES BATTERIES.

Something new in push buttons has been invented at last by an eastern man that bids fair to send the old dry batteries now in use to ring your front door bell, to the ash can. It is quite a simple arrangement, and it is strange that no one should have thought of such a simple device. The button itself is connected to a rod that is geared to a small dynamo, and when the button is pushed the dynamo armature rotates in the field of a permanent magnet, thereby generating enough electricity to ring the bell. The whole unit hardly takes up more space than the ordinary push button, and does away with the constant expense of renewing batteries. By referring to the photos a good conception of the principle involved and also the mechanism can be obtained.

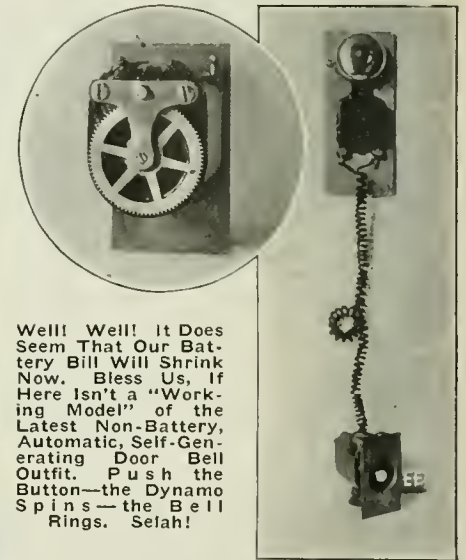

Well! Well! It Does Seem That Our Battery Bill Will Shrink Now. Bless Us, If Here Isn't a "Working Model" of the Latest Non-Battery, Automatic, Self-Generating Door Bell Outfit. Push the Button—the Dynamo Spins—the Bell Rings. Selah!

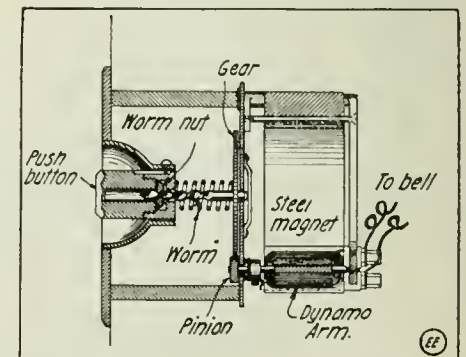

Here's the Secret of the Battery-"less" Bell Ringer. By Means of a Special Nut and Worm, the Dynamo Spins Merrily at Every Push of the Button.

Some Electrical Properties of Silver Sulfide*

By GEORGE W. VINAL

NATIVE silver sulfide is seldom pure but the sulfide may be prepared chemically in the form of a black powder which has a melting point of about 825°C. It was found that the sulfide so melted could be rolled into thin strips or drawn into short wires like a metal. At a

When drawn hot it acts like a metallic conductor with nearly zero temperature coefficient.

In making experiments with the sulfide it was necessary to find some means of making good electrical contact between it and copper lead wires. It was not found possible to solder to the sulfide directly and brass clamps are not desirable, but it was found possible to silver-plate the ends of a piece in a silver-potassium-cyanide solution. After this is done a copper wire can be soldered on with little difficulty.

When the sulfide is rolled at room temperature it has a large negative temperature coefficient of resistance, similar to an electrolyte. When worked at 200°C the temperature coefficient is approximately zero. It is not easy to explain why the mechanical working makes so great a difference in the electrical properties, but it seems likely that rolling at room temperature may produce minute cracks, whereas wire which is drawn hot is probably homogeneous.

The material rolled at room temperature was found to have different resistance when tested with direct and alternating current. When alternating current is applied the resistance increases, when direct current is applied the resistance decreases but shows a tendency to recover upon standing.

The specific resistance at 25°C was found to be 17,300 microhm-centimeters or about 10,000 times the resistivity of copper.

As resistance measurements indicated electrolytic conduction of the cold-rolled strips, experiments were made to discover any electrochemical decomposition. Direct current was applied to a strip having copper leads soldered to its silver-plated ends. An initial current of 25 milliamperes gave no visible effect. The current was increased at intervals until with 200 milliamperes a discoloration of the plate at the anode end was noticed. A still larger current ap-

peared to destroy the silver plating and finally burned off the terminal, but before this happened a myriad of little shiny silver crystals appeared on the black surface of the sulfide as shown in Fig. 1. The appearance of these crystals was studied under the microscope and it was found that they

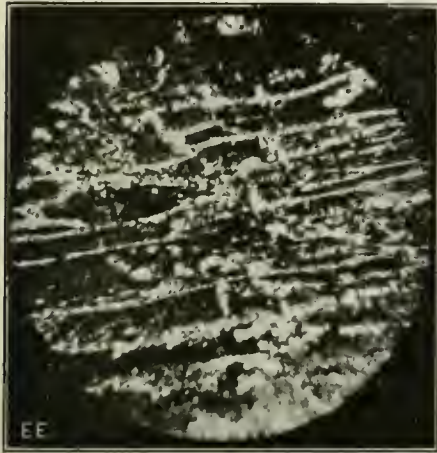

Fig. 1. Outcropping of Silver in Middle of Sulfide Strip. The Direction of the Electric Current Was Approximately Parallel to the Direction of the Lines of the Silver. This Picture Suggests the Possibilities of the Formation of Native Silver in the Earth.



Fig. 2. Anode End Showing Where the Terminal Burnt Off. After the Silver Plating Was Destroyed by the Sulfur, the Outcropping of Silver Took Place. Magnified 50 Diameters.

temperature of about 200°C. it becomes very malleable and may be hammered out on a hot plate or drawn thru a heated draw plate. Working the sulfide at this temperature changes its electrical properties. In the form of a strip which has been rolled cold this substance is both a metallic and electrolytic conductor at the same time.

* Summary of a forthcoming Scientific Paper of the National Bureau of Standards.

occurred to within a small fraction of a millimeter of the anode terminal as shown in Fig. 2. The appearance of some of these crystals suggested that they had been expelled from the interior of the strip with considerable force. The strip appeared to be made up of a multitude of tiny electrolytic cells between which metallic conduction occurred. The cross-section of this strip was 0.3 by 0.01 centimeter.

A 25-MILE BATTERY LAMP SIGNAL PROJECTOR.

A very simple signal projector having a range of some twenty-five miles is shown in the illustration herewith. It consists of a wooden box 12 in. long and 5 in. square, made of 1/4-in. wood. This box contains a 5-in. Mangin mirror.

At the focal point of this mirror is mounted a 6-volt, 1 1/2-ampere Mazda lamp, having a maximum concentration filament. (A 1 1/2 ampere automobile lamp could be used, but the range will not be so great as with the maximum concentration filament lamp.) In the lower compartment of the box are four standard dry batteries connected in series and to the lamp thru a standard telegraph key.—Photo Courtesy Gen. Elec. Rev.

AS TO THE EFFICIENCY OF OPTICAL PROJECTION.

In a recent paper before the Illuminating Engineering Society, Mr. R. B. Chilas analyzes the conditions affecting the efficiency of optical projection in the cinematograph. He estimates that in the most favorable circumstances the screen does not receive more than 5.8 per cent. of the light from the arc, while in many cases it does not ex-

ceed 1 per cent. Various arrangements of carbons with a view to avoiding the shadow cast by the negative have been tried, but with the present lens systems it is difficult to utilize more than 17 per cent. of the light from the crater. On the other hand, it is suggested, an improvement might be made by reverting to an old idea explained

in a Swiss patent by S. Schuckert, as far back as 1889. This involves the use of an ellipsoidal mirror, the crater being at one focus, the objective lens at the other, and the film in between. Theoretically as much as 75 per cent. of the light from the crater can thus be collected.

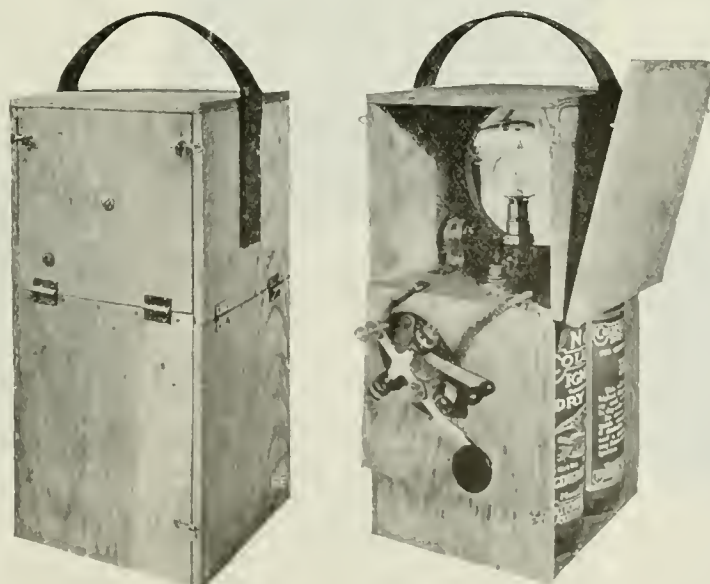

A Military Signal Projector Having a Range of 25 Miles. It is Fitted with 5-In. Mangin Mirror and 6-Volt 12-c.p. Mazda C Lamp. A Telegraph Key Controls the Lamp Circuit.

RUSSIAN SOLDIERS AMAZED AT WIRELESS.

An interesting description is given by a Russian officer of one of the numerous little mobile field wireless outfits operating near the front. The whole wireless station can be unloaded from its auto truck, rigged up and be ready for work in twenty minutes. The seventy-foot masts are hollow and made in sections, which are screwed together when taken off the truck.

The simple peasant soldiers, many of whom come from remote villages where wireless has never been heard of, are greatly fascinated by the station, and like to stand around when they can get a chance and watch the flashing of the spark and listen to its song. "It sounds like butter in a frying pan," they say. They have coined a nickname for the men in the wireless crew, which, as near as possible in English, is "sparkers" or "the spark men."

Experimental Physics

By

JOHN J. FURIA, A. B., M. A. (Columbia University)

LESSON 8.

Light.

MOST people have the erroneous idea that light passes instantaneously from the source to the observer. In the year 1675 Olaf Roemer, a Danish astronomer, found that his prediction of an eclipse was

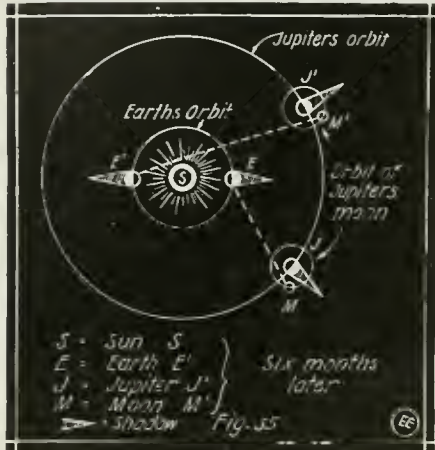

Due to the Difference in Time Elapsed Between the Eclipses of One of Jupiter's Moons, Roemer in 1675 Deduced That This Deviation Was the Time Required for Light to Travel Across the Earth's Orbit.

in error. He had observed and noted carefully the instant when one of Jupiter's moons M (Fig. 35) past into Jupiter's shadow when the earth was at E, and by computation predicted the exact instant when another eclipse should occur six months later when the Earth was at E'. Actually the eclipse occurred 996 seconds later than at the time predicted, and Roemer concluded that the delay represented the time required for the light to travel across the Earth's orbit, a distance which was known to be about 180,000,000 miles. Thus it was found that light travels about 186,000 miles per second. This speed is so great that it would carry light nearly eight times around the Earth in one second, so it is no wonder that the idea prevails that light travels instantaneously. However to the astronomer who deals with the enormous interstellar distances the speed of light seems as the speed of a 1903 model Ford with only one cylinder in working order. It takes 4 and one-half years for light to travel from the earth to the nearest star. If one of us should be up on the Pole star with a tele-

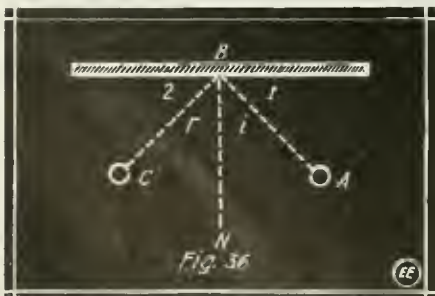

The Principle of Light Reflection; Angle "i", Incident Angle Always Equals "r", the Angle of Reflection.

scope powerful enough to see events on the earth, he would not see the battle of Gettysburg, which occurred July, 1863, until Jan-

uary, 1918, the Pole star is so far away.

EXPERIMENT 46. One of the most important properties of light is that of reflection. When a billiard ball strikes the sides of the table obliquely, it rebounds in such a manner that the angle made by the ball on striking and the angle made on rebounding are equal. In Fig. 36, A is the position of ball before being struck by the cue, B is the point on the cushions of the billiard table where the ball strikes, and C is the position of the billiard ball after rebounding. Angle 1 equals angle 2. If BN is a line perpendicular to the cushion, angle i equals angle r. Angle i is called the incident angle and angle r the angle of reflection. The law of reflection is usually stated **THE ANGLE OF INCIDENCE IS EQUAL TO THE ANGLE OF REFLECTION.** The fact that the law of reflection holds true for light makes possible the use of many instruments, one of the most important at the present time being the periscope. The writer learned the law of reflection at school long ago on those occa-

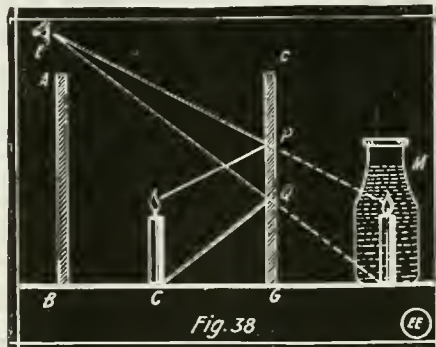

How a Person at "E" Can See a Candle, Invisible at "C", and Apparently Burning Inside a Bottle of Water at "M."

sions when the sun shone into the room and the teacher pulled down the shades. A beam of sunlight would enter the room from the sides of the shades and the writer by means

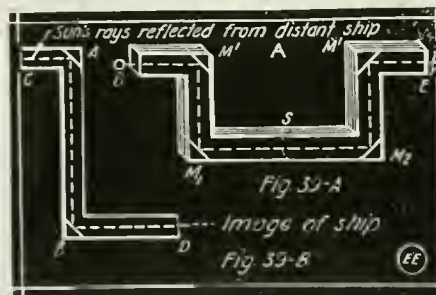

Illustrating the Principle of the Submarine's Periscope. Mirrors Reflect the Image Down the Tube and Around Corners.

of a pocket mirror would reflect it so that the angle of incidence being equal to the angle of reflection, and the teacher's face being along the angle of reflection, it would become illuminated, to the extreme discomfort of the teacher and the unbounded pleasure of the pupils. Things would have fared very well had not the teacher also known the law of reflection, and hence been able to locate the innocent culprit. (Innocent according to the pupils, and culprit according to the teacher.) When a surface is smooth as in the case of a mirror each point of an object is regularly reflected, and a sharp image is formed. When the reflector

is rough, as in the case of ordinary paper or the walls of a room, each particle of the surface reflects regularly, but since the particles are not all on a level stretch, the reflected light is scattered, and this is known as *diffuse reflection*. Some girls' noses are smooth and shiny (regular reflection) but

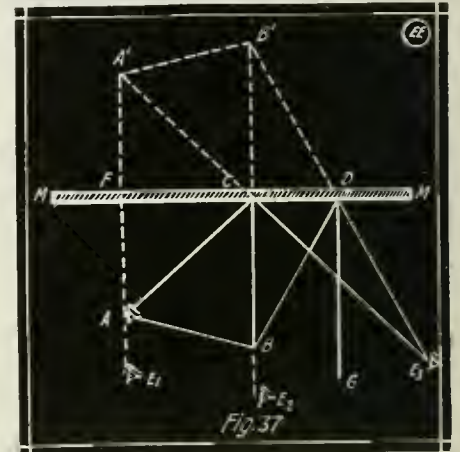

Analysis of the Principle of Mirrors. Each Point of An Image in a Plane Mirror Is As Far Behind the Mirror As the Corresponding Point of the Object Is In Front of the Mirror.

after an application of face powder, the noses are no longer smooth and shiny but rough (diffused reflection). The Sun, a gas flame, etc., are visible because of the light they emit, while ourselves, books, chairs, tables, etc., are visible because of the light reflected. All bodies except those emitting light are visible because of the light they reflect diffusely.

When light meets the eye from a polished surface we do not see the surface. Hence it is possible at Coney Island to create a great deal of amusement by having "mazes" (smooth polished plate glass) into which the unsuspecting victim will walk. Black bodies send no light to the eye but they can be seen because their outlines are distinguished by the light which comes from the background.

EXPERIMENT 47. To locate the image of an object in a plane mirror. Stand a small rectangular pocket mirror on its side, over a piece of paper. Draw an arrow in front of the mirror MM at AB. If now the eye is placed behind A, behind B and to the right of B respectively, in the positions

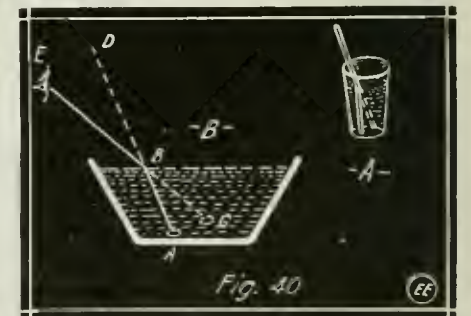

Due to the Change of Velocity of Light Rays Passing Thru a Denser Medium—Water In This Case—An Object Appears As Tho Bent or Misplaced.

E₁, E₂, E₃, the image A' of the point A, will be found on the straight line E₁A prolonged (Continued on page 424)

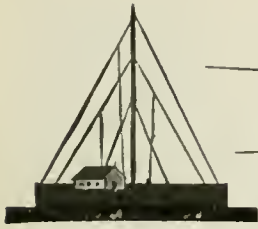

RADIO DEPARTMENT



Radio-Controlled Torpedo Devised by California Genius

A WIZARD of electricity, whose inventions may revolutionize warfare both on land and sea and win victory for America in the great war against Germany, was discovered in the person of Henry H. Hyder, of Los Angeles, Calif., ostensibly an automobile man, but in reality a miracle worker with wireless and electricity.

Seated in his little workshop several miles away, Hyder can explode any one of a field of mines, either in the ocean or on land. He can choose which mine to explode or he can blow them all up—by wireless. No other wireless can interfere with his to set the mine off prematurely or to prevent the explosion. (We are not so sure about this.—Editor.)

In the same way Hyder can release a torpedo at a ship twenty miles off the coast, choose the time to explode it or in case it fails to reach its mark, lock the torpedo, prevent the explosion and bring the costly instrument back to the place from which it started.

It may be the means of dealing the death blow to the submarine menace.

It is possible that it will mean the scrapping of the giant super-dreadnaughts of the world's great navies because of their helplessness when attacked by a torpedo controlled in every way by wireless. It will also mean a great saving in that an expensive torpedo which misses fire can be brought back and used again.

Hyder is only 33 years old and he was born on a farm in Missouri. All of his electrical knowledge has been obtained thru his own efforts, for neither he nor his as-

sistant went to college—but, then, neither did Edison. Study will solve all problems.

Electrician, applicants must be able to receive at least ten words per minute in the continental code, write legibly and spell correctly at the rate of twenty-five words per minute, and have a grammar school knowledge of arithmetic.

(b) To be enrolled as Electricians 3d Class (Radio), applicants must qualify as in (a) and must be competent first grade commercial and amateur operators who can receive twenty words per minute in the continental code.

(c) To be enrolled as Electricians 2nd Class (Radio), applicants must have commercial licenses, must have served at least one year as radio operators on merchant ships with a discharge from such ships, showing excellent service and good reasons for such discharge, and must be able to receive in continental and American Morse code at the rate of twenty-five words per minute.

(d) To be enrolled as Electricians, 1st Class (Radio), applicants must qualify as in (c) and must be radio operators who

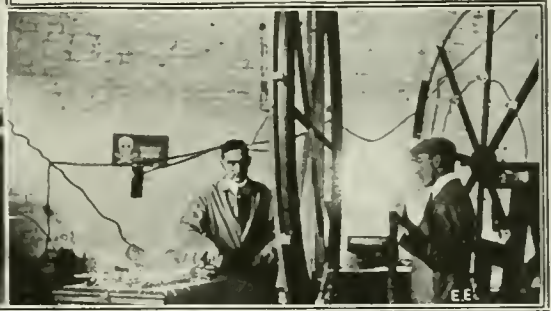

This California Radio and Electrical Inventor Succeeded In Lighting Lamps by Wireless Power and Has Perfected a Radio-Controlled Torpedo Which Cannot Be Interfered With. Photos from C. W. Geiger

able to do he demonstrates with working models in his little workshop with the help of his assistant, Arthur H. McClelland.

For more than four months Hyder and his assistant have been working night and day to perfect the invention so that they can take it to Washington to place it before the Naval Advisory Board. Now they are about ready to demonstrate it and expect to leave for Washington within a short time.

The invention for which Hyder claims so much is not, however, the result of only four months' work; it is the culmination of fifteen years of hard study and drudgery, inspired by enthusiasm and hope. Team work has played an important part, for McClelland, Hyder's assistant, has worked with him during all of the fifteen years.

Hyder's torpedo and mine construction have not been his only accomplishment. He has perfected a system of lighting lamps by wireless which he believes will be utilized in the future to prevent ships from colliding in the fog and will eliminate the block system on the railways. By wireless he can light several lamps wired in series and keep part of them lighted when some of them are removed.

What Hyder terms his torpedo and mine construction is most important at this time.

MR. AMATEUR, "I WANT YOU!" SAYS UNCLE SAM.

UNCLE SAM is offering exceptional opportunities to young men who will join the service at this time, states Mr. Fred Mueller, Gunner (R) U. S. N. R. F. At the present time the U. S. Navy Department desires to enroll in the U. S. Naval Reserve Force radio men who are willing to volunteer for general sea service and who possess the following qualifications:

(a) Must be citizens of the United States.

(b) Must be able to pass a physical and mental examination before enrollment.

(c) Must be able to send and receive the continental code and possess some technical knowledge of radio-telegraphy. Radio men are particularly desired and those applying for enrollment as radio operators will be assigned to active duty upon qualifying.

The following is a list of qualifications required for enrollment in the various grades of radio operator:

(a) To be enrolled as landsmen for Ra-

have served at least two years on a merchant ship and possess a considerable knowledge and acquaintance with radio plants.

(e) To be enrolled as Chief Electrician (Radio) applicants must qualify as in (d), must have a broad knowledge of radio-telegraphy, must have served on ocean-going steamers for at least four years, and must pass an examination by a board of at least three officers, of which two shall be radio operators.

The rates of pay for the above grades of radio operator are as follows:

Chief Electrician (radio) . . .	\$72.00
Electrician (radio) 1st class . . .	61.00
Electrician (radio) 2nd class . . .	52.00
Electrician (radio) 3rd class . . .	41.00
Electrician (radio) Landsman (for training)	32.00

Men who are enrolled in any of the above grades will be assigned to active duty under instruction at one of the U. S. Naval Reserve Radio Schools, where they will be given a course under experienced Navy in-

(Continued on page 417)

Brown University Trains Radio Experts

Brown University has helped to train radio experts during the past summer, conducting a radio class under the direction of Professor Arthur E. Watson, instructor of electrical engineering. More than

and write them down, as correctly as they can, in letters.

Other students practise with telephone head sets operating on dummy aeri-als. Prof. Watson has strung wires from one



Radio Students At Brown University, Providence, R. I., Studying the Ins and Outs of Wireless Transmitting Apparatus.

half a hundred amateurs have been studying one and two nights a week under Prof. Watson, who is the father of wireless at Brown. Almost wholly with his own hands he built the plant on the hill and put the college on the wireless map.

Up to the beginning of the war Brown had one of the best college wireless plants in the East. Prof. Watson and his students placed the apparatus, strung the wires; in short, did everything except build the towers on Maxcy and University Halls.

The apparatus had a radius of between 200 and 300 miles, and from the time of its installation "listening in" was a sport that attracted many students who previously had shown little interest in electricity in general and wireless in particular. For them the wires far above the middle campus hummed a lively and engaging tune. To listen to it once was to come again and again.

The closing of the plant did not greatly interfere with the training of future operators. Prof. Watson is too much of an enthusiast to let such a trivial matter upset his efforts. In his new quarters in the Engineering Building he straightway set up all necessary apparatus, rigged dummy aeri-als and kept going as if nothing had happened.

His night class caught this enthusiasm. Its students have been eager and industrious. A few started as fair amateur operators. Some had only dabbled in the art. The larger number knew nothing at all about it. But in the 10 weeks everybody added to his practical knowledge of radio.

Of all the instruments in the room the omnigraph sender is of the greatest interest. It is a small mechanical device having metal discs—a whole series of them fitting one on top of the other—that show peculiar, irregular edges. These edges are nothing more or less than the dots and dashes of the code. As the discs revolve the listeners pick out the dots and dashes

room to another in the building and by means of them the more advanced students send and receive messages. The visitor always finds it interesting to adjust the headgear and listen in on what may be coming from a distant corner.

"We hope to encourage," said Prof. Watson, in a recent interview, "the formation of groups of students who will train in sending messages as well as in receiving.



Evening Radio Class at Brown University. Even the Young Women Have Caught the Fever, As This Picture Shows.

Our time is all too short for full training, but we shall try to give every student a good grounding in the first principles and to advance the real amateurs, the ones who have worked with home sets, to a fair degree of proficiency."

HOW RADIO SAVED 46 LIVES OF TORPEDOED VESSEL.

The fortitude of a wireless operator in sticking to his instrument made possible the rescue of forty-six men out of fifty, on the American steamship Orleans when she was torpedoed unawares by a German submarine, according to Capt. Allen Tucker, commanding.

"We saw nothing and heard nothing," Capt. Tucker said, "until the torpedo struck us amidships and burst with such force that it seemed to tear the ship asunder. It was a fairly clear night, but the water was very black. I gave orders to launch the boats immediately, and we got all but one, which had been smashed by the explosion, into the water in record time.

"Meanwhile L. F. Larson, our wireless operator, was sitting up in his cabin and sending off S O S calls as coolly as tho they were merely commercial messages. He finally got into radio touch just as the stern began sliding under the water. I ran in, pulled him out on deck and practically threw him overboard, knowing he could swim. Then I followed and we both swam like hell to get away from being dragged under the sinking ship.

"The Orleans sank within ten minutes."

KILBOURNE & CLARKE CO. GET U. S. RADIO ORDER.

This concern has been given a contract by the United States Navy Department for the construction and delivery within nine months of 250 additional radio transmission telegraph sets, at \$988,000, which with the other contracts from the Government held by the company makes a total of 315 sets, at a cost of \$1,112,000. The contract calls for 200 one-kilowatt and 50 two-kilowatt transmission sets for the use of the Navy Department. It is understood some of these are to be installed on naval vessels, while probably the most of the order will be for equipping the vessels of the United States Shipping Board Emergency Fleet.

A wireless station with a night range of 700 miles has been installed at Cape May, N. J., by E. M. Murray, a Philadelphia Marconi engineer, and E. M. Hartley of the Miami station will be superintendent.



The RADIO LEAGUE of AMERICA

HONORARY MEMBERS
CAPT. W.H.G. BULLARD, U.S.N. NIKOLA TESLA.
PROF. REGINALD FESSENDEN. DR. LEE DE FOREST.



H. Gernsback, Manager

W. H. Kirwan, Master of Radio Relays

The Amateur's Opportunity

By the EDITOR

THE letter which we publish herewith is one of the many that come to the editor's desk during the course of a week.

It clearly illustrates one of the strangest situations created by the war, and it likewise has a very pointed moral. The closing of America's radio stations by our Government has had the unfortunate result in bringing to life several hundred thousand "sore heads," who in peace times were fond of calling themselves *Radio Amateurs*.

These good people, whose patriotism has suddenly gone bankrupt, always forget that the same government that granted our radio amateurs greater liberties than any other nation on the face of the earth certainly has some rights of its own.

Where, Oh! where, is our far-famed American patriotism? Where is our highly lauded fair-play? Where is our gratefulness? Sore-headedness seems to be one of our latest acquired national diseases—at least in our American radio amateurs. And we cannot but condemn it in the harshest possible terms.

Why not make the best of it, particularly as the present radio situation is of course only temporary? Sore-headedness and bitter remarks about the Government do not in the least improve matters, but rather tend to make them worse. We all want our stations back after the war; we all want the ether free for all. But the way amateurs are acting now certainly tends to bring the whole fraternity into bad repute at Washington. As if amateurs had not been disliked enough before the war, with all the Q.R.M. nuisance going on in the ether continuously! Why make ourselves disliked still more? What's the matter with the American amateur anyway? Where is his logic? Where is his common sense?

And last, but not least, where does the amateur come in with his silly, nonsensical kicks? What about the wireless manufacturers who have been put out of business—wiped off the map? Are they going about the land lamenting their cruel, cruel fate? Not much. They know that war is *synonymous* with sacrifice. They are doing their bit—their big bit, rather.

What about the radio and technical magazines, which lost 99% of their wireless advertising? Take this magazine for instance, which since its start never made any money. When war was declared it lost \$1,200 worth of radio advertising in a heap, and it will be losing this amount *every month* as long as the war lasts. Have these magazines, the EXPERIMENTER included, ever as much as raised their voices against the

Government? Indeed not, they gladly do their "bit" for their country.

Then amateurs, *where do you come in?* Now, we realize that this is rather plain talk, and it is not pleasant to write it, but truth as a rule is never pleasant and we hope that our amateurs will see that we are working in their very best interest.

interest and his full enthusiasm. It is not pleasant to work for a lot of sore-heads, and the amateurs certainly do not wish the Editor to wash his hands of the whole matter, and "chuck up the job" in disgust.

What we want is ENTHUSIASM and plenty of it!!! Let's pull ourselves together and let us show the world what stuff we are made of. Let's all do our bit in this war, to make the world free and safe forever. To do it Uncle Sam, besides his soldiers and sailors, needs operators—operators—and then some. We have them. Thousands of them. The country's full of 'em. The order of the day is to get them out into the open. And we'll do our best, or perhaps our worst, to get them to come out.

Uncle Sam just now does not require radio experts so much who can send and receive 50,000 words a minute; rather he wants boys who have a fair knowledge of radio and who like the work. Your Uncle Samuel will make an expert out of you in no time, and he will pay you while he is doing it. Radio work in the army and navy is comparatively safe, and while we do not in the least wish to imply that radio amateurs are cowards, we do wish to go on record with the statement that as a rule the radio man stands on a higher plane of intelligence than the average plain soldier or sailor.

Recognizing this, Uncle Sam pays the radio operators and signal-corps men more money than to the soldier or sailor of the rank and file. Now if this does not spell opportunity for you, we'll eat a 5-K.W. transformer, spark gap, wires and all!

Amateurs, again we'll tell you, *you don't realize how really valuable you are to your country*. So why hide yourselves away?

Now then, here is our plan, and we expect full co-operation from every one of you, even if you can't send or receive more than five dots and six dashes per minute!

We are going to compile the most complete file of Radio Amateurs in the country, *who are willing to do their "bit."* The files of the "Radio League of America" now contain some 16,600 names—a pitiful amount compared to the total of some 300,000 amateurs.

We want this list so that when Uncle Sam writes to the Editor asking him for names of radio operators, we will be in a position to send him thousands, where we send him dozens now. Take for instance

the letter published here; all we could send to Lt. C. H. McCann was forty names. A fine showing, that—not! Now to make it interesting for you, amateurs, beginning
(Continued on page 415)

U. S. NAVY RECRUITING STATION
CALUMET BUILDING
714 AND CHESTNUT STREETS
ST. LOUIS, MO.

Aug. 15, 1917.

Mr. H. Gernsback,
Editor Experimenters Publishing Co.
New York City, N.Y.

My dear Sir:

The United States Navy Department has instructed this recruiting office to make every effort to enlist men for service in the radio branch of the Navy.

These men are wanted immediately for active service.

We are unable to find a complete list of all radio operators in the St. Louis District which comprises the entire state of Missouri, with the exception of Jackson and Buchanan Counties, in addition to two counties of Illinois, Madison and St. Clair.

One of your subscribers to the Electrical Experimenter suggested to me that you would be in a position to furnish me with a complete list of all licensed radio operators in this District, and in addition, those men who are amateurs but who have not yet been licensed.

You may be sure that any information given me will be highly appreciated.

Yours very truly,
A. M. Cann
Lieutenant U.S.N.

CHM-CGG

AMATEURS OF AMERICA! I Herewith Propose "THE RADIO ROLL OF HONOR"

I call upon every radio amateur in America to do his "bit" in this war. Amateurs, this is the most important message to you I have ever written. I consider it more important than my Editorial in the November, 1908, issue of "Modern Electrics," which was the direct cause of placing the American Radio Amateur into the Radio Law of 1912, thereby giving you the free use of the ether. Amateur Wireless owes a large debt to America. Now is the time to repay that debt with interest. Will you do it?

H. Gernsback

for the amateur's benefit, giving him the free use of the ether.

The Editor will continue to work in the interest of the American amateur, but he cannot do so without the latter's undivided

A Radio Controlled Model Boat

By H. C. Van Benthuyzen and Max I. Black

FROM time to time in the ELECTRICAL EXPERIMENTER we have read articles on wireless control. We have taken much interest in publications along this line, having constructed a selective control set in the summer of 1916 ourselves; yet we have not run across a set



Appearance of Model Boat Fitted With Wireless Control Apparatus. This Kind of Work Is Bound to be Highly Remunerative and Radio Experimenters Will Do Well to Investigate the Many Unsolved Problems in This Field.

that has mentioned as great a range of use, this set having been used in a small demonstration wireless controlled boat, controlling toy reversible electric trains, shooting fireworks—in fact it can be used with any machine which is controllable by electricity.

In July, 1916, this apparatus was installed in a six-foot electrically propelled boat and on the 4th of that month a demonstration of "The Wireless Control of a Boat" was given at Riverside Park, on the James River, at Mitchell, S. D. In April, 1917, the same apparatus was used for a demonstration and talk on the "Science of Teleautomatics," given before the Mitchell Science Club, a branch of the South Dakota Academy of Science.

This selective set is simple and easily con-

structed. The controlling apparatus is an ordinary coherer set, the relay of which actuates a sounder to which is attached a ratchet wheel control for a second sounder. This second sounder operates an eight-point rotary switch of the commutator type. When used in the boat two segments of this switch are blank. The other six operate two solenoid reversing switches and one solenoid cut-off, which controls the helm motor only. It is possible to use the two blank segments for a solenoid cut-off for the propeller motor altho we did not find it necessary. The order of the points are:—"reverse," "forward," "on," "starboard," "port" and "off." The "on" and "off" control the helm motor so it will not be in operation continuously. The helm motor is geared down by means of a worm drive which also keeps the rudder rigid. This also gives the operator a chance to skip over the starboard and port without altering the course of the boat. With this arrangement the operator has complete control over the boat.

For the selective control of a miniature electric train a four-rail track is used (two rails for the field and two for the brushes so the train may be reversed). With only one reversing switch being necessary, thus giving four blank points on the eight-point rotary switch, instead of two, as in the case of the boat. With these connections a toy electric train.

The radio apparatus is made up of a precision coherer, and a fifty ohm pony relay with an ordinary bell decoherer. The sounder switches are any ordinary fifty ohm sounders with an extension arm which operates a ratchet wheel. (See diagram.)

The solenoid magnets for the reversing switches and the cut-off switch are made of a core consisting of one layer of zinc (wound on a pencil for uniform diameter). Each core is about three inches long. The ends are split and folded out to hold on the fiber ends of the coil. When the core and ends are assembled wind on three lay-

ers of No. 24 D.C.C. magnet wire. Wrap the whole coil with a layer of tape. The armature is an iron rod about five inches long and just large enough to slide easily in the core of the solenoid. The solenoids are placed in such a position on a suitable base that when the armature is clear in, the end will be about one-half inch from the outside end of the core.

IOWA STATE UNIV. WILL TRAIN ARMY TELEGRAPHERS.

In response to a request from the central department signal office of the United States Army, the Iowa State University will give during the next school year a

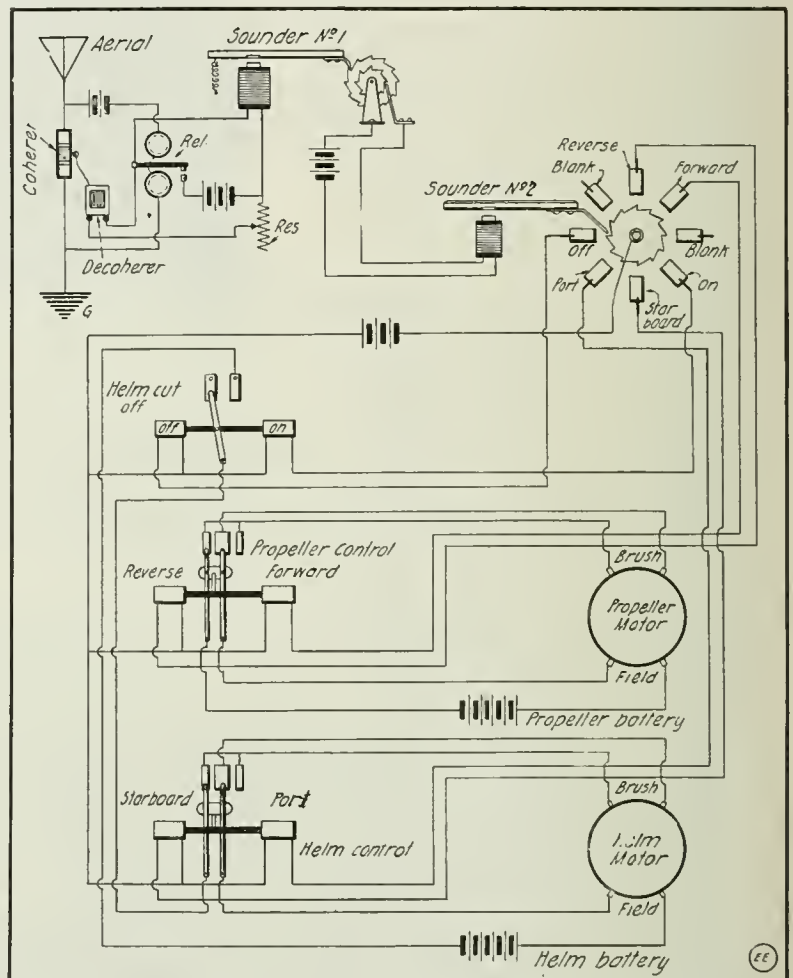

Lay-Out of Circuits, Including Coherer and Sensitive Relay. As Successfully Used in the Radio Control of the Model Boat Illustrated and Described in the Present Article.

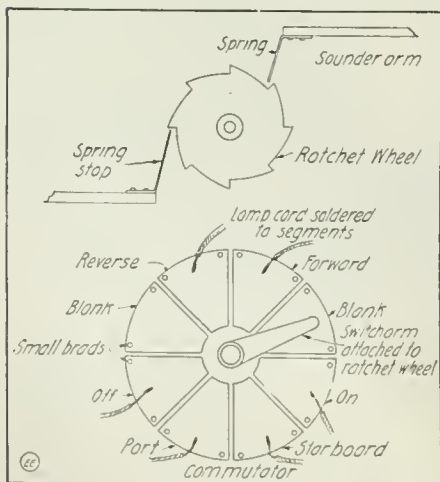

Detail of Sounder and Ratchet Wheel Mechanism for Successively Switching In and Out of Circuit the Rudder Control Magnets, Propeller Control, Etc.

Measurements of Radio Antenna on Shipboard and Some Interesting Comparisons

By F. A. HART

Variations of capacity, inductance and fundamental wave-length have been selected by the author from measurements taken on a large number of vessels, and covering at the same time as broad a range as possible. These data should be of interest to marine engineers and advanced experimenters, especially in the case of aeri-als erected on roofs, such aeri-als being under very similar conditions as regards effect from near-by metal, stays, etc., which materially affect the capacity of the aerial.

In connection with ship stations a great deal has been said about compass troubles, generally attributed by masters to the nearness of the aerial lead-in wires in each specific case. It might be well to point out that exhaustive tests have been made from time to time, and absolutely no disturbance noticed, says F. A. Hart in *The Electrician*, London. On the other hand, the proximity of a motor-generator or other large mass of iron to the compass would tend to have some effect.

The lengths used in the table are given in feet, capacity in micro-farads, inductance in centimetres and natural wave-length in meters.

For simplicity, each type is designated by a number. The overall or total length of wire from apparatus of the "L" aeri-als is taken as the horizontal plus the vertical, and in the "T" aeri-als half the horizontal plus the vertical. All these aeri-als are comparatively small in actual amount of wire compared with aeri-als in coast stations, and a good many should compare very nearly with many amateur receiving aeri-als, some of which are of even greater length.

Aeri-als such as Nos. 6, 9 and 28 are the least efficient for 200 and 300 metre waves, as the fundamental is very large, the capacity low, the radiation resistance high; and in order to reduce the aerial to small wave-lengths the series condenser would have to be less than 0.0004 mfd. As both capacities are so small, the radiation from any set less than one kilowatt would probably not be greater than one-half ampere. Judging by the results, for those who wish to transmit efficiently on 200 or 300 meters, the aerial should be made a "T" where the horizontal length is 120 ft. or over. As a rule, the most efficient working wave-length where a series condenser is not used is about 0.9 of the natural wave-length. For instance, in the case of No. 23 the natural is 230; taking 0.9 of this value and adding it to 230 we get 437, which should give the greatest radiation for that particular size of aerial.

In the case of Nos. 15 and 16, these measurements are identical, with the exception of a trifle greater height and 55 ft. more wire in the horizontal length of No. 16. Everything being equal in both cases, except the relation of the vertical wires to the bridge railings and metal stay in No. 15, this apparently makes up for the 55 ft. of extra length in No. 16.

The most marked of deck and work effects is in Nos. 38 and 39, the vertical length in No. 39 running parallel with three stays from the top of the mast to the wireless cabin. In No. 38 they run practically the same, also considerably increased by the nearness of the funnel. The "T" type aerial has been found as a whole to give the best all-round results, and is less likely to be affected by foreign matters. The spring stay should be removed and all other stays either grounded or

broken up with insulators to ensure against induction and the most effective work from the radio apparatus.

Aeri-als in which stays, decks or other metal work figure largely are Nos. 18, 19, 20, 21, 22, 30, 33, 34, 35, 36 and 37, in every case affecting the vertical length. The ground lead in all examples given does not average over 3 ft., and is sometimes less.

No. 1 is a very good type of aerial for amateurs who wish to transmit. No. 40 is also in line with No. 1; the capacity runs higher, altho the lengths are very small, and the nearness to all metal work and the large number of wires has helped to increase this.

One can readily see from the table how important it is to keep the overall lengths as small as possible where there is any possibility of metal increasing the capacity.

Two-wire Aeri-als.

No.	Type of Aerial.	Height.	Lengths.			Capacity.	Inductance.	Natural Wave Length
			Horizontal.	Vertical.	Total.			
1	T	92	130	50	115	0.00075	22,000	232
2	T	110	151	85	160	0.00090	26,363	290
3	T	90	210	50	155	0.00092	29,860	312
4	T	91	208	64	168	0.00096	30,975	325
5	L	86	216	65	281	0.00101	34,217	350
6	L	135	238	80	318	0.00095	61,434	455
7	T	100	240	80	200	0.00140	30,603	390

Four-wire Aeri-als.

8	L	68	127	90	217	0.00082	49,621	380
9	T	150	250	90	215	0.00096	53,210	426
10	L	70	90	90	180	0.00099	23,600	295
11	L	125	112	75	187	0.00105	41,932	395
12	T	128	178	100	189	0.00108	34,215	362
13	L	90	100	60	160	0.00110	30,100	340
14	L	80	120	50	170	0.00115	20,188	287
15	T	110	170	70	155	0.00115	28,333	340
16	T	100	225	70	182	0.00115	28,333	340
17	T	115	170	88	173	0.00116	22,184	320
18	L	112	220	105	325	0.00130	30,854	380
19	L	100	120	80	200	0.00135	30,784	384
20	T	100	260	58	188	0.00136	23,933	340
21	L	100	150	50	200	0.00140	26,952	366
22	L	105	204	64	268	0.00145	28,038	380

Six-wire Aeri-als.

23	L	55	125	50	175	0.00085	17,532	230
24	L	80	98	50	148	0.00100	33,246	345
25	T	135	150	90	165	0.00102	25,690	305
26	L	125	155	85	240	0.00109	36,272	376
27	T	96	200	85	185	0.00118	21,192	298
28	L	105	270	70	340	0.00120	55,902	488
29	L	94	138	50	188	0.00120	30,085	358
30	L	98	104	90	194	0.00120	20,428	295
31	L	125	225	80	305	0.00124	46,615	453
32	L	115	141	84	225	0.00125	30,335	367
33	T	65	165	35	118	0.00126	20,134	300
34	L	95	150	70	220	0.00128	30,946	375
35	L	115	190	95	285	0.00140	32,200	400
36	L	100	150	60	210	0.00145	38,451	445
37	L	120	200	70	270	0.00150	34,272	424
38	L	145	225	100	325	0.00180	27,343	418
39	L	98	200	60	260	0.00240	21,200	425

Ten-wire Aerial.

40	L	50	80	30	110	0.00068	16,639	200
----	---	----	----	----	-----	---------	--------	-----

L = mean standard inverted "T".

A DUSTPROOF COVER FOR RADIO SETS.

Having an open desk on which my radio set was mounted, and being greatly troubled with dust, I hit upon the following simple but efficient method of protecting it from dust. A shade roller, three feet long in my case was mounted on the wall about six inches above the desk. A cloth three feet wide and long enough to cover the entire set when fully extended was nailed to the shade roller. It operates as follows: When ready to use set, take hold of cloth and pull away from the roller and then let go. The cloth will wind itself about the roller. An ordinary shade will do, but I use a cloth because it presents a neater appearance and is besides more flexible than the ordi-

nary shade. Rollers can be obtained of any length for a nominal price.

Contributed by CARL BERNHARDT.

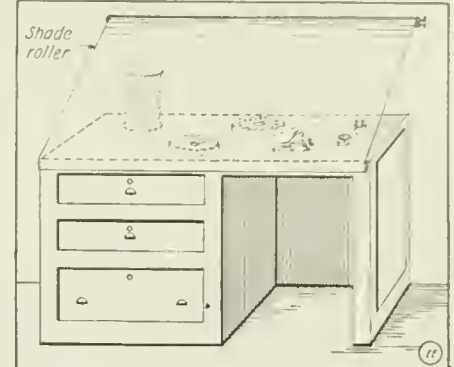

A Convenient Way in Which to Protect Your Apparatus Table From Dust, Utilizing a Common Window Shade.

MAKING THE BUZZER "HY-TONE"

The great trouble with ordinary buzzers used for detector tests, is that they do not emit a high tone. I found that if tightly folded pieces of paper were placed between the magnet and armature and between the armature and spring that carries the contact, the tone was thereby raised. The best thickness of the paper must be found

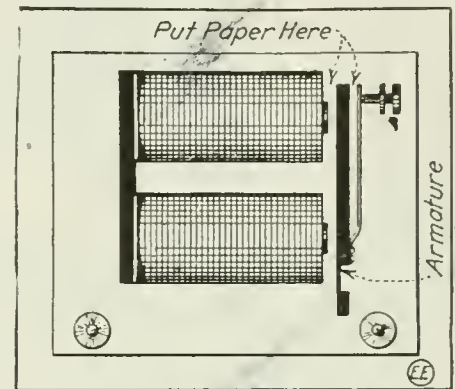

Any Buzzer Can Be Made to Give a High Tone By Placing Paper on Either Side of the Armature, As Shown.

by experiment. Also, the contact screw must be regulated to get the highest tone. Rubber bands may also be used. These are snapt around the buzzer in such a way as to pass thru the same points as occupied by the paper.

Contributed by E. D. PAPKEE.

A LAMP "KICKBACK PREVENTER."

Two lamps are connected across the line, the wire between the lamps being grounded thru the third lamp. With low powers

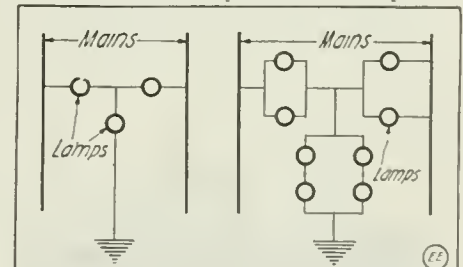

A Kick-Back Preventer Made From Lamps Properly Connected.

there will be little danger of the lamps being burned out, and in the case of higher powers, two lamps may be connected in parallel in place of only one lamp. Carbon lamps are capable of carrying heavy overloads and are good for the purpose.

Contributed by THOS. W. BENSON.

A Key That Will Handle 1 K.W. for \$1.00

Following is a description of a wireless key that is easily made. With a wooden base it costs about \$1.00.

The lever, shown in detail in Fig. 1, is made of a 1/4 inch brass slider rod about

piece or stretching it, until it is the right length, thus eliminating the thumb nut "F."

The binding posts G, G, the thumb nuts F, F, and the key knob I, may be purchased from any electrical supply house for about 6 cents each.

The base may be made of wood, fiber, hard rubber or marble. The latter improves the looks of the key considerably, but it comes rather high and does not improve the working of the key. Nickel plating improves the appearance also. This key will take care of a 1 K.W. set, and if carefully made will equal a \$6.50 key.

Contributed by ALBERT PARDEE.

The "What to do with your Radio Set" Contest Concluded

When the Navy Department declared all radio stations closed, it seemed as if I would have to pack my instruments away for about six months or more, as there seemed to be no further use for them.

However, I decided to use my instruments in some other way than ascribed for them in their original use. Finally I evolved the idea of building a very sensitive microphone.

The following instruments are used: A wireless telephone transmitter (or an ordinary telephone transmitter), an Audion amplifier set and phones. The wire from the aerial is used to connect the different instruments. Where one wire crosses another, the insulators can be used to insulate them. If this set is to be put up between two buildings, a return wire can be used by the ground usually used in wireless. — JACOB FEIGENBAUM.

Radio Instruments Useful in Electro-Chemistry

Any up-to-date wireless outfit may be used in the study of "electro-chemistry." The amateur can make use of nearly all his instruments. The transformer and spark gap will make a fine little electric furnace or open arc. Electrolysis, electroplating, and electrolytic are easy. Delicate indicators and variable instruments will be of use in electromotive force tests. The effects of magnetism and various waves on chemical actions is interesting. Battery jars and electrodes come in handy. The resourceful American amateur would need only glass-ware, some common chemicals, and a text-book, to make a complete laboratory. The EXPERIMENTER might take the place of the text-book. I have made a good chemical laboratory of my wireless room, and am teaching some grammar school boys the mysteries of chemistry. Electro-chemistry is as instructive and interesting as wireless itself, and I recommend it to all other amateurs. — J. FRANKLIN STYER.

Miscellaneous Experiments for the "Radio-Bug"

Imagine yourself to be an amateur who has been presented with an efficient sending and receiving outfit; time—Xmas. Time flies as you persevere over the code. Feb. 3, 1917, U. S. breaks relations with Germany. You are able to hear NAA give out reports and gossip over the war. April 6, 1917, U. S. declares war on the German Imperial Government. April 7, 8, 9, Radio inspectors are around sealing stations. This happens just when you were on the road to Radio fame. Wouldn't it jar you?

Cheer up! Perhaps this will help you. These ideas of mine enable the "Radio-Bug" to use his apparatus in war time without evading the Federal law.

The apparatus used is as follows: Key, batteries, coil or transformer, gap, condenser and helix.

Variable or fixt condenser, loose coupler, detector, 'phones, and buzzer, perhaps a tuning coil and potentiometer.

Idea No. 1 enables you to learn the code or gives you practise so that you won't get out of trim. Uncover that soap box and get out a key, some batteries, a buzzer, 'phones and detector, and the tuning coil or potentiometer. Connect up according to diagram 1. The tuning coil or potentiometer act as rheostats and increase or decrease the pitch of the buzzer. The condensers absorb the spark usually present at the contact point of the buzzer. This is a modified buzzer test. A two station buzzer line has been installed in our high school and we certainly have fun. Here, a key, batteries, buzzer and 'phones are used. (Fig. 2.)

High frequency experiments may be tried and currents obtained by using a transformer or spark coil, batteries, gap and helix. The transformer takes the part of the Tesla coil or Oudin resonator. Look up your old E. E.'s for H. F. experiments. Then get to work, persevere and enjoy yourself. — GEO. KRUEGER.

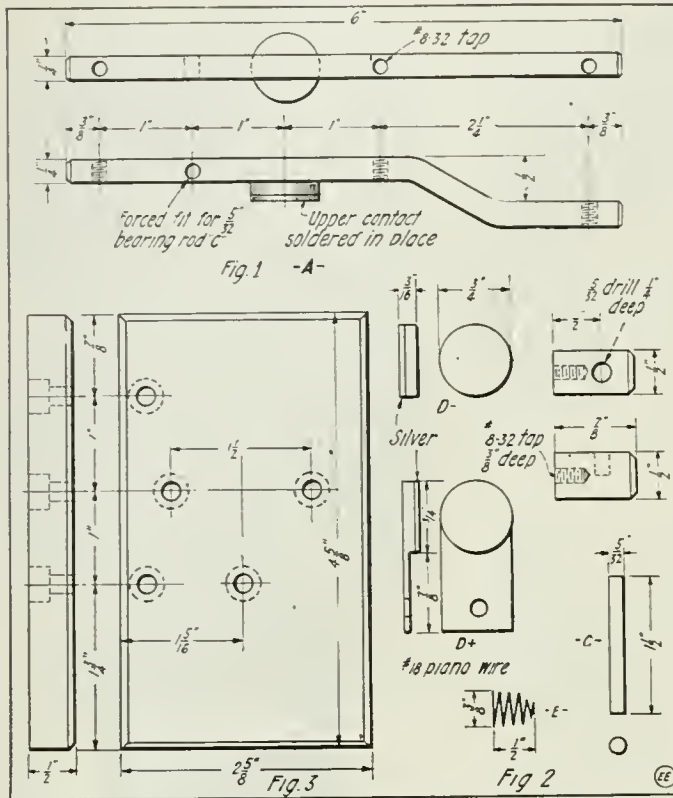

Details for Making a First-Class Radio Key Suitable for Transformers Up to 1 K. W. Capacity.

7 inches long, bent as in the drawing. This can be done by placing it in a vise and carefully tapping it with a hammer. The bearing rod (Fig. 2-c) is made of a short piece of 5/32 inch brass or steel rod. This is forced thru a hole in the lever 1 3/8 inches from the end. A little solder will hold this in place or it may be pinned in position. The bearing posts are of 1/2 inch square brass rod, see Fig. 2-b. The contacts D—D+, Fig. 2, consist of two pennies and two dimes soldered together. The upper contact D— is then soldered to the lever, Fig 1. The lower contact is then soldered to a short piece of copper or brass bar with a binding post mounted on the end. Binding post G, Fig. 4, may be connected to the lever in numerous ways.

A well-known wireless key makes use of a bronze spring pressing up against the lever. Another way is to connect to the bearing post. The tension spring "E" requires

no explanation, except that it may be made of brass spring wire instead of piano wire. This spring may be adjusted before the final assembling of the key by cutting off a small

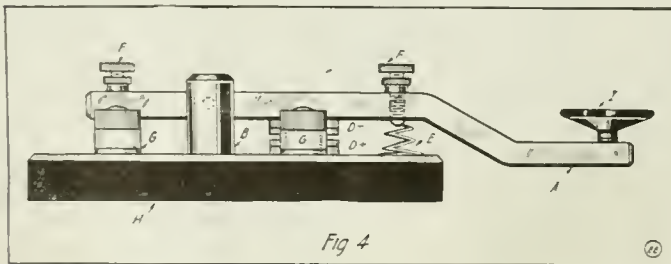

View of Assembled Radio Transmitting Key.

no explanation, except that it may be made of brass spring wire instead of piano wire. This spring may be adjusted before the final assembling of the key by cutting off a small

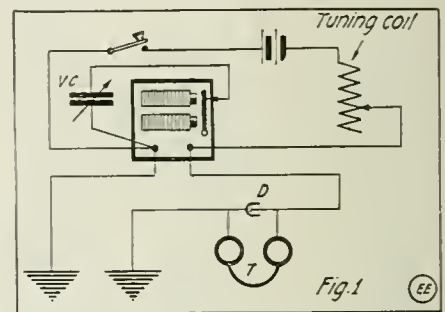

A Simple Buzzer Set for Practising the Code.

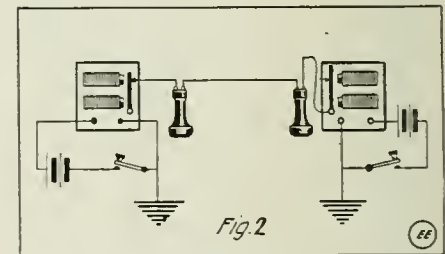

An Efficient Buzzer Telegraph System Good for Several Miles.

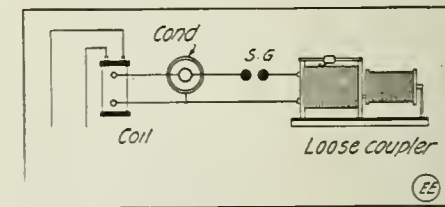

Fig. 3. Old Tuning Coils or Loose Couplers Can Be Used As High-Frequency Oudin Resonators.

RADIO WRITERS — ATTENTION!!!

Can you write radio articles dealing with the practical problems of wireless operating? We can use some good papers on such subjects as "the tuning of radio transmitters"; "the use of the wave meter, including its application to measuring the frequency, wave length and decrement"; "operation of commercial transmitting and receiving sets"; "the operation of army trunk sets"; "improved ways of receiving undamped wave signals," also new ideas and short-cuts for learning the codes. We pay well for all articles accepted. Help yourself, your magazine and your country.

A Simplified Variable Condenser

By R. U. CLARK, 3rd

ALTHOUGH there are a great many forms of variable condensers on the market today, there are few types which can be readily constructed by the average experimenter, which will approach the compactness, and good appearance embodied in many stock articles of this nature.

A condenser constructed on the general lines of the one described herein should comply with the above requirements, and as can be seen from the sketches will require but few materials and little work for its completion.

As various capacities will be desired by the different amateurs who may decide to make this instrument, no definite dimensions will be specified in the following notes, except to show the general relation, in regard to size between the different parts which enter into the construction.

Very few parts are necessary for the work in hand, the complete list of materials is as advised at this point. 1 round tubular fiber or composition case. 1 round top, of metal, fiber, or hard rubber, etc. A small quantity of lead. A few feet of thin brass or copper ribbon, about one inch wide, preferably of soft metal. Several pieces of paper tape, about three-fourths of an inch wide, by about one sixty-fourth thick. 2 short lengths of 1 inch half round fiber. Brass screws, about one-quarter inch long, two small brass screw-eyes, 2 binding posts, a short round brass rod and small composition knob, complete the list with the exception of a short length of flexible copper ribbon.

In order to construct the condenser it is necessary to cut the brass or copper ribbon into two equal lengths, each one inch wide, and with a few of the small brass screws mentioned, fix one end of each piece to the flat surfaces of the half round fiber, one piece of brass to one of fiber. This should be done in such a manner that the end of each brass strip comes to within about 1/8th inch of the center of the fiber, on the flat surface, both brass strips also being positioned near the center of the fiber, in regard to the distance from each end.

The two flat surfaces of the fiber are now fitted together in such a manner that the two pieces form one round rod, with a brass ribbon apparently passing thru the center. One of the pieces of brass should now be wound part way around the rod, till it comes into contact with the other piece.

When the above steps have been taken,

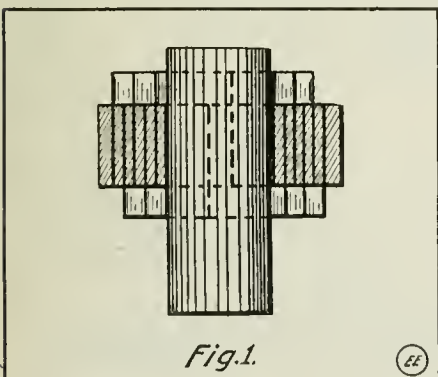

Fig. 1. Showing Detail of Moving Spiral Plate Member of Variable Condenser; the Brass Ribbon Spiral is Held by Molded Lead.

the fiber rods should be slid along on each other, so that if the metal ribbon is wound around the rods, the pieces will overlap at

each end 1/4th of an inch, thus forming a winding 1-1/2 inches wide. Before the winding is commenced however, two pieces of paper tape should be placed between the brass strips, and two additional pieces made fast to the outside surface of the second metal ribbon, in such a position that when the several layers of metal and paper have been wound into a tight coil, there will be an empty annular space 1/4th of an inch deep between the brass strips at each end of the coil, the remaining 3/4ths inch near the center being filled with the paper tape, as shown in Fig. 1.

In order to wind the paper and metal in the manner specified, it will first be necessary to clamp both ends of the fiber together. After the coil has been completely wound, it should be bound with paper tape, until the outside diameter of the paper ring thus formed is equal to the inside diameter of the tubular condenser case. Both ends of the fiber can now be sawed off flush with each other, one end being sawed off about 1/8th of an inch from the end of the coil. The other end should extend about 3/4ths inch beyond the end of the coil; see Fig. 1.

The clamps can now be removed from the fiber ends, and the condenser case split over the coil, which should be pushed into position, so that the short end of the fiber comes to within about 1/8th inch of the top end of the case. Molten lead should now be poured in to fill the remaining space to the top of the case, after a short strip of very thin copper ribbon, about one-fourth inch wide, has been inserted in the space between the pieces of fiber. This piece should be bent over once at the lower end before being inserted, so that when the lead has been poured, the copper ribbon cannot be withdrawn.

The condenser case should now be moved along over the coil of metal and paper tape, until the other exposed ends of the fiber pieces extend beyond the case about 1/8th of an inch. This should cause the upper lead casting to move down about 1 inch.

Several layers of paper tape should next be wound around the lower end of the case to form a mould for the lead base which is integral with the metal portion which holds the lower set of spiral plates as shown in Fig. 2.

The various parts are now removed from the case, and the two sets of spiral plates are carefully pulled apart, the paper tape being removed at the same time. If these parts are now placed in their original positions in the case they should slide freely in and out of each other. In the event of the friction being too great to allow free movement, the lead and fiber on the movable portion of the plates can be filed down a little to permit unobstructed movement.

The top piece for the condenser should now be slotted to allow the copper ribbon to pass thru, the latter being then attached to the round brass rod, mentioned in the list of materials.

The top is next fastened to the case by means of a brass screw eye on one side, and a small screw binding post on the other. The brass rod mentioned above is then

put into place, being slipt thru the screw eye on the right hand side, as in Fig. 2, and using for its other binding support a second screw eye held in the binding post as shown.

A composition or rubber knob placed on one end of the brass rod, and a small binding post fitted to the lead base, complete

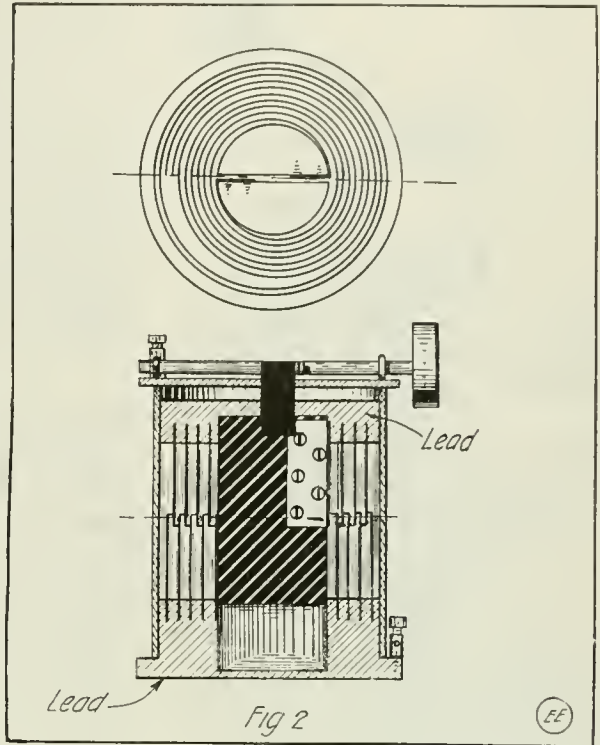

Fig. 2. Unique Variable Condenser, Suitable for Radio and Other Circuits. The Movable and Stationary Plates (Spirals of Brass Ribbon) Are Both Held by Molded Lead at Top and Bottom of the Condenser, As Shown. Oil Dielectric Can Be Used, Giving As High As Five Times the Capacity With Air.

the construction of the condenser.

In operation the plates are separated by turning the knob, the weight of the movable plates causing them to sink into place between the fixed plates, when the knob is turned in the proper direction, and the friction on the rod, brought about by compressing the bearings, prevents the plates from moving on their own account.

This condenser can be shellacked around the bottom joint and filled with oil to increase its capacity, and in this manner a very compact and simple instrument will be obtained which will give excellent results.

MAKES RESERVATION IN "ENGINEERS" BY WIRELESS.

Fearing that he would arrive too late to enlist in the Eighteenth engineers, railway, United States Army, Warren A. Taylor, a railroad man of Cordova, Alaska, recently wirelessed Col. J. B. Cavanaugh, commander of the regiment, to hold a place for him. Taylor arrived in time to enlist at the Eighteenth's emergency recruiting office.

For the last seven years Taylor has been an engine man on the Cooper River Northwestern. On learning that the United States was organizing nine railway regiments to send to France, he began preparations for the trip to Seattle to enlist. He was delayed, but decided to take a chance on getting into the regiment on the eve of its departure for Europe. When the steamship Alaska was two days out he sent the wireless asking for a "reservation."

PORCELAIN KNOBS AS ANTENNA INSULATORS.

The drawing is that of an aerial which is insulated with material which is commonly found around any work shop. By looking at the illustration you will see that it comprises merely two porcelain knob

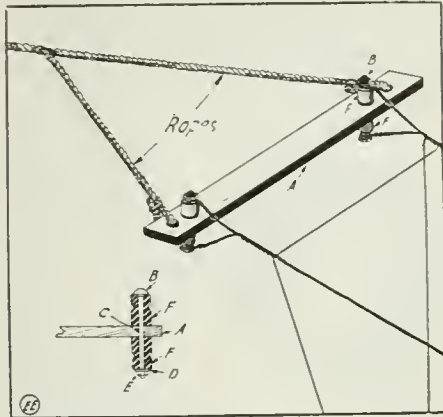

Clever Way of Utilizing Porcelain Knobs in Supporting Antenna or Other Line Spans. The Knobs Are Bolted to the Spar in Pairs as Shown.

insulators, fastened on the spreader by a bolt of sufficient length. This is a cheap but neat insulator and will work very nicely for receiving or small sending stations.

Contributed by **BENJAMIN L. TEAM.**

AN ARCLESS MAGNETIC RADIO-RELAY.

To make this key first take an electromagnet that has a tap hole in one end and rewind with wire that is heavy enough to stand full load current of the transformer, grounding one end firmly to the core. (Allow 800 circular mils per ampere for cross-section of wire.) Then rivet a piece of silver on the end of the core opposite the hole and mount on a suitable base by a bracket B, formed by bending a piece of heavy sheet iron into the shape of an L, but before bending drill three holes in it, two to hold it to the base and one to accommodate a screw to support the coil, as shown. Then make two more brackets, B₁ and B₂, similar to B, of heavy sheet brass. To B₁ (see drawing) is soldered the armature, which is made of a piece of thin sheet steel. On to this is soldered the other silver contact which corresponds to the one on the end of the coil.

The third bracket may be made exactly like B, and will be used to hold the helical spring and its means of adjustment, as

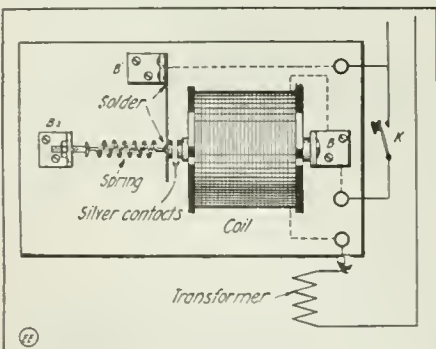

Due to the Fact that the Alternating Current from the Transformer Line Flows Thru the Key Magnet Coil, the Final "Break" of the Circuit Occurs at the Zero Part of the Cycle.

shown. The other end of the spring is soldered on to the armature, as soon. Three binding posts should be provided and

connected, as indicated by dotted lines. The external connections are also shown.

Now, if the key is depressed, current will flow thru the key, transformer and relay coil, the current thru the latter causing it to attract its armature, which will alternately open and close the silver contacts, which are shunted across the key, due to the alternating character of the current flowing in it, the armature flying back when current approaches zero, to be attracted again when it increases again, etc.

Now, if the key is released when the value of the current is great enough at that instance to attract the relay armature, the circuit will not be opened by the key, therefore no spark occurs at its contacts; nor will the circuit be opened until the value of the alternating current has reached a value so low that it can no longer hold the armature, which then flies open, opening the circuit when there is very little current flowing, which means practically no spark at the relay contacts.

The difference in time between the opening of the key is so short that it is unnoticeable, being less than 1-1/120 part of a second when 60 cycle current is used.

Contributed by **LOREN ANSLOW.**

MAKING SWITCHBOARD AND INSTRUMENT BASES OF SLATE.

Owing to the high cost of hard rubber, vulcanized fiber and other suitable materials, many amateurs use wood, with the result that the instruments are not efficient, due to the fact that wood easily absorbs moisture. I would suggest that greater use be made of ordinary roofing slate instead of wood, as it can be worked almost as easily as the latter.

The slate is cheap and can be easily procured. It is cut to the desired size with an ordinary wood saw (lubricate with water), preferably one having about ten teeth to the inch. A hack saw will make a very clean cut but will cut very slowly. I would suggest using a cheap saw such as can be procured in a five and ten cent store, as a good saw would be ruined, or would, to say the least, need "some" re-filing. After the slate has been cut the edges are smoothed and beveled with a file and the whole well rubbed down with fine sandpaper and a block. If the slate is not thick enough, two pieces may be cemented together with thick shellac or may be held together by means of the screws holding the instruments. Holes for binding posts, switches or instruments can be drilled easily with a diamond point or twist drill. Before fastening on the instruments the slate is again well rubbed down with fine sand paper or emery cloth and given a coat of varnish or shellac. The finished base will look very much like hard rubber. Many slate switchboards are simply rubbed up thoroly with linseed oil. Others are given a coat of some good insulating varnish such as black amalac.

Contributed by **JOSEPH BACKERT.**

SECRET "WIRELESS" IS FOUND ON APPAM.

Federal authorities recently found a secret wireless plant aboard the interned steamship Appam, which was taken possession of by United States Marshal Saunders at Newport News, soon after the severance of relations with Germany.

A fine wire was found strung beneath the pipe leading to the whistle on the smokestack of the Appam and extending above it as do the antennae of wireless plants. The wire led to the interior of the vessel where the lighting plant dynamos were kept running. When the Appam was first brought into port, the dynamo in the

A SIMPLE POTENTIOMETER CONTROL.

The carbon ring used in making this potentiometer may be sawed off the bottom of an old wet cell carbon cylinder. It should be about 3/8" or 1/2" in thick-

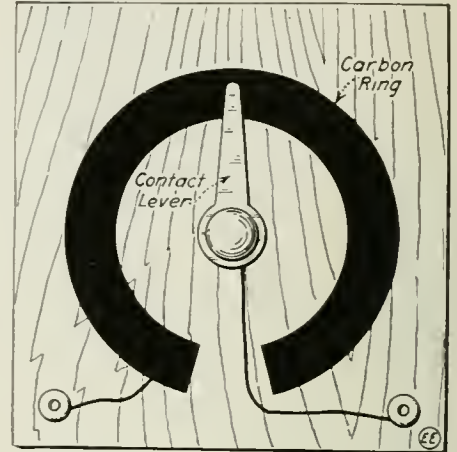

An Efficient and Finely Adjustable Potentiometer Constructed from a Ring of Battery Carbon and a Switch Blade.

ness. After filing and sand-papering the top smooth, it then should be glued to a base with a wire connecting to one binding post. In the center of the carbon circle so formed, mount a hard rubber knob and switch lever so as to make contact with the ring.

This potentiometer is very easily and cheaply constructed. A large number of them may be made from one carbon cylinder. They will prove useful in controlling the current in radio and electrical circuits.

Contributed by **BURT CLARK.**

wireless room was removed by the Federal authorities. Later, however, Lieutenant Berg ran a wire to the wireless apparatus from the dynamo in the boiler room of the steamship and connected it so that he could either send or receive messages.

From the wireless room another wire led to Lieutenant Berg's private room in Norfolk. Messages were flashed to him in the Morse code on his electric light bulb by the simple process used in flashing messages between battleships at sea.

HOW TO IMPROVE ROTARY SWITCHES.

After having trouble with the connections to the moving member of a rotary switch on a loose coupler, I adopted the following scheme:

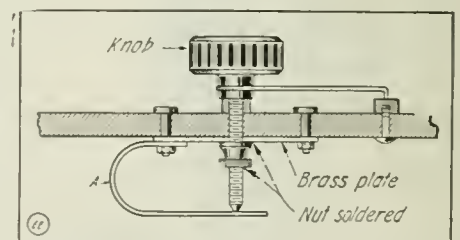

Effective Arrangement of Rotary Switch Blade to Ensure Positive Contact at All Times.

In figure "A" is a phosphor bronze spring, bent as shown, so as to bear on the pointed end of the threaded rod of the switch knob. The contact is kept bright by the constant turning of the switch.

Contributed by **ASA S. KELLER.**

THE CONSTRUCTOR



Making An Electric Clock

By THOMAS REED

Part II.—Wheels.

I MEAN clock-wheels, not the ones in your head. Clock works are pretty hard to make unless you have a lathe, but you can fudge up something that will do out of the works of a kitchen clock. I mean the old-fashioned wooden-case clock with the peaked

the old-fashioned clocks this was apt to be the fact, and that wheel was the one just preceding the 'scape-wheel. So the thing to do is to take the 'scape-wheel off its arbor and put it in place of the gear on the preceding arbor. That isn't so hard, but you can't have a second-hand on, unless you want one running backward. If you have a lot of old clock-wheels, perhaps you can pick out two that are exactly alike, and transfer the motion equally but in opposite directions from your minute-arbor to your old 'scape-wheel arbor, in which case it will run right and come thru fairly symmetrically on your main dial. To extend the arbor in order to carry the second-hand, you can buy some very, very small brass tube (it's made, I assure you) and tuck a piece of it over the end of the arbor, reaming the front hole out to correspond; or you can make up a little tube yourself if you're careful. I made an entire new arbor by filing white rotating in the lathe.

Also, the 'scape-wheel you use must have 30 teeth. Perhaps it seems too much to expect of an old clock to satisfy so many requirements, but lots of them *do* have 30-tooth 'scape-wheels. Junk-stores usually have several of these old clocks for sale cheap, and you're pretty apt to meet up with one that passes the test. If worse comes to worst, you can use an odd gear-reduction, and make up an odd-length pendulum, experimentally, to match it.

Now about the escapement. A plain ratchet-and-pawl is what one first thinks of, with an extra click to prevent its dragging backward; but that isn't satisfactory, as occasionally the pawl will ride over a tooth, or fail to catch it—you can't tell why. Fig. 1 shows a reliable construction, which is a reversal of the so-called *gravity escapement*. When the pendulum lifts the lever on the right, the one on the left drops, forcing the pallet P between the teeth A and B, with a sliding motion into the space C, and moving the wheel 1/2 tooth ahead. On the return swing, the right-hand pallet P', drops between teeth D and E, but can't move the wheel until the left-hand pallet P is lifted an instant later; then pallet P' drops into space F, moving the wheel another 1/2 tooth in the same direction as before. The pallets have to be adjusted to each other to work coincidentally, but you only have to make one of them adjustable, of course (see Fig. 2). It isn't vitally important what part of the circumference the

pallets meet. The pallets are made of steel, and as highly polished as possible. The size varies with the 'scape-wheel teeth; the

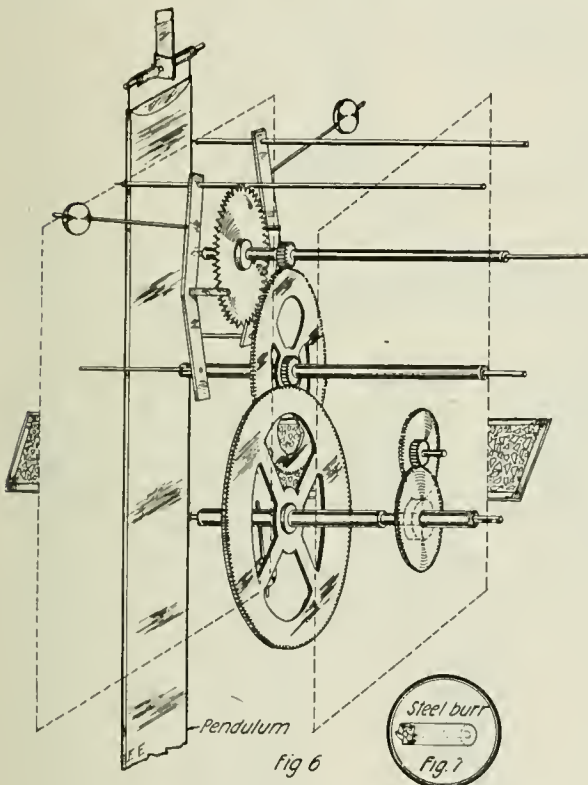

Phantom View of the Modified Clock Movement As Adapted to Be Driven by Electricity. Fig. 7 Shows Detail of Steel Burr for Milling Ends of Arbors.

top, whose works are simple and rugged. You discard, of course, the power-wheel (spring or weight) and any other wheels which occur on the power-side of the minute-hand arbor.

If you were going to use a pendulum of the same short length as the kitchen clock, you would have pretty plain sailing; but I assume you want a *seconds-*

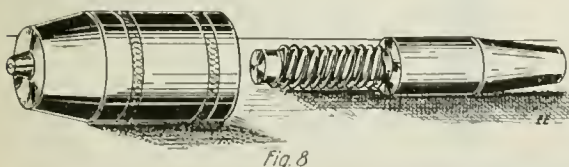

Special Tapered Stud to Hold Hand-drill Chuck in Lathe. The Arbor Burr, Fig. 7, Is Then Held in This Chuck.

pendulum (see Sept. issue), and that makes it hard. In the first place, the works must have been designed so that one of the wheels revolves in just one minute. In

each other to work coincidentally, but you only have to make one of them adjustable, of course (see Fig. 2). It isn't vitally important what part of the circumference the

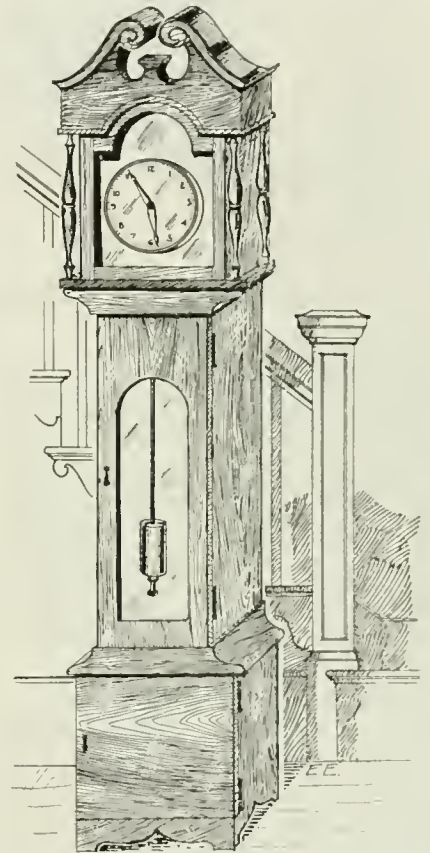

Electrical Experimenters Take Our Advice, Build a Home-Made Electric Clock. You Will Always Be Proud of It.

base of the wedge should be quite a bit wider than the space between the teeth.

In Fig. 1, the escapement bars are hung from arbors, and the impulses are given by the little weights—W, W. The same result could probably be accomplished by mounting the escapement bars on springs, which would be an easier construction for some.

Recess now for a "wrinkle." It's about oiling clocks. Use *toilet vaseline*. I know all the old clockmakers will howl in unison at this, for they say use the "runniest"

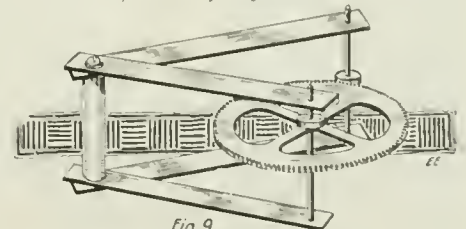

Handy Jig for Matching Up Gears and Determining Their Correct Spacing Between Arbor Centers Before Drilling the Main Frame.

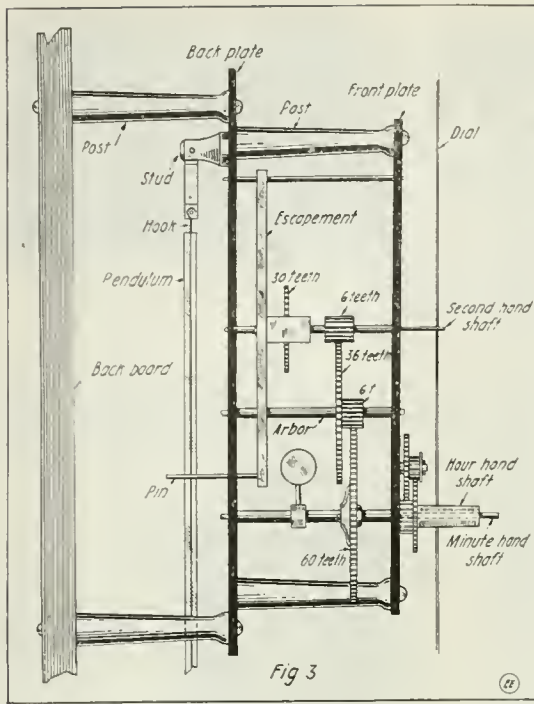

Side View of Complete Electric Clock Movement, Illustrating Suspension of Pallet Levers, Escape Wheel and Pendulum.

that quarter shortly. (Voice from the deep: In 1915-16 four gear people advertised in the "E. E." They all quit, because "E. E." readers did not buy any gears, it seems. Moral: "E. E." readers support advertisers! Editor.)

Wrinkle:—The pinions, or small gears, come in rods, which you have to cut up and drill concentrically; so if your chuck has three jaws you can practically only use a 6-toothed pinion, otherwise it won't center right. If you are adept in lathe work, however, you can drill any pitch gear, concentrically by placing a piece of steel or brass strip around it and then tightening up the chuck. A piece of thin sheet lead is excellent, as there is less chance of damaging the teeth. But this is no obstacle, as you can apportion the teeth of the larger gears to obtain the proper reduction. A good proportion (60-6 and 36-6) is shown in

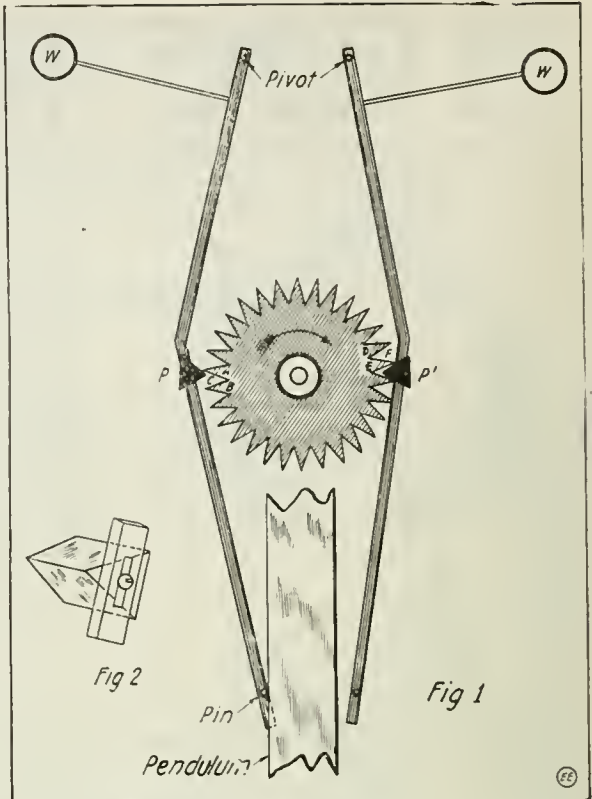

Details of Escapement Mechanism Showing How the Pallet's P and P' Rotate the Star Wheel, As the Weighted Levers Are Moved Alternately by the Swinging Pendulum Bar.

oil there is; but I've tried vaseline and I know. Thin oil tends to run out of the bearings and spread on the plates. My clock was deficient in depth of the counter-sinkings, which are supposed to hold the oil by capillarity, and I had to re-oil it every 6 months or so; but now, with a little daub of vaseline on each arbor-end and on the pallets, I never have to touch it. I added a little graphite scraped from a hard lead-pencil, but really I don't know whether that improved it or not. Vaseline stays where you put it, and doesn't gum. I'd laugh if it should prove a popular lubricant for clocks on my recommendation. I remember I used it on my bicycle years ago, when all the wisecracks said it was the worst thing you could do, and would bring down on the patient tin steed some mysterious calamity resembling the Curse of Muldoon in direness. Everybody's doing it now.

If you have a lathe with a self-centering chuck, you'll want to make your own works, so I give you the detail drawings of mine (Figs. 3, 4, 5, 6). As to the gears—you buy 'em. The various gear companies publish nice illustrated catalogs from which you can select gears and pinions with the proper sizes and numbers of teeth. I could tell you here the name of one good Gear Works, but I won't, because I think they ought to advertise in "E. E."! It's up to the Editor to go get 'em. By the "ads" he already has, I judge he has some irresistible method of pulling 'em in, so I shouldn't be surprised if we heard a peep or two from

the drawings.

Of course the gears referred to are not the broad-faced kind, but the thin clock-gears. The Gear Works sell them and if there's any choice, get the thinnest and tiniest ones you can, as there's no power on them. You can also buy 30-tooth 'scape-wheels—"star-wheels"—with the teeth radiating from the centre (Fig. 1) instead of inclined like those of mechanical clocks. Just as good either way.

isting clock.

About reducing the ends of the arbors to the size of the bearing-holes, you can do this in the lathe with a file all right, and then, after polishing, ream out your holes to fit. The holes ought to be drilled small and reamed (broached) anyway, as a plain drill-hole is pretty rough. A little young reamer for such small holes costs only 10 cents or so. Any watch or clock-maker will sell you one of these tapered reamers—called *broaches*. If you want to take the trouble, instead of filing you can make yourself a small steel "burr" (Fig. 7) which isn't difficult, and then your arbor-ends will all be the same size, and true. Only you have to hold the burr in a drill-chuck set in the tail-stock. Wrinkle: I use the little chuck off of my hand-drill, having made for it a tapered stub with the proper thread (Fig. 8). It's the handiest thing there is about the house, and if I lost it I'd give way to despair and get me to a nunnery—well, you know what I mean, the other kind.

To mill your clock-arbor, you hold it in the head-stock chuck, and while in motion run the burr up on one end at a time, till the distance between the shoulders is the same as that between the front and back plates—with an allowance for ease.

(Continued on page 425)

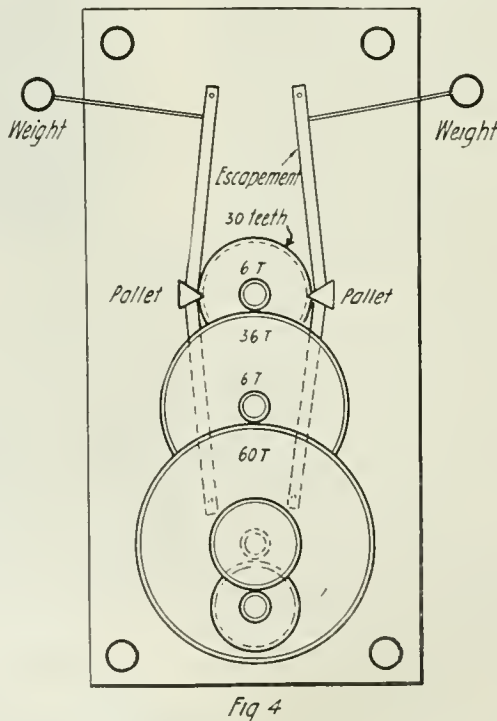

Here, "Bugs," We See the Arrangement of the Electric Clock Gear Train. It's Simple We Assure You.

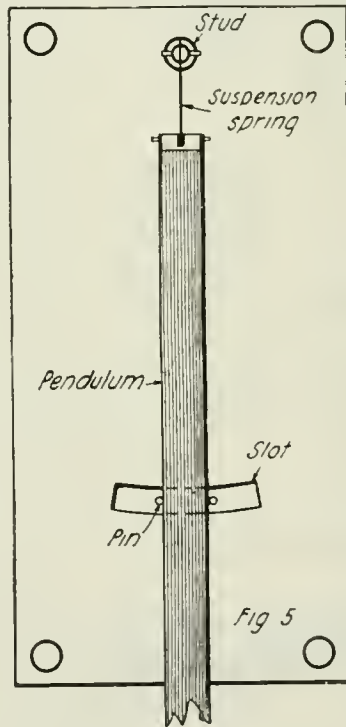

Rear View of Clock Plate. The Pallet Levers Are Moved by Pins on Either Side of Pendulum.

One thing you can't buy, tho. and that's the hand-wheels—those re-entering gears which reduce the minute to the hour speed. You'll have to bone them from some ex-

Building a Good Carbon Compression Rheostat

A rheostat that will serve over a wide range of uses may be made from a number of pieces of sheet carbon. Anyone who has tried water rheostats knows that it is very difficult for these rheostats to keep a constant resistance, owing to the fact that particles of the electrodes either float in the electrolyte or settle at the bottom of the container, and thus increase the conductivity. The longer they are used the lower their resistance becomes, and often considerable damage is done due to this fact. Rheostats made of resistance wire, besides being rather expensive, require some time and trouble in order to make suitable contacts and a more or less elaborate contact arm to swing over them.

A carbon rheostat is cheap and easy to make, will keep a practically constant resistance and is not likely to burn out when overloaded. The one to be described has a range from about 1/2 to a few hundred amperes at a pressure of 1 1/2 volts, tho the details of construction may be varied to suit the purpose for which it is to be used.

The materials needed are a piece of 1/8" sheet carbon 12" by 12", 2 brass rods 3/16" in diameter and 6 3/4" long, 2 pieces of 2" by 2" sheet fiber, about a foot of 5/16" fiber tubing (outside diameter), some 1/8" sheet steel or copper, a fiber wheel 2" in diameter and 3/8" thick, a heavy brass screw (see illustration), some washers, 4 nuts and 4 flat-headed No. 10-32 brass machine screws. Two pieces of 2" by 2" brass, 1/4" (iron or copper 1/4 inch thick will do) thick will also be needed.

top of the base. A slate base is good. Lay off the sheet carbon in 2 inch squares, and drill holes in each piece as indicated. After the holes are drilled, the squares should be cut out, making 36 of them in all. This may be done by carefully cutting the carbon with a hack saw, or a sharp pointed scriber may be run along the guide

ly fasten the 1/4" brass plate to the base. The fiber compression wheel is fastened to the heavy brass screw with machine screws which are countersunk in the fiber. The head of the brass screw has 4 holes drilled and tapped in it for this purpose. The threads are No. 10-32.

Binding posts are fastened to the holes of the projections of the copper plates, and serve as the terminals of the rheostat. The resistance of the rheostat decreases the more the fiber wheel is screwed down, and vice versa. For smaller loads the rheostats may be made more sensitive by using more carbon plates. Carbon rheostats are used for many purposes and in a great many places. They are used by standardizing laboratories such as the Governmental laboratories and in the Universities. They are used by testing departments of practically all kinds of electrical supply companies, whether electric railway or electric lighting, and provide a simple and satisfactory method of regulating direct current for test purposes, if they are properly made. This rheostat provides as indicated in the article, satisfactory control for currents from .5 to a few hundred amperes at battery potential of 1.5 volts. (40 to 50 amperes per square inch of carbon plate surface is a fair value for a steady load; 75 to 80 amperes may be past for short periods.—Ed.)

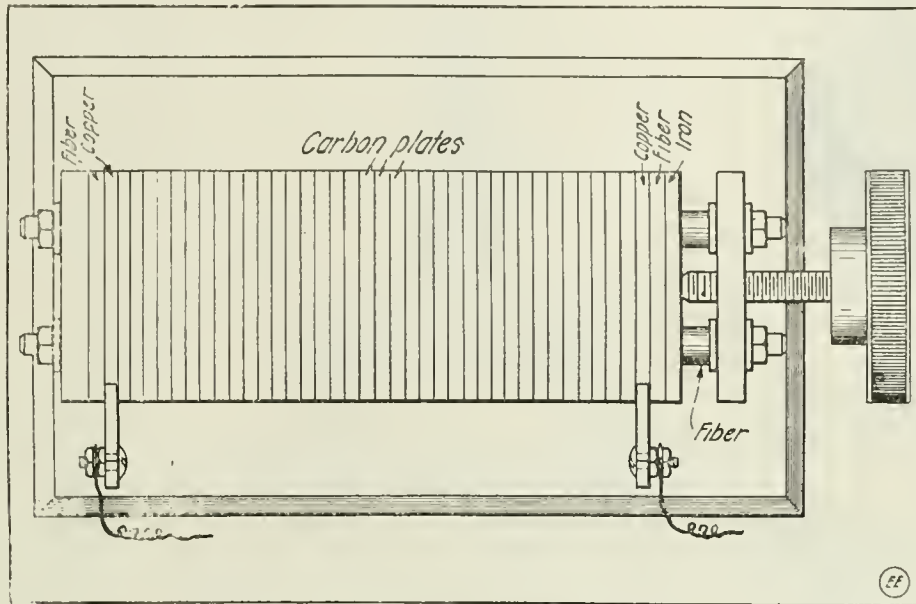

Plan View of a Compression Type Carbon Plate Rheostat of Many Uses. It Will Handle Currents of From .5 Ampere to 200 Amperes. The Resistance is Lowered by Compressing the Carbon Plates and Vice Versa.

lines a few times and the carbon will then break quite easily.

The brass rods should be threaded with a No. 10-32 die which fits them exactly. The two brass plates which are 1/4" thick must have holes drilled in them so as to permit the brass rods to pass thru them. Holes thru their ends also are drilled and tapped to facilitate screwing into the base. All the other square pieces, whether of copper, fiber or carbon, have 3/8" holes drilled in them in the position indicated.

Securely fasten one of the 1/4" brass plates on end, to the base. Slip the rods thru it and fasten with washers and nuts. Then slip a piece of fiber tubing 5 3/8" long on to each rod. The square pieces are then slipped over the fiber tubing and rods in the following order: First a piece of fiber, then a piece of copper with an ear on it, then the 36 carbon plates, then the other copper plate with the ear on it, then the other piece of fiber, then the piece of sheet iron. (See assembly drawing.)

The fiber tubing should now project 1/4" above all the plates and the rods should project thru the tubing. Slip washers on the rods, then put on the last pieces of 1/4" brass plate. This last piece has a 1/4" hole drilled and tapped thru its center to receive the heavy brass screw. Now slip another washer on each of the rods and screw down with nuts. Then secure-

Contributed by ALBERT H. BEILER.

A NOVEL WINDOW ATTRACTION.

This display is to be used chiefly as a flash-light window decoration. It is to represent a large flash-light. A, is a piece of stove-pipe. P, is a piece of wood cut circular to fit end of stove-pipe. M, is a 40-watt electric lamp. N, is socket to hold lamp. E, is a reflector. K, is an imitation push-button. S, is stand to support display. W, is concealed wiring. L, is the lens and H is a front glass taken from an

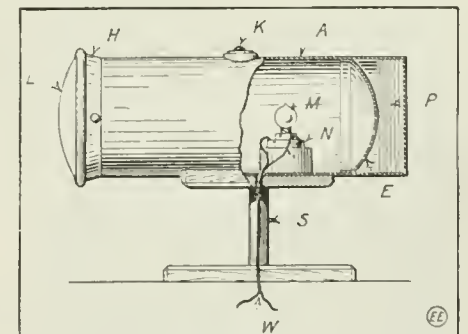

This Nifty Electrical Window Attraction Comprises a Large Dummy Flash-Light, the Lamp Within It Being Winked On and Off By a Flasher.

automobile. The drawing will explain itself. A flasher can be put into the circuit, to give a more novel effect.

This display is worth anyone's time, and the cost is small.

Contributed by OTTO G. CLAWSON.

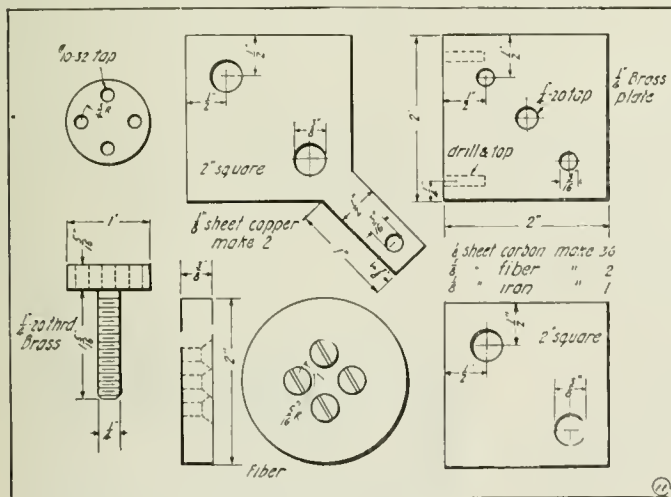

Dimensions of Carbon Plate Units, Compression Screw, Etc., for Rheostat Illustrated Above.

Secure a suitable baseboard about 7" by 4" by 1/2". A piece of marble, slate or asbestos board will be excellent but any hard wood will do. For high amperage, it is advisable, if the base is to be of wood, to fasten some heavy asbestos sheeting to the

base. Slip the rods thru it and fasten with washers and nuts. Then slip another washer on each of the rods and screw down with nuts. Then secure-

How to Make a Magnetic Polarity Indicator

By Samuel Cohen

It sometimes happens that the polarity of a current in a line is required and no available means is at hand. The writer



A Watch Style Polarity Indicator of the Magnetic Type Appeals to Every Electrical Man. Details for Making One Are Given Herein.

was in this predicament at one time and hurriedly constructed an instrument which served the purpose very well, and thought it worth while to show the readers of this journal how to make one of them.

The accompanying photograph shows the instrument complete. Note the relative size of the same. The instrument consists of a watch case, in which a dial, supported on a pivoted permanent magnet, is enclosed. This magnet is acted upon by a magnetic field produced by a small electro-magnet coil.

The constructional details are given. It will be noted that actual sizes are not shown, as it depends mainly upon the size of the watch case. The field or exciting magnet consists of a core made as indicated in Fig. 1. The length A is equal to the inside diameter of the watch, while the width B should not exceed 3/8 of an inch. The width of the pole pieces C will depend upon the general features of the case. The height is determined by the depth of the case. It should be made as high as space permits, in order to enable one to close the back of the case with the cover. The winding of this field will depend on the character of work you desire to use the meter for. The following table has been made to facilitate matters. The resistance of the coil for the three voltages should be as follows: 110 volt circuit—1100 ohms; 32 volts—256 ohms; and 6 volts—25 ohms. The number of turns and size of wire is greatly dependent on the size of the magnet and the figures can readily be obtained from any wire table.

The indicating face of the watch is removed and in its place another circular brass disc 1, Fig. 2 is placed. The magnetic vane 2 is made as shown, the length of which should be three-quarters the diameter of the disc 1 and the width 5/16 of an inch. It is made of the best tool steel, preferably spring steel, and should be magnetized in the usual manner by the application of a strong permanent or electro-magnet. A pivoted rod 3, is fastened to the center of the magnet as shown. This is used to support the magnet between the standard 4, which is a piece of stiff brass bent as indicated and soldered to the rear of the plate 1. A small hole is made on the interior face of this stand-

ard and exactly opposite this another hole is made on the plate 1, in order to hold horizontally the pivoted magnet shaft 3. A paper dial 5, is fastened to the ends of the magnet. Two dial holes 6,6 are drilled in the plate 1. These should so be situated that they cover the ends of the dial 5.

The field or exciting magnet A, is placed in a horizontal position while the magnet 2, is stationed in a vertical position. By the passage of a current of electricity thru the coil in one direction, the needle will be displaced in one direction, but it will change its direction if the terminals of the coil are reversed.

If a known polarity indicator is on hand so as to show the direction of current in the line, it is very easy then to calibrate the instrument or the following simple chemical polarity indicator can be used. Place the two current terminals in a sliced potato and the surface about the wire which bubbles indicates the negative terminal. Connecting the same two wires to the magnetizing coil and knowing their polarity, it is easy to mark either the lower or upper wire as the negative or positive. So if the lower wire is positive, then indicate by (+) on the lower part of the dial. When the current is flowing thru the coil and as soon as the current is released the indicating mark will disappear. The whole arrangement should be placed in the watch case and the coil terminals

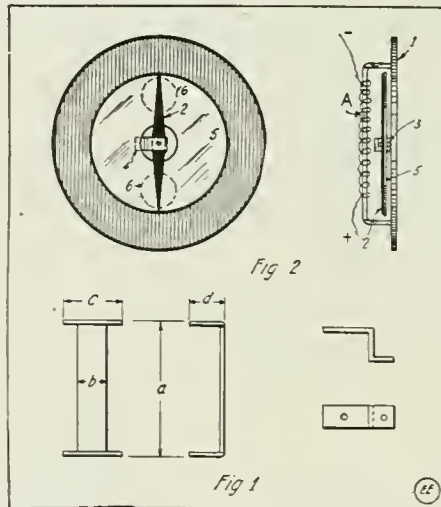

Detail of Magnetized Needle and Electro-Magnet Used in Making Polarity Indicator.

should be led thru the bottom and top of the case by boring a hole in each end and properly insulated.

The time spent in building this instrument will never be regretted by the experimenter as it will amply repay him in future service.

NON-CORROSIVE COBALT ALLOYS.

A recent bulletin of the Canada Department of Mines gives an account of some tests by H. T. Kalmus and K. B. Blake on non-corrosive cobalt alloys. The addition of cobalt or nickel to iron proved beneficial as far as non-corrosive qualities are concerned. Cobalt is somewhat better than nickel in this respect. The extent of corrosion appears to be dependent on time of exposure, but is not a simple function of the cobalt content. A small addition of copper also seems to reduce the atmospheric corrosion of American spigot iron.

AN INDUCTIVE OCEAN CABLE SYSTEM.

I think I have an improvement over Mr. Schultz's invention as described in the April issue. Instead of using buoys I propose that a submarine cable be laid on the exact route of the ship. This would be a guide for the vessel as well as a means of communication with the shore by means of an induction system. Thus the ship will always be on the safe route by constantly communicating with the shore, especially in a heavy fog and gale. In war time a guiding scheme like this would save many a ship from being blown up by mines. A scheme like this would be invaluable on a route running among dangerous rocks and reefs. In time of danger, help can be summoned without delay. This idea, I think, is as good as wireless telegraphy, if not better, because wireless telegraphy will not guide a ship in dangerous waters or be so efficient. By means of my proposition the use of buoys in dangerous waters would be eliminated, and buoys can't always be depended upon.

Contributed by HARRY E. FUCHS.

(This scheme would be feasible if the cable was but a short distance underneath the ship. But to obtain an inductive effect over 500 to 2,000 feet of depth is not possible for the reason that, first, the iron clad cable absorbs most of the inductive currents and, second, because only a few volts and less than 1/100 of an ampere can be used for submarine telegraphy. When stronger currents are used, the cable—which is nothing but an immense condenser—breaks down, as happened to several of our first transatlantic cables.—EDITOR.)

A HOME-MADE FREQUENCY INDICATOR.

In the absence of a more expensive instrument, a frequency indicator which gives good results has been constructed, as shown, says an *Electrical World* writer, from a telephone receiver as follows: Eight strips of 0.006 in. spring steel 5/64 in. wide by 2 in. long marked (1) in the side view of the receiver shown in the accompanying illustration were clamped radially between two burrs (6) on the cork (3) by means of a wood screw (7). The contacting metal surfaces were tinned and sweated together. The whole was then mounted on the diaphragm of a telephone receiver (5) by means of beeswax. The magnet had been previously removed from the receiver, and the brass screw (8) replaced by one of steel.

For use with 110 volts it was found necessary to use a 400-ohm resistance in series. In calibrating this device a motor-generator of adjustable frequency was used in connection with a standard instrument. After setting the machine at 56 cycles, one of the springs was carefully clipped off at the end, piece by piece, until it set up a strong vibration. The machine was then raised to 57, and the operation repeated with the

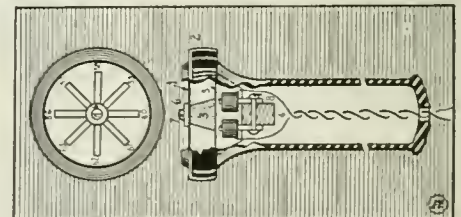

A Useful frequency meter made from a telephone Receiver and a Few Steel Reeds, Properly Calibrated.

next spring, and so on up to 63 cycles. Each spring thereafter vibrated only in response to the frequency to which it was adjusted.

CONSTRUCTING A 1/4 K.W. HIGH FREQUENCY OUDIN COIL.

By George Sutton, Jr.

FIRST I procured a card-board tube in which a Pyrene fire extinguisher was packed, at a local auto supply store. The size of mine is 10 in. long and 4 in. in diameter. Next I painted the card-board cylinder with 3 coats of orange shellac to make it stiff. Then I constructed the wooden heads; they may be turned up on a lathe or with a compass saw if no lathe is available. One head measures 4 1/2 in. in diameter and the other head 3 3/4 in. in diameter. The smaller head is eventually fastened to the base to hold the cylinder in place. I turned the top head, which is made all in one piece as shown, and put the heads on the cylinder and mounted it between the centers of my lathe. The cylinder was wound with one layer of No. 26 enameled magnet wire, between the turns of which I wound a layer of heavy linen thread to separate the turns. I started 1/2 in.

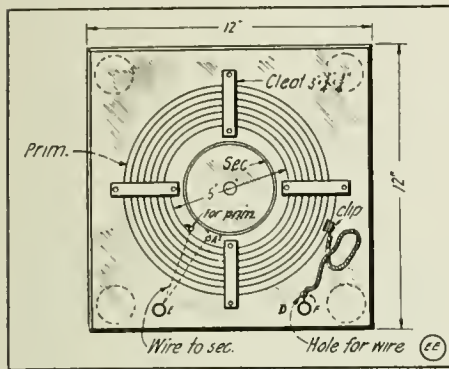

Plan View of Small High Frequency Coil of the Oudin Type.

from the top and finished 1 1/4 in. from bottom; this will take about eight hundred

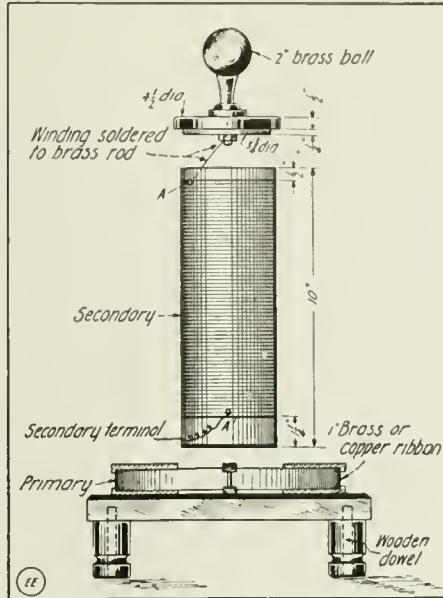

Details of Small Oudin Coil Suitable for Use with 1/4 K.W. Step-Up Radio Transformer or 6 to 8 Inch Spark Coil.

turns. Two holes are punched, one at A and one A¹. The top turn is run thru the hole A, and connected to the brass ball on top; the bottom turn is run thru hole A¹ and thru hole A² and connected to binding post E. After the cylinder is wound it is necessary to coat it thoroly with several coats of shellac, as this prevents the sparks from jumping between turns and also holds

the wire in place. Now comes the base; I used a piece of yellow pine 12 in. square, 3/4 in. thick, then gave it several coats of black asphaltum paint. The brass ball may be obtained from a bed-post or may be purchased from a local hardware dealer. The secondary cylinder was put in place, the bottom turn of secondary connected with binding post E, and the top turn connected with the brass ball. I then constructed the primary; first I took a ring of card-board 5 in. inside diameter and 1 in. wide and fastened one end of the brass tape by binding it with friction tape. The primary is made of 8 or 9 turns of 1 in. brass or copper ribbon separated by a layer of corrugated card-board. When the primary is completed it is bound by winding some friction tape around the outside; the inside turn of primary is also connected to binding post; this flexible wire has a clip attached to it and is connected to binding post D, and run thru hole F, so as not to interfere with making connections with as many turns of the primary as may be needed. Four standard porcelain insulators are used for feet. Sparks from 8 to 12 in. long can be drawn from this Oudin transformer when excited by 1/4 K. W. wireless transformer.

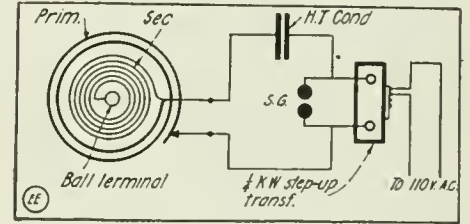

Connections for Oudin Coil, Showing How the Secondary and Primary Windings Are Connected Together.

Trials of a Troubleshooter

By THOS. W. BENSON

HAVE you ever indulged in that great indoor sport of "trouble-shooting." Especially that brand of trouble that infests the network and web of a telephone system in a large town. NO?

Never stood by when a cable "blows up"; when pair after pair goes bad? Never held your breath as that infernal meter on the test table swings over and in its cold, impersonal way quietly shows "dead pairs," "shunts," "opens," "grounds," and what not, knowing meanwhile that you are going out to shoot the said trouble? Great life! Take it from your Uncle Dudley.

Paradise, according to the late Elbert Hubbard, is a town with only one telephone system. Perhaps so, but you can stake your last jitney against a cancelled postage stamp that the said system keeps the recording angel busy at times, even more so when old Jupe Pluvius lets drive with a rain storm.

But there are some troubles that seem to have no rhyme or reason. This is the case when transmission is poor. There are several million different things that can cause this and the majority are not in the text book. It is simply a case of pulling wires and tightening screws till the trouble goes off.

For instance, a certain 'phone goes bad and you jump over to see what the "bug" is. But, curses, the instruments test O.K. The cord seems to have a light shunt on it so you put in a new cord. But behold, next day the same 'phone is on your bogey with the same trouble. An examination shows that the cord is at fault again. And that was a perfectly good cord when put in a few hours before. Well, we will put an-

other one in and see how that works. Test table reports clear and away you go.

But, the next day sees you back at the old stand. Now what in the name of a bald-headed South African flea is wrong? The cords look perfect, not wet or spotted. (It is practically impossible to pick up a single wet spot on a cord.) A new cord and the 'phone is reported clear. Yes, you are now shooting trouble with a great big "T."

Perhaps this will continue till you happen in on the 'phone and find that blamed pet poddle snapping at the cord. Yep, those toy hounds can wet that cord sufficiently by biting on it till the relay at central drops over and flashes up on the board.

Of course you can't warn the dog off, but you would be surprised at the number of times you have to warn off the "PEEPUL." They seem to think that a telephone cord makes a good washline to dry handkerchiefs, or support wet umbrellas, or use it for a pincushion. I suppose it does take all kind of people to make up our old planet. Sometimes they decide to shorten the cord and use a safety pin for the purpose. Of course that means a call from the 'phone Doctor who has to operate and remove the obstruction from the path of speech.

But, as in the previous case obstructions do not always stand up and holler at the "Doc." No indeed not; take the case of the "Mysterious Shunt."

Tests from the table showed that a perfect shunt existed on a certain 'phone. On arriving the troubleman took down the

receiver and found everything O. K. No shunt or anything else seemed to be in that vicinity. The test table swore that was the 'phone reported in, but now it tested clear.

But it came to pass, as the stories go, that an equally good short made itself apparent the following day. Again there was no trouble when "Doc" arrived. "The man is crazy," was his diagnosis of the trouble. And still it came and went, on one day, clear for a while, then on again. Pairs were changed at the cable box. "Hah, faulty pair," was the troubleman's exultant exclamation, as the 'phone was clear for several days. But—that shunt still hung around and dropt on after a week.

"Doc" made up his mind he would kill that trouble or stay there the rest of his days. He fust around, asked for a ring that meant something and finally noted that the shunt would go on as soon as the 'phone was called and drop off later. This looked like a case of renewing the fuses in the lightning arrester and he started up to see if they were faulty. Having looked at these previously they were alright, but on this day he noted the fact that a new curtain had been hung over the window above which the lightning arrester was located. And said curtain had a brass rod that just about touched the ends of the fuses. When a ring came it would jump thru the lacquer on the rod and short-circuit the line and mate; the least little vibration would then break the circuit and the line cleared up. Yes, you could almost count the number of rings

(Continued on page 427)

CONVERTING AN INTEGRATING WATT-METER INTO AN INDICATING TYPE.

By Geo. Sturley.

Have you an old integrating watt-meter among the things you do not use? If so, perhaps you can make good use of it by

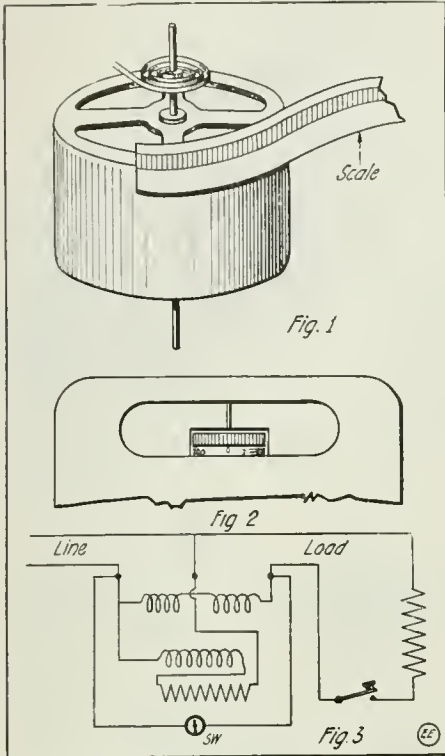

Practically All Tests On Alternating Current Circuits Call for an Indicating Watt-Meter. Here is a Way to Make One from an Old Integrating Watt-Hour Meter.

trying the following. The idea is to rebuild an integrating meter into an indicating one. This is done by removing all the gear-trains and dials of the integrating system and attaching to the shaft of the rotor a hair-spring taken from an alarm clock. Then the twisting effort at the shaft will rotate the cylinder part way around against the tension of the spring. A paper scale (Fig. 1.) marked with drafting ink is glued on the cylinder and all desired calibrations marked on it.

The writer made such an instrument from a Fort Wayne Type K meter of 5 ampere rating and it reads up to 750 watts. And when the scale shows a reading of 100 watts or better, the meter is sensitive to 3 watts.

A paper scale was made from a strip of good ink paper three quarters inch wide, and long enough to reach around the cylinder. Lines about 1/8 inch apart were drawn for scale divisions. The magnets in the meter were left in place as they greatly improved the damping of the instrument. As this meter has a revolving scale, the pointer is arranged stationary, and is nothing more than a heavy cross-line drawn on a piece of card board which is fitted in the glass window where the dials used to be. Fig. 2. When the meter is not indicating, the zero on the scale is right in line with the pointer. The meter was calibrated by a lamp bank, using different numbers and sizes of lamps for the calibrations desired. With a 5 ampere meter it is inadvisable to calibrate higher than 750 watts. This Fort Wayne style of meter is the easiest form to remodel. In the case of changing a meter having a disc-rotor, you will have to turn it bottom-end up for a front, and a circular scale having radial

markings will be required. Also a hole will have to be cut in the bottom to view the scale thru.

The meter can be used in connection with a wireless sending set to conveniently read at any time how much power is being used. When anyone asks, "How much power (in true watts) are you using?", you can tell the amount at once. Fig. 3 is a hook-up whereby the meter is permanently wired in with the primary of the "bug", and a snap switch when closed shunts the current coils in the meter out when no readings are desired. When a reading is desired, open the snap switch and hold down the key. Also the meter may prove useful in determining the power-factor in your transformer primary circuit, if you have a volt meter and ammeter. The power factor is determined by dividing the actual watts (watt-meter reading) by the apparent watts (volts x amps). If you aim to improve your set, this power factor if kept up to a high value will mean your transformer is actually handling more power.

USE OF PERMANENT MAGNET IN A.C. TO D.C. RECTIFIER.

In the May, 1916, issue, there was described a magnetic rectifier, and finding it rather troublesome to have to use batteries for the permanent field excitation, I found that if a steel bar-magnet was substituted instead of the electro-magnet, the device would work as well and save the trouble and cost of the batteries. [Note: By referring to the May, 1916, issue, full description will be found.]

Contributed by A. ALLIN.

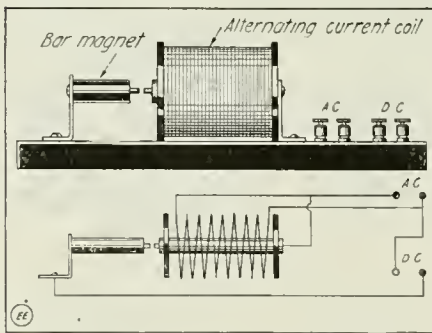

Extremely Simple Form of Vibrating A.C. to D.C. Rectifier Made With a Permanent Magnet Armature.

ODDMENTS FROM THE HOUSEHOLD.

The experimenter whose purse is no deeper than the average will need to extemporize much of his apparatus, and if carefully made such appliances will be quite as serviceable as the shop-made article, tho probably lacking in finish. No opportunity should be lost to secure unclaimed oddments of household utensils. An excellent electro-scope can be made from a lamp chimney, plugging the top with sulfur and embedding the wide end in paraffin wax contained in a flat tin; part of a broken window makes a good fulminating pane if the sharp edges are rubbed down with a file or emery cloth, and many other examples might be quoted.

Contributed by H. J. GRAY.

AN ELECTRICAL SHUTTER RELEASE FOR CAMERAS.

Following is a description of an electrical release for camera shutters, to be used in photographing wild animals and birds from a distance. It can also be used when the experimenter desires to take his own picture, etc.

In the accompanying drawing (Fig. 1), A is the main part of the frame, or base. It is made of 1/4-in. square brass rod, about 6 in. long. It is bent at right angles about

4 in. from one end, and has a 1/16-inch slot cut in the end of the short leg.

B is the clamp to hold the release in place on the bed of the camera. It also is made of 1/4-in. square brass rod, and is bent as shown. These bends CANNOT be made COLD.

C is the movable lever, of 1/4-in x 1/16-in. brass strip, about 5 in. long. It is drilled at the places shown in drawing, and has a short slot cut where the rivet 7 passes thru. The part X of lever C, indicated by dotted lines, is turned up to a horizontal position. This forms a broad striking surface for the release, and is covered with leather.

D is a solenoid, size 1 in. x 1 1/4 in. It is formed of an old hard rubber fountain pen barrel or other tube having an inside diameter of 1/4 in., fitted with two 1/16-in. fiber washers, of 1 1/8-in. diameter, wound with No. 22 gage enameled magnet wire.

E is the core of the solenoid, of 1/4-in. soft iron rod, 1 1/4-in. long. It has a 1/16-in. slot cut in its upper end and a hole drilled for rivet 7.

F is a spring to draw lever C upward, away from the solenoid. The upward movement of lever C is limited by G, which is a short section of cheap watch chain or other small chain, the upper end of which is fastened to a hole in C, and the lower end to screw 5.

H is a block of hard fiber, 1 1/4 in. x 1 in. x 1/8 in., on which are mounted binding posts 1.

I is the clamping screw, made of an 8-32 battery binding post screw, with the head filed flat and the lower end fitted tightly in a fiber washer for a handle. 2, 3, 4 and 5 are 6-32 brass machine screws. 6 and 7 are small rivets.

A small dashpot added between the solenoid and the upright part of frame will make the action much smoother and soften the jar to the camera, but it is not absolutely necessary.

Fig. 2 is given merely as a suggestion for a method of mounting the solenoid. A piece of sheet brass is cut to the shape shown at A, and is bent on the dotted

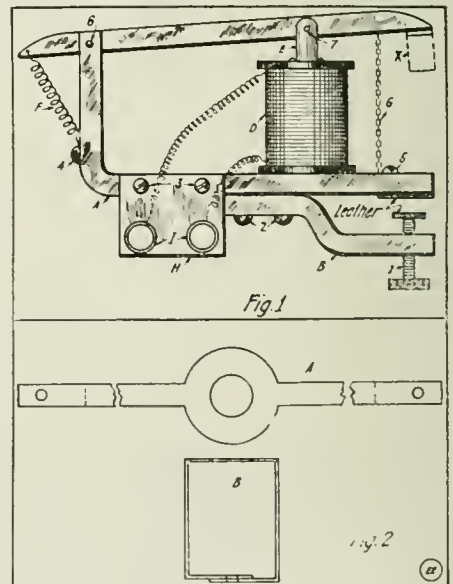

A Good Form of Magnetic Shutter Release for Cameras Is Here Shown. It Can Be Attached and Detached in a Few Moments.

lines to the shape of B. It is then split over the solenoid and fastened to the frame by a screw dropt thru the solenoid into the small hole in clip and screwed into the frame. This will hold the solenoid firmly.

Contributed by J. E. HENDERSON, JR.

Chemical Action of Storage Batteries

By ALBERT W. WILSDON

MANY experimenters have frequently used storage batteries but have possibly never stooped to inquire as to the action which takes place in them. To obtain best results in any branch of endeavor, it is necessary to understand the fundamental principles which govern each individual case. This is also true as regards storage batteries. If improperly taken care of or handled, they will not give satisfactory results, the same as if a gas engine were to be permitted to be run without water, oil or cleaning.

The lead storage battery in the charged state consists of a positive plate of lead peroxide (PbO₂) and a negative plate of finely divided lead, both being introduced into sulfuric acid (H₂SO₄) of about 1.2 sp. gr. When discharged the surface of the plates has been changed to lead sulfate (PbSO₄). The plates may be brought back to their original condition by sending a current thru the battery in the reverse direction.

During the formation the plates are frequently permitted to stand in some corroding solution of acids that produce a thick layer of lead sulfate (PbSO₄), for a certain time. The lead sulfate may then be reduced electrolytically to lead, or oxidized to lead peroxid (PbO₂). When acids other than sulfuric are used, these must be thoroughly washed out before the battery is ready for use. For instance, a mixture of nitric and sulfuric acids would have the effect of producing a layer of sulfate.

By another method the plate is electrolyzed as an anode, but lead peroxid (PbO₂), which would protect the plate from further action, is prevented from forming by adding some salt or acid to the solution, the union of which separates at a lower potential than the peroxid ion and causes the production of sulfate. Lead sulfate (PbSO₄), being a non-conductor, requires the lead below to be penetrated by the current, and as much sulfate may be produced in one step as is desired. Such additions are acetates, tartarates, chlorids, nitrats, chlorats, perchlorats, and the corresponding acids.

Peroxid is not always formed on a lead anode in sulfuric acid, even when no substance is added to the solution to prevent it, which is made apparent by the fact that the lead plate, which is the anode, on discharging, becomes covered with sulfate. If therefore, a lead plate is short-circuited in

cast in the supporting grid. The paste sets and becomes hard, after which it is changed to lead sponge and peroxid by electrolysis in a solution, which may, or may not be, sulfuric acid.

The theory of the lead storage battery which is generally accepted, is known as the "sulfate theory", and is due to Gladstone and Tribe. Sulfuric acid combines with the plates on discharge, and is set free on charge, according to this theory. On discharge hydrogen is deposited on the lead peroxid which reduces it to lead oxid (PbO), which is changed to lead sulfate (PbSO₄), as represented by the equation:

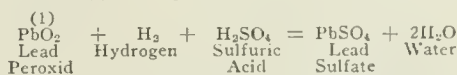

At the same time the sulfate radical (SO₄) is deposited on the lead plate and changes to lead sulfate:—

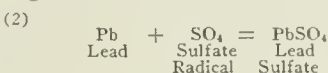

The sum of these two equations is the total change in the storage battery on discharge:—

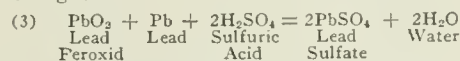

When in the discharged state both plates are covered with sulfate. Upon charging, the reaction on the positive plate is:—

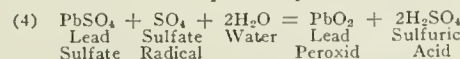

While in the negative plate:—

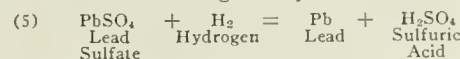

The sum of the last two equations (4 and 5) represents what takes place in the whole battery on charging:—

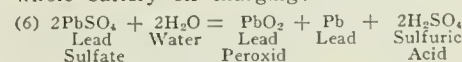

This equation is just the reverse of the sum of the first two equations (No. 3), and the changes taking place both on discharge and charge may be represented by the following reversible equation:—



From right to left this represents the charge, and from left to right the discharge.

By measuring the electromotive force (e.m.f.) of different oxids of lead and hydrats of lead on lead against a zinc electrode and comparing with a charged positive plate it was shown that the charged positive plate is the peroxid of lead and not some other oxid or hydrat.

The tabulated results being:

Pb/Pb ₂ O	—Zn 0.42 volt
Pb/PbO	—Zn 0.46 volt
Pb/Pb ₂ O ₄	—Zn 0.75 volt
Pb/H ₂ PbO ₃	—Zn 0.96 volt
Pb/PbO ₂	—Zn 0.41 volt

A charged plate has a potential of 2.4 volts, showing that lead peroxide is the compound that exists on the positive plate.

Kohlrausch and Heim showed by measuring the specific gravity of the acid on charge and discharge that the production of sulfate on each plate was proportional to the quantity of electricity that had been past thru the cell; the density changing exactly in proportion. A calculation of the

change in specific gravity by means of equation 7 agrees with that found. The calculation is as follows:— The uncharged battery contained 3350 cubic centimeters of acid of 1.115 sp. gr. corresponding to 16.32 per cent acid. The total solution therefore weighed 3735 grams, and contained 610 grams of acid, and 3125 grams of water. After charging with 50 ampere-hours, according to equation 7, the amount of water

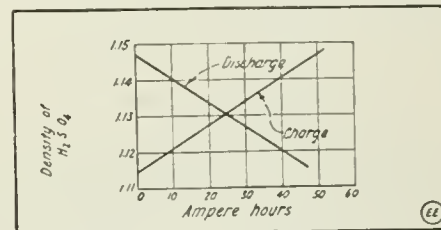

Fig. 1. Curve Showing Change in Density of Acid With Charge and Discharge.

that disappeared was 33.6 grams, and the amount of sulfuric acid formed was 183 grams. The solution therefore contained after charging, 3091 grams of water and 793 grams of sulfuric acid. The total weight was therefore 3884 grams, and the amount of sulfuric acid contained was 20.42 per cent., corresponding to a density of 1.146. The observed density being 1.147.

It is quite evident that since the acid becomes more dilute on discharging a lead battery, the electromotive force must decrease with decreasing concentration. The table given below, shows the relation between the concentration of the acid and the electromotive force, from direct measurements.

Density of H ₂ SO ₄	Per Cent H ₂ SO ₄	E.M.F. at 15 Deg. C.
1.050	7.31	1.906
1.150	20.91	2.010
1.200	27.32	2.051
1.300	39.19	2.104
1.400	50.11	2.330

It will be noticed that the electromotive-force of the lead storage battery, with the concentration of acid ordinarily used, has the unusually high value for a battery of over two volts. Sulfuric acid, if electrolyzed between platinum electrodes, gives a weak evolution of gas at 1.7 volts and at 1.9 a strong evolution. If lead sulfate were spread on platinum, it would therefore not be possible to reduce it to lead and oxidize it to peroxid, for the potential required could not be reached. On lead, however, the over-voltage is so great that the gas evolution does not take place below 2.3 volts, which is greater than the voltage needed to change the sulfate in lead on one electrode and peroxid on the other. If it were not for this high over-voltage on lead, the lead storage battery would be an impossibility.

The temperature coefficient of the lead storage battery for the concentration of acid used is positive, but on decreasing the concentration of acid the temperature coefficient falls to zero and then becomes negative. The curve (No. 2) represents the results of experiments in which the temperature coefficient was determined between 0 deg. and 24 deg. C. The temperature coefficient is constant in value between 10 and 71 deg. C. The heavy line in the plot gives the experimental results.

The mechanism of the reactions taking place in the lead storage battery has been

(Continued on page 422)

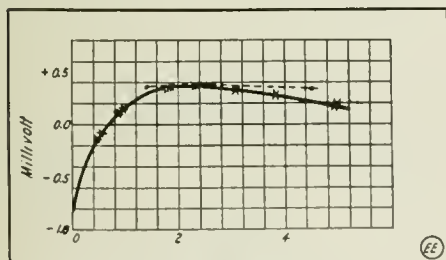
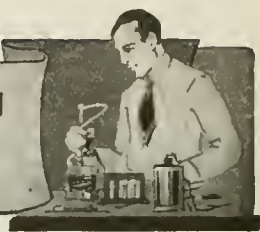

Fig. 2. Temperature Coefficient of Electromotive Force of Lead Storage Battery As Function of the Acid Concentration.

a solution of sulfuric acid with a peroxid plate, it will become covered with sulfate, proportional in amount to the current that flows thru the plate.

In the Faure type storage cell the plates consist of lead with about 5 per cent of antimony. The active material is made by making a paste of lead oxid (PbO) and sulfuric acid, and applying it to grooves

HOW TO MAKE IT



This department will award the following monthly prizes: **First Prize, \$3.00; Second Prize, \$2.00; Third Prize, \$1.00.** The purpose of this department is to stimulate experimenters towards accomplishing new things with old apparatus or old material, and for the most useful, practical and original idea submitted to the Editors of this department, a monthly series of prizes will be awarded. For the best idea submitted a prize of \$3.00 is awarded; for the second best idea a \$2.00 prize, and for the third best prize of \$1.00. The article need not be very elaborate, and rough sketches are sufficient. We will make the mechanical drawings. Use only one side of sheet. Make sketches on separate sheets.

FIRST PRIZE, \$3.00

AT LAST! THE "COLLAR-BUTTON" SWITCH.

I give herewith a description of a "collar-button" switch, which I am contributing to the "How-To-Make-It" Department.

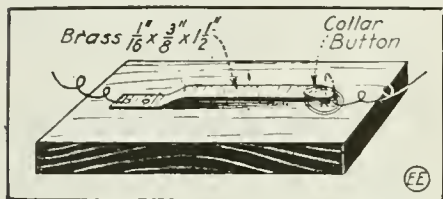

Somebody's Been Reading Faithfully Page 330 of the September "E. E." Instead of an Electrical Stunt with Old Shoe Nails, However, We Are Presented with the "Collar-Button" Switch, for Which We Are All Duly Thankful.

This switch can easily be made with a collar-button and a small strip of brass. By simply putting the head of the collar button down, the switch is "on." This small switch can be used where any battery switch is needed and can be quickly and easily made. (Bugdom extends its sincere thanks, Albert!—Editor.)

Contributed by
ALBERT CHOQUETTE.

A SIMPLE POLARITY REVERSER.

The device described and illustrated herewith is a convenient means of changing the polarity of a pair of wires, of reversing small motors, etc.

It consists of a wooden base upon which are mounted six binding-posts and a pair of two-point switches, so connected by a hard-rubber strip as to move both the switches at the same time. The manner of reversing the polarity at once becomes evident by referring to the diagram. Connections from the binding-posts are made in grooves on

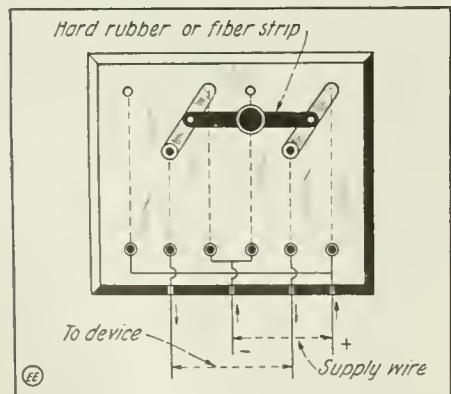

A Handy Polarity Reverser Constructed from Two Switch Blades, Four Contact Points, Some Binding Posts and a Base.

the under side of the wooden base.
Contributed by
PETER J. M. CLUTE.

SECOND PRIZE, \$2.00

ADJUSTABLE LOUD TALKING RECEIVER.

Manufacturers of high-resistance telephone receivers are well aware of the advantages to be gained by tuning the diafram of the receiver to the desired note. However, their's is a compromise. Nearly every radio station emits a tone distinctively its own and the manufacturer has to strike a mean. Receivers have been developed that were adjustable as to the tension on the diafram and worked with satisfaction when both diaframs were tuned alike. A receiver that can be adjusted instantly to any note within a wide range is shown in the attached illustration. It is designed particularly for use with some form of amplifier that allows of its use as a loud-talker, but by using high-resistance windings it will serve in place of the regular receivers for nearby or powerful stations.

To construct this receiver the shell of a long type telephone receiver is required. A hole is drilled in the center of the diafram and a short brass bolt inserted. The threaded end of the bolt is slotted to take

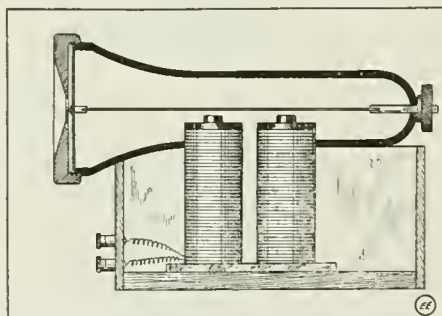

Here's What You've Been Looking For, "Bugs": a Loud Talking Telephone Receiver and Amplifier Which May Be Adjusted for Different Currents and Circuits.

a strip of thin iron 1/2-inch wide and long enough to reach the length of the receiver. One end of the strip is soldered into the bolt on the diafram and the other end of the strip is soldered into the head of a brass bolt that passes thru the hole in the small end of the receiver shell. The latter bolt is fitted with washers and a nut to adjust the tension on metal strip.

A hole is cut in the side of the receiver shell large enough to pass the magnets as shown. If the device is to be used with an amplifier the magnets shown have a low resistance of about 20 ohms. When used in place of the regular receivers they may be taken from a thousand ohm telephone ringer. The magnets are supported in a box and wired to two binding-posts.

The pole pieces of the magnets should come within 1/64th of an inch of the iron strip. In use the apparatus is connected in the circuit in the usual manner. The thumb nut at the small end of the receiver is turned till the strip is just taut.

THIRD PRIZE, \$1.00

ANOTHER PENCIL RHEOSTAT.

The accompanying drawing shows a very simple pencil rheostat. It is simply a common "clutch" pencil as sold anywhere for ten cents, and no work is necessary to convert it into a rheostat—just the con-

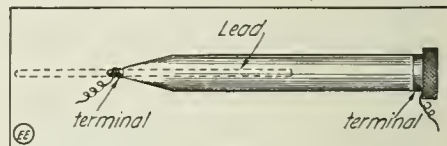

If You Carry a Metal Magazine Pencil You Are a Potential Electrician. Connect a Wire to the Case and Lead, and Presto! You Have An Adjustable Rheostat.

nection that is all. To vary the resistance it is only necessary to slide lead in or out of the pencil case.

Contributed by **G. SCHOENDUVE.**

When the signals come in it is only necessary to turn the nut and adjust the tension on the strip till it is in resonance with the note of the signals, which point will be indicated by the loudest tone.

When high-resistance magnets are used and the instrument is connected direct to the circuit without an amplifier it will be found advisable to use a mica diafram and a steel piano wire instead of the metal diafram and the iron strip.

Contributed by **THOS. W. BENSON.**

AUXILIARY BATTERY POWER FOR WINDOW TAPPER.

When a window tapper is running for a long period, the dry batteries run down, causing the tapper to stop. In order that it may work again the batteries must be disconnected until they regain their full strength. Using the method shown here the tapper can be used continually without a stop.

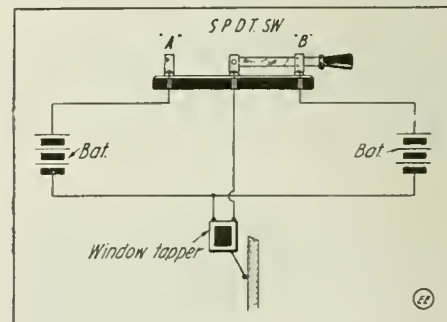

To Prevent Paralyzing One Set of Batteries When Operating a Window Tapper, Use Two Sets Alternately with This Circuit.

The S.P.D.T. switch blade is in contact at "B," making a circuit. When the power is exhausted, it is thrown to "A," putting a new set of batteries in the circuit; while the others at "B" will be recuperating.
Contributed by **FRANK HARAZIM.**

SECRET DOOR LOCK AND ALARM.

The illustration is of an electric door lock and bell alarm for the front door of a home, garage or shop, which is easily made and installed in a very short time.

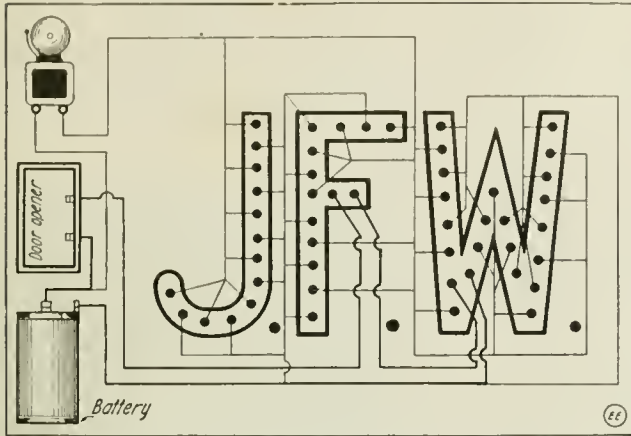

The Electric Puzzle Lock Shown Acts As Its Own Thief Alarm. The Uninitiated Will Invariably Short-Circuit the "Alarm" Contact Points Instead of the "Lock" Circuit Contacts.

It consists of a half-inch quartered oak board large enough for the initials, which are made by driving brass upholsterer's tacks in the board. On the under side of board wires are connected to the tacks as per diagram and should be soldered to the points. An ordinary electric bell and a bell-ringing transformer or dry batteries are connected according to illustration and it is then ready for use. The heavy lines indicate the circuit which operates the lock. A finger ring or any small piece of metal placed in contact with the two tacks on F and W will operate the lock and open the door. Anyone tampering with or not knowing the secret of the lock will cause the bell to ring, as the diagram will show. A push button connected to the lock circuit and located at a convenient point inside will be found very handy. A low-voltage lamp can also be placed in the circuit and will serve to light up the entrance. This device has given excellent service for a long time and is still in fine condition.

Contributed by JOHN F. WALLACE.

KEEP YOUR BATTERIES WARM.

Both primary and secondary or storage batteries (accumulators) are affected by temperature. A battery that gives no trouble in an ordinarily warm room shows a falling off in the output of current if exposed to a very low temperature. This is due to the fact that the internal resistance decreases as the temperature rises, within certain limits. Storage batteries have been found to develop a maximum efficiency at temperatures approaching 50° C. If the temperature is much above or below this figure, the output of current falls off. Since the ordinary temperatures of a room at any time of the year is generally between 12° and 20° C. it will be seen that most storage batteries are not given an opportunity to deliver the maximum amount of energy of which they are capable.

Contributed by H. J. GRAY.

TELEGRAPH RELAY USED FOR VOLTAGE INDICATOR.

Where an operator can not watch his voltage continuously and where a constant voltage is required, the accompanying diagram shows how a telegraph instrument can be made into a voltage indicator in a few minutes' time.

If a motor (J) was operating a flood pump or any other apparatus automatically,

it would be essential that the supply of current is always on the line. If one of the fuses (K) should blow out the line would be dead, and unless the operator was on the scene it might cause serious damage.

With this apparatus he can be in his office and will be notified by the bell that the line is dead. The explanation of this device is as follows:

The current passes in thru the resistance (B) which amount depends upon the voltage and the current in the line; this can be easily calculated by applying Ohm's law. The current continues to flow thru the magnet (E) back to the line; thus the current passing thru the coil will energize it, and will hold the armature down. In case the voltage goes off the line the coil (E) ceases to be magnetized, and the armature is pulled away from the coils, by spring (H)—(which has a tendency to pull the armature away from the coils) and a local circuit is made at

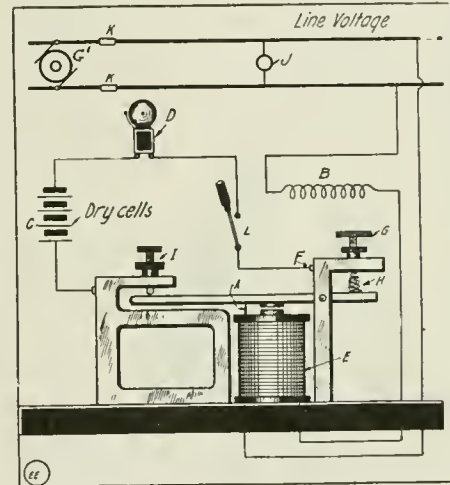

When the Line Voltage Fails the Relay Closes an Alarm Bell Circuit, the Bell Being Placed At Any Point Desired.

contact (I), which in turn is in series with a battery and bell, as shown. A, is a rubber contact to prevent cross-connections.

Besides this use of the indicator it can be put to many other advantageous uses as the operator sees fit.

Contributed by H. E. BEANE.

CHEMICAL EXPERIMENTS.

Spontaneous Combustion: A mixture of potassium chlorat and flour at once takes fire on being touched with a drop of sulfuric acid.

The Spontaneous Combustion of Three Metals: In a perfectly dry ladle place a small piece of sodium with an equal

quantity of potassium. If a little mercury be added, and the whole well shaken, it will take fire and burn vividly.

The White and Black Statue: Construct a small figure or statue of white paper or cardboard, and moisten it with a solution of lead acetat. Expose it to fumes of sulfuretted hydrogen, and it will turn black.

The Kettle that Boils on Ice: Set a small water kettle on a piece of ice, now put a small amount of liquid carbon dioxid into the kettle. The contents will boil violently.

The Blushing Picture: If any plain print or drawing be taken (preferably one of a young lady) and the face, hands and neck be painted with a solution of equal parts of water and methylated alcohol, to which a few grains of phenolphthalein have been added, on subjecting the picture to the influence of ammonia vapor it will "blush" most vividly.

Contributed by ELLIOTT S. BUCHANAN.

UNIQUE GLYCERIN SWITCH MADE FROM SOUNDER.

It is often necessary to break a circuit at relay contact points, where the circuit to be broken carries current at 110 volts. The arcing is intense when the current is much above 1 ampere. A simple and very effective oil switch may be made from material which is almost always on hand.

Secure a brass base from an Edison lamp (one may be removed from a lamp by heating the glass near the base in a Bunsen flame). Drill a hole in the bottom of it for a bolt to pass thru. Screw the socket onto the end of the armature of a telegraph sounder which will serve as the relay. Before putting the bolt thru the socket, slip a soft rubber or fiber washer on to prevent any leaking of oil thru the hole.

A standard which serves as the rear contact may be made from an ordinary fixture crow-foot, a piece of gas pipe and a piece of 3/32" brass or steel which is threaded to receive an adjusting screw. (See illustration.)

The writer had a great deal of difficulty in securing a suitable oil to kill the arc. After trying sweet oil, linseed oil and machine oil he tried—glycerin. And it does the work. Arcs from breaks carrying 10 amperes were successfully quenched by using glycerin in the cup.

It may be also of interest to note that castor oil is quite as satisfactory as glycerin, and a lot cheaper too. The cup may

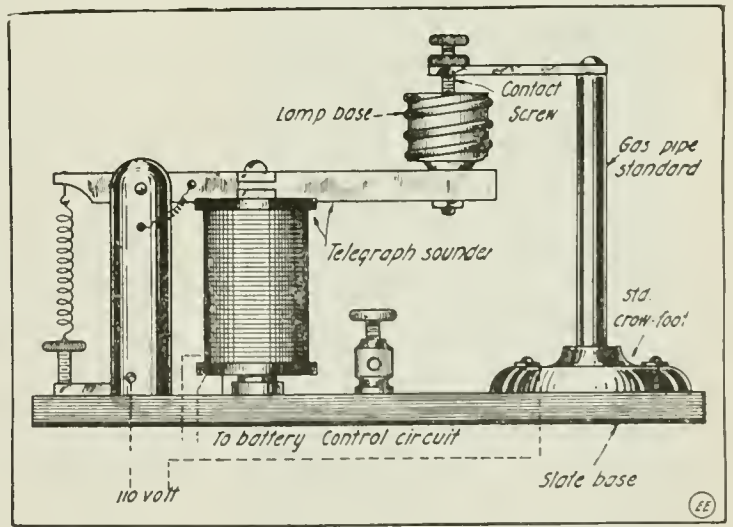

For Breaking Heavy Currents the Arc Is Best Broken in Glycerin. The Latter Is Held in a Cup, Operated by "Sounder" or Other Magnets in the Manner Indicated.

be partially filled with mercury with the oil over the top of it.

Contributed by ALBERT H. BEILER.

Wrinkles Recipes Formulas

EDITED BY S. GERNSBACK

Under this heading we publish every month useful information in Mechanics, Electricity and Chemistry. We shall be pleased, of course, to have our readers send us any recipes, formulas, wrinkles, new ideas, etc., useful to the experimenter, which will be duly paid for, upon publication, if acceptable.

FOR CLEANING VARIOUS SUBSTANCES.

Alabaster.—Use strong soap and water.
Black Silk.—Brush and wipe it thoroly, lay on table with side intended to show, up; sponge with hot coffee strained thru muslin; when partly dry, iron.

To Remove Stains or Grease from Oil Paint.—Use bisulfid of carbon, spirits of turpentine, or if dry and old, use chloroform. These and tar spots can be softened with olive oil and lard.

Stains, Iron Rust, or Ink from Vellum or Parchment.—Moisten the spot with a solution of oxalic acid. Absorb same quickly by blotting paper or cloth.

Rust from Steel.—Take half ounce of emery powder with one ounce of soap and rub well.

Fruit Spots from Cotton.—Apply cold soap, then touch the spot with a hair pencil or feather dipped in chlorate of soda, then dip immediately in cold water.

Grease from Silks.—Take a lump of magnesia, rub it wet on the spot, let it dry, then brush the powder off.

Iron Rust may be removed from white goods by sour milk.

Scorch Stains from White Linen.—Lay in bright sun.

Mildew.—Moisten the spot with clean water; rub on it a thick coating of castile soap mixed with chalk scrapings; rub with end of finger, then wash off.

Oil Marks on Wall Paper.—Apply paste of cold water and pipe clay, leave it on all night, brush off in the morning.

Paint Spots from Clothing.—Saturate with equal parts turpentine and spirits of ammonia.

To Cleanse House Paper.—Rub with a flannel cloth dipt in oatmeal.

Black Cloth.—Mix one part of spirits of ammonia with three parts of warm water, rub with sponge or dark cloth, clean with water, rub with the nap.

Furniture, for Finger Marks.—Rub with a soft rag and sweet oil.

Chromos.—Go over lightly with a damp linen cloth.

Zinc.—Rub with a piece of cotton cloth dipt in kerosene, afterwards with a dry cloth.

Hands from Vegetable Stains.—Rub with a slice of raw potato.

Window Glass.—Paint can be removed by a strong solution of soda.

To Clean Tinware.—Common soda applied with a moistened newspaper and polished with a dry piece, will make it look like new.

DIRECTIONS FOR WHITE METAL PLATING.

By Aaron Van Citters.

A number of firms have advertised white metal plating outfits, for plating knives, forks, spoons, etc., for which they charge from ten to twenty dollars. By following the instructions given below, you can, with the assistance of a blacksmith in making the crucible and hood, set up this outfit complete for about two dollars and a half or less.

To make the crucible.—Take a piece of gas-pipe 4x6 inches, weld a bottom in it, and a band around the top from which it hangs inside the hood.

To make the hood.—Make a flaring cylinder of sheet iron, the small end the proper size to fit under the ring of crucible; the other end about one-fourth larger in diameter, and sufficiently long to hold crucible upright with bottom just clear of the stove or gas plate.

To make the White Metal.—Pure tin, 10 lbs., lead 4 ozs., antimony 2 ozs. Melt and mix thoroly. A better grade is made by using 2 ozs. of pure silver in place of the antimony.

Jar No. 1 (Pickle Solution).—For iron or steel is composed of muriatic acid only.

Jar No. 2 (Dip Bath).—Dissolve 2 pounds refined zinc in 2 quarts fluid hydrochloric acid C. P. When dissolved and cold, add half a teacup of clear rain water or filtered water. (This is a dangerous solution to mix, as it is very violent when the zinc is being consumed, and great care should be taken.)

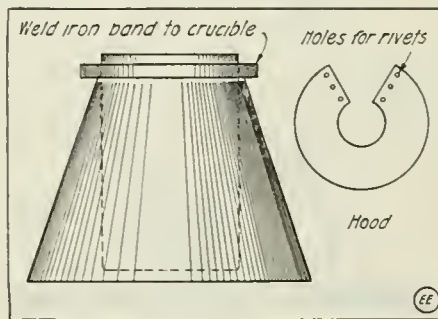

How Crucible Is Made for White Metal Plating.

Jar No. 3 (Chill Bath).—Dissolve 6 ozs. di-ammonia carbonate in 3 pints of filtered water. Use at a temperature of 120 degrees F.

Jar No. 4 (Pickle Solution).—For Irish silver and brass, dissolve 12 ozs. granulated nitratum in 2 quarts of filtered water; then add slowly 2 quarts commercial sulfuric acid. (Note—Unless you are going to do a great deal of plating, Jar No. 4 is unnecessary, as Jar No. 1 answers as a pickle solution for all metals.)

Stripping Solution.—Is composed of 1 pound granulated kali; or potash and 2 scruples of French rouge; dissolved in 1 gallon commercial sulfuric acid.

(The Flux).—Mix thoroly 5 lbs. granulated white ammonia hydrochlorate with 4 drams French rouge. For convenience in using, put a portion in an ordinary tin pepper box.

Directions for Plating.—Place the sheet iron hood on the stove or gas plate, the small end up, then set the iron crucible previously filled with the white metal, inside the hood, so edge will rest on top of same. But little heat is required to melt the metal, which forms a thin metallic solution. Care should be taken not to get it too hot. If after an article is plated it shows a yellowish color, it is because of too much heat, which should be partly turned off. Proceed to plate as follows:

First, put articles to be plated in Jar No. 1, allowing them to remain ten minutes to remove all rust, etc., then rinse in clear, cold water. Next take one piece at a time and rinse in Jar No. 2 for a few seconds; then immerse the article slowly in the crucible containing the melted metal; raise slowly up and down once or twice, sprinkle a little flux on the article, letting some of the flux fall on the melted metal. Then draw article from crucible and immerse slowly into Jar No. 3, which hardens the plate, after which rinse in clear water and it is finished.

Knives, forks and spoons should be plated, one-half at a time; then the operation reversed. About one minute is required to plate a single article. A little practise will make you perfectly familiar with plating in this manner, and you will be able to see at a glance when everything is perfect. When there is much old plate on an article, place stripping solution in a crock, heat it, and immerse article therein until the old plate is all removed; then rinse in clear water, dry with a chamois skin, and proceed to plate as above.

(Special Note)—When much old plate is removed by stripping, it pays to reclaim the silver, which may be done in the following manner: Add common salt to the stripping solution as long as it throws down a precipitate, then pour off the solution. Wash the precipitate with clear water, then add a few small pieces of sheet zinc to it and let stand until the precipitate turns to a black powder, which will take several hours. Then wash the powder several times in warm water, dry between sheets of blotting paper, and pick out the pieces of zinc. The powder will be pure silver which you can melt and run into bars.

VALUABLE HINTS FOR PHOTO WORKERS.

BOTTLES.—Better to send the unknown contents of a bottle down the sink than risk spoiling a formula with it. Do not wait for labels to drop off; give the lot an inspection every three or six months, and replace any which are becoming illegible, says the *Am. Photog's Weekly*. Don't wait till this has happened.

LABELS ON BOTTLES CONTAINING SOLUTION.—Place the label in such a position that you can indicate by an arrow point on the label just how far up in the bottle the stock solution comes when making up a fresh lot.

WASTE BOX.—Do not throw spent matches, plate-box wrappers, bits of string, or anything else (not even cigarette ends) on the floor, but in the waste box (a large-size biscuit tin is just the size and shape). Everything on the floor makes for dust.

SECONDS PENDULUM.—A little over a yard of fire string, the bob of an old clock, a long bit of brass chain. This clicks against the rim of a half-pound tobacco-box lid every second swing. The pendulum hangs from a nail in the wall. The pendulum is forty inches long.

COTTON-BATTING BOTTLE.—This bottle contained caustic potash solution. The stopper being first resisted "firmly but gently" every persuasive invitation to move it. It was tapt off at the neck. The shoulder of the bottle was cut with a file scratch and hot wire. The sharp edge taken off with a hard pebble. It now stands on the sink shelf, and holds cotton batting with which to swab the surface of a negative or use as a quick filter.

TOOTHBRUSH BONE HANDLE.—Filed down to make a finger-nail shaped end, which acts admirably as a plate lifter.

Experimental Chemistry

By ALBERT W. WILSDON

Seventeenth Lesson

Ammonia (NH₃) and Ammonium Hydroxid (NH₄OH)

HISTORY:

THE aqueous solution of ammonia gas and some of its salts, as ammonium chlorid, or sal-ammoniac, were known to the early alchemists, and described by them as "Spirits of Hartshorn." Basil Valentine in the

lecting the gas over mercury. He called it "Alkaline Air" which was later changed to "Volatile Alkali."

Berthollet in 1785 showed that it is composed of Nitrogen (N) and Hydrogen (H), and Davy in 1800 made the volumetric determination necessary for the symbol.

OCCURRENCE AND FORMATION:

Ammonia is found free in small quantity only. A very minute quantity is formed in combination with carbonic, nitric and nitrous acids, during electrical discharges in the air, from the hydrogen of water, and nitrogen of the air. This often combines with an oxid of nitrogen (formed by the same process) to make ammonium nitrat (NH₄NO₃), and the product is finally washed by rain into the earth.

It is also found as sulfate and chlorid near active volcanoes, having been produced by the hot lava flowing over fertile soil containing nitrogen. Ammonia and its salts are formed in the distillation of many organic substances as bones, and other animal tissues and excretions, as well as the putrefaction of nitrogenous organic substances.

Formerly horns, hoofs, and other animal products were distilled, and ammonium carbonat thus produced neutralized with hydrochloric acid, the product after sublimation being known as sal-ammoniac (ammonium chlorid). At the present time coal is used and the supply obtained by a similar process.

PREPARATION:

1. Thru the union of its elements by means of the silent electric discharge.
2. Thru the reduction of the various compounds of nitrogen and oxygen or their acids.

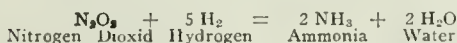

3. Thru solution of many metals in Nitric acid.

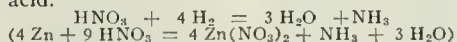

4. By the reduction of nitrats or nitrits by nascent hydrogen in alkaline solution.

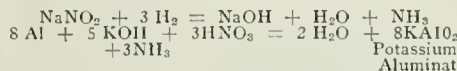

5. Ammonia gas is prepared on a large scale by heating together calcium hydroxid and ammonium sulfate or chlorid.

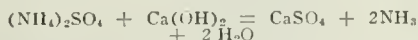

6. For laboratory purposes it is preferable to heat the solutions of ammonia.

7. The hydroxid is prepared by the action of a strong base or one of its salts. The chief salts are ammonium chlorid (NH₄Cl); ammonium nitrat (NH₄NO₃); ammonium sulfate ((NH₄)₂SO₄) and ammonium carbonat ((NH₄)₂CO₃). By mixing any one of these with either calcium, potassium or sodium hydroxid, and applying gentle heat, there are formed ammonium hydroxid (NH₄OH) and ammonia (NH₃). These reactions come under *Barthollet's law of gases*. Sal-ammoniac (NH₄Cl) and slaked lime (Ca(OH)₂), because of their cheapness, are usually employed.

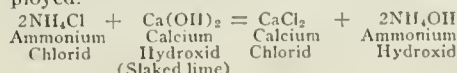

It should be remembered that the hydroxid is only the gas combined with water, and two substances, ammonium hydroxid (NH₄OH) and ammonia (NH₃) are both called "ammonia", but not accurately so. Whenever one of them is found the other usually exists, as *Ammonium hydroxid gives off the gas and ammonia takes up water.*

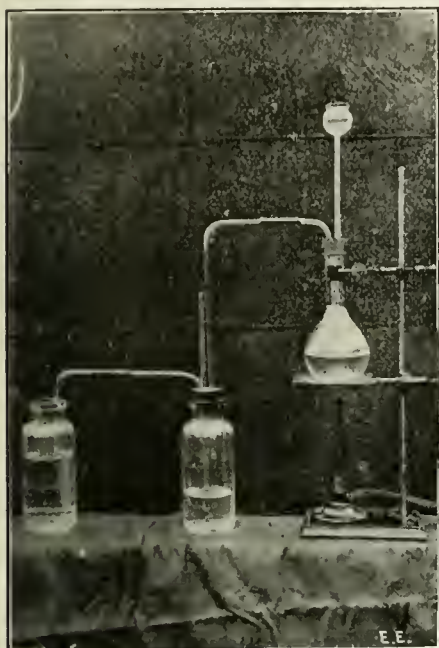

Fig. 84. Apparatus Set Up for the Preparation of Ammonium Hydroxid—NH₄OH.

fifteenth century showed that the gas could be made as we make it to-day; namely, from ammonium chlorid (NH₄Cl). Priestley in 1747 was the first to prepare gaseous ammonia, by heating together sal-ammoniac (Ammonium chlorid), and lime, and col-

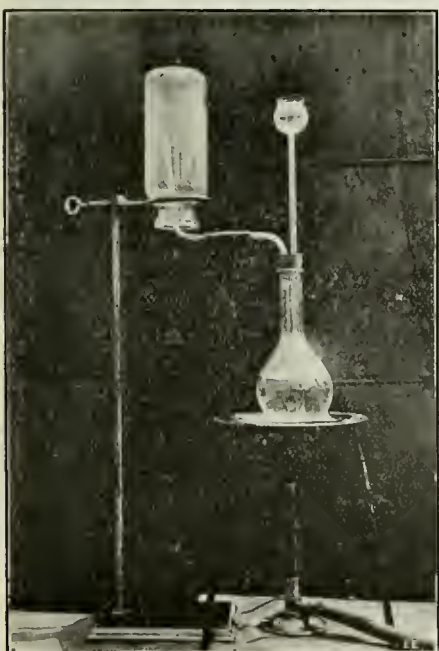

Fig. 85. Necessary Apparatus for the Collection of Ammonia—NH₃—by Upward Displacement.

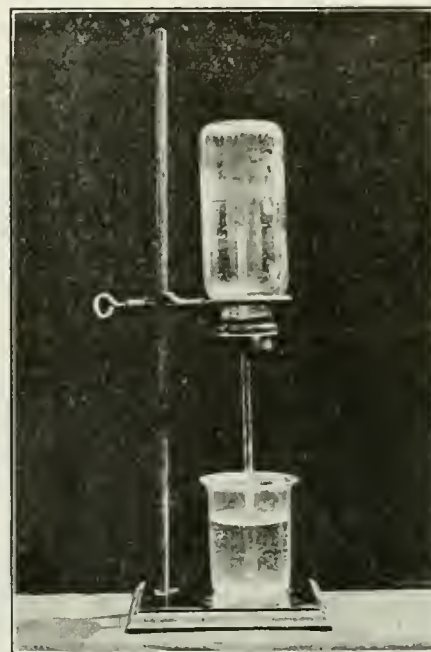

Fig. 86. Simple Apparatus Required in Performing the "Ammonia Fountain" Experiment. It Is Shown Here in Actual Operation.

When required *pure*, the gas must be past over calcium oxid (quicklime) to remove the moisture, and then collected over mercury.

(Continued on page 427)

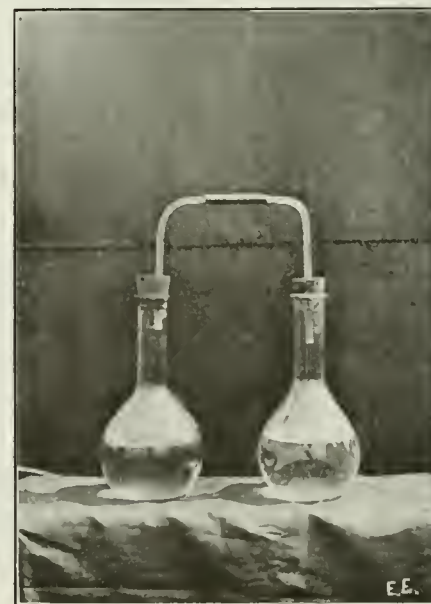

Fig. 87. Apparatus for Illustrating Diffusion and Absorption of NH₃. Left Hand Flask Contains NH₄OH; Right Hand Flask—Water.

WITH THE AMATEURS

Our Amateur Laboratory Contest is open to all readers, whether subscribers or not. The photos are judged for best arrangement and efficiency of the apparatus. To increase the interest of this department we make it a rule not to publish photos of apparatus unaccompanied by that of the owner. Dark photos preferred to light toned ones. We pay each month \$3.00 prize for the best photo. Make your description brief and use only one side of the sheet. Address the Editor, "With the Amateurs" Dept.

At Last an "Electrical Laboratory" Photo!!!

Well, "Radio-bugs," you have got to take off your hat to Mark Slabodnik, of Ely, Minnesota, winner of this month's prize, and mark you, the ONLY prize awarded this month in "With the Amateurs' Department." Now, why is it that we can't receive more photos from "ELECTRICAL LABORATORY" owners, when there are about a million of you scattered thruout the United States at this very moment! As you will remember we made all of you a special offer in the September number, viz., we offered to give not only the \$3.00 monthly prize for the best "Electrical Lab." photo, but 5 (five!!!) additional prizes of one year's subscription to this journal, and a copy of the "EXPERIMENTAL ELECTRICITY COURSE" for the best five photos submitted, after awarding the first prize. But nary a peep from a blessed mother's son of you. Now it is up to you to get busy at once, and photograph that "Electrical Lab." We mean every word of it, "Bugs"! For if you do not, this department is simply going to slide into oblivion. As we have just said, it is strictly up to you whether you wish to take a chance on winning the \$3.00 cash prize, and also if you wish to throw away the chance of receiving "The ELECTRICAL EXPERIMENTER" magazine for one year free of all cost, besides the copy of the *Experimental Electricity Course*, which is worth \$1.00 alone to any electrical student. Address the Editor "With The Amateur's Prize Contest."



A GROUP OF REPRESENTATIVE AMERICAN AMATEUR RADIO STATIONS.

Electrical Laboratory of, 1—Mark Slabodnik, Ely, Minn. (Prize Winner); Radio Stations of, 2—G. Eddie Johnson, Toledo, O.; 3—Nicholas L. Googin, Jr., Cazenovia, N. Y.; 4—Armin Vogt, Jansen, Nebr.; 5—Steddum Bros., Oklahoma City, Okla.; 6—Warren Benson, Brooklyn, N. Y.

That "Perpetual Motion"

WE HAVE never published a prize contest that came within miles of being such a hilarious success as our "Scenic Railroad" hoax. When we published it, we did it more in order to show how young boys are often misled, due to incomplete knowledge, rather than our exploiting a scientific impossibility. In other words, the whole thing simply was a joke.

Imagine then our genuine surprise when immediately after publication, hundreds upon hundreds, nay thousands of letters poured in upon us, telling us why the scheme would not or really *would* work! Up to this time of writing 2,109 letters were received! Imagine such a thing—and they still come and come, and we have as yet to hear from foreign countries!!

The amount of good people who took the thing really serious is little short of astounding. And hundreds really imagined it worked! Even the gentle sex wrote four letters!

Hundreds of letters were alike, most of their writers considering "friction" only.

But the greatest bone of contention was the dynamo-motor point. Almost a thousand correspondents contended that when feeding the storage battery current back into the dynamo, the latter would reverse thus making the car go backward! These good people evidently never heard of an automatic reversing switch, nor did they stop to think that the great Chicago, Milwaukee and St. Paul Railroad actually works on this principle, where the coasting trains pump energy back into the line. Of course, this is not perpetual motion, nor anything near it, it is simply efficiency.

Only one letter, Mr. L. J. Bair's, mentioned this fact, hence the award of the "first prize" to him. Several other good letters are also published and prizes were awarded to the writers.

Scores of correspondents turned unconscious humorists, and we are printing a few choice samples selected at random. We are genuinely sorry that we have not the space to publish several hundred more of them!

First Prize and Subscription to "E E"

As an answer to your Perpetual Motion Scenic Railway Puzzle, I wish to offer the following for your consideration:

The facts resolve down to the following conditions: We have a weight mounted at a height, and in falling or rolling from this height, it attains a certain amount of kinetic energy in foot pounds. It requires exactly the same amount of energy in foot pounds to elevate this weight to the same height as is generated by falling.

From these facts, it is self-evident that were all apparatus and processes of this transfer of energy one hundred percent efficient, the system described would be O. K., but it is also evident that, due to wind friction and bearing friction on the cars, and copper, iron, windage bearing and brush losses, of the generating apparatus and motor equipment, it will be only about 60 per cent efficient at its best. This efficiency is attained by the regenerative apparatus used on the Chicago, Milwaukee and St. Paul R. R. on a three phase electric system over the Rocky Mountains.

The misleading feature of this perpetual motion scheme is that, due to the momentum of the car on the downward slide, it would reach to a high point on the upward grade and requires only a little effort to carry it over the top peak, but when

using the regenerative apparatus, no such momentum will be attained as the speed of the car will be reduced in direct proportion to the amount of current generated.

LEIGH J. BAIR,
111 West 111th Street,
New York City.

Honorable Mention and Subscription to "E E" 100 Words—Count 'Em

The air resistance, friction of bearings, brush on third rail and magnetic drag on armature reduce speed in descending hill so that the momentum of car will not ascend a hill equal in height to its starting point, consequently in order to have the car travel nearly around the ring, each succeeding

drawn from the storage battery and, owing to the losses in the machinery, more power would be consumed than was generated.

WILLIAM C. BELLER,
51 East 123d St.,
New York City

Is He Joshing Us?

The Scenic Railway idea would be fine but for a few obstructions.

The energy loss due to the friction between the flange of the wheels and the rails is hardly worth mentioning. The voltage drop in the iron rails is small. Some energy is also lost in overcoming the air pressure on the front of the car.

Much energy is wasted in starting and stopping.

This could be prevented, however, if the passengers would jump on and off while the car is in motion.

Not counting these few hindrances the idea is fine and it ought to be patented.

C. M. HOLLENBACH,
Saegersville, Pa.

Collisions and Wrecks! Wow, What a Head-ache!!!

The "Perpetual Motion Device" won't work because when the dynamo operates as a motor it will run the car backwards, which would collide with the other cars. Also while ascending cars are using current, the descending cars are sending current in the opposite direction to charge batteries. Thus there would be two electrical currents tending to go in opposite directions in the same conductor, and that is impossible, as each would tend to stop the other.

H. KERSTETTER,
633 Carlton Street,
Toledo, Ohio.

"Closed Circuit"—Bless Its Heart!!

The Scenic Railway cannot operate perpetually, because the dynamo-motor is connected to a closed circuit. To operate a circuit of this kind a dynamo must have sufficient power applied to it. Thus, when descending a hill, the energy required by the dynamo checks the speed of the car so that after a few descents the car must stop altogether.

PAUL R. GROVE,
714 Moore Street,
Huntington, Pa.

Eureka! It Works! Oil!! (Castor Oil?)

The reason why this device will not work is this: Tho the energy generated by the descending car would be sufficient to carry up a similar hill a similar car some of the energy is wasted in heat by friction. Altho by oiling this could be reduced, it could not be eliminated. Then some current would be wasted in heating the wires. If there were fewer cars or fewer people on the next trip it might work. But it would die down in a short time unless power were supplied from an outside source.

JOHN A. MCGUIRE,
30 Hope Street,
Ridgewood, N. J.

Quick—Call an Ambulance!!

The car in going down-hill would generate a current that would, at the bottom of the incline, tend to drive the car back up again, and it would back it up a little way, the car only to come to rest at last at the bottom

LESTER WOLF,
920 S. 11th Street,
South Bend, Ind.

Everett Has the Right Dope!

A car would climb just as far up the last peak without the addition of a generator and storage battery plant as with it, since its momentum would be impeded by the running of the generator, as by the well-known law: The current generated in a conductor by its motion in a magnetic field flows in such a direction that its magnetic field tends to prevent the motion. In other words, the amount of energy used up by the running of the generator is greater than that gained by the motor, the loss being due to resistance, friction in the generator and motor, etc.

EVERETT L. SWEET,
145 Congress Ave.,
Providence, R. I.

This Bird Claims It Will Run 40 Seconds!!
It is impossible for your "Perpetual Motion Scenic Railway" to work for several reasons: Regardless of what height the grades are upon which the cars descend, the dynamo-motor would
(Continued on page 430)

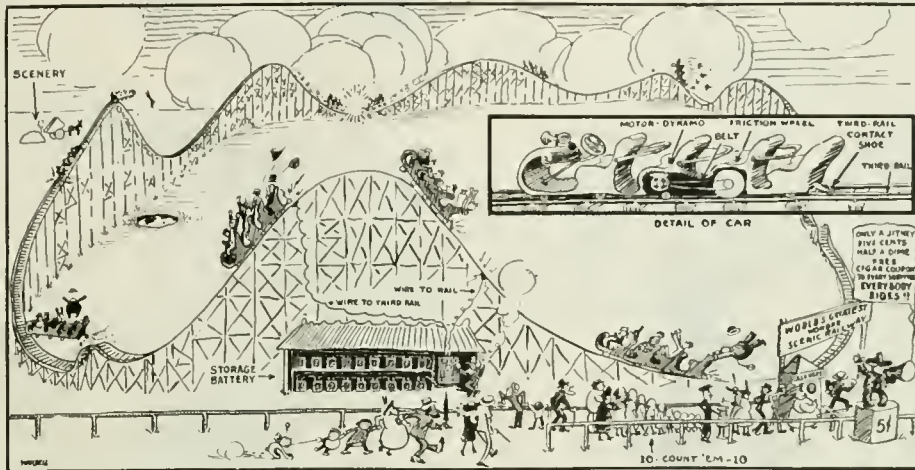

In Our "August" Number We Publish This "Perpetual Motion" Scenic Railway Problem. The Large Storage Battery Was Supposed to Supply Current to the Ascending Cars; the Descending Cars Pumped "Juice" Back Into the Battery, etc., ad infinitum. Here Are Some of the Answers We Received. The Editor's Chair Is Still Oscillating From the Shock.

hill must be less in height. Therefore car will stop some distance below its starting point.

Assuming efficiency of dynamo, storage battery and motor 80 per cent each, then about 51 per cent of energy lost is returned to it as motive power. Therefore, would come nearer performing feat without dynamo attached.

C. F. RUDOLPH.

Honorable Mention and Subscription to "E E"

The fallacy of the idea may be shown in the clearest way by a simple mathematical process. In this solution the loss of energy thru friction, dynamo inefficiency and electrical resistance is disregarded, altho, of course, this would be great enough to make the idea impractical.

It may be assumed that the energy required to drive the car from the point B to C would be equal to the energy obtained from the car traveling from A to B. Let these amounts equal x and x^1 .

Then

$$x = x^1$$

Also let the kinetic energy = K and the electrical energy = E .

Now in traveling from A to B, kinetic energy K will be obtained minus the electrical energy used to charge the storage batteries, or

$$K - E = x.$$

Now from B to C, the energy required will be the kinetic K , which will carry the car to some point C', plus the electrical, from C' to C, or

$$K + E = x^1,$$

and since

$$x = x^1$$

$$K - E = x$$

$$K + E = x^1$$

$$K - E = x^1$$

$$K + E = x^1$$

$$K - E = x^1$$

$$K + E = x^1$$

$$K - E = x^1$$

$$K + E = x^1$$

$$K - E = x^1$$

$$K + E = x^1$$

$$K - E = x^1$$

$$K + E = x^1$$

$$K - E = x^1$$

$$K + E = x^1$$

$$K - E = x^1$$

$$K + E = x^1$$

$$K - E = x^1$$

$$K + E = x^1$$

$$K - E = x^1$$

$$K + E = x^1$$

$$K - E = x^1$$

$$K + E = x^1$$

$$K - E = x^1$$

$$K + E = x^1$$

$$K - E = x^1$$

$$K + E = x^1$$

$$K - E = x^1$$

$$K + E = x^1$$

$$K - E = x^1$$

$$K + E = x^1$$

$$K - E = x^1$$

$$K + E = x^1$$

$$K - E = x^1$$

$$K + E = x^1$$

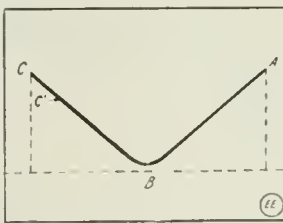

$$K - E = K + E$$

which, of course, is impossible.

JOHN R. MARTIN,
333 E. Morton Ave.,
Jacksonville, Ill.

Honorable Mention and Subscription to "E E"

In explanation of the inoperativeness of the Perpetual Motion Scenic Railway, described on page 249 of the August number of your magazine, I would state the following: It is well known that a dynamo consumes mechanical energy in proportion as it produces electrical energy. Therefore, the power required to drive the dynamo would so retard the descent of the car on the down-grades that, having less momentum, additional power would be required to lift it on the up-grades. This would be

LATEST PATENTS

Illuminated Torpedo

(No. 1,232,671; issued to Alphonse Fernandez.)

This electrically illuminated torpedo is intended for use by mariners, as an aid in discovering the presence of enemy craft at night. The torpedo may contain explosives if desired. To prevent disclosing the location of the ship dispatching the torpedo, a special electric time switch is provided, which does not close



the searchlight battery circuit until the torpedo has reached a predetermined distance away from the ship. Also the inventor provides a centerboard or keel which is automatically released after the torpedo has reached the end of its range, and which device helps to keep the torpedo in a given course; the inventor thus not relying on the ordinary rudder or plane steering mechanism. It is possible to retrieve torpedoes of this type after they have performed their service.

Magnetic Shift for Head-Lights

(No. 1,233,341; issued to Henry S. Gove.)

Electro-magnetic shifting device for rotating head-lights of an auto or other vehicle which involves the use of an extremely simple motor, the head-light being mounted rigidly on a central threaded stem, which engages a relatively heavy iron nut. Normally this nut is sufficiently

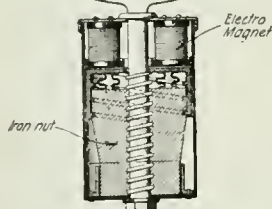

heavy to fall to the bottom of the casing, and maintain the head-light in a straight ahead position. If battery current is past thru the electro-magnets at the top of the casing, the iron nut is drawn upward and in so doing, it causes the threaded cap just under the magnets to rotate, thus, turning the central stem on which the head-light is mounted.

Portable Lamp for Harness

(No. 1,232,201; issued to Carl F. Brown.)

A novel use for a battery lamp designed so as to be quickly attached to or detached from an ordinary harness, the wires carrying the current to the lamp being concealed within the traces. Battery may be

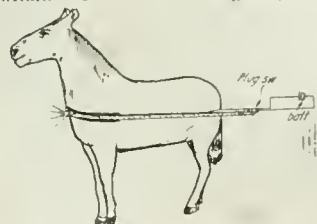

placed in the vehicle, and when the lamp is to be used a simple plug connector or switch can be attached to the trace closing the lamp circuit. An auxiliary switch mounted on the vehicle seat, may be used if desired. The inventor claims by this arrange-

ment to be able to illuminate the road ahead of the horse, and thereby prevent shadows being caused by the animal from the usual lights on the vehicle. When not in use the lamp attachment can be removed in part, and the remainder of the lamp provides a neat ornament upon the breast collar.

Fan Deodorizer

(No. 1,233,039; issued to Bert W. Flanders.)

This invention provides a simple deodorizing attachment which may be readily attached to the wire cage found on all electric fans. The patent relates to refrigeration, and

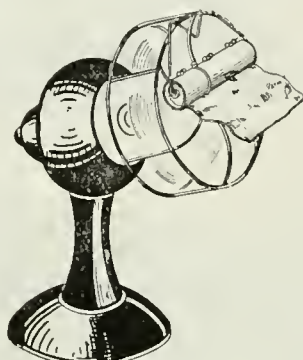

more especially to air coolers and deodorizers which include a fan or other means for pumping air into contact with water or other liquid before it is delivered to the point of use. This attachment includes a reservoir for water or deodorizing liquid, also a moistening surface with a fabric sheet hanging in front of the fan, and means for delivering the liquid as rapidly as may be desired to this surface, so that the air from the fan is blown against the moistened fabric and cooled or dried by the deodorizer before it reaches the point of application.

Thermionic Amplifying Circuit

(No. 1,232,879; issued to Peter I. Wold.)

This invention relates to the amplification of small continuous voltages or currents, and its purpose is to make it possible to detect or measure such voltages or currents, which might not otherwise be detected. Audion type vacuum amplifiers are utilized which are connected in a

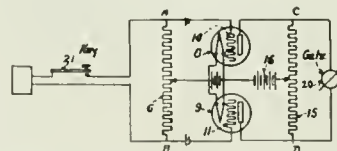

special circuit as shown. It will be observed that current from the battery 16 divides at the middle point of the resistance 15, and flows thru the two output circuits. It is also apparent that the two halves of resistance 15 will be equal and opposite, and points C and D will normally be at the same potential, and no current flows thru the galvanometer 20. When key 21 is closed, however, the current will flow thru the resistance 6, and if the direction is such as to bring the terminal A to a higher potential than the terminal B, the grid 10 will have a higher potential than grid 11. This results in the current flowing thru output circuit to amplifier 8, being greater than that of amplifier 9. Thus point C will be at a lower potential than point D, and current will flow thru the galvanometer 20.

Fire-Detecting Wire

(No. 1,235,028; issued to Charles A. Harsch.)

This invention involves the use of a fusible conductor inclosed within the walls of a cell or tube in the wall of which there is provided an

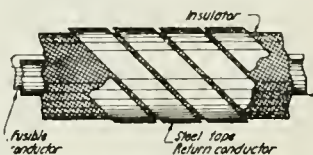

outlet, so that when the metal becomes plastic, it may be forced outward thru this perforation in the wall of this cell, and penetrate thru the fibrous insulating material surrounding it, and establish the desired electrical connection between the inner and outer conductors. The fire-detecting wire as devised by this inventor comprises an inner core of easily fusible metal, a galvanized steel tape of suitable breadth to nearly envelop a soft metal core, leaving a longitudinal slot, a braided insulated wrapping and an exterior conductor, formed preferably of a galvanized steel tape, helically disposed on the exterior.

Radio Receiving Circuit

(No. 1,233,841; issued to Elmer E. Butcher.)

Radio-telephonic or telegraphic signals of any characteristic, and particularly undamped wave signals are received and made audible by the simple arrangement here shown. The patent covers the use of a per-

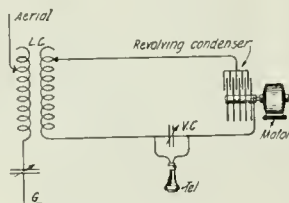

iodically changing capacity constant in the receiving circuit. A constantly changing condenser driven by a motor is shown in the present diagram. It is thus apparent that as the revolving condenser plates rotate, the capacity of the condenser increases to a maximum, and decreases to a minimum periodically; thus throwing the secondary circuit into and out of resonance with the aerial circuit, and an audible signal of a frequency proportional to the speed of rotation of the condenser is produced. No exact tuning is necessary with this circuit, as the revolving condenser, within limits, finds the exact point of resonance automatically.

Microphonic Buzzer Transmitter

(No. 1,234,650; issued to John Patrick Ferriter.)

A buzzer transmitter for the purpose of telegraphing over a wire telephone circuit or for use as a telegraph transmitter over a radio telephone circuit.

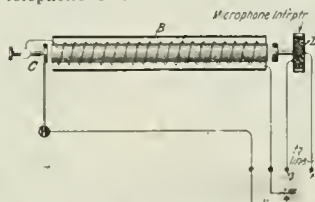

The apparatus comprises an actuating coil as shown, which is inclosed in an open-ended metal tube (B) of brass or copper. At one end of the coil is a spring interrupter

(C), and at the opposite end a microphonic transmitter (D). The coil may be 6 inches long with an iron wire core 1/2 inch in diameter, wound with five layers of No. 23 B. & S. magnet wire. The metal tube (B) absorbs the brush discharges. The microphonic interrupter (D) acts in unison with the spring interrupter (C), but is not electrically connected with it. Terminals (13 and 14) go to the line.

Vacuum Bulb Rectifier

(No. 1,230,004; issued to George S. Meikle.)

An improvement in vacuum tube rectifiers involving the use of an incandescent cathode device in the manner shown. This idea provides

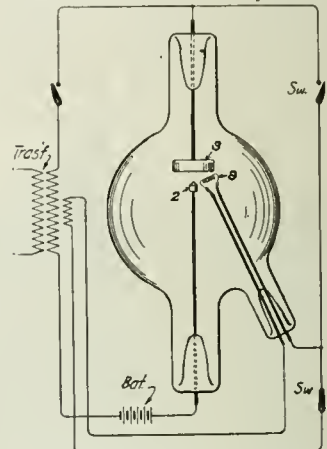

a rugged main cathode, and separate or auxiliary electrode which operates in conjunction with such cathode to spring a starting arc which heats the cathode to incandescence, preliminary to starting the main arc. The cathode tip preferably consists of tungsten; the space within the bulb should be carefully evacuated of all gases and vapors, and the envelop is then filled with an inert gas, such as hydrogen, argon, etc. When the tube is to be started, a suitable heating current is conveyed to the starting electrode 9, from a special winding on the transformer as shown.

Wind-Wheel Electric Generator

(No. 1,233,232; issued to Albert H. Heyroth.)

A very clever form of wind-wheel electric generator in which the

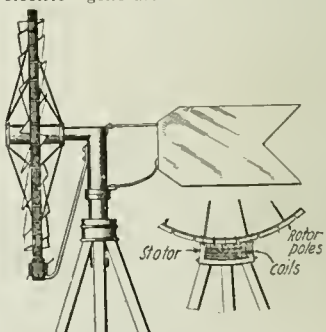

wind-wheel itself acts as the rotor of an alternating current dynamo. The rotating element simply carries inductor plates, which are caused to move by a series of stator poles, which poles carry a series of electro-magnetic windings. The device acts in the same way as an alternating current generator, and also serves as its own exciter. The terminals of the stator windings may be connected with a rectifier to change the alternating current into a continuous one when so desired.

Phoney Patents

Under this heading are published electrical or mechanical ideas which our clever inventors, for reasons best known to themselves, have as yet not patented. We furthermore call attention to our celebrated Phoney Patent Offizz for the relief of all suffering daffy inventors in this country as well as for the entire universe.

We are revolutionizing the Patent business and OFFER YOU THREE DOLLARS (\$3.00) FOR THE BEST PATENT. If you take your Phoney Patent to Washington, they charge you \$20.00 for the initial fee and then

you haven't a smell of the Patent yet. After they have allowed the Patent, you must pay another \$20.00 as a final fee. That's \$40.00! WE PAY YOU \$3.00 and grant you a Phoney Patent in the bargain, so you save \$43.00!! When sending in your Phoney Patent application, be sure that it is as daffy as a lovesick hat. The daffier, the better. Simple sketches and a short description will help our staff of Phoney Patent examiners to issue a Phoney Patent on your invention in a jiffy.

PHONEY PATENT OFFIZZ

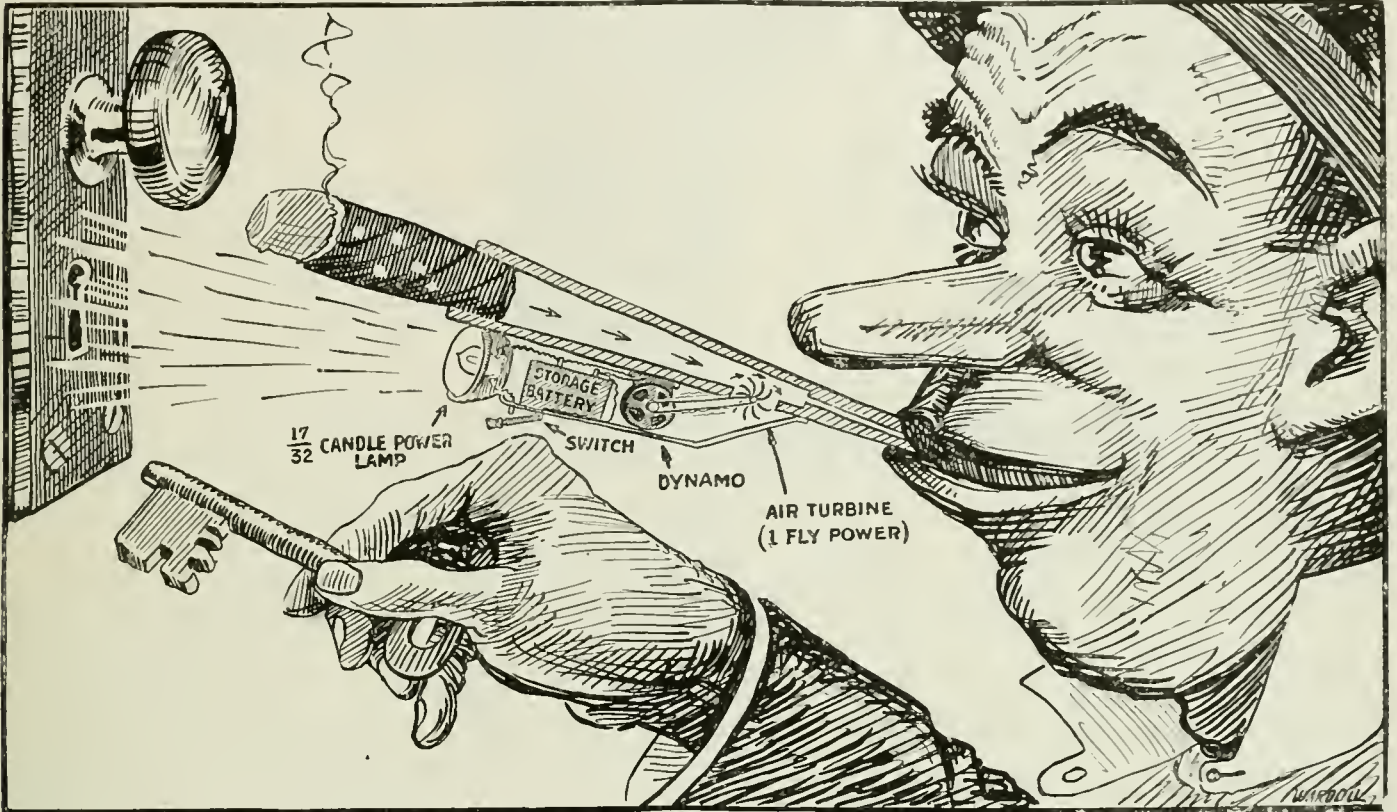

FIRST PRIZE, \$3.00: Smokelight. Works on Vacuum Cleaner Principle. Suction Created by Smoking, Operates Air Turbine, Which in Turn Energizes Dynamo. The Latter Charges Storage Battery Which Feeds the Current to Electric Lamp. Thus Collisions in Dark Are Avoided and Keyholes Are Found Easily. Inventor: F. R. Prey, Somerville, Mass.

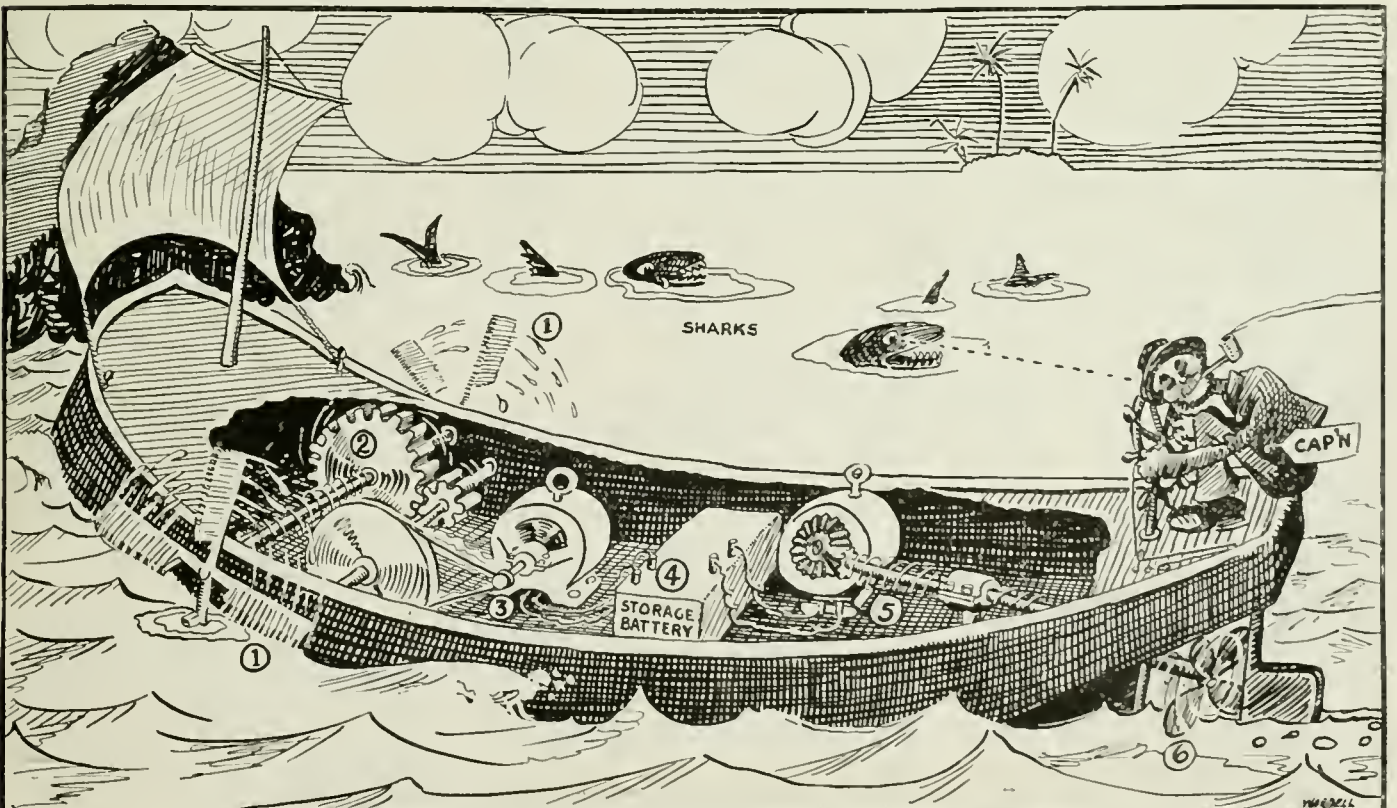

ELECTRIC SAILMOBOAT: Wind Fills Sails Which Slowly Move Ship. Water Turns Paddles 1, Which Thru Gear 2 Work Dynamo 3, the Latter Charging Storage Battery 4. This in Turn Drives High-Speed Motor 5, Which Turns Propeller 6 at 3898 R.P.M. Thus Ship is Driven Forward at 49 1/4 Nots an Hour. Inventor: Albert Branson, Logan, Pa.

QUESTION BOX

This department is for the sole benefit of all electrical experimenters. Questions will be answered here for the benefit of all, but only matter of sufficient interest will be published. Rules under which questions will be answered:

1. Only three questions can be submitted to be answered.
2. Only one side of sheet to be written on; matter must be typewritten or else written in ink, no pencilled matter considered.
3. Sketches, diagrams, etc., must be on separate sheets. Questions address to this department cannot be answered by mail free of charge.
4. If a quick answer is desired by mail, a nominal charge of 25 cents is made for each question. If the questions entail considerable research work or intricate calculations a special rate will be charged. Correspondents will be informed as to the fee before such questions are answered.

RESISTANCE OF SEA-WATER.

(842-A.) O. Saterdale, E. Boston, Mass., inquires:

Q. 1. What is the resistance of sea-water and what current could be transmitted thru 1,000 feet of it?

A. 1. The resistance of sea water varies somewhat of course, but it has an approximate resistance of 5 ohms per cubic centimeter.

Your question is very indefinite, as it makes all the difference in the world whether you wish to compute the amount of current which could be transmitted thru one thousand feet of sea water in a pipe; which would of course be a comparatively easy computation; or whether you wish to make such a calculation for an open body of sea water, such as in a harbor or inlet. In this case, the matter would become very involved indeed, and a number of soundings and breadth measurements of the body of water would have to be taken, and a mean of these values selected, so as to obtain the average cross-sectional area of the water. The resistance of a cross-section of sea water 10 centimeters square would only be 1/100 of the resistance of a cubic centimeter, etc. The current in amperes which could be transmitted thru a certain resistance of sea water would be given by Ohm's law or

$$C = \frac{E}{R}$$

CONDENSER FOR REDUCING SPARKING.

(842.) Charles Honeywell, Gloversville, N. Y., asks:

Q. 1. Can you suggest proper size of condenser to eliminate sparking at bell circuit contact shown in diagram?

A. 1. Concerning the special electrical contact which you are experimenting with, would advise that without more exact details as to how you have the special contact arranged, we cannot very well advise you as to how to overcome the trouble.

We should think that it would be possible to make the spring tension acting on your contact sufficiently strong so that the contact will not be jarred shut by a slight mechanical disturbance.

A condenser will only help you indirectly in solving this problem, if you have the contact member arranged so delicately that the slightest jar will cause it to close. We would like to advise you further, but feel that it would only be a waste of time to discuss matters which we do not quite understand for the reasons above stated. Your trouble apparently seems to lie in the manner of arrangement of the contact. Besides the condenser the principle of the magnetic blow-out could be applied to overcome the arcing at your contact, but even the latter would seem to hardly be of any distinct benefit to you, if the design of the contact is not properly carried out.

The principle of the magnetic blast as

applied to radio keys and other switches carrying heavy currents and liable therefore to severe arcing, lies in the fact that

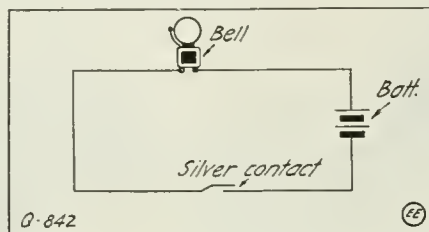

A Simple Yet Difficult Problem. It Is Required to Break This Circuit With a Minimum of Sparking and the Interrupter Is a Delicately Mounted One, Easily Vibrating With a Slight Jar.

a strong electro-magnet is connected in series with the circuit, in most cases. This magnet for small circuit breakers, may be of about the same size as a telegraph sounder electro-magnet, and in any case, this series blow-out magnet should be wound with wire of the same size as that used on the primary of the transformer, spark coil or other apparatus which the key controls.

It is usual to allow from 800 to 1,000 circular mils per ampere, in designing such blow-out coils, and the electro-magnet should be provided with suitable tapered pole-pieces with a small air gap between them, and so arranged that the break between the platinum or other contacts of the circuit-breaker takes place between the magnet pole-pieces. In this way the arc will be blown out by the magnetic field.

ODD PHOTOS WANTED AT \$1.00 EACH!!!

Now is the time to make your Kodak pay for itself in a real practical way. We are after interesting photographs of out-of-the-ordinary electrical, radio and scientific subjects and are willing to pay \$1.00 cash for every one we can use. Please bear in mind that for half-tone reproduction in a magazine, a photograph should be particularly sharp and clear. Of course, if a subject happens to interest us particularly well, we can have the photo retouched. For the general run of subjects, however, it does not pay to go to such expense. Therefore, please take pains to properly focus and expose your pictures. It often happens that a really mediocre subject well photographed wins approval over an excellent subject poorly photographed. And don't send us plate or film "negatives"; send unmounted or mounted "prints," preferably a light and a dark one.

As to what to photograph: Well, that's hard for us to say. We leave that up to you, and every reader now has the opportunity to become a reporter of the latest things in the realm of Electricity, Radio and Science. But, please remember—it's the "odd, novel or practical stunts" that we are interested in. Every photo submitted should be accompanied by a brief description of 100 to 150 words. Give the "facts"—don't worry about the style. We'll attend to that. Enclose stamps if photos are to be returned and place a piece of cardboard in the envelope with them to prevent mutilation. Look around your town and see what you can find that's interesting.

Address photos to—Editor "Odd Photos," ELECTRICAL EXPERIMENTER, 233 Fulton Street, New York City.

ELECTROLYTIC PRODUCTION OF HYDROGEN.

(844.) A. Luchs, Jr., Ridgeway, Pa., asks a number of questions regarding the electrolytic production of hydrogen.

A. 1. With respect to the explosive quality of hydrogen gas, would say that this is an explosive only when mixed with oxygen or with air, which is the same thing.

The most efficient way, and the one now used commercially in the largest oxygen-hydrogen producing plants in the country, is that producing hydrogen or oxygen gas by the electrolysis of water, which is accomplished by passing a strong electric current thru it.

The following data is given by one of the leading manufacturers of oxygen and hydrogen gas. A current of 2 volts and 600 amperes is used per cell and 4.8 cubic feet of oxygen and 9.6 cubic feet of hydrogen per hour are produced with this current of 1,200 watts. The U. S. Army balloon electrolyzers use 1,000 watt hours to produce 7½ cubic feet hydrogen and 5.76 gallons of water per 1,000 cubic feet of hydrogen are required. The electrolytic apparatus used for producing these two important commercial gases is usually designed so that the two gases are collected separately and independently; the hydrogen gas being evolved at the negative electrode and the oxygen gas at the positive electrode. You will do very well to obtain a copy of U. S. Patent No. 1,219,966 describing an improved form of electrolytic gas generator as used for the commercial production of these products, and which we can supply at 10 cents.

With reference to the proper ratio of hydrogen gas and air, to make the most explosive mixture, we would suggest that you try this out by experiment, as it would depend to some extent on the quality of the air; i.e., it would vary for different levels, and an adjustable mixer valve should be used in any such work as this, similar to the carburetor employed universally on all gasoline automobiles.

LARGE AND SMALL WIRE IN SAME CIRCUIT.

(845) E. E. C—, Ohio, asks whether several sizes of wire can be used in the same circuit in a satisfactory manner.

A. 1. With regard to running a 3-phase 7200-volt line one-half mile, to deliver current to a bank of 3-25 K.V.A. 25-cycle, 6600-volt to 440-volt transformers for power load would advise as follows:

We have not made any calculations on this problem, but assume that you are taking care of these calculations yourself. However, regarding the use of various sizes of wire in the transmission line, would advise that so long as the smallest size of conductor used is not below the minimum allowable cross sectional area, in circular mils, as computed by the usual A.C. formula for such circuits, then it will not matter in the least for all practical purposes, whether you use several different sizes of wire in the circuit or not.

That is if, say, No. 6 B & S conductor was given by the usual voltage-drop formula, then so long as any of the pieces of wire to be used are not smaller than No. 6 gage, the circuit will operate satisfactorily. Of course it is the usual case that no one would want to use sections of conductor larger in size than that absolutely required by the conditions surrounding the problem, but of course in your case, there is an exception as you state, owing to the fact that you have a quantity of various sized conductors on hand for the installation in question.

REPELLING TORPEDOES WITH A. C. ELECTRO-MAGNETS.

(846.) John Davidson, Ohio, asks several questions regarding A. C. magnets to be used for repelling torpedoes.

A. 1. We have considered such an electrical device as you describe, and which is supposed to repel metallic bodies such as those made of steel or iron.

Considered from a fundamental electrical viewpoint, an ordinary magnet excited by a direct current will not exert any repelling effect on an iron or other body. It is possible to create a magnetic repulsion effect if powerful alternating current electro-magnets are used, but this effect exists only over a distance of a few inches at the most, and several inventors have recently proposed that it would be a good idea to put a belt of these powerful A.C. electro-magnets around the waterline of a steamship so as to repel torpedoes and the like.

While we are on the subject, it is well to point out that if this arrangement was carried out that firstly, the cost would be practically prohibitive, and secondly there would be no repulsion effect exerted on the torpedo, which is made of steel, for the reason that it would not be of the proper shape. To produce a repulsion effect between an iron core within an a.c. magnet coil and a copper or aluminum inductor, the latter must be made in a ring form either square or round, so that induced currents are set up in this ring which will produce within the ring an opposing magnetic field, which reacts with the inducing a.c. field of the electro-magnet just mentioned.

COMPUTING SIZE OF ELECTRIC LIGHT WIRING.

(847.) Roy N. Meier, Wayne, Nebr., wishes to know how the size of wire for lighting circuits is computed.

A. 1. One of the simplest and most reliable rules for computing the proper size of a conductor to be used for wiring a house for lights, etc., is the modification of Ohm's law which states that the resistance of the wire in the circuit (both legs) in ohms should equal the volts drop in the circuit, divided by the current in amperes in the circuit.

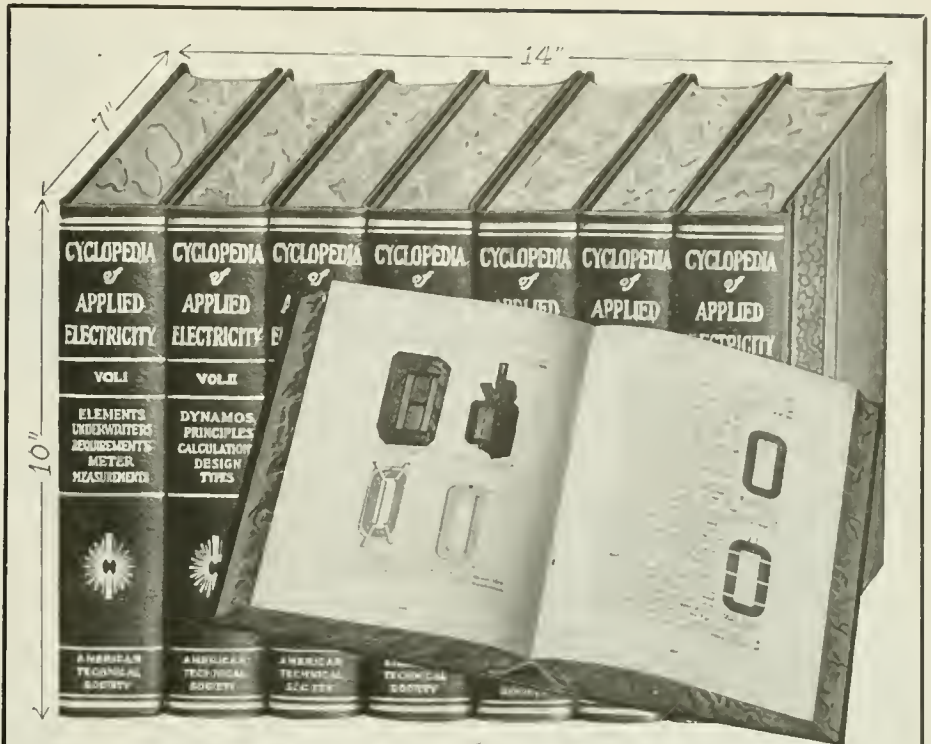

SEND NO MONEY

USE THESE ELECTRICAL BOOKS SEVEN DAYS AT OUR EXPENSE

By merely filling in and mailing the coupon below you can get this complete set of the Cyclopedia of Applied Electricity on trial. Use these books for seven full days before you make up your mind whether or not you want them. If you keep them, you may pay the special advertising price in easy installments of \$2.00 a month. If you don't want them, you may send them back at our expense and you won't be out a penny. Remember, we pay the shipping charges both ways.

A MASSIVE ELECTRICAL LIBRARY—NOT HANDBOOKS

These seven splendid volumes contain all the knowledge you need in order to earn big money in the electrical field. They are not thin handbooks, but thick, encyclopedia-size volumes, handsomely bound in half red morocco leather, gold stamped. Each one measures 7 by 10 inches, and is 2 inches thick.

This big size permits the use of large and comprehensive illustrations, plates, diagrams, etc. Over 3,000 cuts are contained in the Cyclopedia's 3,500 pages.

The completeness of the Cyclopedia will be a revelation to you. Everything electrical is explained in plain, simple English—every technical point is made clear. Each volume is carefully cross-indexed for instant reference.

50c a Week For this sum—an insignificant one—this wealth of electrical information is yours. But you don't have to send us a penny until you have used the books for seven days. Then, if you decide to keep them, send only \$2.00 a month—**50c a week**—until the special advertising price of \$19.80 has been paid. The regular price of these pay-raising books is \$35.00.

Consulting Service Free

A year's Consulting Membership in the American Technical Society—regular price \$12.00—will be included with all orders for a limited time. The advice of an entire corps of electrical experts is yours to help you in your progress—for a whole year **FREE!**

Send No Money—Just the Coupon

See these books for yourself before you buy. Remember, you don't risk a penny or assume a single obligation. The books will be sent by prepaid express to any one within the boundaries of the United States or Canada, and they may be returned at our expense if they fail to please. But you must act now! This generous offer cannot be continued indefinitely. Send the coupon now.

AMERICAN TECHNICAL SOCIETY
Dept. E-7447 CHICAGO, U.S.A.

Read These Subjects

- Elements of Electricity—
- Electrical Measurements—
- Underwriters' Requirements—
- Theory, Calculation, Design and Construction of Generators and Motors—
- Dynamo-Electric Machinery—
- Lighting Machinery—
- Power Transmission—
- Electric Railways—Power Stations—
- Switchboards and Switching—
- Storage Batteries—
- Applied Electro-Chemistry—
- Electric Elevators—
- Electric Welding and Heating—
- Wires and Wireless Telegraphy.

American Technical Society
Dept. E-7447 Chicago, U.S.A.

Please send me the Cyclopedia of Applied Electricity for seven days' free examination. If I decide to buy, I will send you \$2.00 in seven days, and the balance at the rate of \$2.00 a month, until \$19.80 has been paid. Then you will send me a receipt showing that the set of books and the \$12.00 consulting membership are mine and fully paid for. If I think that I can get along without the books, I will return them after seven days, at your expense.

Name.....
Address.....
Reference.....

Mesco Telegraph Practice Set For Learning Telegraph Codes

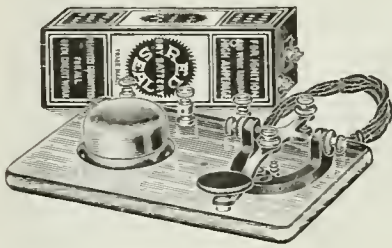

The Practice Set comprises a regular telegraph key, without circuit breaker, a special high pitch buzzer, one cell Red Seal Dry Battery, and four feet of green silk covered flexible cord.

The key and buzzer are mounted on a highly finished wood base, and three nickel plated binding posts are so connected that the set may be used for five different purposes.

For the beginner, the set is of exceptional value, for it may be used for individual code practice or for operation of a two party line, which is an excellent method of quickly learning the code. After the beginner has mastered the code, the set may be used in his wireless outfit for setting the detector in adjustment, and also the key may be used to control the spark coil.

Recommended for schools, as it gives excellent service for class instruction in code work. Full directions with each set.

The main object of the set is to enable the beginner to master the telegraph codes. The buzzer emits a sound similar in pitch and tone to that heard in wireless receivers.

Every beginner needs one of these sets, and as it is the equivalent of five different sets, the price is very low.

- | | |
|---|--------|
| List No. | Price |
| 342. Telegraph Practice Set, with Battery and Cord..... | \$2.70 |
| 344. Telegraph Practice Set only, no battery or Cord..... | 2.55 |

Send for Our New Edition of our Catalog W28 Ready about Oct. 1st

It is pocket size, contains 248 pages, with over 1,000 illustrations and describes in plain, clear language all about Bells, Push Buttons, Batteries, Telephone and Telegraph Material, Electric Toys, Burglar and Fire Alarm Contrivances, Electric Call Bells, Electric Alarm Clocks, Medical Batteries, Motor Boat Horns, Electrically Heated Apparatus, Battery Connectors, Switches, Battery Gauges, Wireless Telegraph Instruments, Ignition Supplies, etc.

Send for the Catalog Now Manhattan Electrical Supply Co., Inc.

New York: 17 Park Place
Chicago: 114 S. 5th Ave.
ST. LOUIS: 1106 Pine St.
San Francisco Office: 604 Mission St.

Electric Row Boat Motor



Make your Row Boat an Electric Launch. Buy a Jewel Detachable Row Boat Motor run by electricity. No odor or dangerous gasoline. Simple, noiseless and powerful. Attaches to any Row Boat and runs on two six volt Batteries. This is our 5th successful year.

OPEN WINDOW BATTERY
Look inside your storage battery through the patented open window. See condition of plates and height of electrolyte. If you need a new automobile starting Battery buy a Jewel and save money. 6-60 Special \$8.50.

Motorcycle Electric Lighting System
The Jewel Generator Motorcycle Storage Battery and complete lighting system is in great demand. Agents wanted. Write for prices and catalog E.

JEWEL ELECTRIC COMPANY, 112 N. Fifth Av., CHICAGO

STROMBERG-CARLSON RADIO HEAD SET \$8.25
Stromberg-Carlson Telephone Mfg. Co., Rochester, N. Y.

It is usual to allow about 3 volts drop from the main panel board to the lamps.

In making the final selection of the proper size of wire to be used for light and power circuits reference should be made to the Fire Underwriters' rules and tables, and if they specify a slightly larger conductor than the one given by the above formula, then that is the one that should be used of course.

With reference to the size of fuses to be used on the main panel board, these should be a multiple of the fuses in the branch circuits. For example if a panel board supplies four branch blocks, each fused at 5 amperes, then the panel board should be fused at 4 times 5, or 20 amperes, etc.

substance (H₂S) is present in the liquid, and can be obtained by evaporation. (This is not, however, the case with HCl.) The solution of the gas will, however, give certain chemical reactions, as, turning litmus, and when deposited on a silver coin, will produce a black stain of silver sulfid.

OSCILLATING A. C. MOTOR.

(850.) E. W. Cleave, Oakland, Calif., wants to know if an A.C. motor can be built in which the rotor will oscillate back and forth instead of rotating.

A. I. Concerning oscillating squirrel-cage A.C. motor, we must say to the best of our knowledge, there is no method of winding such a motor so as to cause the rotor to oscillate back and forth thru say,

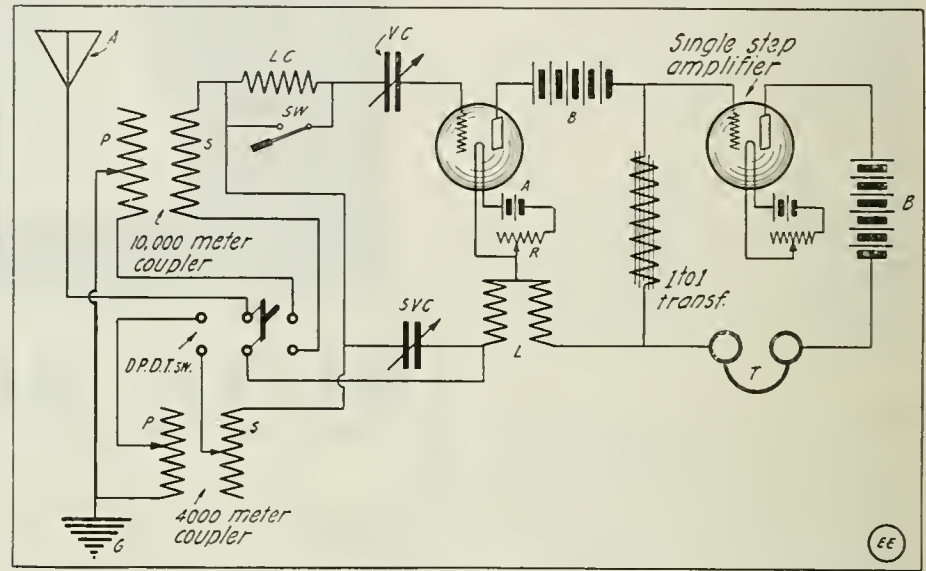

Connections of a One-Step Amplifier and Audion Detector Arranged to be Quickly Switched In For Undamped Waves Up to 10,000 Meters or Damped (Spark) Signals Under 4,000 Meters Wave Length.

WIRING DIAGRAM.

(848.) Leroy F. Bremmer, Fort Dodge, Iowa, wants to know:

Q. 1. What is the wave length of an aerial 80 feet long, 4 wires, 55 and 38 feet high, with lead-in 100 feet long.

A. 1. The wave length of your antenna is 350 meters.

Q. 2. Please show diagram of connections of a one-step amplifier which can be changed from a 10,000 meter undamped wave set to a 4,000 meter spark set by switches. Please show all necessary instruments in hookup.

A. 2. Diagram herewith shows connections of the necessary instruments. The double-throw, double-pole switch is employed for changing from the 10,000 meter coupler to the 4,000 meter coupler. In receiving spark stations it is essential that the grid loading coil is short-circuited by means of the switch as shown. To receive spark station the D. P. D. T. switch is thrown to the left and for undamped wave it is placed to the right.

IS HYDROGEN SULFID IN WATER A PHYSICAL OR A CHEMICAL SOLUTION?

(849.) S. Lenkin, Washington, D. C., wants to know if hydrogen sulfid (H₂S) in water is a physical or a chemical solution, and why.

A. 1. Hydrogen sulfid in water is a physical solution. When the gas is past into the water there is no evidence of any effervescence or of any precipitat forming (unless lead is present in the water which will cause the H₂S to precipitat the lead as an insoluble sulfid). This operation is sometimes called a *simple solution*, the origi-

nal 1/8th of a revolution as you suggest.

We would suggest that you take up this matter with the Engineering Department of the General Electric Co., Schenectady, N. Y., as we have an idea, if we recollect correctly, that that concern have a special alternating current apparatus, which operates on a principle somewhat like the one you outline.

LARGE SPARK COIL DESIGN.

(851.) B. P. B., Chicago, Ill., asks about constructing a large spark coil.

A. 1. It is often the case, as you suggest that the efficiency, and therefore the length, of spark produced by a given induction coil will be intensified by substituting a vulcanized fiber, or a hard rubber tube for a pasteboard one, if that is the kind of tube now separating the primary and secondary coils in your apparatus.

Some makers have used to very good advantage a glass tube, the point at issue being to have the very best insulation possible between the primary and secondary, owing to the very high voltages induced in the secondary winding, which will of course always attempt to jump the shortest possible path or gap, such as around the ends of the primary insulating tube into the iron core.

For this reason in designing large induction coils, above the 2-inch spark size, it is invariably the practise to so proportion the secondary winding that it shall not come all the way to the end of the primary insulating tube, but a considerable distance from it.

You are correct in your statement accompanied by diagram (Fig. 1) relative to the connection between various secondary sections, but this is the older and practically

obsolete manner of making these connections, and most always leads to dissatisfaction at an early date, for the reason that there is a very high potential always exist-

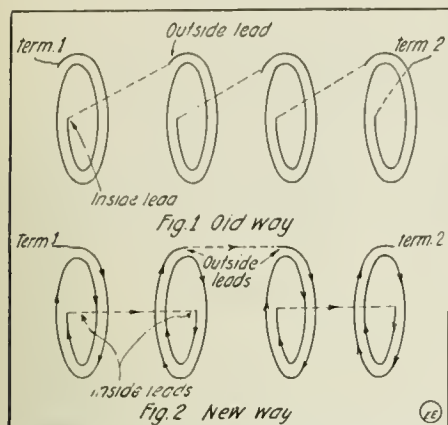

Old and New Method of Arranging Spark Coil Secondary Sections. In Method of Fig. 1, the Full Potential of Each "Pie" Tends to Jump Between the Lead and the Winding.

LEARN WIRELESS

SERVE YOUR COUNTRY

in an important trained capacity. Several thousand operators are needed for Army and Navy Service, our new merchant marine and air fleet.

The licensed Employment Department finds temporary day employment for those who must earn while learning.

ASK FOR FOLDER "B"

EASTERN DISTRICT Y. M. C. A.

Marcy Ave., near Broadway, Brooklyn, N. Y.
13 minutes to New York City Hall



A USEFUL MODERATE PRICE INK PENCIL

"Vulcan" \$1.00 Ink Pencils

The only perfect non-leakable, will suit any hand. Guaranteed. Last a lifetime. Great for general writing or manifolding.



Pure Para rubber with precious metal point. Can be carried point down. Made in red and black. Long and short. (Special 8 Ins., black, \$1.25.) Mail orders promptly filled. FREE supply of ink with retail orders. Agents wanted.

J. R. ULLRICH & CO.,
27 Thames Street New York

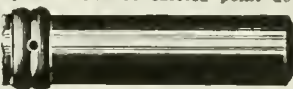

ing between the top of one section or "pie," and the down-coming lead wire from the adjacent "pie." It is the best and modern practise to connect first two inside leads together and then two outside leads, etc., etc., reversing every other "pie" of course as it is placed in position over the primary insulating tube. The Editor has generally found it most convenient and practical to secure the primary element with its insulating tube in place in a vertical position by means of wooden blocks, etc. This could easily be arranged, and a few blocks may be used if necessary to form a sufficiently high base at the point where the first "pie" will come. All leads should be soldered, using a non-corrosive flux. You will find a number of excellent books on this subject illustrated in our "Book Catalog."

BUZZER TRANSMITTER FOR LIGHTING CIRCUITS.

(852.) Cecil Mathers, Miami, Fla., desires a hook-up for a buzzer system to work on lighting circuits.

A. I. We give you herewith diagram of connections for two buzzers, batteries and keys to be used with ground return and electric light or other circuit, for the purpose of transmitting telegraphic signals over a one mile range.

Both telephone receivers (of the usual 75-ohm type) should be connected to the same line wire; i.e., both of them should be connected to either the positive or the negative line wire. If you experience any trouble due to a grounded system, a small fixt condenser should be connected in series with the telephone receiver at each station.

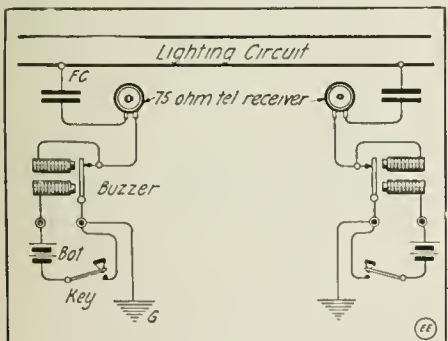

Simple Buzzer Telegraph for Use on Lighting or Power Circuits.

JAPANESE USE ELECTRICITY.

The use of electricity for lighting is rapidly increasing in Japan, even in the homes of the poorest classes in the cities.

"THERE'S MONEY IN IT"

AT HOME LEARN TELEGRAPHY AT HOME

MORSE AND WIRELESS

TEACH YOURSELF

in half the usual time, at trifling cost, with the wonderful Automatic Transmitter, **THE OMNIGRAPH**. Sends unlimited Morse or Continental messages, at any speed, just as an expert operator would.

Adopted by U. S. Gov't. 4 styles. Catalogue free.

OMNIGRAPH MFG. CO.
39L Cortlandt St. New York

The Man Behind the Key

is equally as important today as the Man behind the gun, as well as the Man in the trench.

The Government and Merchant Marine need thousands of TRAINED operators now, the demand far exceeding the supply. Men are needed urgently for the Naval Reserve, Naval Militia, and Signal Corps, etc., etc.

Pick your rating before you are drafted.

Special short code courses, Day or Evening for those desiring to join any branch of Radio for Government Service. Fall classes both Day and Evening start Oct. 1st. Send in your enrollment today. Students from all over the country.

The Eastern Radio Institute is endorsed by the United States Government and Marconi Co.

Send for free booklet today, containing interesting photos, etc.

Eastern Radio Institute
899 B Boylston St.
BOSTON, MASS.

CUT HERE

FREE COUPON

Eastern Radio Institute,
899 B Boylston St., Boston.

Please send to address below your 64-page booklet, giving full information about your school.

Name

Address

ELECTRIC "ZIG-ZAGGER" AIDS SHIPS TO FOIL U-BOATS.

(Continued from page 367)

the first officer of one of the large British merchant ships has invented a simple and very effective "zig-zag control board," which is herewith illustrated. It consists of a board about two or three feet square, carrying in its center a clock, and on each side of the clock a series of alternate green and red cards and glow lamps, each card and lamp corresponding to the starboard and port courses on which the ship is being navigated at any given time. Above the clock, extending across the head of the board, is plotted a zig-zag course which it will take the ship one hour to cover.

In the accompanying chart (top) the straight line represents the true course which, in this case, is, let us say, due north. The ship commences her zig-zag course at, say, 2 o'clock, at which hour the helm is thrown over and the ship's course is altered 30 degrees to port of the true course. [The original conception of this "zig-zag" control board was limited to automatically warning the helmsman every time the rudder was to be thrown over. The helmsman then set the electrical clock contact to ring after the next leg of the course had been completed, thus introducing manual control, which may or may not be a desirable feature. The editors have given this device considerable thought and suggest a full automatic electrical control of the rudder during such "zig-zag" runs, leaving of course the manual control always operative in the event that the course might have to be suddenly changed or when the automatic control might fail.] She continues on this course until seven and one-half minutes past 2 o'clock, when the minute-hand of the clock makes electrical contact with a bell which rings loudly, announcing that the time has come to change course again. (In the original scheme; in the revised plan shown in the diagram herewith the contact closed by the clock hand causes the proper relay to function, running the "port" or "starboard" rudder motor for a predetermined time, sufficient to pull the rudder over sufficiently to start the new course.) The helm is now thrown over, and the ship is put on a course 45 degrees to starboard of the true course. This course is maintained for ten minutes, when another electrical contact is made, the bell rings, and the ship is turned the necessary number of degrees to port until she is on a northern course, parallel with her true course.

There are seven changes of course during the hour, at the end of which, the ship is back again on her true course. In this particular zig-zag a 12-knot ship loses two knots of distance in one hour, which represents a loss of about fifty miles in the twenty-four hours; but it is better, surely, to lose fifty miles of distance than to lose the ship.

The course herewith shown is a purely supposititious one. The navigator can plot any course he may desire in a few minutes' time, and having done that, he has merely to shift the electrical contacts from hole to hole around the periphery of the clock, in accordance with the zig-zag as plotted.

The explanation given so far will undoubtedly make clear the action of the "electrical zig-zag" course apparatus. Let us now consider one change of the course right straight thru to see just what happens.

Suppose the "zig-zag" course is suddenly decided upon. The navigating officer throws in the proper switches to permit the automatic helmsman to take control of the ship's rudder. The clock may be turned

Wireless Taught By Mail

You May Learn Theory, Code and Laws of Radio Communication in Our School or at Your Home



fitting you for positions paying good salaries with wonderful chance to travel the world over. It's the most interesting profession known and the demand for skilled operators is increasing.

Send stamp for catalog giving facts. Resident classes open Oct. 2nd.

NATIONAL RADIO SCHOOL, 14th & U Sts., N. W., Washington, D. C.

WASHINGTON

Offers Special Advantages for These Courses.

The Monitor Detector System

FOR THE

Automatic announcement of fire in its incipency.
Automatic control and closing of factory fire doors and shutters.
Annunciation of rising temperatures in refrigeration plants.
Annunciation of falling temperatures and automatic lighting of heaters in citrus groves.
Automatic control and dropping of asbestos fire curtain and opening all theatre exit doors.
Control of automatic sprinklers, etc.
Complete protection for hotels, homes, steamships, theatres, factories, warehouses, piers, etc.
Illustrated booklet mailed upon application.
Agents wanted and territorial rights granted.
Let us give you a demonstration.



Pat. Febr. 23, '09 other patents pending

NEW YORK BRASS FOUNDRY CO., 104 Centre St., N. Y., U. S. A.

Finished Brass Specialties Marine Supplies Fire Equipment for Steamships and Buildings

UNIVERSAL ELECTRIC MOTORS

OPERATING ON A. C. OR D. C.—110 TO 130 VOLTS
1/40 TO 1/8 H. P. CATALOGUE FREE

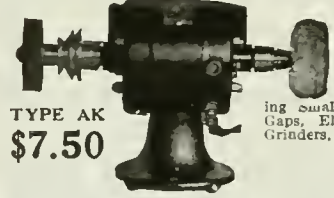

THIS MOTOR \$7.50

1/20 H. P. 6000 R. P. M.

Being Used Successfully for Grinding, Polishing, Driving Small Machinery, Sewing Machines, Fans, Wireless Spark Gaps, Electric Fountains, Check Endorsers, Humldors, Valve Grinders, Electric Hair Clippers and numerous other appliances.

Complete with Pulley
Emery Wheel
Buffing Wheel
Chucks
Cord and Plug

A MOTOR OF UNIVERSAL APPLICATION
Base Pulley and Chucks Easily Detached

Racine Universal Motor Co. 304 South Dearborn Street CHICAGO, ILL
Makers of RACINE FANS, VACUUM CLEANERS, VIBRATORS AND MOTOR APPLIANCES of all kinds

TYPE AK \$7.50

If Your Dealer Cannot Supply You, Order From Us Direct

MAGNETIC RECTIFIER
Patented April 1916



F-F BATTERY BOOSTER

NEW—FULL WAVE—HIGH EFFICIENCY
For Public or Private Use

You yourself can KEEP YOUR BATTERY FULLY CHARGED and give it a REFORMING CHARGE when necessary right in the car. You save a big charging bill and expensive rental battery. No delay, bother or nuisance whatever. Big profit in taking batteries in to recharge.

Operates from Lamp Socket on 110 volt 60 cycle current
Get Bulletin No. 12

\$18 Complete for 6 volt type.

F. O. B. Cleveland

THE FRANCE MANUFACTURING CO., Cleveland, Ohio

Jobbers and Dealers Throughout the United States and Canada



STORAGE BATTERIES FOR ALL PURPOSES
Better Batteries for Less Money

Backed by An Exceptional Guarantee

MARKO STORAGE BATTERIES

WE MANUFACTURE BATTERIES FOR EACH MAKE OF AUTOMOBILE

PAUL M. MARKO & CO., Inc., 1191 Bedford Ave., Brooklyn, N. Y. N. Y. Depot—974 8th Ave., N. Y. City

Capacity

Quality

Price

so that the hour hand with its attached contact is just on the hour. The first stationary contact is thus livened up, causing the rudder motor to function, and the ship to take its first lap on the "zig-zag" course or 30° to port. In order that the helm motor shall run just long enough to throw the rudder

AMERICA! LONG LIVE WIRELESS! to the proper course angle, the stationary clock contact could be made a certain length or else a dash-pot time switch can be used in the circuit to cut off the motor after the proper time has elapsed.

But this is not all of the problem by any means. We can't leave the helm thrown over, say 30° to port, indefinitely, or the vessel would turn a complete circle. We will have to use either an automatic time relay to close the opposite motor circuit and rectify the rudder to a position parallel with the ship's keel, or better yet, rig up a special gyroscopic compass so that when the ship has turned and lined up on its new course, the compass will actuate a relay controlling the opposite helm motor and pull the rudder to its central position. The gyroscopic compass is rugged enough to stand this work, but it would not be necessary to fit any rubbing contacts to it. A Tesla relay would do the work, the relay current passing thru a spark, or the proper contacts could be closed by an inductive mechanism. The plans here shown include tell-tale lamp signals, which indicate the course the ship is changing to, and also two distinct "zig-zag" course charts, each good for one hour's sailing. One course is the exact converse of the other, i. e., the first lap of 7½ minutes on the left-hand chart is run at 30° port; the corresponding lap on the right-hand chart is run at 30° starboard.

THE AMATEUR'S OPPORTUNITY.

(Continued from page 389)

with the November issue we are going to print a monthly list of names of those young men who think sufficiently of their services to Uncle Sam as radio operators.

This list will be termed:

RADIO ROLL OF HONOR.

At the end of this article you will find a blank to be signed by you. Fill it out at once and mail it today. *There are no charges, no expenses.*

Sign the blank, showing that you are a good citizen and that you are prepared to do your "bit" for your country. We pledge ourselves to publish every name sent in to us—even tho we have to run ten solid pages of names a month.

You may never be called for service, but in the years to come you will look with satisfaction and pride upon the "Radio Roll of Honor" containing your name, in mute testimony of your genuine patriotism.

Now amateurs, all together: **LONG LIVE**



You Need a GOOD PLIER

A drop forged steel plier shown here of "RED DEVIL" quality will stimulate your efforts toward better work. Nickel-plated, 6½ in. with combination jaws and screw driver in handle. Style 1024, sample 60c. Circulars of other styles free.

SMITH & HEMENWAY CO., INC.
107 Coit Street, Irvington, N. J.



Big Money in Electricity

The electrical industries offer wonderful opportunities to boys with a liking for Electricity. The salaries paid to trained men are large, promotion comes rapidly and, best of all, the work is fascinating.

The discovery and development of new lines (such as wireless telegraphy and telephony), from time to time, promise attractive and paying fields to those who wish to specialize. The will to do and Special Training will bring success to you.

The International Correspondence Schools can help you to become an expert in electrical work, no matter what branch you like best. Thousands of young men have already won success through I. C. S. help. You can do as well as anybody, if you try. Everything is made so clear that you can learn in your spare time, regardless of where you live or what your work. No books to buy.

There's big money in Electricity. Get after it by marking and mailing the Coupon today. *Finding out costs you nothing.*

RADIO ROLL OF HONOR

Application for Membership in the Radio League of America

I, THE UNDERSIGNED, a Radio Amateur, am the owner of a Wireless Station described in full in this application. My station has been in use since....., and I herewith desire to apply for membership in the RADIO LEAGUE OF AMERICA. I will abide by all the rules of the LEAGUE, and I particularly pledge my services as a Radio operator, or for Signal Corps duty to the United States Government when called upon.

I understand that this blank with my signature will be sent to the United States Government officials at Washington, who will make a record of my name.

Witnesses to signature: _____ Name.....
 _____ City.....
 _____ State.....
 _____ Date.....191

Description of My Station and Apparatus

Sending ..
 Receiving ..
 I can send approximately.....words per minute.
 I can receive approximately.....words per minute.
 My age is.....years.

(10-17)

INTERNATIONAL CORRESPONDENCE SCHOOLS
Box 5356, SCRANTON, PA.

Explain, without obligating me, how I can qualify for the position, or in the subject, before which I mark X.

- | | |
|---|--|
| <input type="checkbox"/> ELECTRICAL ENGINEER | <input type="checkbox"/> CHEMICAL ENGINEER |
| <input type="checkbox"/> Electrician | <input type="checkbox"/> SALESMANSHIP |
| <input type="checkbox"/> Electric Wiring | <input type="checkbox"/> ADVERTISING MAN |
| <input type="checkbox"/> Electric Lighting | <input type="checkbox"/> Window Trimmer |
| <input type="checkbox"/> Electric Car Running | <input type="checkbox"/> Show Card Writer |
| <input type="checkbox"/> Heavy Electric Traction | <input type="checkbox"/> Outdoor Sign Painter |
| <input type="checkbox"/> Electrical Draftsman | <input type="checkbox"/> RAILROADER |
| <input type="checkbox"/> Electric Machine Designer | <input type="checkbox"/> ILLUSTRATOR |
| <input type="checkbox"/> Telegraph Expert | <input type="checkbox"/> DESIGNER |
| <input type="checkbox"/> Practical Telephony | <input type="checkbox"/> BOOKKEEPER |
| <input type="checkbox"/> MECHANICAL ENGINEER | <input type="checkbox"/> Stenographer and Typist |
| <input type="checkbox"/> Mechanical Draftsman | <input type="checkbox"/> Cert. Pub. Accountant |
| <input type="checkbox"/> Machine Shop Practice | <input type="checkbox"/> Railway Accountant |
| <input type="checkbox"/> Gas Engineer | <input type="checkbox"/> Commercial Law |
| <input type="checkbox"/> CIVIL ENGINEER | <input type="checkbox"/> GOOD ENGLISH |
| <input type="checkbox"/> Surveying and Mapping | <input type="checkbox"/> Common School Subjects |
| <input type="checkbox"/> MINE FOREMAN OR ENGR. | <input type="checkbox"/> CIVIL SERVICE |
| <input type="checkbox"/> Metallurgist or Prospector | <input type="checkbox"/> Railway Mail Clerk |
| <input type="checkbox"/> STEAMBOAT ENGINEER | <input type="checkbox"/> Textile Overseer or Supt. |
| <input type="checkbox"/> ARCHITECT | <input type="checkbox"/> AGRICULTURE <input type="checkbox"/> Spanish |
| <input type="checkbox"/> Architectural Draftsman | <input type="checkbox"/> Navigator <input type="checkbox"/> German |
| <input type="checkbox"/> PLUMBING AND HEATING | <input type="checkbox"/> Poultry Raising <input type="checkbox"/> French |
| <input type="checkbox"/> Sheet Metal Worker | <input type="checkbox"/> Automobiles <input type="checkbox"/> Italian |

Name.....
 Present Occupation.....
 Street and No.....
 City..... State.....

NO CHARGES. NO DUES
CUT OUT, FILL IN, AND RETURN AT ONCE

You benefit by mentioning "The Electrical Experimenter" when writing to advertisers.

ELECTRICAL EXPERIMENTERS DEMAND

GOLD SEAL FOR STRENGTH



THE BATTERY WITH A WONDERFUL RECUPERATIVE POWER

MANUFACTURED BY
THE GOLD SEAL BATTERY CO.
NEW YORK CITY

FOR IGNITION AND SERVICE REQUIRING HIGH AMPERAGE.

DRY GOLD SEAL BATTERY

TRADE MARK

THIS BATTERY HAS WONDERFUL RECUPERATIVE POWER

No. 10

FIRING BOMBS BY ELECTRICITY.
(Continued from page 370)

of the cable, and this of course is but a few ounces. Even the sudden jerk after releasing the bomb is not imparted to the wire—the reel takes it nearly all.

Now, the observer thru his trench periscope watches the flight of the bomb. His one hand rests on the switch which is connected to a thirty- or forty-volt storage battery, while the bomb-cable connects with the switch and the battery also. By merely throwing the switch, the man at the periscope can set off the distant bomb at the proper moment. What this proper moment is depends of course upon circumstances as well as the will of the operator.

And now we come to the point showing where this device is superior to the present bomb. Suppose during a dark night we throw several hundred of these bombs in "no man's land" (the strip of land between our own and the enemy's trench). They may rest peacefully here for days or months well hidden by plants or dirt. The fine cables running toward our own trench can hardly be seen. The enemy therefore is unaware of the hidden bombs. It goes without saying that all the cables are connected to one central point under supervision of one or more operators. If now the enemy wishes to raid our trench we can set off the entire string of bombs right under his feet, as he advances toward us. Such tactics are sure to demoralize the bravest troops, and the second advancing column will hesitate, not knowing if there is not another set of bombs, which may go off at my second.

Of course, the electrically fired bomb would probably be used mostly to "bomb" the enemy's trenches, exploding it after its descent into the trench. And after the enemy becomes acquainted with this devilish device, no one will be fool enough to pick up such a bomb with an idea to hurl it back at the sender. For the sender, thru his periscope, would see it before it was two feet above the enemy's trench, when he would explode it of course, thereby almost certainly killing the man who attempted to throw it back.

Also, suppose that due to faulty throwing the bomb does not reach the enemy trench. Is the bomb thereby lost as is the case with its present brethren? Indeed not! For we can pull it back by means of the cable, and throw it once more!

Now let us turn from the murderous to the more humane. Instead of filling our bomb with a high explosive, let us fill it with chloroform. Our Fig. 2 illustrates such a bomb. It is composed of two hemispheres separated by a soft gasket. After partly filling the bomb with chloroform, the remaining air is pumped out, thus leaving a vacuum. This will cause the hemispheres (working on the famous "Magdeburg Hemispheres" principle) to hold together as if riveted. The two ends of the electric cable go to a fusible plug in the wall of the bomb which when melted by a heated platinum wire allows either air or chloroform to leave the bomb. Or otherwise a minute electrically fired charge of explosive will separate the two hemispheres, praying the trench with chloroform. If a sufficient number of such bombs are thrown into a trench, the occupants will promptly fall to sleep for some time to come. No, this idea is not half so ridiculous as it seems, and we may see it tried yet.

If the "powers that be" do not approve of the chloroform bombs, they may replace the narcotic with oil. In this way the entire trench of the enemy can be set on fire when setting off the bombs.

Probably quite a few more ideas will suggest themselves when the electrically fired bomb is tried out in actual warfare.

VIOLET-RAYS!

NEW LIFE, POWER, HEALTH and BEAUTY in the marvelous delightful VIOLET-RAYS. Newest and most powerful form of electricity, causing neither muscular contraction nor pain of any kind.

THE VIOLETTA



High frequency instrument is endorsed by thousands of Physicians who use it daily.

Produces SOOTHING, INVIGORATING, CURATIVE VIOLET-RAYS. Wonderfully quick results obtained in treating SCALP, FACE and BODY. Health bringing OZONE forced into the blood, producing an abundance of VITALITY.

Sent on Free Trial

Simple in construction and operation. The VIOLETTA is especially adapted for personal use in the home. Will operate on alternating or direct current or battery. ABSOLUTELY SAFE and GUARANTEED.

Write for New Free Book

Send for our new beautifully illustrated book on VIOLETTA. Tells all about the marvels of Violet-Rays. Read what scientists and doctors have to say. Post card brings book and all particulars of special low price and free trial offer.

Dealers write **BLEADON-DUNN CO.** Dept. 1A
208 NORTH FIFTH AVENUE, CHICAGO



WIRELESS BOOKS, RAW MATERIALS

While your station is dismantled you can study and build apparatus. Buy from our stocks which we still maintain complete.

THE ELECTRO-SET CO. NOW KNOWN AS
THE NEWMAN-STERN CO., Dept. E-15
Cleveland, O.

GENERATORS! ALTERNATORS!

We have a complete line of sturdy, efficient generators and alternators from 100 to 1000 watts. We furnish complete parts for these finished ready to assemble with instructions to wind Transformers made to order. Send for catalogue

ALL AT FACTORY PRICES

Bergmann Motor Works, 442-446 Niagara St., Buffalo, N.Y.

MR. AMATEUR, "I WANT YOU!" SAYS UNCLE SAM.

(Continued from page 387)

structors in the following subjects:

- Magnetism and Electricity.
 - Alternating Currents.
 - A. C. and D. C. Recording Instruments.
 - Primary and secondary batteries.
 - Motors, motor generators and controlling devices.
 - Gas and oil engines.
 - Primary and secondary circuits.
 - Oscillating circuits.
 - Transmitting and receiving sets.
 - Naval service radio sets and operation.
 - Wave meters and measurements.
 - Radio regulations and fleet work.
- Instruction is also given in drill work, thereby fitting the radio operator for his future duties as *petty officer*.

During the period of training, men will receive, in addition to their regular pay, an allowance of \$1.25 per day with which to subsist themselves.

Upon being called to active service each man will receive a uniform gratuity of \$60.00.

Upon completion of three months' active service men may be examined, and if found competent, will be confirmed in their rating. After such confirmation in addition to their regular pay, they will receive an annual retainer pay, equal to two months' pay of the corresponding rate in the Navy, same to be paid quarterly.

Enrollment in the U. S. Naval Reserve Force is for a period of four years, but in times of peace, a man enrolled may be discharged upon application to the proper authority.

Now, fellow "Bugs", here is an excellent chance to serve your country, at the same time enabling you to broaden your education, build up your physique, come in contact with real men doing real things, save money, get good wholesome food to eat, and free medical attention when you are sick.

A chance to secure advancement in the Radio Profession, an invaluable experience acquired thru coming in contact with up-to-date methods and most modern equipment.

On top of all this you secure an honorable discharge when your enlistment expires from the U. S. Navy, which is a splendid reference at all times in civilian life.

So its up to you, Radio Amateurs, and those desiring further information should present themselves to, or communicate with the Enrolling Officer, Building No. 13, Navy Yard, Brooklyn, New York.

ARE THERE CURRENTS ABOUT A MAGNET?

(Continued from page 381)

noid, "F". At "G", at the upper end of the wooden lever "B", is attached a cord which is led across and over the pulley "I" to the scale pan and weight "K". With "A" just at the level of the pole and inside the solenoid, this solenoid, with the battery which I used, will draw 15.8 grams two centimeters out of perpendicular. Inside, four centimeters from the pole, it will draw 25.8 grams—the additional weight being placed at "K"—the same distance; an increase of power of *sixty-three percent*. At seven centimeters within the solenoid it will draw 22.5 grams; an increase from the poles of *forty-four percent*. At the center of the solenoid the power varies but little from that at the poles. (This will be explained later.) If it were possible to investigate the interior field after the insertion of an iron core, it would probably be found that the point of greatest lateral (outward) attraction is near the center of the magnet.

Learn Electricity at Home!



New, Easy System

Amazingly simple, quickly learned at home in spare time. Big openings everywhere for trained men. Or go into business for yourself anywhere. No text books used. Don't miss this extraordinary opportunity.

TWENTY LESSONS FREE!

We are making this sensational offer to a limited number of new students to advertise our remarkable new, easy method and prove to you that you can become an expert electrician by a few months' home study in spare time. Pay nothing if you *should* fail. No previous experience or study required if you can read and write.

Send This Coupon NOW!

Tomorrow may be too late to profit by this amazing offer of 20 lessons FREE. Act now. You risk nothing. Fill out the coupon and mail it today—sure. Or send a postal to

ALBERT W. WICKS

Bachelor of Science and E. E., Pres., Wicks Electrical Institute
Dept. 5210, 81 W. Randolph Street, CHICAGO, ILL.

Name
Address

ALBERT W. WICKS
Bachelor of Science and E. E.
President, Wicks Electrical Institute
Dept. 5210
81 W. Randolph St., Chicago, Ill.

Without any obligation on my part, please send me full particulars of your 20 Free Lessons Offer and all other information about your wonderful new system for teaching Electricity at home.

On top of all this you secure an honorable discharge when your enlistment expires from the U. S. Navy, which is a splendid reference at all times in civilian life.

ARE THERE CURRENTS ABOUT A MAGNET?

(Continued from page 381)

noid, "F". At "G", at the upper end of the wooden lever "B", is attached a cord which is led across and over the pulley "I" to the scale pan and weight "K". With "A" just at the level of the pole and inside the solenoid, this solenoid, with the battery which I used, will draw 15.8 grams two centimeters out of perpendicular. Inside, four centimeters from the pole, it will draw 25.8 grams—the additional weight being placed at "K"—the same distance; an increase of power of *sixty-three percent*. At seven centimeters within the solenoid it will draw 22.5 grams; an increase from the poles of *forty-four percent*. At the center of the solenoid the power varies but little from that at the poles. (This will be explained later.) If it were possible to investigate the interior field after the insertion of an iron core, it would probably be found that the point of greatest lateral (outward) attraction is near the center of the magnet.



Junior Deaf-Phone

For People With Impaired Hearing

\$15 Complete

THE MICROPHO JUNIOR DEAF-PHONE is a super-sensitive instrument which has been developed to meet the demands for a practical and efficient hearing device at an extremely low price. It is equal to any \$35.00 instrument made and superior to most of them.

The outfit consists of One Super-Sensitive Transmitter with cord connector; One Super-Sensitive Ear Piece with small black cord; One Black Single Headband; Black Case and Two Batteries. **IMPROVED**



Super-Sensitive Microphone Only \$7.50



DETECTAGRAPH \$15

This instrument is offered at an extremely low price. It is excellent for building your own radio amplifier. Can also be used in many experiments where a sensitive microphone is required.

This detecting instrument of marvelous sensitivity can be used for detecting secret conversations. Outfit consists of Sensitive Transmitter, 25 ft. Black Cord, Receiver, Headband, Case and Battery.

Send for one Today and Convince Yourself

MICROPHO-DETECTOR COMPANY
26 Cortlandt St., NEW YORK

Gaeton Boissonnault, President
Makers of Super-Sensitive Microphone Apparatus

Whatever Your Question:—be it the pronunciation of a new name, the spelling of a puzzling word, the location of Thanders, the meaning of futurism, arisick, Diesel engine, etc.

WEBSTER'S NEW INTERNATIONAL DICTIONARY contains a clear, accurate, final answer. This New Creation is an indispensable self-help to success. Hundreds of thousands of people in all walks of life use, profit from, and enjoy this vast fund of information.

REGULAR AND INDIA-PAPER EDITIONS.

G. & C. MERRIAM CO., Springfield, Mass.

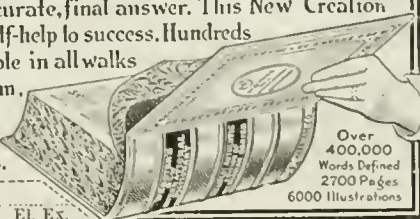

Over 400,000 Words Defined
2700 Pages
6000 Illustrations

Please send me specifications (NAME) FREE POCKET MAPS (ADDRESS) E. E.

WANTED-IDEAS

Manufacturers
are constantly writing me
for new ideas protected by OWEN PATENTS.
Send for my free literature and read their
wants.

FREE! Four finest patent books published! 73 page guide "Successful Patents," "Stepping Stones" (containing list of hundreds of inventions wanted; tells the plain truth about prizes, reward offers, etc.), and "Patent Promotion" (tells how to sell your rights; chief causes of failure, etc.), "Patent Buyers" Publishes over 400 letters from those who desire to buy Owen patents. All sent free upon request.

Very highest references. I help my clients sell their patents or dispose of their applications. Advice free. No obligation incurred by writing me. Free manufacturing facilities. No charge for report as to patentability, practicability, etc.

RICHARD B. OWEN, 164 Owen Bldg., Washington, D. C.

Electricians

Get up-to-date in HOUSE WIRING! Save TIME, MONEY, LABOR and MATERIAL by using our 98 GENUINE BLUE PRINT DRAWINGS, containing all the latest diagrams and connections known in house wiring—every diagram and connection up-to-the-minute as used by first class electricians for wiring BELLS, BURGLAR ALARMS, LIGHTS, ANNUNCIATORS, FIRE ALARMS and ELECTRIC GAS LIGHTING. These drawings are bound in the form of a flexible book (9 x 12) for convenience in using on the job. Send for them, and if they don't make you more efficient as a wireman and save you many times their cost, as a contractor, return them and money will be refunded—you can't afford to be without them. ONE DOLLAR post paid. Send for circulars on other sets of drawings.

PATENT SPECIALTY COMPANY
462 Sanchez Street San Francisco, Cal.

R. MORGAN ELLIOTT & CO.
PATENT ATTORNEYS
MECHANICAL, ELECTRICAL & CHEMICAL EXPERTS
716-724 WOODWARD BUILDING
WASHINGTON, D. C.

It is now possible to map completely the exterior and interior "lines" or currents of a magnetic field; a thing never heretofore truthfully done. Those produced heretofore have been merely guesswork. Fig. 6 shows such a map field. A,A, is the point of greatest compression. This point would also be the point of the greatest interior lateral attraction if it were not for the fact of the conflicting currents from the poles meeting at this point. B,B, on both sides of the magnet is the *neutral line*, or line of repulsion, the point of the *outward flowing currents*, corresponding to the greatest internal pressure. E,E, are the points of greatest relative lateral attraction on the interior of the solenoid. The several lines C,C, are the reverse curve lines on the side of the magnet and the lines D,D, are the *slightly curved* or *straight lines* entering the magnet near the poles. In all of these the arrows indicate the direction in which the iron tends to move and consequently the direction of the force or current. It must be borne in mind that all of these lines have another motion, that is—a *spiral motion*, as has been shown, and that while the spiral lines or currents meet in the center of the magnet, the rotation of the spiral is continuously in the same direction thruout the length of the magnetic field.

These experiments, including the production of *Magneto-graphs* by means of a magnet, prove unquestionably the following negative facts:

The "lines of force" in a magnetic field are not "lines of tension," "mere lines of direction," or "imaginary lines of direction like the lines of latitude and longitude on the earth." It will be noted that these expressions are quoted from high and accepted authority.

That the lines of force in a magnetic field are not continuous from the *North* to the *South* pole, that they do not "exist" from the *North* pole to the *South* pole,

and that they do not "emerge" from the *North* pole, or that so far as the lines about the *North* pole are concerned they do not "pass to" or "enter" the *South* pole.

The same experiments seem to prove beyond controversy the following positive facts:

Currents surround and enter magnets and solenoids and make up the field of force surrounding them, and their effects are due to these currents. The word "currents" is here used and will be continued to be used for the present without reference to the matter which composes them: for, of course, currents must be composed of matter. This is done advisedly, and in due time the nature of the matter will be conclusively proven. There can be no question but that these are currents. A child seeing straws moving about will at once tell you that there is wind—currents—and indicate its direction. This is in conformity with every known fact of physics as shown in liquids and gases. The fact is doubly confirmed by the *Magneto-graphs*. No one except a person seeking some mystic or mysterious cause instead of the plain and simple laws of nature, would question this or assert otherwise. Especially is this true when, as here, the motions are so many and so various, so complicated. No "line of force", "line of direction", "tension", or other mythical cause can account for the results shown in these experiments and especially for the production of *Magneto-graphs*.

The action of the electro-magnet, the permanent magnet, and the solenoid are exactly the same, their effects are the same, and are produced in the same manner, and they are governed by the same laws.

These currents do not *emerge* from either pole of the magnet. They enter at the poles and at the sides of the magnet. They emerge from the center of the magnet, to some extent at least, and if they do not cause a point of actual repulsion, they form a line of neutrality in the center of the magnetic field and from this neutral zone, as well as from other surrounding points, they move toward the sides and poles of the magnet. Beginning at this neutral zone they move in opposite directions.

Currents entering the poles of the magnet meet at the center, or near the center.

Currents, both *inside* and *outside* the magnet, while they move toward the center, are *spiral* and the *motion is continuous*, in the same direction, thruout the magnetic field. The motion of these spiral currents is such that, viewed from above, the rotation is counter-clockwise over the *North* pole and clock-wise over the *South* pole.

The action of the magnet is not due to *molecular arrangement*. Molecular arrangement could in no wise produce the spiral motion nor affect a photographic plate. If the action of the magnet were due to *molecular arrangement*, there would be no attraction at the sides of the magnet near the poles for the reason that, theoretically, the molecules in the body of the magnet neutralize each other and there would be no attraction. Moreover, when the iron core is removed the action continues, being only less in degree, due to the magnetic conductivity of the iron, and there are no molecules to arrange.

Next will be taken up the *nature* and *cause* of these currents, the "field of force" or the magnetic field about a *charged wire*, and the logical accounting for the formation of a magnet and the logical explanation of the several phenomena of magnetism. This will include *Magneto-graphs* produced by a *charged wire*.



U.S. PATENTS

PATENTS AND TRADE MARKS.

LANCASTER & ALLWINE

REGISTERED ATTORNEYS

War Inventions Wanted

History will repeat itself in the present War. The greatest victories will be won, not through overpowering numbers, but through the surprises wrought by invention. Life and property will be saved for the Nations by inventions. The Government is ready to experiment with and carefully consider any inventions which will aid in winning and ending the War. The *Special War Bulletin* just off the press will give you a good idea of what is needed. We will send it to you free of charge. Located in Washington, we are in close touch with the proper Government Officials who should be approached with inventions for use in War time, and we will advise you fully how the disclosure should be sent.

Our cooperation with an inventor is, **First**, to help him establish his rights before sending a sketch, drawing or model to any attorney; **Second**, to give a frank opinion whether it will pay to patent his idea, based upon our extensive knowledge of the patent laws, manufacturers' wants and facilities; **Third**, to obtain for him on reasonable terms, a patent that absolutely protects; and, **Fourth**, advise and assist him in making the invention a source of profit by outright sale, territorial grants, obtaining royalty, or the independent manufacture of the invention.

All matters are held strictly confidential, and personal services are assured by our *Service Guarantee Contract*. **References:** 2nd National Bank, Washington, D. C.; John P. Roth Packing Co., Cincinnati, Ohio; Home Savings Bank, Washington, D. C.; Duskill Mop Co., Paducah, Ken.

Before disclosing the invention to anyone, sign, witness and deposit in our fireproof safe, the form "Evidence of Conception" and establish your rights. A completed sample form in our book shows you clearly how to protect your invention. All are free. Just ask for them on a post card or simply mail coupon below.

Lancaster & Allwine
283 Ouray Bldg., Washington D. C.

FREE

EVIDENCE OF CONCEPTION
The All-World War Patent Coupon
By Home Savings Bank

INVENTIONS
PATENTING
and
PROMOTING

Illustration of an invention

BOOK & FORM EVERY INVENTOR SHOULD USE

COUPON

LANCASTER & ALLWINE,
283 Ouray Bldg., Washington, D. C.

Send me free book, "Inventions-Patenting and Promoting," *Special War Bulletin*, and blank form "Evidence of Conception."

Name

Address



You benefit by mentioning "The Electrical Experimenter" when writing to advertisers.

PATENT ADVICE

Edited by H. GERNSBACK

In this Department we publish such matter as is of interest to inventors and particularly to those who are in doubt as to certain Patent Phases. Regular inquiries address to "Patent Advice" cannot be answered by mail free of charge. Such inquiries are published here for the benefit of all readers. If the idea is thought to be of importance, we make it a rule not to divulge details, in order to protect the inventor as far as it is possible to do so.

Should advice be desired by mail a nominal charge of \$1.00 is made for each question. Sketches and descriptions must be clear and explicit. Only one side of sheet should be written on.

RADIOMETERS.

(172.) Harry Abrams of New York, N. Y., thinks he has a new means of producing electricity by means of ordinary sunlight. The idea is to use apparatus similar to the Crookes radiometer. By placing these Crookes devices in a certain electrical field, he has observed that electrical current can be generated. He wants to know if this idea is practical and also patentable.

A. We have strong doubts as to the practicability of an idea of this kind. It seems that the power that can be obtained from each one of these radiometers would be so infinitesimally small, that it really could not be termed *power*; but at best would only be faint impulses. We doubt if the idea has any commercial possibilities.

GYROSCOPIC AUTOMOBILE.

(173.) Frank C. Stanton of San Francisco, Cal., has submitted to us an elaborate illustration of a gyroscopic motor car, showing an automobile designed to run on two wheels, one behind the other. He wishes to know if he can obtain a patent on this device without litigation.

A. Brennan of England has experimented with a car of this kind, having it run over a small, thin cable. We doubt if you can obtain a patent that would be of any value to you, in view of the fact that not alone Brennan, but also other workers as well have worked along these same lines for quite some time past. Our correspondent also submits illustration for a field wireless set which can be carried complete by one man, and he wishes to know if the idea is feasible and practical.

Nothing new is shown in the illustration or description, and while the disposition does show several novel points, we doubt very much if the novelty is sufficient to warrant a patent.

Our correspondent wants to know if one has to be a subscriber to THE ELECTRICAL EXPERIMENTER in order to contribute to any of the various departments.

Anyone can contribute to any of the departments of THE ELECTRICAL EXPERIMENTER, and one need not be a subscriber in order to send any contributions or participate in any of the prize contests which we conduct from time to time.

AUTOMATIC STEP-LADDER.

(174.) Paul William Dorst of New Albany, Ind., submits to us an automatic step to be attached to hollow steel flag-poles, the idea being that the steps are folded back ordinarily, so that when climbing the pole one step after the other is released automatically as soon as one of the steps is depressed.

A. This is a capital idea, and we have not seen anything quite like it, and are certain that it can be patented. We also think that there should be a good field for a

device of this kind, particularly for steel flag-poles on tall buildings.

CONDENSER.

(175.) H. S. Moody of Edmonton, Alta., has an idea to make a small condenser in a certain manner by using certain dry mounting tissues, etc. Several other means are shown to hold metal foils which are secured by melting the tissue. He wishes to know if an idea of this kind is patentable.

A. Without making a thoro search in the patent office, we are unable to tell whether this idea is of sufficient originality to warrant patenting. We would advise to have a patent attorney make search with a view to ascertaining what has been done in the same field before. The idea seems quite clever.



PATENTS

Send Sketch or Model of Your Invention for Free Opinion as to Patentability

Our Certificate of Patentability is Evidence of Conception of your invention and may prove valuable to you. Our Credit System enables you to file your application for Patent and proceed without delay. Every case receives personal attention of one or both members of the firm.



Patents we secure advertised at our expense in Popular Mechanics Magazine

Write today for Free copy of 104-page book "How to Obtain a Patent and What to Invent"

Talbert & Parker, Patent Lawyers,
4287 Talbert Bldg., Washington, D.C.

PATENTS

Upon electrical appliances are in demand; manufacturers are writing for patents secured through me. your invention. Prompt personal service. Booklet and advice free.

J.R.KELLY 740 D. Woodward Bldg.
WASHINGTON, D. C.

PATENTS

THAT PROTECT AND PAY Books and Advice Free

If you want to sell your patent, take it out through my office. HIGHEST REFERENCES. BEST RESULTS.

WATSON E. COLEMAN, Patent Lawyer
624 F. Street, N. W. Washington, D. C.

PATENTS WANTED

TRADE-MARKS and COPYRIGHTS

Largest Patent Firm in the World



Before sending your invention to any attorney or manufacturer or disclosing your invention, write for our free blank form **PROOF OF CONCEPTION** in order to protect your invention and secure your rights. This should be signed and witnessed and returned to us, together with a model or sketch and description of your invention, and we will give a **FREE OPINION** as to the patentability of the invention. If we report the invention patentable we will furnish a Certificate of Patentability.

SPECIAL OFFER This Certificate of Patentability, together with our blank form Proof of Conception will protect the inventor and serve as proof of the invention until the case can be filed in the U. S. Patent office.

OBTAINING ASSISTANCE FOR INVENTORS—Our certificate is of great assistance to inventors who require financial aid to obtain patents

OUR FIVE BOOKS MAILED FREE

(See Coupon Below)

to any address. Send for these books—the finest publications ever issued for free distribution.

HOW TO OBTAIN A PATENT Our illustrated eighty page Guide Book is a Book of reference for inventors and contains 100 mechanical movements, illustrated and described. Tells how to invent for profit.

WHAT TO INVENT Contains a valuable list of inventions wanted and suggestions concerning profitable fields of inventions; also information regarding prizes offered for inventions amounting to **ONE MILLION DOLLARS**

LIST OF PATENT BUYERS Contains requests from manufacturers, mail order houses and promoters for patents secured by us and suggestions as to **New Ideas** they wish to purchase. We place our clients in touch with capital free of charge. We have recently received over 300 requests from manufacturers.

MILLIONS IN TRADE-MARKS

Shows the value of Trade-Marks and information regarding unfair competition

We advertise **Our Clients' Inventions Free** in a list of Sunday newspapers, in manufacturers' journals and in World's Progress. Sample Copy Free. We save you time and money in securing patents. After the patent is granted we assist you to sell your patent.

WANTED NEW IDEAS

FREE COUPON!

VICTOR J. EVANS & CO.

PATENT ATTORNEYS

New York Offices: 1001 to 1007 Woolworth Bldg. Pittsburgh Offices: 514 Empire Bldg. Philadelphia Offices: 1429 Chestnut St.

Main Offices: 779 Ninth Street, N.W., Washington, D. C.

Name..... Address.....



THE "RADIOTONE"

and What They Think of It

I was very much pleased with the neat and compact looks of the "RADIOTONE." I have not seen one buzzer that can beat it for twice or THREE TIMES THE PRICE. I use it for finding the sensitive part of the mineral in my crystal detector and for learning to receive messages when connected with one or more receivers, and a telegraph key to break the circuit. I also wish to say that I think that any one who invests 90c in a "RADIOTONE" will be better pleased with the results in the short as well as long run than any other buzzer that costs twice the price.

PRIVATE P. H. REMPEL, 4th Co., C. A. C., U. S. ARMY, Ft. Rosecrans, Calif.

I wish to say that your "RADIOTONE" Buzzer works better than I ever thought it would, and I don't think there is a BETTER BUZZER ON THE MARKET. It also gives a very classy appearance to any wireless outfit. It cannot be praised too highly.

PERRY CRAWFORD, 13 Ten Broeck St., Albany, N. Y.

I have given your "RADIOTONE" Buzzer a thro test and find it to give VERY GOOD SATISFACTION. Also that I am very much pleased with it and that it comes up to my expectations. I would recommend it to all learners as a very good Buzzer. In case I have any more orders I will extend them to you.

W. H. CRUDGINGTON, U. S. S. UTAH, Box E, care of P. M., N. Y.

I received my "RADIOTONE" Buzzer a few days ago, and have tried it out in a number of ways. It is exactly like you describe it, and one of the biggest advantages of it is that the sound is always EXACTLY WHERE YOU WANT IT, right in the receivers. It is by far the best buzzer I have seen on the market. It has also a very beautiful appearance, and has one of the clearest and highest pitched tones any buzzer that I have yet come across. Thanking you again for your wonderful buzzer, I am, Yours very truly,

HOWARD A. PAGE, 900 Harrison St., Lynchburg, Va.

Your "RADIOTONE" Buzzer certainly came up to all my expectations. Its tone is exactly like that heard in a regular wireless phone. It is not affected by high altitude nor damp weather. It is as beautiful an instrument as one could wish to see. IT IS SILENT. That is the most important of all in the work for which I use it. It produces a clearer and higher pitched tone on less current than a buzzer of any other make that I have tried. IT HAS NEVER STUCK nor FAILED TO RESPOND instantly to the application of current since I have had it. I wish you and the E. I. Co. every success and I will do everything in my power to help you as you are a PROMPT AND SQUARE DEALING COMPANY.

C. M. McBRINEY, Fort Layard, N. Mex.

I wish to say that your "RADIOTONE" Buzzer is the only test buzzer that I have seen in which I can find NO fault whatever. I received it in good condition and it is that way now. THOUGH I ACCIDENTALLY DROPPED IT SEVERAL FEET. I am using it on a code practicing set. It has the best tone of any buzzer that I have seen.

LESTER SHIPLEY, Care of J. O. Tate Electric Co., 118 Main St., Bedford, Va.

I have given the "RADIOTONE" Buzzer which I have received from the E. I. Co. a thro test and find it satisfactory in all respects. I also used other buzzers, but the "RADIOTONE" IS THE BEST THAT I HAVE EVER USED and BEYOND MY EXPECTATIONS. The other goods that I received are also satisfactory.

A. WITMER, Muir, Pa.

I am very pleased to say that I am satisfied with the results obtained from the "RADIOTONE" Buzzer. It gives a really WONDERFUL IMITATION OF A WIRELESS MESSAGE.

GEORGE DIMON, Lavallette, N. J.

ELECTRO IMPORTING CO.
231 Fulton Street New York City

FROM A RADIO EXPERT

The "RADIOTONE" Buzzer which the E. I. Co. sent me some time ago has been thoroly tested out in my Laboratory, and I am very pleased to give you my opinion concerning its performance.

The tone and frequency of the instrument is TRULY A MOST WONDERFUL and perfect reproduction of a MUSICAL WIRELESS NOTE and when used in connection with a wireless receiver it would be most difficult to distinguish its rich tone from that of a real wireless station with FIVE HUNDRED CYCLES in the primary circuit. One of the most commendable features that the buzzer possesses is that of being capable of standing up under continuous service WITHOUT THE ANNOYING "STICKING" effect that has been so characteristic of other buzzers that I have had occasion to test. In conclusion I can say that both in performance and appearance the "RADIOTONE" is truly a WONDERFUL LITTLE INSTRUMENT. RAYMOND FRANCIS YATES, 815 Niagara Ave., Niagara Falls, N. Y.

I have thoroly tested your "RADIOTONE" Buzzer, which I received a few days ago, and find that it is very efficient in all respects. It is all that you claim it to be. The tone is so soft that it cannot be heard unless the ear is placed a few inches from the instrument. This makes it very desirable for testing detectors. I THINK THAT THERE IS NOTHING BETTER FOR LEARNING THE CODE, since the signal sound just like a high power wireless station. Everyone who has a wireless station or who wishes to learn the code should have a "RADIOTONE." BENNIE GREENSTEIN, 827-11th Ave., N., Minneapolis, Minn.

I received your "RADIOTONE" on June 20th, and tested it thoroly, and found it has the BEST IMITATION OF WIRELESS SIGNALS. All Amateurs should purchase one of these "RADIOTONES" if possible, and do self-practice during the war. I hope all Amateurs, who purchase one of these "RADIOTONES" will find it as great a help to them as I have.

Yours truly, GEO. TANAKA, AMATEUR 6 ATQ, San Francisco, Cal.

After testing the "RADIOTONE" I am pleased to say that it is the best toned buzzer on the market. The main thing is that IT DOES NOT STICK as so many others do, even among the high priced buzzers, when practicing. I am using it with Omniograph transmitter, 2 M.F. Condenser, 75 Ohm phone and small resistance shunt across phone. With the aid of battery rheostat and shunt resistance, I CAN OBTAIN EXACTLY SAME PITCH AS N.A.A.

FRANK WARMINSKI, 806 S. Milton Ave., Baltimore, Md.

I am entirely satisfied with the "RADIOTONE" Buzzer which I bought from you. It works fine, being BETTER THAN I EXPECTED IT WOULD BE AT THE PRICE. At first I didn't think that it would be very good at the low price, but it is all right. It appeals to me mostly because of ITS QUICK RESPONSE to the opening and closing of the key.

JOHN B. MOORE, Delaware Co., Downsville.

I am pleased to say that after testing it out in a student's buzzer set, it comes up to my best expectations.

H. D. STRAUGHN, Ripley, Okla.

Am in possession of one of your "RADIOTONE" test buzzers and wish to say that I could not have expected a more silent instrument, as well as the EXACT TONE OF A HIGH POWERED WIRELESS STATION.

S. W. DEARING, R. 2, Covington, Tenn.

It gives me great pleasure to recommend your "RADIOTONE" test buzzer. I find it very sensitive and responsive, ALWAYS EMITTING THE SAME HIGH PITCHED NOTE. But the best feature of all is ITS SOUND-PROOF CASE.

C. A. W. McMURTRY, 94 Gladstone Ave., St. Thomas, Ont.

I wish to say that I have given your "RADIOTONE" Buzzer a thorough testing and find it stands up beautifully under the conditions. Connected to a 75 ohm phone and a No. 10010 Junior Fixed Condenser per diagram in your catalogue, it makes an ideal practise set, the note of which can HARDLY BE DISTINGUISHED FROM "ARLINGTON." The "RADIOTONE" has EXCEEDED MY EXPECTATIONS by far. E. A. ARMSTRONG, R. R. No. 1, Indian River, Ontario, Can.

I have used your "RADIOTONE" Buzzer, and find it THE BEST EVER USED. I find it very useful for a layman to learn the code quickly. I would recommend it to any one interested in wireless.

ANDREW SCHRINER, 1722 Putnam Ave., Brooklyn, N. Y.

I have had the opportunity of making practical tests with one of your "RADIOTONE" BUZZERS, and I feel justified in making the following statements concerning it:

1. It is handsome in appearance.
2. It is practically noiseless in operation.
3. It gives a clear note of CONSTANT FREQUENCY.
4. It is equal in performance to other buzzers selling AT SEVERAL TIMES ITS COST.

I have been perfectly satisfied with the "RADIOTONE" and I will be glad to recommend it to anyone.

E. K. SNYDER, 717 Lake Boulevard, St. Joseph, Mich.

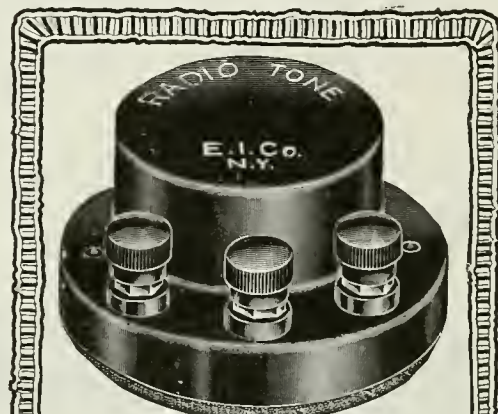

No. HK 1800

The "Electro" Radiotone

HIGH FREQUENCY SILENT TEST BUZZER

The RADIOTONE is NOT a mere test buzzer, it is infinitely more. Mr. H. Gernsback who designed this instrument labored incessantly to produce an instrument which would imitate the sound of a high power Wireless station as heard in a set of phones. This actually has been achieved in the RADIOTONE. This instrument gives a wonderful high pitched MUSICAL NOTE in the receivers, impossible to obtain with the ordinary test buzzer. The RADIOTONE is built along entirely new lines; it is NOT an ordinary buzzer, reconstructed in some manner. The RADIOTONE has a single fine steel reed vibrating at a remarkably high speed, adjusted to its most efficient frequency at the factory. Hard silver contacts are used to make the instrument last practically forever.

Yes, the RADIOTONE IS SILENT. In fact, it is so silent that you must place your ear on top of it to hear its beautiful musical note.

You will be astounded at the wonderfully clear, 500 cycle note, sounding sharply in your receivers, when operated on one dry cell. To learn the codes, there is absolutely nothing like it. With the radiotone, a key and one dry cell and ANY telephone, a fine learner's set is had. Two or more such sets in series will afford no end of pleasure for intercommunication work. Particularly now that we cannot use our Wireless sets, the Radiotone is already in wonderful demand. All the interesting things as described with our CODOPHONE (see our big ad on page 353, this issue), can be performed with the Radiotone, a key, a dry cell and a phone.

Radiotone as described.....each \$**.90**

Shipping Weight 1 lb. Don't forget postage. IMMEDIATE SHIPMENTS

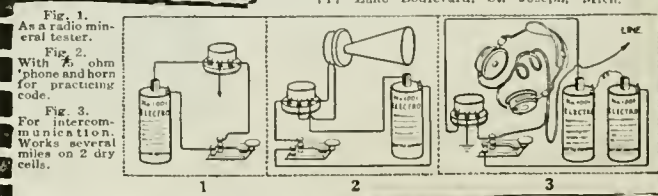

E. I. Co., 231 Fulton St., New York City, N. Y.

On your absolute guarantee that your "RADIOTONE" works exactly as described by you, I enclose herewith 90 cents plus _____ cents for postage for one instrument. You guarantee to refund this amount to me if I am not entirely pleased, providing I return the "RADIOTONE" within 3 days after its receipt. YES

I also enclose NO. 6 cents postage for your 200-page Electrical Cyclopeda, with 600 illustrations, and 500 instruments, etc.

Name _____

Address _____

City _____

NEW ELECTRO-THERAPEUTIC APPARATUS.

(Continued from page 373)

Sinusoidal Machines

One of the most radical new develop-

shape, one moving within the other, this being done by a set of cams, the shape of the cam regulating the type of wave which will be sent into the patient's circuit, and a separate rheostat controls the strength of this current.

Light Therapy

For the treatment of skin diseases a quartz mercury arc lamp was shown which gave off very powerful radiations, the radiations being so intense that the darkest kind of tinted glasses were loaned to the observer before he was allowed to look at the light. From a lamp of this kind a typical case of *sunburn* could be produced in a few minutes time. (See Fig. 4.)

Miscellaneous

A valuable Anesthetizing Outfit was shown (see Fig. 5), operated by a small electric motor of special design for use in operations of the month and head.

An interesting Recording Instrument was shown for obtaining the temperature within the stomach known as *intra-gastric temperature*, valuable in checking up the gastric response to stimulus, showing the action of different foods, both hot and cold, practically in degrees upon the scale of the instrument.

For the man with a microscope there were several new devices, such as a special light for illuminating the stage of a microscope, and one exhibit showed an electrically heated warm stage for the microscope for use in examining different bacteria and micro-organisms which only remain alive in warm temperatures (blood heat).

An Electric Incubator for use in connection with a microscope was exhibited, which can also be used in connection with the development of special animal organisms and bacteria so that they can be cultivated directly under the microscope.

THE EFFECT OF ULTRA-VIOLET RAYS ON MILK AND OTHER ASPECTS.

(Continued from page 383)

it for the protection of their soldiers and horses campaigning at this time in the colonies of Toncken, Asia, and as it had protected the head against the violent action of the ultra violet rays it was quite successful.

At this time England also tried this protection against the ultra violet rays and as an experiment, an under officer of the English army was completely clothed in garments which had been previously treated to withstand the ultra violet rays. It was found that he was able to stay in the sun of midsummer for hours, without feeling any disturbance or inconvenience in any way. Upon this and other experiments the English Government adopted this method for the protection of their Indian troops against the ravages of tropical sunlight.

INCREASE WIRELESS GUARD AT SAYVILLE.

Fifteen United States Marines have been added to the detail which has been guarding the wireless station at Sayville. There are now sixty-five men from the Marine Corps at the station and it is said that about twenty-five more will arrive shortly to augment the force. Ensign W. R. Smith, U. S. N. R., is in command.

The entire acreage belonging to the Atlantic Communication Company, which is in charge of the plant, is being cleaned up. Much of its area was wooded and afforded cover.

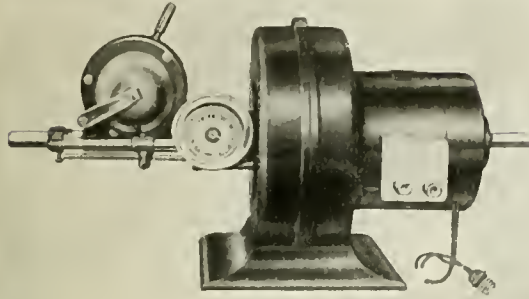
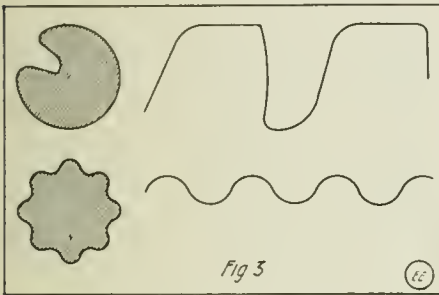
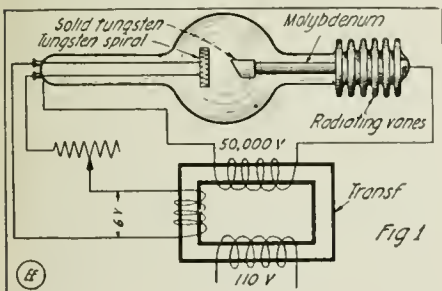

Fig. 3. The Latest Pattern Sinusoidal Generator Which Yields Currents of Any Desired Wave Form. Special Cams as Shown Below, Control This Factor and Can be Interchanged Instantly.



ments in electrical therapeutics was shown in the form of a Morse Sinusoidal Wave Generator. The machine delivers a current of 21,000 alternations or 42,000 impulses per minute and is designed on what is known as the Kennelly design, the principle being a circular layer of spools composed of two separate coils, an inner one with eight layers of fine wire, and an outer one of two layers of coarse wire, the inner coil being connected in a series and constituting a *secondary* coil, while the outer coil, also connected in a series, forms the *primary* coil of the apparatus. A direct current is supplied to the primary coil and to the armature, which is composed of laminated iron. When the armature is made to revolve the primary coils, having a current circulating thru them, magnetizes the field magnets. The magnetic lines of force thus produced remain stationary in the field as long as the armature is stationary, but as soon as the armature rotates the lines of force shift from one side of the magnetic field to the other and cut the current in the wires of the secondary coil, first one side and then the



New Form of X-Ray Tube Which Rectifies Its Own Current, on the Principle of the Hot Cathode. Air Cooling Vanes Are Placed on the Anode.

other, which produces a Sinusoidal current in the secondary coil.

In the apparatus shown, Fig. 3, the primary coil and secondary coil are conical in

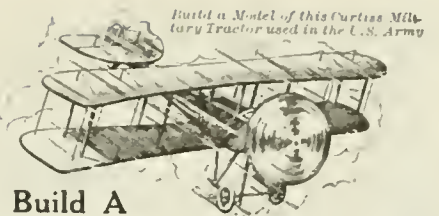

Build A Model War Aeroplane!

It's easy! With "IDEAL" Accurate Scale Drawings and Instructions you can build a 3-foot Model Aeroplane that looks like a real one and that will rise from the ground by its own power and fly 50 to 100 feet. It's a great summer sport, and you can learn a lot about Aeroplanes and how they fly. Send for the Drawings and Instructions for the one you want to build.

- | | | |
|--------------------------|------------|---------------------|
| Curtiss Military Tractor | 25c | Wright Biplane |
| Bleriot Monoplane | | Curtiss Hydroplane |
| Nieuport Monoplane | | Curtiss Flying Boat |
| Taube Monoplane | | Cecil Peoli Racer |

"IDEAL" Aeroplane Construction Outfits, containing all parts and material needed to build these Aeroplanes, are sold by Leading Toy, Sporting Goods and Department Stores. Ask your dealer for "IDEAL" Aeroplane Construction Outfits.

Send 5c For This Catalogue

Tells about Model Aeroplanes and what you need to build them with. 48 pages of useful information—send 5 cents for it right away.

IDEAL AEROPLANE & SUPPLY CO.,
76-82 West Broadway, New York



Driver Agents Wanted

Drive and demonstrate the Bush Car. Pay for it out of your commissions on sales. My agents are making money. Shipments are prompt.



Five-Pass., 34.7 H. P. 32x3 1/2 tires Bush Cars guaranteed or money back. 1918 models ready. Write at once for my deluxe catalog and all particulars. Address J. H. Bush, Pres. Dept. 1041

115-In Wheelbase Delco Ignition—Elect. Siz. & Lts. BUSH MOTOR COMPANY, Bush Temple, Chicago, Illinois

TOOLS For shop, factory, garage and home

—many high class tools attractively priced in our *Odds and Ends* pamphlet which is mailed free on request by

Montgomery & Co., Inc., 105 Fulton St., N. Y. City

Feldman "Geyser" Electric Water Heater

Instantaneous Hot Water

FELDMAN MFG. CO.

1514 Times Bldg. New York City

Edison Says:

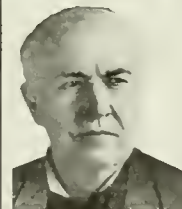

"I have watched the progress of the International Correspondence Schools almost from the beginning. To me their rapid growth is easily understood because I realize the practical value that is back of it and know something, too, of the success attained by many ambitious men who have taken I. C. S. courses."

Edison knows what stuff men are made of who use their spare hours to train themselves for the bigger jobs ahead. And he knows what the International Correspondence Schools will do for the man with the grit to say, "I will."

All men who have made their mark in the world improved their spare time. Didn't Edison himself stay up half the night to read every get-at-able book on electricity? You, too, can possess power, money and happiness if you'll only make the start. With I. C. S. help the way is easy.

Put it up to us, without paying or promising—just mark and mail the coupon and find out.

TEAR OUT HERE

INTERNATIONAL CORRESPONDENCE SCHOOLS, Box 5358, Scranton, Pa.

Explain fully about your Course in the subject marked X:

<input type="checkbox"/> Electrical Engineering	<input type="checkbox"/> ADVERTISING	<input type="checkbox"/> CHEMISTRY
<input type="checkbox"/> Mechanical Engineering	<input type="checkbox"/> Salesmanship	<input type="checkbox"/> Illustrating
<input type="checkbox"/> Mechanical Drafting	<input type="checkbox"/> Commercial Law	<input type="checkbox"/> Farming
<input type="checkbox"/> Civil Engineering	<input type="checkbox"/> Bookkeeping	<input type="checkbox"/> Poultry
<input type="checkbox"/> Structural Engineering	<input type="checkbox"/> Stenography	<input type="checkbox"/> French
<input type="checkbox"/> Architecture	<input type="checkbox"/> Civil Service	<input type="checkbox"/> German
<input type="checkbox"/> Architectural Drafting	<input type="checkbox"/> Rr. Mail Service	<input type="checkbox"/> Italian
	<input type="checkbox"/> AUTOMOBILES	<input type="checkbox"/> SPANISH

Name _____
Address _____

DEPENDABLE KNAPP MOTOR
ELECTRIC SPECIALTIES

Dynamo Motor

For Boys \$6.25

For producing current for inductance coils, re-charging storage batteries, electroplating and hundreds of other uses. Well constructed throughout, exceptionally smooth running and highly efficient. A good, strong, durable dynamo.

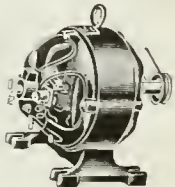

AT ALL LIVE DEALERS
Insist on your dealer showing you the KNAPP line—KNAPP goods are best. If your dealer cannot supply you, order direct. Send for FREE illustrated catalogue showing a complete line of Electrical Motors and Novelties ranging in price from 10c up.

KNAPP, ELECTRIC & NOVELTY CO.
523 West 51st Street, N. Y. City

WOULD THE LAW LET YOU MARRY?

Some States have been wise enough to insist upon a medical examination of the two contracting parties to a marriage before a license is issued. Through the adoption of a law whereby the physically unfit were barred from marriage in every State in the Union, there would indeed be a relatively small percentage of the population that would measure up to the standard.

WOULD YOU BE ONE OF THOSE doomed to go through life alone, without the joys that go hand in hand with a loving wife and healthy children? Our first duty is to posterity. We are not put here by an all-wise Providence merely to live out our lives, and then go out like a snuffed candle. We are entrusted with the sacred duty of perpetuating the race.

LIKE BEGETS LIKE: A man who is torn and racked by physical ailments and excesses of all kinds will some day see these traits in his children. On the other hand the strong, virile man, who jealously safeguards his body and his health, will some day revel in the sight of offspring that are a picture of joyous, bubbling health.

YOU OWE IT MOST TO THAT GIRL The sweetest, purest, dearest girl in the whole world whom you would call wife. Is your body clean? Do you realize the terrible consequences of the follies that are wrecking your body? Remember then that **STRONG-FORTISM** will restore to you the vitality of **MANHOOD**.

I have prepared a little book, "Intelligence in Physical and Health Culture," which should be read by everyone sufficiently interested in themselves to wish for the best in life. It points the way to better health, a cleaner, happier life, and a splendid physique. Three 2-cent stamps will pay for mailing the book. Send for it **NOW**.

LIONEL STRONGFORT, Master of Physical Culture
276 Park Building Newark, N. J.

\$2.50 a Month

The masterpiece of watch manufacture—adjusted to the second, positions, temperature and isochronism. Encased at factory into your choice of the exquisite new watch cases.

21 Jewel Burlington

All sizes for both men and women. The great Burlington Watch sent on simple request. Pay at rate of \$2.50 a month. You get the watch at the same price even the wholesale jeweler must pay.

Write Today for Free Watch Book
See handsome color illustrations of all the newest designs in watches that you have to choose from. Your name and address on a postcard is enough. Get this offer while it lasts. Write today.

Burlington Watch Co. Dept. 7447 19th & Marshall Blvd. Chicago

35 MILES PER HOUR

Is Record Of This Car

Built by a boy from Junior parts furnished by us. Any boy can build this car. Parts very cheap. Send 26 cents for blue prints and price list of parts showing how to build this speedy little car.



SYMPHER MFG. CO.
154 Warren Street
TOLEDO, OHIO

RADIO TO HURL MINES AT U-BOATS.

After working for many months to perfect a new type of mine, electrically controlled by means of a powerful wireless apparatus located at a distance from the mine itself, a device which would enable one submarine to destroy another, it was learned recently that Dr. J. B. Whitehead, of the Johns Hopkins University, had brought his labors to a successful termination.

While Doctor Whitehead refuses to comment on this new invention, it is learned that by means of a powerful electric battery the new style of mine can be directed upon whatever course its operator may desire and can be exploded by simply pressing a button, the wireless waves being employed both in directing it and in its explosion.

The advantage that such a mine will have over the ordinary torpedo used by the submarine is the impossibility of failure to either miss the target or its non-explosion after the target is struck. By this method Doctor Whitehead has solved the problem of destroying submarines by submarines. In connection with this is a report that an instrument has been perfected to locate positions and distances of the submarine to be attacked.

FREE ELECTRICITY FROM THE WIND.

(Continued from page 372)

The invention of this new slow speed design at once eliminates the gear troubles which all others who have attempted to utilize wind-power to drive dynamos have had to employ. It also makes it possible to effect, by magnetic leakage in the machine itself, its own regulation, and eliminating the use of auxiliary apparatus.

A boy sixteen years old can turn a crank fitted on to the wind-motor axle, when the machine is on the ground, and generate sufficient current to magnetize the dynamo fields and to light to full brilliancy three 16-candle-power lights for a period of twenty minutes at a time.

The axles, differential gearing and bearings are contained in a hollow steel housing, the same as a motor car rear axle, and this housing is pumped full of gear grease. Several machines are on record that have not been re-greased for two years at a time.

The drawing shows that the automatic cut-out and cut-in for the battery is a mechanical ball governor, but this cut-out has been substituted by an electro-magnetic cut-out and cut-in. The electro-magnetic cut-out simplified the plant and is located on the switch-board. With an average wind pressure of ten miles per hour for ten hours per day the larger plant has in practise charged a 25 volt battery with 90 A.H. per days, and has maintained a daily discharge for 8 months of 75 A.H. per day.

A BARGAIN ORDER NOW



\$3 Cash with order buys this **BENCH LATHE**

Swing 3 in. 8 in. C. to C. Shipping Wt. 10 Lbs.
Peter Austin 910 W. First. F. E. Muncie Ltd.

DUCK'S

BIG 300pp. ELECTRICAL AND WIRELESS CATALOG

Mailed upon receipt of 8c in stamps or coin which may be deducted on first dollar purchase. Catalog contains 160 pages of wireless instruments and 140 pages of electrical supplies. No bigger or better values are obtainable elsewhere. We have a complete stock of everything listed in this catalog. Wireless orders promptly filled.

THE WILLIAM B. DUCK CO.
230-232 Superior St. Toledo, Ohio

NEW DISTANCES IN RADIO TELEGRAPHY.

The Marconi station at Bandoeng, East Indies, has succeeded in establishing communication with America, Madrid and Berlin, according to *The Batavia Nieuwsblad*. Presumably this refers only to the reception of messages sent out from those parts of the world. Experiments are being made at Bandoeng with a view to the ultimate establishment of regular wireless communication with the mother country, Holland, and a 300 horsepower motor has enabled the operators to secure the promising result recorded.

"BURNELL R. FORD—SCIENTIST—ELECTRICAL WIZARD."

(Continued from page 371)

ing trick of the electrical conjurer known as "The Human Dynamo." The lecturer's assistant lights a candle from a stream of water. The experiment is easily performed by taking the high-frequency current up thru the legs. A piece of wire here and there often helps out the lecturer and prevents him from getting unpleasant shocks. If the current is of sufficiently high frequency no trouble will be experienced in passing it right thru the body. But—don't try letting the current jump to or from the skin or you will rapidly lose your *sang froid*. Arrange matters so that the current jumps to or from a piece of metal in some way. And your conscience need not trouble you, either, for the audience is not being humbugged. The current actually does pass thru your body, just the same. It's simply a case of knowing how to handle the current.

The three lower illustrations are of Mr. Ford in a few more of his electrical rôles. At the left he lights fire balls by high-frequency current past thru his body. (The lecturer stands on a metal plate covered with a rug, the plate being connected to a high-frequency coil. A metal insole should be worn, making contact with a spiked nail in the heel of the shoe, which thus ensures a good large area contact between the charged plate and the lecturer's body.) The center photo shows the lecturer actually lighting up a bank of lamps thru his body. This experiment always attract undivided attention from any audience, large or small. It really is a remarkable demonstration, involving in many cases the transmission of possibly 500,000 volts and several amperes of current thru the body; and 1/10 of an ampere of low-frequency alternating current past thru the heart is said to invariably prove fatal. In the final photo at the right we see Mr. Ford bidding us good-night, and like all good souls, he lights his candle and prepares to retire. But he lights the candle by a spark shooting forth from his tongue. And just to make it interesting we are going to let our electrically inclined reader find out for himself how this trick is done.

CHEMICAL ACTION OF STORAGE BATTERIES.

(Continued from page 401)

explained with the help of the osmotic theory by Le Blanc. The difficulty in applying this theory to the lead storage battery is to know what are the ions in the case of the lead peroxid plate. According to Le Blanc's theory, the lead peroxid, having a definite, though slight solubility, dissolves in the dilute sulfuric acid and then reacts with water according to the following equation:—

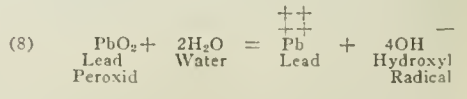

During the discharge the tetravalent lead ions give up two charges of electricity and combine with the SO₄ ions to form lead sulfate. The tetravalent lead ions are replaced, as they are used up, by the solution of more lead peroxid. There is no loss in free energy in this solution and reactions with water, for both of these reactions take place at equilibrium concentrations. The spongy lead electrode is similar to the zinc in a Daniell's cell. It goes in solution as a lead ion, but is precipitated on the lead plate because of the low solubility of lead sulfate. The hydrogen ions of the sulfuric acid combine with the hydroxyl ions of the equation last given, to form water. The equation representing the reactions that take place subsequent to the reaction of the last equation given, for the entire battery are accordingly:—

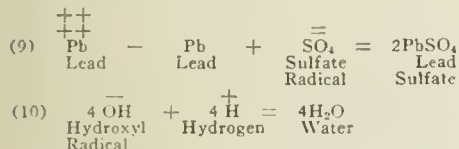

On the charge the reverse of the above reactions take place. Both the positive and negative plates are covered with lead sulfate, and the sulfuric acid surrounding the plates must also be saturated with lead sulfate. On the negative plate the lead ions are deposited as spongy lead, and on the positive plate the bivalent lead ions are oxidized to tetravalent lead. The solution and electrolysis are represented by the equations:—

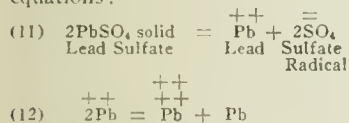

The tetravalent ions then react with the

hydroxyl ions according to the following equation:—

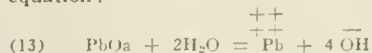

taken in the reverse direction:—

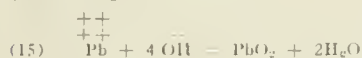
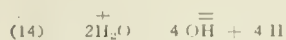

The hydrogen ions corresponding to the hydroxyl ions and the sulfate ions from equation 11, unite to form sulfuric acid:—

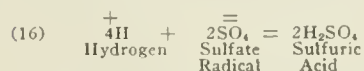

The sum of equations 8, 9 and 10, and of the equations 11, to 16 will be found to result in equation 7. In support of Le Blanc's theory it may be stated that tetravalent lead ions do exist, and they are therefore probably capable of forming by the electrolysis of lead sulfate solutions. Liebenow's theory differs from Le Blanc's

Interested in Science?

Then you will find all of the latest and famous wonders and stunts fully illustrated in *Edelman's 256 pp. book "EXPERIMENTS," \$1.50 Ppd.* A wealth of information that you want and cannot find elsewhere, such as "Ultra-violet Rays," "High Frequency," "Mechanics," "Wireless Exploded Mines," and "Arc Welding"; also "How to Establish Your Laboratory and Make Successful Experiments"; only \$1.50.

Watching Wireless Progress?

Then now is the golden time to get a copy of *Edelman's 272 pp. book "EXPERIMENTAL WIRELESS STATIONS," (1917).* You do not need a set in operation because this plain English book shows you all about tuning, wavelengths, resonance, audion oscillators, etc., so you understand. All modern equipment is given together with new material on wireless telephony, amplifiers, experiments requiring no aerial, and a list of U. S. Radio Patents, \$1.50 Ppd.

Experimenter's Library \$2.85

Both of above books handsomely bound in Gold-Stamped covers, 628 pages, formerly \$3.50, this month only \$2.85 Ppd. *Edelman* books are absolutely guaranteed. You are sure to be satisfied.

Order Now, **P. EDELMAN, Publisher**
1602 Hague Ave., St. Paul, Minn.



Give Your Boys and Girls the knowledge of sex from you could they but know the dangers which confront them.

Before they obtain wrong and incomplete impressions from sources outside the home, give them the proper viewpoint by placing in their hands

The Mysteries of Life Series

Four widely commended volumes by **ISABELLE THOMPSON SMART, M.D.**

They tell with proper delicacy and restraint, yet simply and plainly, the story of the mystery of life; and impart with powerful subtlety an abhorrence of all that tends toward even the slightest lowering of the highest sex ideals.

Warmly recommended by Judge Ben B. Lindsey of Denver; Edward Bok, of the Ladies' Home Journal; Rev. C. H. Parkhurst, New York; Rev. Francis E. Small 12mo. Cloth. Price 75c per volume. All Four for \$2.50.

EXPERIMENTER PUB. CO. Book Dept. 933 Fulton St., N. Y. C.

RADIO TELEPHONES FOR LOAD DISPATCHING

While the government will not permit the use of wireless telegraph and telephone equipment at present except under its supervision, the Public Service Company of Northern Illinois is investigating the practicability of using radio-telephones for load dispatching so that some development can be made along this line when conditions will permit. Two radio-telephone sets suitable for communication between sections 150 miles apart have been purchased and are being tested with the co-operation of the United States Navy Department. If the units prove satisfactory on test, and the indications are that they will, one unit will probably be installed in the system operator's office, which is in the new Lohiet (Ill.) generating station, and the other will be placed in the company's generating station at Blue Island, Ill. It will be possible to use the instruments in these locations to facilitate load dispatching in emergencies that may be occasioned by failure of the company's private metallic-circuit line. If the units prove practicable in these locations, their use will probably be extended to other important switching centers. The use of the radio-telephone rather than the wireless telegraph was favored by the engineering department of the Public Service Company of Northern Illinois because the instrument can be used without a knowledge of the Continental Morse code and because it is possible to transmit messages with greater speed by telephone than by telegraph.

CLIPPING 8,950,368,000,000 HAIRS ON HORSE IN 17 MINUTES BY ELECTRICITY.

Talking about horse hairs, about how

many hairs do you figure our equine friend possesses? Well, there is said to be 32,458,000 horses in the U. S. A., and also that each horse has an average of 8,950,368,000 hairs. Therefore the number of hairs on these horses totals up to 290,421,544,544,000,000,000.

All of which brings us to the problem of clipping these 32 million odd horses. The electric way has proven to be the best and quickest one, the time required for clipping a full-grown horse averaging 17 minutes 3 1/2 seconds.

In the clipping machine pictured, the motor is a vertical type, 1/4 H. P., equipt with ball thrust bearings. The flexible shafting is the hardened steel unit type, 8 feet long, encased in a servicable and neat cover. It is noiseless and the clipping heads are interchangeable. Can be attached to electric light socket. The advantages of a vertical type motor over the old portable motor are manifold—viz.: Out of the way of the operator. No moving of motor. Greater compass in working. Takes up considerably less space, and when thru can be hung up out of the way. Of course the machine can clip other hair besides horse hair. Our illustration shows what the Wall street broker would term "shearing the lamb."

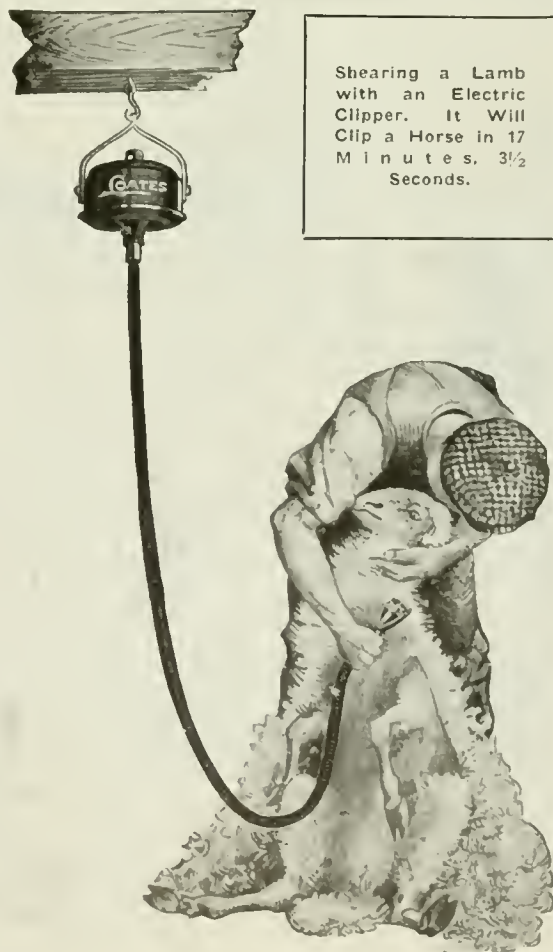

Shearing a Lamb with an Electric Clipper. It Will Clip a Horse in 17 Minutes. 3 1/2 Seconds.

War Conditions Demand ELECTRICAL

men with training. Prepare for service in military or industrial life. Of 193 students in class of 1917, about one-third are already in the Engineer Corps and two-thirds are speeding production in electrical industries. Having trained over 2000 young men in the past 24 years in the fundamentals of Applied Electricity, The Bliss Electrical School, with its well-equipped shops and laboratories, is peculiarly qualified to give a condensed course in Electrical

ENGINEERING



including Mathematics, Steam and Gas Engines, Mechanical Drawing, Shop Work and Theoretical and Practical Electricity, in all branches. Students actually construct dynamos, install machinery and test efficiency of electrical wiring. Course, with diploma, complete

IN ONE YEAR

For practical young men with limited time. 26th year course Sept. 26th. Catalogue on request. 260 Takoma Avenue, Washington, D. C.



Big Powerful MAGNET

Made of finest tungsten magnet steel, absolutely permanent. Length 5 inches. Lifts about 3 pounds. Educational, useful and enables you to perform endless tests, experiments and make other magnets. Nothing better made. Sent parcel post \$1.00 each.

We also have a number of Holtz-Cabot Hand Generators which we will dispose of at bargain prices. Give up to about 100 volts, alternating current. You can make direct if desired. Strictly high grade, fully up to H-C standards. While they last, \$3.00 each.

Watson Electric Co.
122 S. Michigan Ave., Chicago



EVERY INVENTOR

should have this book, "PATENTS AND PATENT POSSIBILITIES." It is chock-full of ideas and practical advice, telling what to invent and where to sell. Write for your copy today. IT IS FREE. I have requests for patents upon sound inventions of all kinds. Can you help supply the demand? My service is individual, prompt and efficient (14 years experience). Every expedient is employed to secure patents at least possible cost. H. S. HILL, 804 McLachlan Bldg., Washington, D. C.



THE MIDGET SLIDE RULE

will add, subtract, multiply, divide, solve problems involving even and uneven roots and powers. It will also give the Logarithms of numbers and the Sines, Cosines, Tangents and Cotangents of all angles. Its operation is very simple and with this instrument one can quickly solve any mathematical problem. This slide rule is made of wood and metal and it is adapted for shop work as well as office use. Size 3 1/4 x 3 1/4 in. Price, with Instructions, 75c. Your money back if you are not satisfied. GILSON SLIDE RULE CO., Niles, Mich.



SMALL ENGINES

Perfected Gasoline Engines—1/2, 1 and 1 1/2 h.p.—for Farm and Shop use. Price \$19.50 and up. Also

WASHING MACHINES

We ship on trial. Send for Booklet and Special Offer Steverkrupp Engine Co., 1401 19th Street Racine, Wis. Starter for Ford Cars



Convert Your Bicycle Into a Motorcycle

Motor fits any wheel. Best, most reliable. Best hill climber. More STEFFEVS in use than all others. A fine motor for running small Dynamos. Lathes and small shops. Motors only as low as \$16.95

Steffey Mfg. Co., 5025 W. Brown St., Phila., Pa.



MOTORCYCLES

and BICYCLES at cut prices. Singles and twins \$25 to \$100. New Motorcycle Tires \$3. Automobile Tires \$3. Best Motorcycle Belts \$5. Carburetors \$6. Spark caps \$6. Second-hand Bicycles \$5. Tandems \$15. New Bicycles at Factory Prices.

Penlger, The Price Cutter, Rochester, New York

Learn Watchwork, Jewelrywork and Engraving.

A fine trade commanding a good salary, and your services are always in demand. Address HOROLOGICAL Department, Bradley Institute, Peoria, Ill., for our latest catalog

only as to the action of the peroxid electrode. According to this theory the lead peroxid goes into solution as doubly charged lead peroxid ions, so that the peroxid plate is to be considered a reversible electrode with respect to the peroxid ions. On discharge, the peroxid passes into the solution surrounding the peroxid plate, which is already saturated with respect to these ions. They then react with the hydrogen ions of the acid as follows:

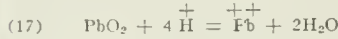

The lead ions then combine with the sulfate ions to form solid lead sulfate:—

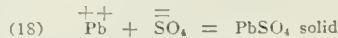

During charge, just the reverse reactions take place. The lead peroxide ions are deposited on the positive plate, and are replaced as they are used up by the solution of the sulfate from the electrode and its hydrolysis:



The work obtainable from a storage battery depends on its capacity and the electromotive-force measured at its poles while the current is flowing. If V is the voltage on charging, E is the open circuit electromotive force, I is the charging current, and R is the resistance of the battery, then

$$(20) V = E + IR \text{ and on discharge,}$$

$$(21) V^1 = E - IR$$

(To be concluded)

EXPERIMENTAL PHYSICS.

(Continued from page 386)

perpendicular to the mirror and E₃C prolonged; the image of B will be found on the straight line E₃B, prolonged perpendicular to the mirror and along the line E₃D. These lines may be marked on the paper after sighting along a ruler or other straight-edge. If now these lines are prolonged after removing the mirror, the intersection of AF and E₃C will be the point A¹ the image of A, and the intersection of BC and E₃D the point B¹ the image of B. Light from A going along the direction AF is reflected back and appears to come from A¹. Light from A going in the direction AC is reflected along CE₃ making the angle of incidence equal to the angle of reflection.

In a similar manner light from B appears to come from B¹ and light from each of the points in between A and B appears to come from definite points in between A¹ and B¹ thus forming the complete image of AB. If the distances AF and A¹F are measured, they will be found equal. The same holds true for BC and B¹C and for any other set of corresponding points. In short, we have learned that EACH POINT OF AN IMAGE IN A PLANE MIRROR IS AS FAR BEHIND THE MIRROR AS THE CORRESPONDING POINT OF THE OBJECT IS IN FRONT OF THE MIRROR.

The question is often asked, "If a person runs toward a mirror, how fast does he approach his image?" The answer of course is, he approaches twice as fast as he is running. The image is just as far behind as the person is in front and hence if the person approaches a certain distance, the image approaches an equal distance, or the image and person are nearer by twice the distance that the person approached. It can be shown that a mirror must be at least half as tall as a person in order that the person may see his whole image. This is left as an exercise to the reader to try, and the author will gladly look over any solutions that may be sent to him.

EXPERIMENT 48. A very simple experiment can be performed which will illustrate the manner in which many of the

magician's tricks are performed. Let M represent an ordinary milk bottle filled with water, GG a piece of smooth polished glass (the window after the pane has been well cleaned will do), C is a candle, and AB a board or other opaque object to screen the lighted candle. When the eye is at E, the observer cannot see the candle C, because it is screened by AB. Light from the candle however on striking the points P to Q is reflected according to our previously discussed law, and appears to come from inside the bottle. Hence we see the image of the candle itself we are mystified to find that a candle may burn in water. Obviously, with large pieces of plate glass and by use of trap doors and strong light a person under the stage may be made to appear on the stage. When the magician shoots his gun at the image or ghost it disappears (lights were turned off underneath the stage). Also men may walk thru other men, men and women may change places in cages, heads without the rest of the human body may be made to appear, etc., etc.

EXPERIMENT 49. A piece of apparatus can be easily made as in Fig. 39-A, the working of which depends solely on the law of reflection, but which seems complicated to the person ignorant of Physics. M and M¹ are small mirrors or pieces of mirror placed at angles of 45 degrees in their respective corners. Mirrors M¹ should each have a hole bored thru them or else be cut and have openings near their centers. If now an object is placed at B and the hand or a brick or other screen at A, the object will be seen by the eye at E, since light from the object B is reflected by mirror M¹ to M₁ and from M₁ to M₂ and thence from M₂ to M¹ and from M¹ to the eye. If now the screen be removed from A and an opaque object placed in the tube at S, the light from B will pass thru the holes in the M¹ mirrors and to the eye at E so that the object will be seen in either case. Care must be taken not to have screens in place at A and S at the same time for then there is no path thru which the light may pass from B to E.

This same principle of reflection is made use of in the modern submarine boat. A long tube AB (see Fig. 39-B) with joints CA and BD extending in opposite directions. Small mirrors are placed at A and B, making angles of 45 degrees. Light from a distant ship is reflected by mirror A to mirror B and the image is seen.

EXPERIMENT 50. When light passes from air to water or some other liquid it is bent. This phenomenon is called refraction. This refraction can be shown to be due to the retarding of the speed of light when passing thru a medium more dense than air. If a spoon or a pencil is placed in a tumbler partly filled with water (see Fig. 40-A), it will appear bent. Place a coin in a bowl and step back from it until you just miss seeing the coin. If water is poured into the bowl carefully by someone without disturbing the coin and you stay in your original position you will find that you suddenly see the coin. The explanation is refraction. While the coin is at A before the water is in the bowl, the observer will see it if his eye is along the line ABD and hence if the eye is at E the coin will not be seen. However when water is poured into the bowl, light from A is bent along the broken line ABE and the coin is seen and appears to be at C, since the eye is accustomed to consider light to reach it thru a straight line path.

At this point it may be well to consider briefly what the present theory of light is, or rather to give the reader a start so that he may later read up intelligently on the subject. Like sound, light is considered to be a wave motion. The theory was first formulated by Huygens, the great Dutch

Physicist, in 1629-1695. The theory met with opposition on two grounds and even the great Newton died without accepting the theory which is universally accepted today. First, light travels thru vacua, and the better the vacuum the greater the speed, whereas sound does not travel thru vacua at all. Hence, if light is really a wave motion it is thought to be a motion of some medium which fills all space, but does not retard the motion of the stars and planets. [Good serials stop at tense moments like this, so we will stop here and say "continued in our next issue."]

MAKING AN ELECTRIC CLOCK.

(Continued from page 396)

When you have your arbors all done and wheels mounted, the hardest job is locating the bearing-holes in your plates, so that your gears will run neither too tight nor too loose. I made an adjustable frame (Fig. 9), in which the wheels could be set; and when they were running just right, I scratched the distance on the plates with the sharpened ends of the arbors. Screw the two plates flat together, and drill them both at the same time. These holes have to be center-punched and drilled with all the care you've got in your system, as a wonderfully small error will make your gears work as hard as getting Johnny home at supper-time.

That's all. Look like a good deal of work? Well, perhaps it is. It's a great pity you can't buy these wheel-works ready made. A movement like Fig. 6 (just the plates and wheels, I mean, without the escapement) would be very simple and cheap for a clock-manufacturer to produce. Maybe, if there was enough call for 'em, the supply houses advertising in the "E. E." would have some made up. Why don't you send the "Ed." a postal saying you are interested? and if enough postals came in, perhaps the Co.'s will get excited and think they see some business. The wheel-work is mainly a nuisance; and with that off his mind, a long-suffering "Bug" would be

free to put his main effort into the pendulum and other mechanisms. There are several principles, such as torsion and scale-spring oscillation, working more or less in time-keeping intervals, that you want to try, but you don't feel like going to the trouble of making up wheel-work for each one.

I want to say right here, that in this clock game it's "no fairs" designing a mechanism to run on an electric-light current. The first rule is, it must run on one dry-cell, and the end to aim at is having the cell dry up on you before the clock takes all its electrical output. You'll find that's hitching your wagon to a star-wheel.

Oh, just to round out the article—as to clock hands—you can make them, of course, but they're very cheap and it doesn't pay to try. The dial you can make all right. Make it of zinc—wood is too apt to warp and stop your hands. Wrinkle: Put a coat of shellac on your zinc before you paint it, otherwise your paint will peel off when very dry. Lay out your figures and circles on paper first, and transfer them to the painted surface with carbon paper. If, like me, you haven't an artistic hand, you can put in the figures with India ink and a ruling pen. You can buy excellent engraved paper dials up to 11 inches diameter, but unfortunately that isn't quite big enough for a really swell looking tall clock.

Fig. 10 is a detail sketch of a tall clock case. The design is copied from a very old clock, and is simple and pleasing and easy to make. Use 3/4" stock. For the arch over the dial, select a nice colored picture and stick it on with shellac.

Final wrinkle: Harden up your heart like—like agate against all married sisters, aunts, friends of the family, and such like fry, for if you begin producing clocks, they'll beg 'em from you faster than you can make 'em. You don't have any difficulty in extorting admiration as in the case of your more mysterious rinktums; they go into fits over 'em, and contemplate larceny on you.

(Continued on page 427)

Radio "De Luxe" Crystal Set
For Commercial, Navy and Army Operators



"Increase your efficiency" is the watchword at the present time.

Here is a very efficient outfit which every Radio Operator should have on his table or carry in his pocket. It is: "The right thing in the right place, and the right place for the right thing."

No more hunting around for that piece of crystal when the signals are not coming in strongly, no more soiled and broken crystals laying around in drawer's corner.

Our Radio "De Luxe" Crystal Set not only abridges this, but the high class minerals furnished with the outfit will prove a boon for every operator.

The outfit consists of a water- and dust-proof, airtight box of special construction, as per illustration. The box can be carried easily in the pocket on account of its flat and neat shape.

It contains:

One piece of tested Radiocite.

One piece of tested Galena.

One piece of tested Silicon.

Furthermore, one 18 Karat Gold Catwhisker and two phosphor bronze catwhiskers of different shapes.

It is not necessary for us to indulge here upon the merits of our "Radiocite" Crystal, as it is in universal use today in all well equipped Radio Stations; we will, however, add a few words of explanation concerning the quality of the two other minerals which we furnish with our set:

We use only Galena of the best and purest grade, especially selected cubic crystals, carefully tested and ultra sensitive.

Our Silicon is fused material, imported by us from England, and we have a good sized stock of same always on hand. Every piece is selected and tested, the same as our Galena and Radiocite. Our tested Minerals should be handled only with pincers, never with bare fingers. We recommend strongly the use of the Gold Catwhisker with our "Radiocite." It is especially invaluable on board ships, as the gold can't rust and no oxidation can set in between the point of the catwhisker and the mineral.

Order one of our Radio "De Luxe" Crystal Sets today.

Price of the outfit as described above, \$2.00.

Shipping weight, 1 lb.

Add sufficient postage to insure prompt shipment.

THE ELECTRO IMPORTING CO. MFRS.
233 Fulton Street New York City

\$2500 College Chemistry Course FREE

DO YOU WANT FROM \$5,000 TO \$20,000 A YEAR?

Of course you do. Well here is YOUR OPPORTUNITY to get it, and at the same time to become a TRAINED man. One with a PROFESSION. A person who is looked up to and whose opinion is respected. A man who can secure a position ANYWHERE, at salaries ranging from \$5,000 upwards. Our Courses are the REGULAR COLLEGE COURSES and will fit you to hold ANY kind of a position ANYWHERE.



\$5.00 MASTER OUTFIT — One of the most remarkable values ever made. Just think of buying an outfit containing 44 expensive chemicals, including Mercury, Iodine, Phosphorus, etc., and the apparatus listed below, for only five dollars, not to mention having your name enrolled with the Z. C. L. Service Dept. Our Master Outfit contains: 44 Chemicals, 2 Pieces Glass Tubing, Bent; 1 Piece Glass Tubing, Bent; 1 Erlenmeyer Style Wash Bottle, 1 Erlenmeyer Style Flask, 1 Dropper, 10 Sheets Imported Filter Paper, 6 Test Tubes, 1 Delivery Tube with Cork, 1 2-ounce Funnel, 1 Test Tube Holder, 1 Conical Engraved Scale Measuring Glass, 1 Chemical Measure, 1 50-Cent Instruction Book, containing 100 Experiments.

Our Course is compiled by some of the best known Professors in America. Professors in Rutgers College, Clark College, The University of London, England, etc., have all helped to make this Course the BEST and the MOST THOROUGH, THROUGHOUT, and when you finish your complete Course, we grant you a Diploma in Chemistry.

These Courses would cost you over \$2,500 in cost of tuition, board, room, clothes and washing for a four year course in ANY State University, and many times more in some of the Large Colleges. Our Courses are the same in every way, and will fit you to hold ANY position that any graduate of ANY College or University could fill. Every Course is a PERSONAL Course, and not simply a few sheets of paper. You get your lessons from time to time, and return to us your answers for correction. Our Courses contain HUNDREDS of Experiments, to make the student get a perfect understanding of his studies and to thoroughly GROUND and FAMILIARIZE himself with his work.

NO SPECIAL EDUCATION NEEDED to study these Courses, as we thoroughly ground you in algebra by our simple method, and by the use of simple experiments, lead you gradually through Physics, and on into the balance of our Chemical Course. ANYONE FROM 15 YEARS UPWARD CAN TAKE UP OUR COURSE.

DOES CHEMISTRY PAY?

There is hardly a large Manufacturing firm in the Country that does not employ a Chemist, and they are looking around trying to find MORE Chemists, but the supply is FAR SHORT of the demand. Fees as high as \$18,500 have been paid to expert chemists for just one single analysis.

We give the regular College Courses in the following: PHYSICS, INORGANIC AND ORGANIC CHEMISTRY, QUALITATIVE ANALYSIS, QUANTITATIVE ANALYSIS, AN INDUSTRIAL CHEMICAL COURSE IN MANUFACTURING STEEL, IRON, PAPER, SOAP, CEMENT, OILS, ETC., ABSOLUTELY FREE, while they would take from four to six years of your time, and hundreds of dollars of your money to take up. Here is your chance to become a Professional Man, a Trained Man, whose services are ALWAYS IN DEMAND. Here is YOUR Opportunity. Will you grab it? THEN SEND IN YOUR COUPON TO-DAY.

DEALERS! We have a great opportunity for you. Get our unique proposition in a field full of possibilities. A few territories still open. Write today.

Zenith Chemical Laboratories, Duluth, Minn.

ZENITH CHEMICAL LABORATORIES,
Duluth, Minn.

Without obligation to me, send me at once your complete Catalog describing all your chemical outfits ranging from \$1.25 to \$38.50 and explain how I am to obtain your big \$2,500.00 FREE College Chemistry Course.

Name

Address

EXPERIMENTERS!

The "Electro" Codophone

(Patents Pending)

Now that we are for the time being, deprived of using our Radio outfits, it behooves us as good Americans to become proficient in learning the Wireless as well as Telegraph Codes. Operators who know the Code are, and will be, in ever rising demand. The Army and Navy need thousands of operators right now.

So far the Government has not been able to obtain any way near all the operators it requires. Not alone does the Federal Government call for thousands and thousands of operators for the army and navy, but nearly all of our many states require operators for the militia. Here is the great opportunity of a life time for you.

Would you rather fight in the trenches, or punch the key behind the lines? Either way you benefit your country. Which do you prefer? And it is SO easy to become an operator. You do not necessarily require a teacher, nor do you have to go to a school to learn. 30 days of intelligent study will make you proficient. Can you qualify NOW? Are you proficient? Can you send and receive when your country calls you?

THE "ELECTRO" CODOPHONE

(Patents Pending)

which we present herewith is the outcome of several months of intense study and experimentation of our Mr. H. Gernsback. It supersedes our former Radiotone Codegraph, which comprised a Radiotone Silent Buzzer, a loud talking telephone receiver and a key. As in all of his work Mr. Gernsback strives for simplicity. So he combined the three above mentioned instruments with one stroke into ONE single instrument. He combined the Radiotone Buzzer and the loud talking receiver into a single unit, not only mechanically, but electrically as well. This involves an entirely new principle, never before attempted, and on which basic patents are now pending.

What this remarkable instrument is and does.

The "Electro" Codophone is positively the only instrument made that will imitate a 500 cycle note exactly as heard in a Wireless receiver, so

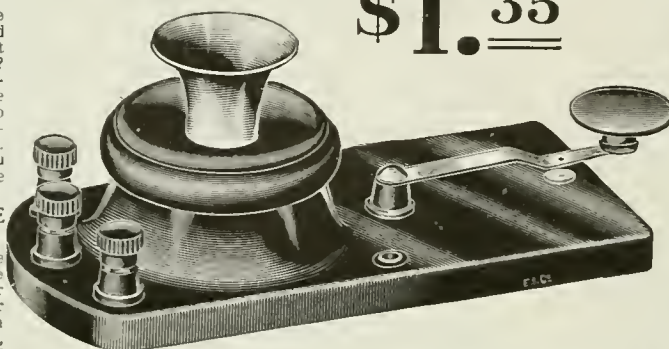

\$1.35

closely and so wonderfully clear, that Radio operators gasp in astonishment when they first hear it. And you need no receivers over the ears to hear the imitation singing spark, which sounds for all the world like a high-pitched distant powerful Radio Station. No, the loud-talking receiver equipped with a horn, talks so loud that you can hear the sound all over the room, even if there is a lot of other noise.

THAT'S NOT ALL. By lessening or tightening the receiver cap, a tone from the lowest, softest quality, up to the loudest and highest screaming sound can be had in a few seconds.

FURTHERMORE, this jack-of-all-trades marvel, can be changed instantly into our famous silent Radiotone test buzzer, simply by replacing the metal diaphragm with a felt disc, which we furnish with every instrument.

FOR INTERCOMMUNICATION. Using two dry cells for each instrument, two Codophones when connected with one wire and return ground, can be used for intercommunication between two houses one-half mile apart. Any one station can call the other, no switches, no other appliances required. No call bell either, the loud-talking phone takes care of this.

AS AN ARMY TYPE BUZZER. Last, but not least, two Codophones with two 75 ohm receivers can be used to converse over miles of fine (No. 36 B & S Wire), so fine that no one can see the wire. Or you can use a long metallic fence and the ground, or you can communicate over your 110 volt line up to several miles, using no wires, only the ground.

Full directions how to do all this furnished with each instrument.

One outfit alone replaces the old-fashioned learner's telegraph set, consisting of key and sounder, which is all right to learn the telegraph code but not the wireless codes.

The "Electro" Codophone is a handsome, well made instrument, fool proof, and built for hard work. Contacts are of hard silver $\frac{1}{8}$ inch in diameter, that will outlast the instrument. Base and housing is of metal throughout, horn and key lever pickel plated and buffed. Three new style metal binding posts are furnished.

There is also a neat code chart and full directions enabling any intelligent young man or girl to learn the codes within 30 days, practising one-half hour a day.

Sizes: 6 3/4 x 3 x 2 5/8". Shipping weight, 4 lbs. **\$1.35**

The "Electro" Codophone as described, complete

Money refunded if instrument is not as represented or does not come up fully to expectation. Ready for delivery Aug. 25th. There will be an enormous demand for this new marvel—place your order now. All orders filled in rotation. Better order two instruments today.

THE "ELECTRO" SPINTHARISCOPE

As usual we lead—others follow. Now the Spinthariscopes, first to be introduced to the American public by us. The Spinthariscopes was originated by the famous English Radium expert, Sir William Crookes. Everyone knows that Radium gives off a tremendous amount of energy which goes on for several thousand years, with undiminished force.

Radium gives off a number of rays of which the Alpha rays are known chiefly for their great power. These electric rays are invisible to the naked eye, the same as are X-rays. But if we take a small amount of Radium and place it in front of a zinc-sulfide screen, the latter lights up. If the radium speck is arranged suitably the Alpha rays will bombard the zinc sulfide with a veritable hail of electrons and the screen begins to scintillate like Fourth of July fireworks.

This is the principle of the Spinthariscopes, which we present herewith. It is a little instrument made of two neatly nickelled metal tubes, one

telescoping into the other. The top tube has a powerful lens. The bottom contains the zinc-sulfide screen and a minute quantity of REAL RADIUM, too small to do any harm. The instrument can only be used in the dark. After the top tube with the lens has been adjusted to the right focus, we observe a vividly illuminated green background, glowing in a soft light. As the eye becomes accustomed to it, we begin to see the **ELECTRONIC BOMBARDMENT** of the Alpha rays from the Radium. It looks exactly like tiny fireflies flashing off and on in the dark night. The more we look the better we see the miniature fireworks. We are now in the presence of the most marvelous substance man ever knew, **RADIUM** and its uncanny forces—Radium, which some day will turn the world upside down.

MAKING RADIUM VISIBLE

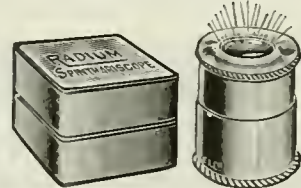

wards, but by greatly simplifying it the cost has been brought down by us to such a nominal figure, that no one can afford to be without this most important and marvelous instrument.

Now this whole outfit as described **\$1.25** costs you only Postage extra. Shipping weight, 4 lbs. Order one today, even if you don't need it now.

Sent Prepaid. IMMEDIATE SHIPMENTS.

LABORATORY OUTFIT!



\$1.25

We have spent considerable time to combine just such a practical outfit and present it herewith to our friends.

The outfit is complete as per illustration and consists of:
1 Stand, made of well quartered oak, varnished three times, so as to be acid proof and grooved on top and bottom, so that it will not warp in getting wet. Size 5 1/2 inches high by 11 1/2 inches long.
1 Glass Spirit Lamp. Size 3 1/2 inches by 2 inches. Uses wood alcohol and is invaluable to the experimenter. Besides being used to heat test-tubes contents as per illustration, it can be used to bend glass rods and tubings, to solder wire, etc.
1 Glass Filter Funnel. This funnel is made of heavy glass that will not break easily. It fits accurately in the hole on top of the Filter stand and is provided with a thick rim on the outlet, so that a rubber hose can be attached to it, without slipping off.
1 Glass Rod, to be used in stirring and mixing.
10 Test Tubes, made from the best imported glass. A new feature of some of the test tubes is that they have a flat bottom and therefore can be placed on any table if desired, needing no special stand.
1 Roll of Copper Clad Steel Wire. This wire is to be used to make a number of useful articles as shown in the illustration.

such as test-tube holders, tripods to support retorts, etc. We furnish a blue print with the outfit, showing how to make all these wire articles.

Now this whole outfit as described **\$1.25** costs you only Postage extra. Shipping weight, 4 lbs. Order one today, even if you don't need it now.

"The Livest Catalog in America"

Our big, new electrical encyclopedia No. 18 is waiting for you. Positively the most complete Wireless and electrical catalog in print today. 200 Big Pages, 600 illustrations, 500 instruments and apparatus, etc. Big "Treatise on Wireless Telegraphy." 20 FREE coupons for our 160-page FREE Wireless course in 20 lessons. FREE Encyclopedia No. 18 measures 7x5 1/2". Weight 1/2 lb. Beautiful stiff covers.

Now before you turn this page write your name and address on margin below, cut or tear out, enclose 6 cts. stamps to cover mail charges, and the Encyclopedia is yours by return mail.

THE ELECTRO IMPORTING CO. 231 Fulton Street, New York City

ELECTRO IMPORTING CO., 231 Fulton St., N. Y.

MAKING AN ELECTRIC CLOCK.

(Continued from page 425)

By this time, you're either got the craze, or are deathly sick of clocks. If the former, I could give you a little spiel on unusual forms of movement, striking-mechanisms, and other daffy dope, but I got to be coaxed—that is, you mail the Editor a nut or something to show you're crazy and not bored, because I don't want him to load up his Mag. with the kind of stuff that you skip when you come to it. I'm a modest and retiring guy—what's that?—Yes I am, too, and I can prove it in court if I have to. Now, is everybody happy?

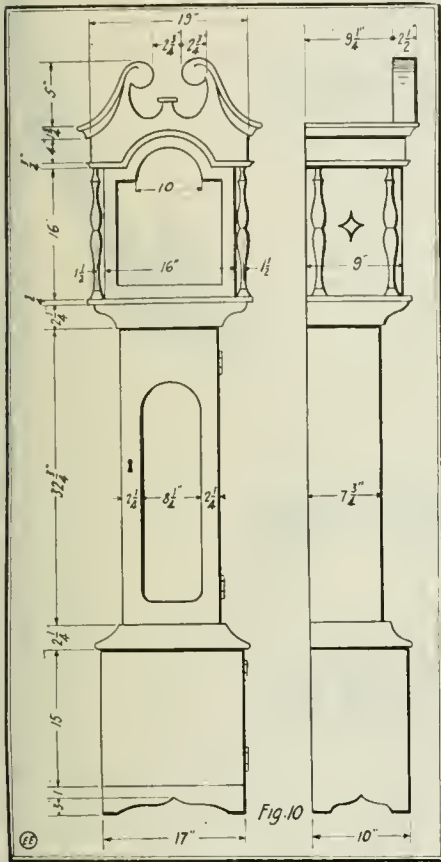

Dimensions of Cabinet for Home-Made Electric Clock As Here Described. A Graceful, Yet Simple Design.

TRIALS OF A TROUBLE-SHOOTER.

(Continued from page 399)

by the tiny black spots on the rod where the lacquer had been burnt.

Yes indeed, trouble shooting is "Sport," sometimes.

There are possibly more chances for ridiculous situations and strange mistakes in the installing end of the game. Trouble is oftimes encountered in properly grounding the 'phone. One subscriber has to water his ground rod every day or so to keep the 'phone working properly. Reminds me of the chap that wanted to ground on a coal bucket. He even offered to allow enough slack so the lady of the house could bring coal out of the cellar.

And streaks of luck, let me tell you about a certain incident that caps them all. On a certain job it was necessary to drill a hole thru the floor to pass a pair of wires. Going down the cellar he started to drill up. After sinking the drill some six inches he began to wonder how thick the blamed floor was. He went upstairs

and lookt for the hole but none was in evidence.

He then returned to the brace and sunk it another three inches before he decided to check up his measurements. After a little trouble he located the place where the hole was coming thru. Where, you ask?

Up a Piano Leg!
And plumb in the center. A quarter inch either way would have broken thru the veneer.

EXPERIMENTAL CHEMISTRY.

(Continued from page 405)

MANUFACTURE:

On a large scale it is made mostly from the ammoniacal liquor of the hydraulic main of gas houses, which results from the destructive distillation of soft coal. This liquor contains dissolved (NH₄)₂S; (NH₄)₂CO₃; etc., and when treated with hydrochloric acid, nitric acid or sulfuric acid, it gives the salts NH₄Cl, etc., and from these salts "liquor ammonia" is obtained. Great quantities of the gas are formed in the preparation of coke in the iron regions.

PROPERTIES:

- Physical: 1. Ammonia (NH₃) is a colorless gas, possessing a pungent and characteristic odor and acrid taste.
2. It is very easily soluble in water, with which it combines to form the hydroxid, which in turn gives off the gas at all temperatures.
3. Ammonia can be liquefied and when in that state it is colorless. The liquid boils at -40 deg.
4. It solidifies at about -80 deg.
5. Its own evaporation may produce cold enough to freeze water, hence the making of artificial ice.
6. Charcoal rapidly absorbs ammonia which may be shown by introducing a piece of charcoal into a tube of the gas over mercury.

CHEMICAL:

1. It is not ordinarily a combustible gas or supporter, but if mixed with a small quantity of oxygen combustion readily takes place on the application of a flame, with the formation of water, nitrogen, and nitric acid.
2. Like other bases, it combines with acids forming salts.
3. It gives a strong alkaline reaction.
4. NH₃ partially dissociates into its elements at 500 deg., as may be shown by passing it thru a red-hot tube.
5. The two elements do not combine under ordinary conditions.
6. It is decomposed at red heat or by the electric spark into nitrogen and hydrogen; when past over heated sodium, potassium, or magnesium, the nitrogen combines with the metal, forming a nitrid, and hydrogen escapes:



When treated with an excess of chlorine or iodine, a salt of ammonia results, which in turn is decomposed by the halogen, yielding very explosive compounds, as nitrogen chlorid (NCl₃) or nitrogen iodid (NI₃ or NI₃).

DETECTION:

(1) Ammonia and its solution (the hydroxid) are very easily detected by the characteristic odor. (2) In smaller quantities by bringing over the suspected solution a piece of moistened red litmus paper, which it turns blue. (3) A still more delicate test is the reaction with fumes of hydrochloric acid. A rod or piece of paper moistened with the diluted acid is brought

(Continued on page 429)

TYPEWRITER SENSATION

FREE TRIAL Use as You Pay. Only \$2.50 a month until the low total price of \$48.80 is paid and the machine is yours.



FREE TRIAL

This is absolutely the most generous typewriter offer ever made. Do not rent a machine when you can pay \$2.50 a month and own one. Think of it—Buying a \$100.00 machine for \$48.80. Cash price, \$45.45. Never before has anything like this been attempted.

Standard Visible L. C. Smith

Perfect machines, Standard size. Keyboard of Standard Universal arrangement writing 84 characters—universally used in teaching the touch system. The entire line of writing completely reliable at all times, has the tabulator, the two color ribbon, with automatic reverse, the back spacer, ball bearing type bars, ball bearing carriage action, ball bearing shift action, in fact every late style feature and modern operating convenience. Come to you with everything complete: tools, cover, operating book and instructions, ribbon, practice paper—nothing extra to buy. You cannot imagine the perfection of this beautiful reconstructed typewriter until you have seen it. I have sold several thousand of these perfect latest style Model No. 2 machines at this bargain price and every one of these thousands of satisfied customers had this beautiful, strictly up to date machine on five days' free trial before deciding to buy it. I will send it to you F. O. B. Chicago for five days' free trial. It will sell itself. But if you are not satisfied that this is the greatest typewriter you ever saw, you can return it at my expense. You won't want to return it after you try it—you cannot equal this wonderful value anywhere.

You Take No Risk—Put in Your Order Now

When the typewriter arrives deposit with the express agent \$3.80 and take the machine for five days' trial. If you are convinced that it is the best typewriter you ever saw, keep it and send me \$2.50 a month until our bargain price of \$48.80 is paid. If you don't want it, return it to the express agent, receive your \$3.80 and return the machine to me. I will pay the return express charges. This machine is guaranteed just as if you paid \$100.00 for it. It is standard. Over one hundred thousand people own and use these typewriters and think them the best ever manufactured. The supply at this price is very limited, the price will probably be raised when my next advertisement appears, so don't delay. Fill in the coupon today—mail to me—the typewriter will be shipped promptly. There is no red tape. I employ no solicitors—no collectors—no chafed mortgage. It is simply understood that I retain title to the machine until the full \$48.80 is paid. You cannot lose. It is the greatest typewriter opportunity you will ever have. Do not send me one cent. Get the coupon in the mails today—sure.

Harry A. Smith, 738, 231 N. Fifth Av., Chicago

H. A. Smith, 738, 231 N. Fifth Av., Chicago, Ill.

Ship me a No. 2 L. C. Smith F. O. B. Chicago, as described in this advertisement. I will pay you the \$40.00 balance of the SPECIAL \$48.80 purchase price at the rate of \$2.50 per month. The title to remain in you until fully paid for. It is understood that I have five days in which to examine and try the typewriter. If I choose not to keep it I will carefully repack it and return it to the express agent. It is understood that you give the standard guarantee for one year.

NAME

ADDRESS

Check the Job You Want!

..... Railway Mail Clerk	\$900 to \$1800
..... Postoffice Clerk	\$800 to \$1200
..... Postoffice Carrier	\$800 to \$1200
..... Rural Mail Carrier	\$600 to \$1200
..... Customs Positions	\$ 600 to \$1500
..... Internal Revenue	\$ 700 to \$1800
..... Stenographer	\$1000 to \$1500
..... Clerk at Washington, D. C.	\$ 840 to \$1500

Name

Address

Sign your name and address and send us this coupon immediately. We will immediately send you (1) a full description of the position checked (2) a list of many U. S. Gov't Jobs now easily obtainable and directions telling how to get free coaching for the position checked. Thousands war jobs open.

Franklin Institute, Dept. G 104, Rochester, N. Y.

Free to You!

Read this Remarkable Offer!

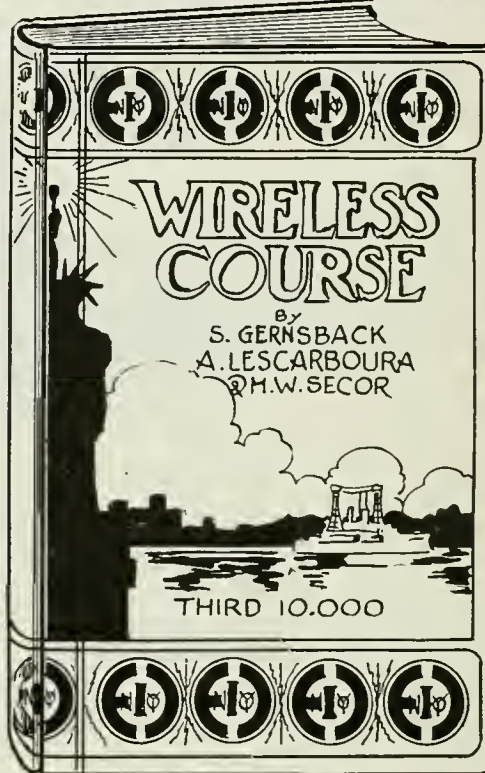
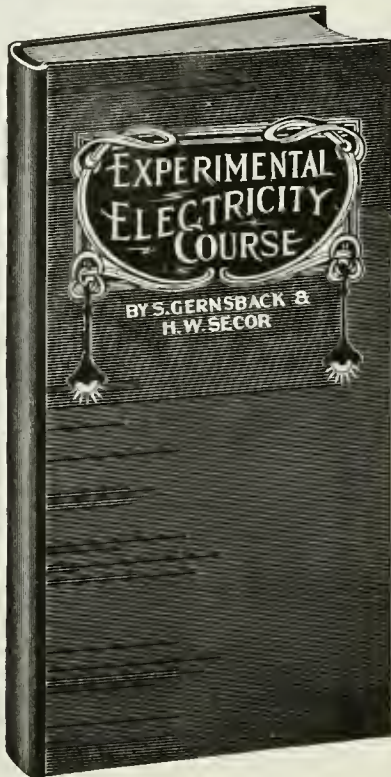

This masterpiece contains 160 pages, 400 illustrations. Size of book 5" x 9". Printed on extra thin paper, so book can be slipped in pocket. Handsome stiff cloth cover.
FREE with a year's subscription.

The most comprehensive Wireless Course ever printed. Contains 160 pages, 350 illustrations. Size of book 6 1/2" x 9". Very fine flexible linen cover.
FREE with a year's subscription.



12 copies of THE ELECTRICAL EXPERIMENTER make a book 9" x 12" and 4" thick. This book will weigh 7 lbs. It is the greatest Electrical and Wireless reference work in the world. And all for \$1.50

This is a very limited offer. It may be withdrawn at any time, due to the tremendous cost of paper, which IS JUST DOUBLE WHAT IT WAS ONE YEAR AGO. We only have about 2000 each of these fine books on hand; after they are gone we cannot reprint the books until conditions become normal again. THIS MAY BE TWO YEARS OR MORE. Now is your chance.

The publishers of this journal have earned an enviable reputation of giving more than 100 cents' worth for each dollar spent with them. Profit by this liberal opportunity NOW; it may never be made again.

HERE'S THE OFFER

Subscribe to THE ELECTRICAL EXPERIMENTER for one year, at the regular subscription price of \$1.50 per year (Canada, foreign and N. Y. C. \$2.00) and we will send you FREE POSTPAID, either one of the above books. If you subscribe for two years, BOTH BOOKS WILL BE GIVEN FREE, POSTPAID.

If you are a subscriber at present, take advantage of this wonderful opportunity anyway. If you do, we will extend your present subscription for one year.

This Offer Limited. Act Now

EXPERIMENTER PUB. CO.,
233 FULTON STREET,
NEW YORK CITY

10-17
Gentlemen:
Please enter my subscription to THE ELECTRICAL EXPERIMENTER for the term of year for which I enclose herewith \$
You will also send me at once FREE prepaid your book
Name
Address
FILL IN - TEAR OUT - AND MAIL

EXPERIMENTAL CHEMISTRY.

(Continued from page 427)

into contact with some of the gas, or over some of the warm solution, when immediately dense bluish-white fumes of ammonium chlorid are formed. (4) When combined with acids, ammonia is detected by first liberating it from its combination with an alkali like potassium or sodium hydroxid, and then applying one of the above tests for the gas; or the solution may be acidified with hydrochloric acid and solution of platonic acid added, when a yellow precipitat of ammonio-platonic chlorid, will slowly separate in minute crystals. (5) *Nessler's Reagent* produces a brown precipitate with ammonium compounds, or if in very dilute solution a brown or yellow color. *Nessler's reagent* is made by adding to a solution of mercuric chlorid (corrosive sublimate) a solution of potassium iodid until the precipitate at first formed is nearly all redissolved. Solution of potassium hydroxid is then added to strongly alkaline reaction and the liquid allowed to settle until it becomes clear, when it is decanted from any sediment.

USES:

Ammonia is widely used in medicine and pharmacy, in making dyestuffs, in calico printing, and in refrigerating operations. Its compounds serve to furnish nitrogen, which is essential to the growth of both vegetable and animal life; hence the use of ammonia in fertilizers for the soil. The three elements necessary to be restored to the soil for the raising of crops are *nitrogen, phosphorous, and potassium*. Compounds of these three elements with others are made into fertilizers by manufacturers. Ammonium compounds, with some nitrats, furnish the nitrogen on which all higher animals depend for the nitrogenous material foods.

The value of ammonia water as a cleansing agent is due to its ability to dissolve grease. Its basic properties also give it a use in the laboratory, whenever a volatile alkali is desirable. Large quantities of ammonia are used in the manufacture of *sodium carbonat* by the *Solvay* process.

Ammonia is very extensively used for making artificial ice and for large refrigerating and cold storage plants. When a gas is liquefied, heat is liberated, and when the liquid returns to the gaseous state, heat is absorbed. The process consists of alternately liquefying ammonia and then vaporizing it. The ammonia gas is first obtained from very strong ammonium hydroxid, and by a compressor pump, and is forced as a gas into pipes, called condensers, upon which cold water is permitted to pass, which together with the compression, makes liquid ammonia, which then passes thru a valve, called the *expansion valve*, into a series of pipes.

These pipes are immersed in a strong brine of Calcium chlorid solution (Sodium chlorid not being so good). As the liquid ammonia goes thru the expansion valve and into the tubes it again vaporizes, and in the process withdraws heat from the brine, cooling it to -20 degs. or over, thus making a freezing mixture of the brine, in which tubes of pure water are immersed and the water frozen. The gas NH₃ then passes back to the pump, where it is used again, the process being continuous.

EXPERIMENT No. 93:

Made from Ammonium Chlorid and Calcium Hydroxid.

Connect a plain Florence flask (125 or 250 cc.) having a two-hole stopper with a thistle and delivery tube (the delivery tube in the Florence flask should just pass thru the stopper, (but the thistle tube should be

immersed beneath the solution), to an 8-ounce bottle, this being fitted with a three-hole stopper. In the second hole a plain piece of glass tubing is inserted so that it projects over the stopper and beneath the liquid. The third hole is to accommodate a second delivery tube which leads to the second 8-ounce bottle which has no stopper. Fig. 84 depicts this apparatus. Both 8-ounce bottles should be about one-fourth full of water. The delivery tube from the first to second bottle should pass below the surface of the liquid.

Put about 10 grams of ammonium chlorid (NH₄Cl) on a piece of paper, and on another about 8 grams of calcium hydroxid (Ca(OH)₂), recently slaked lime being the best. Pour these successively into the flask, add 20 or 25 cc. of water, and mix the contents by rotating the flask: See whether any odor comes from it. Then set the flask on an iron tripod or ring stand, with asbestos or iron gauze, make connections, and apply heat for fifteen minutes. If there is a tendency to froth up and run over; take away the lamp, and, if need be, pour a little water thru the thistle tube. In case the frothing should extend into the tubes or bottles, clean them out and begin again. Observe fully all phenomena in the flask and try to find an explanation.

When ready to stop the action remove the lamp, take out the stopper, and apply these tests in rapid succession to the gas in the flask. They must be made while generation is progressing. (a) Apply a piece of both red and blue litmus to the gas and notice which one is discolored, and conclude what this would indicate. (b) Apply a lighted splint to the gas, in order to test for the combustibility of the gas. (c) Test the odor. (d) Test with hydrochloric acid by pouring two or three cc. of the acid into a dish and dipping a folded paper into it; or the test may be made by bringing the dish to the mouth of the flask or with a tuft of cotton. Dense bluish-white (ammonium chlorid) fumes will appear, the same being a test for free ammonia. Let the flask cool a few minutes after taking away the lamp, then pour in water from a test tube, shake the contents, and pour them into a sink. Any adherent substance may be removed from the flask by using a little hydrochloric acid. Save the liquid in the first bottle for further tests.

EXPERIMENT No. 94:

Properties.—The positive radical or ion of an ammonium salt is NH₄⁺; the negative one OH⁻. The best test for the positive (NH₄⁺) part is to mix a little of the powder to be tested with an equal amount of slaked lime (Ca(OH)₂), heat the mixture and obtain ammonia, in case it is an ammonium salt. A simple test can often be made by rubbing in the palm of the hand a pinch of each substance, moistened, and noting the odor. The tests for the negative radical or ion, in addition to the one with litmus, consists in making insoluble hydroxids as given below.

EXPERIMENT No. 95:

Action on Ferrous Sulfate.—Take a small crystal of ferrous sulfate (FeSO₄), dissolve in 10 cc. of water by boiling (it may first be pulverized in a mortar, if desired), then filter the solution and add to the filtrate a little of the ammonium hydroxid (the liquid in the first bottle of the first experiment of this paper).

Note the color and state of the product. Also note if there is a precipitate. See whether a solution of sodium hydroxid (NaOH) would give the same result as the ferrous sulfate solution. Try also the action of potassium hydroxid (KOH) in solution.

WIRELESS URGENT NEED in SIGNAL CORPS and NAVAL RESERVE

Ninety Day complete courses—complete Commercial Installation—Gov't Instructors—Opportunities to specialize in any branch of this profession—Special arrangements made with enlisted men who desire short courses of intensive training in theory or code.

When looking for an old reliable school investigate the

Y. M. C. A. RADIO SCHOOL
(Founded 1910)

145 East 86th Street New York

Send for catalogue

414 PAGES 145 ILLUSTRATIONS

I.C.S. ELECTRICAL ENGINEER'S HANDBOOK **50¢**

ELECTRICITY!

HERE'S just the book on Electricity that you need to answer your many questions—to solve your knotty problems, to teach you new kinks, to be your memory for tables, rules, formulas and other Electrical and Mechanical facts that some people try to carry in their heads—and fail.

With this "Little Giant" I. C. S. Electrical Engineer's Handbook in your pocket, tool chest, on your work bench, drawing table or desk, an hour or a day need not be lost "digging up" some forgotten rule, some unfamiliar fact; you'll just turn to the very complete index and get it "in a jiffy." Just a few of the subjects treated are:

Electricity and Magnetism; Electrical Symbols; Batteries; Circuits; Magnets; Direct and Alternating Currents; Dynamos and Motors; Belts; Shafting; Electroplating; Electrical Measurements; Meters; Arc and Incandescent Lamps; Mercury Arc Rectifiers; Transformers; Insulation; Electric Cars; Single and Multiple-Unit Control; Transmission; Rail Welding; Tables of Wires—Sizes, Capacities, etc.; Mathematical Rules, Formulas, Symbols; Tables of Constants, Equivalents, Roots, Powers, Reciprocals, Areas, Weights and Measures; Chemistry; Properties of Metals; Principles of Mechanics; First Aid, etc.

The Electrical Engineer's Handbook is one of 22 I. C. S. Handbooks covering 22 Technical, Scientific and Commercial subjects, all crowded with value. They have the contents of a full-size book condensed into pocket-size ready to go with you anywhere and be at your instant command. They are substantially bound in cloth, red edges, goldleaf stamping, printed from new, clear, readable type on good quality book paper. There is an illustration at every point where a picture will help. Hundreds of thousands have been sold on a money-back guarantee of satisfaction.

The regular price is \$1.25, but for a LIMITED TIME you can buy the ones you want, postpaid, delivery guaranteed, for only 50 cents.

You Run No Risk! Money Back if Desired!
International Correspondence Schools
Box 5357, Scranton, Pa.

INTERNATIONAL CORRESPONDENCE SCHOOLS
Box 5357, SCRANTON, PA.

I enclose \$_____ for which send me postpaid the Handbooks marked X, at .50¢ each. I may return any or all and get my money back within ten days from receipt:

- | | |
|--|---|
| <input type="checkbox"/> Electrical Engineer's | <input type="checkbox"/> Advertiser's |
| <input type="checkbox"/> Telegraph and Teleg. Engineer's | <input type="checkbox"/> Business Man's |
| <input type="checkbox"/> Mechanic's | <input type="checkbox"/> Bookkeeper's |
| <input type="checkbox"/> Steam Engineer's | <input type="checkbox"/> Steno. and Correspondent's |
| <input type="checkbox"/> Westinghouse Air Brake | <input type="checkbox"/> Salesman's |
| <input type="checkbox"/> Civil Engineer's | <input type="checkbox"/> Window Trimmer's |
| <input type="checkbox"/> Coal Miner's | <input type="checkbox"/> Cotton Textile Worker's |
| <input type="checkbox"/> Concrete Engineer's | <input type="checkbox"/> Farmer's |
| <input type="checkbox"/> Building Trades | <input type="checkbox"/> Poultryman's |
| <input type="checkbox"/> Plumbers and Fitter's | <input type="checkbox"/> Mariner's |
| <input type="checkbox"/> Chemist's | <input type="checkbox"/> Automobile |

Name _____
Street and No. _____
City _____ State _____



ZEPPELINS!

The Terror of the Old World—The Possible Destruction of the New.

Learn New Aeronautical Ideas: Defend Fort Totten

Five foot complete Model of German War Balloon No Toy or Fireworks display. Equipped with complete parachute and bomb dropping apparatus, silk Parachute and entire inflating arrangement.

Will positively drop parachute from Height of 1,000 Feet and will Fly One Mile.

Is easily retrieved and is practically indestructible. May be flown in only slight wind attached to Cord or be allowed to take its own course and return to earth on expiration of Gas.

Airship is cylindrical in shape with both ends tapering and the Equipment of the above includes complete wood and Fibre Car. inflating device, Silk Circular Parachute of Large Size with Reinforced Edge, Parachute and Bomb Dropping Apparatus, and is guaranteed to fly one mile and give satisfaction when assembled, for which are also supplied diagrams and directions.

Mailed to any address in the world on receipt of \$1.00 and warranted to give more satisfaction than any article heretofore offered in the Aerial Field.

Absolutely new Ideas Involved.
GERMAN OR FRENCH WAR KITE, four feet high, fabric planes complete, Large Reel of Strong Twine, Silk Parachute, Dropping Device, Postpaid for \$1.50.

This kite will carry aloft cameras, Parachute and Bomb at the same flight and will drop them safely and with remarkable precision. Is an exact model of the Man Carrying Kites in Use at the Front Today.

Both of the above will be immediately sent by P. P. or Express, boxed, on receipt of \$2.25.

Manufactured only by the

AERO COMPANY, Dept. 16, Binghamton, N. Y.

CHEMISTS

DO YOU NEED APPARATUS?
WE HAVE THE BEST

Send stamp (1c) for our new circular, giving photograph, description, and price of our big outfit

THE PENSEE ASSOCIATED LABORATORIES
122 1/2 FIRST STREET : EVANSVILLE, IND.

DRAKE'S

New Books for Mechanics

Written in Plain English—You Can Understand Them.

BEST BOOKS for Electricians, Marine and Stationary Engineers, Railroad Men, Carpenters, Builders, Plumbers, Machine Shop Men, Sign and Scene Painters.

NEW AUTOMOBILE BOOKS

Brookes' Automobile Handbook (Leather) \$2.00.

Automobile Starting and Lighting (Leather) \$1.50 (Cloth) \$1.00.

Ford Motor Car and Truck and Tractor Attachments (Leather) \$1.50 (Cloth) \$1.00.

Automobile Mechanician's Catechism and Repair Manual (Leather) \$1.25.

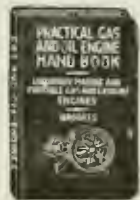

Practical Gas and Oil Engine Handbook. By L. E. Brookes
With Special Reference to the Diesel and other new Oil Engines.

New Edition. 270 pages. 81 Illustrations. Pocket Size.

Leather, \$1.50. Cloth, \$1.00.

A complete instruction book on the latest Gas and Oil Engines. Special attention to care and repairs.

FOR SALE AT ALL BOOKSTORES

or send for our FREE CATALOG. All Books sent prepaid.

Frederick J. Drake & Co.

Dept. 6 1066 Michigan Ave. Chicago

EXPERIMENT No. 96:

The Ammonia Fountain. Ammonia Gas (NH_3). Tests and Properties.—Various tests were applied to the gas ammonia in experiment No. 93. The simplest one is the odor test, which is very characteristic of this gas. Its action on litmus, and inertness to the combustion test, do not distinguish it from other substances. The litmus test is a test for the base OH.

To show its action on water, collect a bottle full of it by upward displacement by use of the apparatus shown in Fig. 85, either from a generator or by boiling about 20 cc. of strong ammonium hydroxid. The latter will give the purer and stronger gas. Have the delivery tube from the generator reach close to the top of the inverted bottle. Close the mouth of the bottle with a one-hole stopper carrying a glass tube, as soon as it is filled with gas (which is made apparent when the odor is observed around the bottle), and at once thrust the outside end of the glass tube into a dish or beaker of water, having the bottle in an inverted position till action takes place. (Fig. 86 illustrates the apparatus for use for the Ammonia Fountain). As the name implies, the ammonia will absorb the water from the beaker, thereby drawing it up into the bottle with such force that a miniature fountain will be formed. Unless the ammonia is unmixed with much air the experiment will not be a success. By having a few drops of red litmus solution in the water in the dish or beaker into which the tube is thrust, a double test may be made. Observe any color phenomena when the litmus is introduced into the beaker.

The reader may have heard or read of reversible reactions and never stooped to inquire as to their meaning. This experiment is an excellent illustration of a reversible reaction. A reversible reaction is one in which the factors become the products and the products the factors. Heating ammonium hydroxid (NH_4OH) gives Water (H_2O) and Ammonia (NH_3). Reverse the experiment by passing Ammonia (NH_3) into water and you have ammonium hydroxid (NH_4OH). Thus the reaction goes either way, according to the conditions, or may go both ways till equilibrium is established.

EXPERIMENT No. 97:

Diffusion and Absorption.—Take two small flasks (125 cc.) each carrying a one-hole stopper, and connect them by means of short glass tubes, connected with a rubber stopper, as shown in Fig. 87. Into one pour 30 or 40 cc. of water and into the other the same volume of ammonium hydroxid. The tubes should not pass below the surface of the liquid, as we are to deal with a gas. Allow them to stand in this manner for a week or so, then test the liquid, both with litmus and Nessler's Reagent, in the bottle which at first contained the water only. Observe any results. This would show that the ammonia (NH_3) from the hydroxid (NH_4OH) past over the tube and again formed an ammonia solution with the water which was in the flask.

THAT PERPETUAL MOTION.

(Continued from page 407)

only run forty seconds or so at each descending.

Consequently, the dynamo would not have enough time to charge the batteries, regardless of the number of cars or how often they run.

Also the continual charging and discharging of the batteries at such minute intervals, would not give them sufficient time to charge properly, and consequently the cars would not run three minutes, much less for years as was suggested.

EDWARD JAMES VAN ALLEN,
Stamford, Conn.

Let's Nickleplate the "Superstructure"!

In the first place you must think of the superstructure upon which the track is laid. Without paint and proper care it would soon rot. The cars also would need attention.

Altho the cars charge the storage batteries when going down grade, they would use up a great deal more current going up. At which rate the current would soon be used up. The distilled water in the storage batteries would evaporate, after which the "bats" would not work.

The friction wheel, third-rail contact shoe and belt would also wear out, after a while of which the device would stop going.

HENRY A. McCOMAS,
Blue Ridge Summit, Pa.

To "Rub" Or Not to "Rub," That's the Question!!

In charging the cells receive a positive and negative charge. Then when the car goes uphill the batteries should discharge, but in discharging the batteries change poles. This would tend to make the car go backwards on the hill, so that the batteries would hinder more than help. The dynamo is not perfect, for it can never cut the lines of force of all its poles and, consequently, can never generate enough power to be 100 per cent perfect. Friction (which is always present), in rubbing places would make the car stop.

SIDNEY KILLIAN,
642 Susque Avenue,
Sunbury, Pa.

Oh Carl, How Could You Be So Cruel in 100 Words!!

This device can impossibly keep going for years, due to the fact that no storage battery ever built could or can last for any number of years since its plates or elements would be decomposed by the electrolyte thereby decreasing the efficiency of the cells so greatly that they would disintegrate to do their work faithfully. Another thing is that storage batteries must be charged at an even rate of current, and in this case it would not be. Also the cars, while descending, would be going so fast as to overload the dynamo, thereby possibly burning out its armature.

CARL HAARMANN,
New Holstein, Wis.

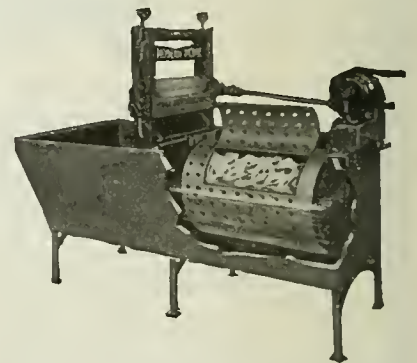

Washing Without Work

This truly wonderful machine has revolutionized washing. It fits in any stationary wash-tub and does all the washing, rinsing and wringing by electricity. All you need do is turn on the switch. The clothes are washed cleaner and whiter than ever before and in the most sanitary way.

The machine washes delicate laces and lingerie without injury; also heavy blankets and small rugs. Clothes washed in it last six times as long as those washed on the rubbing board or at laundries.

MODERN HOME WASHER

* "FITS IN ANY TUB"

This is the only washing machine of its kind that fits and operates in stationary wash-tubs and scores in the tub out of the way, when not in use. It is a great boon in apartments and small kitchens where there is no room for a heavy, bulky washing machine, in the way all the week.

The Modern Home Washer saves its cost many times over each year in washwoman expense and clothes savings. It solves the servant problem and the cost of electricity is only about three cents for a week's washing.

Tested and approved by Good Housekeeping Institute and the Tribune Institute. Awarded a medal at Panama Pacific Exposition. Portable machine for use where there are no stationary tubs.

Electric, Portable Metal Tub Type, complete...\$110.00
Electric, Stationary Tub Type, complete..... 90.00
Hand Power, Stationary Tub Type..... 15.00

No extra tub to pay for.
Write for Catalog today.

Home Devices Corporation
Bush Terminal Bldg. 5
99 Thirty-Fifth Street Brooklyn, N. Y.

Scientific Exchange Columns

UNDOUBTEDLY you have at the present time some things for which you have no further use. Do you wish to exchange them for something, for which you have immediate use? There is no surer and quicker way to do this than by advertising your articles in these columns. The *Very* people, the *Only* people, who could possibly have a use for your things read this journal. More than 75,000 interested people will see your ad. It is furthermore the cheapest advertising medium for you in the country. Dealers' advertising accepted in Opportunity Exchange Columns only.

The rates are: *Three cents per word* (name and address to be counted), minimum space 3 lines. Count about 7 words to the line. *Remittance must accompany all orders.* No advertisement for less than 50c. accepted.

We reserve to ourselves the right to refuse any advertisement which we consider misleading or objectionable. Advertisements for the November issue should reach us not later than September 25th.

The Classified Columns of "The Electrical Experimenter" Bring Positive Results.

Subscribers experiencing trouble in dealing with any advertiser should notify the publisher very promptly.

OVER 79,000 PEOPLE READ THIS JOURNAL

CASH PAID for a set of Bound Volumes belonging to I. C. S. Electric Engineering Course (Part Two). H. Walton, Amigari, Ontario, Can.

WANTED—Your old Wireless Apparatus. I also have a \$50 Wireless Set to trade for a motor-cycle. Enclose stamp. Lawrence Johnston, Fairfield, Illinois.

FOR SALE—15,000 meter coupler, 3,500 meter receiving set, two 3,000 ohm headsets, two 20 ohm telegraph sets, telephone transmitter. Write for photo and description. F. B. Dadisman, Independence, West Va.

HAVE—New Western Electric table fan (\$25). Want typewriter and wireless goods. Mack Simmons, Van Alstyne, Texas.

FOR SALE CHEAP—One new Power's 6-A Motion Picture Outfit, used four weeks. Would consider an immediate cash offer. Austin Miller, Erwin, Tenn.

FOR EXCHANGE—\$40.00 worth wireless and electrical apparatus. Would like 8 x 10 view camera or other photographic goods. Write for list of apparatus and say what you have. K. R. Sipple, 166 Whitney Pl., Buffalo, N. Y.

FIRST MONEY ORDER GETS THESE BARGAINS—D. C. 500 V. 1/2 H. P. Standard Dynamo, \$24.50. Robbins 1-16 H.P. 500 V. new enclosed motor, \$8.75. Both fine for radiotelephones. Smith motor wheel, \$27.25. Tubular audion, \$4. Mignon Receiving Set, \$4.90. P. Edelman, 1802 Hague, St. Paul, Minn.

FOR SALE—Electron Relay and cabinet complete, \$10. New Electron Relay, \$4. 1 K. W. Glass Plate Transmitting Condenser, \$3. 5 H.P. motor starting box, \$4. Ralph Lefler, Tiffin, Ohio.

FOR SALE—New 3 speed bicycle practically new; 2 speed Hub; new Camera and 5 x 7 enlarger, developer and printing set. No. 4 Erector; 1 Transformer; 2 motors. Send for description. Clair Miller, Wilmington, Ohio.

FOR SALE—2,500 Meter Loose Coupler; unmounted 43 plate Variable; unmounted Detector; Brandes 2,000 ohm Phones; 1 1/2" Spark Coil; Jove Key. Expressage extra. Walter J. Schneider, R. R. 2, Mason Rd., Hamilton, Ohio.

ABOUT 1,000 copies specifications and drawings for all U. S. Radio-communication patents from beginning to date; will sacrifice complete collection for \$55. P. Edelman, 1802 Hague, St. Paul, Minn.

WANTED—An Amco or Tesla Transformer. Have apparatus to trade. Write for my list. Robt. Fairchild, Minden Mines, Mo.

WANTED—One H.P. Gas Engine, Redemotor preferred, good condition, cash. Sell—Harley twin, run four thousand miles, thirteen model, ninety dollars, ready to ride, bargain. Write me. H. P. Rea, Carrollton, Mo.

FOR SALE—15,000 meter Navy Type Loose Coupler, \$10; 200 ohm Phones, \$5; Galena and Electrolytic Detectors; 3/4" Spark Coil, 75c.; Shocker, 50c., and \$3.50 Telegraph Set, \$1. Harold Hammer, 3225 23rd Ave., So., Minneapolis.

FOR SALE—Hudson Audion Amplifier Bulb, new, \$500; 3/4" Spark Coils, \$1.25; large Accurate Voltammeter, \$2; also chemicals. All answered. J. C. Swimmer, 1904 Park Pl., Brooklyn, N. Y.

WILL SELL OR TRADE—Complete set Cyclo-pedia of Applied Electricity in A-1 condition. R. O. Miles, Wyand, Ill.

WANTED—150 ohm relay, Vibroplex, Omnigraph, key, sounder, Audion, 15,000 meter coupler, small coupler, storage battery, high tension condenser, rotary gap, ground switch, rheostat. Cash or trade. Write quick, giving best price, to Geo. Rozum, Mitchell, S. D.

WANTED—For cash or trade, an Edison Phonograph with records. Give condition, terms, etc. Frederick Towns, Winchester St., Keene, N. H.

FOR SALE—\$25 Erector Set complete in A-1 condition, used once, \$20. A. E. La France, 40 Ely Street, Holyoke, Mass.

"WANT TO SWAP"?

Do you realize that these "Scientific Exchange Columns" are the World's most renowned "Swap" market? "THE ELECTRICAL EXPERIMENTER" prints 79,800 copies of this issue; that means that at least 160,000 readers see this page and probably a great many more. Our readers who advertise here seldom advertise the same thing twice—usually within five days after the issue is out the advertised article has been sold, or swapped. The many testimonials which we print here from time to time are ample proof of the almost miraculous pulling power of three columns.

Look around in your attic or workshop and you will find dozens of long forgotten articles, useless to you now, but very useful to someone else. At a ridiculously low cost you can either sell or swap such articles.

And remember this fact: The U. S. Postal Laws protect you. No one can "do" or cheat you. Of 3,410 "ads" published in these columns during the past five years, only twelve complaints were reported to us, and each and every one was adjusted to the full satisfaction of the complainant.

It matters not if you have old hooks or magazines, a kodak, electrical or chemical apparatus, scientific instruments, bicycles, typewriters, moving picture machines, air rifles, watches, structural toys, etc., etc. All these and countless others can be speedily disposed of here. Try it and be convinced.

FOR SALE—1 C8 Electrical Engineering Course. 9 Vol. in goods condition. Cost \$100. The best offer takes them. Geo. Fehrenback, 76 Hancock Ave., Jersey City, N. J.

FOR SALE—Wireless Sending and Receiving Apparatus. Large marble switchboard, miscellaneous other electrical apparatus, hooks, chemicals. Want vacuum and X-ray tubes AC and DC meters. Ralph Batcher, 131 Hyland, Ames, Iowa.

FOR SALE—\$50.00 huys \$200.00 complete, good as new, Edison Moving Picture Machine. 135 feet of movie picture film for toy moving machine. \$1.25, 30 foreign coins, \$2.00. Herman David, 711 South Kedzie Ave., Chicago, Ill.

A SNAP Owing to dissolution, \$40 takes one Edison Motion Picture Machine, good order. Enterprise P. & N. Co., Kewanee, Ill.

SYMPHONY PHONOGRAPH with about \$25 worth new Victor and Columbia records, all good, \$16. P. Edelman, 1802 Hague, St. Paul, Minn.

FOR SALE—Electric Therapeutic Apparatus Machine. Second-hand, in good condition, used by physicians for rheumatism and circulation. Will sell at a very reasonable price. John Ferguson, 113 West 63rd St., New York City; home, 364 West 57th St.

WANTED—Copy of book "Michael Faraday, His Life and Work" by Sylvanus Thompson. Also an ohm-meter of the Roller-Smith type or a Wheatstone bridge; must be in first-class condition, and include galvanometer. H. W. Secor, c/o ELECTRICAL EXPERIMENTER, 233 Fulton St., New York City.

MOTION PICTURE MACHINE, Power's No. 6, no lens or rheostat; automatic stereopticon, carries eighteen slides, uses motor; nineteen sets colored song slides; good make snare drum; cash or trade. High-tone rotary \$9; Murdock oscillation \$2.75. Want reliable wireless goods. New \$7.50 Racine A. K. Utility Motor, \$6.50. Verner Hicks, Marion, Ill.

FOR SALE OR EXCHANGE—1915 Indian Motorcycle, in excellent condition, 2-speed, 2-cylinder, 9 H.P., cost \$275. Full equipment, tires almost new. Will sell cheap. Laverne Bushnell, Hanover, N. H.

FOR SALE OR EXCHANGE—Remington No. 6 Typewriter, \$14; \$8 Drafting Set, \$5; Set of "Hawkin's Electrical Guides," \$8. Write for list of other electrical and mechanical books. Want cash or good camera, or what have you? P. Platzer, 119 E. Grand Ave., Chicago, Ill.

FOR SALE—High-grade, second-hand wireless apparatus for sale at a bargain price. Write for list and information. Eldred Hall, Solvay, N. Y.

LARGE WIRELESS receiving set with aerial, \$12. Robert Bowers, c/o F. White, Great Neck, N. Y.

TRADE FOR MOTORCYCLE—\$200 worth of wireless instruments or sell. Denecke, 1539 Ave. A., New York.

EXCHANGE—Bicycle, toy transformer, and electric train for Brandes Superior Phones, 110 volts a.c. motor or gas engine. Frank Low, Jr., 103 S. Pine St., Pauls Valley, Oklahoma.

SELL OR EXCHANGE—New 3-A Kodak, \$36 Meccano, 4-60 Storage. Send for list. Want Thorndarson and other apparatus. Huff, 915 Campbell St., Williamsport, Pa.

SMALL screw cutting lathe, 3 speed lathe and a Roley watchmaker's lathe for sale or exchange. Ralph C. Morse, P. O. Box 147, Foxboro, Mass.

FOR SALE—\$50 set Harvard Classics, 51 books, new, \$30; also 15" spark coil without condensers. If interested write, will send photo of coil and open bids. Any for less than \$40 ignored. Harry J. Frenz, 740 Franklin Ave., Wilkinsburg, Pa.

BARGAINS—6,000 meter Navy Type Coupler, \$4.50. All kinds of wireless apparatus, all new. Write. Walter Johnson, Salem, Nebr.

Opportunity Exchange

YOU will probably find more opportunities and real bargains in these columns than anywhere else in the country. Most good things in life are hard to find and worth going after—these little ads illustrate that point; you alone will be the real loser if you don't take the time to scan through these columns.

Advertisements in this section 4c. a word for each insertion. Count 7 words per line. Name and address must be included at the above rate. Cash should accompany all classified advertisements unless placed by an accredited advertising agency. Ten per cent. discount for 6 issues, 20 per cent. discount for 12 issues from above rate. Objectionable or misleading advertisements not accepted.

Advertisements for the November issue should reach us not later than September 25th.

OVER 79,000 PEOPLE READ THIS JOURNAL

EXPERIMENTER PUBLISHING CO., INC., 233 Fulton Street, New York, N. Y.

AERONAUTICS

AERIAL AGE, America's only illustrated weekly, presents the latest developments in aeronautics throughout the world. Up to the minute technical information concerning aero-engines, aeroplanes, accessories and patents. Complete model news and instruction. Trial subscription six months, twenty-six issues, one dollar. Sample copy 10c. Aerial Age, 280 Madison Ave., New York City, N. Y.

AUCTIONS

AUCTIONEERS make from \$10 to \$50 a day. Free catalog. Missouri Auction School, Kansas City.

BOOKS

TO GET BETTER PICTURES: Read the Amateur Photographer's Weekly; illustrated; weekly prize competitions; print criticisms; many unique features; \$1.50 per year; three months' trial subscription 25c.; Abel Publishing Company, 401 Caxton Bldg., Cleveland, Ohio.

SECRETS, WONDERS, MAGIC, MYSTERIES, Mind Reading. You can astonish everybody. Only 20c for this book if you send now. H. Union Book Co., Palatine, Ill.

BOOKS—Scientific and wireless supplied. Let us know what you want and we will quote you. Experimenter Pub. Co., 233 Fulton St., New York City.

A BINDER for THE ELECTRICAL EXPERIMENTER will preserve your copies for all time. Price, 50c. Postage on 3 lbs. is extra. Send for one today. Experimenter Publishing Co., 233 Fulton St., New York City.

FIRE SALE OF SLIGHTLY DAMAGED BOOKS. Due to fire in our stock rooms, a great many of our books were water stained, but not otherwise damaged. Rather than dispose of them to dealers we prefer to give our readers the benefit. Look at this list! Our celebrated Wireless Course, 160 pages, 400 illustrations; Experimental Electricity Course, 160 pages, 350 illustrations; How to Make Wireless Sending Instruments. These three books for \$1.00 prepaid. Regular selling price of these three books is \$2.50. We guarantee you will be satisfied. Experimenter Publishing Co., Inc., 233 Fulton St., New York City.

OLD E.E. BACK NUMBERS—We have some valuable old E.E. back numbers on hand as per list below:

1915.		March . . . price each \$20	
Jan.	price each \$25	April	" " " "
Feb.	" " " "	May	" " " "
March	" " " "	June	" " " "
April	" " " "	July	" " " "
May	" " " "	August	" " " "
June	" " " "	Sept.	" " " "
July	" " " "	Oct.	" " " "
August	" " " "	Nov.	" " " "
Sept.	" " " "	Dec.	" " " "
Oct.	" " " "	1917.	
Nov.	" " " "	Jan.	" " " " .15
Dec.	" " " "	Feb.	" " " "
1916.		March	" " " "
Jan.	" " " ".20	April	" " " "
Feb.	" " " "	May	" " " "
		June	" " " "
		July	" " " "

We can fill orders at once upon receipt of your remittance and if you have not these numbers already now is your chance to get them as they probably will be snapped up very quickly. Experimenter Publishing Co., 233 Fulton St., New York City.

BUSINESS OPPORTUNITIES

BUILD a profitable money-making business of your own. We will instruct you to manufacture articles that sell rapidly. We will teach you how to make Silver-Plating Powder, Liquid Court-Plaster, Straw-Hat Bleach, Re-Silvering Mirrors, Dressing and Polish for tan shoes, Luminous and Oilcloth Paints, Toothpaste for Collapsible Tubes, Soap-Bubble Liquid. All these formulas with instructions, only 50c. Sidney Specialty Co., 233 S. Fulton St., New York City.

CHEMICALS

URANYL CHLORID (Radio-Active) pure, 1/4 oz., 75c; Uranyl Bromid (Radio-Active) pure, 1/4 oz., 90c; Uranyl Oxid (Radio-Active) pure, 1/4 oz., 85c; Uranium Metal fused (Radio-Active) 1 gram, \$2. The above are guaranteed genuine. Robert J. Hanchett, Nestor, Cal.

STOP playing. Experiment systematically with real chemicals and apparatus. Six cents brings catalogue. Clarence Appel, Mathews Avenue, Knoxville, Pittsburgh, Pa.

HELP WANTED

WAR MEANS THOUSANDS—Men, women, 18 or over, wanted by Government for excellent clerical positions, \$100 month. Steady work. Short hours. Life appointment. Common education sufficient. Write immediately for free list of positions now obtainable. Franklin Institute, Dept. G-27, Rochester, N. Y.

Gentlemen:

When it comes to results the "E.E." is all broke out with it. Rec'd an answer with the same mail that I got the magazine on.

Yours truly,

BERNARD BROWN.

BE A DRAFTSMAN—Big pay; tremendous demand. Study at home; complete course; drawing instruments FREE. Our students filling good positions as Draftsmen and Chief Draftsmen with Government and private concerns. We help you secure position when qualified. Columbia School of Drafting, 25 McLachlen Bldg., Washington, D. C.

MISCELLANEOUS

ELECTRICIAN and Armature Winders. Send \$1.50 for 16 blue prints of motor windings, 10 A. C. Single, two and three phase and 6 D. C. Or, 20 A. C., 6 D. C. and 6 rotary converter drawings, \$2.25. Winding made easy. Superior Electric Co., Pittsburgh, Pa. Lock Box 1372.

MINERALS—Two cents brings catalogue. Clarence Appel, Mathews Avenue, Knoxville, Pittsburgh, Pa.

BIG BARGAIN IN TENNIS RACKETS—We have a small supply of Tennis Rackets, made by one of the largest firms in the country, on hand which we will close out at the following prices: No. 2375—Extra best Tennis Racket, \$5 grade, air dried ash, popular long oval form, concave walnut wedge, superior quality of gut; each, \$2.75.

No. 2377—First grade Tennis Racket, second growth ash, walnut and maple throat, very good grade of gut; handle of cedar with leather cap; a \$3.25 grade; each \$1.85.

No. 2376—Medium grade Tennis Racket made of the same stock as No. 2377 except the gut. A perfect \$2.25 grade. Ideal for beginners. Each \$1.35. Shipping weight of each size two pounds. Send for one today. Our stock is limited and policy is: "First Come, First Served." Don't forget to include money for postage, or we ship express collect. The Electro Importing Co., 233 Fulton St., New York City.

MACHINERY FOR SALE

SEND for circular. 12 in. Semi-quick Change Gear, Screw Cutting Lathe, Compound Rest, Power Cross Feed. Complete \$200. Western Machinery Co., Cincinnati, Ohio.

CASTINGS for "Machine-shop" Bench Lathe, 6 in. swing C. to C. Complete set only, \$7. Louis E. Schwab, 3708 Brooklyn, Cleveland, Ohio.

PATENT ATTORNEYS

IDEAS WANTED—Manufacturers are writing for patents procured through me. Four books with list hundreds of inventions wanted sent free. I help you market your invention. Advice Free. R. B. Owen, 130 Owen Bldg., Washington, D. C.

PATENTS—R. Morgan Elliott & Co., Patent Attorneys, Mechanical, Electrical and Chemical Experts. 716-724 Woodward Bldg., Washington, D. C.

PATENTS—Without advance attorney's fees. Not due until patent allowed. Send sketch for free report. Books free. Frank Fuller, Washington, D. C.

PATENTS worth while. No free booklets, no premiums, no trading stamps—nothing but good service. Samuel Herrick, Master of Patent Laws, Washington, D. C.

PHONOGRAPHS

BUILD YOUR OWN PHONOGRAPH or manufacture them for profit. Drawings, instructions, etc., Twenty-five Cents. Satisfaction guaranteed. Circular free. Associated Phonograph Co., Dept. E, Cincinnati.

PHOTOGRAPHY

MOVING PICTURE FILMS three feet long 10c each or 50 ft. for 50c. Larger quantities at rate of 1c per foot. L. E. Adams, Lewiston, Me.

CUT PRICE developing, printing and enlarging for films, film packs, and plates. Send stamp for price list. N.L. Photo Co., 24 Franconia St., Worcester, Mass.

WE HAVE a limited number of beautiful art pictures of the following famous electrical men on hand. Nikola Tesla, Thomas A. Edison, Guglielmo Marconi, Charles P. Steinmetz and Reginald A. Fessenden. These make a handsome decoration for any laboratory or workshop and should be prominently displayed. Price for five, prepaid, 25c. Experimenter Pub. Co., 233 Fulton St., New York City.

STAMPS

STAMPS—75, all different, free. Postage, 2c. Mention paper. Quaker Stamp Co., Toledo, Ohio.

FREE—12 JAPAN AND 5 UNUSED CUBA to applicants for our approvals. Postage, 2c. Write for premiums.

300 Different..... 30c.

100 Different..... 5c.

Universal Stamp Co., Mt. Clemens, Mich.

TELEGRAPHY

TELEGRAPHY—both MORSE AND WIRELESS, also STATION AGENCY, taught quickly. **TREMENDOUS DEMAND—**much greater than supply—**PERMANENT POSITIONS SECURED. BIG SALARIES—**recently raised. **IDEAL WORKING CONDITIONS—**short hours, vacations with pay, sick and death benefits, etc.—prevaling. **GREAT OPPORTUNITIES FOR ADVANCEMENT. WOMEN OPERATORS** also greatly desired by Railways and Western Union. Tuition reasonable. Cheap living expenses—can be earned. Oldest and largest school established 43 years. Endorsed by railway, Western Union and Marconi Telegraph Officials. Large illustrated catalogues free. Correspondence courses also. Write today. **ENROLL IMMEDIATELY.** Dodge's Institute, Lone St., Valparaiso, Indiana.

TYPEWRITERS

TYPEWRITERS, all makes factory rebuilt by famous "Young Process." As good as new, look like new, wear like new, guaranteed like new. Our big business permits lowest cash prices. \$10 and up. Also, machines rented—or sold on time. No matter what your needs are we can best serve you. Write and see now. Young Typewriter Co., Dept. 362, Chicago.

Succeed Through Electricity

This interesting story shows you the way to greater success in the Electrical Field.

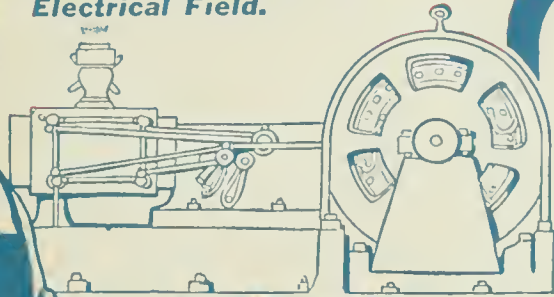

Read These Testimonials

"Any Electrician, Operating Engineer, or Student who wants to do his own construction or further advance himself in the Electrical field should have a set of these books."

JOHN KELLEY
116 Union St., Newark, O.

"For the man not getting a college training and even in that case, I can sincerely say I do not believe there is a better set of books in the market today."

LLOYD D. HUFFMAN
Dayton, O.

"We consider Hawkins Electrical Guides the most compact and complete set of electrical references in the market."

NOGGLE ELECTRIC WORKS
Monterey, Cal.

"Hawkins surely knows the art of condensing information."

ELBRIDGE F. BALL
Buckland, Conn.

Hawkins Electrical Guides Will Show You How

These books are the standard works on Electrical Science. They are a complete and up-to-date course in Electrical Engineering, presenting the information in a way you can use it. Only \$1.00 per volume and owners of the set say there are no better electrical books published at any price.

Specially Arranged for Home Study and Reference

They fit your pocket and your pocket book. Beautifully bound in flexible black buckram with gold edges. Easy to read and handle. You can carry each single volume about with you until you have mastered the subject it contains. Written in the form of questions you would ask and the answers to them—in plain, practical, everyday language, complete, concise, authentic and to the point. Over 3200 pages and more than 4,000 illustrations.

10 NUMBERS IN ALL

1.00
A Number
PAYABLE

1.00
A Month



Shipped to You FREE

YOUR FREE COUPON

Send no money. Examine the books first. Decide for yourself that they are the most complete library of Electricity ever published and that you cannot afford to be without them. Every book is complete in itself, but the complete set is the best bargain. The last volumes are just coming off the press.

Easy Payments

Accept this unusual offer now—today. Each page—every illustration will convince you of the big value we are offering. See the books first, then decide. If you decide to keep them you can make settlement at only \$1.00 monthly until paid for.

A FEW OF THE SUBJECTS
Magnetism—Induction—Experiments—Dynamos—Electric Machinery—Motors—Armatures—Armature Windings—Installing of Dynamos—Electric Instrument Testing—Practical Management of Dynamos and Motors—Distribution Systems—Wiring—Wiring Diagrams—Sign Flashers—Storage Batteries—Principles of Alternating Currents and Alternators—Alternating Current Motors—Transformers—Converters—Rectifiers—Alternating Current Systems—Circuit Breakers—Measuring Instruments—Switch Boards—Wiring—Power Stations—Installing—Telephone—Telegraph—Wireless—Bells—Lighting—Railways. Also many Modern Practical Applications of Electricity and Ready Reference Index of the 10 numbers.

Theo. Audel & Co.
72 Fifth Ave.
NEW YORK

Theo. Audel & Co.
72 Fifth Ave., N. Y.

Please send me for FREE examination Hawkins Electrical Guides (Price \$1.00 each). Ship at once prepaid the TEN numbers. If satisfactory I agree to send you \$1.00 each month until paid.

Signature

Occupation

Business Address

Residence

Reference Oct. E.E.



WANTED Thousands of Trained Men for the Aeroplane Industry



Bud Morriss

Chief Instructor
American School of Aviation

This well-known aviator personally guides the progress of each student. He is assisted by a distinguished Staff of Aeronautical Engineers, Aviators and Aeroplane Manufacturers. These men give you practical, right down-to-the-minute working knowledge of the very highest merit.

If you read the newspapers you know the facts. Right now new Aeroplane factories are being built everywhere. By Spring they will be ready and looking for thousands of trained men who know and understand Practical Aeronautics and the Mechanics of Aviation. Here is your chance. Aviation is the young man's profession—the richest field of opportunity ever opened to "live wires." Are you one? Then write, quick, for full information. Send the coupon below.

War has given to Aviation only its start. The return of peace will see this amazing new industry rivalling the rapid growth of the automobile business, with bigger opportunities for the pioneers, the men who get in NOW and are ready next Spring to step into one of the thousands of big paying positions. You can do it.

Learn in a Few Months ^{By Mail}

No matter who you are, where you live, or what your age, if you can read and write English, you can quickly and easily master this wonderful Course in Practical Aeronautics. Lessons are written in simple, non-technical easy-to-understand language, and illustrated with diagrams and blue prints. You are under the personal direction of practical aviators and aeronautical experts throughout the entire Course. Positively the most PRACTICAL, most interesting and fascinating Course of home study instruction ever prepared.

Prepare NOW for One of These BIG JOBS	
Aeronautical Engineer	\$100 to \$300 per week.
Aeronautical Instructor	\$60 to \$150 per week.
Aeronautical Contractor	Enormous Profits.
Aeroplane Repairman	\$60 to \$75 per week.
Aeroplane Mechanic	\$40 to \$60 per week.
Aeroplane Inspector	\$50 to \$75 per week.
Aeroplane Salesman	\$5000 per year and up.
Aeroplane Assembler	\$40 to \$65 per week.
Aeroplane Builder	\$125 to \$200 per week.

HURRY! RUSH THIS COUPON

There's not a moment to lose. Send this coupon—or a postal today—this minute—for full particulars about this great School, its faculty of famous aviators and its remarkable training Course. We PROVE that we can quickly fit you for any branch of the Aviation Industry you wish to enter. Let us tell you about the wonderful SPECIAL OFFER we are now making for trained men next spring. This offer will be

American School of Aviation
431 So. Dearborn St.
Dept. 803A, Chicago, Ill.

Without any obligations on my part, please send me full particulars of your Course in Practical Aeronautics and your Special LIMITED Offer.

Nothing for effort to be made. Offer will be withdrawn without notice. Act at once—today.

Money Back Guarantee You risk absolutely nothing. We give you an iron-clad guarantee that we will refund every cent paid for tuition if you are not satisfied on completion of the Course. MAIL COUPON NOW WHILE THIS SPECIAL OFFER LASTS.

AMERICAN SCHOOL OF AVIATION
431 So. Dearborn St., Dept. 803A CHICAGO, ILL.

Name

Address