

The GENERAL RADIO EXPERIMENTER

VOL. 2 NO. 8

JANUARY, 1928

The General Radio Experimenter is published each month for the purpose of supplying information of particular interest pertaining to radio apparatus design and application not commonly found in the popular style of radio magazine.

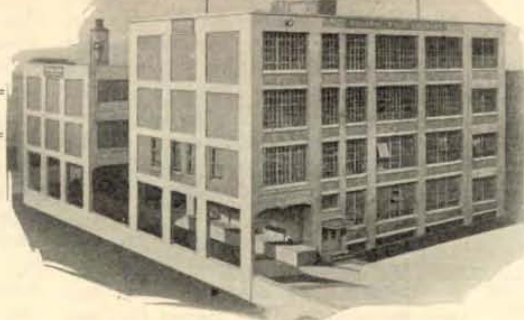

There is no subscription fee connected with the General Radio "Experimenter." To have your name included in our mailing list to receive future copies, simply address a request to the
GENERAL RADIO CO., Cambridge, Mass.

The Development and Use of the Hydrophone

By HORATIO W. LAMSON, Engineering Department

[Editor's Note: The following is the first of a series of articles on The Development and Use of the Hydrophone. Other articles on this subject will appear in future issues of the Experimenter.]

PART I

Our readers are doubtless aware that the late World War served as a tremendous impetus to a wide range of scientific and engineering researches which, aside from their important military applications, have proved to be of great value in the pursuits of peace. Among these is the art of hydrophone engineering which, during the War, had its prime mission in the location of the dangerous unseen U-boats and which has since produced a valuable means of safeguarding lives and property at sea. We believe that an outline of some features of this development will prove of interest in these pages.

It has long been realized that water is a far more reliable medium for the transmission of sound than air. The difficulties and deceptions often experienced in trying to locate fog whistles at sea are, no doubt, familiar to many of our readers. This is due to the inhomogeneous character of the atmosphere, especially in thick weather, whereby fog banks and air currents frequently give rise to baffling reflections and deflections of the sound waves. Sea water, however, being almost completely homogeneous, offers no distortion to the "bee-line" transmission of sound.

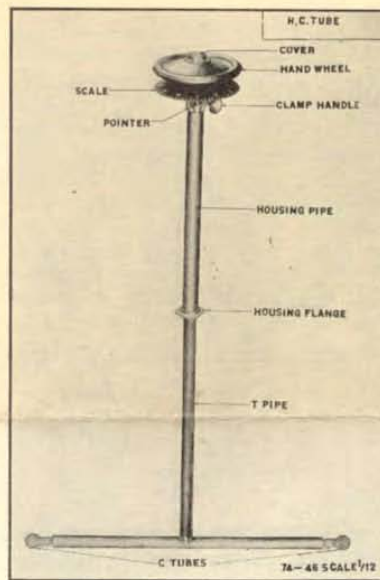

For some time prior to the War use had been made of underwater signaling as an aid to navigation. The usual method consisted of installing a microphone device on the port and another on the starboard side of the ship in such a manner that they were sensitive to sounds traveling in the sea. These microphones were connected by cables to the bridge, where, by means of a simple switching device, either one of them could be placed in circuit with a telephone receiver. Thus the navigating officer could listen to the

sounds received either on the port or starboard of his vessel and could compare their intensity. If a submarine bell, suspended beneath the sea from a lightship, was in some direction off the starboard the sound would then be heard with greater intensity on the starboard microphone, since the port microphone would be more or less in the shadow of the ship. If necessary to know the exact direction, on the compass, of the sound beacon, the ship could be maneuvered until its bow were pointing directly towards the same, when the signals would be heard with equal intensity on both microphones.

This procedure, while successful to a certain degree, has two serious drawbacks. It is evident that if both microphones are not equally sensitive, a rather frequent condition in practice, a corresponding inaccuracy will be introduced. Again, it is necessary to "swing ship" and head directly towards the sound beacon in order to locate the same, a bothersome procedure at best, and one which may become positively dangerous when navigating close to reefs or in otherwise restricted waters.

The modern hydrophone equipment obviates the necessity of swinging ship in that it permits the bearing of a sound beacon to be made at any direction from the ship's keel, while the vessel is kept on its original



IET LABS, INC in the GenRad tradition

534 Main Street, Westbury, NY 11590

TEL: (516) 334-5959 • (800) 899-8438 • FAX: (516) 334-5988

www.ietlabs.com

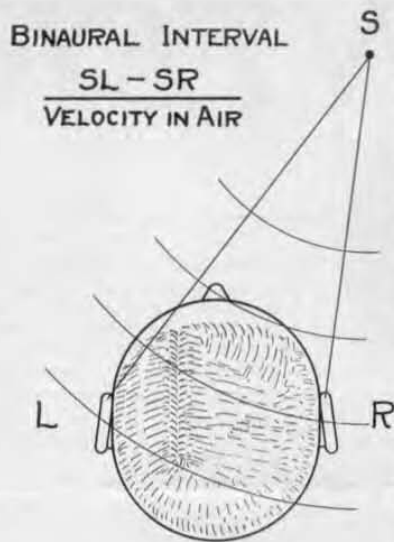

FIG. 1

course. In order to understand how this is accomplished it will be necessary for us to have a clear idea of what is meant by the binaural sense.

Since birth we have trained ourselves subconsciously to locate the direction of sounds by means of this sense. To determine accurately the direction from whence a sound comes we instinctively face it. This unconscious action, common to all animals and birds, serves merely to bring both ears equi-distant from the source under which conditions the binaural sense is most accurate and the audition image is binaurally centered in the head.

If a sound is to the right of us we are conscious of this fact for two reasons. In the first place the right ear, being more exposed to the sound, receives a stronger impression than the left ear, which is somewhat in the shadow of the head, so to speak. However, except for high-pitched sounds whose wavelengths are correspondingly small, the shadow caused by the head is very slight.

The second, and by far the more important, means whereby we locate a sound is as follows: If the source is to the right of the head (See Figure 1) each successive wave front strikes the right ear a certain time prior to striking the left ear because the distance SR is less than SL. This "binaural time interval" between the two ears obviously depends upon the direction of the sound, being a maximum when the sound is in the direction determined by a line drawn through the two ears and zero when in a direction directly in front (or in back) of the head. The two ears unconsciously take cognizance of

this binaural time-difference and give us a resultant audible impression which we have trained ourselves since childhood to regard as a sense of direction. It is this interpretation of a TIME INTERVAL in terms of DIRECTION which is known as the binaural sense. As this action is not a function of the intensity of the sound, a person having defective hearing in one or both ears, so long as neither ear is totally deaf, may still possess a well developed binaural sense.

Experiments have shown that the smallest binaural interval which can be detected by man is about ten microseconds. This means that we can face a distant sound source with an angular precision of the order of one degree, assuming a separation of eight inches between the ears.

During the War attempts were made by American scientists and engineers to employ the binaural sense in the location of submarines. These efforts culminated in the so-called C-tube, a device which was used by our Navy with considerable success in the war zone.

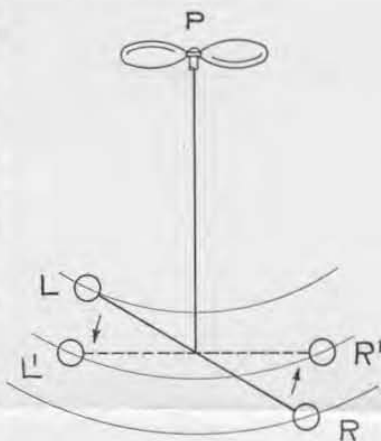

FIG. 2

A hollow sphere of soft rubber makes an efficient receiver of underwater sounds. Imagine two such spheres mounted upon the extremities of a horizontal rod about four feet long which, in turn, is suspended in the sea by means of a vertical shaft rigidly attached to its center point. Provision is made whereby this shaft may be rotated through any desired angle, which may readily be measured upon an ordinary horizontal graduated circle. Simultaneously, of course, the two rubber spheres will be swung in a horizontal circle through the same angle. By means of two independent pipe systems of exactly equal length and a pair of stethoscopes, one hollow

sphere is connected by a continuous air column to the left and the other to the right ear. We have thus virtually taken our ears out of our head and placed them under the sea on the extremities of a four-foot horizontal rod.

Suppose that a distant sound source in the sea, for example, the propeller of an enemy submarine, (See Figure 2) is in a direction making an acute angle with the horizontal rod carrying the hydrophone receivers L and R, and that our left underwater ear happens to be nearer to the source. Each successive sound wave will then strike the left ear a certain time prior to striking the right ear and the sound of the propeller will appear to be on the left side of the head. That is, our binaural sense will make the sound seem to be in a certain direction to the left no matter what direction we are actually facing.

If now we rotate our underwater ears in such a manner as to move the left away from and the right towards the source, the binaural time difference between the two ears becomes less, so that the binaural image moves towards the center of the head and the sound of the propeller appears to travel towards our front.

When both of our underwater ears L' and R' are equi-distant from the submarine propeller; that is, when the horizontal arm carrying the two spheres is perpendicular to the direction of the propeller, both of our real ears will be excited simultaneously by each sound wave and the resultant image will be binaurally centered in the head even if our two hydrophone receivers are of somewhat different sensitivity. To some observers such an image appears straight ahead in front of the forehead while others visualize it directly in back of the head. In either case it is in the "median plane" of the head, i. e., in a plane bisecting the line joining the two ears.

The method of using the C-tube consists, therefore, in slowly rotating the device until the sound of the target to be located appears binaurally centered in the head, whence its direction with respect, say, to the keel of the vessel, may obviously be read upon the graduated scale. It will be apparent that in any given position the hydrophone receivers are focused binaurally upon two opposite directions each perpendicular to the line of the receivers. The ambiguity between these two directions may be removed by employing the correct procedure in rotating the

(Continued on page 4, col. 3)



Plate Supply and Power Amplifier Systems

By A. R. WILSON, Service Department

The introduction of power tubes for use in the last stage of the audio frequency amplifier has meant much to the quality of radio reception. The one serious drawback to the use of these tubes is that they require both a high plate voltage and current which, in the case of the battery operated receiver, places a costly drain upon the batteries.

The development of the Light Socket Plate Supply Unit removes the objection in regard to cost of operations and at the same time provides a thoroughly dependable source of plate voltage for both the power tube and the remaining tubes of the receiver.

It might be well to mention at this time that on account of their relatively high plate current their use requires some sort of coupling device between them and the speaker. This has led to the development of the so-called tone filters or speaker filters. The use of these devices does not necessarily improve tone quality, although in the case of the balanced armature type of speaker it would remove any tendency of clattering caused by the direct current pull of the armature. However, these devices should be used in all cases where the plate current of the tube exceeds 10 milliamperes. A unit of this sort is really insurance for the speaker, as it prevents the high plate current from eventually burning out the windings of the speaker.

Without going into the relative merits of power tubes, there are now on the market two types available that, by their performance, are far superior to all others. These are the 171 and the 210 types.

Prior to the output tube we are primarily interested in securing a voltage amplification gain. The most important characteristics we are interested in, regarding the output tube, are the amount of undistorted power it will deliver to the speaker together with the required plate, filament, and grid voltages. For comparative purposes we are listing the relative undistorted outputs of the UX-171 and UX-210 types of tubes.

UX-171	
Plate Volts	Maximum Undistorted Output (Milliwatts)
90	130
135	330
180	700

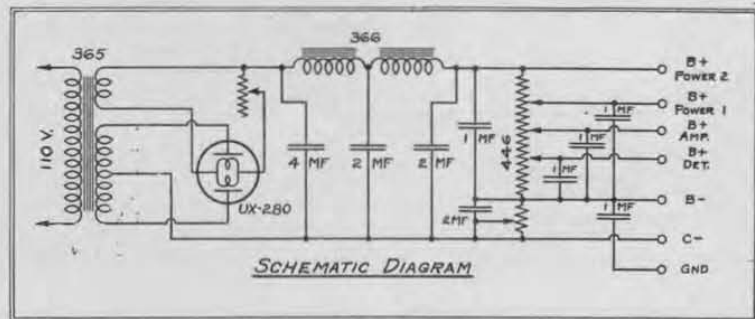

Figure 1

UX-210

90	18
135	65
350	925
425	1540

Since the maximum plate voltage required differs by a wide margin two distinct plate supply devices have been developed, namely, those employing either a gaseous rectifier such as the Raytheon tube or the thermionic rectifier such as the UX-280 and designed to furnish approximately 200 volts. The other type employs either one or two UX-281 rectifying tubes and delivers between 400 and 500 volts.

Every plate supply device consists of four important elements, namely the Transformer, the Rectifier, the Filter and the Output Potentiometer. The Transformer both heats the filament and furnishes stepped-up high voltage to the plate

of the Rectifier Tube through which the current can pass in only one direction. This rectified current is then passed on to the Filter, which is usually a brute force or untuned filter. The pulsating D. C. delivered by the Rectifier is equivalent to the sum of the average D. C. and the superposed pulsating ripple. The D. C. component goes through the filter practically unchanged, being impeded only by the ohmic resistance of the two choke coils. The pulsating ripple, however, is bypassed by each filter condenser and held back by each choke coil in turn until at the end of the Filter practically no ripple is present in the output. The Output Potentiometer apportions the total voltage in a correct manner to supply various voltages as customarily required. This division also contains fixed condensers to by-pass around the resistance of the potentiometer the A. C. energy

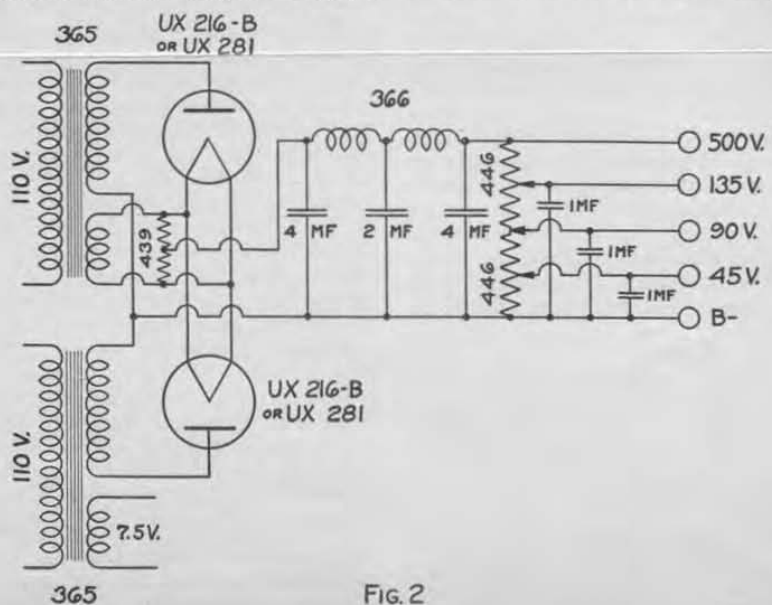

FIG. 2



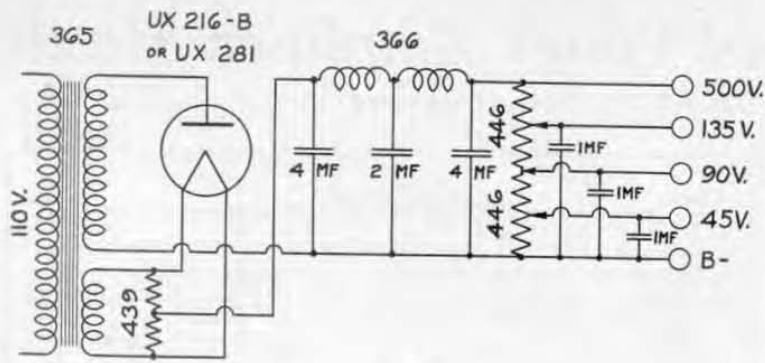

Fig 3

of either radio or audio frequencies. A plate supply unit is in effect a "B" battery of quite high internal resistance, and the by-pass condensers reduce the coupling between tubes operated from the same voltage tap by reducing the effective impedance common to the plate circuit of those tubes.

Fig. 1 is a plate supply and C bias unit designed to furnish approximately 180 Volts at 50 mils. This device is constructed throughout of General Radio parts, with the exception of the condensers, and employs the R.C.A. UX-280 or Cunningham CX-380 Rectifier tube. This tube is of the full wave rectifying type and is thoroughly dependable in its operation. By a few slight circuit changes this device may be adapted for use with a gaseous rectifier such as the Raytheon Tube. Fig. 2 and 3 are, respectively, full- and half-wave rectifying plate supply units designed to furnish sufficient plate voltage to operate the 210 type of tube at its maximum efficiency. In constructing such a unit it would be well to remember to employ condensers having a sufficient working voltage, otherwise breakdown is liable to occur from this source. In a unit of this description the resistance of the potentiometer device should be much higher than that of a 200-volt unit and for this reason two of the General Radio Type 446 Voltage Dividers are connected in series. This is done to re-

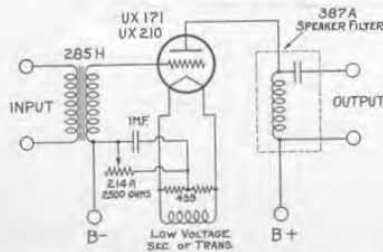

Fig. 4

lieve the rectifying system from undue drain.

It is perfectly permissible in the last audio stage to light the filament of the tubes by means of alternating current obtained from the low voltage secondary of a power transformer. This does not introduce serious complications, since the amount of hum is negligible, and at the same time permits a large power tube to be employed in the output stage with

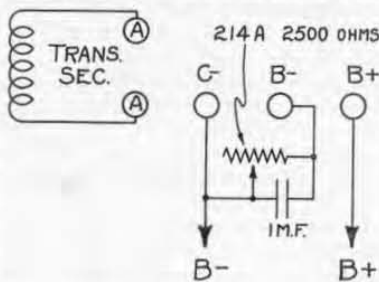

Fig. 5

any type of receiver employing either the dry cell or storage battery type of tubes. The majority of amplifier systems used in the last audio stage are transformer coupled, utilizing either a straight audio transformer or the push-pull circuit. Figure 4 shows the wiring diagram of a one-stage amplifier for use with either a UX-171 or UX-210 tube having its filament lighted by raw A. C. The General Radio Type 214-A 2500 ohm resistance unit is used to secure the proper grid bias, making this stage, when used with one of the plate supply units just described, completely operated by A.C. Figure 5 shows the relative position of the binding posts of the Type 441 Push-pull Amplifier and the proper method of connection in order to secure the grid bias by means of the voltage drop across the 2500 ohm resistor.

By means of these diagrams the experimenter may construct an amplifier or plate supply unit that will

fill his particular requirement. The various parts that are incorporated in these devices are evident from the wiring diagrams. To repeat, do not forget to use condensers of ample working voltage, and employ rubber covered wire for all connections. Because the voltage obtainable from the plate supply units is rather high in some cases, any adjustment of them should not be attempted unless the device is disconnected from the house lighting circuit.

(Continued from page 2)

travel of the binaural image.

The actual separation of the ears has been increased some six fold but, since the velocity of sound in water is about five times that in air, the angular precision of a four-foot C-tube is only 20 per cent greater than that of the normal ears in air.

The C-tube was constructed in several forms, one of which is shown in the illustration. One model was designed to be swung over the side of the ship, another was lowered through the bottom of the vessel, while still another protruded up through the exterior deck of a submarine to be used when running submerged. All types required that the observing ship be practically lying to when making an observation, an evident drawback.

Another disadvantageous feature of the C-tube is due to the fact that a hollow sphere in the sea constitutes a receiver equally sensitive to sounds from all directions. Thus, when locating a distant weak source, stronger sounds at other directions, while binaurally off-center, are nevertheless received with full intensity and tend to limit seriously the range of the instrument.

The methods of modern hydrophone engineering used in overcoming these difficulties will be discussed in a later issue.

NEW GENERAL RADIO APPARATUS TYPE 214-A 2500 OHM RHEOSTAT

The 214-A 2500 ohm rheostat is brought out to meet the need for a high variable resistance for obtaining bias voltage without the use of a bias battery. Methods of using the rheostat for this purpose are described elsewhere in this issue.

The 214-A 2500 ohm rheostat is identical with other G. R. Type 214 resistors. The power rating capacity is 12 watts, current carrying capacity 70 milliamperes. The price of this instrument is \$3.50.