

CIRCULATION LARGER THAN ALL OTHER RADIO MAGAZINES COMBINED

# RADIO NEWS

REG. U.S. PAT. OFF.

20 Cents  
A P R I L  
1921

Over 100 Illustrations  
Edited by H. GERNSBACK

A NEW  
RADIO INSTRUCTOR  
SEE PAGE 686.

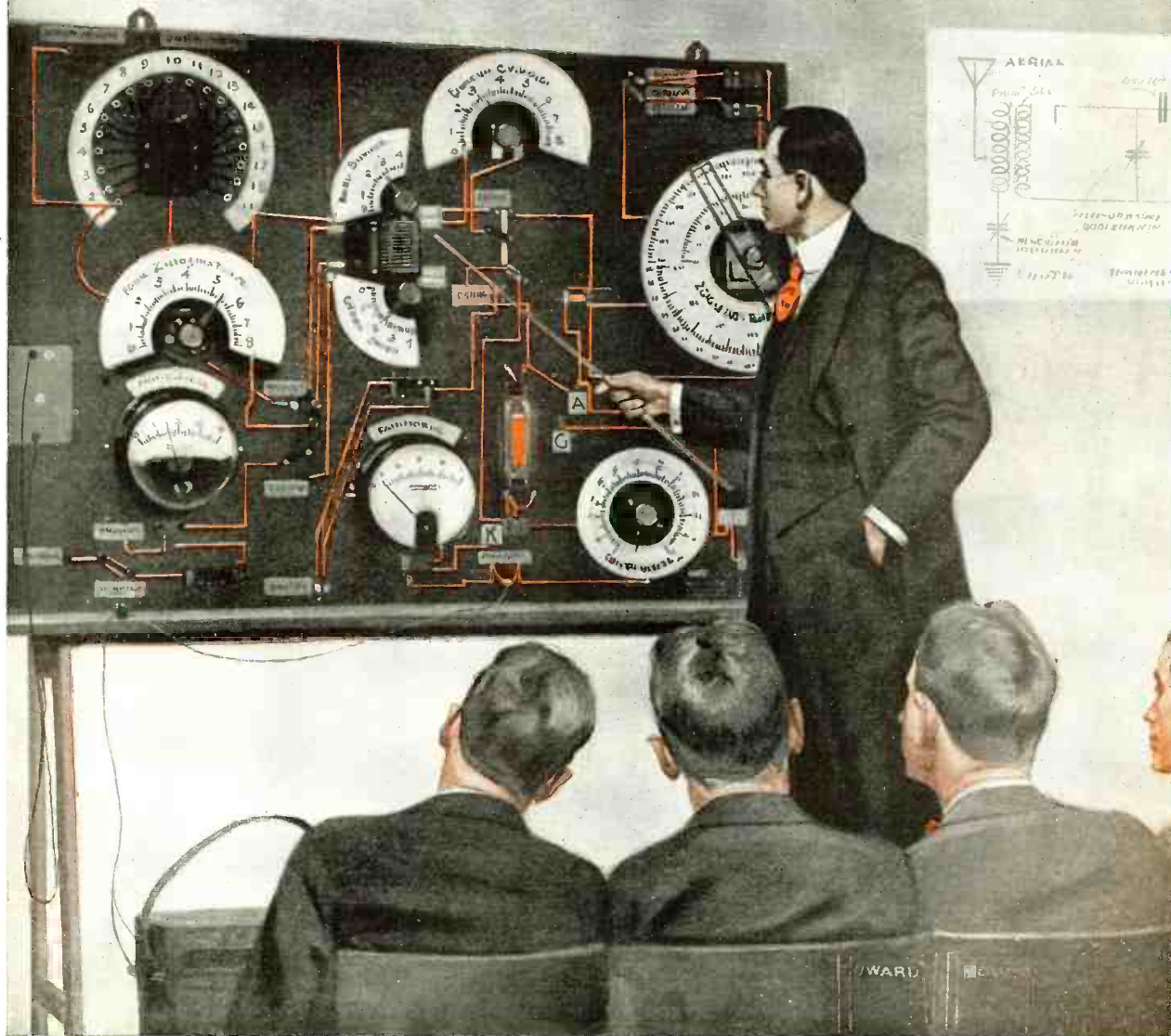

"THE 100% WIRELESS MAGAZINE"

# CUNNINGHAM

## POWER

Type C-302

5 watt output

Price \$8.00



## TUBES

Demand  
Cunningham  
Tubes

The Name is etched  
on the Tube

CW TELEGRAPHY AND TELEPHONY WITH CUNNINGHAM TRANSMITTER TUBES OFFERS THE ADVANTAGES OF  
COMPACTNESS — RELIABILITY — LONG RANGE — LOW POWER — SHARP TUNING

### TRANSMITTER TUBE SPECIFICATIONS

Model	Output Conservative Rating	Filament Amps. Volts	Plate Voltage	Price	Delivery Date
C 302	5 watts	2.35 7.5	350-400	\$8.00	immediate
C 303	50 watts	6.5 10.	1000	30.00	Mar. 10th
C 304	250 watts	15. 12.	4000 Max.	110.00	Mar. 10th

Price of C 303—C 304 fob. New York or San Francisco

C 302 is mounted on the standard four prong receiving tube base. The larger tubes have special bases.

### CUNNINGHAM POWER TUBES

are the latest product of the great Research Laboratory of the General Electric Co. The trade mark GE is the guarantee of their quality. Each tube is built to most rigid specifications. The output ratings are extremely conservative and in actual test deliver greatly in excess of their rated outputs.

### GENERAL ELECTRIC QUALITY PLUS CUNNINGHAM SERVICE

Address All Communications to

TRADING AS  
AUDIOTRON MFG. COMPANY  
35 MONTGOMERY STREET  
SAN FRANCISCO, CALIF.



Specify No. 766, Eveready Wireless Station Battery. Standardized for use in the U. S. Navy



Specify No. 763, Eveready Airplane Wireless Battery. Standardized for use in the U. S. Signal Corps Aviation Section

## Here's your power-plant!

**T**HE Eveready Vacuum Tube Plate Battery was especially designed for radio outfits. It is packed tight with electrical energy that will send your message singing through space to the receptive antennae miles away.

The Eveready is known everywhere as the battery of *endurance*. It stays on the job till the last second.

All the skill and experience of the Eveready engineers have been poured into this battery and sealed up.

Once you know the power and endurance of the Eveready Vacuum Tube Plate Battery, you will never be satisfied with less. But be sure you get the genuine. Sold by leading dealers everywhere. Name of dealer in your locality on request.

### AMERICAN EVER READY WORKS

*of National Carbon Company, Inc.*

226 Thompson Avenue, Long Island City, New York  
Chicago                      Atlanta                      San Francisco

*Makers of Eveready Flashlights and Batteries, Storage Batteries, Miniature Mazda Lamps, Dry Batteries, and Meters*

# EVEREADY

VACUUM TUBE PLATE BATTERIES

# RADIO NEWS

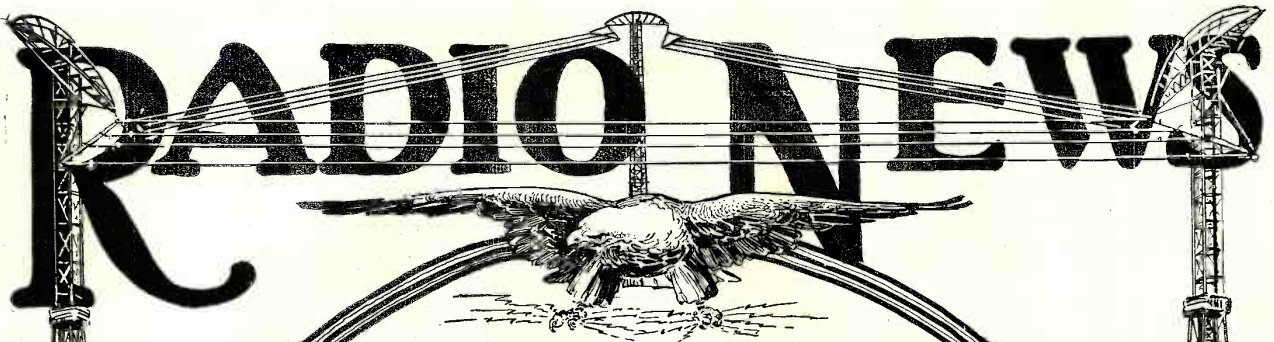

## CONTENTS

VOL. 2

FOR APRIL

NO. 10

	PAGE		PAGE
Underground Loops...By H. Gernsback	677	The H. C. of L. and Burned Out Amplifying Transformers	By Cyril O. Smith 691
Radio Communication		An Ideal Receiving Set for Short and Long Wave-Lengths	By E. G. Shalkhauser 692
By J. H. Dellinger	678	Short Wave Radio Vacuum Tube Transmitter and Regenerative Receiver with Two-Step Audio Frequency Amplifier	By Walter Hyndman 693
Get Your Friends Interested.....	680	Conduction of Electricity Thru Vacuum and Gases with Application to Design of Radio Apparatus. First Part	By E. M. Sargent 694
New Universal Range Receiver		Who's Who in Radio—Sir Oliver Lodge	695
By Arthur H. Lynch	681	With the Amateurs.....	696
Tests of Insulating Material for Radio Use at the Bureau of Standards		Correspondence from Readers.....	698
By S. R. Winters	682	Club Gossip .....	699
Aeroplanes and Radiogoniometers		Radio Digest .....	700
By Armstrong Perry	683	Found by Radio.....	701
Awards of \$100 Portable Radio Prize Contest .....	684	The Radio Constructor.....	702
A "B" Battery of the Edison Storage Type.....By W. H. Farr	685	Junior Section .....	704
A New Radio Instructor.....	686	A Complete Receiving Set for 25c	By John D. Adams 705
First Annual Amateur Radio Show and Convention .....	687	Junior Constructor .....	706
The Radio Dealer and the Beginner		I-Want-To-Know .....	707
By Armstrong Perry	688	News from My Station.	By G. Ridleak V. T. 708
Quenched Gap Transmitters			
By Jesse Marsten	689		
Non-inductive Resistances and How to Make Them.....By P. F. Geagan	690		
Continuous Wave Multi-Stage Receiving Circuit.....By John Scott-Taggart	690		
New German Radio Recording Device..	691		

RADIO NEWS is published on the 25th of each month at 233 Fulton Street, New York. There are 12 numbers per year. Subscription price is \$2.00 a year in U. S. and possessions. Canada and foreign countries, \$2.50 a year. U. S. coin as well as U. S. Stamps accepted (no foreign coins or stamps). Single copies, 20 cents each. A sample copy will be sent gratis on request. Checks and money orders should be drawn to order of EXPERIMENTER PUBLISHING CO., INC. If you should change your address notify us promptly, in order that copies be not mis-carried or lost. No copies sent after expiration.

All communications and contributions to this journal should be addressed to: Editor, RADIO NEWS, 233 Fulton Street, New York. Unaccepted contributions cannot be returned unless full postage has been

included. ALL accepted contributions are paid for on publication. A special rate is paid for novel experiments; good photographs accompanying them are highly desirable.

RADIO NEWS, Monthly. Entered as second-class matter June 6th, 1919, at the Post Office at New York, N. Y., under the Act of March 3, 1897. Title registered U. S. Patent Office. Copyright, 1921, by E. P. Co., Inc., New York. The Experimenter Publishing Co., 233 Fulton Street, N. Y., N. Y. The contents of this magazine are copyrighted and must not be reproduced without giving full credit to the publication.

RADIO NEWS is for sale at all newsstands in the United States and Canada; also at Brentano's, 37 Avenue de l'Opera, Paris.

Published by EXPERIMENTER PUBLISHING CO., INC.  
H. GERNSBACK, President

233 Fulton Street, New York City  
S. GERNSBACK, Treasurer  
R. W. DE MOTT, Secretary

# 50,000 OHMS A. C. RESISTANCE in our Navy Type HEADSET

Special attention of all who are using Vacuum Tubes

To get the highest efficiency from a station equipped with vacuum tubes it is absolutely necessary to use a headset of very high impedance. In our Navy Type Headset with an impedance of 50,000 ohms A.C. at 800 cycles we have accomplished something never before possible in a commercial headset. The extra high impedance of this new model makes it ideal for vacuum tube reception.

This headset is exceedingly high pitch in tone and is consequently very sensitive to high pitch signals. To anyone wishing to receive trans-Atlantic or Pacific signals our High Impedance Navy Type Headset is indispensable.

It is the most sensitive headset built regardless of price and it is backed by one of the most liberal guarantees ever written. Read our offer below.



**NAVY TYPE HEADSET**

50,000 ohms A.C. at 800 cycles. Weight 9 oz. complete with headband and polarity indicating cord. Price \$14.00.

## How We Get An Impedance of 50,000 Ohms

There are four bobbins in each headset—two to each earpiece. Each of these bobbins is wound with 10,000 turns of insulated copper wire. Because of the difficulty of winding small wire the greatest number of turns in any other headset is less than 7,500. No other manufacturer has been able to approach 10,000 turns without making his headset too bulky, heavy and fragile for practical use. Consequently no other headset has over 25,000 ohms impedance at 800 cycles.

In spite of the fact that there are over 40,000 turns of wire in our High Impedance Navy Type Headset it weighs only 9 oz. complete with headband and cord. Its compact, sturdy build insures comfort, reliability and long life.

# BRANDES Matched-Tone HEADSETS

## 100% Receiver Satisfaction

While Brandes Matched Tone Headsets are very light and comfortable they are so sturdily built that there is no danger of them losing their adjustment through hard usage. The shell is made of thick, rigid aluminum and the cap of hard vulcanized rubber. The parts are all securely anchored by hand by skilled workmen who do nothing but make Brandes Headsets. Because the action in our headsets is direct

on the diaphragm less current is required to produce audible signals and the space and weight of unnecessary amplifying mechanism is eliminated.

Brandes Matched Tone Headsets are carefully matched in tone and permanently adjusted at their highest point of efficiency. All of our models are equipped with improved headbands which are instantly ad-

justable to any size head. Check nuts hold the adjustment. This headband is rust-proof, strong and light.

Our headsets are also now equipped with new style conducting cords which indicate the polarity of the receivers. This eliminates any danger of demagnetizing the receiver when used in connection with vacuum valve detectors.

## You can try our High Impedance Navy Type Headset without risk

We want you to give our High Impedance Navy Type Headset a trial. We want your judgment on it. We back this headset with the most liberal guarantee ever placed behind a wireless instrument. Here is our offer: Send us \$14 and we will mail a High Impedance Navy Type Headset. Try it for ten days. Give it every test you can devise. Make rigid

comparisons with the headset you are now using. If it isn't a better headset in every way than any you have ever used or seen, or if for any reason whatever you are dissatisfied with your purchase, mail the headset back to us and we will refund your money immediately and without question. Tear out the coupon in the corner of this page and use it now.

### Transatlantic and Superior

We also make two other models. These are for amateurs whose requirements are not exacting enough to warrant the use of our Navy Type.

#### TRANSATLANTIC HEADSET

Impedance of 25,000 ohms A. C. at 800 cycles. Weight, 11 oz. complete with hew headband and polarity indicating cord. Equal to the best headsets of other makes. Price, \$12.00.

#### SUPERIOR HEADSET

Wound to 2,000 ohms D.C. Weight, 14 oz. complete with headband and polarity indicating cords. A good headset at the low price of \$8.00.

Both these models are guaranteed to give entire satisfaction.

### LISTEN TO THIS

"I have listened in with many different makes of phones during my ten years' experience but I never was so pleased with others as I was with your splendid and sensitive Navy set."—W. F. W.  
 "These Navies have been in continuous service for seven years and have given excellent results."—E. C. N.  
 "After using a pair of your Navy Phones for ten years, I believe that I am qualified to say that there are none better."—F. C. L.  
 "I have not found any of my friends' receivers to equal Brandes Navy in clearness, sensitiveness and lightness."—H. C. M.  
 "Your Navy phones are light, durable, made right, look right, and work right."—H. I. V.  
 "They must improve with age, for I have four other high price sets, but I always go back to the Navy Set."—C. B. H.  
 "I have a pair of your Navy phones here which I took to France with me and used all through the war. They were the best phones we had and much lighter than any issued set."—E. V. D. (Names on request.)

### USE THIS COUPON NOW

C. BRANDES, INC. (R.N.A.)  
 Room 823, 32 Union Square—New York City.

Inclosed find \$..... Please mail me the items checked below. It is understood that I may return them within 10 days if unsatisfactory in any way and you will refund my money promptly.

- Put X here.
- ..... Navy Type Headset.....\$14.00 (High Impedance)
  - ..... Transatlantic Headset.....\$12.00
  - ..... Superior Headset.....\$ 8.00
  - ..... New Head Band Headset.....\$ 1.75 (Fits old style Superior only)
  - ..... 16-page catalog, 5c coin or stamps.

Name .....  
 (Please Print Plainly.)  
 Address .....  
 City ..... State.....

# CONTINENTAL NEWS

APRIL, 1921

PUBLISHED EVERY MONTH IN RADIO NEWS BY CONTINENTAL RADIO AND ELECTRIC CORPORATION

## Mail Order Service

The Continental Store in New York has long been famous as the fairest, pleasantest, and quickest place to buy radio goods in the city.

The Continental Mail Order Dept. is now becoming even more noted, thruout the United States, for these same reasons.

Let Continental Service serve you, order direct from this advertisement, and expect:

Accuracy: Speed: Courtesy

## C W APPARATUS

We are making a specialty of everything used in C.W. transmission. If there is any item you need, not listed below, write us for further information and prices.

### C.W. INDUCTANCES

No. 181 Tuska C.W. Inductances.....	\$7.50
No. 181 Tuska C.W. Inductances, un-assembled .....	5.00
No. 182 Tuska C.W. Inductances.....	10.00
No. 182 Tuska C.W. Inductances, un-assembled .....	7.00
No. 183 Tuska C.W. Inductances.....	12.50

No. 183 Tuska C.W. Inductances, un-assembled ..... 10.00

### CHOKE COILS

Acme 1 1/2 Henry, 500 MA Single Coil	\$6.00
Acme 1 1/2 Henry, 500 MA Double Coil	3.00
Acme 1 1/2 Henry, 150 MA Single Coil	4.00
Acme 1 1/2 Henry, 150 MA Double Coil	6.00
C.E.Co. ZRX. 8 Henry 150 MA Single Coil Choke .....	3.75

### TELEPHONE TRANSMITTERS

Sterling Microphone .....	\$2.50
---------------------------	--------

### RESISTANCES (Ward Leonard)

Ward Leonard Resistance, 5000 ohm	\$1.70
Ward Leonard Resistance 10000 ohm	2.95
Ward Leonard Resistance 1500 ohm	1.50
Ward Leonard Resistance 12000 ohm	3.50
Lavite Resistance 48000 ohm for Radio Frequency amplifiers.....	3.00

### MODULATION TRANSFORMERS

Acme A-3 unmounted.....	\$7.00
Acme A-3 semi-mounted.....	5.00
Acme A-3 unmounted.....	4.50
C.E.Co. ZRM Modulation Transformer	4.50

### GRID LEAKS

Marconi 1, 2, 3, or 5 megohms.....	\$1.25
Chelsea Variable 1/2 to 5 megohms, 10 values .....	3.00
Chelsea Oscillator .....	3.00

### METERS (WESTON MODEL 301)

Model 301 0-3 amperes flush.....	\$3.50
Model 301 0-5 amperes flush.....	8.50
Model 301 0-50 Volts flush.....	8.50
Model 301 0-100 Milli-amperes flush..	8.50
Model 301 0-300 Milli-amperes flush..	8.50
Model 301 0-500 Milli-amperes flush..	8.50
Model 301 0-800 Milli-amperes flush..	8.50

## BALDY 'PHONES

Used by H. D. Selvaige in first amateur trans-continental spark reception, (3300 miles). Used in the Trans-continental relay test, Jan. 18. "Equal to one and two stages of radio amplification."

Type "C"	\$18.50
Type "E"	\$20.00
Type "F"	\$21.00



## PARAGON-RADIOTRON COMBINATION

The Paragon Detector unit is complete with VT socket, filament rheostat, grid condenser, grid leak, and binding posts, with the Radiotron UV 200, it makes a complete VT Detector outfit.

PARAGON UNIT - - -	\$6.00
Radiotron UV 200 - -	\$5.00
Complete Unit - - -	\$11.00

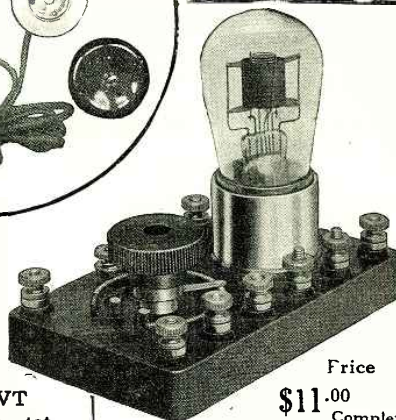

Price \$11.00 Complete

## TRANSMITTING TUBES

### RADIOTRON UV-202



Radio Corporation brings out new 5 watt power tube. Continental has big supply of first shipment.

These new Radiotrons are produced in the great lamp works of the General Electric Company. They are of an improved type, specially designed for long operating life, and unequalled sensitiveness. We have a generous supply of these wonderful new tubes, and can supply you with all the necessary equipment for a first class C. W. transmitting station.

### MODEL UV-202—PRICE \$8.00

5 watts. Filament voltage 7 1/2 volts. Filament current 2.35 amperes. Plate voltage 350 volts.

Be the first in your section to use the Radiotron 202! Send in your order today! Your tube will come by return mail!

### METERS (Hot Wire)

No. 127 Gen. Radio flush 0-1 Amp...	\$7.75
No. 127 Gen. Radio flush 0-3 Amp...	7.75
No. 127 Gen. Radio flush 0-10 Amp...	7.75
No. 127 Gen. Radio flush 0-5 Amp	7.75

### RHEOSTATS

214 Gen. Radio front or back mounted	\$2.50
Paragon Rheo. front or back mounted	1.75
Mesco Porcelain base.....	1.40

### BUZZERS FOR BUZZER MODULATION

Century 168 Buzzer.....	2.50
Mesco No. 55 Buzzer.....	2.50
Mesco 251 Buzzer.....	.95

### HIGH FREQUENCY CHOKE COILS \$1.50

Electrodyn Rectifier consists of 500 V Transformer and 2 rectifying vacuum tubes all Mounted ready for use.

No. 25 RT Rectifier less tubes.....\$35.00

No. 25 V T Vacuum Tube.....Each 7.00

TRANSMITTING TUBES.....\$7.50

Gen. Radio Drum switch..... 6.50

### JEWELL METERS (Model 33)

0-1 flush.....	\$6.50
0-3 flush.....	6.50
0-5 flush.....	6.50
0-50 Volts flush.....	6.50
0-500 Volts flush.....	15.00
0-50 MIL AMP.....	6.50
0-100 MIL AMP.....	6.50
0-300 MIL AMP.....	6.50
0-500 MIL AMP.....	6.50

### JEWELL THERMO AMMETERS

0-1 AMP.....	\$15.00
--------------	---------

0-3 Amp.....	\$15.00
0-5 Amp.....	15.00
0-10 Amp.....	15.00

### TRANSFORMERS (For C.W. Work)

Acme 200 Watt, mounted.....	\$20.00
Acme 200 Watt, unmounted.....	16.00
Acme 50 Watt, mounted.....	15.00
Acme 50 Watt, unmounted.....	12.00

### MOTOR GENERATORS

International 500 V 100 Watt AC Drive .....	\$89.00
International 500 V 100 Watt DC Drive .....	110.00
Electric Specialty Co. 350 V 50 Watt AC or DC.....	97.00

## PARAGON R. A. TEN

Amplifying Short Wave Regenerative Receiving Set

We can fill your order for one of these genuine Paragons by return mail. "The weaker the signal, the stronger the amplification." Wave length 160 to 1000 meters. Amplification 100 times. Two-year guarantee. Price Eighty-Five Dollars.

### CONDENSERS

WE 21 AA 2 MFD tested at 500 volts Each .....	\$2.65
Dubilier 25 MFD Mica Condenser tested at 1800 Volts.....	\$6.00
Dubilier .0005 Grid Condenser for transmitting sets .....	2.00
High Voltage Variable Air Condenser will stand 1000 V. Capacity .001 MFD. Just the condenser for your Antenna circuit .....	\$30.00

Note—Please make remittance by P. O. Money Order or bank draft.

# CONTINENTAL RADIO AND ELECTRIC CORP.

J. DiBlasi, Sec.

J. Stantley, Treas.

Dept. C 33—6 Warren St., New York



# RADIO NEWS

H. GERNSBACK—Editor  
ROBERT E. LACAULT—Associate Editor

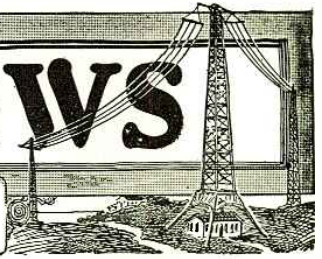

Vol. 2

APRIL, 1921

No. 10

## Underground Loops

Our July, 1920, issue we said editorially as follows:

"It is therefore safe to say that in twenty-five years hence there will be no such thing as a big ponderous aerial mast even for the powerful radio stations sending messages all around the globe. Probably no aerial will be used at all. Perhaps no ground either. Before we reach that stage someone will go and bore a shaft into the earth, possibly a thousand feet deep, and hang an insulated wire into this shaft. He will probably astound the world by finding that by means of this arrangement messages can be sent and received all over the globe just as easily as having a huge mast towering a thousand feet into the clouds."

A few weeks ago there was issued a patent to Messrs. T. Appleby and L. M. Knoll, a patent which seems to mark quite an advance in radio. Not that there is anything new about underground radio. We have spoken of it a good many times, and its principles are pretty well understood. The directive qualities of a buried straight-away aerial are also well understood, but the underground loop invented by Messrs. Appleby and Knoll, not only seems to be well suited for directive effects, but prevents interference and other disturbances as well. It was hitherto conceded that the underground aerial was effective only for receiving, but not for sending, but the inventors of the new underground loop have made it possible to transmit as well. By means of the new system, which will be described at length in our next issue, the loop as well as the apparatus is used under ground in a cavity especially prepared for this purpose, and the loop as well as the instruments is thus shielded entirely from the outer atmosphere, thereby doing away almost entirely with static.

It had been found in previous experiments with the Rogers' Underground Aerial that it becomes possible to greatly reduce static by its use. It therefore does not come as a surprise to understand that static is suppressed almost entirely by means of the underground loop.

The inventors rotate their loop in the usual manner by means of a wheel and graduated indicator for direction finding purposes, but it is of course possible, as they point out, to reverse the combination by using the loop under ground and by extending the shaft above ground, and thus

rotating the loop by the shaft which carries the wheel and the indicating disc. Any such combination can be used. In pointing out the importance of their new system, the inventors say:

"In connection with receiving apparatus employed as a radio compass, because of directive effects as obtained, for example, by a rotatable absorbing coil structure, the accuracy of determination of direction of a source of radiant energy is sometimes materially interfered with by objects, as conducting masses, or earth formations near the absorbing structure, with resultant distortion of the electric or magnetic field, or both, causing a variation of the determined direction from the true direction. By employment of the new underground loop the disturbing effects of distortion are materially reduced. And irrespective of distortion effects, the critical maximum or minimum response in the receiving apparatus is more sharply defined, whereby when the apparatus is so suitably shielded, its directional or compass properties are improved."

In plain English, it seems that the new loop should make it possible to receive and send messages with much greater accuracy as far as direction is concerned than was possible heretofore.

It is interesting to note that the inventors mention that the loop is not only effective under ground, but can be used under water as well. This should be of much interest to ship owners, for it is here where very accurate direction finding is of prime importance. It seems that if the inventors' hopes are carried out, we will soon witness a loop installed down in the hold of a vessel (providing it is not steel plated), from which the signals may be either received or sent. The loop has done wonderful things in the past few years, and it seems certain that in the next decade, most of our cumbersome aerials will be relegated to the scrap heap. Already the loop is coming into more and more favor. Amateurs are recognizing its great importance and are beginning to install loops where heretofore aerials were used. Of course, it must be understood that a loop is of not much use unless it is used in connection with an amplifier of at least two or three stages of amplification. Using crystal detectors with loops yield practically no results.

H. GERNSBACK.

### IMPORTANT TO NEWSSTAND READERS:

In order to eliminate all waste and unsold copies, it becomes necessary beginning with this month to supply newsdealers only with a sufficient amount of copies for which they have actual orders. Please note that your newsdealer will be glad to reserve a copy for you every month.

This costs you nothing and you will be assured of your copies. Hand your newsdealer a slip of paper on which write your name and address with a request to reserve a monthly copy of RADIO NEWS for you. This will be the only way to assure you of your copy hereafter.

# Radio Communication

Elementary Explanation of the Principles of Radio Telegraphy and Telephony

By DR. J. H. DELLINGER  
Bureau of Standards, Washington

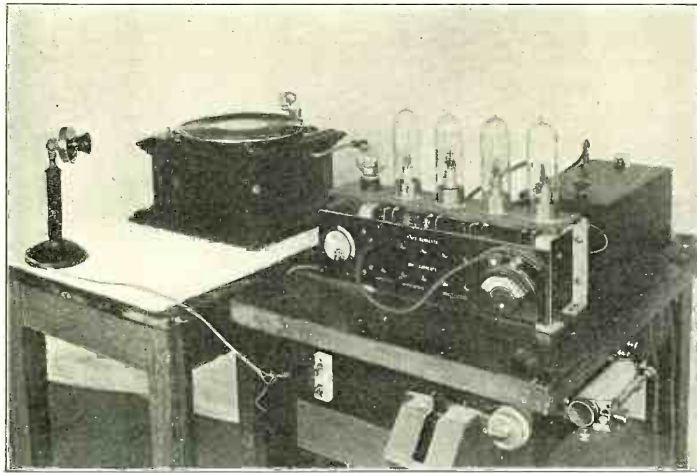
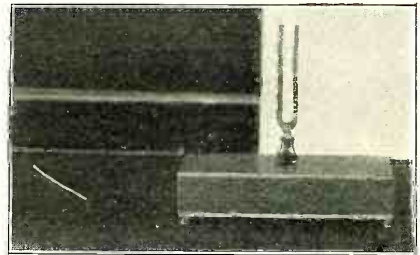

Fig. 1. On the right is a tuning fork used to show the analogy between electric and sound waves. Fig. 12 on the left is a complete radio telephone set using five vacuum tubes to produce high frequency oscillations. A phonograph used to send music is shown in the photograph.



can easily produce waves on a rope by shaking the free end. This illustrates that a wave always consists of some sort of to-and-fro motion. Waves can be slow or fast and of different wave-length. We cannot see electric waves, as we see ripples or the waves on a rope, but there is nothing special or mysterious about them. We cannot see sound waves. If a tuning fork (Fig. 1) is struck it gives off sound waves, which, starting at the tuning fork, travel out into the air in all directions like the ripples referred to.

Sound waves are produced by the motion of the metal prong of the tuning fork. As the prong moves back and forth it causes the air next to it to move back and forth. This motion is handed on to the surrounding air and so moves out to a great distance in the air just as the ripple on the pond spreads out. The slight to-and-fro motion of the air spreading out in this manner is called a sound wave.

Electric waves also consist of a certain kind of to-and-fro motion. Just as the motion of the tuning fork causes alternating pressure in the surrounding air, similarly whenever an alternating current flows in an electric circuit the to-and-fro motion of the current causes alternating electric pressure in the space next to the wire. This to-and-fro or alternating electric pressure in the space surrounding the wire affects the surrounding space and spreads out in exactly the same way as a sound wave in air.

When the key is pressed an alternating current is produced in the wire and a spark occurs at the spark gap, which lets one know that an electric current is flowing. It is to be noted that this apparatus produces at the same time sound waves, light waves and electric waves. The electric waves are also called radio waves and it is

**Editor's Note:**

Despite the fact that countless experimenters are familiar with the principles of Radio, the Editors think this article would be of interest to the numerous new amateurs who have just started in the game.

**M**ESSAGES are now sent without wires between any points on the earth's surface, in the air, or under the ocean. It is possible to sit down to the telephone in your house and talk to persons not only in distant cities but to persons sailing on the ocean or flying in airplanes. The principles which make wireless or radio telephony possible are really not difficult to grasp. While a great deal of mystery has been made of radio, as a matter of fact everything about it is simply a part of principles and ideas well known to science. Since the results achieved in wireless communication are somewhat striking, the newspapers lose no opportunity to use them to incite the wonder of the people.

The radio telephone is not a particular instrument; that is, when you talk into a radio telephone you do not necessarily talk into anything different from the ordinary telephone on your desk. Sometimes people talk of a radio telegraph or even of a radio, indicating an idea that some particular, wonderful apparatus accomplishes the feat of communicating from one place to another without wires. As a matter of fact, radio is a system or method involving a great many instruments and appliances. Some of the instruments are very interesting indeed, among them being the electron tube, of which more will be said later.

The history of radio is all comprised within our own lifetime and has been a steady conquest of distance obtained by radio communication. It increases from three-fourths of a mile the first year, when Marconi performed his startling first experiment, to thirty-four miles the next year across the English channel, and so the distance has steadily risen. Last year the distance finally rose to 12,000 miles. This is the limit, since 12,000 miles is half way round the earth. We cannot communicate any further than this unless we exchange signals with other planets. To be sure the newspapers had us communicating with Mars in April, 1920, but this must be discounted.

The word "radio" suggests its own explanation. It means to radiate. Radio communication is carried on by means of

and received at another. These radiated waves are electric waves, but they have all the characteristics of wave motion possessed by other kinds of waves, such as sound waves or even the simple waves produced in water when a pebble is thrown into the

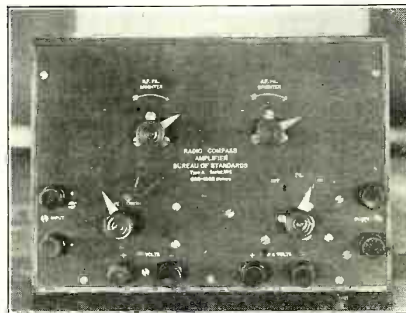
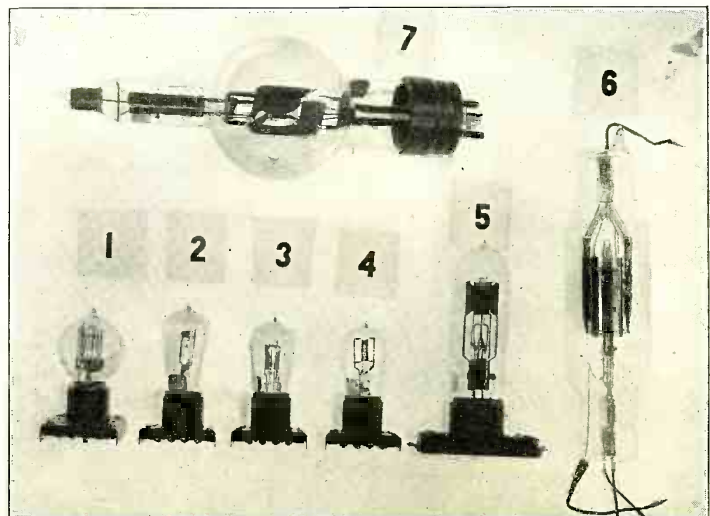

Fig. 11B. This is the Amplifier Used in Conjunction With a Loop Aerial of the Type Shown on the Opposite Page.

pond. Much can be learned about the way radio waves act by watching the spreading out in circular rings of ripples on water. Other simple types of waves are also produced by ordinary mechanical means. One

Fig. 9. On the right are a few of the various vacuum tubes actually in use for transmission and reception. The tubes 6 and 7 are high power tubes delivering 250 watts each. The smaller types, 2, 3, 4, are used for reception and amplification and the tubes 1 and 5 are transmitting tubes for low powered sets.





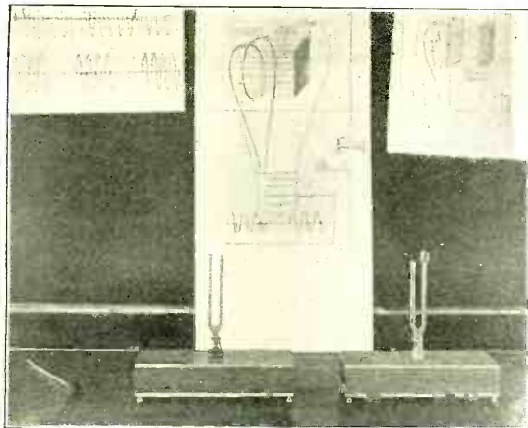
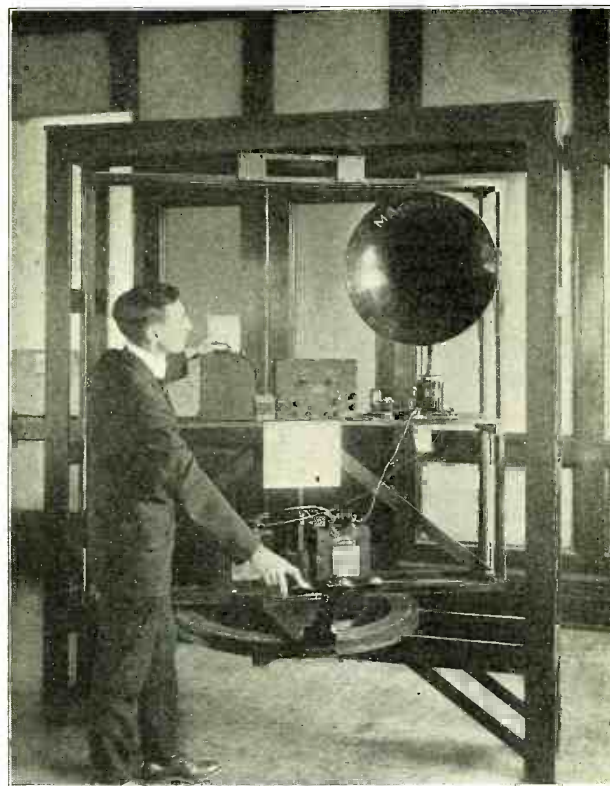

Fig. 5 A. On the left two tuning forks are used to demonstrate the phenomenon of resonance. If some wax is fixt on one of the tuning forks as may be seen on the one placed on the right, this changes the frequency of the sound waves and when the former is struck the latter does not respond.

Fig. 14. On the right is a complete radio compass station, including a loud talker.



by means of them that radio communication is carried on.

It is an interesting fact that radio waves are really of the same kind as light waves. We are all familiar with light waves and it should help to make radio waves less mysterious to know that they both are electric waves. The difference between light and radio waves is the frequency of alternation. Thus electric waves are much more common things than is sometimes supposed. Electric waves are used for many purposes, their use depending on the frequency of the waves. This is shown by the following table showing the frequencies of the various kinds of electric waves. By frequency is meant the number of vibrations per second or the number of to-and-fro alternations of the electric pressure as the wave travels out thru space.

Waves Produced by	Vibrations per Second
Commercial Alternating Currents	.25 to 500.
Telephone Currents	.16 to 3,000.
Radio	10,000 to 30,000,000.
Heat and Light	3,000,000,000,000 to 3,000,000,000,000,000.
X-Ray	3,000,000,000,000,000,000.

All of these waves travel at the same speed. These electric waves are of an entirely different nature from sound waves. Sound waves are not at all electrical; they consist of actual to-and-fro motions of the air particles and travel with a speed of about 1,000 feet per second. The speed at which electric waves travel is much greater than this; it is so great that the passage of any kind of electric wave is practically instantaneous. The various kinds of electric waves shown in the table are much alike in many ways but they have some characteristic differences.

The waves are radiated and spread out more effectively the higher the frequency. The ordinary low frequencies used in the alternating currents which light our houses alternate very slowly. Such waves travel readily along wires. In order to get a wave which will travel effectively thru space, higher frequencies must be used; that is why the frequencies shown in the table for radio communication

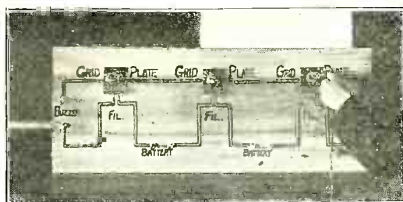

Fig. 6. Diagrammatical Arrangement of Vacuum Tubes Showing the Principle of the Amplifier.

make a large number of vibrations per second.

It is to be noted that these frequencies

are not, however, as high as the frequencies of light waves. Light travels in straight lines, which is one of their characteristic differences from the low-frequency waves of alternating current power which follow along wires. Radio waves are intermediate in character between the two, and can travel in straight lines and also travel along conducting wires. Radio waves are different from light waves also in that they go thru ordinary walls of buildings and other obstacles which are opaque to light.

We are now ready to consider how an electric wave may be produced.

Whenever there is an electric circuit in which alternating current is flowing, an electric wave starts out just as a sound wave starts out from a vibrating tuning fork. A powerful sound can be produced by using a very large tuning fork, and similarly a powerful electric wave is produced by making some part of the electric circuit large in dimensions. The antennae used in radio work, as is well known, often consist of long conductors supported on very high towers. A mechanism for producing a radio wave, therefore, is simply an enlarged or extended portion of an electric circuit in which an alternating current is made to flow. In the space near the antenna, alternations of electric pressure are produced just as alternations of air pressure are produced around a tuning fork. At any instant the electrical condition of the space around an antenna which is sending out radio waves, could be shown by a diagram such as Fig. 5. The arrow on the line extending between the antenna and ground indicates that the electric pressure at a particular moment is in the direction indicated. When the current changes in direction, the direction of this electric pressure will be reversed and the electric pressure already mentioned will have handed on its effect to the surrounding space. Thus the effect of an electric pressure is handed on and spreads out thru space, the direction of this pressure at any point constantly alternating as the direction of the current in the antenna producing it alternates. Lines of electric pressure alternating in direction are thus constantly spreading out from the antenna just as the ripples

(Continued on page 710)

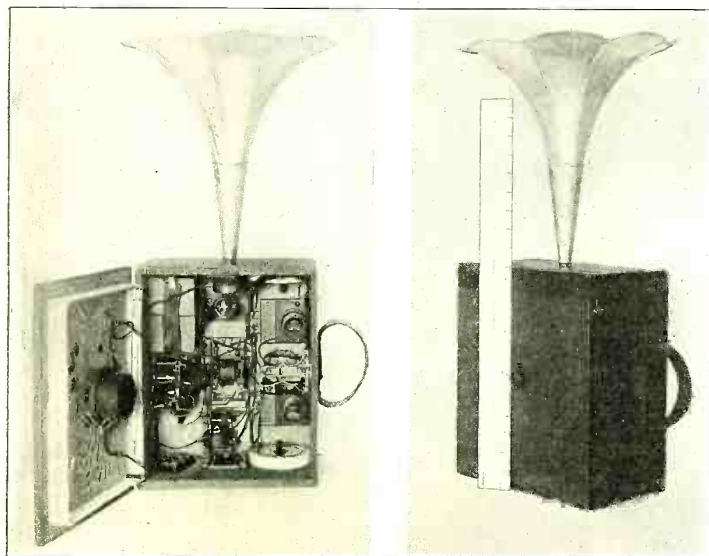

Fig. 13. Here is a complete portable receiver using a loop aerial which is fixt inside the box. The signals are detected and amplified to such an extent that when the horn is fixt on the box, music and speech as well as radio signals can be heard by several persons in a room. This apparatus was designed by the Bureau of Standards.

# Get Your Friends Interested

**T**HERE is no time like the present, amateurs, for getting busy and interesting some of your friends, relatives or neighbors in the fascinating game of Radio. Fellows who "hang out" evenings at the pool-room, dance hall, or movies for want of some place else to go may be just waiting a chance to take up the work and will jump at the opportunity if a "bug" will only make the suggestion.

Aside from the interest and enjoyment a fellow gets out of learning radio and making his own instruments, he is gaining knowledge and education that can be developed into a profession or trade. Many bright boys and young men who are spending their evenings in idleness or bad company simply because they haven't found an interesting "hobby," will make good members for amateur radio clubs, if once interested in the work.

There is undoubtedly a big future for the amateur of today in wireless telephony, as it will assuredly take the place of the telephone within a few years. There will then be many good positions open for the young man who now comes in on the ground floor and gets a thoro, practical knowledge of radio.

There is also a great deal of pleasure connected with amateur work, especially in the long winter evenings. Seated in a

warm, cosy room, the amateur's receiving set brings him all the latest news, concerts by great singers sung many miles away, and he is able to hear European stations in conversation with the United States.

Now, boys, there is an additional reason for getting interested in radio. The "reason" being shown in the accompanying photographs. Some of you fellows may not have known it, but many of the fair sex have gone in for radio and more are taking it up all the time. They are making good at it, too.

What could be more interesting than a radiofone conversation during a long, lonesome evening with a sweet-voiced girl on the "other end"? Wait until the radiofone becomes more universal and we predict many a romance will be started just this very way.

Not only in winter, but in summer as well, Radio is mighty interesting; with the spring the portable sets appear and many a one gets busy on the construction of a complete station to be used during the vacation at camp or on week-end trips.

Just recently, in New York City, we saw two girls with a "vanity case" receiver and

an umbrella aerial receive a message from "somewhere" while walking on Madison Avenue. The antenna was of the spiderweb type altho it is really an umbrella type aerial and sewed on a parasol; the receiver of the smallest kind, was a wonder and using a water hydrant as a ground the two "Radio butterflies" (that's the name for female "Radio bug") could hear the voice of somebody, probably a bug, telling them something funny, if we believe the photograph showing their smiling faces!

After being introduced to the radio butterfly, we took a look at the set which evidently was of the smallest type being built at the present time. The detector was only a crystal, but just wait until some small V. T.'s come out and then we

shall see some real portable sets.

A novel feature in this girl's set is that in the cover of the box is a mirror and the customary powder "tank" and puff! And the box containing all these instruments is only 5" x 4½" x 3½".

In a word Radio is becoming more popular every day among the public, and it is

(Continued on page 709)



This Photograph Shows the Latest in Portable Radio Sets. The Aerial is Sewed on an Umbrella and a Hydrant is Used as a Ground as Shown in the Right Hand Photograph. On the Left is a View of the Two "Ops" Listening in to a Fone Conversation While Out For a Walk. These Two "Ops" are Miss Peggy and Alice Brady, of the Ziegfeld Midnight Frolic.



Here is a Girl Who Owns a Real Set. The Girl and the Set Are in Brooklyn, N. Y.

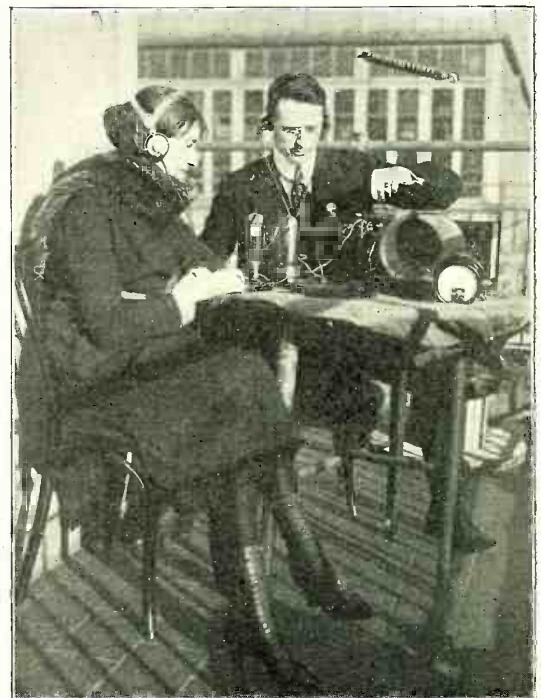

A Girl Amateur Receiving Some Instruction on C.W. Sets at the Radio Convention Exhibition of the Second District.

# New Universal Range Receiver

By ARTHUR H. LYNCH

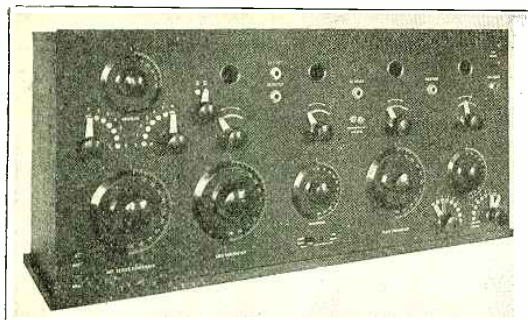

A New Receiver Including a Short Wave Regenerator and a Long Wave Set, With Detector and Three-Stage Amplifier.

coupling coil, which is of the rotary type controlled by the dial-knob, located in the upper left-hand corner of the panel. Maximum coupling is obtained when the setting is at 50 and minimum when at 0. In series with this coupling coil is the grid variometer, controlled by the dial-knob shown at the lower section of the

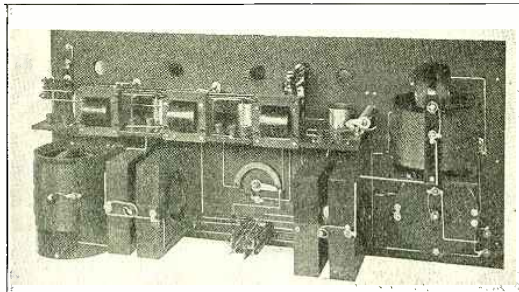

Inside View of the Universal Receiver. Note on the Left the Long Wave Set and in the Center the Switch Changing From Short to Long Waves.

**A**LTHO most amateur reception is carried on within the range of 3,000 meters, many experimenters being satisfied to limit their waves to incorporate that of NAA, there are times when the copying of transoceanic signals are of interest and value. It is to fill this purpose that the set herein described was devised. In the sense, that it will cover all wave-lengths in use, it may be called a "station" receiver.

There are two main groups of wave-lengths, the first, 150-680 meters, is broken up into smaller divisions which interlap, their ranges being 150-375 and 280-680, respectively; the second, 550-20,000 meters, is for the long wave operation. As will be observed from the photograph the wave-length change, from the first or short wave section to the second or long wave section, is effected by simply throwing the anti-capacity key which may be seen in the central lower part of the panel. The two intermediate ranges of the short wave section are controlled by the switch, so marked and located above and to the left of the detector filament rheostat. The two main sections or circuits, with relation to this anti-capacity change-over, have been designed in such a way as to have them terminate or be separated by it, at the points of minimum reaction between the active and the dead circuits.

### THE SHORT WAVE ARRANGEMENT.

The primary circuit consists of a variable condenser in series with the primary of the vario-coupler adjustable in single turns and groups of six turns.

The secondary circuit comprises the

panel, to the right of the antenna condenser control. Wave-length is increased or decreased in this circuit as the figures on the dial indicate. A shunt capacity of .0002 mfd. is thrown into this circuit when waves above 500 meters are desired.

The regeneration and amplifying actions of the plate circuit are produced by means

of the plate variometer, indicated on the panel. This variometer functions thruout the entire range of the short wave plate circuit.

of the plate variometer, indicated on the panel. This variometer functions thruout the entire range of the short wave plate circuit.

sign, telescopically mounted in the large Cellulak cylinder, and a coil of bank-wound litz wound on the exterior of the cylinder. The amount of inductance desired is thrown into circuit by the specially designed switch located in the lower right-hand corner of the panel. With each step of inductance thus added, the wave-length is approximately doubled, as 550, 1,100, 2,200, etc. A tickler coupling is provided wound on a ball-shaped wooden form, orientated in the long wave field by means of the dial-knob shown just above the inductance switch. In conjunction with the tickler winding there is a seven point by-pass condenser, controlled by the second switch at the lower left of the panel. These last two elements are for use in regulating the regenerative action. Altho the degree of selectivity where a single circuit is employed can never be as great as is found in coupled circuits, a resultant signal strength is found to exist affording the same consistent operation.

### THE DETECTOR AND AMPLIFIER CIRCUITS.

In its entirety, the tube circuit comprises a detector and three-stage audio frequency amplifier, entirely under automatic control, and embodying several improvements. The transformers are of a new and rugged design, which does away with the difficulty which occurred so frequently in the past when the windings have been cut by the sharp edges of the core. The tube sockets and amplifying transformers are mounted on a bakelite bracket, fixed behind the panel.

(Continued on page 728)

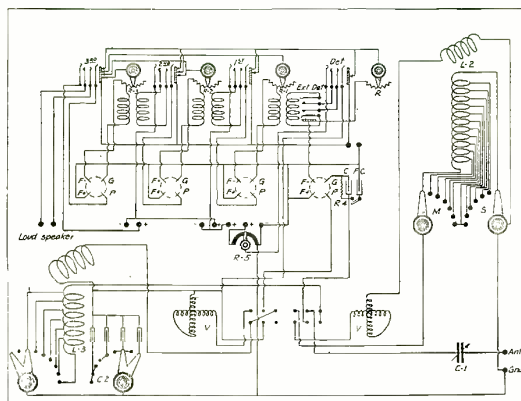

Complete Hook-up of the New Receiver Embodying Several New Features.

### THE LONG-WAVE CIRCUIT.

The receiving is done on long waves, by means of a single circuit. The inductance is composed of a number of universal wound coils of special dimensions and de-

## Some New British Apparatus

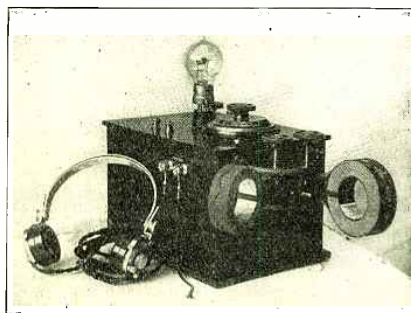

A Complete Autodyne Receiver Using Honeycomb Coils for Tuning. The V.T. is Used as Detector and Oscillator and Only One Knob is Adjusted to Tune the Different Circuits at the Same Time.

A complete receiver, two photographs of which appear on this page, has recently been placed on the market in England.

The set is composed of a receiver using honeycomb coil inductances and fitted with a V. T. detector which acts at the same time as oscillator for the reception of undamped waves.

The other part of the set is a three-stage audio frequency amplifier having but one filament control rheostat. When used together, these two instruments make a very sensitive receiver tuning in any wave-length, on the short aerial that the English amateurs are permitted to erect.

The receiver itself may be used alone if desired and itself forms a complete unit, but with the amplifier, signals are amplified enormously and with a loud talker may be heard very far from the set.

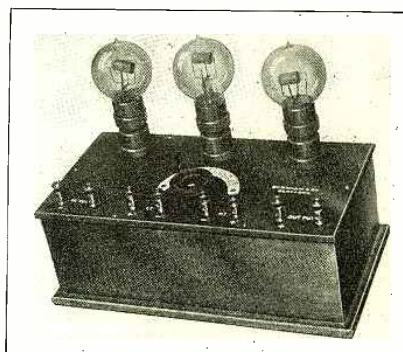

A Three-Step Audio Frequency Amplifier Using R Tubes. Only One Rheostat is Used to Control the Filament Current of the Three Tubes.

# Tests of Insulating Materials for Radio Use at the Bureau of Standards

By S. R. WINTERS

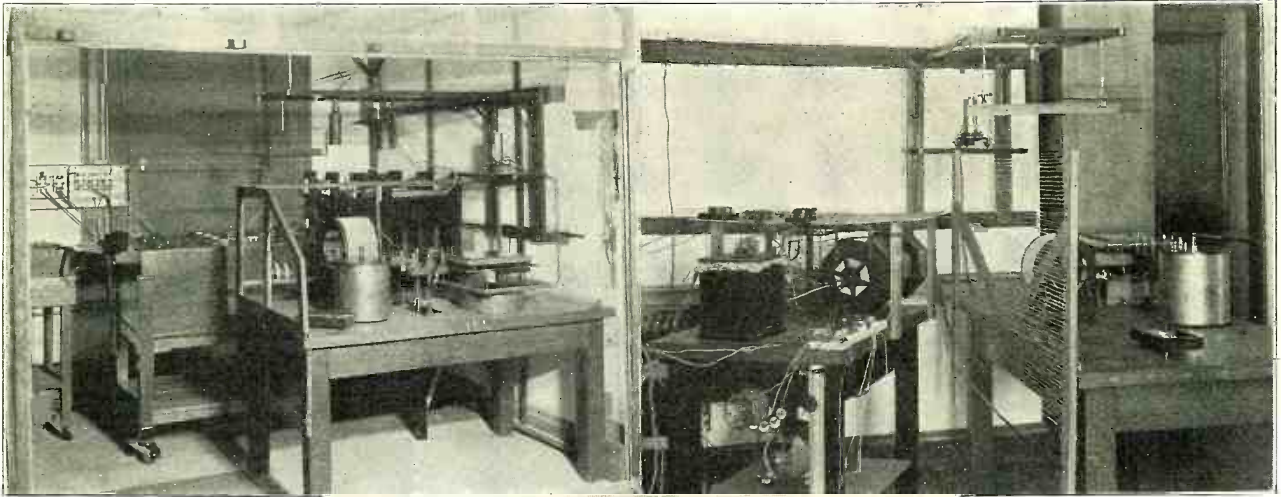

**T**HE quality of paper used, rather than the excellency of the varnish, is a determining factor in manufacturing radio insulating materials, if we are to accept with a degree of finality the conclusions of a series of comprehensive tests conducted by the Radio Communication Section of the National Bureau of Standards. The experiments involving the circumspect examination of properties entering into the construction of wireless apparatus were negotiated by J. H. Dellinger and J. D. Preston, the tests running thru a period of years. The specimens subjected to the rigid observation were obtained from various manufacturers, the investigation having its inception with an insulating company who invoked government analysis by reason of its product suffering a reputation of alleged inferiority from criticism of rival companies.

The conclusion of the Bureau of Standards is that there is no outstanding superiority of one material over any other. That is, one company can produce a product of quality commensurate with that of any other concern provided due attention is pledged to the properties of the material and the factors entering into its composition. The investigation included the class of materials enjoying popularity, namely, those of the phenol or occasionally denominated the bakelite type. A wide variety of electrical and mechanical properties of the materials were measured, altho the principal object of the tests was to determine the suitability of materials for radio uses. The nature of the materials resolved itself into two general classes, the laminated and moulded products. They contain a phenol resin or varnish of the general type invented by Doctor Baekeland. The moulded materials are a combination of the phenol varnish with a filler material in ground or pulverized form, the composite product being poured into a mould and shaped as desired. The laminated materials are made by saturating layers of paper with the

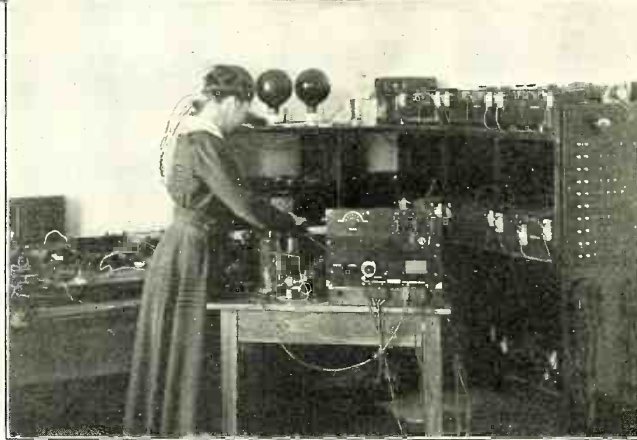

On the Upper Left Hand Photograph is Shown How Some Bakelite Plates Are Tested Under High Tension and High Frequency Current. Behind the Table Are a Receiver and a Wave-meter and on the Shelf Over the Table is a Sensitive Galvanometer Used for Measurement of Losses in Dielectric. On the Right Hand Photograph Can Be Seen the Shield Fixt on the Table Between the High Tension Apparatus and the Various Meters. The Lower View Represents the Test of Dielectrics With a C.W. Set as a Supply of High Frequency Currents. Note on the Right the H. T. Storage Battery.

phenol varnish, creating a composite product in slab form of many layers. The process of manufacture involves the reacting of a mixture of formaldehyde and ammonia or equivalent product upon a phenol at high pressure and temperature. The heat applied is about 110 degrees Centigrade. The varnish is soluble in alcohol, sheets of paper being dipped into the solution and a sheet of specified thickness built up. Under a heated pressure of 1,000 pounds to the square inch in a hydraulic press the process of manufacture is completed.

Insulating materials of the laminated type were investigated from these sources: The Continental Fibre Company, who manufacture bakelite-dilecto; Westinghouse Electric Manufacturing Company, producer of bakelite-micarta; Formica Insulation Company, makers of formica; Diamond State Fibre Company, who manufactures condensire-celoron. The Formica Company uses as a varnish a product termed redmanol, produced by the Redmanol Chemical Products Company, while the other companies employ some form of bakelite

made by the General Bakelite Company or Condensite Company of America. These laminated insulating materials are used in vast quantities for making panels and parts of apparatus for radio and other electrical equipment as well as for technical and commercial uses. Moulded materials containing the same varnish are used for making countless numbers of small parts in electrical apparatus of varying kinds and in other products; notably, records for talking machines. The specimens subjected to measurements to determine their electrical, mechanical and thermal properties consisted of actual sheets of material as regularly supplied for commercial use. To illustrate, for radio measurements condensers were made up using an actual slab of material such as is used in the construction of apparatus; that is, regular stock supplied by the manufacturer.

## DETERMINING TENSILE STRENGTH.

The method of measurement in determining the tensile strength involved the use of samples 12" long by 1" wide with the width reduced in the center to 3/4". The transverse strength test involved the use of a rectangular 12" specimen, loaded in the center of a 10" span. Brittleness was determined in this fashion: A piece 3" long was inserted in a vise, a hammer on a pendulum arrangement delivered blows to the material, and the distance of the swing beyond the specimen was used to compute the energy necessary to break the material. Familiar was the method of revealing the hardness of the specimen; merely, pressing a steel ball into the material and then measuring the diameter of the indentation, by preparing and weighting a small square sample, subsequently giving it a 24-hour bath in water, and then measuring the product, the absorption of the insulating material was made known. The result was expressed as the percentage change of weight. As to electrical measurements; the volume

(Continued on page 683)

# Aeroplanes and Radiogoniometers

By ARMSTRONG PERRY

**S**UPPOSE you were navigating an aeroplane, a mile above the ocean, enveloped in clouds so thick you could not see a hundred yards ahead, going a mile a minute, with only an hour's supply of gas and you didn't know in which direction you were flying nor where you could find a landing place.

What would you do?

Use your radiogoniometer, of course.

This instrument with a long name, which means radio compass, is not hard to understand if you know the principles of radio. Those who do not may skip to the next paragraph while I explain it to those who do. They will understand what I mean when I say that it or one type of it consists of: (a) two loop aerials, triangular in shape, mounted at right angles to each other on a common vertical axis; (b) two field coils, also mounted at right angles to each other on a common vertical axis, with a variable condenser in series with each; (c) a search coil mounted at the center of these field coils, on the common axis but free to turn on it independently; (d) a receiving set, preferably with a valve amplifier. These different elements must be tuned to each other and to the stations whose signals are to be picked up. The standard wave-lengths are 300 and 600 meters.

Even the beginner will understand what I mean when I say that by turning a knob on the radiogoniometer you can make the incoming signals sound louder or weaker.

## CALLS FOR TEST LETTERS.

The airman is always at liberty to ask any radio station to send the test letter, *de-de-de-dah*, for two or three minutes at a time while he is getting his bearings.

The knob turns the search coil and it also turns an indicator arrow. When the signals are loudest, the arrow points exactly toward the sending station. Quickly the airman draws a line on his chart or map, showing this direction. He also indicates North and the direction of his flight as shown by his magnetic compass.

Then he calls another station and notes directions on the chart as before.

If necessary he calls a third.

The point where the lines meet is approximately the position of his machine. Of course he has to make allowance for the distance traveled while making his observations.

He knows the geographical locations of the stations called, or can find them by looking up their call letters in his list. Perhaps one is in New York, one in Boston and one in Norfolk, Va. It does not take him long to decide where to steer to find a landing place.

His calculations might not be exactly correct on account of the variations of magnetic compasses and the difficulty of plotting the curved surface of the earth on a flat chart, but he could correct his course by using his eyes when he was out of the clouds and nearer the earth.

## AMATEUR CAN TRY AVIATOR'S METHOD.

The radio amateur can get most of the sensations of the lost airman finding his way if he will use his ingenuity and his imagination.

Construct a loop aerial by winding antenna wire on a wooden frame four feet, six feet or eight feet square. The larger the loop, the more energy it picks up. On the other hand, the larger the loop, the more static and other interference it picks up.

Use No. 22 annunciator wire. For receiving 200-meter waves—the maximum wave-length which the law permits amateurs to use in transmitting—only one turn of wire is needed. For 600 meters, use three turns. For 1,000 meters or over, use twenty turns.

The spacing of the wires is important. If you have an 8-foot frame, space the turns  $\frac{3}{8}$ " apart; on a 6-foot frame  $\frac{1}{2}$ "; and on a 4-foot frame  $\frac{1}{4}$ ". You may have

then pick up another station and repeat the process.

This method is crude and these observations alone will not tell you which end of your arrow points toward the sending station. If you are not sure of the location look at a map in your geography, but ordinarily you should know where you started, which way you flew and the general direction of important radio stations. Whatever your results, you at least will begin to understand the principle of direction finding.

Another way to practice is to take your receiving outfit and, in a day's journey, chart the directions of the same stations from several different points.

## IMAGINATION INSTEAD OF APPARATUS.

If you have no radio apparatus at all, you can do it all in imagination.

Here we are up in the air.

*Dah-de de-dah de-dah*, in comes NAA.

While he shoots his message to someone somewhere you turn the knob of the radiogoniometer and nail him at 230°.

*Dah-de de-dah de-de-de-de*, there's NAAH. You draw a bead on him at 275°.

You plot the lines. From the point of intersection you extend another to show the distance covered by our machine, at 100 MPH in the three minutes since we picked up the last station.

Are you sure you know where you are? Check it all up and make sure, for it's a lonesome job dropping into the ocean sixty miles from land, even if in imagination you have a flying boat.

A station pointer will make your work quicker and possibly more accurate. You can make one in half an hour.

Lay a dinner plate on a sheet of cardboard and draw a line around it.

Center a tea plate inside the circle and draw another around the tea plate.

Remove the plate, find the center of the circles and mark it. Divide the circumference strip into 36 spaces of 10 degrees each.

If you have patience, mark all 260 degrees, beginning at zero for north and going around as the clock hands travel.

Make three cardboard arms—straight on both edges—long enough to reach from center to circumference. Fasten the three at the center with one pin.

Cut away as much of the cardboard as you can so that you can see your chart thru the holes when the station marker is placed upon it.

Now instead of drawing lines upon your chart, you lay the station marker upon it, with zero at the north. As you pick up your stations, adjust an arm to show the direction of each.

If the observations could be made simultaneously, the center of the station marker always would show the position of our airship. But they cannot, so we have to allow for the fact that we cover five miles or so every three minutes.

Games like these will soon lift you out of that class of boys who have nothing to

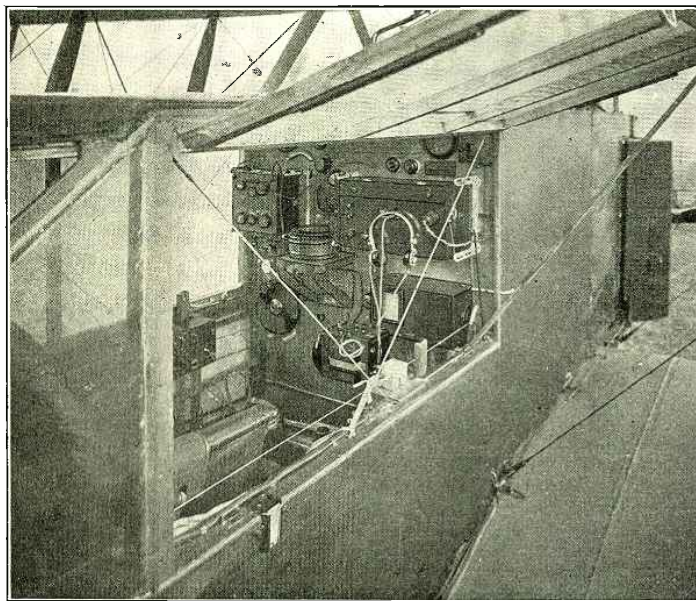

Inside View of the Radio Room Aboard an Aeroplane. Note in the Upper Left Hand Corner the Receiver. On the Right is the Amplifier Mounted on a Frame With Elastic Suspension to Avoid Vibrations.

two or three aerials on one frame, connecting in the single turn, the three turns or the twenty turns, whichever you need for the station to which you want to listen.

Disconnect your flat top aerial and connect the loop aerial, in series with the primary circuit of your receiver. The loop aerial is not grounded, nor connected with the earth.

Listen in until you hear a station.

Write down the call letters, then turn your loop aerial until you get the loudest signals. The plane of your aerial then coincides with the direction of the advancing radio waves. In other words, an arrow stuck thru your coil, passing between the wires on each side and parallel to the earth would point toward the sending station. In practice, operators usually find the minimum position—the position in which the signals are faintest—for the maximum is harder to determine exactly by the ear. Maximum is always just 90°, a quarter of a circle, from minimum.

Draw lines on a chart, as the aviator did,

(Continued on page 752)

# Awards of \$100 Portable Radio Prize Contest

## FIRST HONORABLE MENTION

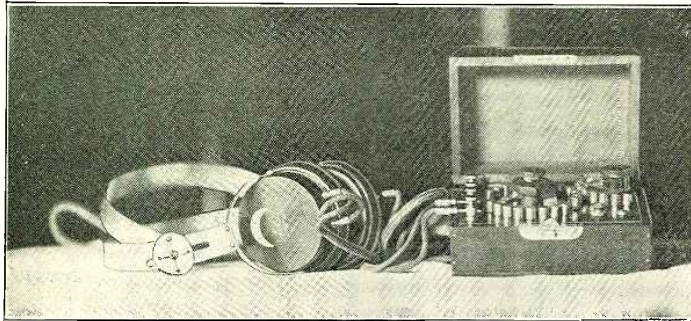

On the left is a view of the complete portable set, which was awarded the first honorable mention, while on the right is a detailed view of the panel.

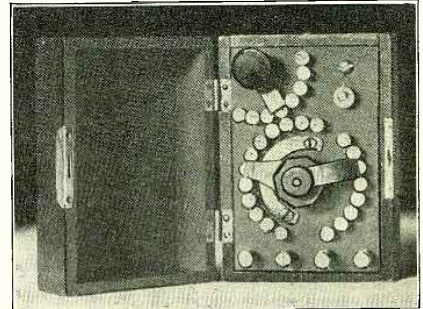

**T**HIS set is of my own design and construction.

A good idea of the size of this set may be obtained by comparing it with the receivers lying beside it, as shown in one of the photographs, and also by comparing it with the hand holding it as shown in another. Altho it is small enough to slip into any coat pocket, including the aerial and ground, it has given me exceptional results.

The outfit itself, as already stated, consists primarily of a one-wire aerial, ground connection, receiving set, and a pair of five hundred ohm fones.

The aerial is composed of two strands of No. 30 bare copper wire twisted into one; one hundred feet long, and a lead of fifty feet taken from one end. To carry in the pocket it is wound on a typewriter rib-

ground clamp with me, so that in case there should be a water pipe handy I could get a ground that is without doubt, superior to the one mentioned above.

The set itself is built into a small wooden cabinet, made of  $\frac{1}{8}$ " material taken from a cigar box, and given a good oak finish. A small lock taken from a Gillette razor case is used to fasten down the lid. It measures  $4\frac{1}{4}$ " by  $2\frac{1}{8}$ " by  $2\frac{1}{8}$ " over all.

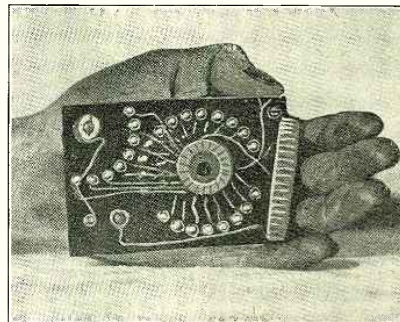

Inside View of the Set. Note on the Right the Primary Coil Removed to Show the Secondary and Taps.

Most every Radio "Bug" has a different idea of what would be the most efficient tuner for portable sets. Some prefer honeycombs, others ordinary tuning coils, others bank wound tuning coils; but I think that the ring wound or doughnut type

transformer when carefully constructed, has them all beaten for compactness, and in most cases in efficiency as well. This transformer will tune to a wave-length of approximately 800 meters. It measures, a minimum diameter of  $\frac{1}{2}$ " for the secondary, and a maximum diameter of  $1\frac{3}{8}$ " for the primary, and is  $\frac{3}{4}$ " in height.

The secondary consists of 320 turns of No. 32 S. C. C. wire, and is tapt once every forty turns, giving eight taps. These eight taps are connected, one tap each, to the eight point switch shown in the upper right hand corner of Fig. 1.

The primary consists of 232 turns of No. 30 S. C. C. wire. Every other turn of the

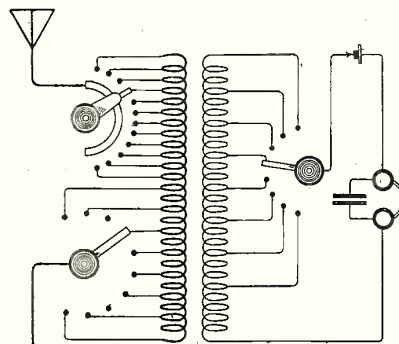

Figure 3

Hook-up of the Receiver Showing the System of Tuning With Unit and Multiple Switches.

bon spool and when to be used, it may be suspended between two trees, buildings, etc., by throwing over a stone or other handy weight, to which a string has been attached, and then drawing the aerial up after it; but first however, fastening a 2-wire cleat at each end to insulate it.

I have tried several kinds of aerials, such as the loop aerial, tree aerial, etc., but have found that a one-wire aerial like the one described above, will give the best results with portable sets using crystal detectors; besides, having the added advantage of being able to be rolled up very compactly, so that it will along with the necessary insulators and twine, readily go into a hip pocket.

The ground connection is simply a  $\frac{1}{8}$ " copper plate,  $2\frac{1}{2}$ " wide, by 4" long, to which a length of No. 18 copper wire is fastened for the lead. To ground the set, the plate is laid preferably in a pond, river or other body of water or, such not being available, is buried a foot or so in as moist earth as can be found. I also carry a

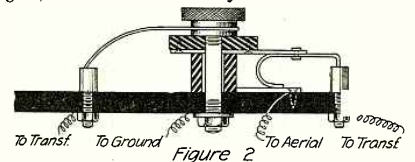

Figure 2

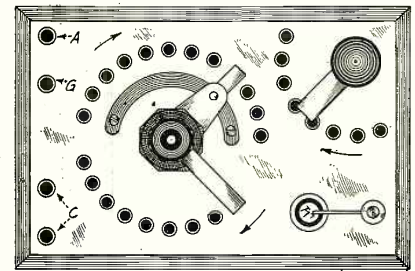

Figure 1

Fig. 1 Shows Layout of the Panel. In the Center are the Primary Unit and Multiple Switches and on the Right the Secondary Switch and Detector. Fig. 2 is a Side View of the Primary Combination Switch.

first sixteen is tapt, giving eight taps. These taps are connected to the eight point section of the primary switch. The remainder is tapt once every eighteen turns, giving twelve taps, which are connected to the twelve point section of the primary switch. These leads are less than  $\frac{1}{2}$ " long.

This method of tapping allows very fine tuning.

The primary switch is made interpolating to conserve space, and is constructed as shown in Fig. 2.

A crystal detector is employed, using a very sensitive piece of radiocite. The cup is the cap from a battery binding post and is fastened to the bakelite panel from the back by an 8-32 machine screw. In this cup the radiocite is fastened by wedging tin foil around it. The contact, or catwhisker, is a piece of No. 28 brass wire, filed to a point at one end, and fastened to the panel by means of another machine screw at the other.

A small fixt condenser, made from two  
(Continued on page 752)



Photograph of Mr. William F. Marquardt, Designer and Builder of the Portable Set.

# A "B" Battery of the Edison Storage Type

By W. H. FARR

HERE is probably no one item in the equipment of the amateur radio station which gives so much annoyance as the "B" battery. Of course most amateurs use some form or other of dry cells, as these are convenient, readily obtained, and the comparatively low first cost makes them appear to be the most economical type of battery. The dry cell, however, is far from being ideal, and has many weaknesses. In the first place, the dry cell is rather short lived at best, and especially so in the smaller sizes, which are usually used in radio work. It has an aggravating habit of running down even when not in use and often gives out just when it is wanted the worst. When once exhausted, it cannot be renewed, but must be thrown away and a new supply purchased. Another fault of the dry cell is that the voltage gradually drops as the cell deteriorates. In fact the discharge curve is rather steep. The result is that when used with vacuum tubes which require a critical adjustment of the plate voltage, the number of cells in the circuit must be adjusted from time to time to compensate for this gradual drop in potential.

## MANY PREFER STORAGE CELLS.

In view of all these facts, many of the more progressive amateurs have abandoned the use of dry cells for "B" batteries, and are using, instead, small lead storage cells. There are many advantages to be gained by the use of storage cells for this purpose. On account of the greater current capacity, a storage battery makes possible the successful use of a potentiometer for voltage control. When used with dry batteries it usually runs them down too fast. As a rule the voltage of a storage cell is much more constant than that of a dry cell, which is a very desirable feature in a "B" battery. One of the biggest advantages, however, is the fact that a storage cell can be so easily recharged when exhausted. (A small electrolytic rectifier for this purpose can easily be constructed by the experimenter.) Finally the life of a storage battery is infinitely longer than the best dry cell made.

The facts which have been mentioned above apply to both types of storage cell, the lead-acid type and the iron-nickel-alkali, or Edison type. A comparison of the characteristics of these two types will disclose several facts which affect their use as "B" batteries. One advantage of the lead-acid storage cell is its comparatively high voltage, about two volts per cell. Also, they are rather easily made, that is if the positive plate is not "pasted" or filled with active material. On the other hand, the lead cell has the disadvantage that it requires considerable care to keep it in good condition. It should be charged at regular intervals, and not allowed to remain in a discharged condition for any length of time, to prevent sulphating. An accidental short circuit will sometimes ruin it. To secure the best results it should be charged at a low rate, which means a long charging period. There is considerable deterioration even when the battery is not in use, which means that it must be charged just about as often whether in use or not, to keep it in good condition. If the cell does not have positive plates which are

"pasted" or filled with lead oxide, it will hold a charge only a short length of time and will have to be charged every few days. Finally the lead cell is heavy, and usually not readily portable, and the sulphuric acid is rather dangerous to handle.

## ADVANTAGES OF EDISON CELL.

In contrast to the above facts, the Edison storage cell has many advantages. It is the most rugged and dependable of any type of storage cell, and is practically "fool-proof." It deteriorates very slowly when standing idle, and is not injured by standing partially or fully discharged. Also it is not damaged by accidental short circuits. It will stand a high charging rate, even up to 300 per cent. of normal, without any injury, which means that it can be brot into service very quickly when found to be run down. The discharge curve is quite flat, which means a very constant voltage throughout the whole period of discharge, a fact

about  $4\frac{1}{4}$ " long and  $\frac{1}{8}$ " in diameter. These have been filled with alternate layers of nickel oxide and flake nickel under heavy pressure. The negative elements are flat pockets of perforated steel about 3" long,  $\frac{1}{2}$ " wide and  $\frac{1}{8}$ " thick, containing specially prepared iron oxide. The electrolyte is a 21 per cent. solution of Potassium Hydroxide in water.

Of course it is necessary to obtain a storage cell and completely dismantle it in order to obtain the material for constructing a "B" battery as described below. However, a large number of these miniature cells can be made from one storage cell. The plates of the size shown in Fig. 2 have 32 elements in each positive plate and 24 in each negative plate. These elements are easily removed from the grids in which they are held, and as they are very substantially constructed, there is no danger of breaking or injuring them in handling.

It will be noted that the elements are a very convenient size for making test tube cells, it being possible to build a cell into a test tube as small as  $\frac{3}{4}$ " in diameter. In building the cells described below the writer cut the positive tube off to the same length as the negative one for convenience in handling.

## DESCRIPTION OF "B" BATTERY.

The following is a description of one of the complete "B" batteries of sixteen cells as built and used by the writer. As will be seen in Fig. 1, the battery is contained in a hardwood case  $4\frac{3}{4}$ " square by 7" high. The individual cells are contained in glass test tubes  $\frac{7}{8}$ " in diameter and 5" long. The test tubes were blocked in place in the case and the intervening space poured full of melted paraffine. This is a very convenient method of holding the cells in place, and it also eliminates any danger of breakage. Each cell is closed with a one-hole rubber stopper having an air vent consisting of a short glass tube drawn down to a small opening at the lower end. The connections to the Edison elements are made with nickel wire (to avoid corrosion), the wires being simply twisted around the elements (not soldered to them). A small block of  $\frac{1}{8}$ " sheet hard rubber is placed between the elements at each end to act as a separator, and they are held together with rubber bands. The terminal wires are threaded thru the rubber stoppers. This construction renders the cell practically air tight, which is necessary to prevent deterioration of the solution. A complete cell with the exception of the test tube is shown at the right in Fig. 1.

A battery of sixteen of these cells gives about twenty-four volts when fully charged. The voltage remains remarkably constant, on one test only dropping two volts in three weeks. In fact, it has been found necessary to charge these batteries only about once in three or four weeks.

A "B" battery that requires so little trouble to maintain and that is so dependable in its performance is a great convenience in the radio station, and the experimenter who is willing to take the trouble to construct one will be amply repaid for his time and labor.

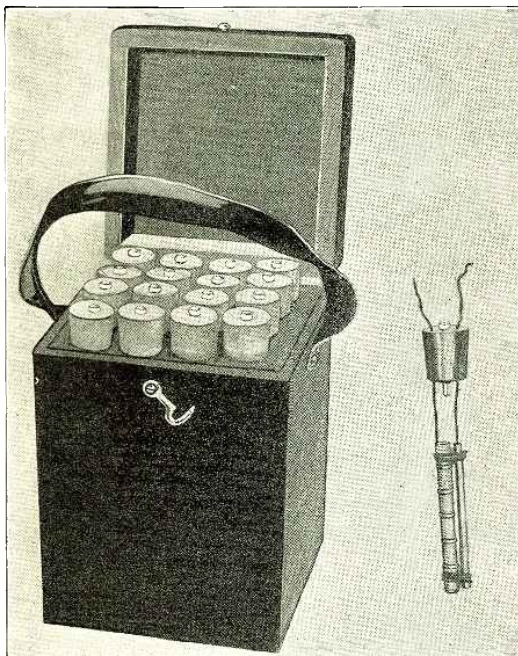

A Practical "B" Battery May Be Built With Elements From an Edison Cell. This Photograph Shows a Portable Battery and a Complete Element Removed From a Tube.

which is not true of either lead storage cells or dry batteries. This is a very desirable feature in a "B" battery. On account of its ruggedness, its life is longer than that of a lead storage cell. It is somewhat lighter than a lead cell and is better adapted to portable sets.

The many superior qualities of the Edison Storage cell as described above, convinced the writer that it would make a very satisfactory "B" battery. It is not marketed in suitable form for such use at present, but the design of the plates lends itself readily to the building of small cells, as will be seen from the following description of the construction of the Edison cell.

The plates of the Edison Storage cell, as will be noted in Fig. 2, consist of steel frames or grids, which hold in place the tubes or pocket of active material. The positive elements are perforated steel tubes,

# A New Radio Instructor

UP to the present time, the blackboard in most of the Radio Schools was used to demonstrate to the students the various hook-ups of the sets used aboard the ships and in land stations.

The theory of the functioning was first explained and then practical demonstrations were made on a set itself; but sometimes this was not very clear to some of the students who could not follow the various circuits and understand the rôle of each apparatus when the set was in operation.

To overcome this, and make the explanations more clear, the Radio Engineers of the Telefunken Co. have designed a special panel, on which are fixed all the instruments composing a set. The wiring is apparent and the set may be operated as a regular set.

When a course is made, the teacher can show the various elements of the set in working order and show what happens when a change is made in the circuit or the set tuned.

This clever idea greatly helps the student to understand the practical operation of a set and at the same time shows the diagram of connections in a clearer manner than any drawing made on the blackboard can do.

A vacuum tube is used as generator of oscillations in the transmitting circuit and as a detector autodyne in the receiver. The set is of the 10-watt type and can tune any wave-length from 350 to 2050 meters.

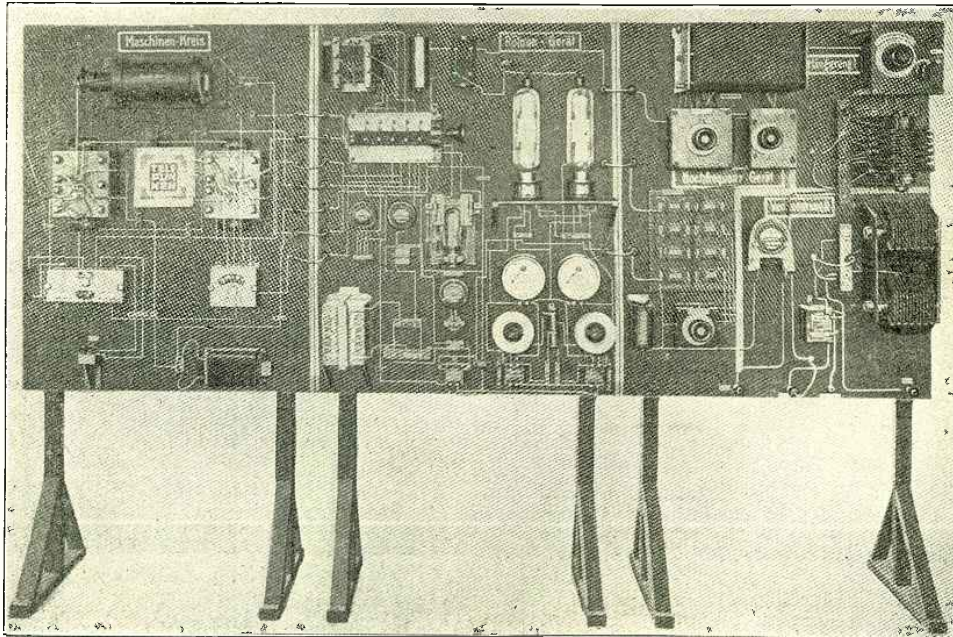

A Complete 1-K.W. C.W. Set Fixed on Panels for Use in Radio Schools. On the Right Are the Transformers and Rectifiers; in the Center the Power Tubes and Generating Circuits, and on the Left the Tuning Elements of the Circuits.

The photograph which appears on this page shows a complete 1-K.W. C.W. transmitter of the same type as the one described.

The power is generated by two 500-watt tubes which may be seen in the center panel and which are supplied with either A.C. or rectified A.C. at a tension of 3,000 volts. This panel set which is complete in itself includes the V.T. rectifiers and the generating and tuning circuit. It may be used for Radio-phony as well.

The panel set shown on the front cover of this magazine represents a complete C. W. transmitting and receiving station with an intermediate tuned circuit which is used as wave-meter to calibrate both sending and receiving circuits.

Several other panel sets, representing the various sets in use, are used in teaching the students and this method has proved far superior to the system consisting of teaching the theoretical and then practical action of a circuit.

## Indoor Aerials and Choke Coil Amplifiers

By P. Jessup

THE first part of this article deals with indoor aerials and the second with choke coil amplifiers.

Using an indoor aerial and a two-step amplifier, I have heard amateurs up to 1665 miles in New Mexico, Texas, Kansas, Nebraska and North Dakota. Using a crystal detector I have picked up amateurs up to 200 miles in 3 districts and commercial stations up to 300 miles.

The aerial is a ten strand inverted L, strung up in the attic. It is 25 feet long and the wires are spaced two feet apart. It is made of bell wire, No. 18 insulated and about 250 feet were used. It runs east and west and is directional to the west. The flat top part is about 35 feet above the ground. The lead-in is taken from the western end and is about 26

feet long. In addition to the amateurs, long wave undamp't comes in equally well. POZ and LCM have been copied about 20 feet from the fones, using a 2-step amplifier.

My receiving set consists of honeycomb coils, audiotron, Illinois variable condensers, home-made 2-step with Moorehead amplifying bulbs and Baldwin fones. The set is spread out over a table with short, direct leads.

### CHOKE COILS

My good results on amateur wave is made possible by the use of choke coils in the amplifier. Choke coils are substituted for amplifying transformers.

A choke coil is merely the secondary of a spark coil. Any spark coil secondary from a 1/2" to a 6" coil will make a fine choke coil. The primary of the spark coil is not used and may be removed if desired. A good iron core is necessary. A closed iron core is better than an open

one, but either will work O. K. The choke coils I am using at present still have the original iron core and the unused primary. One of them is from a 1/2" spark coil and the other from a 6" spark coil. Any garage will sell you old Ford spark coils very cheaply. As for efficiency, well, I get signals from choke coils from two to three times as loud as from amplifying transformers.

(Continued on page 709)

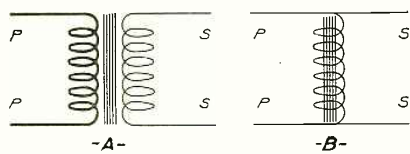
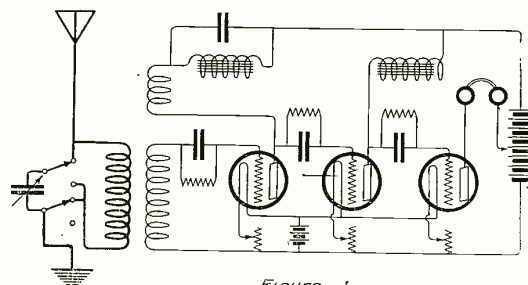

Diagram Showing How a Choke Coil May Be Substituted for an Amplifying Transformer.



Hook-up of an Amplifier Using Choke Coils Instead of Transformers. Note That Some Stopping Condensers Are Used in the Grid Circuits.



# First Annual Amateur Radio Show and Convention

**W**E walked into the spacious Pennsylvania Hotel Roof Garden on the 23rd floor and stepped into the first annual amateur radio show and convention. A noisy welcome greeted us and momentarily our friend who accompanied us and who was talking at the top of his voice could not be heard any more. In other words our hearing suddenly became jammed and stayed so for most of the time that we took in the show. The reason of course was the dozens of loud talkers scattered all over the place, one trying to outshriek the other. There were dots and dashes coming in at a high staccato with a sledge hammer effect, while wireless telephone music received from a great distance shrieked into our poor ears until our hearing almost stopt functioning.

Thus was our reception of the Radio Show under the management of the Executive Radio Council of the Second District. This, by the way, was the first annual amateur radio convention and exhibition which was held March 16, 17, 18, and 19 at the Pennsylvania Hotel in New York.

The affair was a great success and will long be remembered by the amateurs fortunate enough to be present. During the four days 7,000 visitors were in attendance and took keen interest in the displays of Radio apparatus and the interesting programs arranged for every one of the four days. The convention closed Saturday night with a banquet attended by several hundred wireless men, many of whom had never met before but who had often pickt up each other's sigs.

Practically all of the Radio manufacturers were represented and in many of their booths the new wireless apparatus on exhibit attracted a great deal of attention.

One of the especially interesting exhibits was that of the Army and Navy. They had a big display of all the sets used in the Signal Corps and aboard ships. Field sets of various power were exhibited in the Signal Corps booth and music sent from the Bedloe Island Signal Corps station via radiofone was heard almost continuously, thanks to the big loud talker installed. The

Navy, too, gave some interesting demonstrations with a loud talker, signals from distant stations and radiofone music being distinctly audible all over the big exhibition hall.

The Signal Corps and Navy weren't the only ones with loud talkers. Several other exhibitors were demonstrating them and the air was filled with music and signals that made the "ham" feel right in his element the moment he stepped into the hall.

One of the most interesting exhibits was the Radio Controlled Car which was described at length in our June, 1920, issue.

ways well attended and attracted as large a crowd of radio enthusiasts as the demonstration of the small radio controlled automobile which took place twice a day in the hall.

Mr. B. G. Seutter won the world's championship code speed contest, attaining a speed of 48  $\frac{3}{5}$  words a minute. There were more than 60 operators in the contest. The prize given the winner of the title was a handsome silver cup, 14 inches high.

The following firms had booths at the exhibition:

Acme Apparatus Company, Adams-Morgan Company, American Electro-Technical Appliance Company, American Radio Relay League, American Radio and Research Corporation, Burgess Battery Company, Chicago Radio Laboratories, Clapp-Eastham Company, Continental Radio and Electric Corporation, De Forest Radio Telephone and Telegraph Company, F. M. Doolittle Company, Experimenter Publishing Company (RADIO NEWS), Federal Telephone and Telegraph Company, A. H. Grebe & Co., Manhattan Electrical Supply Company, W. J. Murdock Company, Pacent Electric Company, Lehigh Radio Company, Radio Corporation of America, Radio Distributing Company, Ship Owners' Radio Service, Inc., Shotton Radio Manufacturing Company, Super Radio Laboratories, The Radio Club, Irvington, New Jersey, C. D. Tuska Company, United States Department of Commerce, Radio Service; United States Army, Signal Corps, Radio; United States Navy, Communication Service; Westchester Electric Appliance Co., Inc.; Westinghouse Electric and Manufacturing Company, Wireless Press, Y. M. C. A. Radio Schools.

The Executive Radio Council of the Second District who arranged the convention exhibition is composed of two representatives from each of the following Clubs:

Y. M. C. A. Radio Club, New York.  
Stuyvesant Radio Club, New York.  
The Radio Club, Irvington, New Jersey.  
Yonkers Radio Club, Yonkers, N. Y.  
Radio Traffic Association, Brooklyn.  
Bloomfield Radio Club, Bloomfield, N. J.  
Westfield Radio Club, Westfield, N. J.

(Continued on page 710)



Every Day During the Radio Show Examinations for Licenses Were Made by the Radio Inspector, Who Also Calibrated Wave-Meters Free of Charge. This Photograph Shows Some Amateurs Taking the Examination for a License. The Transmission Was Automatically Made by the New Model of Omnigraph, Insuring Perfect Transmission.

This made a hit not alone with the amateurs themselves but with all the visitors and it was uncanny to see the car move and obey orders from Mr. Glavin. The car moved back and forward and turned around very easily. It was propelled by a twelve volt storage battery and did not miss once except when signals became jammed from one of the radio exhibits that was going at full blast a few feet distant.

Lectures were given every day by prominent Radio Engineers for the benefit of the amateurs present. These lectures were al-

## Eliminating Shellac in Coil Windings

By WILLIAM G. WHEAT

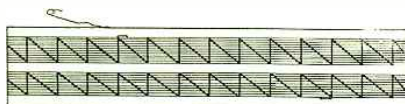

Figure 1

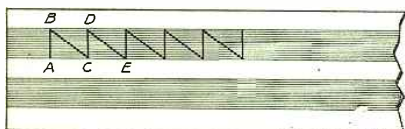

Figure 2

Fig. 1 Shows the Sewed Windings on a Variometer, While Fig. 2 Shows the Method of Fixing the Winding Once it is Done on the Cardboard Tube.

In winding the coils for a Variocoupler and Variometer for use in a regenerative set, the following method was used to hold the wire on the tubes without shellac.

Illustration, Fig. 1, shows the secondary of the Vario with the overcast of silk thread. Fig. 2 shows the method. The needle is forced thru the tube at A and brot up at B where a knot is tied. From B the needle is forced thru tube at C, brot under and up at D. From D back to C then up again at D and over to point E. The same method is used around rests of coil.

Fig. 3 shows the primary. The sewing starts at A over wire to B, thru tube to C and from C over wire to D. This method holds the wires rigid and gives the windings a great efficiency due to the lack of shellac.

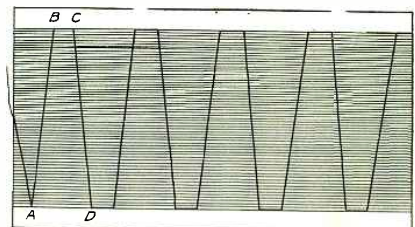

Figure 3

A Long Winding May Be Fixt as Well Without Shellac, as a Short One. This Allows the Experimenter to Use the Wire Again for Other Purposes if He Decides to Change or Improve a Set.

# The Radio Dealer and the Beginner

By ARMSTRONG PERRY

**N**OT long ago I went into a store conducted by one of the leading dealers in radio apparatus and asked for materials for making a stopping condenser to shunt around my fones. I found that they had no tin foil nor oil paper. All they could supply was wire and binding posts.

Another time I tried to purchase the "makin's" for a loading coil. Wire and binding posts were available, but no cardboard tube nor shellac nor material for making a base or panel.

Wishing to erect an aerial I purchased wire from another house on another occasion, but I had to go elsewhere for screw-eyes, side cutting pliers and a soldering tool.

In Pennsylvania I met a youngster, son of well-to-do parents, who had put a considerable sum of money into a toy radio outfit. He had been unable to bring in any signals with it and I did not succeed any better.

In Maryland a boy brot me a battered old 75-ohm head fone and a cup from a crystal detector and asked me how he could rig up a wire and hear something.

Every week I receive letters from beginners who are stuck for the lack of a little advice which the dealer who sold them their first apparatus should have given them.

All these things have set me thinking about the ways of radio dealers. I have been working with boys for a little more than twenty-five years. In that time I have known over four thousand between the ages of twelve and eighteen. A large part of my work has been helping them with their hobbies. I have been a beginner in many things. I think the radio dealer fails to appreciate his opportunity with the beginners.

## BOYS TAKE TO RADIO.

It is easier to interest a boy in radio than in anything else I know of. The subject is getting good general publicity. The boys' magazines are pushing it. The technical magazines take good care of the amateur from the time he reaches the point where he knows what they are talking about. Many high schools give their pupils a few lessons on it. The radio schools advertise alluringly the salaries of radio operators and their opportunities for travel and the advantages really are such as any boy might envy. When the dealers find a way to capitalize the boy's first enthusiasm, help him to get an outfit for what he can afford to pay, make sure that he installs it efficiently, brings in signals and learns to read them, there will be a jump in radio business which will make all previous records look like thirty cents.

A boy is bound to be a small customer at first. If he is made to feel that fact too keenly he is less apt to become a big one. He is always willing to purchase to the limit of his funds—that is the way boys go into things—but his family of course is putting the brakes on. They think it is only another notion and will soon pass out like the rest. In ninety-nine cases out of a hundred their opinion will be justified unless an intelligent dealer makes sure that a boy starts right and keeps on.

## DATA DEALERS SHOULD GIVE.

From my own experience and my observation of other beginners, I believe every dealer in amateur apparatus and supplies should make sure that a beginner receives with his first purchase, the following:

- (1) Diagrams of three or four types of antennae adaptable to country or city conditions, with list of all materials needed, approximate cost, and instructions where to get them;
- (2) Diagram of simplest receiving outfit which will bring in signals in the locality where it will be used, with the simplest possible explanation of what happens from the time the waves are pickt up until they produce audible signals in the fones and the energy

history of every big concern shows the value of "catching 'em while they're young."

A bright boy, properly instructed, can sell to boys better than most older salesmen. It is hard for adults to get the boy's point of view. Often the older salesmen know too much about radio. They talk over the head of the boy customer. He looks wise, not wishing to appear ignorant, but goes away mystified. With another boy he feels more at ease about asking questions.

One subject neglected by dealers is the handling of government and commercial traffic. In fact it seems to be overlooked by the whole amateur fraternity. The whole emphasis is on the experimental side, the different hook-ups, the various types of apparatus. The beginner gets the impression that the whole fun of radio is in experimenting, and even when he gets a transmitter to add to his receiving outfit he seems to think that the squeaking off of unreadable signals at five words per minute is the whole game. Anyone who has tried to copy ship-to-shore traffic knows the awful ultimate results of this point of view. From my experience with boys I can say

positively that for one boy who can experiment intelligently and get results that are worth while there are fifty who by following explicit directions could set up a receiving station and learn to copy traffic rapidly and accurately. All they need is for someone to show them that it is worth while.

If this type of boy had been encouraged before the war he would not only have multiplied the sales on radio stuff, but he would have been a big help in the navy during the war. What every navy vessel needed in the war was a chief who could keep the apparatus in working order and some gobs who could send and read signals. What they got was a lot of short-term students who did not know enough of either theory or operating to be of any use until they had been on board two or three months.

## BOY SCOUTS SHOULD BE INTERESTED.

There is an unworked gold mine of radio profits in the Boy Scouts of America. There are half a million of them, the cream of American boyhood. Every one of them has to learn the International Code among other things before he can get out of the tenderfoot class and no scout likes to remain a tenderfoot long. Signalling is a major subject with the scouts in all their training. There is a merit badge for wireless which they can earn.

In addition to all this the U. S. Navy Radio Amateur Bureau handles the outgoing traffic from the national headquarters in New York to the local headquarters everywhere. The other navy stations all around our coasts have shown their willingness to broadcast messages. With the help of these high power transmitting stations the Boy Scouts of America have an opportunity to become the biggest radio organization in the United States. During the war the scouts distributed 10,000,000 pamphlets for the Committee on Public Information in a single week, covering prac-

(Continued on page 722)

---

**H**ERE is an article which no radio dealer can afford to miss. We consider it one of the most important articles on the subject ever written. It contains a gold mine of information for all those who can see the great opportunities in the amateur radio game. There are more ideas and more common sense contained in Mr. Perry's article than has been our good fortune to see in many months, and we have published some good ones.—Editor.

---

- (3) List of apparatus *required*, with prices;
- (4) List of other apparatus which would increase the efficiency of the station, with a brief but clear statement as to what each piece would do;
- (5) Exact but brief instructions about setting up the station;
- (6) Instructions telling exactly what to do to bring in signals after the apparatus is hooked up;
- (7) A list of stations which the beginner should be able to hear, with wave-lengths and instructions about tuning the apparatus to those wave-lengths;
- (8) Schedules on which these stations work, so that the beginner will know positively that at certain hours there will be something to pick up;
- (9) Operating hints—for example, "Keep your fingers off the crystal;"
- (10) Strong advice about reading the radio laws and obeying them;
- (11) Equally strong advice about obeying regulations of the fire underwriters and local electrical departments;
- (12) Friendly advice about how to save money by building apparatus, with suggestions as to books which will show him how to do it.

## HAVE SETS WORKING IN STORE.

To keep the boy's interest you must help him to get signals at his own station at the earliest possible moment. If you can find him a chance to hear something the day he first visits the store it will help a great deal. I often wonder why more dealers do not have simple outfits in operation in their shops. The man who lets a boy put on the fones and bring in a station for the first time all by himself will be his friend for life and the amateur wouldn't buy so much as a binding post of anybody else if he had to walk ten miles for it.

Of course, it takes time to sell to boys and the sales are usually small, but the

# Some Notes on Quenched Gap Transmitters

By JESSE MARSTEN

**I**N spite of the tremendous interest displayed in continuous wave transmission, particularly of the vacuum tube type, it is refreshing to note that all interest in spark transmitters has not entirely disappeared, and that development and improvements in the design of spark transmitters are still taking place. There should be more discussion of this phase of radio transmission in the amateur periodicals, for spark transmission has not left us for good, as yet, and still plays a very prominent part in radio communication. Practically most of the ship to ship and ship to shore transmission in spark stuff, as well as a goodly part of overland.

A recent article describing a new quenched gap design by Henry Hallberg gives rise to these remarks, and makes it desirable to outline briefly some points in quenched gap operation and design. The essential feature of quenched spark operation is the speedy dissipation of energy in the primary circuit with high damping of the primary oscillations, thus leaving the secondary to oscillate at its own natural frequency with very low damping, and with no interference due to the primary circuit. The more quickly the primary oscillations are damped out, the more the action assumes the nature of true impact excitation, with resultant secondary oscillations of one frequency with negligible decrement, which is the object to be desired.

One of the means used to obtain this effect is to couple very closely the primary gap circuit to the secondary antenna circuit. This facilitates the quick transfer of primary energy to the secondary circuit, which assists in damping the primary oscillations more quickly. This, tho effective, is not the most important means. The greatest assistance in this direction must be sought in the *extremely rapid quenching of the spark*, with restoration of the high initial resistance of the gap in a very short time and consequent reduction of primary oscillations to zero. This will practically leave the primary circuit open, thus preventing the undesired interaction between the secondary circuit and primary. It is for this reason that the problem of quenched gap design is so very important.

Some of the important considerations in their design and conditions which good gaps must fulfill will be briefly enumerated. In the first place the gaps must be short ones. It is well known that the *longer (in length) the spark the more easily it maintains itself and the more difficulty in extinguishing it* which makes the short gap very desirable. But since the power depends upon the voltage it is necessary to have a series of short gaps, rather than one long gap, over which the condenser voltage can be distributed and thus increased power obtained. Hence the best type of quenched spark gap is the one similar to that described by Hallberg and similar to the Navy type, a number of short gaps connected in series.

The sparking surfaces should be uniform and the separation distance should be the same at all points. In the first place a uniform separation and uniform surface insure a uniform distribution of the spark over the entire sparking surface, and not, as in poorly made gaps, a concentration of the spark in one or two spots with resultant excessive heating at those points and poor quenching. In the second place if there are high spots on the sparking surfaces the spark will tend, as indicated just now, to concentrate at these points, resulting in the so-called "pitting" with danger of short-

circuiting the gap at that point. This "pitting" further intensifies the non-uniformity of the gap, and renders the surfaces far more irregular than they originally were. In order to insure uniform separation of the surfaces the insulating gasket must also be of uniform thickness, and if compressible, must be equally compressat at all points. The gasket will be discuss a little more fully below. One further consideration with regard to proper distribution of the spark is the machining of the gap surface proper. Very often the gap surface is poorly machined, leaving the edges and rim of the gap surface irregular and ragged. Sparking then tends to take place over these points at the very edge of the gap surface which is very undesirable. To avoid this the gap surfaces should be rounded at the edges, which in the first place eliminates the ragged edges, and in the second place increases the separation distance of the gap surface at the *edges* and thus prevents sparking at the edges.

Gaps should be as nearly air-tight as possible. Gaps which leak air do not give a

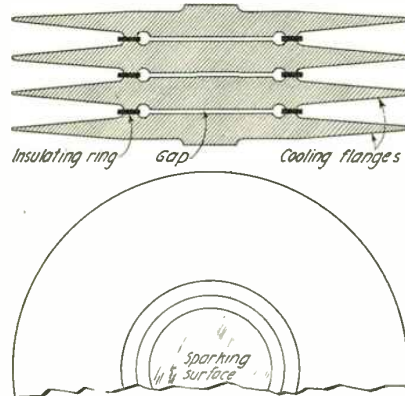

Diagram Showing a Typical Quenched Gap. Several Elements Are Used for High-Powered Sets But They Are All of the Same Type.

uniform discharge, hence the uniformity of the spark note is destroyed, which introduces reception difficulties. The irregularity of discharge of a quenched gap which leaks air excessively is evidenced by a peculiar hissing note. The addition of too much air leakage further results in increasing the conductivity of the gap with greater difficulty in quenching.

The gap must be effectively cooled. The hotter the gap the lower its resistance, hence cooling of the gap assists in restoring the gap to its initial high resistance and thus facilitates proper quenching. In the first place the sparking surfaces must be made of very good heat conducting material. This is exceedingly important, for the heating at the gap is excessively high, for the maximum gap current is many times more than the ammeter reading. Consequently silver or copper is best for this purpose. A consideration of results with both blower cooled gaps and self cooled gaps leads to the conclusion that the self cooled gap is superior. The blower cooled gap, tho effective in cooling, facilitates leakage of air into the gaps by blowing cool air into the gap with pressure. Furthermore, it is found that under the same conditions of operation, i. e., for same power, same wave-length, etc., the blower cooled gap current is higher than the self cooled gap current, consequently the blower cooled gap heats more than the self cooled.

Again under the same conditions, the radiation of the self cooled gap is greater than that of the blower cooled. These considerations point to the use of the self cooled gap rather than the blower cooled. There is another point, not to be ignored altho it does not influence the operation of the gap, namely that the use of the self cooled gap enables us to dispense with the entire blower cooling arrangement, which means a considerable saving of space and money.

The best method of self cooling is to utilize the property of heat radiation, by employing cooling flanges made of a good heat conductor, as copper. These cooling flanges are attached to the backs of the gap surfaces and thus conduct the heat away. They should therefore have comparatively large surfaces exposed to the air. To facilitate cooling, the flanges might be composed of two rectangular copper sheets connected together at the sides but open at the tops to allow of good air circulation from bottom to top. The question arises whether copper is the best material to use for the flange surfaces. There is a rapidly varying current thru the gap, and naturally there are eddy currents flowing in the copper flanges which increases the heating to some extent. Consequently the ideal material for the cooling flange is one which has very low specific heat, as copper, but a high specific resistance. Brass and bronze, to pick two metals at random, have quite low specific heats, almost as low as copper in fact, and have much higher specific resistances. Brass would be preferable because of its lower cost.

Some further considerations and suggestions in the design of quenched gaps follow. The gasket should be made of material which is very incompressible, for otherwise, when two sections of the gap are tightly bolted together the spacing between the gap surfaces may be much lower than the required spacing, and if there are high spots on the gap surfaces pitting and short-circuiting may result. Fish paper is good material for this purpose. If the gasket is treated with some special preparation, as many are, it must be such that heating of the gasket will not impair its insulating properties. As far as the writer is aware no gap has yet been made without the use of a gasket. If the problems of keeping the gap air tight and aligning the gap surfaces could be met without the use of a separating gasket, this would be the best plan.

The gap should be designed with a very simple short-circuiting device. For even in the best designed gaps poor ones may be found. If it is desired to cut these out of service short-circuiting them is far simpler than removing and replacing. It takes much less time. It may also be desired to short-circuit good gaps just to cut them out of service at times.

The gap should be designed with a view to facilitating removal of gaps. Some gaps are designed so that they are clamped tightly by a heavy bolt between two end plates. To remove one gap requires loosening the bolt until the gaps are movable, taking the gap out and replacing it. Then the whole outfit must be tightened again. It is far better to have each gap a separate and distinct unit fitting in a spring device, each unit mechanically independent of the others. All that is necessary is to pull the gap out of the spring holder and insert another.

There must, of course, be provided a simple and ready means for connecting in as many gaps as desired. This is neces-

(Continued on page 746)

# Non-Inductive Resistances and How to Make Them

By P. F. GEAGAN

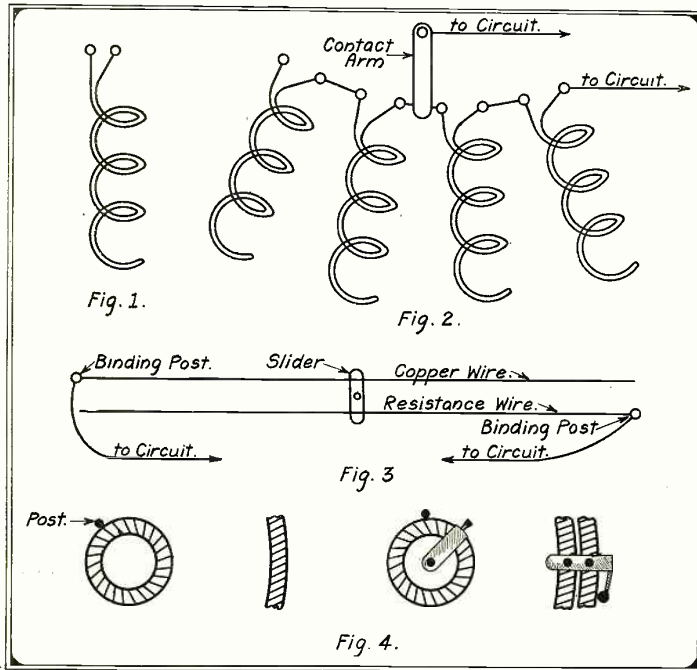

This diagram shows several types of non-inductive resistances and some new ways to wind them. Fig. 4 shows some models of variable resistances which will be found useful in several cases.

THE term "non-inductive resistance" or "non-inductive winding" is frequently met with in electrical and radio literature. By this is meant a special arrangement of the wires composing the resistance or winding so that there will be no reactive volts present when an alternating or oscillating current is passed thru the circuit, the resistance as defined by Ohm's Law being the true opposing factor instead of the impedance as in alternating circuits of inductive winding. The reactive volts in an alternating current circuit is the result of the field of force surrounding the wires springing out from and collapsing back upon the wire carrying the current, and this field cutting the wire at right angles produces an E.M.F. in the wire in a counter

direction to the current producing it. These reactive volts being in opposition to the flow of current have the same effect as a quantity of resistance placed in the circuit would have.

The formula  $2\pi N L$  expresses the reactance value where  $N$  equals the frequency, and  $L$  the inductance of the circuit, and the formula  $2\pi N L C$  expresses the reactive volts value where  $N$  equals the frequency,  $L$  the inductance, and  $C$  the current flowing.

It will be seen then that with any change in the frequency we will get a different value of reactance if the circuit be inductive. The inductance value of a circuit is also determined by the rate at which its field cuts the conductor, and so in circuits

where we wish to change the Ohmic resistance of the circuit without changing its inductance or wave-length we must so arrange that the inductive or reactive volts are eliminated. There are several methods of doing this: one is to wind the wire back upon itself as in Fig. 1, the effect of this is to place the fields of the two wires in opposition and since the current flowing is of the same value in both wires but in opposite directions, the fields neutralize each other and there is no self-induction present.

A number of these coils connected in series and with contact points taken off between coils over which a contact arm moves gives us a variable non-inductive resistance, Fig. 2.

Another method of construction is shown in Fig. 3. Two conductors, one of resistance wire and one of copper wire of the same size and length are laid parallel to each other with opposite ends connected to the circuit and a sliding contact provided. Then as we move the slider along the wires the same length of the copper wire is cut out of circuit as there is of resistance wire cut in or vice versa, thus keeping the inductance constant, since the inductances of the two wires are the same. This method would be applicable only for small resistances as the length of wire required for large resistances would be too great.

For larger resistances a somewhat similar arrangement may be employed as in Fig. 4. Two discs or rings of the same size wire are wound with the same number of turns of the same size wire, one of copper and one of resistance wire. The two windings should be as near as possible duplicates of each other. Opposite ends of the coils are connected to the circuit and a sliding contact bearing on both the rims or peripheries of the coils will produce the same effect as in the case of the straight wires but with a greater range. The slider contact should be pivoted as nearly as possible at the center of the discs in order to avoid eccentricity, and the coils set up so that the end binding posts are at opposite ends of the circuit. Still another way of mounting would be to fix the sliding contact stationary and rotate the two coils.

## Continuous Wave Multi-Stage Receiving Circuits

Employing Retroaction and Self-Heterodyne Principles

By JOHN SCOTT-TAGGART

IN a recent paper read before the Wireless Society of London, the present author drew especial attention to the value of retroactive amplification in the case of continuous wave reception. The problem no longer involves lessening the decrement of incoming wave-groups, as in the case of spark signals, but lessening the effective resistance of the aerial circuits. In other words, the positive resistance of the aerial circuit is almost completely neutralized by what is equivalent to putting a negative resistance in series with it.

Some further examples of the use of this principle are given in Figs. 1 and 2. In the former arrangement, the aerial circuit  $L_1 C_1$  is tuned exactly to the incoming continuous waves, the value of  $C_1$  being kept at a minimum. In the anode circuit of the first valve is a retroactor coil  $R_1$ , whose coupling with respect to  $L_1$  may be varied. The condenser  $C_2$  will usually be omitted. The magnified potentials across  $R_1$  are passed on to the grid  $G_2$  of a second valve, thru a blocking condenser whose purpose is to insulate  $G_2$  from the positive side of the anode battery  $H$ . In the anode circuit of the second triode is an inductance shunted by a condenser,  $C_3$ . This circuit is tuned to a frequency slightly to one side of the incoming frequency. The magnified oscillations are now applied to the grid  $G_3$  of the last valve, which functions as a detector. The anode circuit of this last valve contains the telephones  $T$ , shunted by a by-path condenser, and a retroactor coil,  $R_2$ , coupled to the inductance in the anode circuit of the preceding valve. The circuit is normally so ar-

anged that the first valve acts as a retroaction amplifier, or, in other words, a means of introducing negative resistance into the aerial circuit. The coupling between  $R_1$  and  $L_1$  is adjusted to the point just preceding self-oscillation. The amplified oscillations are, after a second high-frequency magnification, heterodyned by the last valve, the coupling between  $R_2$  and the inductance in the anode circuit of the second valve being adjusted to produce self oscillation in

(Continued on page 748)

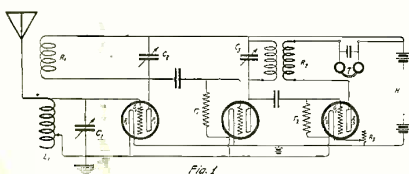

In This Hook-up the Two First V.T.s. Act as Radio Frequency Amplifiers and the Third as a Detector.

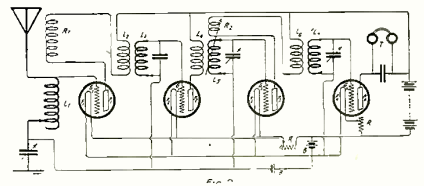

In This Receiving Circuit, Double Feed Back Reaction is Produced in the First and Third V.T. Circuit, Giving a Very High Amplification.

# New German Radio Recording Device

**F**OR receiving by means of tape recording apparatus, a new set of connections was evolved and has been tried out, as is shown in the cut. For receiving apparatus, a receiver of the type E-5 of the Telefunken Company is suitable, which is available for the reception of wave-lengths up to 17,500 meters by the addition of extra condensers  $C_3$  and  $C_4$  to the regular condensers  $C_1$  and  $C_2$ . From the terminals of the second condensers, the leads go to the intensifier and thence to a high frequency intensifier and then on to a set of three tube, low frequency intensifiers. Between these two there is a resonating circuit, without an iron core, which is tuned to the pitch of the aerials. The regular coupling thus gives a very sharp resonant correspondence.

The low frequency audion has in its heating circuit an adjustable resistance  $W_1$  by which the heating current can be regulated so that the signals will come thru the intensifier clear and without disturbance from statics. To obtain a strength of current suitable for the reception of printed characters, there are two intensifying tubes back of the low frequency intensifier with very sharp characteristics. The Siemens and Halske double grid audions  $R_2$  can be used here; the first is used as an intensifier; the second as a rectifier. The connection from the low frequency intensifier to the first audion, and from this to the second one, is done by inductances  $U_1$  and  $U_2$ , with the first and secondary windings of 15,000 and 60,000 turns respectively.

The audions require 90 volts potential. Their first grid is adapted for a potential of 45 volts, while the second grid of the first two has a negative potential of three

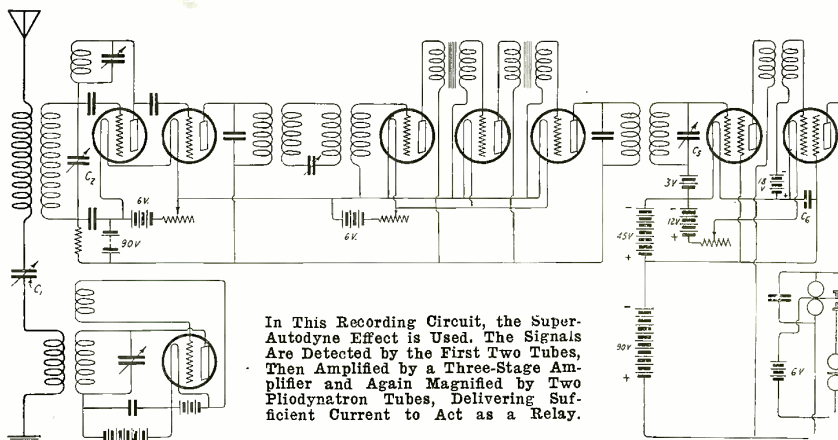

In This Recording Circuit, the Super-Audytone Effect is Used. The Signals Are Detected by the First Two Tubes, Then Amplified by a Three-Stage Amplifier and Again Magnified by Two Rhodotron Tubes, Delivering Sufficient Current to Act as a Relay.

volts and the negative grid of the second tube has a negative potential of 18 volts. The secondary winding of the first inductance  $U_1$ , is adjustable by a variable condenser  $C_3$  for the pitch of the receiving system, and the first grid of the rectifying audion with its 45 volt potential is connected with the cathode thru a condenser  $C_4$  of 1,000 cm. capacity. This connection prevents the production of waves of greater frequency which occur within this tube, and can bring the system to proper pitch.

The strength of current received back of the rectifying audion is so great that a writing apparatus adapted for it, as for instance the Wheatstone receiver, can be used without further modifications; the resistance of the winding of the electro magnets should be raised to about 10,000 ohms

to get good results. If high resistance relays are used in advance of the printing apparatus, especially careful adjustment is not required.

The arrangement is available for high speed reception without further modification; the calculation of its single parts presents no particular difficulty. Especially to be noted are the small requirements in the way of batteries; two heating batteries (A batteries) and two heavy current batteries (B batteries) are all that are required.

If one uses in place of the E-5 receiver with high frequency intensifier an audion receiver, one obtains a very widely available arrangement even for small waves giving sharply defined sounds.

\*Abstracted from the *Elektrotechnische Zeitschrift*.

## The H. C. of L. and Burned Out Amplifying Transformers

By **CYRIL O. SMITH**  
Principal Royal School, Honolulu

**B**EING interested in very high audio-frequency amplification as applied to the modern loud-talker, to allow of our radio classes taking down the incoming signals from any part of a large assembly hall, the writer, with I'm afraid many another, has found that in the final analysis all real radio troubles of the past year may be put down to transformer performance, or rather the lack of it.

After the school had discarded nine Acme Transformers, and other unfortunates right around us had burned out over a dozen more, the local agents wrote the manufacturers for replacement coils and on the arrival of two dozen our hopes revived.

Our share of the plunder amounted to eight coils (at two dollars apiece) yet a few days ago the last three of these gave up the ghost at one fell swoop with

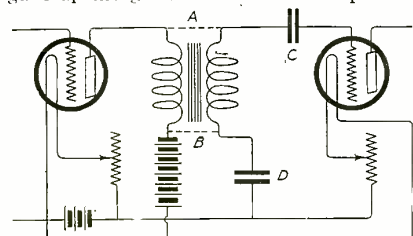

When it Happens That One of Your Amplifying Transformers is Burnt Out, Just Connect it as Shown by the Dotted Line and Introduce Some Stopping Condensers Into the Grid Circuit and it Works Again.

but sixty-six volts on the plate, and there we were, left with seventeen coils on our hands, with primaries gone, but otherwise still in the ring, or rather on the core!

At this point let me say that here in Hawaii we suffer from excessive humidity at times, and on several occasions during the last few weeks the pen of the hygrometer on my triple recorder has wandered off its own field and trespassed on that part of the chart generally given over to temperature,—so that without doubt our transformer requirements are severe, and very possibly no blame may attach to the manufacturers, but blame or no blame, what were we to do?

Buying new coils had proved useless, so the thot occurred to use what we had,—utilize our secondaries just as they were, even leaving the burned-out or otherwise open-circuited primaries within, and make use of the coils in such a way that the least possible change in circuits need be made to adapt them to our existing sets.

Within five minutes the change-over was made, without so much as removing the transformers from their panels, yet even with the low voltage at present in use (twenty-two on the electron relay, and an additional forty-four on the amplifiers) there is no shadow of a doubt in the minds of any of us but that we are getting better amplification and less extraneous noise than with our double-coil transformers, and furthermore the impedance of these secondaries is such

that they are not going back on us as the primaries did.

The hook-up we were using before the modification made necessary by persistent break-down on the part of the transformers, was an external heterodyne and a detector-amplifier circuit as given by De Forest in catalogue D, on page 25, with one "A" Battery and two "B's"—this second "B" Battery being used to boost the amplifiers.

The diagram below shows the very simple changes in the circuit made at each stage to adapt this set to use one coil only of the transformer, and will be found suitable to most other hook-ups as it stands. Only one stage is shown, but all are treated in the same way.

A. With all batteries switched off, place a jumper across each amplifying transformer from Primary one to secondary one.

B. Do the same with jumpers from primary two to secondary two.

C. Insert a small stopping condenser in the grid circuit.

D. Place another small stopping condenser in circuit from lower secondary to filament, then turn on your batteries, and listen in.

The extra condensers required, two per stage, are simply used to prevent battery currents from being carried where they are not wanted, and such stopping condensers may be built up in a few minutes with foil and glass, or better still, using foil and mica.

(Continued on page 750)

# An Ideal Receiving Set for Short and Long Wave-Lengths

By E. G. SHALKHAUSER

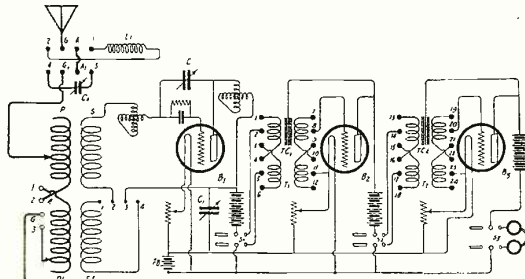

Fig 2

Complete Hook-up of the Set, Showing the Combination Switch Contacts to Change From Long to Short Waves.

detector and first stage amplifier and one between first and second stage amplifier, Fig. 3 is used for the A switch of Plate No. 3 and places the aerial condenser in series with the antenna when desired.

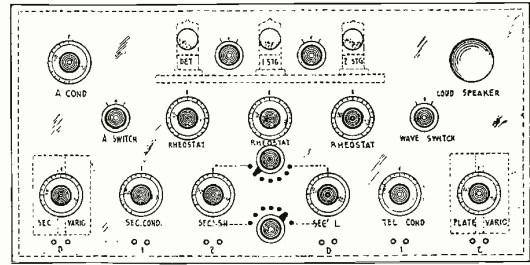

Fig 3

General Layout of the Front Panel of this Complete Receiving Set. Note That a Loud Talker is Incorporated Inside the Set.

**TO VARY WAVE-LENGTHS**

IN a past issue of RADIO NEWS the design and construction of an ideal radio cabinet were outlined. The particular features and advantages of this cabinet over those used heretofore were pointed out and in acknowledgment of the many gratifying reports received by the writer let it be said that the cabinet design has met with general approval for its adaptability and ease of construction. It seems certain that the more progressive amateur will sooner or later build his transmitting and receiving panels in more attractive and business-like cabinets, which also will afford maximum protection and accessibility to the instruments.

In what follows, a receiving set of the most universal and efficient post-war type has been worked out and made ready for use. So many circuits are available which have given and still give exceptionally good results, but to a more or less spasmodic degree. Under adverse weather conditions or in totally different localities such a lineup of apparatus may or may not satisfy us. The thing to guard against most of all is an arrangement of complicated wiring systems and intricate apparatus construction. Nothing seems to meet the fancy of the average amateur more than to have a network of wires and a switch which probably will work a half-dozen ways with as many different combinations. This sort of an outlay may give a pronounced appearance and would even at times work well, but for all-around reliable work only the more simple and less complicated circuits do the business.

In a complete set arrangements should be made to receive both long and short wave-lengths with equal ease and reliability. To be able to switch instantly from short wave coils to those of longer wave-lengths is essential. This can be accomplished in a simple way without the loss of undue amount of energy from the transmitting station. The best means is found in the correct construction of the switching apparatus. A design, which has thru one year's use proved very efficient and reliable will be described.

On plate No. 1 the switches used in this particular receiver are shown in detail. The hard rubber disks upon which the contact segments, shown in Figs. A and B, are mounted, are cut from 1/4" stock to the required sizes. (All the dimensions are given on the drawings.) Disc of Fig. 3 is of the same size and general construction as that of Fig. 1, but has only two contact segments counted. Switch of Fig. 1 is used for the T switches shown on Plate No. 3, of which two are required, one between

to vary the wave-lengths from short to long or vice versa, the switch of Fig. 7, designated as "wave switch" on Plate No. 3, is used. Additional aerial inductance, primary and secondary inductances for the various wave-lengths are controlled by turning the switch. The contact segments shown in Fig. A and B, Plate 1, should be made of phosphor bronze to give the desired springiness and insure the best contacts. They are drilled as shown and fastened as per Fig. 2 of the same Plate. The numbers and letters on the above mentioned Figs. of Plate 1 correspond to like designations on the circuit drawing of Plate 2 and refer to the contact points mounted on the rear of the panel. By tracing thru the circuit and noting how the segments form the closed connection on the contact points for both the short and long wave-lengths a clear idea will be had as to how this switching arrangement can accomplish what is desired. Fig. 2 shows a cross section of the method of mounting the segments, and how these form the connections between the contact points. It should constantly be kept in mind that to insure good results good contacts thruout the receiving circuit are of the utmost importance. High resistance connections increase energy consumption and produce correspondingly weaker and fainter signals. Be sure to make good contacts and connections.

This switch has also been designed to reduce to a minimum capacity effects so frequently encountered in switches of the common type where large amounts of metal are used to complete the connections.

In Figs. 4, 5 and 6 of Plate 1 another feature of this receiving set is shown. These figures give in detail the plug and spring contacts used in conjunction with the telephone headset. In the ordinary plug and jack used in telephone switchboards the mass of metal, of which the jacks are made, prohibit their use in radio work. Experi-

ments have shown that even the capacity effect between the two wires leading to the receiver is enough to affect the signal strength, and switch connections formed by heavy brass plugs and jacks will give a result that can be anticipated without going into experimental proof. The plug shown in Figs. 4 and 5 and pins are made of hard rubber or composition fibre and drilled to receive the cords. A small metal plate or disc to make contact with the outer springs shown in Fig. 6 when the plug is inserted, is attached to the tip end of each pin to which the cords are soldered. These contact discs must be turned outward to make connection with springs one and four of Fig. 6. This process of construction requires a little skill and patience, but is not too difficult to accomplish. The results obtained are well worth the best efforts. The springs of Fig. 6 are of the dimensions shown in Fig. C and bent at the dotted lines. Phosphor bronze is the best material to use as it is of the desired resiliency and always makes good contacts. To obtain the proper connections to the springs the numbers one, two, three and four correspond to like numbers on Plate 2 at the jack associated with the first bulb. The jack connections at the first and second stage of amplification are the same as the one for the detector bulb. The object of having a combination of contacts connected in this manner is to give the maximum flexibility to the set without undue loss of time in switching from one stage of amplification to the other. The circuit thru the three audion tubes and transformers remains closed as long as the plug of the receiving set is not inserted in the jack. With the plug in the first position only the detector tube is in operation. The springs are separated, but contact is made with the upper and lower springs (one and four) which complete the circuit from the "B" battery thru the telephones back to the filament. Upon withdrawing the plug from its position the springs automatically close and complete the circuit thru either one of the transformers to the first stage of amplification. In the second jack, therefore, the detector tube remains in operation and its output transferred to the second tube in the circuit. And in the third jack the complete circuit is in operation and maximum signal strength obtained.

**TWO TYPES OF TRANSFORMERS.**

Two types of transformers have been featured in this circuit, any one of which may be used as desired. It has been found very advantageous to be able to employ either radio frequency coupling or audio (Continued on page 732)

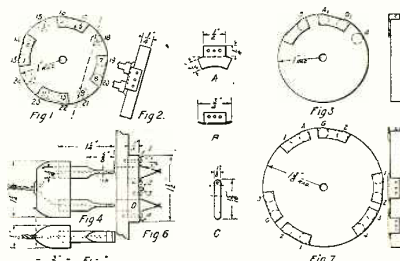

Constructional Details of the Combination Switches and of the Special Plugs for the Fones.

# Short Wave Radio Vacuum Tube Transmitter and Regenerative Receiver With Two-Step Audio Frequency Amplifier

By WALTER HYNDMAN, I. A. T.

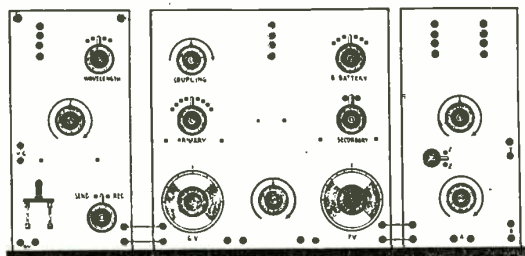

Front View of the Three Units Comprising the C.W. Set and the Receiver With Two-Step Amplifier. Note the Well-Planned Design of the Units.

appearance. The outfit is (with the exception of the transmitter) of conventional design. I have tried to arrange the various switches, dials, etc., so as to be convenient and easy to control.

The receiver is provided with an adjustable "B" battery, as the new tubes are of the low vacuum type. A small con-

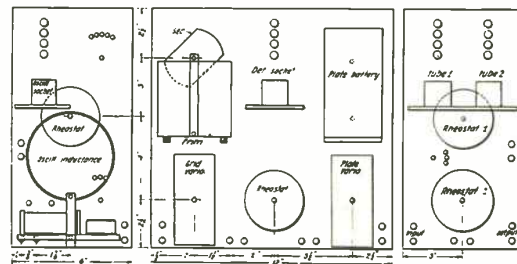

Back View of the Complete Set Showing Arrangement of Parts Inside the Cabinet.

IN these days of the introduction of C.W. for amateur use, most of us are worrying over the type of set to install. The great bulk of amateur operators still stick to the good old spark, which accounts for the amount of interference most of us are complaining of. A few fellows who are lucky enough to be provided with plenty of cash, have installed powerful "fone" or C.W. sets. We all would like to, but motor-generators or rectifiers and transformers cost a lot of money. The only obvious remedy is an outfit that will work on a six-volt battery or other similar source of power.

When I read the article by Mr. H. M. Pruden in November RADIO NEWS I decided that it was just what we have been looking for, so I proceeded to design a compact cabinet set in accordance with his data.

I have much pleasure in placing the results of my work before you. The three units comprise a complete station, which, if carefully made, should prove efficient, up-to-date and of pleasing

appearance. The outfit is (with the exception of the transmitter) of conventional design. I have tried to arrange the various switches, dials, etc., so as to be convenient and easy to control. The receiver is provided with an adjustable "B" battery, as the new tubes are of the low vacuum type. A small condenser is placed around the fones, and a shelf is screwed to the panel, and supported at the rear by a brass bracket, to hold the "B" battery. If a standard tapt "B" battery, the taps may be permanently soldered to the contacts of the "B" battery switch. If this type of battery is not used, one made up of Eveready cells should be used. The tube sockets are screwed to wooden shelves which are screwed to the panel.

In the transmitter, the Century buzzer and the small transformer (the dimensions of which were given in November RADIO NEWS) are mounted on a shelf fastened to the panel and supported at the rear by the same brass strip which holds up the rear of the inductances. This is shown in the rear and side views on the plan. The transfer switch is placed on the lower right hand side of the transmitter and is the

simplest possible. A more elaborate one may of course be substituted. No meters are included, as most amateurs will wish to use theirs for various experimental purposes. However, for those who wish a H.W. ammeter on the panel, the wavelength switch could be moved to the position occupied by the small double pole Trumbell switch, and the ammeter placed in the upper right hand corner. I would prefer Remler rheostats. Binding posts are provided on the panel for connection to the oil-filled Murdock condenser.

The two-step audio frequency amplifier is very compact, and could be used in connection with other outfits. In its design I have followed the suggestions of F. R. Pray in November RADIO NEWS which I think are excellent, as they do away with the expensive plug and jack method used in practically all amplifiers on the market today. As the "B" battery for the amplifier is rather bulky, I decided to place the battery outside, as the amateur will probably need it in his various experiments with other (Cont. on p. 709)

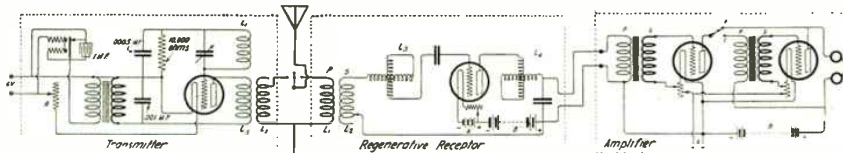

General Hook-up of the Complete Set. Note on the Left the C. W. Transmitter Working With One Six-Volt Battery.

## Construction of Transformers

By BEN H. WOODRUFF

ALL transformers, from your little Thordarson to the ones which handle thousands of volts, operate on the same principle, induction. They all consist of an iron core with the primary and secondary windings.

In this article we will deal with the construction of efficient transformers, i. e., where the input wattage is equal approxi-

mately to the output wattage.

To begin with, it is necessary to know exactly what the transformer is to be used for, or to know the voltage and amperage wanted. Suppose a transformer is wanted to operate on ordinary 110 V. 5 A. 60 cycles, giving a voltage of 12 and the maximum amperage.

Here we must know what size core we are to use. It is best to increase the size of the core as we increase the length. So we will use a core 2" x 2", a total cross section of 4 square inches.

Applying the formula for 60 cycles:  

$$V \times 6.25$$

$\frac{X}{\text{---}} = \text{number of turns when X is}$

the cross section of the core in square inches and V is the given voltage. Substi-

tuting the primary voltage we find that a total of 172 turns will be required. By looking at the table we see that No. 18 B. & S., is the smallest wire which will safely carry 5 A. Substituting the secondary voltage we find that the total number of turns will be 19. Since the wattage (Continued on page 730)



The Windings of the Transformer Are Made on a Form of This Type Before Being Mounted on the Core.

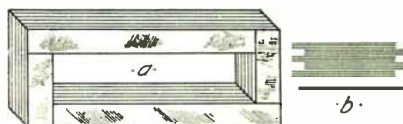

Arrangement of the Iron Core Showing How the Iron Strips Are Interleaved at Each Corner.

# Conduction of Electricity Thru Vacuum and Gases With Applications to Design of Radio Apparatus

By E. M. SARGENT

## First Part

**A**N investigation of the subject of electrical conduction in gases and in a vacuum discloses many facts that are of peculiar interest to the radio experimenter, particularly if the investigation is conducted from a non-radio point of view. Some of the outstanding characteristics of electrical currents when passing thru gases are outlined below, after which follows a more practical discussion of their importance when applied to the design of radio telegraph apparatus.

Gas in its normal state is non-conducting for most practical purposes. For example, when a telegraph line is operated, no account is taken of the leakage current that flows thru the air from the wire to the ground. This leakage current is so small as to be entirely negligible when compared with the leakage thru insulators, etc. Nevertheless, it is there. Where high voltages are used, particularly voltages high enough to cause sparking, gas currents become of importance.

Currents are conducted thru a gas by small carriers called ions. These ions are of two kinds, one having a positive charge and the other a negative one. Negative ions usually consist of single electrons. A normal gas contains equal numbers of positive and negative ions.

Even when undisturbed physically, as when a gas is kept in a covered glass jar, the small particles that make up the gas are in constant motion, and collisions are continually taking place between the molecules and ions. When collisions take place between molecules and ions, some of the molecules are disrupted and new ions are formed, while when collisions take place between ions of unlike sign the charges neutralize and new molecules are formed. When the gas has stood for some time undisturbed it reaches a steady state at which new ions are being formed at the same rate at which they are recombining to form molecules, and the total number of ions in the gas is then constant. When this state is reached, each particle has the same amount of kinetic energy as the others.

Ions are produced in gases in any of the following ways:

1. By heating. "Heating" physically means increasing the amount of kinetic energy in each particle of the gas. When the kinetic energy is increased, collisions will be more frequent and greater forces will take part in them. These greater forces will break up a greater number of molecules, thus forming more ions.
2. By the electric spark. This is a special case of heating, altho the initial ionization takes place in a somewhat different manner, and will be discussed later.
3. By the electric arc. This is also a case of heating.
4. By radio activity. Radio active substances have the power of dissociating the molecules of a gas in the vicinity of the radio active substance. Here the ionizing is done not by the interbombardment of the gas particles but by the bombardment of the gas by the particles that are ejected from the radio active substance. These particles travel with extremely high velocities, some approaching the velocity of light and are capable of producing very high ionization if allowed to act for some time on a gas in a confined space.
5. Light, particularly the sun's rays and illuminating sources strong in ultra violet light produce ionization to some extent.

### REMOVAL OF IONS FROM A GAS.

When either a positive or negative ion comes in contact with a cold metal surface it gives up its charge to the metal. Recombination to form molecules then takes place near the metal surface. Ions may be removed from a gas by passing the gas thru small diameter metal tubing, or thru metallic wool.

In general, negative ions are smaller than positive ones. All particles in a gas in the steady state have the same amount of kinetic energy ( $\frac{1}{2} mv^2$ ). Therefore since the positive ions have many times the mass of the negative ones, the negative particles have much greater velocities. This can be experimentally proved by blowing an electrically neutral gas thru a metal tube having a small diameter. The gas may emerge from the tube with a positive charge. This is due to the fact that in the short time the gas was passing thru the tube, more negative ions than positive reached the walls of the tube, due to their

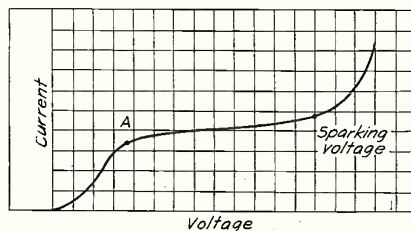

Figure 1

This Curve Shows the Current in a Spark Transmitter. Point A Represents the Saturation Point.

higher velocities. Thus more negative ions than positive were discharged and the gas emerged with a positive charge.

The charge on an ion is about  $3.5 \times 10^{-10}$  electro static units. Expressed in practical units, each ion contains about  $1.17 \times 10^{-19}$  coulombs of electricity. When a current of one ampere is flowing in a circuit, one coulomb of electricity per second is flowing past each point in the circuit, or  $.855 \times 10^{19}$  ions pass each point in the circuit per ampere of current.

When two plates are immersed in a gas, the saturation current that will flow depends only on the ionization between the plates. For a gas of uniform ionization the saturation current will then be inversely proportional to the distance between the plates. The current thru a gas with constant distance between electrodes follows Ohm's law in that the current is proportional to the voltage for very small e.m.f.s. only and quickly reaches a saturation point at which increase of voltage has very small effect on the current. The reason for this is that there are only a limited number of ions available and that when the voltage gets large nearly all the ions are carrying current and a further increase in voltage cannot cause an increase in current until the voltage gets large enough to create more ions. This case will be discussed under spark gaps.

The statement that the current does not follow Ohm's law made above should be strictly interpreted to mean that there is not a straight line variation between current and voltage. There is no known current that does not exactly follow Ohm's law if the law is properly applied. Currents thru the electric arc, electric spark, plate to filament current in a vacuum tube,

and the current described above thru a gas are currents ordinarily referred to as "not following Ohm's law." In all four of these cases the effective resistance or impedance of the medium is a variable that is a function of the voltage and when the proper value of resistance for a particular voltage is substituted in the equation the calculated current will be correct. The same is true of alternating currents where the effective resistance is a function not of the voltage but of the frequency, and the "resistance" must be broadly interpreted as the total impedance to current flow. For all alternating current cases

$$I = \frac{E}{Z}$$

Statements in this paper that a current doesn't follow Ohm's law then must be taken to mean as outlined above.

### IONIZATION OF A GAS BY INCANDESCENT SOLIDS.

If a negatively electrified body be brought near an incandescent pure metal it will be discharged, but if brought near an incandescent oxide will be unaffected. A positively charged body will be affected in the opposite way. The metal will not discharge it but the oxide will. This is an important fact to be considered when selecting material for vacuum tube filaments.

The electrification produced by incandescent solids depends on four factors:

1. The temperature of the wire. The higher the temperature the greater the speed with which the particles are shot off from the wire. They have more kinetic energy at high temperature and therefore are capable of producing greater ionization.

2. Pressure of the gas.
3. Nature of the gas.
4. The nature of the incandescent wire.

Even in a vacuum electrification is produced on bodies near incandescent solids. This electrification is due to particles leaving the solid. Edison noticed in connection with experiments on electric lights that negative electricity escaped from glowing carbon in a high vacuum. This is called the Edison effect, after the discoverer. Emission of negative particles however is not confined to solids.

The saturation current between an incandescent wire and a cold cylinder or plate can be expressed in the form  $I = a\theta^{\frac{1}{2}} c - \frac{b}{\theta}$

where  $\theta$  is the absolute temperature of the wire and  $a$  and  $b$  are constants.

When the hot wire is surrounded by gas instead of being in a vacuum, the electrons ionize the gas at high temperatures and thus produce positive as well as negative ions.

The source of ionization is at the surface of the incandescent metal. The same number of ions will then be produced no matter what the distance between the electrodes is. Therefore the saturation current will be the same for a given incandescence regardless of the distance between plates as the saturation current depends only on the number of ions available to carry current. The voltage required to produce this saturation current however varies greatly with the distance between the plates.

If ionization is confined to the surface of the incandescent metal, the current between the metal and a cold plate will be carried by ions of one sign only, even tho ions of

(Continued on page 746)



# Who's Who in Radio

No. 3

SIR OLIVER LODGE, D.Sc., LL.D., F.R.S.

**S**IR OLIVER LODGE was born on June 12th, 1851, at Penkhill, near Stoke-upon-Trent. At the age of eight he went to the Newport Grammar School, where for several years he was subjected to the strenuous classical education of fifty years ago. At fourteen he was taken into business to help his father, who was in failing health. But his love of Science was developing, and, working in the evenings, he prepared himself for the matriculation examination of the University of London, and for the Intermediate Examination in Science, taking first class honors in Physics. In 1872, at the age of 21, he gave up the idea of a commercial career, and went to University College, London, to pursue mathematics and his other scientific studies without interruption. In 1877 he took the Degree of Doctor of Science at London in the Subject of Electricity, and became Demonstrator and subsequently Assistant-Professor of Physics in University College, London. In 1881 he was elected first Professor of Physics at Liverpool in the newly-founded University College, now the University of Liverpool. In 1887 he was made a Fellow of the Royal Society. In 1888 he received the honorary degree of LL.D. from the University of St. Andrews, the first of an ever-increasing list of such distinctions, and later he was made a corresponding member of several foreign learned societies. In 1900 he was chosen by the Crown as the first Principal of the University of Birmingham. In 1902 he received the honor of knighthood on the Coronation of the King.

It is impossible here to give an adequate account of the brilliant scientific career of which this list of distinctions forms some recognition by his fellow-workers and by the Crown. I can only mention briefly a few of the researches which have won for him a place among the foremost physicists of our time. The scientific work for which Sir Oliver is most famed is a long series of researches, begun more than twenty years ago, on the discharge of electricity and the accompanying phenomena. Starting with an investigation into the behavior of lightning and into the best method of guarding against it, which gave us most valuable knowledge on the construction and disposition of lightning conductors, he was led to make experiments with lightning on a minute scale as manifested in the spark of electric machines and thence to the surging or oscillating character of the discharge along wires, in which he obtained many new and interesting results.

## PIONEER IN RADIO.

One very remarkable experiment is now well known under the name of Lodge's Resonating Jar. We know now that Lodge was really dealing in these experiments with the electro-magnetic waves in air discovered by Hertz in 1888, and there can be no doubt that if Hertz had not made the discovery we should have very soon learned it from Lodge. Indeed, Hertz himself says: "Professor Oliver Lodge, in Liverpool, investigated the theory of the lightning-conductor, and in connection with this carried out a series of experiments on

the discharge of small condensers, which led him on to the observation of oscillations and waves in wires. Inasmuch as he entirely accepted Maxwell's views, and eagerly strove to verify them, there can scarcely be any doubt that if I had not anticipated him he would also have succeeded in obtaining waves in the air, and thus also in proving the propagation with time of electric force" (Electric Waves, p. 3). Prepared by his own researches Lodge at once recognized the immense importance of Hertz's discovery, and thru him and thru Fitzgerald the knowledge of it was rapidly spread in this country. It was largely due, I believe, to British appreciation that the value of Hertz's work, and of the theory of Maxwell which inspired it, was so soon recognized in Germany.

In the earliest years of investigation of electro-magnetic waves Lodge was ever to the fore, devising modes of creating and detecting the waves, investigating their

thru liquids. When the current passes thru a conducting solution of a salt, the molecules of the salt are torn asunder, and its constituents travel in opposite directions. From certain observations and on certain suppositions their speed of travel could be calculated. But Lodge was the first to devise a simple and direct experiment manifesting the travel and enabling the speed to be measured. His experiment confirmed the previous calculations and the theory upon which they were based.

Another celebrated research was in a very different field, consisting in an investigation of the passage of light thru a moving medium.

For this research, and for his researches on electric waves, he received in 1898 the Rumford Medal of the Royal Society, one of the highest honors which the Society can bestow, for it is not confined to our own countrymen.

Everyone in Birmingham by this time knows that Sir Oliver Lodge is not only a great experimenter but also a brilliant expounder of his own work and of the work of others. Ever ready to take up new ideas, he absorbs them, makes them his own, and has in the highest degree the art of communicating them. The lecture which he gave in the Town Hall some years ago on Radium was a great example of this power. Seizing the idea that matter and electricity are identical, he set it forth in a way which will long dwell in the remembrance of his hearers.

There is one more contribution to science, tho of an indirect kind, which deserves special mention—his Presidential Address to section A of the British Association in 1891. For two reasons that address was remarkable. In it he advocated the foundation of a National Physical Observatory, and so started the movement which led, some years later, to the establishment of the National Physical Laboratory at Bushey, supported, tho far from adequately, by the Government, and controlled in a large measure by the learned Societies. This institution is doing most excellent work even in its infancy, and is destined, we may hope, to a sturdy manhood. In that address, too, he advocated, with more courage than would now be needed, the right to recognition of investigations in the borderland where physics and psychology meet—the region of psychic research—investigations on such subjects as thot transference or telepathy. And his interest in the subject and his advocacy of its claims to recognition as worthy of study has gone far to change the attitude of scientific men from one of ridicule to one of, at any rate, toleration.

This advocacy of the study of psychic phenomena is sufficient evidence that Sir Oliver is no mere laboratory student; but further evidence that he is much more than a mere man of science, that he is animated by deep sympathy with his fellow-men, is supplied by his readiness to help in every movement for social improvement and reform, and by his writings on philosophical and religious questions.

Under his guidance the University has developed in many new directions. In his efforts for educational development and reform his colleagues are proud to follow a leader with whose aims they sympathize, a leader whom they regard with esteem and affection.



Sir Oliver Lodge, a Pioneer in Radio, in 1896, Sent Wireless Signals Over a Distance of Several Hundred Yards.

properties, writing papers, giving lectures, and spreading far and wide a knowledge of the new wonder. Among his most brilliant discoveries was that of the "coherer" for detecting the waves. With this detector he devised the first practical wireless telegraph, sending signals over a distance of several hundred yards.

This was all pioneer work, done before Marconi took up the subject, and Marconi undoubtedly built upon the foundation which Lodge had laid.

Whatever developments and changes may be made in the system of wireless telegraphy, there can be no doubt that Sir Oliver Lodge will always be recognized as one of the founders of the system, as a pioneer in researches upon which others have built.

## WORKS IN OTHER BRANCHES OF SCIENCE.

He has been a pioneer, too, in other directions. One of his most interesting researches was on the passage of electricity



**T**HIS Department is open to all readers. It matters not whether subscribers or not. All photos are judged for best arrangement and efficiency of the apparatus, neatness of connections and general appearance. In order to increase the interest in this department, we make it a rule not to publish photographs of stations unaccompanied by a picture of the owner.

We prefer dark photos to light ones. The prize winning pictures must be on prints not smaller than 5 x 7". We cannot reproduce pictures smaller than 3½ x 3½". All pictures must bear name and address written in ink on the back. A letter of not less than 100 words giving full description of the station, aerial equipment, etc., must accompany the pictures.

**PRIZES:** One first monthly prize of \$5.00. All other pictures published will be paid for at the rate of \$2.00.

## R. N. Oakley's Station THIS MONTH'S PRIZE WINNER

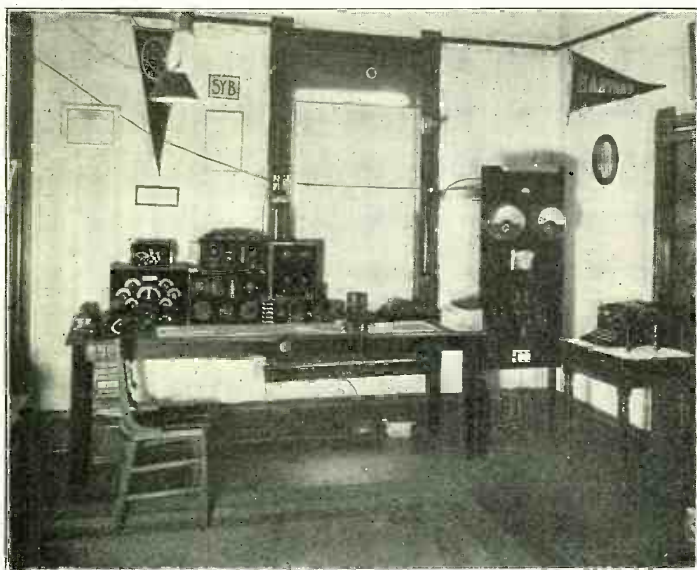

Following is a description of my station, 5YB:

Antennae: 1 inverted L, 86 feet high, 150

feet long; 1 cage, inverted L, 50 feet to 86 feet, 55 feet long. Ground: Counterpoise, water mains, rods driven in ground. Re-

Looks like a real station, eh! Wouldn't it be grand, boys, if all of us had such a room for our sets, instead of a corner in the attic?

ceiving set: Composite, DeForest coils, tickler circuit, with 2-step audio frequency amplifier. Control panel (lower right hand corner of set) provides means for easy control of receiver, the antenna, ground, fones, and batteries being controlled thru it. Connections on the receiving set are exceptionally short; none outside the cabinets is over two inches in length except the antenna and ground. The batteries are installed behind the control panel. I have heard NPO and NPM to LCM and OUI; NBA to NPA, and amateurs in seven districts. The transmitter is made of 1½ K.W. non-synchronous rotary gap set, wave-length 375 meters, Dubilier condensers, edgewise wound copper strip oscillation transformer, all mounted on rear of switchboard. I have had no results as 15,000 volt arc lighting system precludes possibility of work on short waves. Short wave receiving may be done only when the arc lights are out, averaging about two hours per month. Daylight work is impossible on account of other work. Experiments are being carried on however, and it is hoped to escape this interference soon.

I have a C. W. tube set under construction, as also a short wave variometer receiver.

R. N. OAKLEY, 5YB,

Jackson, Tenn.

## Clifford W. Spur's Set

My set consists chiefly of receiving apparatus, as the photograph clearly shows, the only transmitter used being an arrangement of two Ford coils, connected in series. These answer the purpose very well for local work until a half K.W. transmitter, which is now under construction, is installed.

The receiving apparatus consists of two complete sets, one using crystal detectors, and the other an audiotron bulb. The crystal set has a wave-length range of 4,000 meters and consists of a loading coil, Navy coupler, variable condenser and two detectors. In the Audion set, a large Navy coupler and also a set of honeycomb coils is used for tuning. Change from the coupler to coils is made by means of a 4-pole D. T. Anti-capacity switch, which can be seen directly below the primary coil. The D. P. D. T. switch on the switchboard is for changing the aerial and ground from one set to the other, and a similar switch on the left end of the cabinet changes over the telephone leads. The three dials across the top of the panel control the primary, secondary and grid condensers.

The circuit used is a standard three-coil

regenerative circuit and gives excellent results on both long and short waves. Many of the European stations have been heard, and American stations on both coasts. The loose coupler is used for spark stations only.

My aerial is of the inverted "L" type and

consists of four wires 100 feet long, spaced three feet apart. It is 50 feet high, being supported between two steel masts. The fones used are Brandes Superior, and Murdock's 3,000 ohms.

CLIFFORD W. SPUR,  
Rdo. 3FP, Toronto, Canada.

To avoid QRM Cliff uses only two one-K.W. Ford coils for transmitting, but he owns a real nice receiving set, the feature of which is the Kewpie doll, which sets the clock on Arlington time every day.

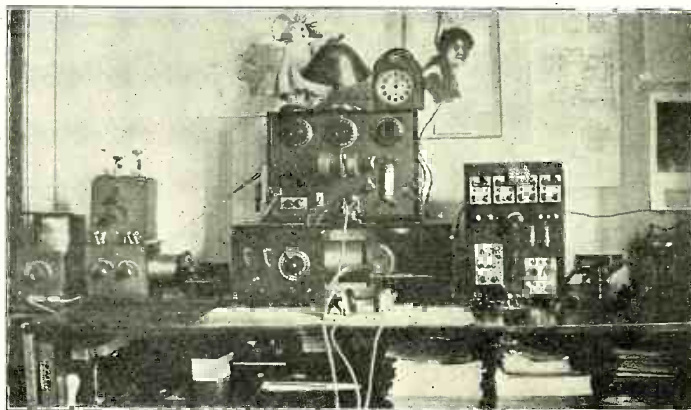

## B. VENEGAZ'S STATION

As I have never seen anything published about Mexican stations in your interesting Radio magazine, I am sending you a view of mine which is almost entirely home-made.

My transmitting station is composed of a 1" spark coil, a Leyden jar type home-made condenser, two home-made gaps, quenched and rotary oscillation transformer and aerial inductance, also home-made.

To supply the current to my coil, I use a step-down transformer.

My receiving set, which can tune in any wave-length between 25 and 15,000 meters, is also home-made.

I have a loading coil, 5" x 20", a long wave coupler, variable condensers, an audion detector and a loud talker. My fones are Holtzer Cabot.

I obtain very good results with this set and every evening I pick up all of the big American stations.

It seems that they have a few good ones in Mexico, too. This complete station is almost entirely home-made, and yet has a very good appearance.

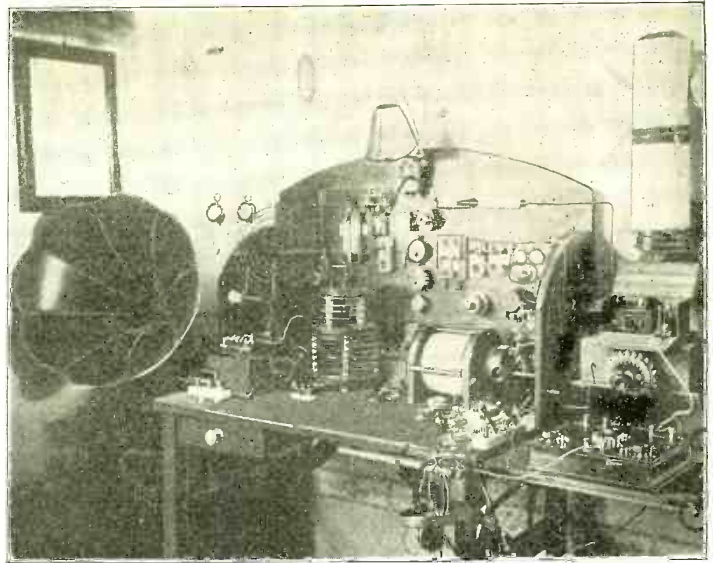

## H. HELLER'S STATION

Here it is, at last! I have been holding this up for some time trying to get at least a half decent photo of my station. After monkeying with the camera, this is what I got on a thirty second time exposure, in a half lighted room.

Regarding my aerial, it is sixty feet long, fifty feet high, four wires, and separated by 2-8-foot long pine wood spreaders, having two coats of shellac. I use bell wire and get dandy results.

In the photo can be seen a Radio cabinet I built containing a variometer, and below it a DeForest 001 mfd. variable condenser. This occupies 1/4 of the cabinet space and the other 3/4 of the cabinet is occupied by an audion detector and two-step amplifier. To the left of the cabinet is a general radio variable air condenser. I generally use my Navy type loose coupler for tuning, and H. C. coils for long wave-lengths. A loud talker can be seen in the upper right-hand corner, which makes Radio telegraphy and telephony audible in any part of the house. I have a pair of 3,000 ohms, Electro Importing Co.'s receivers, and a pair of 2,200 Western Electrics, and get fine results. I use a Stromberg-Carlson combination telephone set for communicat-

ing with a friend of mine a few houses away. My sending set consists of Mesco 1/2" spark coil, Dubilier Army type condenser, Murdock Midget spark gap, and

placed on a board, four feet long and one foot wide, into a closet. Amateurs in the neighborhood visiting my station ask my opinion as to the best magazine and I have

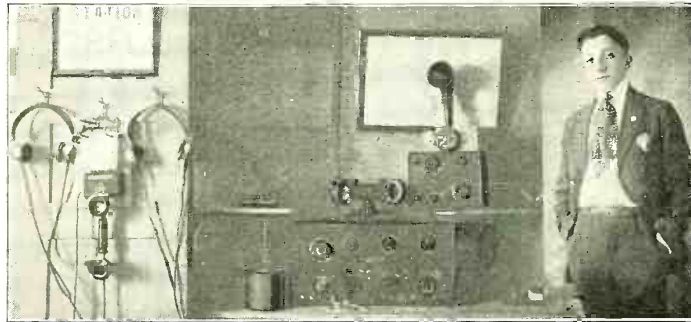

High power spark QRMer, Look! Here is another good boy who uses only 15 watts. We compliment Hym for that and for his good receiving set.

wireless key. Giving this set an input of 15 watts, I am able to call another friend, about 1/2 mile away.

In emergency, I use a small portable galena crystal set, having wave-lengths up to 600 meters. This complete station is all

told them, RADIO NEWS first, "QST" second, and "Wireless Age" third. My call letters are 2BFG and would like to hear from amateurs who hear me.

HYMAN HELLER

134 Amboy St., Brooklyn, N. Y.

## STATION OF DANA L. DARLING

The following is a description of my Radio station at Greenfield, Mass.: The receiving consists of a Duck Navy coupler, Stromberg Carlson fones, crystal and audion detectors and a variety of variables. I also have a cabinet tuner which was used before the war. At present I am working

on a regenerative set with two steps of amplification.

For transmitting I am using spark coils, but this set is temporary. There is a 1/4-k.w. set under the table, but as we will not have electricity put in before spring the set cannot be used.

The Radiofone at the left of the table is home-made. I obtained the hook-up from the July RADIO NEWS.

My antenna and ground connection are not perfect, but I got satisfactory results. I have found out that a good ground is needed more than a good aerial. At present I am using three aerials, two for receiving and the other for

sending.

I hear most all the stations on the Atlantic coast as far south as Key West and many inland stations including amateurs. All these are heard on a crystal detector.

DANA L. DARLING,

Call TRBM.

Greenfield, Mass.

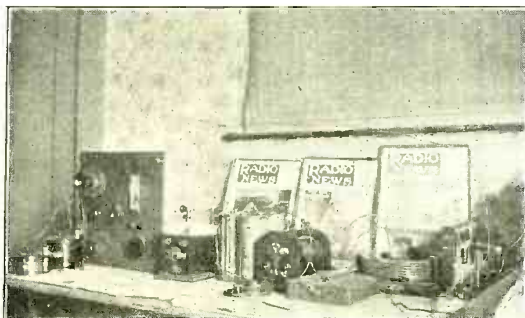

The High Tension Room! On the Left is a Radiofone But it Does Not Work. The Microfones got a Cold!

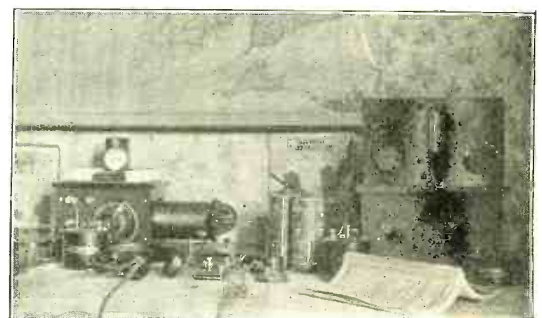

Here is Dana's Receiver. It's a Good Looking Little One With Coupler 'n' Everything.

# Correspondence from Readers

## SOFT TUBES NOT EFFICIENT AS AMPLIFIERS.

Editor RADIO NEWS:

In your February issue you publish an article by Mr. Gordon D. Robinson, of the United States Naval Academy, which is intended to explode the old idea that a hard tube is not necessary as an amplifier.

As I have personally received a letter from Mr. Robinson stating that the soft tube mentioned in his article is the A-P Electron Relay, I am taking the liberty of replying to same. There is no doubt but what a soft tube will serve as a very excellent amplifier under certain very limiting conditions, and from Mr. Robinson's article it appears that his tests were made under the limiting conditions which I shall describe.

The amplification constant of any tube is directly a function of the distance between the upper and lower flat portions of its static characteristic curve. These flat portions of the curve are commonly termed the upper and lower saturation limits. In a hard tube the distance between these saturation limits, and hence its amplification constant, is increased by the application of increased potentials to the plate until the tube breaks down or ionizes with the familiar blue glow. Since our soft tubes break down at 40 or 50 volts, while the hard tubes may be operated on as high as 500 volts, it must be apparent that for proper amplification in the second, third, or more steps of a multi-stage amplifier, a soft tube can hardly be employed.

In addition, for proper amplification—without distortion—the static characteristic curve must be a straight line and such a curve is universally obtained in a hard tube. Distortionless amplification is absolutely necessary for the reception of radio telephone communication. In a soft tube, however, the static curve is very rarely, if ever, a straight line, and is often accompanied by kinks which may be profitably employed, by carefully adjusting the filament current or plate potential, so as to secure extraordinary sensitiveness. Using a soft tube, therefore, as an amplifier for radio telephone speech, considerable distortion would occur which would make the use of such a tube valueless.

There is no doubt but what a soft tube may be used as a suitable amplifier in a single stage of amplification for the reception of telegraphic signals, but this is a very limiting condition, and in the ordinary case of multi-stage amplification, particularly for reception where no distortion must be present, hard tubes are the only ones which can be successfully used.

ELLERY W. STONE,  
General Manager of the Pacific Radio Supplies Co.

## WHY V.T.'S CANNOT BE SOLD CHEAP.

Editor RADIO NEWS:

Some time ago you very kindly gave me an opportunity to contribute our views on the prices of vacuum tubes, and I should like to avail myself of this privilege again.

In your February issue you print a letter from a Mr. Boddington, who proceeds to show that the vacuum tube companies are realizing a profit of 2,800 per cent.

It is difficult to believe that any educated person in this day and age would attempt to estimate the cost or value of any product solely on the basis of the material used therein. As a matter of fact, Mr. Boddington has quite ignored the cost of the base, for which we are charged 25 cents apiece, f. o. b. Newark. Even assuming

that his figures are correct, this raises the price of material to 50 cents, and we have not yet begun to figure in the cost of packing, the actual material of which amounts to over 15 cents per tube; so that so far as cost of material is concerned, a vacuum tube costs many more times the amount given by Mr. Boddington.

If we followed Mr. Boddington's reasoning, the cost of cattle should be the cost of the water and feed on which it subsists, since that is the only material entering into the finish product.

Mr. Boddington also ignores the cost of labor and other overhead expense which must be incurred in assembling, exhausting, testing, packing, selling and shipping tubes. He also dismisses the amount of royalty to be paid on such tubes by saying that it "would naturally increase the cost a little," but such statements are obvious generalities made without any supporting proof.

Mr. Boddington would perhaps generously concede to us the cost of the tube plus overhead, plus patent royalties, plus a fair return on our invested capital, and no doubt figures that these should constitute the cost of vacuum tubes. But he should remember that unless we are to get back to the ancient system of barter and trade, we are compelled to distribute tubes thru jobbers and dealers, with both classes of distributors requiring a fair profit in order to do business and in order to make it possible for customers, such as Mr. Boddington, to obtain any article which they want by immediate application to their dealer. The manufacturer, jobber and dealer are, of course, in business for the purpose of improving their respective states of health and should not be expected to make any profit for this service. I do not like to continue this discussion further and will not impose on you for more of your valuable space, but in closing would like to state that if Mr. Boddington will put up a suitable bond guaranteeing to produce tubes for us at the price mentioned by him, we shall be willing to offer him a position as Chief Engineer at a salary of not less than \$6,000.00 per year.

PACIFIC RADIO SUPPLIES Co.,  
By ELLERY W. STONE,  
General Manager.

## MORE PRAISE FOR RADIO NEWS.

Editor RADIO NEWS:

I have been a constant reader of your "finish product," namely RADIO NEWS, and am here to convince anyone that I find it a very helpful magazine; one that all amateurs should be proud to receive monthly.

Altho I'm not exactly an amateur now—that's what I'd be termed on the outside. So am taking this opportunity of expressing myself on RADIO NEWS, to all whom are concerned.

I have been buying RADIO NEWS at magazine stands ever since it was first published, in fact ever since I first became interested in radio, and have always found it an interesting magazine,—regardless of covers—full of news and helpful diagrams to anyone who is anxious to learn.

I note in one of your last issues that there seems to be an increasing squabble over a suitable cover for RADIO NEWS. Some like it, others don't; those that don't—namely Mr. Instructor, K. C. school, Savannah, Ga., in the November issue.

As you know, due to human nature, you can please some people some of the time, others the rest of the time, but you can't please all the people all the time.

So I'll say keep it up, Mr. Editor, and

carry on as before; those who criticise the seemingly senseless covers must be new "bugs" who don't know the "worth" of RADIO NEWS or else are altogether too deeply devoted to their art. Therefore don't appreciate a little joke once in a while.

Congratulations, Mr. Editor—you explained conditions very nicely in "Editor's Note," November issue, so I trust you will receive no more kicks on a cover for RADIO NEWS. I also trust and hope that Mr. Instructor at Savannah, Ga., snaps out of his hop soon and comes to the realization that radio was not invented for him personally. He'll just have to get used to conditions now existing.

Such as NVL trying to work commercial traffic on 600 while a local radio expert is filling the ether full of "Radio Ridicule."

I'll say better have a little of this said ridicule on a magazine cover, than to have it all out in the ether as QRM.

J. D. KOLESAR, U. S. N.,  
Officer in Charge  
Radio Compass Station,  
Cattle Point, Wash.,  
via Friday Harbor.

## EXPERIENCE OF OPS. ON "OTHER SIDE."

Editor RADIO NEWS:

In regard to the article by H. K. Dunn in your February issue, it may be of interest to add the experience of army operators on the "other side."

The division to which I have reference operated with the British in Northern France and the reception of FL communiques on the ground sets was frequent enough to merit an order from the Signal Officer forbidding the practice, owing to the operator's attention being taken from his regular watch.

We used the well-known French three-stage (3Ter) amplifier in connection with the regulation "aerial" ground pegs set about 50 meters apart, connecting to the amplifier with No. 10 equivalent stranded wire, weatherproof insulation.

I do not think that the amplifier characteristics have any bearing on the subject, as like results were obtained with the British amplifier which had different transformer ratios.

Any infantry signaller with the 27th division can verify the above.

LEE KNOWLSON,  
26 Mt. Vernon St.,  
Newport, R. I.

## MONTHLY ISSUE ENOUGH.

Editor RADIO NEWS:

Concerning an article in a recent copy of RADIO NEWS, I wish to say that the question of issuing that magazine bi-monthly is akin to absurd. It takes at least a month for one to read and grasp all the educational matter in RADIO NEWS.

Of course, if you purchase it simply for the purpose of reading the various fiction stories contained therein from time to time, or if you only wish to look at the pictures, then what you need is a weekly edition, but for the majority of amateurs and professionals who desire to extract something of value from their reading, once a month is plenty.

I have communicated with exactly twenty-one amateurs in Scranton, Pennsylvania, and find that in every instance but one, they voiced my opinions. Keep up the quality and never mind the quantity, we can't have both. Yours successfully,

S. M. BODDINGTON,  
Elmhurst, Pa.

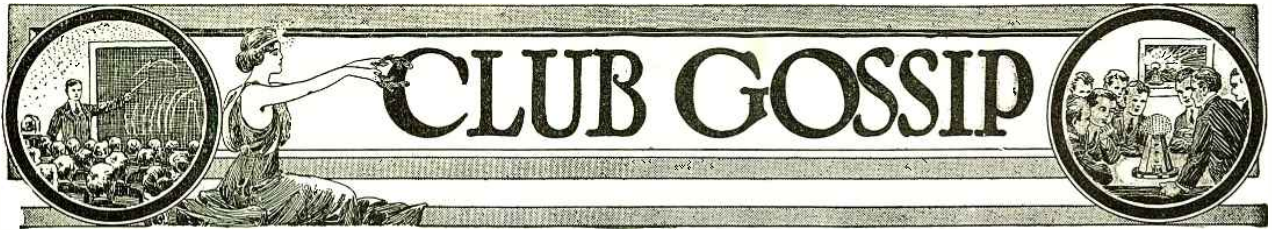

#### UNION COLLEGE RADIO CLUB.

The first code class of the Union College Radio Club was held recently in the electrical engineering laboratory. Special instruction is being given by expert club members to any who wish to take up the practice. The affair is free of charge and is open to all persons interested, townspeople as well as college students. Those who own headphones are requested to bring them with them.

The radio club is receiving letters daily from colleges and organizations of a similar nature, complimenting the members of the club upon their work.

Several reports of the radio club's activities have been reported in various radio magazines, while in almost all eastern reports of stations heard from, the Union club is mentioned. In addition to this, the members of the Schenectady organization have written several articles for publication dealing with the work of the organization for technical magazines upon the requests of these magazines. Letters have also been received from newspapers asking information in regard to the club, its organization and details about the college in general.

The radio club is doing a valuable work in advertising the college in the Eastern part of the country. That this fact is appreciated was shown by a recent act of the publication board in which the radio club was set aside together with the athletic teams as an organization representing the college as a whole and therefore exempt from the Garnet tax.

The new apparatus is expected to arrive soon. The club will then be able to communicate by radio with any part of the country under favorable conditions. It will give the radio club one of the best sending and receiving sets in the country and will be far superior to those owned by many larger colleges.

#### CHARLOTTETOWN WIRELESS CLUB.

The Charlottetown Wireless Club was organized Saturday evening, Dec. 4, for the purpose of helping and encouraging radio amateurs in Prince Edward Island. The membership is 15, with numerous additional "hams."

We are fortunate in securing for a clubroom the wireless classroom of the Navy League. The Navy League wireless station (XEN) is also at our disposal. It consists of a 1/2-K.W. transmitter, long and short-wave regenerative receivers with two-step amplifier. We hope to send complete description with pictures as soon as possible. The officers elected at the organization meeting for the ensuing year are: Gerald Maddigan, chairman; Robert Weeks, vice-chairman; Nelson Rattenburg, secretary-treasurer; Walter Hyndman, chief operator and instructor. A library committee of three was also appointed. We will be pleased to correspond with Canadian amateurs. Address us: Charlottetown Wireless Club, Navy League Building, Charlottetown, P. E. I., Canada.

#### THE COLUMBIA RADIO CLUB.

The Columbia Radio Club held its first regular meeting Feb. 25 at their headquarters at 4 Roland Ave., Baltimore, Md. Officers were elected as follows: J. Stewart Davis, president; Clyde Friz, treasurer; Wm. G. Buck, secretary. Since then one honorary member has joined. The purpose of the club is to create an interesting and instructive interest in radio telegraphy and telephony. At the present time an efficient damp-wave and C.W. receptor has been installed, a short-wave regenerative set is nearly finished and a sending set of ample range is being installed. Code practice is also being arranged for. Correspondence from other clubs is invited. Address all communications to J. Stewart Davis, at above address.

#### IPSWICH RADIO CLUB.

The Ipswich Amateur Radio Club held its first meeting Friday, Feb. 19, at 7.30 P. M., at the house of the president. The following officers were elected: President, Clarence Gould; vice-president, Raymond Cook; secretary-treasurer, William Burke. There were eight members present. At the next meeting there were fourteen present.

It was decided to hold meetings every Friday at the members' houses until a club house can be obtained. The dues are forty cents a month. No fee is charged for admission.

The purpose of the club is for radio research work and to aid beginners in learning the code. We have a very capable president and he is helping members greatly by preparing them for government licenses.

We would be pleased to correspond with other clubs. Address all communications to William Burke, Fellows Road, Ipswich, Mass.

#### TECH HIGH RADIO CLUB.

At the 34th meeting of the Tech Radio Club, on February third, Mr. Metcalf of the Magnavox Co. gave a very interesting talk about the Magnavox loud-talker. He also gave the history of the Magnavox, as well as explaining the principle involved in this electro-dynamic receiver. As the Tech Science Club attended this meeting, much interest was stimulated along the lines of radio.

The next day an assembly of the student body was held. At this assembly a radiofane concert was given. This was only made possible thru the courtesy of the Magnavox Company and Sergeant Travers, of the Signal Corps, located at the Presidio, San Francisco, with whom plans for a lecture and music reception were made.

A small two-wire aerial not over 75 feet long and 40 feet high was used, and another stretch of bell wire wrapped around a water pipe serving for a ground. Together with this a three-step power amplifier using 400 volt "B" battery was employed after stepping up with a two-step amplifier. Most signals could be heard all thru the halls and in front of the school very distinctly.

After President Wallace Brainard, of the club, had made a short talk on the subject of telephony, the bulbs were turned on. The radiofane speech of Sergeant Travers was about fifty times as strong as an average man's voice, being in fact too loud, because of the echoing. After Sergeant Travers had completed his lecture, he played a few records on the phonograph, after which the concert was terminated. Another interesting feature of the assembly was an experiment with an Ingersoll watch which was held up to a microphone. The ticking of the watch could be heard very distinctly all thru the auditorium, much to the amusement of the student body.

During the week eight members were enrolled in the radio club, probably on account of the stimulated interest. We now have our meetings every Thursday afternoon at 3.15 P. M.

#### MANHATTAN ASSOCIATION.

The Manhattan Association of Radio Scouts started November 5, 1920. Since then it has risen in the amateur radio field to a very high point. The club now has a membership of 25 and is open for more members. The requirements are: You must be a member of the Boy Scouts and know something about radio. The club meets every Saturday afternoon at 3 P. M. The club owns a wonderful transmitting set which was donated by the Washington Cutting Co. It is 1/2-K.W. multiple gap, 500 cycle set and can reach a distance of 50 miles during the day and at least 200 miles at night. Members have talked to amateurs in Maine. They also have a receiving set. The operating room is fixt up in the latest style with brass tubing connections as on snaps. They also have a six-wire cage antenna, one of the first in the city. The radio room is open every day in the week and visitors are welcome. The club is supervised by Mr. M. Schwartz, a Boy Scout executive. There are also some noted amateurs among the members such as the President, Joe Pollock, 2BP; Secretary, Mr. Sparks; Chief Operator, Benedict Goldman, 2VA.

The headquarters is 73 Madison Ave., New York City.

#### ELIZABETH, N. J., RADIO CLUB.

The Junior Radio Club of Elizabeth, N. J., holds meetings every Friday evening at 7.30 at the home of Mr. E. Gundrum, 303 Cherry St. The purpose of this club is to get all Elizabeth and vicinity amateurs together for relay and experimental work. Mr. Gundrum entertains the club and other visitors with radio music from many different radiofane stations. All amateurs wishing to join should communicate with Mr. Gundrum at the above address.

Plans are under way for a permanent club room. The club has 10 members at the present time and would like to have more. Fellows you do not have to have a high powered transmitter to become a member of this club, just as ordinary sending or receiving outfit. Code practice is held at every meeting for those who cannot master the code easily.

#### THE HOOSIER RADIO LEAGUE.

The Hoosier Radio League held its semi-annual officers' election Tuesday evening, March 1, at the public library, in Kokomo, Ind. The following officers were elected:

President, Kenneth Schneiderman, of Kokomo; vice-president, Frank Hollingsworth, of Russiaville, Ind.; secretary, Walter Lanterman; treasurer, Vincent Guerin; corresponding secretary, Wayne Bennett.

The League has been going only six months and we have 35 members. Anyone wishing to become an associate member, that is any amateur who lives where he can't attend the meetings, write to the corresponding secretary or vice-president, Frank Hollingsworth, of Russiaville, Ind.

#### MASSENA HIGH RADIO CLUB.

The Massena High School Radio Club was organized during the fifth week of the present school year. The following officers being elected: President, Frank Bailey; secretary, Earle Plante; treasurer, Arthur Robinson; instructor, Frank S. French.

Regular meetings are held every Monday evening at 7 P. M., at which code practice, radio theory, construction and physical phenomena are given and studied. Any member of the high school is invited to join the club, his club rating being based upon the results obtained from written examinations given by the instructor.

Monthly dues of 25 cents are charged, fines being imposed for back payment and for unexcused absences from the regular meetings.

Correspondence with amateurs and other radio clubs is invited. Address Frank S. French, Instructor, Massena High School Radio Club, Massena, N. Y., care Massena High School.

#### BENNINGTON Y. M. C. A. CLUB.

The Radio Club of the Bennington Y. M. C. A. was organized March 11, 1920, and has held weekly meetings at its headquarters in the local Y. M. C. A. regularly, except during the summer recess, when recognized activities ceased because of temporary depletion of membership caused by the school vacation. The club started with 18 members in charge of S. C. Lyons and elected the following officers: Gen. Sec., H. W. Winslow; president, I. Pelsue; corresponding secretary, F. Cowan; and treasurer, E. Ransom. It now has upon its rolls the names of about 40 young men, among whom are some very promising amateurs. Thru the generosity of Mr. Winslow of the Y. M. C. A., the club now possesses a well-appointed radio room, a receiving outfit with single stage amplifier, a 3/4 K. V. A. spark transmitter, and a small, but complete X-Ray outfit. Some good work has already been performed with the receiving apparatus, altho the transmitter has not yet been officially operated, due to lack of a station license. There was organized, recently, a branch of the club at S. Shaftsbury, Vt., and several of the members have private stations, there is plenty of opportunity for team work. All communications should be addressed to Mr. Fred Cowan, School Street, Bennington, Vt.

#### A WIRELESS DANCE.

On March 3 the Technical Research Society of Steel High School, Dayton, Ohio, held an unique wireless dance at a local dance hall. The music was furnished by the McCook's Aviation Field radiofane. It was received at the dance hall and amplified with a Magnavox amplifier to a sufficient intensity for dancing. Several of the latest records were played on the victrola at McCook's Field. The dance was well attended and an advertisement in the newspaper brought gratifying results. Here is a fine idea for radio clubs and other organizations who can arrange to get some nearby station to transmit music. Also this served as an excellent advertisement for the society.

#### LONG BEACH RADIO AND RESEARCH ASSOCIATION.

The Long Beach Radio and Research Association was organized December 20th, 1920, by a few live wire amateurs to carry on and to further radio in this city. The officers of the association are: Mr. Moore, president; Mr. Lithgow, vice-president; Mr. Stiles, secretary-treasurer; and Mr. Collier, corresponding secretary.

The association boasts its own club room and a total of twenty members. At present you are not required to pass a test to obtain admittance into the association. The dues are fifty cents a month per member; this money goes to defray the association's expenses and to buy magazines and needed apparatus.

Meetings are held every Monday night at 7.30 o'clock at the club room, where lectures which have been assigned at the previous meetings are given.

Anyone desiring to communicate with a live-wire association out for members, should correspond with the secretary, Mr. W. A. Stiles, 445 Cedar Avenue, Long Beach, California.

# RADIO DIGEST

## THEATRE MUSIC SENT BY RADIOFONE.

The latest thing in providing entertainment by radiofone in Pittsburgh is the sending out of portions of the program given at a downtown theater. This is accomplished in the same manner as the church services at the Calvary Church in the East End. Telephone transmitters placed in the theater collect and transmit the sound over a special telephone wire to the radio station of the Westinghouse company in East Pittsburgh (Radio KDKA), where it is then sent out by radiofone.

## SECONDARY ELECTRON EMISSION FROM COPPER SURFACES.

By I. Garnett Barber.

### SYNOPSIS

*Secondary Electrons from a Copper Surface Bombarded by Electrons.*—The method used was to measure the current flowing to the bombarded plate as a function of the grid potential. By using sufficiently low pressures the ionization effect was made negligible. (1) The coefficient of secondary emission was found to increase somewhat with the energy of the primary electron up to 500 volts, but never exceeded 1.5 per electron; the coefficient was increased by heat treating the plate and was greatly decreased by raising the temperature of the plate. (2) The energy of the secondary electrons was always less than that corresponding to a fall thru five volts, yet owing to the roughness of the surface an accelerating potential of about 10 volts is required to release most of the secondary electrons from the plate. (3) As to the origin of these rays, the fact that their maximum energy is always less than the energy of the primary rays and the shape of the curves obtained both indicate that the secondary electrons are not reflected electrons.

Reflection of electrotonic rays with energy below 500 volts, from a copper surface seems to be zero, or at least small.

## STABILITY CONDITIONS IN VACUUM TUBE CIRCUITS.

By R. D. Duncan, Jr.

### SYNOPSIS

*Condition for Sustained Oscillations in Vacuum Tube Circuits.*—After reviewing the fundamental requirements for such oscillations in any three electrode vacuum tube circuit, the fundamental equation for the plate current of a tube with a linear volt-ampere characteristic:  $i_p = (v_p + \mu v_g)$   $R_0$  is differentiated,  $-dv_p/di_p$  is put equal to the load resistance in the plate circuit  $R_L$  and thus the equation:  $\mu = -(1 + R_0/R_L)$   $dv_p/dv_g$  is obtained as a general relation between the constants of any oscillating circuit:  $R_0$ , the internal resistance of the plate-filament path  $R_0$ , the amplification constant  $\mu$  and the derivative of the plate voltage with respect to the grid voltage. This expression is evaluated for five standard types of circuit: Hartley, Colpitts, Meiszner, tuned-plate and tuned grid; and it is experimentally verified for the first two.

## RECENT APPLICATION OF RADIO TO MILITARY AERONAUTICS.

THE use of radio communication, both telegraph and telephone, on the military airplane is perhaps the latest application of radio science, increasing tenfold the usefulness of the airplane and already influencing the design of military aircraft. Airplanes have been called the eyes of the army but eyes without means of instantly communicating images and impressions registered upon the retina would find

but a limited sphere of application. It is in the performance of this function that radio finds such an important place in military aeronautics. The dots and dashes of the Morse code transmitted from the trailing aerial of the airplane carry to the ears of the artillery battery commander the correction for each shot fired, enabling him to group his hits on an invisible target with a degree of accuracy as great as is possible when the target can be seen, or bring to a waiting general news of enemy troop movement observed from the air.

Squadrons of Attack Pursuit Planes can be maneuvered in flight by means of the wireless telephone from the airplane of the

## A NEW METHOD OF PRODUCING HIGH-TENSION DIRECT CURRENT.

By M. Schenkel.

For many scientific and practical purposes, small high-tension direct currents are required. Sometimes a few milliamperes are all that is necessary. Generally, accumulators in series have been used, but they are very inconvenient, so that high-tension machinery has sometimes been employed, or even electrostatic devices, in which a condenser is always used. The condenser is certainly simple and cheap, but its voltage rapidly falls off. In order to keep up the voltage, some method of charging it continually must be used. Among these plans may be mentioned those employing rotating contact pieces, which connect the condenser intermittently with the poles of an alternating-current source of power, those employing valve cells, and lastly the so-called vacuum valve tubes. Delon's device, which has already been described by Lichtenstein, is among those which employ rotating contact pieces. Greinacher has used valve cells to produce direct-current voltages up to 10,000; but both these plans have the disadvantage that an external source of power of relatively high voltage must be provided, for a single condenser can at most be charged to a voltage which is equal to  $\sqrt{2}$  time, the effective voltage of the external source. With Delon's and Greinacher's methods, the former of which employs two condensers and two valve cells, the maximum voltage that can be reached is 2.83 times that of the source of alternate-current power. In order to produce 100,000 volts on direct current it is necessary to have an alternate voltage at least of 40,000 volts; this requires a good deal of space and many accessories.

In the present article a new plan is described which also employs condensers, but the necessary alternate-current voltage is much less than before. Let us suppose an alternate-current source of power represented by the winding  $W$  in Fig. 1. Let it be joined in series with the condenser  $C$  and the valve tube  $V$ ; then, as the current passes in the new direction in the winding, the condenser is changed to the maximum value of that voltage, and let us suppose this maximum value to be  $\sqrt{2}$ . While in this first half cycle—i. e., during the charging of the condenser—the voltage of the winding is opposed to that of the condenser, in the other half they will both be in the same direction, so that the winding, together with the condenser, will have a maximum voltage of  $2\sqrt{2}$ . The arrows in Fig. 1 are intended to show this. The new arrangement consists in adding another condenser and valve tube, so that the second condenser becomes charged when this maximum voltage of  $2\sqrt{2}$  occurs. This second condenser, then, becomes charged with the maximum voltage of  $2\sqrt{2}$ , and the charge cannot be lost in consequence of the valve tube. At the next reversal of direction a third condenser can be charged to  $3\sqrt{2}$ , and, if the process is further continued, the voltage can be still further magnified. Thus, if there are five condensers, and an original alternate-current voltage of 15,000, the fifth condenser will be charged to a voltage of 106,000 volts. If we suppose the winding  $W$  to be disconnected, then the condensers will endeavor to discharge thru the valve tubes. In Fig. 1 there are five valve tubes in series, and the voltage is distributed between them. The discharge voltage thru each is, there-

(Continued on page 750)

## Radio Articles in the April Science and Invention

Radio "Talk" Relayed to Land Lines.

With special diagrams showing the various elements comprising the complete radio and wire telephone circuit from the Avalon station, Catalina Islands, to the S. S. Gloucester on the Atlantic Ocean. One of the interesting points shown in diagram for the benefit of radio students is the curves of the different currents in each part of the radio and wire system at any moment.

Audio-Frequency Amplifier in

France. By Robert E. Lacault. This article is of exceptional interest to all radio men and is replete with photos and diagrams of the various hook-ups used in multiple-stage audio amplifiers of the French Army type.

U. S. Bureau of Standards Radio News.

The Oracle—Question and Answer Column.

Electricity from the Air. The latest development in this little known branch of science. With wash drawing and diagrams showing apparatus, etc.

Do not fail to read H. Gernsback's wonderfully entrancing story of a trip in the latest space flier. Mr. Gernsback's article describes all of the principal types of interstellar flying machines and many extremely interesting scientific as well as physical phenomena are interestingly dwelt upon.

squadron commander or from the ground easily as a company of infantry is handled. By the same means, a machine engaged in aerial combat and outnumbered may call for assistance.

Bombing planes lost in the fog or darkness are directed unerringly to the home airdrome by the radio direction finder and airplanes without pilots, controlled entirely by radio, are already a reality.

The Air Service of the Army, realizing the importance of this newest phase of radio, has established a school for the training of personnel to install, operate and maintain the radio equipment of airplanes at all the flying fields throughout the country. Radio engineers and operators, as well as experienced amateurs, may qualify for attendance at this school upon application to any army recruiting officer or to the office of the Chief of Air Service, Washington, D. C.

# Found by Radio

By HARRY WELTON

I 'VE been "op" aboard this old wagon the S. S. Dunkirk for some time and just must spread myself some now.

My radio cabin is of fairish size located aft on the boat deck and is divided into the wireless room and my private "digs." This hookup leaves me more or less disconnected from the rest of the crush aboard, but there is plenty QRM from below and the speaking-tube from the bridge pours out some queer unprintable things. However, you don't want to know so much of this old tub, so I'll tell you how I managed to get that nifty new three-stage amplifier what sleeps with me now, complete with "A" and "B" batteries n'everything.

When I migrates from radiobug-dom to this stage of the game I lugs along my trusty old home-made tuner (no sentiment you compree-) and V. T. detector cabinet which I hooked up to a loop aerial placed on the roof of my "digs" cabin, makin' a fine little direction finder which I experiment with in my off duty hours. You see I keep it in here so's to get away from the main gear and thusly avoid any arguments between the two armies of microhenries and also prevent the grid from leakin' all over the place and maybe spoil some good message forms; but I have to get my "A" and "B" juice from the "op" room as I never have been able since "comin' to sea" to scratch up the necessary coin for these valuable acquisitions, altho I'm hopin' an' hopin' an' wishin' you know and savin' hard as a miser, I don't see any "means" in sight yet. And you must admit I'm some optimistic as I also figures on gettin' a coupla' stage amplifier so's I can work on my D. F. at "all hours" instead of as now only when close to stations.

We were twelve days out from Glasgow for Halifax running a norther course which would bring us out fairly close to Cape Race. The last three days running was thru thick ice and fog and as we hadn't had a "shot" at the sun for that time our position was anything but clear—puttin' it mildly. The old man is pacin' the bridge nervous like as it seems we're pretty handy to the banks. I tells him from the way VCE is drilling into my ears we can't be more than a hundred miles off, which doesn't please him any.

About an hour later I'm sittin' very quiet listening to the goings on when I get a yell from the bridge thru the speakin' tube with orders to get a — radio bearing off Cape Race. I jams in the main switch, swings over to 800 meters at top speed and give VAZ a shout for a QTE. He comes back right smart with "K." I then shoots him the sigs and he must be workin' particular fast tonight for it doesn't seem I have time to ring back to "receivin'" when he comes thru with our bearing. I finish off with him and shouts the word on to the old man. Of course we ain't got our longitude or latitude so this bearing doesn't wisen us up much and as I'm hearin' Sable Island on his smooth musical note O. K. now as he hands a bunch of "Ps" to VCS I figures it's time I pull some

flash play with my own little D. F. plant and thereat I rush into my private shack to get a QTE off VCT while the chance is good. Pronto my ol' loop is goin' the rounds. You see it is located directly over the mushroom ventilator in the deck head right over my table and I have a rod running thru this vent attached to the loop frame and a nice shiny old sewing machine balance wheel at the bottom for a turning handle which carries a pointer and there is a 360° dial right under. VCT is workin' long and fast so I takes him several times, to make sure, and get the same thing. Now you savvé the idea is—where these two bearings—off two different points of land—cross, is the position of our ship. I don't bother with the speak-

with—QST de YOB—S. S. Borderline position unknown bearing by radio 72° off Cape Race—engines disabled, require immediate assistance." He must be buckin' ag'in the same conditions as us I reckons as he don't know where he is. I lose no time startin' up an' givin' him the "I get you," then passin' the dope to the ol' man. He tells me this is very vague—meanin' the position—as this helpless one can be anywhere on that bearing and we would have to chase around till we could see him so I suggests my D. F. again and he laughs a little but says "Try your luck."

Pretty quick I have YOB on the string and after informin' him "we're coming," I request him to pay off some good long sigs for a coupla minutes which he does "toote sweet." I start swingin' my loop again and have time to check the bearing twice before he quits. Rushin' the news to daddy on the bridge he lays my bearing and this guy's bearing off Cape Race down on the chart and finds the "fix" where this guy is supposed to be at, if the bearings are correct. He's only some seventy miles from us. We have hauled around now to a course which will bring us out on top of this YOB fella.

I hear much parley on the bridge about it bein' some job this chasin' thru fog and ice, but they cheer up some when the VCE weather reports come thru which indicate fresh northwest winds. This will lift the fog and sure enough the barometer is rising. Well, we're proceedin' along now with the ice holding us down to seven knots. I stay up most all night communicatin' with our new acquaintance and every once in a while I take a bearing off him and find we're headed his way pretty straight. About six bells in the middle watch I goes out on deck for a look around, you know, and find a stiff breeze blowing and the fog practically all gone, which I figures should be some satisfying to the O. M.

I'm sittin' dopy like from then on as 'bout all I can hear is VCT, VCE and VCS workin' now and then at top speed as they have the ether most to themselves in these wee hours. Every so often I get a shout from our helpless friend and find we're gettin' closer all the time, from the way he's comin' in.

Pretty soon it's time for mornin' eats and when the mate comes down he tells me—speakin' as if he wasn't believin' all along, you know—he says: "Well, Sparks, I guess you're right. I see some smoke about two points on the port bow which looks about twelve miles off—we'll be up to him in less than two hours."

Breakfast over, we're all on deck watchin' the smoke and by two bells in the first watch we're right up close. I won't bore you with the details, but judging from the row on decks of both steamers I figures they're havin' a hell of a time hookin' 'em up, and as I looked it over when they have finisht I figures they have enough lines on to pull the Woolworth Building away.

After some more bangin', etc., we're under way with our tow, makin' about six knots and gettin' clear of the ice pretty

(Continued on page 710)

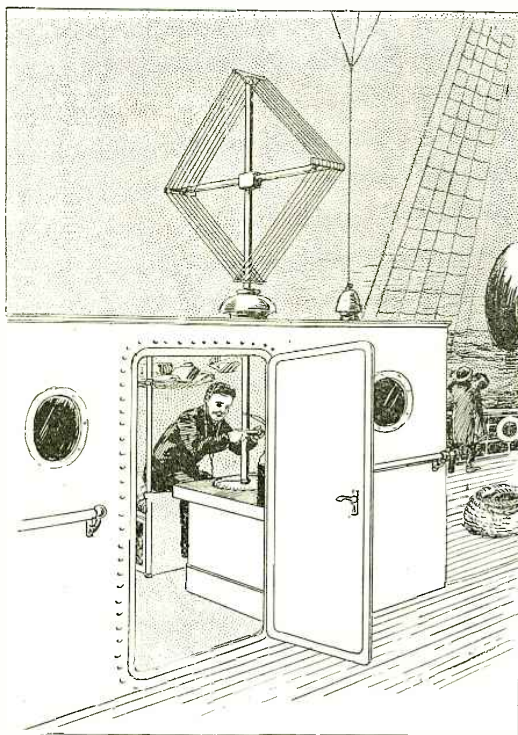

Now as He Hands a Bunch of "Ps" to VCS I Figure It's Time I Pull Some Flash Play With My Own Little Direction Finder.

in' tube but hikes up to the bridge personal and hand the ol' man the news with some explanation. The ginks aboard here have been kinda handin' me the laugh about my "experiments" you know and the "om" frowns a little when he begins to compree what I'm sayin', but I don't wait to see if he believes or not.

About five minutes later tho I feel her swing some to port, and I run along to have a peep at the standard compass by which I see he has hauled her to a more southern course, which is some gratifyin' to me. This will bring us outa reach of the banks.

When I gets back to the works and am comfortable again with the fones amittin' snugly I have just lit a fag for a good draw when some geezer starts up on a note which sounds like a cricket's crick and disturbs the ether somethin' awful

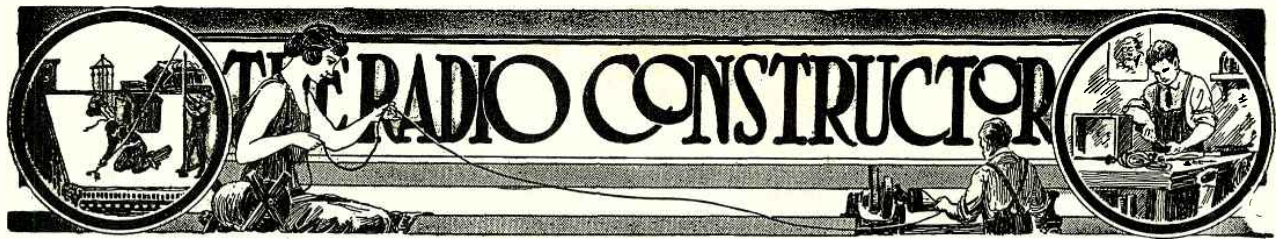

# Two-Step Audiotron Amplifier

By FREDERICK J. RUMFORD, E. E.

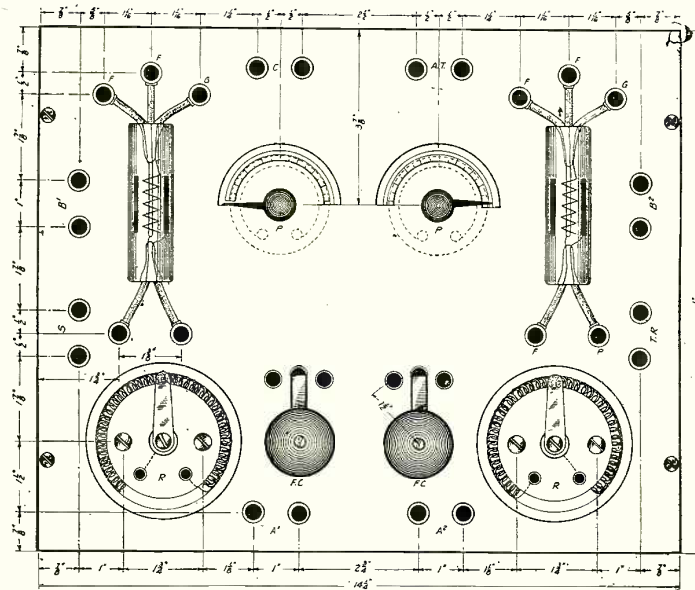

Figure 1

audiotron amplifier, the reader should have the following parts available: two potentiometers; two rheostats; two audiotron vacuum tubes; two 180 degree scales; two filament control switches with complete assembly; twenty-six copper or brass binding posts; one panel which will be fully described further on in this article.

With this outfit there are a lot of stations that can be heard across the room from the operating table with the receivers laid on the table, or again the receivers can have a loud speaking horn connected to them, causing the signals to be heard all over the room. Another interesting fact is that it is possible for the experimenter to connect his outfit onto a loud speaking horn and he can save the additional expense of purchasing extra telephone receivers.

In making the amplifier, start with the panel, which may be of oak, rubber or bakelite. In this particular instance, oak was used as it can be obtained cheaper than either of the other two. A piece of oak suitable for the purpose can be purchased for \$1.00 or \$1.50, but, of course, those of us who can afford to buy bakelite or rubber will obtain better results. However, the oak will do very nicely.

The dimensions of the panel in question are respectively 14 1/4" long, 11 1/2" in width or height and 1/4" or 3/8" thick. It is now advisable that the next step be the measuring and drilling of holes. The panel should then be sandpapered to a smooth finish. After that it is ready to be painted or varnished, just as is preferred. This is a matter of judgment. On the panel in question a glossy black insulating compound was used, which could be highly polish.

It would be a good idea to have the panel engraved and have the indentations filled with a white substance which will designate the different articles and their different uses. It will also give the panel a far nicer appearance and help to set the outfit off to better advantage. The next step in the construction is the mounting of the different articles and their switches, tubes, etc. As will be seen in Fig. 1, the correct dimensions are given for the mounting of the different articles on the front and the back of the panel. The reader will note that the bat-

(Continued on page 742)

**A** TWO-STEP audiotron amplifier is just the thing for the experimenter who has one or more audiotron vacuum tubes and a couple of sets of "B" batteries on hand. Most all experimenters have the above apparatus knocking around their shop or laboratory, and if not, it can be purchased at small cost, when you come to consider the price it takes to buy a two-step amplifier made up. All told, this outfit shouldn't cost more than twenty-five dollars.

Several have been made up and very good results obtained. The outfit is efficient and simple in construction, is easily and quickly assembled, and takes but very little space on the operating table.

It has been the experience of the writer in the past that the largest number of amateurs use the audiotron vacuum tube solely for the purpose of receiving wireless messages, and for that reason, experiments have been conducted along that line and a very efficient and simple amplifier has been developed with the use of two audiotron vacuum tubes. This is the first amplifier that I have seen using the audiotron vacuum tubes, as long as I have been in the radio game, and has only been fully developed by the spending of considerable time and money in a laboratory fully equipt for such experiments.

It would be a good idea to read the description of this article several times before starting to work on the outfit. It is of the utmost importance that very particular pains be used in making up the different parts.

Careful attention should be paid to the

accompanying drawings in order that all hook-ups are connected right. Be careful that the "B" batteries don't get connected on to the audiotron filament as it would burn out the tube. Of course, the experimenter may have ideas as to his own hook-ups, but the one already worked out in this article is really the best that can be obtained because most every hook-up conceivable was tried out in the making up of this outfit.

Fig. No. 1, represents the general assembly of the front view of the panel, showing the wiring which is on the back of the panel, illustrated by the thick heavy lines. It also shows the different apparatus all mounted on the front of the panel. The dimensions are shown by the dot and dash lines, and the concealed apparatus is shown by the dotted lines, also, the brackets assembly, that is if a set of brackets is used. The symbols are: R, rheostat; P, potentiometer; T.R., telephone receivers; F.C., filament control switches; B1, B battery number one; B2, B battery number two; A1, A battery No. 1 for the filament; A2, A battery No. 2 for filament; C, condenser; A.T. auto transformer or spark coil; and S, secondary of the receiving transformer. Figure No. 1 has been drawn to full scale.

Fig. No. 2 shows the general wiring diagram of the whole outfit connected up ready for instant use, including the external hook-ups along with the different symbols designating the different apparatus. In Fig. 2 the wiring has been made as simple as possible and no trouble should be encountered in making the connections.

In order to make up the two-step

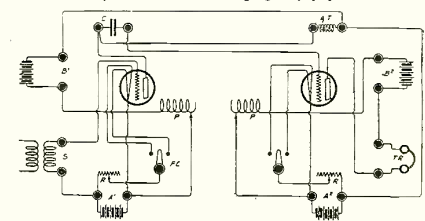

Figure 2

Diagram of Connections of the Audio Frequency Amplifier Using Audiotron Tubes.



# A Synchronous Rotary Gap

By WILLIAM SAMBUR

IT has been found difficult by radio amateurs to introduce the rotary gap in their set because of their using a spark coil. A rotary gap, when used with the ordinary vibrator spark coil, produces a very ragged spark instead of the expected pure one.

For use with a rotary gap an alternating current of about 500 cycles must be used in order to produce the desired results.

I have tested out the ordinary synchronizer, whereby the current is interrupted only, and have found it to be inefficient.

This form of synchronizer, instead of interrupting the current, causes it to be reversed eight times per revolution, and therefore changes it to a true alternating current.

The accompanying drawing shows clearly the construction of the device. The two separate strips on the commutator are insulated from each other.

The interrupter of the spark coil should be short-circuited. Every horizontal slit on the commutator should be in a straight line with a plug of the eight-plug rotary. This arrangement should be adjusted very carefully.

A rheostat should be used to regulate the speed of the motor. The transmitting circuit is such as is used for the ordinary rotary.

For the ham who uses a spark coil, here is a convenient way to build a synchronous rotary gap. On the same shaft an interrupter and the rotor of the gap are mounted.

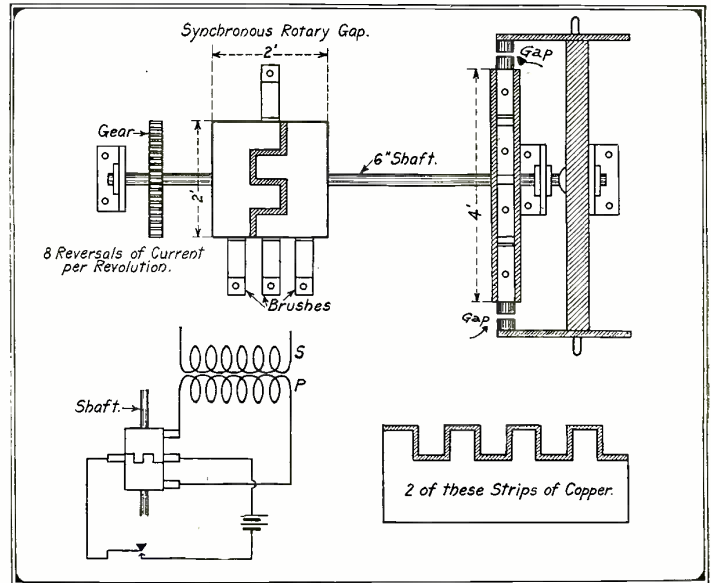

# Ideal Portable Aerial For Vacationists

By CLAYTON B. LE GALLEZ

WITH a satisfactory portable aerial, previously equipt and ready for easy erection on the camping ground, the radio enthusiast need no longer leave his beloved hobby at home nor spend unnecessary time and energy in preliminary mechanical labor when he shall arrive in camp.

For best results, all ideas should be discarded of taking a chance on finding a suitable tree or on being able to climb safely that tree if found (remembering the fickleness of weather and wood).

Before leaving home, prepare a portable pole and aerial, practical and 100 per cent efficient, as follows: Procure four twelve-

foot lengths of spruce—a wood light but strong— $2\frac{1}{2}$ " x  $2\frac{1}{2}$ " in dimension. Shape these pieces in cylindrical form, finishing neatly with sandpaper and paint. Let us call these lengths, sections 1, 2, 3 and 4—the bottom section being No. 1, the next 2, the next 3 and the top one No. 4, respectively.

Fit a brass or iron ferrule 18" long tightly about the upper end of sections 1 and 3, letting it project 9" from the end of the section. Whittle the lower end of sections 2 and 4 so that they may be inserted in ferrule. At upper end of section 2 and lower end of section 3, screw on—using wood screws—an iron band shaped as in diagrams 3 and 4 and large enough to allow two sections to slide freely within.

At lower end of section 1, attach convenient arrangement for winding and fastening hoisting rope; a halyard fastener recessed in pole is excellent. Fasten a pulley for the hoisting rope and three eyes for the guy ropes to the iron band at the top of section 2. (Diagram 3.) Provide each of the 3 guy ropes with snaps. Also fasten an eye to the band at the bottom of section 3 (Diagram 4) for the hoisting rope which should be about 50 feet long and provided with a snap.

At the top of section 4 (Diagram 2), insert a length of  $\frac{1}{8}$ " brass pipe, extending four inches from the end of section and threaded at the top. In the outfit have a large wing nut to fit this. Procure five brass collars, each with a center-hole large enough to slip over this brass pipe—soldering a 50-foot "lead-in" to one and a 75-foot aerial wire to each of the four others. At the ground end of each aerial wire place a Ball insulator and six feet of rope.

Provide also in the outfit four 75-foot lengths of No. 12 R. C. wire (to be used for capacity ground) and an extra length with a connector on the end (Diagram 5) for connecting these wires and lastly sever tent-pegs.

With the material thus prepared, the

rope and wire can be coiled and the four spruce sections strapped together for easy, practical portage or shipment. On reaching camp, the site for the pole can now be selected with reference to one's own convenience rather than to that of nature (as is not the case when depending on trees or other natural supports).

To erect the pole and aerial, slip the lower end of section 2 into the ferrule at the upper end of section 1 and the lower end of 4 into upper end of 3. Lay these two 24-foot lengths parallel to each other on the ground and side by side so they will slide within the iron bands when upright.

Snap the three guy ropes to the top of section 2. Snap the hoisting rope to the eye on the band at the bottom of section 3, thread it thru the pulley at the top of section 2 and bring it to the halyard fastener at the bottom of section 1. Place the brass collar with the "lead in" first on the brass pipe extending from the top of section 4, then the four other collars with aerial wires attached and screw down with the wing nut to form a connection.

Now raise the two lengths in an upright position, mutually encirled with the iron bands. Stretch and fasten the guy ropes securely to three tent-pegs driven in the ground. Pulling the hoisting rope, raise the two combined top sections until sections 2 and 3 overlap about  $2\frac{1}{2}$  feet. Fasten the hoisting rope securely to the halyard fastener.

Attach the lead-in to the set and the four aerial wires to the four remaining tent-pegs by means of the rope already attached, leaving the wires thus some distance from the ground. This forms an umbrella aerial which has proved most efficient for outdoor work.

On the earth, below each aerial wire, lay a length of the R. C. wire for capacity ground, bringing the four together at the base of the pole, connecting with the provided connector on the extra length of  
(Continued on page 748)

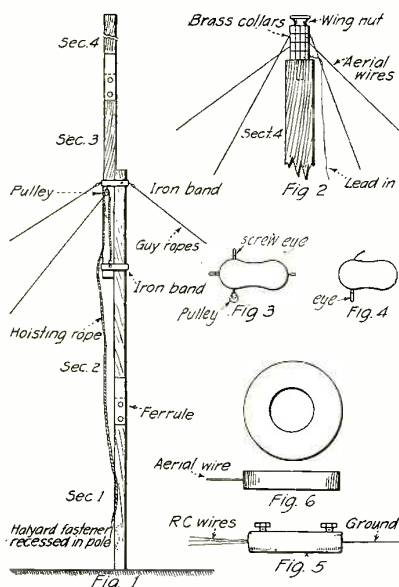

When in a Field or at Camp With a Portable Set, This Mast is the Most Convenient Means of Supporting an Aerial.



# Junior Radio Course

## The Regenerative Receiver

**I**N the last lesson, the principles of the regenerative circuit was explained, which is in itself quite simple. We shall now explain why variometers are used in the short wave sets instead of another type of inductance.

At first it is necessary to explain the functioning of a variometer, which consists of two coils, one of which can be turned to 180 degrees inside the other.

The variometer may be compared to an ordinary variable inductance, the number of turns of which may be varied at will, but the two distinct advantages of the variometer are—the absence of dead end losses caused by the unused part of the inductance, and the variation of wave-length which is as continuous as obtained by a variable condenser.

When the windings of a variometer are in the same direction, the two fields are added and therefore the wave-length is maximum as shown in A, Fig. 1, and equal to a large inductance.

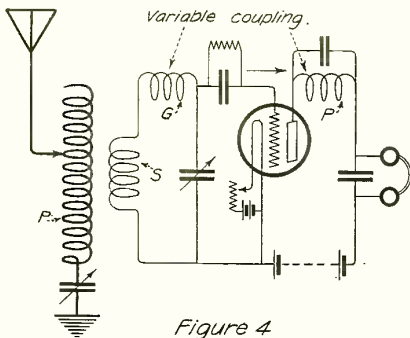

Figure 4

In Long Wave Receivers the Tuning is Generally Made With Fixt Inductances and Variable Condensers Instead of Variometers.

When the windings are at right angles, there is no mutual inductance and the wave-length is shorter and equals about the value of inductance shown in B, Fig. 1.

Then when revolved to 180 degrees, the two windings are in opposition to each other; the total inductance is then minimum and about the same as would be obtained on the fixt inductance in C, Fig. 1. But all this variation is obtained without having any unused part of the winding.

For the reasons explained, this form of variable inductance being the most efficient for a certain range of wave-length, it has been adopted by most of the manufacturers in the construction of regenerative sets.

By referring to Fig. 2, it can be seen that the variometers are loosely coupled, and by referring to Fig. 1 of the Junior Course in the March issue of Radio News, it can be seen that the circuits are practically the same.

Some of the energy in the plate circuit is fed back by induction to the grid circuit, and the amplitude of the original grid oscillations is increased. The same process is then repeated, *regenerating* the oscilla-

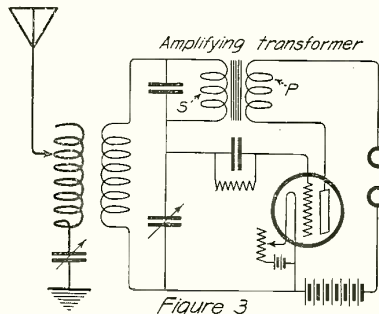

Figure 3

This is the Audio Frequency Regenerative Circuit. Instead of Inductances an Amplifying Transformer is Used.

tions. By this process the incoming signals may be amplified to a great extent and if the coupling between the grid and plate circuits is tight enough, the circuit oscillates, producing undamp't oscillations which may be used to produce beats for the reception of undamp't waves.

### AUDIO FREQUENCY REGENERATIVE CIRCUITS.

On the same principle the audio frequency component of the plate circuit can be amplified as well.

In Fig. 3 is shown the hook-up of an audio frequency regenerative circuit. The oscillations induced in the secondary circuit of the receiver are rectified by the V. T. acting as a detector, and then amplified by the amplifying transformer, the secondary of which impresses upon the grid the amplified current. This amplification is repeated many times, giving very good amplification using only one V. T. as a detector and amplifier, as is the case in the regenerative circuit.

In fact the impedance of the transformer should be the same or greater than the internal resistance of the tube and a condenser of about .002 mf. should shunt the secondary winding to provide a path for the H. F. oscillations.

### LONG WAVE REGENERATIVE CIRCUIT.

For long wave reception, variometers are not used as the range of wave-lengths is too great, and very large variometers especially designed would be necessary to answer the purpose.

It is more convenient to use circuits tuned by means of variable condensers as shown in Fig. 4; a part of the grid coil is

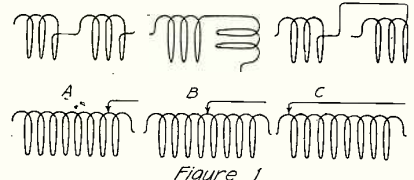

Figure 1

Comparison of the Value of Inductance Obtained With a Variometer and An Ordinary Tuning Coil.

coupled to the aerial inductance and tuned by a variable condenser. The plate circuit is tuned the same way and a small fixt capacity shunting the fones is used as a pass-by for H. F. oscillations.

The coupling between the grid and plate coils G and P being adjustable it is found that the most sensitive regenerative point for spark signals is just before the circuit oscillates.

If the circuit is made to generate oscillations by sufficient coupling of the grid and plate coils, undamp't waves may be received by the beat method already explained.

In this case, where the receiving circuit produces oscillations for the reception of undamp't waves, the method is called *autodyne*, *auto* meaning itself and *dynes*, meaning power; that is to say *which produces its own power*.

When a separate oscillator is coupled to the receiving circuit for undamp't wave re-

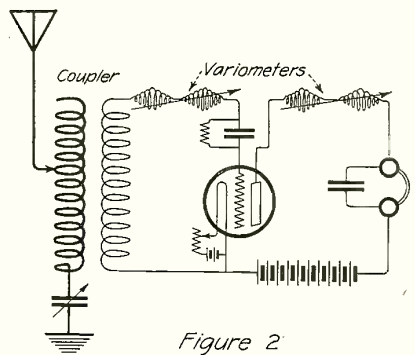

Figure 2

Typical Hook-up of a Short Wave Regenerative Set Having a Means of Tuning in Both the Grid and Plate Circuit.

ception, the method is called *heterodyne*; *hetero* meaning from the outside; the general meaning is then, *power coming from the outside*. But in fact the result obtained is the same, i. e., beats are produced which may be rectified by a detector.

In the circuit described for long waves, either single layer or bank wound coils may be used equally as well, the tuning effected by variable condensers being very sharp with either form of inductance, but the bank wound, or honeycomb coils, have several advantages which have made this type of inductances generally adopted for long wave reception.

### QUESTIONS FOR THIS LESSON.

1. Explain the principle of the regenerative receiver.
2. Why are variometers generally used for short wave reception?
3. How is it possible to regenerate audio frequency oscillations?
4. Explain the meaning of *autodyne* and *heterodyne*.

# A Complete Receiving Set for 25 Cents

By JOHN D. ADAMS

THE one sure way of making a convert to the wireless art is to have him "listen in" long enough to realize that the whole world is waiting to talk to him, and then lead him to the work bench. Doubtless there are thousands of lads who look wistfully at the supply catalogs, but get no further, feeling that the cost is beyond their scant means or that their electrical and mechanical knowledge is insufficient to cope with the construction of the various condensers, coils and detectors so beautifully pictured.

The receiving set illustrated was planned for just these boys, the item of expense and the difficulties of construction having been eliminated. The writer made it complete in one evening and had time to spare. It was designed to get the boys started in a practical way, however small, because any boy, who is a real boy, who receives a message on apparatus of his own construction will no longer be immune to the radio bacillus. He may throw the set away in a month and start after an audion and a bunch of honeycomb coils, but it has served its purpose in making a convert.

In almost every community there is one or more good amateur stations operating on 200 meters or less, and to receive them is such a simple matter that the beginner would never suspect it after seeing the usual array of equipment used. One need not be deterred by the thought of putting up an elaborate aerial on poles—a single wire run from the chimney to the garage, or a large loop in the attic will answer every purpose.

The first thing to do is to get a piece of dry three-quarter inch board, four or five inches wide and six or seven long, the exact dimensions being unimportant. Boil it in paraffine, and on the underside press on a piece of paraffined paper about four by five inches. On this, build the first condenser, which consists in all of three sheets of tinfoil about two by three inches, with thin paraffined paper between and a heavy protective piece on top. Connections to the tinfoil may be readily made by means of a small screw and a washer at each end. Fasten on a small block at each corner, so that when the board is turned right side

up the condenser will not rub on the bench.

The variable condenser is arranged as follows: First press down a piece of paraffined paper and then a sheet of smooth tinfoil on top of this, working out all the wrinkles and bringing the left-hand edge around over the side of the board so that connection may be easily made therewith. The tinfoil should contain an area of from 15 to 25 square inches, depending upon how thin the paper is between the plates. The upper plate consists of a smooth piece of heavy tin, the corners and edges of which have been smoothed off. This is to be fastened down with two screws and is slightly bent down so that the free edge will stand about a quarter of an inch from the tinfoil. Cut the latter away for about a quarter of an inch from around the screw holes and coat with shellac. Cover with a piece of shellacked paper and press flat. Screw down the tin plate, and provide some sort of a screw adjustment so that the distance between the plate and the tinfoil may be

should be added to the coil. If the signals are loudest when the condenser is wide open it is probable that too many turns are being used. The capacity of the condenser itself may be reduced considerably by placing another sheet of paper between the plate and the tinfoil.

We have now only to construct the detector, and here more than on any other feature depends the strength of the signals. Do not use a large crystal. Break it up into pieces not more than an eighth or a quarter of an inch, and then test a dozen or more pieces until a sensitive face is found. To do this the crystal does not have to be mounted. Simply put it on any clean metal surface and carefully go over each with a whisker wire, which may be easily handled by sticking it in the end of a piece of wood. A test buzzer will be necessary, and, of course, connections must be made in the usual manner, which is shown in the small diagram. When a good crystal is found, solder a brass nut or a short piece

of tubing to a piece of sheet brass and fasten to the base, after which pack in the piece of galena with tinfoil.

The essential requirement for a beginner in a crystal detector is to have it so arranged that the entire surface of the crystal may be explored quickly. So many detectors have the whisker wire on the end of a screw and are almost worthless because a sensitive spot is no sooner found than lost, due to a slight wobble of the whisker caused by turning the screw further to adjust the tension. If the whisker is about three-quarters of an inch long the pressure is relatively unimportant after it is once gotten to about the right point. In the design illustrated, a light flat spring is mounted on a block with a single screw which is

set in only fairly tight in order that the spring may be moved to or from the crystal. At right angles to this is riveted a small strip of metal carrying the crystal wire. It will now be seen that by the previous motion and by turning the latter piece of metal on the rivet, contact with any point on the crystal may readily be made. The screw adjustment for pressure may be added, but is really not essential, as the pressure can be changed by bending the flat spring a trifle.

Four binding posts—two for the fones, (Continued on page 730)

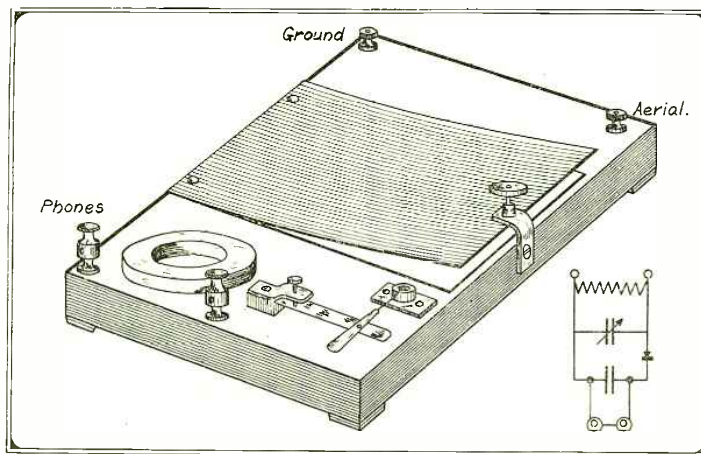

Boys! Here is a Real Cheap Receiving Set That Can Be Built by the Beginner Who Can't Invest Much for a Start in the Game.

altered as desired.

The tuning coil in the usual set is here replaced with a small coil consisting of fifty feet or less of magnet wire. The capacity of the condenser being unknown, no definite data can be given for this; but it is a very simple matter to make a few tests. Take any odd length of magnet wire, say number 22 or 24, and wind it into a coil about an inch and a half diameter, and the chances are that it will work. If the signals keep increasing in strength as the condenser is screwed down, it means that more turns

## Dictionary of Technical Terms Used in Radio

**Resultant Waves**—The two wave-lengths produced in oscillating Coupled Circuits, owing to mutual inductance between the primary and secondary of jigger, being added to and taken from the self-inductance of both circuits at each passage of an oscillation. Thus both circuits have two inductances at almost the same time. The closer the inductance coils are to each other the greater the mutual inductance; therefore, the greater the difference between the resultant waves produced. See Percentage Coupling.

**Retardation**—See Inductance.

**Retentivity**—The property of retaining magnetism.

**Reversible Booster**—Booster used in generating stations to raise the pressure of accumulators during discharge, and to

raise the pressure of generator during their charge.

**Rheostat**—A variable resistance.

**Ring Armature**—Also called Gramme Armature. Has its windings wound spirally round an annular ring or cylindrical core.

**Risers**—Metallic strips attached to one end of commutator bars to which are attached ends of armature windings.

**Rocker**—A casting fixed to casing of dynamo or motor and having insulated standards for retaining brush holders in position. It is capable of variation of position.

**Rontgen Rays**—Electron discharge from cathode in a highly exhausted vacuum tube is concentrated on to a platinum plate, which radiates electro-magnetic pulses of extremely short wave-length,

called Rontgen Rays. These rays have the power of penetrating opaque substances, whereby, with aid of a fluorescent screen, bones in a living body are visible. Also known as X-rays.

**Rotary Converter**—A continuous current dynamo provided with slip rings at opposite end of shaft to commutator. Current supplied to commutator drives machine as a motor. Armature revolving in the magnetic field generates A.C., which is collected from the slip rings. Generally used on board ship to convert D.C. to A.C., when it is known as an inverted Rotary Converter. If it were revolved by mechanical means it would generate both A.C. and D.C. simultaneously.

**Rotor**—The moving part of an Induction Motor.

# Junior Constructor

## SOME VERY USEFUL ARTICLES.

It is very likely that many radio experimenters are unaware of the great usefulness of what is known as the "Bayonet Socket" line. Under this heading there is a large variety of sockets, switches and fittings that will prove to be of great utility around the radio room. Perhaps the best one is that shown in Figure 1, and which is known as a Double Contact Line Union. A few of these properly connected are better than a whole switchboard.

The sketch will show how easy it is to change from one tuner to another, at the same time doing away with lengthy leads, more or less inefficient switches and complicated wiring. Best of all, however, is the ability to change the polarity of the current instantly. Such an arrangement is invaluable in oscillating circuits, as all will admit. By putting register marks on each half of all unions as shown at "A" the correct connections are always easily found. The writer, after one trial of these, threw away an expensive switchboard and equipt all his instruments with them to the greatest advantage. Any combination of instruments is possible with such an arrangement.

Some doubts were had as to how these would look, but they are so well made and finish that the looks of the instruments are really enhanced by them, especially if bright, clean cord and nicked terminals are used. It was also found that the capacity effect was quite small, and, due to the fact that all the connectors are alike, there was no change in capacity when the circuits were switched, unless the leads were of very unequal length. When it is

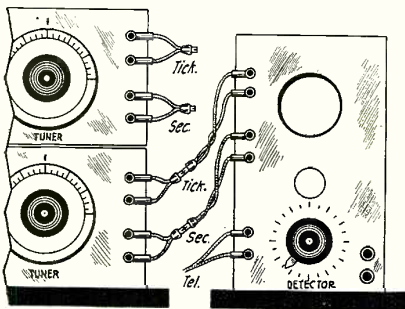

Fig. 1

Here Boys is a Real Idea to Make Quick Connections. Some Plugs Are Used Instead of Switches.

remembered that such an article costs but thirty cents, and will do all that two D. P., D. T. switches will do some idea may be had of its benefits.

Many uses will be found for other articles in this line. The arrangement shown in Fig. 3 is much like that shown above, but requires permanent fitting for the socket. It consists of an ordinary plug and a nicked socket with bayonet lock. It will be found to be quite useful for wall connections, or on a switchboard, if one is used.

Contributed by L. LONG.

## PHONOGRAPH PLATE SPIDERWEB INDUCTANCES

For the benefit of those who would like to make their own spiderweb inductance coils I will describe a cheap but efficient way of doing so.

I secured some old phonograph plates and cut them as shown in Fig. 1A in the following manner:

I turned out two pieces of wood into disks the same diameter as the record and about 3/8" thick. Thru the centers I drilled

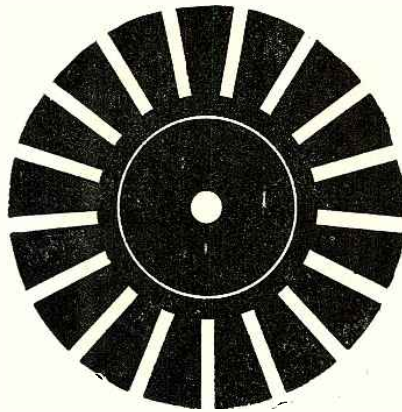

Fig. 1b

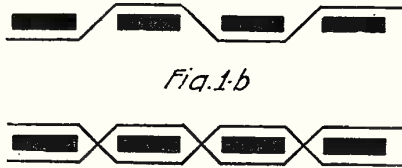

Fig. 1c

You Can Easily Make Some Spiderweb Inductances, Using Some Old Phonograph Records as a Winding Form.

a hole with the same diameter as the hole in the center of the record. Then I slotted the wooden disks as shown in Fig. 1A.

I was now ready to set the disks. I placed a disk on each side of the record and slipped a bolt thru the holes in the center and tightened it (not too tight). The wooden disks were then rotated so that the slots corresponded with each other. Then with a hack-saw I cut the slots in the record using the wooden disks as a guide and supporter so that the record would not snap. (I advise constructors not to attempt to cut the slots in the records without using the wooden disks, for if he does in a short while he will have mother after him for breaking so many records.)

The slots being cut the core was ready for winding. The constructor will have to determine the size and amount of wire to be used in order to secure the desired capacity. Great care must be taken when winding so as to not break the core by drawing too tight on the wire. When the wire is wound the first turn will develop as in Fig. 1B and the second will develop as in Fig. 1C, and so on until the desired number of turns are wound on the core. Then the coil is dipped in shellac and left to dry.

The coils may be then mounted in a small cabinet and coupling secured by opening and closing the two sides of the cabinet on which are fixt the coil. The terminals may be brot out to binding posts and in this manner nearly any circuit used.

Contributed by J. COSMAN.

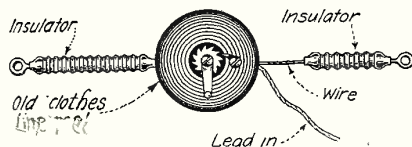

A Portable Aerial May Easily Be Made of a Clothesline Reel. Make One Like This for Your Portable Set.

## A PORTABLE ANTENNA.

An antenna that will not take up much room, and can be made to stretch any length, can be made from an old clothesline reel.

The clothesline is pulled out and cut a few inches from the reel; the copper wire is connected to the remaining few inches of rope.

The reel is then wound full, and before it is completely wound up, a lead-in is soldered to the wire in such a manner that when it is completely wound up the end of the lead-in will stick out.

Short lengths of rope are fastened to the end of the insulator, for connecting to rees, etc. The length of the antenna can be adjusted by the clog which is on every reel.

Contributed by DONALD C. ATHERTON.

## A TIME RECORDING DEVICE.

At times it is desirable for the experimenter to have a device that shows the length of time a certain apparatus is in operation, as for instance a storage battery charging apparatus, to indicate the amount of charge. The writer, being in need of a device of this sort, conceived the following simple idea.

A watch or small clock is secured that keeps fairly accurate time. This is fastened to a small base. On the base also is fastened a magnet, as shown in the drawing at A. The armature of the magnet is pivoted rather carefully, and a wire C, of about 30 gauge, is soldered to it. The end is bent over so that, when no current is flowing thru the coil, the wire is resting on the dial of the watch, within the dial of the

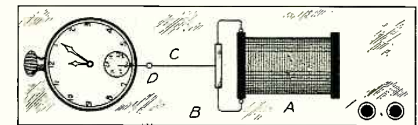
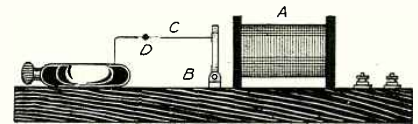

Here is a Practical Device for Closing a Circuit at a Certain Time or Measuring Time During Experiments.

second hand, stopping it when the hand hits it. A small adjustable weight is shown at D. This is for the purpose of adjusting the armature to the different strengths of current.

If the watch happens to have an unbreakable crystal, a small hole can be drilled thru it for the wire.

The coil may be either shunt or series; if shunt, a bell magnet wound with No. 34 or 36 wire will work on voltages up to about ten volts without undue current consumption. If series, No. 14 will probably answer all the requirements of the amateur.

Contributed by RAYMOND ROOF.

## RUBBER GUYS FOR AERIAL.

My aerial is strung between two high trees, and is about 100 ft. long. To avoid the swinging of the trees in a heavy wind, I have placed a piece of motor tubing about 18 inches long between the spreaders and the ropes which are drawn over branches of the trees. This tends to keep the aerial always steady, and does not allow any undue strain to be put on it.

Contributed by E. H. WALTHER.



**T**HIS Department is conducted for the benefit of our Radio Experimenters. We shall be glad to answer here questions for the benefit of all, but we can only publish such matter of sufficient interest to all.

1. This Department cannot answer more than three questions for each correspondent.
2. Only one side of the sheet should be written upon; all matter should be typewritten or else written in ink. No attention paid to penciled matter.
3. Sketches, diagrams, etc., must be on separate sheets. This Department does not answer questions by mail free of charge.
4. Our Editors will be glad to answer any letter at the rate of 25c for each question. If, however, questions entail considerable research work, intricate calculations, patent research, etc., a special charge will be made. Before we answer such questions, correspondents will be informed as to the price charge. You will do the Editor a personal favor if you make your letter as brief as possible.

**AERIAL WAVE-LENGTH.**

(182) Mr. Earl Moore, of Salina, Kansas, asks:

Q. 1. What would be the natural wave-length of a "T" type aerial 150 feet long and about 50 feet high or about 60 feet in all from the ground up to the spread?

A. 1. The natural wave-length of such an aerial would be about 200 meters if the flat top is made of four wires spaced two feet apart.

Q. 2. Does it make any change in efficiency to use, say 12 wires in the spread instead of four, considering a r-k.w. installation? In other words, does increasing the number of wires also increase the range?

A. 2. Increasing the number of wires in the flat top increases the wave-length but does not increase the range.

Q. 3. How would you calibrate a homemade wave-meter when there are no standard wave-meters within 25 miles (so far as I know) and communication has not been established?

A. 3. Wave-meters may be calibrated by the Bureau of Standards in Washington. We suggest that you write for particulars.

**FORD SPARK COIL.**

(183) Mr. Walter O. Schwaver, of Boonton, N. J., wants to know:

Q. 1. Will it improve the transmission of a Ford spark coil by using a glass plate condenser and O. T.?

A. 1. Yes, the use of an oscillating circuit will improve the transmission and cannot be dispensed with according to the Radio laws of the United States.

Q. 2. If so, how many plates 3" x 4 1/2", and how many sheets of tinfoil will it be necessary to use?

A. 2. Each armature should consist of 10 tinfoil sheets 3 1/2" x 2" with a lug for connection. This will require 20 tinfoil sheets and 21 glass plates.

Q. 3. Is it necessary to use a "B" battery switch on an amplifier as I do not believe any current is being consumed when the filament is not lit?

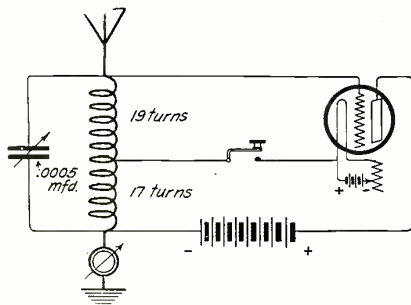

Here is the Simplest Hook-up of a C.W. Transmitter; With Only Two or Three "B" Batteries as H.T. Supply, This Set Has a Very Good Range.

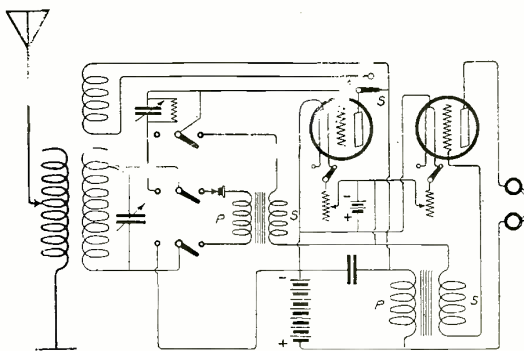

With Only a Three P. D. T. Switch, a Crystal Detector May Be Used with a Two-Stage Amplifier or an Audion and One-Step Put in Circuit for Reception of Undamp Waves.

A. 3. No, a "B" battery switch is not necessary.

**WANTS TO JOIN CLUB.**

(184) Mr. James E. Corley, of Paterson, N. J., inquires:

Q. 1. Is there a Radio club in Paterson?

A. 1. We don't know of any Radio club in Paterson, but if you have some friends interested in Radio why not start one?

**MOST EFFICIENT RECEIVER.**

(185) Mr. William Perry, of Columbus, Indiana, asks the following question:

Q. 1. Which do you consider best, leaving the price out of consideration, a Paragon receiver or honeycomb coils?

A. 1. The former is more efficient for wave-lengths up to 1,000 meters, but for long waves the honeycomb coils have many advantages and are the only practical inductances to use.

**COMPLETE SET HOOK-UP.**

(186) Mr. J. B. Eccles, of Toledo, Ohio, wants to know:

Q. 1. Please advise me the best way to hook up an outfit composed of second-hand Arlington receiving transformer, 2,500-3,000 v., one galena detector, one small Murdock fixt condenser, one set 2,000 ohm fones, one zinc spark gap, one small glass plate condenser, one key, one quarter-inch spark coil, one porcelain base double-pole, double-throw switch, one single-pole, double-throw slate base switch and a test buzzer.

A. 1. A hook-up for the instruments you mention appears on this page. You will note that it is necessary to use an oscillation transformer in the transmitting circuit in order to tune your set to a fixt wave-length.

**TEST WITH BUZZER.**

(187) Mr. R. C. Brewton, of Hagan, Ga., asks:

Q. 1. I have a new complete Radio set consisting of a coupler, galena detector, block condenser and pair of Murdock fones, 3,000 ohms, with a three-wire aerial of 14 gauge copper wire, 100 feet long and about 30 feet high. My ground is two lightning rods driven in a moist place. I cannot hear with this set. Can you find my trouble?

A. 1. It is difficult to say what is wrong with your set, but if there are no broken connections, it may be that your crystal is not sensitive or that there is a broken wire in your fones. The best way to test it is to use a buzzer. When the buzzer is running near your set try to adjust the crystal until you hear the buzz in the fones. If you hear the buzz the trouble is probably in your aerial circuit; if not it is for the reasons mentioned above.

**SHORT WAVE REGENERATIVE SET.**

(188) Mr. Homer Hatch, of Plano, Illinois, requests the following information:

Q. 1. Could two Clapp-Eastham Z. R. V. variometers and a DeForest army type short wave coupler be used in a short wave regenerative set similar to that on page 526 of the February issue of RADIO NEWS?

A. 1. Yes, this is quite possible and would give good results.

Q. 2. What company handles transmitting tubes of Western Electric make and the so-called "U" tube?

A. 2. The "U" tubes are sold by the Radio Corporation of America, 233 Broadway, New York City. Some Western Electric tubes can be had at the Somerville Radio Co., 102 Heath St., Somerville, 45, Mass.

(Continued on page 712)

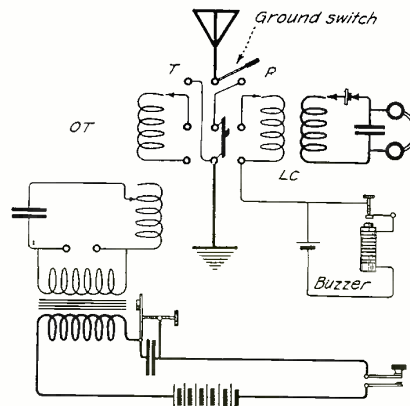

Complete Hook-up for a Simple Transmitting and Receiving Set.

# News From My Station

By G. RIDLEAK, V. T.

Chief Radio Eng. Toronto Lunatic Asylum. (Authorized by Fred. A. Burgess, Keeper.)

**S**INCE the last letter a good many changes have taken place at my station so I thought I would put you wise to a few of them.

In the first place I have hung up a new aerial and installed a transmitting set. Several months ago a sparrow thoughtlessly perched on the old aerial and brot it crashing to the ground so I decided to put up a real good one. It is, I believe, a marvel of modern efficiency, and goes under the name of a "two-wire inverted L." One wire is for sending and the other for receiving, thus doing away with the necessity of a change-over switch. Before attempting the erection of the aerial I consulted many eminent authorities on the subject, including Professor B. I. Ologist's treatise called "The Antenna and its Relation to the Bug." Since I considered myself a radio bug contemplating the erection of an antenna, I felt that this book might prove interesting, but I must say that I was rather disappointed. It is a fine book if you are going to collect bugs but not the least bit of use if you are a bug yourself.

A friend warned me not to stretch my aerial too tight. He said he put up an aerial with one end fastened to a chimney, and stretched it till there was no sag in it. When winter came the cold caused the wire to contract and pulled the chimney down. This sounded like good advice so I let my own aerial hang a little slack. You see, it is supported at each end by a large oak tree and I couldn't bear to think that these patriarchs of the forest might be uprooted during the first cold snap we had. An unforeseen difficulty arose, tho. One warm afternoon in early spring the wire expanded and an old lady tript over it and broke her leg. Now she is damming me for sewages—excuse me, I mean suing me for damages.

At first I found it rather difficult to get a good earth connection because the district in which I live is nearly all blue clay. However, I now keep a flower pot full of choice earth on my operating table and ground the set to this. I recently planted some bulbs in the earth to see how they would grow but so far they haven't even started to sprout.

When I was making my transmitting condenser I naturally felt a little reluctant about using castor oil. Doubtless many other fellows have felt the same about this national beverage. I consulted a doctor, however, and he assured me that Nujol, besides being as regular as clock work, was quite as efficient as castor oil and much more pleasant. If you don't believe me, try it yourself.

It might interest you to hear a little account of how I made my transformer. I purchased an old ozone transformer and carefully removed all the ozone. Spark coils should be treated in the same manner. That is to say, if you buy a Ford coil you should remove the Ford, as it

is neither useful nor ornamental and only gets in the way. I next removed the iron core and replaced it with a hard rubber one. This, so I am told, reduces Eddie's currents to a minimum and also prevents hysteria or hysterics or hiccoughs or whatever transformers are subject to. I once had a transformer that got hysterics while I was sending and jumped out the window. The last I saw of it, it was trying to climb a lamp post two blocks down the street. It probably wanted to get up and eat the raisins off the wires; or no, it's currents that grow on electric wires, isn't it? Or is it figs? I've just forgotten but it doesn't matter. However, let's return to my transformer. Several days after I got it home my wireless room became infested with rats. I couldn't imagine what mysterious attraction an ozone

composed of small pieces of ebonite rod. I have found these very effective as they prevent the gap from arcing. But the rotary part of the gap is most unusual. It consists of one of those old-fashioned lawn sprinklers which you have probably all seen. You know the kind. It has three arms sticking out horizontally from a common centre and when you turn on the tap the whole thing revolves and squirts water all over the place. Well, one of these things is the rotor of my new quenched rotary gap. The source of power is the nearest water faucet, either hot or cold, it doesn't matter. Since water is the juice consumed by this type of gap I naturally use a water rheostat to control its speed. The action of the gap is as follows. When a spark endeavors to jump from a stationary to a rotary electrode the water squirts it in the eye and thus quenches it. The more it gets squirted the more quenched it is. When it gets squirted too much it becomes positively drenched. When this happens you have to turn the tap off for a while and then start all over again.

In connection with the transformer I am using several coils which I believe are called strangling coils. The purpose of these coils is to strangle, choke, or otherwise kill any currents which may be trying to sneak back into the secondary of the transformer after getting cold feet from thinking of the shower bath awaiting them at the spark gap. These coils consist of a few turns of rope wound around a piece of stove-pipe. It doesn't take much. Six feet of good strong hemp soaked in wax will strangle any current that ever saw the inside of a condenser.

As yet I have been unable to get my set to work but this is probably only due to a loose connection or some such triviality. When I get a little spare time I will go over the connections carefully and solder them with a good brand of fish glue. If it doesn't work then I guess I will donate it to the museum and turn my attention to something more modern, such as radiofones or coherers. Till then, I remain, as undamp as ever.

Editor's Note:

Last week our 57th assistant editor went to Mr. G. Ridleak's for an interview.

While in the hall, he heard somebody hollering like barefooted devils on a white hot steel plate.

Our reporter thought at first that Mr. G. Ridleak was talking into the microphone of a new Radiofone using "hard" tubes, but when introduced into the room, our man saw with great surprise that the well-known engineer was experimenting with a new type of cage aerial, composed of steel, paint covered wire, 1" in diameter. He was inside of the cage and tried to pull the wires apart without success. Our reporter was then informed that he could not obtain the desired interview!

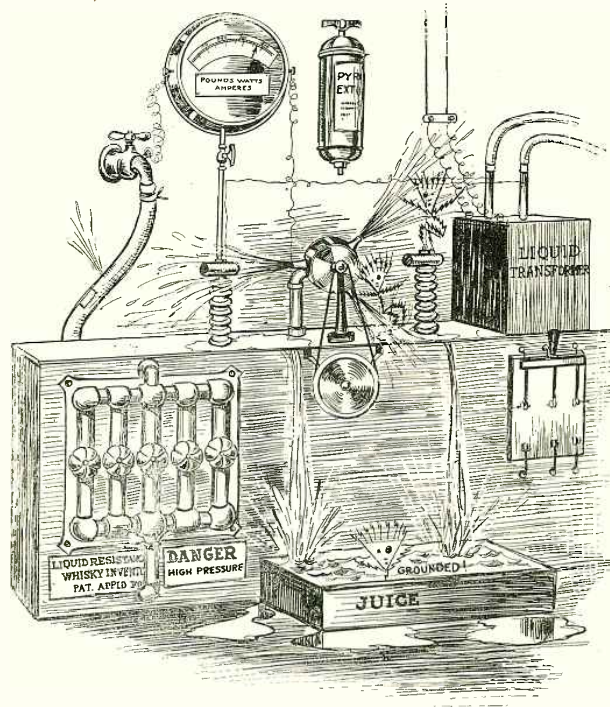

The Quenched Rotary Spark Discharger Has Two Fixed and Three Rotary Electrodes. When a Spark Endeavors to Jump From a Stationary to a Rotary Electrode the Water Squirts It In the Eye and Thus Quenches It.

transformer had for rats but I noticed that they spent most of their spare time, and they had lots of it, nibbling the secondary of the transformer. Upon investigation it proved that the secondary was composed of a large number of pies, assorted flavors, and the rats were making a picnic of them. I immediately removed the pies and replaced them with homemade wire pancakes. In attempting to eat these the rats committed gastronomic suicide and I haven't been bothered with them since.

Another unique piece of apparatus is the rotary gap. Due to its peculiar construction and action I have called it a "Quenched Rotary Spark Discharger." It has two stationary and three rotary electrodes. The stationary electrodes are

## Short Wave Radio Vacuum Tube Transmitter and Regenerative receiver with Two-Step Audio frequency Amplifier

(Continued from page 693)

circuits. Be sure and place the transformers at right angles and wire them carefully so as to prevent "howling."

All necessary details and dimensions are shown on the drawing, and no amateur with ordinary ability should find difficulty in the construction of this outfit. Standard parts are used thruout. Those who do not wish to construct the three units might construct any one as each is complete in itself. The variometers and the vario-coupler may either be constructed, or purchased ready made. Those advertised by Radisco would be suitable.

It might be of interest to you fellows to know that I am a Canadian amateur, which, I hope, will show you that we are not 10 years behind the game as some of you imagine. We can't do much in the way of sending as we are only allowed very short wave-lengths, my limit being 50 meters. How would you like that? But we can receive, to our heart's content, and some of us have very sensitive receptors. I hear POZ, MUU, YN, BZQ, BZL, BZR, and most of the other high power C.W., spark, and fone.

## Get Your Friends Interested

(Continued from page 680)

the duty of every ham to recruit some new amateurs. It is easy to get your friends interested in the fascinating game and if you can get them to listen to some radio

music, half of the work is done, for they are almost sure to be stung by the radio bug. Explain to them how it works and show them how to hook up a set. If you get someone interested and started in the game you have done some good work for the Radio community.

## Test of Insulating Material for Radio Use at the Bureau of Standards

(Continued from page 682)

resistivity is the resistance in ohms between the ends of a specimen one centimeter long by one square centimeter in cross section. The surface resistivity is the resistance between two sides of a square and the surface of the material.

One of the outstanding measurements made in the radio laboratory of the Bureau

(Continued on page 718)

## Lieutenants Needed in the Signal Corps

A competitive examination will be held beginning April 25, 1921, for the filling of 2,585 vacancies in the grade of Second Lieutenant in the Army, of which vacancies 114 are for Signal Corps appointments. Applicants for appointment in the Signal Corps must fulfill the following conditions:

"Candidates must be graduates, or members of the senior class, of educational institutions maintaining four-year courses of instruction in electrical engineering and physics and conferring the degree of bachelor of science in these two courses.

Full particulars relative to the examination may be obtained by writing to the Commanding Officer of the nearest military post, or direct to the Chief Signal Officer of the Army, Washington, D. C.

It is contemplated that successful candidates will be announced or appointed, or nominated for appointment about two months after the final examination.

## Hair Splitting Stuff

Sometimes we hear some "ham" operator "splitting the air" with a mile-a-minute gap, but—it's something new to "split hairs" in a vario-coupler.

Don't think, however, that actual fractional parts of human hairs are to be found lurking about the coupler shown above. Even if they were, they'd be too small to be seen. What we're getting at is that the dimensions of this new, moulded coupler are accurate to the fractional part of a hair's breadth. In fact, micrometer

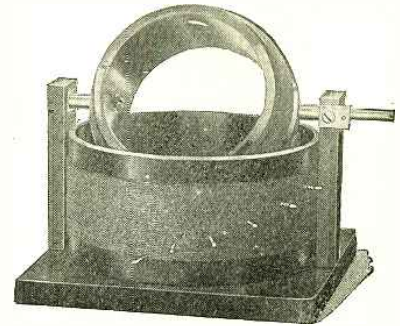

Here is a New Coupler Made of Moulded Composition. The Bearings Are Very Carefully Adjusted, Making Good Contacts and Smooth Running of the Secondary Coil.

measurements show, that in all essential dimensions, the parts for these couplers vary less than .002 of an inch!

That much variation is so close to none at all that you can take parts from different couplers, assemble them differently, and they *always* fit perfectly. That's a great help when you want to replace some part after years of use.

The materials used as a special moulded composition, Formica, and brass. The primary has 12 taps, allowing any combination of turns up to 37. No. 22 single cotton-covered wire is used, thoroly insulated thruout.

Photograph by courtesy of the Radio Distributing Co.

## Indoor Aerial and Choke Coil Amplifiers

(Continued from page 686)

Choke coils may be substituted for amplifying transformers very easily without changing the hook-up much. See Fig. 2. There is a hook-up in the November Q.S.T. for a choke coil 2-step using a separate set of "B" batteries for each bulb. This is found on page 54. On the same page is an editor's note concerning the hook-up, which states that the turns ratio for choke coils was only one to one. That is probably true, but at the same time I would like to state that my choke coil 2-step gives sigs about three times as loud as an amplifying transformer 2-step by actual test. I won't try to tell you why it works, since I don't know myself, but I will tell you what it does and how to do it.

The secondary of an amplifying transformer will work better as a choke coil than when used in its ordinary way. This has also been proved by experiment. However, spark coil secondaries are much better.

An amateur in Ridgewood recently heard 9MT in Colorado on a 1-step and honeycomb coils. The one-step used a choke coil. For emphasis I would like

to repeat that I have heard amateur stations in North Dakota, Nebraska, Kansas, Texas and New Mexico, as well as a hundred other ninth district stations. Another chap in (2BBB) Ridgewood, who uses a choke coil 2-step is picking up stuff as far out as South Dakota. The choke coils are very popular in Ridgewood and practically all the amplifiers, in a town of 70 amateurs, use choke coils.

The hook-up that I am using Fig. 1, uses choke coils and only one set of "B" batteries and it certainly works fine. It is the best amplifier I ever tried and I have tried many. It was originated by 2AGF. The one set of "B" batteries used for all three bulbs is made of flashlight batteries soldered together. It gives much better results than amplifying transformers and it works better than the hook-ups using three sets of "B" batteries. All the grid condensers and grid leaks are very necessary as is the fone condenser across the first choke coil. If a third or fourth step is added, a very large grid condenser is necessary on the last bulb. A 4-step will work

O. K. with choke coils. If the bulbs and chokes are kept separated there will be no squeals. I have mine about six inches apart. 2AGE has a four-step working which picks up commercial stations in California and in Colombia, S. A. He gets 8th district stations so loud his whole fones vibrate.

Consider the cost of choke coils compared to that of amplifying transformers. Choke coils may be purchased for about \$1.50 or \$2 at the most from the nearest garage. If you have some already, so much the better. Amplifying transformers cost from \$5 to \$7. With choke coils a 1-step costs about \$10 including the bulb; a 2-step about \$20 including bulbs. A 2-step with amplifying transformers costs at least \$12 more. Then, too, if you can get the "ham" next door to use his spark coil as a choke coil, there is that much less QRM for you. A ¼-K.W. may be used the same way—if you wish.

I have done quite a little experimenting with amplifiers and this hook-up is

(Continued on page 755)

## RADIO COMMUNICATION

(Continued from page 679)

spread out on a pond. Something very similar to the ripples would be seen if, in some way, the alternations of electric pressure could be made visible and a person were to look down from above on the antenna and the space surrounding it. The waves of electric pressure spreading out and successively alternating in direction would look something like the lines shown in the upper part of Fig. 5. The waves spread out in all directions and go to great distances.

Now think of what is happening at a distance from the antenna. As the wave passes any point there is an alternation of electric pressure going on continuously at that point. The alternating electric pressure or wave action at that point could be illustrated by the wavy line of Fig. 3. The portions of the wave above the horizontal line correspond to the electric pressure in one direction, and the portions below correspond to the electric pressure in the other direction. This can be understood by thinking again of the ripple on the water. Suppose there is a cork or other floating object on the surface of the water at a distance from the place where the ripple starts. As the ripple takes place, the cork rises and falls, partaking of the to-and-fro motion of the surface of the water. Or consider the sound wave. As the sound wave passes out thru the air, it will set in vibration any object which is capable of taking up the motion. Suppose, for instance, that a sound wave produced by a tuning fork passes a second tuning fork which is in tune with it, that is, having the same natural pitch or frequency of vibration as the first tuning fork. Fig. 5a. The

to-and-fro motion of the air will start the second tuning fork into motion. This can be readily shown with two tuning forks, striking one of the forks, thus producing a sound wave. It can be proved that the

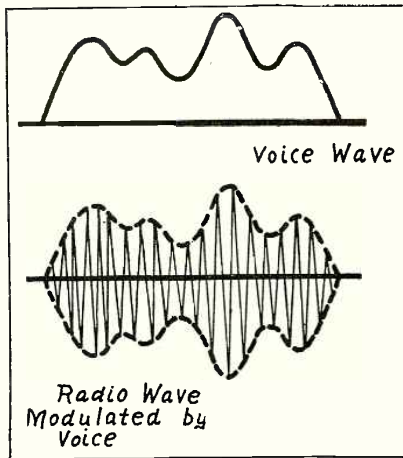

Fig. 10. The Upper Line Shows the Variations of Current Caused by the Voice Along a Telephone Wire. The Lower Diagram Shows How a Radio Wave is Modulated in Radio Telephone.

second tuning fork is set into vibration by grasping the first with the hand so as to prevent its further motion. A sound from the second one can then be heard. The same thing is sometimes illustrated in

a room. If a note is sung or produced on some instrument, a response may be heard from one of the strings of the piano or from a loose portion of a chandelier or other resonant object in the room.

An electric wave can produce an effect at a distance in just the same manner. In any electric circuit the moving wave of electric pressure can produce an electric current alternating with the same frequency as the wave. This is also readily illustrated just as the effect of one tuning fork on another was illustrated. Taking the same electric circuit with its spark gap, which was shown before, and allowing an alternating current to flow in it, it sends out an electric wave which can act on another electric circuit entirely disconnected from the first. The response in the second circuit when a current flows in the first circuit is shown by the fact that an indicating tube in the second circuit lights up when a current flows in the first circuit.

In order that this may take place, the second circuit must be in tune with the first. That is, it must be arranged to respond to the frequency of alternation possessed by the first circuit and the wave which it sends out. This is just like what happens with the two tuning forks and the sound wave. The second tuning fork does not respond to the wave from the first unless the two are in tune. This can be shown by placing a bit of wax on one of the prongs of the second tuning fork, changing the pitch of the fork. When the first tuning fork is struck under these conditions it can readily be demonstrated that the second fork does not respond. In the

(Continued on page 735)

### FOUND BY RADIO

(Continued from page 701)

well too. The fog has all gone and the second mate is busy "shootin'" the sun now and soon we have our "exact" position.

I'm gettin' the glad hand all round now, for you see, fellas, this tow means salvage money for all aboard and as it is a large ship with valuable cargo and we are taking him all the way into Halifax, which is now five hundred miles off, the money should be considerable.—Oh, yes, the steward is shovin' up the good eats and plentiful now and I'm "the white-haired boy."

Just three days later we arrive and drop our burden outside George's Island, proceedin' to dock ourselves. The old man rushes up to the office and comes back with our mail and the glad news that we go into dry dock for about six weeks for repairs. That suits us fine, for by that time this arbitration or whatever board it is will have settled that salvage dope, and sure enough as we're reposin' calm and peaceful like in the dry dock about four weeks later the Capt'n comes down from H. O. and passes the kale around. He must be feelin' some grateful to me, for he pats me on the back and shoves me out an extra ten bucks. Gettin' that tow and those bearings and all, sure put me in right, for the mate does likewise and pretty soon the rest come round and by the time it's all over my share is considerable swelled. The ol' man tells me later on the quiet I can have the carpenter any time to make that new loop an' rig it up anywhere anyhow an' all—you know.

Well, what do I do with all that kale?—bugs—I had them catalogs out like lightning and—well, you know what it would be like—I have 'em—that three-stage amplifier with "A" and "B" juice boxes all new and they're hooked up to that new loop now—settin' right where the old trusty did the good work.

### OSCILLATING AUDIONS

Very little has been said about the oscillating point of the audion. Altho two bulbs may be of the same type, they will not always operate efficiently under the same conditions. Vacuum tubes vary in their characteristics; there are no two alike.

The main trouble with non-oscillating V. T. circuits lies in the "B" battery potential. When trying out a new bulb, test it, using a variable plate voltage, as some tubes are very critical, necessitating careful adjustment. It may be a "hard" one, requiring a high voltage battery, or it may be a "soft" tube using under 40 volts.

The writer had the following experience which proves this statement to be a fact:

He was using a bulb with a "B" battery of 40 volts; the circuit did not oscillate. The wiring was thoroughly overhauled but was found to be correctly connected. As a last resort 20 volts were added to the plate circuit with no result; 20 more volts and the tube oscillated, making a total of 80 volts before this particular audion would oscillate.

Another vacuum tube of the same type was inserted in the socket; 80 volts were found to be high however, the bulb immediately "blueing," proving it to be "soft." The potential was reduced to 40 volts and the tube oscillated with greater efficiency.

The grid leak is worthy of more attention than is given it by the average amateur, and it is often overlooked and that of as an insignificant detail.

Exhaustive tests show that each individual tube operates with greater efficiency when the value of its leak has been determined.

By shunting the "B" battery and fones with a capacity of .0013 mf. the strength of the signals is surprisingly increased.

Contributed by IRVING S. SIMPSON.

### First Annual Amateur Show and Convention

(Continued from page 687)

Armour Villa Radio Club, Yonkers, N. Y. Radio Club of the Bronx, Bronx, N. Y. Ridgewood Radio Club, Ridgewood, N. Y. The total membership of these Clubs is 428.

The Executive Radio Council was formed for the purpose of mutual benefit and general improvement in amateur operating conditions. During its short existence of a few months the Council has accomplished a great deal, has assisted a great many amateurs in the way of a "big brother," and has always promoted the advancement of the science of amateur radio communication whenever possible. The clubs which compose the council are the leading ones of the Second Radio Inspection District, which includes Southern New York, Long Island, Staten Island and Northern New Jersey.

The amateurs of the Second District are undoubtedly the most advanced amateurs in the world, due in part to the fact of being located at the very heart of the radio activity of the world, and so enjoying close contact with a practically unlimited amount of first hand information.

Five commercial radio companies maintain their headquarters in the City of New York and operate stations in or just outside the city. Three great trans-oceanic radio stations are controlled and operated from New York. Hundreds of ships are arriving and leaving the port continually. An untold amount of advanced radio experimenting is done by commercial companies, by colleges and universities within the borders of the district. New York is the home town of the Institute of Radio Engineers and an untold number of smaller radio clubs and organizations are also located here.



# MURDOCK

**THE LATEST VARIOMETER No. 345**  
**VARIOCOUPLER No. 346**

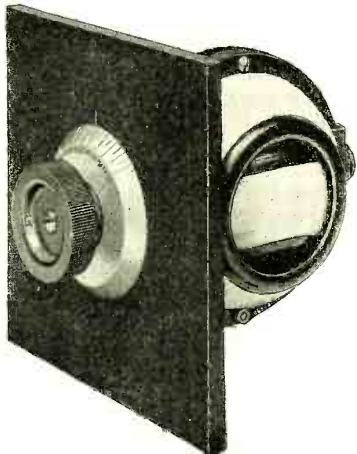

No. 345 Variometer  
**\$7.50**

No. 345-P Variometer, as illustrated ..... \$7.50

No. 345-G Variometer, as illustrated ..... \$7.50

No. 346 Variocoupler, as illustrated ..... \$8.50

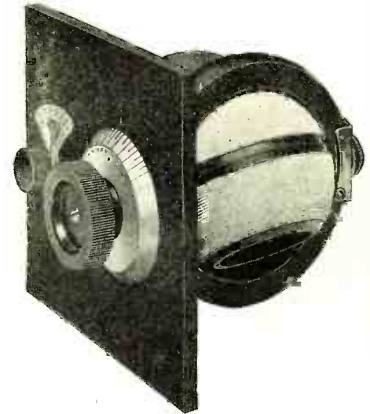

No. 346 Variocoupler  
**\$8.50**

WINDING FORMS ARE  
**"MURDOCK MOULDED"**

"THE PRICE IS UNUSUALLY LOW,  
 THE QUALITY IS  
 REMARKABLY HIGH"

SEE THEM AT YOUR DEALERS

## MURDOCK No. 55 RADIO RECEIVERS

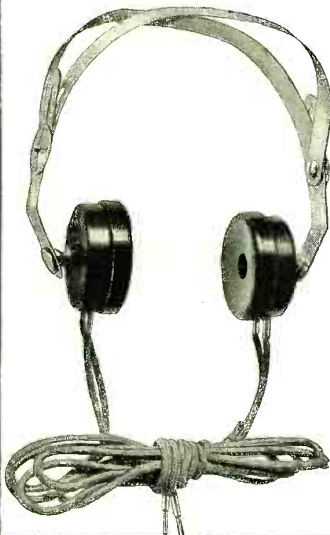

**2000  
 OHM  
 DOUBLE SET  
 \$4.50**

**3000  
 OHM  
 DOUBLE SET  
 \$5.50**

## MURDOCK Variable Condensers

No. 366-43 Plate ..... \$4.75  
 No. 367-43 Plate ..... 4.50  
 No. 368-23 Plate ..... 4.00

### PANEL MOUNT TYPES

No. 3660-43 Plate ..... \$4.00  
 No. 3661-43 Plate ..... 4.25  
 No. 3662-43 Plate ..... 5.00  
 No. 3680-23 Plate ..... 3.25  
 No. 3681-23 Plate ..... 3.50  
 No. 3682-23 Plate ..... 4.25

## MURDOCK Variable Condensers

"PERFECT SATISFACTION GUARANTEED OR YOUR MONEY BACK"

**BUY THEM FROM YOUR DEALER**  
 SEND FOR BULLETIN No. 20

**WM. . . MURDOCK CO.** 50 CARTER STREET  
 CHELSEA, MASS.  
 509 MISSION STREET, SAN FRANCISCO, CALIF.

### "Old Town Canoes"

AN "Old Town" rests as lightly on the water as a sunbeam. The faintest pressure of the paddle gets instant response. It is so steady that rips and white water can be shot with ease.

There is a built-in strength to every "Old Town Canoe" that makes it give many years of service. Buy the Sponson Model for the children—it is safer than a rowboat. Write for catalog. 3,000 canoes in stock. \$67 up from dealer or factory.

**OLD TOWN CANOE CO.**  
134 Fourth St.  
Old Town, Maine, U. S. A.

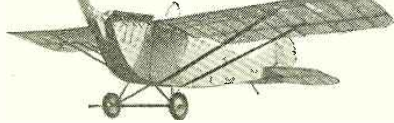
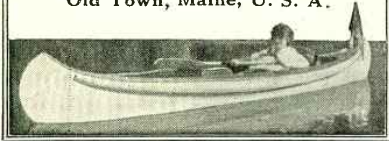

### Build Model Planes

Wading River models are exact scale reproductions of real planes, that's why they fly. You can't go wrong with Wading River plans and parts. Send 10 cents for new 56 page catalogue, showing 25 different models that you can easily build.

**WADING RIVER MFG. CO.**  
Dept. H, 672 Broadway, Brooklyn, N. Y.

## Learn Mechanical DRAWING

LEARN \$35 TO \$100 A WEEK



Are you earning less than this amount? If so my offer will interest you. I offer to give you a thorough, practical training in mechanical drawing by mail, in your spare time, at home. Course includes highest quality set of instruments and Drafting equipment. I guarantee to give you a thorough, practical training that qualifies you for a high salaried position as a professional draftsman. My graduates are making good with big concerns everywhere for free book of information. "Your In-Drafting". Roy G. Clifton, Pres.

Columbia School of Drafting, Dept. 1436,  
14th and T Sts., Washington, D. C.

## 12 Months to Pay

Enjoy your 1921 "Ranger" at once. Earn money for the small monthly payments on Our Easy Payment Plan. Parents often advance first small payment to help their boys along. **FACTORY TO RIDER** wholesale prices. Three big model factories. 44 Styles, colors and sizes in our famous Ranger line. **DELIVERED FREE, express prepaid. FOR 30 DAYS TRIAL.** Select bicycle and terms that suit—cash or easy payments.



SEND NO MONEY—Simply write today for big FREE Ranger Catalog and marvelous prices and terms. **Mead Cycle Company** Special Dept. A116 Chicago Rider Agents

Competent and Prompt Professional Attention to

### PATENT AND TRADEMARK MATTERS

Expert Services in Radio Inventions  
Inventor's Adviser," a cloth-bound library reference book sent free on request.

**William C. Linton**  
Patent Attorney and Engineer,  
932 National Union Bldg., Washington, D. C.

## I Want to Know

(Continued from page 707)

Q. 3. How would tuning variable condensers be connected to a short wave regenerative receiver?

A. 3. One should be connected in series in the aerial circuit, the other as shown in the diagram on page 527 in the February number of RADIO NEWS.

### JAR RECTIFIER.

(189) Mr. Donald S. Jones, of Akron, Ohio, asks:

Q. 1. How can I make a jar rectifier and what solution is used in the jars?

A. 1. Full data for the construction of a jar rectifier was given on page 117 of the September, 1919, issue of RADIO NEWS.

Q. 2. Could I use one of these rectifiers to light an audiotron bulb?

A. 2. It is not advisable to use this type of rectifier to supply the filament current to an audion bulb. A simple and practical hook-up was published on page 447 in the January, 1921, issue of RADIO NEWS.

### ADDRESS OF TELEFUNKEN CO.

(190) Mr. G. Brown, of Rochester, N. Y., sends in the following question:

Q. 1. What is the address of the company in Germany which makes the Telefunken receiving tube?

A. 1. The address of the Telefunken Co. is S. W. 11, Hallesches Ufer 12-13, Berlin, Germany.

### BUZZER TRANSMITTER.

(191) Miss Lucille Rose, of Omaha, Nebraska, wants to know:

Q. 1. How far can I send undamp't waves with an ordinary test buzzer?

A. 1. You cannot send undamp't waves with a buzzer. A hook-up for a buzzer transmitter was given on page 540 in the February issue of RADIO NEWS. The range of it depends on input power.

Q. 2. What is the wave-length of an aerial 20 feet high, 30 feet long, 30 feet lead-in, using four strands of No. 14 wire placed 1 1/2 feet apart, and of another one, 70 feet long, 30 feet high and 30 feet lead-in, using No. 14 wire, four strands two feet apart?

A. 2. The wave-length of the 30-foot aerial is about 100 meters and of the 70-foot one about 150 meters.

Q. 3. Please give a detector hook-up for an audiotron.

A. 3. Such a hook-up appears on page 539 of the February number of RADIO NEWS.

Q. 4. How may my wave-length be increased in sending with an O. T.? Should I increase the number of turns in the primary and decrease the number in the secondary or should I decrease the number of turns in the primary and increase those in the secondary or should I increase both?

A. 4. To increase the wave-length of a transmitter the number of primary turns of the O. T. should be increased and then the secondary adjusted until the greatest intensity is obtained in the aerial. This is shown by the antenna H. W. ammeter.

Q. 5. If I change the power of my sending station and increase it do I have to get a new license?

A. 5. If you make any change in your station you should inform the Radio inspector of your district just what modifications you intend to make.

### LOOSE COUPLER.

(192) Mr. Paul Rumball, of Beverly, Mass., inquires:

Q. 1. Can I use a loose coupler with a Radiotron bulb and what would be the hook-up?

## 10c CHARGES YOUR BATTERY AT HOME WITH AN F-F BATTERY BOOSTER

and your station will never be closed because of a discharged battery. Is it not gratifying to feel that your filament battery will always be ready when you want it and that you will never have to give up in disgust when working a distant station?

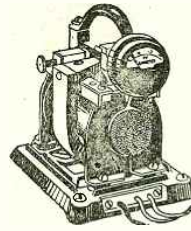

F-F Battery Boosters are automatic and operate unattended. Screw plug in lamp socket, snap clips on battery terminals and see the gravity come up.

The ammeter shows you just the amount of current flowing. The full wave of current is rectified through adjustable carbon electrodes which maintain a constant efficiency and last for thousands of hours. Everything complete in one compact, self-contained unit.

The F-F Battery Booster is a Magneto Rectifier for 105-125 Volt 60 Cycle Alternating Current.

Bantam Type 6 charges 6 Volt Battery at 6 amperes..... \$15  
Type 16 charges 6 Volt Battery at 8 amperes..... 25  
Type 168 charges 6 Volt Battery at 12 amperes... 32

Shipping Weights 10, 12 and 15 lbs.  
Also Boosters for 12 Volt Batteries  
Order from your dealer or Send Check for prompt Express Shipment. If via Parcel Post have remittance include Postage and Insurance Charges. We also ship C.O.D. Also F-F Battery Boosters for charging batteries from Farm Lighting Plans. Direct Current Circuits and Direct Current Generators.

For group charging use the Full Wave, Automatic F-F Rotary Rectifier of 100 Volt, 36 cell capacity.

Order now or write today for Free Descriptive Bulletin No. 32 or Rotary Bulletin No. 32A

**THE FRANCE MFG. CO.,** Office & Works:  
Cleveland, Ohio

## LEARN ELECTRICITY

Make your successful future a certainty. We teach by practical work and scientific methods under practical working conditions. Specialists for 15 years in training young men for

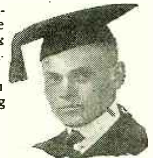

Electrical Engineering with B. S. Degree in 3 Years

A place for every student regardless of age or education. Up-to-date laboratories—faculty of 90 experts; individual instruction. "Earn while you learn" system. Low tuition; athletics and student activities. Write for latest catalog and full details. New term soon starting.

**SCHOOL OF ENGINEERING OF MILWAUKEE**  
Dept RN4 373 Broadway, Milwaukee, Wis.

200 Pages of Radio Kelly & Phillips' new catalogue. The largest radio catalogue in the world. Check full of radio-the-minute apparatus and valuable data you will use every day. Save time and trouble. Follow the exact instructions you want at fairest prices.

Your name and address and 25c brings you a copy by return mail. The quarter doesn't cover the cost to print it, just a show your faith, and will be credited to you. First order only \$20. Don't delay! Thousands read this for a day. The edition is limited. Send for your copy to-day. Do it NOW!

**KELLY & PHILLIPS**  
312 Flatbush Av., Brooklyn, N. Y.

## FREE! Colors & Brushes for Show Card & Sign Writing

Make \$10 to \$25 daily! Make Show Cards, Signs, Advertising Posters and Glass Signs. Big demand. Interesting, profitable profession. Easy to learn in few weeks by unique, novel method; something new! Our wonderful 50-lesson course includes individual instruction by correspondence from expert artists; total cost only \$15. Every student given \$15 assortment of finest "Millierine" colors and brushes—FREE! SEND NO MONEY—Send name and address and receive complete course and Free outfit. Pay \$3 on arrival and \$1 weekly for 12 weeks. Success guaranteed or money refunded. Earn enough first week to pay for course. Send TODAY.  
Empire AG Institute, 2050 Amsterdam Ave.  
New York, N. Y.

## Brass Binding Posts - 5c each Switch Points, nickle - 4c each Battery Rheostats - - - \$1.00

No order for less than 6 Binding Posts or 6 Switch Points accepted.  
All kinds of Wireless Supplies.

**DREYFUSS SALES CORP.**  
4th Floor, 150-152 Chambers St. New York, N. Y.

# Westinghouse Radio Receiving Equipmen

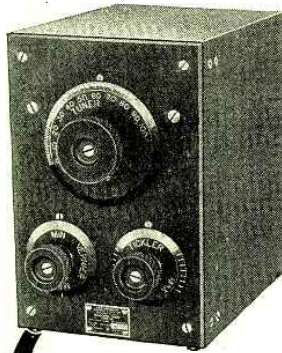

Type RA Short Wave Tuner  
Style 307189, 180-700 Meters



Type DA Detector Amplifier, Style 307190, 2-Stage,  
3 Tubes, Audio Frequency.



**T**HIS high-grade Westinghouse regenerative tuner, and tube detector-amplifier embody the last ideas of two noted radio engineers, Edwin H. Armstrong and Frank Conrad.

This apparatus provides a most efficient set for telegraph and telephone reception over the amateur and normal ship wave length ranges.

Simple in Design—Easy to Operate—Single-Tuning Circuit  
Highly Efficient

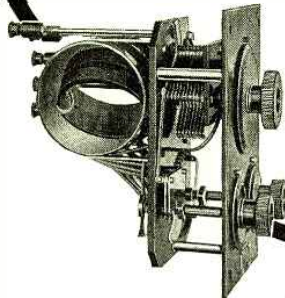

Interior View of RA Short Wave Tuner

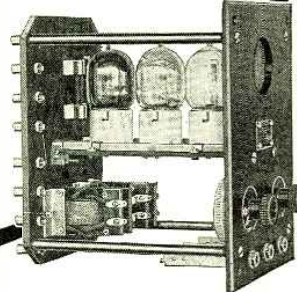

Interior View of DA Detector Amplifier

Our Radio Folder No. 4446 will interest you.  
*Ask your dealer for a copy*

Westinghouse Electric & Manufacturing Company  
EAST PITTSBURGH, PA.

# Westinghouse

3 \$1  
for 1

## PROTECT YOUR VACUUM TUBES INDEFINITELY!

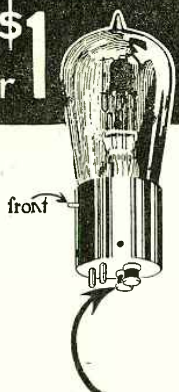

### Sure Protection at Little Cost

A few cents invested in the Radeco Safety Fuse means the sure protection of an expensive Vacuum Tube.

On the same principle as any fuse the Radeco Safety Fuse protects the bulb against any excessive amperage.

## RADECO Safety Fuse

Patent Pending

Easily applied directly upon the filament terminals of any standard bulb. Simply clean filament terminal free of solder and composition and slip fuse on. Two fuses—one on each terminal—protects the bulb indefinitely.

Every radio man in America needs the RADECO Safety Fuse. Send certified check or money order today. Orders sent post paid.

RADECO Safety Fuses are Unexcelled for C. W. Work

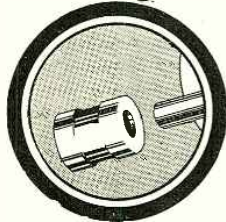

#### Sizes

in 3/4, 1, 1 1/2, 1 3/4, 2 and 2 1/2 Amps. Dimensions 1/4 inch over all.

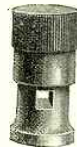

### RADECO Bindo Post

Insures 100% Contact. Will not cut the finest wires. Holds firmly lead wires or terminals. Extreme vibrations cannot loosen lock grip of contact surfaces.

25c SMALL  
30c MEDIUM  
LARGE

### Rotary Quenched Spark Gap \$20.00 Postpaid

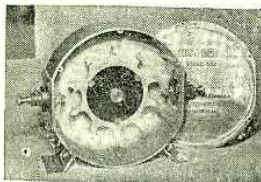

The advantages of a noiseless, super-efficient rotary gap are now within the reach of all. The casing is of cast aluminum with the cover machined to make an airtight enclosure for the extremely light weight aluminum rotor, with bakelite insulation. Stationary electrodes are of copper with bakelite insulation. The smallest gap motor may be used, but is not supplied with gap. GET YOURS SET UP AT ONCE, and INCREASE YOUR RADIATION AND RANGE!

insulation. Stationary electrodes are of copper with bakelite insulation. The smallest gap motor may be used, but is not supplied with gap. GET YOURS SET UP AT ONCE, and INCREASE YOUR RADIATION AND RANGE!

### FILAMENT RHEOSTAT



For Back or Front of Panel Mounting. 6 ohms, 1 1/2 amps, 1 1/8" dia.

\$1.75 Postpaid  
Immediate Shipment.

Standard VT Socket  
Improved Contact Type

\$1.00 Postpaid  
Copper foil condenser  
35c p.p.

### 44 V. VARIABLE "B" BATTERY \$3.60

Include postage on 4 lbs. Complete in handy wooden case and adjustable phosphor bronze "jiffy" connectors. Better than block batteries—if one 4.4 V. unit weakens prematurely, it can be removed and replaced—thereby not impairing total voltage, which makes this the best battery value to be had at any price. Set of 10 Renewal Units, 44 Volt, \$3.10 postpaid. Just the thing for C.W. work.

### GROUND WIRE 8c PER FOOT

\$7.00 Per 100 Feet

No. 4 solid copper—rubber covered—triple braid—include postage on 20 lbs. per 100 ft.

100 amp. 600 volt fighting switches. \$4

### AERIAL WIRE 1c PER FOOT

7 strands No. 22 copper—tin plated to prevent oxidation. Maximum radiation and strength. Include postage on 25 lbs. per 100 ft.

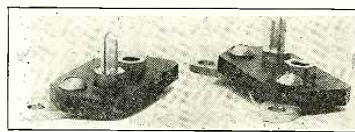

### Honeycomb Coil Adaptor \$1.50 per pair

Attach to binding post of any variable condenser, insert P-C coil, making a tuning unit. Two units make a loose coupler, a third makes a tickler coil, one makes a wavemeter.

**RADIO EQUIPMENT CO.** 630 WASHINGTON ST., Boston, Mass.  
4th Floor

A welcome addition to your library! Send \$2.00 today, plus postage for 7 lbs., and your copy of bound volume No. 1 of Radio Amateur News will come forward by return mail.  
Experimenter Publishing Company 238a Fulton Street, New York City

**SPECIAL!**  
6V. 35-40A Storage Batteries  
Guaranteed 1 year Repairs free  
Price \$18.75  
ELJAY BATTERY CO.  
30 N. CICERO AVE., CHICAGO, ILL.

**POLES**  
(SPRUCE)  
FOR YOUR WIRELESS  
Furnished and erected at reasonable rates  
J. F. BYRNES 578 Gates Ave.  
Brooklyn, N.Y.

A. r. Yes, a Radiotron tube may be used with a loose coupler. The diagram of the connections was given on page 539 of the February issue of RADIO NEWS.

#### ANTENNA.

(193) Mr. Russ Barringer, of Fremont, Ohio, wants to know:

Q. 1. I am figuring on putting up an antenna—four wires, 255 feet long, 65 feet at one end, 40 feet at the other and using two telephone poles for masts. I have on hand about 1,500 feet of No. 10 bare copper toll line wire, but due to the fact that it has been in service for some time it has turned a dark greenish color. Would it be advisable to use this wire?

A. 1. You can use the wire you have for an aerial providing all the connections are carefully soldered. The natural wave-length of the aerial you describe will be about 450 meters.

#### GRID LEAK.

(193) Mr. Stuart K. Little, of Kenmore, N. Y., asks:

Q. 1. Please give the hook-up of a set with which I can receive Arc and Spark stations and whereby I can change from audion and one-step amplifier to crystal detector and two-step amplifier?

A. 1. The hook-up for such a set appears on this page.

Q. 2. How can I make a simple grid leak?

A. 2. A simple grid leak can be made of a piece of stiff cardboard clamped between two binding posts. This cardboard is then darkened from one binding post to the other with a lead pencil, until best results are obtained.

#### RADIOTRON BULBS.

(194) Mr. Reid Cox, of Wallowa, Oregon, sends in these questions:

Q. 1. Give a simple diagram for using one bulb with 45 volts on the plate with necessary apparatus for transmitting short distances with a key.

A. 1. The hook-up for a short range C. W. set is given on this page; the inductance should be wound with 36 turns of No. 16 D. C. C. wire on a form two inches in diameter with a tap taken at the 17th turn. If an aerial ammeter is used it should have a reading scale of 0 to 0.2 amps.

Q. 2. What is the wave-length of my aerial which is made of four wires 1 1/2 feet apart, 150 feet long and 75 feet high at one point and 15 feet at the other?

A. 2. It is difficult to say since you do not state the length of the lead-in and ground and whether it is an L or T aerial. Roughly, it may be from 160 to 210 meters.

Q. 3. Is it necessary to get good results to have a plate battery control on the new Radiotron detector bulb?

A. 3. It is not absolutely necessary to have a plate voltage control for this type of tube altho it permits more critical adjustment. For complete details about these tubes we suggest that you ask for a copy of the Radiotron bulletin from the Radio Corporation of America, 233 Broadway, New York City.

#### RADIOFONE TRANSMITTER.

(195) Mr. Franklin English, of Berkely, Calif., wants to know:

Q. 1. What is the simplest, most efficient and inexpensive Radiofone transmitter that will transmit from five to 25 miles?

A. 1. For the construction of such a Radiofone we refer you to page 690 of the June, 1920, issue of RADIO NEWS where full data was given.

Q. 2. Please give a diagram of three-coil honeycomb mounting the primary with condenser switch on primary, audiotron, (Continued on page 718)

# RADIOTRONS

## “A TUBE FOR EVERY NEED”

Radiotrons are now recognized as the amateur's and experimenter's standard for Radio detection, amplification and power work. They are available at established Radio dealers throughout the United States.

Scientifically designed and manufactured in the country's largest lamp factories, Radiotrons come to the experimenter with uniform and dependable characteristics.

One of the following tubes is certain to meet your requirements

U. V. 200  
DETECTOR  
\$5.00

U. V. 201  
AMPLIFIER  
\$6.50

U. V. 202  
POWER TUBE  
5-Watt  
\$8.00

U. V. 203  
POWER TUBE  
50-Watt  
\$30.00

U. V. 204  
POWER TUBE  
250-Watt  
\$110.00

The Radio Corporation's tubes are covered by patents dated November 7th, 1905, January 15th, 1907, and February 18th, 1908, as well as by other patents issued and pending. Tubes licensed for amateur and experimental use only. Any other use will constitute an infringement.

Your dealer has Illustrated Bulletins on Radiotrons,  
or write direct to

SALES DIVISION, COMMERCIAL DEPARTMENT,  
SUITE 1802

**RADIO CORPORATION OF AMERICA**  
233 BROADWAY  
NEW YORK CITY

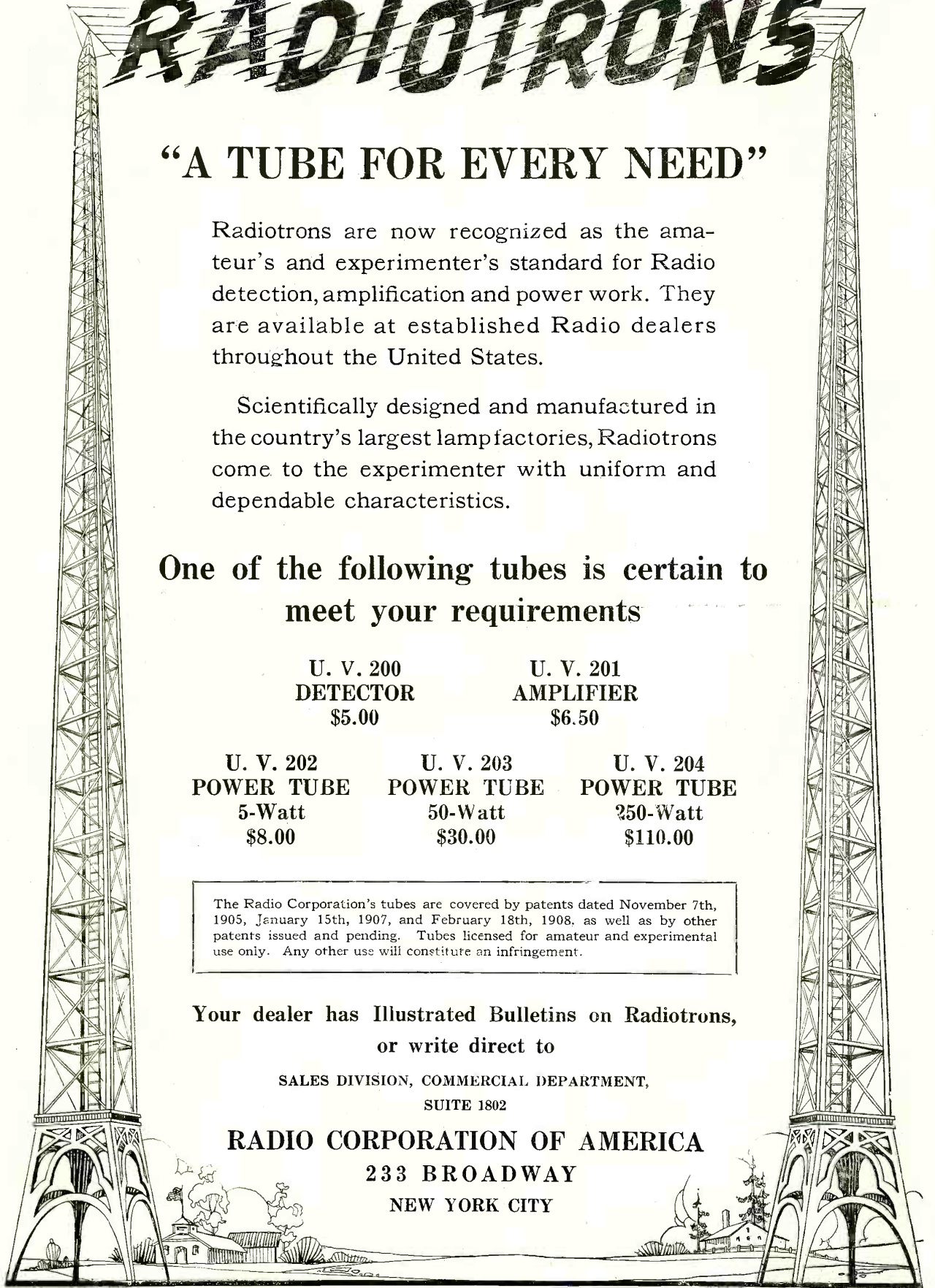

# New Moulded Vari

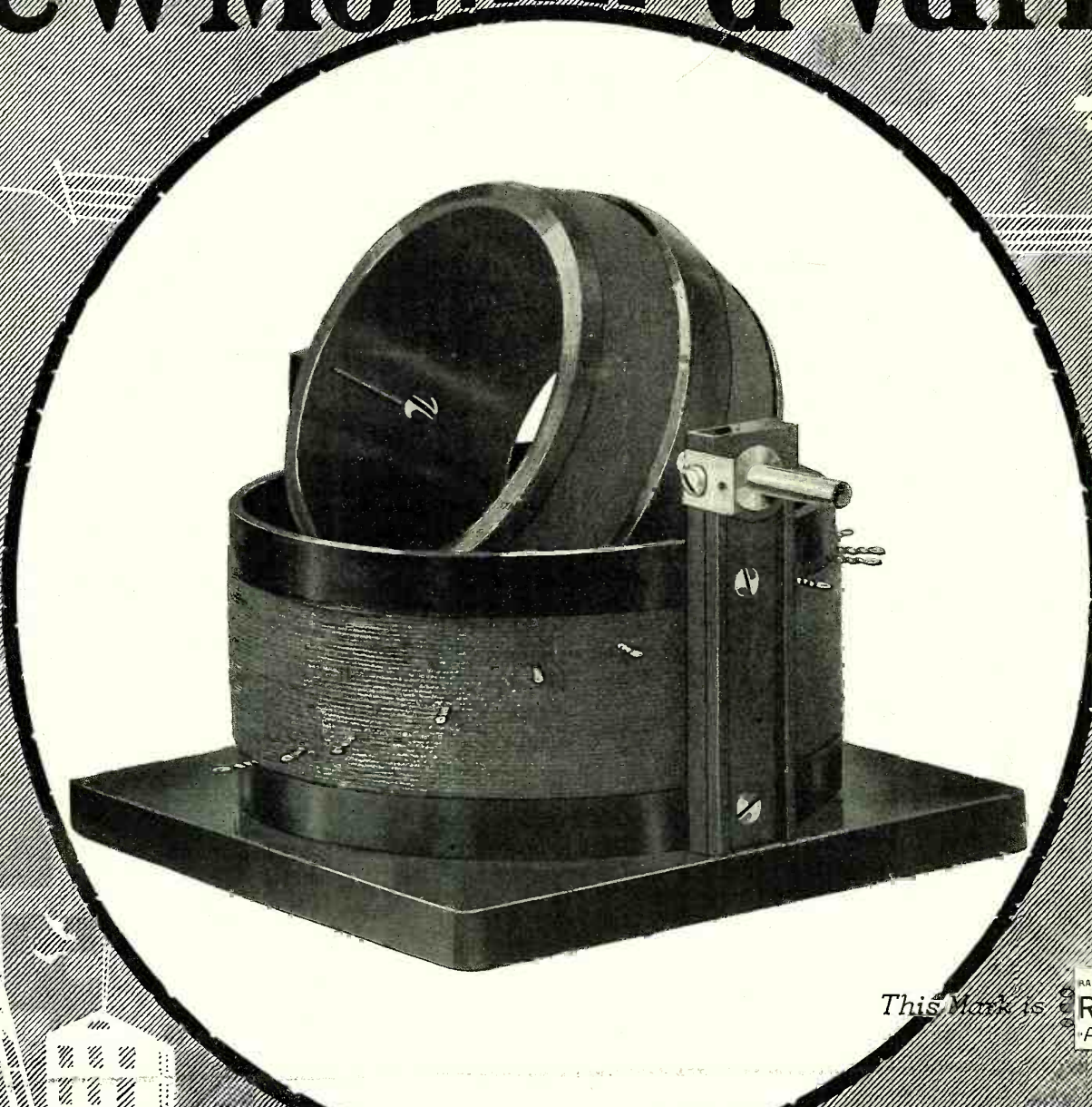

This Mark is  RADISCO  
-APPA

## RADISCO DEALERS

ALBANY, N. Y.  
Shotton Radio Mfg.  
Co.  
8 Market St.

ASHEVILLE, N. C.  
Hi-Grade Wireless  
Instrument Co.

ATLANTIC CITY, N. J.  
Paramount Radio  
Supply  
518 N. Connecticut  
Ave.

BIENVILLE, QUE.  
CAN.  
Canadian Radio Mfg.  
Co.

BOSTON, MASS.  
Atlantic Radio Co.  
88 Broad St.

BROOKLYN, N. Y.  
Kelly & Phillips  
312 Flatbush Ave.

CHICAGO, ILL.  
Chicago Radio Lab.  
1316 Carmen Ave.

EUREKA, ILL.  
Klaus Radio Co.  
Branch, Peoria, Ill.

KANSAS CITY, Mo.  
McCreary Radio Sup-  
ply  
4th & Delaware Sts.

LOS ANGELES, CAL.  
The Wireless Shop  
511 W. Washington  
St.

MONTREAL, P. Q.  
CAN.  
J. B. Miller  
133 Vendome Ave.

N. D. C.  
NEW BRUNSWICK  
NEW JERSEY  
Geo. N. DeLaplaine  
306 George St. and  
8th & Magnolia Sts.

# RADISCO

# Coupler Only \$7.50

## ACCURATE To a Fraction of a Hair's Breadth

**H**ERE'S the new Radisco improved vario-coupler—standardized—machine made—accurate, in all essential dimensions, to the .002 part of an inch.

First, in design and construction, it sets new standards of mechanical and electrical efficiency.

Second, the materials,—special moulded composition, Formica, and brass,—will deliver years of uninterrupted service.

Third, it's entirely standardized and machine made. If, after long service, some parts need replacing, you will find that the new parts will vary less than .002 of an inch—a fraction of a hair's breadth.

**Finally**, the price, only \$7.50. It's hard to compare prices, because there never was a coupler so well-made, so accurate, so good thru and thru; but, at least, you have the satisfaction of knowing that the standardized, machine, quantity production, not only insures a vastly improved instrument, but also gives you unequalled value per dollar.

No printed words can possibly give you the evidence of quality, equal to an examination of this coupler at your Radisco dealer's. But in the meantime, these specifications will indicate the care and value that is put into *every detail* of the construction.

The ball and base are special moulded composition, high polished, which cannot warp. The tube is black Formica that will not shrink or absorb moisture under any conditions. A treatment of special insulating compound and best grade insulating varnish insures perfect insulation thruout.

The hard brass bearings, with phosphor bronze contact springs, are supported by moulded "U-Beam" strips of Bakelite. The shaft projects far enough for panel mounting, and is 3/16" in diameter, to fit the standard Corwin Dials.

The winding consists of No. 22 single cotton-covered wire. Primary is tapped in two groups,—six taps six turns apart and six taps single turns apart. This makes it possible to secure any combination of turns up to 37. Secondary is wound without taps on the moulded ball.

This improved coupler is lighter in weight, sturdier, and more efficient than any of the more expensive models that have preceded it. Your Radisco dealer has a supply now, but it would pay you to see him soon!

Your Guarantee

**RADIO DISTRIBUTING COMPANY**  
NEWARK, NEW JERSEY

# SCOO

### RADISCO DEALERS

NEW ORLEANS, LA. Rose Radio Supply 604 Gravier St. NEWARK, N. J. A. H. Corwin & Co. 4 West Park St. OMAHA, NEBRASKA O-B Radio Supply Co. 406 Brown Building PHILADELPHIA, PA. Philadelphia School of Wireless Tele- graphy Broad & Cherry Sts. PROVIDENCE, R. I. Rhode Island Elec. Equip. Co. 45 Washington St. PITTSBURGH, PA. Radio Electric Co., 3807 Fifth Ave. PORTLAND, ME. Atlantic Radio Co. 15 Temple St.	SEATTLE, WASH. Northwest Radio Ser- vice Co. 609 Fourth Ave. SCRANTON, PA. Shotton Radio Mfg. Co. P. O. Box 3 Branch, 8 Kingshury St., Jamestown, N. Y. TORONTO, ONT., CAN. The Vimy Supply Co. 567 College St. WASHINGTON, D. C. Eastern Radio and Electric Co. 1405 Florida Ave. N. W. WICHITA, KAN. The Cosradio Co. 1725 Fairmount Ave.
--	---

(Continued from page 714)

with double filament switch, damp and undamp switch batteries and fones, rheostat.

A. 2. You will find this hook-up on page 462 of the January, 1921, issue of RADIO NEWS.

Q. 3. Give complete data for 1/4-k.w. transformer of closed core type and state if secondary is over primary or at other end.

A. 3. In a 1/4-k.w. transformer for use on 110 v. 60 cycle current, the closed iron core should be made of thin laminated steel sheeting and have the following dimensions: outside, 7 3/4" x 7"; inside, 4 1/2" x 3 3/4"; thickness, 1/8". The primary which is wound on one leg, consists of 260 turns of No. 14 S. C. C. wire wound in five layers. The secondary, which is wound on the opposite leg, is made in 16 pies, 1/4" thick and wound with 35,438 turns (2,214 turns per pie) of No. 35 D. C. C. This requires about 5.5 pounds of wire or 40,444 feet. The secondary voltage of such a transformer is 15,000 volts.

**CONSTRUCTION OF C. W. TRANSFORMER.**

(196) Mr. Reville L. Swok, of New York, requests:

Q. 1. Please publish the necessary data for the construction of a transformer suitable for the radiofane hook-up shown in Question 159 in the I-Want-To-Know columns for February.

A. 1. The core of this transformer consists of No. 27 gauge laminated steel sheetings, cut to make a core 5" x 5" and 3/4" high. Each lamination is 3/4" wide. Three of the legs of the core should be covered with six layers of empire cloth and well shellacked. The primary into which the impress 110 volt current is applied consists of 50 turns of No. 14 double cotton covered wire. On the other leg the filament secondary should be wound and should consist of 10 turns of No. 16 D. C. C. magnet wire. An additional tap is taken off at the fifth turn. The secondary, or the high tension winding, consists of 500 turns of No. 28 D. C. C. magnet wire and each layer is insulated with two layers of empire cloth. An additional tap is taken on the 250th turn. It is advisable to have each leg wound separately and then completely assembled and properly secured by means of clamping bolts. It will be noted that the delivery side of the H. T. rectifier, A, B is shunted with a high capacity C of the order of six mf., and this condenser is used to make the uni-pulsating currents of the delivery side of the rectifier as much as possible a continuous current. Therefore to help this process and straighten out the alternating current into a constant current 2 additional choke-coil inductances should be used. The high capacity condenser, C, should be constructed of mica, suitable to withstand a maximum potential of 3,000 volts and the condenser section should be properly clamped and insulated and finally immersed in beeswax compound to eliminate losses as much as possible. As rectifiers ordinary transmitting tubes having their grid and plate connected together are used.

**Test of Insulating Materials for Radio Use at the Bureau of Standards**

(Continued from page 710)

of Standards was that of power loss, frequently termed as phase difference of a condenser made of the material. Likewise this test is considered of overshadowing importance. The method employed consisted in placing a metal coating on two sides of the panel of insulating material—

**New Tubes WE HAVE THEM**

UV 200-UV 201  
UV 202-UV 203

**New Accessories WE HAVE THEM.**

Preserve the List Below and Order Direct Until New Bulletin is Ready.

HAVE YOU NOTICED OUR PHENOMINAL GROWTH? THERE'S A REASON! 90% OF OUR SHIPMENTS ARE MADE WITHIN 48 HOURS AND POSTPAID!

"GREATER BOSTON AMATEURS"! OUR LOCATION MEANS LOW OVERHEAD AND OUR SHOP AT YOUR DISPOSAL MEANS BETTER SERVICE. OPEN FRIDAY NIGHTS 8 TO 11 P. M.

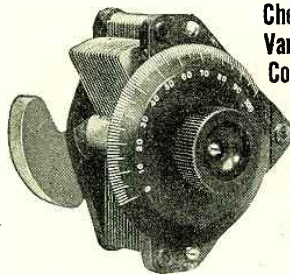

**Chelsea Variable Condensers**  
No. 3 BD \$4.75  
No. 4 BD \$4.25  
0.008 MFD. With Dial Dial Only. 70c.  
Made of real bakelite, 3 1/4" Dia. Accurately Moulded—won't warp.

**NEW! CHELSEA DIAL INDICATOR, \$1.00**  
Consists of knob and dial moulded in one piece, with 1/4" or 3/16" bushing and set screw.

**SOMERVILLE DIAL INDICATOR, \$2.00**  
Better than Type CSU, 4" D. 1/4" bushing calibrations clockwise reading, on upper half of scale. 2" Navy knob.

**RADIOTRON UV 200, \$5.00 POSTPAID**  
**RADIOTRON UV 201, \$6.50 POSTPAID**  
"Four-page booklet given with each VT."  
**GRID CONDENSERS, .0005 and .00025, 25c**  
Double VT Socket, Radio Service make.....\$2.50

**SORALA S10 VT SOCKET \$1.10**

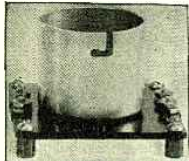

Spun aluminum shell, 2 1/2" x 2 1/2" bakelite base, engraved in white, to designate connections, contacts of nicked bronze brought out to simple connectors. Workmanship up to Navy standards. Won't warp or melt. Guaranteed to please you.

**ACME HIGH IMPEDANCE AMP. TRANS. \$5.00**  
22 volt EVEREADY adjustable B Battery..... \$2.00  
44 volt EVEREADY adjustable B Battery..... 3.75  
(The most satisfactory battery on the market!)  
**USE A TUNGAR RECTIFIER** for charging your storage battery where it stands, 2 amp. size.....\$18.00  
Maximum sensitivity is obtained from RADIOTRONS by using a GR "A" battery potentiometer, for adjusting voltage drop..... 4.00  
GR No. 214 7 ohm, 2 amp. panel rheostat, 3" diameter..... 2.50  
**DOZEN 12c INSULATED BINDING POSTS**..... 1.25  
Black or Yellow Empire Cloth tubing, per in..... .01

2.3 m. h. HIGH FREQUENCY CHOKE COIL..... 1.00  
**TRANSMITTING MICA GRID CONDENSER**..... 1.00  
(.0005 mfd. 1800 volts mounted in Bakelite.)  
Above grid condenser, UNMOUNTED..... .50  
10,000 ohm VITROHM grid leak, \$2.60; 5000 ohm 1.75  
Clapp-Eastham 6000 ohm variable resistance..... 3.00  
**UV202 RADIOTRON POWER TUBE** 5 watt, 350 v..... 8.00  
**UV203 RADIOTRON POWER TUBE** 30 watt, 1000 v..... 30.00  
**UV204 RADIOTRON POWER TUBE** 250 watt, 2000 v..... 110.00  
(Operating data given with each tube.)

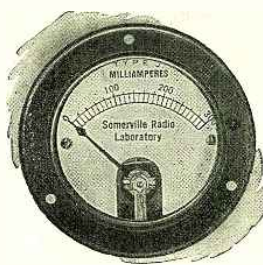

**SORALA METER SERVICE**

means that we'll pay the postage and ship by return mail! The immense popularity of our Type J Meters has made possible larger production, which with lower raw material costs, allows a

**PRICE REDUCTION TO \$6.00**

on all Ammeters and Milliammeters  
D. C. 0-3 Ammeters, Milliammeters, 0-50, 0-100, 0-300 and 0-500 m. A.  
Type J 0-100 Voltmeters..... \$8.00  
Type J 0-500 Voltmeters..... 16.00  
Type J 0-1000 Voltmeters..... 24.00  
These include external resistances and are of the D'Arsonval type.

**GENERAL RADIO FLUSH TYPE A.C. HOT WIRE AMMETERS; NEW PRICE \$7.75**

Ranges, 0-1/2, 0-1, 0-2 1/2 and 0-5 amperes used for radiation or filament current indication.

**TYPE JX A.C. 0-15 VOLTMETER \$8.00**  
(For power tube filament regulation.)

Dia. 3 1/2" flush—similar to Type J—magnetic vane movement—jewel bearings. Your expensive power tube will last twice as long with A.C. on filaments and using PROPER VOLTAGE.

**ACME FILAMENT HEATING TRANSFORMERS**

75 watt, fully mounted, \$12; Unmounted..... \$9.00  
150 watt, fully mounted, \$16; Unmounted..... 13.00  
Bulletin on request.

**ACME 20W WATT CW TRANSFORMER**

Unmounted, \$16.00—Mounted, \$20.00  
Blue print and directions given with each one on how to pass 500 M. A. of plate current, with a chemical rectifier. "Simplest thing in the world, and very inexpensive." Shipping weight, 20 lbs.

**ACME CHOKE COILS**

Single Coil, 150 M. A..... \$4.00  
Double Coil, 150 M. A..... 6.00  
Single Coil, 500 M. A..... 6.00  
Double Coil, 500 M. A..... 8.00  
W. E. 21AA 1000 V. Condenser, 1 mfd..... 2.50  
No. 323W WEST. ELEC. TRANSMITTER..... 4.00  
(With mounting bracket, 50c extra.)  
**ACME SEMI-MOUNTED MODULATION TRANSFORMER**..... 5.00

SEND YOUR ORDER ( NEW PRODUCTS—We Have Them FIRST TO SORALA FOR ( APPROVED STANDARD PRODUCTS—We Have Them ALWAYS.

REMEMBER! We Pay the Postage on Orders Less than 10 Lbs. and Ship Direct from Stock.

**SOMERVILLE RADIO LAB.**

102 HEATH STREET  
WINTERHILL, 45, MASS.



**LONG DISTANCE**

Short Wave Receptors equipped with our NEW MIGNON

**VARIOMETERS & VARIO-COUPPLERS**

HIGHEST EFFICIENCY AT LOWEST PRICES

Write Today for Literature

**Mignon System Mfg. Co.,**

BUFFALO, N. Y.  
U. S. A.

READ the CLASSIFIED ADVERTISEMENTS on PAGES 756-759. YOU'LL FIND MANY GOOD THINGS THERE.



# A Serious Situation Menaces the Radio Art

By G. K. Thompson \*

## A Warning

During the next two years we amateurs will either make or break Amateur Radio. If we continue as at present our liberties are doomed. There is but one way to prevent the fatal climax. We must cultivate at once a conscientious respect for our American laws. Without this respect we will fail not only as Radio Experimenters but as Citizens. We must obey the Law. Our Federal radio regulations are the most liberal in the world. They are the simplest, most easily complied with regulations that could be imagined and if respected would not only save our own future but would solve many of our own QRM troubles.

Now let us analyze these regulations, find out what we must do to comply with them and see how our obedience to the law will vastly improve Amateur Radio.

## License Necessary

If you have a transmitting set, no matter how small, it must be licensed. Radio stations are now so close together and vacuum tube amplifiers are so common that your signals, no matter how weak, are almost certain to interfere with signals being received at local stations from other states. Every time signals from an unlicensed transmitter interfere with the reception of interstate messages the law is being broken. If you didn't know this before, you know it now. License your transmitting station.

## Minimum Power

The law plainly says that you must use only just enough power to maintain communication with any given station. Just because nearly everybody breaks this law is no excuse for disobedience. We must all cut down our power for local work. The most practical method is to use a small induction coil set on a separate single wire antenna. This permits shifting from your large set to your small set instantly without disturbing adjustments.

## Minimum Wavelength

General amateur stations employing spark sets which emit waves longer than 200 meters are operating in defiance of the law. We must stop this practice. An accurate Wavemeter, the Amrad, is available at a low price. If you cannot buy one, borrow one and find out exactly what your wavelength is. The American Radio and Research Corporation was the first Company to produce an accurate wavemeter priced within the reach of all and for a year and a half has sold the Type D Amrad Wavemeter at slightly more than actual cost of manufacture. The Type D is now discontinued and supplanted by the new Type E which tunes from 175 to 340 meters and can be used in a receiving set as an Interference Preventer or as a Variometer. This new Amrad Wavemeter is an instrument that you can use all the time and not merely when you wish to tune your transmitter. Send for Bulletin W-2 which describes the several uses of this unique instrument.

## Re-Adjustments Necessary

In the matter of wave-length many of us have not only exceeded the legal limit of 200 meters but the majority of us have tried to tune our transmitters to exactly 200 meters. This is one of the oddest mistakes we have made. Imagine a crowd of

people plunging into a movie and demanding a seat in the front row orchestra. If we could only see that in Radio we make just such a spectacle of ourselves we would be quick enough to slip into one of those empty back seats—192 meters, 184, 180 and finally down to 150 or less. In these days of amplifiers and efficient quenched gap transmitters 150 or 175 meter waves are actually just as practicable as 200 meter waves. Unless we go to those lower wavelengths at once we will dig our own graves with our keys. We must end the concentration on 200 meters.

Adjust your wave-length according to the power of your transmitter. 1 K.W. slightly under 200 meters;  $\frac{3}{4}$  K.W. about 190 meters;  $\frac{1}{2}$  K.W. slightly under 185 meters;  $\frac{1}{4}$  K.W. 175 meters and small induction coil sets under 175 meters. If you have a long antenna you may require a series condenser. Remember too, that the use of a counterpoise instead of a conductive ground decreases the normal antenna wave-length.

## Short Wave Reception

The problems incident to shorter wave reception have been well provided for in the new receiving unit designs of the American Radio and Research Corporation. Amrad Short Wave Couplers and Variometers, for instance, are expressly intended for tuning down to 175 meters and below. Dielectric and capacity losses, usually excessive at the very high frequencies of short wave-lengths, have been eliminated by use of air cores and single layer coils wound on very thin, porous forms. Amrad Tuning Units are the coming designs and experienced radio men in all parts of the country have been very quick to grasp this fact. Send for Bulletin V.

The usual regenerative receiver will not tune down to wave-lengths lower than 190 meters. We must adapt these receivers to the new conditions by removing from each grid and plate inductance eight to ten turns of wire. Do not hesitate to do this; you will merely lower the wave-length range and not reduce the efficiency of your set.

## Minimum Decrement

Here is a great mystery—decrement. Few of us can clearly explain what it means, but no matter. Of more importance is this fact: Not one amateur transmitter in two hundred emits a wave of lawful decrement. That's the condition we must face and remedy—and here's how:

In using a rotary gap we must do this: Reduce the number of studs on the rotor to six or less. Make each stud paddle shaped and knife edged. Triple or quadruple the speed of rotor; 8,000 r.p.m. is none too high. Loosen Oscillation Transformer coupling *far enough* so that a single, sharp wave is obtained. Use a very low resistance ground connection. This is a large order but unless our transmitters comply with the majority of these requirements the wave emitted will be of excessive decrement (too broad) and we will violate one of the most important Federal regulations.

When using a quenched gap we must be equally careful. A sufficiently high voltage transformer must be used. Sufficient resistance must be used in the transformer primary to produce a smooth note. The set

must be tuned until the very *close* and *critical* coupling point is obtained. A heavily insulated counterpoise or a very, very low resistance ground connection must be used, preferably the counterpoise. Complying with these requirements a transmitter employing an Amrad Quenched Gap will emit a very sharp wave, well within Government regulations. Send for Bulletin Q-2 which contains the last word on quenched gap operation.

## Low Power Sets

The Induction Coil transmitter presents the simplest problem of all. To comply with the law it must be inductively tuned (use Oscillation Transformer) and employ an approved quenched gap. Send for Bulletin P-2 which gives operating directions. The manufacturers of the Amrad Quenched Gap recently reduced the price of the  $\frac{1}{4}$  K.W. model, intended for all classes of Induction Coils, from \$16 to \$12. This heavy cut was made so as to bring the quenched gap within the reach of every station owner as it is the only means of getting any distance and a law-abiding wave with an induction coil set. In combination with the Amrad Induction Coil (Bulletin P-3) the  $\frac{1}{4}$  K.W. Amrad Quenched Gap has covered distances upwards of 200 miles regularly. Induction Coil-Quenched Gap sets will do long distance work as a regular thing just as soon as general readjustments of wave-lengths are effected.

Speaking of gaps the Amrad Quenched Gap has become famous for its superior performance in all parts of the country. The most notable feat was a transcontinental relay on February 15th when three messages were exchanged from Coast to Coast solely by means of Amrad gap stations and under normal conditions of interference and static. There are now hundreds of Amrad Quenched Gap enthusiasts, a permanent Amrad Transcontinental Line has been formed and as more amateurs become experienced with quenched gap operation many phenomenal records will be piled up. Send for latest edition, Bulletin Q.

Before passing the subject of decrement it would be unfair to exclude mention of C.W. transmission. This provides the means of emitting a legal form of wave but its operation calls for considerable skill and specialized knowledge which the majority of us haven't acquired—yet. C.W. is coming nevertheless and it will have its field. Meanwhile there is a fortune invested in spark equipment which we can and will use provided we adapt it to the conditions of the hour and operate it in compliance with the law.

## Citizen Radio

There is a movement on foot to call Amateur Radio, *Citizen Radio*. Let us cooperate in this forward, upward step by operating our transmitters in strict compliance with Federal law, using Minimum Power, Legal Wave-lengths, Legal Decrements and genuine American fair play in everyday communication. Very immediate and vigorous action must be taken by every operator and radio club in the land. Get the situation in hand now. And mark this: The only kind of radio that will survive Amateur Radio is *Citizen Radio*. Only by obeying the laws can we deserve the name *Citizen*.—*Adv.*

\*Amrad Sales Division, American Radio and Research Corporation, Medford Hillside, Mass.



**EASTERN  
RADIO**

899 BOYLSTON ST.  
BOSTON, MASS.

**INSTITUTE  
RADIO**

TEL.  
BACK BAY  
5 9 6 4



# RESULTS

If you are interested in studying Commercial Radio, the RESULTS accomplished by The Eastern Radio Institute should merit your immediate enrollment.

## FOR INSTANCE:

The Eastern Radio Institute was founded in 1913 and is now over six years older than any other Radio and Telegraph School in New England—We are established!

The Eastern Radio Institute moreover has given instruction at this date to over 4,000 different students, and has enrolled, graduated and placed more Commercial operators than all other schools in New England combined! We have accomplished things!

Graduates of The Eastern Radio Institute have actually secured 90 per cent, 89.9 per cent, 89.8 per cent etc., out of a possible 90 per cent in their Commercial operators first grade examination. We know how to give the student proper training!

Successful graduates of the Eastern Radio Institute are found in responsible radio positions all over the world. Why not be one! It costs no more!

Our latest, illustrated prospectus is free. If you cannot visit the Institute send for one. Remember our organization with over eight years of continued Results and Success is behind every student who enrolls. Send in your enrollment today!

F. D. Pitts,  
Director.

the metal really used being mercury, and the size of the panel tested was 25 by 31 centimeters (10 by 12 inches). Determination was made of the resistance and capacity of the condenser at a radio frequency. The ultimate result is claimed to be the phase difference which is proportional to the product of resistance, capacity and frequency. Accurate and rapid measurements were made by the use of a vacuum tube generator. According to the Bureau of Standards, however, it is only recently that precise measurements by the use of a vacuum tube have been possible in radio determinations. A shield for the measuring circuit has enhanced the accuracy and rapidity of the determinations. The study of phase difference yielded interesting observations: The phase difference is essentially constant with frequency. However, in some insulating materials the phase difference increases as the wavelength is increased, while in others it decreases to a similarly corresponding degree. Approximate values of phase differences for various products may be thus expressed: For formica M, 2.8 per cent.; for bakelite-micarta, 2.3 per cent.; for bakelite-dilecto, 2.2 per cent. The high value for formica M, however, was applicable to the output prior to the change in method of manufacturing this insulating material. Strange enough, the tests showed the increase of phase difference in a particular sample of formica from three to seven per cent. after a lapse of six months. Subsequent investigation proved this change to be an actual one, and when the sample was subjected to a baking process the phase difference registered six months before was restored. The observation suggests that the internal varnish reaction during the manufacture of the materials may not always be carried to completion. Age consequently varies the nature of the product.

## NEW APPARATUS.

The experiments in determining the effects of voltage at radio frequencies upon insulating materials have given birth to an entirely new apparatus both for the production of constant high-frequency voltages, for their application to insulation specimens, and for their measurement. The method embodies the placing of a specimen in a radio circuit with electrodes upon its surface in parallel with a condenser and measuring the voltage required to produce certain effects. For example, such as the appearance of corona, flash over the surface, and also puncture of the material, in the event that the latter is desired. Mr. Dellinger of the Radio Communication Section of the Bureau of Standards says: "The flashover and puncture voltages are of very different magnitude at high frequencies as compared with other values at low frequency, for the following reasons: Very much lower voltages produce these effects at radio frequencies than at low frequencies because the dielectric carries a considerable dielectric current. This current heats the specimen in virtue of the absorption phenomenon or dielectric loss in the material and soon raises the temperature to a point where breakdown occurs. The effect is then not a puncture or rupture of the low-frequency type at all, so that instead of hundreds or thousands of volts being required to break down or flash over a specimen, 10,000 volts more commonly suffice. The most important property is the flashover voltage, as this determines whether there will be a failure of the insulation between portions of the circuit such as the projecting metal post placed on the insulating panel."

The apparatus employed for the flashover voltage experiments utilized as a source of power a set of six plotrons, affording considerable current, the plotrons being operated in parallel. Variable inductances

## THERE'S MUSIC IN THE AIR!

Get Your's Now! Order Today!

We have had wonderful results with this

**V. T. Short Wave Regenerative Set**

Which we offer during April and May at a DISCOUNT OF 10 PER CENT. This is complete except for "A" Battery and Ground, which we can't send through

the mail.

Murdock 2000 Ohm Double Head Set..... \$4.50  
Radiotron U. V. 200 Detector..... 5.00  
V. T. Bakelite Control Panel-Cage Type Rho. 6.00  
Standard Variable "B" Battery—large size 3 50  
Turney 3 Coil Regenerative Tuner..... 8.00  
2-Parkin 0.001 M.F.D. Variable Condensers 4.00  
Grid Leak-Cond. and Phone Condensers..... .85  
400 Feet No. 14 Copper Antenna Wire..... 3.60  
OUR PRICE, \$31.90 VALUE \$35.45

Add Parcel Postage for 10 lbs. We insure results and furnish guaranteed hook-up that sure brings in the signals and music. Show Dad how you can save good money. Order today. Immediate delivery.

**10% Discount on Any of Above Items** if you send us names and addresses of 5 amateurs not in Call Book.

Pack up all your troubles in a letter and let our 12 years' experience solve them for you without charge.

Send Stamps Today for Our Latest Bulletin

**RADIO SUPPLY SERVICE**  
SPECIALISTS IN RECEPTION APPARATUS  
AND PARTS

46 Clinton Place Mt. Vernon, N. Y.



## LEARNERS "HYTONE" KEY AND BUZZER SETS With Code

Buzzer has silver contacts and two tone adjusting screws on top.

PRICE \$1.75

same set with flat spring key..... \$1.25  
Lever keys unmounted..... 1.00  
"Hytone" buzzers..... .69  
Lever keys, bakelite base and knob.. 1.50  
All postpaid

Special equipment, binding posts, contacts, etc., made to order.  
Prompt deliveries, low prices.  
Send in your sketches, estimates free.

**AJAX ELECTRIC CO.**  
Palmer St. Cambridge, 38. Mass.

# NOW IS THE TIME TO MAKE BIG MONEY LEARN WIRELESS AT HOME

**Know a Dignified  
Uncrowded Profession**

**In Shortest Time  
At Lowest Cost**

*The Demand for Good Wireless Operators Far Exceeds the Supply*

The New York Wireless Institute—America's foremost fastest growing Wireless Institute gives you the best instruments, theory, text books and diagrams available. We will **MAKE YOU AN EXPERT WIRELESS OPERATOR AT HOME**, qualifying you for first grade license, in your spare time, quickly, easily, thoroughly, in shortest possible time at lowest cost. No previous training necessary. Our Home Study Course prepared by Mr. L. R. Krumm, formerly chief Radio Inspector, Bureau Navigation, New York, now in position of greater responsibility with one of the largest commercial Radio Corporations in the United States. Our radio Experts able to impart their practical and technical knowledge to YOU in an easy to-understand way will direct your entire Course. The graded lessons mailed you will prove so fascinating that you will be eager for the next one. The instruments furnished free will make it as easy for you to learn the Code as it was to learn to talk. *All you will have to do is to listen.*

## BIG SALARIES

Wireless operators receive salaries from \$125 to \$200 a month and it is only a stepping stone to better positions. There is practically no limit to your earning power. Men who but yesterday were Wireless Operators are now holding positions as Radio Engineers, Radio Inspectors, Radio Salesmen at salaries up to \$5,000 a year.

## TRAVEL THE WORLD OVER

A Wireless Operator can visit all parts of the world and receive fine pay and maintenance at the same time. Do you prefer a steady position without travel? There will be many opportunities for you at the numerous land stations or with the Commercial Wireless or with the Steamship Companies.

*The New Intercity Wireless Company will need hundreds of new operators*

**FREE**



## INSTRUMENTS AND TEXT BOOKS

We furnish free to all students, during the Course, the wonderful receiving and sending set exactly as shown in the illustration. This set is not loaned, but given to all students completing the Course. One cell of dry battery all that is required. No additional wiring, aerials, etc., needed. The wonderful Receiving and Sending Set, Text Books, etc., all become your property upon completing the Course. We also include an up to date and complete course in Wireless Telephony, written by our Chief Instructor, Mr. L. R. Krumm.

The transmitter pictured is the celebrated Omnigraph, used by several Departments of the U. S. Government and by the leading Universities, Colleges, Wireless and Technical Schools throughout the United States and Canada. Thousands have learned telegraphy with the Omnigraph. Place the phone to your ear and this remarkable invention will send you wireless messages, thousands of different ones, the same as though you were receiving them thru the air from a wireless station hundreds of miles away.

When you apply for your license the United States Government will test you with the Omnigraph—the same model Omnigraph as we furnish to our students. Ask any United States Radio Inspector to verify this.

## FREE WIRELESS TELEPHONY COURSE

We have incorporated in our institute an up-to-date and Complete Course in Wireless Telephony, written by our Chief Instructor, Mr. L. R. Krumm.

*This Course is also Furnished FREE*

## FREE POST GRADUATE COURSE

A month's Post-Graduate Course, if you so desire, at one of the largest Wireless Schools in N. Y. City—the Wonder City—the largest port in the World and Headquarters of every leading Wireless and Steamship Company.

## Endorsed by United States Government

by allowing our graduates highest credit of any Wireless School in first grade license examinations.

**U. S. SHIPPING BOARD will testify to the great value of our instruction.**

Medina, N. Y.,  
November 28, 1920.  
Dear Sirs:—  
I have found the Theory Course, the Omnigraph Set and Text Books most satisfactory. I think your Wireless Course is the best and easiest to learn for it's interesting from the beginning to end, and the way the questions are written gets you interested at once.  
Yours Truly,  
Signed (S. B.)

Sea Cliff, L. I.,  
December 6, 1920.  
Dear Sirs:—  
Received your letter of December 1, and was very pleased to learn of the lessons in Wireless Telephony to be given to the students of your school. It shows you do not overlook any phase in order to furnish the students with "up to date dope in the Radio line". And I am sure it will be as explicit as your Theory course of Wireless Telegraphy. The course is as thorough and explicit as one could ask for and I wouldn't hesitate a moment in recommending it to any of my Radio friends.  
Respectfully yours,  
(Signed) C. D. II

Milford, Conn.,  
Oct. 25, 1920.  
New York Wireless Institute.  
Dear Sirs:—  
I received your letter and am very glad to tell you that I am completely satisfied with your course. It sure is an easy way to learn.  
Thanking you for your kind attention, I am,  
Sincerely yours,  
Signed J. H. A., Jr.

(Names and address gladly furnished on application.)

### SEND FOR FREE BOOKLET

*Without obligating you in any way, send for our booklet "How to Become an Expert Wireless Operator"—it is free. Mail the coupon opposite or postal or letter—but do it today.*

**NEW YORK WIRELESS INSTITUTE**, Dept. 202, 253 Broadway, New York City

### NEW YORK WIRELESS INSTITUTE

Dept. 202, 258 Broadway New York City  
Send me, free of charge, your booklet "How to Become an Expert Wireless Operator," containing full particulars of your Course, including your FREE INSTRUMENT OFFER.

Name .....

Address .....

City or Town.....

State .....

## COTO-COIL CO.

SELF-SUPPORTING ELECTRICAL COIL WINDINGS

87 WILLARD AVENUE  
PROVIDENCE, R. I.

*2<sup>nd</sup> Letter*

*Mr. Radio Amateur  
Any where, U.S.A.*

*We've taken to writing letters lately. We don't like it, as a rule, because it's hard to find enough dope to fill a sheet.*

*But now we've got a lot to write about, as we are making additions to our line of products constantly - So with each addition, we are sending word to all our friends describing and quoting prices on the new goods. You may be interested, too, but we don't burn that.*

*At any rate, this letter is only written to tell you that we're going to brand our products - A diamond-shaped label like this  with the word Coto written just like that on it will tell the whole story - And it's a story you'll want to burn by heart, too - That's between you & us, tho.*

*And lastly, we'll agree to keep you posted on our products, if you'll send us the answer to this one: - If it takes XX to Bakelite, how many platefuls will filament - ?*

*Yours for H.F. Jay days,  
Coto-Coil Co.*

are connected across the plate and grid of the plotrons set and larger inductances connected to the ends of these. The radio circuit is completed by the connection to the ends of these coils of a condenser of very small capacity. The appearance of the auto transformer together with series resonance are utilized to produce a large voltage across this condenser. The latter was of special design, enabling it to withstand large voltage without failure. To produce a voltage of 50,000 volts at radio frequencies with the six plotrons a condenser of 30 micromicrofarads is employed. This capacity is more than ample for flash-over tests.

### ANALYZATION OF INSULATING MATERIALS.

More concerning the results of the comprehensive tests in analyzing the properties of radio insulating materials: The expensive grades of products are superior in their electrical properties while the reverse obtains with respect to their mechanical strength. The costliness of the materials is determined by the percentage of phenol varnish to paper, the more expensive products having larger percentage to varnish. Insulating materials of the phenol type were introduced as a substitute for hard rubber. The value of the latter for electrical apparatus is attributable to these factors, easily machined, has small power loss or phase difference, and extremely high puncture voltage at radio frequencies. Among the objectionable features of rubber in this capacity are its tendency to shrink, warp, become brittle, deterioration under the glare of the sun, and its high thermal expansivity. The electrical characteristic of greatest significance is the flash-over voltage. However, because it varies with many properties it is not feasible to assign a particular voltage of flashover to the materials circumscribed by these experiments. Carefully prepared varnish did not enhance the value of one type of insulating material, but the judicious selection of paper entering into the manufacture of the material appreciably improved the finished product. The story concludes with this idea uppermost in the mind.

## The Radio Dealer and the Beginner

(Continued from page 688)

tically every American home. With a radio station at every troop headquarters they could deliver a message from the President of the United States or any government department to every community—posting it in public places, giving it to newspapers, telephoning it over farmers' lines—inside of an hour or two.

Slowly—too slowly—they are grasping the opportunity. Here and there a city organization is awakening. The only difficulty is that radio to the layman is still a mystery. The local scout executive, busy with many things, cannot take time to understand it. The public does not know yet that wireless communication is practical and reliable. Only we who handle it daily appreciate its progress and its possibilities.

What a chance for a live dealer! A very little publicity would be required to fire the imagination of the boys. Among the things which could be suggested by dealers are: A radio mobilization scheme by which every scout in town could be called to any designated rendezvous inside of an hour or less; the broadcasting and posting of weather reports (Chief Marvin of the U. S. Weather Bureau has offered to arrange for the scouts to receive state forecasts immediately after they are made up); an emergency communication service for

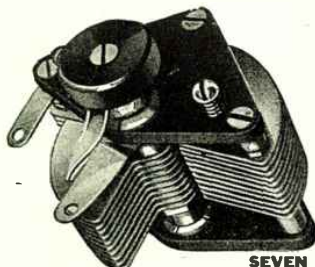

## EMPYREAN VARIABLE CONDENSER

Consistently Brings In the Long Distance Stations

Designed to meet the most rigid physical and electric tests. No insulation break-downs; extremely low energy losses; no short circuits; utilizes the minimum amount of received energy.

Suitable for all classes of Radio Telephone and Telegraph Work

### SEVEN EXCLUSIVE FEATURES

Show the superiority of this condenser over any other, selling at any where near this price.

- (1) Aluminum plates .026 inches thick insuring stability. Plates cannot bend or become displaced.
- (2) Formica insulation used throughout. Not one particle of moulded insulation enters into their construction.
- (3) Bearing plates are machined from 3/16 inch grade M. Formica.
- (4) Finest adjustment is secured with an end block spring which holds the rotary plates in any position. Wear and hard usage will not alter their adjustment.
- (5) All spacers turned from brass stock and accurately gauged before being used.
- (6) Panel type easily mounted on any panel up to 3/4 inch thickness by drilling three holes for set screws and shaft. Furnished with screws, knob, pointer, scale, connecting strip.
- (7) The portable type is enclosed in clear glass case with square end pieces of genuine machined Formica with engraved scale.

PANEL MOUNTING TYPE		PRICES	PORTABLE TYPES	
43 plate—.001 Mfd.		\$4.50	43 plate—.001 Mfd.	5.75
Dimensions—2" x 3 3/4" x 4 1/4"			Dimensions—3 3/4" x 3 3/4" x 3 3/4"	
21 plate—.0005 Mfd.		3.65	21 plate—.0005 Mfd.	5.00
Dimensions—2" x 3 3/4" x 3"			Dimensions—3 3/4" x 3 3/4" x 2 1/4"	
Weight—2 lbs.			Weight—3 lbs.	

EMPYREAN RADIO COMPANY, 1122 Masonic Temple Building CHICAGO, ILLINOIS

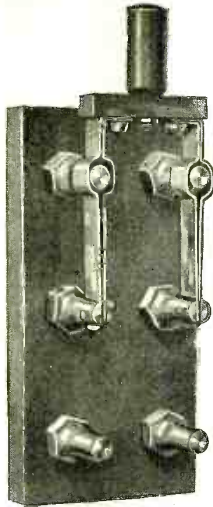

(Illustration exact full size)

Z. R. S. Miniature knife switch is supplied unmounted only, for panel mounting and will harmonize with other fine products of the instrument maker. There is nothing else like it on the market.

Double pole, single throw - - - - 80c  
 Double pole, double throw - - - - 90c

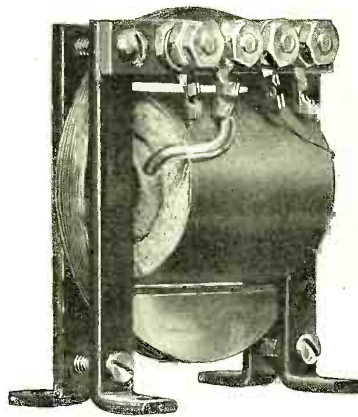

Modulation transformer - - - - \$4.50  
 Choke coil .8 Henry - - - - \$3.75  
 Amplifying transformer - - - - \$4.00

All these are mounted as shown in the illustration and will give you results second to none.

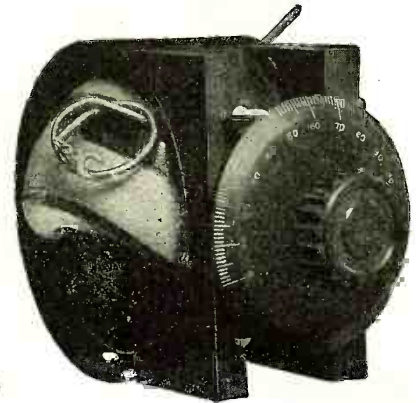

Type Z.R.V. Variometer has unit construction with bakelite shell and hard wood ball. Has low dielectric losses and a range of inductance of 1.25 mil henry maximum to .1 mil henry minimum. Is readily used on table or mounted on panels.

Complete with 3" dial and knob - \$6.50  
 Without dial or knob - - - - \$5.75  
 Variocoupler of same construction - \$7.50  
 Complete Regenerative set - - - \$38.00  
 Regenerative panel set with detector - \$85.00  
 Regenerative set detector and 2 stage amplifier, combined panel - \$140.00

**Complete Catalogs  
 6c Stamps**

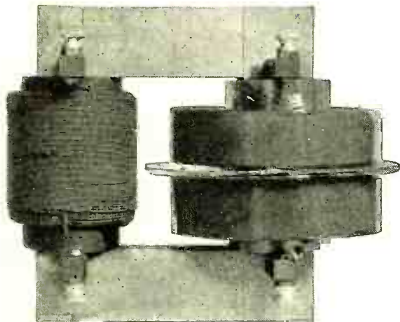

Type ZRL Transformer  
 For use with Rotary Spark Gaps  
 400 Watts. 110 Volts-60 Cycles

Unmounted Price - - - - \$14.00  
 Mounted on Iron Frame - - - - \$15.00  
 The "Cambridge" Rotary Spark Gap Complete with Variable Speed Motor - \$50.00  
 The "Boston" Key - - - - \$7.50



A combination of beauty and convenience. One stage amplifier has binding posts for connecting two as a two stage amplifier. All binding posts for detector, amplifier and Regenerative set correspond for jumper connection.

Tube Control Detector Panel, Z. R. D. - - - \$12.00  
 One Stage Amplifier Panel, Z. R. A. - - - \$18.00  
 Rheostat only - - - - \$1.20

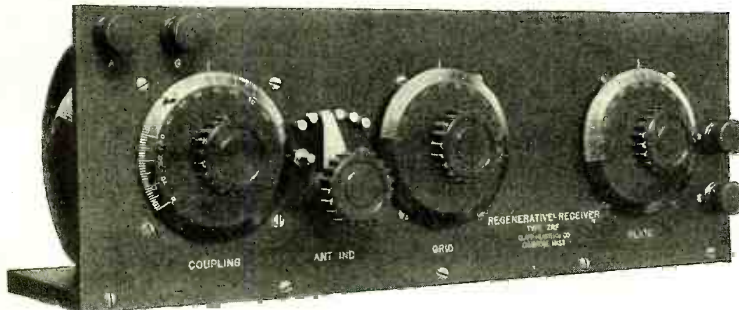

Z.R.F. Regenerative Receiver consists of two Z.R.V. Variometers and a Coupler of similar construction, together with Grid Condenser and Grid Leak with Bakelite Panel machine engraved. Licensed under Armstrong U. S. Patent No. 1,113,149. This exactly matches our Tube Control and Amplifier panels with which it may be harmoniously used. Its range of wave length is 175 to 600 meters.

Price - - - \$38.00

**CLAPP EASTHAM COMPANY**

120 Main Street

Cambridge, Mass.

ALL GOOD DEALERS CARRY OUR PRODUCTS IN STOCK

# JUST WHAT YOU WANT

Shipped  
in  
Twenty-four  
Hours

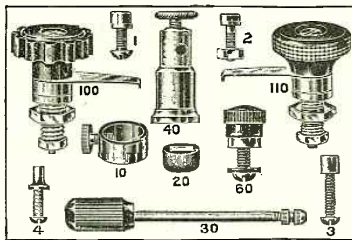

Service  
and  
Satisfaction  
Guaranteed

<b>NICKEL PLATED SWITCH POINTS</b>		<b>DIALS</b>	
No. 1 3/16 x 3/4 inch head.....	\$ .05	Chelsea 3" dial with knob.....	1.00
No. 2 1/2 x 3/4 inch head.....	.05	Chelsea 3" dial without knob.....	.75
No. 3 3/16 x 3/16 inch head.....	.04	<b>FIXED CONDENSERS</b>	
No. 4 Switch stop 3/8" high.....	.06	Grid condenser.....	.35
<b>CRYSTAL DETECTOR PARTS</b>		Grid leak condenser.....	.50
No. 10 Detector cup.....	.35	Phone condenser.....	.35
No. 20 Mounted Crystal.....	.50	<b>V. T. SOCKETS</b>	
No. 30 Detector Rod.....	.35	Single V.T. socket.....	1.10
No. 40 Detector Stand.....	.35	Double V.T. socket.....	2.50
<b>SWITCHES AND BINDING POSTS</b>		Triple V.T. socket.....	3.50
No. 60 Binding Post.....	.12	<b>TUNING INDUCTANCES</b>	
No. 100 Switch Lever, radius 1 inch.....	.60	Turney short wave coils (set).....	6.00
No. 110 Switch Lever, radius 1 inch.....	.60	Radco coils.....	List
No. 130 Switch Lever, radius 1 1/2 inches.....	.75	Arnold loose coupler (Navy Type, 2500 meters).....	20.00
<b>CABINETS</b>		<b>RHEOSTATS</b>	
No. 1A Hand Polished Cabinet, fits panel 6" x 9" x 1/2" inside depth 3 3/4".....	2.00	Paragon.....	1.75
<b>VACUUM TUBES</b>		Remler.....	1.25
Audiotron (two filaments).....	6.00	<b>"B" BATTERIES</b>	
U.V. 200 Radiotron (detector).....	5.00	Standard 22 1/2 Volts, small.....	1.50
U.V. 201 Radiotron (amplifier).....	6.50	Standard 22 1/2 Volts, large.....	2.65
<b>AMPLIFYING TRANSFORMERS</b>		Standard 22 1/2 Volts, variable.....	3.50
Acme (mounted).....	5.00	<b>AUDION CONTROL SETS</b>	
Acme (unmounted).....	4.50	Paragon control set.....	6.00
<b>VARIABLE CONDENSERS</b>		Remler control set.....	8.00
Chelsea .0006 m.f. for panel mounting.....	4.25	<b>PHONES</b>	
Chelsea .0011 m.f. for panel mounting.....	4.75	Brahdes Superior.....	8.00
<b>VARIOMETERS AND VARIOCOUPERS</b>		Baldwin Type C.....	16.50
Variometer (moulded bakelite).....	6.25	Murdock 2000 ohms.....	4.50
Variocoupler (moulded bakelite).....	8.50	Murdock 3000 ohms.....	5.50

## EMPIRE RADIO EQUIPMENT CO.

Manufacturers and Distributors of Radio Apparatus

271 West 125th Street New York City

### Averaged 82% out of a possible 90%

Practical course on the application of Vacuum Tubes to all forms of C-W Transmission and Reception starts Thursday February Tenth.

Thirteen graduates of the MASSACHUSETTS RADIO and TELEGRAPH SCHOOL during the Six Weeks' examination period between November 1st and December 15th, 1920, established this record on their U. S. Government Examinations for First Grade Commercial Operator's license. Their average attendance was 5.1 Months.

The fact that a new United States Radio Inspector did the examining, using new and original questions unfamiliar to the graduates, speaks all the more favorably of our system and methods.

To produce Thirteen graduates, who, within the short period averaging a little Over Five Months, obtained such a high average, is the best way we know of to convince you of the merits of this school. Results Count.

Names, addresses and full data sent on request to anyone.

Why not avail yourself of this service. It costs no more. SEND FOR FREE LITERATURE.

MASSACHUSETTS RADIO AND TELEGRAPH SCHOOL  
18 Boylston Street, Boston, Mass. Tel. Beach 7168

R. F. TROP

G. R. ENTWISTLE

"EVERYTHING IN RADIO"

## WESTERN RADIO ELECTRIC COMPANY

SEND FOR OUR MARCH

STOCK BULLETIN AND PRICE LIST

550 South Flower Street

Los Angeles, Cal.

## VACUUM TUBES REPAIRED

RELIABLE

Marconi  
Moorhead

Cash Must  
\$3.50  
Accompany Order

Electron Relay  
Audiotron

SERVICE

## EASTERN VACUUM TUBE LABORATORIES

178 Washington St.

Boston, 9, Mass.

use in case of fire, flood or cyclone interfering with wire service; the broadcasting of baseball scores and other news of general interest, by arrangement with the local papers.

Any town that was not dead from the neck up would grab a proposition like that as soon as it was understood, provided the practical details were arranged in a way to insure success.

To encourage progress, contests could be arranged. These could be based on the reception of the daily amateur broadcasts transmitted by N.A.H., or on local broadcasts. A daily local broadcast for beginners could be transmitted at five words per minute, another at ten words and one at fifteen words. These messages could be address to individual amateurs. Every boy would listen in if there was a chance that the message might be for him.

In dealing with boy scout organizations radio dealers would need to be careful to avoid ever the appearance of trying to commercialize the movement. Boy scouts are organized for public service, not for private gain. Local organizations are forbidden by their national constitution to enter into any contract or agreement involving the service of the scouts as such, and also profit to a commercial concern without the approval of their national council. But no objection would be raised against a dealer who promoted boy scout radio with real public spirit even tho his trade were increased thru his becoming more widely known and thru the increased interest in radio.

### INTERESTING PARENTS OF BEGINNERS.

The cultivation of the parents of beginners would be profitable to the dealer I believe. Suppose that after a boy from a well-to-do family had bought a loose-coupler, crystal-detector set the dealer should call his father up, or find a chance to see him, and explain how much better work can be done with audions. Or better yet, invite him in and demonstrate what the set will do. Hiram Maxim became interested in radio thru his son and he has been some booster of radio sales. Once get a man and his boy started on radio and you have a combination hard to beat for producing sales. The Y. M. C. A. and the boy scouts are busy promoting father-and-son activities, so the dealer would be right in line with up-to-date ideals. Furthermore, there would be no timorous mother sentiment to buck against as there is in the case of firearms. When Mother learns that a good audion outfit makes the whole world a party line on which she can listen in to her heart's content she may take up radio herself.

A year ago I had an experience which illustrates the good and the poor method of handling beginners. I had started with a second-hand loose-coupler, crystal detector set and had reached the point where I was ready to begin building up something better. I called up a leading manufacturer, who also sells direct to the consumer, and stated that I wanted to purchase a few of his units and then add more as I was able. He advised against my plan—altho it was recommended in his advertising. He said: "You won't have anything unless you get the whole outfit." The fact is that the units I selected would have constituted a much more efficient crystal detector set than I had, and I would soon have purchased the audion units. The result of his argument was that I waited until I had more money and then went to another dealer.

This dealer not only made it easy for me to get a first-class, up-to-date outfit, but also offered to give demonstrations where they might attract other customers. Naturally when men become interested in radio thru me I take them to him.



**Type 104 Panel Switch**

A complete unit for back of panel mounting. The latest and best in rotary panel switches. Better looking, more efficient and easier to mount. Complete with Type 116 Dial and 6 contacts \$2.25. Complete with Type 116 Dial and 11 contacts \$2.50.

**Sheet Materials**

Postpaid Price per sq. in.  
Less than 25 sq. 25 sq. or more

Material	in.	in.	in.
3/16" Bakelite-Dilecto	2-2/3c	2c	
1/2" " " "	4c	3c	
1/2" " " "	5-1/3c	4c	
1/2" Hard rubber	2c	1 1/2c	
1/2" Hard rubber	4c	3c	
1/32" white celluloid	1 1/2c	1c	
1/18" " " "	2c	1 1/2c	
.010 Spring brass	1c	1/2c	
.015 Spring brass	1c	1/2c	
.007 Copper	1c	1/2c	
1/32" Red Fibre	1c	1/2c	
1/16" Red Fibre	1c	1/2c	



**Variocoupler Rotor**

A carefully turned hardwood form for the secondary coils of variocouplers, etc. Size is 3 1/2" in diameter and 2" wide. No. 1C1 Rotor \$1.00.

**Magnet Wire**

Put up in coils of 1/4, 1/2, or 1 lb. and shipped postpaid.

Price per pound

Size	S.C.C.	S.S.C.	Enamel
20	.86	1.26	.72
22	.86	1.38	.78
24	1.12	1.56	.86
26	1.36	1.82	.94
28	1.56	2.20	1.06
30	1.98	2.82	1.12
32	2.40	3.88	1.24



**Type 121 Rheostat**

Suitable for table or back of panel mounting. Has turned aluminum case, convenient binding posts and 6 ohm resistance unit with all off and all on positions. Long bearing and special designed blade insure smooth running and positive contact. Only occupies space 2" in diam. on your panel. No. 121A with Type 116 Dial \$2.50. No. 121B with Knob and Pointer \$1.75.

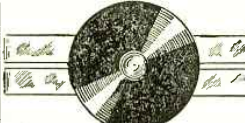

**Brass Machine Screws**

Round or flat heads. Prices per dozen postpaid. Not less than one dozen sold.

Size	2-56	4-36	6-32	8-32
3/8"	.05	.06	.08	.12
3/4"	.06	.07	.09	.13
1"	.07	.08	.10	.15
1 1/4"	...	.09	.12	.18
1 1/2"	...	...	.15	.22
1 3/4"	...	...	...	.27
1 7/8"	...	...	...	.32

**Type 103 Panel Switch**

A rotary panel switch which is double pole and double throw. will change variable condenser from series to parallel, etc. 1 1/2" radius brass finish 75c. Nickel finish 85c.

**Taps and Dies**

These tools are of the highest quality and the dies are of the round adjustable type. Prices are postpaid.

Size	Tap	Die
10-32	25c	90c
8-32	25c	90c
6-32	25c	90c
4-36	25c	90c
2-56	25c	90c

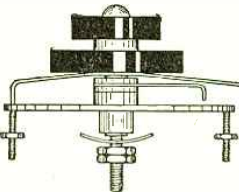

**Type 102 Panel Switch**

A compound switch consisting of two electrically independent switches mounted with concentric knobs. 1 1/2" radius brass finish \$1.10. Nickel finish \$1.25.

**Threaded Brass Rod**

One foot lengths—6-32 or 8-32 thread. Price per length postpaid

**Hex Brass Nuts**

Prices are per dozen postpaid. Not less than one dozen sold.

2-56	6c	6-32	6c
4-36	6c	8-32	9c

**Brass Wood Screws**

Prices are per dozen postpaid. Not less than one dozen sold.

No. 1 x 1/4" R. H.	06
No. 3 x 1/2" R. H.	08
No. 4 x 3/4" R. H.	10
No. 4 x 1" R. H.	12

**Type 131 Binding Posts**

A high grade binding post for use on panels, etc. Has moulded composition top with brass collar and screw.

No. 131A small size, suitable for receiving sets, 10c. No. 131B large size, suitable for power work 20. State thickness of panel and whether brass or nickel finish is desired.

**Type 126 Tube Socket**

Made of genuine bakelite dilecto and solid brass. Is small and convenient for back of panel mounting.

No. 126A Audion Socket 75c.

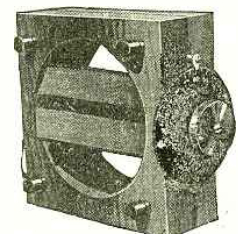

**Brass Rod, Tube, etc.**

Prices are per foot, postpaid. Not less than one foot sold nor pieces longer than two feet sent postpaid.

1/4" Round brass rod	\$.07
3/16" Round brass rod	\$.10
1/2" Round brass rod	\$.15
3/4" Round brass rod	\$.25
1/2" Round brass rod	\$.40
1/4" Square brass rod	\$.20
5/16" Sq. tubing, 1/4" inside	\$.30
3/16" Rd. tubing, 1/4" inside	\$.15
1/16" x 1/4" Reet. brass strip	\$.08
1/16" x 3/8" Reet. brass strip	\$.10
1/16" x 1/2" Reet. brass strip	\$.12

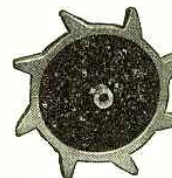

**Type 14B Rotary Disk**

The same style rotor as used on our famous belt driven gap, only with bakelite center and brass bushing to fit your motor shaft. Size is 4 1/2" diam. and 9/16" thick. This rotor being light and perfectly balanced will give excellent results on any small high speed motor. State size of shaft when ordering. No. 14B Rotary Disk \$6.00

**Switch Contacts**

Heads 1/4" x 1/4", Shanks 6-32 x 3/8", 112A Brass, 3c; 112 B Nickel, 4 1/2c; Heads 3/16" x 1/4", Shanks 6-32 x 3/8", 112E Brass, 2 1/2c; 112F Nickel, 4c; Heads 1/4" x 1/4", Shanks 6-32 x 3/8", 112C Brass, 3 1/2c; 112D Nickel, 5c. Heads 3/16" x 1/4", Shanks 6-32 x 3/8", 112G Brass, 3c; 112H Nickel, 4 1/2c.

**Flat Braided Copper Cable**

Used for connecting transmitting sets making oscillation transformers, etc. Price is per foot postpaid.

9/16" wide	\$.10
1 1/8" wide	\$.25

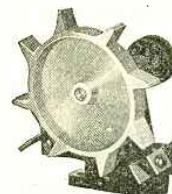

**Type 14A Rotary Gap**

Belt driven, solid balanced rotor of special aluminum alloy, large steel shaft, long brass bearings, well quenched, short leading spark, clear tone, high efficiency. Price \$10.00.

**Type 101 Panel Switch**

A beautiful and efficient rotary switch for general use. Furnished in two sizes. 1" radius brass finish 40c. Nickel finish 50c. 1 1/2" radius brass finish 50c. Nickel finish 60c.

**Buy from your dealer or order from this ad.**  
Prices are postpaid

**Type 5A Var ometer**

Made from Wilcox Variometer parts, completely assembled as illustrated, may easily be mounted on panel if you wish. Wave length range in average circuit with coils in series about 175-450 meters. No. 5A Variometer \$8.

**Our complete catalog sent for 5 cents. Stamps or coin**

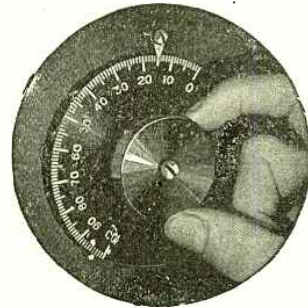

**Type 116 Indicating Dials**

Of polished hard rubber accurately engraved, filled with brilliant white. Furnished complete with knob and bushing to fit 3/16 inch shaft. 90° scale 0-50 or 180° scale 0-100; also 360° 0-100 scale in 2 inch size.

2 inch diameter	\$1.25
3 inch diameter	\$1.50



**Type 5A Variometer Parts**

Set No. 1 contains carefully turned wooden parts including winding form. Price \$2.50. Set No. 2 contains all parts including 3 inch Type 116 Indicating Dial. Price \$5.00.

**Type 1C Variocoupler Parts**

Set consists of No. 1C1 variocoupler rotor, bakelite tube for primary, shaft, two No. 101 switches, 14 switch points, 4 binding posts, one No. 116 dial 90° 90° wire for winding, and instructions for assembling. No. 1C1 Variocoupler Parts. \$5.00.

**SPECIAL OFFER**

This is your chance to get a high grade short wave regenerative set at about one-quarter the usual price. Mention this ad and we will send two complete sets variometer parts, one set variocoupler parts, one bakelite panel 3/16" x 6" x 18", all for \$17.50, postpaid.

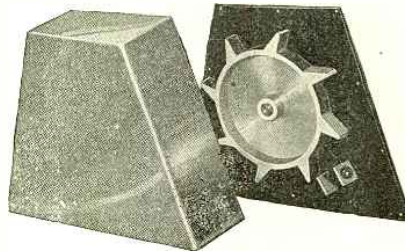

**Type 14C Rotary Quenched Gap**

This enclosed gap has all the advantages of the No. 14A with some additional ones all its own. Like all WILCOX Gaps it runs quietly, and it is surprising how the housing silences the spark. The combination makes this gap nearly noiseless.

In addition to this the practically airtight case greatly improves the already excellent quenching qualities making this the ideal rotary gap.

No. 14C GAP, Postpaid.....\$17.50

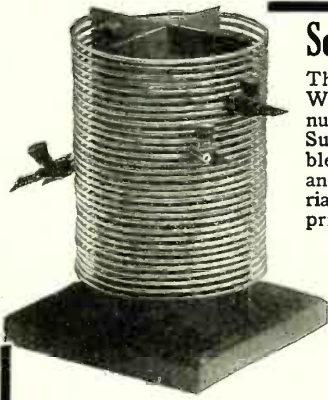

## Something New In C. W. Inductances

The Radio Service Type S50 C. W. Inductance is Wound on a slotted bakelite form of 31 turns of number 9 hard drawn copper wire on a 5 inch diam. Supplied with three clips making adjustment variable to any fraction of a turn. Tunes to 350 meters and suitable for panel or bench mounting. Materials and workmanship the finest obtainable and the price is *only* \$8.50

If you are starting to build a C. W. set the Radio Service Inductance will start you on the right track or if you already have a C. W. Set and you are not getting the proper results try one of these inductances and you will be surprised at the increased operating efficiency.

**ASK YOUR DEALER TO SHOW YOU ONE OF THESE INDUCTANCES. IF HE CAN'T SUPPLY YOU, WE WILL SHIP YOU ONE POST PAID.**

Type S40 Variable Grid Leak  
Helps to increase your signal audibility  
Bakelite Mounted . . . . . 75

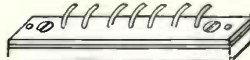

### Reduced Prices On Our Products

- S24—Aluminum Socket only . . . . . \$ .50
- S10—Single Tube Socket . . . . . 1.10
- S 3—Double Tube Socket . . . . . 2.50
- S 4—Triple Tube Socket . . . . . 3.50
- S14—Navy Type Rheostat . . . . . 2.00
- S11—Complete V.T. Control Panel . . . . . 6.00
- S22—Mica Grid Condenser . . . . . .50

All leading dealers or by mail from

**RADIO SERVICE & MFG. CO.**  
Lynbrook, L. I. New York

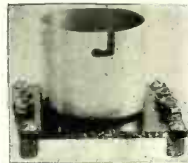

## IS EXPENSIVE APPARATUS MOVING SLOWLY IN YOUR STORE, TOO?

Most all dealers are making this complaint. And right there is where G. A. Condensers, Detectors, and Amplifiers fit into your line.

**LOW RETAIL PRICES AND PROFITABLE DISCOUNTS**

**Grid Condenser 35c**  
0.0005 mfd. for the new tubes

**Phone Condenser 35c**  
0.001 mfd. makes the set oscillate freely

**Grid Leak Condenser 50c**  
0.0005 mfd. and 1 megohm



**THESE CONDENSERS PERMIT A SAVING OF 50 TO 80% OVER OTHER TYPES**

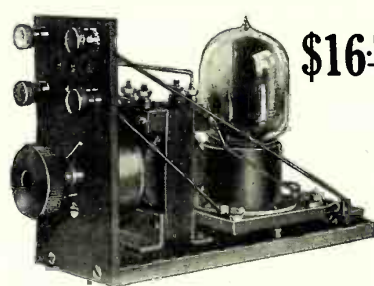
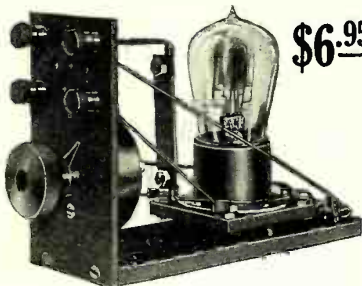

- G. A. DETECTOR, without tube, (1 lb.) \$6.95
- G. A. AMPLIFIER, without tube, (2 lb.) 16.95
- DETECTOR and 1-STEP..(3 lb.) 21.95
- DETECTOR and 2-STEP..(5 lb.) 38.95
- DETECTOR and 3-STEP..(7 lb.) 51.95

- 2-STEP AMPLIFIER.....(4 lb.) \$30.95
- 3-STEP AMPLIFIER.....(8 lb.) 49.95
- RADIOTRON DETECTOR (1 lb.) 5.00
- RADIOTRON AMPLIFIER (1 lb.) 6.50
- G. A. B. G. BATTERY, NAVY SIZE.....(5 lb.) 2.00
- SIGNAL CORPS SIZE....(1 lb.) 1.25

**NO OTHER DETECTOR OR AMPLIFIER AT TWICE THE PRICE IS BETTER MADE OF FINER PARTS. REASON—LARGE PRODUCTION, REASONABLE PROFITS**

**570-N W. 184th St. THE GENERAL APPARATUS CO., INC. New York**

One acquaintance of mine went to a radio store and, as he was prosperous looking, they tried to sell him a \$75.00 outfit. He wanted a beginner's set for his own use and for some boys to learn with and he did not want to put that much into it. I took him to the store where I purchased my outfit and we doped out a set costing \$33.00, including the antenna. Then I took him home and gave him an hour's instruction. That evening he called up, as pleased as a kid with a new toy, to tell me that he had heard the Arlington time tick, was bringing in all kinds of traffic and was already able to distinguish certain letters. In less than a month he was ready for an audition outfit. The first store lost a good customer by trying to oversell him.

### SPARK TRANSMISSION FOR AMATEURS.

Beginners are a good and legitimate market for certain apparatus which is becoming obsolete. Even the spark transmission becomes commercially obsolete, as navy experts say it will in five years, it is probable that beginners will use spark coil transmitters and crystal detectors for decades to come, for C.W. apparatus probably will never be so cheap nor so simple to operate. They will continue to be used in rural districts at least, just as scythes and buggies are used today in spite of all the mowing machines and automobiles that have been manufactured and sold.

The dull seasons in radio can be utilized for starting beginners. A dealer has more time then. A boy of twelve started in July may be far enough along in November to bring in a dozen customers. A group of beginners can be organized into a club by merely giving the suggestion. An hour of code practice a week with an omnigraph, in some corner of the store where they will not be in the way, will soon develop them into paying customers. The older radio clubs do not take care of the younger beginners. Sometimes they even seem to try to drive them out of radio. When you are up against their QRM this attitude—or homicide—seems quite justifiable, but the fact is that a boy is a most reasonable being and will do anything a man suggests if he is sure that the man is an unselfish friend. A dealer, by explaining the evils of interference at the start, could give the beginner an attitude which would be helpful to all concerned.

Another gold mine which dealers have not yet discovered is the summer camp. The Y. M. C. A. and the boy scouts are conducting thousands of them, all over the United States. Most of them lack facilities for quick communication. They need radio, for with scores or hundreds of boys in camp accidents are likely to happen which demand quick assistance from outside.

Most of these camps depend upon the chance that some boy will bring an outfit along. Some of them receive press with fair regularity. But very few of the managers know that for a few hundred dollars they could install a station which would give them reliable communication with their city headquarters. A dealer who would get that into their heads would pave the way for big sales just at the season when ordinary business is dropping off. Incidentally, he might arrange to send a clerk who was not needed during the summer to a camp to serve as an operator, thus giving him a vacation and saving his salary at the same time.

### SOME OP!

Radio Operator to Amateur: I hear that Washington will not send the time signals any more.

Amateur: Oh! Why?

Operator: Because he is dead.

By STEPHEN MORTON, JR.



*De Forest*  
**RADIOPHONE**  
REG. U. S. PAT. OFF.

## Interpanel Sets

**The Most Advanced Idea in Radio Telephone Transmitting and Receiving Apparatus**

**T**HE DeForest RADIOPHONE INTERPANEL Set establishes a new standard of design and efficiency for DeForest Apparatus, and provides the most convenient and all round satisfactory method of purchasing Radio Apparatus yet invented.

The INTERPANEL Set consists of a series of panels, each constituting a complete piece of apparatus in itself, and designed to be combined with other panels, thus forming a Set as complete as may be desired, the operating possibilities depending only upon the total number of panels used. The Set for both Telephone and Telegraph Transmission and reception consists of four panels, as follows:

**Type MT-100**—A complete short wave Tuner of highest possible efficiency;

**Type MP-100** A new Audion Control panel designed especially for tubes of the gaseous type, now considered as standard;

**Type MP-200**—A one-step Amplifier panel complete in every respect; and

**Type OT-3**—A complete Radiophone Transmitter, capable of transmitting speech at least 30 miles, and up to 500 miles.

*(Additional steps of Amplification may be added as desired)*

Panels are all 9 inches high; varying widths. Designed for placing side by side, with binding posts in line and convenient to wire. Adaptable to any operating requirement. Panels may be bought individually and mounted in operator's own cabinet; or bought completely mounted in cabinet. Or panels alone may be mounted on table in either horizontal or vertical style.



*Vertical Panel-style mounting, without cabinet. Two legs hold each panel upright. Any number of panels may be joined and mounted this way.*

### 30 Mile Range for the Telephone Transmitter on Average Amateur Aerial.

Tests show a 30 mile telephone transmitting range for the Set, which can be exceeded under favorable conditions. Telegraph range from 60 to 100 miles with unlimited reception possibilities. One 6-volt storage battery required for all filaments and microphone; Motor-generator, "B" Battery or rectifier supply may be used.

This INTERPANEL Set provides the ultimate in RADIOPHONE apparatus; ease and convenience in installation and operation; minimum space, handsome appearance, great efficiency and extreme economy.

**Send Now for Catalog "E" and Prices**

**Get the full details of this new INTERPANEL idea and get your order placed early.**

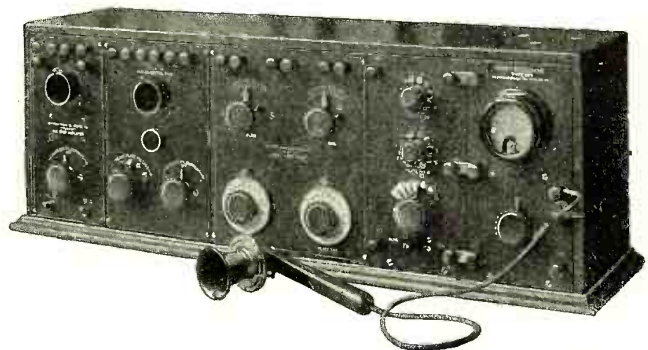

*Complete Set of Four Units, in Cabinet, each panel sold separately for mounting in home constructed cabinet; or completely assembled in cabinet as shown above. Also for mounting in Horizontal or Vertical Table-style. Complete Set as above, without batteries or tubes, type MS-1, \$189.25*

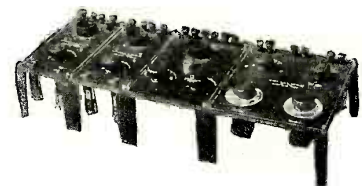

*Horizontal Table-style mounting. Legs attached to corners of each panel. Any number of panels can be mounted in this style. Ample space under panels for batteries. A very convenient and inexpensive method of mounting.*

# DEFOREST RADIO TELEPHONE & TELEGRAPH COMPANY

*Inventors and Manufacturers of High Grade Radio Apparatus*

1415 Sedgwick Avenue

New York City

# C. W. ACME APPARATUS

C. W. Power Transformers tapped in the center for use with rectifying devices or for A. C. directly on the plates.

Apparatus that is guaranteed

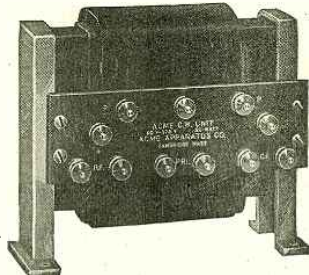

Apparatus that is guaranteed

50 watt rating good for two tubes of 350 volt 50 MA rating each. Filament windings provided.  
 200 watt good for four tubes of 550 volt 50 MA rating each,—also 350 volt taps. Filament winding provided.  
 500 watt good for two tubes of 1500 volt 150 MA rating each,—also 1000 volt taps.

Filament Heating Transformers 1½ Henry Choke Coils. Modulation Transformers

This apparatus carried in stock by leading dealers.

## ACME APPARATUS COMPANY

188 Massachusetts Avenue, Cambridge, 39, Boston, Mass.  
 Transformer and radio engineers and manufacturers.

## CO-OPERATIVE RADIO PURCHASING

Members of this association are securing SERVICE at a SAVING by purchasing all their radio needs collectively. You also can secure these savings and the good service that goes with membership. Stamp brings full details. The following items are indicative of the large and varied assortment we supply. Remit these list prices and secure the same SERVICE our members enjoy.

### RADIOTRON TUBES.

UV-200 Gas content detector.....	\$ 5.00
UV-201 Amplifier.....	6.50
UV-202 5 watt transmitter.....	8.00
UV-203 50 watt pliotron.....	30.00
UV-204 250 watt pliotron.....	110.00

### RADIOTRON ACCESSORIES.

Standard receptacle.....	1.50
Grid leaks complete, mounted.....	1.25
Grid leak units. 1 to 6 megohms.....	.75
Grid leak holders.....	.50
Audio frequency transformer.....	5.00
Special 50 watt receptacle.....	5.00

### B. BATTERIES

22½ volt, small, fixed.....	1.25
22½ volt, large, fixed.....	2.50
22½ volt Standard variable.....	3.50

### CONDENSERS

41-C Connecticut .001 encased.....	6.50
42-C Connecticut .001 panel.....	6.50
No. 1 Chelsea .001 encased.....	5.00
No. 2 Chelsea .0006 encased.....	4.50
No. 3-BD Chelsea with dial .001.....	4.75
No. 4-BD Chelsea with dial .0006.....	4.25

### BAKELITE DIALS

Corwin 3 in. with knob.....	1.30
Corwin 3½ in. with knob.....	1.70
Chelsea "true fitting" dial.....	.75

### AUDION CONTROLS

Fada with automatic cutout.....	17.50
Grebe RORA cabinet.....	12.50
Grebe RORH cabinet.....	17.00
Acme Y-1 new model.....	10.00
Adams Morgan "Paragon".....	6.00

### AMPLIFYING TRANSFORMERS

Arco for panel mounting.....	5.00
Acme for panel mounting.....	5.00
Federal for panel mounting.....	7.50

### TELEPHONE JACKS

Federal closed circuit.....	.85
Federal open circuit.....	.70
Federal two circuit.....	1.00

### STORAGE BATTERIES

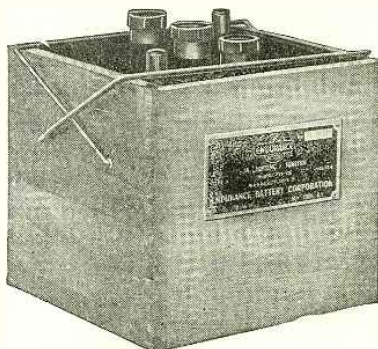

Endurance 6 v 30 ah special.....	12.50
Marko 6 v 20-40 ah.....	14.60
Marko 6 v 40-60 ah.....	18.00
Marko 6 v 60 Ford type.....	17.10
Marko 6 v 80 Ford type.....	21.60

### HEADPHONES

Brandes Superior, new style.....	8.00
Brandes Trans-Atlantic.....	12.00
Brandes Navy style.....	14.00

**MUTUAL PURCHASERS ASSOCIATION** 2 Stone St., Dept. 8  
 NEW YORK CITY

## A New Universal Range Receiver

(Continued from page 681)

A single "A" battery is employed for the lighting of the four filaments. The automatic control, which is effected by the insertion of the telephone plug in the desired jack, prevents any of the filaments from lighting until the plug has been inserted and then only the filaments of the tubes in actual operation are connected in circuit. The jacks are arranged so as to render operative the entire circuit to the point where the plug is placed, by controlling not only the filament current but also the opening and closing of the primary and secondary circuits of the amplifying transformers in their proper sequence. The special design of the telephone plug, furnished with the set, makes possible the use of a "loud speaker" in connection with the third step of amplification. Terminals for the loud speaker are provided on the upper right-hand corner of the panel, which are connected to the third-step amplifier circuit when the telephone plug is pushed half way into the third-stage jack. The regular head set is then automatically thrown out of circuit.

The jack, marked "EXT. DET.," permits the bulb circuits to be used in conjunction with other apparatus for test and comparison purposes, with the exception that in this case the detector tube does not function and should be withdrawn from the socket in order to eliminate unnecessary burning of the filament.

Each of the tubes is provided with its own filament control and the automatic action of the jacks and plug is particularly desirable in a set of this character, where there are a number of tubes to keep adjusted. Once the proper filament current has been secured it is not necessary to change the position of its control rheostat in order to cut off the current.

In connection with the detector tube plate circuit a potentiometer has been provided for minute regulation of the "B" battery supply.

From the wiring diagram and the photo of the interior, it will be seen that a number of terminals are provided, for the regulation of the "B" battery supply, allowing for the greatest possible voltage flexibility in the tube circuits with a minimum of supply. It will be seen that the detector—second and third amplifier circuits have two, while the first amplifier circuit is fitted with three such terminals. The pair adjacent to the detector tube are for the "A" supply. Referring particularly to the photo of the interior, the two outside terminals supply the amplifier circuits if a bridge is placed across the pairs adjacent to the second and third stage tube mountings. The plate voltage of the detector tube is determined by the connection made to the center terminal and that directly to its left. Considering that three stages of amplification are to be used and voltages of their plate circuits vary progressively as their positions in the circuit, a 40-volt battery, placed across the outside terminals of the three adjacent to the first amplifier tube socket, will deliver that voltage to that tube. The next set of three terminals is especially interesting. A battery connected to the center and right-hand terminals will have its voltage effective on the detector circuit alone, but if the remaining terminal is also connected with the battery the voltage will be applied to all the amplifier tubes as well. It will, therefore, be apparent that when the amplifier batteries are connected across to the center terminals a variable voltage on the detector is obtained by connecting from the center terminal to the desired portion

## OUR MAIL ORDER SERVICE IS RIGHT

We ship same day order is received from our large stock of reliable manufacturers products.

Get your name on our mailing list.

**PHILADELPHIA SCHOOL OF WIRELESS TELEGRAPHY**  
 1002 Parkway Building, Broad and Cherry Streets, Philadelphia, Pa.

# Never in the History of Radio Were These Prices Approached

Improved Navy Type Receiving Transformer Again  
Reduced from \$27.50 to the startling price of **\$16.95**

Improved Arlington Receiving Transformer Again  
Reduced from \$15.00 to the startling price of **\$7.75**

## Mail 12 cents

in stamps or coin (not sent otherwise), which amount you are privileged to deduct on first dollar purchase. Revised price list to first edition of catalog, with prevailing prices, mailed on request.

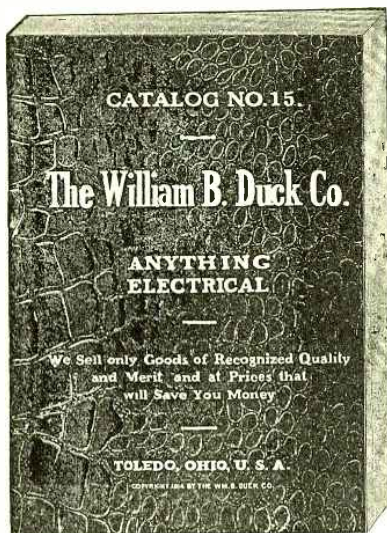

### Other Substantial Reductions On Items in Catalog No. 14

- No. R40 Rec. Set.....\$22.50
- No. R41 Rec. Set.....38.50
- No. R41a Rec. Set.....28.50
- THORDARSON TRANSFORMERS**
- 1 K.W. Type R.....40.00
- 3/4 K.W. Type R.....28.00
- 1/2 K.W. Type R.....22.00
- 1 K.W. Type RS.....30.00
- 1/2 K.W. Type RS.....20.00
- 3/4 K.W. Type RS.....15.00
- No. A1792 Thord. Con.....25.00
- Nos. 50, 51, 52
- Switch Contacts, each......03
- No. 1023 Mica Con......60
- No. B 670 Det.....2.75
- No. A862 Det.....2.75
- No. A1915 Det.....1.50
- No. A367 Murdock Cond.....4.50
- No. A1002 Rec. Set.....9.75
- No. A1916 Con.....1.65
- No. 61x08A Tuning Coil.....2.95
- No. 61x10 Tuning Coil.....4.95
- No. 14 Aluminum Wire, per lb......90
- All Binding Posts reduced 33 1/3%.

### Only a few of the Many New Radio Instruments in Catalog No. 15

- Type C-300 Audio Tron Bulb.....\$5.00
- Type C-301 Audio Tron Bulb.....6.50
- "UV" 200 Radiotron Bulb.....5.00
- "UV" 201 Radiotron Bulb.....6.50
- No. A200 Control Panel.....7.50
- A complete line of new detector regenerative and amplifying sets.
- Connecticut Variable Condenser.....6.50
- Turney Spider-Web Unit.....6.00
- No. 550 Murdock Socket.....1.00
- No. 3660 Murdock Condenser.....4.00
- No. 3661 Murdock Condenser.....4.25
- No. 3662 Murdock Condenser.....5.00
- No. 3680 Murdock Condenser.....3.25
- No. 3681 Murdock Condenser.....3.50
- No. 3682 Murdock Condenser.....4.25
- No. 3664 Murdock Dial Assembly.....1.25

A complete line of Acme C. W. Apparatus and Tuska C. W. Inductances.

Burgess "B" Batteries.

## Substantial Reductions

on many other radio instruments in our catalog No. 14. Circular with reduced prices and a large number of new instruments mailed on request.

**"The Greatest Radio Catalog In The World"**—  
*The Universal Verdict of Tens of Thousands of Radio Amateurs*

## DUCK'S No. 15 BIG 225 PAGE WIRELESS CATALOG. JUST OUT

A Veritable Treasure House of Everything Worth While and Dependable in Radio. The largest, most comprehensive, artistic and educational wireless catalog published. The Beacon Light to guide you right in the selection of your radio purchases, and at prices that will command your attention. Every instrument guaranteed with privilege of return if not satisfied.

The following prices shall prevail until further notice on the following items in our Catalog No. 14.

Concerning our improved type Navy and Arlington Receiving Transformers, our previous reductions were substantial. The prices below show are even lower than pre-war prices and when these instruments did not possess the existing marked and exclusive features.

These instruments can be bought nowhere else. These prices, seemingly unjustified, are subject to advance at any time. We are taking a chance at a reasonable profit on an enormous anticipated quantity production.

### Model 5BB Navy Type Receiving Transformer, Regular Price, \$27.50 Special Price only \$16.95

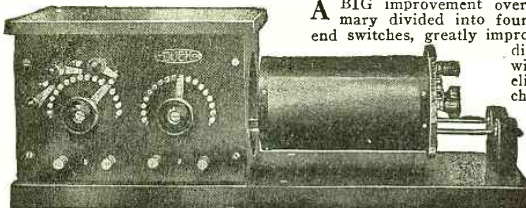

A BIG improvement over our former model. Primary divided into four sections, with three dead end switches, greatly improving selectivity. Secondary divided into three sections, with two dead end switches, eliminating harmonics. The change in the construction of the guide rod support makes it possible to obtain a looser coupling. It is a wonderful improvement over our old model, both in appearance and performance.

### Improved Arlington Receiving Transformer, Regular Price \$15.00 New Price, Only \$7.75

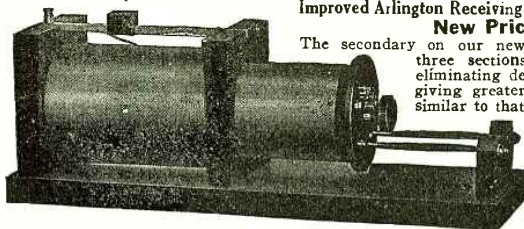

The secondary on our new type Arlington is divided into three sections, with two dead end switches, eliminating dead end effect and harmonics and giving greater selectivity. The end support is similar to that on our Navy, permitting a looser coupling. The base and primary end pieces have a spline to prevent warping or damage in transit. This feature is also on our Navy. It is a beautifully finished instrument.

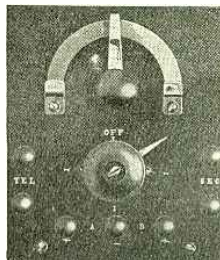

No. A200

An excellent Audion Control Panel for use with new four-prong bulbs. Grid leak and grid condenser are mounted on rear of panel. New type panel rheostat mounted on center of panel. The formica panel is attached to a wood base, upon which is mounted the tube receptacle.

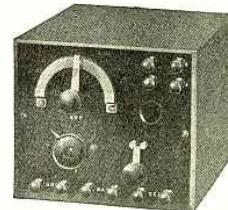

No. A201

No. A200 Panel Detector Sets, less batteries and bulb..\$7.50  
No. A201 Cabinet Detector Set, less batteries and bulb..15.00

Send 12 Cents for a copy of  
Our Big Catalog Today

**THE WILLIAM B. DUCK CO., 231-233 Superior St., Toledo, Ohio**

## DO IT THE EASIEST WAY!

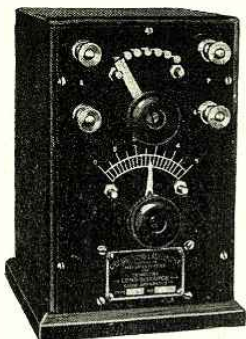

C. R. L. Regenerette

And not only that but combine ease and convenience with efficiency. With our C. R. L. Regenerette you can convert your loose coupler into a modern Regenerative Receiver with absolutely *no* changes in construction. Just modify your connections slightly and bring your set up to date. Full instructions supplied for connection and operation. The Price?

**Only \$15.00**

**CHICAGO RADIO LABORATORY**  
1316 CARMEN AVE., CHICAGO, ILL.

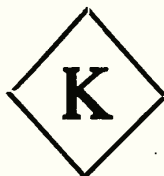

# =B=A=N=G=

## PRICES HIT BOTTOM

Reduced

	From	To
Arnold V.T. Control	\$21.00	\$19.50
Arnold Loose Coupler, (Navy Type)	25.00	20.00
Thordarson Transformers, 1/2 KW	27.00	22.00
“ “ 3/4 KW	33.00	28.00
“ “ 1 KW	45.00	40.00

Watch for announcement next month

**DAVID KILLOCK COMPANY**

57 MURRAY STREET

NEW YORK CITY

### VACUUM TUBE CONTROL UNIT

Type MW

Adaptable to any modern hook-up. Best appearing and highest type Vacuum Control Unit at the price in the market.

Grained formica panel, 5 1/2" x 6 3/4", lettered in white, graduated rheostat dial, variable plate control. Tube socket (standard 4 prong).

Grid condenser and leak mounted in back of panel and so wired that it can be adapted to any modern hook-up.

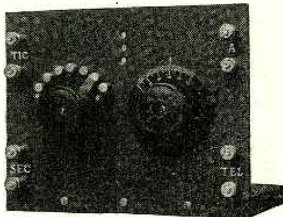

**Price \$10**

Parcel post prepaid in U. S. A. Immediate shipment.

**THE MIDWEST RADIO COMPANY, CINCINNATI, OHIO**  
DEPT. A 3423 DURY AVENUE

WHETHER YOU ARE IN THE MARKET TO BUY OR SELL, THE CLASSIFIED COLUMNS OF RADIO NEWS WILL GET RESULTS FOR YOU. TRY THEM.

of the battery. This scheme besides affording great flexibility has distinct advantages because a minimum number of "B" batteries are required for a maximum voltage supply to the total number of tubes in operation.

When it is desired to place an additional voltage, say 20 V., on the plate of the third stage amplifier tube only, a 20 V. battery is connected to the two terminals at the extreme left. If it is desired to raise the voltage on the two last stages instead of merely on the third stage, the 20 V. battery is applied to the next set of terminals, to the right. Likewise, the three amplifier stages will have their voltages loaded equally if the 20 V. battery be connected in series with the first amplifier battery. From this, it will be seen that any desired combination of plate voltages may be obtained.

Photographs and diagram courtesy A. H. Grebe & Co., Inc.

### A Complete Receiving Set for 25 cents

(Continued from page 705)

one for the aerial and one for the ground—complete the set.

As previously mentioned by the title, the cost of constructing this set need not exceed 25 cents for all needed parts.

This gap, as can be readily seen from the sketch, is made by a piece of heavy split brass tubing such as a bearing of an automobile engine or like part. Some amateurs will probably find this bearing already in two sections. These sections are mounted on a piece of hard rubber, and separated about a sixty-fourth of an inch. This is done by placing a very small strip of celluloid between the two halves. To the one on the right is fastened a length of No. 4 copper wire. The other one is fastened to the earth wire, which is made of a piece of No. 4 galvanized-iron wire, which in turn is joined to a 10 foot length of iron pipe driven into the ground. The wires are joined to the pieces of brass by means of fairly strong rivets. The whole is placed in a water-tight box, and the lead-in and earth passing out thru porcelain insulators. The copper wire, which by the way should be of the insulated kind, is held by two strong cleat insulators to the top of a pole about 7 ft. long, driven in the ground.

To avoid the possibility of water running down the aerial, and thence over to the box, thus causing leakage, I placed a ten cent funnel over the wire, point upwards, and filled in the top of the funnel with pitch. At the extreme top of the copper wire there is fastened a C.E. 3339 "Electro" connector, from which one wire goes up to the top of the house to the lightning switch and the other three to the aerial, which is 40 ft. above the ground.

### Construction of Transformers

(Continued from page 693)

of the secondary is slightly lower than the primary we divide the volts into the wattage of secondary, considering it the same, and get slightly less than 50 for the maximum amperage. Consulting the table we find that the smallest wire which will carry this amperage safely is No. 8 B. & S., cotton covered. By the above process one can readily find the dimensions of a transformer.

In building the transformer it is usually considered best to make the coils and "build" the core in them. The primary winding is divided into two equal sections and one section put on each "leg" of the transformer; the secondary is fixed the same way.

# RADIO APPARATUS

*Distributors of Reliable Radio Apparatus  
to Schools, Colleges and Experimenters  
All Over the World!*

**"PITTSO"**

The sign of service and prompt delivery.

Why not let us prove it!



**"SPECIAL"**

Our New Catalog No. 22 is just out.

Insist upon your copy!

**AMRAD APPARATUS**

Type A. VT detector in cabinet.....	\$15.00
" " One-step amplifier .....	21.00
" " VT detector and 1 step.....	34.50
" " VT two-step amplifier.....	39.50
No. G-1 1 K.W. quench gap.....	41.50
No. G-2 ½ K.W. quench gap.....	24.50
No. A-2 ½ K.W. quench gap resistance.....	5.95
No. G-3 ¼ K.W. quench gap.....	12.00
Type D Variometer in cabinet.....	14.50
" " Vario-coupler in cabinet.....	17.50
" " B Crystal receiving set.....	23.50
Amrad Lightning switches 100 Amp.....	9.85

F. D. Pitts Co., Boston, Mass.

**ACME APPARATUS**

No. P-1 ½ K.W. trans., bakelite panel type.....	30.00
No. M-2 Oil condenser .0035 M.F. Self-heating good value.....	29.00

F. D. Pitts Co., Boston, Mass.

**BUNNELL APPARATUS**

No. B-1 Three slide tuner, 2000 meters. A Dandy.....	4.95
No. 7751 Mascot spark gap, 1 K.W. size, heavy duty.....	2.95
No. 8854 Jore crystal detector.....	2.00

F. D. Pitts Co., Boston, Mass.

**CLAPP-EASTHAM APPARATUS**

No. 652 Large oscillation transformer, 1 K.W. size. Splendid value.....	17.50
No. ZRL 400 Watt power transformer, unmounted type.....	12.95
No. 651 Oscillation trans., suitable up to 1 K.W.....	14.95
No. F-656 Large plain spark gap, marble base, heavy points.....	3.75
No. Z-5002, 10 Step variable inductor.....	13.95
No. F-659 Type D variometer coupler, 1500 meters.....	12.95

F. D. Pitts Co., Boston, Mass.

**DE FOREST APPARATUS**

No. LL-200 Litz coils.....	1.96
No. LL-750 Litz coils.....	2.75
No. LL-1000 Litz coils.....	2.95

No. UCV-1500, .0015 M.F. variable condenser on unit panel.....	13.95
No. CV-1500, .0015 M.F. variable condenser, unmounted.....	13.90
No. CV-500A, .0005 M.F. variable condenser, without knob and pointer.....	3.95
No. CS-1502, .0015 M.F. bridging condenser, in cabinet.....	5.95
No. CS-3002, .003 M.F. bridging condenser, in cabinet.....	5.95
No. US-400 2-point Audion, Ultra Audion switch on unit panel.....	1.95
No. 1 Small variometer tube.....	.25

F. D. Pitts Co., Boston, Mass.

**GREBE APPARATUS**

No. PDA, 4" 0-100 bakelite dials.....	3.00
No. PDE, 4" 0-50 bakelite dials.....	2.75
No. PDC, 3" 0-100 bakelite dials.....	2.50
No. PDD, 3" 0-50 bakelite dials.....	2.25
No. PSA Switch arm.....	.95
No. RORA VT control cabinet.....	12.50
No. RORZ 4 tube mount, ideal for radiophones.....	11.95

F. D. Pitts Co., Boston, Mass.

**KILBOURNE AND CLARK APPARATUS**

No. K-1 ½ K.W. power trans., mounted.....	9.95
No. K-2 ½ K.W. power trans., unmounted.....	7.95
No. K-3 Change-over switch, bakelite base, very rugged.....	4.95
No. K-4 Hand key. A beauty.....	3.95

F. D. Pitts Co., Boston, Mass.

**INTERNATIONAL RADIO APPARATUS**

No. RTD-102A VT control panel.....	13.95
No. RTA-104A 1 step amplifier.....	23.95
No. TXL-100A Oscillation transformer up to 1 K.W.....	14.95

F. D. Pitts Co., Boston, Mass.

**FIRTH APPARATUS**

Type C Baldwin telephones.....	16.50
Type E Baldwin telephones.....	20.00
Type F Baldwin telephones.....	21.00
Baldwin head band only.....	1.75

F. D. Pitts Co., Boston, Mass.

**THORDARSON APPARATUS**

No. T-1 Type R ¼ K.W. power transformer.....	14.95
No. T-2 Type R ½ K.W. power transformer.....	22.00
No. T-8 8-point rotor.....	5.00
No. T-16 16-point rotor.....	5.00

F. D. Pitts Co., Boston, Mass.

**MISCELLANEOUS APPARATUS**

HOYT jeweled bearing 0-3 amps., flush mounting D. C. ammeters, 3" dia. A splendid value.....	6.95
--	------

TUSKA ticklers, in cabinet, will make any circuit regenerate..... 6.95

WIRELESS SPECIALTY, eaton oscillators, in beautiful oak cabinet..... 13.95

RADIO APPARATUS, 3500 meter couplers mahogany thruout. Gets NAA fine..... 24.95

STERLING voltmeters, 3" diameter, 0-50 N.P. front of board mounting. Just the thing for "B" batteries..... 2.95

CENTURY induction motors 1/10 H.P., R.P.M., 1750, runs on 110 or 220, just the thing for Benwood or Bell gap..... 29.95

COUCH Yankee well phones, ideal between house and radio shack, per pair..... 11.95

PITTSO heavy 3 ft. double telephone cords, ideal connectors. While they last..... .19

TECO Honey-comb coil stands, mounts two Murdoch var. condensers, using Honey-comb coil adapters, one of which is movable for coupling, stands only (makes splendid coupler)..... 1.95

WAYNE 50 watt, bell ringing transformers. 20 voltage variations, 4 to 30 volts..... 4.95

HAYWARD rotary spark gap, operates on 6 volt battery, or on 110 volt thru step down trans. Can be used up to ½ K.W..... 9.95

SLEEPERS Radio Experimenters' Handbook. All the new apparatus illustrated and described..... .95

DE FOREST Amateur's Handbook. "How to Set Up a Wireless Station"..... .10

PITTSO No. 22 and 24 specially insulated magnet wire, great for variometers, etc. While it lasts, per lb..... 1.19

F. D. Pitts Co., Boston, Mass.

**Important!** Our new catalogue No. 22 illustrating, describing and pricing our immense stock of radio apparatus sent upon receipt of 10 cents. Insist upon receiving your copy! "Over 100 Pages, Over 150 Illustrations, Over 600 Items."

Pittsco service reaches all over the world! Why not let it reach you!

**F. D. PITTS CO., Inc.**

12 Park Square

Dept. C

Boston, Mass., U. S. A.

Cable address "PITTSO" Boston

R  
KLAUS  
D  
I  
O

# "B" BATTERIES

R  
KLAUS  
D  
I  
O

## One More KLAUS Specialty

Consider these facts before buying your "B" Batteries

Klaus No. 5763 Radio Battery—size 2½ x 3¾ x 2 inches. Initial voltage 22½. In actual tests, when operating thru resistance equal to amateur vacuum tubes, this battery gave 450 hours' continuous service before reaching its cut-off point of 17 volts.

Price \$2.25

Klaus No. 5766 Radio Battery—3 x 6¾ x 4 inches. Initial voltage 22½. Operating under the same conditions as above this battery delivered upwards of 2400 hours' continuous service. After reaching 17 volts it can be connected in series with another battery and used until run down to 12 volts.

Price \$3.50

WATCH THIS SPACE FOR OTHER ANNOUNCEMENTS

Order direct or thru your dealer

# KLAUS RADIO COMPANY

EUREKA, ILLINOIS

## The *MAGECO* Back Mounted Rheostat

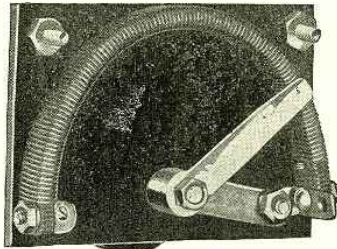
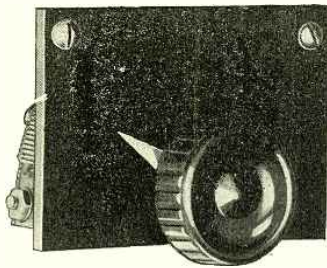

Type R. G. I.

already on a Bakelite panel—can be mounted upon any panel in a very short time and without adjustments. Complete with large knob, shaft, pointer, brass bushing and nickel plated screws for supporting it to the panel.

Price \$1.25  
weight 6 oz.

Our new Loose-leaf catalog for 10c

The Marshall - Gerken Co.  
24 Radio Bldg. Toledo, Ohio

# YOUR CHANCE

SPECIAL

We have just received a large shipment of No. 14 pure solid copper aerial wire. We are offering this wire for a limited time only at this price.

Remember—this is real solid copper wire, guaranteed.

Per 100 Ft. . . . . 58c  
Per 1000 Ft. . . . . \$5.50

Wire Shipped by Express.

DON'T FAIL

To get our new catalogue. Sent on receipt of 10c. This amount deducted from your first order.

"We will surprise you."

**RTS**  
Tested Galena, packed in sealed container, per box 25c.  
Tested Silicon, per box 25c

DEALERS

Write for our Tested Mineral Proposition.

ORDER YOUR AERIAL WIRE AT ONCE

Radio Testing Station, Binghamton, N. Y.

Insure your copy reaching you each month. Subscribe to Radio News—\$2.00 a year. Experimenter Pub. Co., 236-A Fulton St., N. Y. C.

In winding the coils it is best to wind them on a form similar to the one shown in Fig. 1, first winding one turn of "empire cloth" or some other insulation on it and putting a little shellac on the next turn so it will not unroll when the form is removed. Now wind the primary on and shellac it. After this wind on a few turns of empire cloth and then wind on the secondary. Shellac this well and tape the whole thing. It should be baked after this if possible.

When both coils are complete lay them on the bench and assemble the core in them, putting three laminations first one way and then the other, as can be seen in Fig. 2.

After the transformer is completed it should be supported by four wooden blocks placed under the corners and secured to a board. The blocks should be high enough to prevent the coils from coming in contact with the board, or sides of a box, should it be mounted in one.

If a transformer is constructed for the purpose of charging storage batteries using a Tungar, it will be necessary to figure out the voltage the bulb requires and take a tap off at that point in the winding. Then wind the required number of turns to give the required voltage. The tap on the Tungar forms the other terminal.

Size of wire, B. & S.	With rubber, insulations.	Other insulations.	Maximum number of amperes a wire will carry. Approved by underwriters.
18	3	5	
16	6	10	
14	15	20	
12	20	25	
10	25	30	
8	35	50	
6	50	70	
5	55	80	
4	70	90	
3	80	100	
2	90	125	
1	100	150	
0	125	200	
00	150	225	
000	175	275	

## An Ideal Receiving Set for Short and Long Wave-Lengths

(Continued from page 692)

frequency coupling exclusively or both in combination to obtain certain desired results. At any rate, no amateur after having once used this form of selective amplification would want to do without it. A certain amount of leeway is also given with this arrangement and the "experimental bug" gratified. Nobody seems to be altogether without this contagious bug anyway.

The other apparatus used in connection with the receiving set, condensers and variometers, are all of the standard type and design and no detailed description need be given here. Every radio enthusiast will follow his own type of construction.

A short description should be given of the primary and secondary coil design. The primary coil P and PL, Plate 2, is wound on a cardboard tube 4" by 9" outside dimension. For two inches on the left end (see Plate 3 dotted outline). One layer of No. 24 S. C. C. wire is wound up to within ½" from the end. This forms the short wave coil P. Switch contacts X divide this coil into equal number of turns. The right end of the cardboard tube is wound with 2 layers of No. 24 S. C. C. wire using the well-known bank method of winding. The wire should cover 5½" of the tube and is also wound to within ½" from the end.

thus leaving a clearance of 1/2" between coil windings. The latter coil is the long wave or loading coil PL. Both coils should be wound in the same direction around the tube. Five taps are taken off each layer of the PL coil, one at the ends and 3 at equal intervals within the winding and brot out to switch Y. The secondary coils S and SL are of the ball variometer type. The dials on Plate 3 are shown mark "sec sh" and "sec L" for short and long wave-lengths respectively. The coil for short wave-lengths S is wound with No. 26 S. C. C. wire and the one for long wave-lengths SL with two layers of No. 28 S. C. C. wire. Both coils are of the same size and general overall dimension. They are 3 1/2" in diameter so as to permit free rotary movement within the cardboard tube of the primary coils. The connections to be made to the various contacts points are clearly shown on Plate 2.

## PROUDFOOT SPECIALS

Vacuum Detector Cabinet, 7 1/4"x5 1/4".....	\$12.50
Amplifier Cabinet, 7 1/4"x5 1/4".....	18.00
Detector and One-Stage Amplifier, 7 1/4"x6 1/2".....	25.00
Detector and Two-Stage Amplifier, 7 1/4"x9".....	35.00
Regenerative Set, 7 1/4"x14".....	35.00
Regenerative Set with Detector and One-Stage Amplifier, 7 1/4"x18".....	45.00

THESE INSTRUMENTS HAVE:—Panels of 3/16" bakelite; boxes with waxed oak finish, hinged covers, no ugly hooks, special spring ball clasp; black oxidized binding posts; special design transformer; 3-stages of amplification, no howling; fixed condenser in grid circuit; VT sockets highly polished lacquered brass, parts all machined.

ALL instruments 5 inches in depth and wired so that as many stages of amplification can be added as desired.

Wiring of regenerative set such that detector and amplifiers can be added by connecting binding posts directly opposite. NO LOOSE CONNECTION ENDS. Detectors and amplifiers all have standard nickel jacks. ONE PLUG IS SUPPLIED WITH EACH INSTRUMENT ORDERED.

ALL INSTRUMENTS ABSOLUTELY GUARANTEED.

G. M. PROUDFOOT, 361 E. Ohio St., Chicago, Ill.

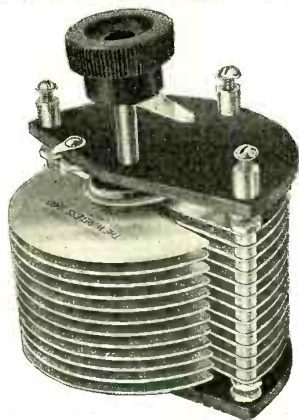

# HERE IT IS— THAT NEW "CW" VARIABLE

## NOW YOU CAN SHOVE UP YOUR PLATE VOLTAGE

### A "WIRELESS SHOP" PRODUCT—"NUF SED" THAT MEANS QUALITY

There has been a growing demand for a Variable Condenser which could be used on CW sets without breaking down when you shove up the plate voltage. Receiving condensers are entirely unsatisfactory for this work, and we have now developed a "NEW CW VARIABLE CONDENSER," designed for just this work.

The plates are widely spaced, and the construction is heavy. Only the best of materials and workmanship are put into these instruments, and you can't go wrong in using "WIRELESS SHOP" condensers exclusively, as they are fully guaranteed to give entire satisfaction, or we will cheerfully refund your money. What more could you ask?

#### PRICES

No. 1500	15 plate, approximately .0004 m.f. max. capacity .....	\$6.00
No. 2500	25 plate, approximately .0006 m.f. max. capacity .....	7.50
No. 3500	35 plate, approximately .0008 m.f. max. capacity .....	9.00

Prices include knob and pointer and mounting screws. A metal dial will be furnished instead of the pointer at 75c extra, or a high grade moulded Bakelite knob and dial, with graduations finely engraved and filled in with white at \$1.00 extra.

Postal charges and insurance must be included in remittance. Insurance charges on any of the CW condensers is only 5c.

*Our new bulletin on all "WIRELESS SHOP" variable condensers is just off the press, and is yours for the asking.*



511 WEST WASHINGTON STREET

LOS ANGELES, CAL.

# BURGESS "B" BATTERIES

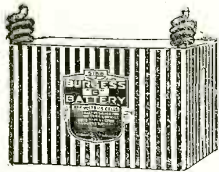

ARE THE NOISELESS KIND—  
made with and without taps

Send for catalogue giving sizes and prices

**BURGESS BATTERY COMPANY**

Harris Trust Building

CHICAGO

## A RAY-DI-CO "QUALITY" SYNCHRONOUS GAP WILL PUT YOU IN THE DX CLASS

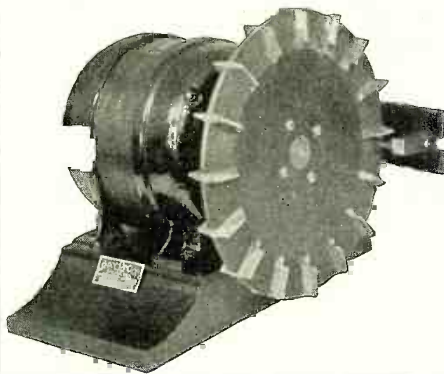

Clear steady signals. Clean cut tone. Constant time intervals between discharges of equal amplitude. Puts the current where it belongs in the antenna. Extra large sparking surfaces  $\frac{1}{8}$ " by 1" accurately spaced upon a 9" Grade XX Bakelite Rotor. Design of revolving electrodes provides a decided air blast giving a quenching effect. Extreme shortness of conductors in rotor allows use of larger condensers. 480 discharges per second. Permits extremely low decrement. Motor single phase, Synchronous type, speed of 1800 R.P.M., 1/6 H.P., 110 volts, 60 cycle, net weight 35 lb F.O.B. Chicago, \$85.00. Rotors built to order.

**RAY-DI-CO**

(Ray-Dee-Ko)

2653A N. Clark St. CHICAGO, ILL.

RADIO 9AG

No dimensions have been given for outside dials shown in front of panel, Plate 3. The drawing, as made to scale, has dials of approximately 3" in diameter and these seem to be of the desirable size. Uniformity and good appearance will be the governing points.

### BAD TEMPER!

First Rectifier:—"I can't seem to satisfy my friends, the transformer and the reactance."

Second Rectifier:—"How so?"

First Rectifier:—"Why, the reactance says he can't take alternating currents without choking, and the transformer can't stand currents direct, so no matter what I do one or the other is always down on me."

By C. W. HALLIGAN.

## Canadian Radio Experimenters

### Lateral Wound Coils.

Turns	App. Wave-Length	Price
25	130—375	\$0.55
40	225—575	.60
75	240—740	.70
100	460—1480	.80
175	750—2400	1.00
325	1375—4500	1.25
550	2250—7700	1.50
750	3000—11200	1.75
1200	6000—20000	2.50

### Special Sizes to order

Special discount to dealers

Plugs and Bands with screws for coils	.....	.75
C.W. Inductances	.....	2.00
C.W. Inductances	.....	7.50
Transmitters for radio purposes	.....	3.50
Vario-Couplers and Variometers	.....	4.25

Send 5c for 20 page catalogue

**J. M. PAQUIN**

The Electrical Shop

787 Queen St. West,

Toronto, Ont.

# PARAGON

MEANS

"A PERFECT MODEL OF EXCELLENCE"

AND IT IS FOUND ONLY ON

RHEOSTATS  
RECEIVERS  
V. T. CONTROLS

CONDENSERS  
VARIOMETERS  
DIALS

DETECTORS  
KNOBS  
SOCKETS

SWITCHES  
AND OTHER  
SPECIALTIES

Manufactured by

**ADAMS-MORGAN CO.**

## No. 70 Paragon V. T. Control

A compact control panel consisting of a standard socket, rheostat, grid condenser, grid leak and nine binding posts mounted on a moulded condensite panel. Polished nickel metal parts. A high-grade inexpensive instrument that will do as good work as the highest priced cabinet.

Price - - - \$6.00

## No. 25 Paragon Rheostat

For either panel or table mounting. Moulded condensite base. Resistance six ohms. Smooth operation. Capacity  $1\frac{1}{2}$  amperes. The highest grade rheostat on the market.

Price - - - \$1.75

MOST ENTERPRISING DEALERS CARRY PARAGON PRODUCTS AS REGULAR STOCK.

Illustrated Bulletins will be mailed upon receipt of a two cent stamp. Send us your dealers name.

**ADAMS-MORGAN CO.**

UPPER MONTCLAIR

NEW JERSEY

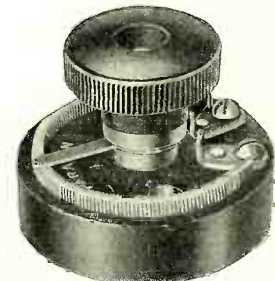
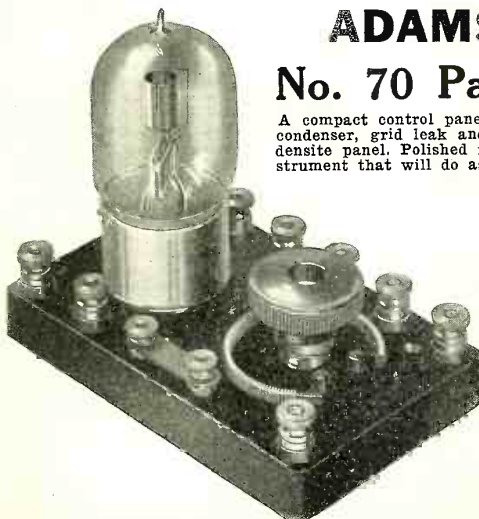



## Radio Communication

(Continued from page 710)

same way the electrical arrangements in the receiving circuit which are used to receive radio waves must be such that that receiving circuit is electrically in tune with the radio wave. By this means the radio receiving circuit can pick out the particular wave which it is desired to receive and not be affected by other waves. This is fortunate because otherwise the interference between different radio messages would be hopeless. It would be just as tho every sound wave which passed thru the air set absolutely everything which it touched into vibration.

As has been mentioned the frequency of alternation of radio waves is very high, so high, in fact, that a sound wave of such frequencies could not be heard. Suppose for instance, that an ordinary telephone receiver was placed in the circuit which is receiving a radio wave. The electric currents of the same frequency as the wave frequency tend to cause motions of the telephone receiver diafram. These motions are, however, of such great frequency that no audible sound is produced. In order to permit the radio wave to be received and transformed into a sound it is therefore necessary to break up the radio wave in some manner. This is done in radio telegraphy by interrupting the wave completely so that it consists not of a single regular series of alternations but of a succession of groups of such alternations, that is, instead of the continuous wave shown in

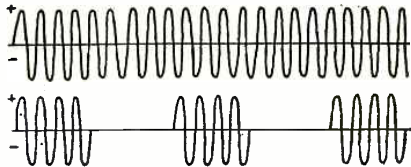

This Diagram Shows a Continuous Wave and the Same Interrupted so as to Form "Trains."

Fig. 3 we use the interrupted wave or group of waves illustrated in Fig. 4. The frequency of the interruptions or of the groups of waves is the frequency which can be heard.

There is another thing that is to be taken into account before it becomes possible to translate the received radio current into a sound that can be heard. When one of the groups of alternations acts on the telephone receiver it causes no motion of the diafram because each variation of the current in one direction is immediately followed by the current in the opposite direction so that the resulting effect of the group of waves upon the telephone receiver diafram is no motion at all. It is therefore necessary, in order to convert the current into a sound, to use something else with the telephone receiver. This something else must be such as to make the current flow thru the telephone receiver in only one direction. It must allow the electric current to flow thru it in one direction and stop current which tries to flow thru it in the opposite direction; that is, it must be some sort of electric valve. The effect of such an electric valve may perhaps be understood more clearly by taking a sheet of paper and placing it upon Fig. 4 so as to block out the lower half of the waves shown. This leaves only the upper halves of the little groups of waves and this is exactly what the electric valve does. It results that successive impulses of current flow thru the telephone receiver and all

# Standardized Radio UNIT Cabinets

Each ABC Unit is complete in itself for its particular purpose. Yet the series is so designed that any combination of units works as if it were a single set. The photograph below shows three of the units—the Receiving set, the VT Detector, and the Two-step Amplifier—hooked up together into an efficient, smooth-working combination.

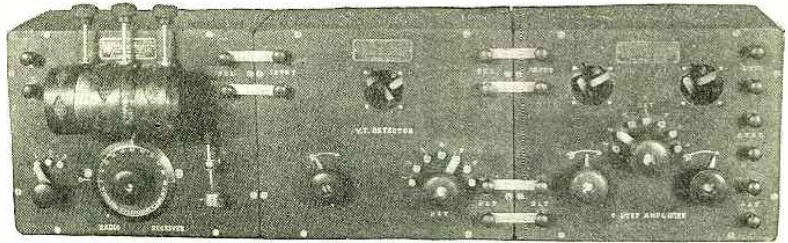

Receiving Set or Radio Receiver. Complete in itself. Equipped with selected galena crystal detector, and three Bi-Lateral Coils. Price, \$24.50.

VT Detector. Simply hook up this detector to your ABC receiving unit, disconnect the crystal detector, and the set is ready for operation. Price (less tube), \$16.50.

Two-Step Amplifier. Adds two stages of radio amplification to any previous combination of units, making a smooth-working, long range set. Price (less tubes), \$45.

## NOW—add to your range gradually—discard nothing!

ABC Units solve the problem of starting off with a small investment, and gradually increasing your range without discarding a nickel's worth of apparatus as you go along.

Start with the receiving unit (complete in itself). Then you can gradually build up your station to include a VT Detector and three stages of radio amplification. Yet, every new combination of units, as you go along is guaranteed to give satisfactory, dependable performance.

Finally, when you have secured the complete system, you have a commercial-grade station—equipped to receive all classes of signals; damped or undamped, code or radio phone, on all known wave-lengths.

The combination shown here is the receiving unit (described above), and the combined VT Detector and one-step amplifier. Further amplification can be secured by adding a one or two-step amplifier at any time. Price of the combined Detector and one-step (less tubes), \$37.50.

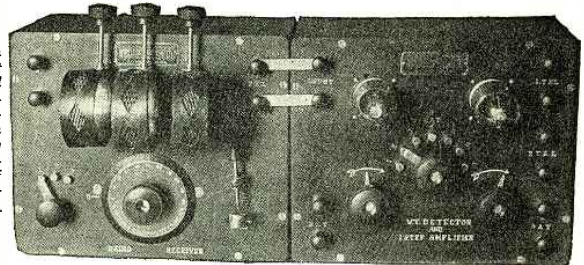

ABC Units are standardized in design, and produced by automatic, machine methods, down to the smallest switch point.

In addition to the progressive, "building up" feature, this standardization offers three distinct advantages:

1st. You can invest in a receiving unit, with perfect confidence that the other units, in the same standard design, ready to hook on, will be ready for you whenever you want them. We took three years of research to make ABC Units right, and the design will remain unchanged in all essentials.

2nd. Every part, even the least important binding post is standardized, and made by unvarying, automatic machines. You can always buy replacement parts that are identical with the original.

3rd. Standardized quantity production in the ABC factory, (the only one of its kind in the world), has brought about economies previously impossible in radio apparatus. That's why we can sell "Professional Radio Equipment at Amateur Prices", and at the same time back up every ABC instrument with our unequalled guarantee, "Your Money's Worth or Your Money Back!"

### Professional Radio Equipment at Amateur Prices

**Standardized Radio WIRELESS EQUIPMENT CO. INC. Pres. Standardized Radio**  
188 GREENWICH ST. NEW YORK CITY

#### Dealers— Amateurs—

The ABC line includes a complete assortment of radio apparatus, both assembled and unassembled. It is a fast selling, profitable line, that makes good. Write for discounts.

The ABC new folder, describes, in detail, the five ABC unit cabinets, the ABC variable condensers, the ABC small parts, Bi-Lateral Coils, the Vibratone, Jr. Transmitter, etc., etc. Slip this coupon and a nickel into an envelope NOW! and your copy will come by return mail.

Wireless Equipment Co., Inc.,  
188 Greenwich St., New York.

I enclose one nickel, Send me by return mail your new ABC folder.

Name .....  
Address .....  
City ..... State .....

# Let's Go!

—the chief battle slogan of the American Army in the World War. The slogan that typified the American fighting spirit—that gave enthusiasm at the right moment.

**Let's go!**—the same spirit permeates American business to-day.

**Let's go!**—in the FADA shop means the extension of my personal service to every radio amateur. It means that if you want the very best in completed instruments or only a piece of bakelite cut to your special size that you will be served courteously, economically and promptly. Panel engraving is a particular feature. Estimates will be cheerfully given on any experimental or machine work.

Send me your order for any parts listed below or for any piece of apparatus made, and know at first hand what my "Let's go" means to you.

Engraving, per letter.....	\$ .09	FADA Mica Condensers made of Bakelite XX and copper foil carefully tested, capacities 0.00025, 0.0005 and 0.001 mfd. 85c
Mounted Galena Crystals.....	.50	Genuine Grade XX Bakelite cut with square edges to your size per square inch, 1/4 in. thick 2c; 3/16 in. thick 3c.; 1/4 in. thick 4c.
FADA Binding Post.....	.16	Federal Automatic Phone Jacks light your filaments with the insertion of phone plug. The most modern instruments use them.
FADA Crystal Detector.....	3.00	Set of 2 for Detector and 1-stage Amplifier.....
Radiotron UV-200 Tubes.....	5.00	Set of 3 for 2-stage Amplifier.....
Radiotron UV.201 Tubes.....	6.50	Set of 3 for Detector and 2-stage Amplifier.....
General Radio Socket.....	1.75	4.20
Four FADA instruments with automatic filament control that have not been equaled by any comparison.		
Audion Control Panel.....	\$17.50	
Detector and 1 Amplifier.....	45.00	
Detector and 2 Amplifiers.....	65.00	
Two Stage Amplifier.....	50.00	

Progressive dealers stock FADA apparatus

**Frank A. D. Andrea,** 1882-A Jerome Avenue, New York City

## ACE Save Time and Money ACE

By Forwarding Your Mail Orders to Us

Our Central Location Makes It Possible for You to Do So

<b>ANTENNA MATERIAL</b>		<b>CRYSTAL RECEIVER</b> .....	\$25.50
Bamboo Spreaders.....		<b>CRYSTAL DETECTOR</b> .....	2.80
8 ft. lengths.....	\$1.00	<b>RECEIVERS</b>	
12 ft. lengths.....	2.25	Baldwin Navy.....	16.50
16 ft. lengths.....	3.00	Brandee Superior.....	8.00
7-22 Std. Wire, per ft.....	.01 1/2	Murdock 55-3000.....	5.50
10" Electrode.....	.75	Murdock 55-2000.....	4.50
Ball type Electrode.....	.35	<b>STORAGE BATTERY</b>	
<b>AMPLIFYING TRANSFORMER</b>		Marko 6V 40A. CAP.....	16.25
Ace Semi-mounted.....	5.00	Marko 4V 40A. CAP.....	10.75
<b>ANTI-CAPACITY SWITCH</b> .....	2.80	<b>VACUUM TUBES</b>	
<b>ANTENNA SWITCH</b> .....	4.50	E. R. Detector.....	6.00
<b>LIGHTNING SWITCH</b> .....	4.50	Amplifier.....	7.00
<b>BURGESS B. BATTERIES</b>		Ex. Hard Transmitter.....	7.50
22 1/2 V-1200 hrs.....	3.50	Radiotron Detector.....	5.00
4 1/2 V-200 hrs.....	.40	ACE VT SOCKET.....	1.50
<b>CONDENSERS—VARIABLE</b>		<b>WIXICO MOUNTING</b>	
Connecticut .001.....	6.50	For D-L or H-C Coils	
C-E Bal. with dial.....	9.50	Table Type.....	8.00
C-E .0006 with dial.....	7.50	Panel Type.....	6.00
Murdock mtd. .001.....	4.75	<b>VARIOMETERS</b>	
Murdock Interior .001.....	4.25	Amrad Mounted.....	14.50
Murdock .0005 mtd.....	4.00	C-E with dial.....	6.50
<b>INSTRUCTION BOOKS</b>		Radeco with dial.....	8.50
Experimenter's Manual.....	2.25	Klithen mtd. in cab.....	9.00
Practical Radio Tel.....	2.25	<b>WAVEMETER</b>	
Audel's Easy Lessons.....	.50	Amrad.....	8.50

MAIL ORDERS RECEIVE PROMPT ATTENTION. SEND IN 3c STAMPS FOR CATALOG

## THE PRECISION EQUIPMENT CO.

2437-2439 Gilbert Avenue Dept. A Cincinnati, Ohio

"You May Pay More But You Can't Buy Better."

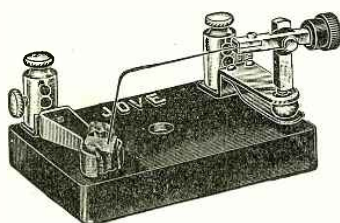

(GHEGAN PATENT)

## Bunnell INSTRUMENTS Always Reliable

### JOVE DETECTOR

Handiest, Handsomest, Best  
Sample by Mail, \$2.00  
Tested Galena Crystal, 25c

We are distributors of the Standard Electric Novelty Co.'s Type B "Cyclone" Audion Batteries. Also of De Forest and all the leading manufacturers of High Class Wireless Apparatus. Send stamp for new edition 42RN Catalog.

**J. H. BUNNELL & CO., 32 Park Place, New York**

Insure your copy reaching you each month. Subscribe to Radio News—\$2.00 a year. Experimenter Pub. Co., 236-A Fulton St., N. Y. C.

of these tiny impulses in any one group add their effects together and produce a motion out of the telephone diaphragm. The interval between one group and the next permits the motion of the telephone diaphragm to subside and this intermittent motion causes what is heard as a note in the receiver.

A number of devices are used to perform the electric valve action which has been mentioned. The most interesting and most effective device of this kind is the electron tube. The electron tube is a very simple device which looks more like an ordinary incandescent lamp bulb than anything else. Your attention is particularly invited to the principles upon which it operates since this is the most important of the apparatus used in radio. While experimenting in the development of the incandescent lamp Edison made the discovery that an electric current could be made to flow in the empty space inside the bulb near the hot filament. If a middle plate is placed inside an incandescent lamp bulb near the filament and if by means of a wire thru the glass this middle plate is connected by wire thru a battery and an indicating instrument to the filament, a current will flow as indicated by the instrument. A current is flowing in the wire and also flowing across the empty space between the filament and the plate. By much patient scientific research, scientists have found out that this current taking place in the lamp consists of the flow of a stream of very small electric particles called electrons. These electrons are shot out into

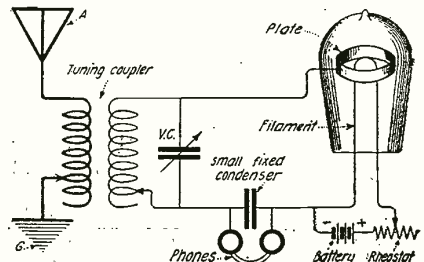

Fig. 7. This Diagram Shows How a Vacuum Tube is Used in a Receiving Circuit to Rectify Wave Trains and Transform Them Into Audible Sounds.

the surrounding space in all directions by the hot filament. The electrons may be said to fill the bulb like a vapor. They move at random in all directions unless there is an electric force to make them move in some particular direction. The battery connected in the circuit outside the bulb supplies an electric force which acts between the filament and plate and makes the electrons move from the filament to the plate. If the battery is disconnected, there is no current, and as many electrons as strike the plate fall off again into the bulb. The current depends on the number and speed of the electrons. The battery is what gives them their speed in the direction filament to plate. The battery performs much the same action as a steam pump would if the bulb were a room into and out of which steam pipes were connected. If the pump were disconnected, there would be no flow of steam and when the pump is connected, steam is made to flow into and out of the room and thru the pipe.

The point of all this is that the electron flow in the bulb has a valve action. The electrons are emitted by the very hot filament and can be made to flow toward the plate by connecting a battery in the proper direction. If the connections of the battery are reversed however, no current will flow because there is no such emission of electrons from the plate which is cold. The electric force produced by the battery in this case has nothing to work on and can

do nothing except prevent the flow of electrons out of the filament to the plate. It should be clearly understood before going further that the action of the electron tube thus depends upon the fact that an electric force can be applied in one direction which causes an electric current from the filament to the plate, but that if this electric force is reversed no current flows. The device gives exactly the electric valve action needed in order to make the incoming radio signals produce sound in a telephone receiver. Suppose that the bulb is connected up to a radio receiving circuit in place of the battery. Suppose also that the indicating instrument is replaced by a telephone receiver. This is shown in Fig. 7. The pulses of current in the radio receiving circuit similar to those of Fig. 4 produce electric force inside the bulb between the filament and the plate which alternates in direction just as the pulses of current do. On account of the valve action, current can flow thru the bulb only in one direction and consequently the pulses of electric force in one direction only are effective. As a result, pulses of current flow thru the telephone receiver in groups, the pulses being all in one direction. This causes a note in the telephone receiver, as already explained.

It might seem that these small electric particles, called electrons, are very remote from any practical use. The study of electrons has in fact been advanced by purely

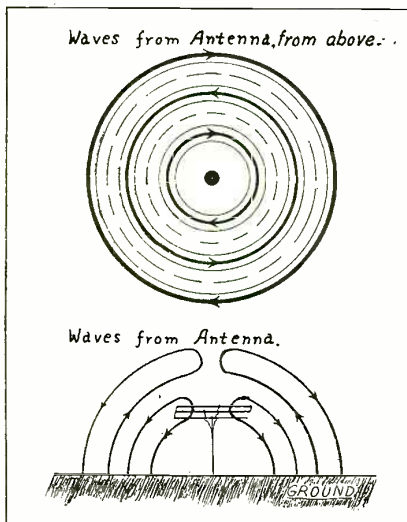

Fig. 5. This Diagram Shows How the Electric Waves Are Radiated From an Aerial into Space.

scientific research not at all connected with any applications. By means of the electron tube, however, very practicable use indeed is made of electrons and their importance is recognized commercially. Scientific research work which has been done in this connection has revolutionized radio and provided a means for great improvements in ordinary wire telephony and also in other uses of electricity.

An improvement in this electron device can be made which very greatly extends its power and usefulness. As shown in Fig. 8 a grid of very fine wire can be placed in the tube between the filament and the plate. The grid is placed closer to the filament than to the plate. The electrons which are emitted by the filament can move freely between the grid wires. If by means of a battery or something else an electric force is established between the filament and the grid, this electric force causes electrons to move away from the filament toward the plate and since the grid is placed much closer to the filament the electric force makes the electrons move much faster than the same electric force between the filament

# THE WORLD'S TUNER MARKET

Y N — France — P O Z — Germany — I D O — Italy. Read in the U. S. with one bulb and single wire aerial 25 ft. high by 40 ft. long. Read unsolicited testimonials and note we always give names. Verify these—we will accept your decision then.

TRESCO TUNERS wound with involute coils have lived to see all others funny wound coils die a natural death.



COMPLETE—NO LOADING COILS NEEDED

- 5000 to 20000 M.....\$10.00 add P. P. Type B.S.
- 700 to 5000 M..... 10.00 add P. P. Type A.S.
- 200 to 700 M..... 10.00 add P. P. Type C.S.

Coils of either for panels \$6.00 plus P. P.

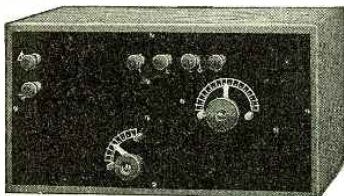

## Hook 'Er To Yer Bulb 200M-P. R. L TUNER

Something new, using a vario-coupler wound with 3/4" copper strip. Very efficient and selective, also including our special variometer. Just as efficient as any Paragon. Weight 5 lbs. Price, \$25.00—add P.P.

### KNOCKED DOWN PANEL

Set it up, save money. Consists of Formica Panel—drilled ready for parts, 1 Rheostat—one 11 Plate condenser, H.V. switches, points, base and necessary binding Posts. V.T. socket \$1.00 extra. Shipping weight, 4 lbs. Price, \$8.00. Add Parcel Post.

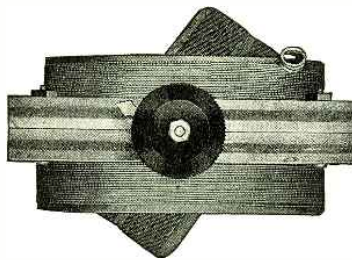
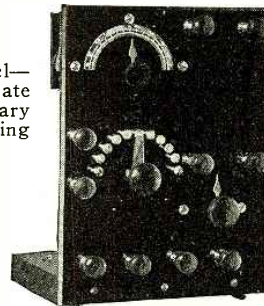

### ELLIPTIC VARIOMETER

Embodying a new principle. Most efficient made. Same as used by us in our P.R.L. Tuners. Shipping weight 3 lbs. Price, \$5.00. Mounted in hard wood finished case, formica top, binding posts, scale. Complete, \$7.50. Add Parcel post.

### RHEOSTAT

Smoothest running that's made for panels. Auto stop that prevents burning out filament. Weight 1 lb. Price, \$1.75. Add parcel post.



### KNOCKED DOWN CONDENSERS

Assemble and save money.

- 11 Plate .....\$1.80
- 21 Plate ..... 2.25
- 41 Plate ..... 3.20

Add P. P.

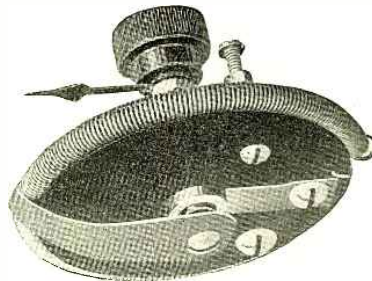

10 cents brings complete catalog full of dope.

# TRESCO, Davenport, Iowa

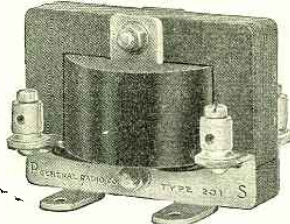

## Keeping Pace with New Tube Developments

The new amplifying tubes are out and they are fine. But are you getting the most out of your tube? A complete amplifier is more than a mere assembly of parts. It consists first of the selection of units of correct electrical characteristics. An amplifying transformer must be more than a coil of wire and a core. It must have incorporated in it the results of engineering skill. In our Type 231A amplifying transformer we have produced an in-

stance is right and the price is right. Send for free Bulletin 907N on the operation of amplifying transformers and completely describing this instrument.

**PRICE COMPLETELY MOUNTED \$5.00**  
**TRANSMITTING TUBE RHEOSTAT**

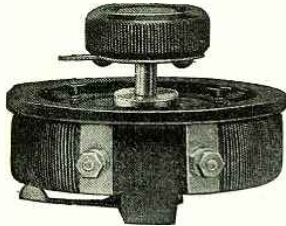

The new five watt Radiotron tubes require a filament current of 2.35 amperes. We have added to our already complete line of Type 214 receiving tube rheostats a 2-ohm transmitting tube rheostat which will carry 2.5 amperes. This resistance is sufficient to regulate the new tubes on as high as a 12 volt supply source. This rheostat does not run hot and may accordingly be mounted inside of enclosed transmitting cabinets where space is often very limited. Like our receiving tube rheostats and grid biasing potentiometers, it is made in two styles, 214A for back of panel mounting and 214B for surface mounting. If you have not already received bulletin 904N, request it when you send for Bulletin 907N.

**PRICE \$2.50**

### GENERAL RADIO COMPANY

Massachusetts Avenue and Windsor Street,

Cambridge, 39

Massachusetts

## ALL RADIO PARTS FOR THE AMATEUR

### SPECIALS

- "B" Batteries, \$1.00 each.
- Trench Set Panels, 50c. each.
- Variocouplers, 600 Meters, \$5.00, \$7.00 and \$8.00.
- Variometers, \$4.50; Others at \$7.00 and \$7.50
- Grid Leaks and Condensers, 35c. each.
- Variable Grid Leaks, 75c. each.

#### PHONES

- Western Electric, \$14.00 each
- Baldwin, \$16.50, \$20.00, \$21.00 each
- Brandes, \$8.00 each
- Murdock, \$4.50, \$5.50 each

#### REGENERATIVE SETS

- Signal Electric, \$35.00
- Grebe, \$65.00
- Tuska, \$65.00
- Paragon RA Ten, \$85.00

We give 10% Discount to all Radio Clubs.

Send for Price List.

### AMERICAN ELECTRO TECHNICAL APPLIANCE CO.

235 Fulton Street

Dept. R

NEW YORK

## WIRELESS

You should have it even if only superficially interested. Around about you every day you read of some marvelous occurrence in which wireless played a distinguished part. It may not be entirely clear to you. The Manual will explain it. To the student of Wireless Telegraphy, the Manual contains much that is indispensable to a proper understanding of the art.

It contains 200 pages, fully illustrating and describing the many instruments used in Radio. 45 pages cover general instructions, diagrams, station calls, tables, codes and other information. The book is printed on highly finished paper with a two-color cover and measures 9 x 5 1/2 inches.



## MANUAL M12

Containing as it does a fund of valuable information not generally contained in a catalogue, it approaches nearer a text book in the fascinating field of wireless telegraphy. No expense has been spared to make it accurate and reliable.

No Wireless Experimenter should be without the Mesco Wireless Manual. We ask 25 cents (25c) for it—give you a coupon receipt which can be applied on any future order.

Send your name and address now and get one of the most complete, comprehensive and reliable wireless books published.

### MANHATTAN ELECTRICAL SUPPLY CO. INC.

17 Park Place  
New York

114 S. Wells St.  
Chicago

1106 Pine St.  
St. Louis

604 Mission St.  
San Francisco

A welcome addition to your library! Send \$2.00 today, plus postage for 7 lbs., and your copy of bound volume No. 1 of Radio Amateur News will come forward by return mail. Experimenters Publishing Company 236a Fulton Street, New York City

and the plate would. Very few of the electrons are taken by the grid and a very small current thus goes thru the wire connected to the grid. Thus a very small current to the grid controls the flow of a much larger current to the plate. Hence a larger current can be taken out of the tube than is put into it. A small electric force acts between grid and filament causing a large electron flow from filament to plate. There results a relatively large flow of current in the apparatus connected outside the tube between the plate and filament. This device is commonly called an electron tube. It magnifies or amplifies electric currents. It accomplishes the control of a large amount of power by a small power. This is just the same thing that a gun does—pressing the trigger several times in a repeating pistol is like the action of the tube with successive pulses of electric force. The grid corresponds to the trigger and the plate to the gun barrel.

A number of forms of electron tubes as used today are shown in Fig. 9. They are used to receive radio waves and make signals just as the simpler device shown in Fig. 7 does and they amplify the signal as well as make it audible. On account of the control of the plate current by a smaller grid current, the electron tube makes possible very wonderful feats. It is worth while to note the explanation quite carefully as it will be shown presently that this explanation contains all the most important features of radio telephony.

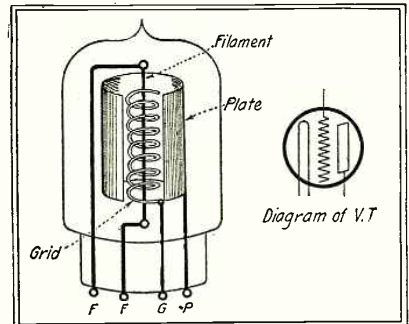
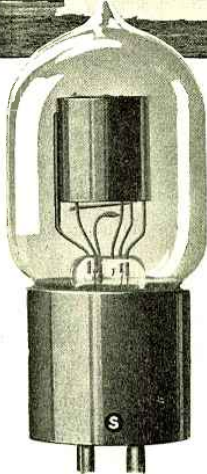
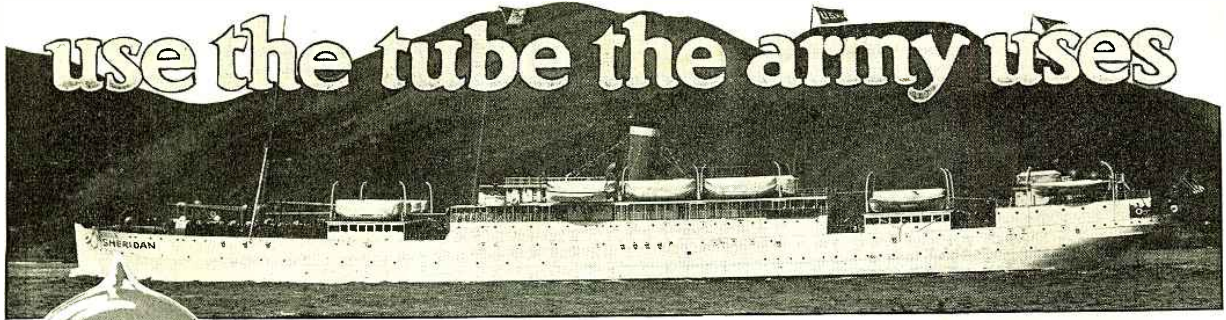

Fig. 8. This is the Type of Vacuum Tube Actually in Use. The Grid is Generally Given the Shape of a Spiral Wound Around the Filament.

It is perfectly possible and quite easy to take the magnified output from an electron tube and pass it into a second electron tube, using that to make a still further amplification of the current. Using one tube after another in this way, we obtain what is called an amplifier. Three tubes joined together in this way are shown in Fig. 6 and the process can be repeated several times using a number of tubes. The current is increased by each tube and handed on to the next without any change or distortion of the current even tho it passes thru several stages.

A demonstration amplifier is shown in Fig. 6. A buzzer is connected between grid and filament of the first tube. Arrangements are provided so that a telephone receiver may be inserted in the buzzer circuit or in the plate circuit of any tube. When the telephone receiver is connected directly in the buzzer circuit a feeble sound is heard; when connected in the plate circuit of the first tube a considerably louder sound is heard and still louder in the second and much louder in the third. A front view of an actual amplifier as used in radio work is shown in Fig. 11b.

The amplifier is of the greatest importance both in radio and in long distance wire telephony. It reduces the amount of power that must be used in a radio transmitting station because when an amplifier is used in a receiving station, signals can be received which are far too feeble to be



The A-P Electron Relay—Price \$8—equipped with the SHAW standard, condensite, four-prong base.

The photograph shows the U. S. Army Transport Sheridan steaming through San Francisco's Golden Gate. Because such ships require the most efficient and most dependable apparatus, the Sheridan and all other Pacific Coast U. S. A. Transports are equipped with A-P Electron Relays. The Transport Service has adopted the Electron-Relay as its standard receiving tube. Use the tube the army uses.

One of the largest radio dealers in the Northwest (name on request) writes:—"You may be interested to know that after trying the new . . . and the new . . . tubes, the amateurs are convinced that there is no satisfactory substitute for the 'E. R.'"

A letter from the Radio Section of the Bureau of Standards furnishes further proof:—"These tubes (Electron Relays are very good detectors, far superior to any of the tubes with which we have made comparisons." Far superior to "any"—Notice that.

Use the tube the Army uses—use A-P tubes for efficiency. Licensed by the Radio Corporation of America under De Forest Audion and Fleming patents, for amateur and experimental use in radio communication.

AND for the best book on RADIO ask your dealer for "ELEMENTS OF RADIO TELEGRAPHY" by Lieut. Ellery W. Stone, U.S.N.; or order from—

ATLANTIC RADIO SUPPLIES CO. PACIFIC RADIO SUPPLIES CO.  
8 KIRK PLACE—NEWARK—NEW JERSEY 638 MISSION ST.—SAN FRANCISCO—CAL.  
Distributors for Moorhead Laboratories, Inc.—Manufacturers of

# The A-P Electron Relay

## THE THIRD EDITION OF THE CONSOLIDATED RADIO CALL BOOK

Very Greatly Enlarged

192 pages. 32 pages more than 2nd edition, better paper, stiff covers, etc.

Some of the special information contained in the new book: Radio rate sheet (charges to and from vessels, etc.); Cable rates; Table for finding cable charges to various points; Weather reports and hydrographic reports of the world; Time signal section of the world; American radio compass stations; French radio compass stations; British radio compass stations; Canadian radio compass stations; General information section; International abbreviations; High power radio stations of the world; Press schedules of spark stations.

The Consolidated Radio Call Book is the only book in print officially listing all the Radio calls as issued by the Bureau of Commerce. Every vessel and land station in the world is represented and listed alphabetically, according to names of vessels or land stations, and according to call letters; Revision of American coastal stations under U. S. Naval control, and their new calls.

Every New Amateur Call Is Listed

SPECIAL—Wireless Map of the World in Colors Given Free With Each Copy

Price \$1.50 Prepaid

Either Direct from us or for sale by the following responsible Dealers:

American Electro Tech. Appliance Co., New York City  
Atlantic Radio Stores, Bridgeport, Conn.  
Atlantic Radio Co., Boston, Mass.  
Bamberger & Co., L., Newark, N. J.  
Benwood Specialty Co., St. Louis, Mo.  
Brods Electric Co., Los Angeles, Cal.  
Bunnell & Co., J. H., New York City  
California Electric Co., San Francisco, Cal.  
Caltion, Neill & Co., Honolulu, T. H.  
Central Radio Co., Indianapolis, Mo.  
Chicago Radio Apparatus Co., Chicago, Ill.  
Continental Radio & Electric Corp., New York City  
Cutting & Washington Radio Corp., New York City  
Detroit Radio Laboratories, Detroit, Mich.  
Dewey Sporting Goods Co., Boston, Mass.  
Doubleday-Hill Electric Co., Pittsburgh, Pa.  
Electro Importing Co., New York City  
Findley Electric Co., Minneapolis, Minn.  
Fuller Co., Seth W., Boston, Mass.  
Gurd & Co., Wm., London, Canada  
Hico Wireless Supply Co., Marion, Ill.  
Holt Electric Utilities Co., Jacksonville, Fla.  
Jenkins, Lester I., New Bedford, Mass.  
Katzenbach & Co. F. S., Trenton, N. J.  
Kendall Co., W. D., Worcester, Mass.  
Killoch Co., David, New York City  
Kluke, Arno A., Los Angeles, Cal.  
Krause & Co., A. F., Detroit, Mich.

Lehigh Radio Co., Luzerne Electrical Supply Co., New York City  
McCarthy Bros. & Ford, Chicago, Ill.  
McClurg & Co., A. C., Chicago, Ill.  
Manhattan Electric Supply Co., New York City  
Motor Electrical Construction Co., New York City  
Meyberg Co., Leo J., Milwaukee, Wis.  
Mohawk Electrical Supply Co., New Era Shop, New York City  
Newman-Stern Co., New York City  
Nola Radio Co., New Orleans, La.  
Noll & Co., E. P., Philadelphia, Pa.  
Northwest Radio Service Co., Seattle, Wash.  
N. S. W. Bookstall Co., New York City  
Pacent Electric Co., New York City  
Paramount Radio Supply So., New York City  
Parks, Henry Francis, New York City  
Pearlman's Book Shop, New York City  
Penn Radio Apparatus Co., New York City  
Pennsylvania Marconi Wireless School, Philadelphia, Pa.  
Philadelphia School of Wireless Telegraphy, Philadelphia, Pa.  
Piedmont Electric Co., Asheville, N. C.  
Pioneer Electric Co., St. Paul, Minn.  
Pitts Co., F. D., Boston, Mass.  
Post Office News Co., Chicago, Ill.  
Precision Equipment Co., Cincinnati, Ohio.  
Radio Distributing Co., Newark, N. J.

Bethlehem, Pa.  
St. Louis, Mo.  
Buffalo, N. Y.  
Chicago, Ill.  
New York, Chicago  
Oshkosh, Wis.  
San Francisco, Cal.  
Syracuse, N. Y.  
Milwaukee, Wis.  
Cleveland, Ohio  
New Orleans, La.  
Philadelphia, Pa.  
Seattle, Wash.  
Sydney, Australia  
New York City  
Atlantic City, N. J.  
Butte, Mont.  
Washington, D. C.  
Reading, Pa.  
Philadelphia, Pa.  
Philadelphia, Pa.  
Asheville, N. C.  
St. Paul, Minn.  
Boston, Mass.  
Chicago, Ill.  
Cincinnati, Ohio  
Newark, N. J.

Radio Electric Co., Philadelphia, Pa.  
Radio Equipment Co., Philadelphia, Pa.  
Radioelectric Shop, Ray-Di-Co., Chicago, Ill.  
Reuter Electric Co., Riverside Laboratory, Rose Radio Supply, Saunders Co., Geo. S. Schmidt & Co., Rudolph, Sears, Roebuck & Co., Service Radio School, Shaffers', Shotton Radio Mfg. Co., Smith Bros., Smith Novotoy Electric, Inc., Southern Electrical Supply Co., United Radio Telegraphers' Assoc., Western Radio Electric Co., Whittall Electric Co., White Co., The White & Boyer Co., Williamson Electric Co., H. E. Wilmington Electrical Specialty Co., Wireless Mfg. Co., Wireless Press, Young & McCombs, Young Men's Christian Assoc., Zamoiski Co., Jos. M.,

Pittsburgh, Pa.  
Boston, Mass.  
Cleveland, Ohio  
Chicago, Ill.  
Cincinnati, Ohio  
Milwaukee, Wis.  
New Orleans, La.  
Boston, Mass.  
Rochester, N. Y.  
Chicago, Ill.  
Washington, D. C.  
Norfolk, Va.  
Scranton, Pa.  
Sarnia, Ont., Canada  
Charlotte, N. C.  
San Diego, Cal.  
Baltimore, Md.  
Los Angeles, Cal.  
Westory, R. I.  
Columbus, Ga.  
Washington, D. C.  
Seattle, Wash.  
Wilmington, Del.  
Canton, Ohio  
New York City  
Rock Island, Ill.  
Los Angeles, Cal.  
Baltimore, Md.

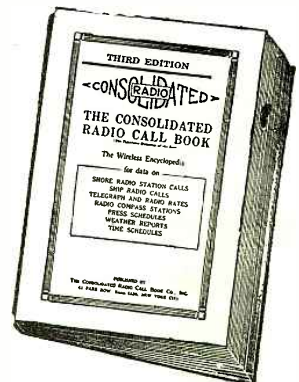

Consolidated Radio Call Book Co., Inc., 41<sup>st</sup> Park Row, New York City

## TWO GOOD AUDION CONTROLS

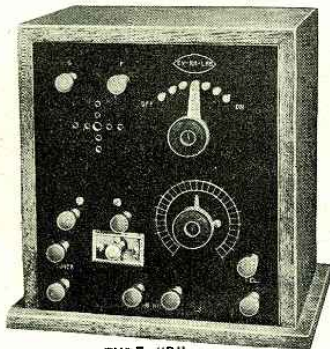

TYPE "D"

There are many audion control units BUT—Do they all provide a good means of adjusting the plate voltage as well as the filament? This Unit provides both and both well. Can be used with any type receiving tube made. Cabinet of selected oak with beautiful "Early English" finish.

Price	Without Cabinet	\$15.00
	With Cabinet	12.00
Eveready 45 Volt Tapped B Battery		\$5.00
Small Size Non-Tapped		2.25

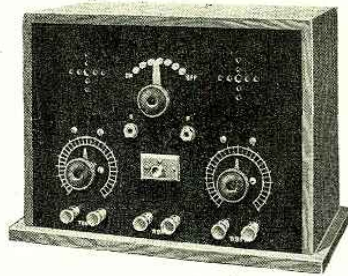

TYPE "DA-2"

In addition to permitting you a fine adjustment of both plate and filament voltages this Unit makes the signals over 25 times as loud. A REAL Instrument at a price which you can afford to pay. Equipped with plugs and jacks for connecting the phones to the desired stage. Cabinet of oak "Early English" finish.

Price	Without Cabinet	\$35.00
	With Cabinet	32.50
Electron Relays		\$6.00
Amplifier-Oscillators		7.00

Catalog sent upon receipt of 10c. which will be refunded on your first \$1.00 purchase from us. It will pay you to get it.

**EVANSVILLE RADIO LABORATORY, 1103 SOUTH THIRD STREET, EVANSVILLE, INDIANA**

## REMLER No. 93 A—BATTERY — POTENTIOMETER

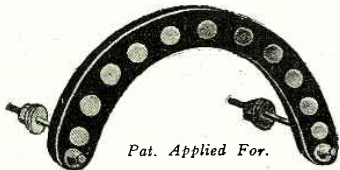

Pat. Applied For.

- No. 93—Remler A-Battery Potentiometer Unit only, with studs for panel mounting ..... **.75c**
- No. 94—Remler Rotary Lever Switch for use with No. 93 Unit ..... **.45c**

**Increases detector sensitiveness and signal audibility.**

THE plate voltage of any detector tube must be carefully adjusted for maximum sensitiveness and signal audibility. Potentiometer control provides close adjustment with ease of operation. This new Remler Unit with metal inserts provides positive definite electrical contact and eliminates the uncertainty of carbon to graphite contact. This Remler Unit is not brittle and is connected across the A-Battery to control the plate potential over a six volt range by half-volt steps. Circuit diagram furnished with each unit.

"Apparatus that Radiates Quality."

## REMLER RADIO MFG. COMPANY

168 Sutter Street      E. T. OUNNINGHAM, Sales Mgr.      San Francisco

## QUALITY RADIO EQUIPMENT



**RADIO MAGNAVOX**  
The latest development in sound amplifiers; constructed on a patent protected electro-dynamic principle. Can be used with excellent results with 2 to 4 dry cells.

**RADIOTRON U. V. 200**  
An excellent new super-sensitive detector and tone frequency amplifier; constructed especially for amateur and experimental stations. Will operate from one standard plate battery.

Full supply of quality Vacuum Tubes, Controls and Parts. Special Dealer's offer. Mail orders filled promptly.

Write for Radio Catalog No. 2.



## DOUBLEDAY-HILL ELECTRIC CO.

715 TWELFTH ST., N. W. WASHINGTON, D. C.

Radio Dept.—Desk B

719-21 LIBERTY AVE. PITTSBURGH, PA.

received without an amplifier. By means of amplifiers to which were connected loud-speaking telephones, demonstrations have been given in which an airplane more than a mile away in the air address large crowds in the streets of New York. One of President Wilson's speeches in the West was spoken into a telephone apparatus and amplifiers were used to make it fully audible to all persons in a very large crowd. The large announcers used in railway stations now make use of amplifiers. By means of amplifiers, submarine vessels can receive radio messages when entirely submerged. It is an interesting fact that an amplifier can be made so powerful that no input current at all is required. This does not mean that it is a perpetual motion machine, because the power to operate it must be supplied by the battery that is connected in the plate circuit of the tubes. It does mean, however, that the electron tube can be used to generate alternating currents as well as to receive and amplify them.

Thus far we have discuss only signals such as are used in telegraphy. The voice can be transmitted and received by the same apparatus and principles. The human voice produces sound waves which cause air vibrations of an irregular character. Such a wave may be roughly illustrated as in Fig. 10. The variations in the wave are much slower than the alternations of current used in radio. It is possible to make a radio wave carry a voice wave, and when this voice-modulated wave is received it can be passed thru a telephone receiver and the voice hear just as the radio telegraph signals are heard. The principle is that instead of breaking up the continuous wave of Fig. 3 by interrupting it, as in Fig. 4, it is caused to vary in accordance with the voice wave and these variations can be made audible. The way in which the voice wave is superimposed upon the radio wave is illustrated in Fig. 10. The alternations of the radio wave are shown by the full lines and the dotted boundary lines show that the intensity of the wave has been made to vary in accordance with the sound wave produced by the voice. This wave can be received in exactly the same way as any wave in ordinary radio telegraphy—no special apparatus is required for receiving radio telephony. The voice at the transmitting station is heard very clearly. It can be made as loud as desired at the receiving station just as radio telegraph signals can be by the use of amplifiers.

The radio wave is really modulated or molded just as a phonograph record is molded by a sound wave. The means by which this modulation is accomplished is the electron tube. If the telephone receiver is replaced by any kind of generator of radio current, then if a person speaks into a telephone transmitter connected between the grid and the filament of the tube the variations caused by the sound of the person's voice are impress upon the radio current in the plate circuit and a modulated radio wave as in Fig. 10 is produced.

A small radio telephone transmitting outfit which is used for demonstration and experimental purposes at the Bureau of Standards is shown in Fig. 12. Music is readily transmitted out into space by playing the music into a telephone transmitter. A phonograph may be used as shown in Fig. 12. The telephone transmitter is connected to the radio telephone apparatus upon which the electron tubes may be seen.

A receiving outfit usable in demonstrations is shown in Fig. 14. The receiving circuit or antenna is entirely contained within the frame shown in the picture and electron tube used as a detector and amplifier and the loud-speaking telephone receiver are all visible. A much more compact radio receiving outfit is shown in Fig. 13. The box encloses the electron tubes, the receiving antenna and all neces-

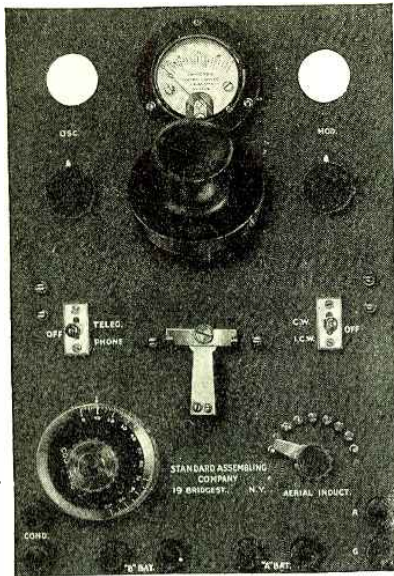

Front View

## SEMI-COMPLETED RADIO EQUIPMENT

The progressive amateur of today does his own construction. Supply houses sell more parts than finished instruments. Given the tools and facilities of radio manufacturers most amateurs could easily duplicate the work of the best constructors. Such equipment is, however, seldom available.

Even the largest manufacturers cannot do all their own work. Many place orders with assembling companies having facilities for drilling, assembling, engraving, machining, etc. In such cases all the manufacturer does is to wire the circuits in accordance with his ideas.

You probably have circuit data and ideas that you know are superior to those of many manufacturers. If so you can apply them to our fully assembled unwired instruments or you can wire in accordance with blueprints of the best circuits. Such prints are supplied with each of our instruments. By doing this part of your work you can have machine made instruments quite as cheaply as you could purchase panels, parts and have the larger drilling and engraving done.

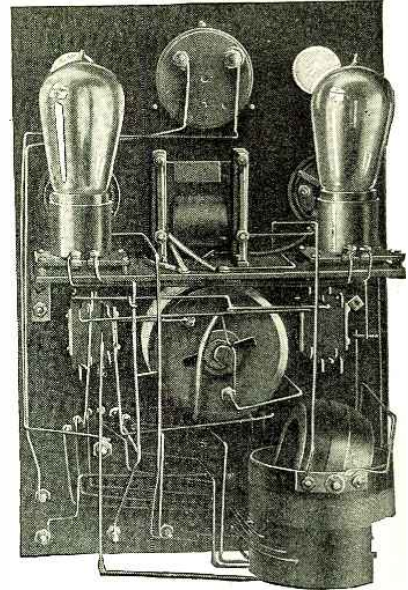

Back View

Our radiophone illustrated here consists of tube receptacles, control rheostats, modulation transformer, indicating meter, key switches, wave switch, triple coil variocoupler, microphone, ICW 6 volt to 500 volt transformer and other necessary equipment for a CW telegraph or telephone transmitter and an ICW telegraph transmitter. The equipment is of the best quality neatly assembled on an

engraved bakelite panel. Completely wired and tested, the price is \$150 including cabinet. Unwired but exactly as illustrated \$80. No tubes or batteries are included.

Details on our other finished and semi-finished instruments, which include Regenerative Receivers, Detectors, Amplifiers, Jewellers' Receivers, Utility Receivers, etc., will be sent you on receipt of stamp.

### Model 1 Radiophone

(as illustrated)

In cabinet, without tubes, \$150

Unwired and without tubes.. 80

**STANDARD ASSEMBLING CO., 19 Bridge Street, NEW YORK CITY**

## THE TURNEY SPIDER-WEB INDUCTANCE

A compact, efficient short wave coil set

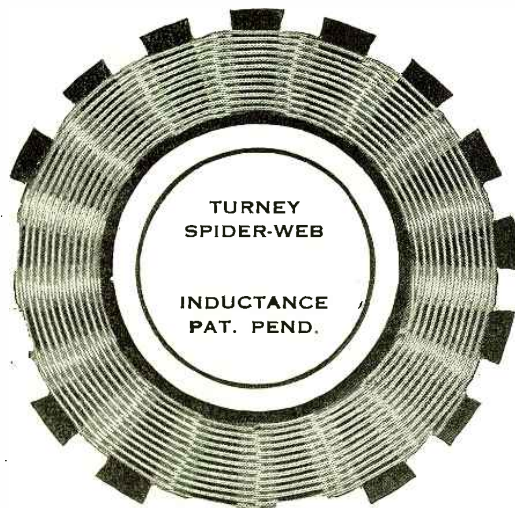

TURNEY  
SPIDER-WEB

INDUCTANCE  
PAT. PEND.

Tunes  
180-400  
Meters

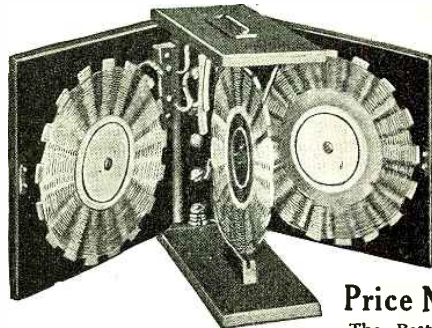

Illustration shows front of cabinet removed  
Patent Pending  
Dimensions, 4 1/2 x 5 x 1 3/4

**Price Now \$8.00**

The Best \$8.00 Worth of Radio You Ever Saw.

### WHAT WE CLAIM—

- 1 Practically no magnetic leakage, which means more mutual inductance and stronger signals.
- 2 Less distributed capacity than any form of lattice winding which means finer tuning.
- 3 Occupies much less space than any other form of winding.

PACIFIC COAST AGENTS  
HERROLD LABORATORIES  
SAN JOSE CALIF.

Ask Your Dealer to Show You ONE or send us \$8.00 plus postage and we will ship same day order is received.

**Eugene T. Turney Laboratories, Inc. RADIO HILL, HOLMES, NEW YORK**

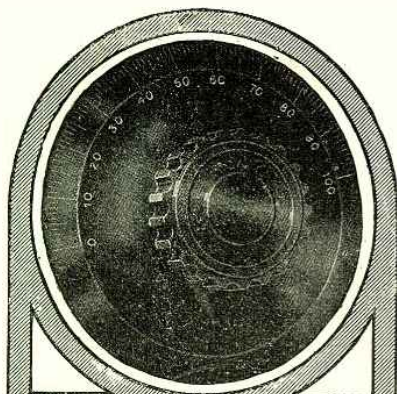

**CORWIN DIALS**

It is just as easy to specify "Corwins" when buying dials, and it implies that you have quality apparatus throughout. Dealers acquire respect for those who specify good makes of radio goods.

3" Dial, 75c—with knob, \$1.30  
3 1/2" Dial, \$1.00—with knob, \$1.70

At all Radisco agencies, and other reliable dealers, or sent postpaid anywhere

**A. H. CORWIN & CO.**  
4 West Park St., Newark, N. J.

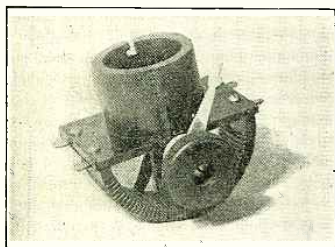

**THE RHEOSOC**

Combination Rheostat and Socket. For back panel mounting. **BAKELITE** throughout.

Type A 9 ohm 1.2 Amp.  
Type B 6 ohm 1.8 Amp.  
Price \$2.50

With Radiotron UV200, \$7.

Postage EXTRA—Loose-Leaf Catalog 5c

**A. K. LAING, RADIO SUPPLIES**  
Pelham Manor, N. Y.

**W H O**

MASTERED CONTINENTAL CODE IN ONE HOUR BY USING DODGE SHORT CUT 50 CENT METHOD

**W H O**

Ask DODGE, Box 200  
Mamaroneck, N. Y.

sary apparatus connected to the horn which projects from the box. This is actually a satisfactory receiving set for demonstration and other purposes. It suggests the possibilities of the future. Radio sets of small enough size to use in any ordinary room or in moving vehicles can easily be made even now.

By means of electron tubes, radio telephone messages were successfully transmitted five years ago over a distance of 5,000 miles. Concerts are already being sent out by radio and are receivable by anyone who has an ordinary receiving set. This result has been accomplished by patient research, scientific study and progressive engineering. In Bellamy's "Looking Backward" describing conditions in the year 2,000 an arrangement is described by which people receive music in their houses any time desired by simply connecting a certain electrical instrument. In this particular the dreams of the prophet have been anticipated by eighty years.

**Two-Step Audiotron Amplifier**

(Continued from page 702)

tery binding posts have been placed sufficiently far apart to eliminate all possible chance of causing a short circuit. In the mounting of the apparatus the utmost care should be taken that all connections are made as per drawing. If they are not, the experimenter is storing up a lot of trouble for himself in the future when he least expects it. As will also be noted on Fig. No. 1, this is essentially two audiotron detector circuits connected in cascade by the means of using a one to one step iron core coil with a high resistance, or in other words an auto transformer.

A 1/4" or 1/2" spark coil would do the trick very nicely, but only the secondary of the coil should be used and care should be taken to see that the vibrator is screwed down firmly to the core. Of course, if a person has the means of removing the primary of the spark coil without injury to the secondary, he can readily do so, but it is not absolutely necessary that this be done. If it is not done, one should not forget to leave the primary leads open. This is absolutely necessary. As a matter of fact, most any winding with an iron core having a resistance of between 6,000 and 7,000 ohms will do very well.

The two audiotron vacuum tubes should be adjusted, as in the case of using the audiotron vacuum tube detector, thereby getting the maximum sensitivity. After the outfit is once adjusted, there will be no further need of adjustment which will, of course, save a considerable amount of time.

The reader can purchase a one to one step two circuit iron core coupling transformer, which will permit the use of the one battery for the lighting of the two filaments on the audiotron vacuum tubes. Such a transformer can be readily purchased at a small cost at most any of the reliable Radio supply houses. By having one of these transformers, the cost on the lighting of the filaments within the two audiotron vacuum tubes can be saved.

The experimenter is ready to do the wiring on the back of the panel. Particular attention should be paid to the wiring and hook-ups as shown in Fig. 2. I would suggest that No. 16 rubber covered wire be used on the panel wiring, and have the wiring bridged. Also

(Continued on page 744)

**HERE'S GOOD NEWS!**

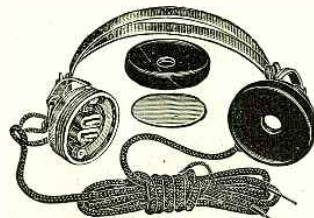

**RED - HEAD RADIO PHONES** **N O \$8.00 PRE-PAID**

1921 Model 3000 Ohms

Incomparably the World's Greatest Phone Value. Guaranteed identically the same head-set as previously sold for \$12.50. Increased production and decreased manufacturing costs make the new low price possible.

**EXQUISITELY SENSITIVE RUGGED AND STURDY**

Aluminum backs, military type head-band, bakelite ear caps, strain loops and posts, extra thin diaphragm, superb workmanship, beautiful appearance, 3,000 ohms resistance—these are a few of the features which have made Red-Heads a triumph in radio phone building.

Send us \$8.00 for Red-Heads today. You take no risk. If Red-Heads do not satisfy we will refund your money.

**EIGHT DOLLARS, COMPLETE, PREPAID**

Furnished with braid covered military type or genuine phosphor-bronze split head-band. Illustration shows phosphor-bronze type.

Price subject to change without notice.

**DEALERS:** Be sure to stock the new Red Head Phones. Be prepared for the big demand.

**THE NEWMAN-STERN CO.**  
Newman-Stern Bldg. Cleveland, O.

Write for Free Catalogue.

**The Smallest Audion Control Panel Made**

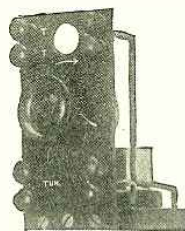

No. AC-5. Equipped with a socket, rheostat, eight binding posts and a grid leak condenser mounted on a hand engraved hard rubber panel, size 4 1/2" x 2 1/4". Price... \$5.50 At your nearest dealer or from the

**WORTH RADIO CO.**

1843 East 12th St.

BROOKLYN, N. Y.

**Grid Condensers Selling Like Hot Cakes**

Prepaid 25 cents

Prepaid 25 cents

Hermetically Sealed



100% Efficiency

Prices must go down. We are the first to start the ball rolling. Selling these condensers faster than we can turn them out. Everybody satisfied.

**Crescent City Radio Company**  
P. O. Box 1104 New Orleans, La.

**Battery Charging Pays \$1500 to \$3000 a Year**

**GET AN KB CHARGER**

Small cash payment starts you in big, permanent money-making battery charging business. Long, easy terms on balance. Money-back guarantee. Write TODAY for our liberal proposition.

HUBBART BROTHERS COMPANY  
Box N47, Troy, Ohio



Small Cash Payment—Balance Easy Terms

**SHELLAC**

**Red Triangle Brand**  
For Radio Work — 50c, 1/4 pt., Post Pd.  
**Shellac Co. of New York**  
Agents Wanted 30 Park Place, N. Y.



# THE RADIO MAGNAVOX



THE RADIO MAGNAVOX when used with a suitable amplifier, will give forth signals of far greater volume than any other receiver and radiophone music may be used for dancing.

THE RADIO MAGNAVOX does away with a continuous watch, allowing the operator to hear what is going on at his station while in another part of the house.

THE RADIO MAGNAVOX is manufactured under the same patents and on the same electrodynamic principle as the Magnavox Radio Tele-megafone, and will reproduce signals with the same volume.

THE RADIO MAGNAVOX is supplied without means of varying the field current. If six volts from a storage or dry battery are applied to the field windings the field becomes saturated and maximum reproduction is obtained.

It is not necessary that the field be saturated for the reception of the average Radio signals. Therefore, we recommend that a variable resistance be placed in the field circuit and no more current be used than is necessary to hear the signals at a good volume. This rheostat may be approximately 8 to 12 ohms resistance, resembling a vacuum tube filament resistance.

**Price \$45 at your Dealers**

If he cannot supply you send remittance direct to the  
**Magnavox Company, Oakland, California**  
 and receive prompt shipment

There is still opportunity for more live radio dealers to handle this line, as well as our transmitter tone arm and hand transmitter for Radiofones.

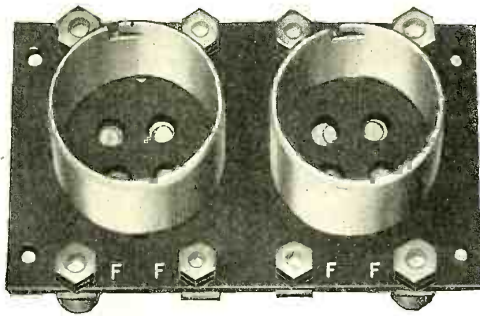

Type WI-182A Socket

## SPEAKING OF SOCKETS



"SERVIVIMUS"

When our Government with all its experience and unlimited facilities, sets to work designing a piece of radio apparatus, you can be certain that said piece of apparatus is the last word. Such is the case with our single, double and triple vacuum tube sockets. They are "EVENTUAL" apparatus. Each socket has a spun aluminum shell that is accurately machined; the tubes fit snugly but do not have to be forced into contact with the spring contactors; and there is no danger of the filament terminals coming in contact with the high voltage of the plate battery. Several features at once distinguish this socket from the many inferior devices now on the market.

Type 181A Single "Eventual" Socket. Price..... \$2.00

Type 182A Double "Eventual" Socket. Price..... 3.90

Type 183A Triple "Eventual" Socket. Price..... 5.80

Bulletin 10R describing the above and other WICONY "EVENTUAL" apparatus will be sent you on receipt of five cents in stamps.

Dealers—deal with us. Amateurs—deal with your dealer.

Wicony Complete Line  
 Dubilier Condensers

Sole Distributors for  
 Pacent Plugs  
 Rawson Meters  
 Special Distributors of Brandes Headsets.

Standard VT Batteries  
 Seibt Condensers

# PACENT ELECTRIC COMPANY, Inc.

LOUIS GERARD PACENT, President

150 NASSAU STREET

Telephone Beekman 5810

NEW YORK CITY

**PLATE BATTERIES!  
Give Your Bulb a Chance!**

Economy Radioplate Batteries are genuine lighting flashlight batteries soldered together with 1/4-inch brass strip connectors which also serve as taps. We are proud of having put this battery on the market. It represents our effort to give you **Maximum Battery Quality** for your money.

Two sizes, you know best if you need either or both.

Ersco No. 503 22 1/2 Volts, Price \$2.00  
Ersco No. 803 36 Volts, Price \$3.20  
Made for Long Life and Heavy Duty. "Always Something Doing" with Ersco Batteries on your plate.

Don't forget our Black Fiber Panels. Paragon size 7 x 20 x 1/4 inches, price \$6.00 or cut to any reasonable size at 2 1/2 cents per square inch.

Make a one-step amplifier complete for \$22. You need 1 Paragon Moulded VT Control Panel (has socket, rheostat, grid condenser and leak all on a base about 5 by 3 inches), price \$6; 1 VT, price \$7; 1 amplifying transformer, price \$5; and 2 Ersco Radioplate Batteries No. 503, price \$4. Total \$22.

We will supply these parts separately or altogether at the prices listed.

We ship parcel post paid anywhere in the United States.

Mail orders should be accompanied by remittance. Reference, Merchants and Manufacturers National Bank, Newark, N. J.

**ECONOMY RADIO SUPPLIES CO.**  
232 Sanford Street East Orange, N. J.

"Always Something Doing"

**BACK TO OLD PRICES**

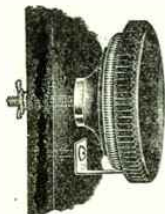

**PARKIN RHEOSTAT**

5000 sold last year at \$1.00

NOW REDUCED TO

**75c**

Due to the general drop in the prices of raw material and to our large production, we have been able to reduce all our prices to their pre-war level, and in some cases even lower.

New Catalog No. 5, listing our complete line, sent free.

Here are a few of the items:

- |  |                 |
|--|-----------------|
| No. 31 Audion panel with rheostat and B battery switch | Postpaid \$3.00 |
| 43 45 volt large B battery                             | 5.00            |
| 50 PARKIN .001 mf. variable condenser, unit only       | 1.50            |
| 51 PARKIN .001 mf. V.C. with knob and pointer          | 2.00            |
| 52 PARKIN .001 mf. V.C. with knob and 3" dial          | 2.50            |
| 53 PARKIN molded bakelite fixed condenser              | .70             |
| UV 200 New Radiotron vacuum tube                       | 5.00            |

DEALERS—If you are not on our mailing list, write for new catalog and discounts.

**PARKIN MFG. CO., San Rafael, Calif**

**A COMPLETE TUNER**

and Audion Detector that gets everything from 150 to 600 meters. All enclosed in walnut finished cabinet with bakelite panel and 40 volt B. battery.

Price ..... **VARIABLE B. BATTERIES** ..... \$35.00

22 1/2 volt.....\$2.50 45 volt.....\$5.00

3,500-meter loose couplers.....\$9.00

Postage extra. Circular for stamp

Jeffery, Crawford Co., 2173 Hillger Ave., Detroit, Mich.

(Continued from page 742)

have the wiring kept from resting on the back of the panel. This can be done by giving the covering on the wire a coat of some good insulating compound and letting it stand until it is dry. A good method of placing this wiring is to plot out the different wires and the way you would like to have them run. Cut and peel them to the required sizes, and then put the compound on them, and just before they are dried, bound them into the shape desired. Now, that the amateur has advanced so far, he has preference as to the mounting of the panel assembly complete upon the brackets or making a cabinet and securing the panel upon the front of the cabinet by means of a number of wood screws. If he decides to use brackets, I will explain how they are made. These brackets are made of 3/8" angle irons and drilled so as to allow for the passing thru of four machine screws, two to a side from the front of the panel, and having a nut fasten onto the back, thus holding the panel firmly upon the brackets itself. These screws can be four machine screws, 1/4" in diameter, and 1" in length, with whatever thread the experimenter desires. That is left to his own judgment. To mount the panel in cabinet form, procure a sufficient amount of oak wood to make a cabinet sufficiently large enough on the outside so that the panel can be mounted firmly and set snugly upon the front of the cabinet. Make the cabinet large enough to place the "B" batteries in the back of it; also make a cover to set on the front of the panel assembly, which will cover the whole outfit and keep dust or dirt from getting on the instruments.

It will also give the amplifier a much neater appearance and it will be easier to handle.

The binding posts can be either copper or brass and there are twenty-six of them. They are 1 1/4" in length and 3/8" in diameter. The thread size is left to the builder's judgment. It is advisable to use plain brass washers on the front and the back of the panel.

The potentiometers used have a resistance of 400 ohms and are the kind that are mounted on the back of the panel. It is also advisable to have spacers go over the screws that hold the potentiometers to the back of the panel to keep the potentiometers from coming in contact with the panel proper. There should be a pointer and scale to go with each one of these potentiometers and the scales can be either brass or celluloid with readings up to 180 degrees.

The rheostats can be of the ordinary battery kind with a resistance of from 10 to 15 ohms. They are mounted as shown in Fig. 1.

The filament control switches are for the purpose of burning either filament of the audiotron vacuum tube. The contacts of these filament control switches are 1 1/4" long with a head on them 3/8" in diameter and 1/4" long. There are six contacts in all. The switch blade knobs are 1 1/2" in diameter and 1 1/4" in length, made of a composition of rubber with a shank 1 1/2" long, and 1/2" in diameter. They may be either copper or brass. The end of this shank is threaded and has a nut fastened onto it, which holds it fast to the back of the panel. The switches swing in a radius of 1 1/2". Two small nails can be used as switch stops so that the switch blades won't run off the switch contacts.

Little copper terminals should be soldered to the five leads on the two audiotron vacuum tubes. This will eliminate any possible chance of the tubes getting loose from the binding posts, and falling

(Continued on page 755)



NEW YORK BOSTON

Offers a thorough course in all branches of wireless telegraphy. Radio Operators earn at the start \$125.00 per month, and first class board, etc., free.

Our school prepares you for your license in three to four months. Positions guaranteed to first grade licensed operators.

Day and evening classes.

The leading Nautical School in U. S. A. Established 1804.

CAPTAIN F. E. UTTMARK, Principal

Write, call or phone for illustrated booklet.

8 STATE ST., NEW YORK, N. Y.

Facing Battery Park, N. Y.

Telephone, Bowling Green 8079

**UTTMARK'S for Nautical Education**

**LOOK AT THIS**

**AUTOMATIC FILAMENT CONTROL.** Three jacks for the automatic control of detector and two stages of amplification or any combination of three tubes. Greatest convenience yet, big saver of battery. Complete with blue print of connections and plug. Limited quantity. Post paid \$5.00.

**PHONE CORDS.** One of the best cords you have ever used. Closely woven over rubber insulation. Regular government standard. Our price while they last, 50c post paid. Specify style tips wanted, regular, spade or for W. E. Fones, or mention fone used.

**FAHNESTOCK CONNECTOR BLOCK.** For connecting fones to tuner. Mounted on Bakelite block 1 1/4 by 2 1/2" which can be screwed on the table. This block insures good firm positive contact at all times which is quickly and easily made. Specially priced at 25c post paid.

**STANDARD PLUGS.** These plugs fit the jacks usually used for connecting fones to detector and amplifier units or various other circuits. Price 50c.

**CHICAGO RADIO SHOP**

326 River Street Chicago, Ill.

**Miniature Rheostat**

Something New for

**\$1.25**

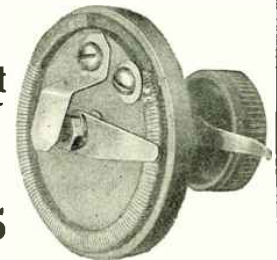

**Detroit Radio Laboratories, Inc.**  
3661 Gratiot Ave. DETROIT, MICH.

**TELEGRAPHY**

(Both Morse and Wireless) and RAILWAY ACCOUNTING taught thoroughly and quickly. Big salaries now paid. Great opportunities for advancement. Oldest and largest school; established 46 years. Endorsed by Telegraph, Railway, Radio, and Government officials. Expenses low—opportunities to earn large portion. Catalog free.

RODGE'S INSTITUTE D Street, Valeraville, Md.

**PIGEONS PAY** Enlarged, any small building, very little space required. Build their own nests, feed their own young. Very profitable business. Get your start with a few good pairs. Write today for 1921 Circular. Pigeon Supply House, Hanover, Pa.

# THE BENWOOD "SUPER" ROTARY DISC.

again we have  
**SOMETHING NEW**

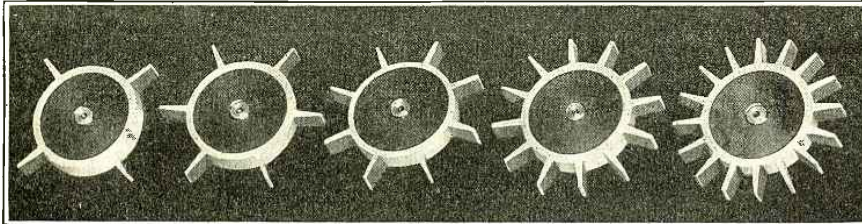

Lighter than the old style BENWOOD discs and yet has the same wide sparking surface. The teeth are longer and far more accurate than has ever been produced before. Complete disc weighs only one-half pound when fully made up. Is of ample size for any 1 KW installation and yet is so light and evenly balanced that the smallest fractional high speed motor will run it with ease.

**DIMENSIONS:-** Diameter, 6 inches - width, 3-4inch - weight, 1-2 pound

Is complete with black fibre center and heavy brass bushing with set screw for fastening to the motor shaft. This is the identical disc that is furnished with the New "SUPER BENWOOD" rotary quenched spark gap.

As shown by the cut these discs are furnished in 4, 6, 8, 12 and 16 points at no extra charge, merely specify which type you desire. Drilled to fit any sized motor shaft, just designate the size of the shaft on your motor. Each bushing is drilled twice and then reamed to the size desired, thus assuring the purchaser of the utmost accuracy.

**ONLY \$7.00 EACH**

Specify size of motor shaft.

**The Benwood Co., Inc., 1300 Olive St., St. Louis, Mo.**

## WANTED—FOR CASH

**Used Radio Apparatus of All Standard Makes**

Our used wireless apparatus department, connected with our local retail store at 233 Fulton Street, New York City, is anxious to buy any radio instruments you may have for sale. These goods are for our New York customers only—we sell no used radio apparatus by mail. But we do have a tremendous call at our store for fine class goods and we will be glad to hear from you if you have any that you would like to dispose of.

### WE PAY CASH

for all such merchandise that we buy, and this is an invitation extended to the radio fraternity to sell us their radio apparatus for which they have no further use. Write us in your first letter what make apparatus you have to sell, and your lowest spot cash price. It must be understood that all transportation is to be paid for by you. All goods to be sent to us prepaid either by parcelpost, express, or freight.

We can use only standard apparatus, no obscure instruments or home-made apparatus can be considered in any event.

If you have friends who wish to dispose of such apparatus, show them this advertisement. Also please note that your letter must state in just what condition the instruments are and that no goods must be sent to us unless we send you a written order to do so.

We invite amateurs residing in New York or vicinity to call at our store and inspect the used radio apparatus which will be placed on sale shortly after this advertisement appears.

*Address all letters to*

**Used Apparatus Department**

**ELECTRO IMPORTING COMPANY**

(Established 1904)

**231 Fulton Street**

**New York City**

**YOU JUST LISTEN AND LEARN**

6 Double Faced Records, 12 Lessons, With Instruction Manual, Price \$6.00

**MARGONI VICTOR COURSE IN WIRELESS TELEGRAPHY**

Will give you the practice in code work you need to get a high rating when you go up for exams. Just what you need to develop your speed in receiving. Everything covered from alphabet to Press with interference and ten letter code words. "They're great."



Send for our book catalog.

**WIRELESS PRESS, Inc.**

326a Broadway NEW YORK

**SIXES & SEVENS**

Save time and freight by getting your apparatus from us. We carry full AMRAD and RADISCO stocks. Order from their catalogs. Also DEFOREST, TRESKO, MURDOCK, THORADSON and others.

- A-P Amplifier Tubes.....\$7.00
- A-P Detector Tubes..... 6.00
- Federal Transformers..... 7.50
- Tube Bases..... 1.00
- Grid Condensers..... .35
- Rheostats..... 1.50
- 2-Stage Amplifiers.....40.00
- 45-Volt B Batteries..... 5.00

**NORTHWEST RADIO SERVICE CO.**  
609 Fourth Ave., Seattle, Wash.

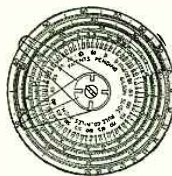

The Midget "FIVE-IN-ONE" Slide Rule is a combination Mannheim, Log-Log, Add and Subtract, Polyphase and Binary Slide Rule. It will instantly add, subtract, multiply and divide any combination involving whole numbers, fractions, decimals and mixed numbers. Gives every possible root and power of every quantity. The graduations are printed on metal coated with white celluloid and are grease and waterproof. While it is the most versatile calculator ever invented, its operation is simple and easily understood. Diameter 4".

Price with 16-page Instruction Book, \$1.50. Leatherette carrying case 50c extra. Catalog free. Your money back if you are not satisfied. Gilson Slide Rule Co., Niles, Mich.

**1/4 H.P. 110 volts, A.C. 60 cycle, single phase, 1750 R.P.M. MOTORS**

LARGE QUANTITIES NEW WASHING MACHINE MOTORS

These are of standard manufacture and carry the full factory guarantee. Shipped in original boxes. Complete as set. Suitable for operating Coffee Grinders, Cream Separators, Bottle Washers, Air Compressors, Small Lathes, Etc.

**\$22.75 Each**

MANUFACTURER'S DISTRIBUTOR  
CHAS. H. JOHNSTON - Box 16 W. E., Pittsburgh, Pa.

**RADIO CLUB PINS**

Special folder of designs and prices in addition to regular school pin and ring catalog free on request. Be sure to see these new numbers which will put new life in your club

Metal Arts Co., Dept. 11, Rochester, N. Y.



**Notes on Quenched Gap Transmitters**

(Continued from page 689)

sary, for the power can be varied by varying the number of gaps in use. (Specifically the power varies as the square of the number of gaps, for it varies as the square of the condenser voltage, and the voltage used varies approximately as the number of gaps.) For low power the gap short-circuiting device is useful, and it might be so designed in the radio set, that it automatically inserts the necessary amount of reactance in the primary of the transformer to reduce the secondary sparking voltage.

Finally gaps should be designed with a view to easy assembly. The writer has seen gaps designed where the surfaces were assembled by bolting together with five or six bolts passing thru holes which had to be fitted with an equal number of fibre separators! One bolt for each gap with one insulator is quite sufficient.

**Conduction of Electricity Thru Vacuum and Gases With Applications to Design of Radio Apparatus**

(Continued from page 694)

both signs are present at the metal surface. If two platinum electrodes are immersed in a vessel containing gas and heated to a bright red, current from a battery will pass between them. If now a cold metal plate be placed between the two hot ones, the current will be completely stopt and will not recommence until the middle plate reaches the ionizing temperature. The reason for this is that the cold plate discharges the ions that were carrying the current and continues to do so until it gets hot enough to form ions itself.

**THE ELECTRIC SPARK.**

When a small potential difference is impressed on two electrodes in air a very small current will flow which will be proportional to the voltage. As the voltage is increased the current will increase in proportion for a short while only, and then will assume nearly a steady value over a wide range of voltage changes. This steady value, A in Fig. 1, is the saturation current. As the voltage is still further increased, a point is reached at which the current again begins to rise, at first slowly, then very rapidly as the sparking voltage is reached. The saturation current is the value of current when all of the ions in the field between the two electrodes are acting as carriers. Then in order that the current may increase past point A, Fig. 1, additional ions must be created in some way. This is accounted for as follows. As the voltage between the two electrodes increases, the force acting to attract the ions in the field increases correspondingly, and the ions travel with greater speed toward the electrodes. When they collide with other ions and molecules while on their way to the electrodes, greater forces take place in the collisions and new ions are formed, the number of new ions increasing with the voltage. Finally with large voltage their speed becomes so great as to result in almost a complete breakdown of all the molecules in the field. At this stage the spark passes.

The sparking voltage, which is defined as the lowest voltage that will cause a spark to pass between two given electrodes, depends upon many factors, among them being the shape of the electrodes, the dis-

**MAGNET WIRE**

We are prepared to furnish best grade magnet wire on 1/4 and 1/2 lb. spools at the following revised prices:

**PRICE PER 1/4 LB. SPOOL**

B&S Ga.	Single Cotton	Double Cotton	Single Silk	Enameled
No. 22	\$0.56	\$0.68	\$0.62	\$0.45
No. 24	.60	.77	.67	.47
No. 26	.65	.88	.71	.49
No. 28	.75	1.10	.85	.52
No. 30	.85	1.24	.97	.53
No. 32			1.15	.55
No. 34			1.52	.59
No. 36			1.77	.69

Price on 1/2 lb. spools double above list.

All prices are net and include cost of spool and delivery charges via Parcel Post to any Post Office address in the United States; safe delivery guaranteed.

Send for Circular 21-A giving prices on other sizes, insulations and quantities of Magnet Wire. This circular lists "WIRE FOR EVERY WIRELESS PURPOSE."

**KEYSTONE WIRE COMPANY**  
P. O. Box 120 SCRANTON, PA.

**Canadian Amateurs**

BUY in CANADA and save \$\$\$\$\$\$

Here are a few additions to our stock Variometers and Variocouplers.

- Transmitters for Wireless Telephone..... \$2.50
- Transmitters, Spoon type..... 7.25

**Brown's Famous Receivers**

- 4000 Ohm with cord..... \$19.25
- 8000 Ohm with cord..... 20.50

Shipping weight 2 lbs.

Send for our list .05c

**THE VIMY SUPPLY CO.**  
567 College Street TORONTO, ONT.

**C. W. APPARATUS**

We have for immediate shipment a complete line of C. W. Apparatus and parts. If you are in the market for any type of Radio Apparatus you should have our Bulletin No. 12. Carbon Grain Transmitters—very best, nickel plated..... \$1.45  
Power Tubes—Radiotron U.V. 202, Price... 8.00  
Modulation Transformers..... Price 4.40  
1 and 2 Mfd. Condensers..... Price 1.23  
C. W. Transformer Core for making your own C. W. Transformer—250 Watt Size Price 5.95

We can quote prices on any special apparatus. Send 2 red stamps for our complete list of Radio Apparatus

**EASTERN RADIO & ELECTRIC CO.**  
1405 Florida Avenue Washington, D. C.

**For Various Reasons—**



P articular  
R adio  
A mateur  
C ustomers  
O rder from us.

**PENN RADIO APPARATUS CO., Inc.**  
Box 110 Reading, Pa.

# Another Grebe Triumph!

150-3000 Meters



After much experimental work, we have succeeded in adopting the Armstrong Regenerative circuit to a receiver having a wave-length range of 150-3000 meters. The result is the



TYPE CR-5  
REGENERATIVE RECEIVER

This is a complete receiver. The only additional equipment needed are 'phones, batteries and a detector tube.

Included in its range are amateur, navy and commercial wave-lengths, special land stations, ship CW stations, navy low-wave arcs, all radio 'phone work and "Time." In operation, it is the last word in simplicity.

Ask to see it at your dealers' today.

**GREBE RADIO apparatus is licensed under the original Armstrong and Marconi patents.**

Bunnell & Co., J. H., New York City.  
Central Radio Institute, Independence, Mo.  
Continental Radio and Electric Corp., New York.  
Detroit Electric Co., Detroit, Mich.  
Doubleday-Hill Electric Co., Pittsburgh, Pa.  
Electrical Specialty Co., Columbus, Ohio.  
Holt Electric Utilities Co., Jacksonville, Fla.  
Hurlburt Still Electrical Co., Houston, Texas.

Kelly and Phillips, Brooklyn, N. Y.  
Klaus Radio Company, Eureka, Ill.  
Manhattan Electrical Supply Co., New York, Chicago, St. Louis.  
Leo. J. Meyberg Co., San Francisco, Cal.  
Newman-Stern Co., Cleveland, Ohio.  
F. D. Pitts Co., Inc., Boston, Mass.  
Philadelphia School of Wireless Telegraphy, Philadelphia, Pa.  
Western Radio Electric Co., Los Angeles, Cal.

**A. H. GREBE & CO., Inc.,**

**72 Van Wyck Blvd., Richmond Hill, N. Y.**



602



800



101

## "SHRAMCO SPECIALTIES"

Large Stock

Immediate Shipment

- No. 90—Shramco Reo, 6 ohm, Panel Type Rheostat, each.....\$2.00
- No. 60—Shramco Oscillation Transformer, with four shielded clips, each.....10.00
- No. 61—Shramco Shielded Oscillation Transformer Clip, each......30

### BRASS SWITCH POINTS

- |   |      |        |        |
|---|------|--------|--------|
|   | Doz. | 50     | 100    |
| No. 626— $\frac{1}{4}$ " dia. x $\frac{3}{8}$ " high, with brass screw.....   | .36  | \$1.10 | \$2.00 |
| No. 627— $\frac{1}{4}$ " dia. x $\frac{1}{4}$ " high, with $\frac{3}{8}$ " threaded shank fitted with nut and washer..... | .36  | 1.25   | 2.25   |
| No. 628— $\frac{1}{4}$ " dia. x $\frac{1}{4}$ " high, with brass screw.....   | .30  | 1.00   | 1.75   |
| No. 630— $\frac{1}{4}$ " dia. x $\frac{1}{8}$ " high, with $\frac{1}{2}$ " threaded shank fitted with nut and washer..... | .36  | 1.25   | 2.25   |

### COMPOSITION KNOBS—We Carry 15 Other Styles

- |   |       |       |
|---|-------|-------|
|   | Ea.   | Doz.  |
| No. 602—1" dia. with 8-32 brass bushing.....                  | \$.08 | \$.85 |
| No. 618—1" dia. with 8-32 brass shank 1" long.....            | .10   | 1.10  |
| No. 606— $1\frac{1}{4}$ " dia. as used on No. 750 Switch..... | .15   | 1.65  |

### BINDING POSTS

- |  |     |      |
|--|-----|------|
| No. 800—Panel Type, complete as shown.....                           | .10 | 1.10 |
| No. 600— $\frac{1}{2}$ " Brass Type with brass screw and washer..... | .08 | .65  |

### PANEL SWITCHES

- |   |      |
|---|------|
|   | Each |
| No. 750—Bushing Type, $1\frac{1}{2}$ " Radius as shown, each..... | .75  |
| No. 751—Brass Finish, $1\frac{1}{8}$ " Radius, each.....          | .40  |
| No. 530—N. P. Finish, bushing type, 1" Radius, each.....          | .60  |

### VACUUM TUBES, ETC.

- |  |      |
|--|------|
| No. 180—Electron Relay Detector Tube, each.....          | 6.00 |
| No. 181—Moorehead Amplifier Tube, each.....              | 7.00 |
| No. 165—V. T. Socket for 4-prong base tubes, each.....   | 1.00 |
| No. 101—Grid Leak and Grid Condenser combined, each..... | .50  |
| No. 102—Grid Condenser, .0005 Mfd., each.....            | .35  |

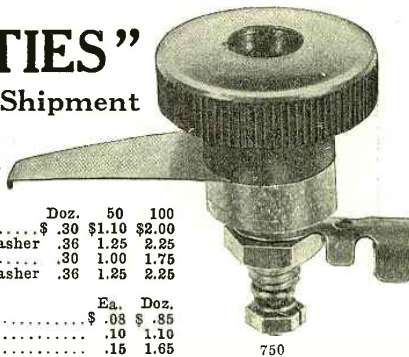

750

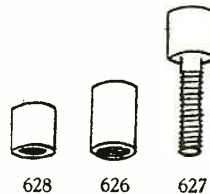

628

626

627

Postage on above extra. Send 5c in stamps for our Catalog K showing complete line of high grade apparatus.

**SHOTTON RADIO MANUFACTURING CO.**  
SCRANTON, PENNSYLVANIA

**LOOK AT THIS**



**COIL MOUNTINGS**

(Pat. applied for.)

Cheapest—Quickest—Simplest—Durable—Anti-Capacity—No Moving Parts—Adjustable Coils Locked in Place—No Wires.  
Solves the lattice coil problem for amateurs. Coils changed in half time.  
Coils lock in mounting when swung to vary coupling. Handle on coil strap provides most convenient means of operating coils.  
All metal parts brass nickel plated; Formica panel, hardwood base.

**WRITE FOR PARTICULARS**

Table Type Mounting..... \$8.00  
Panel Type Mounting..... 6.00  
Plug Complete with Handle and strap.. .70

Above does not include coils. Plugs fit only WIXICO Mounting but are sold separately if desired.

Discount to Dealers.

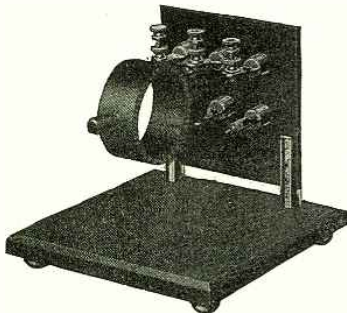

**THE AMOLECCO CO.**  
CINCINNATI, O.



**DUPLEX GAP**

**SENDING RECEIVING**  
An air tight micrometer gap which makes it possible to "Break" as on a land telegraph wire. You can hear the man you are working with through your own sending. Absolutely safe and automatic—no relays on contacts. Just the thing for remote control system. Full instructions. Price \$6.00. Add postage for 1 lb. Request Bulletin 109, which describes this instrument.

**F. M. Doolittle Co.**  
817 Chapel Street

New Haven, Conn.

**Franklin "A" Battery**  
60 Amp. Hour \$12.50  
3 Year Guarantee

**H. F. PARKER & CO.**  
Baltimore Maryland

**Announcing Used APPARATUS DEPT.**

Write for our complete list of bargains in new apparatus as well as used apparatus. Absolutely everything from crystal sets to complete C-W rhomb transmitters, including bulbs, batteries, sockets, rheostats, grid condensers.

Write for particulars.

**WESTCHESTER RADIO SERVICE**  
253 SO. B'WAY YONKERS, NEW YORK

tance between the electrodes, the atmospheric pressure, the humidity or amount of moisture in the air, and the amount of light that is admitted to the sparking space. The sharper the electrodes the lower the sparking voltage. The sparking voltage varies almost directly as the pressure, and the sparking voltage increases with the distance between the electrodes, altho the relation is not a linear one. Sparks will pass at a lower voltage in daylight than in the dark. This is because the light helps some in creating ions.

Whenever a spark passes between two electrodes it is accompanied by a loud crackling sound. This sound is due to the pressure of the spark. The ions in the field of the electrodes acquire considerable kinetic energy. Pressure is proportional to the kinetic energy per unit volume. The actual volume of the spark is very small, so that the ratio of kinetic energy to volume will be high, and therefore the pressure. Pressures of over 100 atmospheres have been measured in some sparks in air.

**Ideal Portable Aerial for Vacationists**

(Continued from page 703)

R. C. wire and running the latter length to the set.

This aerial, designed by the writer, was used with great success for several years by the Albany Signal Corps and it can be un-packt, joined, hoisted and the set attached ready for use in three minutes. Dismantling is equally easy, consisting of disconnecting the set, unfastening the hoisting rope, letting down the top sections, loosening the guy ropes, un-snapping the ropes, unscrewing the wing nut and slipping off the brass collars, pulling section 2 from 1 and 4 from 3, coiling ropes and wires and strapping sections together. Of all the portable aerials I have tried, I consider this "the only one" for its practicability and general utility. I recommend it to the trial of all enthusiastic radio vacationists.

**Continuous Wave Multi-Stage Receiving Circuits**

(Continued from page 690)

the third V.T. The beats produced are rectified by the last valve, whose filament current may be independently varied by means of  $R_4$ .

Various modifications of this circuit are possible. For example, the condenser  $C_3$  may be connected across  $R_2$  if desired. Initial tuning-in to signals may be facilitated by making the first V.T. oscillate and adjusting  $C_1$  and  $L_1$  till the beat note is heard; the coupling between  $R_2$  and the inductance in the anode circuit of the second valve is made less than that required for self-oscillation.

The second figure shows a four-valve re-

**RHAMSTINE★**  
**Radio Products**

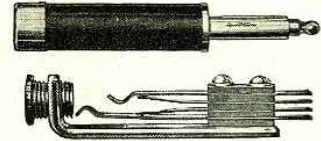

**PLUG and JACK**

Complete - \$1.50 Postage - 4c  
PLUG ONLY, 75c; JACK ONLY, 85c

Ask your dealer for this high-grade, nickel plated plug and jack. Cords easily attached to plug connection. Contacts automatically connect transformer. Eliminates binding posts and switches. If your dealer cannot supply you, order direct. Immediate shipment.

DEALERS WANTED EVERYWHERE

**J. THOS. RHAMSTINE★**  
2152 E. Larned St. Detroit, Mich.

\*Radio Plugs and Jacks.

**BAKELITE CUT THE SIZE YOU WANT IT**

1/8" thick ..... 2c per sq. inch  
1/4" thick ..... 3c per sq. inch  
3/8" thick ..... 4c per sq. inch  
example: 6" x 10" x 1/8" = 60" x 3c = \$1.80 postpaid.

Send for price list of all Radio Supplies & Parts

Agents for Grebe, Bunnell, Federal, Acme, Murdock, etc.

**DETROIT ELECTRIC CO. (Est. 1886)**  
434 Shelby St., Detroit, Mich.

**RADIOTRONS!**

The EFFICIENT vacuum tubes. Designed specifically for the amateur. They give unusual results in standard amateur regenerative circuits.

Radiotron U.V. 200 (Detector and amplifier) ..... \$5.00  
Radiotron U.V. 201 (Pilotron type). 6.50

To get RESULTS that COUNT you should use the new RADIOTRONS. We can make immediate shipment.

**Independent Radio Supply Co.**  
1426 S. Clifton Pk. Ave Chicago, Ill.

Write for Particulars on the New Transmitting Tubes

**ANNOUNCEMENT**

**THE KARLOWA RADIO CORP.**  
STOCK ROOMS, 5TH FLOOR BEST BLDG.  
MAIN OFFICE, 611 BEST BLDG., ROCK ISLAND, ILL.

**HAS PURCHASED THE ENTIRE RADIO BUSINESS OF THE YOUNG & MCCOMBS CO., OF ROCK ISLAND, ILL.**

The new organization solicits your orders as they have heretofore been placed with the old company. A new catalog is in preparation, and until it is issued, you are requested to make your selections from Catalog B and Supplements of the former Young & McCombs Co. Immediate deliveries are guaranteed on all items. Address all orders and correspondence to

**THE KARLOWA RADIO CORPORATION**

611 BEST BUILDING ROCK ISLAND, ILL.

**ANNOUNCEMENT**



# STOP! LOOK! and ACT!

**FREE!** A Plotron V.T. Amplifier, U.V. 201, \$6.50, or an A.P. Navy Type V.T. Amplifier, \$7.00, will be given **FREE** with each Radio Magnavox purchased from us, not later than June 30th.

## THE RADIO MAGNAVOX

*The latest development of the Magnavox Company*

**THE RADIO MAGNAVOX** when used with a suitable amplifier will give forth signals of far greater volume than any other receiver.

**THE RADIO MAGNAVOX** will allow you to have your friends listen to all incoming signals without the necessity for additional apparatus.

**THE RADIO MAGNAVOX** will reproduce radiophone speech, or music to such a degree that it may be used for dancing if sufficient amplification is available.

**THE RADIO MAGNAVOX** does away with a continuous watch, allowing the operator to hear what is going on at his station while in another part of the house.

**THE RADIO MAGNAVOX** is manufactured under the same patents and on the same electrodynamic principle as the MAGNAVOX Radio Tele-megafone.

**THE RADIO MAGNAVOX** will reproduce signals with the same volume as the Radio Tele-megafone.

**THE RADIO MAGNAVOX** can be operated on 2, 3, or 4 dry cells with wonderful results. A six volt storage battery with rheostat is recommended for continuous operation.

**QST**  
**WDNT U LIKE TO HR SIGS**  
**QSA**  
**ALL OVER YR HOUSE?**  
**The Price is within reach of all** \$45.00  
**You need it in your station.**

## THE KEHLER RADIO LABORATORIES

Dept. R, ABILENE, KANSAS

# NOTICE AMATEURS! NOTICE

Our entire stock of Radio Apparatus must be sold at once. 10% flat slash in prices. First come first served. Order now if you wish to take advantage of this offer. Our stock is limited. Only orders accompanied by money orders honored.

### SOME OF THE NEW PRICES

Transmitting	Receiving
Thordarson 1 K.W. transformer.....	C. R. L. Paragon regenerative.....
Thordarson 1/2 K.W. transformer.....	C. R. L.—A-G-N-2.....
Thordarson 1/4 K.W. transformer.....	Grebe C-R-2 regenerative.....
Thordarson Oscillation transformer.....	All other Grebe and Chicago Radio Lab. apparatus at 10% off List.
Benwood super rotary gap.....	Deforest panel units 10% off.
Benwood Discs, 4-8-12-16 point.....	Honey Comb Coils, any size, 10% off.
Amrad 1 K.W. quenched gap.....	Deforest tube sockets.....
Amrad 1/2 K.W. quenched gap.....	Paragon rheostats.....
Amrad 1/4 K.W. quenched gap.....	Magnavox loud speaker, large size.....
Amrad 1 K.W. Resistance.....	Magnavox loud speaker, small size.....
Amrad 1/2 K.W. Resistance.....	A-P Electron Relay tubes.....
Amrad 1/4 K.W. Resistance.....	A P V-T amplifier tubes.....
1 K.W. Dubilier mica condenser.....	A-P Transmitter tubes.....
1/2 K.W. Dubilier mica condenser.....	Radiotrons U-V-200.....
1/4 K.W. Dubilier mica condenser.....	All types of Phones—Baldwin, Brownlie, Liberty, Brandies and Murdock, at 10% off list price.

If your wants are not listed here write us and we will give you prices on whatever you want.

*Everything goes at 10% discount*

## The American Radio Sales and Service Company

GREAT AMERICAN BUILDING, MANSFIELD, OHIO

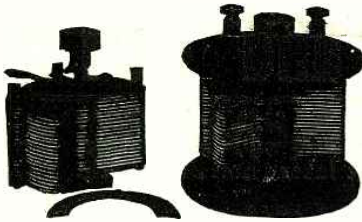

**THE "ILLINOIS" VARIABLE CONDENSER**  
 The Condenser with "Star Spring" Tension  
**MADE RIGHT - STAYS RIGHT**  
 Hard Rolled Aluminum Plates

These condensers are made by a watch mechanic schooled in accurate workmanship and who can't get over the habit of critical inspection.

Three Styles; No. 1, Panel; No. 2, Open Type as shown; No. 3, Fully Encased. Anti-Profitteer. Less than pre-war prices. Fully assembled and tested.

Style No. 1	No. 2	No. 3	Money back if not satisfied.
47 Plates, \$7.00	\$ 5	\$ 4.75	Just return condenser within 10 days by insured Parcel Post.
43 "	3.50	4.50	
38 "	2.75	3.75	
13 "	2.25	3.25	

With Style No. 1, we will, if desired, furnish 3 inch Dial with large knob, instead of Scale and Pointer.

Extra Price 75 cents.

Sent Prepaid on Receipt of Price.

Except: Pacific States, Alaska, Hawaii, Philippines and Canal Zone, add 10c. Canada add 25c.

Foreign Orders other than Canada not solicited.

Kindly note: We issue no Catalog, and make no "trade discounts." We set our prices at the lowest limit, and leave the "middle man" out for the sole benefit of the "consumer."

G. F. JOHNSON

625 Black Ave. Springfield, Ill.

**TUSKA C. W. INDUCTANCE**

Type 181  
 Unmounted

PRICE  
 \$5



Use a Tuska C. W. Inductance in your new tube set. Send your dealer's name and 5 cents for our illustrated C. W. Booklet.

**THE C. D. TUSKA COMPANY**  
 HARTFORD, 3 - CONN.

**Announcing New Location**

**REYNOLDS RADIO SPECIALTY CO.**  
 613-19th STREET  
 DENVER, COLORADO

OUR NEW LOCATION WILL ENABLE US TO CARRY A COMPLETE STOCK OF THE LEADING MAKES OF RADIO GOODS.

Inquire about our new Reynrad Short-wave Coils.

Enclose 6c in stamps for our Catalog and Bulletins.

You can be quickly cured, if you

**STAMMER**

Send 10 cents for 288-page book on Stammering and Stuttering, "Its Cause and Cure." It tells how I cured myself after stammering 20 yrs. B. N. Bouge, 869 Bouge Bldg., 1147 N. 11th St., Indianapolis.

ceiver, which works on the same principle as Fig. 1. The first valve lessens the resistance of the aerial circuit and reinforces the incoming continuous waves which are amplified by the first and second valves, heterodyned by the third and rectified by the fourth. An interesting feature of this arrangement is that it acts as a limiter. The third valve produces oscillations of fixed amplitude, so that incoming signals which are of greater amplitude (when they reach the third valve) than the oscillations taking place there will not produce signals in proportion to their amplitude. When the amplitude of the local oscillations is greater than the amplitude of the incoming oscillations, the signal strength is dependent on the strength of the incoming oscillations. When, however, the local oscillations are the weaker, the signal strength is independent of the amplitude of the incoming oscillations. By taking advantage of this fact, we can use the third valve as a limiting device to prevent very strong signals from completely interfering with weaker ones.

**The H. C. of L. and Burned Out Amplifying Transformers**

(Continued from page 691)

In closing I would like to add that one of my students that the hook-up so satisfactory that he suggested I tell no one until he had had time to go around and buy up all the otherwise-useless amplifying transformers in the City of Honolulu!

**Radio Digest**

(Continued from page 700)

fore, comparatively low. If current is taken from the last of the condensers, it is immediately re-charged by the winding *W*, and this takes place thru the agency of the other condenser; thus the sizes of the condensers vary, and the ones with the highest voltage are the smallest, and the one next the winding will be the largest. In Fig. 1 it is assumed that high-voltage valve tubes are used with cathodes which are heated with current from an external source. The heating terminals are shown

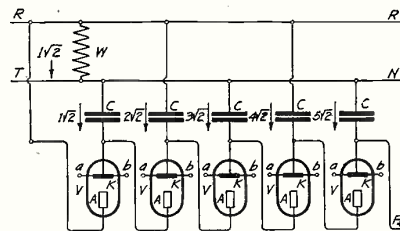

at *a* and *b*. The anodes are shown at *A*. Of course, any other kind of electric valve can be used, if it is capable of withstanding the voltage, or even mechanical commutators. In the latter case we should have a number of rotating contact pieces, mounted on one spindle. This would become somewhat similar to Delon's method, tho it would be simpler, and would not require such a high alternate-current voltage.

The advantage of the new system lies specially in the low cost of the apparatus. If a small amount of current is required, the condensers can be small and cheap. Leyden jars are quite sufficient. The valve tubes are not very expensive. The low voltage of the alternate current is a great convenience. Under suitable conditions,

**BALDWIN PHONES**  
**Special Reduction**

The U. S. Navy, the British, French and several other European Governments, in addition to most professional operators, have adopted BALDWIN PHONES as their standard of electromagnetic receiver excellence.

The reason for this preference is apparent. Exceptional sensitiveness combined with ruggedness gives BALDWIN PHONES their popularity. The diaphragm is made of the finest quality selected mica with the force concentrated at the exact center as in high grade phonograph reproducers. This feature is highly important in the reception of radiophone music.

The small armature is pivoted and designed to act as a fulcrum when connected to the diaphragm by a small link. There is no tension or springing of metal as in ordinary receivers. Two pole pieces of a single solenoid act upon both sides of a highly balanced armature.

Signals that cannot be heard with the best types of ordinary receivers become easily readable with the BALDWIN PHONES.

Original Type "C".....	\$15.50
Regular Price .....	16.50
Improved Type "E".....	19.00
Regular Price .....	20.00
Lighter Type "F".....	20.00
Regular Price .....	21.00

All types are supplied with the standard Baldwin self-adjusting, self-locking headband which is most comfortable to wear.

These BALDWIN MICA DIAPHRAM AMPLIFYING TELEPHONES, which are shipped direct to us from John Pirth & Co., Inc., are absolutely guaranteed to prove fully satisfactory.

**The Kehler Radio Laboratories**

901 West First St., Dept. R, Abilene, Kansas

**NEW ORLEANS RADIO**  
**APPARATUS and SUPPLIES**  
**ROSE RADIO SUPPLY**  
 604 Gravier St., New Orleans, La.  
 Send 10c for Latest Catalog

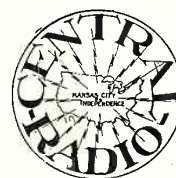

**LEARN WIRELESS**

at the largest radio school in the Central States. Modern complete equipment. Experienced instructors. Dormitory in connection. Students may earn expenses if necessary. Write today for catalogue and full information.

**CENTRAL RADIO SCHOOL**  
 Independence, Mo

**CONNECTICUT RADIO EQUIPMENT**  
 Variable Condensers, Transmitters, Head Bands, Panel Switches, Etc.  
 Connecticut Tel. & Elec. Co., Meriden, Conn.

**STANDARD RADIO EQUIPMENT**  
 AGENTS FOR:  
 MURDOCK BRANDS  
 BURGESS  
 GREBE  
 BENWOOD SPEC.  
 DE-FORREST  
 FEDERAL TEL. AMERICAN RADIO  
 AUDIO TRON.  
 CHICAGO RADIO LAB.  
 DUBLIER  
 TRESCO AND OTHERS  
 U. of I. SUPPLY STORE, Inc.  
 627-29-31 SOUTH WRIGHT STREET  
 CHAMPAIGN, ILLINOIS

**FOR ONE MONTH ONLY**  
 In order to introduce the Radeq Control Panel to the Amateur, we offer these panels complete with tube and B battery for \$15. Add parcel post charges for four pounds. Radio Equipment designed to use apparatus you have on hand. Send specifications for estimate.  
**A. C. PENFIELD** Conneautville, Pa.



# FIRTH RADIO

# SPECIALTIES

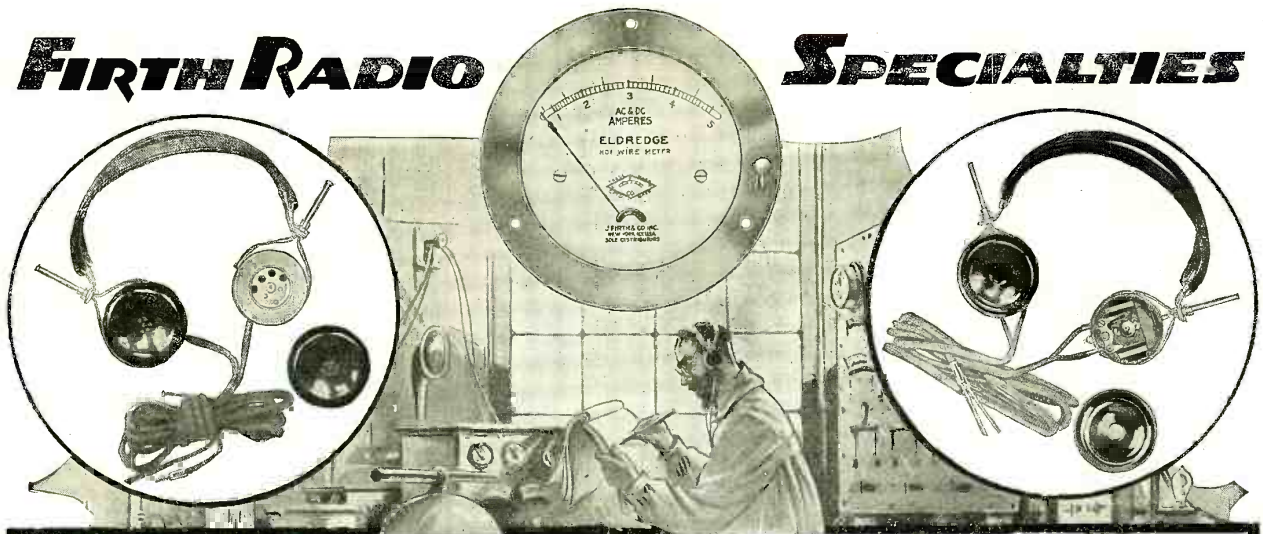

### BALDWIN PHONES

More World's Records.  
On Feb. 11 and 12, 5XB (Agricultural and Mechanical College of Texas), successfully sent radio-telephone messages to 2ZL (J. O. Smith, of Lynbrook, L. I.)  
As usual, Baldwin Phones were on hand to bring in the signals, strong, clear and true. First in H.D. Solvase's 3300 spark reception, then in the trans-continental relay, Jan. 18, now in this 1000 mile radio-telephone reception, Baldys are demonstrating the super-sensitive action of their amplifying mechanism and genuine mica diaphragm.  
Original Type "C" ..... \$16.50  
Improved Type "E" ..... 20.00  
Type "F" ..... 21.00

### ELDREDGE METERS

Each one has hand-calibrated, individually-engraved scale dimensions. Distinguished by their high polish nickel finish, unvarying accuracy over 25 years of service, and the reasonable prices.

Radio Frequency Ammeters and Milli-ammeters \$7.00  
(Model Shown)  
Advance "Midget" Ammeters and Voltmeters, 12 ranges, AC and DC, \$8.00  
Model S-D, specially designed for 60 cycle transformer primary circuits.  
Voltmeters, \$10.00; Ammeters, \$9.50.

### BROWNLIE PHONES

Can be instantly adjusted for changes in signal strength and pitch. Adjustable feature makes them the most sensitive and selective of all metal diaphragm telephones.

Single solenoid core is directly under the exact center of the diaphragm. Eight sensitive springs for support, allow the diaphragm to vibrate thruout its entire area.

One model, 2,000 ohms, light weight, rugged, equipped with Improved Baldwin type headband. Price \$12.50.

Ask your dealer for booklets describing any of the above Firth Specialties.  
If he lacks a supply write, mentioning his name and address, direct to

**JOHN FIRTH & COMPANY, Inc., 18 Broadway, New York**

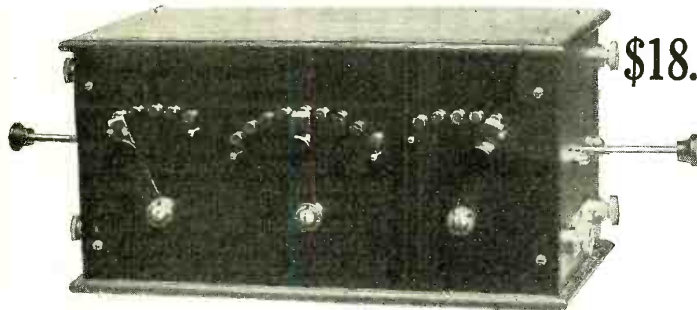

**\$18.**

### Are You Getting Radio Phone Concerts? This Tuner Gets Them Fine

This new Short Wave Regenerative Tuner when used with an audion or vacuum tube detector, a fixed condenser, a headset, and 75 ft. aerial brings in wonderful results from 200-600 meter stations, including radio phone stations.

This tuner has a variable primary, a variable secondary, and a variable tickler coil and has many tuning advantages not possible with fixed inductances. It is the biggest value ever offered for only \$18.00. Finished in quartered oak cabinet and hard rubber panel. It is very selective and efficient. It does not require a variable condenser for 200 meter stations, while many other tuners require two and three variable condensers for best results.

Lyle Halstead, R.D. 5, Auburn, N. Y., says: "I am getting fine results from amateur, commercial and radio phone stations with only one audion detector. Your Short Wave Tuner does all you claim for it and more."

### Can You Hear POZ, YN and the Other Big Stations? Can You Tune Out the Unwanted Stations?

This Long Wave Regenerative Tuner is in a class by itself. The amplification of signals is wonderful. It brings in Arlington time signals as clear as a whistle. Its tuning range includes all of the big trans-Atlantic stations and it gets them too. The peculiar construction and placing of the inductances and couplings enable you to tune in the station you want to read, without interference from other stations.

Price in quartered oak cabinet . . . . . \$34.50  
Price with hard rubber panel . . . . . 40.00

Mr. Carl Woese, President of Radio Club, 802 McBride St., Syracuse, N. Y., says: "Your New Long Wave Tuner is a knockout. Believe me, it works O.K. My aerial is only 75 ft. long. I have heard XDA and NAA very loud, and also have heard POZ and YN with only one bulb. Hear NFF, NDD and WSO all over room with one bulb. With two-step amplifier have heard POZ 100 ft. from phones. With loud speaker, consisting of 1 Baldwin phone clamped onto it and same out of window, my father went half of block away and heard NFF and WSO. Could hear all through house, even down cellar. Your Tuner sure has the wallop, and I never heard one like it. If anybody don't believe it, send them over to see me and I will show them a thing or two."

Send a 2-cent stamp for bulletins

**COLBY'S TELEGRAPH SCHOOL, Auburn, N. Y.**

**\$34.50**

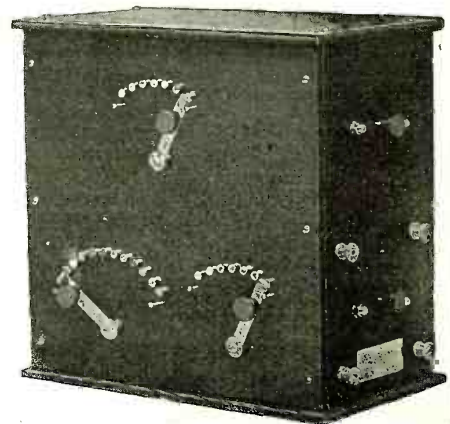

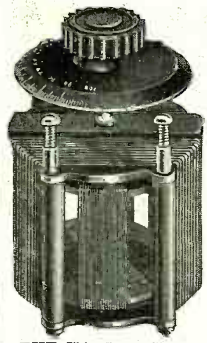

THE VARIOMETER

# The ESCO Regenerative Set

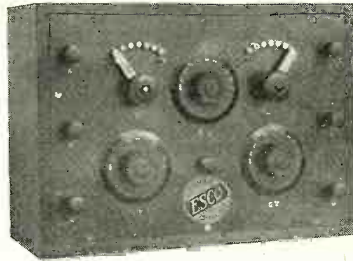

THE SET

## —A Wonderful Success

We again wish to call to the attention of the amateurs the ESCO regenerative receiver. Responses from our first announcement of this set have overwhelmed as well as gratified us. They serve only to convince us the more that we have the most phenomenal success ever attained in regenerative instruments. Orders upon orders for this outfit have piled up and have just as quickly been filled. We have built a large number of these sets in anticipation of just such a rush and are prepared to ship your order upon the day it is received. Price of the set is \$50.00, f. o. b. Columbus, Ohio, or Philadelphia, Pa. Shipping weight is 11 pounds.

Because of the demand by many amateurs who wish to build their own equipment we have decided to market the variometers and couplers as used in the ESCO set separately. The variometer as shown above complete with dial will sell for \$9.50. Without the dial the price will be \$8.50. The vario-coupler which is practically the same as the variometer with the exception that the primary is tapped is priced at \$10.00 complete with dial. Without the dial the price will be \$9.00. Shipping weight on either instrument is 2 pounds. Order direct from us or through your nearest dealer.

DEALERS WRITE FOR OUR PROPOSITION.

## Esco Dials—Plugs and Jacks

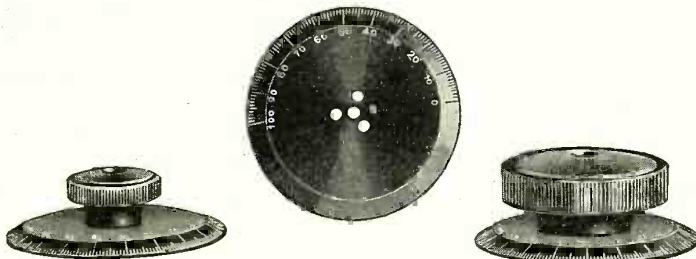

Our dials are of black polished condensite and are 3 inches in diameter with beveled edges. Dials are  $\frac{1}{8}$  of an inch thick and are graduated from zero to 100. Graduations are filled with a brilliant white compound which will not crack or flake.

Plain dial .....	\$0.80
Dial with small knob .....	1.10
Dial with large knob .....	1.50

Shipping weight on any of above 8 ounces.



The cut alongside illustrates a plug and jack which has been on the market for only a short time but have already acquired an enviable following. With their use many practical connections can be affected. Phone and amplifier connections are quickly made in multi-stage circuits. The upper and lower contacts complete a single circuit thru the phones, when removal of the plug automatically connects the amplifying transformer. Jack and plug are nickel-plated and very attractive in appearance.

Plug only .....	\$0.75
Jack only .....	.85
Plug and jack complete .....	1.50

Shipping weight 4 ounces.

Send 15c for our large illustrated catalogue with supplement. This amount will be refunded on your first order for \$1.50 or over. High printing costs makes free distribution impossible.

## Electrical Specialty Company

Dept. R-48-50 So. Front St.  
Columbus, Ohio

Dept. R., 20 N. 9th St.  
Philadelphia, Pa.

ordinary transformers can be used. The accumulators that are necessary for heating the cathodes are the only external accessory. By adjusting the original alternate-current voltage any desired voltage on direct current can be produced, or if the voltage is taken from different condensers, then, again, different voltages with direct current are possible. The high-tension valve tubes protect the arrangement against overloads, as they do not allow more current to pass than that which corresponds to their saturation point. When not in use it can be safely handled. The maximum voltage is not developed in the winding, but in one of the condensers; this is an advantage, inasmuch as a breakdown in the winding might be difficult to repair under many conditions, whereas a condenser or valve tube might conceivably be repaired without great difficulty. In any case, the cheapness of condensers and valve tubes makes it possible to keep a few in stock. The condensers are very easily and quickly charged, so that the direct-current voltage is at once available, and remains substantially constant. Its constancy depends on that of the alternate-current supply.

The defects of the system are, in the first place, that it gives very little current. If a large current is necessary, the capacities must be great, and the apparatus becomes expensive; but this case is not common. Usually a small current suffices. A further disadvantage is the high tension to which the valve tubes and condensers are continuously exposed. The insulation must, therefore, be very carefully designed. Insulation of this sort is not impossible in the present state of our knowledge, but there are, obviously, limitations due to radiation into the air. The device is described in the German patent No. 310,356, which is the property of the Siemens Schuckert works.

\*Abstract of an article in the "Elektrotechnische Zeitschrift," No. 28, 1919.

## Aeroplanes and Radio-Goniometer

(Continued from page 683)

say but "Huh?" when anybody speaks to them in words of more than one syllable.

By the way, "goniometer" means: "An instrument for measuring angles." A radiogoniometer, technically, is an instrument for measuring angles by means of radio.

The Postoffice Department has announced that radio direction finders, including field marking devices, are to be used by mailplanes in making landings in fog, clouds, rain or snow. A non-magnetic non-gyroscopic compass has been devised also. This will overcome the unreliability of the magnetic compass. Whatever improvements may have been made, it is probable that the new direction finders, or radiogoniometers, will utilize the same general principles as that described above. These principles can be studied at first hand by any boy who has or will make a receiving set and connect it with a loop antenna which can be turned to meet the advancing radio waves at any angle.

## Awards of the \$100 Portable Radio Prize Contest

(Continued from page 684)

sheets of tinfoil, 7" by 1½", separated by waxed paper, is rolled into a small bundle, wrap with tape and shunted across the fones.

A schematic diagram of the hook-up is given in Fig. 3.

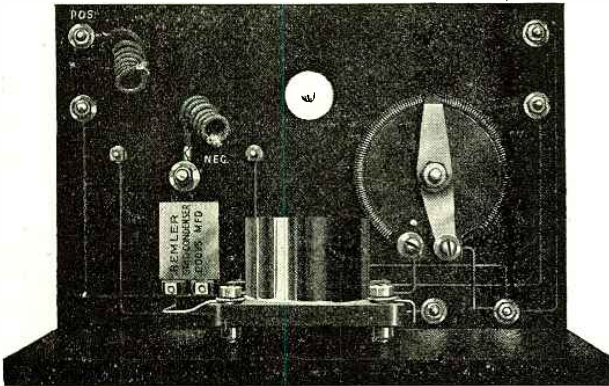
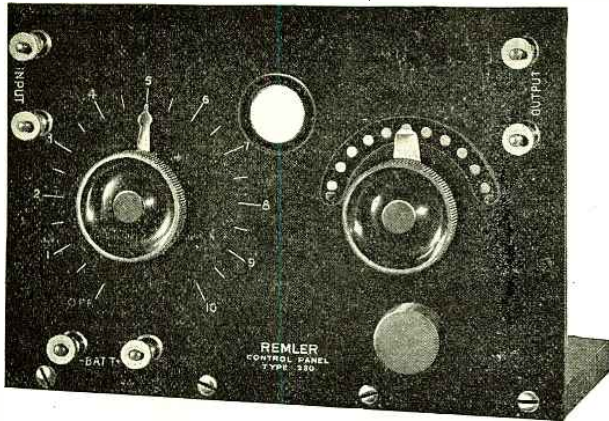

# REMLER TYPE 330 VACUUM TUBE CONTROL PANEL

FOR THE NEW TYPE C-300  
DETECTOR TUBE

*Maximum Value and Quality Through  
Quantity Production*

## THESE SPECIFICATIONS SPEAK FOR THEMSELVES

Genuine bakelite, highly polished, 5" x 7 1/4". White filled engraving. Special smooth running rheostat back mounted. All bakelite VT socket. The new Remler positive metal contact potentiometer for controlling plate voltage. Variable grid leak. Fixed grid condenser. Busbar wiring. Hardwood base. All metal parts polished nickel ..... **Price \$8.00**

DEALERS: Send for our trade proposition on Remler Apparatus.

*"Apparatus that Radiates Quality"*

**REMLER RADIO MFG. COMPANY**  
163 Sutter Street, San Francisco, Cal.

Condenser  
No. 3

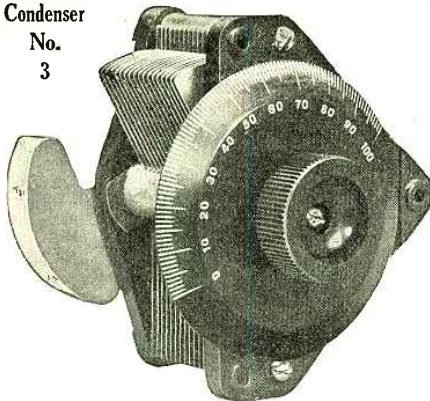

# CHELSEA

Variable Condensers

(Die-Cast Type)

No. 1.—.0011 m. f. mounted.....	\$5.00
No. 2.—.0006 m. f. mounted.....	4.50
No. 3.—.0011 m. f. unmounted.....	4.75
No. 3.—.0011 m. f. unmounted, without dial .....	4.35
No. 4.—.0006 m. f. unmounted.....	4.25
No. 4.—.0006 m. f. unmounted, without dial .....	3.85

Top, bottom and knob are genuine bakelite, shaft of steel running in bronze bearings, adjustable tension on movable plates, large bakelite dial reading in hundredths, high capacity, amply separated and accurately spaced plates.

Unmounted types will fit any panel and are equipped with counterweight.

Purchase from your dealer; if he does not carry it, send to us.

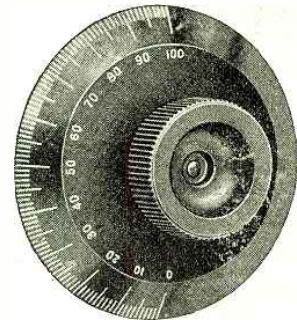

"CHELSEA" BAKELITE DIAL NO. 41.

The Chelsea dials are made of genuine bakelite, beautifully finished, and bear a 100 division semi-circular scale.

The dial is 3 1/4 inches in diameter, 1/4 inch thick, with a long, sloping, easily read marking. Chelsea bakelite dials run true and will not warp.

The complete dial and knob is made to fit either 3/16, 1/4 or 5/16 inch shaft. Specify size when ordering, otherwise the 1/4 inch hole will be furnished.

Chelsea dials are beautiful in appearance, low in price, accurate and durable in service, unexcelled by any, at any price.

Dial and knob complete..... 1.00

Purchase from your dealer.

## VARIABLE GRID LEAK

Permits the selection of the proper leak resistance regardless of the type of tube, or its use as detector, amplifier or oscillator. Ten steps give a range from 1/2 to 5 megohms. Genuine bakelite base and knob.

All our apparatus embodies the highest degree of mechanical construction, electrical efficiency, and good appearance.

Purchase Chelsea Apparatus from your dealer

NEW MARCH BULLETIN SENT UPON REQUEST

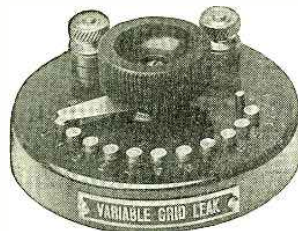

PRICE \$3.00

**CHELSEA RADIO CO., 17 Fifth Street, Chelsea, Mass.**

*Manufacturers of Radio Apparatus and Moulders of Bakelite*

# SPECIAL PREMIUM OFFER

With a Year's Subscription to Radio News or Science and Invention (Electrical Experimenter)

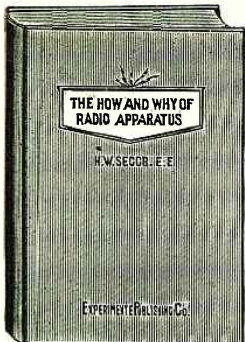

This newest of Radio works, bound in flexible velum and hand sewed, has 160 pages. Size of book 6 x 9 inches.

**Offer A**  
 Science and Invention  
 (Electrical Experimenter)  
 for one (1) year with  
 The How and Why  
 of Radio Apparatus

REG. PRICE	\$3.00
	<u>\$1.75</u>
	\$4.75

**Offer C**  
 Science and Invention  
 (Electrical Experimenter)  
 for one (1) year with  
 A Thousand and  
 One Formulas

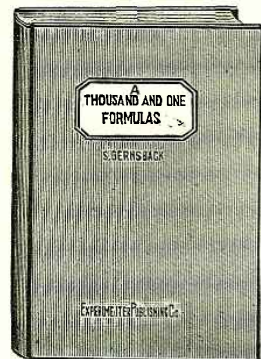

A Laboratory Handbook for the Experimenter. Bound in flexible velum. 160 pages. Size 6 x 9 inches.

**SPECIAL PRICE OFFER, A or C, \$3.75**

**Offer B**  
 Radio News  
 for one (1) year with  
 The How and Why  
 of Radio Apparatus

REG. PRICE	\$2.00
	<u>\$1.75</u>
	\$3.75

**Offer D**  
 Radio News  
 for one (1) year with  
 A Thousand and  
 One Formulas

**SPECIAL PRICE OFFER, B or D, \$2.75**

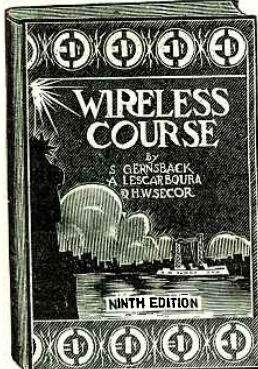

Book is bound in flexible Velum; has 160 pp. Size 7 x 12 inches.

**Offer E**  
 Science and Invention  
 (Electrical Experimenter)  
 for one (1) year with  
 Wireless Course in 20  
 Lessons

REG. PRICE	\$3.00
	<u>\$1.25</u>
	\$4.25

**Offer G**  
 Science and Invention  
 (Electrical Experimenter)  
 for one (1) year with  
 Experimental  
 Electricity Course

**SPECIAL PRICE OFFER, E or G, \$3.50**

**Offer F**  
 Radio News  
 for one (1) year with  
 Wireless Course in 20  
 Lessons

REG. PRICE	\$2.00
	<u>\$1.25</u>
	\$3.25

**Offer H**  
 Radio News  
 for one (1) year with  
 Experimental  
 Electricity Course

**SPECIAL PRICE OFFER, F or H, \$2.50**

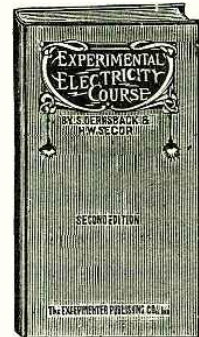

Book is bound in flexible Velum; has 160 pp. Size 5 x 9 in.

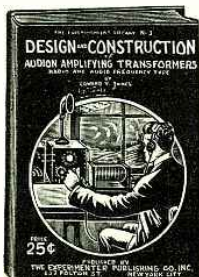

Printed on heavy paper, paper bound. Size 5 x 7 inches. Fully illustrated. The latest book out.



Book has 100 pages. Size 5 x 7 inches. 88 illustrations. Paper cover printed in two colors.

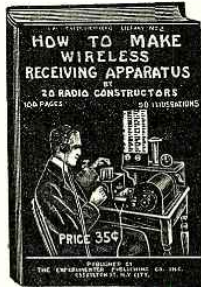

Book has 100 pages. Size 5 x 7 inches. 90 illustrations. Paper bound, in two colors..

**Offer K**  
 Science and Invention  
 (Electrical Experimenter)  
 for one (1) year with  
 Design and Construction of  
 Audion Amplifying-Trans-  
 formers.  
 How to Make Wireless Send-  
 ing Apparatus.  
 How to Make Wireless Re-  
 ceiving Apparatus.

Reg. Price	\$3.00	Special Price to you
		<b>\$3.25</b>
	.95	
	<u>\$3.95</u>	

**Offer L**  
 Radio News  
 for one (1) year with  
 Same Books as Offer (K)

\$2.00	<b>\$2.25</b>
.95	
<u>\$2.95</u>	

EXPERIMENTER PUBLISHING COMPANY, Inc.  
 236-A Fulton Street, New York City, N. Y.

Dear Sir:

I accept your offer ..... Enclosed find \$.....  
 in payment of premium and one year subscription.

Name .....

Address ..... Town..... State .....

With this set connected to the aerial previously described, erected to a height of forty feet, Great Lakes (NAJ) came in loud enough to be heard six inches from the fones. NUR, and a number of ships on Lake Michigan have also been heard, not to mention "Hams."

Altogether it cost me exactly \$2.00 to construct, and I think I am well repaid for my time and trouble, by the results I am obtaining.

WILLIAM F. MARQUARDT,  
4740 N. Ashland Ave., Chicago, Ill.

## Two-Step Audiotron Amplifier

(Continued from page 744)

and breaking, which would sure enough be a calamity in these days of high prices.

Telephone receivers of 2,000 or 3,000 ohm ones should be used. The receivers can be placed in a small cigar box with a hole at the top sufficiently large enough for the placing of a horn, and signals will be heard all over the room. Be sure the diaphragms are facing up toward the hole where the horn is placed in the box.

The condenser used is of the variable type, .0005 or .0002; in fact, the ordinary receiving variable condenser will do the trick very nicely. The condenser should be connected on to the posts marked Con. A grid leak should be used in series or shunted across the variable condenser (1 megohm). A simple grid leak can be made by taking a piece of stout drawing paper and drawing a heavy line upon it with india ink the length of the line to be regulated to the reaching of the desired results.

The other different outside apparatus are connected onto the posts marked for them such as TR, telephone receivers; B1, B battery number one; B2, B battery number two; A1, A battery number one; A2, A battery number two; AT auto transformer, and S is to connect onto the secondary of the receiving transformer.

## Indoor Aerial and Choke Coil Amplifiers

(Continued from page 709)

honeycomb coils. I don't know whether you have QRM but we certainly do have it up near New York. I can copy stuff on my honeycomb coils when nearby regenerative sets are jammed by QRM. That has happened time after time. One relay station in our town, who uses a regenerative set, had to ask for a QTA five times. I copied the message easily the first time with very wide coupling. There is generally so much QRM that I have to put the primary coil almost at right angles to the secondary to get rid of it. Honeycomb coils pick up far distant stations QSA with very wide coupling when a regenerative will not. I picked up 52A in New Mexico with my primary coil almost at right angles to the secondary. I would like to see a regenerative set which would do that with the coils in a similar relation. To my mind it is worth while sacrificing a little signal strength for the great amount of selectiveness. Everybody seems to think that regenerative sets are much better than honeycomb sets. That is not true in our town. My honeycomb set has got better distance than any of the regenerative sets with outdoor aerials. Think it over.

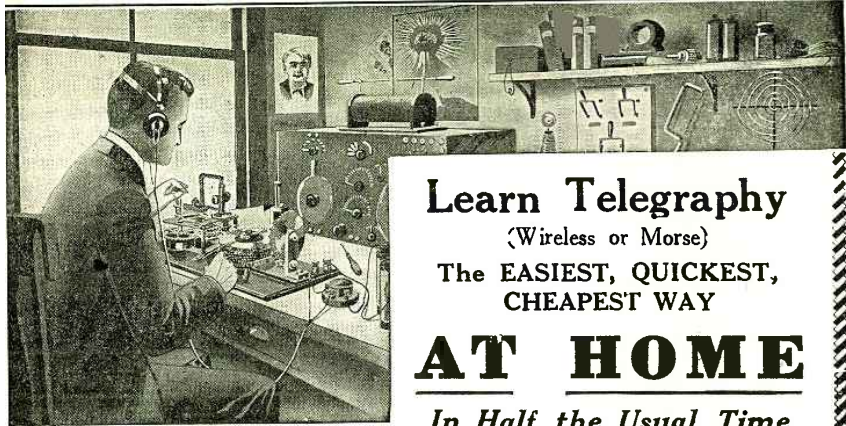

## Learn Telegraphy

(Wireless or Morse)

The EASIEST, QUICKEST,  
CHEAPEST WAY

# AT HOME

In Half the Usual Time

# WITH THE OMNIGRAPH

"Just Listen—The Omnigraph will do the teaching"

The Omnigraph is an *Automatic* Transmitter that teaches you both the Wireless and Morse Codes, at home, without any expense except the cost of the machine itself. Merely connect to battery and your Buzzer, or Buzzer and Head Phones, or to your Sounder and the Omnigraph will send unlimited messages by the hour, at any speed you desire.

USED BY THE U. S.  
GOVERNMENT

The Omnigraph is used by the Government in testing all applicants applying for a Radio License. It is also used extensively by the large Universities, Colleges and Telegraph Schools throughout the Country for teaching Wireless and Morse. Hundreds of the Army's skilled operators who served during the war learned with the Omnigraph.

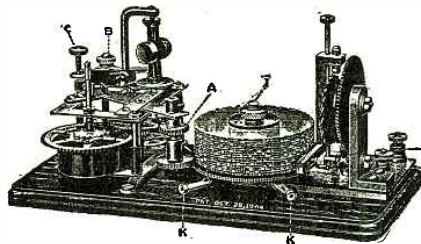

## Let The OMNIGRAPH Teach You Wireless

For a few dollars you can have a complete outfit that will make you an experienced operator in the shortest possible time. No hard, laborious work—just learn by listening. The Omnigraph is adjustable so you can start receiving messages slowly, gradually increasing the speed as you become proficient.

You'll be surprised how quickly you will attain speed. Even if you are already an operator the Omnigraph will help you. It will make you more proficient, more accurate and more confident. Thousands of Omnigraphs are in use today and thousands of operators owe their success to them.

### Write for Free Catalog

Send for a catalog today, showing the 3 different models, \$14 to \$30. Every Omnigraph is sold with the absolute guarantee that you must be satisfied or your money back for the asking. Mail the coupon today—the catalog will come to you by return mail.

The Omnigraph Mfg. Co.  
26 F Cortlandt St.,  
New York City

Gentlemen:—

As per your ad in RADIO NEWS please mail me your free catalog of Omnigraphs.

Name .....

Address .....

City..... State.....

The Omnigraph Mfg. Co.  
26 F. Cortlandt St., New York City



## THE WIZARD "B" BATTERY

Attention Amateurs

15% OFF LIST PRICES

	List Price
No. 1623 Small B Battery, 22½ volts.....	\$1.50
No. 1625 Large B Battery, 22½ volts.....	2.50
No. 1625 Variable B Battery, 1½ to 22½ volts.....	3.50

The above batteries are manufactured according to government specifications. Sent free of parcel post charges. Money back if not satisfactory.

1315 42ND STREET

DEPT. R.

BROOKLYN, N. Y.

## MONEY for You

Spent an hour each day taking subscriptions for the "Radio News." We'll pay you well and you'll enjoy the work. Write for full particulars. Circulation Dept., RADIO NEWS, 236A Fulton St., New York City.

Add to your Salary—Make extra Pin Money. Start a lucrative business of your own.

# OPPORTUNITY AD-LETS

Follow these advertisements every month. Reliable advertisers from all over the country offer you their most attractive specials in these columns.

Classified advertising rate six cents a word for each insertion. Ten per cent discount for 6 issues, 20 per cent discount for 12 issues. Name and address must be included at the above rate. Cash should accompany all classified advertisements unless placed by an accredited advertising agency. No advertisement for less than 10 words accepted.

Objectionable or misleading advertisements not accepted. Advertisements for the June issue must reach us not later than May 10.

## THE CIRCULATION OF RADIO NEWS IS OVER 40,000

EXPERIMENTER PUBLISHING CO. INC., 233 and 234, Fulton Street, New York, N. Y.

### Automobile Accessories.

**Autoists**—"Saviorgas"; easily mixed. Saves gas. Decarbonizer. Recipe, 10c coin. Hawthorne Co., Roslyn, Wash.

**Auto Motors Supplies**—Buick, Michigan, Stoddard-Dayton, E. M. F., Cadillac, Overland, Continental and Buda Motors. All types, \$50 each and up. New Dixie magnetos, \$20; Splitdorf high tension magnetos, \$10; Kellogg pumps \$3.50; Auto-Lite generators, new, \$10; air gauges, 65c; Remy ignition coils, new \$3; electric and gas headlamps, coils, distributor heads, air compressors, etc. Write for catalog. Motor Sales Dept., 16 West End, Pittsburgh, Pa.

### Motor Engines and Dynamos.

**Special Garage Motors**—Manufactured by the General Electric Co.: 1 H.P., \$78.50; 2 H.P., \$110; 3 H.P., \$128.50; 5 H.P., \$166.50. All sizes both single and polyphase motors for immediate delivery. Special charging generators, all voltages. Write for catalog. Motor Sales, Dept. 16, West End, Pittsburgh, Pa.

### Motorcycles—Bicycles.

**Don't Buy a bicycle motor attachment until you get our catalog and prices.** Shaw Mfg. Co., Dept. 1604, Galesburg, Kans.

**Used Parts for all motorcycles.** Schuck Cycle Co., 1922 Westlake, Seattle, Wash.

### Agents Wanted.

**Big Money and fast sales.** Every owner buys gold initials for his auto. You charge \$1.50; make \$1.35. Ten orders daily easy. Write for particulars and free samples. American Monogram Co., Dept. 133, East Orange, N. J.

**Make Big Money**—Sell soldering solution; no acid. Better than paste. Sample 25c. F. Kossatz, Fifth Ave., New Rochelle, N. Y.

### Help Wanted.

**Detectives Earn Big Money.** Excellent opportunity. Travel. Great demand everywhere. Fascinating work. Experience unnecessary. Particulars free. Write, American Detective System, 1968 Broadway, New York, N. Y.

**Be a Mirror Expert.** \$3-\$10 a day; spare time home at first; no capital; we train, start you making and silvering mirrors, French method. Free prospectus. W. R. Derr, Pres., 579 Decatur St., Brooklyn, N. Y.

**Big Money made silvering mirrors, auto headlights, refinishing metals.** Free outfits. Write for particulars. B. Decie Laboratories, 286 Fifth Avenue, New York.

**Young Men!**—Train now for wireless or railway operator or station agent. Largest and only officially endorsed school in Canada. Correspondence and resident courses. Free book R explains. Write Cassan's Wireless School, Toronto.

**Earn \$25 Weekly,** spare time, writing for newspapers, magazines. Experience unnecessary; details free. Press Syndicate, 5665, St. Louis, Mo.

**Wanted**—Radio instructor to take charge of school, A-1 man preferably with teaching experience and college education. Box 100, Radio News.

### Business Opportunities.

**Earn \$50 to \$75 per week tuning and repairing pianos.** We teach you to be an expert. Chicago School of Piano Tuning, River Forest, Ill.

**If You Want to Sell or exchange your farm,** unimproved land, city property or patent, write me. John J. Black, 194th St., Chippewa Falls, Wis.

**Substantial Manufacturing Corporation** wants capable men to establish branch and manage salesmen; \$300 to \$2,000 necessary. Will allow expenses to Baltimore as explained. Address Mr. Clemmer, 603 N. Eutaw St., Baltimore, Md.

**Sell our portable battery charges to wireless operators, car owners, garages, etc.** Average recharge cost ten cents. Price \$15 and up. Attaches to any lamp socket. Harkleroad Co., 1240 First National Bank Building, Chicago.

### Books.

**The Amateur Electrician**—Pocket size, 20c, coin. Joe Tillberg, Proctor, Vermont.

**"Ten Days"**—Stories from Boccaccio's "Decameron"; best you ever read; 35c postpaid. Martin, Box 87, Pontiac, Michigan.

**Safe and Vault Opening Secrets**—How to open 22 different makes. How to work out systems to open any safe or vault, combination setting, etc. Former price \$25; your copy \$5 postpaid. J. Hartmann, Desk C, 913 21st Street, Rock Island, Illinois.

**We Buy and Sell back issues of Radio Amateur News and Electrical Experimenter.** Boston Magazine Exchange, 109 Mountfort St., Boston, Mass.

Roseburg, Ore.,  
Jan. 26, 1921.

RADIO NEWS PUB. Co.,

Dear Sirs:

I put an ad in RADIO NEWS, January issue, 1921, and one day I received a letter from a boy that had read the ad and in two days I had received five letters in regard to the ad. Also, these letters all came before the RADIO NEWS had reached our city.

After this, if I ever want to sell anything, I'll put an ad in RADIO NEWS.

My motto is "It pays to advertise in RADIO NEWS."

Yours truly,

Box 1055 (Signed) EARL PATTERSON.

### Patent Attorneys.

**Patents**—Send for free book. Contains valuable information for inventors. Send sketch of your invention for free opinion of its patentable nature. Prompt service. Twenty years' experience. Talbert & Talbert, 4927 Talbert Bldg., Washington, D. C.

**Patents Secured**—Prompt service. Avoid dangerous delays. Send for our "Record of Invention" form and free book telling How to Obtain a Patent. Send sketch or model for examination. Preliminary advice without charge. Highest reference. Write today. J. L. Jackson & Co., 133 Ouray Bldg., Washington, D. C.

**Millions Spent Annually for ideas.** Hundreds now wanted! Patent yours and profit! Write today for free books—tell how to protect yourself, how to invent, ideas wanted, how we help you sell, etc. 301 Patent Dept., American Industries, Inc., Washington, D. C.

**Mr. Inventor!** Investigate the possibilities of obtaining your own patent. Save \$40 to \$100. We prepare drawings, specifications and claims you file. Quicker action. Let us explain. Enclose stamp. The Plan Bureau, 1929 McCausland Ave., St. Louis, Mo.

**E. T. Brandenburg** (former patent expert, Ordnance Division, War Department), Attorney-at-law and Solicitor of Patents, 927 Loan and Trust Bldg., Washington, D. C. Send sketch and description, or model of your invention for careful investigation at Patent Office and unbiased report as to patentability.

**Competent and Prompt professional attention to patent and trademark matters.** Expert service in radio inventions. "Inventor's Adviser," a cloth-bound library reference book sent free on request. William C. Linton, Patent Attorney and Engineer, 932 National Union Building, Washington, D. C.

### Patents For Sale.

**Stump Fuller, Patent No. 1298372;** outright sale or rights to manufacture on royalty basis. T. H. Monk, 812 Gaskin Ave., Douglas, Ga.

### Chemistry

**Chemistry**—Learn qualitative analysis by the modern simplified chart method, U. S. \$1; foreign countries \$2. Technical Charts, Dept. C-2, 1038 W. Chicago Ave., Chicago, Ill.

**Will Sell chemicals,** chemical, electrical, high frequency and wireless apparatus. Send 5 cents. Karl Peterson, Weldon, Ill.

### Correspondence Courses.

**Dollars Saved.** All kinds of used correspondence courses sold. (Courses bought). Lee Mountain, Pisgah, Alabama.

### For Advertisers.

**Advertise in 100 Magazines.** Words 9c each; three times 18c each. Concordia Magazine, 9A Water, York, Penna.

**Don't Wait for Business.**—Advertise and get it. We will help you. Jacobus Service, 41 Bruen, Irvington, N. J.

### For Inventors.

**Model Making by experts.** Satisfaction assured. Scillitoe, 15 Frankfort St., New York City.

### Health.

**Pyorrhea** (Rigg's disease—bleeding or swollen gums)—hundreds have been helped by "Pyorrident" the successful home pyorrhea treatment. Purifying, healing, preventative. Full month's treatment, consisting of a very beneficial massage paste and an antiseptic tooth-cleansing paste to be used in place of your ordinary dentifrice, together with full directions for treatment. \$1 postpaid. Or write for free booklet "R." Pyorrident Mfg. Co., 439 Seventh St., Brooklyn, N. Y.

**Tobacco or Snuff Habit Cured or no pay;** \$1 if cured. Remedy sent on trial. Superba Co., SB, Baltimore, Md.

### Mailing Lists.

**Canadian Lists of automobile owners, agents, garages, repairers, dealers,** \$3 per 1,000. Lasnier Agency, Bathurst, N. B., Canada.

### Moving Pictures.

**Jazz Movie Portraits,** patented, \$1.50. Machine rights selling. Cenama or Western portraits, 90c set. Samples and list 25c. Tec-Art, 412 Temple, Los Angeles, Cal.

### News Correspondents

**Earn \$25 Weekly,** spare time, writing for newspapers, magazines. Experience unnecessary; details free. Press Syndicate, 566 St. Louis, Mo.

### Novelties.

**Genuine Indian Baskets.**—Wholesale catalogue. Marion Gilhams, Highland Springs, California.

### Phonographs.

**Build Phonographs;** knocked down cabinets, \$2. Catalogue, suggestions on cabinet parts, drawings, dimensions, and instructions, 65c postpaid. Portland Phonograph Supply Works, 48 N. 15th St., Portland, Ore.

**Build Your Own Phonograph.** Big Saving. Blue prints, parts price list, instructions free. Associated Phonograph Co., Dept. R-N, Cincinnati.

**Build a genuine Choraleon phonograph and save over half.** Fine profits building and selling. We furnish motors, tone arms and necessary parts. Send for our catalogue and free blueprint offer. Choraleon Phonograph Co., 421 15th St., Elkhart, Indiana.

### Postcards and Pictures

**Pictures**—"Beach Beauties." Samples 20c. Lucky elephant charm, ivory, 35c. Catalogue 4c. Taylor, Box 1374, St. Louis.

**Two Dimes brings ten San Diego views** which you may return here for mailing. "Fun." "Christies," 2321 5th, San Diego, Calif.

(Continued from page 756)

**Printing.**

Labels, 60c per 1,000 up. Irvin J. Wolf, Station E, Philadelphia.

Everything Printed.—Long run specialists. Samples. Quality Printery, Marietta, Ohio.

100 Cards, business, professional or social; card-case free; 75 cents. Agents wanted. G. B. Pratt, 68 Madison St., Cortland, New York.

**Scenery for Hire.**

Collapsible Scenery for all plays. Amelia Grain, Philadelphia, Pa.

**Song Writers.**

Song Writers!—Learn of the public's demand for songs suitable for dancing and the opportunities greatly changed conditions offer new writers, obtainable only in our "Song Writers' Manual and Guide," sent free. Submit your ideas for songs at once for free criticism and advice. We revise poems, compose music, secure copyright and facilitate free publication or outright sale of songs. Knickerbocker Studios, 319 Gaiety Bldg., New York.

**Stammering.**

St-Stu-t-t-tering and Stammering cured at home. Instruction booklet free. Walter McDonnell, 121 Potomac Bank Bldg., Washington, D. C.

Stammerers—My simple and natural method will correct your impediments. Instruction individual. Samuel I. Robbins, 246 Huntington Ave., Boston.

**Stamps and Coins.**

100 Different Stamps, Nicaragua, Salvador, Victoria, Brazil, Chile, large pictorial French Colonies, etc., album with perforation gauge, only 10c silver. Stamp collections and accumulations bought. Clarence Gibbs, 8932 Juniper, Los Angeles, Calif.

500 Different Stamps, \$1.40; 200, 30c.; 100, 13c.; approvals. Michaels, 5600 Prairies, Chicago.

California Gold Quarter size and Colombia nickel coin 30c; Italy 10 Centimes and catalog 10c. Homer Shultz, King City, Mo.

**Telegraphy.**

Telegraphy (both Morse and Wireless) and Railway Accounting taught quickly. Tremendous demand. Big salaries. Great opportunities. Oldest and largest school; established 46 years. All expenses low—can earn large part. Catalog free. Dodge's Institute, M. St., Valparaiso, Ind.

**Wanted to Buy**

You Can Raise Cash by mailing us any old, broken jewelry, diamonds, platinum, broken watches, false teeth, bracelets, old gold, silver, silver plate, magnet points, platinum wire, contact points or crucibles, mercury and all valuables. We pay the highest prices in spot cash by return mail and will return your goods in ten days if you're not satisfied. The Ohio Smelting & Refining Co., 207 Lennox Bldg., Cleveland, Ohio.

**Wireless.**

Slab Inductances—Set of eight, tuning with .001 MF condenser from 300 to 30,000 meters. Forward money orders \$4.50, made payable at Atlantic Road Brixton to Perry 9 Jelf Road Brixton, London, England, and secure a set post free by return.

Radiosts—10% reduction on Murdock and Clapp-Eastham apparatus. Turney spider-web coils, \$5; copper aerial wire, 100 feet, 60c; 10 Rayolite "B" batteries, \$3.25; Young & McCombs rotary gap, \$14; radiotrons, \$4.75; Wets grid condenser, 20c; galena, per crystal, 15c. Wireless Experimental Testing Station, Stuart St., Binghamton, N. Y.

Laboratory Necessity—Plug type bridge for measuring resistance and capacity, 38 coils, 10 to 4,000 ohms, hard rubber top, mahogany cabinet, blue printed instructions furnished; few left at less than price of wire or plugs alone, \$6.50. Following brand new: 0.32 mfd. mica condensers, puncture proof to 1,400 volts, heavy brass mounting clamp, 85c. Fahnestock connection blocks, 20c; hard rubber encased, 30 ohm, electromagnets, 20c. You pay postage. Western Instrument Repair, 314 N. Fairfield, Chicago, Ill.

Loud Talkers—To those who want an efficient, neat and inexpensive loud talker, one receiver and our horn will fill the want. Three feet long, tapers from 15 in. to 3/4 in. diameter. Hard lacquered, black enamel, inside and out, ornamented with two neat gold bands. Facked, crated, insured and postpaid anywhere for \$2.50. To insure prompt shipments same day order is received, send only money orders to "Loud Talkers," Box 15, Station W, Brooklyn, N. Y.

Stop! Look! and Think! 5 to 30% discount on new well-known regenerative sets, vacuum tubes, power tubes, radiophones and accessories. The Kehler Radio Laboratories, Dept. R, Abilene, Kans.

(Wireless continued)

Build Your Own Regenerative—Seamless, gray cardboard tubes of highest quality for winding forms. Variometer 3/8x2 in. and 4/8x2 1/2 in., per set 25c. Variocoupler, 3/8x2 in. and 4/8x1 1/2 in., per set 35c. 3,500 meter loose coupler tubes 3/4x7 in. and 3/8x7 in., per set 45c. 6,000 meter loose coupler 3/8x7 in. and 4/8x7 in. per set 60c. Loading coils 3/4x14 in., 35c each. 3/8x14 in., 40c each. 4/8x14 in., 50c each. Order today. We'll ship them right off, postpaid. The Taylor Co., Box 1043B, Lowell, Mass.

Stop Look! and Act! New, \$5. Radiotron detectors at \$4.25 each postpaid and insured. New \$6.50 radiotron amplifiers at \$5.75 each postpaid and insured. These are the new genuine super-sensitive radiotron V.T.'s manufactured in the great works of the General Electric Co. and are the result of research work by the foremost vacuum tube experts in the United States. Each and every tube is guaranteed to arrive in perfect condition. The Kehler Radio Laboratories, Dept. R, Abilene, Kansas.

For Sale—Wireless parts. Write J. Donnelly, 107 Talmadge St., Poughkeepsie, N. Y.

Remarkable Bargains—Used radio apparatus. Amateurs in Missouri and bordering states send for list. Central Radio, Independence, Missouri.

Make Your Station Look Alive—Show a set of high-class warning signs. Five wordings—Danger, High Voltage, Do not touch the instruments, Please be quiet while operator is receiving, Government licensed radio station, Experimental radio laboratory, No admittance. 2 for 25c. All 5 for 50c. Postpaid. The Taylor Company, Box 1043B, Lowell, Mass.

Central Radio Company (Incorporated), Independence, Missouri. (Nine miles from the heart of Kansas City.)

Your Call Letters in handsome gold, black-bordered letters 3 inches high. A wonderful addition to your station. Any call letters on 8x10 in. glass sign for \$1.50 postpaid. Your name on the sign also in one inch high gold letters at 10c per letter extra. You want one so order today. The Taylor Co., Box 1043B, Lowell, Mass.

Lightning Service to Central West amateurs. Immense stocks, all leading makes. Catalog free. Central Radio Co., Independence, Missouri.

Make Your variable condensers 1/32 aluminum plates, 4c. Write for particulars. Gravenstede, 84 Hancock Ave., Jersey City.

Want Something Quick?—Order from Central Radio.

Amateurs' Attention!—New wind and weather code chart, neatly arranged on blue print, 10c coin. E. H. Cummings, 18 Richard St., Auburn, R. I.

Wireless Receiving Station Free with our practical new home study course. Write for information. Central Radio School, Independence, Mo.

Radio Equipment of all kinds. Agents for Murdock, DeForest, Signal, Tesco, Cunningham and many other lines. Write for pamphlet describing our Torode rotary spark gap. Garver Hardware Co., Des Moines Iowa.

Central Radio—For lightning service.

Listen Fellows—We make sets to specifications, expert workmanship. Fair prices. Audion sockets 65c postpaid. No stamps accepted. Kenny Radio Laboratories, R. F. D. No. 2, Elizabeth, N. J.

Special Sale of Parts for radio apparatus. In order to liquidate a large stock we are offering at practically half price the following sets of complete units ready for assembly. This is an excellent opportunity to make a start in wireless. We have the following ready for immediate shipment, by parcel post prepaid, on receipt of remittance: receiving tuner, 60c; loose coupler, 2,000 meter, \$2; variable condenser, .005 Mf., \$3; crystal detector, 70c; No. 14 antenna wire, 100 ft coil, 60c; transmitting helix, \$2; 1/2 in. spark coil (complete assembled), \$3.50; zinc spark gap with polished bakelite base, 70c; hand key, 50c; 1/2 K.W. radio transformer, \$1.25; 1,000 ohm head phones, single, \$2; 2,000 ohm head phones, double, \$3.75; strain insulators, 12c each; filament rheostat, 8 ohms, \$1.75; set of tools consisting of pliers, large and small screw drivers, 25c; no catalogues. Send orders immediately. Kilbourne & Clark Mfg. Co., Seattle, Wash.

Get a License before you transmit. Our booklet, "Amateur Licenses and How to Get Them" tells you all you need to know. Postpaid 15c. Order at once, limited supply. First come, first served. Philadelphia Radio Supply, 5714 Hazel Avenue, Philadelphia.

Pre-War Prices—Variocouplers wound on bakelite tubes, \$5.25; variometers, inside windings, \$4.25, assembled for panel mounting; oak cabinets with bakelite panels 5x5x6 in., \$2.25; hardwood rotars, centered, 0.70. All parts carried in stock for regenerative sets. Meade Bakelite Radio Apparatus, 975 Putnam Ave., Brooklyn, N. Y.

Storage "B" Batteries—Fellows end your B battery troubles. Our new alkaline storage B batteries which are equipped with switches giving one cell control and rectifiers for charging will last indefinitely. Thirty-two volts, \$8; 50 volts, \$10; 70 volts, \$12. Pictures and further information upon request. L. W. Kimley, 290 Winslow Ave., Buffalo, N. Y.

(Wireless continued)

Our Special for this Month—This month we are making a special offer on Chelsea apparatus, and for one month we are making an offer of 5% less than list prices and all goods fully guaranteed and will be shipped by insured parcel post paid. We handle all the best grades of radio apparatus and practically make shipment the same day the order is received. Radio Mail Order Supply Co., 533 West End Avenue, New York City.

Radio Phonists' Attention—High voltage generators. We supply motor generator units in various capacities especially designed for radio phone work. Low powered rotary converters, dynamometers, fractional H.P. motors, storage batteries. Various types of meters, condensers, spark gap rotors. The new synchronous spark gap. Get acquainted with our service. Ray-di-co. 2653A, N. Clark St., Chicago, Ill.

Variometers—You can now have as many as you need. We furnish you precision variometer coils ready made, you make the other parts easy. These coils are something new. The dielectric losses are less than half present coils. Send 10c for blueprint instructions and colored circular. Precision Radio Equipment Co., 120 Christie St., Ridgely Park, N. J.

Rewire Your Present Set and hear Hawaiian and German stations with a single bulb. Are you satisfied with your receiving set? Would you like to build one that will receive over 6,000 miles on a single bulb and quit experimenting? One that will be the equal of any regardless of claims or price? Using the instruments you now have you will be able to duplicate the long distance records you read about every day. Get our simple diagram of a complete short and long wave receiver, 175 to 20,000 meters, with which we read Honolulu, California, German, South American, French and English stations, and practically all the high-powered foreign and domestic stations, amateurs as far west as New Mexico and numerous telephone and musical concerts come in good. Diagram and complete instructions, leaving nothing to guess about will be promptly mailed for 50 cents in coin or stamps. Wire a set up and quit wasting good money. Virginia Novelty Co., Martinsburg, West Virginia.

Blue Prints—Twelve proven receiving circuits, each on separate sheet, all for 40c. Ten proven radio phone and two combination VT hookups for transmitting, 50c. Wireless code on large blue print 25c. The Plan Bureau, 1929 McCausland Ave., St. Louis, Mo.

Radio Phonists' Attention—Money refunded if no results are obtained, using my circuit. Complete radiophone outfit, transmits 15 miles clearly. Results are positively guaranteed, operates on 1 "B" battery. Initial cost low, only \$17.40 to construct, upkeep extremely low. Exactly what you have been looking for. Have convincing testimonials from well-known amateurs, praising the circuit highly. Send only \$1 for blue prints and working direction. H. D. Selvage, 1096 Clinton Ave., Dept. R, Irvington, N. J.

Jack to Make One and break one circuit, with plug, 70c; jack to make one and break two circuits, with plug, 90c; jack to make two and break two circuits, with plug, \$1.25. The 90c and \$1.25 jacks have platinum contacts. Heavy brass binning posts, each, 7c; 2000 volt mica condensers, 32 mfd. cap, each, \$1.10; .025 mfd. cap, each, 30c. Litz wire 25-32 per ft., 1c; short wave regenerative receiving set, good construction and very efficient, each \$18.50. Postage extra on all goods. Haupt Electric Supply Co., 2442 Ogden Ave., Chicago, Ill.

Ammeters, new, read 5 amperes charge and discharge, \$1. Postpaid. The Recto Mfg. Co., Inc., 23 W. Third St., Cincinnati, Ohio.

Audion Detector and Amplifier, V.T., 50 cents. Honeycomb coil mountings, 25 cents. Back mounted rheostats, 40 cents. Composition for molding your own knobs, panels, etc. 35c pound. Send stamp for particulars. Palmers Electrical Equipment Co., Palmers, Minn.

The How and Why of Radio Apparatus, by H. W. Scor. E. E. This newest book on radio matters fulfills a distinct gap in wireless literature in that, while the treatment is made as understandable and as free from mathematics as possible, it at the same time incorporates a wealth of technique and instruction for the Radio Amateur—the Radio Operator—the Installation and Designing Expert—as well as teachers and students of the subject in general. A very broad field has been covered by the author, at the same time giving a great deal of information not found in other text books. If you are engaged in any branch of the Radio or allied arts at all, you will surely need this latest contribution to radio literature, which is destined to be found on every radio man's book shelf before long. This newest of Radio Works, cloth bound in Velum de luxe, Gold stamp and Hand Sewed, has 160 pages. Size of book 6x9 inches. "The How and Why of Radio Apparatus," postpaid, \$1.75. Experimenter Publishing Co., Book Dept., 236A Fulton St., New York City.

(Continued on page 758)

(Continued from page 757)

**Electrical Supplies and Appliances.**

Electricians—Wiremen, linemen, send your name and address for descriptive literature of our modern blue print chart method of electrical wiring. Over 350 practical diagrams. Electrical Wiring Diagram Co., Box C-173, Altona, Pa.

De-Sulphating methods are guarded as trade secrets, yet sulphation causes 90 per cent of all storage batteries to be discarded. \$1 brings my guaranteed methods. Secure your A batteries this way. Eugene F. Grossman, electric starter expert, 14 E. Read St., Baltimore, Md.

Storage Batteries for automobiles. We furnish all parts and moulds for making them. Sample plate, 40c. Foreign countries, 50c. Windsor Specialty Co., 5419 Windsor Ave., Chicago, Ill.

Rebuilt starting storage batteries in good condition, 6 volt 60 ampere, \$15 brings it home fully charged. Myer Myerson, 1832 S. 5th St., Philadelphia, Pa.

**Exchange.**

Exchange—Edison Ambrola phonograph with 80 records, for receiving set with audion detector, or sell \$50. Albert Brown, R. No. 4, Greenwich, N. Y.

Genuine "Jupiter" aerial wire now back to the old price of 1 cent per foot, \$9 per thousand. Seven strands No. 22 solid copper. 100% conductivity. No C. O. D's. 15 lbs. per 1,000 feet. Send postage. Lee A. Bates, 8 Moen St., Worcester, Mass.

Bargain—Selling out; 1 K.W. transmitter with a record, complete, \$60; paragon regenerative, \$15; Brandes superior phones, new, \$5; also miscellaneous parts. Barrett, 222 N. Dunn St., Bloomington, Indiana.

For Sale—DeForest unit panel outfit; Ucv 1503 Vernier condenser; U100 variable grid condenser and grid leak; Ulc 400 triple coil mounting; U300 "A" battery switch and phone connections; Uf 200 rheostat; Ur 100 socket; coils 400, 300, 200, 100, 75; price \$30 including cabinet. John Burke, Geldart St., Valley Falls, R. I.

For Sale—Turney, spider-web unit, \$5. Alvan Dean, Brocton, N. Y.

Sell—Transmitting and receiving apparatus, list on request; write. Floyd Daisey, Cape Charles, Virginia.

For Sale—1/2 K.W. Thordarson Type R transformer, Thordarson oil condenser, Murdock oscillation transformer, and Bunnel key, sell all for \$55, you pay express; Meteor phones, cost \$9.19, sell for \$6.50. W. Cooley, 1831A State St., Granite City, Ill.

\$20 Baldwins, \$14—Wireless shop condensers cheap. Everything new. Harold Jones, Ferndale, Wash.

For Sale—8 panel DeForest set includes two-step amplifier, honeycomb coils 150-2500 meters, \$67. W. Cooley, 1831A State St., Granite City, Illinois.

Sell 1/2 K.W. transformer coil \$5; 1 K.W. condenser, \$6; 1 K.W. rotary, \$11; Helix, \$3; key, \$1.50. Hartwig, 4430 Princeton, Chicago, Ill.

Sell—Never used Jewel meters, 500 V. at \$15; 100 M.A. at \$6; 5 A. at \$6 G. R. 2.5 A.H.W. ammeter \$7. E. Hamalaine, General Delivery, Hibbing, Minn.

For Sale—Meccano construction sets cheap, \$15. Johnson hockey skates, size 9, \$8. Maurice Hair, 4734 Congress St., Chicago, Ill.

For Sale—DeForest 15 panel 150-25000 meter receiver, com., \$100; and 2-stage amplifier, \$50; Magnavox radio telegraph, \$60; 1 K.W. transmitter, comp., \$50; radiophone, \$40. Lots others, etc. Write for list and particulars. Hahn's Radio Station, Hamburg, Pa.

For Sale—Short wave regenerative receiver, \$15; detector, two-step amplifier, two audiotron bulbs, no transformers, \$30; large 002 rotary variable condenser, \$10; rotary gap, 30 cycle motor, \$15; large oscillation transformer, \$15; marble switchboard and switches, \$15; 30-cycle 1 K.W. closed core transformer. No junk. Ralph Haynes, 615 Woodlawn Ave., Canon City, Colorado.

For Sale or Exchange—Wireless receiving set (value \$300), for late model motorcycle. A. Greenberg, R. 2, Hackensack, N. J.

For Sale—Slightly used audion panel, \$5; amplifier, \$10. J. Francis, 5230 Superior Ave., Cleveland, Ohio.

Regenerative Units, variocouplers wound on bakelite tubes \$5.25; variometers, \$4.25, inside winding; oak cabinets with bakelite panel, 6x6x6 in., \$2.25; other sizes at proportionate prices; bakelite tubes and panels carried in stock. Meade Bakelite & Radio Apparatus, 975 Putnam Ave., Brooklyn, N. Y.

Sale—R. B. D. 8 Mignon detector, R. C. 2 Mignon receiving set; Brandes Superior phones, 550 feet seven strand copper aerial wire. Fine condition. How much am I offered? Eric Finney, Uhrichsville, Ohio.

For Sale—New DeForest 6 unit panel set, including 8 honeycomb coils, \$38. Write for particulars. Francis Furlong, 733 N. River St., Ypsilanti, Mich.

(Exchange continued.)

DeForest receiving set complete, 3 stage amplifier, paragon regenerative, new, enormous sacrifice; write. Charles Ettl, Leonia, N. J.

Used Apparatus—That's us! Look! V.T. sockets 90c, rheostats \$1.50, panels 6 1/2 x 7, \$1.10; control panels \$6.75, 6 in. bakelite disc 45c, double V.T. sockets \$2.25, triple V.T. sockets \$2.90, knobs 1 1/4 in. 19c. The above is only a few bargains. Get our list. Newark Wireless Exchange, 87 Halsey St., Newark, N. J.

Will Buy Amrad receiving units and sell Kodak. Myron Jacoby, Brentwood, Maryland.

For Sale—Receiving apparatus. Am selling out. Write for list. D. B. Roberts, 1621 Kensington Blvd., Ft. Wayne, Indiana.

For Sale—325 feet copper wire, 500 volt ground switch, 300 ohm phones, 1/2 dozen insulators, 1 wall insulator, 1 anchor gap, 1 plier. \$10 takes everything. H. W. Johnson, Hurley, Wis., Box 751.

For Sale—Wireless instruments cheap. Janitor, 567 Amsterdam Ave., New York City.

New Casting form No. 21, \$4; soulder \$1.50. Hermann Rosenkranz, 781 Grant Boulder, Colo.

For Sale—Mignon RW3 undamped receiver with tube, perfect, \$50; Duck's No. 16 hydro-electric generator, \$10. Might consider trade outside radio line. F. H. Ransford Dalton, Massachusetts.

For Sale—One No. 5 B. B. Duck's loose coupler, \$15; 1 home-made audion control cabinet, complete with bulb and "B" battery, \$15. Ralph Reed, 315 Fifth St. S. East, Watertown, So. Dak.

For Sale—1 K.W. sending set, \$60; same receiving apparatus. Write for list. D. Meirouzw, Pittsfield, Mass.

Harken! Harken! Complete 2,000 mile wireless receiver, with audion, loading coils, phone, "a" everything!—\$30 takes it. Reason—former owner dead. Edward Miller, Woodville, N. H.

Receiving transformer and cabinet, \$10. Send for details. Martinelli, 213 Summit Ave., West Hoboken, N. J.

Bargains—Receiving set, 500 to 12,000 meters, in cabinet 9x12x6 with batteries, but without bulb, \$38.50; regenerative set for amateur commercial reception, \$18.50; 15 amp. ammeter \$5; Ford coil, \$1; polar cub fan, \$3.50; 2-battery bicycle light, \$1.50; new .22 takedown rifle, \$5; hunting knife, \$1.25; 3 pocket flashlights, 55c each. Robert Lehmann, 408 Hastings, Grand Rapids, Mich.

Sale or Trade—Three new Clapp-E amplifying transformers, \$10; one new General Electric type S-1 electric range. Want good transmitting set. C. W. Williams, Cave City, Ky.

Sell Cheap—Mesco coil navy quenched gaps, insulators, other articles. Stamp for list. Winkler, 1332 First Ave., New York.

For Sale—New, never been used, \$3.25 and \$4.25 and postage; 2 Tresco assembled condensers, .001 Mfd. and .0005 Mfd. L. R. Smith, Kennerdell, Pa.

Bargain—Complete panel receiver, less tube, \$25. Herman Seikel, Dover, Ohio

Sell—Regenerative tuner, \$30; 1 1/2 in. coil, \$5; condenser for same, \$1; flanged gap, \$1; heavy antenna switch, \$2.50; Murdock O T., \$3.75; key, \$1; wireless key, \$2.50; Bunnel 150 ohm relay, \$5. Books, etc. P. Schroeder, Wayland Hall, Beaver Dam, Wis. Radio 9AYE.

Exchange—Wheatstone bridge for small lathe. A. Senecal, 437 53d St., Moline, Ill.

Bargain—New navy coupler, 15,000 meters, \$18. Gordon Sargent, 126 Perry St., New Bedford, Mass.

Bargain—Five dial omnigraph with extra dials, \$12; Grebe CR4, \$45; Mignon BD1 audion control, \$18; Blitzen, Murdock 43 plate variable, \$4 each; Hammond typewriter, \$12; two sets of type, \$35. Everything in excellent condition. Wanted Magnavox. Write, phone or call 2HK.

For Sale—Smith Premier typewriter, double keyboard, good condition, \$20. Rollin H. Stewart, 3023 Boulevard Place, Indianapolis, Ind.

For Sale—\$35, or trade for smaller one, large 1 to 5 kilowatt transformer. Write, Francis McKee, Weiser, Idaho.

Pair Brandies Superior phones, complete, \$4; 8 unmounted Universal (honeycomb) coils, 180 to 4500 meters, \$3.75. Add postage on one pound. H. Butterworth, 331 Quincy St., Brooklyn, N. Y.

For Sale or Exchange—Good 1/2 H.P. General Electric D.C. motor. Paul Bietton, 6195 McMillan, Detroit, Mich.

For Sale—1 K.W. Type R Thordarson, \$20; plate glass oil condenser, \$15; "Hyrad" rotary gap mounted, \$15; 1 K.W. oscillation transformer, \$4; a set with a record; Brandes phones, \$5, new. Wanted: Tungar rectifier, half list price. Barrett, 222 N. Dunn St., Bloomington, Indiana.

Regenerative 200-20,000 meter receiving set with two-step amplifier. Audiotron detector and adapter. Radiotron 201 amplifier. Send stamps for description and photograph. Bargain. C. F. Allen, Box 1504, Providence, R. I.

For Sale—20,000 meter loose coupler, \$16; radison detector, \$3.50; vest pocket kodak, \$5; Robert Onstott, Sharpsville, Pa.

(Exchange continued.)

Sale—5 W. E. V.T.'s, W. E. V.T. 2, 12-90 Willard storage battery and 2 9-90's Chamber rotary; Venier rotary, oscillation transformer Marconi jar; 8 pair 2,000 ohm fones; 2 audiotrons; large Universal motor, keys, dial; all A-1 shape; cheap. Walleze, 234 Vine St., Milton, Pa.

For Sale—Complete receiving set for spark reception. F. Kahmer, 1639 W. Lanvale St., Baltimore, Md.

For Sale—1/2 K.W. transmitting set, \$25; 1 DeForest P. 500 audion control panel, with cabinet and "B" batteries, \$15 Wardell Smith, 191 Alexander Ave., Upper Montclair, N. J. Phone 4361.

Bargain—Detector and one-step amplifier in cabinet, with phones, "B" batteries and brand new bulbs, \$55. Isadore Wolf, 1829 Evergreen Ave., Chicago, Ill.

Bargain—For sale, large oak cabinet chemical set, 40 reagents, glass tubing, etc.; all for \$20. Write B. G. Firth, 1109 Broad St., Newark, N. J.

For Sale—Duo-lateral coils, one each, numbers 50, 150, 600; two each numbers 250, 500, 1000, 1500; unit panels, crystal detector "A" battery switch and telephone jack; 15% off prices in DeForest catalogue "D". L. Vexler, 70 Lyons Ave., Newark, N. J.

For Sale—Cheap; radio, electrical and chemical apparatus. Call at Leons, Inc., 28 West 46th St., and ask for Vincent Ingrassia.

Regenerative short wave, complete, bargain, \$65. 2-inch spark transmitter, \$9; Blitzen 43-plate, \$4. Burgess, Closter, N. J.

Selling Out—3,000 meter loose coupler, audion, one-step amplifier and other instruments. Bargains. Write V. S. Scott, Sidney, Ohio.

For Sale—Electro radison detector and potentiometer, \$5; Duck 1500 meter loose coupler, \$4; Brandes Superior phones, \$4; DeForest "A" battery switch and telephone jack panel and double inductance coil panel, \$5. Money orders only. Sent prepaid. Earle Hadley, Bristol, N. H.

Beautiful Receiver in three oak cabinets, DeForest T-200 tuner honeycombs, audion cabinet, "Acc" B 2-step amplifier in cabinet, Brandes phones, 1 A. P. tube, 2 radiotrons, 80 feet antenna, grounds, wire, insulators, "B" batteries, Presto-lite "A" battery, used two weeks, perfect condition, cost \$250. Complete for \$175. L. Weiner, Bicknell, Indiana.

Sell—Motors, power and fan; 10 pounds double cotton covered magnet wire, Crystaloi type "AA" detector, loading coil 36x6, loading coil 36x4 in.; generators, D.C.; small gasoline engine. Write for information. Dwight Ward, Carrollton, Ohio.

Let's Swap! Buy! Sell!—What'd'ye got? What'd'ye want? Forward price, description and quarter for listing, including year's subscription, Swap Bulletin, New York-Detroit-Wichita Falls, Texas.

Swap!—\$55 library for radio apparatus. Mean business or don't answer. Melvin R. Scott, Alamogordo, N. Mex.

For Sale—New typewriter, brass spark plugs, tire protectors, automobile trailer. G. A. Loffelmacher, Fairfax, Minn.

Burned Out V.T.'s.—Have fifteen burned out V.T.'s, mostly transmitters; make offer. Joseph Fairhall, Jr., Electrical Machine Shop, Danville, Illinois.

For Sale—4 in. spark coil with electrolytic interrupter gives 4 1/2 in. spark, \$12; 1 1/2 spark coil with electrolytic interrupter, \$7; \$5 tel-radioc detector, \$2.50; \$37 type X Clapp-Eastham loose-coupler, \$24. Money talks. Randolph Froehlig, 779 Sixth St., Milwaukee, Wis.

Complete Wireless receiving set for sale. Contains receivers, receiving transformer, fixed condenser, variable condenser, audion panel with B batteries and aerial. Price \$45. Delivered. Jack Palmer, Asheville, N. Y.

For Sale—Complete new audion set. Write J. Miller, 3227 Abell Ave Baltimore, Md.

For Sale—V.T., 45 volt B battery, rotor motor and some more radio goods. New cost \$50. Will sell for \$25. Bargain. E. L. Forslund, Madrid, Iowa.

Swap or Sell—Amplifone as described in December issue, page 367, will sell for \$15, or 2 in. transformer coil or rotary gap. R. Fangaroli, 40 Bedford St., New York City.

For Sale—Regenerative set. \$18; money order gets it. Theodore Heinemeyer, 310 Chilton St., Elizabeth N. J.

600 Meter Regenerative Outfit and 2-step amplifier and detector, Grebe mounted on single bakelite panel with battery test voltmeter, with two amplifier bulbs (A-P); first offer \$85; phone (Mesco), \$5. W. D. Cleary, 4 Agate Court, Brooklyn, N. Y.

For Sale—Murdock phones and variable condenser. Write. Elnor Carlson, Comfrey, Minn.

For Sale—1/2 k.w. Packard, \$12. Daryl McCung, 1221-9th Ave., Huntington, W. Va.

For Sale—Four bulb C.W. radiophone set, send stamp for description and price. H. Becker, 3405 Itaska St., St. Louis, Mo.

(Continued on page 759)



(Continued from page 758)

(Exchange continued)

**Receiving Set**—First class, at an attractive price. A. F. McAllister, 1825 Monterey Ave., Chicago, Illinois.

**Bargain**—Audion cabinet with tube, \$10; detector and amplifier units made. R. A. Krauss, 4936 W. 12th St., Philadelphia, Pa.

**For Sale**—Complete wireless set, list free, enclose stamp. Rollin H. Stewart, 3023 Boulevard Place Indianapolis, Ind.

**Swap**—Complete set Hawkins' Guides and Harpers' electrical books for 1-step amplifier. D. Hyman, 51 Sheldon St., Springfield, Mass.

**Sale**—Clapp-Eastham set of regenerative instruments, \$15; iron panel, \$4; violet ray machine, \$10; also B batteries Write R. G. Schlegel, 1113 N. Negley Ave., Pittsburgh, Pa.

**Bargains**—Audion cabinet with one-stage of amplification, phones, switches, wireless keys, spark coils and other instruments too numerous to mention. Send 2 cents stamp for list and prices. Harold Hurley, Box 114, Lake Como, N. J.

**Sale by IAE**—One kilowatt spark transmitter comprising Acme, Dubilier, Benwood, Clapp-Eastham instruments. None separately. Sell complete at nominal price. Prefer local customer but all inquiries answered. Young, 294 Ashmont St., Dorchester, Mass.

**Choice Chamois Skins**—Excellent for polishing and cleaning in the laboratory and home. Guaranteed washable. Large skin \$1; 1/2 skin 60c. We are importers and offer an exceptional opportunity to agents. A Boucher, 23 Kimball, Bradford, Mass.

**Sell**—Marko 4-60, \$6.50; 2,0006 Clapp-Eastham condensers \$6 each; audiotron cabinet, \$8; transportation extra. E. Howard, 218 E. 188th St., New York City.

**Omnigraph Dials** and wireless receiving apparatus for sale cheap. A Hersde, Burlington, Ont.

**For Sale**—Chambers loose coupler, Duck navy coupler, \$12 each. Arlington set, \$10. Five condensers, two switches, Murdock phones. Write, James B. Rich, Hobart, N. Y.

**For Sale**—1 variocoupler, \$10; in excellent condition and tuned good. Carl Staugaard, 4531 N. Rockwell St., Chicago, Ill.

**For Sale**—My valuable stamp collection. First \$3.80 gets it. Clark B. Rice, Jr., 645 Mills Ave., Baton Rouge, La.

**Will Exchange** one 4x5 Serco plate camera for enclosed variable condenser or receiving transformer. Alvin Schaub, Provemont, Mich.

**Found At Last**—A real money maker, indispensable to telephone users. Sells for 25c; costs 1 cent to make. For particulars write That Lab, at Baton Rouge, La., 645 Mills Ave.

**Must Sell** 6 volt, 120 ampere hour Willard storage battery. Bargain, \$12. Geo. Teter, Sheridan, Indiana.

**The How and Why of Radio Apparatus**, by H. W. Secor, E. E. This newest book on radio matters fulfills a distinct gap in wireless literature in that, while the treatment is made as understandable and as free from mathematics as possible, it at the same time incorporates a wealth of technique and instruction for the Radio Amateur—the Radio Operator—the Installation and Designing Expert—as well as teachers and students of the subject in general. A very broad field has been covered by the author, at the same time giving a great deal of information not found in other text books. If you are engaged in any branch of the Radio or allied arts at all you will surely need this latest contribution to radio literature, which is destined to be found on every radio man's book shelf before long. This newest of Radio Works, cloth bound in Vellum de Luxe, Gold Stamped and Hand Sewed, has 160 pages. Size of book 6x9 inches. The How and Why of Radio Apparatus, Postpaid \$1.75. Experimenter Publishing Co., Book Dept. 236-A Fulton St., New York City.

**Just Off the Press**—Design and Construction of Audion Amplifying Transformers (Radio and Audio-Frequency Types). By Edward T. Jones late Associate Editor Radio Amateur News. The transformers shown in this book have never been described in print before and have usually been considered a manufacturer's secret. The designs are very rugged and simple. A book that every radio "bug" should have. Written so you will understand every word. Price 25c postpaid. Experimenter Publishing Co., Book Dept., 236-A Fulton St., New York City.

**Experimental Electricity Course in 20 Lessons**. By S. Gernsback and H. W. Secor, E. E. A course of the theory and practice of Electricity for the Experimenter. New experiments are described and explained and nearly every application of Electricity in modern life is given. 160 pages—400 illustration. Flexible cloth cover, 75c postpaid. Stiff cloth cover, \$1.25 postpaid. Experimenter Publishing Co., Book Dept., 236-A Fulton St., New York.

# They know how—

ONE important reason for the accuracy and speed, which is making Corwin Mail Order Service famous, is that real radio men actually ship your order. Their own thoro knowledge of radio, combined with our up-to-date stock keeping system makes it possible to

send out your order within a few hours after we receive it,—and at the same time fill it correctly and ship it carefully.

Send in your order for any item listed below, and expect the same courtesy, accuracy and speed that have delighted thousands of other amateurs.

## Universal-Coil Mounting Plugs

Anyone can easily make smooth-running mountings with these plugs. No bending, no filing,—they are made to fit exactly in the first place. Suitable for Radisco and all hand-wound coils. A few minutes' work with these plugs will save you dollars that can be put into better apparatus.

Price, 80 cents, postpaid

## New Radisco Vario-Coupler

Described on the center page spread of this issue, now in stock. It's an extremely efficient instrument, accurate to the .002 part of an inch!

Price, \$7.50 postpaid

### VARIABLE CONDENSERS

A. R. Co., .001.....	\$6.25
A. R. Co., .0005.....	5.00
With No. 87 Dial add \$1.00.	
Murdock 366.....	4.75
Murdock 367.....	4.75
Murdock 368.....	3.75
Clapp-Eastham 800.....	7.50
Clapp-Eastham 800A.....	9.50
Clapp-Eastham 800B.....	11.50

Complete with dial.  
Shipping weight One Pound

### GRID CONDENSERS

Radisco, Postage 3 cents.....	.35
-------------------------------	-----

### ANTENNA SWITCHES

Murdock, 3 lbs.....	4.50
Clapp-Eastham, 10 lbs.....	12.50

### OSCILLATION TRANSFORMERS

Murdock No. 424, 5 lbs.....	5.00
-----------------------------	------

### RADIO CRAFT PRODUCTS

Detector.....	15.00
Two Step Amplifier.....	50.00
Detector and 1 step.....	45.00
Detector and 2 step.....	70.00

Postage paid.

### "B" BATTERIES

Radisco No. 1, 2 lbs.....	1.50
Radisco No. 5, 5 lbs.....	2.65

Eveready Storage battery prices on application.

### TUSKA C. W. APPARATUS

181 Coil, 2 lbs.....	7.50
182 Coil, 2 lbs.....	10.00
183 Coil, 3 lbs.....	12.50
170 Filt., 3 lbs.....	16.00

All orders for apparatus not listed as postpaid must be accompanied by postage charges.

# A. H. CORWIN & COMPANY

Dept. B2 4 West Park Street, Newark, N. J.

# Canadian Amateurs

Write to our nearest branch for Price List "B" of Radio Apparatus, Supplies and Publications.

## Scientific Experimenter Limited

Dominion Bldg., Vancouver, B. C.

Arcade Bldg., Halifax, N. S.

Head Office, 11 St. Sacramento St.

Confederation Life Bldg., Winnipeg, Man.

Vaughan Electric Co., 94 Germain Street, St. John, N. B.

MONTREAL, QUEBEC

93 King St., E., Toronto, Ont.

Board of Trade, St. John's, Nfld

Show Rooms, 33 McGill College Avenue

**MONEY for You** Add to your Salary—Make extra Pin Money. Start a lucrative business of your own. Spend an hour each day taking subscriptions for the "Radio News." We'll pay you well and you'll enjoy the work. Write for full particulars. Circulation Dept., RADIO NEWS, 236A Fulton St., New York City.

# "ATLANTIC RADIO" APRIL BULLETIN

## T-A-W HOT WIRE AMMETERS

0-1, 0-2½, 0-5

A FEW LEFT AT

An Exceptional **\$5** Opportunity

Radiotron UV 200 .....	\$5.00
Radiotron UV 201 .....	6.50
Paragon V. T. Control .....	6.00
Paragon 6 ohm Rheostat .....	1.75
Radisco "B" Battery (small) .....	1.50
Radisco "B" Battery (large) .....	2.65
G. E. Variometer .....	6.50
G. E. Variocoupler .....	7.50
"ZRF" Regenerative Set .....	38.00
Murdock Variometer, complete with wood panel, dial and knob .....	7.50
Murdock Variocoupler, complete with panel and 6-point switch .....	8.50
Murdock No. 366 V. Condenser .....	4.75
Interior only .....	4.25
Murdock No. 367 V. Condenser, transparent case .....	4.75
Murdock No. 368 V. Condenser .....	3.75
Interior only .....	3.25
Murdock No. 55 Telephone Headset, 2000 ohms .....	4.50
Murdock No. 55 Telephone Headset, 3000 ohms .....	5.50



**"RADIOTRON" UV-202**

A FIVE-WATT TRANSMITTING TUBE; FILAMENT CURRENT 2.35A. AT 7.5V. PLATE VOLTAGE, 350 V. NOW READY FOR DISTRIBUTION.

**Price, \$8.00 each**

Include Postage on 1 Pound

## Use the "EVEREADY" Six "I" G 60 "A" BATTERY

6 Volt

60 Ampere Hour Capacity  
GUARANTEE—18 MONTHS

### CHELSEA VARIABLE CONDENSERS

No. 1—.0011 m.f. mounted .....	\$5.00
No. 2—.0006 m.f. mounted .....	4.50
No. 3 B. D. .0011 m.f. unmounted .....	4.75
No. 4 B. D. .0006 m.f. unmounted .....	4.25
Radisco Grid Condenser .0005 m.f. ....	.35
G. R. Grid Condenser .0005 m.f. ....	.25
Turney Spider-Web Inductance .....	6.00
"Ajax" Buzzer Practice Set .....	1.75
"Ajax" High Tone Buzzer .....	.50

### EVERYTHING FOR THE AMATEUR

We carry at all times a complete line of the *best* in Radio Equipment.

Our service department will cheerfully answer your questions or give you advice—this service is FREE.

Let us solve your problems!

# C. W. EQUIPMENT

"National" Rheostat, back mt'd, 6 ampere current carrying capacity .....	\$5.50	Acme C.W. Power Transformers	
Tuska Inductance Type 181 (capacity feed-back circuit) .....	2 lbs. 7.50	200 watt mt'd, \$20.00; unmt'd. . . . .	5 lbs. 16.00
Tuska Inductance Type 182 (split-filament type feed-back) .....	2 lbs. 10.00	50 watt mt'd, \$15.00; unmt'd. . . . .	5 lbs. 12.00
Tuska Inductance Type 183 (grid-tickler feed-back) .....	2 lbs. 12.50	Acme Choke Coil, 500 MA capacity .....	3 lbs. 6.00
Tuska Filter, Type 170 .....	3 lbs. 16.00	Acme Choke Coil, 150 MA capacity .....	3 lbs. 4.00
Weston Model 301 milliammeter (plate meter 0-100ma) .....	2 lbs. 8.50	Acme Type A-3 Modulation Transformer .....	2 lbs. 7.00
Weston Model 301 ammeter 0-5A. . . . .	2 lbs. 8.50	Acme Filament Transformers, fully mounted, 50 watt .....	2 lbs. 12.00
G.R. Hot Wire Ammeter, 0-½, 0-1, 0-2½, 0-5A .....	2 lbs. 7.75	Acme Filament transformers, core and coils assembled, 50 watt. . . . .	2 lbs. 9.00
G. R. Tube Socket .....	1 lb. 1.75	Acme Filament Transformers, fully mounted, 150 watt .....	2 lbs. 16.00
"Eldredge" 60-A.C. Ammeter, 0-10A. . . . .	2 lbs. 9.50	Acme Filament transformers, core and coils assembled, 150 watt. . . . .	2 lbs. 13.00
"Hoyt" Flush, Black, A.C. Voltmeter 0-15V .....	2 lbs. 8.00	W.E. Microphone, with bracket .....	2 lbs. 4.05
		Connecticut Microphone .....	2 lbs. 3.95
		Connecticut Microphone, with long arm .....	3 lbs. 4.25

## ATLANTIC RADIO COMPANY, Inc.

88 Broad Street  
Boston 9, Mass.

REQUEST "BULLETIN 14"

Branch: 15 Temple St.  
Portland, Me.

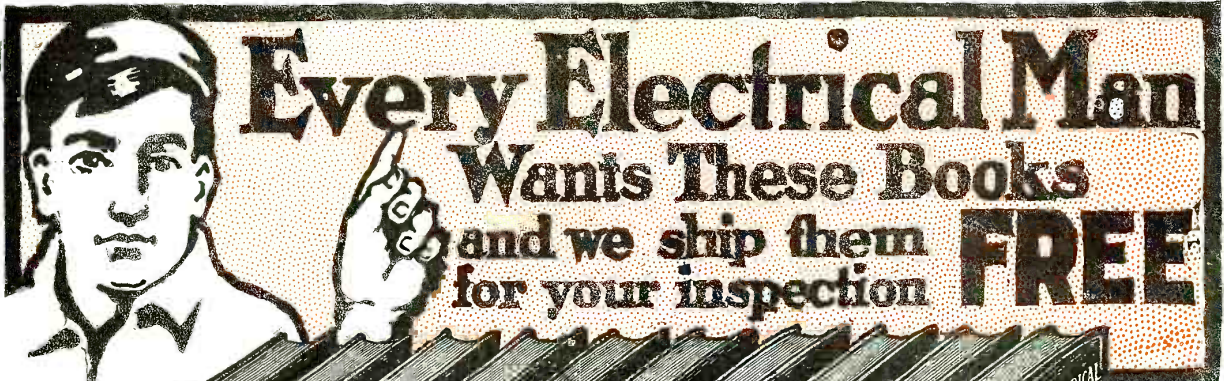

Flexible Covers  
—  
Handy Pocket-Size Volumes

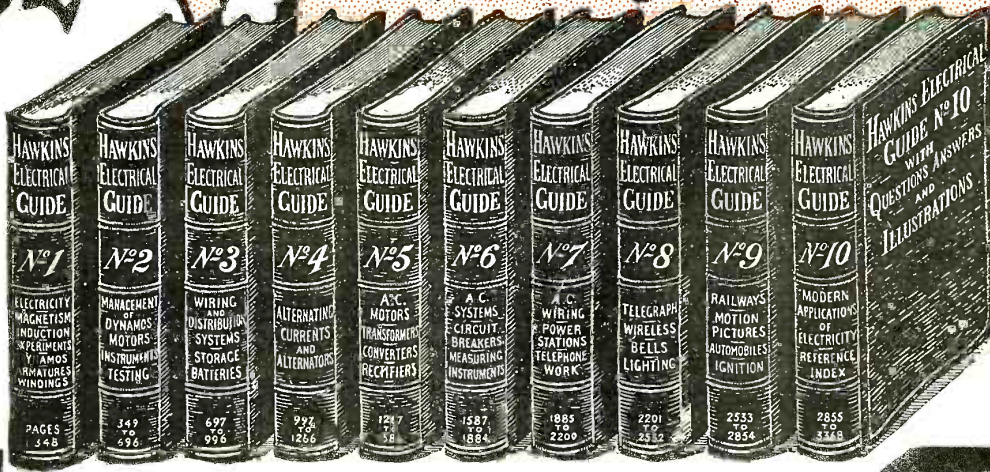

10 Volumes  
3500 Pages  
4700 Pictures  
\$1 Per Volume  
\$1 Per Month

## Just what you need to know to succeed in ELECTRICITY

EVERY electrician, every engineer, every mechanic should know about these wonderfully helpful instructive books, which give in plain words a complete working knowledge of electrical engineering in all its phases.

You run into some new electrical problem almost every day. The information you need to help you in your every day work is in

# HAWKINS ELECTRICAL GUIDES

These books place electricity at your finger ends. They cover every imaginable subject, principle, theory, problem, trouble, and way of doing things electrically. Every subject is indexed so that you can turn right to it. They are a study course and a reference guide in one, written in plain every-day language—no wasted words—only what you need to know—check full of up-to-the-minute electrical knowledge. The guides are a complete course in electrical engineering. They will help you in every detail of the day's electrical work. You can't ask an electrical question that Hawkins Guides can't answer.

### Pocket-Size Flexible Covers

The books are small enough to slip into your coat pocket—handsomely bound in flexible black covers.

You can carry each volume with you until you have mastered its contents. 3,500 pages of actual information and 4,700 illustrations. Once you see these books and put them into actual use you will never again want to be without them. Try it at our expense.

## SEND NO MONEY

It will cost you nothing to receive these books—to look them over—ask them all the questions you can think of—use them in your work—study them—pick up some information that will increase your earning ability. We will ship you the entire set of 10 volumes entirely FREE. This is a sign of our confidence in the guides. Pure gold does not object to being tested. Keep them for seven days and if you do not decide that you can't get along without them, return them to us and owe us nothing.

When you decide to keep them you only have to pay \$1.00 down and remit the balance of \$9.00 on the easy payment of \$1.00 a month till paid for.

Use this coupon to get the books. It will pay you many times over.

**THEO. AUDEL & CO.**  
72 Fifth Ave. New York, N. Y.

SEND NO MONEY - USE THE COUPON

### READ THIS PARTIAL LIST OF CONTENTS

**No. 1** Contains 348 pages, 388 illustrations. Electrical signs and symbols—static and current electricity—primary cells—conductors and insulators—resistance and conductivity—magnetism—induction coils—dynamo principles—classes of dynamos—armatures—windings—commutation—brushes, etc.

**No. 2** Contains 348 pages, 394 illustrations. Motor principles—armature reaction—motor starting—calculations—brake horsepower—selection and installation of dynamo and motors—galvanometers—standard cells—current measurement—resistance measurement—voltmeters—wattmeters—hour meters—operation of dynamos—operation of motors, etc.

**No. 3** Contains 300 pages, 423 illustrations. Distribution systems—wires and wire calculations—inside, outside and underground wiring—sign flashes—lightning protection—rectifiers—storage battery systems, etc.

**No. 4** Contains 270 pages, 379 illustrations. Alternating current principles—alternating current diagrams—the power factor—alternator principles—alternator construction—windings, etc.

**No. 5** Contains 320 pages, 614 illustrations. A. C. Motors—synchronous and induction motor principles—A. C. commutator motors—induction motors, transformers losses, construction, connections, tests—converters—rectifiers, etc.

**No. 6** Contains 298 pages, 472 illustrations. Alternating current systems—switching devices—circuit breakers—relays—lighting protector apparatus—regulating devices—synchronous condensers—indicating devices—meters—power factor indicators—wave form measurement—switch boards, etc.

**No. 7** Contains 316 pages, 379 illustrations. Alternating current, wiring power stations—turbines—management, installation, location, erection, testing, running, care and repair—telephones, etc.

**No. 8** Contains 332 pages, 436 illustrations. Telegraph—simultaneous telegraphy and telephony—wireless—electric bells—electric lighting—photometry, etc.

**No. 9** Contains 322 pages, 627 illustrations. Electric railways—electric locomotives—car lighting—trolley car operation—miscellaneous applications—motion pictures—gas engine ignition—automobile self-starters and lighting systems, electric vehicles, etc.

**No. 10** Contains 513 pages, 599 illustrations. Elevators—cranes—pumps—air compressors—electric heating—electric welding—soldering and brazing—Industrial electrolysis—electro plating—electro-therapeutic—X-rays, etc.

Also a complete 126-page ready reference Index of the complete library. This index has been planned to render easily accessible all the vast information contained in the 10 electrical guides. There are over 13,500 cross references. You find what you want to know instantly.

**THEO. AUDEL & CO.**  
72 Fifth Ave.  
New York, N. Y.

Please submit me for examination Hawkins Electrical Guides (price \$1 each). Ship at once, prepaid, the 10 numbers. If satisfactory I agree to send you \$1 within seven days and to further mail you \$1 each month until paid.

Signature.....

Occupation.....

Employed by.....

Residence.....

Reference..... R. N. April

### What Electrical Men Say Helped Him Make Good

"It is only right for me to recommend highly the Hawkins Guides, for they have been of the greatest assistance to me in placing me in my present position as Superintendent of Construction Department of one of Ohio's largest Electrical Companies. I would like to see every man have a set of Hawkins Guides."  
Geo. Knecht, Columbus, Ohio.

### In the Naval Electrical Dept.

"The Hawkins Guides are great help to me in the Naval Electrical Department, which they cover very thoroughly."  
C. J. Cornell, U. S. Receiving Ship, Brooklyn, N. Y.

### Superintendent

"I am now superintendent of the Dunnville Hydro-Electric Systems, and Hawkins Guides were a great help to me in holding down a responsible position."  
W. E. Swartz, Dunnville, Ontario.

### Wireless Operators

"I have worked wireless for ten years—but I wish I had these books years ago, as they have saved me a great deal of trouble."  
H. Marshall, Steamer M & B No. 2, Walkerville, Ont.

# LEARN WIRELESS At Home By Mail

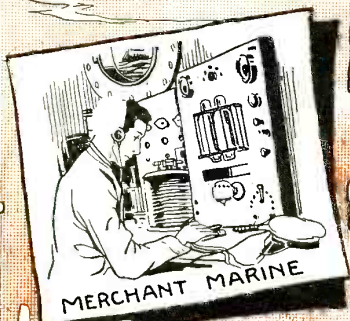

MERCHANT MARINE



LAND COMMERCIAL RADIO



TRAIN DISPATCHING

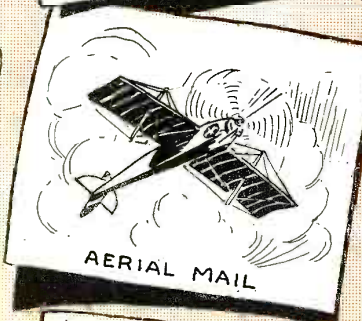

AERIAL MAIL

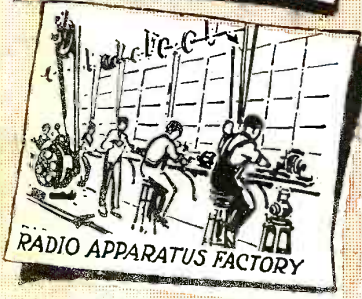

RADIO APPARATUS FACTORY

**W**IRELESS Operators Employed at Good Salaries by Merchant Marine, Commercial Land Radio Service, Radio, Supply Factories, U. S. Navy, Government Service and Aerial Mail. National Radio Institute experts will teach you Wireless at your home by mail, through fascinating course of copyrighted lessons and our famous Automatic Natrometer.

Read About This Splendid Opportunity for the Young Men of America.

### Salaries up to \$3,500

At the very start our graduates are paid \$125 a month which with their allowance for room and board is the equivalent of about \$200 a month. Promotion is sure and steady for the well-trained Wireless man. One of our graduates has risen to \$6,000 a year. Positions and pay are as follows: Supercargo and Wireless Operator—\$175 a month; Radio Mechanic \$1,500 to \$2,000 a year; Radio Aid—\$6 to \$8 a day; Radio Inspector—\$1,500 to \$3,000 a year; Radio Engineer—\$6,000 a year up; Radio Draftsman—\$7 to \$10 a day.

### Travel Without Expense

As a Wireless Operator you can travel, visit foreign countries, increase your knowledge of world affairs while drawing excellent pay. On shipboard you are rated as an officer with fine living quarters. If you do not care to travel, there are positions nearer home at Land Radio Stations and Offices.

### Experts of Nation's Capital Teach You Wireless at Home

The National Radio Institute is headed by experts of the Nation's Capital who have been closely allied with government training of men for wireless positions. Instruction of students is under direction of Jas. E. Smith, former director of Radio Dept. Howard University, and E. R. Haas, formerly of the Radio Division of Yale University. These experts, assisted by a large staff of well-known Radio men, will teach you Wireless by mail, in your home, quickly and easily, in a fascinating practical way, just as they have already taught hundreds of students throughout the world.

### Remarkable Automatic Wireless Instrument FREE

In addition to all necessary text books, including a full set of our up-to-date, copyrighted Lesson Pamphlets, for home study, we present FREE to each student, while taking the course, our remarkable Automatic Wireless Instrument—The Natrometer. It transmits messages in 600 different combinations just as though coming from thousands of miles away. It can be regulated to any speed from 1 to 30 words a minute, works automatically without use of aerials, and comes to you complete with phones, etc., in a neat carrying case. Teaches you practical Wireless at home in a simple though scientific way. It is yours to keep upon completion of the course.

### Pay as You Learn

A small first payment will start these practical lessons on their way to you. You pay as you learn. Many of our students secure wireless positions before completing the course.

### Oldest and Largest Correspondence School of Wireless in America

The National Radio Institute, established in 1914, is today the oldest and largest Wireless School in America teaching Wireless by mail. Our graduates are making good all over the world. We are fully recognized by the U. S. Department of Commerce which allows our graduates five to ten points credit when taking First Grade Government License examinations. The National Radio Institute heads the printed list of Wireless Schools recommended by the U. S. Shipping Board.

### Special Free Offer

Students who enroll promptly receive in addition to our complete course in Wireless Telegraphy, a complete Special Course in Wireless Telephony, and if you wish, a one month Post Graduate Course at our big Washington School. These special privileges are free only to N. R. I. Home Study Students.

**NATIONAL RADIO INSTITUTE**  
Dept. 528  
WASHINGTON, D. C.

# FREE

Write Today for FREE BOOK

Send the following coupon, or a post card today for a copy of our interesting book "Wireless, The Opportunity of Today."

### MAIL THIS COUPON TODAY

National Radio Institute,  
Dept. 528, Washington, D. C.  
Send me your FREE book, "Wireless the Opportunity of Today." Tell me about your Home Study Course in Wireless Telegraphy and Telephony—and free post-graduate course—and your Special Instrument offer.  
Name .....  
Age ..... Occupation.....  
Address .....  
City ..... State.....