

CIRCULATION OF THIS ISSUE OVER 242,000 COPIES

# RADIO NEWS

REG. U.S. PAT. OFF.

25 Cents  
April  
1923

Over 200 Illustrations

Edited by H. GERNSBACK

A RADIO ROMEO

You  
Are Invited  
to

The **RADIO SHOWER**  
MORE THAN  
**750 PRIZES**  
**WORTH** OVER **\$5000.00**

GIVEN FREE BY LEADING  
RADIO MANUFACTURERS

SEE PAGE 1786

THE 100% WIRELESS MAGAZINE

CIRCULATION LARGER THAN ANY OTHER RADIO PUBLICATION





*Immediate Demand for*  
*New*  
**Cunningham**  
*Amplifier*  
**Tube**

**Type C-301-A**

**List Price \$9.00**

The most efficient vacuum tube ever placed on the market for amateur and experimental use. The engineers of the General Electric research laboratories have at last succeeded in perfecting a tube that every owner of a radio set has been waiting for.

**Greater Power Amplification  
 Only  $\frac{1}{4}$  Amp. Filament Current**

**T**HIS new and improved Cunningham C-301-A Amplifier is a high vacuum tube designed for use as an amplifier and detector, containing a new Tungsten Filament, the characteristics of which are long life, low power consumption, low operating temperature and greater power amplification than any previous amplifier tube. The tube has a standard four prong base, and the glass bulb has the same dimensions as the C-300 and the C-301.

The greatly reduced filament current permits the use of four of these tubes without exhausting the A battery any faster than when using one of the previous type of amplifier tubes.

Complete instructions for the care and efficient operation of this new Amplifier Tube are packed with every tube.

Insert a C-301-A in your amplifier set today. Note the improved quality and increased audibility.

*The Cunningham Technical Bureau is at your Service. Address your problems to Dept. R*

248 First Street  
 San Francisco, California

154 W. Lake Street  
 Chicago, Illinois



# FIRST FOR PRICE, QUALITY AND SERVICE. WE SAVE YOU MONEY MAKE YOUR SET WITH GREAT LAKES QUALITY PARTS WE PAY TRANSPORTATION CHARGES IN THE UNITED STATES AND U. S. POSSESSIONS

### PHONES

Genuine Frost, Baldwin and Brandeis head sets complete with cords.

Frost D182—Double head sets, 2000 ohm .....\$4.25

Frost D188—Double head sets, 3000 ohm ..... 4.90

D168—Genuine Type C. Raldwin type phones .....10.50

Type C unit..... 5.75

Brandeis Superior D166—Double head sets 2000 ohm ..... 7.20

### MAGNAVOX

The genuine R-3 Radio Magnavox with the 14 inch horn is the ideal loud speaker for use in homes, offices, amateur stations, etc. It operates from your 6 volt storage "A" battery and amplifies as it reproduces. "B" battery voltage should be 90 to 100 for best results. "Radio brings it. Magnavox tells it."

D170—Radio Magnavox .....\$32.50

### FROST JACKS AND PLUGS

Jacks are polished nickel, nickel-silver springs, pure silver contacts. Nickel washers for mounting on any panel 1-8 to 3-8 inch thick. Spread terminals make soldering easy.

D136—One spring (open circuit). Each.....\$0.46

D134—Two spring (closed circuit). Each..... .52

D131—Four spring (two closed circuits) Each..... .63

D135—Three spring (two open circuits, commonly called "single circuit filament control"). Each..... .70

D136—Five spring (two open and two closed circuits, commonly called "two circuit filament control"). Each..... .88

D132—Plug, telephone type with short knurled grip dial. Each..... .35

D137—Plug (as shown), cord fits into plug..... 1.05

D139—Plug with threaded barrel instead of set screw. Takes cord tips..... .55

### VARIABLE GRID LEAK

Pencil mark type. Removable black enameled cap.

D50—Grid Leak ..... 2c

---

### GRID AND PHONE CONDENSERS

Mounting holes spaced to fit screws of above Grid Leak. Mica insulation, wrapped with varnished cellophane tape. Capacity, .00025 Mfd.

D55—Grid Condensers .....15c

D59—Phone Condenser, .001 Mfd. ....20c

### CABINETS

Mahogany finished cabinets with hinged top, sturdy but light. These make a wonderful appearance. Panels not included. See table for panel sizes.

D217—6x12 1/2	.....\$2.45
D216—7x9 1/2	..... 2.75
D218—7x12 1/2	..... 3.10
D228—7x18 1/2	..... 3.80
D224—9x14 1/2	..... 3.65
D221—7x14 1/2	..... 3.85
D234—12x14 1/2	..... 4.30

---

### PANELS

Genuine Formica Panels to fit our cabinets.

D267—6x12 1/2	.....\$0.65
D269—7x9 1/2	..... .80
D268—7x12 1/2	..... 1.10
D266—7x18 1/2	..... 2.30
D274—9x14 1/2	..... 2.30
D261—7x14 1/2	..... 2.65
D284—12x14 1/2	..... 3.05

### SPAGHETTI AND WIRE

For cabinet wiring. Yellow finish spaghetti.

D33—Per 40 ft. length..... 27c

D32—Tinned Copper No. 16 Wire..... Ft. 2c

D33—Wire with insulation similar to spaghetti on it. Wire is tinned for soldering. Price 10 feet......37c

### INSULATORS

These are very strong strain type insulators. Each Doz.

D360—Moulded Insulator shown above .....\$1.10

D365—Porcelain Insulators ..... .69 .85

### ANTENNA WIRE

The following are 100-ft. coils of 7 strand cable of No. 22 wire, which makes the best Aerial. Use tin snips, where the span is 100 feet or more. It is stronger.

D350—Stranded Phosphor Bronze, 100 Ft.....\$1.47

D355—Stranded Copper, 100 Ft..... .77

D356—Single No. 14 bare solid Copper Wire, 100 ft..... .42

### OUR GUARANTEE YOUR PROTECTION

Your satisfaction guaranteed. If for any reason you do not feel satisfied with your purchase, you may return it and we will refund your money. We will pay return transportation charges.

### 180° VARIOCOUPLER

The primary and secondary windings of this coupler are properly proportioned and spaced. The center of the secondary is always in the center of the primary field. Unlike most couplers, it aids in tuning. High base, brown formica tube and nickelled metal parts. Panel or table mounting.

D1100—Coupler .....\$2.75

### 180° MOULDED ROTOR TYPE COUPLER

This 180 degree variocoupler has heavy black tube and moulded rotor shell. Wound with green silk wire and has 10 taps on the primary. Metal parts are brass nickel plated. Furnished without base, but can be mounted on panel or table.

D1120—Variocoupler .....\$3.75

**DAYTON MOULDED VARIOCOUPLER**  
This is one of the highest grade moulded couplers made.

D1122—Variocoupler .....\$7.20

### VARIABLE CONDENSERS

Very best mechanical construction. Hard aluminum plates. The vernier types are furnished with moulded dial and small knob for adjusting vernier. Plain types have 1/4 inch shaft.

D1443—45 plates .001 Mfd. without dial.....\$2.25

D1423—25 plates .0005 Mfd. without dial..... 1.75

D1411—11 plates .00025 Mfd. without dial..... 1.35

D1403—3 plates .00005 Mfd. without dial..... 1.35

D1441—11 plates vernier .001 Mfd. with dial..... 4.95

D1442—21 plates vernier .0005 Mfd. with dial..... 4.25

### THORDARSON VERNIER CONDENSERS

D1523—25 plate vernier .0005 Mfd. with dial.....\$3.65

D1543—43 plate vernier .001 Mfd. with knob and dial..... 4.35

### INDUCTANCE COIL MOUNTINGS

For base or panel mounting. Connecting leads furnished. Coil settings are adjustable by means of knobs. Made entirely of bakelite with nickelled brass metal parts. Coil position can be locked by knurled set screws.

D1603—Three coil mounting.....\$3.50

D1602—Two coil mounting..... 2.75

D1601—Single coil mounting..... .50

### INDUCTANCE COILS

Rigidly wound, nicely finished, low distributed capacity. All coils are equipped with standard mountings. We can supply any of these coils without mounting plugs, for 5c less than the price shown. The wave lengths shown are range limits, based on a variable condenser of .001 Mfd. capacity.

Number of Turns	Wave Lengths	Price, Mtd.
D1725	25 125-250	\$0.95
D1727	35 175-350	1.05
D1728	50 240-480	1.05
D1728	75 390-910	1.10
D1729	100 500-1450	1.14
D1731	200 900-2250	1.28
D1732	250 1200-3500	1.38
D1733	300 1500-4500	1.38
D1734	500 2800-6100	1.95
D1737	750 5000-12000	1.65
D1738	1000 7000-15000	2.30
D1739	1250 8750-18500	2.55
D1740	1500 14500-26500	2.70

### SWITCH POINTS & STOPS

Brass, polished nickel finish. Screw size, 6/32x3/8 ins. long, two nuts with each contact point and one with the stops. Stops high enough for any type of lever and point.

D130—Switch Point diam. 3/4 inch; height, Each Doz. dret.....\$1.40

D131—Switch Stops 3c 20c

D150—Switch Stops 1c 20c

### SWITCH LEVERS

A high grade, polished nickel-plated lever with solid moulded black composition knob. Complete with panel bushing.

Each Doz.

D151—1/4 in. Radius 18c \$2.10

D152—1/2 in. Radius 18c 2.10

D155—1 1/4 in. Radius 18c 2.10

### VARIOMETERS

For efficiency, perfect inductive ratio, low capacity effect and neatness of design these variometers are unequalled. All metal parts are nickel plated. Stator and ball mahogany finish. Furnished completely assembled and tested.

D1200—Variometer, No. 30 wire.....\$2.55

D1300—Variometer, No. 18 wire..... 2.65

The following knocked-down variometers have the stator windings wound and cemented ready to put in place. Two sizes of wire as listed. Complete with wire and metal parts.

D1205—Knocked-down variometer with No. 20 wire.....\$1.85

### MOULDED TYPE VARIOMETER

This variometer is made of high grade black moulded composition. Wound with green silk wire. Metal parts are nickel plated.

D1220—Moulded variometer.....\$4.95

### DAYTON MOULDED VARIOMETER

This is a bank wound variometer.

D1222—Variometer .....\$6.95

### AUDIO FREQUENCY AMPLIFYING TRANSFORMERS

Correctly designed for minimum distributed capacity and low core loss. Shielded, beautifully finished in nickel and black enamel. Ratio 5% to 1.

D1506—Shielded Transformer.....\$3.75

The unshielded types listed below have terminals mounted on Bakelite panel. Two ratios.

D1510—Transformer, 10 to 1 ratio.....\$3.55

D1503—Transformer, 3 to 1 ratio..... 3.50

### RADIO FREQUENCY AMPLIFYING TRANSFORMERS

Radio frequency transformer circuits help to eliminate static and interference, thus permitting easy, sharp tuning of long distance stations. Enclosed in cast case for shielding and can be mounted in tube socket if desired. Wiring diagrams furnished with each transformer.

D1500—Transformer. Each .....\$3.47

### "B" BATTERIES

Standard high grade radio "B" batteries. Never over five days old.

D230—22 1/2 volt Signal Corps type. Size 3 1/2x2 1/2x 2 1/2 inch. Variable.....\$1.80

D235—22 1/2 volt U. S. Navy variable—5 positive plates. Size, 5x3 1/2x3. Price..... 2.25

D245—45 volt large size. Leads only. Size, 13x1 1/2x3. Price..... 4.00

### BINDING POSTS

Complete with screw and washer. All brass finished, polished nickel or with black composition top as listed. Order by number.

Each Doz.

D110—Large size, all nickel..... 10c 95c

D122—Medium size, nickel, with hole for phone tip or wire 4c 45c

D112—Medium size, black composition top..... 5c 48c

D120—Large size, composition top. 8c 85c

### STORAGE "A" BATTERIES

Built of entirely new parts. With the proper care they should last several years. The De Luxe type has rubber case and cover top as pictured, the Standard type has black wood case similar to ordinary automobile type. Guaranteed to give full rated capacity. All 6 volt batteries.

Number	Hour Rating	Shp. Wgt.	Price
DD 60—De Luxe.....	60	40	\$15.50
DD 80—De Luxe.....	80	50	17.50
DD100—De Luxe.....	100	62	20.50
DS 60—Standard.....	60	35	12.25
DS 80—Standard.....	80	40	14.25
DS100—Standard.....	100	50	16.25
DS110—Standard.....	120	60	18.25

The above storage batteries are the only items on which we do not pay transportation charges. We will ship by Express Collect.

### HOW TO ORDER

Order from this page. Please give number, description and price of the articles you order to help us avoid mistakes. Total amount of your order and send Post Office money order, certified check or draft with order. Enclose for the year name and street address on both letter and envelope. Do not include money for transportation. We pay it except on storage "A" batteries. See ads of previous months for other items.

### BATTERY CHARGER

Charge your storage "A" battery at home by connecting to a 110-volt current. Directions with each charge.

D1500—Battery charger .....\$13.90

### VACUUM TUBES

Genuine Cunningham or Radio-tron made by the General Electric Co. Every tube guaranteed new and in original package. We do not sell "bootleg" tubes.

D-C200—Detector .....\$4.40

D-C201—Amplifier ..... 5.90

### METAL AND BAKELITE SOCKETS

Bakelite brown or silver plated panel or base mounting. Double spring contacts held rigidly in place.

D1076—Bakelite socket.....\$0.65

D1075—Bakelite metal socket..... .45

### WD11 WESTINGHOUSE TUBES

This tube eliminates storage batteries and is operated by a 1/4 volt dry battery. It can be used in any tube having the proper socket or adapter.

D11—Tubes .....\$5.90

### WD11 BAKELITE SOCKET

This socket is to be used with the above tube.

D1077—Bakelite socket.....\$0.75

### WD11 ADAPTER

The purpose of the adapter is to mount directly on back of panel. Usable for a WD11 Tube.

D1078—Adapter .....\$0.80

### VACUUM TUBE RHEOSTATS

This is a reasonably priced, smooth acting rheostat that will mount directly on back of panel. Bakelite arrow knob.

D1050—Rheostat .....45c

Genuine Cutler-Hammer rheostats we believe are the best rheostats on the market today.

Arranged for panel mounting. The picture shows the vernier type. All metal parts nickelled. Plain type is similar.

D1061—Vernier type C. H. Rheostat.....\$1.40

D1062—C. H. Rheostat without vernier..... .85

D1064—Howard vernier rheostat operates on one knob.....\$1.40

D1065—Howard rheostat without vernier..... 1.00

### DIALS

Genuine Bakelite Dial as pictured. Sharply engraved divisions and figures filled with brilliant white. Three-inch composition diameter with bushing for 3/16-in. or 1/4-in. shaft. Set screws included. Each Doz.

D500—Dial.....\$56.40

Three-inch moulded composition dial as pictured. Has a luster that cannot be told from Bakelite. Set screws included. Each Doz.

D550—Dial, 3/16 in. shaft.....\$2.75

D555—Dial, 1/4 in. shaft..... 28c 2.75

### OOSE COUPLER AND TUNING COIL

This loose coupler is preferred by many because of its wide range—200 to 300 meters. All metal parts are brass, mahogany finish. All metal parts are brass, nickel and highly buffed. Secondary has 12 point switch mounted on Bakelite coil head. Windings are green silk-covered wire.

D800—Size, 3 1/2x5 1/2 inch.....\$6.50

D805—Two Slide Tuning Coil..... 2.60

### CRYSTAL DETECTOR

A very high grade glass enclosed crystal detector including the crystal, all metal parts nickel plated. Adjustable to any point on the crystal.

D30—Enclosed crystal detector.....\$1.30

A lower priced but nicely constructed detector. Crystal included.

D30—Detector ..... 88c

### TESTED CRYSTALS

Selected and tested galena or silicon. Each box contains enough for four to six ordinary crystals.

D12—Galena, per pkg.....\$0.12

D13—Silicon, per pkg..... .12

### LIGHTNING ARRESTER OR PROTECTOR

Mount indoors. Porcelain base, nickel-covered core. Listed by the Underwriters' Laboratories under April, 1922.

D300—Protector .....\$1.40



# RADIO NEWS

## CONTENTS

VOL. 4

FOR APRIL

No. 10

	Page		Page
Editorial .....	By H. Gernsback 1771	With the Amateurs .....	1800
Transmission of Photographs by Radio By R. S. Winters .....	1772	About Condenser Aerials .....	1801
Radio Receivers in the Making .....	By D. H. Moss 1774	Super-Experience .....	By Marius Logan 1801
Multiple Receiving .....	By Capt. Fred G. Borden 1775	Notes on the WD-11 Tube .....	1802
Overcoming Difficulties in Radio Reception in the Country .....	By William Harper, Jr. 1775	Calls Heard .....	1802
Radio-Telephony on Transmission Lines .....	1776	High Frequency Resistance and Its Measure- ment By Means of the C.W. Oscillator By L. R. Felder .....	1803
The Itch for Distance .....	By Armstrong Perry 1777	A New Radio Frequency Receiver By Wayne R. Jamison .....	1804
Electrons, Electric Waves and Wireless Tele- phony .....	By Dr. J. A. Fleming 1778	"Popularizing Radio" Once More .....	1805
Some Comparisons Between Light Waves and Radio Waves .....	By Jesse Marsten 1782	An Efficient Detector Amplifier Unit By Arthur W. Lambert, Jr. ....	1806
Awards of the Super-Regenerative Contest .....	1784	Theory of Operation of Crystal Detectors By Bert T. Bonaventure .....	1808
Controlling Models by Radio—Part III By Major Raymond Phillips .....	1786	Radio Digest .....	1809
Radio Shower Party .....	1788	Awards of the \$50 Radio Winkle Contest .....	1810
The Telephone and Microphone .....	By John Depew 1790	Correspondence From Readers .....	1812
The White Radio Bill—H.R. 13773 .....	1792	New Radio Patents .....	1813
Cover Prize Contest .....	1792	Radio News Laboratories .....	1814
Radio in England .....	By M. B. Sleeper 1794	American Stations Heard in Holland By G. J. Eschauzier .....	1815
Mr. Brownlee's Loudtalker By Ellis Parker Butler .....	1797	Club Gossip .....	1816
British Radio News .....	1798	Receiving Without an "A" Battery By Francis J. Andrews .....	1816
Some Suggestions for the Broadcasters .....	1798	Radio Humor .....	1817
C.W. ....	By William A. Griffith, Jr. 1799	With The Sea-Going Op's .....	1818
		I-Want-To-Know .....	1819
		Index to Advertisers .....	1764

RADIO NEWS is published on the 25th of each month. There are 12 numbers per year. Subscription price is \$2.50 a year in U. S. and possessions. Canada and foreign countries, \$3.00 a year. U. S. coins as well as U. S. Stamps accepted (no foreign coins or stamps). Single copies, 25 cents each. A sample copy will be sent gratis on request. Checks and money orders should be drawn to order of EXPERIMENTER PUBLISHING CO., INC. If you should change your address notify us promptly, in order that copies be not mis-carried or lost. No copies sent after expiration.

All communications and contributions to this journal should be addressed to Editor, RADIO NEWS, 842 Jamaica Avenue, Jamaica, New York; or 63 Park Place, New York, N. Y. Unaccepted contributions cannot be returned unless full postage has been included. All accepted contributions

General Advertising Dept., 53 Park Place, New York City. Western Advertising Representatives, Finucan & McClure, 720 Cass Street, Chicago, Ill. Kansas City Representative, Geo. F. Dillon, Republic Bldg., Kansas City, Mo. Pacific Coast Advertising Representatives, A. J. Norris Hill Co., Hearst Bldg., San Francisco, Cal.

Published by EXPERIMENTER PUBLISHING CO., INC., Publishers of "Radio News," "Science and Invention" and "Practical Electrics." Publication Office: Jamaica, N. Y. Editorial and General Offices: 53 Park Place, New York City. H. GERNSBACK, President. S. GERNSBACK, Treasurer. E. W. DEMOTT, Secretary.

are paid for on publication. A special rate is paid for novel experiments; good photographs accompanying them are highly desirable.

RADIO NEWS Monthly. Entered as second-class matter at the Post Office at Jamaica, N. Y., under the act of March 3, 1897. Title registered U. S. Patent Office. Copyright, 1921, by E. P. Co., Inc., New York. The Experimenter Publishing Co., 53 Park Place, N. Y. The contents of this magazine are copyrighted and must not be reproduced without giving full credit to the publication.

RADIO NEWS is for sale at all newsstands in the United States and Canada; also at The International News Co., Ltd., Bream's Building, London E. C. 4, England, and at Brentano's 37 Avenue de l'Opera, Paris.



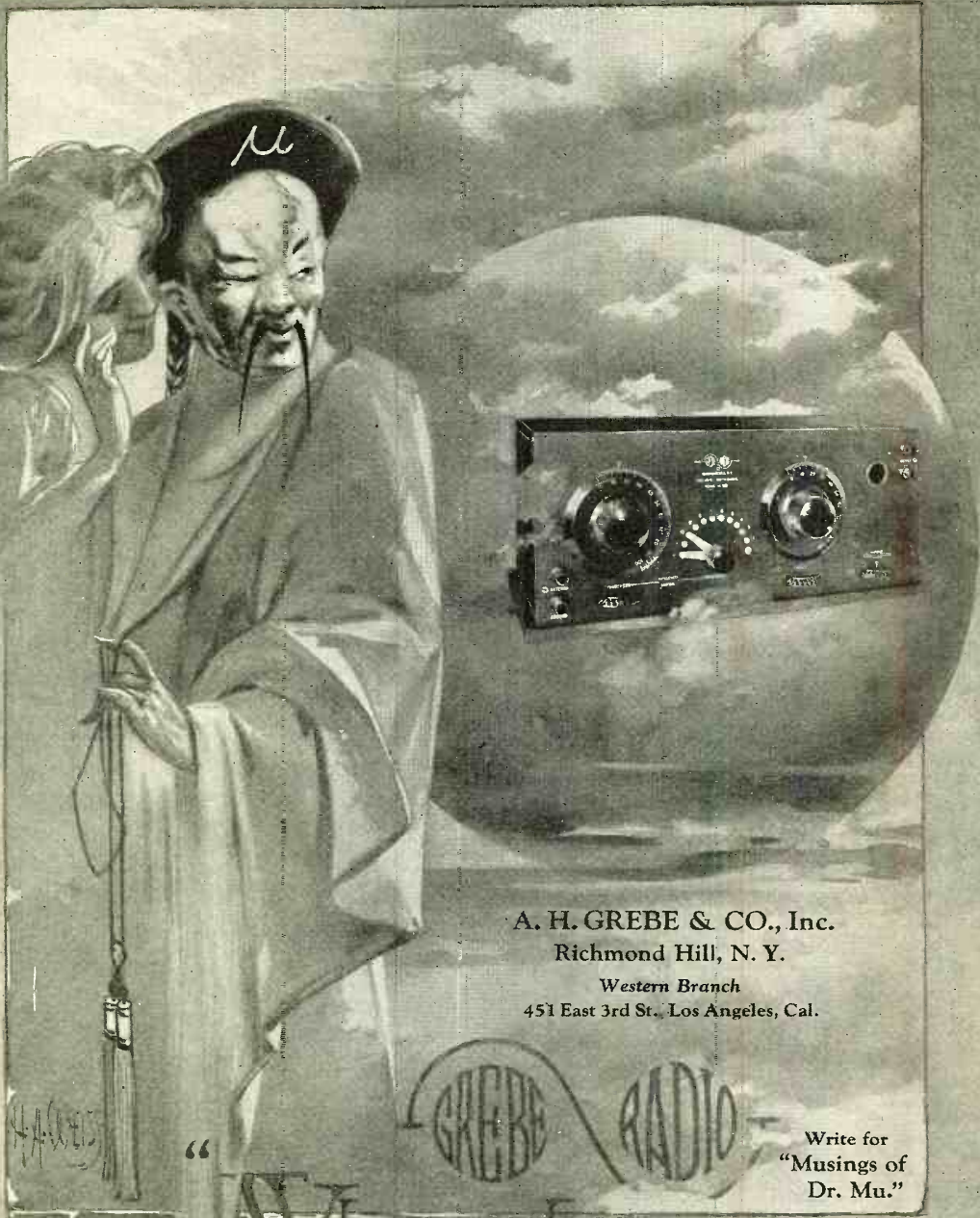

A. H. GREBE & CO., Inc.  
 Richmond Hill, N. Y.  
 Western Branch  
 451 East 3rd St., Los Angeles, Cal.



Write for  
 "Musings of  
 Dr. Mu."

"What is whispered — in  
 the ear is heard miles away."  
 said Mencius.  
 The wise radioist hears voices  
 a thousand miles  
 away with a **Grebe Receiver.**

*Doctor Mu.*

Licensed under Armstrong  
 U. S. Pat. No. 1113149



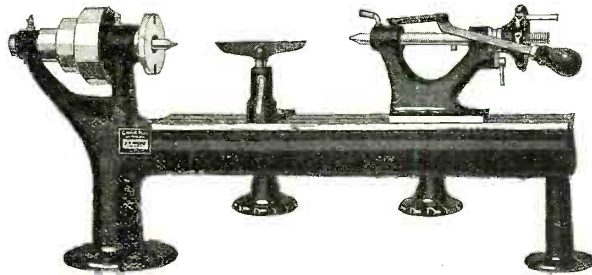

Bench Lathe  
No. 494  
Price, \$40.00

**“Radio work means money for someone,” says Mr. Punch**

Someone is going to size up the opportunity in the radio business. He is going to equip himself with a fine set of tools, and this Bench Lathe will be his first choice.

He will get in on the ground floor and help the radio amateurs to develop their sets. With this lathe, he can wind coils perfectly besides the thousand-and-one things for which lathes are made.

It isn't too costly for a small shop, and it's good enough for a big one. It's a great help, too, in garages, electrical service stations, and miscellaneous repair shops.

Choose from these 1500 good tools. Send for a catalog showing the Goodell-Pratt 1500 Good Tools. Each one is right for its particular job—made by men who know good tools and love them.

GOODELL-PRATT COMPANY, Greenfield, Mass., U. S. A.

*Toolsmiths*

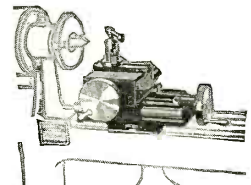

Slide Rest No. 132  
Price, \$17.00

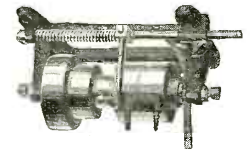

Countershaft No. 130  
Price, \$12.00

**Good tools for motor cars**

Like all the Goodell-Pratt 1500 Good Tools, these are made for good workmen—the most exacting judges of good tools—by toolsmiths who have spent their lives in the business.

Write for complete details concerning the Goodell-Pratt Bench Lathe and other motor tools.

**GOODELL-PRATT  
1500 GOOD TOOLS**

Condenser  
No. 3

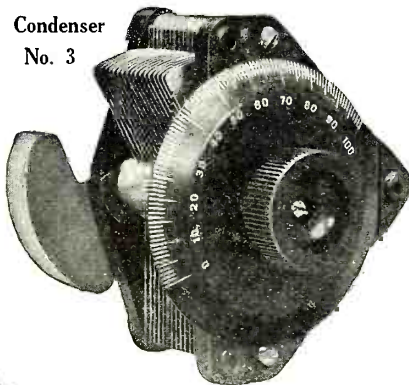

**CHELSEA**

Variable Condensers  
(Die-Cast Type)

- No. 1.—.0011 m. f. mounted..... \$5.00
- No. 2.—.0006 m. f. mounted..... 4.50
- No. 3.—.0011 m. f. unmounted..... 4.75
- No. 3.—.0011 m. f. unmounted, without dial 4.35
- No. 4.—.0006 m. f. unmounted..... 4.25
- No. 4.—.0006 m. f. unmounted, without dial 3.85

Top, bottom and knob are genuine bakelite. shaft of steel running in bronze bearings, adjustable tension on movable plates, large bakelite dial reading in hundredths, high capacity, amply separated and accurately spaced plates.

Unmounted types will fit any panel and are equipped with counterweight. Purchase from your dealer; if he does not carry it, send to us.

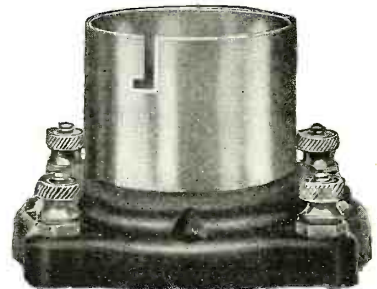

“Chelsea Bakelite Socket No. 60”

This socket has a bakelite base supporting four external, readily accessible binding posts. The tube receptacle is highly polished nickel and will take any standard detector and amplifier tube as well as the smaller size power tubes. It is primarily designed for receiving circuits, and may be mounted on either table or panel. Positive contact springs.

An added beauty to any radio station.

Price as shown, \$1.00

Purchase from your dealer.



NO. 50, PRICE AS SHOWN, \$4.50

The Chelsea Amplifying Trans-  
fer is a supreme attainment in  
design of Audio Frequency  
condensers. It embodies the  
best of materials obtain-  
able in design, which re-  
sults in a high efficiency factor. It is un-  
usually electrical char-  
acteristic.

**GOODELL-PRATT CO., 150 Fifth Street, Chelsea, Mass**

Radio Apparatus and Moulders of Bakelite



# Index to Advertisers

A	Page
Acme Apparatus Co., The.....	1829
Adams-Morgan Co.....	1853
Airway Electric Appliance Corp.....	1870
Aitken Radio Co.....	1894
Ala Mfg. Co.....	1854
Alden Mfg. Co.....	1902
Allen-Bradley Co.....	1845
American Bell Radio Corp.....	1848
American Electric Co.....	1822
American Electrical Heater Co.....	1865
American Governor Company.....	1914
American Hard Rubber Co.....	1873
American Radio Mfg. Co.....	1896
American Radio Stores.....	1877
American Time Clock Repair & Supply Co.....	1908
American Transformer Co.....	1874
Amsterdam Service Exchange.....	1882
Andrae & Sons Co., Julius.....	1880
Andrea, F. A. D.....	1906
Angiers, U. S. A.....	1860
Atlantic-Pacific Radio Supplies Co.....	1855
Atwater Kent Mfg. Co.....	1768-1769
Audiotron Sales Company Inside Front Cover	
Automatic Electrical Devices Co., The.....	1866-1867
Autoyre Company.....	1900
B	
Baehm Paper Company, Inc.....	1904
Bakelite Corporation.....	1901
Barawick Company, The.....	1850-1851
Barkelew Electric Mfg. Co., The.....	1847
Bel-Canto Corporation.....	1882
Bergen Radio Supply Co.....	1840
Bierman-Everett Foundry Co.....	1862
Bogue, B. N.....	1908
Brach Mfg. Co., L. S.....	1858
Brandes, Inc.....	1897
Briggs & Stratton Co.....	1866
Broadway Electrical Novelty House.....	1846
Bunnell & Company, J. H.....	1913
C	
C & K Radio Mfg. Co.....	1838
Carter Radio Company.....	1901
Central Radio Laboratories.....	1844
Chaslyn Company, The.....	1866
Chelsea Radio Co.....	1836
Chemical Institute of New York, Inc.....	1765-1908
Chicago Radio Apparatus Co., Inc.....	1906
Chicago Salvage Stock Store.....	1861
Clapp-Eastham Company.....	1823
Clarke Coin Company.....	1910
Clearstone Radio Company, The.....	1856
Connecticut Tel. & Electric Co.....	1830
Consolidated Radio Call Book Co., Inc.....	1852-1886
Continental Fibre Co., The.....	1832
Continental Radio & Electric Corp.....	1883
Copper & Brass Research Ass'n.....	1902
Coto-Coil Company.....	1874
Coyne Trade Schools.....	1910
Crosley Mfg. Co.....	1821
Cutler-Hammer Mfg. Co., The.....	1911
Cut Rate Radio Co.....	1904
D	
D-X Radio Co.....	1875
Davis Radio Phonograph Co.....	1876
Delfelco Battery Corp.....	1832
Delta Electric Company.....	1864
Demaree, C. S.....	1910
Diamond State Fibre Co.....	1831
Dictograph Products Corp.....	1871-1876

	Page
Dodge, C. K.....	1893
Dodge's Institute.....	1870
Donnell Mfg. Co., L. H.....	1897
Douglas Shoe Co., W. L.....	1912
Dreyfuss Company, Inc., P. M.....	1840
Dubilier Condenser & Radio Corp.....	1900
Duck Company, The Wm. B.....	1865
E	
E. I. Company, The.....	1887
Economic Appliance Co.....	1899
Eiseman Magneto Corp.....	1864
Ekko Company, The.....	1822
Elco Radio Co.....	1895
Electric Specialty Co.....	1862
Electric Storage Battery Co., The.....	1859
Electrical Research Laboratories.....	1838
Electro Importing Co.....	1849
Elwood Electric Co., Inc.....	1864
Engravers & Printers Machinery Co.....	1904
Ernest Electric Co.....	1868
Evans & Company, Victor J.....	1890
Experimenter's Information Service.....	1877
F	
F. R. S. Radio Corporation.....	1882
Fedders Mfg. Company, Inc.....	1883
Federal Radio Electric Co.....	1906
Federal Tel. & Tel. Co.....	1891
Ferbend Electric Co.....	1898
Finch Radio Mfg. Co.....	1903
Formica Insulation Co., The.....	1766-1767
Four Way Co.....	1872
France Mfg. Company.....	1870
Freshman Company, Inc., Chas.....	1880
Frost, Inc., Herbert H.....	1828
G	
Galena Crystal Mfg. Co.....	1902
Geiger, J.....	1835
General Electric Co.....	1840
General Radio Company.....	1892
General Radio Corp.....	1902
Gibbons-Dustin Radio Mfg. Co.....	1895
Goodell-Pratt Company.....	1879
Gould Storage Battery Co.....	1902
Great Eastern Radio Corp.....	1830
Great Lakes M. P. Company.....	1876
Great Lakes Radio Company.....	1761
Grebe & Company, Inc., A. H.....	1763
H	
Hammerlund Mfg. Company.....	1834
Harris Laboratory, The.....	1896
Harvard Radio Laboratories.....	1905
Hayden Radio & Research Co., A. C.....	1826
Hayes & Newton.....	1868
Hearwel Company.....	1872-1904
Hommel & Co., Ludwig.....	1917
Hygrade Electrical Novelty Co.....	1900
I	
International Insulating Corp.....	1914
J	
Jackson & Co., J. L.....	1910
Jefferson Electric Mfg. Co.....	1904
K	
K Electric Company.....	1907
Kehler Radio Laboratories.....	1834
Kellogg Switchboard & Supply Co.....	1891
Kennedy Co., The Colin B.....	1905
Kensington Radio Supply Co.....	1913
Killoch Company, David.....	1896
Kimley Electric Co.....	1832
King Am-Pli-Tone.....	1834
Klosner Improved Apparatus Co.....	1898

	Page
Lacey & Lacey.....	1910
Lancaster & Allwine.....	1890
Lefax, Inc.....	1842
Leich Electric Co.....	1862
Lenk Mfg. Company.....	1906
Lewis & Derooy Radio Corp.....	1902
Liberty Radio Company.....	1884
M	
M. P. M. Sales Co.....	1908
Magnavox Company, The.....	1827
Magno Storage Battery Co.....	1896
Marko Storage Battery Co.....	1876
Martin-Copeland Co.....	1882
Mass. Radio & Telegraph School, Inc.....	1832
Metric Metal Works.....	1894
Michigan Radio Corporation.....	1915
Michigan State Automobile School.....	1910
Midwest Radio Company, The.....	1878
Mitchell & Co., R.....	1894
Montgomery Ward & Co.....	1848
Montrose Mfg. Co.....	1904
Mu-Rad Laboratories, Inc.....	1907
Murdock Company, Wm. J.....	1872
N	
Nassaut Radio Company, Inc.....	1904
National Airphone Corp.....	1888
National Radio Institute.....	1843-1917
National Radio Products Corp.....	1870
National Vulcanized Fibre Co.....	1834
Newman-Stern Company, The.....	1909
New York Coil Company, Inc.....	1909
North American Radio & Supply Corp.....	1826
Novo Mfg. Company.....	1914
O	
O'Brien, Clarence A.....	1912
Omnigraph Mfg. Co., The.....	1842
Owen, Richard B.....	1890
P	
Pacent Electric Co., Inc.....	1884-1903
Parker, C. L.....	1912
Pennsylvania Radio Stores.....	1894
Philadelphia Storage Battery Co.....	1825
Pignolet Instrument Company, Inc.....	1832
Pioneer Radio Corp.....	1892
Pitts Co., F. D.....	1836
Pittsburgh Radio & Appliance Co., Inc.....	1824
R	
Radio Company.....	1858
Radio Corporation of America Back Cover	
Radio Cut Price Company.....	1896
Radio Directory & Publishing Co.....	1917
Radio Distributing Company.....	1894
Radio Equipment Co.....	1893
Radio Experimenters League.....	1824
Radiogem Corporation, The.....	1881
Radio Guild, Inc., The.....	1844-1846-1856
Radio Improvement Company.....	1837
Radio Industries Corp..... Inside Back Cover	
Radio Institute of America.....	1862
Radio Instrument Company.....	1879
Radio Instrument & Panel Co.....	1854
Radio Parts Mfg. Co.....	1905
Radio Research Guild.....	1908
Radio Service & Mfg. Co.....	1868
Radio Shop of Newark, The.....	1915
Radio Specialty Co.....	1920
Radio Stores Corp.....	1839
Radio Testing Station.....	1870
Randolph & Company.....	1912
Rasla Sales Corp.....	1834
Rauland Mfg. Co.....	1881

	Page
Regal Typewriter Co., Inc.....	1912
Remler Radio Mfg. Co.....	1895
Reynolds Radio Company, Inc.....	1830
Rhamstine, J. Thos.....	1902
Riggs Mfg. Co., The.....	1830
Rose Radio Supply.....	1889
Rusonite Products Corp.....	1889
S	
Sadler Mfg. Company.....	1871
Saturn Mfg. & Sales Co., Inc., The.....	1880
Scholes Radio & Mfg. Corp., The.....	1914
Shaw Walker.....	1910
Shinn Mfg. Co., W. C.....	1830
Short Cut Radio Corporation.....	1860
Signal Electric Mfg. Company.....	1910
Signal Radio & Electric Corp.....	1836
Simon Company, M. A.....	1880
Sinclair, Mr.....	1870
Spaulding & Sons Co., Inc., J.....	1909
Spencer Mfg. Co.....	1856
Springfield Wire & Tinsel Co.....	1860
Standard Metal Mfg. Co.....	1906
Standard Radio & Electric Co.....	1869
Steinmetz Wireless Mfg. Co.....	1915
Stover Mfg. & Engine Co.....	1898
Stransky, John A.....	1910
Stromberg Carlson Telephone Mfg. Co.....	1824
T	
Telephone Maintenance Company.....	1878
Timmons, J. S.....	1872
Toledo Metal Furniture Co., The.....	1822
Trade Circular Addressing Co.....	1908
Trego Radio Mfg. Co.....	1868
Trimm Radio Mfg. Co.....	1826
True Tone Radio Mfg. Co.....	1884
Tuska Co., C. D., The.....	1770
Twentieth Century Radio Corp.....	1858
Twitchell, S. A.....	1906
U	
Union Construction Corp.....	1898
United Mfg. & Distributing Co.....	1864
Universal Radio & Research Co.....	1900
Universal Sales Co.....	1894
V	
Valley Electric Co.....	1896
V-De-Co Radio Mfg. Co.....	1900
Vesco Radio Shop.....	1856
Vesta Battery Corp.....	1860
W	
W. E. Supply & Service Corp.....	1863
Walbert Mfg. Co.....	1898
Walnat Electric Mfg. Co.....	1892
Ware Radio Corporation.....	1899
Waveland Radio Company, Inc.....	1841
Webster Electric Co.....	1913
Westinghouse Union Battery Co.....	1889
Weston Electrical Instrument Co.....	1858
Wicks Electrical Institute.....	1870
Willard Storage Battery Co.....	1857
Wilmington Fibre Specialty Co.....	1874
Wireless Mfg. Co., The.....	1874
Wireless Shop, The.....	1911
Workrite Mfg. Co., The.....	1833
World Battery Co.....	1824-1907
Y	
Y. M. C. A. Radio School.....	1830
Young Mfg. Co.....	1903



**CHEMISTS PREDICT STARTLING NEW ERA**  
Sun's Rays, Earth's Rotation and Atomic Energy in Matter to Be Used.  
SEE REVISING OF BIBLE  
Light Like Firefly's May Be Produced by Chemistry, American Society Hears.

**DEMAND FOR INDUSTRIAL CHEMISTS INCREASING**  
"It is probably not far from the mark to assert that there are more than 25,000 chemists employed in the United States today and the number is constantly increasing." declared Charles E. Merrett, of the Department of Chemistry, Washington University at the opening of the evening preparatory school of the Y. M. C. A. recently.

**SAUSAGE GETS ATTENTION OF CHEMISTS**  
is One of Many Topics in Pictorial Drawings

**CHEMISTRY EXPERT HEADS 'CLEAN CLOTHES' COLLEGE**  
In Eleven Weeks He Teaches How to Remove All Traces of Hardship From Linen and Makes Student a Real Laundryman.

**Chemistry in the Home**  
50 of our great-grandmothers' recipes have handed down to mother to daughter. But few know to be of any use. No one thought of calling it a day. The work of the kitchen as to-day's chemists have entered into it. Both home and house are the good fairies in a fairy tale. They both work together and give the more materials with which to work. Among the chemists, Dr. E. M. Smith, of the University of California, Berkeley, California.

**AMERICA'S FUTURE BEFORE CHEMISTS**  
Dr. E. M. Smith Urges Upon Associates Recognition of Nation's Claims.

**CHEMICAL SCIENCE MAY OUTSHOE PRICES**  
New Methods in Tanning to Be Discussed by Experts at Meeting of American Society.  
4,000 EXPERTS TO ATTEND  
Sessions Will Be Held at Columbia University Next Month—Scientists to Speak.  
Show prices may trend downward as a result of new processes of tanning based on a solution of electrical discharge and their various factors, which will be discussed by the American Chemical Society, which will meet at Columbia University Sept. 10-12.

**CHEMISTS CHANGE ALCOHOL INTO HIGH QUALITY SILK**  
Government Experiments Set Pace for New Industry Already Under Way and Patent Silkworm May Lose Popularity

**CHEMISTS IN MONTREAL LEARN OF NEW GLASS**  
Said to Admit Unlimited Light and Air All Heat.

# The United States Needs Chemists

What did America get out of the War? You often hear that question asked, yet few people realize just what material advantage the United States did gain. She gained industrial supremacy. Hundreds of manufactures formerly almost unknown here, have come to this country to stay. With hardly an exception they belong to the so-called Chemical Industries, for which the services of trained chemists are essential. The dyestuff industry alone gives employment to thousands of chemists, for whom there was little demand prior to 1914. Outside of the laboratory there are innumerable executive positions which can be filled only by men who understand chemistry.

The salaries of chemists are good, and the work is fascinating. Opportunities are plentiful for independent work in agriculture, medicine, food purification, water supply, the development of patents, and countless other fields. Now is the time to get into this fruitful profession while it is yet uncrowded.

## Learn Chemistry at Home

Dr. T. O'Connor Sloane, the eminent scientist, will teach you Chemistry in your own home. You do not need to give up your present employment; the lessons may be studied in your spare time. Dr. Sloane has written the course in a simple yet comprehensive way. His many years of teaching and practical experience are placed at your disposal. The lessons and experimental work are so entertaining that it becomes a pleasure to study. No previous schooling is required. The course gives you as thorough training in general chemistry as you would have obtained in college. It is endorsed by leading scientists and educators, and is considered the most unique course of its kind ever presented.

## Easy Monthly Payments

You can pay in small monthly amounts as you go along. The price of our course is very reasonable, and includes everything necessary for its completion. There are no textbooks to buy extra, and the chemicals and apparatus used for experiments are supplied without additional charge to the student. Our plan places an education in chemistry within the reach of everyone.

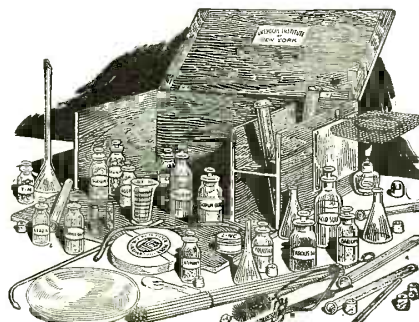

## EXPERIMENTAL EQUIPMENT

Given to Every Student Without Additional Charge

The experimental outfit illustrated here is furnished to every student. It comprises 42 pieces of apparatus and 18 chemicals, all enclosed in a hinged box which is itself a useful laboratory accessory.

## The Value of Chemistry

Did you know that aluminum formerly cost over \$100 a pound? In 1886 an American chemist, C. M. Hall discovered a cheap method for extracting it from its ores, which brought the price down to 25 cents a pound!

Did you know that carborundum, the universal abrasive was unknown until E. A. Acheson, another American chemist, discovered it in 1891?

Did you know that silicon, an important ingredient of special steels, fell from \$100 an ounce to 10 cents a pound, due to a cheap method of production evolved by American chemists?

Did you know that the dye, indigo, dropped from \$4.00 a pound to 15 cents a pound when the chemists learned how to prepare it in the laboratory?

Did you know that between 1914 and 1917 the American dye exports jumped from 2 million to 57 million pounds?

Did you know that vanillin, the flavoring principle of vanilla, was reduced in price from \$800 a pound to \$10 a pound, when chemists perfected a method for its synthesis?

Did you know that John Hyatt, an American chemist, invented the useful commodity, celluloid? Did you know that Thorium Nitrate, used in gas-mantles, sold for \$200 a pound in 1895? In 1916 it was priced at \$2.60 a pound, due to improved chemical methods of refinement.

These are only a few of countless instances where Chemistry has revolutionized industry. The same chance awaits you if you will master the science.

## Chemical Institute of New York, Inc.

Home Extension Division 4 140-R LIBERTY STREET, NEW YORK CITY

Dr. T. O'Connor Sloane Will Teach You



T. O'CONNOR SLOANE  
A. B., A. M., Ph. D., LL. D.

Noted instructor, lecturer and author. Formerly Treasurer of the American Chemical Society, and a practical chemist of vast experience, with many valuable achievements to his credit. Dr. Sloane has taught and practiced Chemistry for a great many years. He is now Educational Director of the Chemical Institute of New York. All of our students receive his personal instruction and supervision of their training.

## Special 30-Day Offer

For a short period we are making a special offer, which it will be worth your while to take advantage of. Write for our free book, using the coupon below or simply a postal card. This will not obligate you in the least. Do not wait until tomorrow. Send the coupon now while you think of it, and let us tell you our story.

CHEMICAL INSTITUTE OF NEW YORK  
Home Extension Division 4  
140-R Liberty St., New York City.

Please send me at once without any obligation on my part, your free Book, "Opportunities for Chemists," and full particulars about the Experimental Equipment given to every student. Also tell me about your plan of payment and special 30-day offer.

NAME .....  
ADDRESS .....  
CITY .....  
STATE .....  
R. N. -4'23



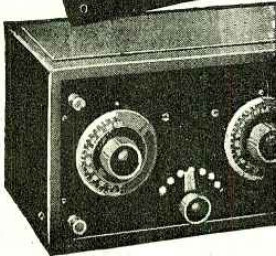

# The Leading Radio

## Manufacturers of Complete Radio Sets Using FORMICA

Acme Apparatus Co.  
 A.C. Electric Co.  
 Adams Morgan Co.  
 Amateur Radio Supply Co.  
 American Radioc & Research Co.  
 Andreas, Frank A. D.  
 Benwood Company  
 Beamish Elect. Co.  
 Boston Scale & Machine Co.  
 Bowman Co., A. W.  
 Briggs & Stratton  
 Bristol Co.  
 Canadian Machine Telephone Co.  
 Capitol Phonolier Corp.  
 Chelsea Radio Co.  
 Chicago Radio Apparatus Co.  
 Cino Radio Co.  
 Clapp-Eastham Co.  
 Clearstone Radio Co.  
 Cleveland Radio Mfg. Co.  
 Cleveland Radio Laboratories  
 Cleveland Products Co.  
 Consolidated Radio Call Book Co.  
 Connecticut Telephone & Elect. Co.  
 Corwin Co., A. H.  
 Crosley Mfg. Co.  
 Central Station Equipment Co.  
 DeLancey, Felch & Co.  
 Doron Bros. Elect. Co.  
 Dryfuss Co., P. M.  
 Duck Co., Wm. B.  
 Echo Radio Company  
 Electric Machine Corp.  
 Experimenters Information Service Co.  
 Fargo Radio Service Co.  
 Fast Feed Drill & Tool Co.  
 Federal Institute of Radio Telegraphy  
 Federal Telegraph Co.  
 Federal Telephone & Telg. Co.  
 Freed-Eiseman Co.  
 Galvin Electric Co.  
 General Apparatus Co.  
 Great Eastern Radio Corp.  
 Halliwell Electric Co.  
 Hartman Electric Co.  
 Heslar Radio Co.  
 Hyman & Co., Inc., Henry  
 Ingersoll Radio Shops  
 Kennedy Co., Colin B.  
 Klaus Radio Co.  
 Kilborne & Clark  
 Laurence Radio Electric Co.  
 Magnavox Co.  
 Marshall-Gerken Co.  
 Manhattan Elect. Supply Co.  
 McCorkel Mfg. Co.  
 Meteor Radio Laboratories  
 Michigan Radio Co.  
 Midwest Radio Co.  
 Missouri Radio Co.  
 Moon Radio Corp.  
 Mutual Purchase Assn. (Standard Radio Co.)  
 National Radio Institute  
 Nairsand Radio Mfg. Co.  
 New York Coil Co.  
 Paramount Radio Corp.  
 Premier Radio Mfg. Co.  
 Precision Machine Co.  
 Precision Equipment Co.  
 Radio Apparatus Co.  
 Radio Amusement Co.  
 Radio Service & Mfg. Co.  
 Radio Shop of Newark  
 Radio Distributing Co. (Radisco)  
 Radio Products Co.  
 Radio Electric Company  
 Radio Shop of California  
 Radio Instrument Co.  
 Radio & Scientific Apparatus Co.  
 Raymond Radio Corp.  
 Ray Mfg. Co., J. A.  
 R. T. Radio Corp.  
 Reynolds Radio Co.  
 Scientific Engineering Co.  
 Signal Electric Co.  
 Simplicity Mfg. Co.  
 Simplex Radio Co.  
 Ship Owners Radio Service Co.  
 Smith & Smith  
 Stanley & Patterson  
 States Radio Corp.  
 Stern & Co.  
 Sleeper Radio Corp.  
 Telephone Maintenance Co.  
 Tresco.  
 Tuska, C. D.  
 Waveland Radio Co.  
 Western Electric Co.  
 Western Radio Co.  
 Winckler, Frederick  
 Wireless Shop, The  
 Wireless Mfg. Co.



# FORMICA

Made from Anhydrous Redmanol Resins

**SHEETS TUBES RODS**



# Manufacturers use *and* like

# FORMICA

The radio engineers of the leading radio manufacturers all over the United States have approved Formica in the most sincere and convincing way—by adopting it and using it in their production of radio equipment.

No other insulating material for panels, tubes, and other parts can show a list of makers of high grade radio equipment using their material that is comparable to that printed on the page opposite. It is practically a directory of independent radio manufacturers in the United States.

This overwhelming preference for Formica among the men who, among all others, know most intimately the qualities and characteristics of radio insulation means only one thing.

**IT MEANS THAT FOR YEARS FORMICA HAS MAINTAINED A QUALITY AND UNIFORMITY THAT IS NOT TO BE HAD ELSEWHERE.**

These men like the handsome Formica finish. They like the way it works with ordinary tools. They like its high dielectric strength and the wonderful uniformity of the product. They like the fact that it improves with age instead of deteriorating. The trained engineers and purchasing agents of these manufacturers can scarcely be mistaken in their judgment of materials. The amateur is perfectly safe in following their lead.

**DEALERS:** Formica advertising and sales support is the most aggressive and effective in the industry. The Formica Insulation Company treats you right.

**THE FORMICA INSULATION COMPANY**

4618 SPRING GROVE AVE., CINCINNATI, O.

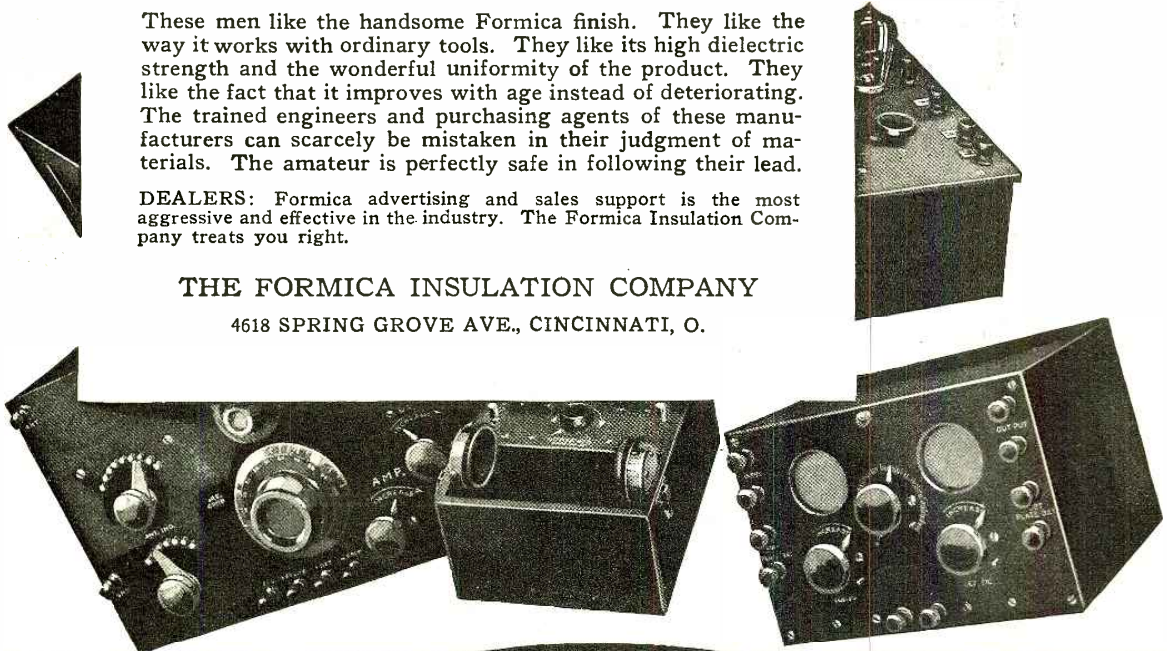

---

# FORMICA

Made from Anhydrous Redmanol Resins  
**SHEETS TUBES RODS**

---



# ATWATER KENT

Radio Receiving Sets and Parts

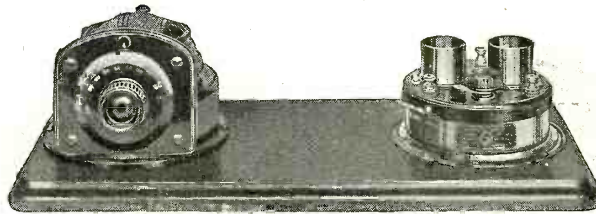

Complete Receiving Set—Coupled Circuit Tuner and Detector 1-stage Amplifier  
A similar set is furnished with Detector 2-stage Amplifier

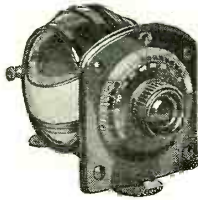

Mounted Variometer

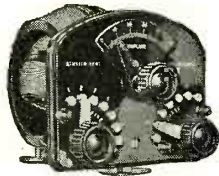

Mounted Variocoupler



Detector Unit

ATWATER KENT products sell on appearance; they stay sold on quality of performance.

This is the reason for the popularity of ATWATER KENT Radio Equipment.

Look over the illustrations. They show a portion of the line, which includes complete sets, as well as parts from which the radio fan may build his own receiver.

There are various sets all mounted on mahogany bases and wired ready to attach to antenna and battery. No bothering with hook-up.

Use a set as *YOUR* demonstrator



Detector 1-stage Amplifier  
A similar unit is furnished in a 2-stage Amplifier



Detector 2-stage Amplifier



Standard Tube Socket



1 1/2-Volt Tube Socket

ATWATER KENT MANUFACTURING COMPANY, PHILADELPHIA, PA.  
Radio Department 4943 STENTON AVE. Write for Literature



# ATWATER KENT

Radio Receiving Sets and Parts

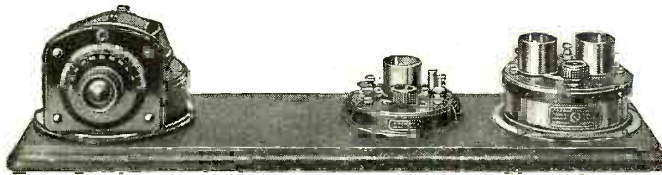

Complete Receiving Set—Coupled Circuit Tuner, Detector Unit and 2-stage Amplifier  
This Set is also furnished without Amplifier

THESE sets are attractive enough in appearance to be installed in the most "exclusive" home or club; moderate enough in price to be within reach of anyone; and excellent enough in operating qualities to satisfy the most particular.

For the fan who wants to experiment with varying hook-ups there are parts which will meet every requirement.

ATWATER KENT Radio Sets and Units sell readily and are a very profitable line.

*They're always SEEN in the show windows*



Unmounted Variometer



Unmounted Variocoupler



Condense Dials  
in 50 or 100 pt. graduations  
for  $\frac{1}{8}$ " or  $\frac{1}{4}$ " shafts



Type L Transformer A.F.



Transformer A.F.



Panel Rheostat



Table Rheostat

ATWATER KENT MANUFACTURING COMPANY, PHILADELPHIA, PA.

Radio Department

4943 STENTON AVE.

Write for literature



# Popular!

## - for good reasons

**R**ADIO enthusiasts wanted an expertly designed, moderate-priced set that any intelligent man or woman could operate. So we built the Popular, to sell at a popular price.

Just two dials to turn to find the stations broadcasting within a range of 500 miles. As you become more experienced you can reach out twice as far. You don't have to become an expert to operate this set to your complete satisfaction. But the more you know about radio, the better you will appreciate it.

The fine piano finish, mahogany case, moulded and shielded panel, Bakelite dials and splendid beauty of the Popular promises you a set you will be proud to own. And that promise comes true! It is the ideal set for busy folks who want the thrills of radio.

THE C. D. TUSKA CO., Hartford, Conn.

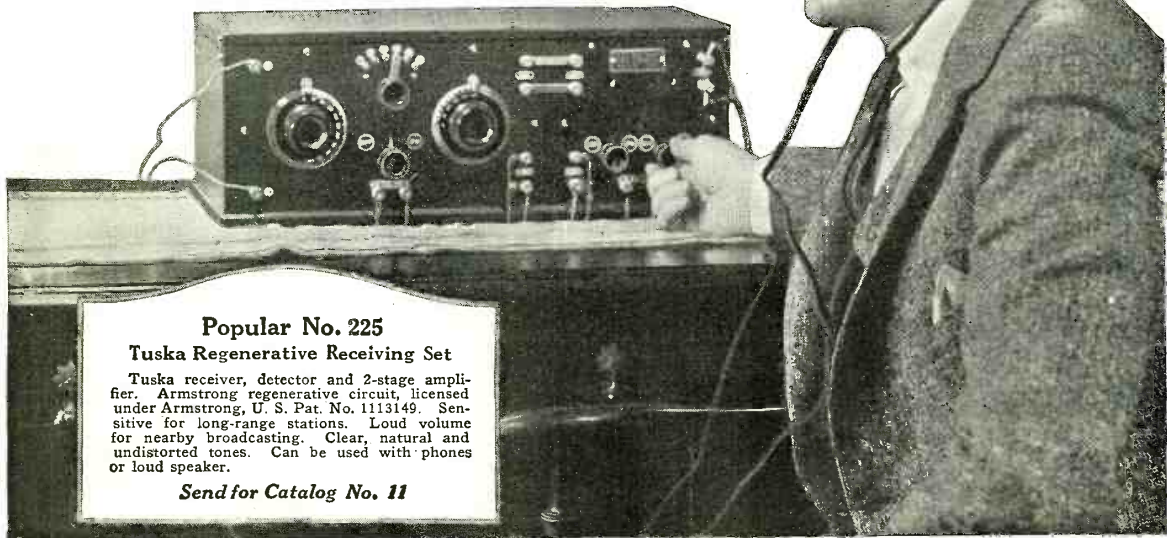

### Popular No. 225

#### Tuska Regenerative Receiving Set

Tuska receiver, detector and 2-stage amplifier. Armstrong regenerative circuit, licensed under Armstrong, U. S. Pat. No. 1113149. Sensitive for long-range stations. Loud volume for nearby broadcasting. Clear, natural and undistorted tones. Can be used with phones or loud speaker.

Send for Catalog No. 11

# TUSKA RADIO







# RADIO NEWS

H. GERNSBACK—Editor and Publisher  
ROBERT E. LACAULT—Associate Editor

EDITORIAL AND GENERAL OFFICES, 53 PARK PLACE, NEW YORK

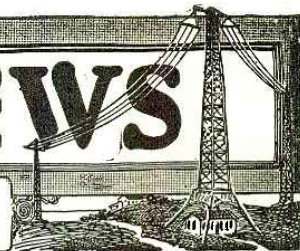

Vol. 4

APRIL, 1923

No. 10

## Radio and Education

ONE of the great uses for Radio in the future undoubtedly is education. More and more educators themselves are beginning to realize that Radio is the one means that will spread education more thoroughly, more economically and far better than any other means known. When it is realized that a teacher or a professor can stand on a platform and give a lecture, any morning, that can be readily heard by a million or more school children or students, we begin to understand dimly the tremendous importance of the new art. This thought alone should set at rest those very few doubters who still have an idea that Radio is a fad and that it will not last. Indeed, we venture the guess that in a time not too far away, the States' or the Federal Government will have to subsidize broadcasting stations, which will be used primarily for educational purposes and secondarily for entertainment. This is the day of specialization, also the age when every one of us, from the most modest downwards, has and is continuing to get the best to be had if anywhere possible. The farmer in Idaho, in his modest shanty can read the best books for a few cents, while for a dollar or less he can hear Caruso sing any time he chooses, and at no cost whatsoever he can listen in by radio to Clemenceau as he gives his farewell speech in New York before departing for France—all things that were impossible 25 years ago.

Of course, numbers of our radio stations, even today, are making a specialty of sending out lectures, etc., but most of these are sent during the evening, mainly, for entertainment purposes, the lecture itself being given for that purpose primarily. Those of us in the right frame of mind who listen to such lectures retain a good bit of the information and thereby we are educated. We are afraid, however, that a large percentage of adults are more or less bored by dry lectures, and endeavor to tune out a lecture unless it has a special appeal to them.

When we speak of education and Radio, we have in mind schools and colleges, and this is a big thought that is now occupying our great pedagogues. If Professor Pupin, of Columbia University, delivers an historical lecture in New York, only a few hundred or, at the most, a thousand students can listen to his words. The rest of the country must be satisfied with the printed lecture. Or if Professor Einstein gives a few lectures here and there, the total number of persons who actually hear him speak is perhaps less than 5,000, when really it ought to be 10,000,000!

Now every educator knows that the effect of a student listening to a lecture and a student reading the same printed lecture gives vastly different results. When we listen to a great man as he delivers his lecture, and if we are at all interested, we follow his discourse with the greatest interest and we eagerly imbibe every word he utters. The same lecture, printed, becomes a cold, lifeless thing that does not at all hold the interest for us as does the spoken word. The ideal combination is that we first listen to the lecture by ear and then read it over by eye. That gives a 100 per cent retentivity value of the mind, as has long been realized by experts.

Now it is precisely this thing that is made possible by Radio. It is only a matter of time when every schoolroom and every classroom will have its radio outfit and its loud talker, so that the whole room can hear the lecture. The time will come when any lecture given in any part of the country will be listened to by all the schools and all the colleges of the land. It will be done as follows:

If in New York City, for instance at Columbia University, an authority gives a lecture, his words will be picked up and relayed to the New York Broadcasting Station, where the lecture

will be immediately broadcast. The receiving stations within a small radius will pick up this lecture and such schools and colleges within range will have no trouble tuning in to it, so that the entire class will hear every word loudly and distinctly. For stations located many hundreds or thousands of miles away, the following system will be used: The local broadcasting stations will receive the distant lecture on a specially-constructed super-sensitive receiving outfit. The sounds as they come in, which will be more or less weak, will then be picked up and amplified and rebroadcast. In other words, we have here the relayed broadcast which the writer advocated in a recent editorial entitled "Popularizing Radio." This plan, by the way, has now been endorsed by Mr. W. P. Davis, Vice-President of the Westinghouse Electric Co., who advocates this same plan. The local broadcasting station will then broadcast the lecture so that all schools or colleges within its radius will be able to listen to the distant New York lecture without trouble.

Nor will this thing be done just once in a while, but it will be a daily routine. If a famous professor speaks at San Francisco or at St. Louis, his words will be heard in New York classrooms loudly and distinctly by such relayed broadcast. Moreover, such lectures will be given and listened to each and every day, in the morning hours, and the early afternoon. It is realized that broadcast fans who listen for amusement only are still at business at this time of the day, and for that reason these hours, which happen to be school hours anyway, will be the ideal ones for such educational work. It will, of course, be realized that not only will lectures thus be heard in every classroom throughout the country, but every other educational subject imaginable can and will be given. The best teachers of languages will give their daily lessons, as will the best lecturers on mathematics, elocution, drama, geology, geography, and all other subjects that can be broadcast in the same manner.

Let no one think that this will do away with the teachers in the schoolrooms or classrooms. Quite the contrary. It will supplement their work, and their usefulness will be increased because, after all, it is the teacher who is the one in close touch with the pupils or students. When a great man gives a lecture, there are always many points not readily understood by the pupils, and the ensuing discussion after such lectures will be stimulated by the teacher himself.

Until the relayed broadcast has become perfected—it is admitted that it is as yet not perfect—we have another means of obtaining the same results, and that is by the Hoxey Palophotophone. If, for instance, a lecturer at Princeton gives an important talk, this lecture can be photographed on a film and preserved for all time; 10 or 50 years hence this lecture can be listened to by students at will, but for the present copies of the films can be made and sent to the various broadcasting stations which can broadcast the lecture at any time they choose. In other words, although a lecture is given in Princeton on a certain afternoon, it can be heard at various times in the future, in any school or classroom of the country, as it best suits the broadcast program.

Once it becomes universally known that such educational programs are being broadcast each and every day at stated hours, not only will schools and colleges make use of such lectures and information, but grown-ups in every part of the country, from mansions down to the humblest shacks, will eagerly listen to such educational programs and improve the mind which has not had the opportunity during youth to acquire a needed education.

H. GERNSBACK.



# The Transmission of Photographs by Radio

By S. R. WINTERS

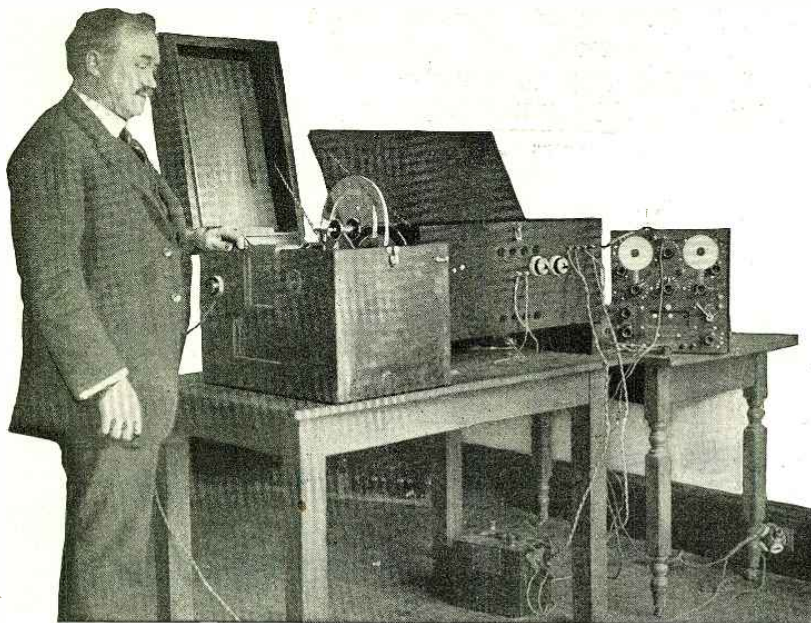

Mr. C. F. Jenkins and His Apparatus for the Transmission and Reception of Photographs by Radio. This Apparatus Copies Half-Tone Camera Studies from Flat Surfaces, Transmits Them, and at the Receiving End They Are Impressed on Common Photographic Plates.

THE transmission of photographs through space by means of radio apparatus is an accomplished fact. Pictures of President Warren G. Harding and Secretary of Navy Edwin Denby were recently borne on electro-magnetic waves from the radio research laboratory of the United States Navy Department at Anacostia, D. C., to the second floor of a building at 1519 Connecticut avenue, a distance of approximately seven miles. The process of sending the likenesses of these Government dignitaries required about six minutes each and at the receiving point the lights, shadows and half-tones common to picture reproduction were impressed on a conventional photographic plate.

The transmission of photographs by both wire and wireless is not a recent scientific departure. A Frenchman, a German, and more recently an Englishman, are credited with having invented methods for speedy conveyance of pictures by radio, but for the most part line etchings are the mediums by which the picture characteristics are translated into photographs at the receiving points. Invariably, too, all photographs are transmitted and received on cylindrical surfaces. The epochal demonstration recently signalized in Washington, the fruition of an invention of C. Francis Jenkins, is said to be the first time in which half-tone camera studies were copied from flat surfaces, impinged on electro-magnetic waves, and impressed on common photographic plates at the receiving point. When developed, these negatives proved to be likenesses of the subjects treated at NOF, the naval radio research laboratory at Anacostia.

The demonstration was witnessed by representatives of the United States Navy Department, United States Post Office Department, and the amalgamated motion-picture industry. The interested group of spectators from the Navy Department included Admiral F. S. Robinson, member of the general naval board; Admiral Henry R. Zeigemeier, in charge of the bureau of com-

munications; Commander Stanford C. Hooper, head of the radio division of the Bureau of Engineering; Captain J. T. Tompkins, and Lieutenant-Commander E. H. Loftin, in charge of patents for the radio division of the Navy Department. J. C. Edgerton, then in charge of the radio division of the Post Office Department, and John M. Joy, representing the motion picture industry, also viewed the reception of the pictures at the laboratory of the inventor, at 1519 Connecticut avenue.

The transmission of the photographs from Anacostia was supervised by Commander A. Hoyt Taylor, in charge of the radio research laboratory of the Navy Department at this point, or NOF, as it is popularly identified by wireless amateurs. Four subjects were broadcast within the course of one-half hour, photographs of President Harding and Secretary of Navy Denby, and two penciled sketches. The latter consisted of a map and a sketch containing both written and printed letters. The likenesses of President Harding and Secretary of Navy Denby, as may be seen from the prints reproduced with this article, are not clear from a photographic viewpoint, but the resemblance of the subjects is faithfully preserved. Six minutes were required in which to effect the transmission of each photograph, a period of time the inventor contemplates reducing to one-sixteenth of a second. The latter time factor, if made possible, will render feasible the broadcasting of motion pictures.

The photographs of these two Government dignitaries were transmitted from Anacostia on a wave-length of 412 meters. While the pictures are being sent through space, a strange, irregular noise may be heard by those having radio-telephone receiving sets. Consequently, the newspaper reporter who used the caption "Pictures Seen and Heard in Radio Demonstration," in his story of the epochal event, did not distort the fact to such a great extent, save that he might have added that these noises cannot be interpreted. Variations in picture

characteristics, of course, cause changes in the sounds produced. Moreover, James Robinson, a laboratory assistant of the inventor, was enabled to identify the picture of Secretary of Navy Denby as it was being received since he had transmitted and received this particular photograph so frequently previous to the official demonstration that certain sounds seemed to be common to the picture characteristics of the likeness of the subject. Other wireless receiving outfits in the vicinity of Washington, in resonance with a wave-length of 412 meters, doubtless "heard pictures being broadcast," but were unable to determine the cause for the strange succession of sounds.

When the writer visited the laboratory of C. Francis Jenkins, inventor of the first motion-picture projecting machine, he found his laboratory staff busily engaged in sending and receiving photographs from one room to another. The transmitting unit in appearance resembles a stereopticon machine, and really some of the mechanism fits this description. The photographic copy, sketch, sheet of music, or other positive print is first illuminated, either by a projection lantern or stereopticon. Stationed directly in the path of this illuminating device are four prismatic rings, which revolve about their axis. Two of them rotate very much slower than the other pair. Concerning this prismatic ring, Mr. Jenkins says:

"This prismatic ring is equivalent to a glass prism which changes the angle between its faces, and in rotation gives to a beam of light having a fixed axis on one side of the prism, and a hinged or oscillating axis on the other side of the prism.

"That is, a small pencil of light coming from a fixed source and passing through the overlapping surfaces of two rotating prismatic rings, having their diameters at right angles where the diameters cross, and one of the plates rotating many times faster than the other, will cause this pencil of light to sweep across the picture in adjacent parallel lines, until the whole surface of the picture negative is covered."

This newly designed optical shape in glass, for which a patent has been granted, is the heart of the invention which makes possible the radiation of pictures through ether. By use of these revolving glass rings, the lights and shadows that constitute a photograph are built up, line by line. The dense areas

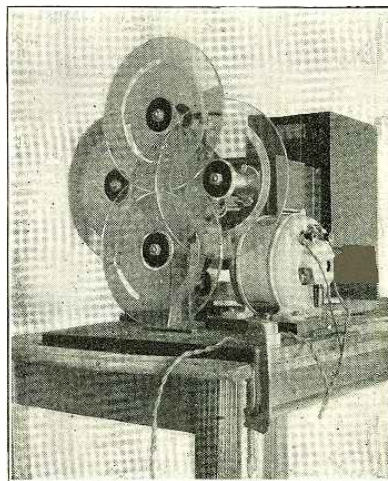

Part of the Receiving Apparatus. By Use of These Revolving Glass Rings, the Lights and Shadows of a Picture Are Built Up, Line by Line.



make highlights; less opaque parts of the surface, the half tones; and extremely thin areas, the shadows of a picture.

From these revolving plates of glass the light beam goes to a dark box, containing a so-called photo-electric cell, containing selenium or other chemical sensitive to light. A "chopper" in the pathway of the light

by radio apparatus through a specially designed incandescent electric-light bulb. The filament of same is surrounded with hydrogen. Approximately two volts of electric energy from a storage battery are conveyed constantly through this filament so as to produce a red glow in the bulb. As the electric or amplified radio current varies in

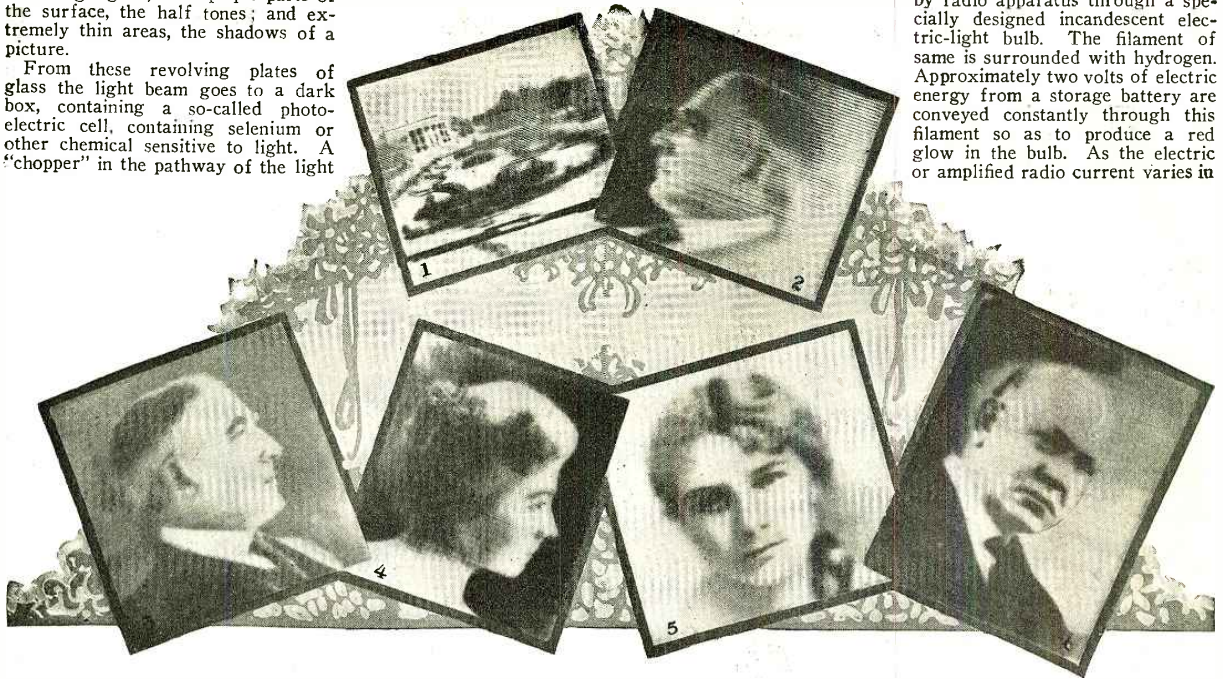

Some of the Photographs Transmitted by Radio, Among Them Being Pictures of President Harding and Secretary of Navy Edwin Denby. The Photo marked 2 Shows Each Shaded Line as it Was Received.

beam, located between the optical rings and the photo-electric cell, causes the light beam to shoot up and down about 500 times a second. An oscillating device would also serve this purpose. The light characteristics are then converted into electric current characteristics by passing through a transformer. At this point two stages of radio amplification are introduced in a conventional wireless sending set, after which electro-magnetic waves become the vehicle for broadcasting pictures just as music and speech are now universally disseminated. An antenna, extending 15' above the three-story building in which the Jenkins laboratory is housed, completes the equipment both for sending and receiving photographs by wireless. He also maintains transmitting and receiving outfits at his laboratory in his home on Sixteenth street.

When these modulated wireless waves arrive at the receiving point, whether it be in an adjoining room or seven miles away, as in the case of the sending of the pictures of the Government officials, the electric characteristics are re-converted into picture characteristics. This is accomplished by duplicating the apparatus at the transmitting station, namely, by use of two pairs of the newly shaped optical glass rings. Two methods of receiving pictures have been devised by Mr. Jenkins, both of which employ an ordinary radio-telephone receiving outfit.

Certain additions, however, are made to the wireless receiving set. On the metal diaphragm of the receiver is mounted a tiny mirror, which vibrates in accordance with the diaphragm as the wireless oscillations are recorded. Focused on this mirror

is a strong ray of light, which is reflected through a shutter when the mirror is stationary. As the electric impulses are set up by the transmitting station, this mirror oscillates with the metal diaphragm on the receiver and the reflected ray likewise oscillates across the shutter hole. Consequently, when this diaphragm is vibrating widely more light from the ray filters through the aperture than when the vibrations are narrow. The electric current variations received by wireless are accordingly transformed back to light variations. The latter are impressed on a sensitized photographic plate just as they were originally transmitted from the sending station. Here, again the new formation of optical glass—or prismatic ring, if you please—are indispensable. These unpretentious chunks of glass, to tell more about them, are circular in appearance and about 10" in diameter. The rim of each of these glass rings is beveled so as to form a prism of spiral shape and of gradually increasing thickness at the edge. As the beam of light or picture characteristics from the reflecting mirror strikes these revolving prisms, a pair being used because of slight error in one unit, it is bent along a perpendicular path downward across the photographic plate. The procedure is repeated until, line by line or section by section, the original photograph is in complete form.

However, these light variations must be reproduced in perpendicular "strips" or "slices" across the area of the photographic plate just as they were originally transmitted from the sending station. Here, again the new formation of optical glass—or prismatic ring, if you please—are indispensable. These unpretentious chunks of glass, to tell more about them, are circular in appearance and about 10" in diameter. The rim of each of these glass rings is beveled so as to form a prism of spiral shape and of gradually increasing thickness at the edge. As the beam of light or picture characteristics from the reflecting mirror strikes these revolving prisms, a pair being used because of slight error in one unit, it is bent along a perpendicular path downward across the photographic plate. The procedure is repeated until, line by line or section by section, the original photograph is in complete form.

The second method for the reception of broadcast pictures, and the one more recently applied by Mr. Jenkins, involves the sending of the electric current as amplified

intensity it is reflected by this filament—thus lighting up or being dimmed as half-tones, shades or other picture characteristics are reflected directly on the photographic plate.

Not only does the Jenkins invention permit of the broadcasting of camera studies by that popular vehicle, radio, but prints and plates may be eliminated and the likeness of a subject sent out through space offhand. In fact, this wonderful feat has already been achieved. In the laboratory of the inventor, at 1519 Connecticut avenue, a girl placed her face against a window as a means of steadying herself and her likeness was transmitted on electro-magnetic waves to the laboratory of Mr. Jenkins, on Sixteenth street, about five miles distant. The image of the subject was illuminated by daylight and by means of the revolving prismatic rings this light beam was thrown onto the photo-electric cell.

Mr. Jenkins says his apparatus is comparable to a camera with a lens in Washington and its photographic plate in Boston, "with this difference, that the one lens, in Washington, may put its picture on 10 one hundred or one thousand photographic plates in as many different cities at the same time, and at distances limited only by the radio power of the broadcasting station."

Speaking further of the possibilities of this remarkable invention, Mr. Jenkins says: "With this new apparatus wireless distribution of news pictures for daily-paper illustration insures the distribution of picture news as promptly as telegraphic news; which means that pictures of news events get into the daily papers as early as telegraphic text. It means just exactly that, and it takes no particular imagination to visualize the value of such service to the newspapers."

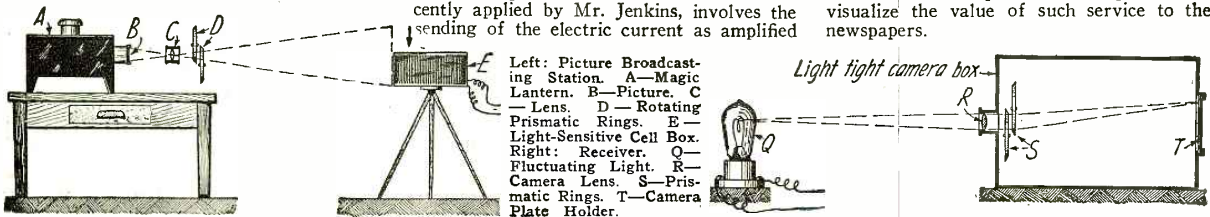



# R. T. M. TUNER & DETECTOR

Has a Tuning range of 150-650 meters. Tuning is very simple, brings in the music sharp and clear. Cabinet has mahogany finish, panel is made of hard rubber and has also the appearance of mahogany finish. All wiring is in the back of the panel, thus giving it a very neat front appearance. The B battery is contained within the set and outlets for A battery leads in the back. Price ..... **\$38.00**

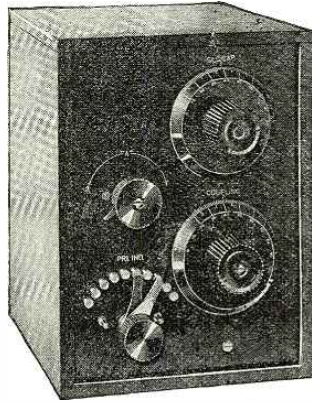

R.T.M. two steps complete finish connected to the R.T.M. tuner by means of bust bars... **\$38.00**

*Send for Dealer's Proposition*

**RADIO TELEPHONE MFG. CO.**  
150-152 Chambers Street NEW YORK CITY

the "B" or plate battery. The positive terminal of the "B" or plate battery should then be connected to one terminal of a pair of telephone receivers. A wire is then run from the remaining terminal of the telephone receivers to the terminal "P" of the vacuum tube socket. Where a "B" battery provided with regulating taps is used it may be well for the operator to change the position of the wire connected from the plate terminal of the socket until the best position is found. This method is indicated in Fig. 5.

Where even finer adjustment of the plate voltage is desired and this is frequently found to be the case when certain classes of vacuum tubes are used for detection, the use of an "A" battery potentiometer is valuable. The name of this little device is enough to frighten most beginners, but it is a very simple unit to connect in circuit and equally as easy to use. Three terminals are provided; the two outside connections being made, one each to the positive and negative terminals of the "A" battery and the third connected to the 18-volt tap of the plate or "B" battery.

The potentiometer is made up of a high resistance connected directly across the "A" battery with a movable arm passing over and making contact with the resistance. Manipulation of the movable member permits the voltage regulation on the plate circuit from approximately eighteen to twenty-four volts. The potentiometer is shown in the diagram Fig. 3, by R2. The condenser, C4, is that which was used in the circuit employing a crystal detector, described last month. Its use increases the clarity of the signals.

### MAKING A SIMPLE REGENERATIVE SET

Just as soon as the person uninitiated in radio runs upon a description of a regenerative circuit he quite frequently loses heart. There is little more complication in this form of circuit than those we have been considering and but a single change is necessary in the diagram shown in Fig. 4 to make a suitable regenerative circuit for broadcasting reception.

Again we come to one of those awe-inspiring terms, when reduced to practise and stripped of its vagueness is not very formidable and is the only detail necessary to transform the circuit we have been considering into a regenerative circuit and that unit is called a "Variometer." The circuit is the same as Fig. 2 the only difference being that a variometer is placed between the terminal "P" of the vacuum tube socket and one terminal of the telephone receivers. This variometer is used to tune the plate circuit and actually controls the regeneration permitting amplification of the received energy, by the method discovered by Armstrong to be described in detail later on.

### TO OPERATE THE V.T. RECEIVER

Whether we use the regenerative or not will depend upon just how much time we are able to devote to the circuit as well as the amount of money at our disposal between the first installment of this series and the second to describe the details of the construction of a variometer. See page 171 of this issue. We hope to see you that those who are interested in the regenerative circuit and variometers will find the information they have been looking for.

Start at the beginning of Radio and go step by step, in clear diagrams and full explanations, from the first set-up to the final listening in, with a copy of

## "RADIO for EVERYBODY"

By AUSTIN C. LESCARBOURA  
MANAGING EDITOR, *Scientific American*

Here's the book you've have been waiting for—the A B C of Radio with all explanations and instructions written so everyone can understand them.

This book is a complete guide on what to buy, how to set up, how to operate and listen in—authoritative, complete, easily understood.

Price \$1.50, by mail \$1.60

**SCIENTIFIC AMERICAN**  
MUNN & CO.  
237 BROADWAY NEW YORK CITY

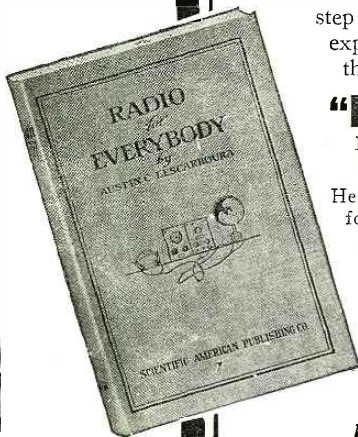

352 pages.  
180 diagrams  
and illustrations

## KNOCK DOWN CONDENSERS (STRAIGHT LINE TYPE)

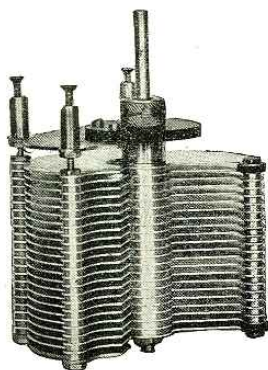

Plates 1/32" thick

- |                  |           |        |
|------------------|-----------|--------|
| 31 plate .001    | Knockdown | \$4.75 |
| Assembled,       |           | 6.00   |
| 45 plate .0015   | "         | 5.00   |
| Assembled,       |           | 7.50   |
| 23 plate .00075, | Assembled | 5.00   |
| 15 plate .0005   | "         | 4.50   |

Dealers write for discounts

**MONTROSE MFG. CO.**

619 St. Johns Pl.  
BROOKLYN, N. Y.



# Radio Receivers In the Making

By D. H. MOSS



Left: These Machines Wind a Complete Bobbin in Less Time Than It Takes to Tell It; 3,500 Turns of Wire Per Minute Are Put in Place. A Special Counting Device Tells the Operator When the Proper Number of Turns Are Placed. Right: This Expert Mechanic Is Grinding the Pole Faces of the Magnets. Great Care Must Be Taken as the Removal of a Hairbreadth of Metal Too Much, Seriously Affects the Receiver's Operation.

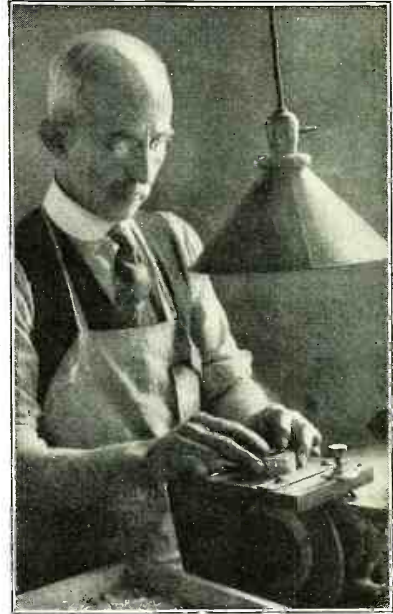

**T**HE radio headset is the most vital part of radio, since it is by the use of this instrument that we are able to convert weak electrical signals into audible sounds. The amount of current transformed into audible sounds depends entirely upon the scientific construction of the headset. That a sensitive receiver requires only .00000000016 ampere to give an audible signal is indeed a convincing argument

years of experience in manufacture that allows a producer of phones to place in the hands of the public a thoroughly reliable and efficient instrument.

The first operation in the construction of a radio headset is the cutting and forming of the receiver case. This is done on a huge punch press, which not only cuts the metal but forms it in cup shape. The metal used is  $\frac{1}{8}$ " thick. Aluminum is one of the most desirable metals for this purpose, since it is both light and strong. After the receiver cup is produced, it is placed in another heavy press and the top edge is pinched up or "swedged." It is this operation that produces a shoulder for the threads that engage with the cap. This cutting of threads takes place on a large screw machine and what is known as a geometric die head does the actual cutting. A geometric die head is a threaded cutting tool which stops automatically after it has traveled a certain distance. After the threads are cut a tool comes forward and cuts off the end of the receiver case so

duction of headsets. The bobbin cores must not only be made of the most carefully selected and special steel, but they must all be of exactly the same size. Therefore, the first operation is that of placing the core in what is known as a "go-and-not-go" gauge. The cores that do not "go" are rejected. They must be within the accuracy of .002 of an inch to pass inspection. Each bobbin has two bobbin heads. These bobbin heads are slipped in place next, one at a time. The first one is slipped on by a special machine and the bottom is then passed on to a second machine where the second head is placed on. In this operation both the bobbin heads are securely fixed in place. The operation is a semi-automatic one, the bobbin heads being placed on a rotating disc. They are fed in at the front of the machine and are automatically discharged at the back. In this operation the bobbin heads are simply slipped in  
(Continued on page 1876)



Here We See How the Depth Micrometer Is Used in Measuring Up the Distance of the Pole Faces from the Edge of the Receiver Case.

for its high sensitivity. This trifling whiff of energy is barely measurable and this fact should at once impress us with the importance of purchasing headsets that will make the most of the weak currents that we feed into them from our radio receiving set. Trying to obtain maximum efficiency from our radios without the use of accurately constructed headsets is like trying to carry water in a leaky pail.

A highly sensitive receiver must be a product of the most skilled workmanship. A good receiver is more than a mere assemblage of case, magnets, bobbins, diaphragm and cap. The acoustic, as well as the electrical principles, of a receiver are such as to present problems that require the utmost painstaking care in design and engineering. The slightest deviation in design in a radio receiver can make a great change in its sensitivity. It is only constant experimentation and

that the diaphragm will be locked tightly in place and will lie perfectly parallel to the pole faces.

The threads on both the receiver caps and cases must be accurately cut and for this reason costly sets of master gauges are used to constantly check the thread cutting tools.

The construction of the bobbins is a most important and interesting operation in the pro-



This Machine Measures the Resistance of the Bobbins and Tells Whether or Not the Winding is Grounded. The Resistance is Read Directly Off the Scale. It is the only Machine of its Kind.



# Multiple Receiving

By CAPTAIN FRED G. BORDEN, SIGNAL CORPS

**D**URING the past three months experiments have been conducted by the Signal Officer at the General Service Schools, Fort Leavenworth, Kan., along the lines of re-broadcasting concerts received to various locations around the post. The receiving set is illustrated below. Behind the set and not shown in the illustration are additional tuning condensers and also a double throw switch which connects either an inverted "L" type antenna through the tuner at the left to the radio frequency amplifier or in reverse position connects the loop antenna with a .001 Mfd. bridged condenser directly to the center unit which is the three-stage radio frequency amplifier. The signals are then detected and amplified two stages and are conducted to a No. 7A Western Electric amplifier; they are then ready to be distributed to the various loud speakers.

At the beginning distribution was effected through spare pairs in the cables of the post telephone system; although induction was negligible and results were satisfactory, it was decided to construct a separate distributing system, the latter consisting of about two miles of twisted pair stranded wire on porcelain knobs. The distributing circuit is not connected directly to the W. E. amplifier, but is inductively coupled to it by means of a 26A repeating coil. This coil not only tends to balance the line, but it avoids physical connection between the outside circuit and the set.

Loud speakers are installed in multiple at such locations as the hospital, officers' club, enlisted men's barracks, etc., and at the present time there are 14 loud speakers on the circuit, including one in the tower of

the College Building, which can be heard for several blocks.

The loop antenna is used for receiving concerts from nearby stations and by means of the loop concerts have been re-broadcast as received from such stations as Davenport, Dallas, Atlanta and Minneapolis. With the antenna connected, concerts from Regina and Winnipeg, Canada; Havana, Cuba; Schenectady and Los Angeles have been distributed in sufficient volume to be heard 15' to 20' from any of the loud speakers, most of which are similar to the one shown in the illustration, which was constructed from a junk automobile reflector by Signal Corps personnel at the post and which is very efficient.

The concerts, as re-broadcast, are clear and free from extraneous disturbances, the set is simple and reliable and is operated about five hours each day. It is believed that several additional loud speakers could be added without seriously affecting the reception at the various points where they are installed.

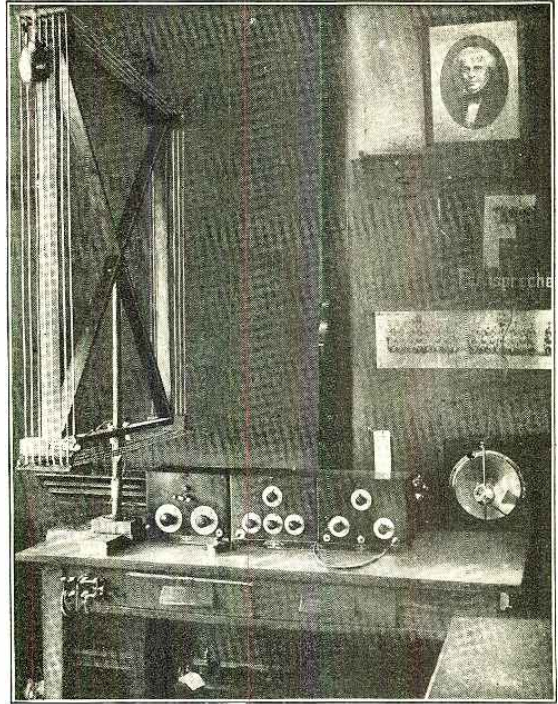

A View of the Receiving Outfit at Fort Leavenworth, Which Is Used to Re-transmit Concerts to Various Locations Around the Post.

## Overcoming Difficulties In Radio Reception In the Country

By WILLIAM HARPER, JR.

**T**O the city radio fan, who has many times exhausted his patience in trying to tune out some exasperating interference, most probably coming from a neighbor's careless adjustment of his regenerative circuit, the thought that if he only lived away off in the country districts he would be rid of these annoyances, may be an oft-repeated wish. It is, therefore, the purpose of this article to set forth the fact that Mother Nature, even in radio, follows the precept that the sweetest rose must have its thorns, and I sometimes wonder whether this is not a wise provision, so that we may never lack for opportunities in which to exercise our gift of ingenuity.

Now radio reception out in the country should be quite a good deal easier and better than in the city with the city's maze of steel structures and many local interferences. It certainly is easier and better in respect to distance, clearness and volume under normal conditions, but this predication is in explanation of what I mean by normal conditions.

Static is the chief difficulty, and is much worse in the country than in the city chiefly because of the absence of steel structures, which drain the air, so to speak. Then you may be so far from a broadcasting station that a signal can only be picked up on critical regenerative adjustment; this condition quite often brings in an harmonic wave of some high-powered telegraph station, or more frequently some inconsiderate amateur sending at about the broadcasting wave band and once you get such a C. W. tuned, it is

difficult to shake him off. Then again, as has been my own experience, in living in a little country town down in central Pennsylvania, where Uncle George had already introduced radio, there may be another kind of interference. Not from your neighbor's tubes, either; there, at least, they are considerate, but the country telephone systems are not, and for a while this seemed to be an insurmountable obstacle.

You see in a country town all the wiring is overhead on poles, electric light and telephone, and may I digress to state that if the country folks ever take to radio as they have to the "Party telephone line," the broadcasting stations will have to work overtime, as the telephone now does.

This overtime pressure has resulted in a most wicked little instrument known as a buzzer being installed in the telephone central's switchboard to do the bell-ringing which has gotten beyond the bounds of old fashioned hand work. This buzzer results in nothing more or less than a transmitter of the most awful noises and ear-splitting cracklings when heard through the head phones of a radio set.

The electric light wires, as well as the various telephone circuits, act as aerials and it is continuously tuned over the whole length of wave bands and cannot be cut out at the receiver within a range of a mile or so from the telephone central.

At first I assumed that these emanations could be readily stopped at their source by proper grounding and condenser shunting circuits from the various aerials and after

consulting several radio authorities in New York, who prescribed similarly, I journeyed back to the country with full assurance to Uncle George that our mutual pest would soon be silenced. After the most careful application of ground circuits and condensers of all capacities, the enemy was as much alive as ever and we again fell back on our former persuasive tactics of frequent libations of ice cream sodas and boxes of candy to be laid at the feet of the fair Goddess who happened to preside that evening at the switchboard. We asked that she most mercifully desist in the association of that awful automatic buzzer during a few hours of the evening, that we might also sit at ease with our own ear muffs on and listen to something more than the gossipy telephone visiting that it was her fortune or misfortune to intercept.

Probably this lamentable condition would have persisted indefinitely if we had relied solely upon the telephone company's engineers, or rested our efforts after appealing to the big electric manufacturers who were marketing the various radio apparatus we were trying to use. Something seemed to tease me along towards a solution, and I am happy to say at last that the ether is now undisturbed from any more radiations from the maze of overhead wiring.

As it may be of use to some other similarly afflicted community, I will try, in detail, to describe the method.

This telephone buzzer is an arrangement of transformer and magnetic vibrator by  
(Continued on page 1874)

# Radio-Telephony On Transmission Lines

The System of the Societe Francaise Radio Electrique

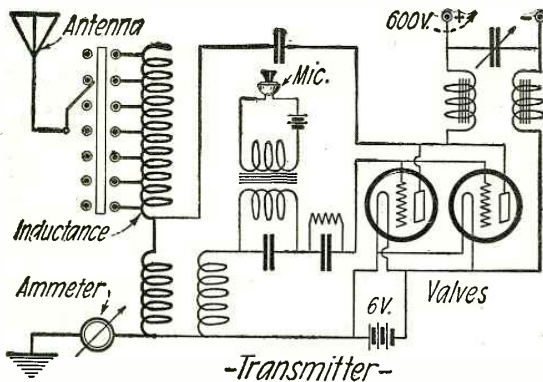

The Small Transmitter Developed in France Which Well Lends Itself to the Transmission of Voice Over Power Lines or Through the Air.

**I**N many electrical undertakings the establishment of permanent, certain, and instant communication between the principal departments is one of the chief concerns of the officials.

Owing to the impossibility of relying on the French state-owned telephone system, which is slow, not always in operation, and not always available near the power stations and networks, several companies have been led to construct special telephone lines, often using no other supports than those already existing for other purposes, such as the State lines or power transmission lines.

The initial cost and the cost of maintaining such installations is very high, and they do not give complete security. This is particularly true in the case of power transmission networks. When there is a break in the high-pressure line the telephone line is usually damaged and put out of use, just at the time when it is most necessary; moreover, the inductive effect of the power lines on the telephonic network creates in the latter permanent troubles harmful to the apparatus, and adversely affecting the efficiency of transmission.

The Societe Francaise Radio-Electrique claims that the perfect operation which it has obtained with wireless telephony affords a remedy for all these troubles, and gives officials reliable communication at small cost and free from the drawbacks above mentioned.

The company has made and used a valve-pattern wireless telephone, type F.D.C.O., of small power. This apparatus gives all the usefulness and security of the ordinary telephone with wires, employing very little power, and, being very simple to use, it can be put in the hands of anyone after a short demonstration. Also, the F.D.C.O. set is very economical, so much so that the cost is covered by the saving in the cost of working—valuable qualities if we consider, in comparison, the cost of installing and maintaining a private telephonic network.

The F.D.C.O. set can be connected to a fixed aerial, and ensures good communication to a distance of 30 kilometers if the aerial has a mean height of at least 15 meters. It also forms a small portable and very light outfit, the aerial being fixed on a telescopic mast 12 meters high.

It lends itself very well to the utilization of the power transmission network, part of the waves sent out by the aerial placed near

the line being collected by the latter. The transmission of intelligible speech is maintained, even if the power lines are accidentally broken and fall to the ground; the waves leaving the broken line jump through the intermediate space, and are picked up by the other end.

Speaking more generally, in all cases where several places are joined by a conductor, even a discontinuous one, the F.D.C.O. set can be used to obtain a range very much superior to the normal compass. It can be connected with advantage to the wires of overhead or submarine telephones. In spite of the small power, its range is

then 100 kilometers.

In all cases the apparatus is put into service with the facility of the ordinary telephone (call by bell, put in action by the unhooking of the combined receiver, transmission and reception simultaneous).

An F.D.C.O. installation consists essentially of a transmitter and a receiver connected to the aerials for transmission and reception. In the case of transmission along a high-pressure overhead power line, the aerial consists of two wires carried parallel to the line for a length of 100 to 125 meters, at a distance of 1 to 2 meters, in such fashion that they cannot under any circumstances even accidentally come in contact with the live wires. There is no connection between the network and the apparatus.

In order that the stations may hear each other they must be tuned to the same wave-length.

In the case of an undertaking comprising several stations, one allots to each station a predetermined wave-length, to which its receiver is regulated once for all. To converse with this station it is necessary to transmit on its own wave-length; transmission on a different wave-length is not noticed and cannot trouble it.

The transmitter permits of the use of seven different wave-lengths, which can be changed by pushing a plug into one of the seven holes provided. These wave-lengths correspond to those of the different receiving stations of the network. All the wave-lengths are regulated, once for all, at the first installation of the network.

The receiver is completed by a caller with

a bell, which gives notice when the station is called. The bell is arranged to ring on the wave-length for which the receiver is tuned, but on no other.

The accompanying diagrams will help to explain the operation of the apparatus: transmitter, receiver, and caller.

The energy necessary for the operation of the system is furnished by a converter set supplied either directly from the network or from a battery, in order to have an installation capable of working even in the case of the failure of a section.

Telephonic communication with F.D.C.O. sets is said to give greater security than does the ordinary telephone, especially in the case of transmitting along a power line. To emphasize the simplicity of their operation, the method of use is indicated below:

To call a station:—

Fit the plug on the transmitter into the hole corresponding to the station it is desired to call.

Press the call-button for about 10 to 15 seconds.

Unhook the receiver and give your name (rather than say "Hallo").

To reply to a station:—

When you hear the bell, unhook the receiver and listen. When you hear the name

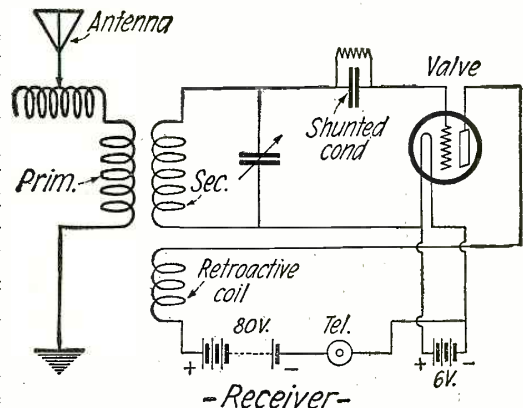

The Circuit of the Receiver. For Reception Over High Power Transmission Lines the Receiving Aerial Is Placed Parallel to Them.

of the calling station, fit the plug on the transmitter into the corresponding hole and answer.

These proceedings can be simplified if the stations are furnished with call indicators.

The call-bell is connected so as to continue ringing after once starting, until the receiver is lifted. It is therefore not necessary to have someone continually on watch near the apparatus. But where a station can be called by several others it is necessary that the call should be accompanied by an indication of the calling station. To accomplish this, a supplementary fitting, called a call indicator, has been designed, by means of which the ringing of the bell is accompanied by the illumination of a small lamp indicating the calling station.

The call-button on the transmitter is replaced by a call dial. This consists of a small disk which automatically produces signals of a predetermined rhythm (a letter of the Morse alphabet).

The call indicator consists of several relays which are put in

(Continued on page 1876)

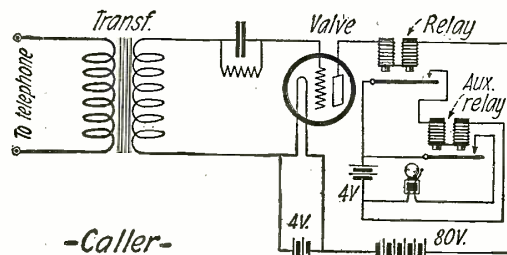

The Caller Circuit Used in Conjunction with the Main Receiver. The Bell is Arranged to Ring on the Wave-Length for Which the Receiver is Tuned.



# The ITCH for Distance

By ARMSTRONG PERRY

**A** LONG time ago it used to happen that some pupil at a district school would suddenly be seized by a strange ailment. First he showed a growing restlessness. He would squirm a good deal, pucker up his face into odd expressions and scratch various portions of his anatomy.

Then some other pupil would get to going. Then another and another. Eventually almost everybody in the school would be affected. In order to reach inaccessible spots in the middle of the back the victims would even take to stropping themselves on shagbark hickory trees the same as razor back hogs.

They called it "the itch." Sometimes it was temporary. Often it was reputed to be of the "seven-year" variety. With some it seemed to be chronic.

Modern medicine appears to have brought this disease under control, but a mental ailment has taken its place. It is the itch for distance. It attacks persons of all classes. A hitherto sane, conservative business man suddenly becomes restless. He begins to neglect the reading which he once enjoyed in the evening hours. He buys a radio set. He sits down before it with the phones clamped to his ears. He grabs the knobs and switches one after another, but never leaves one of them in adjustment for more than a few seconds.

One minute the gentle wife, whispering to grandmother that the baby shows symptoms of growing a tooth, is yelled at savagely to stop her infernal racket. The next moment, having settled silently into the depths of the beauty page she is yelled at to jump to hubby's side instanter—he's got Schenectady.

Just as in the old-time itch, this heretofore well-balanced man no sooner scratches one spot than another bites him. The instant he hears the announcer's: "This is WGY," he tries to tune him out and get KYW. He seems to have lost all interest in everything except unusual arrangements of the alphabet. He attempts to cover large pieces of paper with three- and four-letter combinations that spell nothing.

Once this man enjoyed music. Now he listens impatiently to a few bars and storms because the announcer takes so long in telling where he is. He neglects the home phonograph, for which he once purchased a record a week at least, but the scratchiest, blindest note of canned music received by radio is greeted like a one hundred per cent stock dividend, if it comes from Kentucky, Louisiana or Colorado.

Sometimes such a man reports phenomenal success. A letter from one of them is capitalized in a radio ad with a black-type headline: "Heard 14 concerts in one evening."

Now I ask you, did any man ever hear fourteen concerts in one evening? When I compare notes with a musician after attending a Werrenrath recital or a Damrosch orchestral matinee I realize that I never really heard even one concert. I joyously listened and absorbed as much of the music as my mental equipment would permit, but there were a thousand examples of melody and harmony that never touched me.

Or, would any man start out in his evening clothes to attend fourteen concerts on the same date? Would he poke his head through the doors of fourteen auditoriums and then run around town the next day

bragging that he had been present at that many entertainments? No, even if there were fourteen Winter Gardens in a row the tired business man who ever telephoned his wife that he was detained at the office wouldn't go farther than the first one where he could buy seats in the front row.

Then why the enthusiasm over hearing thirty seconds worth of music, messed up with weather reports, fashions, hog markets, stolen automobiles, plain and fancy scandal, code traffic and miscellaneous bedlam from each of a dozen stations at all points of the compass? Let pathological experts answer. It is beyond my ken, even when I do it myself.

It seems to me that the planting and nurturing of the itch for distance by radio manufacturers and dealers is the quickest, surest form of business suicide. There is to be sure a certain curiosity, inherent in most human beings, that leads us to travel, read and look at pictures to acquire information about doings in distant places. The possibility of listening-in directly on what is transpiring a thousand miles away whets that curiosity for a time. In the winter of 1921-22 we saw how far it could be developed by modern publicity methods. Then, along in the summer of 1922 when manufacturers and dealers got ready to de-

velop what man hearing the clicks, as the railroad car passes a cross-over, stops to think that a different kind of steel has to be used at that point because the ordinary rail steel is not hard enough? What automobile owner ever gets under his car except when necessity compels him? We are not technically minded, most of us. We like to appear up to date and to know a little about everything that everybody is talking about, but when the newspapers of the country suddenly drop their technical radio departments and cut the radio news down to a mere running program of near-by broadcasts and a half dozen news items per day, it is safe to assume that the public curiosity is satisfied. Liberal advertising patronage by radio dealers may keep the editorial matter in the papers up to a column or two. Even chess problems find a place in some publications. But the itch for distance is running its course. The popular radio of the future will be that which gives folks what they want to hear, when they want to hear it, not from distances that make it impossible to guarantee continuously satisfactory results, but from stations near enough to be as unfailing as the letter-carrier.

Bicycling was once a craze as all-enveloping as radio was a year ago. As a sport, it was better physiologically because it provided exercise. It had social features that radio so far has failed to develop. It took its devotees out into the fresh air and into pleasant places. It had a broader basis, apparently, than popular radio. It waned before the automobile took the place of the smaller vehicle completely. I have heard of statistics purporting to prove that there are more bicycles sold today than there were during the craze. If there are, they must be going to foreign countries. There are millions of persons who cannot afford automobiles. They could get just as much fun out of a wheel today as they ever could and it would be just as useful. There seems to be no reason for the decadence of the bicycle

---

**I**N this article, Mr. Armstrong Perry, much to our personal regret, has hit the nail upon the head. Every one of us, whether we are amateurs, fans, or novices, has been thoroughly inoculated with the "itch for distant stations." We all like to play "radio golf"; that is, score as many miles in radio distance as we possibly can each night. It is all so very dear to our hearts that it never occurs to us that there is anything wrong about it. But if we search our hearts, after reading Mr. Perry's article, we must admit that he is right.

The "itch for distance" is all nonsense, and we are simply building ourselves unconsciously. Besides it is all wrong, because it serves no real purpose.

This very important article gives a lot of food for thought, and we hope that all of us will be frank enough to admit that we should rid ourselves of this "itch," pleasant though it is to most of us.

—EDITOR.

---

liver the stuff that customers were fighting for, six months earlier, we discovered how very easily the popular curiosity had been satisfied and had evaporated. The itch for distance has not entirely run its course. It may always be with us in some degree, but the epidemic is passing and it is an unsafe foundation upon which to build a business that should rival steel, cosmetics, photography, candy, booze and phonographs.

The technical amateur, who is the itchiest of all itchers, will always be a good customer unless he closes his eyes to the danger brought upon himself by disregarding the wishes of other citizens and is eliminated by legislation. He wants distance and has a reason for wanting it. He has seen his efforts bearing fruit in the increasing efficiency of radio communication and incidentally has been able to sell his technical ability in a very good market if he cared to use it in business as well as in the sport of radio. But 999 per cent of the population has too little interest, actual or potential, in technical radio to even inquire, when the amateur interferes, what it is trying to do. Nor can this condition ever be changed unless human nature changes.

Who cares today how a sewing machine is made? Who knows or cares how to figure the focal distances in a camera?

except that the bicycle business was built on a fad basis. The itch for distance was inoculated into the public. People were taught, not to enjoy to the full the scenery near at hand, but to get as far away as possible. Naturally, when the automobile made it possible to go faster and farther and with less effort, the bicycle was junked. In this case many a bicycle manufacturing plant was quickly adapted to the manufacture of automobiles or parts. What are the radio plants going to do when the itch for distance is scratched to the point of satisfaction?

This *Sarcoptes scabiei* or itch-mite of radio causes some queer symptoms. Normally, a man takes pride in the local industries and public works of his home town. If he has a visitor he takes him out to show him the school house, the new river bridge, the municipal ice plant. But the New York or Philadelphia or Washington man who entertains a caller with a radio set seems bent on showing him that Davenport, Louisville and Atlanta are the only towns on the radio map. He sometimes acquires such a murderous hatred of the local broadcasters, the commercial traffic stations and the radio transmitters of his Government that he organizes to force them out of the air or into stray corners of it where they cannot be

(Continued on page 1828)

# Electrons, Electric Waves and Wireless Telephony

By Dr. J. A. FLEMING, M. A., D. Sc., F. R. S.

## Part III

WE are then naturally led to consider the very important question of atomic structure and architecture to which all the foregoing discussion has been only preliminary.

The first step in this knowledge was taken about 1898 or 1899, when Sir Joseph Thomson began his epoch-making work which led to the discovery of the *corpuscule* or *negative electron* as a constituent element of all atoms. This work grew, very naturally, out

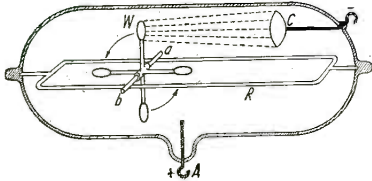

Fig. 36. Crook's Electron Mill. B—Highly Exhausted Bulb. C—Cathode or Negative Electrode. A—Anode or Positive Electrode. W—Little Rotor with Mica Vanes Which Rotates and Rolls Along Glass Rails R. Under Impulses of Electrons Radiated from Cathode.

of the previous researches of Sir William Crookes on electric discharge in high vacua, and the discovery in 1895 by W. Röntgen of the so-called X-rays, which marked the beginning of a new era in physics.

Crookes had found that when a glass bulb exhausted to a very high vacuum had one platinum electrode, called the cathode, sealed through the glass connected to the negative terminal of an induction coil, and another similar electrode, called the anode, connected to the positive terminal of the coil in action, not only was the glass rendered fluorescent, but particles of some kind were projected from the cathode, which moved away in straight lines, normal to the surface of the cathode. These could produce fluorescence in many substances placed in their path, could cause little mica vanes to rotate like a windmill, and also could cast shadows of metal objects on the glass wall of the tube (see Fig. 36). Crookes showed that these particles each carried a charge of negative electricity.

Crookes named these particles "radiant matter," but they were subsequently called "cathode rays" or "cathode ray particles." Up until 1895, this high vacuum electric discharge hardly possessed more than a purely scientific interest, but in that year W. Röntgen made a discovery of great practical importance. He found that when such a high vacuum tube was in operation and the glass fluorescent, paper or wood coated with a fluorescent material such as barium platinocyanide, was also made fluorescent, even outside the vacuum tube, when held near it, and, moreover, that some substances, such as heavy metals, stopped the radiation producing fluorescence, whereas this radiation passed freely through wood, paper, leather and other materials opaque to light rays.

The great sensation of that day was, however, the discovery that the new rays, then called X-rays, from their unknown nature, passed freely through the fleshy tissues of the living human hand, but were more or less stopped by the bones. Also that since these rays could affect a photographic plate enclosed in a black paper envelope, it was possible to photograph the bones in the living hand and unerringly fix the position of any metallic bodies, e.g., bullets, needles, etc., in the flesh (Fig. 37). Again, it was found

that these X-rays produced a certain degree of temporary electric conductivity in air or other gases through which they passed.

The investigation of the nature of the cathode rays and of the X-rays was taken up very carefully about the end of last century. Two views had previously been held as to the cathode rays. Crookes and his followers maintained that they were material particles of some kind projected from the negative electrode in the high vacuum tube. Other physicists regarded them as some form of aetherial vibration.

Sir Joseph Thomson settled the question by experiments of a remarkably ingenious and important character. If an electrified particle is made to move across the space between the poles of a powerful magnet in a direction at right angles to the line adjoining these poles, it experiences a deflecting force which is at right angles to the direction of its motion and that of the so-called magnetic force which last lies in the direction of the line joining the magnetic poles. This magnetic force is a quantity measurable in certain units. Let us denote by the letter *H* the magnitude of this magnetic force. Let the velocity of the electrified particle be *v* centimeters per second, and let it carry an electric charge, denoted by the letter *e*, as regards amount. Then when the particle carrying an electric charge of *e* units moves with a velocity *v* in a direction at right angles to a magnetic force *H*, it experiences a deflecting force numerically equal to the product *Hev*, which is in a direction at right angles to the direction of *H* and *v*.

Under these conditions the electrified particle of mass *m* is being continually acted on by a force at right angles to its direction of motion and hence it moves in a circle of radius *r*, such that  $Hev = mv^2/r$ .

Therefore we have the relation

$$\frac{m}{e}v = Hr.$$

Suppose in the next place that we cause an external electric force to act on the electrified particle having an electric charge *e*. Let the magnitude of this electric force be denoted by *E*. Then a force measured by the product *Ee* acts on the particle. Let the direction of the impressed electric force *E* be so adjusted that the deflecting force produced by it on the electrified particle is exactly opposite in direction and equal in amount to the deflection produced by the magnetic force. We can then equate the two expressions for the deflecting force acting on the particle and have the equation

$$Hev = Ee$$

or 
$$v = \frac{E}{H}$$

Hence, if we measure, as we can do, the magnetic force and the electric force, we can determine from their numerical ratio the velocity *v* of the cathode particle.

Again, having found the velocity *v*, we can from the previous equation, viz.,  $Hev = mv^2/r$  or  $Hev = mv$ , find the ratio of *e/m* or of electric charge to mass of the cathode particle. For from the above equations we see that

$$\frac{e}{m} = \frac{E}{H^2 r}$$

Hence, if we measure the radius of the circular path of the cathode particle when deflected by the magnetic force *H*, and also

the electric force *E*, at right angles to *H*, which is necessary just to annul the deflection, we can calculate the value of  $E/H^2 r$  and thus determine the ratio *e/m*. This ratio is an extremely important number and the investigations for its exact determination have been very numerous. The apparatus generally used is shown in Fig. 38. It consists of a glass tube about two inches wide, ending in a large bulb *B*, 10 or 12 inches in diameter. At the extreme end is sealed in a platinum wire, ending in an aluminum dish *C*, which forms the cathode or negative electrode. The positive electrode *A* is another wire sealed into a short side tube. When these electrodes are connected to the secondary circuit of an induction coil, or, better still, to the poles of an electrostatic generator such as a Wimshurst electrical machine, which keeps the cathode negatively electrified, a torrent of cathode particles are projected from it, when the tube is highly exhausted of its air so as to make a good vacuum in it.

In the vacuum tube are placed a pair of baffle plates, *E*, with small holes in them, which allows a thin stream of cathode particles to pass. These fall on the spherical end of the tube, which is coated inside with a phosphorescent material called willemite, or with powdered zinc blende. The cathode particles impinging on this screen make a bright green spot of light on it. Within the tube are also placed a pair of metal plates, *fg*, which can be electrified, one positively and the other negatively, so as to create the required deflecting electric force we have denoted by *E*. Also that same part of the tube is placed between the poles of a powerful magnet so as to supply a deflecting force *Hev* in the contrary direction, but in the same line as the electric force *E*.

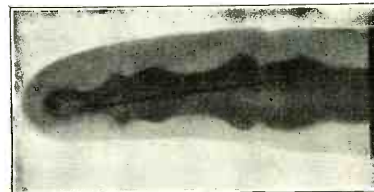

Fig. 37. Two X-Ray Photographs, one of a Hand with Shot Embedded in it and the Other of a Finger with a Needle Embedded in it.



From the deflection caused by the magnetic force alone we can find the radius  $r$  of the curve along which the cathode particle moves, and we can thus determine both the velocity  $v$  and the ratio  $e/m$ .

When these experiments are carefully conducted, it is found that the velocity of the cathode particle will vary with the potential difference, as it is called, of the electrodes, but in a high vacuum tube may be of the order of 100 million feet per second, or about one-tenth of the velocity of light. This is an enormous speed, and it is due to this immense velocity that the cathode particles are able to make a luminous spot on the phosphorescent screen.

Sir Joseph Thomson found, in 1899, that the ratio of  $e/m$  for the cathode particle was quite independent of the metal of which the cathode was made or of the residual gas in the tube. Under all circumstances exactly the same ratio was obtained. The numerical value was nearly  $1.77 \times 10^7$  when the charge  $e$  is measured in the so-called electromagnetic units. This electromagnetic unit of quantity is the quantity of electricity conveyed by a current of 10 amperes when flowing for one second or one ampere when flowing for 10 seconds, or about the quantity of electricity which passes through the filament of a 16 candle-power 200-volt lamp in a minute and a half.

This constancy in the ratio of  $e/m$  for all particles indicates that they are identically the same in every case.

We must make a little digression to explain the manner in which this ratio can be determined for the hydrogen atom and what conclusions can be drawn from it.

If we place two platinum or gold plates in water which is slightly acidulated and connect these plates with a storage battery of a couple of cells, we see bubbles of gas arising from both plates. By collecting these gases in separate tubes we can prove that the gas arising from the plate in connection with the positive pole (marked red) of the storage cell is oxygen and the gas collected at the other plate is hydrogen. By measuring the volume of these gases collected we can find that the passage of a current of one ampere for one second through the acidulated water liberates 1.04 ten-thousandths of a gram of hydrogen in the form of gas. These two gases are produced by the electro-chemical decomposition of the acid which is mixed with the water. Suppose for the sake of simplicity that we consider the water to have been acidulated with hydrochloric acid. Each molecule of this acid consists of an atom of hydrogen united to an atom of chlorine and the chemical formula is therefore  $HCl$ .

Absolutely pure water is not a conductor of electric current, or at least is a very bad one.

If we put into this water a little hydrochloric acid the water causes a number of the hydrochloric acid ( $HCl$ ) molecules to become separated into atoms of hydrogen which are positively electrified and atoms of chlorine which are negatively charged. In this state the electrified atoms are called *ions* and the acid is said to be, partly *ionized*. The word *ion* means a wanderer and they are so called because they wander about in the liquid. When a hydrogen ion collides with a chlorine ion they may become reunited into a hydrochloric acid molecule for a short time, but presently the ions are detached again. If then we place in the acid water two metal plates which are electrified, the negative plate attracts and draws to it at the instant when it is free the positively charged hydrogen ion and the positive plate similarly attracts the chlorine ions.

The chlorine ions, however, have a strong affinity for hydrogen ions and they even take these away from molecules of water, thus reforming  $HCl$  and liberating oxygen ions against the positive plate. These hydrogen

ions then take negative electricity from the negative plate and the oxygen takes positive electricity from the other plate, re-forming hydrogen and oxygen atoms which in turn unite, pair and pair, to form molecules, and these constitute the bubbles of gas liberated.

We see, therefore, that the electric current which passes through the electro-chemical vessel consists of charges of electricity which are carried by hydrogen and chlorine ions. To every hydrogen atom there corresponds a certain electric charge. If, therefore, we wish to determine the ratio of charge to mass for a single hydrogen atom or ion we have only to determine how much electricity passes, corresponding to the liber-

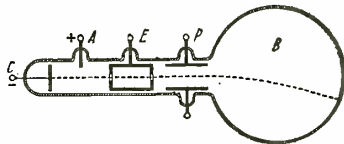

Fig. 38. Cathode Ray Tube and Bulb. C—Cathode or Negative Electrode. B—Highly Exhausted Bulb with Fluorescent Screen on its Spherical End. A—Anode. E—Baffle Plates. P—Deflecting Plates.

ation of one gram of hydrogen at the negative electrode. Now, exact experiment shows that a current of one ampere flowing for one second, conveys a quantity of electricity called one coulomb, which is one-tenth of an absolute unit of electric quantity, and this liberates 0.0000109 grams of hydrogen. Hence, the ratio of charge to mass or  $e/m$  for the hydrogen ion is a number near to 10,000 or  $10^4$ . We have seen, however, that the ratio of charge to mass or  $e/m$  for the cathode particle is  $1.77 \times 10^7$  or  $1,770 \times 10^4$  or 1,700 to 1,800 times greater than  $e/m$  for the hydrogen ion.

The question then at once arose: is this difference due to a difference in charge or to a difference in mass between the cathode particle and the hydrogen atom or ion?

#### CATHODE PARTICLES OR ELECTRONS

Sir Joseph Thomson gave a reply to this question in 1899 by experiments of extraordinary skill and ingenuity.

It was found that particles in every way similar to cathode particles are liberated from the surface of polished zinc and some other metals when they are illuminated by ultra-violet light or light rays of very short wave-length. Also they are liberated from radium and the X-rays of Röntgen liberate them from molecules of air.

When produced by either of these methods these cathode particles have the power of condensing round themselves water vapor present in air and forming a minute water spherule or drop of water.

The white clouds we see floating in the sky are composed of such small water drops. All air, unless specially dried, has in it a certain proportion of water vapor which is an invisible gas. If, however, the air is cooled below a certain point it cannot hold as much water vapor in solution and it gets rid of and deposits the excess by forming a cloud or mist. This is the explanation of the early morning mists in the atmosphere which are really formed during the night, when the atmosphere is cooled and the excess of water vapor condensed to water spherules. These small drops of water fall very slowly through the air owing to the friction or viscosity of the air.

Many years ago Sir George Stokes gave a formula connecting together the diameter ( $d$ ) of the drop with viscosity ( $q$ ) of the air and the final or constant velocity ( $v$ ) which the falling drop attains. This for-

mula is  $v = \frac{1}{18} \frac{gd^2}{q}$  where  $g$  stands for the

acceleration of gravity and is nearly 981 in centimeters and seconds as units.

When moist air is chilled by being suddenly expanded it has been found that the excess of moisture is not readily converted into droplets or mist unless there are dust particles in the air. These, however, assist the condensation by affording nuclei round which the water vapor condenses. Many years ago it was discovered by Mr. C. T. R. Wilson that cathode particles could act in the same manner in perfectly pure dust-free air.

If such pure air is suddenly expanded and cooled a cloud does not form but the air becomes supersaturated with moisture. If then cathode particles are introduced a cloud forms at once. Wilson found that if the supersaturation did not exceed a certain amount only the negative or cathode particle acted as a nucleus or core for the condensation of water vapor around it, and a cloud or mist is formed in the vessel in which the moist air is suddenly expanded.

Sir Joseph Thomson and Prof. H. A. Wilson applied this method to determine the cathode particle electric charge as follows:

He suddenly expanded pure dust-free air in a glass vessel and thus supersaturated the air with moisture. He then introduced into this air a number of cathode particles either by allowing ultra-violet light to fall on a zinc plate in the vessel or else by exposing the air to the X-rays. The expansion was performed in a glass vessel having in it two metal plates, an upper and a lower, which could be connected at pleasure to a voltage battery of a certain number of cells so as to make the upper plate positive and produce a certain electric force in the space between the two plates. When the cloud was formed by the condensing action of the cathode particles each of the latter condensed round itself a drop of water and began to fall downwards. The rate of falling, by Stokes' law, is determined by the size of the drop, and from the observed rate of sinking of the upper sharp surface of the cloud we can calculate the diameter of the minute drop of water from the formula given above and hence the mass of the drop. When the cloud has sunk a certain distance the upper metal plate is given a positive electric charge and this produces an electric force  $E$  in the space between the plates which can be adjusted until it just arrests the fall of the drops.

We then know that since each drop contains a cathode particle of electric charge  $e$  we must have the equation

$$Mg = Ee$$

Where  $M$  is the mass of the drop and  $g$  the acceleration of gravity. From this equation  $e$  can be determined.

Some admirable measurements of the same kind, only using oil or mercury vapor in place of water vapor, have been carried out by Professor R. A. Millikan in America. The best and final result is that the cathode particle carries a negative electric charge of  $4.774 \times 10^{-10}$  electrostatic units or  $1.591 \times 10^{-20}$  electro magnetic units. In other words, six million billion cathode particles carry between them a quantity of electricity equal to that conveyed by a current of one ampere in one second.

It was thus found that this very small quantity of negative electricity is a natural unit which cannot be divided, and is in short an *atom of electricity*. Electricity was thus seen to be a commodity like cigars or cigarettes or things of the kind that are supplied only in multiples of some finite unit.

To this atom of negative electricity the late Dr. Johnstone Stoney gave the name of *the electron*, but the term electron is now applied to the cathode particle, or negative corpuscle as a whole.

It became clear, therefore, that identical electrons were constituents of all material atoms and could be extricated from them.

#### ELECTRONS AS CONSTITUENTS OF ALL ATOMS

It was not then a long step from this point to the suggestion that atoms consisted of groups of electrons, arranged in a certain way and held together by the attraction of some form of charge of positive electricity. The first suggestion was that this positive charge of electricity, the nature of which was unknown, existed in the form of a sphere of the size of the atom and that the negative electrons were distributed through it like pits in an or-

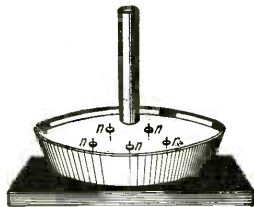

Fig. 39. Mayer's Magnet Experiment. Little Magnetized Needles Floating Vertically in Water were Caused to Arrange Themselves in a Pattern by a Magnet Held Over Them.

ange, but able to circulate about or revolve in it.

The late Lord Kelvin made this suggestion first, and its consequences were mathematically developed by Sir J. J. Thomson.

If we suppose the sphere of positive electricity to be composed of stuff which attracts electrons external to itself with a force which is inversely proportional to the square of the distance, then it can be shown that a sphere of such positive electricity would attract an electron embedded in it, towards its center, with a force proportional to the distance of the electron from the center. If then by any means the electron is set in motion, it will revolve around the center of the sphere of positive electricity in a circular orbit included within the boundary of that positive sphere.

If a number of such electrons are included in the sphere they will arrange themselves in certain rings or orbits, certain arrangements being stable and others unstable. An illustration of this sort of structure is found in an interesting experiment due to Mayer.

A large number of sewing needles are thrust through the little discs of cork. The needles are all magnetized and then, if placed in water in a basin with the cork button slid along to one end, the needles will all float vertically in the water. If then the upper ends are all similar magnetic poles, the needles will repel each other like electrons, and if left to themselves will get as far apart as possible.

If the opposite pole of a bar magnet is now held near the surface of the water the needles will be drawn to it but will be mutually repelled. Under this double action they will arrange themselves in certain forms (see Fig. 39). Thus three needles will set themselves at the angular points of an equilateral triangle, four at the corners of a square, five at the corners of a pentagon. Certain arrangements are, however, unstable, especially if the needles or electrons are in rotation round the center, and when more than a certain number of needles or electrons exist in the group the arrangement is not stable unless they are arranged in two or more rings.

Certain facts discovered by Sir Ernest Rutherford, and strongly supported by the theoretical investigations of Professor N.

Bohr, of Copenhagen, seem to militate against the view that the positive electric charge is diffused over a sphere the size of the atom, but strongly support the view that it is concentrated in a small center or nucleus which is very small compared with the size of the material atom itself, and perhaps not large even compared with the size of a negative electron.

The theory of atomic structure now somewhat widely held, called the Rutherford-Bohr theory, is that a chemical atom consists of a nucleus which is composed of negative electrons, held together by still smaller positive electrons, the positive electrons predominating in number so that the whole nucleus has a resultant charge of positive electricity if we assume that the charge of positive and negative electrons taken singly are equal.

Thus, for instance, the nucleus of the Helium atom is supposed to contain four positive electrons and two negative, which are bound by mutual attraction and repulsion into a compact mass, which Rutherford concludes has a diameter of not more than one ten-thousandth part of that of the whole atom, which we have seen to be of the order of one-hundred-millionth of a centimeter. This nucleus has, therefore, a resultant positive charge equal to two units, taking the unit to be the electron charge. Around this nucleus circulate two negative electrons like planets round the sun and the atom, taken as a whole, is therefore electrically neutral.

The atom, on this theory, is a solar system in miniature. The nucleus corresponds to the central sun and the negative electrons to the planets circulating round it. The electrons need not revolve in the same plane nor even all in the same directions, and each orbit may have not only one planet but two, three, or more, even up to eight, as the case may be.

It will be seen, therefore, that an atom forming what we usually call solid matter is in fact a very open or porous structure, consisting of a certain number of very dense and extremely small particles distributed throughout a certain space, otherwise unoccupied, which we call the volume of the atom.

#### A MODEL OF AN ATOM

Thus if we desired to make a model, say, of a helium atom, we might place a sphere, say, the size of a football, at a certain position to represent the positively charged nucleus. Then at distances of about  $1\frac{1}{4}$  miles, we should have to locate two golf balls to represent the two negative electrons and to assume that these were revolving round the football like planets round the sun, but not necessarily in the same plane nor in the same direction as regards rotation.

In the case of an atom of hydrogen, the nucleus consists of a single positive electron and a single negative electron, the two revolving round their common center of mass. When two atoms of hydrogen unite to form a molecule, we have two positive electrons at a certain distance apart, and two negative electrons revolving in a circle, the plane of which is perpendicular to the line joining the two positive electrons and its center on that line.

The two negative electrons are at opposite ends of a diameter of the circle in which they revolve (see Fig. 40).

It appears from certain considerations that the diameter of this circle may be different in different molecules of hydrogen, so that these molecules are not in all cases of exactly the same volume.

We have seen that the mass of the negative electron is only about  $1/1,700$ th of the mass of the positive electron and this leads

to the conclusion that the true mass or gravitative mass of the atom resides almost entirely in the positive electrons. The reason for this may be in the much greater density and smaller size of the positive electron.

In addition to this Rutherford-Bohr theory of the structure of the atom, another view has been advanced and supported by Langmuir, which regards the negative electrons assembled round the nucleus as stationary and not in revolution. We shall not enter into the discussion of this theory because it entails much greater mathematical difficulties than the Rutherford-Bohr theory, in that we have to account for the fact that there must then be localities round the nucleus to which the forces acting on the negative electrons converge in all directions so as to produce stability.

#### ELECTROMAGNETIC FIELDS, FORCES AND RADIATION

##### Lines of Electric and Magnetic Force

Before dealing at greater length with the problem of atomic structure, it will be necessary to enter into certain elementary expositions of the nature of electromagnetic fields and forces and of electromagnetic or so-called electric waves.

Theory shows that when an electrified sphere or electrically charged body is set in motion in any direction it not only exerts a force on other electrified bodies near it, called electric force, but also when moving, acts on magnets or exerts a magnetic force along certain directions. In the case of a small charged sphere in uniform linear motion, the lines of electric force are radial and the lines of magnetic force are circles whose centers lie on the line of motion and planes are perpendicular to it. The regions near electrified bodies or magnets are called *electric* or *magnetic* fields, and in these fields forces of attraction or repulsion are exerted on other electrified bodies or magnets which are called electric and magnetic forces respectively. These forces are exerted along certain straight or curved lines called lines of electric or magnetic force. Faraday considered that these lines of force are not merely ideal lines like lines of latitude or longitude, but that they have some actual physical existence and are regions in which some special actions in a universally diffused medium called ether, are taking place.

Hence we may say that an electric or magnetic field has a certain discreteness or atomic structure, and that the space within a small tubular region surrounding a line of force is in some way different from the space outside.

In the case of an electrified sphere the lines of electric force radiate from the sphere as from its center, being equally distributed in all directions, provided the sphere is at rest. Faraday showed by numerous experiments that it is impossible to create a charge of electricity of one kind without creating also an equal quantity of the opposite kind. Hence we must consider that a line of electric force must be either an endless line or, if not, must have its ends terminated by charges of electricity

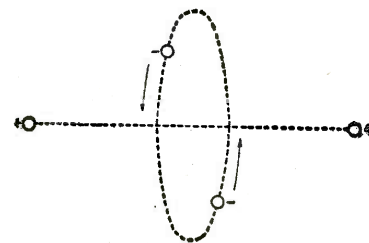

Fig. 40. Model of a Hydrogen Molecule.



of opposite sign, say, by ending on positive and negative electrons respectively, or else must start from an electron and be extended to an infinite distance.

There is, however, an interconnection between lines of electric and lines of magnetic force which may be explained as follows:

If a line of electric force is moved parallel to itself or in a direction at right angles to its own direction it creates a line of magnetic force which runs in a direction at right angles to that of the line of electric force and to that of the motion of the latter.

The relation of the directions may be

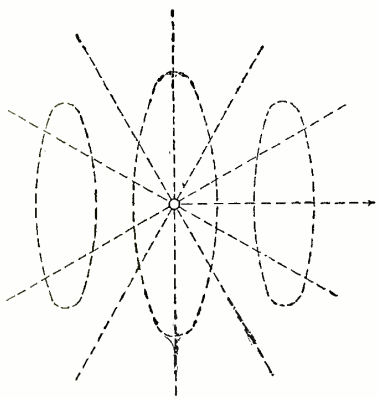

Fig. 41. Lines of Electric and Magnetic Force Around an Electron.

memorized by means of a "hand rule," as follows: Hold the thumb, forefinger and middle finger of the *right* hand in positions mutually at right angles like three co-ordinate axes. Then let the direction of the forefinger denote the direction of a line of electric force, and that of the thumb the direction of the motion of this line at right angles to its own direction. Then the direction in which the middle finger points will be the direction of the magnetic force produced by its motion. It should be remembered that by usual conventions the direction of an electric line of force is the direction in which it would cause a free positive electron or positively charged particle placed on it, to move. Hence for a negative electron the lines of electric force are directed *towards* the electron.

If then we consider an electron carrying its system of radial lines of electric force to be *in motion*, we see that the result is to surround the electron with a family of circular lines of magnetic force which all have their centers on the line of motion and all have their planes perpendicular to it (see Fig. 41).

The magnetic force at any point is proportional to the velocity and also to the resolved part or component of the electric force which is at that point perpendicular

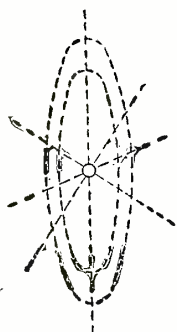

Fig. 42. Lines of Electric and Magnetic Force Around an Electron Moving with High Velocity.

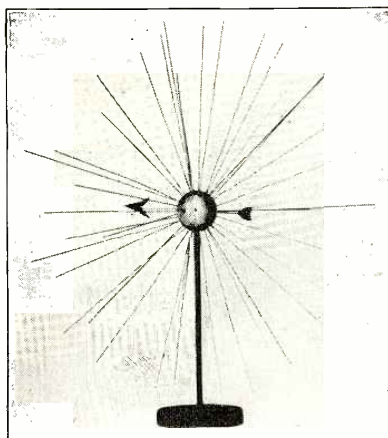

Fig. 44. A Golf Ball with Radial Wires in it to Represent an Electron in Motion. The Electrostatics Crowd Up Into the Equatorial Plane.

to the direction of motion. It can be shown mathematically that when the velocity or speed of the electron approaches that of light, viz., 300,000 kilometers per second, the radiating lines of electric force all crowd up into the equatorial plane, which is a plane through the center of the electron and perpendicular to its direction of motion (see Fig. 42).

The radial lines of electric force and embracing circular lines of magnetic force then form a sort of spider's web pattern in that equatorial plane. This is called the electromagnetic field of force of the electron. This electromagnetic field represents a store of energy. If a substance of mass  $m$ , whether a bullet or a railway train, to be in motion with a velocity  $v$ , it has energy called kinetic or motional energy associated with it, which is in amount equal to  $\frac{1}{2}mv^2$  or to half the mass multiplied by the square of the speed. It can be proved, though the proof is somewhat difficult, that when an electrified sphere moves with velocity  $v$  it has energy associated with it measured by

$$\frac{1}{2} \left( m + \frac{4e^2}{3d} \right) v^2$$

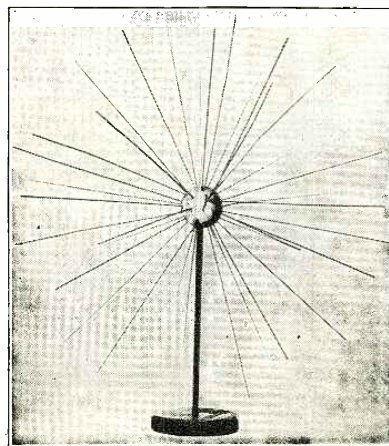
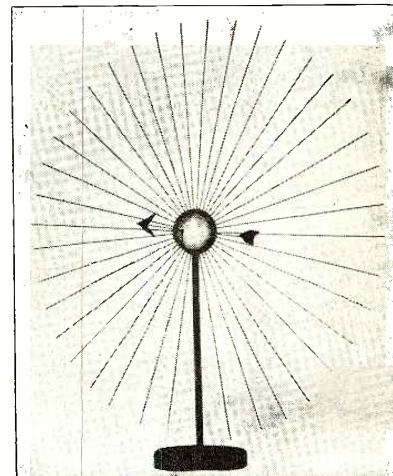

Fig. 43. A Golf Ball with Radial Wires in it to Represent an Electron with its Electrostatics.

where  $e$  is the electric charge, which in the case of an electron is  $1.6 \times 10^{-20}$  electromagnetic units, or  $16/10^{20}$  Coulombs, and  $d$  is the diameter of the sphere or electron. The letter  $m$  signifies the ordinary mass and  $4e^2/3d$  is called the electrical mass.



Another Illustration of an Electron in Motion.

### SIZE AND MASS OF AN ELECTRON

The question has been much discussed whether the electron has any mass other than the electrical mass, and certain experiments by Kaufmann strongly indicate that it has not. If this is the case then the whole mass  $m$  of the electron is represented by the value of  $4e^2/3d$  and the diameter  $d$  is equal

to  $\frac{4e}{3m}$ . But now we have seen that the

ratio of charge to mass or  $e/m$  for an electron is nearly  $1.774 \times 10^7$  electromagnetic units and that the electric charge  $e$  is  $1.6 \times 10^{-20}$  electromagnetic units. Hence the

diameter of an electron is  $\frac{1}{3} \times 1.774 \times 1.6$

$\times 10^{-31}$  of a centimeter or  $0.38 \times 10^{-12}$  cm, that is about one-third of a billionth of a centimeter. A million times a million electrons, put in a close row, would only extend a distance of about one-sixth of an inch. A negative electron is therefore very small compared with an atom, about one hundred thousandth part of the diameter of an atom. Small, however, as is the negative electron, the positive electron is probably still smaller. We have seen that in a hydrogen atom, consisting probably of a single positive and single negative electron, the negative electron contributes only 1/1,700th part of the mass. This implies that if the charge of the positive electron is the same as that of the negative the diameter of the former is only 1/1,700th part of that of the latter. We see, therefore, that the negative electron has a diameter of only about a hundred thousandth part of that of the whole atom and that the positive electron is perhaps 2,000 times smaller. We are now able to make a pretty clear mental picture of what an atom of matter is like according to the above theory. Imagine a cricket ball suspended in the air. At a distance of 100 or 200 feet or so from it let there be a few dozen grains of dust each not more than 1/100 inch in diameter. Let these grains, representing electrons, revolve round the cricket ball, representing the nucleus in circular orbits, the grains being arranged in shells or groups of 2, 3, 4 to 8, in various orbits, up to say 100 feet radius. This would suggest what an atom would look like if it could be magnified a billion times and be then viewed from a distance of several hundred yards.

### ELECTROMAGNETIC WAVES

Before considering the problems of atomic structure at any greater length it may be  
(Continued on page 1882)

# Some Comparisons Between Light Waves and Radio Waves

By JESSE MARSTEN

**B**OTH light and radio communication are wave phenomena, which means that disturbances at any point in the medium in which the phenomena take place, are transmitted throughout the medium without any permanent motion or displacement of the medium in the direction in which the disturbance is transmitted. Thus

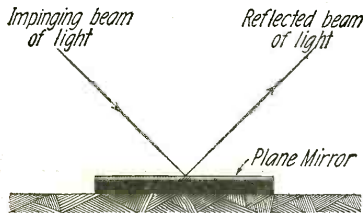

Fig. 1

Illustrating the Reflection of a Beam of Light from a Mirror.

a candle in space creates a certain light disturbance around it, and this disturbance is transmitted throughout space in all directions without any apparent motion or displacement of the medium. We see the light of the candle a block or a mile away, depending upon its intensity. The disturbance, in the form of light waves, has moved, but nothing else. Similarly a radio transmitting station creates an electro-magnetic disturbance in the medium surrounding the antenna and this disturbance is transmitted throughout the space-filled medium to other points (as evidenced by signals received at these points) without any motion or displacement of the medium in the direction of transmission.

It has been quite conclusively established by the mathematical researches of James Clark Maxwell and later by the experimental researches of Hertz, that light is an electro-magnetic phenomenon, the velocity of propagation of electro-magnetic wave being the same as that of light waves in space, namely 186,000 miles per second. We are not here concerned with the nature of the medium in which these waves are supposed to travel, or whether there is such a medium, or the manner in which these wave motions are supposed to be transmitted. The point is that both light and electro-magnetic radiation are wave motions transmitted in the same medium or the same manner. In view of this fact, we should expect that there would be some characteristic points of similarity in the behavior of light and radio waves. It is the aim of this article to describe some of these similarities.

Since light is the phenomenon more familiar to everyone and since most people are acquainted with light terms and expressions we will consider these similarities in terms of light expressions. In this connection we must bear in mind that light is made evident to us by means of the sense of sight, whereas radio waves are made evident to us most commonly by means of the sense of hearing, namely by signals in a telephone receiver. (Of course, radio waves may be made evident to us also by the sense of taste or smell, as suggested by Dr. A. N. Goldsmith and Mr. E. T. Dickey in an article in the December, 1920, issue of RADIO NEWS on "Taste Reception.") Thus when speaking of light casting a shadow, we understand that in the region of shadow we see no light; light waves are absent in

that region. Similarly when we talk of a radio shadow, or radio waves casting a shadow, we are to understand that there are no radio waves in that region of shadow, and hence that in the radio shadow we cannot hear the signals carried by the radio waves.

Since both light and radio phenomena are wave motions they each have certain frequencies of vibration. Of course different colors have different frequencies of vibration, and similarly there are different frequencies of vibration for radio waves. However, there is a certain range of frequencies which are distinctly light frequencies and there is a certain range of frequencies which comprises radio frequencies. Light wave-lengths are extremely small and range between .00000003 and .00000008 meters. Radio wave-lengths are much larger and range between 50 to 25,000 meters (practical figures).

### ABSORPTION

When light waves pass from the sun to the earth they pass through empty space and atmosphere having various degrees of density. The light that reaches the earth is much less intense than it is when it has just left the sun. This is due to a number of reasons, one of these being that some of the light energy is absorbed by the medium through which the light passes. Light waves, passing through different mediums, do not continue undiminished in intensity. A number of things hap-

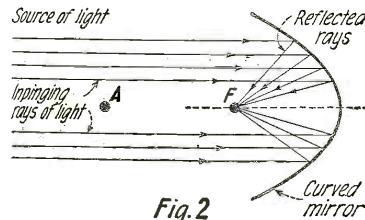

Fig. 2

Light is More Intense at F Than at A (on Account of Concentrated Reflection at F) Even Though A is Nearer the Source of Light Than F.

pen to the light waves, they may be reflected, refracted and so on. One of the causes for the diminution of energy contained in light waves is absorption of energy by the intervening medium. Thus light passing through different grades of glass will be found to have varying degrees of intensity after its passage through each piece of glass, all these intensities being less than its original intensity. After accounting for the loss of light energy due to other causes such as reflection and refraction, there still remains some to be accounted for, which goes towards heating the glass. This energy is absorbed by the glass. Energy thus lost by absorption goes towards heating the medium in which it is absorbed. This is made most evident when light impinges upon some black object which neither transmits nor reflects light. In this case the light energy is absorbed and converted into heat, as can be told by feeling the black object. The amount of energy thus lost in absorption depends upon the nature of the medium through which the light waves pass. Thus mediums which are very good reflectors of light, as mirrors, will absorb little energy, and mediums which are very transparent to light will absorb little energy. Those which are neither good re-

flectors nor are transparent will generally absorb considerable light energy.

Similarly the passage of radio waves through space is accompanied by considerable energy absorption. As in the case of light waves described in the previous paragraph, the amount of absorption depends upon the nature of the medium through which the radio waves pass. Thus in the path of radio waves there will generally be found structures such as bridges, steel buildings, etc., trees and other forms of vegetation, mountains and other natural obstructions. If these obstructions were perfect insulators they could not absorb any of the passing electro-magnetic wave energy, since a perfect insulator is an absolute non-conductor of electricity. However, they are not perfect insulators, but are, as a matter of fact, very imperfect conductors; that is, conductors having very high specific resistance. Hence they absorb considerable energy from passing radio waves and dissipate this absorbed energy in the form of heat. Thus in the case of vegetation the juices in the trees are probably conducting liquids and the energy absorbed from passing waves is run to earth by way of these juices. As quite conclusive proof that vegetation does extract considerable energy from passing electro-magnetic waves, experiments have been made where a tree was used as an antenna and quite fair reception obtained. The poor reception generally obtained during the summer may thus be partially attributed to the fact that absorption by vegetation is a maximum during that season since trees and other plant growths are at full bloom, and hence absorb most then. Likewise obstructions such as mountains, and structures such as bridges and buildings absorb much energy from passing radio waves. Mountainous obstructions generally contain some conducting crust which draws energy from the wave, and the other structures have enough good conducting metal to extract considerable energy from the air. Poor reception inside of steel buildings may thus be accounted for. Also in certain sections of Brooklyn it is well known that the audibility of the received broadcasting is generally lower than in Manhattan. This is partially due to the absorption of energy by the bridge structures running into Brooklyn.

When we consider the earth or ground over which the waves travel we are again confronted with the phenomenon of absorption. The bottom of the radio waves is always in contact with the ground. It would, therefore, be reasonable to expect that there is some absorption in the ground, and that this absorption depends upon the nature of the earth. Earth varies in conductivity from good, as sea water and

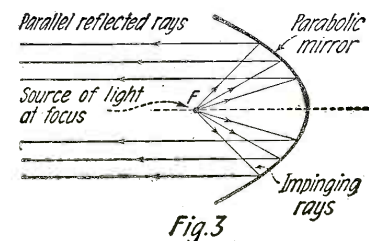

Fig. 3

Showing How Source of Light at Focus of Parabolic Mirror Reflects Parallel Rays in One Direction.



marshy land, to very poor, as dry, rocky earth and sand. If the earth were a perfect insulator it would be impossible for it to absorb any electrical energy. On the other hand if the earth were a perfect conductor (which means no losses in it due to electrical current) there would also be no absorption. However, at best, the earth is a very poor conductor having fairly high resistance, and hence any currents flowing in it due to absorbed energy will be wasted in the form of heat. The greater this resistance is the more will be the absorption of energy from the radio waves. This accounts for the fact, partially, that transmission over sea (a ground of low resistance and hence low absorption) is far superior to transmission over dry land (a ground of higher resistance and hence high absorption.)

Finally let us consider the rarified medium through which the radio waves pass, namely the atmosphere around the earth and above it. Here too we have a case of absorption of energy. If the atmosphere were a perfect dielectric there could be no loss of electrical energy in it. However, the atmosphere is not completely a perfect dielectric, hence some absorption and loss of energy do take place in it. What complicates matters here is that the atmosphere is not uniform in properties throughout space. Thus its density is a maximum at the surface of the earth and decreases with the distance from the surface of the earth. Also at or near the earth's surface the atmosphere may be considered a perfect dielectric, hence its insulating qualities are perfect. Thus no absorption of radio wave energy takes place in the atmosphere near the earth. However, the insulating qualities of this dielectric become poorer as it recedes from the earth and becomes more and more rarified. In other words, the farther up the atmosphere reaches the more conducting it becomes. Consequently we may expect that radio waves which are long enough to reach these rarified portions of the atmosphere will suffer absorption. This accounts for the fact the longer waves are more subject to atmospheric absorption than the shorter waves, since the shorter waves cannot reach these higher altitudes. Now the reason for this increased conductivity of the upper portions of the atmosphere is generally attributed to ionization of the atmosphere. This in turn is due to a number of causes, all arising from the fact that the upper portions of the atmosphere are nearer the sun and hence subject to the action of the sun's intense rays and ionic bombardment. Since this is the case it is obvious that the ionizing effect should be greater during the daytime than at night, hence absorption during the daytime is greater, and, therefore, transmission should be much better at night. That this is the case is well known and the above reason is assigned to this phenomenon.

**REFLECTION**

When a beam of light impinges upon a smooth surface a number of things may happen to the beam. Some of the energy in it may be absorbed by the surface, as described in the previous section, some of it

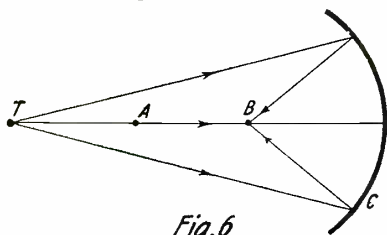

Fig. 6

Intensity of Radio Waves at B May be Much Greater Than at A, Even if A is Nearer T, on Account of the Reflected Waves from C Adding to the Original Waves at B.

may be transmitted through the surface, some of it may be reflected from the surface, i.e. another beam of light sent back from the surface, Fig. 1. Whether and how much a light wave is reflected depends upon the nature of the reflecting surface. The smoother and the more opaque the surface is the better it will reflect. Thus a silvered mirror is an excellent example of a very good reflector, for it is very smooth and opaque. The direction which a reflected beam of light takes depends upon the direction at which the original impinging beam of light strikes the reflecting surface. In some reflectors, as spherical mirrors, if a beam of light parallel to the axis of the mirror strikes the reflecting surface this beam of light will be reflected to only one point, namely the focus of the mirror. Hence the intensity of the entire beam will be concentrated at one point. It is thus possible, as in Fig. 2, that the intensity of light due to a given source, may be much greater at a distance than near the source of light (contrary to ordinary ideas) due to the concentrated effects of the reflected rays. Furthermore if a source of light is placed at the focus of a parabolic mirror such as an automobile headlight, for example, all of the reflected rays of light will constitute a single beam of light, i.e. all the reflected rays are transmitted in one and the same direction, see Fig. 3. If the mirror is rotated about its focus as axis, the reflected beams will similarly be rotated, thus enabling the reflected light to be transmitted in any desired direction, as in Fig. 4. These two ideas have important counterparts in radio.

This phenomenon of reflection takes place in radio exactly as it does in light. If a radio wave impinges upon a perfect insulator it is neither reflected nor absorbed.

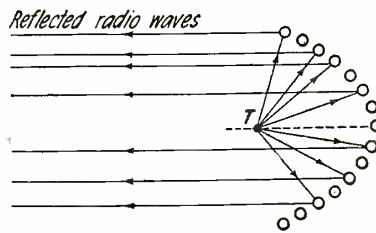

Fig. 5

Vertical Section Showing Transmitting Antenna T, and the Wires Forming an Electrical Mirror.

However, if it impinges upon a conductor some of the energy is reflected. The better the conductor the more energy it reflects. A perfect conductor having zero resistance would constitute a perfect electrical reflector. The actual experimental proof of the reflection of electro-magnetic wave was given a long time ago by Hertz, and more recently by Marconi, at a meeting of the I. R. E. giving a very striking illustration of reflection. A vacuum tube oscillator excites a transmitting antenna T, Fig. 5, which consisted of a metal rod about 1 1/2" high. This antenna was placed at the focus of a parabolic electrical mirror consisting of a number of metallic rods similar to the transmitting antenna, these rods being placed around the transmitting antenna in the form of a parabola.

The radio waves emanating from the transmitting antenna at the focus and striking the reflecting surface of the mirror, as seen in Fig. 5, will be reflected in a unidirectional parallel beam, and these reflected waves can be detected by a sensitive receiver and loud speaker. Now if the parabolic mirror were rotated in the automobile headlight the direction of the reflected beam would change. Thus we could flash the reflected light in any direction we pleased. Similarly by rotating the electrical mirror

the direction of the reflected radio waves is changed, as is readily determined by the receiver. For if the direction of the reflected radio waves is shifted away from the position of the receiver no signals are heard. This immediately suggests the possibility of directive telegraphy in one direction only, the subject with which Marconi was concerned. For waves, as generally employed in radio communication,

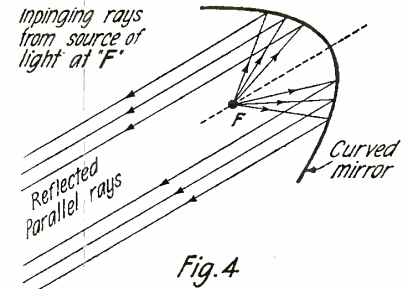

Fig. 4

Showing How Shifting the Mirror Without Moving Source of Light F Results in Shifting Direction of Parallel Reflected Rays, Thus Enabling Us to Control Direction in Which Reflected Light is Flashed.

this method of reflection is not very practicable. In the experiment, waves as short as one meter were employed. The mirror was of the same order of magnitude. For efficient reflection to take place it is essential that the reflecting mirror be at least of the same order of magnitude as the length of the waves. Thus for reflecting light in practice we use mirrors many times greater than the wave-length of light. In order to reflect a 300 or a 600 meter wave it is evident that enormous electrical mirrors must be employed which are somewhat unwieldy and impracticable. It is for this reason that researches in this direction are carried out with a view towards working on wave-lengths of 50 meters or under.

In the above case pure metallic conductors were used to show reflection. However, a reflector need not necessarily be metallic, almost any conductor will reflect radio waves. Thus reflection of radio waves takes place from the upper conducting portions of the atmosphere, or from intervening conducting obstructions as hills, etc. This fact accounts for much of the unusual reception feats so often heard about. For the wave may be reflected as from a parabolic mirror and is concentrated at one point where the audibility is, therefore, very great. This may account for the fact that frequently a low power station carries much farther than a higher powered set. Furthermore, the reflected wave may add to the originally transmitted wave. Thus in Fig. 6, the waves emanating from the transmitting station T may travel to points A and B, but at C, say, the wave is reflected, due to atmospheric or other conditions, and the wave reflected back to B, where the transmitted waves and reflected waves are in phase and add together. Thus at B the intensity may therefore be much greater than at A which is nearer to the transmitter. Of course there will be points where the reflected and original waves do not add, but oppose. These will be considered later in the section on interference. But these examples of reflection will suffice to show that unusual reception may be due to this phenomenon.

**SHADOWS**

The shadow in light is a very familiar phenomenon. If an opaque body is placed near a source of light as in Fig. 6A the region behind the opaque body is a shadow, no light reaches it due to the obstruction of the opaque body. This opaque body may absorb the light which strikes it, or it may

(Continued on page 1834)



*"Listen to others' advice—but act on ours"*

## THESE ARE GOOD IF YOU NEED THEM

### THE KLEIN VARIABLE CONDENSER

Capacity, 23-plate 0005 m.f.d. Capacity, 43-plate .001 m.f.d. A very reliable condenser, beautifully made in aluminum with brass 1/4 in. shaft and fittings; bakelite bushings, set screw tension.

Price No. 106, (23 plate) \$3.25  
Price No. 105, (43 plate) \$4.25

### THE KLEIN 3-COIL MOUNTING



A decided improvement. The binding posts at base make connections easy and quick, besides acting as legs. Well made in polished bakelite with nickel-plated mountings.

Price, Each \$5.50.

### THE KLEIN VARIOCOUPLER AND VARIOMETER



Range 150 to 600 metres; 3/16 in. shaft. A well made instrument that has earned popular favor with our customers.

No. K. 104 Price \$5.00 (dial extra).

### THE KLEIN SUPERSENSITIVE GALENA CRYSTAL DETECTOR



A very desirable compact, little instrument. No glass shade to obstruct vision while operating. Nickel-plated brass on bakelite base.

Price, with crystal \$1.50; without crystal \$1.25.

### THE KLEIN VARIOMETER



We recommend this variometer for its special feature of a spring contact which assists in eliminating tube noises. Workmanship and efficiency up to our usual high standard.

Price \$5.00. (Dial extra).

*Our early connections and favorable arrangements with all reliable sources of Radio Equipment ensure regular shipments from the factories. Write for price list of Complete Sets and Parts. Special terms to Dealers. EXPERT ADVICE FREE. Phone Beckman 1767-2999.*

**The Klein Radio & Electrical Supply Co.**

48 FULTON ST.  
(Near 3d Ave. L.)  
NEW YORK, N. Y.

position in which it was found to bring in signals with the crystal detector. The coupling-distance between the active part of the primary and secondary windings—should be rather close and the condenser across the secondary should be left at zero. Now rotate the lever of the filament rheostat R1 until the filament of the vacuum tube is heated. Do not increase the filament current too rapidly and just as soon as signals are heard in the telephone receivers, adjust the variometer after the position of the primary slider and the switch used to control the number of turns in the secondary winding are found, keeping the primary as far from the secondary as possible without reducing the intensity of the signals. Follow these adjustments by manipulating the variable condenser, C2. Do not burn the filament of the vacuum tube any more brilliantly than absolutely necessary because that is bound to reduce its life. It is mighty good practise to thoroughly adjust every other part of the circuit before you increase the filament brilliancy to increase signal strength. There is a strong tendency among folks not thoroughly familiar with vacuum tube operation to overheat the filament. It is a costly practise and should not be indulged in.

So much for this circuit. We may now spend a moment or two in considering the manipulation of the variometer used to produce regeneration and amplification and illustrated in Fig. 4. It is usually safer to spend some time operating the non-regenerative circuit in order to become familiar with its adjustment before attempting the regenerative form, which only takes a minute or two for the insertion of the variometer in the "hook-up" as radio circuits are popularly called. We assume, therefore, that a knowledge of the manipulation of the first type of circuit has been obtained and the proper connection for the variometer between the telephone receivers and the plate of the tube socket has been made.

Proceed as in the former case and leave the variometer at its zero position. After all the other adjustments have been made it is but necessary to slowly rotate the movable coil of the variometer until the signals are heard at their maximum, which it is found to be several times as loud as those received before. If the variometer is rotated too far the signals are likely to become mushy and lose their natural tone and a "howl" is likely to be heard in the telephone receivers. It does not take long to become adept in the adjustment of the regenerative circuit of this character and very satisfactory results may be obtained where it is employed. In operating any of the circuits described so far, it should be borne in mind that there is really nothing difficult about them and it is sometimes found helpful to review the subject from time to time, picking out the slight changes made in the circuits as we progress.

### Should We Put the Brakes On Radio

(Continued from page 1088)

man. Radio takes such artists to the cultured audiences that cannot come to them. Is the love of music likely to die, with this new means of communication in its infancy?

Loneliness is given more frequently than any other reason for the desertion of the farm and removal to the town. The attempt of the majority of farmers to get off the soil and at the same time buy the

## EFFECTIVE LIGHTNING PROTECTION

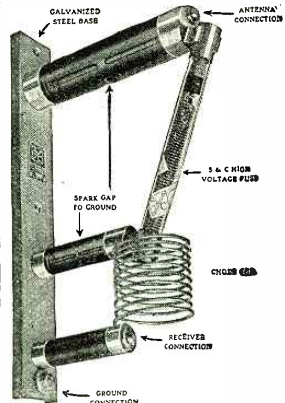

### With the S & C Radio Protector

The S & C High Voltage Fuse in Combination with Two Enclosed Close Spark Gaps, Direct to Ground

**Eliminates** { Danger To The Operator  
Danger To The Receiving Set  
Danger To The Building

No more worry about that Ground Switch—You Need None

You May "Listen In" on a stormy night with a feeling of Security

No Danger from Lightning or Crosses with High Voltage Power Circuits.

Installed Outdoors. Never Fails to Intercept and keep Outdoors, High Potential Currents of any Nature

S & C Fuses are Depended upon for the Protection of High Voltage Power Equipment up to 150,000 Volts

WALL MOUNTING TYPE \$12.00  
STRAIN TYPE ..... 6.00

DESCRIPTIVE MATTER ON REQUEST

**SCHWEITZER & CONRAD, INC.**  
4437 Ravenswood Ave. CHICAGO, ILL.

## "A"



# JAXON STORAGE BATTERIES

Sold direct from the Factory to you at a Big Saving

## "B"



<p>"A" STANDARD. Wooden cases, cedar separators; TWO YEAR GUARANTEE.</p> <p>6 Volt 60 Amp. Hr. .... \$13.25</p> <p>6 Volt 80 Amp. Hr. .... 16.35</p> <p>6 Volt 100 Amp. Hr. .... 18.00</p> <p>"A" ARMORED. One piece rubber composition "Permenenta" case; rubber and cedar separators. The good qualities of both and none of their faults; THREE YEAR GUARANTEE.</p> <p>6 Volt 60 Amp. Hr. .... \$17.50</p> <p>6 Volt 100 Amp. Hr. .... 22.50</p>	<p><b>\$5.75</b></p> <p>Prepaid or from your dealer</p> <p>SENT EXPRESS COLLECT</p>
---	---

"B" STORAGE. Rechargeable; large capacity, variable voltage; full charged; pasted Plates; Rubber Separators. TWO YEAR GUARANTEE. Prepaid or from your dealer, \$5.75

Send for our Radio supply list with prices.

**JACKSON BATTERY CO., 1124 R Jackson Blvd., Chicago, Ill.**



# Awards of the Super-Regenerative Contest

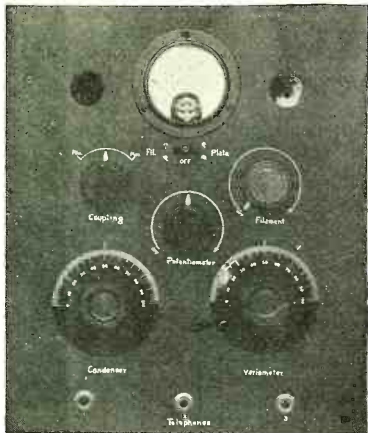

Front View of Mr. Norton's Super-Regenerative Receiver. This Set Incorporated the Use of a Potentiometer Which, However, is Not Necessary.

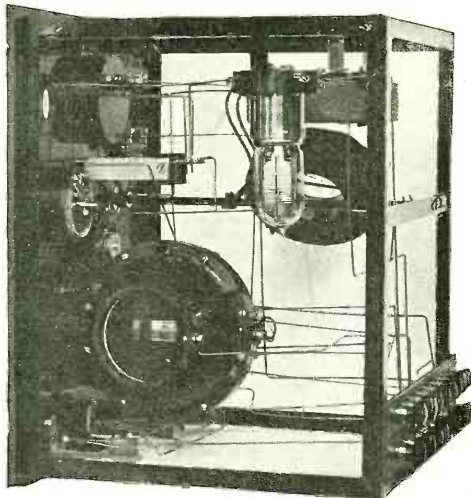

Rear View of the Receiver. The Leads from all the Instruments Connect to Separate Binding Posts so That Different Circuits May Be Tried. Note the Downward Suspension of the Tube Socket.

**I**N selecting the prize winning articles in the super-regenerative contest, the judges gave every entry equal consideration. The merits of the contributions were based upon the following points: Novelty, neatness of construction, simplicity, ease of control and adherence to the rules of the contest. We feel that the final decisions are well balanced. Only two descriptions of super-regenerators suitable for amateur C. W. reception were received and for this reason only two prizes were awarded under this section. Therefore a fourth prize of \$15 has been added to the section of super-regenerative sets for broadcast reception. Aside from the prize winners there are three honorable mentions which will be published and paid for at our usual rates. The two "first prize" articles are published in this issue. The others will follow in sequence.

## First Prize Class I A Single Tube Super-Regenerative Receiver

BY JOHN T. NORTON

The use of the super-regenerative circuits has greatly increased the amplifying power and sensitivity of the vacuum tube, and has made possible a really practical receiver employing a small loop aerial and a single vacuum tube. Such a set has been constructed by the writer and has given very gratifying results.

The arrangement of circuits is shown in the diagrams. Fig. 1 is a simplified equivalent circuit, and Fig. 2 is the complete wiring diagram of the set. It will be noticed that the arrangement is very similar to one of the common types of regenerative

circuit employing variometer tuning in the plate circuit. The only change is the omission of the grid condenser and leak and the addition of the oscillator coils. These coils make it possible for the tube and its circuits to oscillate at the comparatively low variation frequency which is characteristic of the super-regenerative circuits. This frequency is of the order of 10,000 cycles per second, and the circuit oscillates very readily. The constants of the various component parts of the set are given on the diagram.

The set was designed for experimental purposes, and for this reason, the leads to the various instruments were brought out to a terminal board on the back, so that different connections could be made without changing the permanent wiring of the set. The frame was made of half-inch brass angle, and to this was fastened a quarter-inch bakelite panel the size of which was 11" x 13". The panel was rubbed to a dull finish, and marked with white drawing ink. All of the instruments, with the exception of the oscillator coils and tube socket, were mounted on the panel. The voltmeter was arranged so that the switch immediately below it connected it to either the filament or the plate of the tube, the plate connection including a multiplier which multiplied the scale reading by ten. The jacks at the bottom of the panel allowed the use of three pairs of telephones in either series or parallel. The photographs show the arrangement very clearly.

The variable condenser used with the set was designed by the writer. It consisted of two plates, one of tinfoil, and the other of mercury, separated by a dielectric of thin sheet mica. The mercury was the only moving part of the condenser, and it gave very satisfactory service. The loop aerial was square, three feet on a side, and was wound with 10 turns of No. 18 wire spaced 1/2" apart. Taps were taken at every turn from the third to the tenth and connected to an eight-point switch in the center of the loop, and from this a pair of twisted leads ran to the set.

In the operation of this receiver, a plate voltage of between 60 and 70 has been found most satisfactory for both telephone and continuous wave reception. A "C" or grid battery of 4.5 volts may be used, but it does not seem to improve the results. A radiotron U. V.-201 tube was very successful in this set, but a Western Electric V. T.-1 gave the best results. The tuning

of this set is no more difficult, and is almost identical to that of the well-known regenerative receiver. The tube should be lighted to its normal brilliancy and the oscillator coupling set at a maximum. The note of the variation frequency should now be heard loudly in the telephones. If not, the connections to one of the oscillator coils should be reversed. With the tube oscillating strongly at the variation frequency, decrease the coupling slowly until a loud click is heard, but the variation frequency note is still audible. The set is now oscillating at both radio and variation frequency, and is tuned in the ordinary manner with the variable condenser, variometer and filament rheostat. The variation frequency note is heard at all times during reception. If the oscillation coupling is decreased too far, the variation frequency oscillations will cease, and the set operate as a plain regenerative receiver.

The set has been in operation in Boston, Mass., for about two months, and the results obtained have been very gratifying. On broadcasting wave-lengths, WOC, Davenport, Iowa, (1,150 miles) has been heard several times. KYW and WDAP in Chicago (980 miles) have been heard quite often, and KDKA in Pittsburgh (550 miles) comes in very regularly. Reception from local stations is of sufficient strength to operate a loudspeaker in excellent shape. The receiver seems at its best in the reception of continuous wave signals. On 200 meters during the trans-Atlantic tests, over

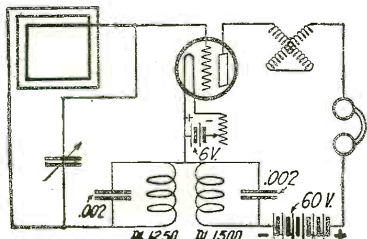

Fig. 1

Fig. 1. Diagram of the Circuit Employed. Fig. 2. Complete Wiring Diagram of the Connections of the Set.

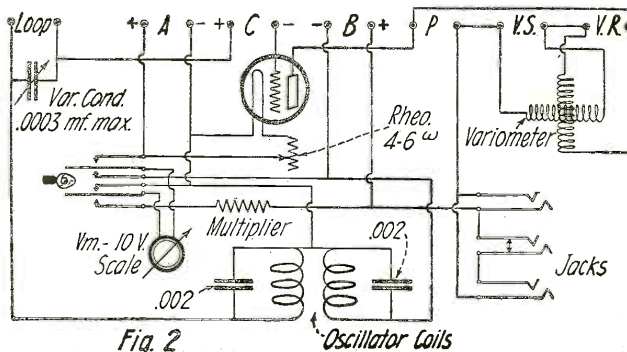

Fig. 2

**Prize Winners**

Super-Regenerators for Broadcast Reception

**First Prize \$50**

MR. JOHN T. NORTON  
Massachusetts Institute of Technology, Cambridge, Mass.

**Second Prize \$25**

MR. ALLAN T. HANSCOM  
Woonsocket, R. I.

**Third Prize \$15**

MR. ERNEST W. CUTTING  
Albion Public Schools, Albion, Mich.

**Fourth Prize \$15**

MR. W. HARPER, JR.  
43 West 84th Street, New York City

Super-Regenerators for Amateur C. W. Reception

**First Prize \$50**

MR. A. L. GROVES  
Brooke, Virginia

**Second Prize \$25**

MR. PAUL C. JONES  
Carter, Oklahoma

**Honorable Mention**

MR. G. V. BRADBURY  
441 Sheidley Bldg., Kansas City, Mo.

MR. H. L. HODSON  
Box 121, Cardin, Oklahoma

MR. T. KEIL  
718 Newhall Street, Milwaukee, Wis.

200 amateur stations in every district except the sixth and seventh were copied. Several Canadian amateurs were also copied. 9CM and 9DQ in Wisconsin were the farthest, about 1,200 miles. The set is practically worthless for the reception of spark signals because the spark tone is destroyed to such an extent that the signals are almost unreadable. It seems as if a receiver of this type with a loop aerial approximating the proportions of an outdoor antenna would be of great value to the amateur in handling long distance traffic.

**First Prize Class II  
A Super-Regenerator for  
Amateur C. W.**

BY A. L. GROVES

Entering your prize contest, I herewith present a type of super regenerator that is

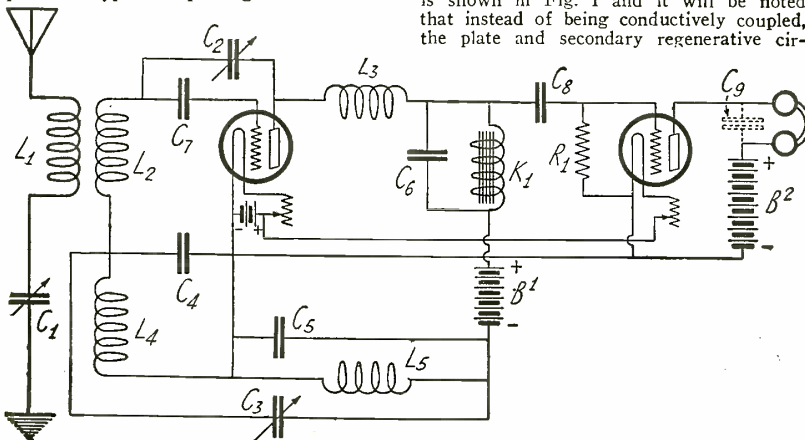

Feb. 2. The Same Circuit with the Addition of a One-Stage Choke Coil Audio Frequency Amplifier. Separate "B" Batteries Are Used for Each Tube.

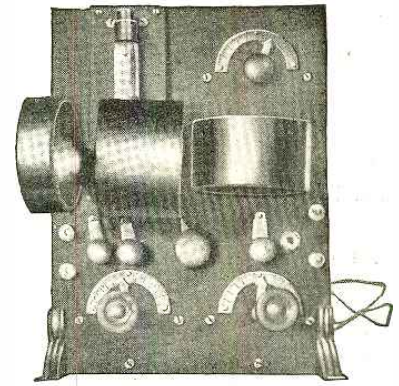
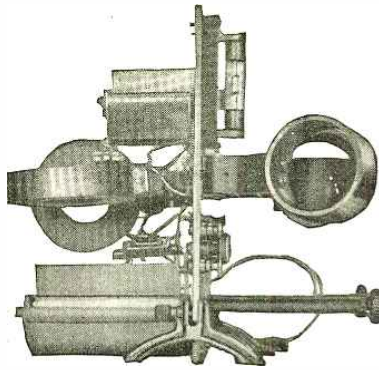

Front and Side Views of Mr. Groves' Super-Regenerator. The Two Honeycomb Coils Are Mounted on the Rear of the Panel Directly Behind the Main Inductances. It Will Be Noted That a Myers Tube is Used with This Set.

somewhat different in construction and operation from the usual arrangements and which, unlike others, operates to best advantage when used with an aerial inductively coupled to it.

Heretofore distance has been somewhat limited by the use of super-regeneration due to the fact that they operated best with

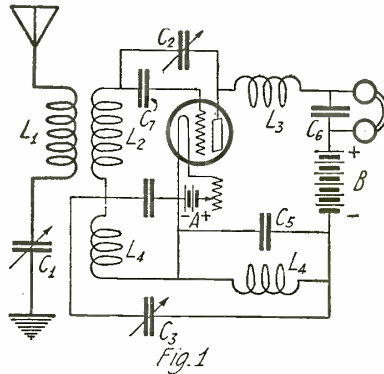

The Circuit of the Set Described in This Article. Capacity Feedback is Employed.

loops, but with this arrangement full benefit can be taken of the aerial in securing maximum distance and signal strength which makes it a distinct advantage for the reception of amateur C. W. signals, and although not intended for regular broadcast reception, it will receive phone signals sufficiently loud and clear for all general amateur purposes where head phones are to be used.

The diagram of connection of this set is shown in Fig. 1 and it will be noted that instead of being conductively coupled, the plate and secondary regenerative cir-

cuits are coupled by means of the condenser C2 which serves as the tuning condenser for both the secondary and plate regenerative circuit. Likewise the secondary and plate oscillator circuits are coupled and tuned by the condenser C3. This circuit, however, needs no tuning during operation and once set for the desired frequency may remain so for a considerable change in wave-length. Therefore, for all practical purposes there are only two controls on the set, C1 for the primary and C2 for the tube circuits.

In making up a "super" the first consideration should be towards selecting a suitable tube. These should be as hard and free from gas as it is possible to obtain. The set herewith described uses a Myers "Hi-Mu" tube because an exceptionally hard and gas-free tube of this make happened to be on hand. The Western Electric amplifier or 5-watt transmitter tubes are probably the best for this purpose on the market today.

Whatever type of tube is selected, the set must be built with care, with a minimum amount of wiring, and assembled in a minimum space. The set is very sensitive and all undue parts and leads brought about by scattering the parts here and there pick up stray currents and make for noisy operation, poor tuning and general unsatisfactory results.

The set herein described is built on a Bakelite panel 3/8" thick, 8 3/4" wide and 11 3/4" high. The parts are as follows:

- Tube receptacles for Myers tube.
- C1, Illinois 67 plate variable condenser.
- C2, Illinois 7 plate variable condenser.
- C3, Illinois 67 plate variable condenser.
- C4, Dubilier .0025 manufactured type 600 fixed condenser.
- C5, Dubilier .001 manufactured type 600 fixed condenser.
- C6, Dubilier .001 manufactured type 601 fixed condenser.
- C7, Dubilier .0002 manufactured type 601 fixed condenser.
- C8, Remler No. 43 coupling plug, for primary coil.
- Remler No. 42 panel plug, for secondary coil.
- Remler No. 42 panel plug, for plate coil.
- Remler No. 42 panel plug, for grid oscillator coil D1-1,500.
- Remler No. 42 panel plug, for grid plate coil D1-1,250.
- Remler No. 91 switches for series-parallel connection.
- Remler No. 91 switch for on and off filament.
- Fada No. 120-A rheostat.
- Frost No. 135 jack.

Binding posts are provided for aerial, ground and "A" battery as shown, while clips with flexible leads attached are provided for the "B" battery connections.

(Continued on page 1902)



# Controlling Models by Radio

By MAJOR RAYMOND PHILLIPS, I.O.M.

## Part III

**T**HE relay described in my previous article is designed in such a manner that its construction should not present any difficulties to an amateur mechanic possessing a few tools such as a vice, hack-saw, files, drill brace, taps, etc. All terminals can be purchased ready

F, adjusting screw G, balance spring H with clamping pillar K, contacts J and J1, for opening or closing a circuit connected with a decohering device, ratchet K, drum L, contacts M and M1, support (for spindle of drum and ratchet) N, vulcanized fibre base O with supports P and P1, check spring S for ratchet K, eight terminals (two only shown) T and T1.

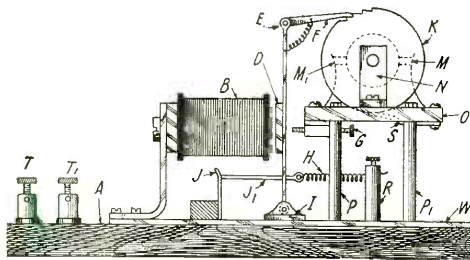

Fig. 1

The Automatic Selector Used to Open and Close Various Local Circuits.

made, so that a lathe will not be required.

Practically any wood turner will undertake to make the bobbin for a small sum, and those enthusiasts who desire to only assemble the relay will find that most small engineering shops will readily undertake to cut to length and screw-thread (where required) the various component parts, and at the same time improve the appearance of such parts by machining and lacquering where necessary.

The relay shown in Fig. 1, in my last article, is a more sensitive type than that described in Part I of my last article, but as its construction would involve the use of a lathe, I do not propose at present to furnish constructional details of same.

I explained in my previous article that the receiving apparatus for use in connection with the wireless control of a model electric train will comprise a coherer, relay, and a simple selector. The latter is a form of relay, but arranged to open or close a series of circuits.

### THE SELECTOR

I shall now commence to furnish details and diagrams of a simple selector (*i.e.*, selection by sequence) suitable for use with the receiving apparatus in question, which will be so arranged that a motor fitted to a model electric train can be started, stopped or reversed. It will thus be apparent that the model train can be caused to run backwards, or forwards and stopped as desired.

The selector will also be arranged to open or close a circuit connected with a miniature electric lamp. The latter will act as a signal which will indicate to an operator at the transmitter that the receiving apparatus is responding to the transmitted wireless waves.

In the event of the model train being controlled from a point which renders the electric lamp in question invisible to the operator, the signal will no doubt interest any spectators who may be watching the model, more especially if the transmitter is not installed in the same room as the receiving apparatus. The presence of a brick wall separating the two instruments appears to make no difference to the transmission and reception of wireless waves.

Fig. 1 shows the complete selector. It consists of a baseboard A (with metal base W), electro-magnet B with support C, armature D with support E and base I, pawl

any possibility of the ratchet K with drum L revolving in an opposite direction.

**CLOSING THE CIRCUITS**

It will thus be apparent that by causing the drum L with ratchet K to revolve in desired stages, the contacts M and M1 can be caused to open or close other local circuits as required.

The contacts M and M1 will (for the receiving apparatus in question) be arranged to open or close circuits conveying electric current to the model electric train and signal lamps previously referred to in this article.

Fig. 2 shows respectively plan and side elevation of the electro-magnet B, which consists of a yoke A, cores B and B1, and bobbins C and C1.

The yoke A should be made of Swedish charcoal soft iron  $1\frac{1}{2}$ " long by  $\frac{5}{8}$ " wide by  $\frac{3}{8}$ " thick, as shown.

The cores B and B1 should also be made of Swedish charcoal soft iron, each core being  $1\frac{1}{4}$ " long by  $\frac{3}{8}$ " diameter, and secured to the yoke as shown by means of two cheese-head brass screws  $\frac{5}{8}$ " long by  $\frac{3}{8}$ " diameter.

The bobbins C and C1 should be made of boxwood  $1\frac{1}{8}$ " long, with flanges  $\frac{3}{4}$ " diameter by  $\frac{1}{8}$ " thick, and should be fully wound with No. 25 gauge single silk-covered copper wire.

**WINDING THE BOBBINS**

To wind the bobbins, each should be mounted upon a mandrel, and winding should be commenced by passing the leading-in wire through a hole in one of the flanges of the bobbin, and a piece of silk should be placed over the leading-in wire when commencing to wind the second series of layers, to prevent any possibility of short-circuiting subsequent layers.

Each bobbin should be wound in the same direction, otherwise complications will be involved when connecting the two windings together.

The finishing coils should terminate at the end opposite to the leading-in wire. The end of the last layer of wire should be secured by passing it twice under the last single coil.

Fully 6" of spare wire should be left at each end of the windings, so that it can be neatly coiled up and connected to

various terminals as required. There will be no advantage gained by leading in and finishing the windings with a larger gauge of wire, as specified for the relay described in my previous article, as the gauge of wire used for winding the electro-magnet for the selector in question is sufficiently strong to obviate risk of breakage. At the same time every care should be taken when handling the wire to watch that the silk covering is not damaged.

When the winding of the two bobbins is completed as described, each bobbin should be gently forced over the cores B and B1 of the electro-magnet, and the leading-in wires from each winding connected together as shown in Fig. 2.

It will be well to test the windings by connecting each of the two remaining terminal wires with the terminals of an ordinary  $3\frac{1}{2}$ -volt pocket lamp dry battery. Current from the latter should then cause the electro-magnet to strongly attract a piece of bar iron held near the cores.

The same test can be applied to the windings of the relay described in my previous article.

It will be observed that a small piece of brass wire (No. 18 gauge) is forced into a hole bored in the end of each core. The object of this is to prevent the armature D (Fig. 1) actually touching the cores. Such a precaution precludes the possibility of an armature sticking, the latter defect being due to residual magnetism in the cores after electric current has been cut off from the windings of an electro-magnet.

It will be understood that a selector can be made in various forms, according to the number of mechanisms it is desired to control.

The selector in question is designed in such a manner that an amateur mechanic should not experience any difficulty in constructing same. On referring to the diagrams, Fig. 1 and 2, it will be observed that so far I have furnished constructional details of the electro-magnet B, and brass support for same. The latter can be made of strip brass, No. 10 or 12 gauge, which can be bent to the specified shape, and afterwards cut off to the length required and cleaned up as desired.

The selector in question is designed in such a manner that an amateur mechanic should not experience any difficulty in constructing same. On referring to the diagrams, Fig. 1 and 2, it will be observed that so far I have furnished constructional details of the electro-magnet B, and brass support for same. The latter can be made of strip brass, No. 10 or 12 gauge, which can be bent to the specified shape, and afterwards cut off to the length required and cleaned up as desired.

The selector in question is designed in such a manner that an amateur mechanic should not experience any difficulty in constructing same. On referring to the diagrams, Fig. 1 and 2, it will be observed that so far I have furnished constructional details of the electro-magnet B, and brass support for same. The latter can be made of strip brass, No. 10 or 12 gauge, which can be bent to the specified shape, and afterwards cut off to the length required and cleaned up as desired.

The selector in question is designed in such a manner that an amateur mechanic should not experience any difficulty in constructing same. On referring to the diagrams, Fig. 1 and 2, it will be observed that so far I have furnished constructional details of the electro-magnet B, and brass support for same. The latter can be made of strip brass, No. 10 or 12 gauge, which can be bent to the specified shape, and afterwards cut off to the length required and cleaned up as desired.

The selector in question is designed in such a manner that an amateur mechanic should not experience any difficulty in constructing same. On referring to the diagrams, Fig. 1 and 2, it will be observed that so far I have furnished constructional details of the electro-magnet B, and brass support for same. The latter can be made of strip brass, No. 10 or 12 gauge, which can be bent to the specified shape, and afterwards cut off to the length required and cleaned up as desired.

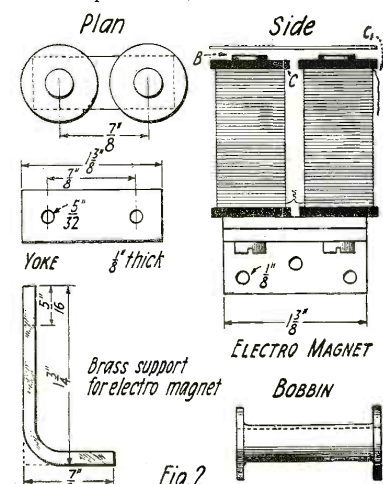

Fig. 2

Details of the Electro-Magnets Used in the Selector.

## BASEBOARD

The cores of the electro-magnet B can then be secured (by means of two brass cheese-head screws) to the soft iron yoke, and support, as shown. The baseboard A should be made of white pine, 10" long by 5" wide by  $\frac{5}{8}$ " thick, and should either be French polished or shellac varnished.

The metal plate forming the base W should be either brass or aluminum, 6" long by 4" diameter by  $\frac{1}{8}$ " thick.

The terminals, T and T1, are standard pattern. Eight will be required for the selector, and they can be fitted to the baseboard A in any convenient manner, and in any suitable position, so long as none make contact with the metal base W, except where necessary in connection with the contacts, J and J1, for the de-cohering device to be described in due course.

The four pillars, P and P1 (two only shown), should be made of brass,  $2\frac{1}{4}$ " long over all by  $\frac{3}{8}$ " diameter.

Those amateurs not possessing a lathe can purchase a  $\frac{3}{8}$ " screw-threaded brass rod, and cut such rod to the lengths required. Brass nuts can then be used for securing the pillars to a vulcanized fibre base O, and metal base W, so that the distance between the former and the latter does not exceed  $1\frac{1}{2}$ ".

## THE ARMATURE

The clamping pillar R should be made of brass,  $1\frac{1}{8}$ " long by  $\frac{3}{8}$ " diameter, fitted with clamping screw, and drilled to admit one end of the balance spring H, being passed through as shown. The latter spring should be a closed coil type, 1" long by  $\frac{1}{4}$ " diameter, and made of No. 22 gauge hard-drawn brass wire.

A loop should be formed at one end of the spring, and about 1" of straight wire left at the other end for passing through the hole drilled in the clamping pillar R. The vulcanized fibre base O should be  $3\frac{1}{2}$ " square by  $\frac{3}{8}$ " thick.

The brass ratchet K should be either  $1\frac{1}{2}$ " or  $1\frac{3}{8}$ " diameter, and should contain not less than 100 teeth. Ratchets can be purchased from most dealers in clock material.

The armature D should be made of Swedish charcoal soft iron,  $1\frac{1}{2}$ " long by  $\frac{5}{8}$ " wide by  $\frac{1}{8}$ " thick, and should be secured to the support E as shown, by means of two brass screws, the latter engaging with two screw-threaded holes in the armature.

## PAWL AND RATCHET

The armature support E should be made of strip brass, 3" long by  $\frac{5}{8}$ " wide by  $\frac{1}{8}$ " thick, with contact J1 attached to same. Both ends of the support should be rounded off, or bent round, as shown in Fig. 1, and arranged to accommodate a steel pin  $\frac{5}{8}$ " long by  $\frac{3}{8}$ " diameter. The pin lengths required can be cut off from an ordinary steel knitting pin.

A slot should be cut (a file can be used for the purpose) in one end of the support E to accommodate a pawl F, as shown in Fig. 1. A steel knitting pin will be found useful in connection with bending round the ends of the support E; the operation being easily effected with the aid of a hammer, vice, pair of pliers, or preferably pincers, and the steel knitting pin used as a mandrel, and gauge for the holes at each end of the support E.

The pawl F can be made of brass, 1" long by  $\frac{1}{4}$ " wide, No. 20 gauge, and bent round at one end as shown in Fig. 1, and arranged to be attached to the support E by means of a steel pin. A light spiral spring (made of No. 30 gauge hard-drawn brass wire) should be attached to the pawl, and support in order that the pawl may be kept in contact with the ratchet K.

The base I can be made of strip brass,  $\frac{1}{2}$ " wide by  $\frac{3}{8}$ " thick, as shown in Fig. 1. The contact J should be made of sprine brass, no 26 gauge, and attached to a vul-

canized fibre block ( $\frac{5}{8}$ " square by  $\frac{1}{2}$ " thick), as shown in Fig. 1.

## BRACKET AND SUPPORTS

The adjusting screw G can be made to engage a screw-threaded hole in a block of brass ( $\frac{1}{4}$ " square by  $\frac{5}{8}$ " long). The latter can be secured to the vulcanized fibre base O by means of two screws.

The brackets or supports N (two in number), should be made of strip brass, 1" long by  $\frac{1}{2}$ " wide by  $\frac{1}{8}$ " thick, bent and secured to the vulcanized fibre base O, as shown in Fig. 1. It will be observed that the total length of each bracket, including its base is approximately  $1\frac{3}{8}$ ".

The drum L should be made of a vulcanized fibre tube  $1\frac{1}{2}$ " long by  $1\frac{1}{4}$ " outside diameter, cut into two equally divided parts, and such sections should be mounted upon two brass or aluminum flanges, with two brass spindles ( $\frac{3}{8}$ " diameter), and ratchet, as shown in Fig. 1.

The vulcanized fibre drum should have four equal divisions marked upon same, and three  $\frac{3}{8}$ " tapping holes should be drilled on each division line to accommodate three  $\frac{3}{8}$ " by  $\frac{1}{8}$ " brass cheese-head screws.

## CONTACT SCREWS

The length of the spindles outside the flanges of the drum should be  $\frac{1}{2}$ ", so that at one end the free length will be  $\frac{3}{8}$ ", assuming the brass ratchet is  $\frac{1}{8}$ " thick.

Six of the contact screws fitted in the vulcanized fibre drum should be connected together (i.e., three opposite each other) by

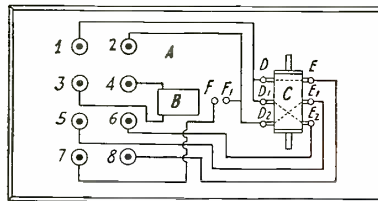

Fig 3

Wiring Connections of the Selector Including the Electro-Magnets B and the Revolving Drum C.

soldering (inside the drum) a short length of insulated flexible instrument wire.

The soldering of the flexible wires can be effected by disconnecting the two halves of the vulcanized fibre drum from its flanges and when the soldering is completed, care must be exercised to see that all wires are insulated from each other before again assembling the drum, and its component parts.

## SELECTIVE ACTION

Four of the remaining contact screws in the drum should be connected in the form of a cross.

The object of reversing the connections is to cause a reversal of polarity of the electric current in a circuit connected with such contact screws, when the drum is caused to revolve step by step by impulses from the electro-magnet B as shown in Fig. 1.

The two remaining contact screws should be connected together (i.e., opposite each other) with a short length of instrument wire as previously described.

The contacts M and M1 (six in number), should be made of No. 28 gauge spring brass ( $\frac{3}{8}$ " wide), mounted, and secured by screws on the vulcanized fibre base O.

The contacts should be shaped in such a manner that no contact is made with the contact screws fitted to the drum, when the latter is in mid-way position.

The check spring S, Fig. 1, should be made of No. 26 gauge spring brass, and secured to the vulcanized fibre base O by screws, as shown in Fig. 1.

When assembling the selector it will be advisable to loosely fit a brass washer  $\frac{3}{8}$ " thick to each of the drum spindles. Such

a precaution will obviate any possibility of the brackets, or supports, coming in contact with the ratchet (fitted at one end of the drum) and drum flange, thus reducing friction.

## FINAL ADJUSTMENTS

Care should also be exercised when mounting the drum, and particular notice taken that the latter revolves freely when set in motion by magnetic impulses.

The contact springs should be so adjusted that any unnecessary friction is eliminated.

On referring to Fig. 1 it will be observed that the balance-spring H can be adjusted until the desired tension is attained. The adjusting screw G should be so arranged that the distance of the armature D from the cores of the electro-magnet B does not exceed  $\frac{1}{8}$ ".

The eight terminals can be attached to the baseboard, and connected up as shown in Fig. 3.

To simplify matters the diagram is arranged as a skeleton plan, and shows a baseboard A, electro-magnet B (armature not shown), drum C with contacts D, D1, D2, and E, E1, and E2. Contacts F and F1 are for connecting with a de-cohering device to be described in due course.

## CONNECTING UP

It will be observed that the eight terminals are numbered 1 to 8 respectively, and connected up as shown. No. 18 gauge double-cotton-covered copper wire may be used for connecting the terminals to the electro-magnet B, and various contacts.

The wire should be laid in slots or grooves cut in the baseboard A, and can thus be neatly hidden. The slots, or grooves, should not be cut on the surface of the baseboard upon which the electro-magnet and other component parts are mounted, otherwise the general appearance of the selector will not be enhanced.

After assembling the selector it will be advisable to test all circuits.

On connecting terminals Nos. 3 and 4 with the terminals of a 4-volt storage battery (the latter comprises two cells made up as a complete unit), electric current should traverse the windings of the electro-magnet B, energizing the latter, which should then strongly attract its armature.

## TESTING THE SELECTOR

Immediately electric current is cut off from the windings of the electro-magnet B, its armature should be automatically released, and the pawl (attached to the armature support) engaging with the ratchet attached to the drum C should cause the latter to revolve a step forward.

Contacts F and F1 (Fig. 1) can next be tested. This can be effected with the aid of an ordinary electric bell, one terminal of the latter being connected with terminal No. 7 on baseboard A. The other bell terminal can be connected with one terminal of a 4-volt storage battery; the other terminal of the latter being connected with terminal No. 2.

On further connecting terminals Nos. 3 and 4 with the terminals of the storage battery in question, contacts F and F1 should immediately close, and thus admit electric current to the electric bell (used for testing purposes), thereby functioning same.

The contacts F and F1 (Fig. 3) are marked J and J1 in Fig. 1,

## CONTROL MOTOR

My reason for adopting such a course is that as electric current for the whole apparatus (including the model electric train to be wirelessly controlled) will be provided from such a "source of energy," it is obvious that the tests applied will be the same as those to which the apparatus will be subjected when in actual use.

Contacts D and E can be tested by connecting one terminal of an ordinary electric

(Continued on page 1905)



# Radio Shower Party

## \$5,000.00 Worth of Radio Goods Given Away

**M**ARCH 29 will be a red letter day for radio fans all over the country. It will be an event that will be talked about for a long time.

This Radio Shower Party is being given by the leading manufacturers of the radio industry. The party is conducted by RADIO NEWS in conjunction with the famous broadcasting station, WJZ, at Newark, New Jersey.

On the evening of March 29 the Editor of RADIO NEWS, Mr. H. Gernsback, will give a radio lecture at WJZ, and at the conclusion of this lecture he will ask 10 questions, which 10 questions will be found printed at the end of this article.

The contest itself will be rather simple, and does not require an unusual knowledge of radio. The questions are such as every one could answer without much trouble. There are five questions for regular broadcast listeners, those who do not know much about radio technicalities, and then there are five questions which any amateur or, in fact, anyone acquainted with radio, should have little trouble in answering. You need answer only one set of five questions. If you are a broadcast listener, you answer the first group; if an amateur, answer the second group—or, at your option, you may answer both sets of questions.

In order to make sure that prizes go to only those who actually listen in to the lecture, and to the questions asked over WJZ broadcasting station, the questions as printed in this issue of RADIO NEWS are correct in every way, but are not printed in their correct order. Each question as printed at the lower right-hand corner of this page, has a little box printed before it. When you are listening in, therefore, on the evening of March 29, Mr. Gernsback will call off the questions and he will say "Question No. 1...., Question No. 2....," etc. It is up to the listener to put the correct number in each square. Unless this correct number is given, the reply will be thrown out of the contest. In other words, it is absolutely necessary, in order to compete, that you listen in to WJZ in order to get the correct order of the questions.

There will be 50 or more prizes for each district, as explained further on. These prizes will be given to the lucky winners in the various districts, in the following manner: The first prize will be the most expensive or most elaborate outfit. A list of these prizes is given at the end of this article. Other prizes will be given in the same fashion.

It should be understood that it is not necessary at all for anyone competing to buy a copy of RADIO NEWS in order to study the questions, or copy them. The questions will be read by Mr. Gernsback from WJZ twice in succession, slowly and distinctly, so that any broadcast listener can write them down. The announcer of WJZ, before the lecture starts, will advise listeners to obtain pencil and a pad, so that they may all write down the questions. The rules of the contest will also be read by the announcer, to make sure that all listeners, whether they read RADIO NEWS or not, can participate in the contest.

### PRIZES

The prizes are enumerated at the end of this article. There will be a different set of prizes for each of the 12 zones as

listed below. Each district, therefore, will have its own set of prizes: (One Special Prize for the farthest reply.)

### ZONES:

- (1) Maine, New Hampshire, Vermont, Massachusetts, Connecticut and Rhode Island.
- (2) New York, New Jersey and Delaware.

### What It Is All About

**T**HE Radio Shower Party is being given by the leading radio manufacturers of the United States.

There will be over 700 prizes totalling in value over \$5,000.

In order to get a prize, it is necessary for you to listen in to WJZ at Newark, New Jersey, on the evening of March 29, 1923.

Mr. H. Gernsback, Editor of RADIO NEWS, will give a radio lecture, at the end of which he will ask 10 questions.

If you answer these questions correctly you stand a good chance of getting one of these prizes.

It is one of the greatest radio contests ever staged, and we advise you to read the article to familiarize yourself with the rules of the contest.

- (3) Pennsylvania, Maryland, Virginia and West Virginia.
- (4) Ohio, Indiana, Michigan, Illinois, Wisconsin and Kentucky.
- (5) Tennessee, North Carolina, South Carolina, Mississippi, Alabama, Georgia and Florida.
- (6) Minnesota, Iowa, Missouri, North Dakota, South Dakota, Nebraska, Kansas, Montana, Wyoming and Colorado.
- (7) Arkansas, Louisiana, Oklahoma, Texas and New Mexico.
- (8) Washington, Oregon, Idaho, California, Nevada, Utah and Arizona.
- (9) Dominion of Canada.
- (10) Mexico, Cuba, Panama Canal Zone and South America.
- (11) England, France, Spain, and Mediterranean Cities.
- (12) All other places not named, including the High Seas.

### CONDITIONS OF THIS CONTEST:

- (1) The contest is open to all radio en-

thusiasts everywhere, not only in the United States, but all foreign countries as well.

(2) Every contestant must give the hour and minute that was given as the official time when the final question was broadcast.

(3) The questions must be answered in the same order in which they are broadcast by WJZ.

(4) The questions as printed in this issue of RADIO NEWS are correct, BUT, they are not printed in the correct order. This makes it necessary to listen in to WJZ in order to win a prize.

(5) Prizes will be awarded not only for the best and most correct answers, but for the SHORTEST correct answers. Correctness and brevity will win the prizes.

(6) All answers must be addressed to "RADIO NEWS SHOWER CONTEST, 53 Park Place, New York City, N. Y."

(7) The date of mailing, as shown by the postmark, the simplicity of the language used in answering, as well as brevity, legibility, etc., will all be taken into consideration.

(8) All replies must be mailed by April 9, 1923. No replies bearing a later postmark than April 9 can be considered.

### Zone No. 1

Maine, New Hampshire, Vermont, Massachusetts, Connecticut and Rhode Island

Following the name of the prize is the name of the donor.

Prizes will be awarded in the following order:

1. M. R. 5 Regenerative Set and Two Stage Amplifier—The Radiocrat Co., and 1 W. T. 501 Peanut Tube and Adapter—Radio Research Guild.
2. 1 D412 Detector and Two Stage Amplifier Acme Apparatus Co., and 1 W. T. 501 Peanut Tube and Adapter—Radio Research Guild.
3. 1 R O R N Tuned Radio Frequency Amplifier Unit—A. H. Grebe & Co., Inc.
4. 2 Rasla Radio Frequency Transformers and 2 Rasla Audio Frequency Transformers—Rasla Radio Corporation, National Distributors for Radio Service Laboratories.
- 4.A 1 "Signal" Tuner and Detector—Signal Electric Mfg. Co.

### PRIZE QUESTIONS:

#### BROADCAST LISTENERS' QUESTIONS

- What interests you most in radio?
- What is your pet radio aversion?
- What actual benefits do you derive from your set outside of pleasure?
- What 3 rules should every radiophone owner observe?
- Why must a vacuum tube be evacuated?

#### AMATEURS' TECHNICAL QUESTIONS

- What is static?
- What is a carrier wave?
- What advantage has a single circuit tuner over a two-circuit one?
- What advantages has a two-circuit tuner over a single circuit one?
- What is happening when, during receiving, the detector tube starts to oscillate?

TO BE FILLED IN BY ALL CONTESTANTS:

The correct time at which the lecture was finished was..... P. M.

My set consists of .....

I am  a broadcast listener

a radio amateur

(Place a cross (X) in square for correct information)

The air distance from my station to WJZ is.....miles.

5. 1 Homecharger—Automatic Electrical Devices.
6. 1 48-Volt Willard Radio "B" Storage Battery—Willard Storage Battery Co.
7. 1 National Airphone Crystal Set, Model G—National Airphone Corp., and 1 W. T. 501 Peanut Tube and Adapter—Radio Research Guild.
8. 1 Ricohorn—Radio Industries Corp., and 1 Carter Two-way Plug—Carter Radio Co.
9. 1 Crystal Set—Standard Radio & Electric Co., and 1 W. T. 501 Peanut Tube and Adapter—Radio Research Guild.
10. 4 No. 269 2 1/2-Volt Variable "B" Batteries—Novo Mfg. Co., Inc.
11. 1 Set Constructional Drawings of Ten Tube Super-Hetrodyne—Experimenters Information Service.
12. 1 Gould "B" Battery—Gould Storage Battery Co.
13. 1 Dictograph 3000 Ohm Head Set—Dictograph Products Co., and 1 Carter Two-way Plug—Carter Radio Co.
14. 1 Model 301 Filament Voltmeter—Weston Electrical Instrument Co.
15. 1 Trimm "Professional" 3000 Ohm Head Set—Trimm Mfg. Co., and 1 Carter Two-way Plug—Carter Radio Co.
16. 1 Connecticut Variable Condenser—Connecticut Telephone & Electric Co.
17. Goodman Wave Tuner—L. W. Goodman.
18. 1 Cole Audio Frequency Transformer—A. B. Cole, Inc.
19. 1 Frost 3000 Ohm Head Set—Herbert H. Frost, and 1 Frost No. 138 Multiple Fone Plugs—Herbert H. Frost.
20. 1 Murdock Loud Speaker—Wm. J. Murdock Co., and 1 Carter Two-way Plug—Carter Radio Co.
21. 1 Murdock No. 56 Head Set—Wm. J. Murdock Co., and 1 Carter Two-way Plug—Carter Radio Co.
22. 1 Rico Double Head Set—Radio Industries Corp., and 1 Carter Two-way Plug—Carter Radio Co.
23. 1 Membership in the Radio Guild Co-operative Service Bureau—The Radio Guild.
24. 1 Connecticut Audio Frequency Transformer—Connecticut Telephone & Elec. Co.
25. 1 Fada Variocoupler—Frank A. D. Andrea.
26. 1 Large Type "B" Battery—Hipwell Mfg. Co.
27. 1 2 1/2-Volt Defelco "B" Battery—Defelco Battery Corp.
28. 1 45-Volt "B" Battery—National Electrical Novelty Co., Inc.
29. 1 Variocoupler—WorkRite Mfg. Co.
30. 1 Variometer—WorkRite Mfg. Co.
31. 1 No. 1 Complete Pattern, Diagrams & Instructions for Making Short Wave Regenerative Set; 1 No. 2 Complete Patterns, Diagrams & Instructions for Making Detector and Amplifier Radio Units; 1 No. 3 Complete Instructions and Blue Prints for Making Radiophone Crystal Set; 1 Twenty Radiophone Diagrams and Hook-ups of Crystal and Audion Receiving Circuits, Amplifier Circuits, Regenerative Circuits, Sending Circuits, with Key Chart of Symbols, and Pamphlet How to Read Diagrams; 1 Fourteen Radio Formulae and Diagrams; 1 Complete and Detailed Instructions, How to Build and Install Every Known Aerial for the Amateur—Consolidated Radio Call Book.
32. Barkelew Lightning Arrester Switch—The Barkelew Electric Mfg. Co.
33. 1 Variometer—F. S. Radio Corp.
34. 1 Year's Subscription to SCIENCE & INVENTION—Experimenter Publishing Co.
35. 1 Year's Subscription to RADIO NEWS—Experimenter Publishing Co.
36. 1 A. C. H. Sharp Tuner Dial—A. C. Hayden Radio & Research Corp.
37. 1 A. C. H. Sharp Tuner Dial—A. C. Hayden Radio & Research Corp.
38. 1 Brach Lightning Arrester—L. S. Brach Mfg. Co.
39. 1 Formica Panel—The Formica Insulation Co.
40. 1 Subscription to PRACTICAL ELECTRICS—Practical Electrics Co., Inc.
41. The WestWyre Condenser—The WestWyre
42. 1 Bradleyometer—Allan Bradley Co.
43. 1 Memory Course—C. K. Dodge.
- 43A. 1 Antenna Plug—Chas. Freshman Co. Inc.
- 43B. 1 Variable Resistance Leak with .00025 Micon Condenser—Chas. Freshman Co. Inc.
44. 1 Bradleystat—Allan Bradley Co.
45. 1 Klossner Model 200 Vernier Rheostat—Klossner Improved Apparatus Co.
46. 1 Resistance Unit and Mountings—Daven Radio Co.
47. 1 Pair Bates Ear Cushions for Head Sets—Bates & Co.
48. 1 Consolidated Radio Call Book—Consolidated Radio Call Book Co.
49. 1 Autostat—Automatic Electrical Devices Co.
50. 1 Autostat—Automatic Electrical Devices Co.
51. 1 Barkelew Four Phone Plug—The Barkelew Elec. Mfg. Co.
52. 1 Marco Series Parallel Switch—Martin-Copeland Company.
53. 1 Bradleyadapter—Allan Bradley Co.
54. 1 Bradleyswitch—Allan Bradley Co.
55. 1 Battery Testing Outfit—The Chaslyn Co.
56. 1 Saturn Perfect Jack—Saturn Mfg. & Sales.
57. 1 Radiogem Receiving Set—The Radiogem Corp.
58. 1 Saturn Automatic Plug—Saturn Mfg. & Sales Co.
59. 5 W. D. 11 Fuses—Radio Equipment Co.
60. 1 .006 Micon Condenser—Chas. Freshman Co. Inc.

## Zone No. II

- New York, New Jersey and Delaware
1. 1 Reflex Regenerative Receiving Set—De Forest Tel. & Tel. Co., and 1 W. T. 501 Peanut Tube and Adapter—Radio Research Guild.
  2. 1 RORN Tuned Radio Frequency Amplifier Unit—A. H. Grebe & Co., Inc.
  3. 1 D412 Detector and Two Stage Amplifier—Acme Apparatus Co., and 1 W. T. 501 Peanut Tube and Adapter—Radio Research Guild.
  4. 1 Kellogg Head Set, 1 Kellogg Variable Condenser, 1 Kellogg Variocoupler, 1 Kellogg Variometer, 1 Kellogg Rheostat, 1 Kellogg Socket, 1 Kellogg Plug, 3 Kellogg Jacks—Kellogg Switchboard & Supply Co.
  5. 1 80-Ampere Willard All Rubber Radio "B" Battery—Willard Storage Battery Co.
  6. 2 Rasla Radio Frequency Transformers and 2 Rasla Audio Frequency Transformers—Rasla Sales Corp., National Distributors for Radio Service Laboratories.
  7. 1 Crosley Model "V" Regenerative Receiver—Crosley Mfg. Co., and 1 W. T. 501 Peanut Tube and Adapter—Radio Research Guild.
  8. 1 Warren Radio Loop Type 2537, V-De-Co.—Radio Mfg. Co.
  9. 1 A & B Battery Charger—Valley Electrical.
  - 9A. 1 "Signal" Crystal Receiving Set—Signal Elec. Mfg. Co.
  10. 1 National Airphone Crystal Set, Model G—National Airphone Corp., and 1 W. T. 501 Peanut Tube and Adapter—Radio Research Guild.
  11. 1 Ricohorn—Radio Industries Corp., and 1 Carter Two-way Plug—Carter Radio Co.
  12. 1 Crystal Radio Set—Standard Radio & Elec. Co., and 1 W. T. 501 Peanut Tube and Adapter—Radio Research Guild.
  13. 4 No. 269 2 1/2-Volt Variable "B" Batteries—Novo Mfg. Co., Inc.
  14. 1 Set Constructional Drawings of Ten-Tube Super-Hetrodyne—Experimenters Information Service.
  15. 1 Gould Radio "B" Battery—Gould Storage Battery Co.
  16. 1 Dictograph 3000 Ohm Head Set—Dictograph Products Co., and 1 Carter Two-way Plug—Carter Radio Co.
  17. 1 5-Watt Power Tube—Automatic Elec. Devices Co.
  18. 1 Trim "Professional" 3000 Ohm Head Set—Trimm Radio Mfg. Co., and 1 Carter Two-way Plug—Carter Radio Co.
  19. 1 Connecticut Variable Condenser—Connecticut Telephone & Elec. Co.
  20. 1 Goodman Wave Tuner—L. W. Goodman.
  21. 1 Cole Audio Frequency Transformer—A. B. Cole, Inc.
  22. 1 Frost 3000 Ohm Head Set—Herbert H. Frost, and 1 No. 138 Multiple Fone Plugs—Herbert H. Frost.
  23. 1 Murdock Loud Speaker—Wm. J. Murdock Co., and 1 Carter Two-way Plug—Carter Radio Co.
  24. 1 Murdock Head Set No. 56—Wm. J. Murdock Co., and 1 Carter Two-way Plug—Carter Radio Co.
  25. 1 Double Head Set—Radio Industries Corp., and 1 Carter Two-way Plug—Carter Radio Co.
  26. 1 Membership in The Radio Guild Co-operative Service Bureau—The Radio Guild.
  27. 1 Audio Frequency Transformer—Connecticut Telephone & Elec. Co.
  28. 1 Fada Variocoupler—Frank A. D. Andrea.
  29. 1 Large Type "B" Battery—Hipwell Mfg. Co.
  30. 1 2 1/2-Volt Defelco "B" Battery—Defelco Battery Corp.
  31. 1 45-Volt "B" Battery—National Electrical Novelty Co., Inc.
  32. 1 WorkRite Variocoupler—WorkRite Mfg. Co.
  33. 1 WorkRite Variometer—WorkRite Mfg. Co.
  34. 1 Barkelew Lightning Arrester Switch—The Barkelew Electric Mfg. Co.
  35. 1 No. 1 Complete Patterns, Diagrams & Instructions for making Short Wave Regenerative Set; 1 No. 2 Complete Patterns, Diagrams & Instructions for making Detector and Amplifier Radio Units; 1 No. 3 Complete Instructions and Blue Prints for making Radiophone Crystal Set; 1 Twenty Radiophone Diagrams and Hook-ups of Crystal and Audion Receiving Circuits, Amplifier Circuits, Regenerative Circuits, Sending Circuits, with Key Chart of Symbols and Pamphlet, How to Read Diagrams; 1 Fourteen Radio Formulae and Diagrams; 1 Complete and Detailed Instructions, How to Build and Install Every Known Aerial for the Amateur—Consolidated Radio Call Book
  36. 1 Variometer—F. S. Radio Corp.
  37. 1 Year's Subscription to SCIENCE & INVENTION—Experimenter Publishing Co.
  38. 1 Year's Subscription to RADIO NEWS—Experimenter Publishing Co.
  39. 1 A. C. H. Sharp Tuner Dial—A. C. Hayden Radio & Research Corp.
  40. 1 A. C. H. Sharp Tuner Dial—A. C. Hayden Radio & Research Corp.
  41. 1 Brach Lightning Arrester—L. S. Brach Mfg. Co.
  42. 1 Formica Panel—The Formica Insulation Co.

43. 1 Year's Subscription to PRACTICAL ELECTRICS—Practical Electrics Co., Inc.
44. 1 WestWyre Condenser—The WestWyre Co.
45. 1 Bradleyometer—Allan Bradley Co.
46. 1 Memory Course—C. K. Dodge.
- 46A. 1 Antenna Plug—Chas. Freshman Co. Inc.
47. 1 Bradleystat—Allan Bradley Co.
- 47A. 1 Variable Resistance Leak with .00025 Micon Condenser—Chas. Freshman Co. Inc.
48. 1 Klossner Model 200 Vernier Rheostat—Klossner Improved Apparatus Co.
49. 1 Resistance Unit and Mountings—Daven Radio Co.
50. 1 Pair Bates Ear Cushions for Head Sets—Bates and Company.
51. 1 Consolidated Radio Call Book—Consolidated Radio Call Book Co., Inc.
52. 1 Autostat—Automatic Electrical Devices Co.
53. 1 Autostat—Automatic Electrical Devices Co.
54. 1 Barkelew Four-Phone Plug—The Barkelew Elec. Mfg. Co.
55. 1 ShurGrip Plug—Martin-Copeland Company.
56. 1 Bradleyadapter—Allan Bradley Co.
57. 1 Bradleyswitch—Allan Bradley Co.
58. 1 Battery Testing Outfit—The Chaslyn Co.
59. 1 Saturn Perfect Jack—Saturn Mfg. & Sales
60. 1 Radiogem Receiving Set—The Radiogem Corp.
61. 1 Marco W. D. 11 Adapter—Martin-Copeland.
62. 1 Marco W. D. 11 Adapter—Martin-Copeland.
63. 1 Saturn Automatic Plug—Saturn Mfg. & Sales Co.
64. 1 Set Phone Clips—Star Mfg. Co.
65. 5 W. D. 11 Fuses—Radio Equipment Co.
66. 1 .006 Micon Condenser—Chas. Freshman Co. Inc.

## Zone No. III

Pennsylvania, Maryland, Virginia and West Virginia

1. 1 Broadcast Receiver—The Radio Guild, and 1 W. T. 501 Peanut Tube and Adapter—Radio Research Guild.
2. 1 D412 Detector and Two Stage Amplifier—Acme Apparatus Co., and 1 W. T. 501 Peanut Tube and Adapter—Radio Research Guild.
3. 1 RORN Tuned Radio Frequency Amplifier Unit—A. H. Grebe & Co., Inc.
4. Two Rasla Radio Frequency Transformers and Two Rasla Audio Frequency Transformers—Rasla Sales Corp., National Distributors of Radio Service Laboratories.
5. 1 Type "G" Battery Charger—France Mfg. Co.
6. 1 National Airphone Crystal Set, Model "G"—National Airphone Corp., and 1 W. T. 501 Peanut Tube and Adapter—Radio Research Guild.
7. 1 Ricohorn—Radio Industries Corp., and 1 Carter Two-way Plug—Carter Radio Co.
8. 1 Crystal Set—Standard Radio & Elec. Co., and 1 W. T. 501 Peanut Tube and Adapter—Radio Research Guild.
9. 4 No. 269 2 1/2-Volt Variable "B" Batteries—Novo Mfg. Co., Inc.
10. 1 Set Constructional Drawings of a Ten-Tube Super-Hetrodyne—Experimenters Information Service.
11. 1 Gould Radio "B" Battery—Gould Storage Battery Co.
12. 1 Dictograph 3000 Ohm Head Set—Dictograph Products Corp., and 1 Carter Two-way Plug—Carter Radio Co.
13. 1 Trimm "Professional" 3000 Ohm Head Set—Trimm Radio Mfg. Co., and 1 Carter Two-way Plug—Carter Radio Co.
14. 1 Wood Horn Loud Speaker—Inter-Ocean Radio Corp., and 1 Carter Two-way Plug—Carter Radio Co.
15. 1 Connecticut Variable Condenser—Conn. Telephone & Elec. Co.
16. 1 Goodman Waver Tuner—L. W. Goodman.
17. 1 Cole Audio Frequency Transformer—A. B. Cole, Inc.
18. 1 Frost 3000 Ohm Head Set—Herbert H. Frost, and 1 No. 138 Multiple Fone Plug—Herbert H. Frost.
19. 1 Murdock Loud Speaker—Wm. J. Murdock Co., and 1 Carter Two-way Plug—Carter Radio Co.
20. 1 Murdock Head Set No. 56—Wm. J. Murdock Co., and 1 Carter Two-way Plug—Carter Radio Co.
21. 1 Double Head Set—Radio Industries Corp., and 1 Carter Two-way Plug—Carter Radio Co.
22. 1 Membership in The Radio Guild Co-operative Service Bureau—The Radio Guild.
23. 1 Audio Frequency Transformer—Connecticut Elec. & Telephone Co.
24. 1 Fada Variocoupler—Frank A. D. Andrea.
25. 1 Large Type "B" Battery—Hipwell Mfg. Co.
26. 1 2 1/2-Volt Defelco "B" Battery—Defelco Battery Corp.
27. 1 45-Volt "B" Battery—National Elec. Novelty Co.
28. 1 WorkRite Variocoupler—WorkRite Mfg. Co.
29. 1 WorkRite Variometer—WorkRite Mfg. Co.
30. 1 Barkelew Lightning Arrester Switch—The Barkelew Elec. Mfg. Co.
31. 1 No. 1 Complete Patterns, Diagrams & Instructions for Making Short Wave Regenerative Set; 1 No. 2 Complete Patterns, Diagrams & Instructions for Making Detector and Amplifier Radio Units; 1 No. 3 Complete Instructions and Blue Prints for Making Radiophone Crystal Set; 1 Twenty Radiophone Diagrams and Hook-ups of Crystal and Audion Receiving Circuits, Amplifier Circuits, Regenerative Circuits, Sending Circuits, with Key Chart of Symbols and Pamphlet, How to Read Diagrams; 1 Fourteen Radio Formulae and Diagrams; 1 Complete and Detailed Instructions, How to Build and Install Every Known Aerial for the Amateur—Consolidated Radio Call Book

(Continued on page 1906)



# The Telephone and Microphone

By JOHN DEPEW

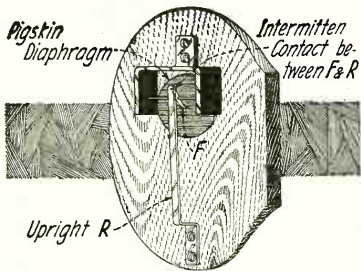

Fig. 1. An Early Type of Phone Invented by Reis. It Was Made of Wood and Shaped Like the Exterior of a Human Ear.

IN pursuing some researches in Photoelectricity, the writer had need to ascertain the extent of our present day ignorance on this and allied subjects, all touching on the transformations of the various forms of energy into each other, and of our great inability to direct but a small percentage of the resultant form to a useful purpose. He has unearthed, among other things, some 57 varieties of phones, on which enormous amounts of energy and money have been expended during the past 70 or 80 years.

A brief resumé of their principles will interest many Radio enthusiasts, and will help them to attack intelligently the problems of constructing microphonic relays and loud speakers from common materials, and with common tools, making choice planning replace to some extent the fine workmanship of the commercial articles.

One of the earliest types of speaking phones is shown in Fig. 1, made by Reis in 1855 or 1857. It was made of wood and shaped like the exterior of a human ear, with a contact arrangement similar to Fig. 2, where a thin platinum strip, fastened to a membrane of a pig's bladder was caused by the sound waves to make intermittent contact with an adjustable angular piece above it. Obviously it would distort the reproduction, if only because of the fact that the contacts are made only during the peak of the vibrations. A similar contact scheme is shown in Fig. 3. Every piece of apparatus shown in this article has been used by its inventor, both for receiving and for transmitting. Paradoxical as it may seem at first, it is possible to make any carbon transmitter button "talk" by proper manipulation, although a Bell receiver may do it better; Reis originally used his phones in duplicate.

Soon after that Bell produced his electric harmonica (Fig. 4), which was made as follows: To each pole of a channel-shaped magnet was attached a row of steel reeds of varying pitch, with a strip of soft iron, surrounded by an oval coil, placed between the two rows of reeds. If two such instruments are connected so that the coils are in a closed circuit (without batteries), and a reed on one instrument is

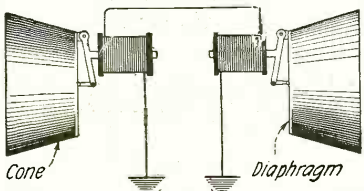

Fig. 4. Bell's Speaking Phone, Patented in 1876. Probably the First Magnetic Type of Receiver.

struck, causing it to vibrate, it sets up an induced alternating current in both coils, by reason of the fluctuations in the permanent magnetic flux caused by the changing distances between the reed and its soft iron armature strip (core). This induced current set into vibration that reed in the distant instrument which happened to have a corresponding pitch, thus enabling the operator to transmit musical sounds, either way, singly or in combinations, but no speech.

In Fig. 5 is shown a speaking phone patented by Bell in Jan., 1876, where the motion of a diaphragm causes, through some compound levers, the fluctuating motion of an iron magnetic pin into and out of a coil inducing a varying current which actuated a similar instrument at a distance. This was one of the forerunners of the present day Bell magnetic receiver.

In Fig. 6 we see a receiver, produced by Gray, with which batteries were used. The horizontal diaphragm had a metal rod attached to its center, which dipped into a cup filled with some high resistance liquid forming a circuit through the liquid with a projection in the bottom of the cup. By bending the head and speaking downward into the diaphragm, the vibrations caused variations in the distance between the end of the rod fastened to it and the bottom projection, thus continuously altering the re-

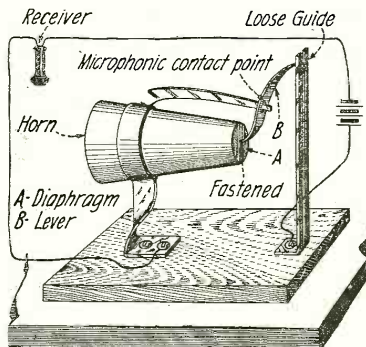

Fig. 3. A System of Contact Similar to That Used by Reis.

sistance of the layer of interposing liquid, and thereby actuating any receiver device at the far end of the circuit. This is the prototype of a host of "electrolytic" transmitters, which "break out" at intervals to this day. Polarization, corrosion, evaporation, inertia, volta effect, and other things militate against the steady performance of these types.

Fig. 7 shows a Bell transmitter of 1876 made on the same principle.

It is truly surprising to what extremes we may go in eliminating things from a phone design and still have it work. In Figs. 8 9 and 10 we have three of the many Ader's phones; No. 8 is a receiver, composed of a block of wood, with a thin, long iron nail driven through it and wires fastened to both ends of the nail running to the binding posts on the block. A fluctuating current sent through the nail causes momentary changes in the length of it, from thermal, electric and other causes, thus vibrating the block which emits sensible sounds held against the ear. These sounds can be intensified by attaching a weight as at F in Fig. 9 to the point of the nail, of about twice the weight of the block of wood, and still further intensified by passing the current through a modern telephone induc-

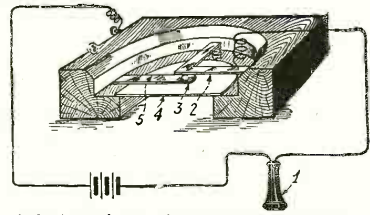

Fig. 2. The System of Contact Used in the Reis Speaking Phone, the Lower One Being Fastened to a Membrane Diaphragm.

tion coil. We have here then a receiver without magnets or diaphragm! Fig. 9 is similar to Fig. 8 except that the current passes through a coil loosely wound around the nail, causing the changes in length mainly by magnetic induction, and partly as before, by heat, hysteresis, etc. Fig. 10 shows a block of wood with a coil fastened to it by a brass nail or by glue. It works without a core or diaphragm probably because the mutual induction of the layers and turns causes minute lateral movements which are communicated to the block. In fact, the writer has heard speech from a coil alone. Fig. 11 shows a modern type of Ader's phone, its distinctive feature being an iron ring embedded in the ear-cap just over the diaphragm, which concentrates a greater percentage of the total magnetic flux through the thin iron diaphragm than would otherwise pass through it; the ring M is a nickel plated magnet of round cross section serving also as a handle.

Fig. 12 is a curious system, patented in 1899, in which a high tension discharge from any source is caused to jump the gap between the adjustable point and the center of the diaphragm. In speaking against the diaphragm, variations are set up in the length of the gap, thus causing corresponding surges in the circuit shown and thereby actuating a receiver, such as Bell's. Fig. 13 shows a receiver with a "resonating chamber" added to its conventional diaphragm (of doubtful value). Fig. 14 represents the Gower receiver, the Father of all watch-case receivers. This used a magnet, which could lift 11 lbs. although it was very small, and, when used also as a transmitter was provided with a tube fastened to the cover, and a reed near the diaphragm. By blowing into the tube, the reed would cause the diaphragm to vibrate violently, inducing similar screeches in the receiving phone, thus calling the subscriber to the phone, as the screech can easily be heard all over a large room. The reeds interfere in no way with the normal transmission and reception of speech, between two

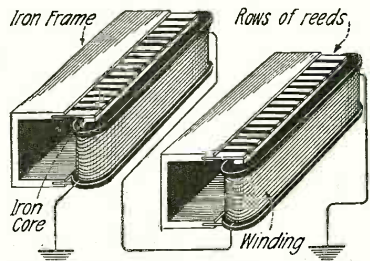

Fig. 5. Bell's Electric Harmonica, the Principle Being that of the Sympathetic Action of Vibrating Members.

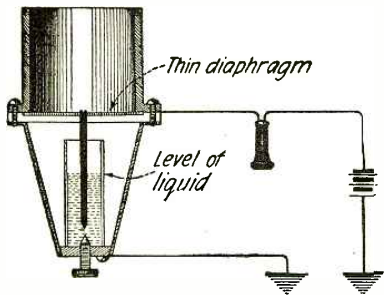

Fig. 6. A Receiver Produced by Gray. Vibration of the Diaphragm Caused Variations in the Distance Between Two Points Immersed in a High Resistance Liquid Varying the Battery Current in a Local Circuit.

Gower's phones or in combination with any other transmitter or receiver. A very clever arrangement.

Fig. 15 shows a leading British phone used extensively in Radio work. The steel reed E, adjustable, in this model by screws DD (in other models by an adjusting knob in center of case H moving the magnet core and coils), is fastened to a conical aluminum "diaphragm" which displaces the air without flexing sensibly. A narrow parchment ring C is placed above it (probably to help damping). Fig. 16 shows the Grant receiver produced by a firm in Cleveland, Ohio. Its novelty consists in that since the instrument is kept on the table, much greater latitude is offered the designers in points of size and weight of its component parts, while the headband and tubes remain very light and comfortable. This instrument also has means for adjusting the distance between the armature and the pole ends of the magnets, all being accomplished by turning and locking the knurled button on the top.

Figs. 17 and 18 show the classic "photophone" element of Bell's, a type which offers unlimited possibilities to the adroit and reasoning experimenter at a small outlay of time, effort and expense. It consists of a silver mirror with the silver removed from the glass, as shown in Fig. 17, making a long, narrow zigzagging clear space, which is filled by smoking it over with a deposit of lampblack, and two thin plates of any metal clamped one to each section of the silver on the glass, with a wire soldered to each plate. If such a mirror is placed in a circuit in series with a battery and any receiver, and an intermittent beam of any light is made to fall on it, a loud sound is heard in the receiver of the same pitch as the fluctuating beam, the resistance of the carbon changing in proportion to the illumination. A weaker sound will also be heard without a battery, and in the dead of the night, the flame of one candle falling through a slotted revolving disc, on this mirror, will produce a continuous sensible sound in a good phone receiver. A similar

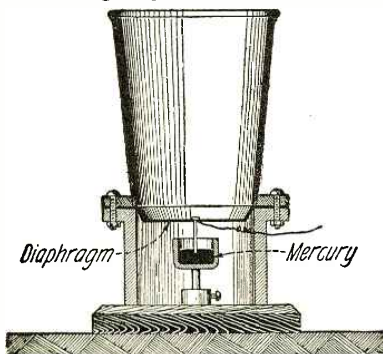
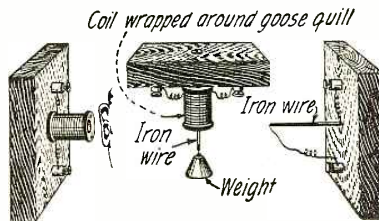

Fig. 7. Another Type of Transmitter Produced by Bell, the Action of Which Is Similar to the One Invented by Gray.

mirror can also act as a receiver, in combination with this or any other type of transmitter, often without any battery in the circuit, indeed at times even without a circuit in the ordinary sense, because it can produce:

1, A fluctuating current from fluctuating illumination; 2, a fluctuating control (varying resistance) of a battery current, from a fluctuating illumination; 3, a sound can produce in it the same reactions as a fluctuating beam; 4, it can speak, responding to changes in light, or in current of very small as well as sizable values; 5, it can respond, by producing sounds simultaneously to current and light variations, to either or to both; and finally, it can and does all the above five things in all their varying combinations, at once and it is feasible, by suitable controls to make it talk and sing in response to light, and current, or vice versa, create or control other currents in response to other sounds or magnetic fluctuations and "heterodyne" any of these effects simultaneously, and without confusion. It can speak, sing, see, hear, feel electricity, feel magnetism, produce and control electricity, respond in a choice of ways to infra red, ultra violet and X rays, if impressed at different frequencies, all at once. As an acrobatic instrument it can outdo all the triodes extant, and cannot burn out. Fig. 18 shows one variation, where light falls intermittently, through a spongy silver mirror onto a carbon element within, while it



Figs. 8, 9, 10. Three Types of Phones Developed by Adler. Their Principles and Actions Are Very Interesting.

is being acted upon by a "speaking" current, causing it to speak while singing the tone of the light interruptions.

Figs. 19, 20, 21 and 22 show the classic Hughes microphones. Fig. 19 is a glass tube 3" long filled with bronze powder, sealed with coke, in a circuit in series with a battery and Bell receiver. The tube lays on a resonating base. Fig. 20 is a "nail" microphone of excellent transmitting quality. Figs. 21 and 22 are loose contact carbon microphones; a fly walking across D (base) can be heard in a Bell receiver, also words spoken in an ordinary tone of voice 8 or 10 yards away from the microphone can be easily heard in the receivers. Fig. 23 shows Berliner's patent system, of July 7, 1877, using carbon contact microphones with two batteries and induction coils, substantially the same as many systems in use today.

I will close by quoting Professor Hughes' own explanation of the microphone action, which after 50 years, still holds good in the main:

"The problem I tried to solve by the microphone is as follows: To introduce into an electric circuit an electrical resistance, which shall vary in exact accord with sonorous vibrations so as to produce an undulatory current of electricity from a constant source, whose wave-length, height and form shall be an exact representation of the sonorous vibrations; this was the first step. The second step, which is of great importance, was solved by the discovery, that when an electrical conductor in a divided state, either as a powder, filings or surface, is put under slight pressure, far less than would cause cohesion, but more than would

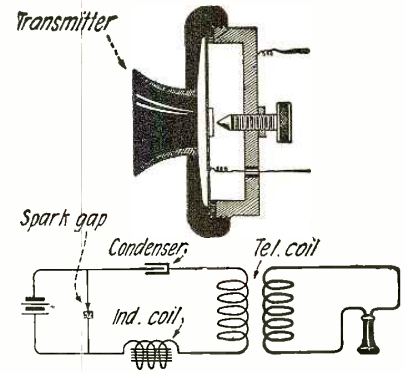

Fig. 12. In This Arrangement Upon Speaking Against the Diaphragm, Variations Are Set Up in the Length of the Gap, Thus Causing Corresponding Surges in the Coupled Circuit.

allow it to be separated by sonorous vibrations, the following state of things occur: The molecules of these surfaces being of a comparatively free state, although electrically joined, do of themselves arrange their form, their number in contact, or their pressure, that they change in resistance to an almost fabulous degree. It is only necessary to observe certain general considerations to produce endless variety, each having a special range of resistances. The tramp of a fly or the cry of an insect requires little range, but great sensitivity, and two surfaces merely superimposed are enough, a range quite unsuitable to reproduce a man's voice."

Hughes then shows a plate of charcoal carbon, glued to a board, the carbon being, about 1/2" square by 1/8" thick, with a similar piece laying on top of it, and a wire leading to each.

"Let the lower piece be called A and the upper B; when we subject the board to sonorous vibrations, we cannot imagine in the charcoal an undulatory movement of one actual wave-length of a sonorous vibration as the value for that is several feet, nor can we imagine a wave of any length, without admitting that the force must be transmitted from molecule to molecule throughout the entire length. How is it that the molecular action of the surfaces of A and B so vary in conductivity or electrical resistance as to throw it into waves of the exact form of the sonorous vibrations? It cannot be because it throws up the upper portions making an intermittent current, because the upper portion is fastened to the lower, and the galvanometer needle does not indicate any interruption of current whatever. It cannot be because the molecules arrange themselves in stratified lines, becoming more or less conductive, as then a surface would not be required, that is, we should not require discontinuity between blocks A and B, nor would the upper surface be thrown up if the pressure be removed as sand is, on a vibrating glass. The throwing up of this upper piece B, when (Continued on page 1866)

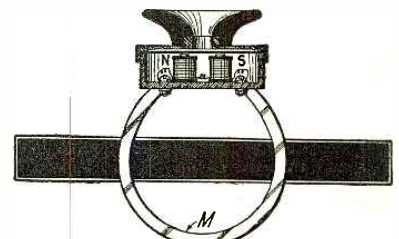

Fig. 11. A Modern Type of Adler's Phone in Which a Permanent Magnet Is Employed for Concentrating a Magnetic Flux Through the Diaphragm.



# The White Radio Bill H. R. 13773

**I**N our September, 1922, issue we printed the complete text of the old White Radio Bill, H. R. 11964 (S. 3694). In that issue (Page 450) we also commented upon this bill and voiced our opinion that it was satisfactory from the amateur's standpoint, and that we had no suggestions to make. It was believed by our legal advisers that there was nothing in this bill that was in any way derogatory to the amateur, or amateur interests, and for that reason no recommendations or amendments were proposed at that time by us.

When, last year, hearings were arranged before the Committee on the Merchant Marine and Fisheries of the House of Representatives, RADIO NEWS had its representatives there, simply as observers, since RADIO NEWS, and the *Radio League of America*, which it represented, had no recommendations to make. We felt that Representative White, of Maine, the author of the bill, had drafted a bill that could not be improved upon, and for that reason we kept aloof.

Not so with other organizations. They flocked to Washington and at once came forward with a number of proposed amendments, which, if they had been secured, would have done the American amateur more harm than good.

The spokesman of the American Radio Relay League, Mr. Hiram Percy Maxim, during this hearing, made some remarkable statements. Here are a few, selected at random:

"Our reason for this is as follows: It would be a simple matter to interpret 'general public service' as excluding the amateur, for the reason that it might be argued that this operation *serves no direct and immediate public service*. Such an interpretation makes it possible to withhold a station license from a worthy amateur applicant or to cancel all amateur station licenses. This is not fair or just to the amateurs of the country, and we hope nothing ulterior is intended in this peculiar wording. We believe we are justified in asking for the protection which our amendment gives."  
(The italics are ours.)

In other words, Mr. Maxim himself believes that the public thinks the amateur "serves no direct and immediate public service."

Along further, Mr. Maxim wanted only amateurs on the advisory committee, and asked that the six members other than Government representatives be selected from the ranks of those who had no commercial affiliations.

The members of Congress who were listening did not seem to take to this idea very much, and it brought forth this retort from Mr. White:

"I took the opposite slant on it because I believe that speaking generally—and I should say there ought to be a representative of the amateurs on such a body—that when you have included the representative of the amateurs on that body, you will get your valuable suggestions as to the development of the radio art from the people who have a real and substantial interest in it."

And then again Mr. White:

"His amendment absolutely excludes from membership on this committee anybody who is connected with any of the great scientific laboratories of the concerns interested in the manufacture of radio apparatus; anybody who is affiliated with an operating company, anybody who is directly or indirectly affiliated with a company which handles or sells radio apparatus of any sort. Now, speaking generally, as I say, outside of the pure amateur and outside possibly of men connected with some of your educational institutions, that is where you have got to go to find the men who know radio and who are interesting themselves in the advancement of the art."

And further on Mr. Chindblom:

"I want to dissent from the view that any representative of the classes just described by Representative White should be excluded from this advisory committee on account of the danger that they might influence the committee. There are already six Government representatives on his committee. If you give them one, two, or three amateurs,

the people who are not interested financially have the clearest majority, and I think the committee ought to be open to such men, for instance, as distinguished engineers or chemists or people of that kind, scientists, experts, or even, if you will permit, an humble lawyer who knows something about the laws relating to radio."

Mr. Maxim (in reply):

"That, again, is something which does not concern the existence of the amateur, which is really the only thing he is vitally interested in."

A little later on, the following remarkable discourse was heard:

Mr. Davis: "Mr. Maxim, what is your definition of a radio amateur?"

Upon which, Mr. Maxim gave the following answer:

"We regard a radio amateur as a person who is interested in the advancement of radio communication without any hope of any financial gain, and who is interested in it from the standpoint of altruism or advancing the art."

After this there was a discussion to put a definition of the amateur into the bill.

Mr. Bankhead: "Do you not think it would solve a good many unfortunate developments that might arise to have a definition in the bill?"

And now comes a classic answer.

Mr. Maxim: "Oh, yes; we would like very much for you to define us so that we may know what we are."

In other words, Mr. Maxim admits that the amateurs do not know what they are!

Let no one think that all of this is said as a personal criticism of Mr. Maxim or the A. R. R. L. Quite the contrary. We hold the very highest regard for this gentleman and for the great work he has done. But it serves as a sidelight on our "Is the Radio Amateur Doomed?" controversy. It again proves what we have maintained right along, that no one in the country knows the status of an amateur, because we have never sold the country on it.

Aside from all this, none of the recom-  
(Continued on page 1869)

## \$100.00 Cover Prize Contest

**W**E beg our readers' indulgence this month, for our mutilated cover. This cover, by the way, to the editor's mind, is the best one, barring none, that we have ever published. However, when our big *Radio Shower Party* came along, something had to give way, because we wanted to invite the whole country to this Party, and in order to do so we had to put the invitation on the front cover, where it belongs, naturally. This meant that the cover for this month had to give way.

For this we again apologize, and to show that we really mean what we say, we are going to give you \$100 in prizes for the slight inconvenience.

As will be seen, the caption reads "A Radio Romeo." Now we know that there are not many such Romeos loose, and that the *Genus* "Radio Romeo" is a rather rare bird. We do not know whether you have ever seen one in captivity, but if you have not, here is a good chance to use your imagination. Cut out a piece of white paper and put

### PRIZES

1st Prize.....	\$50.00
2nd Prize.....	\$20.00
3rd Prize.....	\$15.00
4th Prize.....	\$10.00
5th Prize.....	\$ 5.00

it over the circle on our front cover. Then draw a picture giving your version of the "Radio Romeo."

You appreciate that the radio feature is a very important part, and we leave it to your imagination just how our "Romeo" works it.

Readers who cannot draw are not excluded from this contest. If you can see in your mind's eye what this picture is, give a description of less than

50 words, and this will be considered as a legitimate entry in the contest.

The complete cover, as we originally had intended to use it in our April issue, will be run in our May issue so all of our readers can check up on their attempts to solve the mystery.

#### RULES OF THE CONTEST:

(1) Entries will be accepted either in sketches or in word descriptions. No description may be longer than 50 words.

(2) This contest closes April 10th, 1923, at midnight.

(3) Contestants may send in more than one idea, if they so desire.

(4) In the event that two contestants submit the same prize-winning idea, design, or description, the same prize will be paid to both.

(5) Use only one side of the paper. Typewritten descriptions are preferable, or else they should be written in ink.

(6) Address all contributions to "Editor, Cover Contest," in care of this publication.



# With the Broadcasters

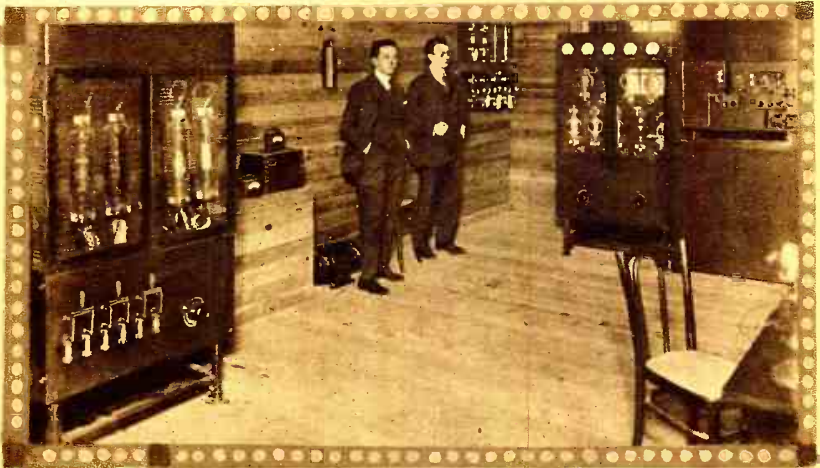
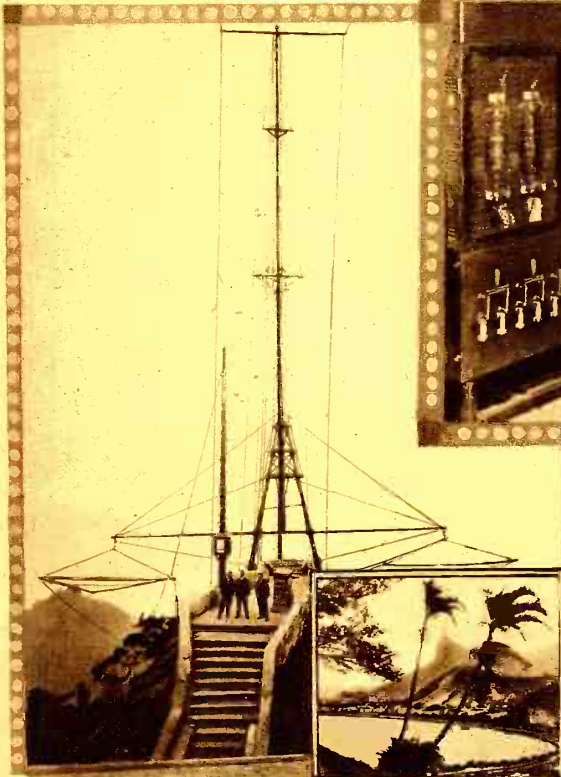

Above and to the left are two views of SPC, the new broadcasting station situated on the peak of Mount Corcovado at Rio de Janeiro, South America. This has the distinction of being the highest broadcasting station in the world, having an altitude of 2,175' above sea level. This station is now operated as a feature of the Brazilian Centennial by the Westinghouse Electric International Company, which broadcasts grand opera direct from Rio de Janeiro.

(c) Kadel & Herbert



Below: View of the transmitting panel of CKAC, Canada's largest broadcasting station and the only one in the world that broadcasts in both French and English. It is operated by the French newspaper "La Presse." Instead of employing the usual motor-generator, the supply is obtained from the city A. C. current mains, being converted to D. C. by means of large rectifying tubes. The controls are such that only one operator is necessary. This station transmits on 430 meters.

(c) Kadel & Herbert



Above: The receiving set at CKAC, which is of English manufacture. A detector and six stages of amplification are employed so that constant reception may be had from European stations. The picture shows Operator R. Duchesne receiving news dispatches from Bordeaux, France, at the "La Presse" headquarters in Montreal.

(c) Kadel & Herbert

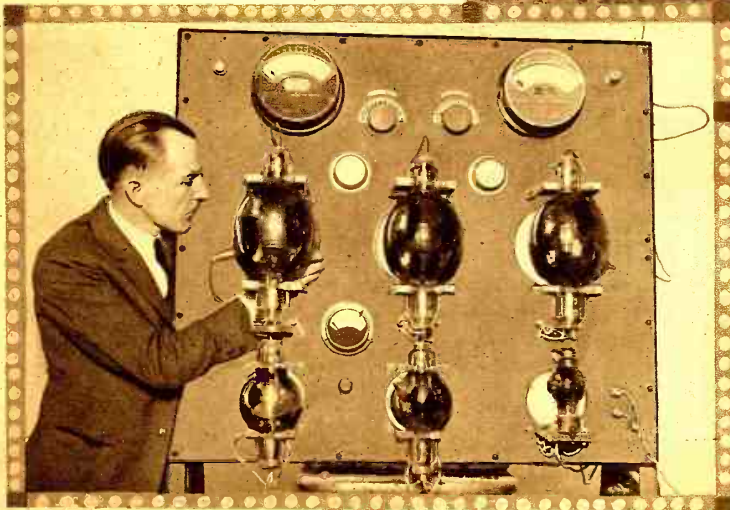



## More New Pacent Radio Essentials

**Pacent Audioformer**

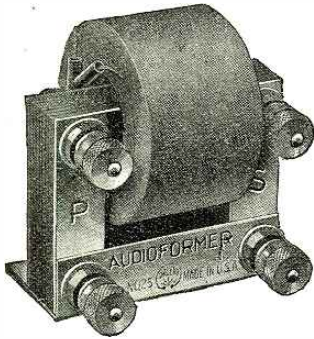

Here is the smallest and most efficient audio-frequency transformer on the market today. It is being manufactured especially for the reception of radio telephone music and speech and is so designed as to give maximum efficiency at all audio-frequencies. The Pacent-made Audioformer will make music worth listening to.

Catalog No. 25  
Pacent Audioformer Price . . \$6.00

**Dubilier Type 600  
Condenser**

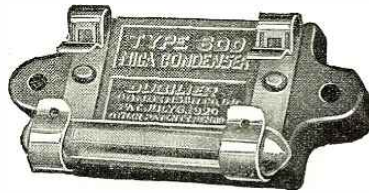

This condenser manufactured by the Dubilier Condenser Company by the superior Dubilier process can be secured for your receiving equipment. The Dubilier Type 600 Condenser has accommodations for a grid leak, yet the condenser costs less than a grid leak or a condenser purchased separately, and is provided with Fahnestock connectors. Use Dubilier Condensers.

Capacities up to 0.005 mfd.  
Price . . . . . \$0.75  
Capacities over 0.005 to .01 mfd.  
Price . . . . . \$1.00

**Pacent Crystal Detector**

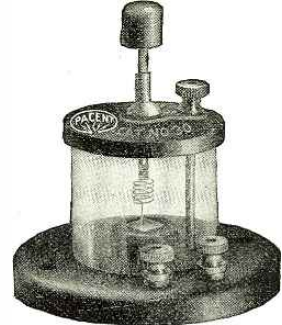

The Pacent Crystal Detector is perfect in construction and reasonable in price. It is dust-proof, rust-proof and fool-proof. Has moulded top and base with glass cover. Crystal instantly accessible. All parts heavily nicked and highly polished. A truly beautiful instrument incorporating every feature a good detector should have. Pacent-made and Pacent-stamped.

Catalog No. 30A Crystal Detector.  
Price without crystal . . . . \$1.50  
Catalog No. 30 Crystal Detector.  
Price with crystal . . . . . \$1.75

### Pacent Electric Company, Incorporated

LOUIS GERARD PACENT, PRESIDENT

150 Nassau Street

New York City



MEMBER OF RADIO SECTION, ASSOCIATED MANUFACTURERS OF ELECTRICAL SUPPLIES



# THE "ALL-AMERICAN"

## RADIO FREQUENCY AMPLIFYING TRANSFORMER

EFFICIENT ON 150---550 METERS

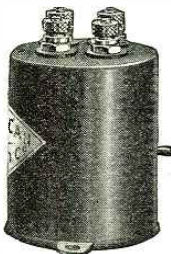

Designed for amateur and commercial broadcasting receiving instruments—sharp enough for the discriminating amateur and absolutely practical for the average layman who finds tuning complicated. Perfect shielding with low distributed capacity and properly impregnated to protect it from atmospheric conditions—giving pure amplification without annoying tube noises and distortion. Static disturbances are eliminated to a great extent. Can be used with Radio-tron—Cunningham—Moorehead A. P. or Meyer tubes. Guaranteed to give satisfaction.

**TYPE R-10 (AT YOUR DEALER) \$4.50**

## AUDIO FREQUENCY TRANSFORMERS

**TYPE R-3 Ratio 10 to 1 Mounted \$4.50**

**TYPE R-2 Ratio 3 to 1 Mounted \$4.25**

THE "ALL-AMERICAN" IS THE ORIGINAL 10 TO 1 TRANSFORMER

They are manufactured strictly on a quality basis and are guaranteed to give satisfactory service. Comparison will show that they are without question the most efficient on the market. The fact that such a large number of manufacturers of AMPLIFYING units use our transformers is proof that they are superior.

We are placing on the market radio and audio frequency amplifiers to fit every receiver. Write for our bulletins describing the new "ALL-AMERICAN" radiophone receiving apparatus.

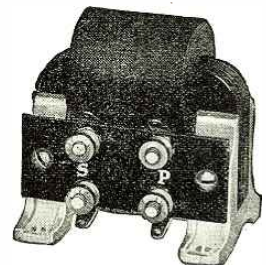

**RAULAND MANUFACTURING CO.,**  
35 S. Dearborn Street CHICAGO, ILL.

Successors to All-American  
Electrical Manufacturers



# Radio In England

By M. B. SLEEPER

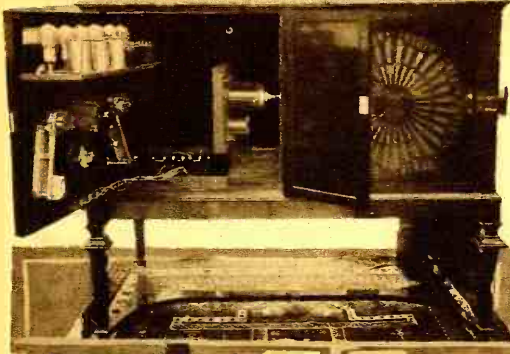

Top Left: A Seven-Tube Receiving Set of English Design. The "B" Battery and Loud Speaker Are Seen in the Interior of the Cabinet. Top Right: An English Set of the Desk Type. When Closed, it Resumes an Upright Position. Left: A Variometer With Windings Similar to Those of the Honeycomb Coil. Variation is Accomplished by a Handle Protruding From the Base of the Instrument.

manufacturers, the trust, or B. B. C., has arranged with the Post Office to limit the number of licenses for experimental receiving sets. Such a license is necessary for any station not using a factory-built set bearing the B. B. C. mark, on which heavy royalties have been paid to Marconi's and the B. B. C. Consequently, the small manufacturer of parts, supplies and separate instruments has had his market taken away, except among the 6,000 experimenters who have the special licenses. If the small concern wants to build complete sets, he must buy a share of the B. B. C. stock for \$4.50, and make a deposit of \$225 as a guarantee of good behavior. Since most of them are running from hand to mouth, they can't raise that

**L**ONDON is a dreadful place for an American at this time of the year. I haven't seen the sun in ten days. Sometimes the fog is down on the ground, thick, wooly stuff that turns my lungs into a water tank. Again, it hangs about two hundred feet up, so saturated with smoke as to make the sky quite as dark as at midnight. Street lights are burning twenty-four hours a day. Moreover, there is no heat anywhere. Hotel rooms are provided with smoky fireplaces in which a coal fire can be had at a shilling a filling. In others, an electric heater can be hired at a shilling for three hours. Over here they call our system "central heating" and exclaim over the stuffiness of our homes and offices, whether they have been in the States or not. By this time I am innoculated against the cold, however. Actually, they grumble more about the fog, cold, crooked streets, scarcity of telephones and innumerable other inconveniences here than I do, although they say nothing about remedying conditions.

As to radio—I don't know where to begin. There isn't any radio business or any broadcasting. The public interest, all aroused last summer, has dropped. Newspapers, then prepared to go in for radio as ours have done, were discouraged by the attitude of the trust. After holding up progress to prepare themselves to take full advantage of the "boom," they have tied radio into such knots that, whatever revival may

take place, radio will never have the send-off that it had in the States. More than a hundred times I have heard this delay attributed to the desire of the British Broadcasting Company, the organization which has arranged with the Post Office to handle all broadcasting, to avoid the "chaos" experienced in America. This idea has been drilled into the public, dealers, manufacturers and engineers by thorough propaganda to the extent that nearly everyone I have talked to discounts by 90 per cent. what I tell them of such work as everyone does at home. Moreover, they all think that Wanamaker advertises bargain sales and cut-priced goods by radio, and that the Detroit News has ruined its circulation by giving away all its news. You can't imagine their conception of affairs in our free-air country.

To make things most difficult for small

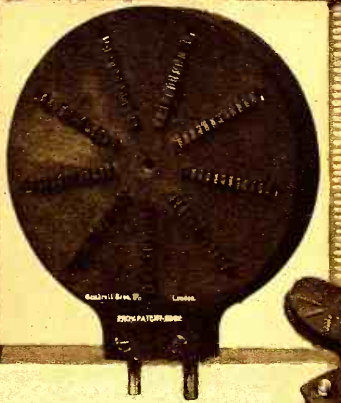

Left: A fixed inductance coil of the multi-layer type with plug attachment. An air space is left between each layer similar to the Morecroft inductance. Below: A small receiving set employing three of these coils.



much money and must quit. In addition to the surplus war material still on hand, quantities of sets, not conforming with the new regulations, and all kinds of separate instruments are being dumped by despairing manufacturers. Conditions in that respect are worse here than they were in the States last fall. As we know the radio industry, it doesn't exist in England. Oh—I forgot to tell you that this British Broadcasting Company, which, with the



consent of the Post Office, is running and ruining everything, doesn't actually exist as a corporate entity. Such as it is, however, it is carrying on in Marconi House.

From our point of view, the retail and distributing situation is in very bad shape.

Two Receiving Outfits of the Unit Panel Type Which May Be Interchanged or Added to From Time to Time.

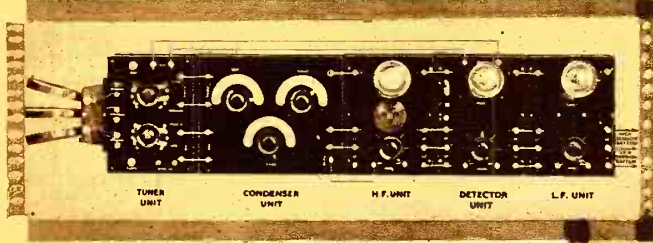

The men who are operating such stores as are selling wireless have no conception of merchandising, service, or methods for popularizing radio with the public. They have tried to organize as a protective measure against the trust, but their association is torn by dissention and lack of mutual confidence. Colonel Malone, a well known public man and a Member of Parliament, has tried to help them, but the personality of the members prevents their growth into a strong body. They are held in contempt by the trust.

When it was announced that member companies of the B. B. C. must open their books at any time for inspection, but would not be allowed to inspect the books of the B. B. C., and other regulations of a similar character were presented, a dealer asked Godfrey Isaacs what Marconi's would do with phones they were bringing from Austria. He replied, "The Marconi Company

Most of the English Receivers Are of the Slanting or Desk Type, Two Being Shown Here. A Very Neat Appearing Table Receiver is Shown Below. The Entire Apparatus is Concealed When the Doors Are Shut.

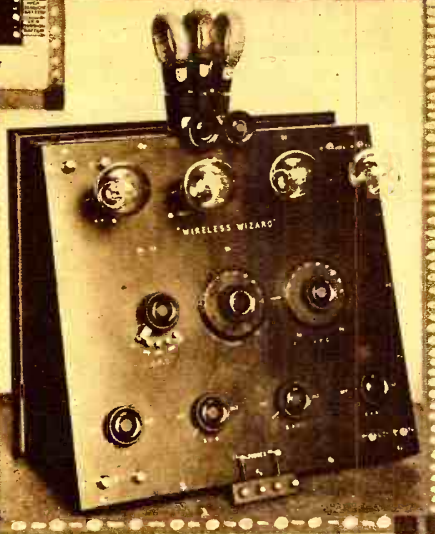

will mind its own business and I advise you to do the same." The dealer promptly resumed his seat. This episode epitomizes the relations between the trust and the small manufacturers and dealers. They have no real radio retail stores as we know them.

The only thing really low in price is the vacuum tube. Marconi valves sell at \$3.94, and they are excellent ones, too. The same type, operating on 60 volts, is used for detecting and amplifying. Since Mullard won the suit brought against them by Marconi, they are selling valves at \$3.38, while Dutch and German types can be bought for \$2.25, or less.

Prices of broadcast receiving sets, bearing the B. B. C. mark, are very high. First off, a license fee of \$3.38 per socket must be paid to Marconi's. It was originally planned that a royalty of 10 per cent. of their sales should be paid by manufacturers to the Broadcasting Company. This arrangement was altered, and a series of fixed charges levied. They are as follows: For a crystal set, \$1.60 each; mechanical amplifier, \$1.60; crystal set with one-valve amplifier, \$5.10; crystal set with two-valve amplifier, \$6.78; one-valve set, \$4.50; two-valve set, \$7.88; three-valve set, \$11.13; four-valve set, \$13.38; telephone receivers, 6 cents per pair; loud speaker, 75 cents. In addition, a royalty of \$3.75 must be paid Marconi's for each valve for which the set is arranged. Thus the total royalties on a receiving set with a detector and two-step amplifier are \$22.38, an amount nearly equal to the manufacturing cost.

The effect is to make simple equipment appear expensive, since the fees are larger in proportion to the value of those sets than the expensive types.

What may happen later cannot be foretold, since these fees may be turned upside down at any moment or given up altogether. Discounts are not established. In some quarters the discount depends upon the ten-

acity with which the buyer holds to his offer. Such schedules as are being maintained only allow 20 to 30 per cent., even in quantities.

Perhaps the most discouraging feature of all is the attitude of those most intimately concerned. They say, "Yes, I suppose things do seem bad, but you know the English always muddle through somehow." I have heard this dozens of times. Well—they are certainly muddling all right now. Later on we shall see how they get through.

We are as far apart as the poles, on apparatus design. The most striking thing about English equipment is the elaborate display of lacquered brass. It is fairly dazzling. This precedent, I suppose, is well established in the minds of the people. For polished brass fairly screams at me all around the country. To judge from the amount of elbow grease I see put upon it every morning as I walk to my office, I am sure that polished brass is as much a part of the Englishman's existence as his whisky and soda. Not only are the parts finished elaborately—although they soon become very dull and shabby when time attacks the lacquer—but the profligate employment of handwork is positively shocking to an American accustomed to judge design details in

(Continued on page 1860)



# Radio Pictorial

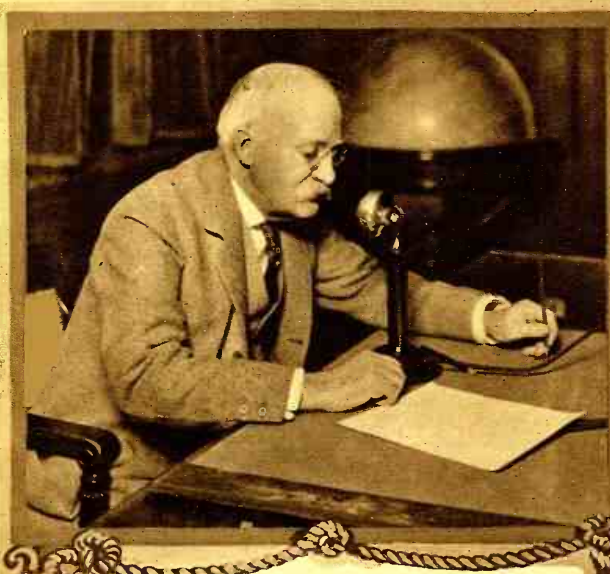

The Photograph Above Shows H. B. Thayer, President of the American Telephone and Telegraph Company Talking to England via the Radio Telephone from His Office in New York City.

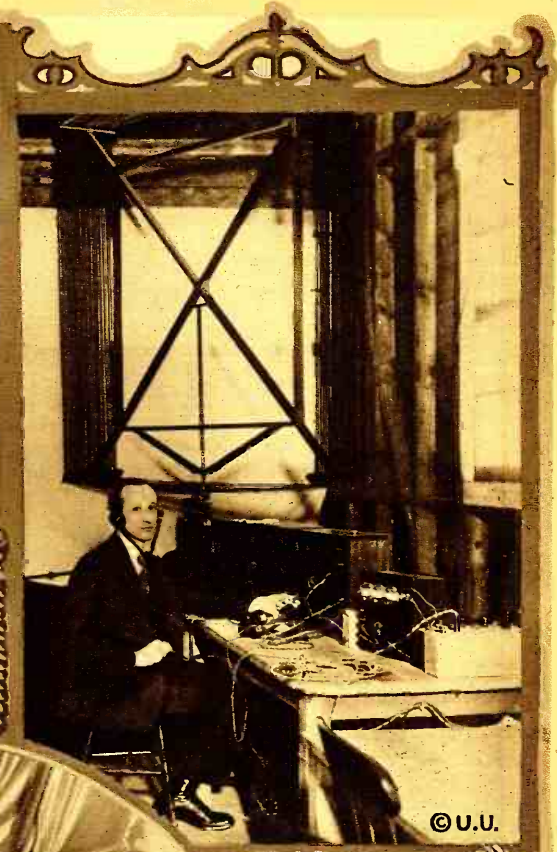

© U. U.

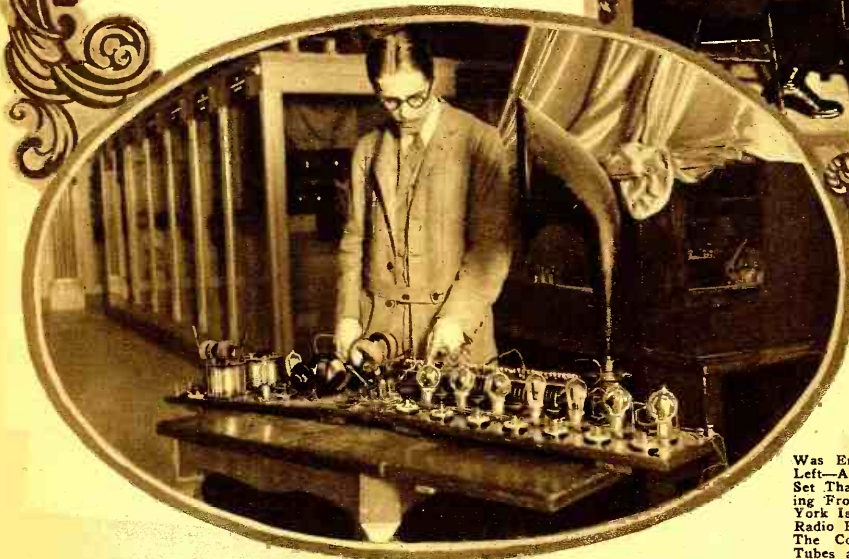

Above — The Western Electric Company's Receiving Station at London, England, Which Picked Up the Voice of H. B. Thayer Who Spoke From His Office in New York City. Note the Large Loop Aerial Which Was Employed During the Tests. Left — A Portable Super-Heterodyne Set That Has Received Broadcasting From San Francisco and New York Is the Latest Feature At the Radio Fair At the Hotel Imperial. The Complete Set Utilizes Nine Tubes and Was Made By W. H. Blucock.

## Radio Golf

OVER 3,576 miles per hour is the distance covered by Radio by Robert H. Anthony, 18 Cleveland Road, Needham, Mass. This speed was maintained December 30 and 31 over a period of six hours and twenty minutes. Among the cities visited (by radio) were San Francisco and Long Beach, Calif., Roswell, N. Mexico, Colorado Springs, Dallas and Fort Worth, Texas, and Havana, Cuba, not to mention such nearby communities as

Milwaukee, Chicago, St. Louis, Atlanta, Birmingham, etc.

The broadcasting of all these cities and many more totalling 45 in all, was received during 14 hours and 20 minutes operating time on the evenings of December 24, 25 and 30, and the early morning of December 31. The total number of miles covered during this time was 39,345, which establishes Mr. Anthony's claim to a Radio Golfist of high rank.

Higher Radio Golf Cards may have been turned in, but it is believed this is a record considering the time of play. "Radio Golf" is a new game invented by Frank Jones of Tuinucu, Cuba. It is a gentleman's game. Everyone keeps his own score. A record is kept of the broadcasting stations heard. A broadcasting station can only be computed once. The mileage between the broadcasting station and the radio

(Continued on page 1860)



# Mr. Brownlee's Loudtalker

By ELLIS PARKER BUTLER

Author "Pigs is Pigs"



If, Now, He Bored Two Holes in the Rear of the Piano and Fastened the Ear Phones There, Why Shouldn't the Piano Wires Absorb the Static and Vibrate To the Sound Waves?

**W**HEN Mr. and Mrs. Brownlee departed from their little home in Westcote, Long Island, to take dinner with the Carbottles in their apartment in New York, Mr. Brownlee said nothing to Mrs. Brownlee, and Mrs. Brownlee said nothing to Mr. Brownlee. This business of going to New York and taking dinner with the Carbottles, and spending the evening there, was supposed to be a pleasure event and Mr. and Mrs. Brownlee should have been eager and happy, but each was so mad that neither dared say a word.

"If I allow myself to say one word—one single word—" thought Mrs. Brownlee. "I'll not be able to stop until I tell Edward Brownlee a few things I think of him, and if I begin I'm in no mood to stop. If I say one word I'm apt to have hysterics and scream and say things I'll regret all my life. I'll keep my mouth shut."

"If I let myself say one word of the way I feel," thought Mr. Brownlee, "I'm liable to rip loose and tell Sophia Brownlee some things that will entitle her to sue for divorce, libel and damages. If I begin I won't be able to stop. I'll keep my mouth shut."

So not a word was said on the way to the station, or on the train, or in the cab. Not a word was said by either until Mrs. Carbottle welcomed them.

"Thank heaven!" thought Mrs. Brownlee. "I'll have one pleasant evening at

least; these Carbottles haven't taken up radio."

"Thank goodness!" thought Mr. Brownlee. "This evening I'll have a good time; Carbottle isn't one of these know-it-all radio men. I can tell him all about radio and he'll listen; it will all be new and wonderful to him. I'll enjoy it and he'll enjoy it."

The trouble between the Brownlees was that Mr. Brownlee was the most enthusiastic sort of radio amateur, while Mrs. Brownlee's main object in life—just as it is with all married ladies in Westcote—was to continue to have a hired girl. All hired girls in Westcote are held by a hair—a very delicate hair—and to keep one is the greatest triumph in female Westcote circles. If Alexander the Great came to Westcote and said "I have conquered the world!" a Westcote lady would look at him in scorn and say, "Poof! That's nothing; I have kept a kitchen maid two months!" and Alexander would wilt like a stale lettuce leaf and sneak away.

Mr. Brownlee was plain mad because his wife was making him leave his home for an evening. A man who is making, and unmaking, and remaking his radio set doesn't want to leave home, and Mr. Brownlee was doing more than this—he was making a loudspeaker. And you know how a man feels about wasting an evening elsewhere when there are still two or three things in

the house he has not yet tried to make a loudspeaker of—the silver turkey platter and the goldfish bowl for example. After a man has used the dishpan and the chopping bowl and the coffee pot it stands to reason he can't be happy until he has tried to see what sort of loudspeaker he can make out of the silver turkey platter and the goldfish bowl. He resents being dragged from home. It is a crime to waste an evening eating dinner and playing cards with friends when he might be profitably at work soldering an ear-phone to the turkey platter or cutting an orifice in the goldfish bowl with the glass cutter that is on the hind leg of the can opener. That was why Mr. Brownlee was mad, and properly so, just as you and I would be. Wives, if I may be permitted to say so, are at times a nuisance. The poor things actually believe there is something as important as radio.

Mrs. Brownlee, on the other hand, was angry because she was sure Marjatta meant to "give notice" in the morning. Marjatta was the maid and, although she was docile and more or less stupid in some ways, she had a vein of deep melancholy (such as some northern races have) and also the northern trait of going blind-mad with rage when things went too wrong. She would begin, for example, by sinking into a dull broken-heartedness, too deep for tears when she

(Continued on page 1854)



# British Radio News



Left: England's oldest "scadog," the Hon. Sir Edmund Robert Fremantle, Rear Admiral of the United Kingdom since 1901, is seen listening to a radiophone concert, broadcast from the Eiffel Tower, in the cabin of his old ship, H. M. S. Impregnable. He has long been noted as a writer of naval matters.  
(c) U. & U.

Below: Constable W. Woodin, of the Metropolitan Police of London, a regular Bobbie, is shown with his wireless set. Most of it he made himself and he is able to listen in to New York in the early morning hours after his tour of duty is finished.  
(c) International Newsreel

Below: Sir Arthur Shirley Benn, President Asst. Board of Commerce; Sir Evelyn Murray, Secretary G. P. O., and Senator Marconi receiving the first radio telephone message sent from New York to London.  
(c) Kadel & Herbert

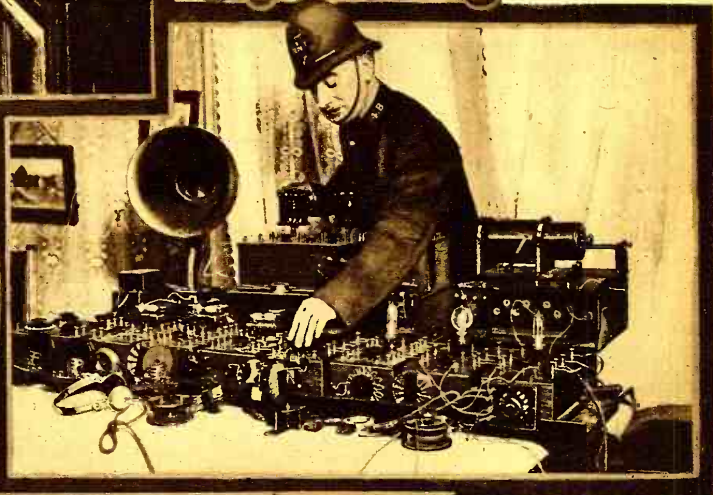

## Some Suggestions for the Broadcasters

ONE of the most perplexing situations which confront the country today, is the deplorable condition which exists, due to interference between the many broadcasting stations throughout the land. Being an operator at one of the above mentioned stations and coming in close contact with this situation, I wish to offer a few suggestions which may help crystalize public sentiment to the point where coöperation will result.

Coöperation is one of the basic laws of nature's forces. There must be forced coöperation between motor and generator, generator and tubes, microphone and amplifiers, modulators and oscillators, talent and microphone, and announcers and operators. In other words all radio communication whether transmitted or received is one vast example of coöperation. But why hasn't coöperation been extended between the broadcasting stations of the country? Simply because broadcasting is a different mode of transmission than any other employed in the radio world. It is the one way transmission only and the broadcasting stations haven't as yet realized the value of coöperation to give the public who listen in, the benefit of the true efficiency which these stations are capable of producing.



Coöperation, therefore, is the keynote of the whole situation and also is the main remedy. I am of the opinion that if all broadcasting stations operating throughout the United States would coöperate with one another and also with the Department of Commerce, the present interference would be transformed into an orderly succession of concerts starting in Maine at 7:00 P. M.,

E. S. T., and continuing straight across the continent until 10:00 P. M., P. S. T.

How is this to be accomplished? I will endeavor to lay my plan in the form of a chart, which in part will be self explanatory.

### EASTERN ZONE

Eastern St'd Time

Mon. 7-9	Tues. 7-9	Wed. 7-10	Thurs. 7-9	Fri. 7-9	Sat. 7-9	Sun. 7-9
----------	-----------	-----------	------------	----------	----------	----------

### CENTRAL ZONE

8-10	8-10	8-10	8-10	8-10	8-10	8-10
------	------	------	------	------	------	------

MOUNTAIN AND WESTERN ZONE  
Pacific St'd Time; Mountain St'd Time

9-11	9-11	8-12	8-11	9-11	9-11	9-11
------	------	------	------	------	------	------

(Continued on page 1873)



# C. W.

By WILLIAM A. GRIFFITH JR.

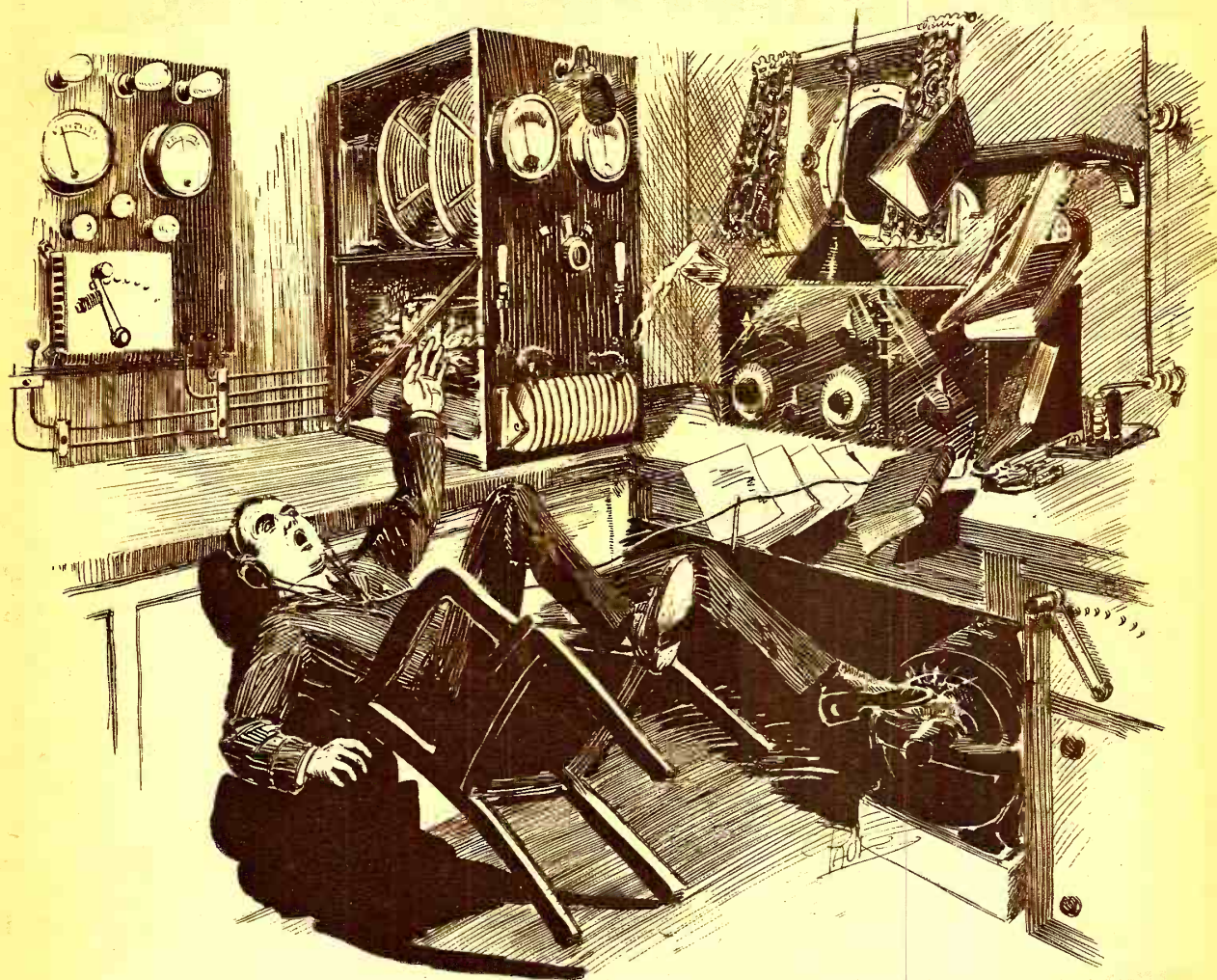

Catapulted, as it were, over the back of the Chair, he landed with his left leg across the brushes of the alternator. His flying arm came up abruptly against the condenser rack. A blinding flash and Perry lay inert, burned, bruised and silent.

**T**HE music had been so fascinatingly "jazzy," and the girl so entertaining, and magnetic, that Perry, glancing at his watch, discovered he had danced away the entire last five hours of his eight hours of relief from duty. Now after the entrancing strains of "Tomorrow" had ended and Miss Merton had been shown safely to her stateroom, he dragged himself wearily to the radio room of the *Palisades*. Henry Gray, second operator, glad to be relieved, laid down his phones, and turned to go. With one hand on the door-knob he called Perry's attention to a note on the table. "The 'Old Man' just phoned down for compass bearing, so you had better give Cape May a call the first thing. I failed to rouse them a couple of minutes ago." With a "good-night" Gray was gone. Perry thought of the eight long hours of watch ahead as he reached sleepily over and threw in the D. C. switch. Pushing the automatic starter button, and sending a few preliminary EV's, he called Cape May at three intervals before he received an answer. After receiving their GA, he began the

monotonous MO MO MO MO. His thoughts wandered; he'd have a little phone music after his task was complete, glad he'd struck a ship to work on equipped with a tube set. "Wonder what old WSB was filling the ether with on tonight's 'All-night ship at sea' program?" Finishing his MO's Perry reached for the cutout switch; as his hand was still hunting for it he was thrown violently backward. Catapulted, as it were, over the back of the chair, he landed with his left leg across the brushes of the alternator. His flying left arm came up abruptly against the condenser-rack. A blinding crash, and Perry lay inert, burnt, bruised and silent. A section of books over the table had been jarred off the shelf; they had landed on the key just as Perry had shorted the high voltage condenser circuit, and the low voltage alternator. His body had taken the full charge, and now lay on the floor in front of the 2-KW panel. The generator hummed merrily on and the books still lay on the key, but the gap was silent, the condensers blown.

Almost immediately the speaking tube,

began to whistle shrilly, followed by a deep voice roaring through it, "Radio room, Sparks! Hey you, down there, wake up!" But Perry lay unconscious. A moment later the door burst open and the "Old Man" himself rushed in. He stopped short as he saw Perry sprawled on the floor. A mate following him in, dropped to his knees and felt Perry's wrist. "He still lives, sir," the mate replied to the captain's inquiring look. The captain spoke then for the first time since entering the room, "Get the other operator, Gray, at once, and then send the surgeon to look after this lad." The mate rushed off, the captain pulled a piece of paper from the rack, and wrote vigorously.

When Gray rushed in a second later the room was again empty, save for Perry still lying limp on the floor. Gray gave him no heed but went immediately to the table, and shoving the books from the key, picked up the captain's note. It read: "Call for help at once. We rammed a derelict and are dangerously crippled. In all probability will sink. Do not leave the radio room until I release you. Capt. O. S. B."

(Continued on page 1862)





**T**HIS Department is open to all readers. It matters not whether subscribers or not. All photos are judged for best arrangement and efficiency of the apparatus, neatness of connections and general appearance. In order to increase the interest in this department, we prefer to publish photographs of stations accompanied by a picture of the owner.

We prefer dark photos to light ones. The prize winning pictures must be on prints not smaller than 5 x 7". We cannot reproduce pictures smaller than 3 1/2 x 3 1/2". All pictures must bear name and address written in ink on the back. A letter of not less than 100 words giving full description of the station, aerial equipment, etc., must accompany the pictures.

**PRIZES:** One first monthly prize of \$5.00. All other pictures will be paid for at the rate of \$2.00 each.

## Lyndon Farwell's Station, Radio 60W

This Month's Prize Winner

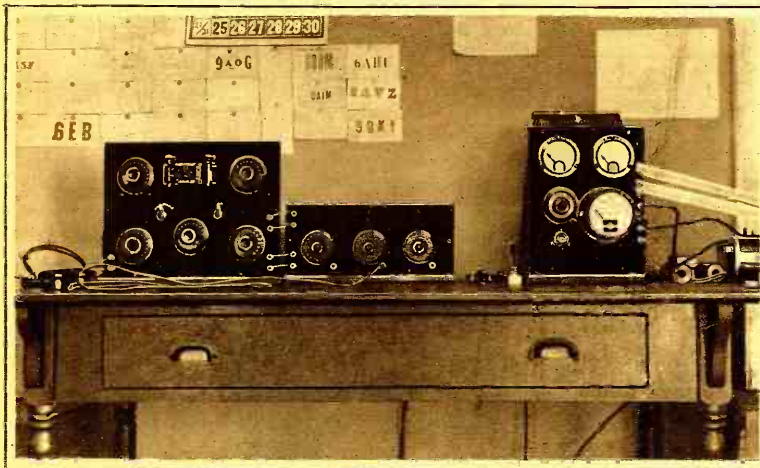

This Station is Neat in Appearance Due Particularly to the Absence of Unsightly Wiring. The Short- and Long-Wave Receiver is on the Extreme Left Followed by the Detector-Amplifier Unit. The 15-watt C.W. Transmitter on the Right Radiates 3 1/2 Amperes on 200 Meters.

**H**EREWITH is a photo of my station 60W. The antenna system is composed of a 4-wire cage inverted L 60 feet high on the free end, 50 feet on the other end and 80 feet long. The counterpoise is rectangular and contains over a thousand feet of wire. A single wire antenna at right angles to the transmitting one is used for reception, thus eliminating a change-over switch.

On the left is the 15-watt C. W. transmitter. It is very compact, uses the Hartley circuit with 1100 volts A. C. on the plates supplied by an R. C. A. transformer. The set is wired with copper strip. The radiation on 200 meters is 3 1/2 thermo-couple amperes. This set has been in operation for three months, the farthest transmission being 2CAD. A 1 K. W. spark set with a radiation of eight amperes was in operation, but has been sold.

The receiver is a long and short wave set with two steps of A. F. amplification with Baldwin phones.

For short waves a variometer set is used and honeycomb coils for long waves. All the districts have been copied and many eastern broadcasters.

LYNDON FARWELL,  
Los Gatos, Calif.

## Mr. H. E. Cerny's Station

**E**NCLOSED is a photo of radio station 9BXJ.

The aerial used here for both transmitting and receiving is a six-wire cage, 50' high at the free end and 40' at the other end, with a cage lead-in. The wires in the aerial are equally spaced on 28" bicycle rims and those in the lead-in on 12" hoops. A fan counterpoise consisting of six wires 12' high is used in connection with the aerial.

The cabinet on the left contains the entire receiving set. This is of the widely used variometer and variocoupler type. The tuner, together with the tube control, is assembled in one cabinet, making a very compact receiver. Murdock No. 56 phones are used with this set and all districts have been copied, as also the greater part of the broadcasting stations.

The transmitter at the right is a 5-watt C. W. and phone set. The power is obtained from an Acme 75-watt power transformer which furnishes 375 volts for the plate and 10 for the filament. The plate supply is rectified by a chemical rectifier consisting of 10 jelly glasses in which pure lead and aluminum plates are immersed in a solution of borax and distilled water. The filter, though not very elaborate, has given splendid results. It is made up of a 1-M.F.

condenser and a 90-turn R. F. choke. This transmitter uses the 1DH "sure-fire" circuit, which for simple tuning and high radiation is the ideal circuit. The main inductance consists of 32 turns of No. 9

wire on a 6" frame, spaced 1/8" apart, about 50' of wire being used. The grid coil is wound with 27 turns of "bell wire" on a 4" tube tapped every two turns after 13 turns have been wound on. The coupling

This Transmitter is of the 5-Watt Type Employing Mr. Whittier's "Sure-Fire" Circuit. Despite the Low Power, 9BXJ Reaches Out.

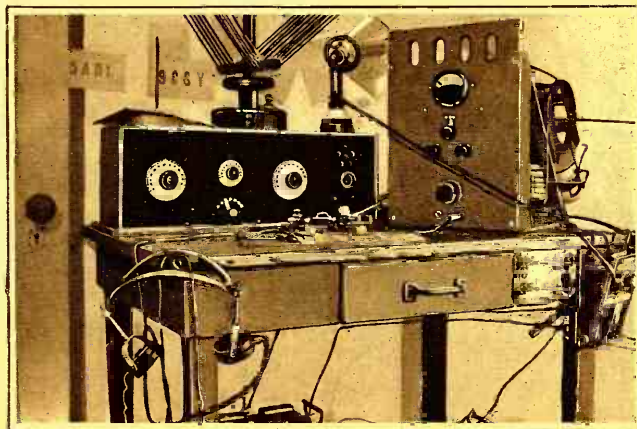



is made variable by sliding it on two rods inside of the main inductance. This is made handy by a rod with an insulating knob attached, which is also fastened to the tap switch so that both adjustments can be made without putting the hand in among live wires. The grid condenser used is made up of four pieces of tin  $2\frac{1}{2}$ " by  $2\frac{1}{2}$ ", separated by old photo plates cut 3" by 3". This condenser gives good results when used with an R. C. A. grid leak. A 5-watt Radiotron, socket, rheostat, and an H. W. ammeter completes the apparatus with the exception of two jacks and one plug which are used to change from C. W. to phone and vice versa. When constructing this set provisions were made for larger power which explains the four peep-holes. This set delivers from .5 to .8 on C. W. and from .2 to .5 on voice into the aerial system. Up to date, a total of 40 cards has been received reporting my signals QSA. Among these are cards from 6PL, 6BOA, 6XAS, 5OK, 5ADL, 5MY, 8IJ, 8CDZ, and Canadian 3OH, the farthest distance being 1,800 miles to 6XAS, who received me QSA on detector alone. On phone, the range seems to be about 50 miles. The modulation has been reported O. K. with very little A. C. hum. All this work has been done in less than two months of continuous operation.

I would appreciate a card from anyone hearing my signals.

9BXJ is QRV for QSR.

H. E. CERNY,  
Belle Plaine, Ia.

### 3UN

The call 3UN has been issued to Mr. Wesley Wilson, 2233 Sherwood Avenue, Baltimore, Maryland.

The C.W. set will be composed of five 5 watt tubes with a chopper for I.C.W.

Would appreciate word from anyone hearing my signals.

## About Condenser Aerials

### By MOHAMMED ULYSSES SOCRATES FIPS

#### Head Office Boy

Editor, RADIO NEWS:

In your last issue you printed an article entitled: "Experiments with the Two Plate Condenser Antenna."

This writer bird claims to have discovered something entirely new in radio. Permit me to point out to him that he has another guess coming. Condenser aerials are nothing new. As a matter of fact, I played with them many years ago. If you wish to have historic, as well as printed proof, turn to page 158 of the May, 1912, issue of MODERN ELECTRICS. From this you will see that I have gone Mr. Warner a few better, and what is more, the device works!

If you have a vacuum tube set, you need use a loop no longer, as this device will positively work. Not only have I shown here a condenser aerial, but a variable condenser all rolled into one. I reproduce the drawing herewith, as well as the description. I should like to hear from my many admirers how the device works with them

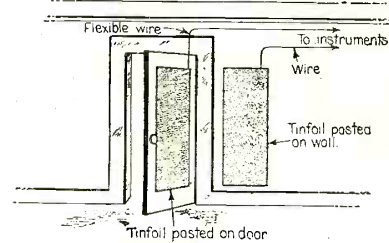

Of course if anyone should move the door you lose your station—and temper.

after a lapse of some eleven years. Here's the historic article.

"You will agree with me that the following design is the simplest and most ingenious one that you have ever seen. Its capacity is enormous and the cost practically nothing. This condenser can be constructed by anyone in less than half an hour.

"On the inward side of the door paste sheets of tinfoil, as shown in illustration. At the upper corner near the upper hinge, tack or screw a piece of brass on top of the tinfoil and to this brass piece attach a piece of flexible cord, as shown. This flexible cord is necessary to make connection with the tinfoil and does not interfere when opening and closing the door.

"Now open the door till it touches the wall of the room. Mark off the corners of the door on the wall and paste sheets of tinfoil on the wall as illustrated. The total surface of these tinfoil sheets should not be larger than that of those pasted on the door. A wire is attached to the tinfoil on the wall in a similar manner as described above. The two wires are now led to the instruments.

"When the door is closed the capacity of this condenser is zero. At an angle of 90° the capacity is still zero (0 per cent). As the door is opened further the capacity gradually increases. The maximum capacity is reached when the door knob touches the tinfoil on the wall.

"I equipped all the doors in our house with these condensers, and besides being quite ornamental, they add considerably to my wireless outfit."

P. S.—I think I am pretty clever, you will admit.

## Super-Experience

### By MARIUS LOGAN

UP to a few moons ago we tightened the tickler coupling and fed the juice back to the grid for a re-supply of vitamins. If we shoved the old coil too far the juice fermented and the jazz got groggy.

One night our old friend Armstrong took a look at the sensitizing circuit and commenced to show signs of extreme agitation. Three nights later a radio store was minus a 1250 and a 1500 honeycomb coil. So much for the history of things.

Personally we weren't stuck on this new do-dinkus, but we were inquisitive enough to try and find out what lay beyond the 60° coupling on our tickler, so we decided to give it a trial. After much argument, the one-tube type was chosen. Since only one tube was available, the argument was unnecessary, but we are men of theory and very seldom delve into the practical side of radio. To be truthful, excellent results have been obtained in our "laboratory" without a single piece of apparatus—aside from two "mouth pieces."

Well, to resume, with one tube, eight condensers, two pairs of phones, a variocoupler, an inductance wound on a whiskey bottle, 110 volts D.C. for the "B" and a pound of bell wire, we made a beautiful puzzle worthy of Einstein's mentality. Each using two hands and a foot, we proceeded to tune. Changes of inductance and capacity at one end of the table were relayed to the other end by wireless, where corresponding changes manifested themselves.

The results were tremendous—the silence appalling. After five hours of tinkering we discovered that our oscillatory circuit was

shorted. The short was discontinued. Lord, what a mistake! The variation frequency made itself evident somewhere between four and five thousand. Many handshakes. Seven hours later the four to five thousand started to take effect. The mental complex was ghastly. Squealing, squealing everywhere, but not a single sig.

The family had already left. We were going fast. We shut the hellish thing off. The variation frequency continued; life seemed hopeless. Bloomingdales loomed through the horror until I—I had the brains to start reading Coue's auto-suggestion. I formed a philosophy. The now tottering brain of my compatriot was saved by my repeating—second by second in every way the variation frequency is getting lesser and lesser. Lo! It disappeared.

Five coffees and a cheese sandwich later we regained our nerve. The "super" was duly started percing again. This time we raised the variation frequency to "about that."

After many struggles and knob turnings something commenced to buzz, howl and squeal. "What do you suppose that is?" said my compatriot. "I'll bite," said I. "What is it?" Well, you'd be surprised. It was station XYZ as sure as blazes. The Hicktown Symphony Orchestra was playing "Carry Me Back to Old Virginney," accompanied by the carrier wave. Sacre blue, it worked.

After the first "howling" success the process of elimination took place. Slowly but surely condensers evaporated, and incidentally the necessity of using our feet.

With each piece of apparatus discarded the results were better, which goes to prove that simplicity is the keynote of efficiency—even with the "super."

When the aerial and ground were done away with, it was feared that we might end up with a "super" consisting of nothing but two crossed wires, obtaining the super-effect of course from the thermal action.

The super as is and as was are two different animals. With but two condensers, a variometer and the soup coils, the old broadcasters came in like a ton of C. W. transformers. With expressions of contentment we sit two rooms up from the "lab" and listen to the latest dope on how to grow a golf links or some other appropriate subject. Heaven may be found down on 200. As Lincoln said, "Don't it beat hell!"

### MORE FROM ENGLAND

I hope you will consider it of sufficient interest to your readers to publish the following results obtained during five nights only. The stations heard were received with only two valves (detector and low frequency) except for the last night when a stage of high frequency was also used. I listened on the last night of the tests, when eight were received. The other calls were received while the American stations were doing their ordinary transmission.

I hope that the operators of the stations mentioned will drop me a line saying where their stations are located and their aerial

(Continued on page 1906)

# Notes On the WD-11 Tube

**T**RUE to our promise in the last issue, and upon request, we are beginning a series of articles on the layout of apparatus and circuits of various types of receiving sets to be used with the WD-11 tube. It is to be understood, though, that the circuits published are adaptable as well to other tubes such as the UV-200, C-300, etc.

It is because of the WD-11's popularity that we shall make special mention in these articles of the smaller details covering its use as a detector and amplifier. Probably the most popular set at the present time is the three-circuit regenerative receiver

having identical numbers in both Figs. 1 and 2. They are as follows: 1, ground; 2, units inductance switch; 3, tens inductance switch; 4, aerial; 5, variocoupler; 6, grid variometer; 7, .00025 M.F. grid condenser; 8, grid; 9, filament; 10, plate; 11, plate variometer; 12, headphones; 13, 22½-volt "B" battery; 14, .002 M.F. fixed phone condenser; 15, filament rheostat; 16, 1½-volt dry cell; 17, 2-megohm grid leak.

After the set has been tested out, it can, if desired, be mounted in a cabinet. The design of the panel and the cabinet will be left out, since there is no specific standard and it is more a matter of the builder's

Placing the grid and plate variometers at zero setting and the rotor of the variocoupler parallel to the stationary coil, tune the primary of the circuit by means of the two switches until a station has been picked up. The grid variometer is now increased to the point where signals are loudest. The secondary or grid circuit is now in tune to the station being received. The plate variometer is now varied and the signals will again become louder, due to regeneration. A point will be reached where oscillations begin and the signals become distorted; this "spilling over" into oscillation is accompanied by a click or plucking noise

Fig. 1. Showing the Standard Layout for a Set Employing Two Variometers and a Variocoupler. The Wiring is Clearly Shown So That None Should Find Difficulty in Connecting Up a Similar Outfit. Each Numbered Instrument is Mentioned in This Article.

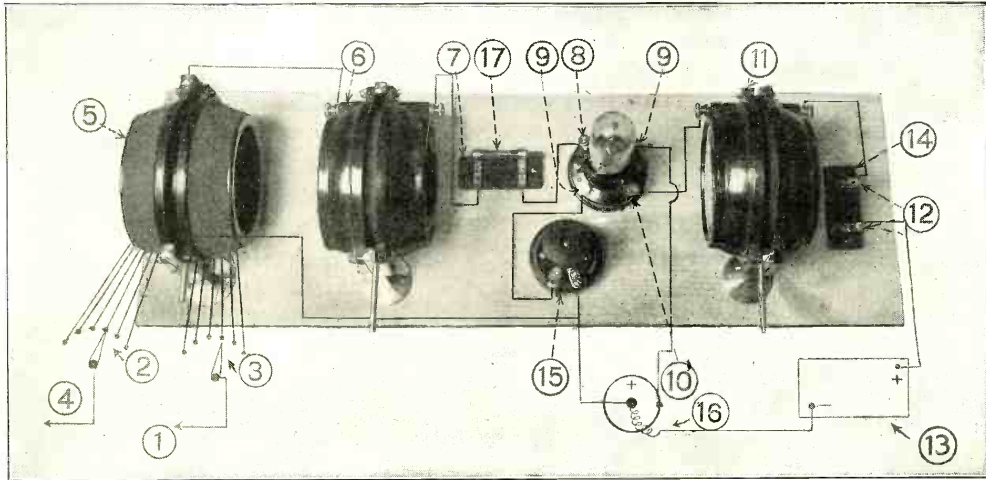

employing two variometers and a variocoupler for tuning and regeneration. This type of outfit is superseding the former single circuit receivers which sadly lack selectivity. To the beginner, the operation of the three-circuit receiver is rather ticklish. However, with patience and practice, the matter of its operation becomes easy and the results will be more than enough to repay for the work put into it. We are suggesting this type as ideal for the novice who desires to build his own. An important factor in the building of a vacuum tube receiver is the layout. It is good policy when starting to mount all apparatus on a board, wire it temporarily and test it out: If it does not live up to your expectations, it is a simple matter to rearrange the apparatus and change the connections. Fig. 1 shows the standard layout for the three-circuit regenerative receiver. The wiring can easily be followed, but for additional reference, the complete circuit diagram is shown in Fig. 2. The various instruments

preference. As to the operation of this set, after connecting the aerial, ground, "A" battery, "B" battery and phones to their proper terminals as marked in Figs. 1 and 2, the set is ready for operation. Turn on the filament rheostat and increase it to a point where the filament burns a dull, cherry red.

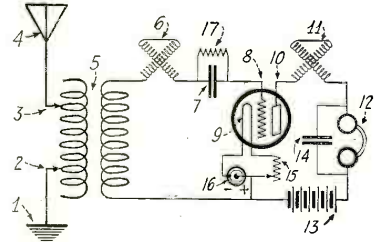

Fig. 2. The Circuit Hook-up of the Above Receiver. The Numbers Here Correspond to Those on the Photograph.

in the phones. The desired position for reception is just below this point. In order to simplify the operation of tuning, it is advantageous to vary the grid and plate variometers at the same time. It will be noted that for perfect balance of the two circuits, the position of both variometers will be practically the same. If interference is encountered, the coupling of the variocoupler should be loosened, in other words, the rotor should be moved until the angle between it and the stationary coil is noticeably increased. The eventual position can only be determined by trial. After the primary and secondary circuits have been adjusted to a definite wave, most of the tuning can be accomplished with the plate and grid variometers. Remember, tune with the grid variometer and follow up with the plate variometer. After the operator has become acquainted with the characteristics of his set, perfect control will be a simple matter.

## Calls Heard

Space is set aside each month for the listing of amateur radiophone calls heard. We invite you to send us a list of the stations you heard, typewritten if possible, or at least sufficiently readable to prevent mistakes. Print the calls on a separate sheet of paper, using but one side. These should be arranged alphabetically for each district. To distinguish the stations that have been worked, they should be put in parenthesis, and, according to the rules now in use, the C. W. stations should be mentioned in a separate list; both spark and C. W. lists covering the period from the first of each month to the first of the following. The lists should reach us by the tenth of the month for publication in the following issue.

**RADIO 7MF. EUGENE, OREGON**  
(C.W.) 1BC, 1HX, 1CIK, 1BCF, 2FP, 2OM, 2XB, 3ZO, 3ZS, 3FS, 3BNU, 4BQ, 4BX, 4EB,

4EH, 4GL, 4FR, 5AN, 5EK, 5EC, 5FT, 5HH, 5IH, 5MC, 5MY, 5NN, 5OT, 5RH, 5TJ, 5TM, 5TY, 5UN, 5UK, 5UI, 5VM, 5ZA, 5ACF, 5ZAP, (6AK), (6AX), (6BM), (6CC), 6CZ, (6EA), 6EB, (6FH), (6GR), 6GF, 6KA, (6LV), (6OO), 6PJ, (6RM), (6TI), 6XK, (6ZX), 6ZZ, 6ZO, 6ZI, 6ZQ, (6ZS), 6ZAF, (6ZAC), (6AAT), 6AAK, (Phone) (6ABX), (6ZH), 6AKI, (6AWT), 6AWP, (6BQC), (6BOG), (6BJC), 6BCJ, 6BRU, 7AD, (7B), 7BS, (7DP), (7DC), (7DU), (7EQ), (7FD), (7FH), (7GE), (7HI), (7HM), (7IG), (7KE), (7KF), (7MH), (7NN), (7OO), (7OM), (7PE), (7QT), 7SF, 7TT, (7TH), (7TO), (7UU), (7VX), 7XC, 7ZK, 7ZV, 7ZU, 7ZO, 7ZS, 7YJ, 8BK, 8BO, 8AB, 8MZ, 8OW, 8ZY, 8ZZ, 8AQO, 8BPM, 8BRY, 8BZY, 8AAF, 8BWH, 8XV, 9II, 9UU, 9ASN, 9ZN, 9EI, 9FS, 9AIY, (9BH), 9APS, 9DKY, (9AMD), 9ZY, 9BBF, 9BRI, 9BFG, 9ARZ, 9BXQ.

### 9APK (SPARK)

All spark: (1BOQ), 1CNI, (2FP), (2OM), 3AHR, 3HJ, (4FB), 5AQ, 5DK, 5JF, (5JD), 5KC, 5RZ, 5TO, 5UD, 5ZR, 6AQV, 7HN, 7HW, (8AEO), 8AIB, 8AII, (8AIT), (8AKQ), (8AUV), (8AXN), (8BDA), 8BKR, 8BPG, (8BXC), 8CKV, 8CNR, 8CNI, (8CTD), (8CXI), (8EB), 8IL, (8IQ), 8ZE, 8ZH, 9ACB, 9ACW, 9AFL, 9AHO, (9AJE), (9AMK), 9ASG, 9ASK, 9AVP, (9AUV), (9AOI), 9AYW, (9AZF), 9BCJ, 9BLU, (9BMN), 9BCC, 9BOF, (9BOO), (9BPV), 9BUE, (9BXC), 9BXR, 9CTW, (9CUP), 9EDD, 9EFA, 9EFC, (9JN), 9JV, (9OF), 9PN, 9RR, 9ZC, (9DAG), (9DAY), 9DCW, (9DGV), 9DHG, (9DHz), 9DJB, (9DNC), 9DTN, 9DWB, (9DXK), 9DXV, (9DZU), (9DZY), (9TV), 9VN, (9VZ). Canadian 3DS. Glad to QSL all cards.



# High Frequency Resistance and Its Measurement By Means of the C. W. Oscillator

By L. R. FELDER

**T**HE measurement of inductance and capacity with the aid of the C. W. oscillator described in the January and February issues of RADIO NEWS is a relatively simple matter as compared to the measurement of resistance. This is because inductance and capacity, though they vary somewhat with frequency, may be considered as having practically constant value over the range of radio frequencies. Resistance, on the other hand, varies considerably with the frequency. Thus, a certain coil which measured 3 ohms resistance at 600 meters was found

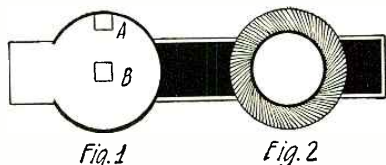

Fig. 1. A Flow of Direct Current is Uniformly Distributed Over the Entire Cross-Section of a Wire. Fig. 2. An Alternating Current Flows Only Through the Outer Surface of a Wire.

to have a resistance of 7.3 ohms at 200 meters. Furthermore, the effective resistance of a coil depends upon a variety of factors, such as distributed capacity of the coil, proximity of other coils and circuits, manner in which the coil is wound, etc. As a result, it is apparent that resistance and its measurement are worthy of special study.

The first important point to be made in this connection is the distinction between the resistance of wire for direct current and for alternating current. Experiment and theory show that the resistance of any given wire is less for direct current than for alternating current of high frequency, and that this resistance for alternating current increases as the frequency increases. This increase of the resistance with increase of frequency of the current is due to a phenomenon called "skin effect." The reason for this increase in resistance with frequency will at the same time make clear the reason for this peculiar name "skin effect." For the benefit of the novices and new amateurs it should be noted that the larger the cross-section of the wire through which the current flows the less will the resistance of the wire be, and vice versa. With this important principle in mind, the explanation of "skin effect" is as follows: A direct current always flows in one and the same direction. This is why it is called a direct current. Since it does not change its direction of flow, the current has sufficient time and chance to diffuse and distribute itself uniformly over the entire cross section of wire. In other words (see Fig. 1), as much current flows through unit area of the wire at point A as at point B. Thus the entire cross section of the wire is used to conduct the current uniformly, the wire is therefore used most efficiently and its resistance at direct currents is a minimum. Suppose, then, that the current could only flow through a part of the cross section of the wire, say, for example, it could only flow through the outer portion of the cross section of the wire, the shaded ring in Fig. 2. Then, obviously, only a part of the cross section of the wire would be conducting the current, and, according to the principle emphasized above in this paragraph, the resistance of the wire would be greater for this current which traversed only a part of the cross section of the wire. This is what happens when

alternating current of high frequency flows through a wire.

Alternating currents change their direction of flow through a wire; they are therefore called alternating currents. For a certain length of time—depending upon the frequency of the current—the alternating current flows in one direction through the wire. Then it reverses its direction and flows in the opposite direction through the wire, and so on. The current only flows in one direction a very short period before it reverses its direction. As a result the current is not given very much time to penetrate from the outside of the wire to the center, and, therefore, does not have the chance of diffusing and distributing itself uniformly over the entire cross section of the wire. Thus by the time the current has penetrated to the bottom of the shaded ring in Fig. 2, it may reverse its direction and must begin again to bore its way in towards the center of the wire. Of course, the current distributes itself very rapidly, but it should be kept in mind that when we are dealing with radio frequencies we are dealing with frequencies of the order of 500,000 times per second, hence it can be seen that the alternations are so rapid that the current has a chance to flow only on the outside of the wire. Thus, for alternating currents, since only a portion of the conducting wire is used, that is, the effective cross section is smaller, the resistance of the wire must be greater.

If the above explanation is the case, it stands to reason that the greater the frequency of the current, that is, the more rapidly it changes its direction of flow, the less chance it has to penetrate to the center of the wire. Thus for very high frequencies, like radio frequencies, the current only has an opportunity to flow through the top layer of the wire, just through a skin on the wire, as it were. At these frequencies, then, the cross section of the wire utilized by the current is extremely small, hence its resistance must be very high, and increases with the frequency of the current. Since the current at radio frequencies only flows through a skin on the wire this phenomenon is called the "skin effect." This will make clear why direct current resistance is always much less than radio frequency resistance, and because of this "skin effect" at radio frequencies it will be clear why it is so important to keep down the values of the coil resistances in sets. We see now why such a statement as "The coil in my set has a resistance of 5 ohms" has no meaning at all, and may in fact be misleading. For the coil may well have a resistance of 5 ohms at direct current, while at the wavelength it is used, say 360 meters, its resistance may be as high as 10 ohms. Whenever one gives the resistance of an inductance coil, or any other item, for that matter,

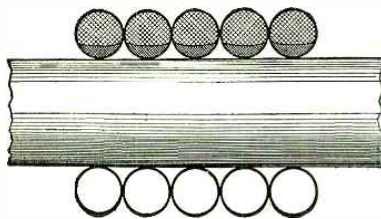
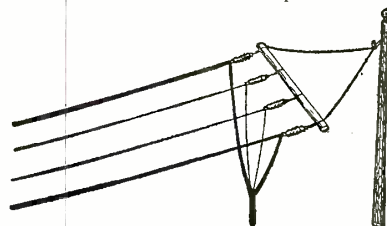

Fig. 3

The Current Density in a Coil of Wire is Greatest on the Inside as Shown by the Shaded Portions.

one should always specify at what wavelength it has this resistance.

The great importance attaching to this "skin effect" in high frequency work may, perhaps, be more evident when we consider that it manifests itself not only in ordinary conductors carrying current, but also in coils and antennae. For example, when a straight conductor is wound in the form of a cylindrical coil as in Fig. 3, there will result a redistribution of current throughout the cross section of the wire composing the coil. Both theory and experiment show that this redistribution takes place in the



Showing the Distribution of R. F. Current in a Four Wire Flat Top Inverted "L" Antenna.

manner shown in Fig. 3, namely, the current density is heaviest on the inside of the coil wires, shown by the heavy shading, while it decreases as the outside of the coil wires is approached. The "skin effect" phenomenon in antennae is especially predominant in those having three or more wires, of forms other than the cage type. Consider a four-wire antenna of the flat top type, say an inverted "L" antenna. The current flowing in the flat top behaves exactly in the same way as the current in a wire, namely, at radio frequencies it flows on the outside conductors. In the case of the antenna here considered there are two central wires and two outside wires, hence the current tends to flow more in the outside wires and less in the center wires. This "edge effect," as it is sometimes called when talking of antennae, is equivalent to a reduction of the effective cross section of the antenna wires, and hence results in increased resistance of the antenna.

These preliminary remarks should make it clear how important is a good understanding of the subject of resistance, and how important it is to be able to measure this quantity correctly. In the case of direct currents one can frequently calculate the resistance of a coil or wire almost as accurately as if one measured it. In high frequency work, calculation is almost always out of the question, due to such complications as distributed capacity in the coil, the manner in which the coil is wound, the presence of skin effect, and so on, all of which factors are so indefinite as to defy calculation. In radio work, therefore, determination of resistance is always a matter of measurement.

In the measurement of resistance, most of the methods employed require some kind of a standard resistance. This standard must meet some very stringent requirements if it is to be any good. Thus, for example, its self-capacity and inductance must be negligible at the frequencies used in order that it should not influence the tuning of the circuit. This is generally obtained by the use of very thin and very short resistance wire. Secondly, its resistance must be constant over a very wide range of frequencies; in other words, its "skin effect" must be negligible. This extremely difficult

(Continued on page 1898)

# use A-P tubes for efficiency

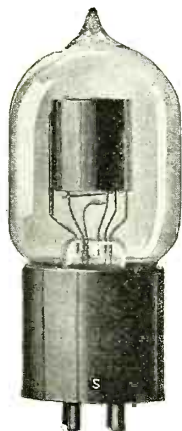

THE A-P ELECTRON RELAY

—the most sensitive detector of spark signals known to the radio art. Price \$5.00.



THE A-P VT AMPLIFIER OSCILLATOR

—the Amplifier used by the U. S. Navy. "Use the tube the Navy uses." Price \$6.50.

—“the tubes that are used by those who **KNOW**”

A-P tubes are licensed by the Radio Corporation of America under DeForest Audion and Fleming patents for amateur and experimental use in radio communication. Equipped with the SHAW standard four-prong base.

**Atlantic Pacific Radio Supplies Company**  
Henry M. Shaw, President

638 Mission Street, San Francisco, California  
Eastern Office: 5 Kirk Place, Newark, N. J.

National distributors for the Moorhead Laboratories, Incorporated.

CALIFORNIA HEARS  
NEW YORK

**3,000  
miles**

WITH  
**A=P Tubes**

On March 25, 1922, Rock Ridge Radio Station, (KZY) Oakland, California, succeeded repeatedly in receiving both music and speech by radio telephone from the broadcasting station of the General Electric Co. (2X1), Schenectady, N. Y., an air distance of approximately 3,000 miles. A-P Tubes were used exclusively in the Rock Ridge receiving apparatus —“The tubes that are used by those who know.”

**USE A-P TUBES FOR EFFICIENCY**

Equipped with the SHAW standard four-prong base

Don't Let Dissatisfaction  
and Lost Radio Business  
Remind You Next Month  
to Place Your Orders with  
**RAY-DI-CO**

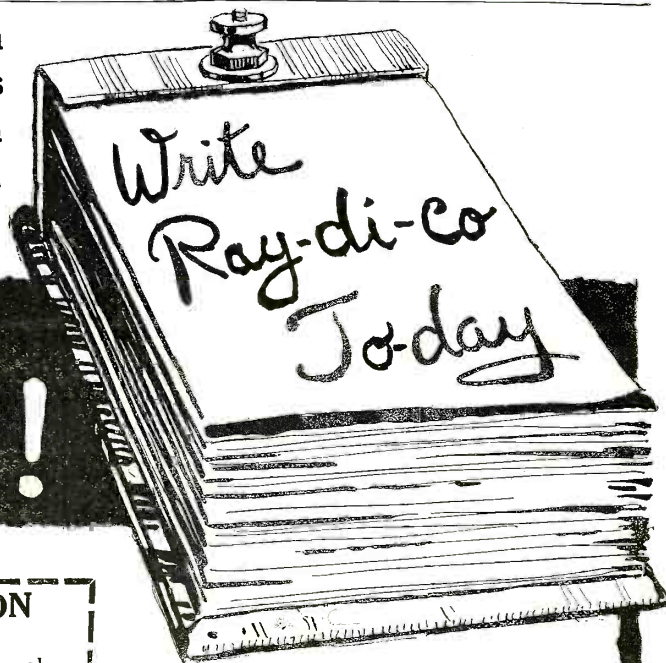

# DO IT NOW!

USE THIS COUPON

**RAY-DI-CO ORGANIZATION**  
1547A North Wells Street

Send me prices and information on the following Radio Apparatus:

\_\_\_\_\_

\_\_\_\_\_

Name \_\_\_\_\_

Address \_\_\_\_\_

**RAY-DI-CO ORGANIZATION**

1547A N. Wells Street

Chicago . . . Illinois





# The Radio Constructor

## A New Radio Frequency Receiver

By WAYNE R. JAMISON

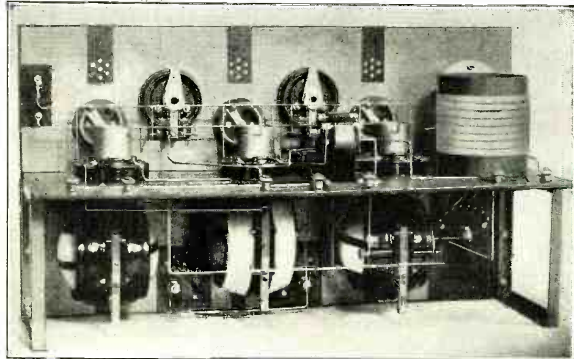
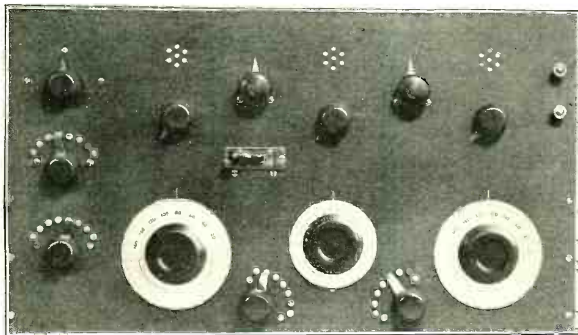

Here is a Real DX Receiver, Composed of a Two-Stage R. F. Amplifier and Regenerative Receiver. Note the Shielded Panel and Neat Wiring Arranged for Minimum Stray Capacity.

**W**ITH the winter season upon us, there is the usual presentation of outfits utilizing new and radically different methods of reception. This year, radio frequency amplification seems to be one of the greatest steps in the advancing art of radio. It does what was formerly considered impossible, namely, it doubles at least the receiving range, improves the quality of speech and music, sharpens tuning, decreases tube noises, and makes the use of a loop aerial practicable.

The set described in this article consists of a two-step radio frequency amplifier, short-wave regenerative receiver and detector. It is the ideal installation for both the concert listener and the "DX" fiend, for it brings in distant stations loudly and clearly and at the same time provides the sharp tuning needed on amateur and broadcasting work, due to the fact that it contains two separate tuners, a combination that will weed out almost any QRM. It may also be used with a loop aerial, and with the addition of a two-stage audio frequency amplifier, will furnish sufficient strength of signals to operate a loud speaker.

The list of parts needed and the approximate cost of each are:

- 1 Bakelite panel 12"x21"x $\frac{1}{8}$ ".....\$ 6.30
- 1 Bakelite panel 8"x21"x $\frac{1}{8}$ "..... 4.20
- 1 piece of 3 $\frac{1}{2}$ " tubing,  $\frac{1}{8}$ " wall, 4" long..... 50
- $\frac{1}{2}$  lb. No. 20 D. C. C. wire..... 70
- 5 Fada inductance switches..... 2.00
- 3 Fada rheostats..... 2.25
- 3 R. C. A. tube sockets..... 3.00
- 1 Federal anti-capacity switch..... 2.65
- 9 Fada binding posts..... 1.35
- 2 Atwater-Kent variometers..... 16.00
- 1 Atwater-Kent vario-coupler..... 8.00
- 30 Nicked contact points..... 1.20
- 8 Nicked switch stops..... 40
- 1 Radio Service Laboratory transformer, Type RT-6..... 6.00
- 1 Radio Service Laboratory transformer Type RT-6A..... 6.00

- 2 R. C. A. potentiometers..... 4.00
- 1 Dubilier grid condenser, .00025 mfd..... .35
- 2 4" Somerville dials..... 3.50
- 1 3 $\frac{1}{4}$ " Somerville dial..... 1.50
- 1 Vernier condenser..... 2.25
- 6 ft. spaghetti..... .60
- Brass for shielding and angle brass 3.85
- Miscellaneous; nuts, bolts, etc.... 2.00

Total.....\$78.60

It is not essential that the above-mentioned makes of apparatus be used, but it was found that they worked well together. It has also been suggested that Moorehead tubes be used, but whether they are more efficient in this type of circuit is left to the builder. It was also found that the Radio Service Laboratories transformers were more efficient than the U. V. 1714 shown in the photograph. The hook-up has been drawn to include the first mentioned type,

and they should be located at the places indicated by an "x" on the drawing.

It will be noticed that in the layout no exact measurements are given, but merely center lines for the location of parts, as it was thought that other types of apparatus than those mentioned might be used, when specific dimensions would only prove inaccurate and confusing.

The main panel is divided into two parts by the sub-panel, which is supported on brass frames 5 $\frac{3}{4}$ " high by 6" deep, made of  $\frac{1}{2}$ " angle brass,  $\frac{1}{8}$ " thick. These frames are held to the panels with flat head 6-32 machine screws.

On the lower half of the main panel are mounted the two variometers and the coupler, together with the necessary units and multiple switches. The coupler is in the center with the grid variometer to the right and the plate variometer to the left. The right hand switch is multiple, and the left,

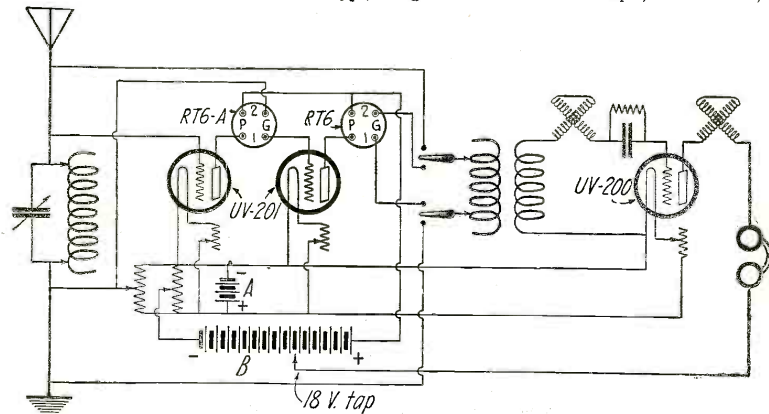

Hook-up of the DX Receiver. By Means of Two SPST Switches Only the Regenerative Set May Be Used. The Tubes May Be of Any Suitable Make, Such as Radiotron, Cunningham, etc.





# An Efficient Detector-Amplifier Unit

By ARTHUR W. LAMBERT, Jr.



View of the Tuner and Detector-Amplifier Units. An Article on the Construction of the Tuner Appeared in the October Issue of Radio News

**S**INCE my article *A Novel Short-Wave Regenerator* appeared in the October number of RADIO NEWS I have been kept busy answering letters from those who desired to build the set. Many wanted to know what the four binding-posts at the left of the panel were used for—those marked G, T, T and F. In answer to this question I will say they are my abbreviations, respectively, for Grid, Tickler, and Filament. And, as mentioned in the article, are provided in case an external detector, with or without amplifiers, is to be used.

I am also receiving requests for hook-ups, dimensions and "minute details" for constructing a detector-amplifier unit to go with this outfit; and as my time is limited to the extent that individual answers of such extensive nature are out of the question, I thought it best to "broadcast" this information through the columns of RADIO NEWS where all who are interested may see it.

A view of the two units (the original short-wave regenerator and the herein described detector-amplifier unit) is shown in an accompanying photograph. The smaller cabinet on the left contains a detector and two stages of audio frequency amplification. The binding-posts for connecting the detector-amplifier unit to the tuner are on the left of its panel, matched to the four relative binding-posts marked G, T, T, and F on the original. This makes it necessary to employ only four short bits of wire to hook together the two units. These connections are made in front because with them so placed it is easy to disconnect the short-wave set and hook on another tuner at will. The battery connections are all in the rear.

To some it might seem unnecessary to include another detector. However, the added cost of duplicating the detector socket, rheostat and one or two other items is small compared with the great convenience of having a detector-amplifier unit that will function with any other tuner the builder may want to work with it. The writer is now using such a unit and is continually changing it from his short-wave set to a honeycomb outfit so as to get Arlington and the long waves. Of course it is not necessary to employ two detector tubes.

Many of the letters received in quest of information regarding the construction of the short-wave-regenerator were from novices who knew next to nothing about radio. These prompt me to advise such beginners in this fascinating field that it is wise to make haste slowly. Mount the instruments "laboratory fashion" first. Place them on a board in any convenient manner. Connect them up in any old way to begin with—and make them work. In this way you will become accustomed to the way dif-

ferent things act. After this so called "undress rehearsal" a neat job resulting in a cabinet receiver is a mere second step. The arrangement and dimensions herein given are merely suggestions. The dimensions may have to be changed slightly if apparatus of different makes than those listed by the writer are used. However, by following the details carefully the constructor is sure to come across useful little kinks that may be employed with benefit.

The following materials are necessary for the construction of this unit. Standard apparatus of other makes may be used if desired; only care must be taken, as mentioned above, to see that they fit in place properly. Like the short-wave regenerator, this unit is completely panel-mounted, which

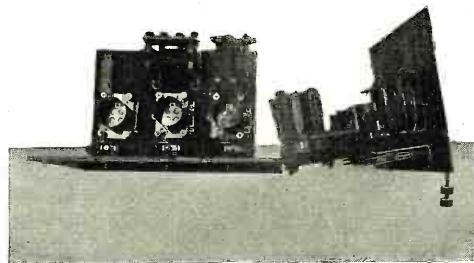

Interior View of the Detector-Amplifier Unit Clearly Showing the Arrangement of the Parts

makes it easy to remove the "works" from the cabinet for alteration or repair.

**MATERIAL NEEDED**

- 1 Cabinet, oak, mission finish, 7" x 11" ..... \$4.00
- 1 Hard rubber panel ..... 1.50
- 3 Vacuum tube sockets ..... 3.00
- 3 No. 131 Frost jacks ..... 2.70
- \*2 Amplifying transformers ..... 9.50
- \*\*3 Cutler-Hammer filament rheostats ..... 3.00
- 1 Grid condenser and grid leak (home-made) ..... —
- \*\*\*11 Binding-posts ..... 1.10
- 1 Oz. tinfoil ..... .10
- 1 Wood board, 8½" x 6" x ½" ..... —
- 12 Ft. spaghettti ..... 1.20

Perspective Drawing of the Described Unit. The Sockets and Transformers Are Mounted on a Shelf, a Most Convenient Method.

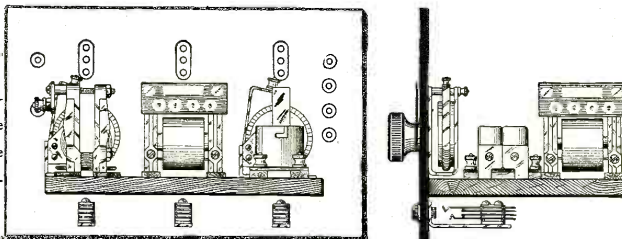

- 20 Ft. No. 14 aerial wire ..... .10
- 3 Doz. ½" No. 4 round-head brass woodscrews
- 1 Doz. ¾" No. 6 round-head woodscrews
- 1 Doz. No. 6 brass washers
- 3 2" No. 6 flat-head woodscrews
- 8 1" No. 8-32 round-head brass machine screws
- 8 No. 8-32 hexagon brass nuts
- Total cost, about ..... .50
- 6 Small two-cell flashlight batteries ..... .60

\$27.30

\*Any good amplifying transformer may be used.

\*\*It is recommended that the vernier type of rheostat be purchased for the detector tube.

\*\*\*The writer uses binding-posts having a 1" No. 8-32 machine screw with brass base-lug and thumb-nut tapped clear through. This makes it unnecessary to fit the binding-post to any special panel thickness, and leaves plenty of room for heavy inter-unit connections.

Should the builder desire to economize, he can build his own cabinet. Dimensions for it will be seen in Fig. 4. Also, since this set was constructed, radio materials have flooded the market and prices noted above can nearly always be beaten at the present time.

Fig. 1 shows the layout of the panel. This layout should be copied on a sheet of paper, full size, and this paper used as a pattern to locate the holes. Except for the difference in dimensions and lettering, the laying out and preparation of this panel is identical with that for the panel for the short-wave regenerator and it is recommended that the instructions relative thereto given on page 700 of October RADIO NEWS be closely followed.

The four binding posts on the left should be marked G, T, T, and F. The two binding posts on the right should be marked OP (referring to output). And under each rheostat knob mark respectively the words Detector, 1st Step and 2nd Step. Name plates like these may be purchased from radio dealers and attached to the panel with small escutcheon pins. A series of arrow-heads are stamped at intervals around each rheostat knob as a position indicator for the pointer. A close scrutiny of the photograph will show this marking.

Although shielding is not as essential in this unit as in the short-wave regenerator unit, it is a good precaution to take, and inexpensive. The writer prefers to shield the inside of the entire detector-amplifier cabinet. Heavy tinfoil is stuck in place with shellac, and a layer of brown wrapping paper smoothed on over this. This shielding should then be grounded. Although not shown herewith, an additional binding-

Fig-2

post in electrical contact with the shielding may be put on the back, in a position so as not to interfere with the battery connections. This post may then be connected with a short length of wire to the regular ground connection.

Fig. 2 shows the back and side views of the panel assembly. No dimensions are given as the instruments should be mounted according to the make used. It will be seen from this sketch how the unit system of mounting all instruments to the panel is accomplished.

The only item of importance not shown in detail with dimensions, is the socket-transformer shelf. This is only a board measuring  $8\frac{1}{2}'' \times 6'' \times \frac{1}{2}''$ . It should be a piece of well dried wood, shellacked, and held in position by the three 2" No. 6 flat-head woodscrews. The holes in the panel should be countersunk for these three screws. The position of these screws is clearly shown in the side view of Fig. 2.

The writer recommends that the mounting be in the following order:

- (1) Mount the rheostats.
- (2) Mount the jacks.
- (3) Mount the binding-posts.
- (4) Mount the wooden shelf (countersink screwheads).
- (5) Mount the tube-sockets (keep the G and P to the rear).
- (6) Mount the transformers (at right angles as shown).

If everything is laid out as indicated, it will be found that ample clearance for the tips of the vacuum tube (if Radiotrons or Cunninghams are used) is provided for. However, if any slight changes are made this should be made sure of, and in case there is not enough clearance, holes should be bored in the lid of the cabinet to permit its being closed.

After all the instruments are mounted, as shown in Fig. 2, the unit is ready for wiring, but before doing this the whole should be carefully tested for accidental grounds to the shielding. This is the time to make certain that no such grounds occur. An accidental ground discovered and remedied at this stage of the construction may save hours of hunting and repairing later.

A battery and buzzer or a battery and flashlight should be used to do this testing. One wire from the tester should be held in firm contact with the tinfoil shielding and the other brushed against all the other instruments in turn. Also ascertain that each instrument is electrically insulated from other instruments.

When sure that no accidental grounds exist, the unit is ready for wiring.

The hook-up for this unit is shown diagrammatically in Fig. 3. This is a standard detector two-step audio frequency amplifier circuit.

The attention to the builder is directed to the two batteries in the grid leads of the amplifier tubes (marked "C"). These batteries are seldom used and may not be necessary; nevertheless their use will probably improve the amplification of the tubes considerably. Provision should be made for inserting these batteries after the unit is complete. They may be placed in the cab-

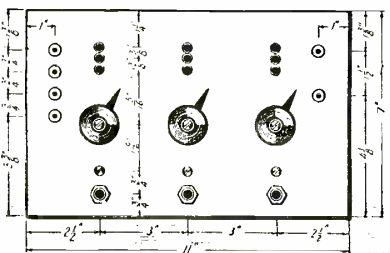

Dimensions for the Layout of the Panel.

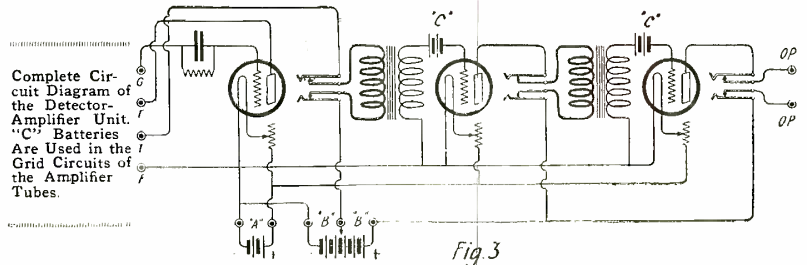

Fig. 3

inet. The proper voltage will have to be ascertained by trial. This will probably be found to be somewhere between four and eight volts. As the "C" battery supplies practically no current, small two-cell flashlight batteries of ten-cent store variety may be used. They will last indefinitely.

G, T, T and F in Fig. 3, as mentioned before, refer respectively to Grid, Tickler and Filament connections. The binding-posts marked OP are "Output" posts. Connections to a loud speaker may be made here, or another step of amplification added if one might be desired.

The "A" battery terminals are shown at A and the "B" battery terminals shown at B. Any 6-volt storage battery may be used

voltage at bottom, positive at top—negative at bottom.

To facilitate panel removal, five screws with brass washers should be put in the rear edge of the socket shelf-board and the "A" and "B" connections as shown in Fig. 3 made to them. These "sub-terminals" should be connected to the binding posts on the back of the cabinet with 12" lengths of flexible lampcord.

All wiring should be made with No. 14 bare copper wire, and the liberal use of spaghetti for insulation is encouraged.

It is recommended that a beginner make the connections as best he can and not try to make too neat a job until he becomes more familiar with the action of such a combination of apparatus. For a "professional" job, the wiring should be properly right-angled and should hug the instruments as closely as practicable. A glance at Fig. 2 will show a clear space from back to panel. If the wiring is made to hug the instruments and the panel, shields may later be placed between each amplifier step to further increase the efficiency of the unit.

The wiring of this detector-amplifier unit is a far more complicated matter than the wiring up of the Short-Wave Regenerator and far greater care should be taken. However, if the builder will make a light pencil sketch of the diagram of connections, and go over each connection heavily as soon as it is made, he should be able to complete the job without trouble.

When the hook-up is complete; TEST, TEST, TEST!

Make sure that there are connections where they should be, and that there are not any cross connections or short circuits where there should be insulation. And above all make sure that no "B" battery voltage gets into the "A" battery circuit. Whatever you do, do not put the tubes in place with "B" batteries connected until you know that everything is right. It might cost \$18 in real money to replace the tubes.

The cabinet shown in Fig. 4 was made of  $\frac{3}{8}''$  oak, mission finish, measuring  $7'' \times 11''$  by  $8\frac{1}{2}''$  deep. This matches perfectly with the novel short-wave regenerator unit previously described; in fact, it is the same cabinet except that it is  $11''$  instead of  $18''$  wide. Fig. 4 gives all important dimensions and shows the locations on the back for the battery binding posts.

When all is ready the panel assembly should be placed half-way in the cabinet and the flexible leads from the "A" and "B" battery sub-terminals soldered to the proper binding posts on the back. Then push the panel assembly in place and fasten the panel to the cabinet with  $\frac{3}{4}''$  round-head (preferable nickel finish) woodscrews. To avoid confusion the holes for these screws were not shown in the panel layout; but a close look at the photograph of the complete outfit will show the location.

The lettering on the panel should now be filled in with white shoe-polish as explained in the former article, and the binding posts on the rear of the cabinet should be marked for identification.

A final test should now be made to make sure that the filaments of the expensive vacuum tubes will not be burned out when

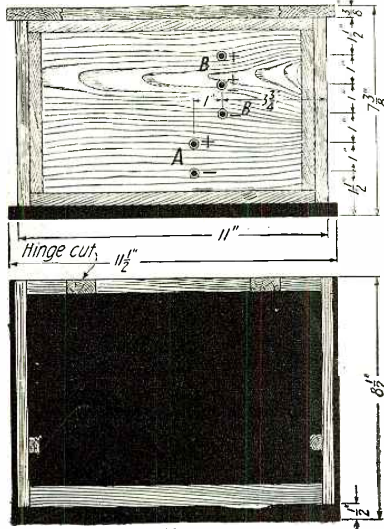

Fig. 4

Constructional Details of the Cabinet.

as an "A" battery; however, as three amperes are drawn when Radiotrons are used, the battery for such tubes should be of 60 ampere-hours capacity or larger, to obviate too frequent charging. If peanut tubes or other low voltage tubes are to be used, care should be taken to have the proper "A" battery and to place sufficient resistance in the circuit to prevent burning out the filament. For "B" battery a 45-volt battery with a tap at  $22\frac{1}{2}$  volts, or two small  $22\frac{1}{2}$ -volt "B" batteries may be used.

The battery binding posts are shown schematically in Fig. 3 in vertical rows, as they are shown in the cabinet plan in Fig. 4. With this scheme of battery binding post arrangement it will be found easy to make all battery connections. Beginning at the top we have respectively: (1) Positive terminal of plate battery; (2) Terminal for  $22\frac{1}{2}$  detector plate voltage tap; (3) Negative terminal of plate battery; and below and in a line to one side; (4) Positive terminal of storage battery; and (5) Negative terminal of storage battery. This gives as a simple rule to follow when hooking on batteries; namely, high voltage at top—low

(Continued on page 1828)



# Theory of Operation of Crystal Detectors

By BERT T. BONAVENTURE

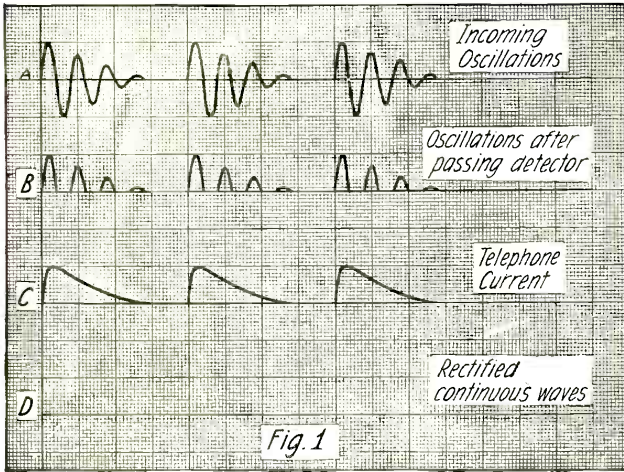

A Graph Illustrating the Original Energy Impressed Upon a Reception Circuit, its Character Upon Being Rectified, and the Consequent Telephone Current.

WITH the advent of the wave of popular radio and its attendant flood of crystal detectors, there are, no doubt many users who would like to know the whys and wherefores of this most essential part of their radio equipment. Many owners of receiving sets have fussed and fumed with their crystals, more with a neophyte's enthusiasm than with a clear understanding of the operation of the detector, through the lack of which understanding they have not been able to get the best possible results from their sets. Fortunately, this stage of aimlessness is beginning to pass and the radio fan is beginning to ask pertinent questions about the functionings of his apparatus. By far the most important single instrument in a receiving set is the detector and in this article, the writer shall describe the operation of the crystal in detail.

Crystal detectors are divided into two main groups, with some crystals possessing properties of both classes. In the first group are the crystals which possess the property of unilateral conductivity; that is, a current of electricity is able to flow through the crystal much better in one direction than in the other. In the second group are the crystals which do not adhere to Ohm's law over a range of applied voltages. These crystals possess a non-linear voltage-current curve. In both cases, detection is accomplished by a rectification of the incoming signal. The rectified current charges the phone condenser and is smoothed out therein before the condenser discharges into the telephone receivers, thus producing an audible sound. The most sensitive crystals are furnished by the first group, but they are also accompanied by the disadvantage that they are easily jarred out of adjustment. Since they require an extremely light pressure of the catwhisker wire in making contact on the surface of the crystal, if the table or set is subjected to even a small jolt, the adjustment is lost. This annoyance is rendered still more disagreeable by the fact that the whole surface of the crystal is not uniformly sensitive and more or less time is lost in finding a new spot which responds well to the incoming signals.

Crystals of the second group are more stable in operation as a heavier pressure is usually used at the point of contact. Such crystals are favored on board ships where the rock and roll of a vessel will knock a sensitive galena crystal out of adjustment,

requiring the repetition of part of the message being sent.

Galena is by far the most sensitive crystal!

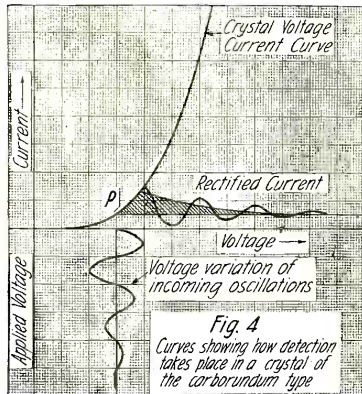

Illustrating the Voltage Characteristics of a Carborundum Crystal.

of the first group, with iron pyrites (fool's gold) a close second. If a piece of galena be examined closely, it will be seen that the

surface is covered with fine serrations running in but one direction. Upon breaking the crystal the serrations can be seen running in a perpendicular direction, thus showing the formation of the substance as cubic. On a bright, smooth surface it will be found that the sensitivity is usually zero, the maximum sensitivity occurring at places where the serrations are located or where a depression is formed by the criss-cross ridges.

Just what the action is that goes on in the crystal, which enables it to rectify high frequency currents, is a subject open to dispute. Fleming found that this rectifying power is lost when the rectifying substance is powdered and moulded into rods under great pressure. Heating the compressed rod in an electric arc could not restore its previous properties, the rectifying power seeming to depend on the crystalline structure. With other substances, rectification seems to depend on a surface action, which Goddard calls surface rectification, maintaining that these solid rectifiers operate in a manner similar to the electrolytic rectifiers.

Quite a number of hypotheses have been advanced to explain the action of crystal detectors, the assumptions being that the phenomena depend on thermo-electric properties, photo-chemical properties, electrolysis in solids, electrostatic attraction, etc. The thermo-electric theory seems to be the most plausible. With this hypothesis, the observed phenomena depend on three main conditions, viz:

1. Temperature variation of resistance.
2. The Peltier effect. (Absorption or generation of heat by the passage of a current through a junction of dissimilar metals.)
3. The Thompson effect. (The production of an EMF between different parts of the same substance at different temperatures.)

Just which phenomenon or combination of phenomena produces the rectification, and the considerations, pro and con of their effects, involves a discussion which cannot be entered into in this paper, both for lack of space and on account of its highly technical nature, being primarily a matter of pure physics. Those inclined to delve more deeply into the nature of these phenomena will find a full and elaborate discussion in a paper by W. D. Eccles. (Proc. Phys. Soc. Lond. p. 273, vol. 25, 1913).

In brief, the incoming signal traverses a point of very small cross-section (therefore (Continued on page 1896)

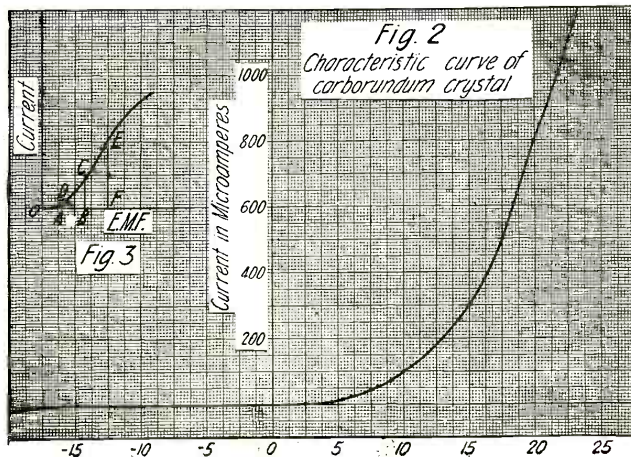

Characteristic Curve of a Carborundum Crystal Showing the Relative Current at Various Applied Potentials.

Fig. 3

# Radio Digest

From 12:15 p. m. to 12:30 p. m.  
6:15 p. m. to 6:30 p. m.  
8:00 p. m. to 8:15 p. m.

## WHITE BILL AWAITS SENATE ACTION

The White Radio Bill, which was passed by the house, has been transmitted to the Senate, where it awaits assignment to a committee. Some indication as to whether it should go to the Commerce Committee or the Interstate Commerce Committee has been encountered. Senator Kellogg, who favors it and will sponsor the bill in the upper chamber, is a member of the latter committee, but as Chairman Cummins is out of town, early action there is not promising. Literally, it should go to the Commerce Committee, as the original bill was passed as a commerce measure in 1912, and radio is under the Commerce Department today.

When the bill is signed, early action is still hoped for, although some Senators admit that if it is likely to incur much debate and obstacles are thrown in its way, it will be impossible to pass it this session. It passed the house after two days' discussion and suffered little thereby, but such speedy progress in the Senate is hardly hoped for, with other important legislation pending.

Secretary Hoover, after a conference with Senator Kellogg, was sanguine as to the bill's passage in the Senate this session, unless some obstructionists interfere.

Questioned as to why radio came to be under the Commerce Department instead of the Post Office, as it is in many European governments, Secretary Hoover said it was probably because it required regulatory supervision, which duties did not devolve upon the Post Master General. At first, no department seemed to want radio, Mr. Hoover explained, adding that as he believed some governmental department should foster its development, he volunteered, although he realized it would mean considerable additional work.

Based upon the present number of stations and operators and at rates now set forth in the bill, the Department expects to collect annually a sum approximating \$186,000 in fees for licenses. This would offset a large part of the expenses of administering, inspecting and licensing the stations and individuals. This money would not be received in cash by the radio section of the Department but would be collected through the sale of Government revenue stamps and would constitute additional income to the Government. Thus, it is explained radio interests and individuals would actually be paying for supervision and service, which would require almost double the work.

The bill does not carry any salaries for the members of the Advisory Committee, who are not Governmental employees, but provides for the payment of their expenses when in session in Washington. One of Secretary Hoover's first acts following the passage of radio legislation would be to secure the appointment of this committee and call a session for the immediate revision of the wave assignment schedule, it is understood.

## RECENT DEVELOPMENTS OF RADIO-TELEGRAPHY IN CZECHO-SLOVAKIA

On November 7, 1922, radio-telegraphic communication was established between the 1-k.w. Czecho-Slovak radio-telegraph station at Brno, Moravia (Station Call, "OKB"), and the Swiss radio-telegraph station at Berne, Switzerland (Station Call, "HBB").

Radio-telegrams are now despatched from the Brno station during the following periods (Middle European time):

The principal station for radio-telegraphic communication in Czecho-Slovakia is at Prague, the capital. This 10-k.w. station has been in operation since June, 1920. At Vinohrady, a district of Greater Prague, a ¼-k.w. radio-telegraph station is also in operation, serving the aeroplanes on the air routes from Prague to Warsaw and from Prague to Vienna, and transmitting exchange rates and press reports to all parts of the Czecho-Slovak Republic for the Czecho-Slovak State Press Office.

At Kbely, a suburb of Prague, the construction of a 1-k.w. radio-telegraph station is nearing completion. This station will be of special service to the aviation field at Kbely, but will also be available for press purposes and for the use of the general public. At Karlovy Vary (Carlsbad), another 1-k.w. radio station is being built which will be used principally during the "Cure" season.

A 5-k.w. station is in course of construction at Pödebrady, Bohemia, which will soon

Pödebrady (Bohemia) ..... 5 k.w.  
Pödebrady (Bohemia) ..... 50 k.w.  
PROJECTED STATION  
Bratislava (Slovakia) ..... 5 k.w.

## RADIO STANDARDIZING COMMITTEE SELECTED

The Conference on Radio Standardization which met in New York recently resulted in the unanimous agreement of about 100 representatives present that standard for radio apparatus and service should be formulated, but no definite plans were announced. It was agreed that a broadly representative national committee on standardization should be formed under the leadership of the Institute of Radio Engineers and the American Institute of Electrical Engineers. The procedure of the American Engineering Standards Committee will be followed by the committee in outlining standardization planned.

Dr. A. N. Goldsmith of the Institute of Radio Engineers and Mr. L. T. Robinson of the American Institute appointed an advisory committee of 13 members to assist in the organization of the sectional committee and the necessary technical sub-committees.

The members of the advisory committee follow:

Department of Commerce, Dr. J. H. Delmunder S. C. Hooper; Army, Major L. B. Bender; National Radio Chamber of Commerce, G. H. Lewis; Associated Manufacturers of Electrical Supplies, M. C. Typinski; National Retail Dry Goods Association, Wm. A. Fitzgerald; Pacific Radio Trade Association, Max Lowenthal; Consulting Engineers, J. V. L. Hogan; American Radio Relay League, K. B. Warner; Institute of Radio Engineers, Donald McNicol and Dr. A. N. Goldsmith, and American Institute of Electrical Engineers, L. T. Robinson.

## Some Interesting Articles Appearing In This Month's Practical Electrics

Motor Without Visible Field

Electric Target

By Albert Neuburger, Berlin Correspondent, Practical Electrics

Modern X-ray Apparatus

Electrical Pumps

By F. R. Kingman

The Electric Ghost

By Clyde J. Fitch

Million Volt Sparks

become the center of radio-telegraphic communication for the Czecho-Slovak Republic. At Pödebrady, also, a station with two 50-k.w. generators is being erected which will be used for international radio communication. It is expected that this last station will be ready for operation next year. Other radio-telegraphic stations now under way are a 1-k.w. station at Moravska Ostrava, to serve the air route to Warsaw and for general communication in this very important industrial center, and a 5-k.w. station at Kosice, Slovakia, for general telegraphic purposes.

The Czecho-Slovak Ministry of Posts and Telegraphs is also planning to erect in the near future a 5-k.w. radio station at Bratislava, Slovakia, for the use of the International Danube Commission and navigation on the Danube.

Briefly summarized, the radio-telegraphic service in Czecho-Slovakia shows the following stations in operation, in course of construction and projected:

### IN OPERATION

Prague ..... 10 k.w.  
Brno (Moravia) ..... 1 k.w.  
Vinohrady (Prague) ..... ¼ k.w.

### IN COURSE OF CONSTRUCTION

Kbely (near Prague) ..... 1 k.w.  
Karlovy Vary (Carlsbad) ..... 1 k.w.  
Moravska Ostrava (Moravia) ..... 1 k.w.  
Kosice (Slovakia) ..... 5 k.w.

## THE BROADCASTING SITUATION

By CARL BUTMAN

For the first time since broadcasting began in September, 1921, fewer new stations were licensed during the month of January than dropped out, indicating that the field for broadcasting is practically filled. This is not to be wondered at, officials point out, because the "saturation point" has been reached. Many fans say, "well, there are enough anyway; we don't want any more; let the better ones survive."

Today, there are 570 broadcasting stations, 28 of which are in the B Class on 400 meters, the balance being on the more popular 360-meter wave. On January 1 there were 576, showing a loss of six during the month. While there were 28 new stations licensed in January, 34 old ones failed to renew their licenses.

On the first of February last year, there were but 36 stations licensed in the new pastime of broadcasting; today, there are almost 16 times that number. Many people believe that this is far too many, particularly since they are not well distributed on the 360-meter wave. The radio bill, however, provides for the distribution of a large number of new waves, which will aid in decreasing the interference. Competition is creeping into the game. The best equipped stations giving the best service to the fans will probably become the permanent ones in the long run, it is believed.

## SEVEN NEW BROADCASTERS

Within one week, recently, seven new broadcasters were licensed by Mr. Hoover's (Continued on page 1870)



# Awards of the \$50 Radio Wrinkle Contest

## First Prize

### A GOOD PORTABLE LOOP AERIAL

By WILLIAM F. GEHRIG

The following is a description of a folding loop antenna. The outstanding features are: Original design allowing the cross-arm to fold up against the vertical support and its compactness when knocked down for transportation.

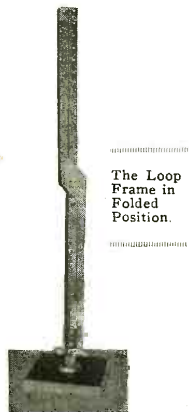

The Loop Frame in Folded Position.

Fig. 1 shows the loop closed. A small shaft fits in a bushing mounted on the wooden base. This permits rotation of the loop. Fig. 2 shows the loop ready for use with the flexible stranded wire wound around the rubber headed tacks on the cross-arms. There are six of these tacks on both sides of each arm. When winding the wire on, it is started from one of the binding

posts at the bottom and wound from the center out on one side, then crossed over to the other side and wound from the outside to the center, there being fastened to another of the binding posts. As to the constructional details, the vertical support is a piece of wood 1" square and 3' long as shown in Fig. 3. The horizontal support consists of two pieces each 17 1/2" long. Brass plates on each side of the frame attach them to the vertical support by means of long brass bolts, two being through each of the horizontal arms and one through the vertical arm, this one acting as a pivot. The drawing of Fig. 3 is self-explanatory. The dimensions of course can be changed to suit the requirements of the builder.

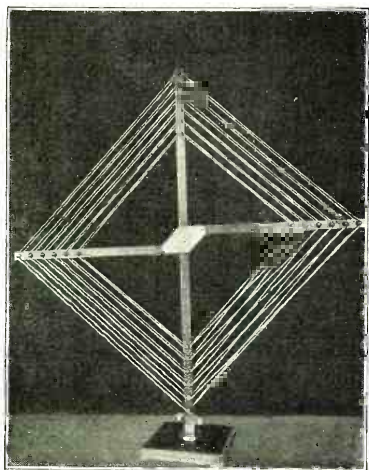

This photograph Clearly Shows the Details of the Loop. The Wire is Wound Around Rubber-Headed Tacks and Fastened to Binding Posts at the Bottom.

Constructional Details of the Variable Condenser. The Method Used for Variation of the Plates is Very Clever. No One Should Find Difficulty in Making One of These.

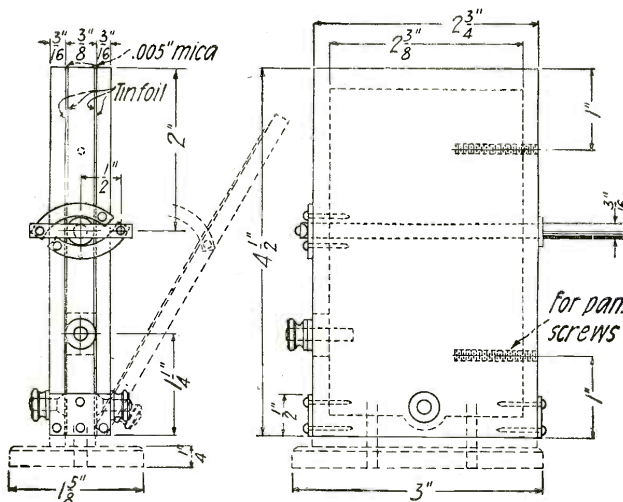

## Second Prize

### AN EASILY MADE VARIABLE CONDENSER

By CHRIS. N. SCOTT

The average amateur usually hesitates before beginning a circuit having a number of variable condensers in it because of the high cost of these instruments which are

least 3/4" wide and must make good electrical contacts with the sheets of foil. A piece of mica 2 3/4"x4 1/2" and about .005" thick is shellacked on the sides of the central piece over the tin foil. The side pieces are fastened to the central piece by means of two 1/8"x1/2"x3/4" strips of brass which are fastened to the central part with two 5/8" escutcheon pins or small brass screws, while another pin in the lower corners of the brass strips acts as a hinge for the side pieces, the inner edges of which should be slightly rounded so that the pieces will turn out smoothly. These pieces should be so adjusted that they will fit up closely against the central piece when they are closed.

The capacity of the condenser is varied by moving the plates out from the center. This is accomplished by means of a small double crank made by splitting the end of the brass shaft with a hacksaw for 3/4 of an inch. The ends are bent back at right angles with the shaft and a small hole is drilled in each end. These ends are then connected to the side pieces with a short piece of brass and a small screw or pin. A washer should be fitted to each end of the shaft which should have a small pin through it so that it cannot move back and forth but is still free to turn easily. A half turn of the shaft will then spread the side plates to an angle of almost 45 degrees with the

## Prize Winners

### FIRST PRIZE \$25

William F. Gehrig,  
291 South 11th St.,  
Newark, N. J.

### SECOND PRIZE \$15

Chris. N. Scott,  
Iloilo High School,  
Iloilo, Iloilo, P. I.

### THIRD PRIZE \$10

J. R. Balsley,  
Ridley Park, Pa.

usually almost impossible for the amateur to construct satisfactorily. The condenser described below has proven quite efficient and was entirely constructed in a small laboratory with few tools except a hand-saw and a drill. The material was all pick-up and could easily be obtained anywhere.

The body of the condenser is a piece of well seasoned dry pine 3/8"x2 3/4"x4 1/2". The piece was squared up and sanded smooth. A 1/8" hole for the shaft is drilled through the piece 2" from the top. Two pieces 1/8"x2 3/4"x4 1/2" of the same material are used for the movable plates. Pieces of heavy tin foil 6x10 centimeters or 2 3/8"x4" are shellacked on both sides of the central piece and on one surface of the side pieces. Strips of tin foil must lead out to the binding post on the edge of the central piece and to the terminal at the bottom of each side piece. These strips should be at

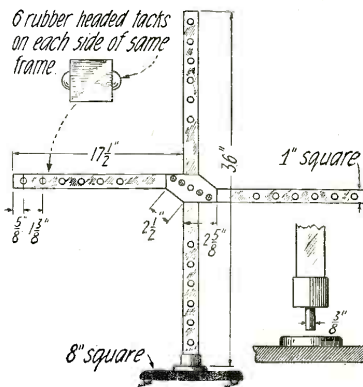

Further Details and Dimensions of the Portable Loop Series. Suitable Binding Posts Can Be Placed at the Bottom for Fastening the Wire.

central piece. The terminals of the side pieces should be connected with a piece of flexible wire. The condenser may be mounted on the panel with two wood screws driven through the panel into the front edge of the center piece which should be separated from the panel about  $\frac{1}{8}$ " by means of washers to permit free movement of the side pieces, or the condenser may be fitted with a small base for table mounting. The shaft should extend far enough through the panel so that a knob can be attached to it.

The capacity of the condenser as described is very close to .001 M.F. when the plates are closed. This condenser if well made should operate satisfactorily and is much cheaper than a 43 plate variable having about the same capacity.

### Third Prize

#### DIAL MOUNTED SERIES PARALLEL SWITCH

By J. R. BALSLEY

Following is a description of an arrangement for operating a variable condenser in series or parallel with an inductance by merely revolving the dial through 180°. For the first 90°, the capacity is in series and

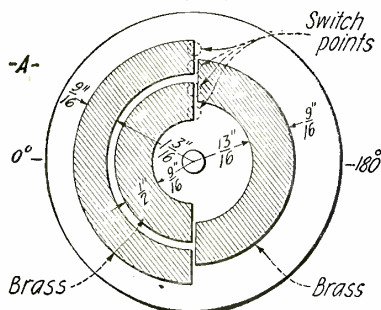

The Series-Parallel Switching Arrangement is Mounted Directly on the Rear of the Dial. This is a Very Good Scheme.

diminishes up to the point where it changes to a parallel connection after which it increases for 90° more. Using it in this manner, only one-half of the brass strips on each side are brought into play. If so desired, the condenser may be used in series through the entire 180° and in parallel for the next 180° as may easily be seen by studying A of Fig. 1. This switch requires the use of a flat back 4" dial of which there are many on the market, four switch points and a piece of brass or copper sheet  $\frac{3}{16}$ " in diameter

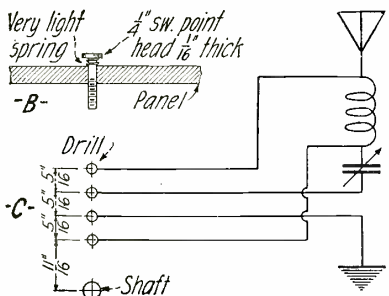

The Layout and Connections for the Series-Parallel Switch. Small Springs Underneath the Switch Points Provide the Necessary Friction Contact Against the Brass Strips.

together with a few inches of fine wire to make four light springs. The brass strips when cut to size, can be glued to the back of the dial more easily than fastening by countersunk screws. This is very easily made and eliminates the necessity of using the usual unsightly series parallel switch.

This Method of Fastening Coil Ends Does Away with the Necessity of Drilling Holes Through the Tubing. A Bit of Tape Is All That Is Required.

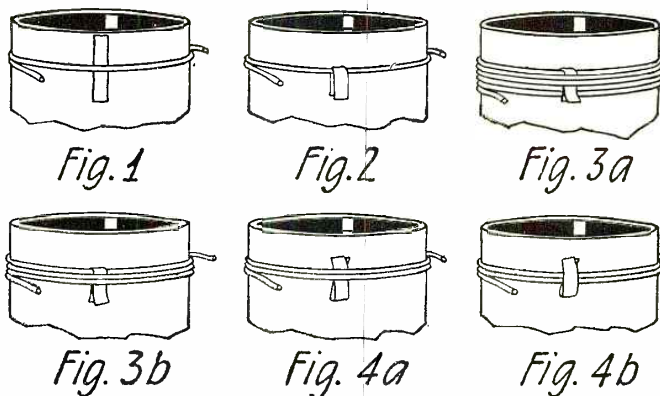

#### FASTENING COIL ENDS

Here is an easy way of fastening the extreme ends of a home-made coil. I have found that in using this wrinkle, it is possible to do away with drilling holes in the coil form for fastening the ends of the wire. It also prevents the wire from slipping while winding the coil. Following is the method of procedure:

Cut two strips of  $\frac{1}{4}$ " cotton tape 2" long. Place one strip and end of wire on form as shown in Fig. 1. Fold the tape over the wire as shown in Fig. 2. Wind from two to six turns over the loose ends of the tap thereby securing the portion of each to the surface of the form as shown in Fig. 3B. Lift the loose ends of the tape from the surface of the form and wind two or three more turns, then pull the ends of the tape and cut them off close to the wire and continue winding until reaching a point five or six turns from the intended end of the coil. Fold the other piece of tape in half and place as shown in Fig. 4B. Wind from two to five turns over the loop as shown in Fig. 4A. With this done, cut the wire, leaving enough loose end for necessary connections. Pass this loose end of the wire through the loop and pull the loose end of the tape tight so that the loop will secure the end of the wire. Cut the loose ends of the tape and you have a very neat appearing coil.

Contributed by C. M. Hallar.

#### A MULTIPLE CRYSTAL RECEIVER

I have used a double or two-crystal detector all summer with splendid results. Two-crystal, two-phone condensers with three binding posts are mounted on one base and connected as shown in the diagram, and two terminal posts, A and B, for connection to any ordinary receiving set.

In the ordinary crystal receiver only one-half of the incoming alternating current is rectified and passed to the receiving phones, that is, the pulsations running in one direction only, enter the phones. With two crystals, hooked up as shown in the diagram, the alternating pulsations are separated and those of one direction enter one phone while those of the opposite direction enter the other phone. It should be remembered that it is the number of turns of wire on the

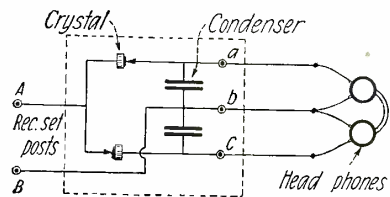

This Is a Good Stunt and Well Worth Trying. Both Halves of the Incoming Wave Are Made Use of.

magnet of the phones that is desirable and not the high resistance. With the double crystal and the two phones connected separately, the results are the same as half the resistance with the same number of turns. This greatly increases the efficiency. If the phones are provided with three wires, you will find that you can connect them up not only with the double crystal detector but by connecting the two outer wires, A and C, to the binding posts of any ordinary receiving set, they will work exactly the same as with two wires. It is also possible to connect the center and one of the outer wires (B and C or B and A) to the posts of a receiving set and listen in with either phone or with two together as usual, thereby allowing a comparison of the effect of the resistance of one phone on the receiving set against that of both.

Contributed by A. N. Olson.

#### A VARIABLE RESISTANCE

The old type of resistance made by a pencil mark or India ink over a small piece of ebonite is well known to every amateur who has used it for a long time as either an anode resistance or grid leak.

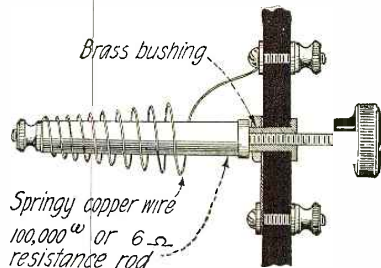

Here is a Unique Means of Varying a Resistance. This Makes a Very Effective Rheostat or Variable Grid Leak.

This has the chief disadvantage of varying its value with changes in atmosphere. On the other hand, some excellent types of resistance rods have been placed on the market by reliable manufacturers. With the B batteries offered on the market at present, it is no longer possible to vary quickly the resistance according to particular needs. Nevertheless, it is very simple to have a variable resistance with one of these carbon rods. Fig. 1 shows how this is done.

A springy copper wire is coiled around the rod and fastened to one of its ends while the other end is provided with a suitable knob. The screw which fits the knob to the carbon rod passes through a brass bushing secured to the panel. The connections are taken from one end of the resistance through the bushing and from the other end by means of the coiled wire. Convenient

(Continued on page 1874)



# Correspondence from Readers

## THIS MAY HELP YOU

Editor, RADIO NEWS:

This is for the benefit of any amateurs who are attempting to operate receiving sets in close proximity to an electric generating station and find that they are unable to get satisfactory results, owing to the unearthly noises produced in the phones. I tried for months to discover the cause of noises of this kind in my receiving set, using all kinds of hook-ups as suggested by friends, all sorts of choke coils, antennae, etc., without result.

This set was located about 200 yards from a small power plant, in which was operating a direct current generator. I could count the revolutions of this machine by listening in my phones. The more I amplified, the louder became the noise, until it drowned out all signals completely. I tried the "Quizz Column" of several radio magazines and received a lot of good advice, but no relief.

While watching the generator in question, one night, I noticed that there came a slight flash on the commutator at each revolution, and at the same place always, and was informed by the attendant that it was caused by a "flat" spot on the commutator and it could be stopped by turning off the commutator.

After considerable string-pulling it was arranged to have this job of turning done; the result was remarkable. All noise ceased and all signals came in loudly and clearly. I have since found that a like condition existed in a nearby city where all radio sets for a radius of four city blocks were completely knocked out by a small generator in a certain hotel.

I am writing this, hoping that it will meet the eye of some poor amateur who is up against this same proposition. It will be found practically impossible to get any kind of satisfactory results in the vicinity of one of these flat commutators. I might almost say that this condition might be classed as a nuisance and handled accordingly. It will be found that this condition prevails only where the generator is of the direct current type. As all alternating current machinery is without commutators, no trouble will be experienced from that class.

C. C. HEYDER,  
Hansford, W. Va.

## THE RIGHT SPIRIT

Editor, RADIO NEWS:

I have just this moment finished reading Messrs. Swallow and Bradley's letter in the December RADIO NEWS. It has invoked this reply and I would that you allow me to address this letter direct to them. It may be somebody's salvation.

Men, you are selfish. Furthermore you are jumping at conclusions. We amateurs do not intentionally do the things of which you accuse us. We are here for your good interests as well as our own. We have asked the radiophone listener to join our ranks. We want to be friends with him and divide the ether with him. In return we expect and have the right to expect certain considerations.

First you say you are interrupted on a wave-length of from 360 to 1000 meters. Are you aware that these are not the amateur wave-lengths? The amateur very seldom interferes on these waves. If he should, the law requires that he be reprimanded and perhaps severely punished. What you were listening to perhaps was ship and coastal stations operating on those wave-lengths, only YOU DID NOT KNOW. Let me ask you if you are using

a single circuit receiver? If so you have the very poorest type of tube set. Get a three-circuit set. If you do not understand them, I will be pleased to advise you as to who in your town can help you, or will volunteer my own services. It is well known that single circuit sets will not tune sharply and unnecessary interference will result. Will you let us amateurs help you?

Second, you are mistaken in thinking that amateurs are not allowed to transmit before ten in the evening. The law allows them to transmit at any time, providing they obey the other laws of transmission. The rule that asks the amateur to stand by until ten o'clock WAS MADE BY THE AMATEUR FOR THE BENEFIT OF YOU PHONE LISTENERS. Is this not a concession alone worth being thankful for? The amateur has made such rules in order to be your friend and he expects to be met half way.

Third, when you state that you have spent a great deal of money on your re-

ceiving set, that the circulation of RADIO NEWS would in all probability dwindle, if you did not take another stand toward the amateur, and in reference to this, I take my pen in hand and write you.

Personally, I don't know how any of your readers can say that you are making a broadcast magazine of RADIO NEWS. The many splendid and helpful articles you print each month are proof that you are eager to help the fellow who operates a spark station, and possesses a receiving outfit. Besides publishing numerous manuscripts which the average radio "fan" finds helpful, you also print articles that are bound to interest every class of readers. You are far-sighted enough to realize that not every reader likes to read articles of a technical nature. I believe that is why RADIO NEWS has such a large circulation. In its pages we find all sorts of articles, dealing with nearly every phase of the radio game. Besides giving us technical articles, you also publish stories that tell us what is going on in radio all over the world. If other wireless magazines would publish such a wide variety of articles as RADIO NEWS, I am certain they would increase in circulation, instead of standing just about where they started years or months ago.

C. A. REBERGER,  
Roselle Park, N. J.

## OPERATOR OF WJAJ SPEAKS

Editor, RADIO NEWS:

In the January issue of your magazine, I noticed an article from a reader in San Antonio, Texas, regarding the designating of a silent night and the penalties to be imposed on that night.

Has the "Evening News" the power to dismantle a station and revoke a license issued by the Department of Commerce? The "Evening News" notified amateurs to be present, but the amateurs failed to send a representative. Would it not have been better had the "Evening News" invited the amateurs to this meeting? The average owners of a broadcasting station and the class of people known as "radio fans" think the amateur is a criminal and should be in jail, but so long as the amateur complies with the radio laws, he does not have to worry about owners of broadcasting stations or meetings of "radio fans." If the broadcasting stations could keep the amateurs quiet through the process of law, they would have done so long ago, but they couldn't, so are trying to bully them, thinking the amateur is not familiar with the regulations governing radio communication. If the people who listen to broadcasting stations would make or purchase receivers capable of sharp tuning, they would not be bothered by interference and you, as editor of RADIO NEWS, would do well to inform the general public through your magazine, of the rights of amateurs as established by law.

Jos. H. O'CONNOR, 8YU-WJAJ,  
Dayton, Ohio.

## YES, WHY NOT?

Editor, RADIO NEWS:

Why do not all announcers at their respective stations state, after each number, who they are? The writer often wonders whether or not they are ashamed of their program or artists. Many nights we have unexpectedly tuned into a station, awaited the conclusion of the number only to hear either another number without an introduction or merely "Our next number will be," etc. Is it possible that the announcer

(Continued on page 1842)

## Radio Articles Appearing In the March Issue of Science and Invention

Talking Across the Atlantic.  
Under-River Radiophone Reception.  
Secrecy in Radio at Last. By A. P. Peck.  
Radio for the Beginner. No. 13.  
How to Select a Head Set. By Armstrong Perry.  
An Amplifier for Your Present Tuner. By Bert T. Bonaventure.  
Awards in the \$100.00 Interference Preventer Contest.  
Announcement of the \$100.00 Bind-up Post Contest.  
Complete Revised List of Radiophone Broadcast Stations.  
Radio Oracle.

ceiver you must remember the much larger sums spent by the amateur himself. His receiver must be the most delicate possible and his transmitter costs twice or thrice or more than thrice as much as his receiver. So again the amateur must ask for half the evening—and he is giving you the very heart of the evening now.

I have been wondering if you were not sorry sometimes that you wrote such a rash letter and sent it in to RADIO NEWS. Possibly written on the spur of the moment and regretted afterwards. The only way we can get things accomplished is to take it easy and be sure of our ground as we go. In that way possibly some means may be devised to put us both on a better operating basis.

N. A. CANFIELD,  
Luverne, Minnesota.  
Radio 9BVY.

(A very commendable letter and a still more commendable spirit. That's the kind of stuff amateurs must do in order to be recognized by the public. Co-operation, not sneers, is the new war cry—EDITOR.)

## THANK YOU

Editor, RADIO NEWS:

In several of the past numbers of your splendid publication, various writers stated



# New Radio Patents

## RADIORECEIVING SYSTEM

(Patent 1,434,984. Issued to Harold H. Beverage, of Riverhead, New York, November 7, 1922.)

The present invention relates to radio receiving systems, and more particularly to a system which permits of the reception of signals coming from more than one direction upon a single antenna.

As indicated in the drawing, a long horizontal

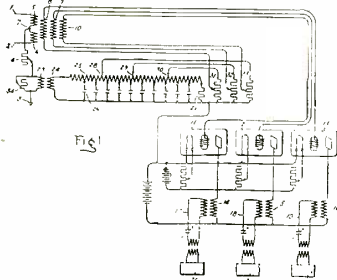

receiving antenna is made up of two conductors 1 and 2, which are grounded at the ends 3 and 4. If this antenna is constructed with distributed constants of such value that the current wave therein travels at the same velocity or substantially the same velocity as the ether wave, the current wave in the antenna will gradually build up and become a maximum at the end farthest from the transmitting station. Currents produced at the end 3 by ether waves traveling from that end toward the end 4 will have substantially zero value at the end 3 and will increase to a maximum value at the end 4. In the same way currents produced by ether waves traveling from the end 4 toward the end 3 will have a minimum value at the end 4 and a maximum value at the end 3. In order to prevent reflection of the current waves flowing in the antenna from the ends, the ground connections are made through resistances 5 and 6 having a value substantially equal to the surge impedance of the antenna.

## SYSTEM FOR PRODUCING MODULATED WAVES

(Patent 1,436,252. Issued to Raymond A. Heising, of East Orange, New Jersey, November 21, 1922.)

This invention relates to the production of modulated high frequency electromagnetic waves by varying the current or voltage supplied to an arc in accordance with signals; for example, sound signals.

Referring to Fig. 1, a generator 5 constitutes a source of direct current for supplying an arc circuit which comprises the anode-cathode path of the electron discharge device 6, the high frequency choke coil 7, the electrode 8, electrode 9 and conductors 10 and 11. The frequency of the discharges across electrodes 9 and 12 is controlled by the magnitudes of inductance 13 and capacity 14 in the control circuit 15, which circuit includes electrodes 12 and 9. The electromagnet 17 maintains a field across the space between electrodes 8, 12 and 9 which serves to extinguish the arc after each discharge. The magnet 17 is energized by source 5. The device 6 includes an anode 18, a filamentary cathode 19

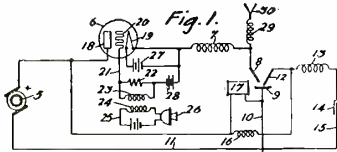

and a grid or impedance controlling element 20. Connected to the grid and the cathode is the input circuit 21 comprising resistance 22, shunted by the secondary 23 of a transformer to which is coupled the primary 24, said primary 24 being located in series with the controlling microphone or an equivalent device 26 in the circuit 25. The usual sources 27 and 28 are provided for heating the cathode and maintaining the grid negative with respect thereto respectively. The arc across the electrodes 8 and 9 is included in the path to ground of the antenna circuit which comprises inductance 29 and the serial 30. With proper

adjustments the radiated frequency will be an approximate sine wave of the same frequency as the frequency of the discharge across electrodes 9 and 12.

## ELECTRICAL SIGNALING

(Patent 1,439,947. Issued to Louis Cohen, of Washington, D. C., December 26, 1922.)

This invention relates to the art of electrical signaling, particularly, receiving radio signals, and a system for use in practicing the same.

The object of the present invention is to eliminate interferences in the reception of radio signals and thus insure greater reliability in radio communication.

In carrying this out, the incoming signals are acted upon by local oscillations which combine with them producing beats. The beat frequency current is then impressed upon a Wheatstone bridge, the constants of the arms of which are so adjusted as to produce zero potential across the bridging arm for the current of the beat frequency, and hence no current flows in it. The indicating instrument is coupled to two arms of the bridge and also to the bridging arms. By properly adjusting the couplings in the matter

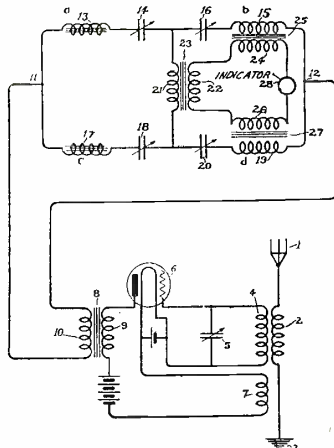

of direction and magnitude, a condition is obtained where the interference effects are balanced out, and the indicating instrument responds only to the signals which are to be received.

## WIRELESS RECEIVING SYSTEM

(Patent 1,440,432. Issued to Chester T. Allcutt, of Pittsburgh, Pennsylvania, January 2, 1923.)

The object of this invention is to provide a receiving system for undamped signal impulses which embodies the heterodyne or "beat" principle of operation.

In a well-known type of receiving system for undamped signal impulses, reception is effected by heterodyning the received signal currents with those from a local source to cause the formation of beat currents.

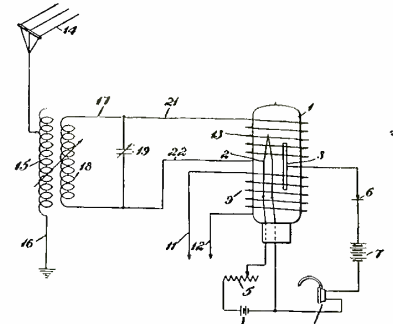

I have found, however, that similar results may be obtained by combining the magnetic fields of the signal and local currents to form a resulting magnetic field of beat frequency and then

causing the resultant magnetic field to control the impedance of a vacuum-tube device.

The desired result may be obtained by employing a two-electrode vacuum tube, of well-known form, and surrounding the tube with magnetizing windings which are associated with wave-responsive apparatus and with a local source of high-frequency currents.

## RADIORECEIVING SYSTEM

(Patent 1,435,009. Issued to Edward W. Kellogg and Chester W. Rice, of Schenectady, New York, November 7, 1922.)

Our present invention relates to radio receiv-

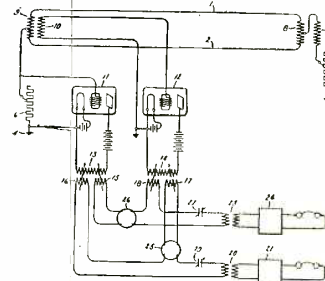

ing systems, and more particularly to a system which permits of the simultaneous reception of a plurality of signals at a single receiving station.

In carrying out our invention, we make use of a long horizontal receiving antenna made up of two conductors 1 and 2 which are grounded at the ends. In the drawings we have shown only one end of these conductors with the ground connection 3 at that end. If this antenna is constructed with distributed constants of such value that the current wave therein travels at the same velocity as the ether wave, the current wave in the antenna will gradually build up and become a maximum at the end farthest from the transmitting station. If the velocity of the current wave in the antenna differs somewhat from that of the ether wave then for a certain distance the waves will add, but a point will finally be reached where one wave will be so far in advance of the other that the two will be in phase opposition. Interference will then occur and the current wave will start to decrease.

## VACUUM-TUBE SOCKET

(Patent 1,432,992. Issued to John O. Gargan, of Brooklyn, New York, October 24, 1922.)

This invention relates to socket structures, and has for its object the provision of a socket in which spare vacuum tubes used in telegraph sets may be carried without undue vibration or liability to breakage.

In the operation of the device, a tube is inserted in the socket 6, the pin 17 entering slot 16, and the electrodes 10 entering apertures 9. As the tube is thrust into the socket sufficiently far to permit it to be turned so that pin 17 will enter the side portion of slot 16, the electrodes contacting with disk 12 will depress the same against the action of spring 13. The compression of spring 13 will thereafter tend to maintain the bayonet lock effective so that the tube will have no tendency to fall out. A provision of the re-

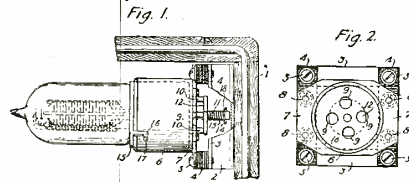

sistent portions 4, on which the socket and tube are mounted, prevents any vibrations or jars contributed to the casing to which the bracket 2 is attached, from seriously affecting the lamp.

## RADIORECEIVING SYSTEM

(Patent 1,434,707. Issued to Edward W. Kellogg, of Schenectady, New York, November 7, 1922.)

The present invention relates to radio receiving systems, and more particularly to systems of the class in which a plurality of widely separated

(Continued on page 1822)



# Here at Last — the radio head set you have been waiting for



### Superior Features

Lightweight, 12 oz. Extremely sensitive. No distortion. Anchored cords. Matched receivers. Centered pull on diaphragms. No hair catching projections. Small, compact; maximum efficiency.

Backed by years of experience in the making of voice reception apparatus this head set is the last word in unequalled distinctness, extreme sensitiveness and pure clear tonal qualities.

Your receiving outfit equipped with this radio head set will assure you of maximum service in faithfully reproducing all broadcasted vocal and musical sounds.

The sanitary headband is self-adjusting, with a spring tension that automatically takes up the wear. The wearer is assured of the greatest comfort with minimum surface pressure. The removable interiors are entirely insulated from the case and allow for temperature changes.

Give yourself a treat—try them—you will find they are all we claim—and more.

**Dictograph Products Corporation**  
220 West 42d Street New York, N. Y.



**EASTERN  
RADIO**

**INSTITUTE**

TEL  
BACK BAY  
5 9 6 4

**899 BOYLSTON ST.  
BOSTON, MASS.**

*RADIO today is commanding the interest of more people than any other industry! Splendid opportunities are NOW available for those who are alive enough to see the possibilities. My fifteen years' experience in Radio tells you that FORTUNES will be made within the next five years for those who train themselves now and take advantage of the present opportunities.*

The EASTERN RADIO INSTITUTE is the OLDEST, LARGEST and BEST EQUIPPED Radio school in New England. THOUSANDS of satisfied graduates tell our story best! Day and Evening classes. Start any Monday.

REMEMBER:—Our ORGANIZATION with YEARS of PHENOMENAL EXPERIENCE and SUCCESS is behind EVERY man who enrolls!

"Ask any man in Radio—he will tell you!"

Our illustrated prospectus for the asking.

F. L. PITTS, Director.

**TIMES  
APPLIANCE CO.**

**145 West 45th St.  
NEW YORK, N. Y.**



Distributors for

RADIO CORP. of AMERICA  
WESTERN ELECTRIC CO.  
CLAPP-EASTHAM CO.  
The BRANDES CO.  
DE FOREST RADIO TEL. & TEL. CO.  
FEDERAL TEL. and TEL. CO.  
And Other Reliable Radio Manufacturers

WHOLESALE ONLY  
Write for Price Lists

We Handle

Transmitting and Receiving  
Equipment of All Kinds

You want these

**TIMES ESTED SPECIALS**  
FIXED PHONE CONDENSERS  
FIXED GRID CONDENSERS  
FIXED GRID LEAKS

products of the soil at the same prices that they commanded when everyone had at least a vegetable garden, has led to some legislative efforts, to control natural laws, that would make King Canute realize that he was a "piker" if he could look back from across the Styx. Are folks who still live on the soil, either by reason of unusual success in agriculture or of failure to acquire the wherewithal to leave it, going to give up their air-neighbors? Will they stop buying radio just as it begins to put them one jump ahead of the buyer in the race for profits? Will they turn deaf ears to the friends who, after the day's work, give them a show better than the average fellow who has moved to town can have except by using the same means?

A few dozen centuries ago a scientist by name of Archimedes informed the world that he could pry the globe out of its orbit as easily as he could fork a potato out of its hill if he could only find a place to put the end of his lever. The fellow who undertakes to change the course of radio, except by making it easier for the public to use, is going to encounter a similar difficulty. If we put on the brakes, the only result will be a squeal and a trail of smoke from the brake band.

The shutting off of publicity may seem to some persons a means of retarding the speed of the advancing wave of interest in radio. A short and convincing study of this method can be made by interviewing anyone who has tried to suppress information that was of interest to the public. If money could hush up anything the daily papers would be smaller than they are and more profitable to the owners. Politicians have sometimes made use of propaganda about one issue to turn public attention from another, when the matters were not so near to the heart of the people that they would be conscious of loss or damage, whichever way the scales balanced; the use of publicity in restricting the sale of products long considered as necessities was well tested during the war; but an attempt to keep the public waiting for a thing that everybody wants, just to enable manufacturers and dealers to play safe, is less apt to succeed than an appeal to the "cop" at 42nd Street and Fifth Avenue to hold up the traffic while a kid hunts for the penny he has dropped.

There have been suggestions of a monopoly in radio, an organization that held the situation in the hollow of its hand. One of the means by which this alleged monopoly is said to be able to slow down the business if it wants to is by refusal to license competing manufacturers to use certain circuits that are supposed to be indispensable to highly efficient apparatus. But one manufacturer at least is putting out a receiver that is said to work as well as the patented circuits, and it does not and cannot employ those circuits. Another manufacturer markets a receiver that, according to report, any user can convert into a type supposed to be monopolized, simply by changing a connection or two. I asked a dealer if he thought this practice was honest. He replied that it was no more dishonest than taking your money out of one pocket and putting it into another to foil the designs of a pickpocket! Honest or dishonest, the public will find a way to get the use of the thing it wants. It willingly or grudgingly pays the man who has control so long as he is not hopelessly hoggish, but once it is convinced that a man or a corporation is getting more than its due, it must be mollified by concessions or at least made to think that it is getting them. Putting prohibition into radio only stimulates a genius similar to that of the home brewer.

There are a certain number of brakes that are being applied to the rapidly-mov-





## Apparatus Awarded Certificates

### ACE VERNIER VARIABLE CONDENSER

Being intended for use at moderately high voltages, the plates are well spaced in this condenser manufactured by the Precision Equipment Company, 2437-39 Gilbert Avenue, Cincinnati, Ohio.

The vernier is a gear system with a

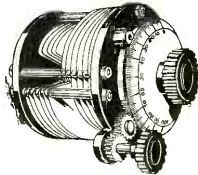

ratio of approximately 4 to 1. Connection to the movable plates is made through a pigtail at the base of the instrument. Hard rubber end plates are used and the construction is rugged throughout. As measured on a capacity bridge, at 1,000 cycles, the maximum capacity was found to be 374.97 micromicrofarads, minimum 25.74 micromicrofarads. The equivalent dielectric losses were zero ohms and 12 ohms respectively. Corresponding to these readings, the phase angle difference was negligible in the first case and approximately 12 minutes in the second case. For mounting purposes, two threaded pillars are provided. The construction is of the balanced type and has a total of 22 plates arranged symmetrically on either side of the shaft.

Arrived in excellent packing. AWARDED THE RADIO NEWS LABORATORIES CERTIFICATE OF MERIT NO. 76.

### BRIGHT STAR "B" BATTERY

When placed on a continuous discharge at several rates, the average ampere hour capacity of several samples of this dry cell "B" battery was found to be 4 ampere hours. The watt hour capacity was 65. In one test, when the discharge rate was 5 mils., a total of 1,200 hours elapsed before the voltage dropped to half of its initial value. At several different times throughout the period of discharge, the battery was tested for internal action



which would produce noises in a vacuum tube receiver and the operation was found to be entirely satisfactory. Fifteen flashlight cells of the larger size are moulded into a block of encasing sealing compound. Taps are taken off after 16½ volts in 1½-volt steps until the total of 22½ volts has been reached. Binding posts are provided for these taps.

Manufactured by the Bright Star Battery Co., 304-316 Hudson St., New York City. Arrived in excellent packing.

AWARDED THE RADIO NEWS LABORATORIES CERTIFICATE OF MERIT NO. 77.

### RADION VACUUM TUBE SOCKET

The American Hard Rubber Company, 11 Mercer Street, New York City, manufactures this moulded hard rubber socket.

It takes the standard four-prong tube, the contacts for the prongs of which are provided by four springs at the base of the socket. The socket is intended only for table or base mounting as no provisions are made for panel mounting. Overall dimensions 2¼" square by 1¾" high.

Arrived in good packing.

AWARDED THE RADIO NEWS LABORATORIES CERTIFICATE OF MERIT NO. 79.

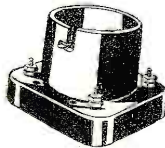

### GOODMAN TUNING UNIT

The mounting system for this spider web coil tuning unit is rather unique as may be seen from the illustration. The coils are wound on bakelite forms and the leads are brought to two long nickel plated brass strips fastened to the legs. These brass strips fit snugly into the spring receptacles provided on the mounting base itself. Two of the coils may be swung through an arc of 90°

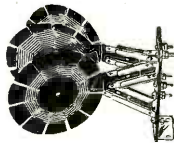

about the center coil. Connections are brought out through the rear of the mounting panel. Three different coils were submitted, intended for primary, secondary and tickler coils respectively. The primary coil when used with a standard amateur antenna of 0.00025 mfd. capacity was found to respond to wave-lengths up to 370 meters. With a 0.0005 mfd. condenser across the secondary the wave-length range covered was from 130 to 410 meters. Regeneration was possible over the entire range. The spider-web forms are 4" in diameter and the whole instrument occupies a panel space of 2" by 4½" and extends 6¼" in front of the panel. It may be incorporated with any set as the coils and their respective mounting spring clips are removable from the base furnished with the unit.

Manufactured by L. W. Goodman, 10 Forrest Ave., Drexel Hill, Pa.

Arrived in good packing with no instruction sheets enclosed.

AWARDED THE RADIO NEWS LABORATORIES CERTIFICATE OF MERIT NO. 80.

### BRADLEYSTAT

Desiring to incorporate several improvements on their Bradleystat, the Allen-Bradley Company, Milwaukee, Wis., has submitted its new model of filament control rheostat.

The internal construction has been improved and the overall dimensions have been made smaller. Provision is made for changing the cut-off current value to suit different tubes. The knob has now the popular tapering effect. Also the mounting screws can be so located that they may be hidden under the knob. The variation of current

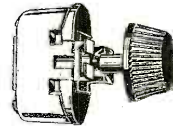

can be finely adjusted by compressing or releasing the pressure on the carbon pellets which constitute the resistance element. Transmitting tubes up to 5 watts power rating may be controlled with the Bradleystat. Tested for six hours at 3 amperes.

Arrived in excellent packing. Complete instruction sheet, template and mounting screws enclosed.

AWARDED THE RADIO NEWS LABORATORIES CERTIFICATE OF MERIT NO. 78.

### BELL V. T. SOCKET

Desiring to improve on the method of making contact with the prongs of a vacuum tube, the Bell Manufacturing Company, 11 Elkins Street, Boston, Mass., offers this V. T. socket.

Provision is made for spring contact to both the bottom and the sides of the prongs of a vacuum tube when it is placed in the socket. Both the off-set based tube or the standard based tube can be accommodated. This is done by means of a two-way slot cut in a reinforced portion of the shell. The instrument may be used either for table or panel mounting. When used for the latter purpose, a brass insert is placed in the protruding portion of the shell and is held against the face of the panel by means of a

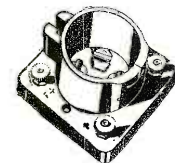

screw through the front, clamping the socket in a rigid position. The socket is



made of bakelite, finished in a maroon color. Overall dimensions  $2\frac{1}{2}$ " square by  $1\frac{3}{4}$ " high.

Received in good packing, with no instruction sheets enclosed.

AWARDED THE RADIO NEWS LABORATORIES CERTIFICATE OF MERIT NO. 65.

**WESTINGHOUSE UNION "B" BATTERY TYPE 22-M-2**

After having been discharged at several rates, this lead storage "B" battery manufactured by the Westinghouse Union Battery Company, Swissvale, Pa., was found to possess an average ampere hour capacity of 1.089 ampere hours. The average watt hour capacity was 26 watt hours. There are 11 individual cells in glass containers, which are placed in an oak finished box measuring approximately 15" long,  $2\frac{1}{2}$ " wide and  $2\frac{1}{2}$ "



high. The active area of the plates is about  $2\frac{3}{4}$  square inches. Lead vent plugs are provided at the top of the cells which may be removed when it is necessary to add distilled water to replace loss of electrolyte by evaporation. Individual cells are connected together by means of lead straps so that any voltage may be obtained by the use of clips gripping the connection between cells.

Arrived in excellent packing.

AWARDED THE RADIO NEWS LABORATORIES CERTIFICATE OF MERIT NO. 74.

**WESTINGHOUSE UNION "B" BATTERY TYPE 22-L-2**

This battery is intended for heavier duty than the type 22-M-2. The average watt hour capacity was found to be 150 watt hours and the average ampere hour capacity

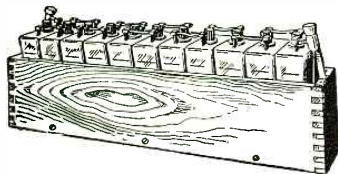

was found to be 7.07 ampere hours. The over-all dimensions of the battery are 17" long, 4" wide and 5" high. The end cells of the group of 11 are provided with binding posts for connections to the set. The active plate area of this type is about  $6\frac{1}{4}$  square inches. The vent plugs on this type are made of hard rubber and screw into suitable threads on the top of the composition filling the tops of the cells. Lead strips are used for connecting individual cells.

Manufactured by the Westinghouse Union Battery Co., Swissvale, Pa.

Arrived in excellent packing.

AWARDED THE RADIO NEWS LABORATORIES CERTIFICATE OF MERIT NO. 75.

**NA-ALD WD-11 SOCKET**

This socket is made especially for use with the WD-11 tube and is manufactured by the Alden-Napier Company, 52 Willow Street, Springfield, Mass.

The shell is of moulded condensite with a maroon finish. Phosphor bronze springs, of sufficient elasticity and stiffness, make contact to the sides of the prongs of the tube when it is inserted in the socket. Binding posts are furnished for external connections. The diameter of the base of the socket is  $2\frac{3}{8}$ ", height  $1\frac{1}{8}$ ". Two holes are provided in the base for mounting purposes.

Received in excellent packing.

AWARDED THE RADIO NEWS LABORATORIES CERTIFICATE OF MERIT NO. 73.



**WESTWYRE VARIABLE CONDENSER**

This vernier variable condenser is manufactured by the Westwyre Radio Co., Westfield, Mass.

A separate shaft operating through the main one controls the vernier element, which consists of a single plate. Condensite end plates are used to support the metal pillars which hold the stationary plates. A  $\frac{1}{4}$ " brass shaft is provided with a phosphor bronze strip which provides a wiping elec-

trical contact to the movable plates. The vernier also has a pig-tail connection to the movable plate. A 23 plate condenser submitted for test gave the following measurements at 1000 cycles: Capacitance, maximum, 482.33 mmf.; minimum, 14.16 mmf. The equivalent dielectric losses were 90 ohms and 50 ohms, respectively. Corresponding to these values, the phase angle difference was two minutes in the first case and two degrees, 20 minutes in the second case. Three screws are provided for panel mounting. Over-all dimensions of the condenser are  $3\frac{1}{2}$ " in diameter by  $2\frac{5}{8}$ " in height.

Received in excellent packing with instruction sheets and template enclosed.

AWARDED THE RADIO NEWS LABORATORIES CERTIFICATE OF MERIT NO. 66.

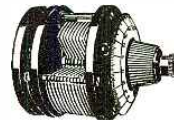

**COTO-COIL TUBE SOCKET TYPE 7000**

Departing from the usual practice in vacuum tube socket design, the Coto-Coil Company, 87 Willard Avenue, Providence, Rhode Island, incorporates a desirable feature in its socket.

Instead of the usual flat spring contacts which make contact to only the bottom of the prongs of a vacuum tube, this socket has springs which grip the sides of the prongs. A specially shaped slot is provided to guide the tube into its proper resting place in the socket. The spring clips are made of phosphor bronze. All the rest of the socket is made of polished brass. Bakelite strips insulate the various binding posts. The method of concealing mounting screws is unique.

Arrived in good packing and with no template or instruction sheet enclosed.

AWARDED THE RADIO NEWS LABORATORIES CERTIFICATE OF MERIT NO. 72.



**American Amateur Stations Heard In Holland**

By G. J. ESCHAUZIER

JUST as in the year past, so this year, I have devoted some of my night's rest to listening to the American amateurs, but with far better results: where I formerly succeeded in receiving from a single station, this time I managed to pick up 78.

In the past year, I gave IBCG two hours of watching, the receiver remaining entirely without change and after two hours of listening, I was afraid that the station was not coming back and that I would miss it again. This year another system was adopted. As soon as a station was heard and received from, it was immediately dropped and an effort was made to find another. Although I began to hear 11 stations the first night, I thought to myself, "these are certainly Americans and cannot be a set of French or English amateurs, who are taking advantage of this opportunity to see how they come out with their sending." The reception was carried on with a three-coil receiver and two low frequency bulbs. Honeycomb coils, however, were not used but flat spools 1 inch thick wound with No. 18 and 26 wire mounted on plug attachments. The detector and

low frequency amplifying tubes and antenna were the same as in the preceding year. Much disturbance was received from LY so that whenever the station did work, the whole range from 200 to 275 meters gave a harmonic of his signals. The statics were at the beginning very strong. Here follows a list of the stations which in the various nights were heard:

1ZE, (1AW) ? 1XM, 1YK, 111, 1FB, 1AQO, 1BCG, 1BET, 1BDI, 1MCK, 1BFC, 1ASF, 1BDT, 1CNE, 1BRQ, 1CPK, 1CDR, 1TOK, 1XNT, 1BNT, 1CDO, 2ZK, 2ZN, 2FP, 2GK, 2FO, 2YK, 2HJ, 2BML, 2CKR, 2BET, 2AWF, 2CPD, 2CBX, 2AWL, 2AYV, 2BQN, 2CJN, 2BQH, 2COZ, 2CKN, 3CG, 3NH, 3GH, 3ZZ, 3MX, 3ZW, 3XM, 3FS, 3CQ, 3HG, 3BF, 3AAU, 3AFB, 3BNU, 3BGT, 4ZW, 4ZS, 4XM, 4OI, 4BY, 4EA, 5XK, 5AGI, 6ZZ, 8AQO, 8XAE, 8ADZ, 8AGD, 8BUM, 8DET, 9ZN, 9CM, 9CXA.

2BML and 2CKR sent at the same time and at precisely the same wave-length. A curious thing was that they did not grow weak at the same time but about one minute after each other. This took place on the evening of December 12th. IBCG, old

friend of the preceding year, was exceptionally good and could be received holding the phones 4 inches from the ear and was receivable at the very weakest periods. 3ZZ and 4BY were also very good. 2FP came through fine, in fact so strong that it was hard to believe that it was an American amateur transmitting. On the evening of December 21st, a telephone was picked up on 360 meters, call of which was lost. The station at the time was broadcasting a piano solo (Second Hungarian Rhapsody from Liszt). A little later, a man began to speak but could not be understood. This telephone was heard with but one low frequency bulb operating; two could not be used on account of the great statics. There were heard, too, the old stations 1CDO, 2FP, 2CKR, 2GK, 3BGT, 8AQO, 1FB, 1XM with a code word of YMZZO and 2AWF with code word GJAGA. The statics were very strong. Herewith for the ensuing year, the tests were concluded. We still have to see if the French and English amateurs will be as fortunate in being heard in America.

—Abstract from Radio Nieuws, old



**FIRESTONE PARK RADIO CLUB**

This Club was formed October 10th, 1922, for the purpose of Promoting the Interest of Radio, by five charter members acting as executive committee as follows: Mr. Dwight Stevens, Mr. F. A. Bollinger, Mr. D. Goodenberger, Mr. Smallsreed and Mr. Loren Wilson all of the Firestone Tire & Rubber Co., Akron, Ohio.

Our meetings are held on the second and fourth Wednesdays of the month at the Firestone Club-house. We now have a membership of 55 members. The club has given one Radio Show and are now planning to give a Radio Dance.

The Club has purchased for its members to date over \$550 worth of Radio material and supplies.

**RADIO CLUB OF BROOKLYN, N. Y.**

This Club is again located at 2211 Bedford Ave., Brooklyn, N. Y. The meeting nights have been changed to the second and fourth Fridays of the month. At our last meeting, the following were elected and appointed to office:

- President—L. Jaquet.
  - Vice President—M. Carter.
  - Secretary—D. Kirchick.
  - Treasurer—K. Knudson.
  - Trustees—C. Caggiano and M. Greene.
  - Chairman Traffic Committee—M. Greene.
  - Chairman Membership Committee—D. Talley.
  - Editor "Radio Log" club paper—C. Caggiano.
- A most cordial invitation is extended to all interested in radio to drop us a line or pay us a visit. Address all communications to Secretary D. Kirchick, 409 Osborn St., Brooklyn, N. Y.

**THE SOUTH PHILADELPHIA RADIO CLUB**

The last meeting of the South Philadelphia Radio Club was held on Friday, January 19th, at the South Philadelphia Free Library. The following officers were elected:

- Mr. R. Kantrow, President.
- Mr. T. Ritter, Vice President.
- Mr. E. Welsh, Treasurer.
- Mr. J. Bieberman, Secretary.

The regular meetings are held every Friday evening at 8 P.M. The purpose of this club is to increase interest in radio in South Philadelphia and to get the amateurs together so as to keep them from interfering with each other with their transmitting sets.

Mr. Kantrow, who is president, gave an interesting talk on the radio problems in Philadelphia. Some of the members brought apparatus to the meeting, which was sold at auction. The proceeds went to the Treasury. This club will gladly receive correspondence from other radio clubs.

Address all correspondence to J. Bieberman, 1507 Milfin Street, Philadelphia, Pa.

**SAINT JOHN RADIO CLUB**

For many months there have been radio enthusiasts in the city of Saint John, New Brunswick, Canada, but it was not until recently that it was decided to form a local Radio Club. Long before there were any distributing centers for sets, small boys, who know the days of real sport, had

rigged up a home-made "wireless" set and had some wonderful results. Later, when the craze arrived in Saint John in earnest, it was seen to be something more than a plaything and Radio Fans sprang up on all sides.

Then there followed naturally the formation of a local Radio Club. This took place at the Board of Trade Rooms when William Longmire was elected President and Lee Atkinson, a well known amateur, was chosen Secretary.

The membership is to be made up of all interested in Radio whether they possess a set or not, as it is one of the objects of the Club to encourage amateurs. The demonstration of a set will be a feature of the next meeting.

Excellent suggestions were contained in an address given by J. M. Coulton, the Government Wireless Inspector for the Port of Saint John. He told of the organization of the Montreal Radio Club and how the broadcasting stations were erected. He advised amateurs not to transmit during the latter part of the evening so that others may listen in on concerts without interference. He also recommended that those who have transmitting sets should have their wave-lengths checked so as not to interfere with the Direction Finding Station at Red Head, near Saint John.

In the discussion which followed, members told of hearing programs as far off as Havana, Jacksonville, Florida, and Montreal, and Toronto, Canada.

The meeting broke up with every indication that the newly formed Club will be both beneficial and enjoyable to local Radio fans.

**MILWAUKEE AMATEURS' RADIO CLUB**

The Milwaukee Amateurs' Radio Club's first meeting of the new year was devoted to reports of the results of the 1922 trans-Atlantic tests of the A. R. R. L. The signals of one member, Marian Szukalski, Jr., 944 P. were reported, heard in Manchester, England. Attorney L. J. Topolinski, the club's recently appointed general counsel, reported the progress of the case of "McWilliams vs. Bergman" in which an Illinois amateur is being sued on grounds of interference by a broadcast listener.

R. E. Lathrop, 9ATX, of the technical committee, read a paper, entitled, "Elimination of Distortion in Receivers" at a recent meeting, and at a later one gave an informal talk on the topic of electric wave traps. Under the leadership of E. T. Howell, Sc.M., technical committee chairman, several discussions have been had in which much light was thrown on the subject of filters for C. W. transmitters.

Through the efforts of Charles S. Polachek, a former secretary-treasurer, but now a resident of San Francisco, Business Manager L. S. Baird was able to present a report on the activities of the well known San Francisco Radio Club. Axel G. Berg, Chicago sales representative of the Radio Corporation of America, addressed the society on the attitude of large radio corporations towards amateurs.

At the suggestion of the committee on relays

and interference, the club will again enforce the ruling of no testing at 7:00 p. m. All Milwaukee amateurs are asked to adhere to this rule as well as other local A. R. R. L. traffic regulations.

**NEWARK PREPARATORY SCHOOL RADIO CLUB**

Students of the Newark Preparatory School have organized a radio club.

Members of this club have long been interested in radio activity and five of the members are prepared to take their examinations to become licensed operators.

The officers who were elected at the first meeting of the club are: Chief operator, S. Fishman, and recorder, H. C. Bantin. Other prominent members of the club are: C. N. Frey, Newark, N. J.; J. W. Cleveland, Elizabeth, N. J.; S. H. Eckhouse, Newark, N. J.; B. D. Caro, Montclair, N. J.; A. L. Smyth, Bound Brook, N. J.; J. DeGraf, Paterson, N. J.

At present the members are constructing a honeycomb set using two stages of amplification, the cost of which has been appropriated by the directors of the school.

As soon as the members receive their transmitting licenses they will construct a 20-watt phone and C. W. transmitter.

**ROSELLE PARK RADIO CLUB**

At the annual meeting of the Roselle Park Radio Club, held recently in our splendid headquarters, officers for the ensuing year were elected as follows: President, Robert H. Horning, 2KK; vice-president, J. M. Scott; secretary, R. Elson Timbrook; treasurer, Ralph Roe; publicity manager, C. A. Reherger; traffic manager, Gunard Hagberg, 2CBP; radio adviser, Ralph Powell, and radio inspector, William Pinter.

The annual session was one of the most interesting and enthusiastic held for some time and it was very gratifying to note the large attendance. This fact alone vouches for the interest that the fellows are taking in the welfare of the club, and from present indications the membership will be much larger with the passing out of the present year. The race between President Horning and J. M. Scott was a very interesting one and we are glad that Mr. Horning will continue to guide the doings of our club. At present we are preparing a spring program of activities, which keeps many of the members very busy and will tend to maintain their interest.

In addition to other things, we are planning to build a 50-watt C. W. set and when this is completed we will make application for a special operating license. We have improved the appearance of our headquarters in many ways in the last few months and much of the improvements are due to Ralph Roe, chairman of the house committee. Being enthusiastic amateurs and taking an interest in the activities of neighboring radio clubs, we are eager to hear from other organizations. Our secretary's address is 134 Westfield Avenue, East, Roselle Park, N. J.

**Receiving Without An "A" Battery**

By FRANCIS J. ANDREWS

HOW many times has the amateur asked himself: "Isn't there any practical way in which I can eliminate the storage battery from my receiving set? And then these "B" batteries; the cost is small and they last quite a long while, but then, are they the most satisfactory arrangement for supplying the necessary direct current for the plates of the vacuum tube in a receiving set?"

There have been many methods devised by which it was hoped to utilize the alternating current which is supplied to the majority of homes. Many of these methods have proven failures, while others are very successful, but the cost of the additional apparatus for such a device is prohibitive to the average "Ham."

Probably any of the readers who happened to be in the air service during the war remember that certain airplane transmitting and receiving sets were operated

from the direct current obtained, using a small wind-driven generator mounted on the plane. This current was not only used

for the plates and filaments of the transmitting tubes, but also for heating the filaments. (Continued on page 1865)

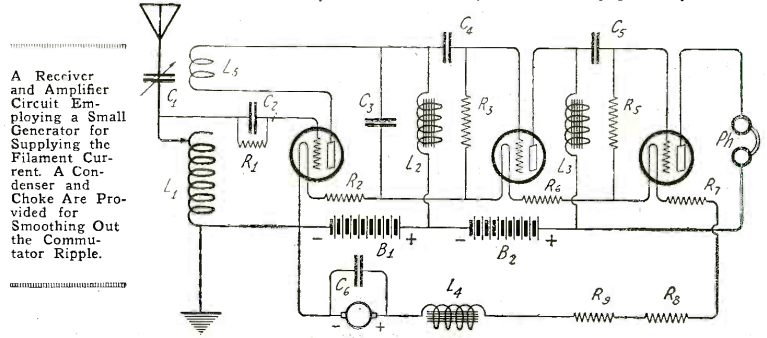



# Radio Humor



A DIFFICULT HOOK-UP



BODY CAPACITY



A CHEAP CRYSTAL SET



A GRID LEAK

## Testimonials

By JOHN D. FORREST

Messrs. Rackett & Clatter.

I saw your advertisement in the Collar Button Journal. Before using your kitty-kat whiskers my set was working poorly. Eiffel Tower only came in loud enough to tear three doors off the hinges. After using only twenty-seven dozen of your Kitty-kat Whiskers the signals have now torn the house down and we are living in the cyclone cellar.

Truly,

WILLIE BLEEVIT.

Bang & Battle Co.

Before using your Spaghetti-Wound Variometer I could only hear Saigon, India, but now I can hear all over the coal house, 963 feet from the phones.

Your friend,

HELVA NOYES.

Earthquake Loud Speaker Corp.

With only fourteen stages of amplification I brought in Annapolis so loud last night that the police broke the door down thinking it was a street car strike. Thanking you again.

MANUEL ACUTEAR,  
Pickledale, Conn.

Hurts Wave Company.

Using your excellent blueprints I built a transmitter which radiates 1000 milliamps to the ampere. Mr. Humm Dingger at American Tickle, Nova Scotia, reports my signals as QRT. This is over a distance of nearly 69,732½ miles.

Lovingly,

DAN MCGREW.

Wrattle & Squeak, Inc.

Your brass plated radio panels are the best we have ever used. The canary bird concert from BANG came in so loud that two legs of the table were nearly bitten off.

Your friends,

PHAN BROTHERS.

Wampus Kitty Whisker Co.

One night last week I listened in for three days, and using your DF Receiver, heard 786 stations at the same time. Signals were clear and strong as Sloan's Liniment.

Faithfully,

DENNY LYDE.

P. S.—Your Micolite Diaphragms are grate.

Clankety Clank & Bro.

I can faithfully say your Double Barreled Grid Leaks are the worms shoulders. Using only 600 volts on the filament I worked 2DFS with 39 amperes in the phone cords.

Yours,

OTTO KROKE.

Hiwide & Handsome Co.

The Fur Trimmed Ground Clamps shipped to me are O. K. Inserted in the phone condenser they increased the current 37 per cent. I now copy the transmitter across the street with only one phone.

Truly,

DE LEERIOUS LASHAWAY.

Marcel Wave & Tone-Ique Co.

Your Variable Phone Cord Tip is greatly efficient. The plates are well aligned and the inductance much higher than the binding posts I have used before.

Cordially,

SETH TROOLY.

WOW!

Pat, listening to a song over a badly working set: "And where does it come from?"

Young Amateur: "From the ether."

Pat: "I thought I recognized it; it sounds like Mary Ann when they took out her ap-pindyscedus."

## Sh!—

By NATHAN J. STRAUSS

Recently I visited my friend Polyp. The Polyp home had always been a noisy one. The phonograph was stopped only when the piaola was started. Little Alice was ever being urged by her proud parents to play "Hearts and Flowers" on the piano. The twins, Jack and Tom, appeared at intervals, and without being urged, gave their original impression of "Mr. Gallagher and Mr. Shean," followed with a rapid-fire duologue, and ended by harmonizing the latest "Blues." The baby, when not crying, obliged with a drum solo or squeaked his rubber doll. And through it all, like an undercurrent ran the continual stream of Mrs. Polyp's small-talk.

I rang the bell and Polyp himself answered. There was a happy, contented expression on his worn face; a new light in his tired eyes. I had always known Polyp as a worn-out, nervous little fellow, and here he was as tranquil and calm as a nun. "Sh!" he said.

I thought I had stumbled in when someone in the family was ill. The house was as quiet as the chess room up at the club.

I followed him into the living room and there, seated in a semi-circle about a small oblong box, phones on their ears, was the Polyp family. Gravely, silently, they nodded to me.

I sat down. The chair squeaked.

Little Alice stamped her foot.

"They're listening in on Pittsburgh,"

Polyp explained in a hushed whisper.

"Sh!" warned Mrs. Polyp.

Polyp sighed contentedly, sat back in his chair and puffed on his cigar.

I looked around. Dust lay on the phonograph. The piaola was mute, silent as a coffin. The baby's drum and doll had disappeared.

Outside, far away, a dog yelped faintly. Little Alice again stamped her foot.

(Continued on page 1876)



EX-STATIC INTERFERENCE

—From Judge

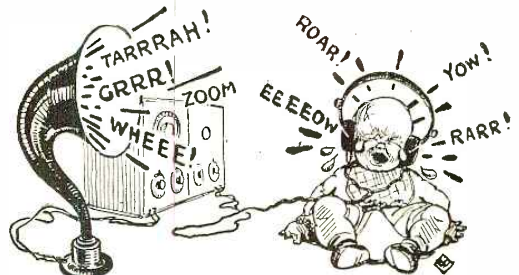

A COMPETITOR IN THE FIELD



## The Location of the Ship's Radio Room

By CLAUDE C. LEVIN

**W**HILE the trend of the times is toward standardization in all fields, both industrial and maritime, up to the present very little attention has been given by designers of ships, to a standard to be followed in the location, construction and to a certain extent, installation of the ship's radio room and equipment.

In the early days of radio, it was not to be expected that the location decided upon would be the one most conducive to efficient operation, but one would imagine that the ships now coming off the ways would be the last word in radio efficiency. Looking back over the last ten years of ship construction, however, shows that the all so necessary standard is glaringly absent.

The one definite step made towards the establishment of a standard, prior to America's entrance into the war, was the fact that on none of the new ships coming out, was the radio room located on the after, or poop deck, as it is called. The disadvantages of this location were so apparent, that it was abandoned altogether for the radio room.

During that period, on the new ships, the locations were about evenly divided between the upper deck aft, and the after end of the officers' quarters, just under and abaft the bridge. International Law requires that there be efficient means of communication between the radio room and the bridge. In all cases, practically, a speaking tube with flexible ends, or a telephone, is fitted. It can be stated without fear of contradiction, that at best these devices are not particularly efficient. The speaking tube is fitted with a whistle at either end so that the attention of the officer on watch may be called. Unfortunately, these whistles have a tendency to emit a constant noise at sea, especially when the wind is blowing, and it often becomes necessary to stuff the mouth of the tube with paper, or adopt some other measures so that the annoying noise may be eliminated. When this is done, the purpose of the speaking device is defeated. Frequently too, the tube becomes choked with dust or other matter, somewhere in its length, which is very difficult to remove.

A telephone however efficient on land, is particularly subject to the effects of electrical induction at sea, and this destroys its efficiency as a means of communication between the radio room and the bridge. In general, at sea, under ordinary conditions, communication between the radio room and the bridge takes place by means of messenger, the officer on watch usually sending the quarter-master with a message or request for bearings or whatever else he may desire, unless something particularly urgent comes up, or in time of heavy weather, when the speaking devices are used.

During the war, standardization of almost everything else connected with shipping, except radio, was developed to the nth degree, and radio men hoped that a

standard for general practice in radio would be adopted.

In the general era of standardization, some progress was made in the radio field, but not to the extent that it should have been. For illustration, while the Navy Department evolved a standard spark transmission and receiving unit of  $\frac{1}{2}$  and 2 Kw. capacity, no definite standard was adopted for the all important location of the radio room, and C.W., the apparatus which was just then emerging from the experimental to the practical stage, remains even today, unstandardized in general.

Of the war-built fleet, the vessels built by the "Submarine Boat Corporation" at Port Newark, New Jersey, 152 in number, have the radio room located on the after-end of the mid-ship house, directly over the galley. This location depends entirely upon the correct functioning of the speaking devices required by law for quick communication between the radio room and the bridge, and is only reached from the bridge by descending to the main deck,—crossing the open section and then climbing to the boat deck, atop the mid-ship house.

The battery room is located right next to the operating room, as are the sleeping quarters. This arrangement, as far as the radio unit is concerned, and aside from the location, is an ideal one. These ships carry a crew of less than 50 men, and are not required by law to carry radio at all. American steamship owners, however, prefer to equip their ships and carry one radio man.

Aside from the question of equipment which may be assumed to be the best of the various types installed, at least three locations prevail on the various types of the different ships. On some we find the radio room located on the main deck, in the officers' section, three decks below the bridge, which requires a long lead-in, and for other reasons mentioned is not ideal. On others, the location is the usual favored one—atop the after end of the mid-ship house, usually over the smoking room. On vessels of the "535" type, the location is on the promenade deck, which, however convenient from the standpoint of passengers who may desire access for the purpose of sending messages, is not so from the standpoint of the ship's navigation and communication.

The coming into general use of the radio compass brings the radio telegrapher into extremely close touch with the ship's navigators. Hitherto, he was a

mere sender of messages, now he becomes a valuable co-worker with the officers of the deck department. All of these facts should make it increasingly clear that the best location for the radio room of today is on the navigator's bridge or directly abaft of it, where the officer on watch can step into the radio room, practically speaking, without leaving the bridge.

The two steamers, Manchuria and Mongolia, now owned by the American Line, have long had their radio rooms located just abaft the bridge, and these ships have a record for efficiency that is well known.

This matter of location is one which should be taken up at the next International Radio Telegraph Convention and a standard should be adopted. Other matters too, should be considered from a purely scientific standpoint, and rules adopted, under which the ships of all nations can communicate with each other and with the shore stations, with the utmost efficiency, as Radio communication knows no boundary lines. This is an important subject and one on which every commercial operator should voice his views as it may affect future ship construction.



(c) Photonews.

Wireless Officer L. H. Tamplin, of the S.S. Berengaria Operating the New Siemens'  $1\frac{1}{2}$ -KW. Transmitter. This Set Has a Range of 3000 Miles Transmission and is Being Used for the First Time on the Above Named Transatlantic Steamer.



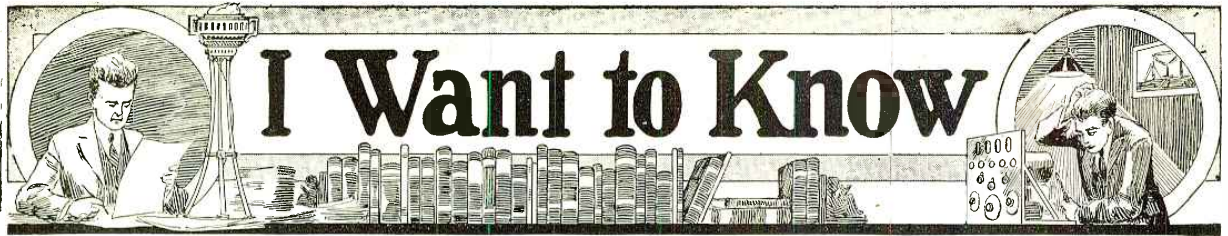

# I Want to Know

**T**HIS Department is conducted for the benefit of our Radio Experimenters. We shall be glad to answer here questions for the benefit of all, but we can publish only such matter as is of sufficient interest to all.

1. This Department cannot answer more than three questions for each correspondent.
2. Only one side of the sheet should be written upon; all matter should be typewritten or else written in ink. No attention paid to penciled matter.
3. Sketches, diagrams, etc., must be on separate sheets. This Department does not answer questions by mail free of charge.
4. Our Editors will be glad to answer any letter, at the rate of 25c for each question. If, however, questions entail considerable research work, intricate calculations, patent research, etc., a special charge will be made. Before we answer such questions, correspondents will be informed as to the price charge. You will do the Editor a personal favor if you will make your letter as brief as possible.

### AERIOLA SR. HOOK-UP

(636) Mr. S. M. Barney, Scio, N. Y., asks: Q. 1. Please show the hook-up of the Aeriola Sr. receiver, describing the instruments used.

A. 1. This hook-up will be found in these columns. The two variometer stators are wound on the same tube. The stator of the variometer in the antenna circuit is continued for five turns on each side of the stator winding of the plate variometer. Two binding posts are used for the antenna connection. If connected to one binding post a fixed condenser will be in the antenna circuit so the set can be tuned to lower wave-lengths.

Q. 2. Will the Suneco Adapter advertised on page 1330 of the January issue work with this hook-up?

A. 2. If a standard tube socket is used, this adapter may be used so that a W.D.-11 tube can be inserted. There are special sockets on the market, however, for this tube, which make adapters unnecessary.

### R. F. WITH AERIOLA SR.

(637) Mr. Charles Traylor, Indianapolis, Ind., wants:

Q. 1. Please publish the hook-up of the Aeriola Sr.

A. 1. This hook-up will be found under question No. 636.

Q. 2. Can radio frequency amplification be used with this set and if so, can the 1½-volt tubes be used?

A. 2. Yes, radio frequency can be added to this set in the conventional way. The W.D.-11 tubes may be used if desired, but it would be

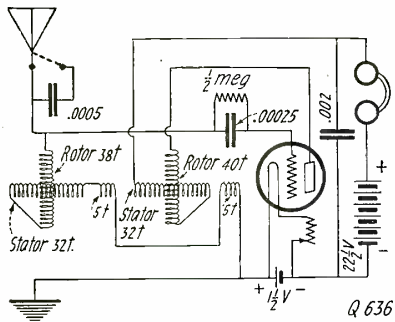

Diagram of the Aeriola, Sr. Receiver. Two Variometers Are Used, One as the Tuning Unit and the Other in the Plate Circuit.

best to use W.D.-11-A tubes, which have a higher vacuum and are better amplifiers.

Q. 3. Can any standard variometers be used in this set?

A. 3. As described in the answer to question No. 636, specially wound variometers are used, but any standard instrument may be used with good results.

### SWITCH FOR RADIO AND AUDIO FREQUENCY

(638) Mr. Harold Brown, Broomfield, Colo. wants to know:

Q. 1. Is it possible to wire a receiving set so that the amplifying tube can be used either as a radio or an audio frequency amplifier at will, by means of a switching arrangement?

A. 1. This is not practicable. An arrangement of this sort would require such a multiplicity of switches and wiring, that even if it could be done, it would operate considerably below average efficiency.

### DE FOREST TYPE D REFLEX RECEIVER

(639) Mr. J. B. Parsons, Toronto, Canada, requests:

Q. 1. Will you kindly publish the circuit used in the De Forest Reflex receiver?

A. 1. This hook-up appears on these pages.

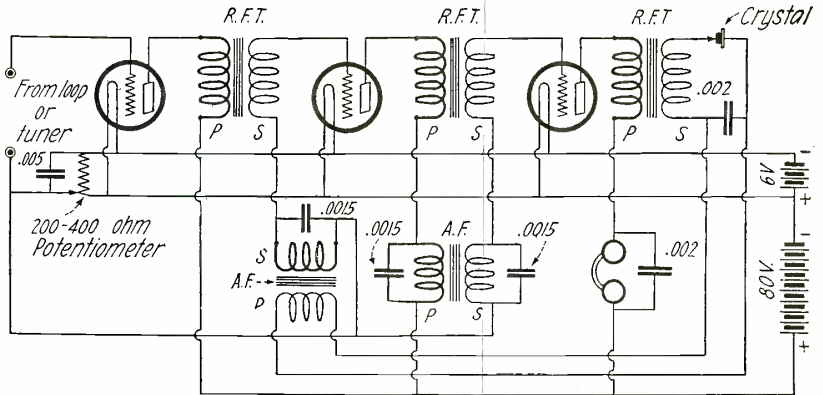

Here is the DeForest Reflex Circuit. Three Tubes Are Used for Five Stages of Amplification. A Crystal is Used for the Detector.

A crystal detector is used and very clear reception is obtained.

Q. 2. Is this receiving outfit designed for loop reception, or can it be used with the regular aerial?

A. 2. This receiver is designed to be used with a loop, but it can be used with a regular antenna in conjunction with a good receiving tuner.

### POWER TUBES FOR AMPLIFICATION

(640) Mr. J. C. Neufeld, Freeman, S. D., wants to know:

Q. 1. Can power tubes be used in place of the regular amplifying tubes and detector in a Westinghouse R. C. set?

A. 1. Power tubes can be used to advantage in any amplifying circuit, provided enough voltage is put on the plates. This would be advantageous in the second stage, but there would be very little advantage in the first stage. Better results will be obtained by using a soft tube for the detector.

### CONDENSERS AND WAVE-LENGTH

(641) Mr. Wadsworth, Havana, Cuba, asks:

Q. 1. Does increasing the capacity of a series condenser increase or decrease the wave-length?

A. 1. A condenser in series with an inductance will decrease the wave-length, but if the capacity of the condenser is increased, the wave-length will increase, but it will never equal the wave-length of the inductance alone.

Q. 2. Does increasing the capacity of a condenser shunted across an inductance increase or decrease the wave-length?

A. 2. A condenser shunted across an inductance will increase the wave-length of the inductance. Increased capacity will always increase the present wave-length of any circuit.

Q. 3. What is the value of the resistance in a resistance coupled amplifier using Radiotrons?

A. 3. This will vary between 50,000 and 70,000 ohms. The higher the internal impedance of a tube, the higher the resistance can be.

### BANK WINDING

(642) Mr. Sidney P. Schapen, Madison, Wis., requests:

Q. 1. Please publish detailed information in regard to bank winding.

A. 1. We are showing in these columns a diagram that illustrates fully the method of winding bank-wound coils. When turn No. 5 comes around, between and above turns No. 2 and No. 4, it is bent sharply across turn No. 4 and continues around above and between turns No. 3 and No. 5. When it comes around again, it is bent sharply down to the tube and continues as

shown in the diagram. The winding should be kept fairly tight and a fairly large size wire should be used, such as No. 22 B. & S. gauge. If smaller wire is used, difficulty will be experienced in banking.

### LIGHTING CIRCUIT AS AN ANTENNA

(643) Mr. Paul F. Mumma, Ellwood City, Pa., wants to know:

Q. 1. Would it be as satisfactory to use the lighting circuit for an aerial, using the Antinella in series?

A. 1. This would depend largely upon certain conditions, such as length of wire in the circuit between the transformer and instruments, etc. As a rule good results are obtained, although a regular antenna is preferable.

Q. 2. Can WD-11 tubes be used satisfactorily in this circuit?

A. 2. Yes, these tubes will work efficiently in any standard circuit.

Q. 3. Please publish the hook-up of the De Forest D-7 Reflex receiver.

A. 3. This will be found in this issue in answer to question No. 639.

### JACKS IN A REFLEX CIRCUIT

(644) Mr. H. F. Hodder, Park Rapids, Minn., writes:

Q. 1. Please give a hook-up using three tubes for four stages of amplification, and using jacks to control the audio frequency.

A. 1. Jacks cannot be used in this kind of a circuit. This hook-up, minus the jacks, will be found in the February issue in answer to question No. 611.

Q. 2. Is this circuit as efficient as a five-tube set would be?

A. 2. If this set is carefully constructed, properly wired, etc., very good results will be obtained.

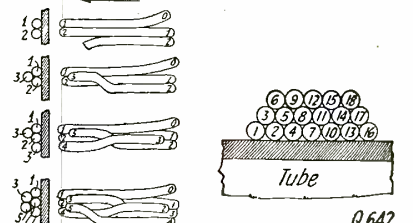

Method Used in Bank Winding. This is Fully Described in Answer to Question 642.

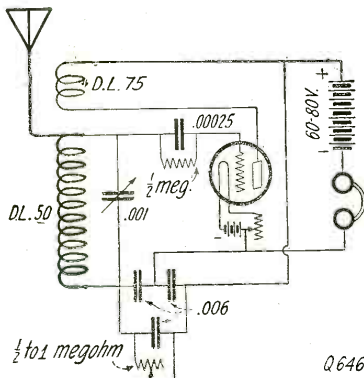

The New Flewelling Circuit. The Resistance Across the .006 Mfd. Condenser is Very Critical.

although the efficiency will probably not be quite so high as a standard five-tube receiver.

Q. 3. Is it advisable to use a grid leak when using more than 60 volts on a U.V.-201 when used as an A.F. amplifier?

A. 3. A grid leak is not used in an amplifying circuit. A leak should always be used in the grid circuit of a detector.

**AUDIO FREQUENCY AMPLIFICATION**

(645) Mr. E. A. Alltrup, Arcadia, Mo., asks: Q. 1. What make of audio frequency transformers would give greatest amplification, and what ratio should be used for first and second stages?

A. 1. The first stage can use a transformer with a ratio of 5 to 1, and the second stage transformer should have a ratio of 3 to 1. Good results can sometimes be obtained in the first stage with a 9 to 1 ratio, but as a rule this is too high. Any standard transformer will give good results.

Q. 2. Can any standard audio frequency transformer be used with good results with the Myers Hi Mu Audio?

A. 2. Yes, any good transformer will prove satisfactory with these tubes.

Q. 3. Please publish a hook-up using a loose coupler with detector and two stages of audio frequency amplification, using only two tubes.

A. 3. This cannot be done. Two tubes could be used for detector, one stage of radio and one stage of audio frequency, but not for detector and two stages of audio frequency.

**FLEWELLING CIRCUIT**

(646) Mr. Abraham B. Cox, New York City, writes:

Q. 1. Please publish a hook-up showing the Flewelling circuit with all apparatus named.

A. 1. This hook-up appears herewith. No ground connection is needed and very selective results are obtained. The resistance across the .006 mfd. condenser is very critical and should be variable. All instruments are named on the diagram.

**EFFICIENT ANTENNA LENGTH**

(647) Mr. Alvin Ziegler, Scranton, Pa., wants to know:

Q. 1. What is the most efficient length of a one-wire antenna with a series condenser for broadcast work?

A. 1. The best all round antenna is one wire, about 150' long including the lead in and ground. This will have a natural period of 210 meters, which will leave sufficient inductance to be used in the tuner.

Q. 2. Which is more advisable, a short antenna, directly connected to the set, or a longer one with a series condenser?

A. 2. A long antenna is better. The series condenser will give a finer degree of tuning than can be accomplished by means of switches on the tuner.

**A 15-WATT C.W. TRANSMITTER**

(648) Mr. J. F. Avitch, Grand Forks, N. D., requests:

Q. 1. Will you please publish a good hook-up for a 15-watt transmitter?

A. 1. This hook-up will be found in these columns. This set can also be used for telephone transmission.

**CRYSTAL SET TROUBLE**

(649) Mr. Geo. Rollisson, Hanford, Cal., writes:

Q. 1. Why doesn't my crystal set work any more? Have been getting good results up to now.

A. 1. If the wiring is all correct, it is possible that you need a new crystal. Try cleaning your crystal with soap and water. The cat-whisker on the detector may be oxidized on the point. Cut a small piece off to make a new surface.

Q. 2. My aerial is about 40' from, and at right angles to the power line. Will this prevent reception?

A. 2. If no disturbing noises are present in your phones, you are having no trouble from this source.

**R. F. WITH R. C. SET**

(650) Mr. C. C. Dicken, Louisville, Ky., requests:

Q. 1. Will you please show how to connect radio frequency to an R. C. set without disturbing the wiring?

A. 1. This hook-up appears herewith.

**RADIO FREQUENCY TUNING**

(651) Mr. Cranston Coen, Excelsior Springs, Mo., writes:

Q. 1. I have been told that sets using radio frequency are very difficult to tune. Is this true?

A. 1. Radio frequency will make the set tune sharper, but if the radio frequency unit is constructed correctly, it should not prove more difficult to tune than the average regenerative set.

Q. 2. What is the difference between tuned and untuned radio frequency amplification?

A. 2. Untuned radio frequency uses transformer or choke coil coupled amplifiers. Tuned radio frequency is where the amplifying tubes are coupled by a small inductance which is shunted by a variable condenser for tuning. A variometer may also be used for this purpose.

Q. 3. What are the chief disadvantages in using radio frequency?

A. 3. If the set is constructed correctly, there are no real disadvantages except the further current consumption of the storage and "B" batteries. In view of the great range obtained, this of course can be ignored.

**ANTENNA DESIGN**

(652) Mr. E. B. Moore, Stuart, Va., wants to know:

Q. 1. Which is the best aerial, one wire, two wires or a four-wire cage, 50' high and about 130' between masts?

A. 1. For receiving purposes, the one wire would prove as efficient as the others. If a transmitting antenna were desired the four-wire cage would be best, but the length would have to be cut down to about 70' to be under the 200-meter amateur transmitting wave-length.

**POWER AMPLIFIER HOOK-UP**

(653) Mr. Gunnar Skalet, Mayville, N. D., writes:

Q. 1. Please publish the hook-up for the Westinghouse power amplifier.

A. 1. This circuit was published in answer

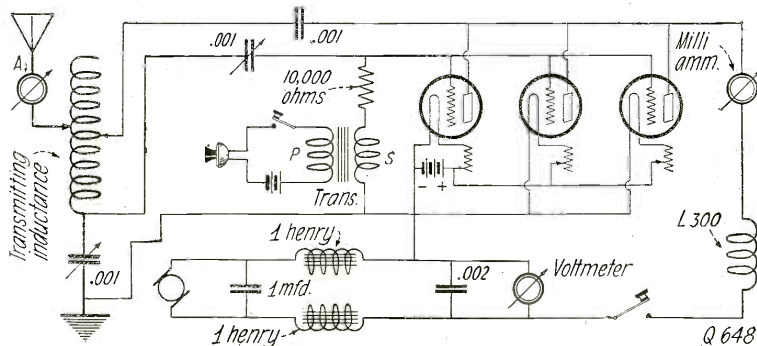

Here is Shown an Efficient 15-Watt Transmitter. The Colpitts Oscillator Circuit is Used and a Very Good Range Can Be Obtained.

to question No. 557 in the December issue of RADIO NEWS.

Q. 2. Can one step only be used to advantage over an ordinary amplifier? If so, please publish hook-up.

A. 2. A power amplifier will not give much better results than an ordinary amplifier if only one stage is used after the detector. A one-stage power amplifier used in conjunction with a one- or two-stage amplifier would be worth while. Such a circuit can be found in answer to question No. 553 of the December issue of RADIO NEWS.

Q. 3. Can the split type of transformer used in the Westinghouse power amplifier be purchased?

A. 3. These transformers are only to be had in conjunction with the amplifying unit, and cannot be bought separately.

**CARDBOARD TUBE INSULATION**

(654) Mr. C. A. Dakin, Digby, Nova Scotia, asks:

Q. 1. Will you please advise of a black paint suitable for waterproofing cardboard tubes?

A. 1. Any good black enamel paint will waterproof cardboard tubes, but it cannot be recommended as an electrical insulator. A good grade of shellac should be used.

Q. 2. I have been advised that acid should not be used in soldering electrical connections, on account of corrosion. Is this true?

A. 2. If the acid is not wiped off after solder-

ing, it will naturally corrode the wire to some degree after a while. If fairly large wires are soldered, this will make no difference. Where very fine wires are connected, such as are used in amplifying transformers, it is best to use some non-corroding paste.

Q. 3. I have a detector tube that stops oscillating at times, but will start again by moving the primary switch. Can you inform me what is the trouble?

A. 3. This might be caused by a bad connection in your set. Perhaps the contacts of your tube socket are loose and do not make a firm contact. Examine all connections at the binding posts. We do not believe that this is caused by the tube itself.

**LOUD SPEAKER AND CRYSTAL**

(655) Mr. E. Macmillan, Vancouver, B. C., wants to know:

Q. 1. Could the loud speaker shown in the "Wrinkle Contest" in the January issue be used with a crystal set?

A. 1. This loud speaker could not be used with a crystal set unless two stages of amplification were used. The output of a crystal set is very small and no loud speaker could be used with it alone.

Q. 2. Instead of a 2,000-ohm Murdock phone, would a 1,000-ohm phone do?

A. 2. A 1,000-ohm phone would work satisfactorily with this loud speaker.

**THE REFLEX HOOK-UP**

(656) Mr. W. Leonard Stevens, Somerville, Mass., asks:

Q. 1. Please publish a hook-up showing how the reflex circuit of question 611 in the February issue may be used with jacks.

A. 1. This circuit cannot be used in conjunction with jacks. This circuit, to work efficiently must be perfectly balanced and even if jacks could be inserted, the whole set would be thrown out of resonance by so doing.

Q. 2. Will a variable condenser of .0005 mfd. capacity be of benefit across the secondary, assuming the coils are honeycombs?

A. 2. A variable condenser is absolutely necessary across the secondary coil to tune the grid circuit.

Q. 3. Will a circuit of this kind give as good results as may be obtained by the use of separate tubes?

A. 3. Very good results will be obtained with this circuit if it is properly constructed, but the efficiency will not be quite as great as a regular five-tube set.

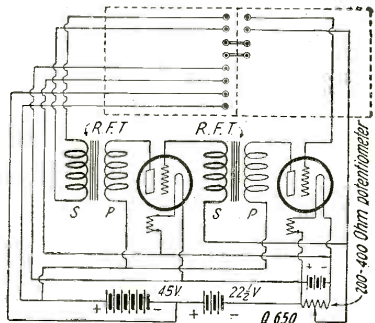

The Proper Way of Connecting Two Stages of Radio Frequency to a Westinghouse R.C. Receiver is Shown Above. It is Not Necessary to Disturb the Interior Wiring of the Set, All of the Connections Being Made Directly to the Binding Posts. A 45-Volt "B" Battery Is Used for All Four Amplifying Tubes.



# Wide Range Proves Crosley Efficiency

Sebring ~  
Florida  
Hears  
Honolulu ~  
Hawaii

HONOLULU

Every day there comes to us unsolicited new evidence of the remarkable results achieved with various models of Crosley Radio Receiving Sets.

Sebring, Fla., using a Model X. Crosley Receiver—(price only \$55 for this four tube set)—“clearly hears three selections and two announcements from KDYX at Honolulu, 4900 miles away.”

Centerburg, Ohio, receives 1920 miles from Los Angeles, Calif.; 950 miles from Fort Worth, Tex.; 1200 miles from Havana, Cuba; and 750 miles from South Dartmouth, Mass. A Crosley Model VI, a two tube set that costs but \$28 was used.

With a Crosley Harko Senior, \$20.00—a man from Rock Valley, Iowa had these very satisfactory results—“I have tested out the Harko Senior and am ready to agree that you made no over statements. We have heard Winnipeg, Canada; Dallas, Tex.; and many other points.”

These are just a few quotations from among the hundreds that satisfied Crosley users are constantly sending us.

No matter what Crosley Instruments you choose, you may be sure that it will perform everything claimed for it—and more besides.

Every Crosley Model, ranging in prices from \$16 to our beautiful console Model XXV at \$150 offers the highest efficiency at the lowest cost.

Listen in on a Crosley and be convinced.

We also manufacture a complete line of parts for those who wish to make their own outfit. Among these are Variable Condensers, Knobs and Dials, V-T Sockets, Variometers, Variocouplers, Rheostats and the well known Crosley Radio Frequency Amplifying Tuner.

**CROSLEY**  
BETTER—COST LESS  
RADIO RECEIVERS

**CROSLEY MANUFACTURING CO.**  
422 Alfred St. Cincinnati, Ohio

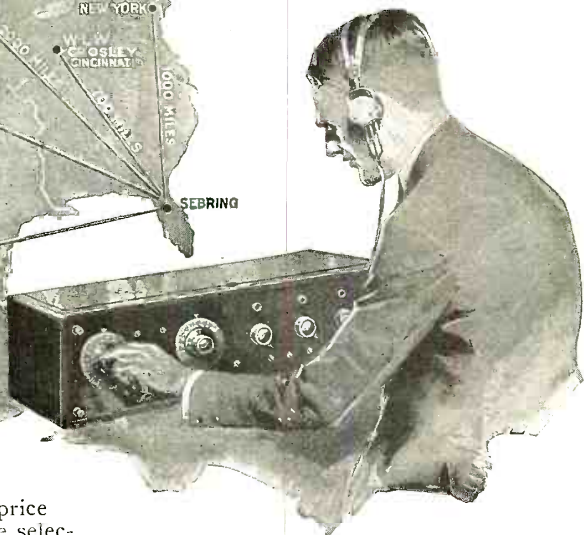

## THE THREE MOST POPULAR RECEIVERS ON THE MARKET

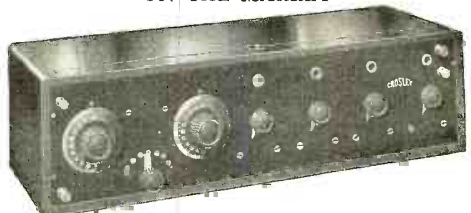

**CROSLEY MODEL X.** A four tube set that gives remarkable results. Combines one stage of radio frequency amplification with a tuner, audio detector and the Crosley Two Step Amplifier. Price without bulbs, batteries or phones .....\$55.00

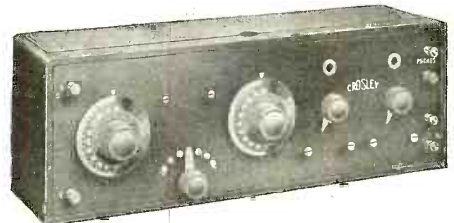

**CROSLEY MODEL VI.** A two tube set that gives uniform satisfaction everywhere. Combines one stage of tuned radio frequency with tuner and audio detector. Price without bulbs, batteries or phones .....\$28.00



The Crosley Harko Senior, a one tube non-regenerative receiver, of which thousands have been sold—retail prices \$14, \$15 and \$18. Similar instruments, but using Armstrong Regenerative Circuit, manufactured under license under Armstrong Patent No. 1,113,149 dated October 6, 1914 can be obtained from the manufacturers,

The Precision Equipment Co., Powell Crosley, Jr., Pres., Cincinnati, Ohio. Write them direct.

# UHL STEEL Radio Table



No. 7990 Radio Table

Ground this table and it will reduce the howl by practically eliminating body capacity. Makes tuning more stable and in many instances, shielding unnecessary.

Convenient, durably built, low in price. Just the thing for your set. Top is 16"x24". Drawer for supplies; large size. Shelf for "A" and "B" batteries and charging outfit. Hook for ear phones. Steel throughout. Finished in olive green or maroon (to match mahogany) baked on enamel. Shipping weight K. D. 35 lbs. Price, \$10.00 f. o. b. Toledo.

See your dealer. If he cannot supply you, we will ship direct.

## Radio Operator's Chair



No. 8500-V-WB

The Toledo Metal Furniture Co.  
1700 Hastings St. Toledo, O.

Sit all night without fatigue. No more backache. Built to fit the body and holds it in correct posture. Approved by American Posture League. New in principle. Low price. 2" fibre casters that roll freely over floors and rugs.

No set complete without an Uhl Steel Radio Operator's chair. Get literature.

## New Radio Patents (Continued from page 1813)

receiving antennae are connected by transmission lines to a central receiving station.

One of the objects of this invention is to provide an improved method of operating such a system whereby an efficient reception of desired signals may be secured and the effects of disturbing influences either from nearby stations or from static may be minimized. Another object of this invention is to provide an improved system of the class described whereby a more efficient reception of desired signals may be obtained.

In order to attain the objects of the invention a plurality of receiving antennae are located at widely separated points, so chosen geographically

Fig. 1

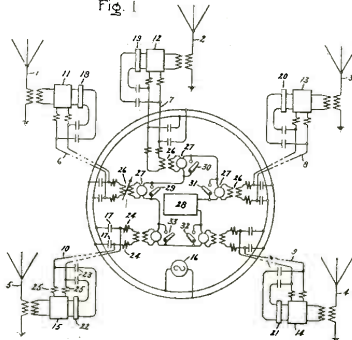

that the intensity or phase relation between the signaling impulses and disturbing influences will be different at the different points of reception. In addition means for varying the phase and intensity of the currents impressed upon the receiving apparatus are provided so that by suitable adjustment the signaling currents received upon different antennae may be brought into phase or approximate phase with one another and caused to add amplitudes in the receiving apparatus while the disturbing influences will at the same time be more or less out of phase and will combine in heterogeneous phase relation and therefore increase less rapidly than the desired signal with an increasing number of receiving antennae. As a result the stray ratio will be greatly improved.

In case continuous wave signals are to be received it is desirable that the detected currents shall all be of the same frequency, and that a constant relative phase relation shall be maintained. To secure this result, we use a single source of current at the receiving station for controlling the operation of all of the detectors and utilize the transmission lines for transmitting this current to the individual detectors. In order to eliminate the necessity of transmitting any high frequency current over the transmission lines, this source may be of comparatively low frequency, and by providing frequency multipliers at each receiving antenna the frequency of the current transmitted may be multiplied to produce the high frequency current desired for the operation of the detectors.

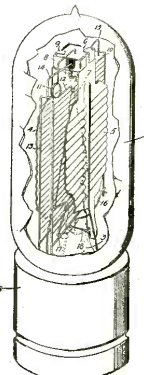

VACUUM TUBE

(Patent 1,438,969. Issued to Lawrence R. Spengeman, of Jersey City, New Jersey, December 19, 1922.)

This invention is particularly applicable to vacuum tubes in which a plurality of electrodes are used such as a filament, a plate and a grid, the space relations between which must be maintained constant, in order that the proper operation of the device will result.

## ekko

Makes a loud speaker of your phonograph



### listen to radio through your phonograph

Ekko connects your head phones with the tone arm of your phonograph and transmits Concerts and Programs through the tone chamber.

EKKO now \$2.75

The best Loud Speaker you can use—utilizes the scientific design of the phonograph tone chamber, produces a mellow pure tone. Not adapted to crystal sets without amplification. If your dealer does not yet carry Ekko, use the coupon—send \$2.75 and we will mail one immediately, postpaid. Money back if not satisfied. Mention the make of your Phonograph and name of your local dealer.

#### THE EKKO COMPANY

911 Harriet Trust Bldg., Chicago.  
Enclosed \$2.75. Send me one Ekko Radio phonograph adapter. Money back if not satisfactory.

My phonograph is a .....

Name .....

Address .....

Dealer's name .....



High  
Efficiency

## HEAD SETS

Army and Navy Type:  
2500 ohms, per pair ..... \$10.00  
3200 ohms, per pair ..... 12.00

Swedish-American Type:  
2200 ohms, per pair ..... 8.00

Victor Type:  
Single coil, double magnet ..... 6.00  
Jacks, Plugs, Microphones and other Radio Parts  
Ask for our Liberal Trade Prices

American Electric

COMPANY

CHICAGO - U. S. A.



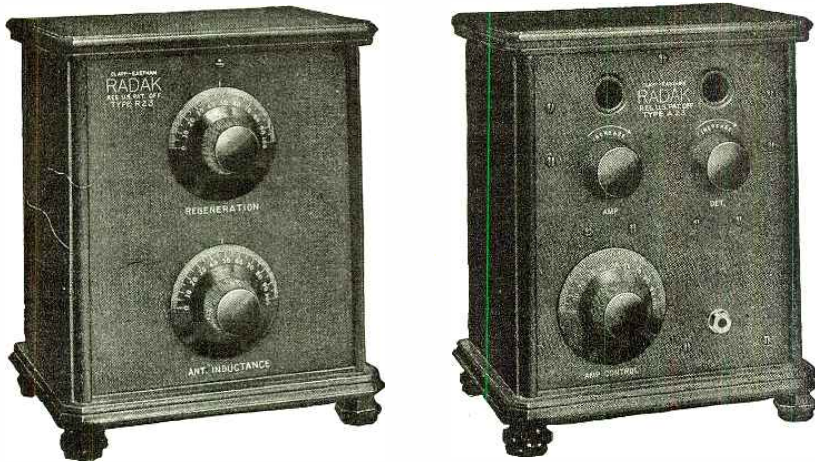

**Models R23 and A23 Radak**  
**Only Set Combining Regeneration with Radio Frequency**

Regenerative receiver with one stage each of radio frequency and audio frequency amplification. Model R23 contains tuning elements only, Model A23, detecting and amplifying elements. Controls simplified to final degree three tuning dials only, with two filament rheostats to control brilliancy. New Radak vernier dials. Receives 175-550 meter wave lengths. Size of each cabinet 9 in. wide, 10 3/4 high, 7 deep. Retail, together, for \$100. R23 separately, \$40; A23, \$60. (Licensed under Armstrong U. S. Pat. 1113149.)

# New Radak Models

Reg. U. S. Pat. Off.

We show here the newest developments in the Radak line. Two new sets which will be of great interest to every progressive radio enthusiast. If your electrical or radio dealer is not yet showing these new sets write us for further information. RADAK BOOK, containing fascinating radio information, free on request.

## CLAPP-EASTHAM COMPANY

America's Oldest, Largest Manufacturers of Radio Equipment Exclusively

107 Main St., Cambridge, Mass.

New York Sales Office 295 Broadway.

Pittsburgh, 332 Third Ave.

Chicago, 33 So. Clinton St.

### Model C3 Radak

Regenerative receiver with two stages of audio frequency amplification. May be used either with ear-phones or loud speaker. Has simple control, using the new, sensitive Radak vernier dials. Wave lengths 175 to 3000 meters. Beautifully finished figured walnut cabinet, size 16 1/2 in. wide, 10 in. high, 8 3/4 in. deep. A perfect home set, and a great value at \$100. (Licensed under Armstrong U. S. Pat. 1113149.)

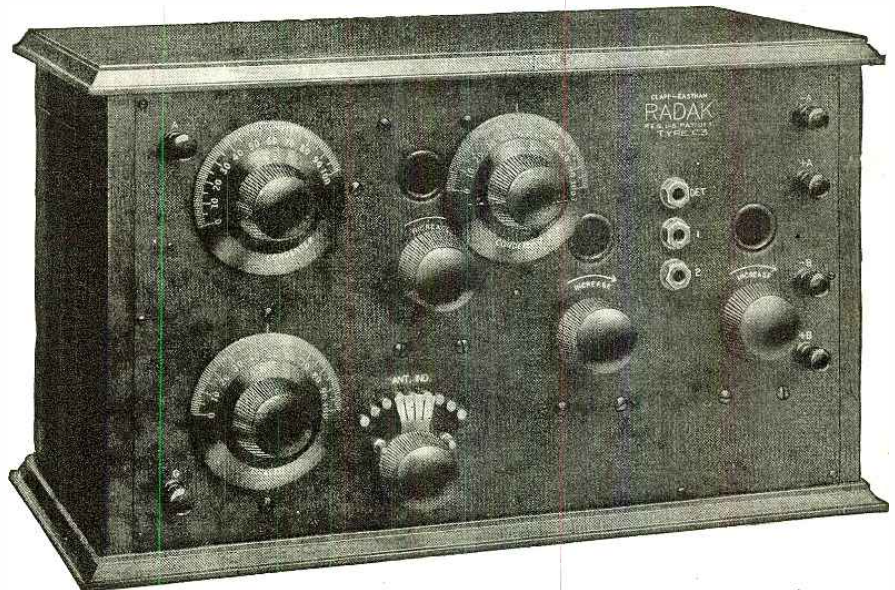

# GET OFF TO A FLYING START UNIFORM YOUR UNITS

BUY THE BEST — ADD THE BEST — AND YOUR RESULTS  
WILL BE THE BEST

VACUUM TUBES	
No. UV-200 Detector	\$ 5.00
No. UV-201 Amplifier	6.50
No. UV-201 5 watt transmitter	8.00
No. UV-203 50 watt transmitter	30.00
No. UV-204 250 watt transmitter	110.00

ATLANTIC-PACIFIC	
A. P. Detector	5.00
A. P. Amplifier	6.50

Send us your orders for Tubes,  
Our stock is complete

SOCKETS	
No. 550 Murdock	1.00
No. UP-552 Radio Corp.	1.50
No. UR-542 Radio Corp.	1.00
No. UV-541 Radio Corp.	2.50
No. 30 Paragon	1.00

CONDENSERS	
No. UC-1014	2.50
No. UC-1015	5.75
No. UC-1803	5.00
No. UC-1806	7.00
No. UC-1831	9.00

CHOPPERS	
No. PX-1638 motor driven	7.25
Shaft Bushings for 1/4 or 5/16 shaft, each	.20



REGENERATIVE RECEIVERS	
No. RA Westinghouse 150-700 meters	68.00
No. DA Westinghouse two stage	70.00
No. RC Westinghouse short wave	132.50
No. C. B. load coil for same	6.00
"Aerola Jr."	25.00
"Aerola Sr."	75.00

LOUD SPEAKERS	
No. A-3 Magnavox, new type	45.00
VOCALOID, station type	30.00

SEND US YOUR ORDERS—NOW

TELEPHONES	
Type C Baldwins	\$12.00
Type E Baldwins	13.00
Type F Baldwins	14.00
No. 55 Murdock 2000 ohm.	5.00
No. 56 Murdock 3000 ohm.	6.00

RHEOSTATS	
No. 25 Paragon	1.50
No. 214 General Radio	2.50
No. 560 Murdock	1.00
No. 120-A FADA new type	1.00
No. 810 Remler 4 ohm.	1.00

AMPLIFYING TRANSFORMER	
No. A-2 Acme semi-mounted	5.00
No. UV-112 Radio Corp.	7.00
No. 231 Gen. Radio	5.00
No. 231 Gen. Rad'g.	5.00

POWER TRANSFORMERS	
No. UP-1368—325 watt.	25.00
No. UP-1016—750 watt.	38.50
No. UL-1008—Oscillation	11.00

"B" BATTERIES	
No. 763 Eveready 22 1/2 volts	2.00
No. 766 Eveready 22 1/2 volts tapped	3.00
No. 5156 Burgess 22 1/2 volts tapped	3.00
No. 2156 Burgess 22 1/2 extra large	3.50

Please include sufficient postage with all C. O. D. orders

**MISSOURI RADIO SUPPLY COMPANY**  
4623 Maryland Ave. SAINT LOUIS MISSOURI

## — MOULDED — RADIO — ACCESSORIES —

MANUFACTURED OF  
APPROVED MATERIAL

Specifications Solicited

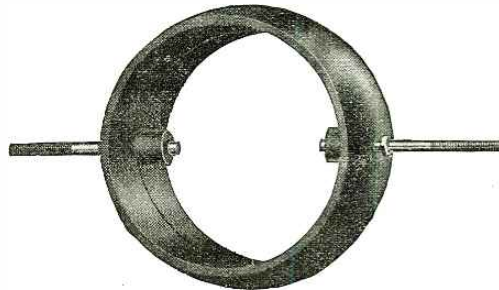

form  
the des  
Transf  
highest gra  
able and prop  
fects the resu  
high amplification  
equalled either in  
acteristics or good appear

Dials Rotors Couplers Panels Stators

**ATIONAL INSULATING CORP.**

**CHELSEA RAL** RK CITY

FACTORY  
SPRINGFIELD, MASS.

Manufacturers of Rad.





*"That's Davenport"*

He always says "Davenport, I-o-w-a where the West begins."

Instantly recognized, distinct, clear as a bell the voices and music, within the radius of your outfit, come to you if your radio is equipped with the

### Stromberg-Carlson Radio Headset

Quickly adjustable to any size head, very comfortable and so sensitive, faint long distance signals are reproduced accurately.

Its forked cord construction makes it do double duty when necessary. The receivers can be separated and used by two observers at the same time.

Backed by 8 years' experience in the manufacture of radio apparatus and 28 years' experience in the manufacture of high grade telephone equipment.

*That's why it's the Headset for you.*

Order Stromberg-Carlson apparatus through your electrical merchandise dealer or write for free bulletin describing exclusive Stromberg-Carlson features.

**Stromberg - Carlson Telephone Mfg. Co.**  
Rochester, N. Y.



The invention comprises an insulating block positioned near the upper end of the lamp, from which extends a spring wire in a curve to a point beneath said block where the spring is connected to the filament. Between the point of the block from which the spring wire extends and the point of connection with the filament, the spring wire is given one or more turns in the form of a pigtail twist to give it an added spring effect. The figure shows a lamp of the vacuum tube type as adapted to employ this invention.

#### ELECTRIC-CURRENT-CONTROLLING DEVICE

(Patent 1,435,455. Issued to H. P. Donle, of Meriden, Connecticut, November 14, 1922.) This invention relates particularly to what is commonly termed a vacuum tube type of device.

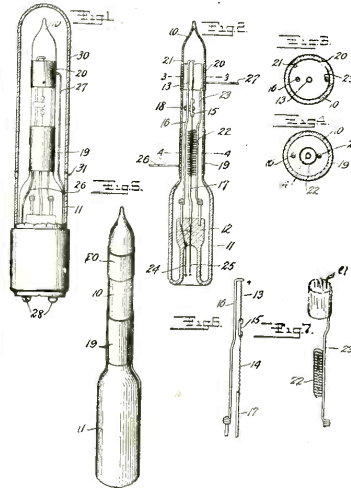

The main object is to provide a simple and compact construction which can be economically and readily manufactured, which will produce a maximum effect with a minimum power and be durable under normal conditions of use.

Another object is to construct a device which with a small power input will produce relatively great variations of output current.

In its preferred form the tube is of glass and contains a filament having two active portions in series and disposed longitudinally of the tube. This filament constitutes the cathode or emissive element. The anode embraces the tube outside of one portion of the filament and a control electrode or plate embraces the tube adjacent to the other portion of the filament. Inside of the tube is an element which may be termed an equalizer, consisting of an annular or cylindrical portion surrounding or partially surrounding one portion of the filament within the influence of the control and cathode, and a connected plexus or network interposed between the other portion of the filament and the anode. The annulus and plexus are electrically connected to each other but not metallically connected to anything else.

#### ELECTRIC-DISCHARGE DEVICE

(Patent 1,432,931. Issued to Howard W. Weinhart, of Elizabeth, New Jersey, October 24, 1922.) This invention relates to electric discharge de-

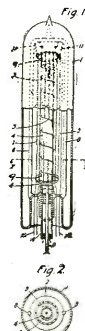

vices of the audion type, and its object is to construct a device of the above character which will have a much larger power capacity than those heretofore made.

In this invention the purpose is to so construct and arrange the plate element that it will be able to dissipate a much greater quantity of heat. Such an arrangement will make vacuum tubes of this type largely independent of the heating factor, which heretofore has been a serious limitation to



## World Radio Batteries

# SAVE YOU 50%

WRITTEN 2YR-GUAR

### SOLID RUBBER CASE

Factory-to-user selling methods and low operating costs make possible the remarkably low prices that we quote below, and the proved worth of the World Battery warrants the iron-clad guarantee that we give to every purchaser.

#### Designed Especially for Radio

The World Noiseless Radio Battery was designed with the special requirements of radio operation in mind. It is not an experiment! It is made by an old established company that for years has been making the very highest type of batteries. Remember that the success or failure of your set depends upon the quality of battery that you buy. The correct construction of the World Battery makes it non-leak, non-conductive, non-deteriorating, and prevents hissing and fringing noises. We back these statements with a two-year written guarantee.

#### Special Solid Rubber Battery Case

Because of the extensive demand for a battery case that will insure home radio users against acid leakage we have designed our special Solid Rubber Battery Case. It is absolutely indestructible and acid proof.

#### Users Are Delighted

T. B. Grove, 718 East Park Av., Fairmont, W. Va., writes: "Battery arrived in excellent condition and to say that I am pleased is putting it very mildly. Your promptness in shipping was appreciated and will do all that I can to advertise your product in this vicinity. Again thanking you."

Frank C. Wozniak, Rt. 4, Box 101, Michigan City, Ind., says: "I am more than thankful to you for the kind and prompt shipment of the Batteries. They are just what I wanted."

#### Save 50% on Your Next Battery

No other manufacturer offers such a high quality radio battery in a solid rubber case at such a low price. Save 50% on your next battery and get better and longer service. Buy a World Radio Battery. Write today—at once.

### WORLD BATTERY COMPANY

Dept. 10  
1219 S. Wabash Ave., Chicago, Ill.

---

### WORLD RADIO BATTERIES

6 Volt. 80 Amp., \$13.50  
6 Volt. 100 Amp., \$16.00

## Panel Service

We offer to the amateur and dealer **Real Panel Service.** Our panels are cut to your order. Only genuine Bakelite or Formica used.

$\frac{1}{8}$ "	per square inch	.02
$\frac{3}{16}$ "	" " "	.02 $\frac{1}{2}$
$\frac{1}{4}$ "	" " "	.03

We also carry a full line of radio essentials. Dealers will find it profitable to have our latest price list and discount sheet.

### PITTSBURGH RADIO AND APPLIANCE CO., INC.

"Pittsburgh's Radio Shop"  
DESK A  
112 Diamond St., Pittsburgh, Pa.



This official 14K. gold plated lapel button is now being given free to all new members of the Radio Experimenters' League. See special notice under Wireless heading in Classified Section this issue. Old members who have not yet received their lapel buttons send at once for one FREE. Tell your friends to join. New dope sheet covers complete constructional details of set, using new W. T. 501 Peanut Tube.

### RADIO EXPERIMENTERS' LEAGUE

68 Glen Ridge Ave. Glen Ridge, N. J.

# Equip your Radio with these remarkable new

## PHILCO DYNAMIC RADIO BATTERIES

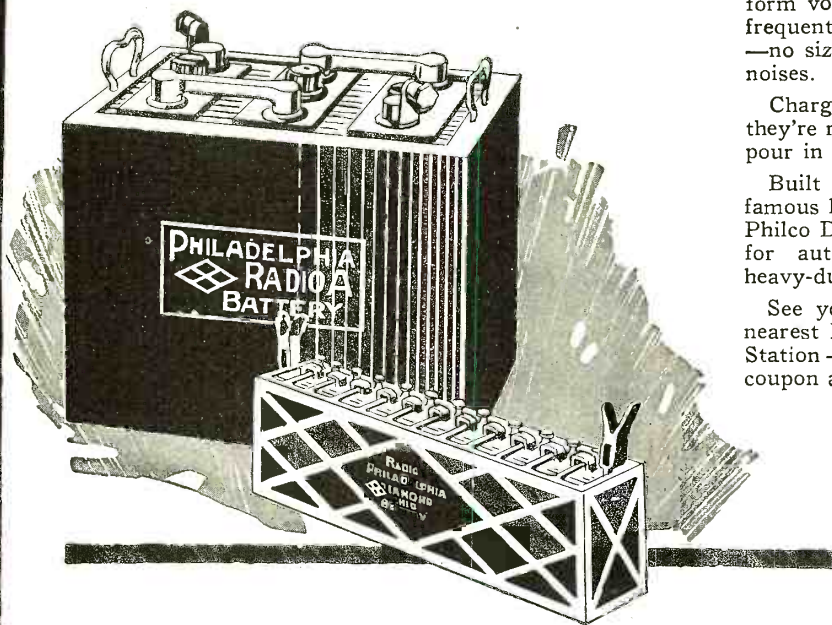

Far longer service per charge — far longer battery life — far less cost per month of battery service.

Deliver steady current at uniform voltage. That means no frequent, troublesome tuning in — no sizzling, cracking battery noises.

Charged dry at the factory, they're ready for use when you pour in the Philco Electrolyte.

Built by the makers of the famous long-life, high-powered Philco Diamond-Grid Batteries for automobiles and other heavy-duty services.

See your radio dealer — the nearest Philco Battery Service Station — or fill out attached coupon and mail to us at once.

### Add tremendously to the pleasure and satisfaction of radio reception

RADIO DEALERS—Philco Drydynamic Radio Storage Batteries are shipped to you charged but absolutely DRY. No acid sloppage. No charging equipment. No batteries going bad in stock. Wire or write for details.

**Philadelphia Storage Battery Company**  
Philadelphia

Mail This Coupon Today

Sirs: I want to know more about the new Philco Drydynamic Radio Batteries.

Name.....

Street.....

City.....

State.....

Business.....



# Dots and Dashes

## Live wires and dead wood

**YOU** radio dealers are up against a hard proposition. But a whole lot of your nightmares would fade away if you had the kind of jobber that backed you up. You find a few rare specimens of the species called "live wires" but, oh boy! How many flocks of the "dead wood" variety are still sitting on the wood pile. Now the Kaiser may find it a pleasant occupation to saw wood, but even he doesn't waste his time on dead wood.

A certain Chicago dealer tells about his experience with a radio and electrical supply jobber: "Yes, Jones was a pretty good sort of a fellow. He took me out to see a musical comedy and gave me a pretty good bottle of hooch for any sick spells I might have. Well, I got sort of mellow and loaded him up with quite a bunch of orders. Then the trouble began. Holy Smoke! What a picnic I had. Most of the sets wouldn't work worth a hill of beans. Even the tubes made me trouble. When I sent damaged ones in for exchange he would stall and hold them till he got some from the manufacturer. My customers used to come in and put up a howl and I had to give them new ones without waiting or else tell them 'no' and lose their trade. Some times it was two months before I got new ones in replacement. But when it comes to the advice he gave me about buying—say he couldn't have known anything about the business or else he was trying to unload junk on me that he got stuck with. Any rate, I learned a darn good lesson. From now on I'm going to play ball with you fellows because I like your policy"

Maybe it isn't always wise to toot one's horn too loud, but we stick to the creed that's been hanging on the wall since the time we started. It reads like this:

To aid our dealers in every way consistent with honest, fair dealing to everyone . . . . To carry standardized advertised radio products that have a definite resale value. . . . To guarantee satisfaction or money back. To always provide facilities for prompt shipment. To give courteous, just treatment to all. . . . To carry a complete line of products in the radio line from which dealers may have a wide opportunity for selection. To give favorable discounts to all. . . . To furnish an advertising service to those dealers who desire it. . . . To sell only at wholesale and only the best.

Now if you think that's the sort of a concern you want to do business with, why just drop me a line for catalog and price lists, care of The North American Radio & Supply Corporation, 7 Columbus Circle, New York.

*Ray Myre*

their efficiency. This result has been obtained by having a circulating medium in contact with one surface of the anode plate element which is in the form of a recess projecting within the tube, which arrangement serves as a means for cooling the anode; and of the various agents which may be used, it has been found that water or oil is particularly suitable. This cooling of the anode, as herein described, has made possible a manifold increase in the amount of power which the audion tube can handle.

### COMBINATION LIGHT AND RADIO FIXTURE

Invented by Christian A. Voli of 1817 Wallace Street, Erie, Pennsylvania.

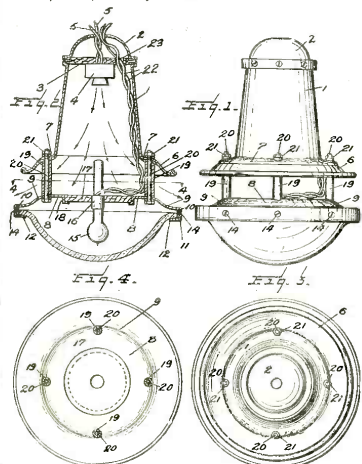

This invention relates to a combination light and loud speaking fixture. The features claimed in this set are:  
 1—Electric light fixture  
 2—Camouflag of the horn  
 3—Even sound distribution  
 4—Greater volume  
 5—No echo effect  
 6—Price of fixture not exceeding present loud speaking horns.

Its usefulness will be found particularly where a great volume of sound should be obtained, particularly on steamships, in hospitals, churches, clubs, open street reports and in private residences. The drawings clearly illustrate the aforementioned features of the combination.

### WE WISH IT WOULD

The other evening I attended my first radio concert. The next morning I was speaking quite enthusiastically about it to the stenographer who occupies the desk next to mine. Miss B— asked me where the concert had been held and I replied that it was held in the office of one of the largest automobile concerns of the city.

"Well," said Miss B—"I don't see how they can receive radio messages there."

"Why?" I asked.  
 "Because," said Miss B—"I should think the machinery would interfere with the static."

### UPSILATS WANTS TO KNOW

Enclosed you will find a 2-cent stamp for which please tell how to make a radio with antenna attached, and do I need any ohms and if so how many?

Will a 300-meter set receive 7,000 miles or will I need a potentiometer?

The fellow next door to us is a blacksmith and has a yard full of gooseberries. Will this affect our generation?

What is the use of a condenser and will the coiled tube from my father's still do just as well?

I am sending you a diagram of my set, but I think I will make a whole new outfit as I can't even hear the aurora borealis.

Hoping you will answer a few months sooner than the other editors, I am,

Yours r. s. v. p.,  
 CHMZLY UPSILATS,  
 17545 Zkmpust Fwkkk Steetos,  
 Yigozipyslovakia.  
 (Translated by Paul McGinnis.)

## USE A CH SHARP TUNER DIALS

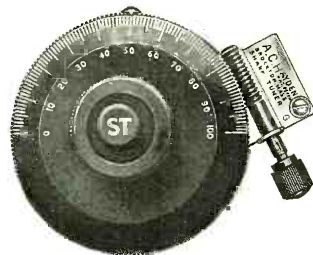

### Your Choice of

Rough tuning with dial or one thousandth of an inch in either direction with the Sharp Tuner Knob. Both controlled by center Knob ST.

Eliminates a vernier condenser. Locks instrument automatically. Dial grounded, reducing body capacity.

### Guarantee

If purchased direct and you find the ACH Dial does not warrant your own personal award of merit, return it and we will refund your money, what better guarantee can we give.

Regular fitting 5/16" hole, 1/4" and 3/16". Bushings, 5c. each extra. 10c. for all.

Price of ACH 3" Dial Complete..... \$2.50  
 With ACH Condenser ..... 4.00  
 ACH Condenser without Dial ..... 2.50  
 Free Plan with mail orders on request.

**A. C. HAYDEN**  
**RADIO & RESEARCH CO.**  
 BROCKTON, MASS., U. S. A.  
 Mail Orders sent prepaid in U. S. A.

**PROFESSIONAL**  
 Quality at a  
**Rock Bottom Price**  
 NOW Was \$10.00 **\$7.65**

3000 Ohms

**TRIMM HEADSETS**  
 The same high quality demanded by expert radio operators is found in the Trimm Head Set at a price any amateur can afford—the lowest price for which a strictly high grade headset can be made and sold.  
 TRIMM Professional phones are guaranteed equal to other headsets selling for \$10.00 to \$15.00. Positively guaranteed for one year against any defect.  
 Accurately matched. Perfect reproduction and articulation at any range. Designed and built by highly skilled experts of long experience.  
 One-piece magnet, formed (not punched), guarantees uniform tempering and magnetizing. Cases and caps made entirely of high grade Phenol compound, free from sulphur and corrosive gases; odorless and waterproof. New type head band insures perfect comfort.  
**Free Trial** If you do not find the TRIMM headset return it and your money will be refunded. Professional superior to any \$10.00 headset.  
**DEALERS:** Our wholesale and retail distributors are fully protected. Write for quantity discounts and full particulars. We ship your first order on approval.  
**TRIMM RADIO MFG. CO.**  
 DEPT. 36 24-30 S. CLINTON ST., CHICAGO

## Magnavox prices are the result of Magnavox quality

**I**N the long run, the price of the really successful and satisfactory product is set by the purchaser—not by the maker or the dealer.

Because when the manufacturer and dealer charge too much for a product, they destroy its market; and when they charge too little they destroy its quality—which results in the something—loss of market.

Magnavox Radio products are of the highest quality—and their prices bring them within reach of every serious radio user.

### R2-18 Magnavox Radio (With 18-inch horn)

This instrument is intended for those who wish the utmost in amplifying power; for clubs, hotels, dance halls, large audiences, etc. It requires only .6 of an ampere for the field.

Price \$60.00

### R3-14 Magnavox Radio (With 14-inch horn)

As illustrated

The ideal instrument for use in homes, offices, amateur stations, etc. Same in principle and construction as Type R-2.

Price \$35.00

### AC Magnavox Power Amplifier

As illustrated

For use with the Magnavox Radio and insures getting the largest possible power input.

2-stage, \$55.00

3-stage, \$75.00

Magnavox Radio, can be used with any receiving set of good quality. Ask your dealer to demonstrate it with the Magnavox Power Amplifier, as illustrated. This combination produces the most satisfactory results.



*What matters bad weather  
when Radio entertains?*

**R**ADIO'S "every-hour-every-where" broadcast schedule is the most stupendous organization of the means of entertainment the world has ever witnessed.

So responsive have people been to the opportunity of enjoying these programs at their best that Magnavox equipment has become synonymous with the full enjoyment of radio music and speech for an ever-greater circle of satisfied users.

Magnavox Products can be had from good dealers everywhere. Our interesting new booklet will be sent on request.

The Magnavox Co., Oakland, California  
New York: 370 Seventh Avenue

**MAGNAVOX**  
Radio  
*The Reproducer Supreme*





Price \$2.50

A Frost Multiphone Plug Lets the Family Listen In

## FROST-RADIO

**NOW** the family can listen in, thanks to the Frost Multi-Phone Plug. Each member of the family may have his or her own Frost-Fones, enjoying the broadcasting program with no loss of clearness or efficiency in reception.

Made with engineering precision, like all Frost Radio Products. May be used with any number of Frost-Fones up to and including four. This superior plug connects the Fones in series. Our tests have shown this to provide best results.

Go to your dealer today. Ask him for a Frost Multi-Phone Plug. The price is low for a product of such high quality. At the same time secure a set of Frost-Fones for every member of your family. You then will have obtained radio enjoyment for all, at a surprisingly small outlay.

## FROST-FONES



Frost-Fones — "like postage stamps, used everywhere" — are today the world's fastest-selling head-fones. Their high quality, clear, sweet tone, and low price have made them so. Order several sets for use with Frost Multi-Phone Plug.

No. 152 2000 Ohm Set \$5.00  
No. 153 3000 Ohm Set \$6.00

**HERBERT H. FROST, Inc.**  
154 WEST LAKE STREET, CHICAGO, ILLINOIS.

## An Efficient Detector-Amplifier Unit

(Continued from page 1807)

the "B" batteries are connected. Put the bulbs in place but do not connect the "B" batteries. Now connect the storage battery (six volts) across the "B" battery terminals. The bulbs should not light. If they do, something is wrong and the fault must be rectified. If the bulbs remain dark, it is a sign that it is safe to connect the "B" batteries to the unit. The "A" battery should then be connected in its proper place, and if the rheostats work properly and the bulbs light the unit is ready for action. To connect to the tuner it is only necessary to make the G, T, T and F connections with four short pieces of wire.

The whole outfit is shown ready for business in the photograph. If the work is carefully done it makes a receiving station that any amateur may be proud to display to his friends.

Unless a word of warning is here given the writer knows that he will be kept busy answering letters requesting "minute information" concerning filament control jacks. The writer will be glad to answer all inquiries regarding the sets described by him if self-addressed and stamped envelopes are enclosed; but he begs relief on the subject of automatic filament control. Plenty of good diagrams are printed from time to time which can be readily used by the experienced constructor; however, on account of the complication, their use by the novice is not recommended.

## The Itch for Distance

(Continued from page 1777)

heard even by ships in distress that need their services.

At a meeting that I attended, all the stations in the city came up for action. The commercial broadcasters were all to be requested to eliminate mechanically-produced music during the evening because stations from five hundred to a thousand miles away were transmitting music direct from orchestras and singers. The Government official who gave the public health lectures was to be requested to shorten them, make them more to the point, read more clearly. The last part of the request amused me particularly because, from personal experience, from the beginning of the Public Health Broadcasts, I knew that, with simple apparatus that did not bring in interference from half the continent, every word he spoke could be easily understood in that city. It was asserted that a physician had said that the lecture on cancer had brought swarms of women to him to be examined and that it was all wrong to get folks excited about diseases that most of them did not have. The fact urged by an older man in the audience, that there had been a "cancer week" in town that week, with sermons in all the churches, lectures in all the clubs and stories in all the papers for the purpose of arousing the population to find out how many had the disease and what could be done to stamp it out, seemed to make little impression upon the leader of the meeting. His mind was all made up that the United States Public Health Service needed to be spanked and he intended to perform his duty.

The market reports were on the list for attention also. The leader wondered if anybody cared for them. He did not. One

## How to Hook-Up a Transmitter Button to Make an Efficient Loud Talker

A Transmitter button with a few dry cells and a telephone receiver will make a remarkably simple and efficient loud talker. A Microphonic amplifier of this type is just the thing for use with a radio set. The weak music and signals may be amplified many times their original value. It is possible to entertain a large audience with a simple radio equipment if a transmitter button is used in the circuit as explained in diagram A.

The cost is extremely low and the results are comparable with those produced by highest grade of expensive loud talkers.

As may be seen in the diagram, two dry cells or a small storage battery are connected in series with the transmitter button and a 4 to 75 ohm telephone receiver. The transmitter button is secured to the diaphragm of the telephone in the radio receiving set. To accomplish this properly, scrape off the enamel (if diaphragm is enameled) on the face of the diaphragm and solder the small hexagon nut supplied with the button to the exact center. Care should be taken that the thin diaphragm is not bent or otherwise

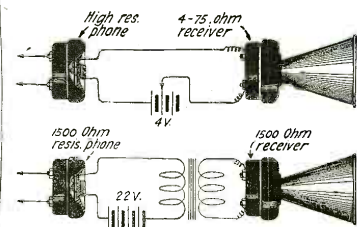

harmful. The transmitter button is then screwed into place. Connections, as shown in the diagram, are made with flexible wire. A horn may be placed over the low resistance receiver if desired. When the radio set is properly tuned and signals are being received, the transmitter button is operated by the vibration of the diaphragm of the receiver. As the receiver diaphragm vibrates, the mica diaphragm on the transmitter button also vibrates. The carbon grains are compressed at varying pressure; the current flowing through the local battery circuit is thus varied and results in an amplification of the sounds in the low resistance telephone loud talker.

Diagram B, which includes a step-up transformer, is to be used with loud talking receivers of high resistance. The primary of the transformers should have a resistance of about 75 ohms. An ordinary telephone induction coil will serve as the transformer in this circuit.

You can get the above-described transmitter button FREE in subscribing to "Practical Electric Magazine" at \$2.00 per year (12 months). Send your subscriptions today.

Make all remittances payable to Practical Electric Co., 53 Park Place, New York City. —Advertisement

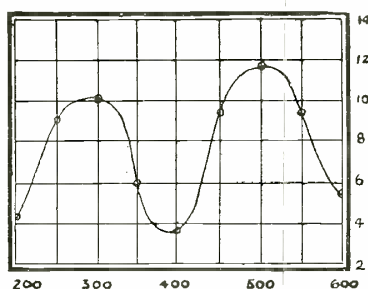
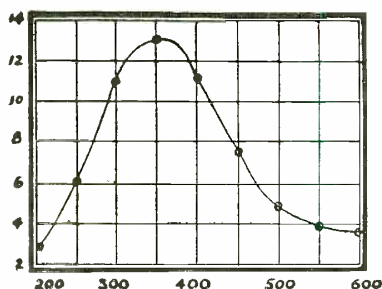

## How to get distant stations clearly

*Why the Acme Radio Frequency Transformers eliminate distance and distortion*

**B**EFORE you purchase a radio frequency amplifying transformer find out if it has marked depressions and peaks in its amplification range between 250 and 500 meters (indicating absence of amplification in the depressions) — or whether the amplification range curve is uniform.

### *A Test*

THE two charts above tell a graphic story of tests made on radio frequency transformers in the laboratories of a well known concern. The chart at the left plots the amplification range curve of 12 Acme R-2's taken from stock. (Note: the Acme R-2's are made with a special iron core and windings.) The chart at the right represents a composite plot of the curve of 6 ordinary types of different makes taken from stock. The superiority of the Acme R-2 is self evident. Note its steadily increasing amplification curve with its maximum at 360 meters—just where it is most needed.

### *Better results—greater distance*

TO HEAR the distant station is not enough. To understand them—to be entertained by them—that is the real thrill. The Acme

R-2 used in a radio frequency amplifier builds up wave energy without distortion before passing it on to the detector. Even the simplest and most elementary type of set either vacuum tube or crystal receiver type will have its useful range tremendously increased when the Acme R-2 and a vacuum tube are employed.

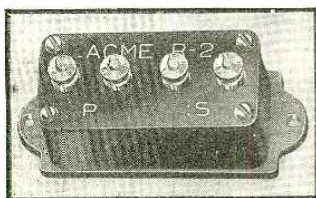

Acme R-2 Radio Frequency Amplifying Transformer. Price \$5.00 East of Rocky Mountains

### *The best method*

TO GET the distant stations clearly, use Acme Radio and Audio Frequency Amplification.

This insures maximum sensitivity and intensity, quietness in operation and freedom from distortion. A small indoor antenna or loop may be used and sufficient intensity obtained to operate the Acme Kleerspeaker providing perfect entertainment for a roomful of people.

You can get these and other Acme Products at radio, electrical and many hardware stores. Write for booklet R-2 showing proper hookups and other information.

### THE ACME APPARATUS CO.

Pioneer transformer and radio engineers and manufacturers  
CAMBRIDGE, MASS., U. S. A.

New York, 1270 Broadway  
Chicago, 184 W. Washington St.

# ACME ~ for amplification



## This Tells the Tale

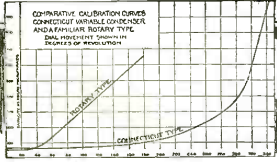

### Which Variable Condenser Is Best for Your Set

Up to 400 micro-microfarads—the extreme capacity ordinarily employed in designing circuits for short wave lengths—the CONNECTICUT Variable Condenser has over 300 degrees of dial movement.

This gives a working range two and one half times greater than that of the plate type instrument. Dial movement makes such slight capacity change that most accurate settings are possible.

Enthusiastic users all over the country declare the CONNECTICUT Variable Condenser the most practical improvement that can be made in any set.

## CONNECTICUT RADIO

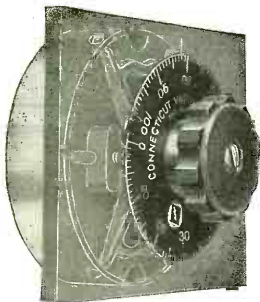

Panel Type, J-108.....\$5.50  
Portable Type, J-107.... 6.50

Booklet 100-D describing CONNECTICUT Variable Condensers in detail will be sent upon request.

CONNECTICUT TELEPHONE AND ELECTRIC COMPANY

## RADIO OPERATING

Taught by experts. Our graduates on ships and land stations in many parts of the world. Complete and rapid course under expert instructors. Fully equipped laboratory. Kleinschmidt Automatic Transmitter used for code instruction. Positions assured. Full particulars on request.

### Y. M. C. A. RADIO SCHOOL

"The Best Radio School in the East"  
158 East 86th Street, New York, N. Y.

Telephone, Lenox 6051  
NEW YORK CITY READERS ARE CORDIALLY INVITED TO VISIT THE SCHOOL.

### WIRING DIAGRAM FREE

Complete detailed wiring diagram of our 5 tube radio-audio frequency receiving set, with single tuning control, sent free. Enclose 2c. for postage. Great Eastern Radio Corp., 25 W. Broadway, N. Y.

man in the audience, apparently having some knowledge of the produce business, ventured to state that such reports were eagerly sought by merchants as well as farmers. The leader consented to send a mere request that the Government conduct an exhaustive investigation to find out whether anyone in the vicinity of the station (which is sometimes heard as far away as Australia!) received the market reports. He felt very sure they should be eliminated. No doubt the Government was astonished at itself for never having thought of going into the matter until this was suggested by a little group of listeners-in! The hydrographic reports and code weather reports transmitted by the Navy were stated to be utterly useless. A request was to be made for their elimination. The one local broadcast that seemed to be acceptable to the leader was the weekly concert by the Navy orchestra. He liked that and was up in arms over a rumor that it was to be discontinued.

The enthusiasm of the leader, who wanted to straighten out a difficult local broadcasting situation, was most commendable. His eyes showed the strain of night work in the unselfish promotion of what he believed to be for the good of all local radio listeners. But it seemed perfectly obvious that to him, as to all afflicted by the itch for distance, the charm of what he heard lay not so much in what it was, as in how far it came.

I listen to everyone I can bring in from Cuba to Canada and from ships in the Atlantic to amateurs on the opposite edge of North America. I often hear better operators doing their best with better apparatus than mine. It is as interesting to me as it is to them, for my itch seems to be chronic, though intermittent. But in fairness I must say that the most interesting things brought in from long distances are the call letters of the stations, and that I have seldom heard, or met a fellow itcher who has heard, a concert or a lecture all through with satisfactory quality and volume, if it was in progress five hundred miles away or more. No doubt it is done, but I seldom hear of a case that can be authenticated by a listener who really wanted to hear music or get information other than call letters.

When a man makes up his mind that he wants to hear a certain program from a distant station, tries for it, gets it and listens to it he has, of course, achieved something worth while. But usually, especially now that so many newspapers have stopped printing all but the local and near-by programs, the itch for distance is treated by aimless groping in the ether. Purposeful or otherwise, the attempt to bring in distant stations usually ends in bitter complaints against the local broadcaster who is spending his own money to serve the majority of listeners.

The local broadcast is taking on greater importance with the improvement in loud talkers. A year ago, the best I heard were harsh, tinny and disagreeable. Today anyone in our house can turn on a detector, plug in a power amplifier and loud talker and bring in a concert that fills the place with music that makes us forget all about radio. It would not be difficult to conceal the outfit and make an average crowd believe that the musicians were right in the house. But force the detector bulb and turn on the maximum amplification, and the entertainment is ruined for music lovers, not only because the music itself is distorted out of all semblance to what it was where it was produced, but also because the sensitive outfit picks up other things in such volume and variety as to rival the barkers at Coney Island.

Instead of the itch for distance I would try to develop, if I were in the business of manufacturing and selling radio outfits to common folks, a deeper appreciation of the opportunity to get good music and valuable

## RIGGS RECTIFIER

\$12.50



Prepaid anywhere in the U. S.  
CHEAPEST, BEST AND MOST EFFICIENT ON THE MARKET ONLY ONE ADJUSTMENT.

We guarantee the type B-3 to please you. Not only to do all we claim for it, but to please you. If you don't like it, we will take it back and return your money.

THE RIGGS MFG. CO.  
Urbana, Ohio      Everett, Washington

## Louder, Clearer RADIO

by using the

## AMPLITONE Radio Antenna

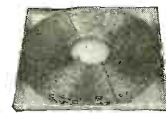

Gives Louder, Clearer Signals. Reduces Ripping and Increases Range. Makes the Little Set Work Well and the Big Set Work Better. With Amplitone you no longer need aerial spreaders and a lot of special apparatus to erect an aerial.

Gives much greater efficiency than ordinary copper wire or similar makeshifts, because it is specially designed for radio use. Braided flat of 10 pure copper wires, affording greater capacity, essential in bringing in signals clearly.

A single 75-foot length of Amplitone will give better results than a number of single wires or other makeshifts.

Amplitone Antenna, 75-foot length, with 2 antenna clamps, shipped prepaid for \$4.50.

We manufacture the Shinn-Flat System of Approved Lightning Rods, which prevent Lightning Losses, rendering any building absolutely safe. Ask for booklet.

W. C. Shinn Mfg. Company  
1301 Lytton Bldg., Chicago Ill.

## DENVER

COLORADO

9ZAF REYNOLDS RADIO CO. KLZ

1534 Glenasm. St.

LARGE RADIO DISTRIBUTORS



## When every hour counts

**B**ILL wanted to make his radio set as quickly as possible. The ABC station was broadcasting some "great" concerts every day.

But at the very beginning there was a delay in getting his panels. It wasn't a long delay, but he was impatient and wanted to make every hour count.

You, Bill, and every radio set-builder can avoid such a delay by getting Celoron Standard Radio Panels. These panels are made in seven sizes, selected to meet every requirement of the set-maker. You don't have to wait for your panel to be cut. There's no extra expense for cutting to your order. You go to your dealer and give him the size. He has a Celoron panel which you

can carry home with you at once.

Thus, for the first time, as far as we know, panels are on the market ready for the consumer. Each panel comes trimmed and wrapped separately in glassine paper to protect the surface. On each one are full instructions for working and finishing.

Celoron makes an ideal panel. It is easily worked, machine drilled and tapped and will engrave evenly without feathering. After thorough tests it has proved to have all the essential characteristics for radio work. It has high surface and volume resistivity, high dielectric strength and low dielectric losses. That's the reason thinking radio enthusiasts who want the highest type panel insist upon Celoron.

Select from these sizes the one you need:

- |                               |                              |
|-------------------------------|------------------------------|
| 1. — 6 x 7 x $\frac{1}{8}$    | 4. — 7 x 18 x $\frac{3}{16}$ |
| 2. — 7 x 9 x $\frac{1}{8}$    | 5. — 9 x 14 x $\frac{3}{16}$ |
| 3. — 7 x 12 x $\frac{1}{8}$   | 6. — 7 x 21 x $\frac{3}{16}$ |
| 7. — 12 x 14 x $\frac{3}{16}$ |                              |

*Make every hour count in making your radio set. If your radio dealer has not yet stocked these panels, ask him to order for you. Or write direct to us. Be sure to designate by number the size you want.*

### Diamond State Fibre Company

BRIDGEPORT (near Philadelphia) PENNSYLVANIA

BRANCH FACTORIES AND WAREHOUSES

BOSTON CHICAGO SAN FRANCISCO

Offices in Principal Cities

In Canada: Diamond State Fibre Company of Canada, Limited  
245 Carlaw Avenue, Toronto

**To radio dealers:**

Condensite Celoron Radio Panels in standard sizes offer an exceptional opportunity in quick sales and substantial profit. Write for special dealer price list showing standard assortments.

CONDENSITE  
**CELORON**  
STANDARD RADIO PANEL



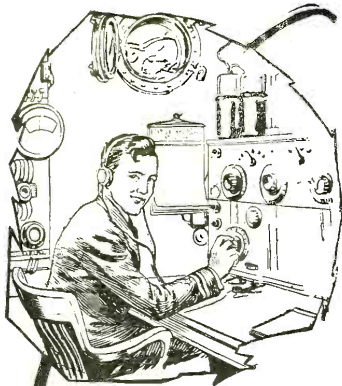

## Uncle Sam's Choice!

Eight years of strenuous service in the U. S. Navy and Signal Corps have proved Bakelite-Dilecto (xx grade) supreme for radio insulation.

## bakelite dilecto!!

(A Laminated Phenolic Condensation Product)

Makes the perfect radio panel.

Tough, durable and super-resistant.

Finished a smart, sleek black. Cannot warp. Machines readily.

Electrical men can get B D X X cut and drilled to your specifications.

**THE CONTINENTAL FIBRE CO.**  
Factory: Newark, Delaware

Dealer Service From:  
New York, 233 Broadway  
Pittsburgh, 301 Fifth Ave.  
Chicago, 332 S. Michigan Ave.  
San Francisco, 75 Fremont St.  
Los Angeles, 411 S. Main St.  
Seattle, 35 Connecticut St.

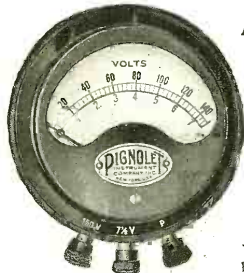

### Pignolet RADIO VOLT-METER

One Instrument Makes All Tests

Write for booklet with suggestions for testing and adjusting Radio Sets.

**Pignolet Instrument Co., Inc.**  
116 Liberty Street, New York, N. Y.

information. The limitations of those who spend their leisure time in listening to jazz and reading scandal are obvious and the man whose ideals are so high that he cannot stoop to help them up one step at a time will promote the progress of humanity only like a lofty mountain that is looked up to from afar by we who labor in less interesting, but more productive earth.

Books have lasted. Some that were written centuries before the Christian era are still read with interest. King Tutenkhamen has popped out into the limelight after several thousand years of rest in Egypt and his art treasures interest more millions of persons today than they did hundreds in his own time, for he opens a long lost chapter in the story of the human race. The charm of music is fundamental and it grows stronger as its meaning is revealed to those who love it. Government has become a complex function and its recent failures, plunging millions to death and destruction, have awakened a desire on the part of the governed to know more and do more in working out their own salvation. The desire for knowledge, wisdom, self-expression, should be fanned into action. To promote radio only as a gigantic toy business under these conditions is to show a narrowness of vision, a penny-wise, pound-foolish policy unworthy of an enlightened age.

If we proclaim that the distance from which a reading, a song, a news item or the voice of a Government official is received is the main attraction, we act like babies who pound on a mirror with a hammer, not knowing the proper use for either. What difference does it make how we get ideas into our heads, just so we get them there? Radio needs to get into the foundations of life instead of performing difficult little stunts like an organ grinder's monkey. In every home and office the receivers ought to be busy all the time, telling in voices loud enough to be heard, but low enough not to interfere with the work in hand what is going on that might interest us. Subconsciously I hear my phones droning away and when they begin something that I want to listen to attentively I put them on as much as a matter of course as I answer my own bell when it rings among others that mean nothing to me.

Five thousand radio dealers, it is stated, are on the edge of bankruptcy. Yet fifty million Americans, I venture to assert, have never yet heard a radio concert or a radio lecture. Because the fad was so intense we imagine that it swept away everybody. To correct that impression, just ask a few persons how much they have really heard.

There are still very few places where a man who wants to select a radio set can have a satisfactory demonstration. The itch for distance prevents it. I asked a dealer why there was no place in his store where prospective customers could hear something by radio and he said it was because every demonstration killed a sale! And this was in a city where the broadcasters are organized and do not overlap or interfere. The prospective customers, being taught by the publicity that distance is the only thing worth trying for, want to buy only on that basis and no demonstration, satisfactory from that standpoint, is possible. It is time to turn the publicity into sensible channels, swing public opinion toward the proper use of radio, and sell radio sets to those Americans who have gray matter enough to realize that our marvelous new means of communication is intended primarily for the exchange of ideas. As a sport, fishing for call letters is not quite as useful as fishing for fish because you can't eat call letters.

A good deal of itch used to be cured by the liberal application of soap and water, which removed the itch bug. To cure the itch for distance we need to scrub away the false ideas that certain radio bugs have injected into the radio public.

## DEL Felco Radio B BATTERIES



### The Battery with a Reputation Built In!

Larger cells of extra-heavy construction guarantees absolute dependability and longer life. They are built to "stand up!"

Small size, 22½ volts .....	\$2.00
Large size, 22½ volts .....	3.00
Small size, 45 volts .....	4.00
Large size, 45 volts .....	5.50

Postage Prepaid.

### DEL Felco

### BATTERY CORPORATION

General Office: 12 Meeting St.  
Factory: 23 Bayley St.  
Pawtucket, R. I., U. S. A.

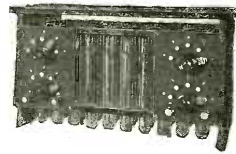

## KICO Radio Storage "B" Batteries for EFFICIENT Receiving

THINK over the following FACTS before buying again.

1. KICO "B" batteries allow single cell variations by means of switches on mounted panels. (The first in the market with this feature.)
2. Alkaline type.
3. One charge lasts from three to six months in the detector plate circuit.
4. Rechargeable from your 110-volt A. C. line in connection with the rectifier supplied.
5. Neat, efficient and compact.
6. Unlimited life.
7. Your money back if unsatisfied within a 90-day trial.

	(Plain)	(With Panels)
16 cell 22 volt .....	\$6.50	.....
24 cell 32 volt .....	8.00	\$12.00
36 cell 48 volt .....	15.00	14.00
50 cell 68 volt .....	12.00	17.00
78 cell 100 volt .....	16.00	21.00
108 cell 145 volt .....	21.00	26.00

Literature gladly furnished.

### KIMLEY ELECTRIC CO.

1355 Fillmore Avenue Buffalo, N. Y.

## RADIO SCHOOL

Positions Guaranteed Graduates

Send for Catalog

MASSACHUSETTS RADIO &

TELEGRAPH SCHOOLS Inc.

18 Boylston St. Boston, Mass.

G. R. ENTWISTLE, Radio Director

# “WorkRite”

## Super 180° Variocoupler

\$3<sup>50</sup>

\$3<sup>50</sup>

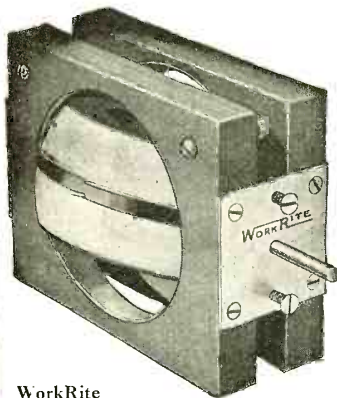
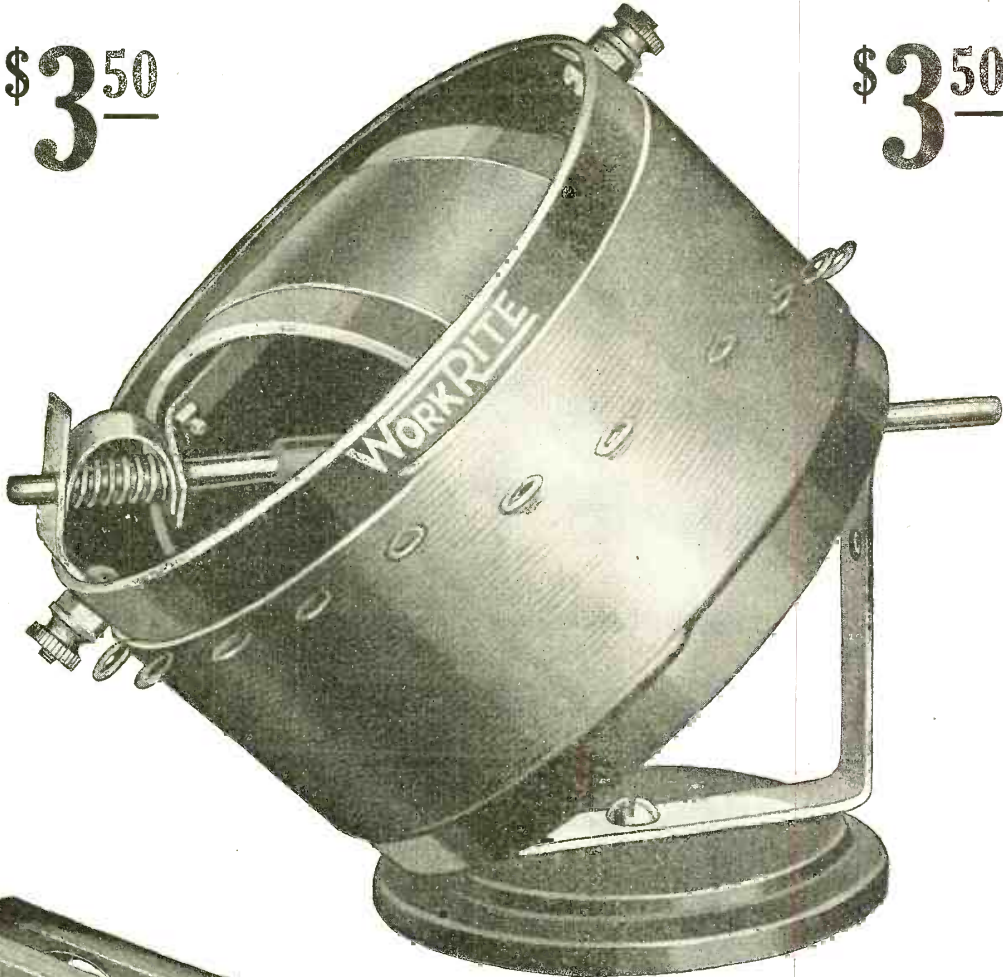

WorkRite Super Variometer

This instrument represents perfection in getting all dimensions and number of wire turns JUST RIGHT. Both primary and secondary are made from molded Bakelite and are wound with green silk wire. Range from 180 to 800 meters. Has 12 taps. Tunes twice as sharp as the ordinary 90° coupler. One WorkRite Super 180° Variocoupler and two WorkRite Super Variometers make up the WORKRITE TUNER TEAM—the most selective circuit obtainable. Can also be used in single circuit.

The prices on these instruments have been reduced from \$6.00 each last spring to \$3.50 each now. The enormous demand for these reliable WorkRite instruments has made possible large quantity production and this big reduction in prices. Can you equal them any place? If your dealer cannot supply you, we will ship direct by mail prepaid.

WorkRite Super 180° Variocoupler ..... Each **\$3.50**  
 WorkRite Super Variometer ..... Each **\$3.50**

*Other WorkRite Products are WorkRite Concertolas, WorkRite E-Z-Tune Dial, WorkRite Super Vernier Rheostat, WorkRite Head Sets, and WorkRite Hydrometers.*

“WORKRITE RADIO PARTS WORKRITE”

**THE WORKRITE MANUFACTURING CO.** 5505 EUCLID AVENUE CLEVELAND, OHIO

Branch Office, 2204 Michigan Avenue, Chicago



## Try REYNOLDS RADIO Service

(Old)  
"9ZAF"

(New)  
"KLZ"

### from DENVER

<p><b>FEDERAL JR. RECEIVING SET.....\$25.00</b></p> <p>No. 14 Stranded Aerial Wire, 100 ft.....\$1.00                  No. 14 Stranded Aerial Wire, 150 ft..... 1.50                  No. 14 Solid Aerial Wire, 100 ft..... .75                  No. 14 Solid Aerial Wire, 150 ft..... 1.10                  Hopewell Insulators, All Sizes</p> <p style="text-align: center;"><b>BOOKS</b></p> <p>Experimental Wireless Stations. Edelman....\$3.00                  Wireless Telegraphy &amp; Telephony. A. P. Morgan 1.50                  Radio Hook-ups. M. B. Sleeper..... .75                  Design Data. M. B. Sleeper..... .75                  Design of Modern Radio Sets. M. B. Sleeper.. .75</p> <p>Acme 200 Watt CW Transformers.....20.00                  Clapp Eastham Filament Transformers .....12.50</p>	<p style="text-align: center;"><b>MAGNET WIRE</b></p> <table border="0" style="width: 100%;"> <thead> <tr> <th>Spool</th> <th>Size</th> <th>SCC</th> <th>SSC</th> </tr> </thead> <tbody> <tr><td>4 oz.</td><td>20</td><td>\$.45</td><td>\$.50</td></tr> <tr><td>4 oz.</td><td>22</td><td>.50</td><td>.55</td></tr> <tr><td>4 oz.</td><td>24</td><td>.50</td><td>.65</td></tr> <tr><td>4 oz.</td><td>26</td><td>.55</td><td>.70</td></tr> <tr><td>8 oz.</td><td>20</td><td>.65</td><td>.80</td></tr> <tr><td>8 oz.</td><td>22</td><td>.75</td><td>.90</td></tr> <tr><td>8 oz.</td><td>24</td><td>.80</td><td>1.00</td></tr> <tr><td>8 oz.</td><td>26</td><td>.85</td><td>1.15</td></tr> <tr><td>12 oz.</td><td>20</td><td>.90</td><td>1.10</td></tr> <tr><td>12 oz.</td><td>22</td><td>1.00</td><td>1.25</td></tr> <tr><td>12 oz.</td><td>24</td><td>1.10</td><td>1.40</td></tr> <tr><td>12 oz.</td><td>26</td><td>1.25</td><td>1.65</td></tr> </tbody> </table> <p style="text-align: center;"><b>COMPLETE LINE JEWELL METERS</b></p> <p style="text-align: center;"><i>Include Postage with all orders</i></p>	Spool	Size	SCC	SSC	4 oz.	20	\$.45	\$.50	4 oz.	22	.50	.55	4 oz.	24	.50	.65	4 oz.	26	.55	.70	8 oz.	20	.65	.80	8 oz.	22	.75	.90	8 oz.	24	.80	1.00	8 oz.	26	.85	1.15	12 oz.	20	.90	1.10	12 oz.	22	1.00	1.25	12 oz.	24	1.10	1.40	12 oz.	26	1.25	1.65
Spool	Size	SCC	SSC																																																		
4 oz.	20	\$.45	\$.50																																																		
4 oz.	22	.50	.55																																																		
4 oz.	24	.50	.65																																																		
4 oz.	26	.55	.70																																																		
8 oz.	20	.65	.80																																																		
8 oz.	22	.75	.90																																																		
8 oz.	24	.80	1.00																																																		
8 oz.	26	.85	1.15																																																		
12 oz.	20	.90	1.10																																																		
12 oz.	22	1.00	1.25																																																		
12 oz.	24	1.10	1.40																																																		
12 oz.	26	1.25	1.65																																																		

**REYNOLDS RADIO CO., 613 19th Street DENVER, COLO.**

## WETMORE - SAVAGE COMPANY

BOSTON, MASS.

*Jobbers of*

**ELECTRICAL SUPPLIES**

**AUTOMOTIVE EQUIPMENT SUPPLIES**

*Have recently entered the field of*

### RADIO APPARATUS and SUPPLIES

We will do a Wholesale Business only and solicit correspondence with reliable manufacturers who are desirous of receiving the best representation for the New England States.

### Edelman's Raytainer

(Registered)

A complete wireless telephone loud speaking receiver. Handsomely mounted in phonograph style cabinet with scientific wood horn. Patented. Patents Pending. Licensed for Experimental and Amateur Use. May be used without outside aerial. Uses the famous Edelman Radio Concentrator. Guaranteed satisfactory. This is the real machine, and at a popular price.

Type R.S.4, Four vacuum tubes.....\$225  
 Type R.S.3, Three vacuum tubes..... 185

**PHILIP E. EDELMAN, E. E.**

### Edelman's Famous Multitone Supplies

Two step amplifier. Audio Freq., \$30.00, Radio Freq. ....	\$36.00
One step amplifier. Audio Freq., \$18.00, Radio Freq. ....	21.00
Same, fitted with loud speaking horn, extra....	13.50
Rubber dired V.T. sockets (Best Yet).....	1.00
Multi audio frequency transformers.....	4.50
Multi, radio frequency transformers.....	6.00
Rheostats, single—Vernier.....	1.35
Rheostats, double, for both detector and amplifier, 5 ohms, 4 amps.....	2.35
Variable condensers, .0005 M.F.....	4.25
Mica phone diaphragms, make your headset musical toned.....	.55
Multitone phonograph connector, attaches to any machine, loud.....	5.00
Wizard, complete crystal set with phones and aerial.....	14.00

Catalogue sent for 25c

Dealers and Agents Wanted. Prompt Deliveries.

**Radio Div., 9 Church St., New York, N.Y.**

## Radio Galena Crystals

Perfect and Sensitive

Direct from Mine

Sizes—Twelve and Twenty-five Cents

*Discounts in quantity orders*

### Empire Electric Machinery Co.

401 Penn Ave. Joplin, Mo.

### NOTICE

TO ALL RADIO CLUBS

On and after May 1st we deal with radio clubs and amateurs direct on Wizard "B" and Witherbee A Batteries wholesale and retail. Club secretaries send for our Bulletin R. C. I. Amateurs send for Catalog 6. No A Batteries sold retail. Postage paid on "Wizards."

**RADIO CLUB BATTERY HOUSE**  
 Richmond Hill, L. I., N. Y.

Ref.—Lawson Silk Pkg. Co., 83 Grand St., New York.  
 J. K. Wheten, Vice-Pres.; Dictator Ftn. Pen Co.  
 342 Madison Ave.

### SHELTER TENT #145

Made of olive drab, 10 oz. waterproof canvas. Easily packed and carried, being in 2 sections which tightly fasten together with double buttons. Folds into compact bundle weighing approx. 7 lbs. Size 7 ft. x 4 ft. 6 in. Sold as high as \$10.00. Our 30 Day Anniversary Sale price \$1.45, plus 60c for packing and postage. Satisfaction guaranteed.

**ATLANTIC STORES**  
 446 Koplin Bldg. Atlanta, Ga.

ing radio business. One of these is dishonest advertising. Many a man is spending hard-earned money for a receiver that he is led to believe will enable him to hear grand opera and everything else that is in the air, and then finding that he can hear nothing at all with it unless he moves nearer to the transmitting station. Dissatisfied customers will spoil a lot of sales for honest apparatus, honestly advertised. Another thing that sooner or later will retard the game is the partial or complete failure of demonstrations of apparatus that is highly efficient, from the standpoint of the technical radio amateur, but that is judged on the one unsuccessful performance by persons who witness but the one trial. Recently I was present at such a demonstration before an audience in which the President of the United States was the guest of honor. KDKA and WJZ were within range but they could not be brought in with sufficient energy to be audible to any but those who used head phones. The timely assistance of local phone transmitters saved the situation, but the impression made was not as strong as the character of the audience demanded. The explanation that atmospheric conditions were bad raised questions in the minds of the listeners which would not have arisen if they had been led to expect only local stations.

Even at a great radio convention the demonstration of a receiver that was to provide the feature of the program was a failure. Yet, in the same city, a boy in his teens with a receiver that he made himself brought in KDKA strongly enough to fill a hall many times larger than either of those in which the failures took place. He, of course, had the advantage of better atmospheric conditions, but when the public goes to hear a radio telephone at work it does not expect it to be subject to the same limitations as a July picnic in a region famous for thunder showers. For a while it will not be necessary everywhere to promise music from a city hundreds of miles away. If a phonograph can be heard playing two miles away, most of the audience will marvel at it. If they come to hear that and happen to hear live artists singing a thousand miles away, the impression made is quite different from that created when they are promised the latter and only get the former.

Radio is still so new to the bulk of the population, even the well-informed part of it, that an amateur who knows the code can amuse groups by the hour just by copying code broadcasts and the twaddle of the hams.

The lack of service is dragging many a wheel that some day will have to be released from its brake and oiled. Radio clerks who are competent report that they are making good money these days by installing and repairing apparatus and giving instructions to beginners, but they are unable to keep up with the demand. Let any man who has had any experience with radio make it known and questions are showered upon him by those who want to know.

There is a persistent fear on the part of many amateurs, manufacturers and dealers that the government is going to jam on the brakes good and hard. If it does, it will be in response to a strong public demand. I doubt if anyone keeps in touch with the various government departments that are concerned with radio more persistently than I do, yet I have been unable to discover anyone in any department who has shown the slightest tendency to restrict anybody's use of radio any more than is necessary to give some other citizen his share of the ether. The report of the Technical Committee following the radio

## An unusual Equipment for an unusual Service

The National Vulcanized Fibre Company is the result of the consolidation of three large and well-known fibre manufacturers. Each of these three organizations has contributed unusual equipment and facilities for the manufacture of Vul-Cot Fibre and Vul-Cot fibre products.

### Three-fold service

The present organization offers to manufacturers unprecedented fibre service—a service with three-fold equipment for speedy production, three-fold facilities for quick deliveries and a three-fold reputation.

### Make it of Vul-Cot Fibre

The guaranteed purity of Vul-Cot Fibre—its strength, toughness and work-ability has made it a part of the products of a host of well-known manufacturers. If there is a place for fibre in your product—either in a very minor or very important position—this unusual experience in the manufacture of all sorts of fibre articles and parts, this unusual service is at your command.

### Just a reminder

The three organizations that have combined to form the National Vulcanized Fibre Company with headquarters in Wilmington, Delaware, are the National Fibre and Insulation Co., the Keystone Fibre Co., and the American Vulcanized Fibre Co.



**96% Perfect**

HIGHEST AWARD  
GIVEN ANY  
CONDENSER BY

Radio News  
Laboratory

**HAMMARLUND**  
VERNIER  
VARIABLE  
CONDENSER

Affords super-accurate tuning for long distance reception. Eliminates annoying "cut-ins" from undesired stations.

Spec. Alloy	List for Panel Mtg.	Nickel Pltd.
14d. Alum. Pl.	.....001 mfd. cap. 43 Plate.....	.....\$8.50
5.00	.....0005 mfd. cap. 23 Plate.....	7.00
5.50	.....00025 mfd. cap. 13 Plate.....	6.50
3 1/2"	Bakelite Dial, \$1.00	Legs for Table mtg. 50c.

At your dealers—otherwise send purchase price and you will be supplied postpaid.

**HAMMARLUND MFG. CO.**

144-146 W. 18th St. New York City

## Some Comparisons Between Light Waves and Radio Waves

(Continued from page 1783)

reflect the light, but it does not permit the light to pass through it. The shadow is not uniform in darkness, but decreases as we move farther away from the opaque ob-

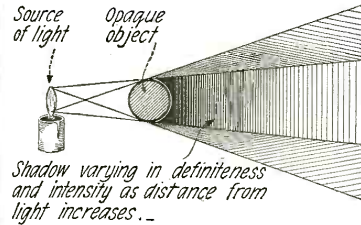

Fig. 6-a

Shadow Varying Definiteness and Intensity as the Distance from the Light Increases.

ject, as the illustration shows. The shadow is darkest right behind the opaque object, we see no light in this space.

Almost an exact counterpart is to be found in the case of radio waves. Suppose (Fig. 7) we have an antenna A which transmits radio waves. At some distance away is another antenna B, and still farther away is an antenna C. Both B and C are receiving from antenna A. Suppose for a moment that antenna B is not present. Then the waves from station A will reach antenna C and will be detected and heard in the phones. If now antenna B is in position and is also tuned to the oncoming waves a radio shadow will be formed behind it. The antenna B behaves like the opaque object above. This antenna B will either absorb the oncoming waves or reflect them, or both. If the antenna has resistance it will absorb some of the energy and reflect some back. If it has extremely high resistance it will absorb all the energy. If it has no resistance it will reflect all the energy. In any case, whether it absorbs or reflects the waves are kept out of the region between B and C, hence there is a distinct radio shadow, and no signals can

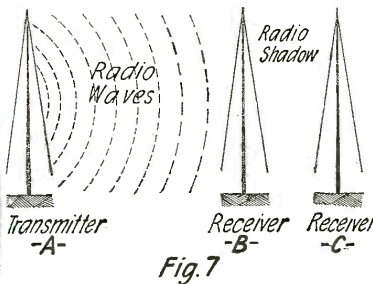

Fig. 7

Station B Absorbs and Reflects Wave Energy, Preventing Any from Reaching C, Thus Making a "Radio Shadow" Behind B.

therefore be heard in that region. Of course, as in the case of light, the farther away from B we move the less distinct will that shadow be, as evidenced by increasing signal audibility. This throwing of a radio shadow may be accomplished by any conducting structures, not only antennae, and

## Unequaled Quality of Volume and Purity of Tone

are assured by adding to your Radio Set the newly constructed 100% perfect Audio Frequency Transformer RT-A2. This Audio Transformer is exactly the same shape and size as the RT-6 Radio Transformer, but the color is brown, thus making a neat match when both Radio and Audio transformers are used together. Why build up beautiful tone quality with Radio Frequency and destroy it with inferior Audio transformers? For best results on both tone and distance, use Radio Service Laboratories Radio Frequency (RT-6 and RT-6A) in the black case, retail price \$6.00 and Audio Frequency (RT-A2) in the brown case, retail price \$6.50.

Order by type number, accept no substitute and remember that all Radio Service Laboratories Transformers are individually triple tested and unconditionally guaranteed. For sale at all reliable electrical or Radio Stores or order direct from us.

Send ten cents for new booklet on Radio Frequency with schematic diagrams—a most valuable and helpful publication for the radio amateur and expert.

**RASLA SALES CORPORATION**

National Distributor

Dept. A, 10 East 43rd St. New York City.



The new member of the Rasla Family—in the brown case.

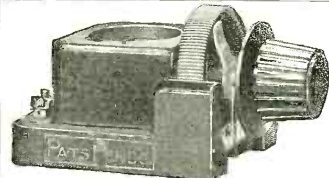

**KING RHEO-SOCKET**

Price \$3.00, f. o. b., N. Y. C.

This rheostat embodies compact, increased efficiency, having shorter connections, and less wiring. It will bring in stations you have never heard before.

Make this King Rheo-Socket a part of your up-to-date set. A high-grade article in red bakelite with phosphor-bronze contacts and alloy resistance wire.

For base or panel mounting  
**KING AM-PLI-TONE**

82 Church St., New York City  
Mfrs. of the famous King Am-pli-tone

Jobbers:  
Wire or write for interesting proposition.

**KRL**

Myers High-Mu Audion A tube which brings in the stations five times louder than other tubes. Try one of these efficient little vacuum bulbs, \$5. Receptacle, \$1. KRL Circuits, Postage and insurance free.

**THE KEHLER RADIO LABORATORIES, Dept. R ABILENE, KANSAS**



# REDUCED PRICES

	REGULAR PRICE	OUR PRICE		REGULAR PRICE	OUR PRICE
Radiotrons UV 200 .....	\$ 5.00	\$ 4.00	Ammeter Jewell 0-5 Thermo .....	\$ 12.00	\$ 8.40
Radiotrons UV 201 .....	6.50	5.20	Ammeter Jewell 0-7-½ Thermo .....	12.00	8.40
Radiotrons UV 201A .....	9.00	7.65	Ammeter Jewell 0-10 Thermo .....	12.00	8.40
Radiotrons WD-11 .....	6.50	5.90	Voltmeter Jewell 0-15 A.C. ....	7.50	5.25
Radiotrons UV 202 .....	8.00	7.20	Voltmeter Jewell 0-10 D.C. ....	7.50	5.25
Radiotrons UV 203 .....	30.00	27.00	Thompson Levering Variometer .....	6.00	4.20
Audio Amplifying Transformers			Sleeper Variometer Moulded .....	7.50	4.75
UV 712 .....	7.00	5.30	Atwater-Kent Variometer .....	8.00	6.40
Radio Amplifying Transformers			Atwater-Kent Variocoupler .....	8.50	6.80
UV 1714 .....	6.50	4.80	3" Dial & Knob Moulded .....	.90	.44
Baldwin Phones .....	16.00	12.67	4" Dial & Knob Moulded .....	1.50	.91
Western Electric Phones .....	12.00	9.60	Variable Condenser Unmounted		
Brandes Superior Phones .....	8.00	6.25	.001 MF .....	4.00	2.80
Western Electric Loud Speaker .....	55.00	45.00	Black Formica Panels 19x6½x3/16" ...	3.80	2.60
Western Electric Loud Speaker .....	161.00	129.00	African Mahogany Cabinets		
Western Electric 216A Tubes .....	12.00	9.60	19x6½x6¾" .....	11.00	6.10
Eveready 22½ Volt B Battery 766....	3.00	1.80	Black Formica Panels 19x8x¼" .....	4.62	3.31
Eveready 45 Volt B Battery 767 .....	5.50	3.30	African Mahogany Cabinets 19x8x6¾"	10.50	7.10
Bradleystats .....	1.85	1.65	Porcelain Antenna Insulator 2½ "Diam.	.25	.08
Magnavox R-3 .....	45.00	37.50	No. 14 Bare Copper Wire .....	.01 ft.	½ ft.
Storage Battery 6 Volt 110 Amp. Hour	20.00	16.00	No. 12 Tinned Copper Wire .....	.02 ft.	.01 ft.
Homecharger .....	18.00	16.00	R. C. Rheostats PR 535 .....	3.00	2.40
Tungar Charger 2 Amp. ....	18.00	16.90	R. C. Potentiometers PR 536 .....	2.00	1.65
Tungar Charger 5 Amp. ....	28.00	25.90	Open Jacks .....	.70	.45
Ammeter Jewell 0-100 Milliamp. D.C.	7.50	5.25	Two Circuit Jacks .....	1.00	.70
Ammeter Jewell 0-250 Milliamp. D.C.	7.50	5.25	Plug, two pairs phones .....	1.50	1.00
Ammeter Jewell 0-500 Milliamp. D.C.	7.50	5.25	Antenna Protector UQ1310 .....	2.00	1.60
Ammeter Jewell 0-1 Amp. D.C. ....	7.50	5.25			

	REGULAR PRICE	OUR PRICE
Westinghouse Radiola Grand .....	\$350.00	\$280.00
Westinghouse Radiola IV .....	275.00	220.00
Westinghouse Radiola V .....	132.50	106.00
Westinghouse Radiola VL .....	162.00	130.00
Westinghouse Radiola RC .....	132.50	106.00
Westinghouse Radiola Combination .....	263.00	211.00
Westinghouse Radiola AR-1375 .....	40.00	32.00
Westinghouse Radiola I .....	25.00	19.00
Westinghouse Radiola Jr. ....	25.00	19.00
Westinghouse Radiola Sr. ....	65.00	49.00
Westinghouse Radiola Sr. AC Amplifier .....	68.00	44.00
Gen. Elec. Radio Receiver AR-1300 .....	50.00	39.00
Gen. Elec. Detector-Amplifier AA-1400.....	75.00	59.00
R. C. Loop HG 1380 .....	25.00	19.20

**ALL NEW MATERIAL. IMMEDIATE SHIPMENTS**

*No C. O. D.'s. Add Parcel Post*

*Offered Subject to Prior Sale*

**J. GEIGER** Suite 612, Candler Building  
TIMES SQUARE, NEW YORK CITY



## CHELSEA REGENERATIVE RECEIVER

**A real Broadcast Receiver**

**Range 150 to 800 meters**

- † Perfection in design
- † Pleasing appearance
- † Simple and accurate tuning

**\$40.00**

**A Chelsea product, embodying Chelsea equipment throughout.**  
Licensed under Armstrong U. S. Pat. No. 1113149. For amateur use only.

Write for our new No. 7 catalogue

### CHELSEA RADIO COMPANY

179 Spruce Street

Chelsea, Mass.

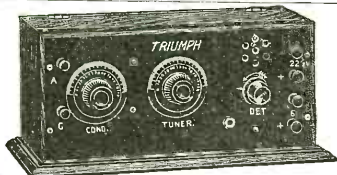

### TRIUMPH

#### No. 1A RADIO RECEIVING SET

This highly sensitive vacuum tube receiving set combines high efficiency and scientific construction with greatest simplicity. This set embodies the famous "Triumph" combination Coupler-Meter which accomplishes the result of two instruments in one—also a 48 plate condenser of superior quality—a coupler dial guaranteed Socket and Rheostat, a hand engraved "Radio" Panel, guaranteed not to warp. The set is housed in a beautiful cabinet of solid mahogany or oak which will grace the finest surroundings.  
Size of set is 15 1/2 x 6 3/4. Height 7 in.  
List price \$30.00

Distributors wanted in every town.  
64R UNIVERSITY PLACE NEW YORK

Write us for our interesting proposition.  
**SIGNAL RADIO & ELECTRIC CORP.,**

this accounts for no reception or very poor reception often obtained in certain localities. The poor reception due to absorption explained in a previous paragraph may thus be considered as a case of poor reception due to casting of a radio shadow. Any conducting bodies intervening between a transmitter and receiver may result in absorbing or reflecting the radio waves and thus casting a radio shadow in the vicinity of the receiving antenna, thus producing poor reception. If you are inside a steel building or your antenna is right behind a steel building, the building being between the transmitter and receiver, you may be in a radio shadow and reception results will be disappointing.

#### REFRACTION

The phenomenon of refraction is perhaps not so familiar as that of reflection or shadows. Everyone has noticed at one time or another that a spoon placed in a glass of water appears to be bent at the surface of the water. This apparent bending is due to what is called "refraction," and is the name given to the phenomenon where a beam of light bends as it passes from one medium into another of different density. Thus a beam of light passing from water into air will bend, Fig. 8, and appear to

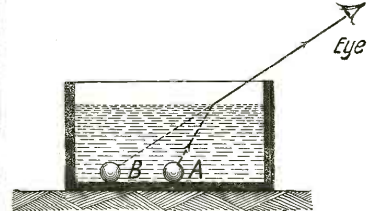

Fig. 8

Object A in a Bowl of Water Appears to be at B. Due to the Refraction or Bending of Light Rays in Passing from Water to Air.

# RADIO MERCHANDISE

## F. D. PITTS COMPANY

(Incorporated.)

219 COLUMBUS AVE., BOSTON, MASS., U. S. A.

Wholesale Only

#### Distributors for

- A. H. Grebe and Co.
- Acme Apparatus Co.
- American Eveready Works
- American Radio and Research Corp.
- Atwater Kent Mfg. Co.
- Baldwin, Nathaniel Co.
- Burgess Battery Co.
- Chelsea Radio Co.
- Clapp-Eastham Co.
- De Forest Tel. and Tel. Co.
- Dubilier Condenser Co.
- Electrose Mfg. Co.
- Fada.
- Fahnestock Elec. Co.
- Federal Tel. and Tel. Co.
- France Mfg. Co.
- Frost, Herbert H. and Co.
- General Radio Co.
- Jewell Elec. Inst. Co.
- Magnavox Co.
- Mitchell, R. and Co.
- Murad Laboratories
- Murdock, Wm. J. Co.
- Pacent Elec. Co.
- Radio Corp. of America
- Remler Radio Mfg. Co.
- Signal Elec. Mfg. Co.
- Western Elec. Co.
- Weston Elec. Inst. Co.
- Wireless Press



### "GREBE RADIO"

- Grebe CR-3 Receiver, 150-1000 meters.....\$65.00
- Grebe CR-5 Receiver and Vacuum-tube Unit, 150-3000 meters.....\$80.00
- Grebe CR-8 Receiver and Vacuum-tube Unit, 150-1000 meters.....\$80.00
- Grebe CR-9 Receiver, Detector and Two-stage Amplifier, 150-3000 meters.....\$130.00
- Grebe CR-10 Radiotone Concert Receiver, Detector and Three-stage Amplifier, Victrola type.....\$315.00
- Grebe RORK Two-stage Amplifier.....\$55.00
- Grebe RORD Detector and Two-stage Amplifier.....\$75.00
- Grebe RORN Tuned Radio Frequency Amplifier.....\$60.00

"Without going out of doors," said Lao-Tzu, "one may know the whole world." "Let a GREBE RECEIVER bring the whole world to your evening fireside."

**DEALERS—Attractive discounts and immediate deliveries from stock! Send for Our Latest Price List, No. 3.**

**"F. D. PITTS CO. NEW ENGLAND DISTRIBUTORS OF GREBE RADIO"**



# Less Holes to Drill in Panel

NO SOLDERING

## IMPROVED

ANTI-CAPACITY

# RADIO JACKS and Switches

Improved Radio Jacks and switches are radically different in design and construction from other types of similar products. They are made especially for radio use and save money, time and labor in assembling a radio set. May be had from most dealers or direct on receipt of money order or bank draft.

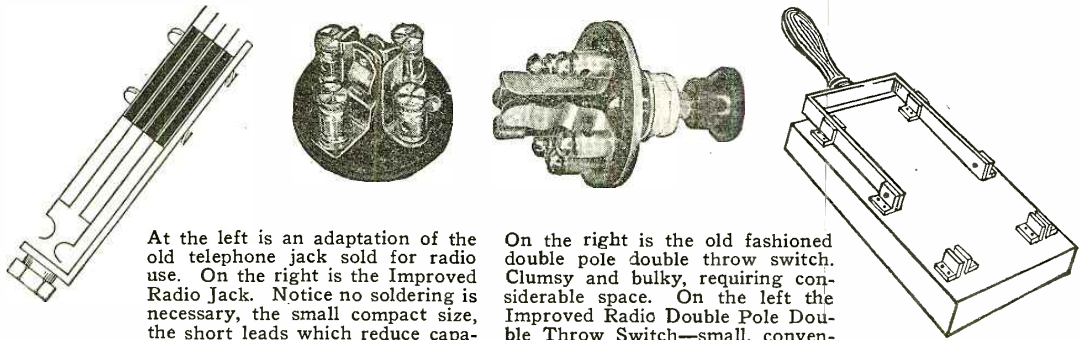

At the left is an adaptation of the old telephone jack sold for radio use. On the right is the Improved Radio Jack. Notice no soldering is necessary, the small compact size, the short leads which reduce capacity effects. Any standard plug fits the Improved Jack. Price \$1.00.

On the right is the old fashioned double pole double throw switch. Clumsy and bulky, requiring considerable space. On the left the Improved Radio Double Pole Double Throw Switch—small, convenient, requiring one hole and no soldering. Price, \$1.60.

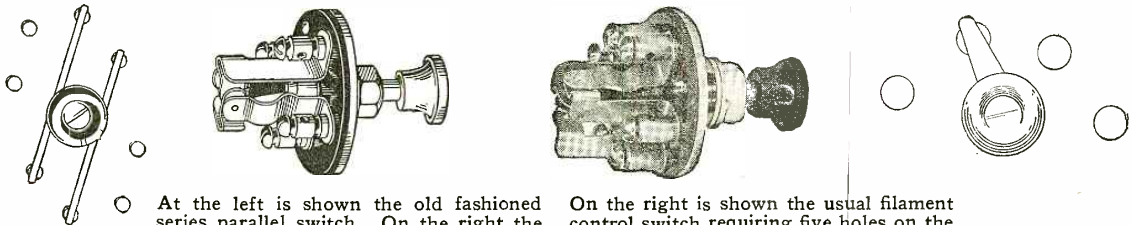

At the left is shown the old fashioned series parallel switch. On the right the Improved Radio Series Parallel Switch. The old requires nine holes in the panel. The Improved one—and no soldering. Think of the time saved. Price \$1.50.

On the right is shown the usual filament control switch requiring five holes on the panel with soldering in back. On the left the improved detector amplifier switch. One hole no soldering. Price, \$1.50.

All Switches Fitted With Attractive Red Caps.

Save Time

Save Money

Save Space



Double-throw, single pole anti-capacity switch Price \$1.25



Open circuit Price 70 cents



Single filament control Price \$1.00



Closed circuit Price 85 cents



Double filament control Price \$1.25



Single-throw A-battery switch Price \$1.00

**RADIO IMPROVEMENT CO., 29 W. 35th St., New York**

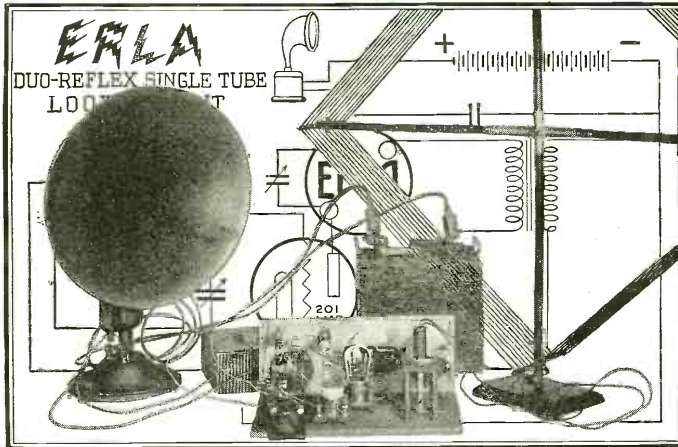

## The Most Powerful Single Tube Circuit Ever Built

A single vacuum tube now operates a loud speaker, and this with a loop aerial, using the Erela Duo-Reflex circuit, the most powerful single-tube circuit yet designed.

Two stages of amplification, one radio and one audio, are provided by this circuit, with but a single tube. Further saving in cost results from the elimination of variometers, variocouplers, potentiometers, and ground connection.

Here is an ideal circuit for apartment use, the loop aerial answering most satisfactorily except for extreme long distance work, where an outside aerial is advisable.

Tuning is exceptionally sharp, a movement of only one degree on the control dials serving to cut out undesired stations. Tone volume, with a loud speaker, is surprisingly ample, and the quality of reproduction unusually excellent and clear.

Designed especially for this circuit, and responsible in great measure for its efficiency, is the new Erela Duo-Reflex radio frequency transformer. Overcoming the high capacitance effects of domestic vacuum tubes in unique degree, this transformer provides maximum amplification without distortion.

Blue prints of this new circuit, together with full directions for its construction, are now available. Ask your dealer, or write us, giving your dealer's name.



Unequaled amplification and tone quality are assured by Erela radio frequency transformers. List price \$4.00



Any receiving set benefits 100% in looks by installing Erela bezels. Fit 1 1/4" hole in 3/8" to 1/2" panels. List, 20c



Triple plated nickel parts and polished Radion base of Erela sockets match the finest receiving set. List, \$1.00

**JOBBERS**—Sales of dependable Erela products are steadily mounting upward, in season and out. Get your share by writing for our liberal terms and discounts.

Electrical Research Laboratories  
Dept. D. 2515 Michigan Ave., Chicago

# ERLA

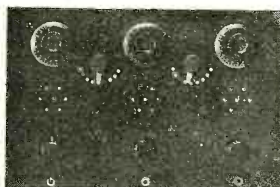

Tuner Detector  
and 2-Stage  
Amplifier  
(Unwired)

Only \$35.00

Set B

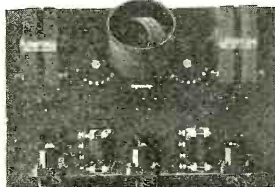

This wonderful loud talker at the low price of \$35.00. All apparatus mounted rigidly on 12 x 18 Bakelite panel. We furnish full instructions and wiring diagrams. Enabling anyone to wire same.

Above outfit unmounted with drilled Bakelite panel \$30.00. Write for data on sets we manufacture.

## C & K Radio Manufacturers

299 7th Street

Brooklyn, N. Y.

come from another point. This bending of the light waves is called refraction and gives rise to some interesting and peculiar effects. One of these is the apparent bending of an object partially immersed in water. Another is the separation of sunlight or white light into different colors. When a beam of white light is passed through a glass prism as in Fig. 9 and the transmitted light thrown upon a screen, instead of white light there will be seen all the colors of the rainbow. What has happened

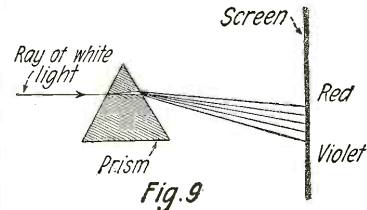

Showing How a Prism Refracts White Light and Resolves it Into Different Colors, Each Color Being Refracted a Different Amount on Account of Difference in Wave-lengths.

is that the white light in passing from air through glass, and from glass to air has been refracted. Now white light is a composition of all the various colors, and each color has a different wave-length. Each wave-length is refracted a different amount, that is, each wave-length, in passing from one medium into another of different density, is bent by a different amount. Hence the various colors will be bent a different amount and will be seen separately on the screen. The phenomenon of twilight is really due to refraction. For even when the sun is below the horizon, hazy twilight is still seen, and this is due to the sun's rays being bent towards us.

The same form of bending takes place with radio waves. Refraction takes place here too, and as explained for light in the previous paragraph the amount of refraction depends upon the wave-length. Refraction in the atmosphere takes place because of the varying density of the atmosphere. Inasmuch as the density of the lower portions of the atmosphere is greater than that of the upper portions, the bending of the waves will be different in both cases. The top of the waves bend over in the direction in which they are traveling and are in advance of the feet of the waves. This refraction or bending may be so great, that the angle at which the radio waves strike the receiving antenna may be very disadvantageous, or the wave may be bent to such an extent that it misses the receiving antenna entirely, resulting in extremely poor reception. Inasmuch as the waves are bent from the vertical due to this refraction the waves will have a very strong horizontal component. Hence it is necessary to make the receiving antenna so that it has a horizontal portion. Great vertical height is not so essential to a receiving antenna, for this reason, and this explains why the straight vertical antenna is not so efficient.

We frequently hear that in transmission some wave-lengths carry much farther than others under the same conditions of power, atmospheric, etc. This selectivity is due to refraction to a large extent. Just as in light various wave-lengths suffer different amounts of refraction so in radio the amount by which a wave is refracted or bent depends upon the wave-length, hence the difference in the carrying power.

### INTERFERENCE

The phenomenon of interference is of the greatest importance in radio reception. The phenomenon is of course present in light and may be explained as follows: A wave motion is generally represented as in the



# Filkostat Proven Best Filament Control



Comparison of Fine Adjustment Control Range of Filkostat With Rheostats and Other Filament Controls Clearly Indicates Filkostat Superiority, as it Permits Perfect and Gradual Current Increase With Infinite Adjustments.

Tests made on Bureau of Standards Instruments

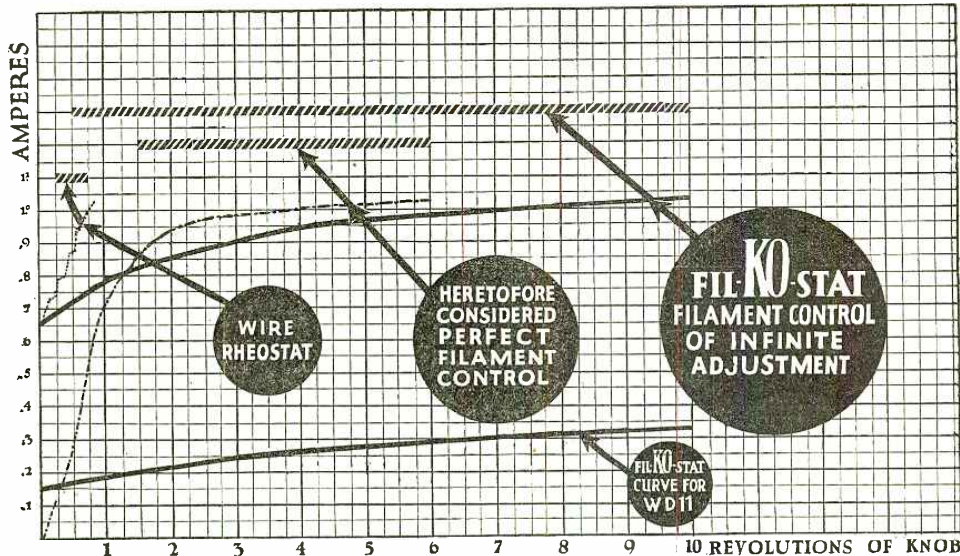

**I**N the Filkostat, a new filament control just perfected by S. R. Hipple, well known as an inventor of apparatus for the control of electric currents, there is at last presented an instrument which is distinctly designed to utilize the great tuning possibilities of the vacuum tube itself. Radio set builders, amateurs and manufacturers have been looking forward to the advent of just such a device. They have realized that all rheostats and other so-called filament regulators, are merely adaptations of pre-radio day devices, not capable of adjusting the infinitesimal graduations of filament HEAT which adjustments are essential to perfect tuning.

### PERFECT TUBE CONTROL

The Filkostat permits perfect regulation of filament heat. Since the heat emitted varies as the square of the current, fine current regulation becomes extremely necessary to accomplish. This governs the flow of electrons. Proper control of the electronic flow in the tube permits the very finest tuning conceivable. The fine adjustment of the Filkostat starts slightly before the tube begins to function. With other filament controls, what minute adjustment there is, starts when the filament is almost at maximum heat. Between 1800 degrees—

considerable increase in tube life. Furthermore the extreme degree of fineness in increase and decrease of electronic flow by infinitesimal variations, makes the Filkostat control ideal.

The perfection of design including ample internal contact is the cause of this new instrument being non-microphonic, absolutely silent, and free from all noises.

### IDEAL FOR W D I I'S AND DX WORK

The lower curve on the graph above is eloquent testimony as to the Filkostat's adaptability to any dry cell tube. These tubes using only a fraction of an ampere demand an instrument that is so finely adjusted that this fractional current can be perfectly regulated. This the Filkostat accomplishes.

### OTHER FILKOSTAT FEATURES

The Filkostat has a *definite off*. It is so designed that the filament extinguishes abruptly indicating that the A battery supply is completely disconnected.

At *Full On* the Filkostat resistance is practically zero.

The Filkostat consists of a hollow cylinder containing the special resistance material placed between two large adjustable contacts controlled by turning the knob.

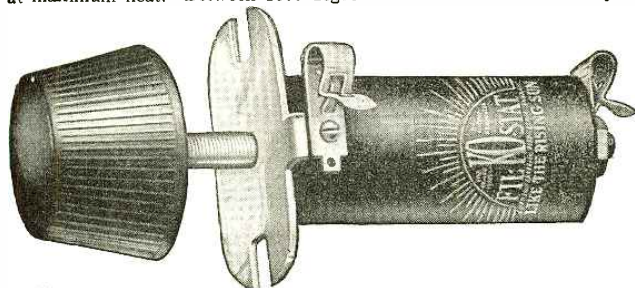

The Filkostat is to all purposes "fool proof." It is compact in form, takes very little space on the panel and so mountable that it can replace any other control without redrilling.

dull red glow—and 2050 degrees—white heat—the Filkostat control is so fine that increases of temperature of *fractions of a degree*, with corresponding variations of electronic flow from the filament to the plate, are obtainable.

### LONGER TUBE LIFE; NO NOISES

The initial inrush of current prevents the crystallization of the filament which so many experts claim occurs when the current is fed too slowly at first as is done in other forms of filament controls. This means

THE RESISTANCE ELEMENT is so finely divided that no further division is possible. There are no disks to break or chip.

The RESISTANCE remains CONSTANT at any position eliminating current variations once set. Such variations are not apparent to the person tuning excepting in "fading out" of stations and noises. But in the laboratory, where such a test as that shown on the above graph can be made by anyone, this feature and all the other points of superiority of the Filkostat are immediately apparent.

—Advertisement.

## 12 & 4 Reasons Why you should say 'Filkostat' for filament control—

- 1—Distinctly DESIGNED for vacuum tube adjustment not adapted to it.
- 2—A REAL Filament control, NOT just a rheostat.
- 3—Permits infinite adjustments of filament HEAT.
- 4—Infinitesimal control electronic flow.
- 5—Permits fine tuning needed for DX.
- 6—Control of small current makes it ideal for W D I I's.
- 7—Fine adjustment starts where tube BEGINS to function.
- 8—DEFINITE OFF—indicating A battery disconnection.
- 9—At FULL ON Resistance is practically zero.
- 10—No current variations—resistance always constant.
- 11—Resistance element so finely divided further division impossible.
- 12—No disks to break or chip.
- 13—Operation absolutely silent.
- 14—Connection posts with Fahnestock Clips and solder contacts.
- 15—Adjustable mounting—no redrilling of panel.
- 16—GUARANTEED—Unbreakable, Replaced within 1 year if broken.

Manufactured and guaranteed by

# \$2 DX INSTRUMENT CO. \$2

Harrisburg, Pa.

At Dealers Everywhere

Ask to see "Graph" proving Filkostat Superiority

If Your Dealer has none in stock yet send \$2.00 and his name direct to

Sole International Distributors

## RADIO STORES CORPORATION

Benj. Gross, Pres.

218-222 West 34th Street, New York

Wire orders filled to Jobbers and Dealers

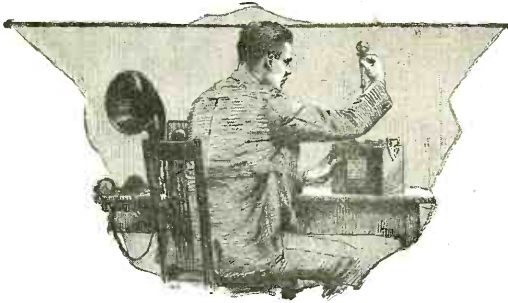

## Your Battery Should be Kept Fit

The Tungar Battery Charger makes it a simple matter to keep your storage battery tuned-up and fit. With it you can recharge your battery at home—and at little cost.



**Tungar**

is a small, compact rectifier, which can be connected with any a-c. lighting circuit. It is easy and safe to operate—in fact, requires no attention after starting. And when properly connected, the current can go only the one way, eliminating any danger of ruining the battery.

There is no excuse for allowing your battery to run down and spoil the evening's fun. A Tungar doesn't cost much—and it charges the starting and lighting battery in your automobile also.

Send for our new booklet on Tungars for radio, if your dealer cannot supply you.

Address Merchandise Dept., General Electric Company, Bridgeport, Conn.

**General Electric Company**  
 General Office Schenectady, N.Y. Sales Offices in all large cities 35A-72X

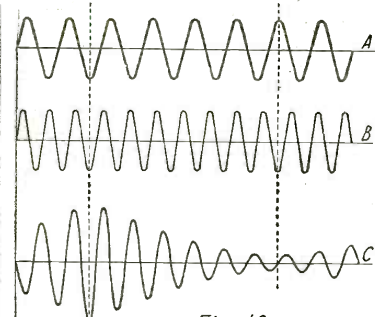

Fig. 10

The Effect of Wave Motions A and B, Acting Together in the Same Space, is Shown in C.

curves of Fig. 10. Suppose there are two wave motions as shown in the two upper curves of Fig. 10, these wave motions being somewhat different in frequency. If these wave motions act together in the same space their effects will add together. Thus at point A it will be noted that the wave motions oppose one another, one is positive and the other negative. Hence the added effect of these wave motions will be zero, if their strengths are the same, since one neutralizes the other. If these wave motions are due to light waves, then at this point there will be a dark spot, since the waves neutralize each other. At point B on the other hand the wave motions are in the same direction, hence they assist one another, and in the case of light the light will be more intense. In other words these two wave motions interfere with one another and the resultant effect is the sum of the two. The sum of these two waves is given by the third wave, C, where we see that there are variations in the net effect, or amplitude, ranging from zero where the two waves oppose, to a maximum where the maximum amplitudes of each add to one another. Thus in the case of light we would have a series of light spots and dark spots due to interference, these alternations being called "beats."

Exactly the same phenomenon occurs in the superposition of radio waves. If two radio frequency waves are superimposed on one another they will interfere with each other and give rise to beats, namely zero amplitudes and maximum amplitudes. Now these beats occur at certain regular intervals which are given by the difference between the two frequencies which interfere. Thus if one of these radio frequency waves has a frequency of 500,000 cycles per second, and the other 499,000 cycles per second the beat frequency due to interference will be 1,000 cycles per second, which is an audible frequency and hence can be heard in a pair of telephones. Immediately this suggests a practical method for detecting continuous wave oscillations. If a radio signalling wave of 500,000 cycles per second is received and a local generator at the receiver generates a wave of 499,000 cycles per second, and the two are superimposed on the same circuit a beat frequency of 1,000 cycles will be developed. Since this beat frequency is audible the incoming signal will be heard. This in fact is the basis of the heterodyne method of reception.

Other points of similarity may be mentioned, but those given above are really the outstanding ones. It will be clear that these points, reflection, refraction, absorption and so on, are very helpful to a thorough understanding of many vague or obscure phenomena occurring in radio reception and transmission. These ideas will, therefore, be very helpful and interesting to those who have mastered the rudimentary ideas of radio.

### PERMANITE: The Wonder Crystal

An absolute innovation in the radio crystal field. Permanite Synthetic Crystal is invariably sensitive on EVERY PART OF ITS SURFACE. Lasts two years. No loss of sensitivity through spark reception. Sold on money-back guarantee.

PERMANITE and SPECIAL CAT WHISKER ..... 75c.

Sole Distributors

**P. M. DREYFUSS CO., Inc.**  
 150 Chambers Street, New York City

### RADIO GOODS AT BARGAIN PRICES

\$5.00 Detector Tubes .....	\$3.00
\$6.50 Amplifier Tubes .....	3.50
\$6.50 1 1/2 v. Detector or Amplifier Tubes (Fit Standard Sockets) .....	5.25
\$5.00 U.V.200 Detector Tubes .....	4.50
\$6.50 U.V.201 Amplifier Tubes .....	3.98
Wardock Phones, 2000 Ohms \$4.49, 3000 Ohms 4.98	
Genuine Baldwin Phones .....	10.50
Thordarson Transformers \$3.59, Acme .....	4.25
2 1/2 v. Cyclone Var. B. Batt. \$1.00, Large ..	1.75
Triumph Coupler Meter .....	5.50

Numerous other bargains in our FREE PRICE LIST sent upon request. Goods shipped POST-PAID promptly upon receipt of money order or registered cash.

ALL MERCHANDISE GUARANTEED

**Bergen Radio Supply Co.**

Mail Order Department  
 606 Bergen Ave., New York City



# BUILD YOUR OWN RADIO

DON'T WAVER SAVE MONEY WRITE WAVELAND

Complete **\$20.00**  
Parts to Build this Set Pre-paid

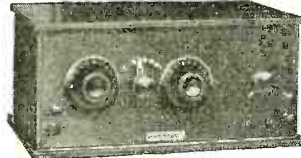

View of Waveland Concert Receiver

**\$18.00** Additional

Everything you need including beautifully engraved 6x14 in. Formica panel with all holes drilled. Easily followed instructions and Lefax Handbook free with outfit.

covers the cost to you of all accessories needed including W. D. 11 Tube, batteries, headphones, aerial, etc. Nothing extra to buy.

**When Assembled According to Our Instructions**  
**We Guarantee you can listen in on stations over 1000 miles Away**

Because of the patent royalty on the regenerative circuit we cannot wire the above apparatus *but you can* in about thirty minutes time. A pair of pliers and screw driver are all the tools needed.

## Waveland

### Two-Stage Amplifier

**\$25.00** Unwired  
**\$27.50** Wired



Amplifier when Completed

If it is desired, to amplify the concerts etc. so that a loud speaking horn can be used, enabling a number of persons in one room to listen without headphones, It is necessary to have **Waveland 2-stage Amplifier**. To put it in operation **THE ACCESSORIES** including two tubes (which operate on ordinary dry batteries) and **WAVELAND DIE CAST WOOD LOUD-SPEAKING HORN** **\$29** will cost an additional . . .



You need one of these Die Cast WOOD HORNS as it is the only material known that will produce a perfect tone. No tinny, metallic distortion. Height, 12 inches; Diameter, 10 inches; Weight, 3 1/2 pounds.

- J-357 Mahogany Finish Horn with Baldwin Receiver . . . . . **\$15.00**
- J-358 Mahogany Horn with Automatic Receiver . . . . . **\$12.50**
- J-359 Mahogany Horn with no Receiver . . . . . **\$ 8.00**

## The Newest in Loud Speakers



Die-Cast Wood puts an end to the jangle of metal horns. A boon to radio because they produce that clear, soft, musical resonance that can only come from Die-Cast Wood. Imagine a violin made of brass or sheet steel. Or a tin guitar! Or a metal talking machine cabinet or piano case. Everybody wants a wood horn. Make your selection NOW.



J-361

## Any Standard Phone Receiver Can Be Fitted Into the Base

- J-360 Floral Pattern . . . . . **\$15.00**
- J-361 Clearspeaker (Horn and Cabinet) **25.00**
- J-362 Shell Pattern . . . . . **18.00**

Any of these designs can be furnished in Ivory, Verdi Green or Tiffany Gold finish.



J-362

## The H. K. Switch

Everyone knows the difficulty encountered in drilling holes in panel for switch points and getting them spaced correctly. The H. K. Multiple Switch does away with this troublesome drilling. Can be mounted on a panel in about the same time it takes to mount a rheostat. Has 15 contact points, each fitted with two nuts for connecting from inductance. Complete, with dial calibrated from 0 to 14. **J-850** . . . . . **\$2.00**



## An All Bakelite Socket

with four nickel plated binding posts for connections. Can be placed in smaller space than any other socket on **35¢** market. **J-553**



## Friction Vernier Knob

One of the best aids to fine tuning yet produced. To attach simply drill 1/4 inch hole in panel, insert the bushing and shaft and replace the cotter pin. The tapered adjusting bushing takes up wear as well as inaccurate drilling, and the spring keeps the friction even and constant. **J-210** . . . . . **25¢**

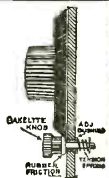

## Attention!

**Radio Frequency Fans**  
Here is just the type of loop you have been looking for. Made of mahogany finished wood, high frequency (Litz) cable and Formica ends. Measures 33 inches from base to top. 26 inches in width. Cable of 37 strands of No. 38 wire. Loop is directional and can be set up either as a radial or box type. Especially designed for super-regenerative sets. **J-802** **\$10.00**



## Lightning Arrester

The spring and summer storms are coming. Antennas attract lightning. Protect your set against lightning and high voltage with an arrester approved by the fire underwriters. This type of arrester is also used to protect telephone lines. Mounts indoors. Never grounds. **J-811** . . . . . **\$1.50**



## Six Can Listen

as well as one with this plug. This multi-terminal plug overcomes the difficulty in making connections when two or more pairs of receivers are used. It provides positive and instantaneous connection for all standard headset terminals by merely inserting the tips into the holes provided in the plug. From 1 to 6 pairs of receivers may be accommodated in such a manner that maximum electrical efficiency is assured. **\$2.00** Prepaid.



## Radio Handbook Every Radio Enthusiast

Should Have One  
An up to date book on Radio in every day language. Tells you all about new and old circuits, how to connect up sets, put up aerials, etc. Gives complete list of all broadcasting stations in America. Up-To-The-Minute radio information mailed to each owner semi-monthly. Book given free with every first order amounting to \$20 or more. **J849** **\$3.50**

## Special Bargains

- W. D. 11 Tube (Peanut 1 1/2 volts) . . . . . **\$ 6.50**
- Baldwin Headset . . . . . **12.00**
- Baldwin Loud Talking Unit with Cord . . . . . **6.00**
- 2000 OHM Headset . . . . . **5.00**
- Everready "B" Battery 22 1/2 volts . . . . . **1.75**

## "Waveland" Products are all carefully tested and all of the very Highest Quality, fully guaranteed.

Our radio-engineering department always at your service, for consultation and advice, no charge.

**"Waveland Pays the Postage"**  
anywhere in North America (on everything except storage batteries.) **Write for Catalog.**

Dealers Send for Discounts

# WAVELAND RADIO CO.

1348 NORTH CLARK ST.

Incorporated

CHICAGO, ILL.



# What about RADIO in 1925

## Can You Keep Pace With Its Progress?

FAR fetched, indeed, would it be for any publisher to claim that a book on RADIO published *to-day* can also be an authority TO-MORROW, in 1924, and in 1925, for who can foretell what great changes will mark the progress of RADIO before it attains its final state of development? LEFAX, however, has gone very far to attain just such a goal by publishing in loose-leaf form an authoritative book on RADIO and then supplementing this information each month with *additional* pages that keep pace with the rapid developments of RADIO science.

### The One Best Book on RADIO

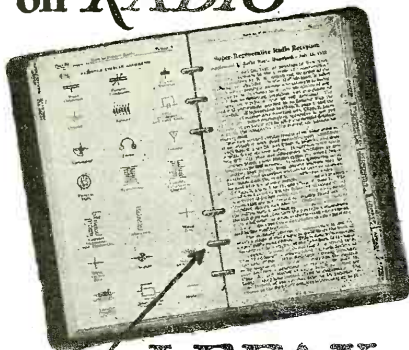

## LEFAX

*Never Grows Old*

#### Four Big Features

**Never Grows Old**—About once a month additional pages are sent out to purchasers of the book, thus keeping it perpetually up-to-date.

**Eminent Authors**—The book, as well as the supplementary service, is written by the two chiefs of the Radio Laboratory, U. S. BUREAU OF STANDARDS, Dr. J. H. Dollinger, and Mr. E. L. Whittemore.

**Stations List and Apparatus Section**—Contains a list of broadcasting stations, which is kept continuously revised. Also contains a section devoted to apparatus, which is continuously supplemented by new pages.

**Neat and Convenient**—Finest imitation morocco leather binder, nickel plated "snap-back" rings—chapters separated by handy linen index tabs.

**\$3.50**

For sale at all Radio Dealers—  
Dept. Stores—Book Stores and  
Principal Stationers

Lefax, Inc. 147 S. 9th St.  
Phila., PA.

## Correspondence from Readers

(Continued from page 1812)

thought his was the only station in operation, or was he so embarrassed with the preceding number that he did not want to tell what station his was? It surely must have been one of the two above reasons.

The writer is deeply appreciative of the splendid programs that are being sent out nightly and at no expense to the "listener in," but while this is being done it surely is a very simple matter to tell where all these good entertainments are coming from. Just recently a splendid program was being sent out from some station; the entertainers were real artists, and we wanted to express our appreciation to these artists, but we never found out where this was being sent from. Four numbers were broadcast without any information concerning the station. To be honest, we got disgusted and tuned them out.

It is an insult to the artists, in our opinion, not to announce the station after each number. As stated above, we are most appreciative of all these good things given to us without cost, but we mention this oversight to bring to the attention of thoughtless announcers the condition from the viewpoint of the "listener in."

A LISTENER IN,  
Frankfort, Ind.

### THE GALENA PUZZLE

Editor, RADIO NEWS:

Referring to long distance galena records, I wish you would print something about the possibility of the seeming long distance signals coming, in fact, by relay from a nearby tube set. I got St. Louis recently, a distance of 980 miles, and a friend with a tube set is trying to explain it as above. I referred him to the bit you wrote in your January editorial about the galena "puzzle" but he declines to be puzzled. Quite illogically, it seems to me, he grants that I can get KDKA at 450 miles and my lesser "gets." He got these himself in the crystal stage of his experience.

Now, if it be true that each tube set is a transmitter, not merely of squeals but of good radiophone, it raises hob with all records of distance whether by galena or tube set, for if galena can get these local relays, the tube sets can also, with all the more reason. This leaves it free for the owner of the best set to claim that the weaker sets are not really getting Mexico and San Francisco, but are merely hearing him get them. This ought to stir things up. Important, if true. Also it ought to be easily proved. If Jones with the big set goes to bed, no more fine "gets" that night, etc., etc.

And what about the thousands of crystal sets in cities, mixed in promiscuously with tube set relays? Why does it not make them all good? Why the exceptional set anyway? Did not galena make fine records before tubes were invented? How about records in vessels at sea with no relays near? What, why, how?

JUNIUS T. HANCHETT,  
Antrim, N. H.

(Yes, Why? "We want to know."  
Watch for our "Galena Record Prize Contest."—EDITOR.)

### RADIO VS. PHOTO

Editor, RADIO NEWS:

This little ditty is entitled "Why Radio Sales Fall Off, and Generally Take the Buyer with Them," continued from page 1094 of the December issue of RADIO NEWS.

Before I was bit by the bugorium radiorum, I was more or less a photograph cam-

## LEARN THE CODE AT HOME

"Just Listen—The Omnigraph will do the teaching"

with the

### OMNIGRAPH

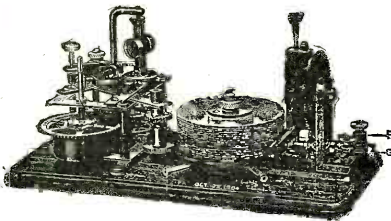

**THE OMNIGRAPH** Automatic Transmitter will teach you both the Wireless and Morse Codes—right in your own home—quickly, easily and inexpensively. Connected with Buzzer, Buzzer and Phone or to Sounder, it will send you unlimited messages, at any speed, from 5 to 50 words a minute.

**THE OMNIGRAPH** is not an experiment. For more than 15 years, it has been sold all over the world with a money back guarantee. The **OMNIGRAPH** is used by several Depts. of the U. S. Govt. all applicants applying for a Radio license. The **OMNIGRAPH** has been successfully adopted by the leading Universities, Colleges and Radio Schools.

—in fact, the Dept. of Commerce uses the **OMNIGRAPH** to test all applicants applying for a Radio license. The **OMNIGRAPH** has been successfully adopted by the leading Universities, Colleges and Radio Schools.

Send for **FREE** Catalog describing three models, \$14 to \$30. **DO IT TODAY.**

**The Omnigraph Mfg. Co., 20 Hudson St., New York City**

▲ If you own a Radio Phone set and don't know the code—you are missing most of the fun.



# You Can Fill One of These Big Pay Positions Waiting In Radio, \$2,500 to \$10,000 a Year

Training in the profession of Radio will enable you to earn a good living, to travel, to see the world if you wish or locate in a position near your own home. No other training offers such opportunity for success and rapid advancement as a certified Radio-Trician. While in itself a fascinating highly-paid profession, it is also a wonderful stepping stone to leadership in this great field. Honor, power, position, wealth—all are easily possible for those who enter this great new profession NOW while it is growing.

**R**ADIO has jumped into the front rank of the world's great industries. In its colossal growth it has swept across the face of the earth. The shores of every continent are dotted with Radio stations. Nearly every vessel on the seven seas is a floating Radio station. Thousands of factories are busy day and night supplying the tremendous demand for equipment and apparatus. Every night millions of people "listen in" to Radio broadcast news, music, entertainment and education.

Radio operators on swift ocean greyhounds are traveling the world over, visiting famous scenes, enjoying a wonderful life of romance and adventure—and at the same time getting a splendid salary. At land and broadcasting stations, operators, aids, specialists are doing this new and interesting work—and making big money doing it. Under their fingers flows the story of the world's progress. To them comes news from far-off countries speeding through the skies. Factories, stores, laboratories, banks, cities, business houses, newspapers and schools are employing Certified Radio-tricians as

operators, maintenance, repair and installation experts, engineers, technicians, aids, designers, demonstrators, salesmen, instructors.

Yet Radio is only in its infancy. Despite the marvelous advances of the last few years we are only on the threshold of the Radio era. We have barely scratched the surface of its vast possibilities. We have merely guessed its yet undiscovered wonders! Great as Radio is today it will be a thousand times greater tomorrow! The man who gets into Radio today—who prepares NOW to grow up with this wonderful new science—will have a great share in its glorious future. He will be able to win fame, honor and wealth in this fascinating profession.

## How You Can Qualify At Home for a Fine Radio Position

For the ambitious man, Radio offers greater opportunities for success than any other profession or trade. No matter what your ambition, no matter what your education or your ability, there is a special field in Radio where your natural talents will bring you a wonderful position; doing easy, interesting work at a fine salary; where your success is almost certain.

The National Radio Institute, known the world over as the oldest and largest Radio training organization, will prepare you quickly in your spare time at home to qualify for the position you want. Hundreds of our graduates are today reaping big returns from their instruction. Some of them are radio inspectors and engineers. Others are in charge of land and sea stations. Still others are in charge of radio departments in stores or are in business for themselves. But no matter in what special field they have gone, all of them are earning more money than they ever made before.

See in the panel at the left how much a few of our graduates are making in REAL MONEY. Most of these men, when they started our course, knew little or nothing about Radio. Yet, in a few short months, our instruction qualified them to earn big money as Certified Radio-tricians. The same instruction, the same help that brought quick success to these men, is now offered to you. You have the same opportunities, you have the same prospects they had. Take advantage of them.

In the panel on the left are just a few of the positions open to the Certified Radio-trician. Thousands of splendid big-paying positions are going begging for want of men able to handle them. Get into Radio Now. Grow up with it. Advance with it.

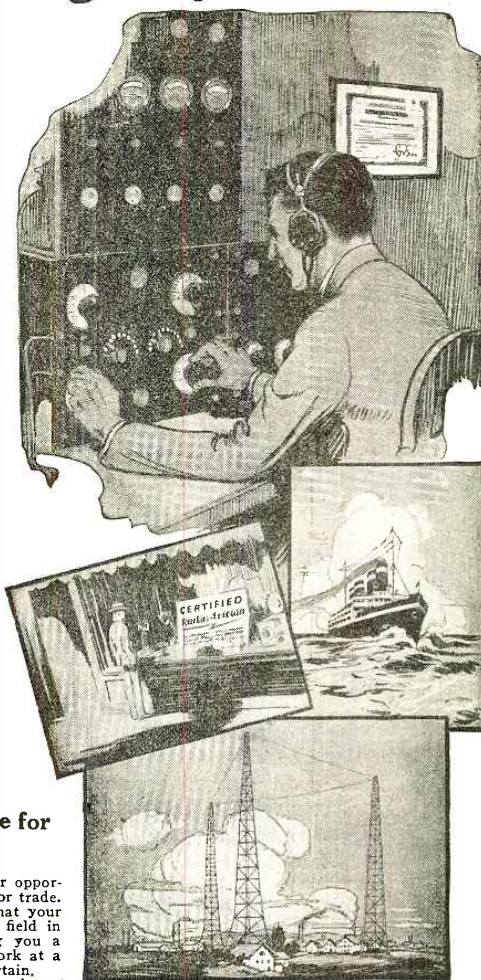

## Special Opportunity Now Open

The urgent need for radio experts and the calls which come to us for our students prompt us to make a special offer open to new students for a limited time. Through this special offer your enrollment will be accepted at a special rate, and you will receive, without extra cost, our new course in Wireless Telephony.

## Send For Free Book

We have just prepared a new book which is filled with the latest information about the wonderful opportunities in this newest and fastest growing profession. It will be sent to you absolutely free. Send for this book. It will tell you all about how we prepare you for, and help you to get or secure the wonderful positions open in this fascinating field. Send for this Free Book today.

## National Radio Institute

Dept. 13-D, 1345 Pennsylvania Ave., N.W.  
Washington, D. C.

NATIONAL RADIO INSTITUTE,  
Dept. 13-D, 1345 Pennsylvania Ave.,  
Washington, D. C.

Send me your free book, "How to Learn Radio at Home," with full particulars about the opportunities in Radio, and how you will quickly train me in my spare time at home to become a Certified Radio-trician. Also, tell me how your free Employment Service will help me to a position and particulars of your special short-time offer.

Name ..... Age.....  
Street .....  
City ..... State .....

### What Some of Our Graduates Earn

Leo A. Goldblatt, as ship operator and clerk averages \$165 a month.

Revere B. Gurley, another graduate is getting \$7.00 a day as inspector in a radio factory.

R. D. Kimmel is earning big money as a Radio Salesman.

K. R. Bloomer has become an inventor of Radio Equipment.

Frederick H. Graening is in the Radio Department of the Telephone Maintenance Company of Chicago.

Thomas E. Lepson operates the Broadcasting Station at Washington, D. C.

James F. Nicholls is Radio Instructor at the Walter Reed Government Hospital and is paid \$150 a month and all expenses.

Edwin L. Powell, Expert Radio Aide at the Washington Navy Yard earning a handsome salary.

J. Webster Stevens, an electrician works at nights, as a Certified Radio-trician installing sets, repairing, etc. Averages \$150 a month in his spare time.

### Pick Out the Job You Want. We Will Help You Get It.

This is a brief list of the positions in the Radio field today, and the salaries paid:

Radio Mechanic, \$1,500 to \$2,000 a year.

Radio Inspector, \$1,800 to \$3,000 a year.

Radio Auditor, \$1,200 to \$1,800 a year.

Radio Salesman, \$2,000 to \$5,000 a year.

Radio Engineer, \$3,500 a year and up.

Radio Executives, up to \$10,000 a year.

Radio Instructor, \$100 to \$150 a month.

Radio Aide, \$6 to \$10 a day.

Radio Draftsman, \$7 to \$10 a day.

First Class Ship Operator, \$105 a month, all expenses paid.

Second Class Ship Operator, \$95 a month, all expenses paid.

Third Class Operator, \$85 a month all expenses paid.

Commercial Land Station Operator, \$150 a month and up.

Broadcasting Station Operator, \$125 to \$250 a month.

## WARNING!

Ours is the one complete Course that prepares you for a first class government license. It is complete in every detail. Necessary practice instruments are supplied free. Don't be confused by cheaper or free courses. They cannot secure for you a government license which is necessary to obtain a good position in Radio.

conference at the Department of Commerce indicated a desire to give everyone his share of the ether.

Of course, the technical amateur, and the business broadcaster, and everyone who wants to transmit or listen in, will say that all he wants is his share of the time and wave-lengths, but some men's idea of their share resembles the German conception of the Vaterland's share of the universe. There are approximately 110,000,000 citizens of the United States and twenty-four hours in the day. My share of the ether is twenty-four hours divided by 110,000,000, which is .00000021 of an hour, plus. This is .018144 of a second. Now as there are 20 available bands of wave lengths, I might feel entitled to twenty times that fraction of a section on one of them. That would make a little more than one-third of a second. But as the people of the United States, through their representatives in Congress have passed laws that lump their shares and put their transmitting into the hands of government and commercial stations except on one band of wave-length, I can claim only one-twentieth of my one-and-eight-tenths per cent of a second for the operation of my own transmitting set. That is .000907 of a second. If there are 1000 localities in which radio is used and I can operate in my locality without disturbing anyone in any of the others, then I figure that I ought to have 1000 times as many seconds, and that is about nine-tenths of a second.

A small difficulty creeps in here. In my locality there are ten million people within range of even a low power transmitter. So instead of dividing the time with 110,000, the average population of the thousand localities, I should divide with more than 91 times that number, which cuts me down to about .01 of a second. Also, I would like my share of time, about 8:30 P.M., after dinner is over and I know the amateur I want to radio to is home and ready for business. But that is just the time when all the other folks find it most convenient to open up or listen in. Somebody has to wait or else, in justice, we have to divide up the two or three most desirable hours among the ten million instead of figuring on a basis of twenty-four hours.

I heard a gathering of amateurs vote, after deliberate consideration, that they would not wait for anybody, unless compelled by law to do so. They knew that probably ten million people had, or soon would have, lumped their shares of the ether and, without asking for a chance to transmit, seek only to enjoy radio entertainment provided by stations that were able to give them what they wanted. The attitude of these amateurs appeared to be that it was up to the Government to give the minority the ether regardless of the majority. Their main argument was that they were engaged in technical research and experimentation which was so valuable to the country at large that it deserved to be protected. It made me wonder how many of them were prompted by their interest in science to listen for the United States Bureau of Standards, or the Army and Navy laboratories, or the transmitters of the companies that maintain trained scientific men, before opening up, and possibly causing interference. To be sure, the Government has reserved bands of wave-lengths for its own use, and yet it is possible for Government experimenters, while listening in, to be interfered with by nearby amateur transmitters.

The value of the work of some technical amateurs is undeniably great and is generally recognized. It is my impression, however, after much listening in, that the men

# Give Your Radio Set the Advantage of WESTINGHOUSE RADIO BATTERIES



Westinghouse "A" Batteries are especially built for the peculiar requirements of radio work. They deliver a constant, dependable flow of low voltage current. They are built to give long, low-cost service. They demand a minimum of attention.

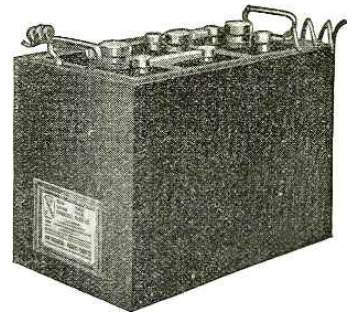

In the Westinghouse "B" battery you have a storage battery for "B" work—the latest development in radio practice. It has all the reliability and dependable performance of a storage battery and none of the disadvantages of a dry cell. The Westinghouse "B" gives a steady, continuous, noiseless service. It lasts indefinitely.

When exhausted it is easily recharged. The first cost is the last cost.

*Don't lose the enjoyment of your Radio by operating under unsatisfactory conditions. Get Westinghouse "A" and "B" batteries from your radio dealer or the nearest Westinghouse Service Station.*

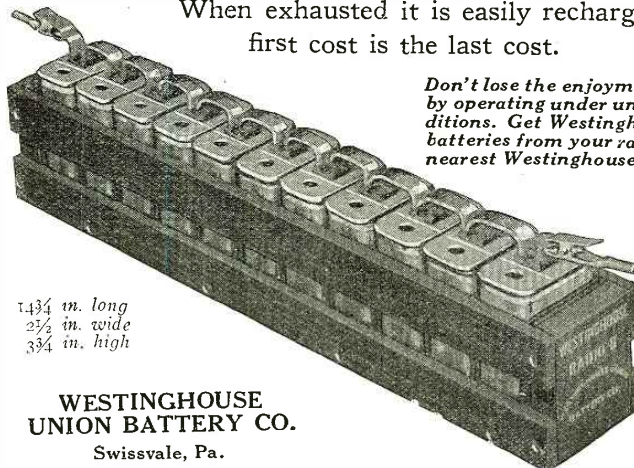

1 3/4 in. long  
2 1/2 in. wide  
3/4 in. high

**WESTINGHOUSE  
UNION BATTERY CO.**  
Swissvale, Pa.

*"The best  
Westinghouse  
can build"*

(My) \_\_\_\_\_ (Name) \_\_\_\_\_ (is) \_\_\_\_\_

Boys and  
Grown Ups

**MEMO - CODE**

Makes You a  
Real Radio  
Operator

Copyrighted

KNOW MORE THAN THE OTHER FELLOW!

By my System and Chart, you will know the Code in 30 minutes. Get the real thrill of "Radio News"

**COMPLETE SYSTEM \$1.00**

Ask Dealers or Direct

**H. C. FAIRCHILD**

**588 Broad St., NEWARK, N. J.**



## The Radio Guild

**NEW  
REDUCED  
PRICES**

RECEIVE NAA, the new broadcasting on 710 meters and higher wave-lengths with the

### "MULTI-RANGE" COUPLER

*"The finest bank-wound coupler ever produced."—N. Y. Evening Mail Laboratories.*

Permits the easy construction of a complete radio receiver at low cost.

Increased production to meet the enormous demand permits a new reduction in prices.

Multi-Range Senior, 170-3400 meters Now \$9.00 From your dealer or direct.  
 Multi-Range Junior, 170-1800 meters Now \$7.00

### Read the Harkness Book on Super-Regeneration

48 pages, 30 photographs, wiring diagrams and mechanical drawings. The most complete book on the subject ever published. Explanation of the theory of super-regeneration is a revelation. Tells how to construct three different types of sets.

Send for your copy today—Price 50c. From your dealer or direct.

The Minneapolis Daily News Says: "Radio books have come and gone in plenty. None has seemed to be worthy of special mention. One came this week, however, which absolutely demands mention, not to say praise, by its merits. It is THE CONSTRUCTION AND OPERATION OF SUPER-REGENERATIVE RECEIVERS by Kenneth Harkness."

## The Radio Guild, Inc.

256 WEST 34th STREET NEW YORK CITY

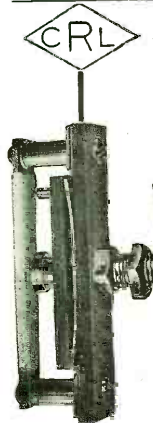

Adjustable Grid Leak (with condenser)  
Patent applied for

### The Correct Grid Potential

Are you using the grid potential that gives you the *maximum signal strength*? No matter how sharply you can tune your set, you are losing big opportunities—much satisfaction—if you neglect to provide some quick and reliable method of adjusting the grid potential.

Equip your set with a

### CRL Adjustable Grid Leak

Its cost is small. A turn of the polished black knob will enable you to get the one and only correct potential that provides the *maximum signal strength*. There's no guess-work about it—no time lost in fussing with makeshift equipment.

No. 106 (without condenser) .....	\$1.50
No. 107 (with grid condenser) .....	1.85

Order from your dealer or, if he has none in stock, we'll be glad to supply you direct. Include 10c additional for postage and packing.

### CENTRAL RADIO LABORATORIES

(Makers of CRL Rheostats, Vernier Rheostats, Potentiometers, Vernier Potentiometers, and Grid Leaks)

MILWAUKEE
305 16th Street
WISCONSIN

era enthusiast, and spent many enjoyable hours delving into its mysteries. About all the instruction I gained was through the usual channels, namely, the dealers and the magazines. I don't believe I was ever stung on a piece of apparatus, and the time and patience some of those dealers took with me was truly marvelous. But they were repaid, I am sure, for most of them are in business today, with a nice little financial rating, and many I have numbered as my friends.

But time passes and along comes a greater, and more interesting hobby, and, of course, after a time I succumbed, and after I made my crystal set, and my first tube set, and then got two stages going pretty good, I became interested in experimenting, and then my troubles began. I could not find a certain piece of fibre, and went to several dealers requesting that they purchase same for me, and they all told me they didn't have the time to bother with such "trash." Then I wanted some 26 D. C. C. wire and I hunted and hunted, but without success. The average radio dealer hasn't time to bother with you unless you are in the market for a \$50 or a \$100 set. If you buy a piece of defective apparatus and return it, he feels insulted; the attitude of the average radio dealer is one that does not invite confidence, and I fear unless that attitude soon changes it is going to cost the manufacturers a nice little sum of money, besides the interest that they destroy. Personally, I have come to the point that if I am looking for some particular piece of apparatus or material, I send direct to the manufacturer for it, where I receive courteous treatment; they are always willing to give me the desired help. The few of us who have called this matter to your attention I am sure are not the only ones who have been disappointed in their dealings with the average radio retailer, and it's up to him if he intends to show a balance this year.

W. A. DUSTIN,  
Chicago, Ill.

#### BROAD MINDED

*Editor, RADIO NEWS:*

Complying with your request in the January issue of your magazine, I will endeavor to supply a little information on the Canadian amateur in this vicinity.

Radio is just beginning to get a foothold in our city, but is limited to receiving only. Our nearest broadcasting station is about 18 miles distant and its broadcasting is almost entirely limited to canned music of a rather uncertain vintage. The majority of my fellow bugs (I will include myself) depend upon the various stations of the U. S. A. for amusement. Toronto, another Canadian station regularly heard, is a fairly good station, but is not to be compared with WGY, or KDKA.

There is but one C.W. transmitter (limited to telegraph only, at the present time) in our neighborhood. Ford coil "Sparks" are springing up nightly and no doubt we shall have one or two more C.W. stations in the near future.

The present conflict between the so-called "Old Timer" and the newly budded "Phone Bug," as heralded by your publication, is surely amusing and also disgusting to some extent. There are surely some spoiled children on both sides. It is reasonable to say that everyone cannot be a first-class operator and also that the concerts broadcast have become as much a necessity to the average individual as the telegraph is to the carrying on of communication.

When one of these "dye in the wool" fellows makes the statement that the "phone" will never supplant the "telegraph," it only recalls what was said when the first steam engines and automobiles were introduced. As futurists, some of these "hams" can't see any farther than their own equipment,



# Bradleystat Superiority Confirmed by Oscillograph Tests

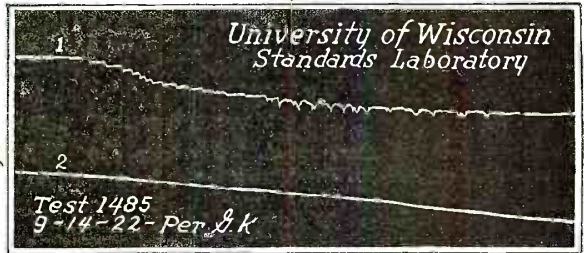
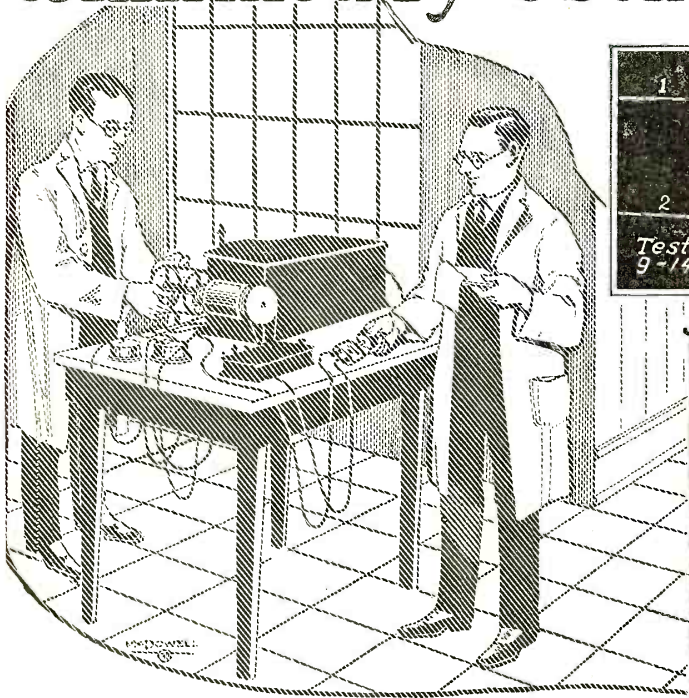

### An Important Test

The Oscillograph is a delicate instrument which records on a moving photographic film any fluctuations in electric current flowing through a rheostat connected to the oscillograph.

**Test No. 1**—See the violent fluctuations, the jerky, noisy control of a regular wire rheostat. Imagine the hissing and whistling such rheostats create in your detector tube.

**Test No. 2**—Now look at the smooth, stepless control of the Bradleystat. No hissing, no frying nor loss of exact control. Such noiseless, gradual control extends your range immensely.

Fully  
Guaranteed



### Replace your Rheostats with Bradleystats

Just compare the oscillograph curves above, made in the Standards Laboratory of the University of Wisconsin. The superiority of the Bradleystat is strikingly evident. Thousands are now installing Bradleystats in place of their wire rheostats, and get quicker tuning, greater range and louder detection. Try one, tonight, and note the amazing improvement.

A new Allen-Bradley product is the Bradleyometer, the Perfect Potentiometer. If you use a potentiometer in your set, send for a Bradleyometer bulletin.

**Allen-Bradley Co.**  
Electric Controlling Apparatus

287 Greenfield Ave. Milwaukee, Wis.  
Member of the National Radio Chamber of Commerce

Retail Price  
**\$1.85**  
P.P. 10c extra

# Bradleystat

REGISTERED U.S. PAT. OFF.

## PERFECT FILAMENT CONTROL





## "Radio Frequency Receivers"

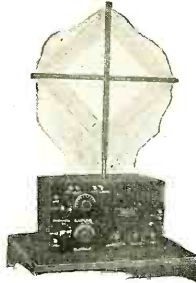

The RADIO GUILD specializes in the construction of RADIO-AUDIO FREQUENCY AMPLIFYING RECEIVERS of the highest efficiency and quality. These make possible the reception of stations over 1000 miles distant with a small loop aerial supplied with each set. These receivers all employ the new RADIO GUILD "Radio-Frequency" coupler which insures absolute selectivity when receiving with an outside aerial and ground. Send 10c for illustrated catalog N-4 giving full description of RADIO GUILD sets and parts.

**NEW BOOK BY KENNETH HARKNESS**  
**"The Theory and Practice of**  
**"RADIO FREQUENCY AMPLIFICATION"**

now off the press. By the author of "The Construction and Operation of Super-Regenerative Receivers." Latest information on radio frequency amplification. Scores of photographs, drawings and wiring diagrams. Complete instructions for the home construction of various types of radio frequency amplifiers and complete receivers. For the first time the construction of the best radio frequency transformers shown in detail with photographs. Tells you how to make a high frequency oscillator covering all wave-lengths. Every phase of radio frequency amplification thoroughly explained. Send for your copy today. Price \$1.00. From your dealer or direct.

**Radio Guild**  
**"RADIO FREQUENCY" COUPLERS.**

For use only with 2 or more stages of R. F. amplification

Selectivity on an outside aerial with radio frequency transformer amplification cannot be obtained with standard coupler. The new RADIO GUILD "Radio Frequency" couplers give just the proper degree of coupling to eliminate interference. Complete hook-ups enclosed with each coupler.

Short wave "Radio Frequency" coupler (190-450 m.).....\$6.50  
 Multi-Range "Radio Frequency" coupler (190-2000 m.)...\$8.00  
 Bank-wound loading coil (for secondary circuit of Multi-Range "Radio Frequency" coupler).....\$4.00

From your dealer or direct.



**The Radio Guild, Inc.** 256 West 34th Street, New York City  
 Specialists in radio frequency amplification.  
 Distributors of DX radio frequency transformers

### MAKE YOUR OWN RADIO SETS

Variometer .....	\$ 2.50
Variocoupler .....	2.50
Socket V. T. ....	.25
Rheostat .....	.25
Paper Condenser .....	.15
Variable Condenser	
23-Plate .....	1.65
43-Plate .....	2.00
Acme Transformer .....	3.75
2000 ohm Murdock Phone .....	3.50
Baldwin Phone .....	10.00

**FREE CATALOG—**  
 Write to Dept. A.  
**DAVID KILLOCH COMPANY**  
 57 Murray Street  
 New York

**PAY NO EXPRESS**  
**APRIL SLAUGHTER**

Sent postpaid anywhere upon receipt of money order, cash or check.

\$6.50 1/2 volt detector and amplifier.....	\$5.25
Guaranteed dry cell tubes fits any socket	
5.00 Detector tubes .....	3.80
6.50 Amplifier .....	3.50
8.00 Federal or Elwood Phones.....	5.95
3.75 23 Plate variable condensers.....	1.95
4.75 43 Plate variable condensers .....	2.65
5.00 Varie Couplers or variometers.....	2.50
9.00 All Wave couplers (silk wound).....	6.95
25.00 Crystal outfit complete with phones and aerial outfit.....	14.55
1.00 Rheostats, V. T. Sockets or 2" hard rubber dials (all 3 for \$1.35).....	.49
3.50 Double slide tuning coils.....	1.95
3.00 Mahogany pocket receiving outfits.....	1.95
1.75 Cyclone B. Batteries 22 1/2 V. Variable .....	1.10
4.00 Cyclone B. Batteries 45 V. Variable .....	2.75
.35 Galena, grid or phone condensers.....	.15
.50 Pyrites or grid leak condensers.....	.25
4.50 Thordarson Transformers .....	3.85
6 Volt guaranteed U. S. Storage Batteries (sent by express collect) 7.50 up	

Price List Free

Old customers send for special price list of 200 electric bargains.

Broadway Electrical Novelty House  
 134 Third Ave., Dept. 4N New York

Then after knocking the broadcasting, etc., they start pounding away at the owners of receivers, and in all their correspondence not one of them mentions the fact that they were rank novices at the beginning. Also, is it not possible that at least some of these "phone bugs" will graduate into something more than mere listeners?

On the other hand, there is the bird that wants to listen in all day and all night with never an interruption from some C. W. or spark "brass pounder." He, also, ought to be banned. He seems to forget that some "ham" in the vicinity, who gets as much pleasure trying to raise the poles as he does listening in, is waiting for a hole into which to wedge a few dots and dashes, and if the said "ham" doesn't happen to wait for the said hole, he yells "blue murder" because one concert in twenty-four hours is slightly mused up.

In my estimation, the owners of receiving and transmitting apparatus should get together and know each other better, split the ether fifty-fifty, develop a sense of fair play, and cut out this eternal chewing the rag. Of course, as the saying goes, "You can please some of the people some of the time, but not all of the people all of the time."

J. CHAW,  
 St. Thomas, Ont., Can.

**CONSTRUCTIVE CRITICISM**

**Editor, RADIO NEWS:**  
 In reviewing the article by Mr. H. E. Metcalf in the December issue of RADIO NEWS, on the subject of design and construction of a radio loud talker horn, several points have come to mind which were not covered by the article. Mr. Metcalf discusses, primarily, the question whether or not a metal horn is as efficient as a wooden horn and giving his opinion in the affirmative uses as an example the metal horn of the Edison phonograph, which he states (truly) is free of any "tinny" sound.

The writer has no intention of discrediting Mr. Metcalf's views and does not wish to enter into any particular discussion of the matter. However, sound reproduction has always been one of his hobbies and consequently he wishes to express his views of the subject.

Mr. Metcalf states in his article that the difference in reproduction could not be distinguished in the metal and wooden horns. The writer disagrees with this statement (to a certain extent) and cites the following experiment.

When a Magnavox type of reproducer is placed at the end of a well-constructed metal horn, such as that used in several of the leading phonographs, the tone is decidedly inferior to that produced when it is placed at the end of the all wooden tone passage of the Sonora phonograph, or at the end of any well-constructed wooden horn.

At the Panama Exposition, the Sonora, in competition with all of the leading phonographs of the world, won the highest score for tone quality. As stated above, the Sonora is equipped with all wooden tone passage from the sound box to the large end of the horn. This, the makers declare, is the main attributing feature of its tone superiority. It has been claimed that the sound box was responsible for the decision of the judges, but when the writer placed a Sonora sound box on a nationally known phonograph with metal horn, a very harsh scratchy sound was emitted.

The so-called "tinny" sound in certain commercial phonographs and radio loud talkers is not caused by any horn construction. Such noises are caused by faulty reproducers and not by wooden or metal horns.

However, the wooden horn is superior to the metal horn in the respect that a metal horn will clarify all sound emitted by the reproducer including false sounds (such as

**MONEY for YOU** Add to your Salary—Make extra Pin Money. Start a lucrative business of your own. Spend an hour each day taking subscriptions for the "Radio News." We'll pay you well and you'll enjoy the work. Write for full particulars. Circulation Dept. RADIO NEWS, 53 Park Place, N. Y. C.



# BARKELEW

## RADIO ACCESSORIES

### Antenna Equipment

### Four Phone Plugs and Posts

**LIGHTNING ARRESTER**  
Required on the antenna of every Receiving Station.  
Cat. No. 606 Price \$2.00

**FOUR PHONE POST**  
For Vacuum Tube Sets  
Connects four or less head-sets in Series.  
Cat. No. 618 Price \$0.75

**FOUR PHONE POST**  
For Crystal Sets  
Connects four or less head-sets in Multiple.  
Cat. No. 615 Price \$0.75

**FOUR PHONE PLUG**  
Connects four or less head-sets in Series to any Radio Set using telephone jacks.  
Cat. No. 616 Price \$1.50

**LIGHTNING ARRESTER SWITCH**  
For Receiving Stations Demanded by those who want the best.  
Cat. No. 602 Price \$3.50

**FOUR PHONE PLUG**  
Connects four or less head-sets in Multiple to any Radio Set using telephone jacks.  
Cat. No. 614 Price \$1.50

**GROUND SWITCH**  
Required on all Transmitting Stations. Built of 60 Ampere copper.  
Cat. No. 600 Price \$2.50

**GROUND SWITCH**  
Required on all Transmitting Stations Built of 100 Ampere copper.  
Cat. No. 601 Price \$3.15

**PORCELAIN PEDESTAL**  
Brown Glaze  
For spacing Switches No. 600, No. 601 and No. 602. 5" out from the wall.  
Cat. No. 611 Price \$0.50 pr

**"LEAD IN" INSULATOR**  
LATOR  
For Receiving Stations  
Spaces the "Lead In" Wire 5" out from the wall.  
Cat. No. 612 Price \$0.50

**FOUR PHONE POST**  
Adapted for Acetate Series  
For four or less head-sets in Series. Remove nuts and slip over phone posts.  
Cat. No. 617 Price \$1.00

**"LEAD IN" INSULATOR**  
For Transmitting Stations  
A large petticoat insulator on a treated wood pin.  
Cat. No. 613 Price \$1.00

In this grouping of Radio Accessories, we present to the radio trade a variety of parts which are in keeping with the reputation of BARKELEW Products.

The Four Phone Plugs and Posts shown at the right are of unique design, compact and practical. On old sets they are easily applied by anyone. Manufacturers are installing them on new sets to meet the public demand.

### Accessories of Merit and Quality

Our Lightning Arrester Switch No. 602 is recognized by Radio Engineers as the most effective device yet developed for that purpose. All of our switches and Lightning Arresters are approved by the Underwriters' Laboratories.

Insulators and Pedestals meet the best Radio Engineering practice as well as the latest requirements of the National Electric Code.

All radio material is packed in paper boxes and labeled, making excellent shelf stock.

### To Radio Distributors and Dealers

Trade discounts to Radio Distributors and Dealers who have established standing or can prove their status.

Local distribution is through Dealers where available.

### To Customers

Try your Dealer first; if he cannot furnish write our Middletown Office for name of one who will.

## THE BARKELEW ELECTRIC MFG. CO.

MIDDLETOWN, OHIO

15 S. Clinton St., CHICAGO  
75 Fremont St., SAN FRANCISCO  
411 Main St., LOS ANGELES

603 Century Bldg., PITTSBURGH  
1487 Broadway, NEW YORK CITY  
Denham Bldg., DENVER

Export Department, 29 Broadway, NEW YORK CITY



**Radio Catalogue FREE**

One copy of this complete Catalogue of Radio Outfits, parts, Dictionary of Radio Terms, Instruction Book, and Guide to Successful Radio Work—one copy is yours Free.

Simply write us a post card and we will mail the complete book to you Free, by return mail.

It quotes the lowest prices, amazingly low prices on everything for the expert and the amateur. Every improved part, the most up-to-date outfits, everything that is needed of the most modern type—at the lowest possible prices.

It gives a list of broadcasting stations, and gives much information about radio construction and operation. Every one interested in Radio needs this complete catalogue and book of instruction.

**Why Pay Higher Prices?**

Montgomery Ward & Co. has for fifty years dealt on a Money-Back basis, absolutely guaranteeing everything they sell. With quality absolutely assured, why pay higher prices elsewhere? Write today for this Free Radio Book and see for yourself the Saving it will bring you. One copy is yours Free. You need only write us a post card.

**Write to the house nearest you. Address Dept. 2-R**  
Chicago Kansas City St. Paul Fort Worth Portland, Ore.

**Montgomery Ward & Co.**  
The Oldest Mail Order House is Today the Most Progressive

**GUARANTEED**

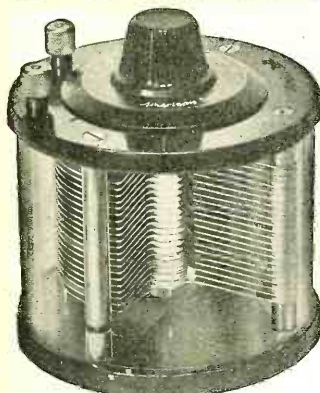

"Certified" American Bell Condenser

**SUPREME TO ANY OF ITS TYPE**  
With You As A Judge

If not satisfied that it is *Better* than the *Best*, you can return within 10 days from purchase and receive full amount of purchase cost back.

A wonderful instrument of mechanical perfection. Endorsed by radio engineers, journals and fans, from all over the U. S. A trial will mean a most marvelous surprise to you in radio satisfaction.

Don't delay trial—send at once  
You are absolutely guaranteed.

- 43 Plate Variable Condenser complete with Dust Proof Transparent Case ..... **\$5.50**
- 23 Plate Variable Condenser complete with Dust Proof Transparent Case ..... **\$5.00**

State if for Panel or Desk Set.

**AMERICAN BELL RADIO CORPORATION**  
316 75th Street, Brooklyn, N. Y.

**Money for You** Add to your Salary—Make Extra Pin Money. Start a lucrative business of your own. Spend an hour each day taking subscriptions for the "Radio News." We'll pay you well and you'll enjoy the work. Write for full particulars. Circulation Dept., RADIO NEWS, 53 Park Place, N. Y. C.

scratching, low humming, etc.), whereas a wooden horn has a tendency to absorb false noises.

There is a certain amount of vibration in any horn, regardless of construction, and a metal horn does actually vibrate more than a wooden horn, and so tends to depreciate the quality of the sound, and even though the depreciation is very slight it is quite often noticeable.

On the other hand, the metal horn is less expensive in construction and since generally used in a large room where minor sounds are lost, it seems fairly well adapted to radio loud speakers.

Nevertheless, the writer is quite sure that Mr. Metcalf will agree that could construction costs be removed, the leading loud speaker and phonograph companies would substitute wooden horns for the metal horns now in use.

E. J. NAUMANN,  
Baltimore, Md.

**CHANGE WAVE-LENGTH BANDS**

Editor, RADIO NEWS:

The past few months of rapid advance in radio have undoubtedly set the amateur in a serious condition. The amateur who has been in the service for many years remembers how clear the air was when he started the game, and even when broadcasting started, the few powerful stations furnished a great deal of enjoyment without interference. Today, however, you might say a perfect piece of broadcasting cannot be had; the traffic is far too great for the laws.

Suppose in a large city no traffic laws prevailed. What would happen? Why, everyone would interfere with the others, and of course the city ordinance would be changed.

The same with radio. The laws made for it do not govern it, and like any other laws that do not prove efficient, they will have to be changed.

Here is my idea of a good band of wave-lengths:

- 0—300 Amateur service.
- 300—500 General service.
- 500—700 Government market and weather reports and general service.
- 700—up Government private air.

This is quite a band of wave-lengths, but I think that any set may be made to work well on same.

Let's hear from some of you fellows. It is for the public betterment, and for our betterment.

GEORGE HIMBARGER,  
Wymore, Nebraska.

**A GOOD SUGGESTION**

Editor, RADIO NEWS:

One would wish that the broadcast announcers would not be so careless, and would make known the call letters of their station and its location after each number. I have in mind the WWJ office of Detroit, which broadcast a band concert recently and four musical numbers were played without a break when ordinarily after each number the announcer could have given his call. WGY is not an offender in this respect, but often after a number goes off the wire with the announcement "Just a minute, please," but with no designation of his office.

Recently I listened for more than a half hour to a station testing, without being able to determine its whereabouts. This was the method of procedure. "One, two, three, four. Hello, hello, hello-o-o." This was repeated with variations, with an occasional "yoohoo" whistle and a phonograph record. I could have wrung the operator's neck and I was forced to abandon the opportunity to find out what station it was.

I think the normal amateur enthusiast thinks more of getting an opportunity to



# A Chemistry Laboratory for \$7.00

Think of it, fellows! Here is a real chemistry outfit with regular chemical apparatus that performs those fascinating, actual chemical experiments.

This outfit is not a toy, put up merely to amuse, but a practical laboratory set, with all the chemicals, apparatus and reagents necessary to perform real work and to teach the beginner all the secrets of inorganic chemistry. With this outfit we give free a book containing a Treatise in Elementary Chemistry, useful data and recipes, and 100 instructive amusing experiments.

## DESCRIPTION OF THE OUTFIT

The outfit consists of forty-four (44) chemicals all C. P. (chemical pure) put up in appropriate wooden boxes, glass bottles and hermetically closed jars. The acids are put up in glass bottles, with ground-in glass stoppers, and there is a sufficient quantity of chemicals supplied (mostly one to two ounces) enough to make dozens of experiments with each.

The apparatus furnished are all of the best obtainable make and of standard laboratory size and shape. 17 pieces of apparatus furnished with this outfit.

The instruction book is a real Chemistry Course for the Beginner. Some of the Contents

are: Division of Matter: This is a Treatise on Elementary Chemistry, and deals with the theory of the Elements, Molecules and Atoms, etc.

## 100 EXPERIMENTS

How to make chemical tricks; how to make invisible and magic inks; how to test flour; how to test soil; how to make chlorine gas and smoke (German War Gas); how to bleach cloth and flowers; how to produce oxygen and hydrogen; how to make chemical colors; how to test acids and alkalies, and hundreds of interesting hints and formulas.

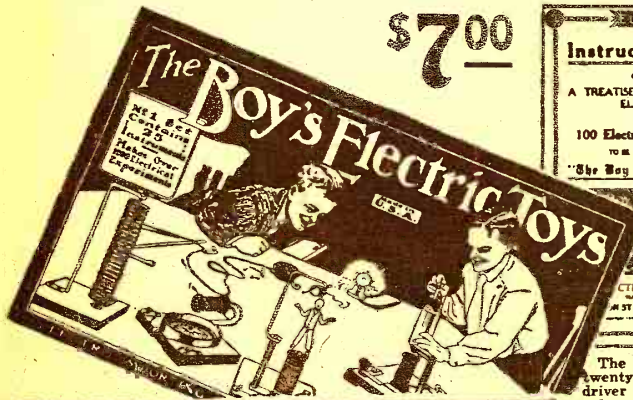
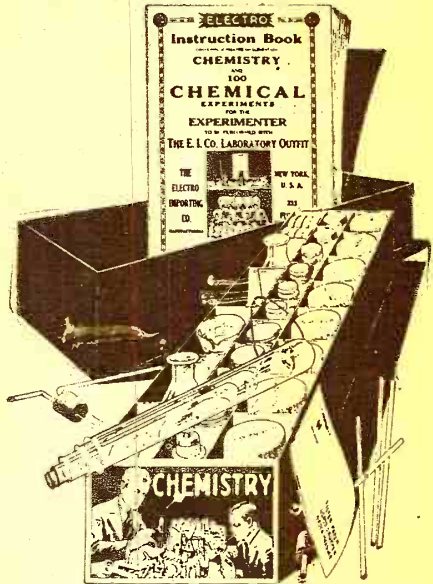

Every Fellow Wants the **BOY'S ELECTRIC TOYS**

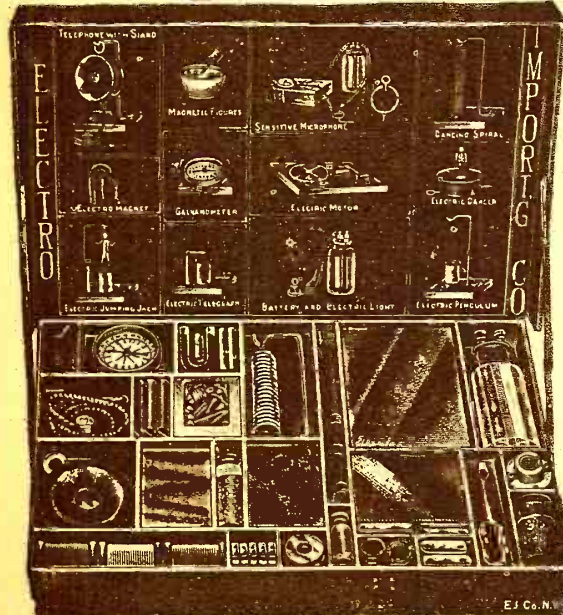

The Boy's Electric Toy contains: Enough material to make and complete over twenty-five different electrical apparatus without any other tools except a screw-driver furnished with the outfit. Student's chromic plunger battery, compass-galvanometer, solenoid, telephone receiver, electric lamp.

Enough various parts, wire, etc., are furnished to make the following apparatus: Electromagnet, electric cannon, magnetic pictures, dancing spiral, electric hammer, galvanometer, voltmeter, hook for telephone receiver, condenser, sensitive microphone, short distance wireless telephone, test storage battery, shocking coil, complete telegraph set, electric riveting machine, electric buzzer, dancing fishes, singing telephones, mysterious dancing man, electric jumping jack, magnetic geometric figures, rheostat erratic pendulum, electric butterfly, thermo electric motor, visual telegraph, etc., etc.

This does not by any means exhaust the list, but a great many more apparatus can be built actually, and effectually.

With the instruction book we furnish one hundred experiments that can be made with this outfit, nearly all of these being illustrated with superb illustrations. No other materials, goods or supplies are necessary to perform any of the one hundred experiments or to make any of the 25 apparatus. Everything can be constructed and accomplished by the means of this outfit, two hands and a screw-driver.

The outfit contains 114 separate pieces of material and 24 pieces of finished articles ready to use at once.

We guarantee satisfaction. The size over all the outfit is 14 x 9 x 2 3/4. Shipping weight, 8 pounds. "The Boy's Electric Toys" outfit as described, \$7.00. Immediate shipment.

**SEND FOR YOUR SET TODAY**

**REMEMBER**

**JUST CLIP THE COUPON—DON'T SEND MONEY**

**ELECTRO IMPORTING CO., 233 Fulton St., New York City**

ELECTRO IMPORTING CO.,  
233 Fulton St., New York.  
Please send me by express THE CHEMICAL LABORATORY. If I don't like it I need not accept it. If I want it I only pay \$7.00 plus the few cents express charge.

ELECTRO IMPORTING CO.,  
233 Fulton St., New York.  
Please send me by express THE BOY'S ELECTRIC TOYS. If I don't like it I need not accept it. If I want it I only pay \$7.00 plus the few cents express charge.



# BUILD YOUR SET WITH BARAWIK STANDARD

## PLATE CIRCUIT "B" BATTERIES

You can make real savings on these batteries. Don't buy more. We guarantee them to equal any on the market regardless of price. Absolutely uniform. Extra long life.

- P180 Signal Corps type, small size, 15 cells, 2 1/2 volts. Each... .95c
- P184 Variable Large Navy size, 6 1/2 x 1 1/2 inches 5 tops, giving range from 1 1/2 to 2 1/2 volts in 1/2 volt steps. Each... \$1.80
- P188 Combination Tapped 45 volts 30 cell, 1 1/2 x 3 1/2 battery. Tapped to give 45, 22 1/2, 21, 15 1/2, 13 and 10 1/2 volts. Handles both detector and amplifier tubes. Each... \$3.55

## HOMECARGER BATTERY CHARGING RECTIFIER

Charge your battery at home overnight for a few cents. Simply connect to any 110 volt 60 cycle light socket, turn on current and rectifier does the rest automatically. Will work for years without attention. Simple connections. Gives a tapering charge which should have. You can make it pay a profit charging your own batteries. Long connecting cords with pair battery clips.

- P201 For 6 volt battery... \$13.95
- P203 For 12 volt battery... \$19.95

## STORAGE "A" BATTERY

A very high grade battery made especially for radio service. Guaranteed for three years. Properly cared for will give many more hours of service for filament lighting. Made of best new materials. High capacity. The best battery buy on the market. Try one of these batteries on your set for 10 days. If at the end of that time you are not fully satisfied with the battery return it and we will refund the purchase price.

- P184 6 volt, 40 ampere size. Each... \$10.00
- P186 8 volt, 30 ampere size. Each... \$12.50

## BATTERY CLIPS

Clip onto storage battery terminals, lead coated. Make positive non-corrosive contact at all times.

## WIRE CONNECTING CLIPS

Small connecting clips for quick fastening leads onto posts, etc. Handy and useful. Every radioist should have at least a dozen.

## PORCELAIN BASE SWITCHES

Fine white porcelain bases. Copper contact blades. Can be used as a antenna switch.

- P387 Single Pole Double Throw. Each... .20c
- P384 Double Pole Double Throw. Each... .50c

## FILAMENT CONTROL RHEOSTATS

Cresley—Wound on vulcanized fiber. Adjustable to any panel. Complete with knob.

- P130 Each... .45c
- P132 Each... .45c

## POTENTIOMETER

Same style as above rheostat. Gives the "B" battery adjustment. Resistance 200 or 300 ohms.

- P133 Each... .95c

## VERNIER RHEOSTAT

Gives exceedingly fine control of "A" battery current. A necessity for best receiving results.

- P135 Each... .78c

## QUICK ACTING VERNIER RHEOSTAT

Gives very fine control of current and can be switched on or off instantly at any desired point.

- P124 Each... \$1.19
- P136 Each... .78c

## MURDOCK LOUD SPEAKER

This speaker gives excellent results and is actually superior in quality and volume of tone to many others selling at several times the price. You will be pleased with it. One of the best radio values ever offered. Black moulded base. Reproducing unit directly attached to aluminum sound chamber. Fibre amplifier horn. Five foot connecting cord included.

- P610 Each, complete... \$4.78
- P612 Each Model R3 genuine Magnavox... \$34.50
- WORKRITE JR. LOUDSPEAKER P614 Each... \$10.80

## WE PAY TRANSPORTATION CHARGES EAST OF THE ROCKIES

THE PRICES QUOTED DELIVER THE GOODS TO YOUR DOOR FAST SERVICE—TRY US AND BE CONVINCED

THIS GUARANTEE PROTECTS YOU—Examine the goods we ship you. They must suit you in every respect. If you are not satisfied with your purchase return the goods at once and we will refund the price you paid.

## AGENT-DEALERS WANTED

We want Agent-Dealers in every locality to handle our line of goods. Our Proposition Means Money to You

## SEND FOR OUR CATALOG

We have selected a line of goods—both completed sets and parts to assemble sets—that will enable you to supply every demand and make money. You can make a good income on our proposition with a very small investment.

Our catalog shows the merchandise you should handle, gives much radio information and will help you establish a successful business. Enclose 10c for the catalog. Tell us what you can and want to do, and how much you can invest. We'll do the rest.

## For the Person Who Makes His Own Set

Our catalog is interesting and valuable. Even if you are not interested in radio as a business you will find many interesting things in this catalog and you will save money buying your supplies from us.

## VACUUM TUBES

- Standard Brands—Cunningham Radiotrons. Every one guaranteed new and perfect. We will ship any brand in stock unless you specify otherwise.
- P105 Detector. U.V.200 C300 Ea. \$4.38
- P110 Amplifier U.V.201 C301 Ea. \$5.85
- P118 3 Watt Transmitter... 7.20
- P107 WD11 1 1/2 v. Fil. Each... \$3.85
- P108 WD11 Socket. Each... \$3.85
- P109 WD11 Adapter. Each... \$3.85

## FOUR-IN-ONE SCREW DRIVER

Especially suitable for radio work. Will handle any size screw used. Smaller drivers nest inside larger one and are held in place with screw cap. Made of steel, nickel finished. Every radio builder can use several of these handy tools.

## VACUUM TUBE SOCKETS

Our Special Socket. A wonderful value. Moulded entirely of brown bakelite. Four binding post connections. Right angled contact springs.

- P149 Each... .35c

## PORCELAIN BASE AND TUBE

High Grade combination type for panel or table mounting. Metal tube. High insulation base. One of the best sockets made.

- P144 Cresley for either panel or table mounting... .35c
- P146 Each... .45c

## TWO AND THREE GANG SOCKETS

These sockets make it easy to build a variable capacitor and a d amplifier units and make a neat compact work-manlike job. Perfectly made of high grade materials. Quickly mounted on panel or base.

- P142 Two-gang socket... \$1.05
- P143 Three-gang socket... 1.45

## FIXED CONDENSERS

Moulded cases, nickelled binding posts.

- P604 Each... .48c

## CARBON PRESSURE VERNIER RHEOSTAT

Current regulation is obtained by changing of pressure on carbon. This permits of infinitely fine variation of current. Very durable. Resistance 15 ohms. Capacity 2 1/2 ampere.

- P131 Each... \$1.65

## RADIO TUBES

Tubes for winding coils. Strong solid material, with smooth clean surface.

- P850 Diameter 3 inches, per foot... .20c
- P851 Diameter 3 1/2 inches, per foot... .25c
- P852 Diameter 4 inches, per foot... .30c

## COIL PLUGS

Made of moulded bakelite. Fits any standard plug. Mounts any standard honeycomb coil.

- P344 Each... .55c

## PANEL MOUNTING COIL PLUGS

Take a standard mounted coil. Made of moulded bakelite, mounted on brackets.

- P345 Stationary. Each... .89c
- P346 Movable with anti-capacity handle. Each... \$1.10

## RADIO FREQUENCY AMPLIFYING TRANSFORMER

P995 Very special... \$2.95 This transformer will get the long distance stations loud and clear. Permits of easy sharp tuning. Helps cut out static and interference. Makes your set sensitive enough to use a loop aerial. Enclosed in metal case affording perfect shielding. Suitable for panel or base mounting. Because of its special design can be mounted in any V. T. socket. Works with any style of tuner. Wave ranges 150 to 550 meters. Wiring diagrams included.

## OUR SPECIAL AUDIO FREQUENCY AMPLIFYING TRANSFORMERS

As high as three stages can be used without howling due to proper impedance ratio, minimum distributed capacity, low core losses and proper insulation. Mounted style has bakelite panel with binding post connections. Unmounted has core and coils assembled with two holes in core for fastening to apparatus.

## THORADARSON AUDIO FREQUENCY AMPLIFYING TRANSFORMER

An especially high grade transformer with correct character of core. Cunningham Radiotron or A. P. Tubes. Wonderful results without distortion on one, two, or three steps. Low distributed capacity. Fully moulded bakelite panel.

- P232 6 to 1 Ratio. Ea. \$3.63
- P233 6 to 1 Ratio. Ea. \$4.15

## RADIO CORPORATION TRANSFORMERS

Audio Frequency Amplifying Transformer. Especially designed for Radiotron tubes. 9 to 1 winding ratio.

- P712 Each... \$6.40

## RADIO FREQUENCY AMPLIFYING TRANSFORMERS

Range 200 to 5000 meters. For long distance reception.

- P714 Each... \$5.95

## OUR COMPETITOR AUDIO FREQUENCY AMPLIFYING TRANSFORMERS

While these are very low priced transformers, nevertheless they will give excellent results. They are carefully designed and carefully made. Quantity production and small profits make the low price possible. They will equal in results many transformers selling at much higher prices.

- P235 Unmounted, with wire leads... \$2.00
- P236 Mounted, with binding post connections, completely shielded... \$2.75

## BARAWIK SPECIAL PANEL MOUNTING VARIABLE CONDENSERS

P112 12 plate .0001 Mfd. \$2.29  
P113 21 plate .0005 Mfd. 1.80  
P114 11 plate .0025 Mfd. 1.32  
P115 3 plate .001 Mfd. 1.05  
These are especially high grade condensers and we guarantee them to be mechanically and electrically perfect. Fine polished end plates of heavy bakelite. Shafts 1/4 inch diameter. Heavy aluminum plates perfectly spaced to insure smooth, even reliable capacity. Our low prices save you money. These condensers are of the very best and are not to be compared with many inferior cheap condensers offered. We guarantee them to please you or your money back.

## COMBINATION VERNIER VARIABLE CONDENSERS

P842 22 plate .0005 Mfd. with dial and knobs. Price... \$3.25  
P826 32 plate .001 Mfd. with dial and knobs. Price... \$3.95  
The latest improvement in condensers consists of regular variable condenser controlled by large knob and dial mounted with a three plate vernier condenser, which is controlled by separate knob mounted above knob on dial. This arrangement permits of very fine tuning. Compact convenient mounting on panel. High grade design and construction. Finely finished.

## ENCLOSED VARIABLE CONDENSERS

One of the best made condensers in the field, accurately spaced aluminum plates. Formica ends. Engraved scale. Knob and dial pointer. Clear transparent case.

- P805 13 plate .001 Mfd. \$3.95
- P808 21 plate .0005 Mfd. 3.25

## KNOCKED DOWN VARIABLE CONDENSERS

You can save money by assembling your own condensers. Furnish top and base. Complete with all parts not assembled. Go together easily and perfectly. Panel moulding type.

- P821 41 Plate .001 Mfd. \$1.95
- P821 21 Plate .0005 Mfd. 1.60

THE BARAWIK CO. Chicago's Original Radio Supply House Beware of Imitations 102 South Canal Street CHICAGO, ILL.



# RADIO GOODS---DEPENDABLE QUALITY---LOWEST PRICES

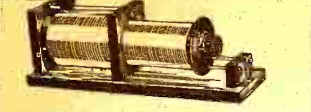

## ARLINGTON RECEIVING TRANSFORMER

Will tune in all stations up to 3,500 meters. Very efficient on short waves and for radio-telephone reception. Used with our Detector Two Step Amplifier it produces very excellent results. Also does good work with crystal detector. Silk covered windings on formica tubes. Very fine mahogany finish wood cabinet. Base also 8 1/2 inches. Slider controls primary winding, 12 point switch on secondary. Can be tuned very close. Brass metal parts nickel finish. A wonderful value at our price.

P720 Price .....\$6.39



Rance up to 950 meters. Wound with bare copper wire, machine spared. Ends of mahogany finished hard wood. Two easy sliding contacts on polished brass rods, four binding posts. Substantial, attractive. Length, 8 3/4 in.

P722 Price .....\$2.45



P410—Completely assembled, price \$2.69. Perfect in design and construction. A circular wood form of genuine solid mahogany. Correct inductive ratios. Solder baked windings. Positive contacts. Highest efficiency. A real bargain.

P411—Not assembled nor wound but all parts complete except wire, including winding form. \$1.49

P412 Price .....\$2.45

With this loose coupler and two variometers, together with the necessary other parts, a highly efficient tuning set can be made. Easily mounted on panel. No base included. Primary winding on formica tube inductively coupled for 180 to 600 meters. Multiple taps permit fine tuning.

P416 Not assembled nor wound but all parts complete except wire. Price .....\$1.18

P417 Rotor ball only. Each ..... 29c

P408 Bakelite stator tube only. Each ..... 35c

P415 Price, completely assembled .....\$2.45

P416 Price, completely assembled .....\$2.45

P417 Price, completely assembled .....\$2.45

P418 Price, completely assembled .....\$2.45

P419 Price, completely assembled .....\$3.78

P420 Price, completely assembled .....\$6.39

P421 Price, completely assembled .....\$2.45

P422 Price, completely assembled .....\$2.45

P423 Price, completely assembled .....\$3.60

P424 Price, completely assembled .....\$3.30

P425 Price, completely assembled .....\$3.00

P426 Price, completely assembled .....\$4.20

P427 Price, completely assembled .....\$4.70

P428 Price, completely assembled .....\$3.40

## PRESERVE THESE PAGES—ORDER FROM THEM AND SAVE MONEY FAST SERVICE—TRY US AND BE CONVINCED

THE PRICES QUOTED DELIVER THE GOODS 'O YOUR DOOR OUR GUARANTEE PROTECTS YOU—We handle only the best goods, carefully tested and checked by expert radio engineers. You are assured of getting just what you need at the lowest possible price. We do not attempt to deceive or mislead. Our reputation for fair dealing is our most valued asset.

HOW TO ORDER—Write your Order plainly, state Article Number, Description and Price of Items wanted. Send Postal Note or Express Money Order. Certified Check or Bank Draft is also acceptable. Prompt Shipment is assured when the above directions are followed.



OTHER STANDARD BRAND HEADSETS  
P751 Murdoch 56, 200 ohm .....\$4.20  
P752 Murdoch 56, 3000 ohm .....4.25  
P754 Baldwin Type C with universal jack plug .....\$12.00  
P755 Baldwin Type C unit ..... 5.50  
P756 Red-Head, 3000 ohm ..... 5.78  
P758 Western Electric, 2200 ohm ..... 9.50

These headsets have proven on rigid tests to be one of the very best on the market. The tone quality is excellent with an unusual volume. Skilled workmen make them from only the best selected materials. The receiver cases are fine polished finish with polished black ear pieces. Fabric covered head band comfortably and quickly fitted to the head. Supplied with 5-foot cord. These sets were designed to sell for much higher prices than we ask, and at our prices are a wonderful bargain. We guarantee that you will be pleased with them and agree that they are the best value by far yet offered. If they don't suit you we will cheerfully return your money.

P770—2000 ohm .....\$3.75



P397 Each .....\$3.98  
Take two pairs of hand set terminals. Quick easy connections. Polished round barrel. Fits any standard jack.

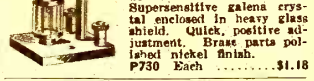

One of the finest crystal detectors on the market. Supersensitive galena crystal enclosed in heavy glass shield. Quick, positive adjustment. Brass parts polished nickel finish.

P730 Each .....\$1.18

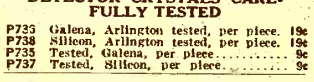

Easy fine adjustment. Crystal mounted in cup. Moulded base and knob. Brass parts polished nickel finish. An unexcelled value.

P732 Each .....59c

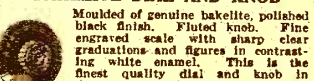

P735 Galena, Arlington tested, per piece. 19c  
P738 Silicon, Arlington tested, per piece. 19c  
P735 Tested, Galena, per piece ..... 9c  
P737 Tested, Silicon, per piece ..... 9c



P725 Price set. 32c  
All metal parts for crystal detector. No base included. Easily assembled. Polished nickel finish.

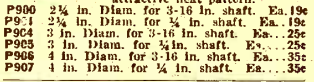

Moulded of genuine bakelite, polished black finish. Fluted knob. Fine engraved scale with sharp graduations and figures in contrasting white enamel. This is the finest quality dial and knob on the market. A very attractive pattern. Two inch cannot be supplied for 1/4 inch shaft.

P915 2 in. Diam. for 3-16 in. shaft. Ea. 38c  
P902 3 in. Diam. for 3-16 in. shaft. Ea. 38c  
P903 3 in. Diam. for 1/2 in. shaft. Ea. 38c  
P915 4 in. Diam. for 1/2 in. shaft. Ea. 45c

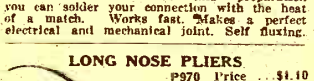

Moulded in one piece of polished black composition with clean white engraved scale and numerals in contrasting white enamel. Ribbed knob to fit the hand. An attractive neat pattern.

P900 2 1/2 in. Diam. for 3-16 in. shaft. Ea. 19c  
P901 2 1/2 in. Diam. for 1/4 in. shaft. Ea. 19c  
P904 3 in. Diam. for 3-16 in. shaft. Ea. 25c  
P905 3 in. Diam. for 1/2 in. shaft. Ea. 25c  
P906 4 in. Diam. for 3-16 in. shaft. Ea. 35c  
P907 4 in. Diam. for 1/2 in. shaft. Ea. 35c



Self fusing. Especially designed for soldering electrical connections. Fine for use with above electric iron. Coll will last a long time.

P958 Per-tube .....19c



Best grade jacks. Improvable in design. Best materials. Superior bronze springs. Silver contact points. Nickel finish. Mount on panels 1/4 to 3/4 in. thick.

P390 Open circuit. Each ..... 43c  
P391 Closed circuit. Each ..... 49c  
P392 Closed circuit. Each ..... 49c  
Only P393 Silver circuit filament cont. 69c  
P394 T.C. circuit filament cont. 65c

P395 Plug. Large space with set screws for attaching cord. Each ..... 48c

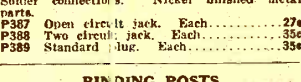

Well made, durable, smooth working. Interchangeable with any standard Jacks and Plugs. Solder connections. Nickel finished metal parts.

P387 Open circuit jack. Each ..... 27c  
P388 Standard plug. Each ..... 35c

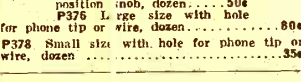

Brass, polished nickel finish. Washer and 6-32 in. screw extending 1/2 in.

P370 Large size—barrel and knob 9-16 in. long, dozen. 85c  
P372 Smaller size—barrel and knob 9-16 in. long, dozen. 70c  
P374 Two circuit with one position knob, dozen. 50c  
P376 Large size with hole for phone tip or wire, dozen ..... 80c  
P378 Small size with hole for phone tip or wire, dozen ..... 35c

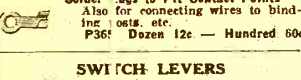

Brass polished nickel finish. All have 1/4 in. long size 6-32 screws and two nuts. All prices the same.

Dozen 18c  
Order by Article number  
P360 Head. 3/4 in. Diam. 1/4 in. High  
P362 Head. 3-16 in. Diam. 1/4 in. High  
P364 Head. 3-16 in. Diam. 1-16 in. High  
Also for connecting wires to binding posts, etc.

P361 Dozen 12c — Hundred 60c



Moulded composition knob. Exposed metal parts polished nickel finish. Fitted with panel binding screws. One and two set nuts. A high grade switch.

P312 1 1/2 in. Radius 19c  
P313 1 in. Radius 19c  
P314 1 1/2 in. Radius 19c

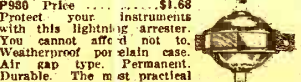

Brass, polished nickel finish. P386—Dozen 12c. Hundred \$1.05.

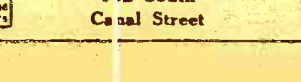

Mounts switch point and contact levers behind panel. Enables you to build neat attractive set. Only one hole needed to mount on panel. 15 switch points, any number of which may be used. Dial indicates position of lever. Smooth wiping contacts. Attractive tapered knob. Durable. The most practical quality arrester obtainable. Underwriters approved.

P988 Price .....\$1.68



Fine looking cabinets solidly built. Made of genuine solid mahogany in elegant hand rubbed finish. You will be proud of your set mounted in one of these cabinets. Hinged tops. Front rabbeted to take panels. Panels not included. Prices are transportation paid.

Panel Size	Inside High	Wide	Deep	Art. No.	Price Each
6x7	5 1/4"	6 3/4"	7"	P420	\$2.48
6x10 1/2	5 1/4"	10"	7"	P422	2.73
6x14	5 1/4"	13 1/4"	7"	P424	3.60
7x14	6 1/4"	13 1/4"	7"	P423	3.30
7x18	6 1/4"	17 1/4"	7"	P426	3.00
7x21	6 1/4"	20 1/4"	7"	P425	4.20
9x14	8 1/4"	13 1/4"	10"	P428	3.70
12x14	11 1/4"	13 1/4"	10"	P430	4.40
12x21	11 1/4"	20 1/4"	10"	P432	5.25

## RADIO "BAKELITE" PANELS

Notice our very low prices on this high quality material. We supply genuine Bakelite, Condensite, Celoron or Formica, all of which are materials with practically identical mechanical, chemical and electrical properties. Machines well without chipping. Won't warp. Waterproof. Highest mechanical and dielectric strength. Attractive natural polished black finish which can be sanded and oiled for extra fine work.

Panel Size	1/4" thick	3/8" thick	1/2" thick	3/4" thick	Art. No.	Price Each
6x7	P450	\$0.50	P460	\$0.75	P470	\$0.98
6x10 1/2	P451	.75	P461	1.11	P471	.47
6x14	P452	1.05	P462	1.35	P472	2.05
7x14	P458	1.20	P468	1.80	P478	2.40
7x18	P453	1.55	P463	2.30	P473	3.10
7x21	P454	1.78	P464	2.65	P474	3.60
9x14	P454	1.80	P464	2.30	P474	3.10
12x14	P455	2.10	P465	3.10	P475	4.10
12x21	P456	3.15	P466	4.65	P476	6.25

## ETCHED METAL NAME PLATES

Made of brass. Silver plated characters and borders on black background. All plates are 1 inch long and 3/4 inch wide, except "INCREASE CURRENT" which are quarter circle 1 1/2 inch over all, and "ON" "OFF" which are 3/4 inch long. Attaching holes pierced.

P503 Per Dozen .....\$5.75  
Not less than one dozen assorted sold. Specify marking wanted as follows:

Plate Variometer	Secondary	Aerial
Grid Variometer	Primary	Ground
Vacuum	Trip	Phones
Primary Condenser	Lead's Coil	Input
Secondary Condenser	Coupling	Output
Increase Current	Ballast	On
(to right)	Switch	Off
Increase Current	Detector	1st Stop
(to left)	A Battery	2nd Stop
	Battery	3rd Stop

(Blank—takes pencil or marks.)

## ELECTRIC SOLDERING IRON

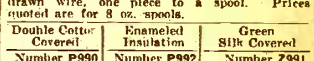

P957 Price .....\$5.75  
Especially adapted to radio work. Will enable you to do neat clean work quickly. Simply attach to any light socket 110-120 volts. Complete with six foot cord and attaching plug. Renewable solder pot. Will last a lifetime for ordinary home or light shop work. A wonderful value at the price.

## MAGNET WIRE

Insulated copper wire. Best quality even drawn wire. One piece to a spool. Prices quoted are for 8 oz. spools.

Double Cotton Covered	Enamelled Insulation	Green Silk Covered
Number P990	Number P992	Number P991
Gauge	Price	Gauge
18	50c/20	45c/20
20	60c/20	55c/20
22	75c/20	65c/20
24	85c/20	75c/20
26	95c/20	85c/20
28	\$1.15/20	95c/20
30	1.65/20	1.25/20

## STRANDED ANTENNA WIRE

Cabled of fine copper strands. Very flexible. High tensile strength. Best for aerials.

P248—100 ft. coil 72c P249—300 ft. coil \$3.20

## SPAGHETTI

For covering connecting wires in sets. For size 12 and 14 wires.

P955—Finest quality braided and saturated with best baked lustrous transparent insulating cambric, 3 feet for ..... 20c  
P956—Best quality braided and coated with black insulating compound, 3 feet for ..... 15c

## ANTENNA INSULATORS

P260 Size 1 1/2 in. Two for ..... 17c  
P262 Size 2 1/2 in. Two for ..... 58c  
P264 Size 1 1/2 in. Two for ..... 30c  
P266 Size 1 1/2 in. Two for ..... 31.35  
P260 P262 P264-6

## SOLID BARE COPPER WIRE

Solid bare copper wire for aerials, leads or wiring instruments.  
Solid Bare Copper Wire, size 14. P240—100 ft. coil 45c P242—500 ft. coil \$2.15  
Solid Bare Copper Wire, size 12. P244—100 ft. coil 61c P245—500 ft. coil \$2.75



**50c EACH** THE BIGGEST SUCCESS IN RADIO: CONSOLIDATED RADIO CALL BOOK CO'S. **EACH 50c**  
**PATTERNS and DIAGRAMS**

**Complete Patterns, Diagrams and Instructions**  
**How to Make Your Own**  
**SHORT WAVE REGENERATIVE**  
**RADIOPHONE SET**

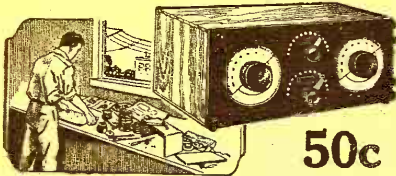

**50c**

One of the foremost Radio engineers constructed this set for us; it's simple to follow our patterns and assemble the parts comprising this set with which spark, C. W. signals and Radiotelephony may be received. We don't only give you pictures of how the apparatus looks, but each pattern is full size and printed on heavy blue print paper. Only standard parts are used.

**PATTERN No. 1**

Consisting of a Five-Page Illustrated Direction Pamphlet, size 8½x11½ inches, One Blue-Print pattern, size 16x22 inches and One Blue-Print pattern, size 17½x22 inches, all contained in a heavy Two-Color printed Envelope, 9x11 inches.

**SENT POST-PAID**

**DETECTOR and AMPLIFIER**  
**RADIO UNITS**

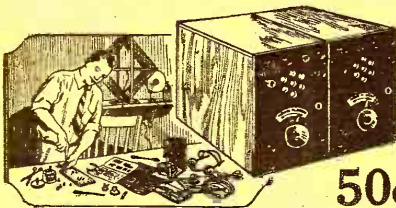

**50c**

You can build this detector and the amplifier units anywhere in your house; no machine shop is needed. When built they may be used with any type of Regenerative Receiver or short wave set, with which spark, C. W. Signals and Radiotelephony may be received. We've tested these patterns by actually building the outfit—they're perfect! Only standard parts are used in making the outfit.

**PATTERN No. 2**

Consisting of a Four-Page Illustrated Direction Pamphlet, size 8½x11½ inches, One Blue-Print pattern, size 16x18 inches, and One Blue-Print pattern, size 13½x15 inches, all contained in heavy, Two-Color Printed Envelope, size 9x12 inches.

**SENT POST-PAID**

**RADIOPHONE CRYSTAL SET**

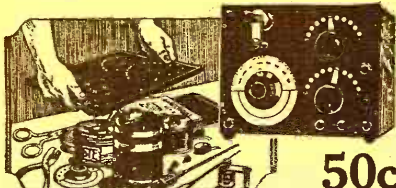

**50c**

We designed these patterns especially for those who are without technical knowledge but who are sufficiently abreast of the times to desire a radio receiving set in their homes. An instruction pamphlet comes along with the blue prints and all you have to do is follow the simple instructions. This radio set can be tuned in from stations within 30 miles. Standard materials only are used.

**PATTERN No. 3**

Consisting of 4-page illustrated Direction pamphlet, size 8½x11½ inches, one Blue-Print pattern size 16x22 inches. All contained in two-color printed envelope, 9x12 inches.

**SENT POST-PAID**

**14 RADIO FORMULAE**  
**AND DIAGRAMS**



**Usefulness!**

**Economy!**

**Pleasure!**

**50c**

With this packet of radio knowledge you need never worry about schematic wiring diagrams, measurements and radio tables. All formulas and diagrams are printed on heavy paper in black and blue; and contained in two-color printed envelope, 9x12 inches.

**SENT POST-PAID**

**ALL ABOUT AERIALS**

**12 Diagrams How to Construct and Erect**  
**All Types of Aerials**

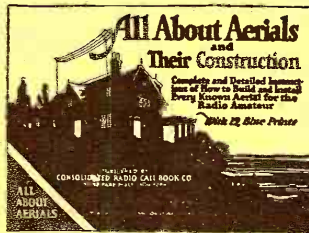

**RECEPTION**

**and**

**TRANSMISSION**

**ALL FOR**

**50c**

THESE ARE DIAGRAMS THAT EVERYONE with a radio set wants and needs. These blue prints were made after practical erection of each aerial, and point out to you how simple it is to erect not only the proper aerial for your particular need, but how to erect this aerial in the most practical manner and at the least expense.

Consists of 12 blue prints 8½x11 inches and one four-page instruction pamphlet 8½x11 inches. All contained in a heavy two-color printed envelope 9x12 inches.

**SENT POST-PAID**

**20 Radiophone Diagrams and**  
**Hook-Ups of**

**Crystal and Audion Receiving Circuits, Amplifier Circuits,**  
**Regenerative Circuits, Sending Circuits**

**with**

**Key Chart of Symbols and Pamphlet**

**"How to Read Diagrams"**



**50c**

These diagrams show how to get the best possible efficiency from the instruments you make or purchase. They cover hook-ups from the simplest to the most complicated, in a way that any amateur can understand and follow without difficulty. Get this set, and hook up right.

All 20 diagrams are printed on heavy paper, each sheet size 8½x11½ inches, and together with KEY CHART OF SYMBOLS and pamphlet "HOW TO READ DIAGRAMS" are contained in a heavy two-color printed envelope, size 9x12 inches.

**SENT POST-PAID**

**ORDER FROM YOUR DEALER—or direct from us**

**CONSOLIDATED RADIO CALL BOOK CO., Inc.**

**98 Park Place**

**PUBLISHERS**

**NEW YORK CITY**



locate a station than he does to receive a concert. Anything that keeps him guessing doesn't do the game any good, and those stations which make a practice of having long drawn out concerts without signing, should lose their licenses.

I think the plan of designating each letter of a call station by a name such as A for Alice, W for William, and the like, is a very good one, particularly where E. Z. C. B. T. D. K. A. are pronounced so nearly alike. I live near WNAC, Boston, but I have never been able to distinguish between the N and M in its announcements.

J. F. SLOCOMB,  
Cambridge, Mass.

**FROM A RURAL DEALER**

Editor, RADIO NEWS:

Formerly of the U. S. Navy, and of the Radio Division, I am now running a small radio supply company in Waxahachie, Texas, and I have the time to observe the effects that radio has on the people who live a distance from the cities. I have sold several sets that carry loud speakers and many small sets of the one-tube type. Just last night I was out with a set that I had sold to an old gentleman who had not been out of the house in several years. Of course, he had all of his grandchildren and quite a few of his neighbors in and that made it more interesting. It is astonishing to know how many people there are today who know nothing about radio. Out of the bunch that was there, there was only one who had any idea of how a set should work.

I hooked this set up and the first station that I brought in was WWJ, with a splendid program of dance music. Well, the girls and boys used it to the best advantage.

To watch the effect that radio music has on the farmers is worth every cent that it has cost me to learn all I know of radio. You men who deal with radio in the cities don't realize the good that one little set does in the hands of some lonesome farmer, or some old grandmother or granddad who is too old to travel to the city and see things as they are today. I know an old mother and father who are too weak to get around much. They had a few dollars saved up and they bought a small one-tube set, and now if you should take it away from them it would be to them like losing one of their children. It is a shame to see how some of the big radio concerns will advertise that they have a set for so much and one is sold to some farmer who knows nothing about radio whatsoever. Then when it is delivered, it has no phones, no tubes, no batteries and possibly several other pieces missing. I say that if a company is going to advertise a set for a certain amount, it should state whether it is complete or not. I have been called out on several trouble-shooting jobs and have found that the people had put all they had in the thing only to find that they had just started to buy. When a man comes in my store and asks about a set, the first thing I do is to find out if he knows anything about radio, and the second is to find out if he is contemplating buying a set. If he is, I make him a price on a complete set, leaving out nothing. And another thing is this: if a man comes in and says he wants some article that I know will do him no good, I tell him so. I will admit that I have lost several good sales by telling them the truth, but I have more than made it up through having them as good customers. I had one man get up on his high-horse because I told him that a certain part would do no good, but later he came back and apologized for getting sore. Now, then, I don't claim to be a model, but if some of the larger concerns would do a little thinking about this, I believe there would be less dissatisfied radio users.

D. R. MILLER,  
Waxahachie, Texas.



—And they're all talking at once these nights! If you want what you want when you want it, you might as well stop struggling with single-circuit receivers.

Under present conditions, with several hundred powerful broadcasting stations all operating on one narrow wave band, the single-circuit receiver is utterly inadequate to give you satisfactory results.

The Paragon three-circuit receiver gives you the station you want when you want it — *and no other*. You can tune in accurately on any station and get a clear, complete program without interruption or disturbance.

Ask some experienced amateur what he knows about

# PARAGON

Reg. U. S. Pat. Off.

## RADIO PRODUCTS

The amateur will tell you that the Paragon three-circuit receiver, because of its greatly superior selectivity and sensitivity, can pick and choose between broadcasting stations of about the same signal strength with less than one per cent differential.

This means that with a Paragon receiver you get what you want when you want it—complete messages and clear music from the station you tune in on, without interruption and jamming. Until you have listened in with a Paragon three-circuit receiver, you cannot guess the real pleasure and fascination of radio.

Long before broadcasting popularized radio with the general public, Paragon equipment was the choice of the experienced amateur. He will tell you today that if you want quality and satisfaction, Paragon Radio Products are the best and safest buy on the market.

*An illustrated Catalog of Paragon Radio Products is Yours For the Asking*

**DEALERS** — The Adams - Morgan Company has an interesting proposition to make to reputable radio dealers who believe in quality merchandise. Details on request.

**ADAMS-MORGAN COMPANY**  
6 Alvin Ave., Upper Montclair, N. J.

Also Manufacturers of PARAGON	
Radio Telephone	Amplifier
Transmitters	Transformers
V. T. Control Units	Control Dials
Rheostats	Amplifiers
Potentiometers	Receivers
V. T. Sockets	Switches
Detectors	Variometers

Type RD-5 Regenerative Receiver and Detector—\$75.00  
Type A-2 Two-Stage Amplifier—\$50.00  
(Licensed under Armstrong Patents.)

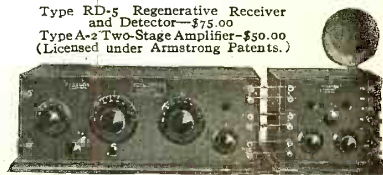



## Immediate Shipment on Clapp-Eastham Sets

Type HR Regenerative Receiver, and type HZ two step amplifier. Regeneration is perfect on all wave lengths between 180 and 825 meters.

The range or distance from which signals are received and the clear sharp tones are a revelation to the experienced Radio man as well as to the person who "listens in" for the first time. The specifications tell the story to the expert and the Clapp-Eastham guarantee of satisfaction protects every purchaser of a Clapp-Eastham Radio set. Expert and Amateur alike.

### SPECIFICATIONS

**PANELS**—Formica, handsomely finished.  
**CABINET**—Solid mahogany.  
**CONDENSER**—Balanced type with vernier.  
**DIALS**—Indestructible metal.  
**ANTENNA-INDUCTANCE**—Wound on formica tube.  
**PLATE INDUCTANCE**—Wound on molded ball.  
**BINDING POST**—Black rubber covered.  
**SWITCH**—Fan Blade.  
**RHEOSTAT**—Clapp-Eastham, type H400.  
**CIRCUIT**—Single circuit regenerative. Licensed under Armstrong U. S. Patent.

### DEALERS — DEALERS

We can ship Clapp-Eastham sets within twenty-four hours.  
 Write for our interesting sales proposition.

**THE WHITALL ELECTRIC COMPANY**  
 SPRINGFIELD, MASS.

# FOR SALE

## Broadcasting Radiophones

- No. 660 500 Watt Type 300 to 500 miles Range
- No. 880 1000 Watt Type 500 to 1000 miles Range
- No. 990 2000 Watt Type 1000 to 3000 miles Range

*Automatic Panel Type, using very latest domestic and foreign developments, insuring perfect modulation and maximum range. Early deliveries.*

Newspapers, Department Stores, Universities and others may obtain full particulars from

**MR. C. C. MUIR**  
 104 East 25th Street **8th Floor**  
 NEW YORK CITY

**211 RADIO MANUFACTURERS and DEALERS are now using our  
 BINDING POSTS, SWITCH POINTS, ETC.**

*The Reason QUALITY, SERVICE, PRICE*

**PREMIER DENTAL MFG. CO. 60 N. 2d St., PHILA, PA.**  
 SCREW MACHINE PRODUCTS *Get Our Literature*



## SEXUAL KNOWLEDGE

320 Pages Illustrated Cloth  
 By WINFIELD SCOTT HALL, M.D., Ph.D.  
**SEX FACTS MADE PLAIN**

- What every young man and every young woman should know
- What every young husband and every young wife should know
- What every parent should know

**\$1.00**  
 Postpaid Mailed in plain wrapper  
 Table contents & Commendations on request  
**AMERICAN PUB. CO., 624 Winston Bldg., Philadelphia**

## MAKE AND REPAIR YOUR OWN DEVICES

# ELECTRIC HEAT

**JUST OUT**—For the Journeyman and Experimenter  
 How to Figure and Build Units. Where to Get Real Resistance Wire Without a License. What Materials to Use and How. What not to Use and Why. The Results of 5 Years and \$100,000.00 of Electrical Heating Development Exclusively. Learn the Branch of Electricity With the Biggest Future. Handy Pocket Size, Cloth Bound, for Only \$2.00, Postpaid. Money Returned if Not Satisfactory. Send Today.  
**ALEXANDER SWAN, 2d**  
 314 E. Third Street Los Angeles, Calif.

who are doing the most valuable work do it after the most of us are in bed and asleep. They seem to select the hours when there is the least danger of their creating or encountering interference. Incidentally, they are not as a rule the hardest kickers. They accommodate themselves to the schedules of the majority.

For a number of years my work necessitated my estimating carefully the percentage of members of an efficient organization, who carried out its program consistently and achieved results. From this experience I feel safe, though I hope I am not, in offering to anyone who will prove to me that one out of every four of the organized radio amateurs of the United States is doing work that compares favorably in usefulness with that which is done under government auspices, a dinner at the Waldorf-Astoria and a pair of seats at any show he wants to see. If so many were, would not the published lists of calls heard be longer? These lists seem to show that comparatively few members are reporting to their own organizations. If the majority believed that their reports were of value, would they not send them? On the level, how many have any ideal before them except to enjoy the use of the latest scientific marvel and entertain a limited circle of friends? How many are doing work that would justify giving them the right of way at any time when a larger number of citizens wanted the ether? How many of the "calls heard" represent messages that could not have waited until after all danger of interference with an evening concert or a government broadcast had passed?

The promotion of radio as a means of exchanging individual communications has already resulted in making the air around our cities sound like a swimming pool when the boys' class is in. You may be able to distinguish a word now and then but you don't know who said it. This type of radio activity is putting the brakes on itself as effectually as a pair of skis that decide to go in different directions. Even when local amateurs attempt to regulate themselves, their success is possible only so long as their number is limited to a very small proportion of the population. If amateur transmitters continue to multiply, the complaints against them will eventually set a brake with a Government seal on it or their activities will automatically drive out all but those who are selfish enough to outdo their fellows in jamming.

The answer to the whole problem, from my point of view, is: put the brakes on transmission and boost the business of listening to broadcasts. It would be unjust to place insurmountable difficulties in the way of even the boy who has already purchased a spark set, but is it not a worse injustice to encourage beginners to install transmitters in view of the present situation, except in isolated districts? Temporarily, manufacturers, dealers and customers may be embarrassed by a shortage of receiving apparatus, but it will not take American manufacturers long to solve that difficulty.

Promote interest in the Government broadcasts. They will always be more important than any others and to many they will always be more interesting even than the excellent amusement programs provided by private concerns. There is something wrong with the citizen who does not want to hear what his Government is doing. A good many have acquired only enough interest so that they wire their representatives to find out what Congress is doing and stop it. Radio will enable us to get in a few minutes a day enough direct informa-

# ACCURACY Is Necessary

Guesswork with a battery doesn't pay. So finely developed are storage batteries that you must *know* absolutely what the charge is all the time; else you will ruin your battery or lose an interesting message.

## READ-EASY HYDROMETER Accurate Readings Instantly

This is a quality instrument for those who demand the best. It must not be compared with the cheap make-shift devices that do not—because they cannot—give accurate simple readings.

**Made for Amateurs  
Preferred by Professionals**

We worked for simplicity and ease of operation and have produced the most accurate Hydrometer you can get. There are cheaper ones, but they cannot give the service of the *Read-Easy*.

**Anyone Can Read It**

Be sure to get the *Read-Easy*. Do not accept cheap, inaccurate instruments. At your dealer's, or direct if he will not supply you, at \$1.25 postpaid and insured.

Radio Division 12

**ALA MFG. CO.** 401-417 S. Sangamon Street  
CHICAGO, ILL.



## Mr. Brownlee's Loud- talker

(Continued from page 1797)

had mixed her biscuit dough and reached up her hand for the rolling pin and it was not there because Mr. Brownlee had taken it to wind wire on to make a tuner. All the joy would go out of life in an instant, and when she got out the ironing board and reached for the paraffine wax to wax the sole of her sad iron and discovered that Mr. Brownlee had used it for impregnating coils, she would "wax" sadder and sadder.

It had been bad enough when Mr. Brownlee melted her sealing-wax in her aluminum stew-pan and began using all her clothes lines and can openers and kitchen knives, but when he began inventing a loudspeaker that would not spit or bark and that would have a tone as soft as silk and as clear as a razor edge, Marjatta went right up in the air. She burst into rushes of angry words that sounded as if her mainspring had come loose. She sounded as if she was so full of static she was liable to fuse her lightning arrester. My, oh! she was mad! Because when a man is really eager to invent a first-class home-made loudspeaker it stands to reason he has to try the dishpan and the bread-board and the cake box and the flour-sifter. He has to try everything, even the drip pan from under the ice-box. Until a man tries the frying pan and the colander and the nutmeg grater how can he know they are not the very things that will give that soft clear tone he is seeking?

When Mrs. Brownlee closed the front door to go to the Carbuttes for dinner Marjatta was jumping up and down in the kitchen, swearing in Finnish with an Eskimo accent, because Mr. Brownlee had soldered the kerosene funnel on the back of the large bread pan after cutting a large hole in the bread pan, and Marjatta had not discovered it until her bread was ready for the oven. Of course, Mr. Brownlee was the real owner of the bread pan and the funnel but Marjatta did not seem to care who owned them. She was most unreasonable about it. Her thoughts were like this: "Son-of-gun boss all time taking my things, busting them up for radio! I no stand it! I quit! Misses she hears radio, boss he hears radio, everybody hears but Marjatta, and son-of-gun boss steals my dish pan, stew pan, drip pan, bake pan. I quit! Radio house no good. I quit. Hot-tentot! Salmagundi! Pumpernickel! I quit!"

I am not an expert linguist in Finnish with an Eskimo accent, but you'll grasp the meaning. And Mr. Brownlee grasped it. For some days he had been grasping it.

"Marjatta's peevish," he said to himself. "The trouble with my wife and with Marjatta is they don't get what I get out of radio. They can't enter into it and share it with me. If Sophia and Marjatta could get the joy out of radio that I get out of it they'd love it—they'd be happy and joyful and contented. I wish I could do something about Marjatta, but I can't. I've got to experiment. I've got to try things. If she gets mad and quits I can't help it. And if Sophia gets mad and goes home to her mother I can't help that. I'll hate it, but I'll have to bear it. When a man gets really interested in radio—"

Then he would wonder, suddenly, if the piano would not make a good loud talker. If, now, he bored two holes in the rear of the piano and fastened the ear phones there, why shouldn't the piano wires absorb the static and vibrate to the sound waves? And off he would go to find a jig-saw to cut the holes in the piano. A few pianos mean

You pay 2 much when you spend \$6 or \$8 for Moulded Variometers or Couplers

**SPECIAL OFFER 2 Variometers \$15.25  
1 Coupler**

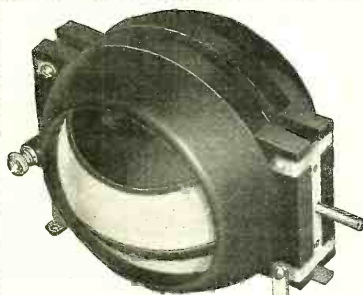

### Moulded Couplers \$5.00

**COUPLER.** 180° Rotor moulded of hard rubber, all windings of green double silk covered wire. Primary tube made of high dielectrical composition of  $\frac{1}{8}$ " thick mounted at 45° angle, adapted for base or panel mounting. Shaft  $\frac{3}{16}$ " or  $\frac{1}{4}$ " nickel plated finish. Primary wound with 30 turns of wire tapped every fifth turn. Effective tuning range 150 to 650 meters.

### Moulded Variometers \$5.50

**VARIOMETER.** The stators and rotor are moulded of hard rubber, and are highly polished. Green, double silk covered wire used. All parts nickel plated. Clearance between rotor and stator is .0005 with a + or - of .0002 either way. Large dimensions permit the use of low resistance wire. No paraffin shellac are used in wiring. Shaft  $\frac{3}{16}$ " or  $\frac{1}{4}$ ". Wave length 150 to 650 meters.

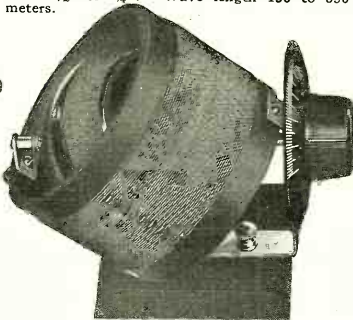

We pay transportation charges. If you are not satisfied in every way with our equipment, return it at once and we will refund the purchase price.

**RADIO INSTRUMENT and PANEL CO.** 26 N. DESPLAINES ST.  
CHICAGO, ILLINOIS

**WANTED**—Back numbers of Radio News, Sept., Oct., Nov. and Dec., 1921, Jan. and Feb., 1922. Experimenter Publishing Co., 53 Park Place, New York City.



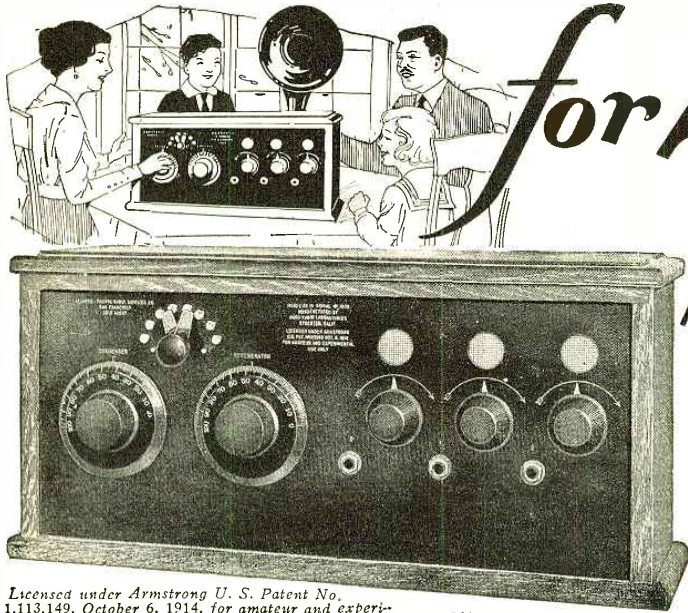

for **75**

Licensed under Armstrong U. S. Patent No. 1,113,149, October 6, 1914, for amateur and experimental use only. Oard Radio Laboratories, Stockton, Cal., Mfrs.

## Type AR-10 Long-distance Regenerative Receiver, Detector and 2 Stage Amplifier.

Listen! Hear that music . . . those rich, full tones, the AR-10 is bringing that concert to you over a *thousand miles*. Where are the batteries? "Peanut" tubes are being used, and both the A and B batteries are *inside* the cabinet. Splendid idea, isn't it? Saves scattering the apparatus about.

Don't see any wires either do you; just the lustrous Bakelite panel in front, mounted in a sturdy quarter sawed oak cabinet, with a beautiful French grey finish. For, when "Peanut" (WD-11) tubes are used, the AR-10 requires only two external outlets, one for the ground, one for the antenna, both in the rear. No mass of wires to detract from the compact, handsome, artistic appearance. Quality, the *highest* quality, in every line and feature. Absolutely nothing omitted that would increase either efficiency or attractiveness. A supreme product of a pioneer radio manufacturer.

Two stages of Audio frequency amplification provided so you can hook right up with a loud speaker to entertain. Fully shielded to eliminate capacity effects from

foreign bodies and to make tuning easier and quicker. Uses either WD-11 ("Peanut") or standard tubes. Individual rheostats provided for each tube. Three jacks provided, permitting use of either the detector, or the first or second stage of amplification independently at will. Only quantity production makes the low \$75 price possible for so complete and wonderful a set.

Mail the coupon below for folder, and in the margin write in name and address of your favorite radio dealer so that we may make arrangements for you to witness a demonstration of this marvelous set. Don't delay. It is probable that for several months the demand will far exceed the AR-10s that can be produced. **Mail the coupon NOW!**

—brings in broadcasted programs a thousand miles or more.

—saves cost of 2 stage amplifier, this included in set.

—saves room, both A and B batteries can be placed inside the cabinet, with "Peanut" tubes.

—appearance, quality, workmanship, and performance **FULLY GUARANTEED.**

# ATLANTIC-PACIFIC RADIO SUPPLIES CO.

Manufacturer's Agents: 646 Mission St., San Francisco, California

Also included in the A-P quality line distributed by this company are the following:—

Cutler-Hammer . . . . . Rheostats  
Cutler-Hammer . . . . . Potentiometers  
Carter Radio Co. . . . . Plugs and Jacks  
Dayton Fan & Motor Co.

Variometers  
Dayton Fan & Motor Co.

Variocouplers  
A-P RADIO PARTS—Transformers, Condensers, etc.

OARD PHANTOM RECEPTOR the No-Ground, "no aerial" set.



**MAIL THIS COUPON**

Atlantic-Pacific Radio Supplies Co.,  
646 Mission St., San Francisco, California.

GENTLEMEN:—  
Without cost or obligation, please send me folder describing your Type AR-10 Long-distance Regenerative Receiver, Detector and 2 Stage Amplifier.

NAME .....

ADDRESS .....

CITY ..... STATE .....

*Write name and address of your favorite Radio Dealer in the margin.*



**DO YOU?**

Do you want to save 20 to 40 per cent on all your purchases of standard radio apparatus?

Do you want the personal advice and counsel of the greatest radio authorities in the country in solving your problems?

Do you want to receive free of charge a quarterly publication giving you a digest of the latest findings of radio science, telling you how to construct and operate both simple and advanced radio receivers and transmitters, together with a fund of other useful information.

**Of Course You Do!**

Then send us a post-card immediately, asking for Booklet R-1, describing our Co-operative Service Plan.

**The Radio Guild, Inc.**  
Co-operative Service Bureau  
256 WEST 34th STREET  
New York City

Quality CLEARSTONE Price

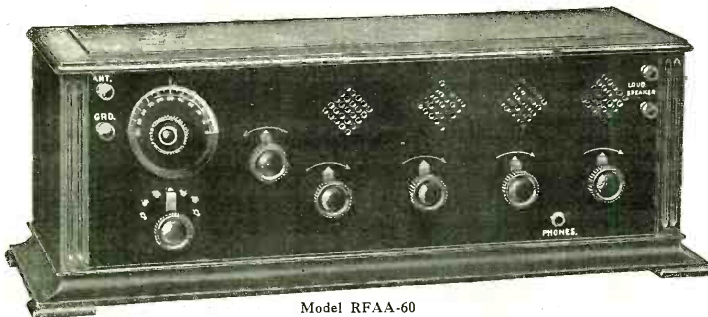

Model RFAA-60

This wonderful new CLEARSTONE development represents the greatest opportunity for the purchase of high class merchandise at a reasonable price, that has been yet offered to the general public. So simple that any child can operate it and yet so efficient that results far surpassing any regenerative set may be obtained by anyone. The set comprises one stage of Radio Frequency amplification, detector, and two stages of audio frequency amplification in that beautiful CLEARSTONE solid mahogany cabinet that is so famous by this time that it needs no description.

The list price of this astonishing new CLEARSTONE creation is only \$60.00. At this price a four tube set embodying the well known principles of radio frequency amplification is within the reach of all.

So confident are we that you will find this set all that we claim for it and even more, that we will ship it anywhere in the United States C. O. D. subject to your inspection before you pay for it.

Attractive proposition to dealers.

Model RFAA-60 code word 'abroad' \$60.00.

**THE CLEARSTONE RADIO COMPANY**

McMILLAN and ESSEX PLACE

CINCINNATI, OHIO, U. S. A.

**VARIABLE GRID LEAK**

0 to 5 Megohms. Price, 35 Cents

Smooth Unbroken Adjustment While Tuning

**SPENCER QUALITY RECEIVING SETS**

- 1 Stage Tuned Radio Frequency Amplifier, Detector & Tuner ..... Price \$35.00
  - 2 Stage Audio Frequency Amplifier ..... Price \$35.00
- THE HEIGHT OF BEAUTY AND EFFICIENCY**  
SPENCER MFG. CO., Aurora, Nebr.

**PHANTOM - CIRCUIT**

**Build Your Own.** This marvel of mystery, using no loop, no aerial and no ground brings in music instead of interference. We have heard stations 350 miles distant on one tube. By using WD-11 tube set can be entirely self contained. Very easy to build from our instructions, use your own spare parts, nothing complicated like radio frequency or super regenerative. Only one tuning control. Complete instructions, with hookup and photo of circuit mailed to you for 60 cents. Stamps accepted.  
Vesco Radio Shop Box RN-704 Vacaville, Calif.

nothing to a really enthusiastic loud talker maker.

When the Brownlees reached the Carbuttle's apartment Mrs. Carbuttle embraced Mrs. Brownlee and cried, "My dear! It has been ages since you were here! So glad to have you come!" and Mr. Carbuttle grasped Mr. Brownlee's hand and said "Well, this is great, Brownlee!" and—as dinner was ready—all went at once to the dining room. Mr. Brownlee tried to talk radio, but Mr. Carbuttle was a big and overpowering man and he wanted to talk coal, so he talked it.

"No freezing in this apartment, hey, Brownlee?" he demanded. "Nice and warm here, hey? Coal shortage doesn't bother us, you bet! Bet you're freezing, this winter, out there in your house, hey? City is the place to be—good steam heat all the time. You don't have steam heat, do you?"

"A furnace," said Mr. Brownlee meekly. "Old style hot air furnace. It's in the cellar. I—I hate it!"

"I bet!" cried Mr. Carbuttle. "Eats coal by the ton; no heat goes up the heat pipes—"

"It's not that," said Mr. Brownlee. "I hate it because it takes me away from my radio. I have to go down cellar and attend to it, and it takes me away from my radio. Now, tonight, for example. Tonight I was soldering a clip onto the oven—the sheet-iron oven of the gas-range. My theory is that the vibrating quality of a sheet-iron oven, when used as a loud speaker—"

"Edward!" exclaimed Mrs. Brownlee severely.

"Mercy!" cried Mrs. Carbuttle. "Is your husband a radio fan! I do pity you, Sophia—"

"Cheese!" ordered Mr. Carbuttle, raising his hand toward Mr. Brownlee. "Cut it out! Can it! No radio talk here, Brownlee. Rule of this house—no radio talk. It's a fad of mine—two things that can't be talked here, prohibition and radio. It's a notion I have—one place where a man can come and not hear prohibition or radio. Only place in the world where radio isn't talked twenty-four hours a day. It's a haven, Brownlee; a sanctuary. Great idea, what?"

"If you only knew what we radio wives have to stand!" exclaimed Mrs. Brownlee, but Brownlee did not say a word. The evening was ruined for him. He finished his dinner in silence, and in silence followed his hostess into the parlor. He sat moodily staring at the aluminum-painted radiator at the side of the room. The steam hissed from the acorn-shaped valve in the end of the radiator, but it meant nothing to Brownlee. He was sad and gloomy. Everything in the world was sad and gloomy.

Then, suddenly, the radiator began to make noises. It went "clack! clack! ching! clack, clack!" as radiators do at times. Instantly Mr. Brownlee was straight in his chair. A smile of bliss spread over his face.

"Static!" he exclaimed. "Static and code! That's what's the matter with that radiator, Carbuttle—too much static, and code. Now, if I were you—"

"Static nothing!" scoffed Mr. Carbuttle. "Steam-heat radiators don't have static. You're dippy, Brownlee—that's what's the matter with you—you're dippy! Too much radio on the brain. That clang-clang is the janitor, down in the basement, whanging on a pipe, or the water bubbling in the boiler. A thing like that you can hear all over the house— Here! What's the matter? Where are you going?"

Mr. Brownlee had leaped from his chair and rushed to the entry where his coat and hat hung. Mr. Carbuttle rushed after him, but was too late; he was only in time to see the door slam and, when he went into the hall, he heard Brownlee clattering down



# Get This Book It's FREE!

It tells how to cut out noise.

How to increase volume of sound with your present apparatus.

How to keep your set operating at high efficiency, and how to save money, at the same time.

Go to the nearest Willard Service Station today and ask for this book. Ask also about Willard "A" and "B" Radio Storage Batteries the only complete line of radio batteries. They represent thirty years of battery-building experience.

**WILLIARD STORAGE BATTERY COMPANY**  
280 East 131st Street, Cleveland, Ohio

Made in Canada by the  
Willard Storage Battery Company of Canada, Ltd., Toronto, Ontario.

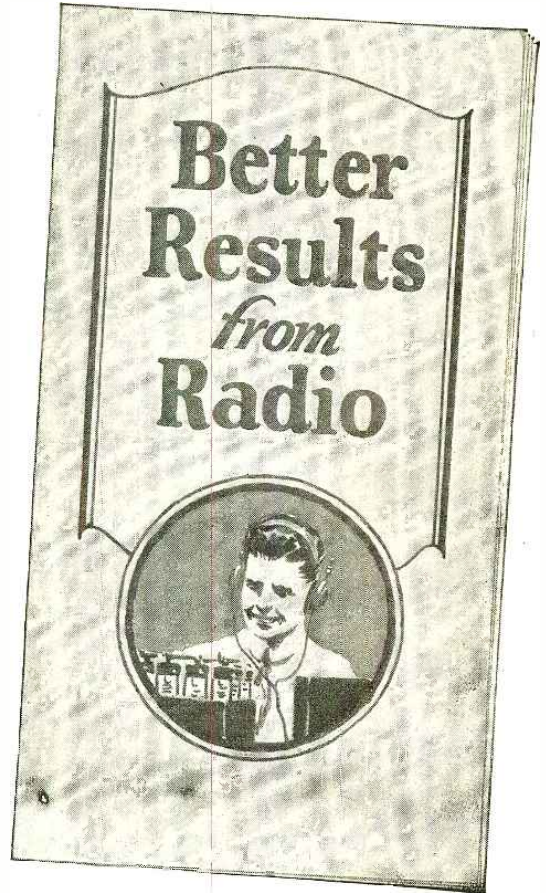

The Willard All-Rubber Radio "A" Battery (5 volt) delivers steady current for long periods. No need for frequent retuning; made in 40, 80 and 120 ampere-hour capacity.



The Willard "B" Battery (24 or 48 volt units) was especially designed for radio service by Mr. T. A. Willard to eliminate battery noises and give long life free from battery troubles.



You can get this book also by writing direct to the Willard Storage Battery Company, Cleveland, Ohio.

# Willard Storage Batteries for Radio

"The Watch Dog of the TUBE"

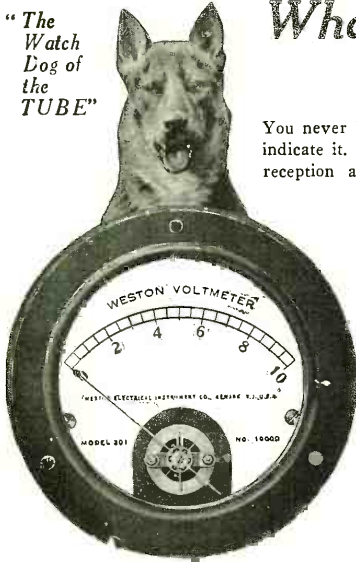

## What VOLTAGE are You Using?

You never know—unless you have the proper instrument to indicate it. Using too much or too little voltage means poor reception and difficulty in duplicating results. Excessive voltage also means shortened life of tubes—and often premature burn-outs.

Regardless of the make of tube—or whether you use dry cells or storage battery—you need a Weston Filament Voltmeter to indicate voltage, or a Weston Filament Ammeter to indicate current. It is only a one-time investment and pays for itself quickly in increased satisfaction and a saving in tube cost.

Booklet J. gives you full information on Weston Voltmeters, Ammeters, Milliammeters, Thermo-Ammeters and Thermo-Galvanometers for amateur, advanced experimenter or commercial station. FREE. Send for it.

Weston Electrical Instrument Co.  
173 Weston Ave., NEWARK, N. J.

Electrical Indicating Instrument Authorities since 1888



Don't Take Chances With Your Radio  
Safety and Pleasure Is Assured When You Install the

# BRACH VACUUM RADIO PROTECTOR

It Lasts For Years

Engineers whose experience qualify them as competent judges acknowledge the Brach Vacuum Arrestor to be unsurpassed as an instrument for reducing static interference, insuring clear signals and protecting home and radio from lightning.

Approved by the National Board of Underwriters

Mend Your Wires and Joints With



At All Dealers or by Mail at 25c a Tube.

## SOLDERALL

A Metal In Paste Form

Insures perfect reception. All you need is a tube of this paste solder and a match to heat it. Results guaranteed equal to bar or wire solder.

L. S. BRACH MFG. CO., Newark, New Jersey  
COAST REPRESENTATIVES—Pacific States Electric Co., San Francisco, Los Angeles, Oakland, Seattle, Portland, Spokane



PROLONGS LIFE OF TUBES  
AUTOMATIC FILAMENT CURRENT ADJUSTER  
ELIMINATES TUBE TROUBLES  
FROM YOUR DEALER OR  
RADIALL COMPANY \$1.10 MOUNTING  
99 WARREN STREET NEW YORK

RADIO DEALERS  
In addition to carrying the usual Radio Corporation products, we are now distributors for New York State of the well-known Paragon Radio products, famous throughout the world. Write for latest bulletin and price discounts.  
20th Century Radio Corporation  
565 Fifth Avenue, New York City

the stairs, for Mr. Brownlee had no time to waste waiting for an elevator.

When, a few hours later, Mrs. Brownlee reached home she was a very angry woman. Never in their married years had Mr. Brownlee deserted her in this rude and uncavalier manner. She opened the front door and stepped into the hall. Instantly she heard, coming from the parlor, the musical strains of Bink's Marine Band (W.P.O., Turneyville, N. Y., 11:30 to 12 P. M.). The music came loud and clear, as it had never come from one of Mr. Brownlee's loud speakers before.

"Now, if you please, Edward Brownlee," said Mrs. Brownlee in her severest tone as she entered the parlor, "I'll ask you to kindly explain why you—"

She stopped short. Brownlee was not in the parlor. No one was in the parlor. Not even the radio set was in the parlor. With an angry toss of her head Mrs. Brownlee went out of the parlor and crossed the hall to the dining room. From the dining room, loud and clear, came the musical strains of Bink's Marine Band (W.P.O., Turneyville, New York, 11:30 to 12 P. M.). It was playing the Washington Post March.

"Edward! Edward Brownlee!" called Mrs. Brownlee, but Mr. Brownlee was not in the dining room. He was not under the table nor under the sideboard nor under the serving-table. Mrs. Brownlee went into the kitchen. Loud and clear the music of the Washington Post March greeted her in the kitchen (Bink's Marine Band, W.P.O., Turneyville, N. Y., 11:30 to 12 P. M.). But Mr. Brownlee was not there.

With increased anger Mrs. Brownlee climbed the stairs. In every room the horns and drums and trumpets and cornets of Bink's Marine Band—one of the best in the country, it is said—filled her ears. It even greeted her in the bathroom. But Mr. Brownlee did not greet her. There was no Brownlee on the second floor. Mrs. Brownlee climbed the stairs to the third floor. She saw a light glimmering under the door of Marjatta's room. She tapped on the door.

"Coom een!" said Marjatta's voice, and Mrs. Brownlee opened the door.

In her bed sat Marjatta, propped against the pillows, her face beaming and wreathed in smiles, and she was listening to the sweet and strong music of Bink's celebrated Marine Band.

"Nice moosik, missus!" said Marjatta. "Is my husband here?" demanded Mrs. Brownlee. You can imagine how she would demand that. No nonsense about it!

But Mr. Brownlee, dear man, was not there.

"Boss been in cellar," said Marjatta. "Nice moosik; I don't quit."

Mrs. Brownlee hurried down cellar. Standing by the huge furnace that occupied the center of the cellar was Mr. Brownlee, and the smile on his face was even more ecstatic than the smile on Marjatta's face had been. Now and then he moved from one of the bulky tin heat-pipes to another, turning off the music from one room and turning it on in another, or—turning them all on—he flooded the whole house with music through the heat-pipes. Mr. Brownlee was blissfully, supremely, triumphantly happy. He had made a loud talker out of his hot-air furnace.

### WHERE ARE THE REST?

The circle of Radio nuts is extending. Mr. Nutt showed up recently in the person of a baritone singer in one of the Radio concerts, and now it is Ethel M. L. Chestnut, who delights with soprano solos on the Pacific coast. Welcome to our midst.



# Exide

## BATTERIES

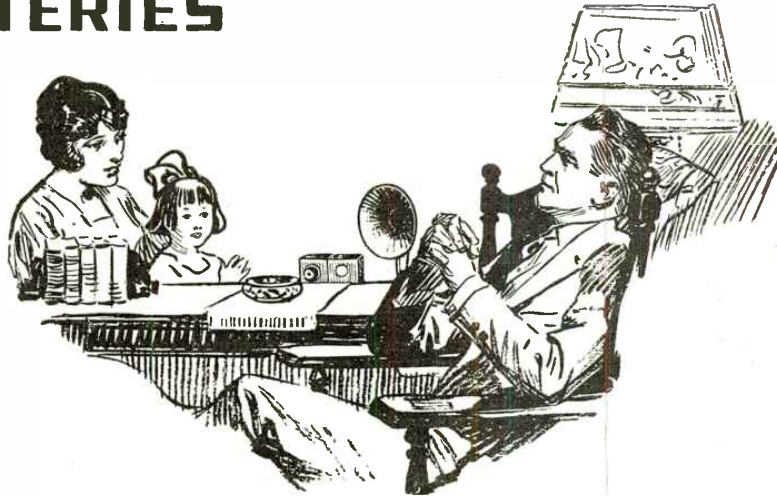

### For uniform filament current

To meet the requirements of radio service, the Exide Radio Battery was specially designed for the maintenance of a uniform voltage during a long period of discharge. You will take great satisfaction in a battery whose voltage does not drop quickly to a point where frequent adjustment of the apparatus is necessary.

Plates, separators, jars, terminals, every part and each detail of this battery is the result of the experience of the makers of Exide in building batteries for every purpose since the beginning of the storage battery industry.

Exide Batteries are used by governments and great industries all over the world. They propel mine locomotives and submerged submarines; they operate the fire alarm system and send your voice over the Bell telephone. Most of the government and commercial wireless plants are equipped with Exide Batteries.

You can get Exide Radio Batteries at every place where radio equipment is sold and also at all Exide Service Stations.

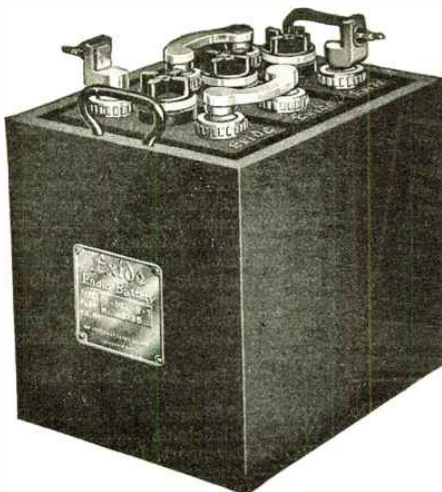

**THE ELECTRIC STORAGE BATTERY CO.**  
Philadelphia

*Oldest and largest manufacturers in the world  
of storage batteries for every purpose*

# Increase your Range

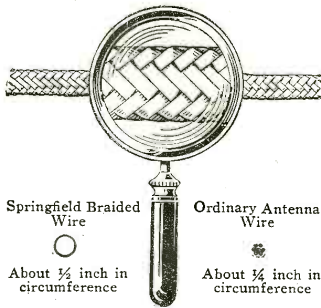

with your present equipment

## Springfield 16 Strand Braided Antenna

125 feet in your attic, in strands 3 feet apart, gives better results than 150 feet of ordinary wire outdoors. *Read what they say:*

"Proven far superior to anything, after extensive tests."  
 "Very best thing obtainable for loop antennae."  
 "45% more efficient than 7 strand No. 22."  
 "Far superior to ordinary copper."  
 "1000 miles—with 3 turn loop with detector alone."

"Received clearest tone ever been able to get."  
 "15% increase, when substituted for common strand copper wire."  
 "Over 100% increase, when connected to old set."  
 "900 miles with two 65 ft. strands, using detector tube and 2 steps of audio amplification."  
 "Cleverest aerial wire on the market."

At Your Dealers—or send us \$2.50 for 100 ft.  
 Dealers and Jobbers—Write for prices and terms.

SPRINGFIELD WIRE & TINSEL CO., 387a Main St., Springfield, Mass.

# Good bye Aerials!

Just perfected! SHORT CUT ANTENNA—an ingenious cylinder which takes the place of aerials, loops, plugs, etc.—and makes your set portable!

Eliminates lightning dangers, static interference, distortion—brings clearer signals and tone. Fits all standard vacuum tube sets—simply connect SHORT CUT between aerial and ground terminals of your set and listen!

Price postpaid \$5.00—  
 Satisfaction guaranteed.

**Short Cut Radio Corporation**  
 243 West 54th Street  
 New York

In the Greater New York District SHORT CUTS can be had at leading department stores and electrical shops—elsewhere write us direct.

**RADIO FANS!**  
 Fill in coupon and get the graphic story of SHORT CUT.



Size, 6 1/2 ins. by 2 1/2 ins.

SHORT CUT RADIO CORPORATION  
 243 West 54th St., New York

Send me at once your booklet on the SHORT CUT ANTENNA. I have a

Name .....

Street .....

City .....

State .....

## Radio in England

(Continued from page 1795)

terms of its value as a means to an end. On the other hand, they have not made efficiency a paramount consideration, nor have they achieved adaptability, mechanical strength, or permanence of construction. The finish generally stops on the surface. An important factor in American methods is the influence of the general public upon design details. We have had a hard schooling at their hands, and they have required us to make equipment foolproof. No doubt their own equipment will go through the same axle of change when radio is widely used in England.

Several points distinguish their apparatus—the use of hard rubber, mounting the tubes outside the cabinets, their horizontal or sloping panels and the absence of stamped and molded parts. The interior appearance of their sets is in no way equal to American equipment, nor is it open to inspection, unless the screws holding the panel to the cabinet are removed. The use of real bus bar wiring, with its straight lines and square corners, is at least for the present distinctly ours.

While these remarks contrasting the progress of broadcasting and apparatus design may be interesting, there is little basis for their application as criticisms, because their methods are as satisfactory to them as ours are to us. A study of radio developments in England is really a research into the Englishmen themselves, for this remarkable science involves matters of a technical, public, financial and political nature. The psychology of English scientist and his interpreter, the designer, is clearly seen in their radio equipment, following, as it does, the old established precedents; the public, true to form, discuss volubly the shackles of regulations and restrictions which are holding back the wide enjoyment of broadcasting and hampering the development of the industry; the business man of the big interests is upholding the reputation of his class in carefully arranging the field to bring it under the proper control, and doing it all in a way to obtain the sanction, not only of the government, but of that great class of conservatives who feel more keenly the loss of one motor car by a man who has a dozen, than over their own inability to have any at all.

## Radio Golf

(Continued from page 1796)

receiving set is computed from the map and the various distances added up.

Mr. Anthony is New England Manager for R. Thomas Sons Co., manufacturers of electric porcelain. The equipment with which he made this phenomenal record was a standard Amrad Radio Frequency Receiver 3500 employing one stage of radio frequency, and two stages of audio frequency amplification. San Francisco was heard clearly through a loud speaker horn.

Listed below is Mr. Anthony's score card:

	Miles
WAAK—Milwaukee	920
WIP—Philadelphia	290
WOC—Davenport, Ia.	1035
WGY—Schenectady	87
WRR—Dallas	1610
WDAC—Springfield, Ill.	1006
WHK—Cleveland	575
WHB—Kansas City, Mo.	1294
WQAA—Parkersburg, Pa.	317

**BRASS** Rods in round and square. Machine screws, any size. Tubing and sheet. Nuts. Small drills and taps. Knobs and dials.

ANGIERS, U. S. A.  
 STREATOR, ILL. BRUCE ST. PLANT

Vesta "A" and "B" batteries for radio sets are noted for their long life.

# VESTA

COSTS LESS PER MONTH OF SERVICE



Largest  
Radio  
Store  
in  
America

Buying Direct—in Quantities—for Cash, and operating on a  
"SMALL PROFIT—BIG SALE—QUICK TURN" basis  
MAKES POSSIBLE THESE VALUES

Largest  
Radio  
Store  
in  
America

RADIO SUPPLIES PURCHASED HERE ARE SOLD UNDER A POSITIVE  
GUARANTEE OF SATISFACTION. WE CARRY THE LARGEST  
NEW STOCK OF FIRST QUALITY NEW MERCHANDISE

## Complete Parts for Reinartz Circuit

Includes 1 7x18 Formica Panel, 1 Bakelite Socket, 1 Howard Vernier Rheostat, 23 Plate Condenser, 11 Plate Condenser, 3 Switch Levers, 2 Dozen Switch Points, 1 Reinartz Wound Coil, 1 Freshman Variable Grid Leak, 8 Binding Posts, 25 Feet Tinned Wire, 1 Base for Coil, 1 Mounting Base Board, and Diagram to Construct This Set. Complete..... **\$11.45**

## COMPLETE KNOCKDOWN RECEIVING SET

This includes 2 Variometers, 1 Coupler, 3 Dials, 1 Rheostat, 1 Cunningham Detector Tube, 1 Bakelite Socket, 1 Mahogany Cabinet, 7x18 Formica Panel, 6 Binding Posts, 1 Switch Lever, 12 Switch Points, 2 Stops and 1 Diagram to construct this set. Set is capable of receiving 1,000 miles if installed with outdoor aerial ..... **\$17.95**

## VARIABLE CONDENSERS

\$4.30 Value, 43 PLATE, now .....	\$1.75	\$3.10 Value, 5 PLATE, now .....	\$1.25
\$3.70 Value, 23 PLATE, now .....	\$1.45	\$2.70 Value, 3 PLATE, now .....	\$1.15
\$3.30 Value, 11 PLATE, now .....		\$1.35	

## U. S. A. Signal Corps <sup>Aviation Type 194-W</sup> Western Electric Phones, \$7.95

Each Phone Cap is covered with large soft rubber ear cushions, and an aviation leather helmet goes with each set! These are the only phones to pass the Government specifications for sensitiveness and loudness, the requirements called for in aircraft reception.

## COMPLETE PARTS FOR FLEWELLING CIRCUIT

Includes 6x14 Formica Panel, 23 Plate Condenser, 3 Micon .006 Condensers, 1 Freshman Variable Grid Leak 1 Remler Leak, 2 Coil Mount, 2 Honeycomb Coils, 2 Coil Plugs, 1 Socket, 1 Howard Vernier Rheostat, 8 Binding Posts and 1 Diagram to Wire and Construct this Set. Complete ..... **\$12.45**

MAGNAVOX, Loud Speaker,  
Type R3 ..... **\$34.95**

FORMICA PANEL, 1/8 in. thick,  
Square Inch, Black or Brown..... **1 1/2c**

VARIOMETERS <sup>Genuine Mahogany \$5 Value, NOW</sup> ..... **\$1.95**

VARIOCOUPERS <sup>NOW \$4.50 Value</sup> ..... **\$1.75**

HONEYCOMB COILS

1,500 Turns Coto Coil.....	\$1.50	150 Turns .....	60c
1,250 Turns Coto Coil.....	1.50	100 Turns .....	50c
1,000 Turns .....	1.25	75 Turns .....	40c
750 Turns .....	1.00	50 Turns .....	40c
250 Turns Coto Coil.....	75c	35 and 25 Turns.....	40c

MICROMETER VARIOCOUPLER,  
A Super Efficient Coupler with 180° Rotor Movement (For sharper tuning) and having 20 Antenna Taps ..... **\$2.95**

## Signal Corps Super Sensitive Microphone Transmitters . . **\$2.45**

Solid Copper Aerial Wire, 100 ft. ....	35c	2-Slide Tuning Coils, at .....	<b>\$1.95</b>	Anti-Capacity Switches .....	<b>\$1.50</b>
Spaghetti Tubing, yard .....	10c	3-Coil Honeycomb Mountings, with Knobs.....	<b>\$3.45</b>	Lightning Switches .....	<b>\$2.65</b>
Corp Tip .....	60c	Phone Caps, for mostly all phones .....	25c	Hydrometers, now at .....	45c
Brach Lightning Arresters .....	95c	Signal Corps Hot Wire Ammeters, at .....	<b>\$5.45</b>	Freshman Variable Grid Leaks .....	95c

\$8.50 Guaranteed 3,000 Ohm HEADPHONES ..... **\$3.65**

Thordarson Amplifying TRANSFORMERS \$4.50 Value, Now ..... **\$2.95**

FRAMINGHAM RHEOSTATS ..... **45c**

500 OHM POTENTIOMETERS ..... **\$1.45**

Sponge Rubber EAR CAPS, Aviation Type Pair ..... **50c**

SWITCH LEVERS ..... **20c**

DIALS, 2, 3 and 3 1/2 in. .... **25c**

BINDING POSTS, per doz. .... **50c**

GREWOL DETECTORS ..... **\$1.45**

## Original Type C **Nathanial Baldwin** Mica Diaphragm Loud Speaker Units . . . . **\$4.95**

We Guarantee All Merchandise Purchased of Us

Mail Orders Receive Immediate Attention and We Pay Transportation Charges

# CHICAGO SALVAGE STOCK STORE

509 SOUTH STATE ST.

Dep't RN.

CHICAGO, ILL.

# "ESCO" Battery Chargers

To meet an insistent demand for  
**RUGGED—  
RELIABLE  
NEVER FAILING  
MOTOR-  
GENERATORS.**

For charging Batteries in Wireless Operation. We have developed a complete line of **MANY SIZES.** With or without panel boards. ESCO quality thruout. You know what that means.

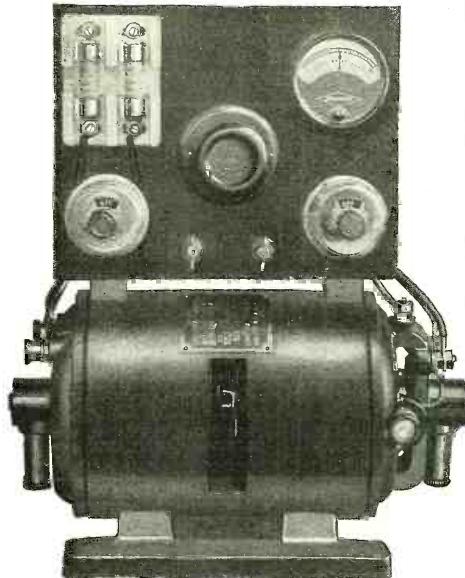

Ask for Bulletin 242

## ELECTRIC SPECIALTY CO.

211 South Street  
STAMFORD, CONN., U. S. A.  
Pioneers in Developing Quality Wireless Apparatus

# NON TUNE RADIO RECTIFIER

Reliable "A" Battery Charger for Home Use

### CHARGING RATE

The Non Tune Radio Rectifier charges at a uniform rate which will maintain a radio battery yet will not damage the battery plates if neglected for a time greater than regular charging period. Takes less than a forty watt lamp to operate.

### RELAY LOCK

A most important feature of the Non Tune type of rectifier is the relay lock which will prevent a discharge of any current whatsoever from the storage battery back into the rectifier if power current fails.

### RELIABILITY

Thousands of Non Tune Rectifiers are now being operated continuously 24 hours daily in connection with Railway Signal Batteries where reliability is absolutely essential. In this service contacts of Non Tune Rectifiers operate years without requiring renewals.

Ask your dealer or write giving your dealer's name.

REQUEST RADIO BULLETIN No. 100-C.

**LEICH ELECTRIC CO., Mfrs., Genoa, Ill.** *Non Tune Rectifiers—Leich Comfortable Headphones*



### A WONDERFUL OPPORTUNITY

The Eastern Division of the RADIO CORPORATION OF AMERICA accept no inexperienced applicants in their services as Wireless Operators other than our graduates. Investigate the advantages offered through taking either our HOME STUDY or RESIDENCE course in Radio.

### RADIO INSTITUTE OF AMERICA

(Formerly Marconi Institute) 324 Broadway New York City

### Crystal Detectors Sacrificed

Either complete, or in parts; parts being standard and suitable for use on any detector. As we have discontinued the manufacture of wireless parts, we are offering the above at PRICES FAR BELOW ACTUAL COST.

—Samples Gladly Submitted—

**BIERMAN-EVERETT FOUNDRY CO.**  
Irvington, New Jersey

WJZ—Newark	201
WHD—Morgantown, W. Va.	544
WAH—Eldorado, Kansas	1438
Local Stations	15
<hr/>	
	9332

#### DEC. 25—5 HRS. PLAY

WJZ—Newark	Miles 201
KYW—Chicago	892
WHD—Morgantown	544
WJAX—Cleveland	575
WGY—Schenectady	87
WWJ—Detroit	633
CFCF—Montreal	259
WBZ—Springfield, Mass.	66
KSD—St. Louis	1092
WOO—Philadelphia	290
WYJ—Los Angeles	2712
Local Stations	10
<hr/>	
	7361

#### DEC. 30-31—6 HRS. 20 MIN. PLAY

WEAF—New York City	Miles 201
WGM—Atlanta	978
WIP—Philadelphia	290
KDKA—Pittsburgh	489
WFI—Philadelphia	290
PWX—Havana	1571
WAAK—Milwaukee	920
KSD—St. Louis	1064
WRK—Dallas	1610
WKM—Memphis	1179
WPA—Ft. Worth, Texas	1639
WDAC—Chicago	892
KHD—Colorado Springs	1869
WMAF—So. Dartmouth	64
KNJ—Roswell, N. Mex.	1984
KSS—Long Beach, Calif.	2703
WSB—Atlanta	978
KDN—San Francisco	2818
WSY—Birmingham, Ala.	1093
Local Stations	20
<hr/>	
	22652

GRAND TOTAL—39,345 Miles in 14 Hrs., 20 Mins.

## C. W.

(Continued from page 1799)

Gray turned from the table and pulled Perry away from the panel. As he turned back to the key the surgeon arrived, and knelt down beside the unconscious Sparks. As Henry Gray started to pound out S O S, he realized for the first time that the books had held the key down, and that the set was dead. Crossing to the panels he ascertained at once that the condensers were blown. "Dickens to pay now," he muttered, "but guess I can get the auxiliary set from the battery room installed in the rack in time to signal." As Gray stepped from the door on his way to the battery compartment, the lights on the ship glowed yellow, and suddenly were gone. A boat was just being lowered from its davits about 20' from where Gray stood. The shrieking women, the swearing seamen, and the darkness, broke Gray's nerve. As the lifeboat hit the water, Gray jumped from the rail—he had taken flight—the easiest course for the moment—the coward's course always.

Failing to hear the crashing Sparks, the captain again came rushing into the radio room, flashlight in hand. "Where is that kid Gray? Why isn't he sending for help?" the captain demanded in a rage. The surgeon calmly looked up from his patient. "He just ran out of the door, and from the speed at which he left. I don't think he'll be back." "Well of all the hellish tricks—in ten minutes we are doomed, and you had better get the lad there into a life boat and stay with him," the captain, now cool again,



# RADIO SUPPLIES—LOWEST PRICES

WE SELL STANDARD RADIO AND ELECTRICAL MERCHANDISE AT ROCK-BOTTOM PRICES. OUR CATALOG GIVES A FULL LINE OF RADIO PARTS, COMPLETE RECEIVING SETS—ELECTRICAL GOODS AT GREATLY REDUCED PRICES.

OUR GUARANTEE: All merchandise offered is standard and guaranteed perfect in material and workmanship. If any goods are found defective they will be exchanged or money promptly refunded.

**Our Prices  
Speak Louder  
Than Words**

Order Direct From This List

- Magnet Wire 20 per cent. off list.  
**RHEOSTATS:**  
 \$1.00 Rheostat ..... \$ .32  
 Homecharger De Luxe ..... 13.25  
 Johns-Manville Bk. Com. Tubes,  
 3-in. .... .25  
**DETECTORS:**  
 \$ .75 Crystal Detector ..... .35  
 \$ .40 K. D. Crystal Detector ..... .16  
 \$1.50 Multi Jack ..... 1.15  
 \$1.50 Twin Adapter ..... 1.15  
 \$1.25 Universal Plug ..... .75  
**BATTERY CHARGERS:**  
 \$18.00 Westinghouse battery  
 Chargers ..... 14.40  
 \$19.50 Westinghouse Battery  
 Chargers for A. & B. Bat-  
 teries ..... 15.00  
 70c Open Circuit Jack ..... .22  
 85c Double Circuit ..... .30  
 75c Battery Hydrometer ..... .35  
**KNIFE SWITCHES:**  
 Knife Switch S. P. S. T. .... .14  
 Knife Switch S. P. D. T. .... .22  
 Knife Switch D. P. D. T. .... .35  
 Wooden Horn ..... 5.50  
 Contact Points ..... .06  
 \$5.00 Standard Metal Horn ..... 4.00  
 \$7.50 Standard Metal Horn ..... 6.50  
 \$20.00 WESSCO Battery Charger ..... 12.95  
 \$3.00 Battery, 2 1/2 V. Variable,  
 highest quality guaranteed. .... 1.45  
 Large size ..... 1.75  
 \$1.75 B Battery, 2 1/2 V. Vari-  
 able, highest quality guaran-  
 teed. Small size ..... .75  
 \$7.00 Westinghouse Storage B  
 Battery ..... 5.50  
 \$1.09 W. D. 11 A Battery ..... .55  
**CONDENSERS:**  
 \$5.00 WESSCO 23-pl. Variable  
 Condenser ..... 1.85  
 \$5.50 WESSCO 43-pl. Variable  
 Condenser ..... 2.10  
 8-plate Verrier Variable Con-  
 denser ..... .70  
 50c Mica Condensers ..... .25  
 Thordarson Oil Condenser ..... .10  
 Bronze Bus Bar, tinned, ft. .... .02  
**PANELS:**  
 Guaranteed Genuine Bakelite  
 Panels—7x10, \$1.25; 7x18,  
 \$1.85; 9x10, \$1.00; 9x5, 47c;  
 5x9, 95c; 6x12, \$1.25; 7x12,  
 \$1.50; 7x9, \$1.15; 12x11, \$3.00;  
 7x24 ..... 3.00  
 \$1.50 Microstats ..... .85  
 Spaghetti, per length ..... 07 1/2  
**SPECIAL ELECTRIC SOLDER-  
 ING IRON, TWO HEAT.** ..... 4.95  
 20c Bezel ..... .15  
**PHONES:**  
 \$10.00 WESSCO Phones ..... 4.95  
 \$5.00 Murdock Phones ..... 3.55  
 \$1.00 Prestman Variable Grid  
 Leak ..... .68  
**WIRE:**  
 109 ft. coil No. 14, 7-strand pure  
 copper Aerial Wire ..... .55  
**SOCKETS:**  
 \$1.00 Genuine Bakelite Socket ..... .45  
 \$1.00 Sockets ..... .35  
**DIALS:**  
 \$1.00 Genuine Bakelite Dials—  
 3-in. 45c; 4-in. .... .55  
**VARIOCOUPLES:**  
 \$7.00 Guaranteed Genuine Bakelite  
 Pioneer Variocoupler, silk wound ..... 4.75  
 \$4.25 Variocoupler, guaranteed  
 high quality ..... 2.25  
 \$9.00 Moulded Variocoupler, high-  
 est quality ..... 4.50  
 \$5.00 Shamrock Variocoupler ..... 2.59  
**TRANSFORMERS:**  
 \$5.00 Acme Transformer ..... 3.40  
 \$3.00 Radio Frequency Transform-  
 ers ..... 1.50  
 \$6.50 Wessco Audio Transformers,  
 highest quality guaranteed ..... 3.25  
 Thordarson Transformer ..... 2.75  
**VARIOMETERS:**  
 \$6.50 Pioneer Variometer, genuine  
 Bakelite, silk wound ..... 4.50  
 \$6.60 Wessco Variometer, highest  
 quality guaranteed ..... 3.25  
 \$4.50 Variometer, guaranteed high  
 quality ..... 2.40  
 \$6.50 Moulded Variometer, high-  
 est quality ..... 3.50  
**BATTERIES:**  
 \$24.00 A Battery, 100 amp., 6 V. 16.75  
 \$19.00 A Battery, 20 amp., 6 V. 11.45  
 \$14.50 A Battery, 60 amp., 6 V. 8.75



5c.  
Charges  
your  
"A"  
Battery  
with a  
Wessco  
Battery  
Charger  
De Luxe



\$5 Wessco 23 Plate Variable  
Condenser.  
Special \$1.85



\$5.50 Wessco 43 Plate Variable  
Condenser.  
Special \$2.10



\$20  
Wessco Battery Charger  
De Luxe  
\$12.95  
Special  
Introductory  
Price

**"Better Than The Best"**  
**AERIAL-A**  
 The Radio  
 Tube Set  
 W.E. Supply & Service Corp. 18 Murray St. N.Y. U.S.A.  
 That  
 Made Good  
 in a Night  
 WESSCO  
 QUALITY

Price Complete  
 Ready  
 To  
 Use  
**\$35**  
 Complete  
 including  
 Batteries,  
 Tube, Phones,  
 Aerial, etc.

This is the most outstanding value ever offered in a highly efficient Vacuum Tube Receiving Set.  
 We guarantee the Aerial A to be perfect in all details. Can be set up in less than an hour. This set is guaranteed to receive 250 miles in summer and 500 miles in winter. The price \$35.00 includes, Receiving Set; "A" Battery; "B" Battery; Vacuum Tube; Phones; Aerial; Insulators, etc. No extras to buy. Write for our descriptive bulletin.

**The Wessco Policy**  
 Every WESSCO product is guaranteed and is backed by the principles of Highest Quality; volume production and small profit which combine to give you greatest value and complete satisfaction.



\$10 Wessco Phones.  
Special \$4.95  
Guaranteed to be superior to any phones on the market at \$10.



\$6.50 Wessco Audio Amplifying  
Transformer. High Ratio.  
Special \$3.25

**Terms:** Orders must include postage. Money order, bank draft or check acceptable. All merchandise offered is standard and guaranteed on a money back basis against defective workmanship.

Manufacturers, Jobbers and Importers of Radio Supplies and Household Electrical Goods.

**W.E. Supply & Service Corp**

18 Murray St., Dept. RN New York

Ask for new Illustrated Catalog

tion to decide whether what the Government is doing should be stopped or encouraged. Incidentally, it will be a help to manufacturers who are maintaining expensive broadcasting service to have Government broadcasts to fall back on if the increasing demands of entertainers, song writers and lecturers make the cost prohibitive. There must be something in the air all the time in order to keep the receiving sets selling.

The Government broadcasts, being usually on higher wave-lengths, create a demand for different types of receivers and a well-distributed demand is far better for the radio business than a demand concentrated on short-wave apparatus.

Boys should be interested in learning to receive code broadcasts. Picking up telephone stuff will not interest live youngsters long. It is too easy. They want to know something that everybody does not know. The Government offers them connections with the Army and Navy which do not obligate a boy to become a soldier or a sailor but to give him a sense of importance and a spirit of responsibility.

We should interest every community in completely organizing its radio service and getting everything that is in the air that would be of benefit to any of its citizens. The present radio craze can be turned into many useful channels. Successful American newspapers are never monopolized by one subject or a single group of subjects. Men seldom read the fashion pages, but these pages sell a lot of papers. Women pass over the sport news, but this appeals to thousands of men. Every department from the automobile column to the daily chess problem interests somebody. And so in radio we should encourage the market broadcast, the health lecture, the talks on radio and aeronautics, the business report, the weather forecast, the news digest, the toll broadcasting, the experimental work that is in competent hands. We should encourage all these in a definite way. We should encourage radio from the bottom up—from the home-made tuning coil and the crystal detector to the multi-stage amplifier. We should encourage it by making it possible for people to hear something worth while, and that means giving the "ham" his share of the air at a time of day when he will interfere least with the majority of radio users. It is unfair to concentrate on developing in the beginner the idea that transmitting is the all-important thing and then forcing prohibitions upon him. The painless and constructive method is to concentrate on teaching every beginner first to listen, and making him see that the big thing in radio is to pick up information of importance and give it to those who will be benefitted by it. By so doing he will be of immediate and definite value to his home town, to his Government and to Radio—a driving wheel and not a brake.

**An Ultra Compact Radio Receiver**

(Continued from page 1083)

posts are required, but these are mounted on the case, and not on the panel.

The size and construction of the case is shown in Fig. 4. The box is made, neatly, of three-eighth-inch hardwood, the entire box and lid being made in one piece and then sawed in two along the line marked "Saw Cut." This method overcomes many of the construction difficulties involved otherwise. As previously mentioned, the binding posts are mounted on the outside of the case, one for antenna, for ground

# CONN RADIO CONCERTS

from  
*Ocean to Ocean*



Brass Choir  
San Francisco Symphony  
Orchestra



Pictured here are some of the artists appearing in Conn Radio Concerts. Above—Frank Westphal's Rainbow Garden Orchestra, Chicago.



Ernest Pechin  
Cornet Soloist



Mathew Amature  
Saxophone Soloist



John Dolan  
Cornet Soloist



Simone Mantia  
Euphonium Soloist



Eugene LaBarre  
Cornet Soloist

## THIRD OF NATIONAL SERIES Friday Evening, May 19

CONN radio concerts have taken the nation by storm! Our programs of March 17 and April 14 by America's leading dance orchestras and nationally famed soloists have occasioned universal admiration for Conn enterprise.

Isham Jones, Joseph Smith, Frank Westphal, Hal Nichols, D. C. Rosebrook and their orchestras have already played; Benne Henton, Charles Randall, John Leick, Mable Keith Leick and Fred Tait have given solos. More of their calibre are to appear.

Travelers on shipboard 1500 miles from the Atlantic and Pacific coasts, people in Northern Canada and in Central America will enjoy the same music which will be heard throughout the United States May 19.

**Think of it—Conn Ltd. is entertaining people by wireless a quarter of the way around the globe**

May 19 programs will be broadcasted from:

- |                             |                              |
|-----------------------------|------------------------------|
| New York, Station WJZ;      | Pittsburgh, Station KDKA;    |
| San Francisco, Station KDN; | New Orleans, Station WAAB;   |
| Detroit, Station WWJ;       | Denver, Station Z.F.         |
| Chicago, Station KYW;       | Kansas City, Sweeney Station |
|                             | Seattle, Wash., Station KGB  |

Conn dealers are entertaining at radiophone concerts. Watch for local announcements.

Write to Conn Ltd. now for new saxophone book; FREE. Tells why the Conn is the world's finest, choice of the famous artists on the radio programs.

**690 Conn Building C. G. CONN, LTD. Elkhart, Indiana**  
Agencies in All Large Cities

- |   |                                       |
|---|---------------------------------------|
| Conn New York Co., 233-5-7 W. 47th St.    | Conn Chicago Co., 62 E. Van Buren St. |
| Conn Detroit Co., 243 E. Grand River Ave. | Conn Seattle Co., 1609 Third Ave.     |
|   | Conn New Orleans Co., 317 Baronne St. |
|   | Conn Portland Co., 127 Tenth St.      |
|   | Conn Cleveland Co., 1220 Huron Road   |



**WORLD'S LARGEST MANUFACTURERS OF HIGH GRADE BAND AND ORCHESTRA INSTRUMENTS**



# DELTA

## GOLD STRIPE RADIO HEADSET



Best seller, because it is best made and best priced.

DELTA Distributors say:  
"Most mechanically perfect headset ever used"

Order today

### DELTA ELECTRIC COMPANY

470 DELTA BLOCK,  MARION, INDIANA

Standard Makers of Radio Apparatus, Bicycle Lamps, Auto Spotlights, Lanterns, Flashlights and Flashlight Batteries

NEW YORK

SAN FRANCISCO

WINNIPEG

### "UNITED" Radio Instruments Give Wonderful Results

No set can measure up to its full possibilities of range and tone quality until it is equipped with "United" Variable Condenser and Audio Frequency Transformers.

#### United Condensers

Design, material and workmanship combine to produce a valuable condenser that will not "short." Ends are Bakelite; plates, hard aluminum; posts and shaft, brass, highly nicked.

43 plate \$4.00 23 plate \$3.50 11 plate \$3.00  
5 plate 2.50 3 plate 2.25 postpaid

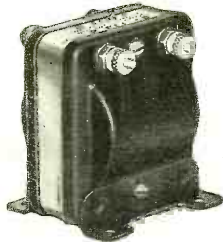

#### United Transformer

Way ahead of ordinary transformers in design, workmanship, finish. Has special features on which we have applied for patent. Gives loud, clear signals. Price postpaid .....\$4.50

COMING! A wholly new variable condenser with Vernier. Get your name on our mailing list for Bulletin when issued.

### United Mfg. & Distributing Co.

536 Lake Shore Drive, Chicago

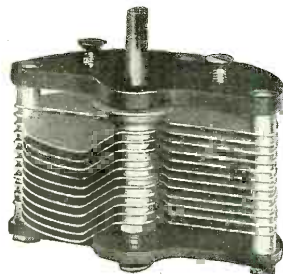

**EISEMANN**  
RADIO UNITS  
Made to the highest electrical and mechanical standards.  
EISEMANN MAGNETO CORP'N  
Chicago BROOKLYN, N. Y. Detroit

**ELWOOD ELECTRIC CO. INC.**

Bridgeport, Conn., U. S. A.

Manufacturers of

Radio & Telephone Equipment

told the surgeon. But Perry's eyes were open. He had caught the captain's words, "we are doomed!" The disabled boy whispered, barely audibly, "S O S will bring help; you send it, Cap!" As Perry closed his eyes the surprised captain fumbled for the key. He did know code; why shouldn't he send it? But his efforts were met with silence from the gap. Then he knew why Gray had deserted, for although the generator hummed steadily, on its auxiliary current, the set was useless. "Get out of here," he shouted, "save yourselves." The captain then rushed back to his post on the bridge, from which the mate, already aware of trouble in the wireless room, had rockets soaring skyward.

When the surgeon tried to move Perry, he again opened his eyes, and spoke, this time with more strength, "Help me to the table; not too late yet." His words were jerked out from weakness and pain. The surgeon, thinking that if they stayed longer it meant missing all possibility of gaining a boat, but always loyal to his ship, assisted Perry into the operator's chair. Assisted, did I say? Rather lifted him bodily, for poor Perry's right arm hung useless, and his legs were limp. Nevertheless, Perry reached for the key, and knew at once amidst the terrible hum and whirl in his aching head, that the set was gone, worthless. With his left hand he tore the connections from the key; he then connected the ground wire of his receiver to one post of the key and the other connection was made to the ground post of the tuner with a piece of wire from the table drawer. Gasping for breath, his head rocking from side to side, the courageous Sparks turned up the already glowing vacuum tubes until a faint, almost imperceptible whistle came from the phones. Then, with his head almost laying on the table, and his left hand awkwardly grasping the key, he sent S O S S O S S O S DE NTK NTK NTK SINKING SINKING LAT 45°N LONG 66°W S O S, etc. How long he kept this up the watching surgeon, fascinated at this display of will power, and subconsciously aware that the tilt of the ship meant that only minutes were left, moved only when Perry fainted and slid to the floor. Then picking Perry up he plunged through the door and hurled himself and burden overboard! They were almost immediately picked up by a raft of sailors.

Several hours later Perry opened his eyes to find himself in a brightly lighted cabin, one of the Cunard liners, he later found. But all he cared about just then was the sweet voice, and the soft arms of Miss Merton as she sat beside him on the lounge. The captain, standing at the head of the lounge leaned over and spoke, as he realized Perry had regained consciousness. "Lad, you saved a thousand lives tonight. Captain Milborn of this ship says they did not see our rockets, but that his first operator picked up your signals, quite weak but sufficiently loud for them to gain the necessary information which brought them to our aid. We have picked up all but one of the life-boats and rafts, and feel certain of finding the lost one shortly." Perry moved restlessly but quieted at once when Miss Merton smoothed his hair; the captain continued speaking, "Tell me, Sparks, how did you do it? The set was dead, for I tried it myself, and I know that no message was sent out after I left, for no one heard the crashing of the spark gap." "C. W.," murmured Perry wearily, "didn't think it was radiating—knew it had been done—took a chance," and his eyes closed. In spite of his aching bones and bad burns, he smiled as he sank into a deep sleep, for a smiling girlish face bending over him promised him days of joy to come.

**Receiving without an  
"A" Battery**  
(Continued from page 1816)

ments of the receiving tubes. The plate current for the receiving tubes was obtained from two small dry cell batteries, known in the service as the 763 battery.

Then again we have all undoubtedly seen loud speakers, in conjunction with a power amplifier, using a generator to supply the high voltage direct current for the plates of the power tubes.

Pondering these statements, the question naturally arises, "Since the air service used a generator for the filaments of receiving tubes alone and received good results, and a generator can be used to supply the plate voltage of tubes in a loud speaking device, why cannot the two be combined and good results obtained?"

Absolutely right! It can be done. The writer has been experimenting along these lines for a certain large radio corporation for the past year and has found that the idea is not only feasible, but that when the finished product is tested out in comparison with batteries, the results are far superior, and the cost is about the same as that of a good storage battery and charger.

The diagram accompanying this article shows how to use a motor-generator for the filaments of the receiving tubes, while small "B" batteries are used for the plates. The set consists of a detector and a two stage amplifier set for the reception of phone, code and C.W.

Coupling between the three tubes is effected by means of resistances in place of the usual audio frequency amplifying transformers.

The coil L-1 is the primary of any good 150 to 800 meter vario-coupler. There should be approximately ten taps on this coil.

The variable condenser C-1 has a capacity range between .00003 and .00075 mfd. It is connected in series with the aerial and the coil L-1. Tuning is effected by means of this condenser and the coil L-1. The detector and two amplifying tubes are connected in shunt across the coil L-1.

A lead is taken off between the antenna tuning condenser C-1 and the coil L-1 and leads to one side of a grid condenser C-2 of approximately .0001 mfd. capacity. The other side of the grid condenser leads to the grid of the detector tube. The grid condenser is shunted by a grid leak R-1 of two megohms resistance.

The plate potential of the detector tube is supplied by one standard 22½ volt "B" battery. A second "B" battery is connected in series with the detector battery and gives a combined voltage of 45 volts for the plates of the amplifier tubes.

Following are the uses to which the remaining instruments are put:

C-3. .0005 mfd. condenser. Acts as a bypass condenser for the radio frequency component of the plate current of the detector tube.

L-5. Rotor of the vario-coupler. This coil acts as a tickler coil for regeneration. It is connected between the plate of the detector tube and the condenser C-3.

C-4. .015 mfd. condenser. To prevent the positive potential of the detector tube plate circuit from imposing itself on the grid of the first amplifying tube.

L-2. Iron core choke coil of 15 henries. Prevents the audio frequency component of the plate circuit of the detector tube from passing through the "B" battery B-1, thereby forcing the audio frequency component into the path of the condenser C-4 and the condenser which is formed by the grid and the plate of the first amplifying tube. In this manner the audio frequency changes

**"American Beauty"**

**Electric  
Soldering  
Iron**



**The  
Best Iron  
Made**

**For Soldering all connections, parts, etc. Ready for use by attaching to any electric light socket. The cost of operation is insignificant.**

**Many thousands in use by amateurs, engineers, manufacturers, telephone companies and many others.**

**For radio, telephone and all light work our latest Model No. 3138 is ideal; also two larger sizes for doing heavier work.**

**For twenty-eight years our name and trade mark have been a guarantee of quality and dependability.**

**AMERICAN ELECTRICAL HEATER COMPANY**

**DETROIT, U. S. A.**

**Oldest and largest exclusive makers. Established 1894**

**DUCK - Radio Pioneer**

**Announces Startling Reductions**

The Leading Line Since 1909

At Prices to You Less Than Dealers' Cost

**FREE** Illustrated pamphlet comprising sixty-two Duck radio instruments and sets with reductions averaging 30% mailed on request. Send postal today. Any old time radio amateur will tell you who we are and our reputation. Only a few years ago almost one-third of the radio instruments sold at retail, exclusive of sales in only a half dozen large cities, were sold by Duck.

A Few of the Many Duck Products at Startling Prices: Rheostat, 70c; Bakelite Moulded Positive contact, 70c; Bakelite Moulded dial, 55c; superselective moulded variometer, \$4.65, worth \$8.00; radio frequency potentiometer, \$1.15; solid mahogany form variometer, \$3.60; 43-plate panel-type variable condenser, pigtail connection, \$3.15; detector panel, \$5.25; receiving set, mahogany cabinet, detector and two stages of audio frequency, \$59.50; radio frequency receiving set with one-stop radio and detector, \$29.75.

Send 25 Cents in coin or money order for our big 256 pp. combined Radio Catalog and Text Book. For radio information and hook-ups it is worth many times the retainer asked.

**THE WILLIAM B. DUCK COMPANY**

**231-233 Superior St., Toledo, Ohio**



**DUCK'S NEW  
PANEL TYPE  
VARIABLE  
CONDENSER**

acclaimed by all that have seen it to be the peer of any on the market. Pigtail connections, i. e., no sliding contacts. Base and top moulded bakelite. Aluminum separators, i. e., even spacing and simple means of adjusting plates. Mounting screws furnished. Concealed by dial. Brass bearings. ¼" shaft.



# HOMCHARGE



Your  
RADIO  
BATTERY  
for  
A NICKEL

Enjoyable concerts and maximum receiving range are obtained only when your battery is fully charged.

## THE HOMCHARGER

charges your "A" or "B" battery over night for a nickel without removing it from your living room. No muss—no trouble—no dirt—requires no watching.

After the concert connect to any lamp socket, snap the clips on your battery and "turn in." While you sleep the HOMCHARGER is silently charging your battery, the charging rate being governed automatically. In the morning it is fully charged. No OTHER battery charger can boast of such quick and economical performance.

The HOMCHARGER is the only battery charger combining all of these NECESSARY HOMCHARGING features—SELF-POLARIZING—FIVE to EIGHT AMPERE charging rate—UNDERWRITERS APPROVAL—beautifully finished in mahogany and old gold—UNQUALIFIEDLY GUARANTEED. OVER 90,000 NOW IN USE.

Sold complete with ammeter, etc., by all good radio and electrical dealers for \$18.50. (\$25.00 IN CANADA.)

See the RADIO HOMCHARGER DE LUXE at your dealer's or write direct for our FREE circular showing why the HOMCHARGER is the BEST battery charger at any price.

## MOTORISTS

The HOMCHARGER will also charge your AUTO Battery.

## The Automatic Electrical Devices Company

118 West Third St. CINCINNATI, OHIO  
Largest Manufacturers of Vibrating Rectifiers in the World

Easy, Now to Check Up Your Radio "A" Battery

Just insert nozzle in cell and draw up some acid; then, without removing from cell, "read" the condition of acid by the way the three balls of differing colors and densities sink or swim.

"White—right; Green—lean; Red—dead," gives you the key.

Set also includes Depth Gauge and air-controlled Stopper for distilled water bottle.

If your Dealer can't supply you, send one dollar and his name and address. Set will be sent postpaid.

THE CHASLYN COMPANY  
4315 Kenmore Ave., Dept. 1  
CHICAGO



## Designed! Not just made!

The market is over-run with head phones. Some are "made to sell"—others designed to perform a service—a service measured in terms of sensitiveness, tone quality, clarity—phone efficiency.

Such are the Basco Radio Head Phones—built first for service. Deep, natural-voice pitch—keenly sensitive—clear, scratchless. Coils encased in aluminum—light weight—easy on the head. Light diaphragm set to thousands-of-an-inch accuracy form magnet poles. Horseshoe type magnet. See your dealer.

Dealers and Jobbers: Write for particulars on our complete line of parts.

Briggs & Stratton Co.  
Milwaukee PRODUCT Wisconsin

in the plate current of the detector tube are passed on and impressed on the plate of the first amplifying tube.

L-4. Iron core choke coil of 15 henries. Produces the same action of the plate current of the first amplifying tube on the second amplifying tube, as was outlined above between the detector and the first amplifying tube.

C-5. .015 mfd. condenser. Same action as that of C-4.

R-3. Grid leak of one megohm resistance for the first amplifying tube.

R-5. Grid leak of one megohm resistance for the second amplifying tube.

R-2, R-6, R-7. Resistances of 13, 19, and 13 ohms respectively. Used to control the filament temperature of the three vacuum tubes.

L-4. Iron core choke coil to eliminate commutation noises from the generator. .02 henries.

C-6. 1.0 mfd. condenser. To reduce commutation noises from the generator. It is connected in shunt across the terminals of the generator.

R-8, R-9. Resistances of 35 and five ohms respectively. Limit the current to the filaments of the vacuum tubes. Are connected in the positive lead of the generator in series with the choke coil L-4.

This set is designed to operate with Western Electric tubes and the values given for the filament resistances are for these tubes. However, if other tubes are to be used, care must be taken to see that the resistances which are used are sufficient to regulate the flow of current to the filaments. Bear in mind, though, that the best results will be obtained with this set when using Western Electric tubes.

The generator should have an output of approximately 75 watts at 25 volts. A generator of the high speed type is best. About 3450 R.P.M. Look into the number of commutator bars with which the machine is equipped. Get a machine with as great a number of these as possible; 38 would be most desirable.

The cost of equipment for the complete set is approximately \$75 including the tubes.

## The Telephone and Microphone

(Continued from page 1791)

the pressure is removed, proves that a blow, press, or upheaval of the lower part takes place; that this takes place there cannot be any doubt, as the surface, considered

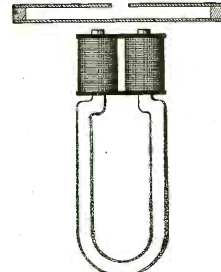

Fig. 13. A Receiver of the Magnetic Type Employing a Resonating Chamber in Conjunction with the Diaphragm.

alone (having no depth), could not bodily quit its mass, in fact there must have been a movement to a certain depth, and I am inclined to believe, from numerous experiments that the whole block increases and diminishes in size at all points, in the center as well as on the surface, exactly in accordance with the form of the sonorous wave. Confining our attention however to points on A and B, how can this change in molecular size or form produce a change in the electrical waves? This may happen in

WANTED—Back numbers of Radio News, Sept., Oct., Nov. and Dec., 1921, Jan. and Feb., 1922. Experimenter Publishing Co., 53 Park Place, New York City.

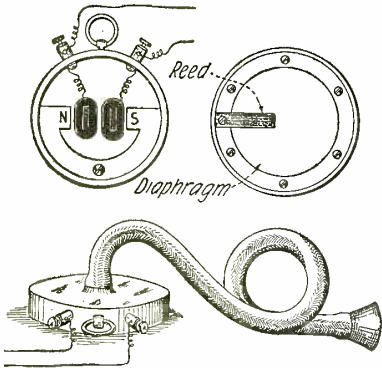

Fig. 14. The Gower Receiver. The First of the Watch Case Type. This Used a Magnet That Would Lift 11 Lbs.

two ways: First, by increased pressure on the upper surface, due to its enlargement or, second, the molecules themselves, finding a certain resistance opposite to their upper movement, spread themselves making innumerable fresh points of contact. Thus an undulatory current would appear to be produced by the infinite changes in the number of fresh contacts. I am inclined to believe that both actions occur, but the latter seems to me the true explanation, for if the first were alone true, we should have a far greater effect from metal powder, carbon, or some elastic conductor such as metalized silk, than from gold or other hard unoxidized matter. But as the best

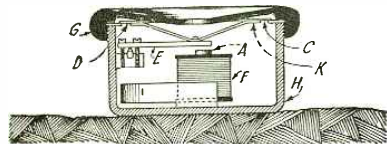

Fig. 15. S. G. Brown's Receiver Used Extensively Today in England. The Diaphragm is Made of Aluminum.

results, as regards the human voice were obtained from two surfaces of solid gold, I am inclined to view with more favor the idea, that an infinite variety of fresh contacts, brought into play by the molecular pressure, afford the true explanation. I have been very much impressed by the great mechanical force exerted by this uprising of the molecules under sonorous vibrations. With vibrations from a music box two feet in length, I found that one ounce of lead was not sufficient on a surface of contact of 0.4" square to maintain constant contact, and it was only by removing the box to a distance of several feet that I was enabled to preserve a continuity of contact with a moderate pressure. I have spoken to 40 microphones at once and they all seemed to respond with equal force. I have examined all portions of my room, wood, stone, metal, even india rubber. All

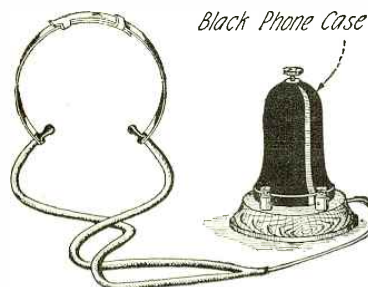
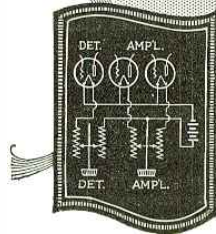

Fig. 16. The Grant Receiver Produced a Number of Years Ago for Radio Work. The Pole Pieces Are Adjustable.

# A Big Stride forward

## The Autostat

### A Super Rheostat



Can be used with 6-Volt or WD11 Detector Tubes, two Amplifying Bulbs, or one 5-Watt Power Tube.

THE AUTOSTAT presents an entirely new principle in filament rheostat construction and radio takes another BIG step forward.

No longer is it necessary to turn a "hair's breadth" to tune in that elusive station, for with the AUTOSTAT you can give the knob a substantial turn and get a superfine adjustment. No other rheostat to date possesses the necessary "fineness" of adjustment to eliminate interference and "tube howls" under all conditions. But the AUTOSTAT, with its micrometer adjustment, will positively give these much-sought-for results.

#### How It Works

Two parallel mounted resistance tubes are connected in series by a "micrometer-operated" slider—the length of wire in circuit depending upon the location of this movable slider. Forty turns of the AUTOSTAT knob are required to complete the variation from minimum to maximum resistance—against one-half to three turns on others.

This exclusive patented construction means:

1. One full turn of AUTOSTAT knob produces finer tuning than a "hair's breadth" turn on any other.
2. Economical—only two AUTOSTATS required for a three-bulb set.
3. Greatly increased receiving range and clearness of signals.
4. A uniform change in resistance with each turn of the AUTOSTAT knob.
5. Indestructible wire-wound fireproof lava resistance element.
6. Unqualifiedly guaranteed.

Popularly priced, **\$1.35**

#### Dealers

The AUTOSTAT will be nationally advertised. And all HOMCHARGER dealers and jobbers know that when we say "advertising" we will dominate the field and convert their stocks of AUTOSTATS into cash QUICKLY and PROFITABLY.

AUTOSTATS come in neat individual boxes, which, in turn, are packed in "business-getting" display cartons—with plenty of live dealer helps, and discounts that net real profits.

Order a carton of AUTOSTATS from your HOMCHARGER jobber TODAY—be the first in your locality to "cash in" on what is destined to be radio's fastest-selling filament rheostat. If he can't supply you, write us direct.

#### Jobbers

Write or wire for radio's most attractive merchandising proposition.

**THE AUTOMATIC ELECTRICAL DEVICES CO.**

118 W. Third St., Cincinnati, Ohio.

Builders of Precision Rheostats Since 1914





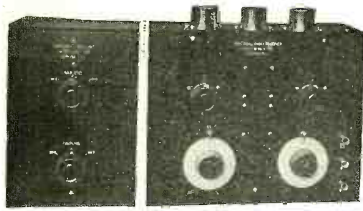

## If You Have Never Tuned a Radio Receiving Set By Variable Condensers

You cannot realize the wonderful results possible which this type of tuning affords you in the Universal Radio Receiver and Coil Unit.

By this method of tuning the following desirable features are attained:

- First: The wave length range possible is approximately four times that attained with variometer tuning.
- Second: The signal strength is exceptionally stronger.
- Third: Interference from other stations is very much less.
- Fourth: By means of the vernier condenser used to tune the Secondary Circuit, extremely sharp signals are possible.

Several other important features incorporated in this set are:

1. Permanent negative potential is automatically applied to the grid of each amplifier tube whenever they are in operation thus preventing distorted signals.
2. The coupled circuit is used for signals received on waves from 180 to 2400 meters, however, the maximum wave length possible is 6200 meters with an average antenna.

General Radio parts are used in the construction of the Universal Radio Receiver and Coil Unit.

A demonstration of our set will prove conclusively that it is an ideal Radio Receiver for the most discriminating buyer. If your dealer cannot supply you, kindly write us.

Price F.O.B. Factory

Universal Radio Receiver \$90.00      Universal Coil Unit \$10.00

### HAYES & NEWTON

Machinists and Manufacturers of  
Scientific Instruments and Testing Machines

115 North Market Street,      URBANA, ILLINOIS

## Tune in on All of Them with a TREGO!



1000  
to 2000  
Mile Range

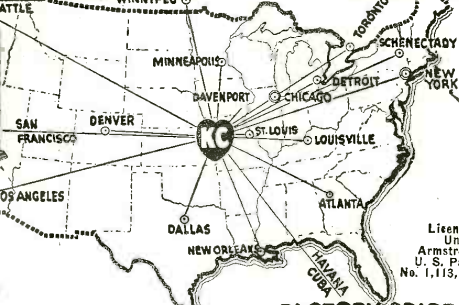

Here is the TREGO Long Distance Receiver. Map shows stations actually being received daily. 1,000 to 2,000 mile range guaranteed. Polished Walnut Cabinet—Bakelite Panel—Standard parts built in complete. Operates on single W. D. 11 Tube and ordinary dry cells. Sold under rigid factory guarantee.

#### READ WHAT TREGO USERS HAVE TO SAY

"Listened in on Havana, Cuba," S. T. DeForest, Woodhall, Ill.  
"Heard New York, Chicago, Cleveland and Dallas," J. W. Lang, Omega, Ga.  
"Heard Havana, Cuba, clearly," Dr. J. K. Hill, Bonner Springs, Kansas.  
"Got St. Louis, Chicago, Louisville, Davenport, Atlanta, Pittsburgh, Schenectady and New York," A. G. Williams, Eldorado, Kansas.  
"Heard Regina, Sask, Canada, and Los Angeles," A. C. Johnson, Dalhart, Texas.  
A. portcard will verify any of above statements.

Express Prepaid We will prepay express charges any place in U. S. if remittance accompanies order. Ask for price list on complete instruments or parts.

TREGO RADIO MANUFACTURING CO., Dept. N, Kansas City, Mo.

FACTORY PRICE  
**\$33.75**  
Regular 45 VALUE

Jobbers and Dealers  
Write for Special Prices



### Radio Headsets

3000 OHMS SUPERSENSITIVE

Guaranteed One Year

Price, \$3.98

Plus 20c postage—Total, \$4.18  
Dealers wire for sample

Ernest Electric Co.  
4847 Easton Ave., St. Louis, Mo.

Variable Grid Leaks	.....	\$ .45 each
Tubular Grid Leaks (all resistance)	.....	.50 each
Tubular Grid Leaks mounting	.....	.35 each
Single V. T. Sockets Type S-10	.....	.90 each
Triple V. T. Sockets Type S-4	.....	2.70 each
Bakelite WD-11 Sockets	.....	.50 each

### RADIO SERVICE & MFG. CO.

(Established 1918)

Factory—Lynbrook, L. I.

We carry a Complete Line of Radio Apparatus

(Spongy) silver mirror

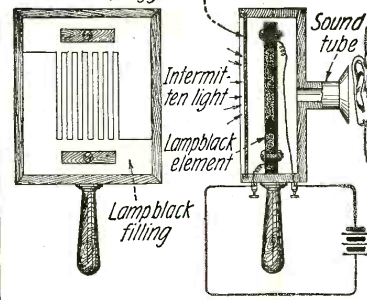

Figs. 17-18. Bell's Photophone. It Can Speak, Sing, See, Hear and Feel Electricity and Magnetism Aside from a Few Other Choice Accomplishments.

were in molecular movement whenever I spoke. As yet I have found no insulation for the vibrations. The question of insulation becomes now important. If we can insulate the instrument so as to direct its power on any single object, such as on a moving fly, it will be possible to investigate that object undisturbed by the pandemonium of sound revealed by the microphone where formerly we thought complete silence prevailed.

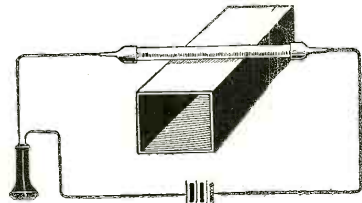

Fig. 19. One of Hughes' Microphones. The Glass Tube is Filled with Bronze Powder. Its Action is Similar to That of the Carbon Grain Type of Microphone.

"I have recently made the following curious observation: A microphone on a resonating board is placed in a battery circuit, together with two telephones (receivers) and when one of these is placed on the resonating board a continuous sound will emanate from the other; the sound is started by the vibration which is imparted to the board when the telephone is placed on it, and the impulse in passing through the microphone sets both telephone discs in motion, and the instrument on the board, reacting through the microphone causes a continuous sound to be produced, which is permanent so long as the independent current of electricity is maintained through the microphonic relays. It follows that the question of providing a relay for the human voice in telephony is thus solved. "The transmission of sound through the microphone is perfectly duplex,—for if two correspondents use microphones for transmitters, and telephones as receivers, each can hear the other, but his own speech is inaudible, and if each sings a different note, no chord is heard. Experiments on the deaf have proven that they can be made to

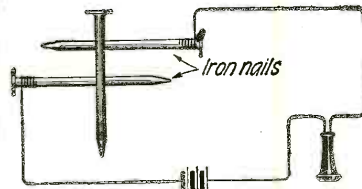

Fig. 20. The Hughe's Nail Microphone Its Function Resting on Imperfect Contact.

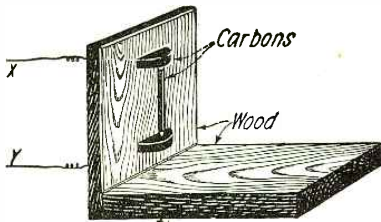

Fig. 21. One Form of Loose Contact Carbon Microphone Which Employs a Local Battery Circuit.

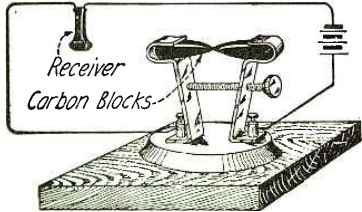

Fig. 22. Another Form of Carbon Microphone Provided with an Adjusting Screw.

hear the tick of a watch, but not as yet the human speech distinctly, and my results in this direction point out conclusively that we only hear ourselves speak through the bones and not through the ears.

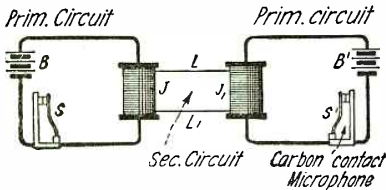

Fig. 23. A System Patented by Berliner in 1877 Using Carbon Contact Microphones, Batteries and Induction Coils, Similar to Systems in Use Today.

### The White Radio Bill (Continued from page 1792)

mendations of the American Radio Relay League to have amendments incorporated in the bill met with favor. *Not a single amendment went over.* The bill as it stands now, H. R. 13773, is practically the same as it was before, with the exception that the amateurs have been allotted more freedom, as far as wave-length is concerned, which in the new bill represents the use of 150 meters to 275 meters.

There is, however, nothing gained in this either, because in the Radio Act of 1912 we could send anywhere from one meter up to 200 meters, whereas at the present time we are restricted within a narrow band of 150 meters to 275 meters. We lost more than we gained.

At the present time this, perhaps, is a good thing, but who will say that 10 or 15 or 25 years hence we would not be glad to have our wave-length back below 150 meters? For there is no question that a wonderful future lies in the very low wave-lengths.

All in all, the amateur, however, has no cause for complaint, and we personally are glad that the bill went over as it did.

The bill finally passed the House of Representatives on January 31, but this does not make it a law. Indeed, it is doubtful whether the new bill will be enacted, or will be placed upon the statute books this year. This was written before March 4. If the bill has not been reached for definite action by the Senate before that date it is doubtful that we shall have a new radio law this year.

We will publish in our next issue the complete text of the bill H. R. 13773.

# GIBLIN RADIO APPARATUS

Every product manufactured by us is the result of the inventive genius of Thomas P. Giblin. For years this master inventor has concentrated on the development of wireless telegraphy and telephony. The three leaders illustrated here are perfect in design and construction, and their performance is guaranteed.

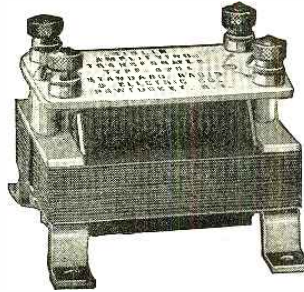

### Audio-frequency Amplifying Transformer

This transformer has won the approval of radio enthusiasts from coast to coast. It is designed for use with standard amplifying tubes, and gives maximum amplification without noise or distortion. May be placed in any position without pre-magnetic coupling and squealing. Price mounted, \$4.50; unmounted, \$3.50.

### The "RADIOEAR" Vacuum Tube Receiving Set

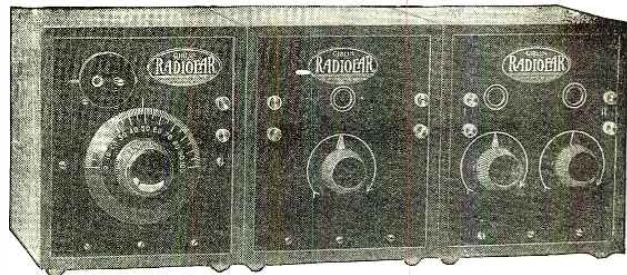

This set includes the new Giblin receiver, detector and two-stage amplifier. The single-control tuner is easily and quickly tuned with full efficiency on any wave length. Local and distant stations can be heard with perfect clearness. The amplifier secures maximum volume without distortion. For the average radio enthusiast, this set will do all that could possibly be desired. Price, \$50.00.

### Radio-frequency Amplifying Transformer

Features: Simplicity of operation; elimination of static and interference; loop reception of signals made possible regardless of the distance of transmitting station; maximum amplification; maximum resistance without the use of iron; maximum coupling between primary and secondary winding; minimum of distributed capacity. Price, \$7.00.



Buy Giblin Radio products from your dealer.

Radio Department  
**STANDARD RADIO & ELECTRIC CO.**  
PAWTUCKET, RHODE ISLAND



# Here's the Radiolean Jr.

Everybody wants this popular price Radio Set

Looks like a Detector Tube Set and can be changed into one at small cost. The Biggest Value ever offered by any Radio manufacturer.

This wonderful crystal receiving set is being sold for \$12.50 retail price which includes all equipment except phones. Head phones from \$3.00 upward. Get our prices on any radio goods you need and compare same with other dealers.

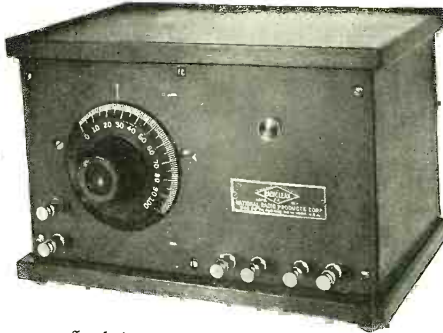

The "Radiolean Jr."

PRICE \$12.50 without Headset

\$15.00 with Headset

### SPECIAL OFFER

- WESTERN ELECTRIC HEAD-SETS (Army type)..... 7.50
- U. S. NAVY TUBES (Amplifying, Detector and Transmitting).... \$4.25
- PORCELAIN RHEOSTATS Each..... 35c

Order the Radiolean Jr. at any Radio Dealer, Department Store, etc., or Direct from

## NATIONAL RADIO PRODUCTS CORP.

509 Fifth Avenue New York

**RADIO "A" & "B" STORAGE BATTERIES CHARGED, AT HOME, FOR FEW CENTS, WITH "PATENTED FULL WAVE" 100-130 Volt, 60 Cycle A.C. AUTOMATIC MAGNETIC TAPER CHARGING**

## F-F RADIO RECTIFIER

Eventually You Will Buy An F-F RECTIFIER Why Not Now? The Sooner You Buy It The More You Save.

IT CHARGES AN 6 Volt RADIO "A" & AUTO Batteries; & All RADIO "B" & LOUDSPEAKER Storage Batteries Up To 120 Volts In Series Inductively At Home Overnight. Disconnecting & Multiple Connections Unnecessary. Charging Circuits Separate. Nothing Like It Made. No Chance For Grounds Or Short Circuits. No Skill Required. AMMETER Eliminates Guess Work. It Costs You Less To Buy An F-F RECTIFIER than To Be Without One. You PAY for ONE Whether You Buy One Or Not, for it Costs An Average Of \$2. for Charging & Rentals Every Time An Auto Battery Is Charged By Others, but Only A Few Cents When You Charge Your Own From A Lamp Socke With An F-F Battery Boosting RECTIFIER. If You Have Never Known The Delightful Feeling Of Having Your Storage Batteries Always Fully Charged for RADIO & AUTO You Will Experience A New Thrill When You Have An F. F. RECTIFIER Which Gives You A Fully Charged Battery Overnight At A Cost of A Few Cents & A Pleasant Feeling Of Things Well Done. Those Who Own Them Feel Their F-F RECTIFIER is Their Faithful Friend. It Charges Automatically & Being Clean Can Be Placed Anywhere. Nothing To Stop Over Be Filled Burn Out Need Attention Or Cause Trouble. Both Waves Are Rectified Thru Infusible Carbon Rectifying Brushes, Maintaining Constant Efficiency Uninterruptedly. While Its FULL WAVE Delivers RAPID TAPER CHARGE Recommended By All Storage Battery Manufacturers. The F-F RECTIFIER is A Complete Compact Portably Handy Charging Unit. Delivers Service Day & Night Automatically & Will Charge Dead Battery. Do Not Think Battery Dead & Worn Out Simply Because It Will Not Start Your Car. Buy An F-F RADIO RECTIFIER & Fill It With LIFE. It SAVES MORE than Its Cost & Lasts Lifetime. Leave Your Battery In Car, Or Where Ever It Is, Without Even Disconnecting It. Screw RECTIFIER Plug In Lamp Socket. Snap RECTIFIER Clips On Battery Terminals; Turn Switch & Battery Will Be Charged In Morning At Cost Of Few Cents. Is It Not Gratifying To Be Ready For All RADIOPHONE BROADCAST Music Sermons & News When Friends Call? Never Having To Be Careful Of, or Tell Friends Your Batteries Are Dead & to Feel Your Car Respond Like A Greyhound, Spinning Engine With Power When You Throw In STARTER? Fully Charged Battery Starts Car Quick & Requires Fewer Expensive Replacements. INSIST ON THE F-F RECTIFIER. Built By A Master Of The Art in 7 Types. So Many Thousands Are Being Sold It Has Made Possible These POPULAR PRICES

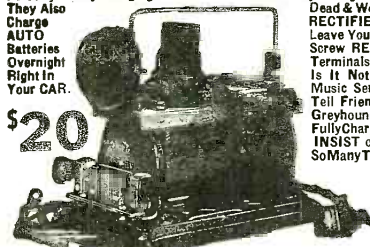

\$20

Patented Combination.

CHARGES "A" & "B" RADIO & AUTO BATTERIES. The Lower 3 are Large TYPES Built For Heavy Batteries, or Where Time Is Limited. SHIPPING WEIGHTS Complete With AMMETER & BATTERY CLIPS 11 to 15 Lbs. Purchase From Your DEALER Or Mail Check For Prompt Express Shipment. If Via PARCEL POST have Remittance Include Postage & Insurance Charges or WRITE Us To Ship TYPE Desired at Home. Other F-F Battery Boosters Charge Batteries From Farm Lighting Plants & C. D. Circuits & for GROUP CHARGING Economy Use Our 8 Ampere 12 Battery Capacity Automatic Full Wave F-F ROTARY RECTIFIER described in ROTARY BULLETIN 32A. ORDER Now, or WRITE Immediately for FREE Descriptive RADIO & AUTO BOOSTER & ROTARY BULLETINS 32A & 32

**FRANCE MFG. CO.** General OFFICES & WORKS: CLEVELAND, OHIO, U. S. A. Canadian Distributor: The Jack V. Elliot Co., Hamilton, Ontario, Canada

- TYPE 6 Charges 6 Volt Radio "A" & Auto Batteries At 5 Amperes..... \$5
- TYPE 12 Charges All 12 Volt Batteries At 5 Amperes..... \$15
- TYPE B Charges All Radio "B" Storage Batteries Up To 120 Volts..... \$15
- Type A-B is a Combination of TYPES 6 & B..... \$20
- TYPE 16S Charges All 6 Volt Batteries At 12 Amperes..... \$20
- TYPE 1612 Charges All 12 Volt Batteries At 7 Amperes..... \$20
- TYPE 1626 Is A Combination Of TYPES 16S & 1612..... \$28
- ALL TYPES BUT "B" ALSO CHARGE AUTO BATTERIES. Where Time Is Limited. SHIPPING WEIGHTS Complete With AMMETER & BATTERY CLIPS 11 to 15 Lbs. Purchase From Your DEALER Or Mail Check For Prompt Express Shipment. If Via PARCEL POST have Remittance Include Postage & Insurance Charges or WRITE Us To Ship TYPE Desired at Home. Other F-F Battery Boosters Charge Batteries From Farm Lighting Plants & C. D. Circuits & for GROUP CHARGING Economy Use Our 8 Ampere 12 Battery Capacity Automatic Full Wave F-F ROTARY RECTIFIER described in ROTARY BULLETIN 32A. ORDER Now, or WRITE Immediately for FREE Descriptive RADIO & AUTO BOOSTER & ROTARY BULLETINS 32A & 32

## Radio Digest

(Continued from page 1809)

Radio Section, and two Class A stations were transferred to the B Class, on the 400-meter wave.

### LIST OF NEW BROADCASTING STATIONS

- WRAV—Antioch College, Yellow Spring, Ohio—200 watts.
- WQAO—Calvary Baptist Church, New York, N. Y.—100 watts.
- WPAZ—Koch, Dr. John R., Charleston, W. Va.—20 watts.
- KFCV—Mahaffey, Jr., Fred, Houston, Texas—50 watts.
- WRAJ—Pickering Co., M. H., Pittsburgh, Pa.—500 watts.
- WQAR—Press Publishing Co., Muncie, Indiana—10 watts.
- WSAA—Sprague, B. S. Elect. Co., Marietta, Ohio—25 watts.

### TRANSFERRED FROM CLASS A TO CLASS B STATIONS ON 400 METERS

- KFI—Anthony, Earle C., Inc., Los Angeles, Calif.—500 watts.
- KPO—Hale Bros., Inc., San Francisco, Calif.—500 watts.

### BROADCASTERS WHICH HAVE STOPPED

The thirty-four broadcasters which have not renewed licenses, and consequently were deleted from the records of the Commerce Department during January follow:

### BROADCASTING STATIONS DELETED

- WLAO—Anthracite Radio Shop, Scranton, Pa.
- KZY—Atlantic-Pacific Radio Supply Co., San Francisco, Calif.
- WNAJ—Benson Co., Chicago, Ill.
- KFBN—Borch Radio Corp., Oakland, Calif.
- WOE—Buckeye Radio Service Co., Akron, Ohio.
- KDYO—Carlson & Simpson, San Diego, Calif.
- WPE—Central Radio Co., Inc., Kansas City, Mo. (Relicensed at Independence, Mo., Jan. 5th).
- KFBM—Cook & Foster, Astoria, Oregon.
- WSX—Erie Radio Co., Erie, Pa.
- KDZW—Gerdes, Claude W., San Francisco, Calif.
- KFAC—Glendale Daily Press, Glendale, Calif.
- WDAQ—Hartman-Riker Electric & Machine Co., Brownsville, Pa.
- WKAZ—Landau's Music & Jewelry Co., Wilkes Barre, Pa.
- WKAD—Looff, Charles, East Providence, R. I.
- WBAJ—Marshall-Gerkin Co., Toledo, Ohio.
- KVQ—McClatchy, James, Sacramento, Calif.
- WDVA—Muskogee Daily Phoenix, Muskogee, Okla.
- KDZP—Newberry Elec. Corp., Los Angeles, Calif.
- KFC—Northern Radio & Elec. Co., Seattle, Wash.
- WBAB—Potter, Andrew J., Syracuse, N. Y.
- WAAX—Radio Service Corp., Crafton, Pa.
- KYY—Radio Telephone Shop, San Francisco, Calif.
- WNAG—Rathert Radio & Elect. Co., Cresco, Iowa.
- WGAS—Ray-Di-Co. Organization, Chicago, Ill.

## R.T.S. Equipment Cord Tip Jack

This R.T.S. Cord Tip Jack leads the way in quality, service and price. Constructed of spring phosphor bronze, highly nickelled. Wiping spring contact insures clean, positive contact at all times. Where others sell from \$1.00 to \$2.50, this R.T.S. Cord Tip Jack retails at..... one paid sale jobbers and Dealers; Send today for new wholesale catalog with scale of prices and discounts to the trade.



RADIO TESTING STATION Dept. R-4 25 Sturgis St. Binghamton, New York

WHY not spend Spring, Summer and Fall gathering butterflies, insects? I buy hundreds of kinds for collections. Some worth \$1 to \$7 each. Simple outdoor work with my instructions, pictures, price list. Get posted now. Send 10 cents (NOT STAMPS) for my Illustrated Prospectus. Mr. Sinclair, Dealer in Insects, Dept. 33, Ocean Park, Calif.



## ELECTRICAL Training Book FREE

Send me your name and address and I will send you my big new Electrical Training Book Free. It will show you how to qualify for high paying jobs in Electricity. Thousands now open. Prepare at home—quickly—during spare time under an Electrical Engineer. Take advantage of this unusual offer—only temporary. A. W. WICKS, President WICKS ELECTRICAL INSTITUTE Dept. 1077 3602 Michigan Ave. CHICAGO

## TELEGRAPHY

(Morse and Wireless) and RAILWAY ACCOUNTING taught thoroughly by salesmen's great opportunity. Oldest, largest school. Endorsed by Telegraph, Railway, Radio, and Government officials. Opportunities to earn high wages. Catalog free. WICKS' INSTITUTE, 3602 Michigan Ave., Chicago, Ill.

GREEN SEAL AIR-WAY RADIO Equipment appeals to the discriminating user for its genuine quality at fair prices. Write for Free Air-Way Bulletin of Complete Sets and Standard Parts. Attractive dealer proposition. Air-Way Electric Appliance Corporation, Toledo, Ohio.

WFO—Rike Kumler Co., The, Dayton, Ohio.  
 WPJ—St. Josephs College, Philadelphia, Pa.  
 KFBQ—Savage Elect. Co., Prescott, Arizona.  
 WHW—Seeley, Stuart W., East Lansing, Mich.  
 WSN—Ship Owners Radio Service, Inc., Norfolk, Va.  
 KJC—Standard Radio Co., Los Angeles, Calif.  
 WACQ—Tri-State Radio Mfg. & Supply Co., Defiance, Ohio.  
 WJAL—Victor Radio Corp., Portland, Me.  
 WNAH—Wilkes Barre Radio Repair Shop, Wilkes Barre, Pa.  
 WJAU—Yankton College, Yankton, S. D.

**NEW BROADCASTERS**

One new Class B broadcaster and six Class A stations were licensed during the week ending January 27.  
 The Commercial Publishing Co., (Commercial-Appeal), Memphis, Tenn., was licensed as a Class B station on 400 meters, with 500 watts.  
 The following class A stations were licensed on 360 meters:  
 KFCP—Ralph W. Flygare, Ogden, Utah, 25 watts.  
 WPAV—Bangor Radio Laboratory, Bangor, Me., 20 watts.  
 WQAJ—Ann Arbor Times-News, Ann Arbor, Mich., 100 watts.  
 WQAM—Electrical Equipment Co., Miami, Fla., 250 watts.  
 WRAC—State Normal School, Mayville, N. D., 50 watts.  
 WRAD—Taylor Radio Shop, Marion, Kan., 10 watts.

**FIRST AMERICAN AIRCRAFT LICENSES ISSUED**

Radio as a safety measure for the protection of pilots and passengers has come into its own in air travel as well as on the sea, where its value was first realized. Seven airplanes and flying boats now are equipped with radio and answer to regular calls.  
 The first American aircraft, other than those of the Army and Navy, which are all radio-equipped but not licensed, to be licensed as a limited commercial station was one belonging to the Airline Transportation Company of California. The Aeromarine Company followed with the "Buckeye" in December and licensed five more recently. Radio-equipment, officials believe, will make for greater safety in over-sea travel and insure aid when air boats are forced down.

**AIRCRAFT LICENSED AS LIMITED COMMERCIAL STATIONS ON 525 METERS**

KFBI—Airline Arrow, No. 1, Airline Transportation Co., Los Angeles, Calif. Aug., 1922.  
 KFBY—Balboa, Aeromarine Airways, Inc., New York City. Jan. 18, 1923.  
 KFBA—Buckeye, Aeromarine Airways, Inc., New York. Dec. 22, 1922.  
 KFBF—Gov. Cordeaux, Aeromarine Airways, Inc., New York City. Jan. 18, 1923.  
 KFBJ—Nina, Aeromarine Airways, Inc., New York City. Jan. 18, 1923.  
 KFBM—Ponce de Leon, Aeromarine Airways, Inc., New York City. Jan. 18, 1923.  
 KFBZ—Santa Maria, Aeromarine Airways, Inc., New York City. Jan. 18, 1923.

**TEN NAVAL RADIO STATIONS CLOSED**

Secretary of the Navy Denby has directed that four Naval radio stations be sold, four others abandoned, and two radio compass stations be closed and dismantled. In carrying out the recent recommendations of the Rodman Board in the interests of increasing fleet efficiency, particularly in

**Announcing the NEW**



**SENIOR**

**THE COMPLETE LOUD SPEAKER STANDS 32 INCHES HIGH 14 INCH BELL**



Price \$25.00 complete with 6 ft. cord

A marvel of construction—beautiful crystalline enamel finish—NON-METALLIC HORN. A perfect TRUE-TONE REPRODUCER.

This horn contains a built-in loud speaker of a newly improved type which brings this loud speaker to a perfection without parallel in the radio field. For long distance work use the TRUE-TONE SR. with two stages and be satisfied.

*The Tone Quality Is True*

**SADLER MANUFACTURING CO.**

86 FOURTH STREET

SAN FRANCISCO, CALIF.

**Do You Want a Real Headset?**

**The Dictograph is the Best Headset in the World at Any Price**

This is the same supreme Dictograph Headset that has always sold for \$12—same in quality, same in guarantee, same in everything but the price—\$8 complete. Made by the makers of the world standard Dictograph Products—the marvelous "Acousticon" for the Deaf, the famous Detective Dictograph, the Dictograph System of Interior Telephones and the Dictograph Radio Loud Speaker for the Home.

**Read a few of the many letters we have received from Dictograph Headset users. You, too, can enjoy the utmost in Headsets if you own one.**

U. S. Marine Hosp. No. 43  
 Ellis Island, N. Y.

"The undersigned has for the past sixteen years been an amateur, commercial, and government operator, and has used every known make of radio receiver on the market. On April 21st. one of your Type R-1 3000 ohm receivers was purchased and it can be safely said without dispute that they are absolutely the best radio receivers on the market today; bar none."

C. H. West, U. S. P. H. S.

LAPORTE, IND.

"I wish to compliment you on the 3000 ohm Headset you now have on the market retailing at \$12.00 (now \$8.00). I have been experimenting with the radio game for the past year. In my experience I have tried out 14 different headsets, including the... which I purchased for \$16.50. I at last have found the ideal phone where tone quality excels, and harshness is eliminated, and I cannot express myself in words as to the wonderful results I have obtained."

J. T. Bachman.

Go to your dealers today and listen in with this supreme instrument. Note the difference. Buy two or three Dictograph Headsets and let the rest of the family enjoy your set. Always insist on Dictograph Products. They are fully guaranteed.

Dealers:—The Dictograph is the fastest selling Headset on the market today. Order through your jobber or write direct for names of authorized distributors.

**DICTOGRAPH PRODUCTS CORPORATION**  
 220 West 42nd Street New York City  
 Branches in All Principal Cities



**The Standard of the World**

Type R-1, 3000 ohms. For all types of crystal and vacuum tube receiving sets



**THIS IS THE SWITCH**  
 that does the trick  
 Turn it 'till you hear it click

FOUR WAY COMPANY. SPRINGFIELD, MASS. U.S.A.

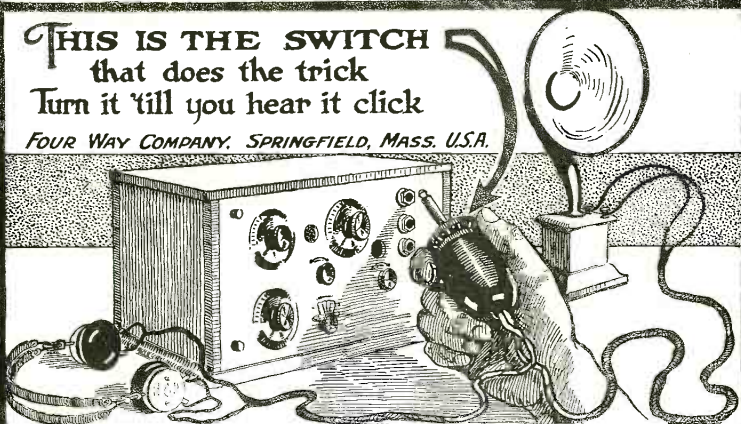

TURN 1: Head Set  
 TURN 2: Loud Speaker  
 TURN 3: Both in Series  
 TURN 4: Both in Parallel

**The latest and greatest improvement in Radio!**

A switch plug which makes it possible to tune in through head set and switch in loud speaker by turning dial. Two head sets can be readily attached, or one head set and loud speaker. Both can be used at the same time or either one alone.

**\$1.50**

**FOUR WAY COMPANY**  
 Dept. G, SPRINGFIELD, MASS.

communication, the Secretary is disposing of unnecessary radio stations.

The station at Cape May, N. J., will be closed and abandoned by Naval personnel at once, its work hereafter being handled by the station at Cape Henlopen. At Seattle, another station will be abandoned as soon as the Navy Yard at Puget Sound can take over the traffic. Grande Isle in Louisiana has been ordered closed and abandoned, as has also the station at Navassa Island in the West Indies.

Radio stations at Baltimore, Md.; Mobile, Ala.; Miami, Fla., and Port Arthur, Texas, will be offered for sale as soon as invitations for bids can be drawn up. It is also planned to dispose of the station at Managua, Nicaragua when commercial facilities are provided at that place.

The War Department has been asked if it desires to take over any of the 10 Naval radio stations on the Great Lakes, but it is not likely that the Signal Corps will accept any except those at Buffalo and Cleveland. Such stations as the Army does not take over will remain closed, as the Navy does not need them and cannot afford to continue their operation. Three compass stations on the Lakes, however, will probably be opened in the spring as aids to navigation.

Radio compass stations at Pass a Loutre, La., and St. Petersburg, Fla., will be dismantled and the land vacated by the Navy. Several other stations are being held subject to abandonment as soon as the handling of existing traffic is arranged.

In closing the stations, the Navy Department does not desire to interrupt traffic in radio, but, on the other hand, as commercial traffic was only handled when other facilities were lacking, officers are of the opinion that commercial interests may now be induced to open general traffic stations at points previously covered by the Navy. The prime purpose of Naval shore radio stations is to aid the fleet, and when a station ceases to benefit the fleet, it becomes a liability to the Government instead of an asset.

**FRISCO MAYOR TUNES IN PURSE FOR \$3,000.**

Recently, Mayor Ralph, of San Francisco, officiated at the opening of a new radiophone station.

"I want to know how far my voice carries," he broadcast in a speech. "Wire me collect, you fellows in Seattle and Chicago and, you in the Middle West, if you hear me."

It was a perfect night and they all seemed to hear him.

"That idea cost me about three thousand dollars," the Mayor lamented.

**BOOTLEG BROADCASTING**

Recently in one of the large cities, a famous man delivered an address on an important subject before a large and distinguished audience. Permission to broadcast this speech by means of microphones within the auditorium was sought by the local stations, but was refused for reasons that seemed sufficient. Nevertheless, the speech was broadcast!

Just how this was done still remains a mystery. However, the story goes that just before the speaker began, a truck containing a complete transmitting outfit drove up beside the theater building and connected its transmitter with a wire that ran to a concealed microphone inside and that "happened" to be dangling out of one of the windows.

If this did occur, it was an illegal proceeding. Unlicensed broadcasting is strictly prohibited, under penalty of confiscation of the apparatus employed and a heavy fine. There are, however, great possibilities in the method. Imagine the shock that would be experienced by a band of anarchists,

**The TIMMONS' TALKER**

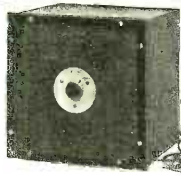

**"WHY NOT?"**  
 Complete Your Set!

NO matter if you are a "brand new" beginner or a real "old-timer" your radio set isn't complete without a good loud speaker.

JUST one night's tryout of a TIMMONS' TALKER will be enough to convince you. Attach it to your set and be able to entertain your family and friends "the unselfish way."

THE TIMMONS' TALKER is not a headphone with a horn attachment needing all sorts of extras, but is a self-contained instrument ready for use just as shown.

IT has a wide amplification, needs no extra batteries and is built in a handsome mahogany cabinet which will improve the looks of any set. You'll always be proud of your TIMMONS' TALKER. If your dealer does not sell them write for interesting information about this instrument to



**J. S. TIMMONS-PHILADELPHIA-PA.**

**DON'T**

Bore Holes in Your Window or Wall. Use an Ajax Window LEAD-IN, inconspicuous and safe. Less than a Minute

to install. 50c Complete—postpaid.

HEARWEL CO.

53 Devonshire St.

Boston, Mass.

**MURDOCK RADIO**

STANDARD APPARATUS SINCE 1904

counterfeiters or kidnapers on receiving word that the public was listening with intense interest to their conference through broadcasting arrangements installed by Ralph, the Radio Detective! From now on every one desiring to indulge in a private conversation should search the room for hidden microphones and suspicious writing. Politicians, diplomats, labor leaders and capitalists should be especially cautious. Security has ceased to exist.

—From "Judge."

**RADIATIONS**

Operators of broadcasting stations are warned by the Radio Section of the Department of Commerce not to communicate with other stations by either telegraphy or telephony as broadcasting licenses do not permit direct communication. Some stations have been guilty of acknowledging letters, telegrams and telephone calls, which, the Department points out, is direct communication. The suspension or revocation of the operator's license is the penalty for infractions of this rule. Owners are also cautioned to observe the rules laid down by law else their station licenses may be endangered.

**Some Suggestions for the Broadcasters**

(Continued from page 1798)

8-10 8-10 7-11 7-10 silent 8-10 8-10

Now here is where the cooperation comes in, for instance, the Eastern Zone will finish at 9 P. M., E. S. T. By strict observance of this time by signing off at exactly 9 P. M. and not a minute later. For the Central Zone will commence broadcasting at exactly 8 P. M., C. S. T., and sign off at exactly 10 P. M., C. S. T. The Mountain and Western Zone will take up the broadcasting at 9 and 8 P. M., M. and P. S. T. respectively.

The program of a broadcasting station, I have found from observation, may be so arranged that it will last through the period allotted to a station and no longer.

By separating the large stations of each zone on different wave-lengths so they will not interfere, the listeners of the Central and Western Zones could enjoy the concerts of the Eastern Zone, the same conditions existing throughout each zone for the listeners of the other two zones. One night a week for each zone would be designated as a silent zone. This would enable listeners in that zone to hear distant stations such as Canadian, Cuban, Mexican, South American and European Stations.

The above plan would encourage newcomers in radio to procure only sensitive receiving sets, which would enable them to get the concerts of other zones and also eliminate the present interference between broadcast listener and the amateur.

This cooperation could be brought about by designation of the transmitting hours of each station by the Department of Commerce and charging the Radio Inspectors of each zone with the duty of seeing that each station comply with its schedule right to the dot. In this manner no organization would have any power or rights over another station as this power would be vested in the Department of Commerce where it should be.

Why not through the columns of your interesting paper, request the readers to submit their ideas and plans on this subject? It might bring to light some interesting ideas and plans which would bring this situation to a head and result in changes beneficial to every last radio bug in the country.

Contributed by W. F. Ludgate,  
Opr. WL of Station KSD.

*Important Announcement*

To protect our customers against inferior imitations, the name of your old friend RADION (panels and parts) now is made safe by the registered trade mark RESISTON. This name stamped on panels or parts means the best in radio insulating materials.

**RESISTON  
RADION  
Panels and Parts**

RESISTON RADION is a superior grade of hard rubber developed exclusively for Radio use.

RESISTON RADION is mechanically better than ordinary panel insulations, because it will not warp under normal conditions; it is easily worked with simple tools, cuts and drills clean without chipping, is easily engraved.

RESISTON RADION has a beautiful satin-like polish comparable to the finest finish ever put on hard woods.

RESISTON RADION excels all other insulations in the four most important characteristics required for Radio use, viz.: (1) low phase angle difference, (2) low dielectric constant, (3) high resistivity and (4) non-absorbent qualities. Tests by disinterested organizations including the N. Y. Electrical Testing Laboratories establish these claims beyond question.

RESISTON RADION costs no more, in most cases LESS, than phenolic, laminated phenolic or other insulation materials usually offered for panels.

RESISTON RADION is made in two colors, black and mahogany. The latter resembles fine old mahogany in appearance.

RESISTON RADION is made in 15 stock sizes of panels, hence it can be used with minimum waste. Each panel packed in envelope to protect beautiful finish. Also made into dials, knobs, sockets, antennae insulators, etc.

RESISTON RADION is economically moulded to any specifications at our factories.

*Inquiries from those interested in the best insulating material are solicited.*

**American Hard Rubber Co.**

11 Mercer Street

New York

*Manufacturers and Moulders of*

**RADION**

*"The Supreme Insulation"*



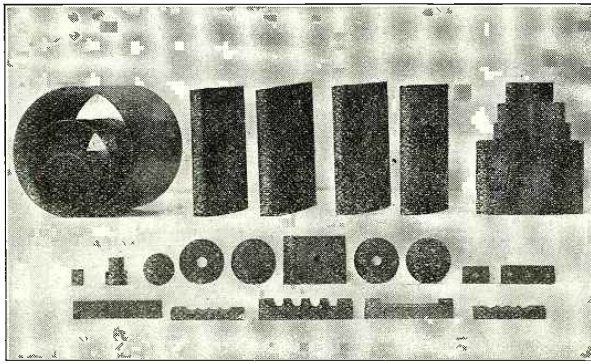

### RADIO INSULATION

Vulcanized fibre is the best insulation that can be secured for your Radio Apparatus because of its high dielectric resistance, mechanical strength and adaptability of being machined accurately into almost any shape. It should be used for panels, coil cases and other insulating parts in your wireless outfit. Write today for samples and full information of

**"THE INCOMPARABLE INSULATION"**

which we manufacture in sheets, rods, tubes and all kinds of special shapes.

**DELAWARE HARD FIBRE CO.** :: :: **Wilmington, Del.**  
 New York.....50 Church Street  
 Pittsburgh.....1st Nat'l Bank Bldg.  
 San Francisco.....235 Pine Street  
 Toledo.....415 Ohio Bldg.  
 Chicago.....564 West Montoe St.  
 New Haven.....209 Plymouth Bldg.  
 Boston.....170 Summer Street  
 Philadelphia.....Fuller Bldg.  
 Rochester.....1040 Granite Bldg.  
 Dayton.....314 Dayton Savings & Trust Bldg.

and two for 'phones. The positions of these may be varied to suit the taste of the constructor.

The circuit for wiring is shown in Fig. 5, and is a standard loosely-coupled crystal circuit. If the constructor finds it possible to add a variable condenser across the secondary, additional tuning accuracy will be found as well as an increase in wave length.

The original tuner is shown in Fig. 6, alongside of a Marconi Type 106 ship tuner. Some idea of the size can be formed

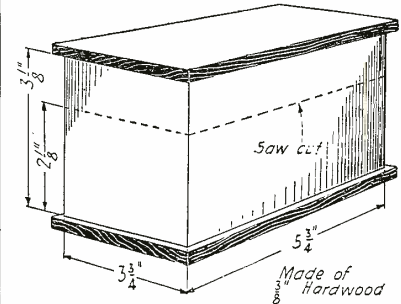

Details of the Cabinet Construction.

### CONDENSERS

**W** 43 Plate with 3" dial..... \$5.00  
 23 Plate with 3" dial..... 4.00  
 3 Plate, with 3" dial..... 3.00

1½" Rotary Switch Lever with 14 contacts, 2 Binding posts, 2 stops..... \$1.00

**Crystal Detector**  
 Price \$1.00

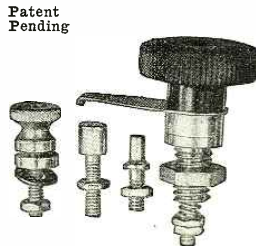

**WESTFIELD MACHINE CO., Westfield, Mass.**

New York Office 50 Church St.

from this comparison, and some of the details can be distinguished in the cut. This tuner, the small one, is being used in the vicinity of New York City, and at a distance of thirty miles from the radiophone broadcasting station, WJZ, at Newark, N. J. The music from this station was picked up on a small bell-wire antenna. The voice and music was very clear, the intensity good for the distance and antenna used. Ships on 600 meters came in fine; WHE could be heard on 1,800 meters, but required an additional loading inductance for that purpose. The general efficiency of this tiny set is very high in comparison to standard commercial and naval crystal receivers, and if each detail is carefully worked out, a fine little receiver will be the result, one well worth the time and money spent.

### Recruiting by Radio

(Continued from page 1080)

present increasing popularity, no one can forecast the vastness of its future, but it is safe to say that in the next few years there will be an opportunity for the trained man in this field of endeavor that will be comparable to the early days of the motor car. The Air Service today presents its strongest appeal to the young man mechanically and electrically inclined, but, who through lack of experience, is unable to fill a position in a commercial shop. One enlistment in the Air Service well spent will fit that man to hold his own in any trade that he may have followed in the service. If you think that you have the qualifications and desire to join the Air Service you should apply to the Recruiting Officer, Army Building, 39 Whitehall Street, New York City, for further information, or better still, come out to Mitchel Field and see an aviation field in actual operation and have the Post Recruiting Officer go into the matter with you in detail. Who knows, but that this may be the very opportunity you are waiting for?"

Thus it was possible for everyone for miles around, and ships far out at sea, to

### KECO-RADIO STORAGE BATTERIES

The highest grade of battery built especially for the wireless instruments.

Solid oak box, natural finish, highly varnished, 6 Volt, 7 heavy "Cristol" Plates per cell, 60 Amp.

We are the largest builders of exclusive wireless batteries in the country. Thousands in use. Sold by all leading dealers or shipped direct, \$15.50 F.O.B.

**KALB ELECTRIC CO.** - - 7323 Manchester Avenue, St. Louis, Mo.

Dealers write for discounts for 1922



### CONDENSERS

VARIABLE, 23 AND 43 PLATE  
 \$3.25 AND \$4.25; DIAL EXTRA

### PHONOGRAPH ADAPTORS

FOR ANY COMBINATION OF  
 RECEIVER AND PHONOGRAPH \$2.00  
 IMMEDIATE SHIPMENT

MANUFACTURER

**STUCKEMAN BROS., Inc.**  
 18 RUTH ST. PITTSBURGH, PA.

Our new receiving sets are out this month. The ideal set for the beginner at an attractive price

### The CONCERTINA \$45.00

We rewind your phones to any ohmage.  
 With No. 40 wire, per phone.....\$1.25  
 With No. 44 wire, per phone..... 1.50

**The Ridgewood Radio Shop**  
 1603 Myrtle Ave., RIDGEWOOD, L. I.

# Here's a Pair of Winners

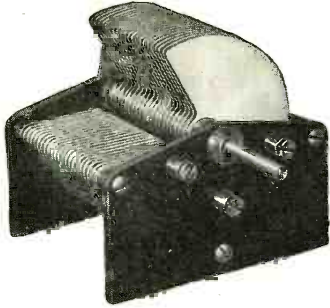

The Wimco Condenser

Made to meet a demand for quality—highest efficiency, 3 plate, 23 plate and 43 plate sizes.



The Carco Coupler

Just the thing for the popular receiving set. Bakelite tube, and rotor, silk covered wire, perfect contacts.

*We invite Dealer and Jobber inquiries.*

Send for literature and prices on Wimco Socket for WD11 tube.

**THE WIRELESS MFG. CO., CANTON, OHIO**  
 MANUFACTURERS                      DISTRIBUTORS

## A Variable Resistance

(Continued from page 1811)

values for the resistance rods are about 100,000 ohms and 6 megohms. The former is suitable for anode and the latter for grid leak. When turning the knob to the right, the wire winds around the carbon rod progressively shorting the resistance and continuously lowering its value. With this variable unit, any change required can be quickly made allowing an increase in the efficiency of the detector tube.

*Contributed by Marius Thouvais.*

## CONNECTING PHONES

One often desires to connect two or more pairs of phones in series for the benefit of visitors who would like to "listen in." It is usually the case that nothing is handy for this purpose. The sketch herewith

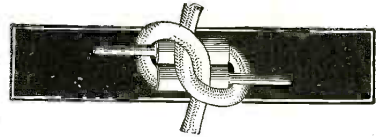

If You Are In a Hurry to Connect Up Two or More Pairs of Phones Do It Like This. It's Simple.

shows a quick as well as a practical method for doing this. The cord tips are held in firm contact by an over hand knot. Care must be taken to make the knot tight, otherwise, stray noises and scratches will be produced. The drawing is self-explanatory.

*Contributed by S. H. Emmes.*

## Just Consider

—the essential features necessary to make an audio frequency transformer a good one—

1. High Amplification.
2. Minimum Distortion.
3. Low Interstage Linkage.
4. Convenient Mounting.
5. Compactness.

Cotoco transformers make these ideal features facts. And the finish will surely please you.

"Built First to Last"  
**\$5.00**  
 At Your Dealer's

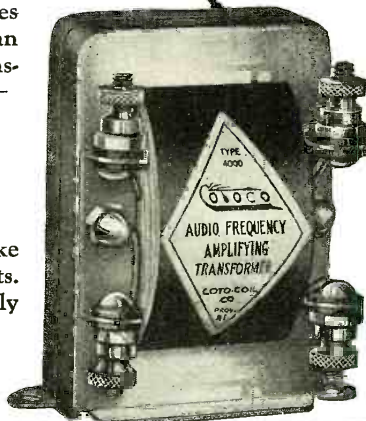

**COTO-COIL CO. PROVIDENCE**

## Overcoming Difficulties In Radio Reception In the Country

(Continued from page 1775)

which current is taken from the 110-volt lighting wires and stepped down to low pressure, interrupted at low frequency and then stepped up to very high potential but low amperage. The resultant current is then intermittently sent over the various phone circuits to ring the bells of the subscriber who is wanted on the phone. It, therefore, follows that there are four separate wires running from the inductances in this telephone buzzer and they all act as aerials from which high frequency waves are discharged. The first step is to persuade the telephone company's engineer to follow your instructions, which is not so difficult in a small country town, and get him to produce four telephone condensers of one M. F. capacity each. Next it is necessary to have on hand three pounds of No. 22 S. C. C. magnet wire and about a foot piece of 3/4" mica composition hollow tube, to be used as a core for the four special choke cores that must be made up.

It is necessary to intercept each of the four wires with choke coils just at the place where they come outside the box that usually encloses the mechanism of the buzzer proper and between the box and the choke coil shunt a ground wire with a condenser in series (make sure that none of the condensers are shorted before you put them in the line.)

Now the chokes for the telephone part of the circuit are not difficult to make as they are to permit the passage of a very low frequency phone current, and may be 200

## The AMERTRAN

super audio frequency amplifying transformer  
 —Audibility amplification, 33.6—  
 without distortion

Perfect tone Price \$7. Maximum volume  
 American Transformer Co., Newark, N. J.

## VULCANIZED

# FIBRE

Be sure and specify

"WILMINGTON FIBRE"

Sheets, Rods, Tubes, Washers, Etc.,  
 Specialties  
 Wilmington Fibre Specialty Co., Wilmington, Del.  
 Branch Offices "Everywhere"



turns or so of magnet wire wound about a piece of mica tubing 3" long. The wire is wound on in several layers, and as a magnetic core, insert some wire finished nails, with heads cut off, of course, until the hollow mica tube is snugly filled.

Now the chokes on the electric supply side of the circuit are quite another matter, and here is the trick: Take the remainder of the mica tubing, which should consist of two pieces 3" long, and rig up some kind of a winding device that will turn this 3" length of tube on mandrel at not too fast a speed. Wind on eight layers of the No. 22 S. C. C. magnet wire, each layer 2 1/2" long and be sure to wrap a piece of empire insulating cloth between each layer so that it extends 3/4" at either end beyond the layer of wire. Empire cloth is a varnished cambric material and if not available, white cambric may be coated with several treatments of clear shellac and cut in strips 3" wide for the same purpose.

In country towns the electric current is usually A. C. 60-cycle, so that the cores of these chokes will have to be made so that they will not impede this frequency, or the buzzer will refuse to function at all. I found that a core with a closed magnetic field made up of a lot of very fine soft iron wire is just right.

Procure about two pounds of what is known, at the hardware store, as stove pipe wire; it is about 1/8" in diameter. Cut this up into pieces about 10" long and run these pieces through the hollow-wound tube until it is well filled, but in doing this see that every other one of the wires protrudes alternately about 1" further from one end of the tube than the other, stagger fashion.

Next, one by one, bend the extending ends of these wires backwards along one side of the coil, which, by the way, should have as its outside layer a liberal wrapping of some insulating material made fast by a layer of light cord shellacked in place.

The ends of the iron core wires should butt up to one another if you have staggered them properly in the tube; these butt ends will occur at different places in the oval loop so that there will be formed a continuous magnetic field with lap segments of its iron core. To hold the wire ends bunched tightly together, simply twist some short piece of the same wire around the bunch of core wires at frequent intervals.

It will be found that if these choke coils have been properly made, they will not interfere with the regular functioning of the buzzer when they are inserted in the input power lines. Of course shunt the power lines between the choke coils and the buzzer with the remaining two condensers to the ground.

The next and final precaution to take is to have a sheet metal box made that will completely enclose buzzer, choke coils and all.

This box is most convenient if made with lid used in the form of a shallow tray into which all the mechanism is fastened, providing proper insulation from the metal for the coils, wires, etc. The box proper is then used as the lid and slipped in place over the buzzer mechanism with its sides overlapping the tray part to which it can be attached by hooks on either side. Be sure to ground the metal box also. It should be noted that most of the telephone buzzers have electric lamps in series with all their four wires; this is a safety device in case of a short circuit or over charge. Be sure to leave these lamps still in series, but on the outside of all the choke coils and condensers.

**A SNEEZE DOESN'T CARRY WELL**

It is reported that Czecho-Slovakia is developing Radio slowly. Radio probably balks at some of those Balkan languages.

# D-X

(DISTANCE)  
**BARGAINS!**



**A GREAT ARRAY OF RADIO BARGAINS**  
Illustrated Free Catalogue Sent on Request. Remittance Must Accompany All Orders. No Checks or Stamps Accepted. Merchandise shipped post paid east of Mississippi. Our mail order department works quickly and without error. Drop your money order in the mail today.

**VARIABLE CONDENSERS**



DX 8 Plate Reg. Price \$2. Our Price ..\$1.10  
DX 13 Plate Reg. Price \$3. Our Price ..\$1.75  
DX 23 Plate Reg. Price \$4. Our Price ..\$2.25  
DX 43 Plate Reg. Price \$4.50. Our Price ..\$2.75  
Vernier with Dial 13 Plate Reg. Price \$5.00 Our Price ..\$3.00  
Vernier with Dial 23 Plate Reg. Price \$5.50 Our Price ..\$4.50  
Vernier with Dial 43 Plate Reg. Price \$6.00 Our Price ..\$5.00

**VARIO WAVE TUNER**

Range 150 Meters to 3500 Meters Price \$8.50



**TRANSFORMERS**

U.V. 712 Amplifying Reg. price \$7.00. Our Price ..\$8.10  
U.V. 1711 Amplifying Reg. price \$6.50. Our Price ..\$5.45  
W.D. 11 Amplifying Reg. price \$5.00. Our Price ..\$4.00  
Murad Radio Frequency Reg. price \$6.00. Our Price ..\$3.50  
D.X. Radio Frequency Reg. price \$3.00. Our Price ..\$7.10

**GRID LEAKS**

We recommend SAFE-T Tubular Grid Leaks. They are unflinching, triple tested and accurate.



1/2 - 3/4 - 1 - 1 1/2 - 2 - 2 1/2 - 3 - 3 1/2 - 4 - 4 1/2 - 5 MEG.

**LEAK MOUNTINGS**

Reg. price 75c. Our Price .....40c

**HEADPHONES**



James Ross of London Phones are designed for D. X. work and should be used for faint signals. Reg. Price ...\$10.00 Our Price ...\$6.00  
Brands Superior Matched Tone. Reg. Price ...\$8.00 Our Price ...\$6.50



**V. T. SOCKETS**

For W.D. 11 Reg. price \$ .75 Our Price .....55c  
For U.V. 199 Reg. price \$1.00 Our Price .....75c  
Moulded Reg. price ...\$ .75 Our Price .....40c

**VARIOCOUPLES**

Fischer 180° Soldered Leads Reg. price \$5.00 Our Price .....\$2.25  
Fischer No. 54 (Range up to 400 Meters) Reg. price \$5.00 Our Price .....\$2.95  
Fischer No. 52 (Range up to 600 Meters) Reg. price \$6.00 Our Price .....\$3.50

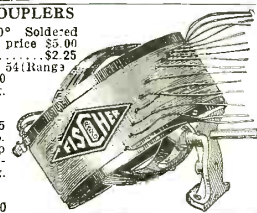

**INDUCTANCE COIL MOUNTINGS**

Asterloid Composition. Triple Coil Mounting—Reg. Price \$5.00. Our Price \$3.60  
Double Coil Mounting—Reg. Price \$4.00. Our Price \$3.10  
Single Coil Mounting—Reg. Price 90c. Our Price 50c.



**V. T. ADAPTERS**

For W.D. 11 Reg. Price \$1. Our Price...75c  
For U.V. 199 Reg. Price \$1. Our Price...75c

**VARIOMETERS**

Fischer No. 51 (Range up to 400 Meters) Reg. price \$3.00. Our Price .....\$2.25  
Fischer No. 53 (Range up to 600 Meters) Reg. Price \$6.00. Our Price....\$3.50

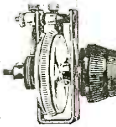

**C. H. VERNIER RHEOSTAT**

Genuine Cutter Hammer Product. Necessary for fine adjustment. Reg. Price \$1.50 Our Price .....\$1.20  
Other Reliable Rheostats Fada Type Reg. Price \$1.00. Our Price 65c

**D - X RADIO CO**

123 Liberty Street  
New York City



# DICTO-GRAND

The New Radio Loud Speaker  
with the Adjustable Airgap

## ON SALE APRIL 1ST

Ask Your Dealer

The Most Wonderful  
Loud Talker in the World

**THE DICTOGRAPH PRODUCTS CORP.**  
220 West 42d Street New York City

Branches in All Principal Cities

### Radio-Telephony On Transmission Lines

(Continued from page 1776)

action by the signals received. To each letter of the Morse alphabet corresponds a lamp, which is illuminated when that letter is received.

The whole of the apparatus described above is made by the Société Française Radio-Electrique for a network of eight stations as a maximum. But the company can, if necessary, establish more important networks without having to solve any new technical problems. In the case of large networks it often happens that not all the stations need to be able to communicate with each other; the network can then be divided into sections, of which only the central stations are able to communicate with the corresponding stations of the other sections. In this case the standard equipment is perfectly suitable.

Where communication is necessary over a greater range than can be obtained with the F.D.C.O. sets, the company can supply similar sets of greater power.

This system is installed at the power station of the Société des Mines de Lens at Pont-à-Vendin, which was visited by the "Electrical Review" party during the French tour in October last year; the messages are sent into the high-pressure transmission lines in the manner above described, and are received at the sub-stations in the same way. The members of the party were greatly interested in the device, which was understood to be perfectly satisfactory in operation.

Sh!

(Continued from page 1817)

I pondered. Polyp's is only one of a million radioized homes. A million homes as silent as a pretty girl with a front tooth missing; a million sanctuaries of quiet! What a tremendous volume of silence there must be in this jazz-ridden land of ours!

A thought entered my mind. "What if you should have a loud speaker?" I asked. "SHHHHHHHHHHHH!!!" said Polyp viciously.

### Radio Receivers In the Making

(Continued from page 1774)

place and the metal is punched in such a way as to hold them there.

Insulation is another important feature in successful receiver manufacture, and so it is necessary to place a very special grade of insulating tape over the bare steel core of the bobbins before they are passed along to the winding machines. An automatic bobbin winding machine has indeed a busy time of it. The wire placed on the bobbins is almost as fine as a human hair, and yet these little machines with their individual electric motors swell the bobbin up with wire at the rate of many thousands of turns per minute. When the proper amount of wire has been placed upon the bobbin, the machine automatically stops. In the meantime the girl operating the machine has prepared a second bobbin and the winding on this is immediately started. In this way these little machines are kept

## BUILD IT YOURSELF!

for  
**\$20.00**

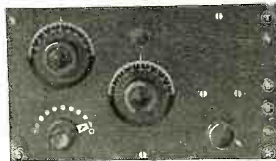

and  
**SAVE \$40.00**

**BURGESS,**

The Well Known Radio Expert, Will Show You How

With his help and parts we furnish, you can build this extremely efficient receiving set in a few hours. Why pay some manufacturers \$40.00 profit—you don't need any special tools to construct this set. Burgess' instructions are so clear that even a child can understand them. This set can be used with either storage battery or dry cell, and when properly installed will receive from stations 1000 miles away. Can be used with amplifier if desired.

Parts Include the Following—All First Class:

- |   |   |   |
|---|---|---|
| 1 Formica Panel, 3/16"x1"x12", drilled.                         | 2 1/4", 8"x32" flat head brass machine screws for variable condenser. | 1 Filament rheostat fitted with 2 set-screws.                       |
| 9 Switch points,  | 1 Grid leak,  | 8 Composition binding posts,  |
| 18 Hexagonal nuts, for switch points,                           | 1 Grid condenser .00025 mfd.  | 1 Phone condenser .0005 mfd.  |
| 1 Switch lever, fitted with bushing, nut, collar and set-screw, | 1 Nuts and washers for grid leak and condenser.                       | 1 1/2", 8"x32" flat head brass machine screws for phone, condenser. |
| 2 Stops,  | 1 Vacuum tube socket,   | 1 8"x32" hexagonal brass nut for phone condenser.                   |
| 2 Hexagonal nuts for stops,                                     | 2 1/4", 8"x32" flat head brass machine screws for tube socket,        | 2 "phone" composition dials,  |
| 1 Variocoupler,   | 2 1/4", 8"x32" Hexagonal brass nuts for V. T. socket,                 | 6 ft. of spaghetti tubing,  |
| 2 3/4", 8"x32" flat head brass machine screws for coupler,      |   | 6 ft. of No. 18 copper wire,  |
| 1 23 plate variable condenser,                                  |   | 10 ft. of No. 24 copper wire,                                       |

**EVERYTHING COMPLETE . \$20**

Simply send \$2.00 with your order. Pay balance of \$18.00 after you have examined the set and you are satisfied in every way. If you do not consider it the best Radio buy, instruct the Express Company to return it to us and we will refund your deposit.

**DAVIS RADIO PHONOGRAPH COMPANY, 314-324 West 43rd Street, Chicago, Ill.**

### VEEDEX Radio Tools

TO BUILD YOUR OWN SET

Pliers \$1.25, Postpaid U. S. A.  
GREAT LAKES M. P. CO.

1049 Main Street Buffalo, N. Y.

### A QUALITY BATTERY

Always Dependable

Marko Storage Battery Company  
1484 Atlantic Ave.  
Brooklyn, N. Y.





# SPECIAL BARGAINS

## IN RADIO SUPPLIES

**Complete Crystal Receiving Set . . . \$7.50**  
(List Price \$18.00)

**Federal Crystal Set with Phones . . . \$10.00**  
(List Price \$25.00)

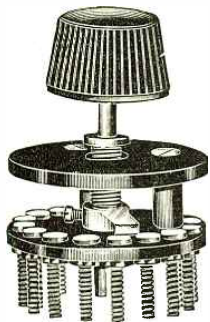

Back Mounting Inductance Switch **75c.**

RHEOSTATS	
Reeps—Vernier—Precision Type . . . . .	\$1.35
Framingham Vernier . . . . .	.80
Pada Type . . . . .	.40
Regal . . . . .	.75
Acemstat . . . . .	1.45
CONDENSERS	
Sleeper, 43-plate Variable—.001 . . . . .	\$2.00
General Radio, 43-plate Variable—.001 . . . . .	3.50
General Radio, 43-plate Variable—.0005 . . . . .	3.50
43-plate special—.001 . . . . .	1.45
23-plate special—.0005 . . . . .	1.25
PHONES	
Federal—2200 ohms—List \$8.00 . . . . .	\$5.00
Kellogg—2400 ohms—List \$12.00 . . . . .	6.00
Brands—Matched Tone—List \$8.00 . . . . .	5.75
JACKS	
Double Circuit . . . . .	45c
Single Circuit open . . . . .	30c
Single Circuit closed . . . . .	35c
AUDIO FREQUENCY TRANSFORMERS	
Jefferson No. 45 Navy Type. List \$7.00 . . . . .	\$4.20
General Radio . . . . .	5.00 3.75
Federal . . . . .	7.00 5.20
RADIO FREQUENCY	
Murad T-11 . . . . .	List \$6.00 \$3.80
Murad T-11-A . . . . .	List 6.50 3.90
Baldwin . . . . .	List 3.50 1.80

FIXED CONDENSERS	
Micon—Noiseless	
.0025 . . . . .	30c
.0003 . . . . .	30c
.0005 . . . . .	30c
.001 . . . . .	35c
.002 . . . . .	35c
.005 . . . . .	70c
.006 . . . . .	70c
.0025 Condenser and Variable Grid Leak . . . . .	75c
METERS	
We have a complete line of Weston—Roller Smith and General radio—Volt and Ammeters in stock—Price on request.	
LOUD SPEAKERS	
Western Electric—complete . . . . .	\$161.00
Patche . . . . .	18.00
Jelly Phone . . . . .	33.50
Woodhorn . . . . .	7.00
Magnavox . . . . .	35.00
VARIOMETERS	
Baldwin . . . . .	\$4.00
Enco—moulded . . . . .	6.00
Queens . . . . .	3.50
VARIO-COUPLERS	
Enco—1.80' . . . . .	\$5.00
Queens—1.80' . . . . .	3.00
Baldwin—90' . . . . .	3.75
R. M. C.—100-600 Meters—90' . . . . .	3.50
R. M. C.—150 to 3000 Meters . . . . .	7.00
All Ware (Capital) . . . . .	7.00
Multi-Wave (Cardwell) . . . . .	7.00

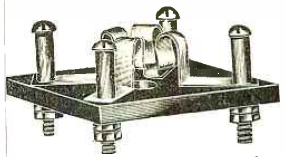

W.D.-11 Socket **35c.**

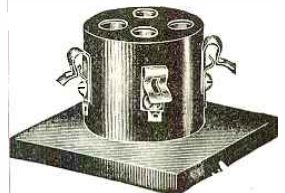

W.D.-11 Socket

SPECIALS	
Sleeper Unit with D. D.-11 Socket—	
Mounted on Unit . . . . .	\$4.50
Sleeper Radio Fil. Amp. . . . .	5.30

Order Direct From This Ad. or Write For Our Price on Any Other Goods You Want

AMERICAN RADIO STORES, 235 Fulton Street, New York City

## Armstrong Super Heterodyne Receiver

*"The Rolls Royce Method of Reception"—E. H. Armstrong.*

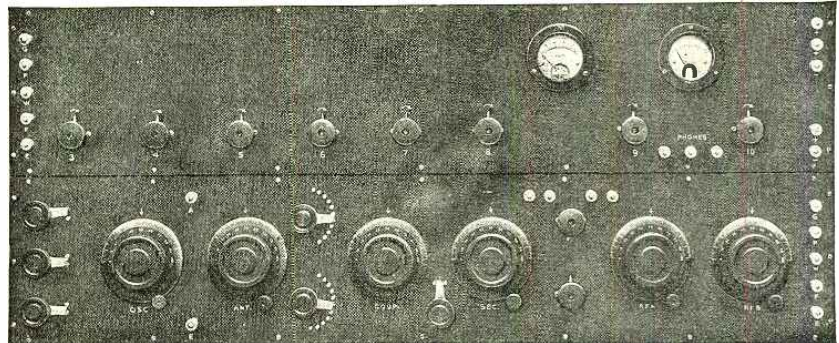

Obtainable Exclusively Through

### EXPERIMENTERS INFORMATION SERVICE

*Designers of the Highest Class Radio Apparatus in the World*

220 West 42 St., 23rd Floor

New York City

Ask for 1923 Catalog No. 20

# The Receiver

which promises to Break  
All Sales Records



## Telmaco Type B. R. Tuner

Manufactured exclusively for us by the Tri-City Radio Electric Supply Co., licensed under Armstrong U. S. Patent No. 1113149, Oct. 6th, 1914, for use in amateur stations and for radio experimental work. Only the best materials are used throughout:

### Specifications:

Panel—Formica grained and machine engraved. Vario Coupler—TELMACO special silk wound. Condenser—Special 13-plate with Bakelite ends. Rheostat—Single knob control, Vernier type. Socket—Highly nickel-plated shell, Bakelite base. Dials—are polished, presenting pleasing contrast with dull panel. Workmanship—manufactured according to TELMACO'S rigid specifications. This guarantees your satisfaction. Remarkable ease in tuning. Either 6 volt or 1½ volt tube may be used.

**Price \$25**  
The ultimate in value.



**Quality Radio Exclusively**  
**BONA FIDE JOBBERS**—If our salesmen have not yet reached you with our proposition, write or wire for it TODAY.

### Telmaco Type B. A. Two Stage A. F. Amplifier

Matches the above in size and construction. The greatest Amplifier value on the market. Price \$20.00. Write for our new Free Catalog.

**RADIO DIVISION**  
**TELEPHONE MAINTENANCE CO.**  
20 S. Wells Street Dept. B Chicago, Illinois

## Miraco Gets 'em 1500 Miles Away



Users of the MIRACO Radio Frequency Broadcast Receiver report wonderful results. St. Louis hears Schenectady—Davenport hears Newark—Cincinnati hears San Francisco. Reception is clear and distinct, tuning is very sharp, and there's practically no interference.

MIRACO sets may be used with either WD 11 tubes and 1½ volt dry cell or 6 volt tubes and 6 volt storage battery.

Order your MIRACO set TODAY and be sure to specify tubes to be used.

**Retail Price — \$54.50**

**DEALERS**—When you get our proposition in detail—you'll WANT TO PUSH THE MIRACO LINE.

**AGENTS** wanted everywhere.

**THE MIDWEST RADIO CO.**  
804 Main Street Cincinnati, Ohio

constantly busy winding many hundred thousands of feet of wire in a single day. Those who have attempted to handle No. 40 wire, which is the size used, will at once understand what a wonderful combination of delicacy and efficiency the winding machine represents.

The manufacturer of telephone receivers must be constantly on the alert for grounds or short circuits. The least electrical defect is apt to cause a partial ground or leakage which will completely destroy the sensitivity of the receiver. Immediately after the bobbins are wound they are tested on a high voltage D.C. circuit to make sure that the winding is in no way grounded. A sensitive indicating instrument is connected in the circuit and the action of its needle immediately gives the operator a warning.

After the ground test, a very careful resistance test is made, since it is necessary that the resistance of all bobbins be practically uniform. To measure the resistance of each one of these bobbins on a regular Wheatstone bridge would be a tedious task, which would interfere greatly with the progress of manufacture owing to the slowness of this method. Therefore, a direct reading ohmmeter fully as efficient for the purpose is used. Like a measuring gauge, this ohmmeter is operated on the "go-and-not-go" principle. Two limit marks are placed on its scale and the indicating needle must fall between these. If it does not, the resistance of the bobbin is either too high or too low and it must be relegated to the scrap heap. Variation in resistance must not amount to over 5 per cent plus or minus. This is only another instance where the phone manufacturer must strive for uniformity in production.

The next operation of importance is that of soldering on the lead in wires. If the tiny wires used on the magnets were used to make the connections, they would be sure to break in time and render the receiver useless. To overcome this probability, a heavy wire is used to make the connections.

The finished bobbins are placed in trays where they are allowed to remain for one month without being disturbed. This ageing process allows the moisture to dissipate thoroughly.

Eternal vigilance is the watchword of the scientific phone manufacturer. At the end of the ageing process, the lead-in wires are clipped and skinned and the bobbins are again given a "ground" and an "open" test. This is to check up any changes that may have taken place during the ageing. Of course, in these tests only the perfect bobbins are acceptable. Every bobbin that shows the faintest trace of a ground is rejected.

Rapid assembly is the problem of every manufacturer, and now that all the parts that go to make up the receiver have been described, it is interesting to know how quickly they are placed in the proper relationship to each other within the receiver case. This is done with a special fixture. First the empty cup is placed in this fixture. The bushings for the terminals and the terminal screws are automatically set in place. Then the bobbins are put in their positions and the pole faces automatically aligned. A few turns of the handle bolts the bobbins tightly in place and the receiver is passed along to where the magnets are placed and locked in position. The lead wires are then soldered to the terminals and the receiver is practically finished—finished at least as far as assembly is concerned; they then await only those finishing touches that cure them of any ills they may have before they receive the final stamp of approval.



DX ⚡ DX ⚡ DX ⚡ DX ⚡ DX ⚡ DX ⚡ DX ⚡ DX ⚡ DX

## TRANSCONTINENTAL RECEPTION NOW A DAILY ACCOMPLISHMENT

USERS OF THE DX RADIO FREQUENCY TRANSFORMER who are located on the ATLANTIC COAST are now hearing CALIFORNIA BROADCASTING STATIONS regularly, with the use of *small indoor coil aerial*. (Names of persons having these unusual results furnished on application.)

COAST TO COAST 200 meter amateur reception also accomplished with DX RF TRANSFORMERS.

**Note New Prices**

Wave-length Range	Price
DX-1 170—450.....	\$6.40
DX-S 400—1200.....	6.60
DX-2 900—3000.....	6.60
Standard Mounting.....	.90

*INSIST ON  
DX*

*Attractive proposition to  
Jobbers and Dealers.*

Write for Literature

**IT PAYS TO HAVE THE BEST**



**RADIO  
INSTRUMENT CO. COMPANY, INC.**  
WASHINGTON, D. C.

DX Radio  
Frequency  
Transformer



Patented Dec. 19, 1922

THE PIONEERS  
IN RADIO  
FREQUENCY

DX ⚡ DX ⚡ DX ⚡ DX ⚡ DX ⚡ DX ⚡ DX ⚡ DX

## What's a screw-driver for?

"That's like asking what time the 3 o'clock train leaves," says Mr. Punch. "Of course, any ordinary screw-driver will drive a screw. But you can't be satisfied for long with just an ordinary screw-driver."

The Goodell-Pratt Plain Screw-Drivers are designed on modern lines. Blades are hammer-forged from a high grade of tool steel and are carefully hardened and tempered. Handles are polished hard wood cunningly designed. It's all the same to these drivers whether you drive one screw or a thousand.

Radio work demands other good tools. Goodell-Pratt automatic drills, hand drills, bench drills, ratchet screw-drivers, tap holders, and bench lathes are tools that have been tried and proved.

If your hardware dealer does not have these Goodell-Pratt Screw-Drivers, he can get them for you easily.

GOODELL-PRATT COMPANY

*Tootsmiths*

Greenfield, Mass., U. S. A.

GOODELL-PRATT

1500 GOOD TOOLS



Plain Screw-Driver  
No. 909

This model comes in twelve sizes, with blades 2 inches to 18 inches long. Blades range in price from \$3 a dozen for the 2-inch to \$15 a dozen for the 18-inch.

## FRESHMAN PRODUCTS—ACCURATE AND DEPENDABLE



**"MICONS"**

**Tested Mica  
CONDENSERS**

Assure absolute noiselessness—  
clarity of tone—accuracy—constant  
fixed capacity.



**Antenella**

No antenna or aerial needed. Eliminates all the inconveniences in radio operation from any light socket. Price only **\$2.00**

At your dealers—otherwise send purchase price and you will be supplied without further charge.

## Variable Resistance Leak

With .00025 mfd. Micon Condenser **\$1.00** Without Condenser **75c**

Unbroken range—Zero to 5 Megohms. Clarifies signals, lowers filament current, increases battery life, eliminates hissing.



Size	Price	Size	Price
.00025	\$0.35	.0025	\$0.50
.0005	.35	.005	.75
.001	.40	.006	1.00
.002	.40	.01	1.50

.006 MICONS and Variable Resistance Leaks especially adapted for New Flewelling Super Circuit.

**Chas. Freshman Company, Inc.**  
97 Beekman Street, New York

DEALERS: Discount 33-1/3% on all orders \$15.00 and over. We pay parcel post, express or freight charges. Literature and display card free on request.

## Noise Mistaken for Static!

In most cases, when the results with the Receiving set are not satisfactory, Static is blamed. Usually the fault is loose connections. With Saturn Products there are no loose connections and consequently no noises.

The Saturn "Automatic" Radio Plug. It solves many problems. One "Automatic" replaces several common plugs. No dissembling. Terminal Tips put in and taken out by a touch of the finger. The more you pull the better the contact. Each Plug sealed and fully guaranteed. Sells for \$1.50.



## The Saturn Perfect Jack



Built on proved Mechanical and Electrical Principles. Strong and durable. Used on some of the best known instruments. Time savers for Manufacturers. Crow-foot offset, allows easy soldering. Brass Bracket with rounded corners. German Silver Spring Blades, reinforced where most needed. Sterling Silver Contacts. Shoulder type Nipples with two 1/16" washers. All Brass parts Nickel and Polished.

No. 1 Single Circuit Open.....\$0.65 No. 2 Single Circuit Closed.....\$0.75  
No. 3 Double Circuit Closed.....0.90 No. 4 Single Filament Control.....1.00  
No. 5 Double Filament Control, \$1.25

**THE SATURN MFG. & SALES CO., INC.**

Dept R. N.

48 Beekman Street



New York, N. Y.

## FREE Radio Catalog

Our big stock of standard makes of radio sets, parts and supplies, fully illustrated. Play safe—buy standard equipment from a reliable house. We ship from stock. Send \$6.50 for genuine Westinghouse WD-11 "peanut" tube—no storage battery needed. 60 cents extra for signal socket. \$1.00 for Bradley Adapter. Wonderful results.

**JULIUS ANDRAE & SONS CO.**  
In business since 1880  
117 Michigan Street, Milwaukee, Wis.

## ELECTRIC SOLDER IRON

Fits Any Standard Appliance Plug



**150**  
**IRON ONLY**  
100 Watts 108-115 Volts  
**RADIO—AUTO—HOME**  
Does Work of Any \$15.00 Iron. Use Your Own Appliance Plug, or Send \$1.00 Extra for Plug & Cord as Shown. Plain String Solder, 60c lb. Acid or Rosin Core String Solder 90c. lb. Add 10c for Postage

**A. Simon Co., 520 Pine St., St. Louis, Mo.**

The early life of a telephone receiver is full of tests. After the assembling operations are completed, each receiver again receives a ground and open test as well as a careful visual inspection.

The distance separating the pole faces and the diaphragm of a good receiver must be carefully adjusted to the proper degree. In fact it is upon this very point that the efficiency of a telephone receiver largely rests. Theoretically the closer the diaphragm is to the pole faces of the bobbin magnets the more sensitive the receiver will be. On the other hand the diaphragm must be free to move and if it is placed too close it will strike the pole faces and clear reception will be impossible. That is the effect we get when a receiver is overloaded.

The distance between these members is adjusted with a grinding process. The receiver case is passed over a rapidly moving grinding wheel in such a way that only the pole faces come in contact with it. The contact is light and only a very small amount of metal is removed. The operator then measures with a micrometer depth gauge the distance that the pole faces are below the edge of the case. This process is repeated until the correct distance is found. A variation of more than one-half of one one-thousandth of an inch is not allowed to pass.

Now the tops of the pole faces are lacquered and the interior of the receivers are carefully cleaned out with previously dried air, which effectively removes any remaining traces of metal dust and dirt.

The magnetizing of the receiver magnets is done in the twinkling of an eye. The receivers are simply placed on a moving belt which passes rapidly over the pole pieces of a powerful magnet. So powerful is this magnet that a fraction of a second's exposure to its field is sufficient to bring the magnets of the receiver to a point of saturation.

A bent or deformed diaphragm would seriously impair the sensitivity and reproduction of a phone, and for this reason great caution must be taken to see that only perfect diaphragms are used. This makes it necessary to give each diaphragm a careful test for flatness, before it is put in place. The diaphragm is a vital part of a receiver, since it is this which vibrates and actually creates the sound under the influence of the magnetic field.

After the caps are screwed in place the receivers are given an audibility test and after this, their tone is matched. The matching of the tone is done by an experienced operator whose duty it is to select and pair receivers that have exactly the same acoustic properties. In other words he mates them, placing together only those that produce exactly the same sound when tested with a very faint note of uniform frequency. Although the receivers are made under exactly the same conditions, and all of their parts are of exactly the same size, yet each receiver has acoustic properties of its own, which, although they vary within narrow limits, make it necessary to bring together two receivers having approximately the same characteristics. This insures maximum sensitivity and clarity of tone permitting the clear and distinct reception of extremely weak signals. It is only through matching the tone that a listener is able to hear the same sound in both ears.

Photos courtesy C. Brandes, Inc., N. Y.

## FOR THE DICTIONARY

The influence of Radio is felt everywhere. The Buffalo Commercial says: "Thousands of persons within a R-A-D-I-O-U-S of several hundred miles." We assume that this is a new word, a combination of "RADIO" and "RADIUS."



# The RADIOGEM

(Patents Pending)

**\$1** Receiving Set—The Simplest Radio Outfit **\$1**  
 Made—Yet as Practical as the Most Expensive!

You need know absolutely nothing about wireless to operate and enjoy the RADIOGEM. It is so sturdy, so simply constructed that it is small wonder radio engineers who have tested it have pronounced the RADIOGEM a brilliant achievement. The RADIOGEM is a crystal radio receiving set for everyone at a price anyone can afford.

**Why The RADIOGEM Can Be Sold For Only \$1**  
 Here's the secret: The RADIOGEM Construction eliminates all unnecessary trimmings, cabinets and the like, which do not play any part in the operation of a set. You receive the RADIOGEM unassembled, together with a clearly written instruction book, which shows you how to quickly and easily construct the set, using only your hands and a scissor. The outfit comprises all the necessary wire, contact points, detector mineral, tube on which to wind the coil, etc., etc. The instruction book explains simply and completely the principles of radio and its graphic illustrations make the assembling of the RADIOGEM real fun. Remember the RADIOGEM is a proven, practical radio receiving set and will do anything the most expensive crystal set will do.

**The RADIOGEM is the Prize Winner of the Age**  
 Out of hundreds of radio models submitted recently in a great nation-wide contest, radio engineers, the judges, unanimously chose the RADIOGEM as the winner—the simplest radio-receiving set made! And the RADIOGEM costs you nothing to operate; no form of local electricity is required.

**DEALERS** The RADIOGEM is the wonder item of the radio age. It is storming the country, for the RADIOGEM'S price is so low everyone is able to buy one. Write immediately for full particulars before that shop across the street beats you to it.

Hear the programs of the Broadcasting Stations on the RADIOGEM

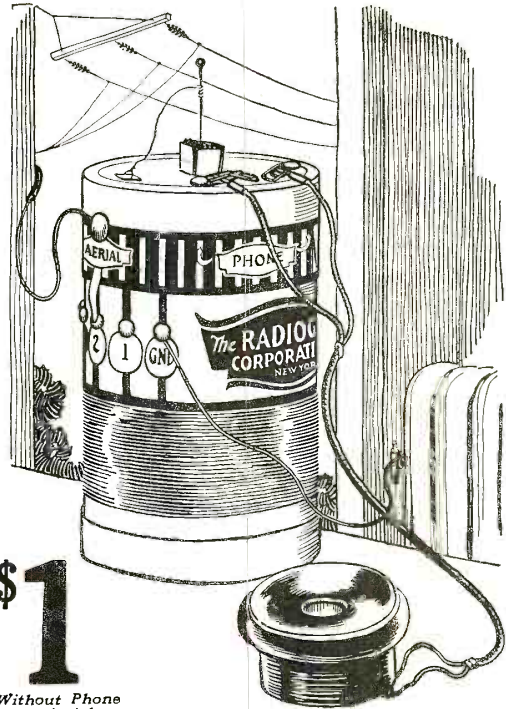

**\$1**

Without Phone or Aerial

Receives up to 20 Miles

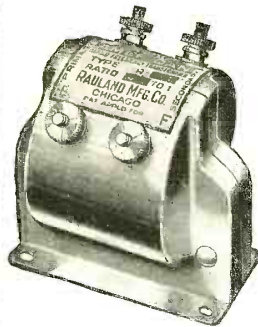

Tell Your Dealer  
**“ALL-AMERICAN”**  
 or nothing

when you buy Radio Transformers, and stick to it—for your own protection.



**“All-American” Amplifying Transformers** (Radio and Audio Frequency) have proved their superiority in every competitive test, and won the approval and adoption by the leading makers of sets.

Electrically correct, splendid examples of high-class workmanship, from the best materials; built by experts; rigidly inspected and every one tested singly before leaving our factory.

- R-10 Radio Frequency (150-550 meters)
- R-12 Audio Frequency (Ratio 5 to 1)
- R-13 Audio Frequency (Ratio 10 to 1)
- R-21 Audio Frequency (Ratio 5 to 1)

Send for circular “Cascading of Amplification.”



**RAULAND MFG. CO.**  
 35 So. Dearborn St., Chicago, Ill.



THE ACOUSTICAL AMPLIFIER

# BEL-CANTO

TRADE-MARK

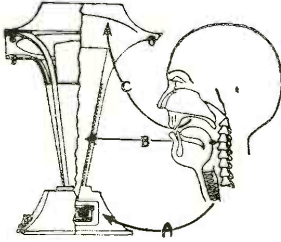

## LOUD SPEAKER

**Amplifies without Distortion**

Built along scientifically correct principles, following minutely the natural functions of the human throat. The unexcelled acoustical amplifier!

The receiver is the vocal cord (A); the long tapering inner horn is the throat (B); and the sounding board at the top is the roof of the mouth (C).

With this superlative amplifier you can readily distinguish the delicate tonal differences between a harp and a piano, even when the two are playing together. A test never before equalled.

Is adjusted for regenerative two stages of amplification, also five tube radio and audio frequency.

Special phone, cord and plug, price \$30.00 F. O. B. New York. If dealer can't supply, we can.

Full line of radio parts.

**BEL-CANTO CORPORATION**  
417 East 34th Street New York City

For consistently good receiving, install

# Mar-Co Tuner

## Type 300A

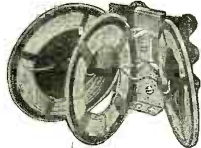

**THE MAR-CO TUNER**  
made with a combination of three small inductances performs consistently well in currents oscillating at the higher frequencies.

**THE GREATER VALUE**  
of the MAR-CO TUNER is its receiving power in telephonic broadcasting. And around this instrument practically all the successful regenerative circuits for short wave length work may be constructed.

**TUNING with a MAR-CO**  
is done with exterior variable condensers and by changing the coupling between the coils. No liquid dielectric are used in these coils and they are specially wound, assuring the best possible results.

**THE STABILIZING EFFECT**  
of the metallic rings which support the inductors (and may be grounded) gives a great relief from the body capacity effects in adjustment.

**PRICE \$7.00**  
FROM YOUR DEALER

**MARTIN-COPELAND COMPANY**  
PROVIDENCE, R. I.  
Makers of High Class Radio Products

## APRIL

Many famous men and women were born in April (also May, June, July, August, September, October, November, December, January, February and March).

Why not have us get that birthday gift for you and, if you wish, have it delivered to the friend or relative you designate.

No charge for our Service.

**Amsterdam Service Exchange**

**AMSTERDAM OHIO**

## TUNE IN DISTANT STATIONS



F. R. S. Complete Two-Stage Long Range Receiver Set includes two "Audio" transformers, condenser, two moulded variometers, moulded variocoupler, three V. T. sockets, filament rheostats, dials, Bend 'Em binding posts, switch points in attractive cabinet and drilled panel complete, ready to hook up. A \$125 Radio for..... **\$40**

**F. R. S. RADIO CORP.**  
409 East Fort St., Detroit, Mich.

## Electrons, Electric Waves and Wireless Telephony

(Continued from page 1781)

well at this stage to outline our present views on the nature of an electric or electromagnetic wave. We have seen that from an electron we consider lines of electric force to radiate. These lines may for the sake of brevity be called *electrolines*, and we may therefore picture to ourselves an electron as something like a golf ball in which have been stuck very long straight wires radiating equally in all directions, which wires represent the electrolines. These electrolines possess an elasticity of a certain kind. They resist stretching and endeavor to make themselves as short as possible. In fact the attraction between positive and negative electrons may be regarded as the result of the endeavor of these lines to shrink up in the direction of their length. Also these lines possess a quality equivalent to mass or inertia and the so-called electric mass of the electron to which we have already referred is merely the mass of the entirety of these electrolines and of the magnetolines produced by their motion.

Suppose then that an electron at rest is caused to make a sudden jump forward. It carries with it the ends of the electrolines which terminate on it, but the inertia of the line causes the rest of the line to be left behind for a moment and the result is the production of a *kink* or dislocation in the lines (see Fig. 45). This kink, however, travels outwards along the lines as the whole electroline picks up the motion. We have, however, seen that the lateral or sideway motion of an electroline gives rise to a magnetic force at right angles to itself and to the direction of its motion. Hence, as the "kink" in the electroline travels outwards it is accompanied by lines of magnetic force or magnetolines created by the motion of the electrolines.

These two sets of lines are at right angles to each other and to the direction of motion. Experiment shows that this kink travels outwards with a velocity of 300,000 kilometers per second in empty space or with the velocity of light in any medium in which the electron is placed.

This movement of electric and magnetic lines of force in the same plane is called an *electromagnetic pulse* or solitary wave and is also called *electric radiation*.

The same kind of electric radiation will be produced if an electron in uniform motion is suddenly stopped or has its velocity changed or suffers acceleration. There are,

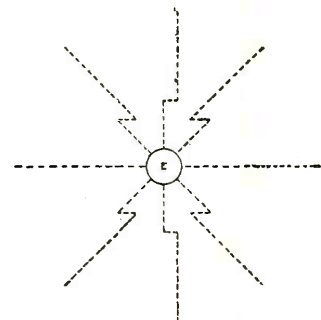

Fig. 45. Kinks Produced on Radial Electrolines of an Electron E When the Latter Suddenly Jumps Forward. The Dotted Lines Denote the Electrolines.

Insure your copy reaching you each month. Subscribe to Radio News—\$2.50 a year. Experimenter Publishing Co., 53 Park Place, N. Y. C.



however, two kinds of acceleration. Velocity may be changed in amount, but not in direction, as when a stone is falling towards the earth, or the velocity may be continually changed in direction but not in magnitude as when a mass revolves with uniform speed in a circle. It appears, for reasons too long to give at this point, that an electron when revolving with constant speed in a circle round a nucleus, although in one sense of the term experiencing an acceleration towards the nucleus, is yet not radiating electromagnetic waves and therefore not losing energy. On the other hand if an electron jumps backwards and forwards in a straight line it does radiate, although the direction of its motion is always in one line. If then we imagine a number of electrons to be placed in a row in one line and all to jump to and fro in that line through a small range simultaneously, the whole lot of them would radiate and would produce an electromagnetic wave, the wave surface of which would be a co-axial cylindrical sheath or surface to the line of electrons. We shall see, when we come to discuss the subject of wireless telephony, that this is just what happens in the case of the aerial of a wireless telephone transmitter.

Before proceeding further with the consideration of the problem of electric radiation by the atoms and electrons, it will be necessary to return to the discussion of a few more matters connected with the architecture of atoms.

**THE PERIODIC LAW OF ATOMIC PROPERTIES**

It was long ago pointed out by the English chemist Newlands, and the Russian chemist Mendelejeff, and by Lothar Meyer, that if the names of the elements are written down in the order of their atomic



THE SYMBOL OF SERVICE

**CONTINENTAL**

*"New York's Leading Radio House"*

**for 25c!**

**Get it today!**

**208 Page "Modern Radio"**

Sent postage paid if you write for it now. Ten pages of circuit diagrams—fifteen pages on operating—nine pages of popular hook-ups—tables, data, symbols, codes, wire sizes, list of radio books—information and pictures of standard equipment, parts, supplies—all the "dope" you ought to have. Use the handy coupon below—and why not use it now!



**CONTINENTAL RADIO and ELECTRIC CORP.**  
Six and Fifteen Warren Street, New York

Enclosed is 25c—Send MODERN RADIO

To .....

Street .....

City and State .....

2028-Q

**"It's Havana, Dad!"**

You can enjoy the real thrill of Radio with a Fedders Radio Ranger Model J. R. H. Receiving Set.

The whole family will gather around after dinner to listen to a voice or music, perhaps more than a thousand miles away. Every night brings an unexpected thrill.

New stations—different talent brought miles and miles across ether to perform for you in your own home.

These stations were heard in one evening as "clear as a bell" on an indoor loop. You can enjoy just such a concert in your own home.

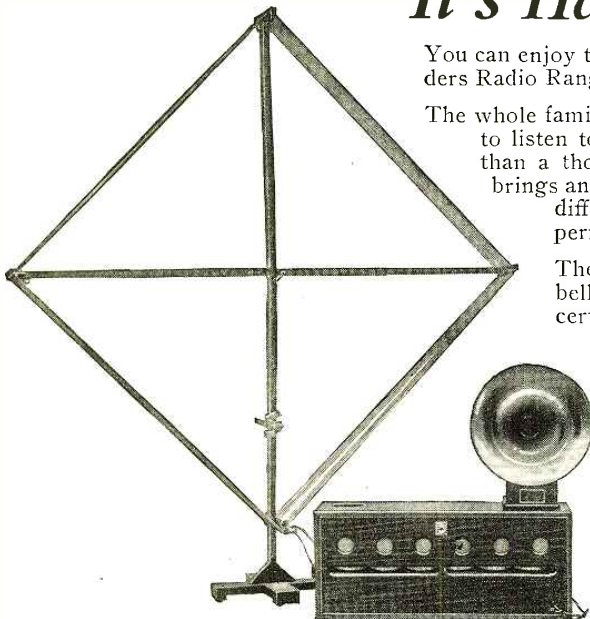

**THURSDAY, DECEMBER 28, 1922**

TIME	STATION	CITY	TIME	STATION	CITY
5:00	KDKA	Pittsburgh	9:05	WHAS	Louisville
6:30	WIAO	Milwaukee, Wis.	9:15	GFCB	Toronto
6:40	KOP	Detroit, Mich.	9:20	WGAE	Pittsburgh
6:45	WGY	Schenectady, N. Y.	9:25	WCX	Detroit Free Press
6:52	WOC	Davenport, Iowa	9:30	WOO	Philadelphia
6:58	2XB	New York City	10:05	KSD	St. Louis
7:00	WOR	Newark	10:15	WJAX	Cleveland
7:10	WHAM	Rochester	10:30	WGM	Atlanta Constitution
7:20	WBAP	Ft. Worth	10:45	WGI	Med. Hillside
7:27	WWJ	Detroit	11:00	WMAC	Cazenovia, N. Y.
7:35	WBZ	Springfield, Mass.	11:12	WLW	Cincinnati
7:45	WEAF	New York City	11:20	WMAF	So. Dartmouth
8:00	WLAG	Minneapolis	11:30	WDJ	College Park, Ga.
8:05	WHB	Kansas City	11:45	WSB	Atlanta Journal
8:30	WMAK	Lockport	12:25	KSD	St. Louis
9:00	KYW	Chicago	12:50	WDAF	Kansas City

Stations from these cities are frequently heard from Buffalo with this set.

Los Angeles  
Vancouver, B. C.

Portland, Ore. Oregonian  
Denver

Winnipeg, Manitoba, Can.  
Havana, Cuba

Dallas, Texas  
Salt Lake City

*Let us send you literature.*

**FEDDERS MANUFACTURING CO., INC., 55 Tonawanda Street, BUFFALO, N. Y.**



hear Mitchel Field's call for two hundred men. After sending out the above call, the field is now determined to back up every statement made, in order that men reporting to this station for enlistment will not be disappointed in their desire to learn a technical trade to which they may turn upon going back to civil life.

### Unsteady Arcs

(Continued from page 1080)

After a number of days at sea, the operator gains confidence in his ability, and his timidity in handling the arc disappears. He feels that he is now prepared to break all long-distance records, and begins to overload his arc to its limit, and oft-times discovers that he is unable to balance the absorbing circuit with the antenna circuit, which are now indicating, say, for instance, 8 and 10 amperes, respectively; a fact which shows that the circuits are out of balance to the extent of 2 amperes. This does not phase him in the slightest, and the fact that the radiation meter is swinging from 8 amperes to 10 amperes each time the key is depressed seems natural. This is due to his spark habit of watching the meter go up and down the scale while transmitting. With the arc radiating 10 amperes into the antenna he feels that he should do great work, but to his surprise he is told by the receiving operator that his tone is unsteady and that he is much harder to read than when his signals were weak.

After many repetitions he finally gets his traffic off. His admiration for arcs falls rapidly; he begins to lose interest and to condemn the arc and its complications. He does not realize that oft-times the cause of the trouble lies in his formed habit of watching the radiation-meter swing each time the key is closed; and that, in arc operation, the only time the radiation meter makes any appreciable change in its readings while transmitting is when it is out of balance. This is an indication that the arc needs adjustment.

It is surprising how many operators will deliberately unbalance their arcs to see their antenna radiation increase. The fact that the antenna circuit is radiating 2 amperes more than the absorption circuit pleases them instead of giving them cause for worry. When one of the radio-frequency circuits indicates 8 amperes while the other reads 9 or 10 amperes radiation, a very unsteady and unsatisfactory note will be emitted by the arc due to the change in the generator's speed and e.m.f., which is caused by the swinging load. The greater the load, the greater will be the e.m.f. drop and the slower the speed of the generator, and vice-versa. This causes the motor-generator to race back and forth, producing a constantly varying voltage on the arc, and causing it to draw more or less current. The arc-length adjustments for 8 amperes and 10 amperes radiation are slightly different, hence another factor adding to the propagation of an uneven tone.

An experienced arc operator knows that a steady arc where the radiation meter barely moves when the key is depressed—and the load thereby shifted from the absorbing circuit to the antenna circuit—can be copied at a great distance on 7 amperes radiation than a baldly balanced arc on 9 amperes. It seems difficult to convince the "off the scale" spark operators of this fact. This is one of the most common causes of the unsteady arc tone when the apparatus is operated by inexperienced CW men, and the sooner they learn to balance their radio-frequency circuits properly so that the radiation meter varies only slightly, if at all, its position on the scale when the key is being manipulated the better will be the results obtained,





No. T-100



No. T-101



No. T-102



No. T-103



No. T-104



No. T-105



No. T-106



N-S NAA CRYSTALS



N-S "RED-HEAD" PHONES

### Introducing Seven Better Radio Instruments

15 years of direct contact with the radio field has enabled us to develop these products. Each has new and unusual features that place it far ahead of common types—not one is a rushed-on-the-market experiment.

### HERE THEY ARE

**No. T-100 Reversible Rheostat**—All metal type for table or panel mounting. For use with any detector or amplifier built—smooth action, perfect contact, substantial pointer with insulated knob.  
—a BETTER rheostat  
**Price \$1.00**

**No. T-101 V. T. Socket**—Mechanical features that make it the only socket on the market that is genuinely rigid and strong when used for panel mounting and yet perfectly adapted to table or base mounting. All metal with Babelite contact support.  
—a BETTER socket  
**Price 75c**

**No. T-102 Stopping Condenser**—Heavy metal plates of novel design form substantial case for condenser. Mica dielectric, capacity .00029 MF. Highly nickelled and polished, mounted on insulating base. Can be removed for panel mounting.  
—a BETTER stopping condenser  
**Price 75c**

**No. T-103 Grid Condenser**, of similar design as above. Proper capacity for grid circuit in V. T. Hookups.  
—a BETTER grid condenser  
**Price 40c**

**No. T-104 Moisture-Proof Variable Grid Leak**—arranged for front of panel mounting in connection with Grid Condenser. Nickelled and Polished cover.  
—a BETTER grid leak  
**Price 60c**

**No. T-105 Crystal Detector**—New and ingenious design provides every adjustment to facilitate proper contact with the crystal. Contact wire can be moved to any point on crystal. Pressure can be easily regulated. Contact wire instantly renewable.  
—a BETTER crystal detector  
**Price \$1.00**

**No. T-106 Adaptaphone**—Converts the sound chamber of phonograph into a loud speaker. Made of high-grade rubber. Will not scratch or mar parts or phonograph. Not necessary to remove cap from receiver. Will fit all phonographs except the Brunswick.  
—a BETTER adapter  
**Price \$1.00**

**N-S "Red-Head" Phones**—3000 ohms. A triumph in Radio Receiver design. Beauty of design and ruggedness of construction coupled with a supreme sensitiveness are features that make "Red-Heads" the ideal telephone receivers for radio work.  
**Price with Cords \$8.00**  
—and better than ever the famous

**N-S NAA (Arlington Tested) Supersensitive Crystals**, individually tested and packed in convenient metal boxes. Galena, Silicon or Goldite, price each \$25. Same mounted in cup, 40c each.

Number yourself among our thousands of friends and customers who know the reliability and accuracy of N-S Radio Products.

Send for new Bulletin which describes these products in detail.

**Dealers: Write for our very attractive proposition IMMEDIATE DELIVERY**





## RADIO BATTERY HANDLES

Send **50 cents**  
Canada 65c

**Buffalo Sales Co.**  
322 Ellicott St.,  
BUFFALO, N. Y.

Dealers wanted

ENAMEL		SCC.				
Size	1 lb.	1/2 lb.	1/4 lb.	1 lb.	1/2 lb.	1/4 lb.
22	.48	.28	.16	.95	.52	.30
24	.55	.31	.18	1.05	.57	.32
26	.60	.34	.19	1.21	.65	.36
28	.64	.36	.20	1.36	.73	.40
30	.68	.38	.20	1.70	.89	.48

LITZ WIRE, AERIAL WIRE  
from 20c to \$1.25 per 100 ft.

TUBES for TUNING COILS

Etc. Etc. Etc. Etc. Etc.

REEL EASY PRODUCTS

**I. R. NELSON COMPANY**  
BOND STREET  
NEWARK, N. J.



**It's Here!**

**A Quality Plug at A Popular Price**  
 This plug will do everything that can be expected of any plug at any price.

**PACENT**  
 — of course

*Don't improvise  
 "PACENTIZE"*

Write for Descriptive Bulletins RN4

**PACENT ELECTRIC COMPANY**  
 INCORPORATED

Executive Offices: 22 Park Place, New York, N. Y.

BRANCH OFFICES

Philadelphia Washington, D. C.  
 Chicago San Francisco  
 St. Louis Minneapolis

Canadian and British Licensees:  
 Colonial Radio, Ltd., Hamilton, Can.  
 Members, Radio Section, Associ-  
 ated Mfrs. of Electrical Supplies

**"True-Tone"**  
 SUPERSENSITIVE  
 3000 Ohms

The Only Quality  
 3000-Ohm Guaranteed  
 Head Set for **\$5.00**  
 3000 Ohms

**TRUE - TONE RADIO MFG. CO.**  
 188 No. La Salle Ave. CHICAGO, ILL.

**SPECIALS**

	List	Special
Meyers tubes .....	\$ 5.00	\$4.75
VT2 Tubes .....	12.00	8.45
Master Baldwins Doubles .....	12.00	8.95
Master Baldwins Singles .....	6.00	4.45
Klosner Vernier Rheostats .....	1.50	.65
Lightning Arresters .....	2.50	.95
Fischer Variocouplers .....	5.00	2.25
Fischer Variometers .....	5.00	2.25

These are only a few of thousands of other items we have to offer

**LIBERTY RADIO CO.**  
 Address orders to Dept. F.  
 106 Liberty St. New York City

HAVE YOU SOMETHING TO SELL OR EXCHANGE?  
 A classified ad in RADIO NEWS will reach over 242,000 at a cost of only 15 cents a word

weights, the same kind of properties repeat themselves at regular intervals in the series.

It is now usual to arrange the elements in a table called the Periodic Series, which brings out these points clearly.

If we rule up a sheet of paper into nine columns and twelve rows, we can write in each of these spaces, or in nearly all of them, the names of the elements in order of their atomic weights, proceeding from left to right in each row and downwards in each column.\* We then find that when arranged as shown in the table all the elements of similar character fall into the same column or group.

The atomic weight of hydrogen is 1.008, when that of oxygen is taken as equal to 16.

The columns are number 0 to 8. In column 0 we find all the elements like helium, argon, neon, etc., which are non-valent and do not form any chemical compounds. In column 1 we have the mono-valent highly electro-positive alkaline metals like lithium, sodium, potassium, etc. In column 7 the haloid elements, like fluorine, chlorine, bromine, iodine, and in column 8 certain groups of three metals.

At the end of the series we come to the radio-active elements radium, thorium and uranium, this last being the heaviest atom, with an atomic weight of 238.2.

(See table page 1890)

We can also attach to each element a number, called its *Atomic Number*, given in italics in brackets in the table, which represents its numerical order of the elements in the series. The atomic number of hydrogen is 1 and that of uranium 92.

It is seen that at the beginning of the series the atomic weight is about double the atomic number, or at least differs only by zero or a small number. At the end of the series there is, however, a great difference between the atomic weight and double the atomic number.

Mr. Stephen Miall, in his little book on "The Structure of the Atom" (Benn Bros., London), has pointed out that the atomic weight *w* is related to the atomic number *n* in the manner expressed by the formula  $w = 2n + b$ , where *b* may be called the dead weight or ballast.

Van der Broek made the suggestion adopted now very generally, that the atomic number represents the resultant number of positive electrons in the nucleus, or what is the same thing, the number of planetary electrons circulating round it in a neutral atom.

Thus the nucleus of the helium atom consists of four positive electrons bound together by two negative electrons. The resulting positive charge is then 2 units. The atomic number of helium is two, and its atomic weight is 3.99 or nearly 4. It has two negative electrons which circulate round the nucleus. In this case the "ballast" weight is zero. In the case of uranium, however, the atomic number is 92, the atomic weight is 238.2. Hence the "ballast" is 54.2.

One important thing discovered is that the chemical properties of the atom are more closely related to the atomic number than to the atomic weight. In short, it is possible to have atoms of identical chemical properties but different atomic weights. These atoms have been named by Professor Soddy *isotopes*. Thus there appear to be several different kinds of atoms of the metal lead of slightly different atomic weights, but all having the atomic number 82 and all the same chemical properties.

It was long ago suggested by Prout that all atoms were built up of multiples of a certain primordial element, and hence that



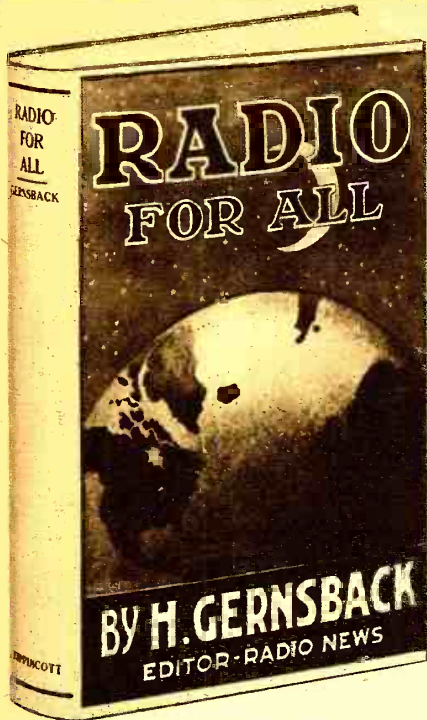

# RADIO FOR ALL

By H. GERNSBACK

Editor "Radio News," "Science and Invention" and "Practical Electrician"

With over 130 illustrations and diagrams, and 12 photographs, 300 pages, size 8 1/4" x 5 1/2".

What the novice in radio needs is a book in which he can get all the information necessary for him to understand radio telephony and telegraphy, to make or buy a receiving set suitable to his means, to know how to operate his set, and after he has an understanding of the radio art, information that will enable him to advance and get the most out of his outfit. All this must ordinarily be dug out of text-books, pamphlets and government publications, but the aim of this book is to have all the data and information that the beginner will need from the time that he takes up radio. It is a permanent, comprehensive reference book for the dyed-in-the-wool dabbler in Radio.

### What the Book Is.

A combination of a radio course for the novice in radio telegraphy and telephony with a reference book for the more experienced amateur. Half a dozen books in one.

### For the Beginner.

The theory of radio carefully explained with drawings.  
Description of and instruction for operating instruments of receiving and sending sets, with all picture diagrams of the wiring of the apparatus.  
How to make your own receiving set, costing from \$3.00 to \$50.00.  
How to read diagrams; for every picture diagram there is a corresponding technical diagram using the symbols instead of drawings.  
How to tune sharply and eliminate interference from other stations.  
How to protect your set from lightning and the laws regarding installation.  
Explanation of time and weather signals.

### For the More Experienced Amateur.

How to make a practical vacuum tube detector, two stage amplifier set costing less than \$50.00, that will work.  
How the radio compass works.  
All about underground aeriels, loop aeriels and directional aeriels.  
Formulas for finding wave length; miscellaneous formulae for finding capacity of condenser and other instruments. Tables of wire resistances, wave lengths and their corresponding frequencies, approximate wave lengths for different aeriels, tuning coil data, and much more invaluable information.

### Special Features.

Lists of all the broadcasting stations in the United States and Canada for concerts, time signals, weather reports, press, stock market reports, etc., with their call, wave length and time of sending.  
Detailed description of Washington weather signals and their translation.  
Description of a modern broadcasting station and its operation.  
Large map showing location of all U. S. radio telephone broadcasting stations suitable for hanging up in radio room.  
Collection of miscellaneous radio information for the amateur.

### In Other Words.

The information that you ordinarily have to dig out of government publications, text-books, pamphlets, etc., is handily combined in this one book.

The Complete Book of All Radio Information  
PRICE POSTPAID **\$2.00**

## You'll Need These Three "Little Wonder" Radio Books:

### How to Make Wireless Receiving Apparatus



The 20 radio constructors who wrote the book know how articles should be made from simple materials.  
Only modern apparatus is described, such as Receiving set without aerial or ground, magnetic detector, wireless relay, wireless lecture set, etc., etc. Book has 100 pages, each 5 x 7 inches, 90 illustrations, many full pages, paper bound, in two colors.

Price 35 Cents

### How to Make Wireless Sending Apparatus



Contains information on how to make 30 different pieces of wireless sending apparatus from materials, easily obtained.  
Tells How to Make an Experimental Arc Set, Speaking Arc, Quenched Gap, K. W. Transformer, Oscillation Transformer, Photo Phone, etc., etc.  
Book has 100 pages (size, 7 x 5 inches), 88 illustrations, paper cover printed in two colors.

Price 35 Cents

### Design and Construction of Audion Amplifying Transformers



Radio and Audio Frequency Type  
This book will be of great interest to all radio amateurs. The transformers have never before been described in print. The possessor of vacuum tubes cannot afford to do without this book. It will enable him to build the necessary amplifying transformers very readily. The book is printed on good paper and has an attractive cover in two colors. Paper bound. Size, 5 inches by 7 inches. Contains many illustrations, diagrams and working data.

Price 25 Cents

## A Thousand and One Formulas

By S. Gernsback

A Laboratory Hand Book for the Experimenter and for Everyone who wishes to "do things."

A Book brimful with very important and priceless information. The recipes and formulas are classified in such a manner as to be available quickly, without long research.

Invaluable for Students, Engineers, Physicists, Experimenters, etc.

Here are some of the chapter headings:

Cements and Glues; Composition of All Kinds; Glass and Glassworking; Inks; Leather Polishes; Metal-craft; Perfumery, Soaps and Extracts; Photography; Blue Print and other Paper; Plating; Pyrotechny; Polishes and Stains; Varnishes and Paints; Various Cleaning Formulas; Wood-craft; Chemical Laboratory Hints and Experiments; Mechanical Laboratory Hints and Experiments; Electrical Laboratory Hints and Experiments.

There are a score of tables and hundreds of illustrations and diagrams. It contains 160 pages. The paper has been specially selected to stand rough handling in laboratories.

Size, 6 x 9 inches.

Cloth bound in Vellum de Luxe, stiff covers, hand-sewed, gold stamped, each **\$1.75**

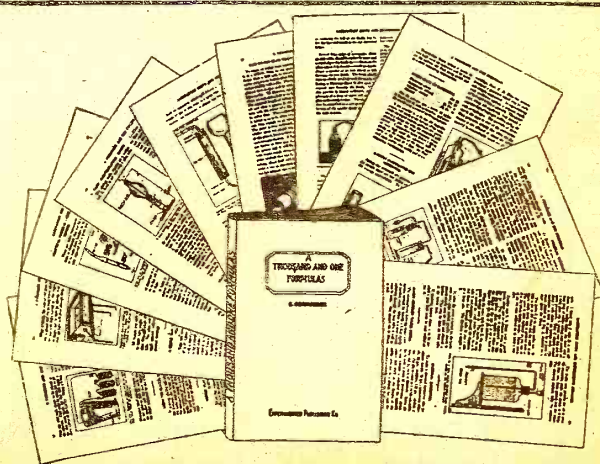

This Wonderful Volume of Formulas—  
You Should Have It In Your Home

DEALERS—Ask for wholesale discount

EXPERIMENTER PUBLISHING CO., Inc. : 53 Park Place, New York



# Know Who Is Sending

Get twice the pleasure and usefulness out of your receiving set. Look up the name and location of any ship or land station whose messages you pick up—learn the name and address of that amateur whose sending set you just heard.

## 4th EDITION OF THE CONSOLIDATED RADIO CALL BOOK

In a new large size — 280 pages — 88 more valuable pages than the 3rd Edition and featuring

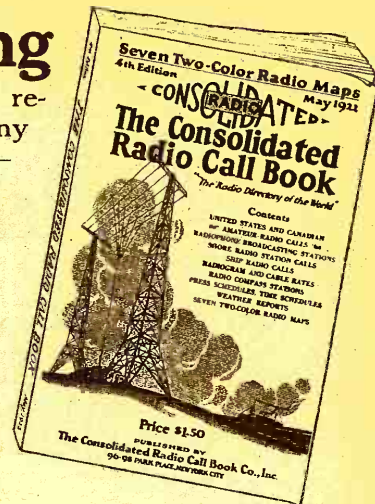

### 7 Two-Color Radio Maps

Five of them are Continental Maps showing all stations throughout the world handling commercial traffic, with their calls; one showing the amateur radio districts of the United States and the principal radiophone broadcasting stations with their calls; and a map of the United States Weather Forecast Zones. Seven wonderful, two-color radio maps with a wealth of information that will give you a great deal of pleasure and knowledge.

## Every Amateur Call in the U. S. and Canada is Listed Besides Other Valuable Information Contained in This New Book

All Amateur Radio Calls of the United States and Canada; Every Vessel, Coast Station, and Radio-Compass Station in the World; Radiophone Broadcasting Stations of the United States; Every High-Power Station in the World, Special Land Stations of the United States; Time Signals. Hydrographic and Weather Reports of the United States and Principal Foreign Countries, International Abbreviations; Assignment of International Calls; Press Schedules; Radiogram Rates; Cable Rates; International Morse Code and Continental Signals; and Complete General Information covering Distress Calls, International Safety Signal, Use of 800-Meter Wave Length, Amendments and Changes in Various Government Regulations. How to Determine Charges on Radiograms, Free Medical Advice by Radio to Vessels, and much other useful information.

And every vessel and land station in the world is represented and listed alphabetically, according both as to name of vessel or land station, and to letters. The Consolidated Radio Call Book is the only book in print officially listing all the Radio calls as issued by the Bureau of Commerce. And the New Radiophone Broadcast Section is particularly complete and gives all available information concerning calls, wave lengths, PROGRAMS, etc.

**\$1.50**

Prepaid

The third edition of 10,000 copies was exhausted in two weeks. The fourth edition is selling just as quickly. Don't wait until it is all gone. Order at once, either direct from us or from your favorite dealer.

Published by

**Consolidated Radio Call Book Co., Inc.**  
96-98 Park Place, New York City

## Great 40-Page Supplement FREE to all who have the 4th Edition Call Book

As a special service to the readers of the Fourth Edition of the Radio Call Book, we have printed, at great expense, a 40-page supplement containing the latest amateur radio calls of both the United States and Canada, and other calls issued very recently. It is absolutely free to all those who write for it, provided you have bought a copy of the fourth edition of the Consolidated Radio Call Book. This wonderful supplement brings the call book up to the very last moment and on account of the many changes that have taken place and which are fully covered by this supplement, every radio amateur or professional is urged to send for his free copy of this supplement today.

Send to us direct or get it from the dealer from whom you bought the 4th Edition Call Book.



**These Dealers Carry Our Books:**

- Atwater, H. E., Plattsburgh, N. Y.  
 B. & H. Supply Co., Providence, R. I.  
 Bullocks Hdw. Co., York, Nebraska.  
 Burlington Elec. & Nov. Co., Burlington, N. J.  
 Beard's Temple of Music, Paragould, Ark.  
 Bishop Electric Co., Johnson City, Tenn.  
 Burgess Elec. Co., Bluefield, W. Va.  
 Broadway Dept. Store, Los Angeles, Calif.  
 Brilliantone Radio Products, New York City  
 Berman Radio Co., Boston, Mass.  
 Badger Radio Co., Milwaukee, Wis.  
 Bickett Bros., Zion City, Ill.  
 Bryan, R. E., Tyler, Texas.  
 Centell Co., S., Strand, London, W. C. 2.  
 Continental Elec. Sup. Co., Washington, D. C.  
 De Laplaine, New Brunswick, N. J.  
 Diamond News Co., Havana, Cuba.  
 Dewey Sporting Goods Co., Milwaukee, Wis.  
 Eberhardt & Son Co., Astoria, L. I.  
 Evers Hardware Co., Denton, Texas.  
 Electric Shop, New Brunswick, N. J.  
 Ernest Electric Co., St. Louis, Mo.  
 Electric Auto App. Co., Denver, Colo.  
 Elite Electric Shop, El Paso, Texas.  
 Electrical Shop, Honolulu, Hawaii.  
 Electric Appliance Co., San Francisco, Calif.  
 Electric Co., (Grenda & Sether)  
 Fergus Falls, Minn.  
 Finch & Hahn, Schenectady, N. Y.  
 Foster Book & Cigar Co., St. Louis, Mo.  
 Foster Radio & Elec. Co., Wilkes-Barre, Pa.  
 Findley Electric Co., Minneapolis, Minn.  
 Flecks Electric Service Sta., Tiffin, Ohio.  
 Gee Electric Co., Wheeling, W. Va.  
 Galveston Wireless Supply Co., Galveston, Texas.  
 Goetz's Music Store, Fort Worth, Texas.  
 Huse & Sons, W. A., Providence, R. I.  
 Hunter, J. B., Boston, Mass.  
 Hubbard Elec. Co., Battle Creek, Mich.  
 Hygrade Elec. & Nov. Co., New York, N. Y.  
 Hynson Electric Co., Portland, Oregon.  
 Hill Co., Geo. A., Lowell, Mass.  
 Hentzschel, W. W., Baltimore, Md.  
 Heinemann Electric Co., Philadelphia, Pa.  
 Hamilton, H., Greensburg, Pa.  
 Interstate Elec. Co. of Ala., Birmingham, Ala.  
 International Radio Corp., Winnipeg, Man. Can.  
 International Electric Co., Wellington, New Zealand  
 Jacksons Radio Eng. Lab, Waco, Texas.  
 Knoxville Radio Co., Knoxville, Tenn.  
 King, H. W., Des Moines, Iowa.  
 Koch, John R., Charleston, W. Va.  
 Law, E. M., Norristown, Pa.  
 Laws Blythe Electric Co., Atchison, Kansas.  
 Linze Elec. Supply Co., St. Louis, Mo.  
 Modell's, New York City.  
 Mechanics Co., H. C., Fort Worth, Texas.  
 Murray Spring Co., W. A., Cincinnati, Ohio.  
 Macaulay Bros., Detroit, Mich.  
 McArthur Electric Co., Chicago, Ill.  
 Natick Book Store, Los Angeles, Calif.  
 Northwest Radio Service, Seattle, Wash.  
 Noll & Co., E. P., Philadelphia, Pa.  
 Nelsons Radio Supply Co., Phoenix, Ariz.  
 National Auto Supply Co., Terre Haute, Ind.  
 Public Library, Detroit, Mich.  
 Phila. Wireless Sales Corp., Philadelphia, Pa.  
 Perrault, F. J., Natchez, Miss.  
 Polozynski & Co., B. E., Detroit, Mich.  
 Peerless Electric Co., Minneapolis, Minn.  
 Phila. Sporting Goods Co., San Francisco, Calif.  
 Roberts Bros. Electric Co., Philadelphia, Pa.  
 Radio Eqp. Co. of Texas, Dallas, Texas.  
 Radio Concert & Eqp. Co., Los Angeles, Calif.  
 Radio Electric Shop, Cleveland, Ohio.  
 Reutter Electric Co., Cincinnati, Ohio.  
 Reynolds Radio Co., Denver, Colo.  
 Randolph, J. O., Higbee, Mo.  
 Radio Electric Co., Fort Worth, Texas.  
 Radio Chain Stores, Trenton, N. J.  
 Radio Specialty Co., New York City.  
 Self Service Phonograph Co., New York City.  
 Skokos, S., Perth Amboy, N. J.  
 Spectator, The, Bruce, Mines, Ont., Can.  
 Snell Co., Geo. W., Philadelphia, Pa.  
 Schroeder Electric Co., Albany, N. Y.  
 Smith, H. E., Batavia, N. Y.  
 Southern Elec. Co., Jacksonville, Fla.  
 S. A. S. Radio Co., Paterson, N. J.  
 Steiger & Co. E., New York City.  
 Sykes & Co., Rochester, N. Y.  
 Security Radio & Supply Co., St. Louis, Mo.  
 Superior Radio & Eqp. Co., Columbus, Ohio.  
 Steward Elec. Service Co., Urbana, Ohio.  
 Utzinger Book Store, Astoria, Oregon.  
 Universal Supply Co., St. Louis, Mo.  
 Veihl Crawford Hdw. Co., Fort Worth, Texas.  
 Vulcanizers Supply Co., Kansas City, Mo.  
 Virginia Radio Service, Medford, Ore.  
 Viking Radio Co., New York City.  
 Wile, Eugene G., Philadelphia, Pa.  
 Woodhead, L. F., Rosewell, N. M.  
 Williams Book Store, Boston, Mass.  
 Wilbur Electric Co., Baltimore, Md.  
 Williamson Electric Co., Seattle, Wash.  
 Wilson, J. L., New York City.  
 Wilson, F. B., (Archway Book Store) Seattle, Wash.  
 Zibart Bros., Nashville, Tenn.

**Get These Wonderful Radio Books**



**LOUD-TALKERS**

**HOW TO BUILD THEM**

By **H. WINFIELD SECOR**

Associate Editor of Science & Invention

This book describes how to build two distinct and different types of radio loud-talkers, which can be built with either electro-magnetic field to be excited from storage battery, as well as permanent magnet field requiring no separate battery excitation. The third chapter deals with improvised loud-talkers and gives clear and complete instructions on how to build suitable horns

for use with radio receivers of the Baldwin and other types. Several elaborate hook-ups are given of the author's own radio receiving set, comprising one stage of radio-frequency, detector and three stages of audio-frequency amplification, together with all the connections for the loud-talker.

Complete data is given for all the parts of the loud-talkers, including the field magnet windings, as well as the diaphragm or moving coil windings, and also the step-down transformer to be connected between the vacuum tube amplifier and the loud-talker proper.

In preparing these designs the point has been constantly kept in mind to use the simplest parts possible, so that practically anyone can build a successful loud-talker equivalent to the commercial types costing \$40.00 or more.

Even where the experimenter does not possess the skill or the time to make all the parts himself, which are really few in number, he may save a great deal of money, or at least half the price of a commercial loud-talker, by having the difficult parts made in a local machine shop, and then assembling them and winding the coils himself. Circuit connections and data for the size of wire, etc., are given for placing the loud-talker on a separate floor or in another part of the house not occupied by the radio receiving set. A very valuable book, giving data which cannot be obtained anywhere else and which has not been published before.

64 pages, 25 illustrations, bound in beautiful two-color cover, size 5 1/2 x 7 1/2 inches; Price prepaid, 25 cents.

**HOW TO MAKE RADIOPHONE RECEIVING SETS**

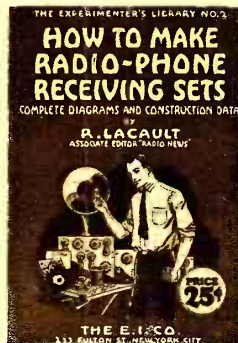

**EVERY RADIO ENTHUSIAST SHOULD HAVE A COPY OF THESE BOOKS WRITTEN BY THE FOREMOST AUTHORITIES IN EVERY BRANCH OF THE SUBJECT**

**RADIO FREQUENCY AMPLIFIERS AND HOW TO MAKE THEM**

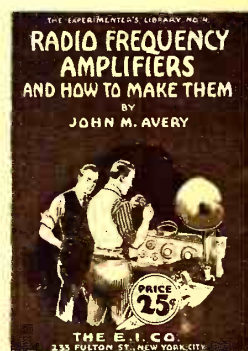

A non-technical book for the beginner. Gives complete constructional data on the building of a complete Crystal Detector Set, Tuning Coil, Loose Coupler and a Single Audion Tube Set with Amplifying Units. It furnishes all dimensions and working drawings of every part that must be constructed by the amateur. Written in plain, simple language that anyone can understand. The opening chapter gives a complete description of the theory of radio and tells what it's all about, teaching the principles of wireless so that the constructor knows what he is doing.

48 Pages, 26 Illustrations  
 Bound in Beautiful Two-Color Cover  
 Size, 5 1/2 x 7 1/2 inches. Prepaid 25c.

**25c.**

**Each**

**Postage Prepaid**

This book is for the more advanced amateur, showing the construction of the Radio Frequency Amplifying Transformer and giving complete constructional data. It shows the application of Radio Frequency to amplifying units that the amateur may already possess and gives 15 hook-ups showing practically every use Radio Frequency Amplifying Transformers can be put to.

32 Pages, 15 Illustrations  
 Bound in Beautiful Two-Color Cover  
 Size, 5 1/2 x 7 1/2 inches. Prepaid 25c.

Order from your dealer—or direct from us

**THE E. I. COMPANY** 233 FULTON STREET  
 NEW YORK CITY, N. Y.

Dealers: Write for our attractive wholesale proposition.



# NATIONAL AIRPHONE PRODUCTS

**"TALK OF THE TOWN"**  
 Gentlemen:  
 The NATIONAL AIRPHONE Radio receiving set is, to my understanding, the best crystal set made. I am receiving broadcast over a distance of fifty miles and do not doubt its capability of receiving still further. I am truly very much pleased with this set, and it is the talk of my community.  
**JOE BUSS,**  
 3617 Crestmont Av.  
 Los Angeles.

**"BEATS TUBE SET!"**  
 Dear Sirs:  
 Your splendid set received and I am more than delighted with it. I sure was surprised how simple in operation and clear-toned it is. It beats one-tube sets. Write me name of nearest AIRPHONE user to Alton. Will form club.  
**J. J. WISEMAN,**  
 Alton, Ill.

**"LOUDEST AND clearest OF ALL"**  
 NEW YORK UNIVERSITY  
 College of Engineering, Department of Mechanical Engineering  
 Dear Sir:- I wish to say that I am more than pleased with the AIRPHONE which I purchased. It gives the loudest and clearest tone of any crystal set I have seen anywhere. As I told you, I have not had much to do with vacuum tube sets as there is always distortion of the tone which is not worth enduring for any local receiving. The most noticeable feature of the AIRPHONE is the fool-proof detector which saves a great deal of irritation not to say profanity caused by tinkering with cat whiskers, and can be adjusted in the dark. I find that as soon as I hear any tone, a very light rubbing of the finger on the milled circumference of the cartridge brings out the loudest tone better than actually turning.  
**PROF. WM. F. TURNBULL.**

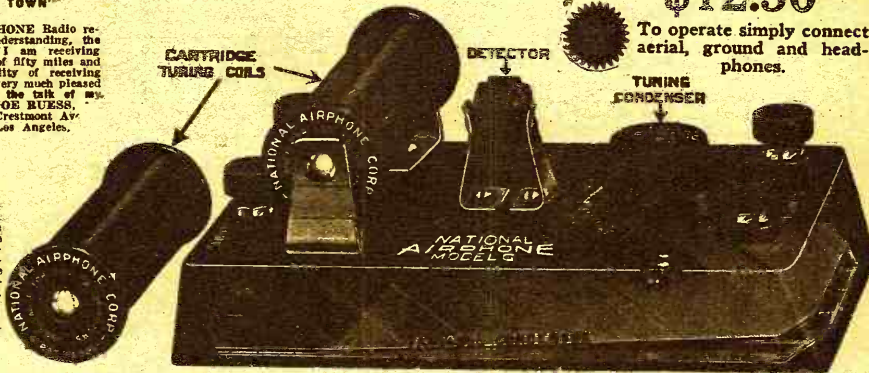

**\$12.50**

To operate simply connect aerial, ground and headphones.

PATENTS PENDING

## NATIONAL AIRPHONE (MODEL G)

Pronounced by experts as the greatest radio receiver ever made. Awarded Certificate of Merit by the "Radio News Laboratories," "New York Tribune" and "The Evening Mail" Institutes.

### OUTSTANDING POINTS OF SUPERIORITY:

1. Most compact radio receiving set made. Rugged construction throughout. Nothing to get out of order.
2. Entire casing constructed of hard rubber composition. No warping, no losses through leakage.
3. Interchangeable cartridge tuning coils give wide range over which radio broadcast and signals can be heard.
4. Two cartridge tuning coils supplied with each outfit. One takes in general broadcasting stations 150 to 400 meters, the other takes in 500 to 1000 meters.
5. Ultra-sensitive fool-proof detector, entirely enclosed in composition case. Air and dust-proof. No catwhisker, no fussy minerals.
6. Variable Mica Condenser of high capacity permits selectivity and close tuning.

## NATIONAL AIRPHONE

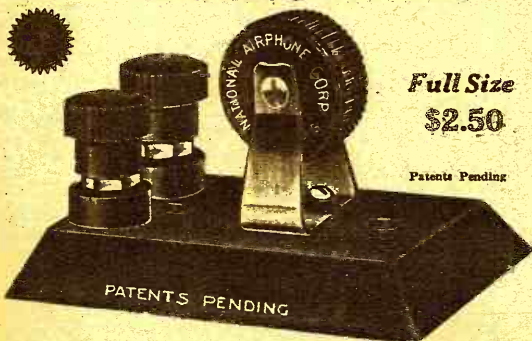

Full Size  
**\$2.50**

Patents Pending

## "GOLD-GRAIN" DETECTORS

Actual Size

After you have fussed with catwhiskers, springs, balls and adjustment handles, and after you have almost become a nervous wreck, hunting for "the elusive sensitive spot"—you will welcome with open arms our 100 per cent. **GOLD GRAIN DETECTOR.**

This Detector has no catwhiskers, no springs, no balls, no adjusting handles; no fussing; 100 per cent foolproof. The Detector is entirely enclosed in hard rubber composition cartridge, but it is NOT a fixed detector.

A special crystal is used, while contact elements are made of pure gold. There is always a multiplicity of contacts. The Detector is sealed hermetically. The contact with the crystal is always perfect.

Due to these revolutionary improvements, this Detector has been pronounced by experts to bring in signals and sounds louder than any other detector on the market. You will be surprised at the great volume of sound you are able to obtain with the **GOLD GRAIN DETECTOR.**



\$2.00

FOR PANEL MOUNTING

### You are protected by this Guarantee:

Should any National Airphone or "Gold-Grain" Detector not be in first-class condition when purchased and within five days you return it to us unbroken, or unopened, we will refund your money or give you another one as you may prefer.

**SEND NO MONEY**  
 COUPON

National Airphone Corporation,  
 18 Hudson Street, New York City, N. Y.

Gentlemen:  
 Please send me prepaid for which I will pay the postman the amount advertised on this page. If within five days I do not find the apparatus all you claim for it, or if for any reason I am not satisfied, I may return same to you in good condition and you will refund the full purchase price.

NAME .....  
 STREET AND NO. ....  
 CITY ..... STATE .....

Distributors--Write for Exclusive Territory  
 Dealers--for Price List

NATIONAL  
**AIRPHONE**  
 CORPORATION  
 18 HUDSON ST. NEW YORK



atomic weights should all be integer multiples of some unit. As, however, analytical chemistry progressed it was found that this was not the case. Enormous skill and knowledge have been brought to bear of late years upon the determination of the atomic weights and it has been found that Prout's hypothesis is not supported by facts.

Take, for instance, the atomic weight of chlorine, which is 35.46, when that of oxygen is 16. The weight of the atom chiefly resides as we have seen in the positive electron, and there must be an integer number of these positive electrons in the nucleus. The suggestion has therefore been made that there are two kinds of chlorine atom or two isotopes, one with atomic weight of 35, and the other with an atomic weight of 37. They both have the same chemical properties and ordinary chlorine gas is a mixture of these two kinds of chlorine atoms in such proportions that the average atomic weight is 35.46.

The explanation of this may lie in the fact that small variations in the ballast weight of the atom may take place without variation in the atomic properties. Thus the atomic number of chlorine is 17. One kind of chlorine atom has an atomic weight of  $35 = 2 \times 17 + 1$  and the other isotope is  $37 = 2 \times 17 + 3$ , and 1,300 atoms of ordinary chlorine gas comprise about 1,000 atoms weighing 35 and 300 weighing 37 units, equivalent to 1,300 in all, weighing 35.46 on an average.

It is a singular fact that taking the oxygen atom to weigh 16, the following atoms have nearly exact interger atomic weights, helium = 4, carbon = 12, nitrogen = 14, fluorine = 19, sodium = 23, phosphorus = 31, sulphur = 32, arsenic = 75, iodine = 127, and caesium = 133.

On the other hand, Dr. Aston, of Cambridge, working with improved methods originated by Sir Joseph Thomson, has determined with great exactness that the following elements comprise two isotopes: lithium of atomic weight 6 and 7, boron 10 and 11, neon 20 and 22, chlorine 35 and 37, argon 36 and 40, potassium 39 and 41, bromine 79 and 81. Whilst krypton, tin, xenon, mercury, magnesium and lead, have many more than two isotopes.

It appears quite clear therefore that the atomic number which gives us the total number of negative electrons circulating round the nucleus in the neutral atom is the determining factor in the chemical behavior of the atom. It is now considered that these planetary electrons are arranged in rings or shells, one outside the other.

Thus in the carbon atom of atomic number 6, there are six resultant positive units of charge in the nucleus of two shells or rings of planetary negative electrons, the inner containing two and the outer layer four negative electrons, making six electrons in all. In the oxygen atom there are eight electrons in all, viz., 4, 2, and 2 in three shells, and in the sulphur atom there are 16 in all, arranged in four shells of 8, 4, 2 and 2, reckoning from within outwards.

The electrons in these shells or zones are in rapid rotation round the nucleus, but the different groups do not necessarily all revolve in the same direction nor in the same plane.

The outer shell or layer of negative electrons in the atom is that which chiefly determines the type of chemical compound formed with other atoms and these are termed the *valency electrons*. Some of these valency electrons are easily detached in the case of metallic atoms. In a mass of metal, say, copper, there are, therefore, free electrons which are jumping about from atom to atom and moving in the inter-atomic spaces with a velocity of approximately 50 miles per second.



## Hook up your radio to these

EVERY radio fan wants his set to deliver its utmost in radio satisfaction. Batteries. It's worth getting the very best. There's no uncertainty about their performance when they're Westinghouse. These batteries are built for *highest efficiency* in radio work. They're up to the latest advancements in radio science and embody the finest engineering, materials and workmanship Westinghouse can command. Can be easily and repeatedly recharged. No more battery replacements! No more discouraging results from run-down batteries!

**Westinghouse "A" Batteries** are carefully constructed, full-capacity, slow-discharge, long-life batteries. Made in 4-, 6- and 8-volt sizes with 3, 5, 9 and 13 plates per cell, to meet various filament-battery requirements.

**Westinghouse "B" Batteries.** The Westinghouse 22-MG-2 (22 volts) is a marvel for steady, noiseless, full-powered service. Glass case; visible interior; sealed-in tops. Larger types, too; also 2-volt single cells for "C" batteries.

At radio dealers and Westinghouse Battery Service Stations everywhere. Write for illustrated folder, "Westinghouse Radio Storage Batteries."

WESTINGHOUSE UNION BATTERY CO.  
Swissvale, Pa.

# WESTINGHOUSE

## RADIO "A," "B" and "C"

### BATTERIES



**CRYSTAL RECTIFIER**  
MULTIPOINT (Patent Pending)  
A Synthetic CRYSTAL DETECTOR sensitive over its entire surface. Eliminates all detector troubles. Extraordinary clearness and volume. Endorsed by Radio experts and press. Sold in Sealed Packages only. Join the ever increasing Rusonite fan.  
Price, Postpaid, mounted 50c  
Sensitiveness guaranteed  
**RUSONITE CATWHISKER**  
14 Karat Gold Multiple Contact Super Sen-25c  
Order from your dealer or direct from us.  
**RUSONITE PRODUCTS CORP.**  
16 Park Row, N. Y. Dept. "R"

## ☸ RADIO ☸

Complete Stock—Both Sets and Parts—All Makes

**ROSE**  
**RADIO SUPPLY**

129 CAMP STREET  
New Orleans, La.

Send 10c for interest catalog







# Federal Standard Radio Head Sets

Federal Standard Head Sets are made with 2200 Ohms and 3200 Ohms resistance.

All Federal instruments are reasonably priced.

## Increase the Efficiency of Your Receiver

THE high efficiency, wide distance-range and perfect clearness of Federal Standard Head Sets are the logical result of 22 years' experience in the making of communication apparatus.

Federal Standard Head Sets include permanent magnets made only from high grade steel, treated and tested to insure permanent uniform magnetic attraction, coil cores of highly permeable magnet iron, accurate machining as to diaphragm clamping, with special attention to accuracy of air gaps between the magnetic poles.

Use Federal Standard Head Sets and get professional efficiency from your radio.

**Federal makes a complete line of Radio Apparatus**

For sale by leading dealers.

Write for descriptive literature and prices.

**Federal Telephone & Telegraph Company**  
BUFFALO, NEW YORK

## Kellogg Radio Equipment for Better Results

A better product of unusually fine workmanship

No sliding contacts

Nothing to wear

Will not produce tube noises

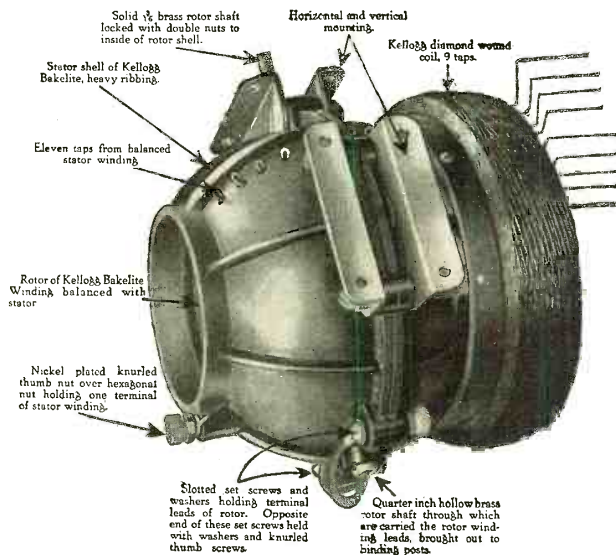

High induction and low distributed capacity

The No. 502 Diamond wound coil increases the wave length from 500 to 2500 meters

No. 501—Varicoupler \$8.00 - With No. 502 Coil as shown above \$12.00

**KELLOGG SWITCHBOARD & SUPPLY CO., CHICAGO**



## Beauty that is "more than Skin deep"

The outward beauty of Pioneer instruments *sells* them, on sight. And the *inward* beauty—their precision-workmanship, scientific design and high-grade materials; and their wonderful *performance* in every radio set—make every buyer a perpetual booster.

### VARIOMETERS and VARIOCOUPLERS

molded from Bakelite, with rich green silk-covered rotor winding and highly finished nicked brass hardware.

Send for Illustrated Circular

**PIONEER RADIO CORPORATION**

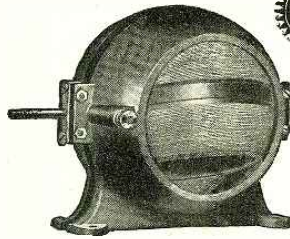

Pioneer Variometer .....\$6.50

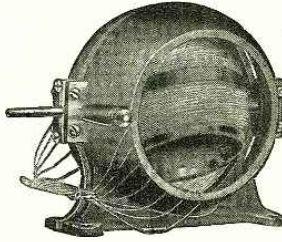

Pioneer Variocoupler....\$7.00



A negative electron revolving in an orbit is therefore equivalent to an electric current and produces a magnetic field. Hence atoms in which the negative electrons revolve in the same direction and nearly in the same plane, will exhibit magnetic polarity, and this may account for the magnetic properties of the oxygen and iron and nickel atoms.

#### RADIO ACTIVITY

A brief reference must then be made to the special qualities of the so-called radio-active elements, of which the most remarkable is the element radium.

It is found that certain of the atoms of high atomic number break up spontaneously and gradually are transformed into atoms of lower atomic number and weight. In the case of an atom like uranium, of atomic weight 238.2, the nucleus is a very bulky thing relatively to that of the hydrogen atom, which, according to a prevalent view, consists simply of a single positive electron, with a single negative electron revolving round it. The uranium atom, on the other hand, has 92 planetary electrons, and 92 effective and probably about 240 actual positive electrons packed into its nucleus, and perhaps about 148 negative electrons as well.

As the planetary electrons revolve round the nucleus they may set up strains in it or tidal actions, which may increase to such a point that the nucleus breaks up. When this is the case, we have thrown off from it either one or more negative electrons called *B*-particles or else one or more helium nucleus called *a*-particles. The helium nucleus consists of a group of four positive electrons and two negative electrons, having thus two effective positive charges. These six electrons must be bound together very tightly because the helium nucleus appears to be a remarkably permanent and indestructible article.

When the nucleus is ruptured or broken up these *a* and *B*-particles are shot off with immense velocity approximately to that of light waves, viz., 300,000 kilometers per second. In addition to this the impact of a *B*-particle against other molecules gives rise to the production of certain very short electromagnetic waves called *γ*-rays, which are like X-rays in properties.

The atoms of which the nuclei can break up in this way are called *radio-active* elements. Prominent amongst them are radium itself, thorium and uranium, all of which are atoms of large atomic weight and relatively bulky or heavy nuclei.

We all know that when a heavy flywheel is in rapid rotation it contains a store of energy measured by half the product of its so-called moment of inertia and the square of its angular velocity.

If the flywheel bursts the fragments are flung away far and wide, generally with disastrous results. In the same manner when the nucleus of a radio-active atom breaks up its *a* and *B*-particles are hurled away with such enormous velocity that they break up or ionize other atoms in their neighborhood. The nucleus may therefore be in extremely rapid rotation.

The break up of a radio-active nucleus, however, is not exactly like the bursting of a flywheel. It proceeds by various stages and the various intermediate atoms which are successfully formed have "lives" of very different duration, varying from a few minutes to many thousands of years.

Thus for instance, beginning with the atom of uranium, with atomic weight 238.5, its average life is 5,000 million years. It throws off an *a*-particle, thus reducing its atom weight by four units, to 234.5, and is

## A CONTINUOUS VERNIER

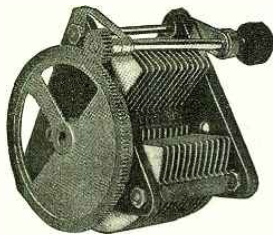

Why attach a cumbersome vernier requiring two settings to your condenser when you can get a better adjustment with but a single setting? And why accept an inferior condenser when a scientifically designed, low-loss condenser may be obtained for the same price?

For seven years the GENERAL RADIO COMPANY has been supplying radio condensers that have been a standard for low losses and excellency in construction. These condensers are found in the government and commercial laboratories as well as in thousands of amateur radio sets.

Our latest addition to our line is the equipping of our Type 247 condensers with a pinion and gear permitting of a micrometer adjustment. The price is within reach of experimenters. For example:

Type 247-H Condenser, Panel Mounting, Capacity .0005 M.F., with Slow Motion Gear Adjustment .....\$5.00

This is but one of four popular priced types. Send for FREE RADIO BULLETIN 914-N and learn about them all.

**GENERAL RADIO COMPANY** Massachusetts Avenue and Windsor Street  
CAMBRIDGE, 39, MASSACHUSETTS  
*Standardize on General Radio Company Equipment Throughout*

Do not confuse the products of the GENERAL RADIO CO. with those of the other concerns using the words "General Radio." The General Radio Co. has been manufacturing radio and scientific instruments for many years. It has no affiliation with any other concerns.

## "WALNART" Friction Vernier Knob

List Price \$0.25

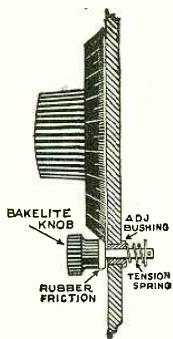

This is one of the best aids to fine tuning yet produced. To attach, just drill 1/4 inch hole in the panel, insert the bushing and shaft and replace the cotter pin. The tapered adjusting bushing takes up wear as well as inaccurate drilling and the spring

keeps the friction even and constant. No radio set is complete without the "Walnart" Friction Vernier Knob.

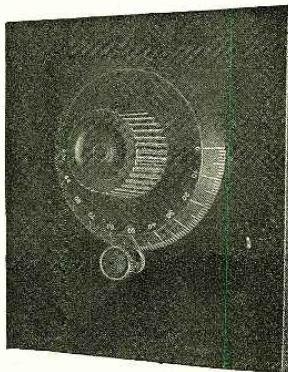

**WALNART ELECTRIC MFG. CO.**

1251 W. Van Buren Street

Dept R.

CHICAGO, ILL.

Also Makers of "Walnart" Condensers and Tube Sockets.

then transformed into a substance called uranium X<sub>1</sub>. This, however, only lasts a few days (about 25) and is then transformed into uranium X<sub>2</sub>. The latter gives off a B-particle, which does not sensibly alter the atomic weight, and is thus transformed into a far more permanent atom called uranium II, which has a life of about two million years. This, by the loss of two successive α-particles thus becomes ionium and finally radium, with an atomic weight of 226.5. This in turn gives off a gaseous "emanation," which has an atomic weight of 222.5, and is often called niton. Finally, by further losses of α and B-particles, this last substance is transformed into metallic lead, with an atomic weight of 206.5.

There is another chain or series of atomic transformations starting from uranium II which, in the end, also yields lead, but with an atomic weight of 210. Finally, from the thorium atom, there are a series of descendants ending also in lead, with an atomic weight of 208. Hence the lead atom exists in several isotopic forms, and there are atoms, all of which chemically speaking, are lead, but have different atomic weights. Accordingly, some part at least of the atomic weight of lead, viz., that over and above twice its atomic number, which is 82, has no influence on the chemical properties, for all these varieties of lead atom have the same atomic number.

Thus, in a certain sense, the dreams of the old alchemists have been realized. Although we have not been able to transform lead into gold, as they hoped, we now know that the element uranium is slowly and spontaneously changed into radium and finally into lead.

It appears therefore as if the nuclei of all atoms are built up in part of the extremely permanent helium nuclei, held together in some way by negative electrons, into a very compact mass. Possibly also free positive electrons or hydrogen nuclei may be present as well.

From certain experiments made by bombarding nitrogen and oxygen gas with α-particles, Sir Ernest Rutherford has shown that nuclei or atoms of an atomic weight of three carrying two, or it may be one, positive electric charges, are liberated. It seems as if these nuclei were composed of three positive electrons, held together by one negative electron or perhaps two.

It has been long known that the atomic weights of many elements which are integers can be represented by the general formula  $w = 4n$  or  $w = 4n + 3$ , where  $n$  is some integer. This seems to support the view that the atomic nuclei in these cases are built up of helium nuclei of mass four and of the unnamed nuclei of mass three, the atomic number being then given by  $a = 2n$  or  $2n + 1$ .

Harkins has suggested that all atomic nuclei are built up of hydrogen nuclei, helium nuclei, and the above unnamed nucleus of mass three, but having one positive charge and not two.

When the helium nuclei or α-particles are expelled from the disrupted nucleus of a radio-active atom, they are flung off with velocities which may be of the order of 20,000 kilometers per second, or, say, 12,000 miles per second, a velocity which would take them round the earth in two seconds. Since the mass of a helium nucleus or α-particle is about four times that of a hydrogen atom, or, say, nearly  $6 \times 10^{-24}$  of a gram, the energy of the α-particle is about

$$\frac{1}{2} \frac{6}{10^{24}} 4 \times 10^{18} = 12 \times 10^{-6}$$

ergs, or, say, 12 microergs.

Different capacity tubes require different capacity fuses. When ordering therefore, please state what tube fuses are for. Special size for

WD11 . . . 50c. each

201A . . . 50c. each

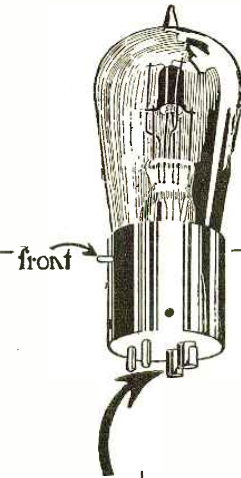

"\$6<sup>50</sup> Gone to——!"

Every second you operate without the

# RADECO SAFETY FUSE

Patent Pending

You are open to the loss of your tube. One extra notch of the rheostat, an accidental contact on the wire and,—!

The only absolute safeguard (and it is absolute) against the loss of tubes through "blowing out" is the Radeco Safety Fuse—a specially designed fuse that fits directly on the filament terminals of the tube itself where no excess current whatever can pass it to get at the filament.

The Radeco fits any standard tube used in any standard socket and does not affect the efficiency of the set. Positively reliable. Thousands in use.

4 In standard package \$1

At your dealers or by mail

## RADIO EQUIPMENT CO.

630 WASHINGTON ST.

BOSTON, MASS.

New England's Oldest Exclusive Radio House

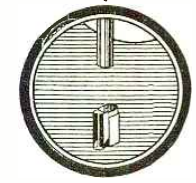

### CAUTION

Do not force fuse on filament terminals. If contact solder is rough, file or sandpaper down so that fuse slips on easily. Filament terminals are the two farthest from the locking projection on base of tube.

# MEMORIZE IN ONE HOUR

BKUMA YRLSBUG  
TRADE MARK REG. U. S. PAT. OFF.

Attentive Beginners Who Use

## DODGE TWO DOLLAR RADIO SHORT CUT SMASH ALL RECORDS

Best NINE Records reported by NINE Beginners in NINE Districts (all now Licensed Operators) AVERAGE 37 MINUTES.  
For ONE DIME will mail Records by many Beginners in all Districts who easily became Licensed Operators, and to help enlighten and encourage others, have told the story of their Quick Success.

C. K. DODGE

Dept. N, Mamaroneck, N. Y



# SIMPLICITY

## REFILLABLE FUSES

**THE LATEST DEVELOPMENT IN ELECTRICAL PROTECTION**

These new fuses are made with only two parts and the tiny refill. No tools are needed for refilling it and it can be accomplished without any danger of shocking. Women all over the country are demanding their installation to protect the lighting circuits in their homes.

**UNEQUALLED FOR RADIO WORK**

**SIMPLICITY** Fuses are the best obtainable for Radio work. They are approved in all capacities by the National Board of Underwriters and hold to the requirements of their tests exactly. Their molded insulation construction also harmonizes well with modern radio apparatus design.



**SPECIAL OFFER**

**SIMPLICITY** Fuses retail for 35c each and 3c for the refill. For a limited time we will send four fuses and a half dozen refills for \$1.00. SPECIFY RATING DESTINED.



**FOR STORAGE BATTERIES**

Better practice now demands complete protection for your "A" battery. Fasten a fuse block to your battery case—install **SIMPLICITY's** and for a few cents you are fully protected.

**COTE BROS. MFG. CORP.**  
1425 First National Bank Bldg.  
Chicago, Ill.



Choose the best insulation the Radio Industry has to offer

# Condensite

Its properties speak for themselves.

High dielectric strength.  
Strong mechanically.  
Acid and heat resistant.  
Quality finish.

Condensite Company of America  
BLOOMFIELD, N. J.



## STOP! LOOK! and ACT!

Type R-3 Radio Magnavox with 14 inch horn \$45.00, input 5 watts, premium 1 Ace 45 volt large size B battery, \$5.00 each. Type R-2 Magnavox with 18-inch horn, \$85.00, input 20 watts, premium 1 A. P. MOORHEAD or RADIOTRON amplifiers, \$5.50 each. Magnavox two stage power amplifier, \$30.00, premium 1 type C power tube, \$7.50 each. MAGNAVOX 3 stage power amplifier, \$110.00, premium 2 type C power tubes, 12 hour service or your remittance returned. F. O. B. Abilene. Satisfaction or your goods subject to return within five days.

**THE KEHLER RADIO LABORATORIES, Dept. R, ABILENE, KANSAS**

# RADIO DIARY

**\$1 and Instructor**

Keep a record of interesting "listen-ins" Good for a year—START ANY DAY. INSTRUCTOR contains full details of making outfits—setting up, etc. Illustrated. Sent postpaid for \$1. Dealers, write for proposition.

WM. W. AYRE & CO.  
Dept. C. Montclair, N. J.

## DEALERS ATTENTION!

We can furnish you with switch parts, binding posts, contact points, etc. We manufacture all kinds of Radio parts.

*Write us and get service*

**SYPHR MANUFACTURING CO.**  
1524 Fernwood Ave., Toledo, Ohio

even though it be necessary to reduce radiation to 6 amperes to obtain this effect.

**POPPET VALVES**

The most common cause of a bubbling or spluttering tone is due to air leaking into the arc chamber. Generally this leak takes place through the poppet valves. Carbon or soot which has formed in the arc chamber is exhausted through the valves due to the explosions occurring while starting an arc after long periods of rest. This soot accumulates around the valve-seats causing them to become dirty, and hindering their operation to the extent of allowing air to leak into the chamber.

To remedy this, remove the poppet valves and, if the seats are not pitted or very dirty, merely cleanse thoroughly, using gasoline and a small brush of some sort, such as an old toothbrush. Where the valves are pitted, even though slightly, procure a small amount of grinding compound from the engineers and grind each valve in its seat so as to give a firm, smooth surface. A slight touching up of the valves every month or so will do wonders in maintaining a steady tone.

I might add here that the inherent characteristics of the arc are such that the manipulation of the key must be somewhat slower and more careful than with spark transmitters, and should never exceed twenty words per minute. Characters should be executed in a heavy, drawn out manner, known among operators as "laying on the key." "Snappy" sending is difficult to read on this type of apparatus and should never be used.

### Designing and Building C. W. Power Transformers

(Continued from page 1085)

in figuring out to the exact turn the filament lighting winding. We can consider that the Primary voltage as Primary turns

Fil. Lighting V.	Fil. winding turns
Then:	
Primary voltage 110	14,666 (ratio)
Filament voltage 7.5 for radiotrons U.V.202	
Fil. winding turns 270 turns	14,666
	18.41 or 18.5 turns.

Three layers of empire cloth are placed over the primary winding and the filament lighting winding is wound right on top of it. The middle tap is taken off at nine and one-quarter turns—and must be as near center as possible for efficient operation in the self-rectifying circuit. The winding will cover about one and one-half inches of space over the primary winding. The most accurate method of obtaining the middle tap is to ascertain the length of wire required to wind one turn. Wind nine turns and then measure to the fraction of an inch the length of wire required to make one-quarter turn. When the exact spot is located—bare the wire a little and solder a connection to it, afterwards applying electricians tape until the bare spot is totally covered. From that half on consider the complete turn from that point where the tap was taken off and when nine more turns are placed on the winding measure another quarter turn as explained above and secure it to the form with electrician's tape.

**WINDING THE SECONDARY**

It will be remembered that No. 36 double cotton covered wire was selected for the

# RADIO PRODUCTS

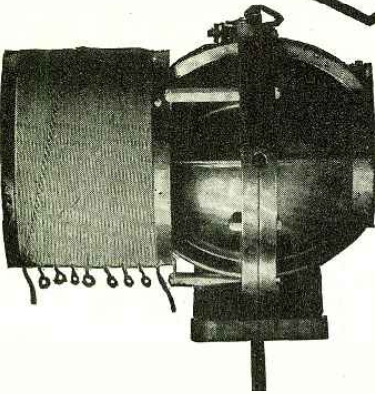

## SE-AR-DE Molded RADIOMETER

*Build Your Own Single Circuit Tuner*

CATALOGUE No. 165

### \$13.00

Range . . . . . 180-3100M  
" . . . . . 300-3280M

## R. MITCHELL & CO.

255 ATLANTIC AVENUE      BOSTON, MASS.

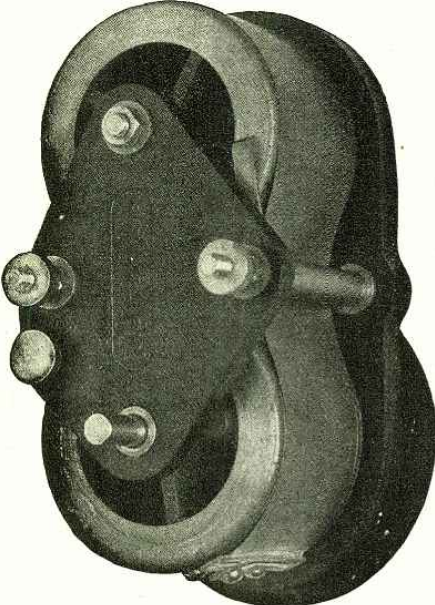

## BROOKS VARIABLE CONDENSER

Two Ribbons furnished  
Easily interchangeable  
(Max. .0005-Min. .00001)  
(Max. .001-Min. .00001)

Adaptable to all receiving circuits.  
Shorting of plates eliminated.  
Nicety of adjustment.  
Straight line capacity curve.  
Low internal resistance.  
Loud Signals.

Jobbers Wanted:  
Write for prices and discounts.

Retail Price, \$4.75 each  
Complete with dial.

Manufactured by  
**Metric Metal Works**  
of  
**American Meter Co., Inc.**  
ERIE, PA.

### \$6.50 Dry Cell Tubes \$5.00

Fits Standard Sockets

\$5.00 Detector Tubes, best grade.....	\$2.85
6.50 Amplifier Tubes, best grade.....	3.95
3.50 23-plate Variable Condensers.....	1.79
1.00 3-inch Hard Rubber Diaphragms.....	.39
.35 Grid or Phone Condensers, 2 for.....	.25
1.75 Variable B. Batteries, 22½ volts.....	1.15
4.00 Variable B. Batteries, 45 volts.....	2.35

SENT PREPAID UPON RECEIPT OF MONEY ORDER OR CASH (REGISTERED).

**PENNSYLVANIA RADIO STORES**

Mail Order Dept. R. N. 4  
203 WEST 34TH ST.      NEW YORK

## GENUINE GERMAN MAUSER

Latest model 9 shot automatic. Shoots standard cartridge—lies flat in pocket—World's famous Luger 30 cal. \$20.75 — Hand Ejector Revolver, swing out cylinder 32 cal. \$16.95, 38 cal. \$17.95. All brand new latest models. Guaranteed genuine imported. Pay on Delivery **SEND NO MONEY** Plus Postage

Satisfaction guaranteed or money promptly refunded

25 cal. Pocket Automatic; 25 cal. Blue Steel Army Automatic \$8.45; 32 cal. \$10.45; Officer's Automatic; 3 safeties, 25 cal. \$11.95; Military Trench Automatic, 32 cal. 10 shot extra magazine FREE, \$11.65. Just like you used over there. Imported Top Brake Revolver. 32 cal. \$8.65; 38 cal. \$8.95.

Universal Sales Co. 165 E'way, Desk 283 New York



FREE

Complete price list of radio parts.  
Write Aitken Radio Co.,  
504 Superior St., Toledo, Ohio.

**RADISCO RADIO PRODUCTS**  
THE RADIO DISTRIBUTING COMPANY  
Newark, New Jersey

On the other hand, the *B*-particles are thrown off from radio-active atoms with a velocity of about 0.9 of that of light, or, say, 270,000 kilometers per second. Since, however, the mass of an electron is only  $9 \times 10^{-28}$  gram, we have the kinetic energy of a *B*-particle given by

$$\frac{1}{2} \frac{9}{10^{28}} \left( \frac{9}{10} \times 3 \times 10^{10} \right)^2 = \frac{1}{3} \times 10^{-9}$$

nearly, or nearly one-third of a microerg. Therefore the single *a*-particle has 30 or 40 times the kinetic energy of the single *B*-particle.

In consequence of their very small size and of the very porous or open structure of atoms generally, the chances of a *B*-particle being stopped when fired through a volume of air, is much smaller than that of the larger *a*-particles. The *B*-particles scarcely lose half their velocity in passing through a thickness of air of one meter, whereas the *a*-particles are stopped completely by a few centimeters.

Owing to the very open or skeleton structure of atoms which has already been mentioned it is possible for the *a*-particles to pass through thin sheets of metal, but the *B*-particles can pass through plates of several millimeters, or even inches, in thickness.

In the passage of the particle it will come into close proximity with other atoms of the metal plate and be deflected from its path. Thus an *a*-particle may come close to some other atomic nucleus and will then whirl round it and be flung off in a hyperbolic path just as a comet is affected when passing round the sun. Similarly a *B*-particle will be deflected by atomic electrons.

When an *a*-particle strikes a screen covered with fluorescent material, such as zinc blende, its impact gives rise to a tiny flash of light which can be observed through a lens or microscope. This fact was utilized by Sir William Crookes in the construction of an instrument he called a *spintharoscope*, in which a minute fragment of radium salt on the head of a pin was held near a small fluorescent screen and the little flashes due to the bombardment of this target by the *a*-particles was observed through a lens.

Sir Ernest Rutherford and many other investigators have made use of this method in a highly ingenious manner to determine a maximum limit to the size of the nucleus of atoms by calculations made from observations of the deflection of an *a*-particle by a thin plate of metal.

By bombarding molecules of hydrogen gas in this manner with *a*-particles, it has been found that the centers of the hydrogen and helium nuclei must approach within a distance of  $1.7 \times 10^{-13}$  centimeter. Hence the sum of the radii of these nuclei must be if anything less than the above number.

We can conclude, therefore, that the diameter of a single positive electron such as forms probably the nucleus of a hydrogen atom, is less than  $0.8 \times 10^{-13}$  centimeter. Now this is less than the diameter of a negative electron. Moreover, since we know the mass of the hydrogen nucleus, which is  $1.66 \times 10^{-24}$  gram, we see that the density of the hydrogen nucleus or positive electron must be of the order of  $7 \times 10^{14}$ , an enormous number when compared with the mean density of atoms themselves, or masses of matter.

Hence we arrive at the conclusions that atoms are very open or porous structures, but the particles, viz., the positive and negative electrons of which they are made, have a stupendous density.

From experiments made by the deflection of *a*-particles in passing through sheets of various metals, Sir Ernest Rutherford has



concluded that the diameters of the nuclei of atoms are of the order of  $10^{-13}$  centimeter, or one billionth part of a centimeter. (To be continued.)

## Popularizing Radio Once More

(Continued from page 1805)

"In the first class, we think there should be a limited number of stations of high power with wave-lengths arranged so that they will not interfere at any point, and located where program material will always be available. These will be National stations. They should be, if possible, privileged to the greatest extent permissible, so that they may avail themselves of existing facilities such as telephone and telegraph lines, or other means of communication from point to point, for the purpose of picking up interesting features. They should, also, insofar as the public policy will permit, be privileged, if necessary, to requisition program features for this public service.

"The national stations can, if it is desired, transmit at two wave-lengths, that is, on the present wave-lengths of 360 or 400 meters and also on a wave-length, that can be relayed. The local stations should be given wave bands that will permit existing receiving apparatus to tune in on them, but these wave bands should be separated sufficiently from the national stations so as to have no interference. It is our belief that the shorter wave-lengths are desirable for the local stations, as it gives opportunity for more stations with less interference.

"As many of these local stations can be allowed as the discretionary powers of this Commission determine, with the fact of the proper service in view to make them non-interfering. Adjacent stations can be made non-interfering by proper allocation of the wave-lengths within the wave band available for this service; these local stations should hold their licenses so long as they give a service satisfactory to their listening public and to the Commission.

"In operating, these local stations would supply features of local interest and in addition would relay programs or parts of programs of the National stations, selecting from the National stations such material as would interest the listeners.

"A plan of this kind can be worked out and would, in our opinion, permit the widest possible use and development of broadcasting. The service of the local stations would allow crystal set reception of distant National stations through the relaying of their programs by the local station. On the other hand, it would not prevent those having suitable receiving sets, selecting programs at will of such of the National stations as they could receive. The privilege of operating a radio receiving set shall be subject to such rules and restrictions as the Interstate Radio Commission, acting in the interest of the Public may find it desirable to enforce."

This plan obviously would furnish a service of special importance, and especially for those who cannot afford expensive receiving sets, as it would give them the equivalent of elaborate long distance receiving sets and would place both the National and local services at their command.

### IT'S OPTIONAL AT WOC

The Radius and the Ulna are two of the bones in the forearm. Radio has become so popular that when the radio-ulna circulation was described in a scientific article, a Press Clipping bureau sent it in with Radio material.

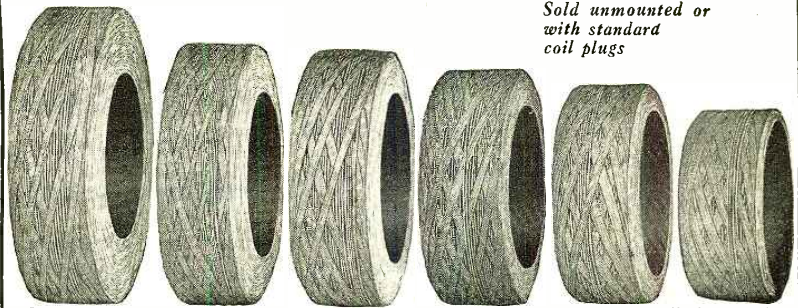

Seventeen sizes between 20 and 1500 turns. Sold unmounted or mounted on Remler coil plugs which fit any standard coil mounting.

Sold unmounted or with standard coil plugs

## Use GIBLIN-REMLER INDUCTANCE COILS

For Maximum Signal Strength With Minimum Interference

**DUE** to their special features of construction, GIBLIN-REMLER INDUCTANCE COILS have MORE INDUCTANCE, less DISTRIBUTED CAPACITY, and a LOWER HIGH-FREQUENCY RESISTANCE than any other coil, of an equal number of turns, on the market. These are the three features essential in order to obtain MAXIMUM SIGNAL STRENGTH, and MINIMUM INTERFERENCE.

In any receiving set it is always necessary to tune one or more circuits to the frequency of the incoming wave. This is done by adjusting the inductance and capacity of the circuit so that it will have no impedance to an alternating current of that particular frequency. Then, the only resistance to the incoming signal is the high-frequency resistance of the coil. This high-frequency resistance, which depends on the direct current resistance and type of winding, is lower in the GIBLIN-REMLER COIL than in coils employing any other form of winding.

This is explained largely by the fact that resistance is directly proportional to the length of the wire. In the GIBLIN-REMLER COIL all of the turns are parallel and the turns in each layer are wound close together, hence it requires fewer turns, less wire, and lower resistance to obtain a given inductance than with any other type of winding.

The LOW DISTRIBUTED CAPACITY of the GIBLIN-REMLER COIL is a big factor in obtaining MAXIMUM SIGNAL STRENGTH and MINIMUM INTERFERENCE. In a vacuum tube detector circuit the signal strength depends on the potential difference between the grid and filament of the tube. In a coupled circuit receiver the secondary coil is connected to the grid and filament of the detector tube and literally supplies this potential difference. Its distributed capacity, that is capacity between layers of the coil, tends to

short-circuit the coil and reduce the potential difference at the terminals. This is particularly true in the case of the very high-frequency current encountered when receiving the short wave lengths, that is, wave lengths between 200 and 600 meters. The amount of this loss depends upon the amount of capacity and potential across it. Capacity always decreases with an increase in the distance between two conductors. In the GIBLIN-REMLER winding the layers are spaced with a cotton yarn of high dielectric strength in such a manner as to not only reduce the total distributed capacity but also to make it a minimum at the point of greatest potential difference between layers.

A sharply tuned circuit is one that has an extremely low resistance to a current of the particular frequency to which it is tuned, and a high resistance to currents of all other frequency. In any receiving circuit there are two kinds of resistance—one, the straight high frequency of the coil, and the other, the resistance caused by the impedance of the coil and the condenser used with it. The first remains fairly constant over a small range of wave lengths. The second resistance is zero at one particular wave length and increased as the wave length varies in either direction; hence, it is easily seen that when the inductance of the coil is extremely high in proportion to the high-frequency resistance, which is the case in the GIBLIN-REMLER COIL, the circuit in which it is used may be made to have practically no resistance to signals on one particular wave length, and yet have a proportionally high resistance to signals on all other wave lengths. This condition, which is always obtained in circuits using the GIBLIN-REMLER COIL results in a SHARPLY TUNED CIRCUIT, that is, one giving MAXIMUM SIGNAL STRENGTH on the desired wave length, with a MINIMUM OF INTERFERENCE from signals on any other wave length.

Write for price list and table of constants and complete information regarding these coils

Send 10c for new 40-page Remler Catalogue containing circuit diagrams for Remler Apparatus and other useful information, including a table of inductance, capacity and wave length.

The Remler Technical Bureau is at your service. Address your problems to Dept. N.

## REMLER RADIO MANUFACTURING COMPANY

Factory and Home Office  
248 FIRST STREET, SAN FRANCISCO, CAL.

Eastern Sales Office  
154 W. LAKE STREET, CHICAGO, ILL.

## LETTER THAT RADIO SET!



Engrave your Radio Set with ELCO TRANSFERS. Make the most amateurish set look like a professional job. Come in card of 35 different words and characters; everything necessary for the most complete receiving set. Letter panels in Five Minutes. Elco transfers come in gold with black letter; enhance appearance of your set 100%. Are indestructible.

Price per Card, with Directions (in coin) 35c

If your Dealer cannot supply you, send us 35c with his name and address. DEALERS AND MANUFACTURERS Write for samples and discounts.

ELCO RADIO CO. 937 LIBERTY AVENUE  
PITTSBURGH, PA.

## Hit it anywhere!

MAGNETITE  
RADIO-CRYSTAL

The most sensitive Crystal Detector on the world market. Unaffected by handling or moisture and will render efficient service indefinitely. Price 50 cents at ALL DEALERS—or mailed direct. GUARANTEED by

GIBBONS-DUSTIN RADIO MFG. CO.

OWNERS AND NATIONAL DISTRIBUTORS

518 WEST 9TH STREET

LOS ANGELES, CALIF., U. S. A.

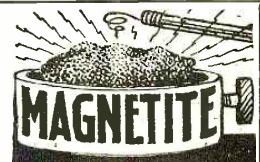

## The BEST BATTERY

for  
**Dry Cell  
Tubes**

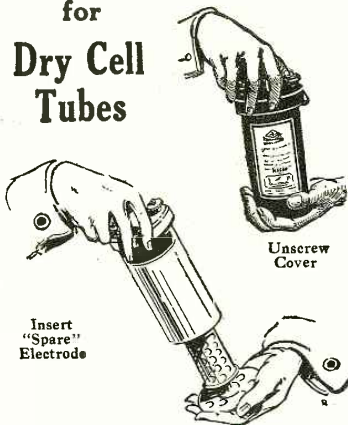

Insert  
"Spare"  
Electrode

Unscrew  
Cover

## Instantly Recharged

"Spare" electrodes exchangeable at your dealer's or direct from us at 40c each.

One 40c MAGNO electrode will operate one to three dry cell tubes. Furthermore one MAGNO charge lasts several times longer than dry cells. Voltage always sufficient, assuring long distance reception minus bothersome battery noises.

"Spare" electrodes never run down when not in use. Don't keep buying dry cells. Think of the money this battery will save you, giving at the same time ideal service. Write today for descriptive folder.

## STORAGE BATTERY MAGNO



Price only  
**\$4.00**

Exchange  
Electrode  
**40c.**

**Magno**  
Storage Battery  
Corp.

Aeolian Building  
New York

## Radio Supplies

All Standard Goods--Immediate Deliveries

Distributors for  
**BALDWIN, BRANDES and FEDERAL  
PHONES, FADA, FEDERAL and MONROE  
RECEIVING SETS**

Erla, Acme, Dubilier, Chelton, Burgess, Meyers  
Tubes, Magnavox and many others. A Complete  
Line. Largest Stock in the Middle West. Write  
for latest 64 page Catalog.

DEALERS 35% DISCOUNT

**American Radio Mfg. Co. Dept. A.**  
107 E. 13th ST. KANSAS CITY, MO.

### Genuine GANAERITE Crystals

Individually Tone Tested.  
Most Sensitive Mineral Rectifier Developed  
Mounted Crystals, Postpaid, 50c.  
Trade Discounts to Dealers and Clubs.  
Now Delivering Promptly on Large Orders.

**THE HARRIS LABORATORY**  
26 Cortlandt Street New York City

## Theory of Operation of Crystal Detectors

(Continued from page 1808)

of high resistance) and the energy in the wave train is dissipated as heat at the contact of the catwhisker wire and the crystal. The temperature of the locality of the contact is raised by this heat generation, introducing the Thompson and Peltier effects. Being a junction of dissimilar metals, a direct electromotive force is produced, giving rise to sound in the telephone receivers.

Most of the good rectifying substances are oxides or sulphides. Other good rectifiers use a metal and a non-metal contact. Among the list of the substances which give good results as contact detectors are silicon, boron, graphite, tellurium, arsenic, chalcopyrites (FeS+CuS), bornite (3Cu<sub>2</sub>SFe<sub>2</sub>S<sub>3</sub>), molybdenite (MoS<sub>2</sub>), zincite (ZnO), brookite (TiO<sub>2</sub>), iserine ([FeTe]<sub>2</sub>O<sub>3</sub>), psilomelane (MnO<sub>2</sub>), cuprite (Cu<sub>2</sub>O), cerussite (PbCO<sub>3</sub>), etc. Of these, the most common types are zincite and chalcopyrite (Perikon), zincite and bornite, iron pyrite and gold, carborundum and steel, silicon and gold, galena and graphite, platinum or copper. Some of these crystals also come under the category of the second group, such as carborundum and silicon. It is interesting to note that good contact rectifiers possess strongly contrasted photo-electric properties.

The operation of crystals of the first group is as follows:

It is assumed that the transmitter sends out wave trains that are damped and occur at an audible frequency, say 500 cycles per second. When the receiving set is tuned to the incoming wave, the potential difference that is applied to the detector is of the form A in Fig. 1. The telephone condenser acts as a low impedance by-pass for the radio frequency current around the phones and allows this potential to be applied undistorted in wave form to the detector. Assuming that our crystal is a perfect rectifier, the lower half of each oscillation will be suppressed so that the rectified current has the form B, Fig. 1. The telephone condenser stores these individual pulses which occur at radio frequency and discharges finally into the telephone receivers, the wave form of the current being indicated at C. Since these wave trains are arriving at the rate of 500 per second, hence 500 of these rectified, smoothed-out pulses actuate the receiver diaphragm, thus producing a 500 cycle note. Since the crystal is an imperfect rectifier, the wave form shown at B is not quite a true representation of the conditions actually existing in the receiver. The crystal allows a small part of the reverse cycle to pass and this negative current would be shown below the zero line of the time axis. However, the upper half of the cycle preponderates to such an extent that this reverse current detracts but little from the effective telephone current. Should a continuous wave signal be received, the telephone current exists as a more or less steady uni-directional flow due to the fact that the incoming oscillations keep the phone condenser fully charged at all times, thus supplying the telephone receiver with a steady current as shown at D, Fig. 1.

The relation between the high frequency energy received and the D. C. energy supplied to the phones is a linear function but if plotted on graph paper, does not pass through the origin, showing that there is an initial value of the high frequency energy below which rectification will not take place. The efficiency of some forms of detectors, (the ratio of D. C. energy to H. F. energy supplied) was found by Eccles to be 9.3 per cent for the carborundum detector, 13

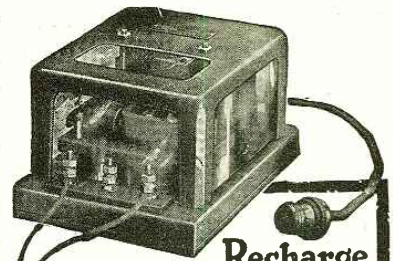

## Recharge Your Battery at Home

Charges Both A and B Radio Batteries

Don't be without the use of your Radio Receiving Set while your battery is being charged. Get a Valley Charger and charge your battery right at home.

Attach the Charger to your home lamp socket--attach the clips to the battery terminals and you will get a quick, tapering charge which just exactly charges your battery, but cannot over-charge or harm it in any way.

Will charge the A 6 volt battery at a 5 ampere rate, and the B 2 1/2 volt battery at the required 1/2 ampere rate. 46 volt B batteries may be connected in parallel so that they can also be charged.

**SATISFACTION GUARANTEED.** If your local distributor cannot supply you, write direct to

**VALLEY ELECTRIC COMPANY,**  
Department R, ST. LOUIS, MO.

----- Mail the Coupon -----  
Valley Electric Co., Dept. R, St. Louis, Mo.

Gentlemen: I am enclosing money order (or check) for \$18.00, for which send me a Valley Battery Charger with five-panel glass display case and indicator. If not satisfactory, I will return it and get my money.

Name

Address

**\$18.00**  
F.O.B. St. Louis

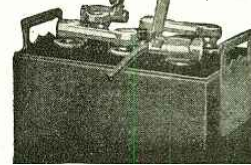

## CUT PRICES

To Consumers

	Regular List	Our List
UV 200 Tubes .....	\$ 5.00	\$4.20
UV 201 Tubes .....	6.50	5.50
WD-11 Tubes .....	6.50	5.50
Baldwin type C Phones	16.00	13.00
Magnavoxes .....	45.00	37.00
Murdock Phones, 2000 Ohm .....	5.00	4.20
Murdock Phones, 3000 Ohm .....	6.00	4.90
Acme Transformers ...	5.00	4.20
Plugs .....	1.50	.59
Rheostats .....	1.00	.50
Moulded Sockets .....	.75	.45
B Batteries, 2 1/2-volt ...	1.25	.80
Crystal Detectors ...	1.00	.60
Contact Points, per doz	.35 per doz.	.15
Switches, tapered knob	.35	.20
Honeycomb Coils, all sizes	25% discount.	
Paragon Ra 10 .....	110.00	68.00
Variometers .....	3.50	2.50
Variocouplers .....	1.50	1.10
Dreyfuss Phones .....	8.00	7.00
3-inch Dials .....	.75	.30
Rheostat Dials .....	.50	.23
No. 14 Hard-drawn Aerial Wire, C ft.....	.60 C ft.	.38

We give a discount of 10% on all standard merchandise not listed.

MAIL ORDERS ONLY No STORE TRADE

Mail check or money order.  
No stamps or currency.

## RADIO CUT PRICE CO.

320 Broadway, New York City



per cent for the Perikon detector, and about 3 per cent for a graphite-galena detector.

This brings us to the crystals of the second group. The best insight into the operation of these crystals is obtained from a study of their characteristic curves. Such a curve for carborundum is shown in Fig. 2. This curve, except for numerical magnitudes, is typical of crystals of this type. It is seen from Fig. 2, that when a small voltage is applied to the crystal and is gradually increased, the current through the crystal increases, but more rapidly than the voltage after a certain critical voltage has been applied. Up to the critical voltage, the increase in current is at a slower rate than the increase in voltage. When the voltage is reversed, the current is also reversed but it is considerably less in value for the same potentials applied, (unsymmetrical characteristic with respect to the current axis), showing that the crystal possesses unilateral conductivity also. It has been found that with carborundum, this rectifying power increases with increasing temperature, reaching a maximum sensitivity at from 400° to 500° Centigrade.

In operation such a crystal is clamped between two electrodes and a potential is applied, being regulated by a potentiometer. Thus there is a certain amount of current always flowing through the crystal. The potential of the applied EMF is adjusted so that the crystal operates on the knee of the curve, the potential being in the direction in which the crystal conducts best.

When electrical oscillations are impressed on this detector, they are super-imposed on the uni-directional current already flowing through it, thus periodically increasing and decreasing the value of the effective EMF. Since the current-voltage curve is non-linear, the current increases suddenly with the application of a small additional EMF. When the signal EMF is in the opposite direction so as to detract from the unidirectional voltage on the crystal, the decrease in current is small as compared to the increase produced by the same potential, if reversed in sign.

Fig. 3 will make this more clear. Suppose the local EMF is equal to OA. Then an increase in voltage due to an incoming oscillation, positive wave AB, causes a sudden increase of current BC-AD. By its negative wave OA, it produces a decrease in current, AD. Hence rectification takes place in a positive direction. Suppose the local EMF applied is OB. Then the oscillatory EMF produces no rectification at all for the reason that the curve is practically straight on each side of point B. Suppose the local EMF applied is equal to OF. Then the oscillatory signal EMF produces negative rectification since the negative wave produces a greater decrease in current than the increase produced by the positive wave.

The actual phenomena can be inferred by referring to Fig. 4. By adjusting the potentiometer so as to apply a voltage corresponding to the point P on the characteristic curve, the crystal is in a condition for best reception. The damped oscillatory EMF is represented by the sine wave form on the Y axis directly below P. The variation of EMF across the crystal is the algebraic sum of the unidirectional EMF applied and that due to the incoming oscillation. Since the incoming EMF is sometimes in the same direction and sometimes opposing the steady EMF, the currents through the detector assume an unsymmetrical oscillating form, which is much greater in value upwards than downwards, being almost negligible in the latter case. The root-mean-square value of this damped unsymmetrical oscillation is shown by the cross-section hatching and it is this value which is useful in actuating the telephone diaphragm.

With this additional information digested, it is hoped that the radio fan will be able



# Brandes

ARE you getting long distance radio stations—are you catching clear and distinct the faintest signals that mark the extreme range of a good receiving set? A Brandes Matched Tone Radio Headset will make the faint signals understandable. The two receivers are perfect sound-mates—they are matched in tone to improve the clearness of the message. Brandes Matched Tone Headsets are guaranteed to get the best results obtainable from any set.

Send ten cents in stamps for the "Beginner's Book of Radio." It explains radio in terms that anyone can understand.

District Offices:

76 Pearl Street, Boston, Mass.	53 South Clinton Street, Chicago, Ill.
729 Mission Street, San Francisco, Cal.	1220 Nicollet Ave., Minneapolis, Minn.
Munsey Building, Washington, D. C.	704 Granite Building, Pittsburgh, Pa.
802 Forsyth Building, Atlanta, Ga.	1028 Fourth Ave., Huntington, W. Va.

Distributors in Australia and New Zealand:  
International Electric Co., Wellington, N. Z.

Made in Canada and England by  
Canadian Brandes, Limited, Toronto and London  
Distributed in Canada by Perkins Electric, Limited  
Toronto — MONTREAL — Winnipeg

CBrandes, Inc. — 237 Lafayette St., N.Y.C.

## Matched Tone

TRADE MARK REG. U.S. PAT. OFF.

## Radio Headsets

## Spirola BETTER LOUD SPEAKERS

AT HALF THE USUAL PRICE  
Real Cabinet Type—Not Just a Common  
Horn Built Into a Cabinet  
Beautiful—Compact—A tone comparable  
only to the finest cabinet phonographs

We make a complete line—of the highest class construction throughout, with fine hand-rubbed finishes. All SPIROLAS are sold under moneyback guarantee to equal in volume and far surpass in beauty and tone any other up to twice their price.

SPIROLA DUPLEX—for use with any headset. Improved type with separate tone chamber for each phone, eliminating usual interference between phones. Satin black finish with nickel-plated fittings (Model D2)..... \$3.85

Oak (DO) or mahogany (DM) finish, bronzed throat and fittings..... \$4.85

SPIROLA SIMPLEX—for use with Baldwin or other unit. Black (SB), oak (SO) or mahogany (SM) finish, same prices as DUPLEX.

SPIROLA CONCERT—complete with built-in special unit and cord ready to attach in place of phones. Oak (CO) or mahogany (CM) finish, bronzed throat \$12.50

At Dealers or postpaid, carefully packed (C.O.D. if preferred).  
L. H. DONNELL MFG. CO., DEPT. A, BOX 70, ANN ARBOR, MICH.



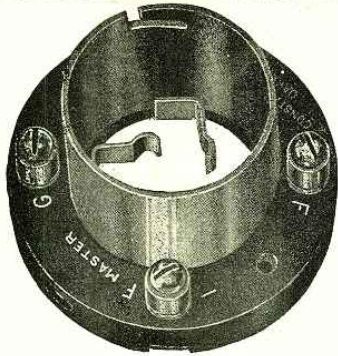

Type S401 List Price \$1.25

1/4" Spring contacts on Side of Tube prongs.

-A Better Socket  
worthy of the mark



"Our QUALITY mark"

other "Master" Products

- RHEOSTATS POTENTIOMETERS
- VARIABLE CONDENSERS
- VERNIER CONDENSERS
- BAKELITE DIALS
- AUDIO FREQUENCY TRANSFORMERS
- RADIO FREQUENCY TRANSFORMERS
- MOULDED VARIOMETERS
- MOULDED VARIOCOUPERS
- RECEIVING SETS
- RADIO FREQUENCY AMPLIFIERS
- AUDIO FREQUENCY AMPLIFIERS

Manufactured by  
**UNION CONSTRUCTION CO.**  
Electrical Division, OAKLAND, CALIF.

Jobbers, Dealers and Manufacturers  
Write for Bulletins and quantity discounts.

## RADIO ANTENNA TOWERS

Simple. Sturdy. Easy to erect. Built of galvanized steel. Will last for years. 100 ft. high or less. Fitted to take pipe mast at top. Immediate shipment. Write TODAY for prices.

Radio Department  
**STOVER MFG. & ENGINE CO.**  
FREEMPORT, ILLINOIS

to draw the last particle of performance from his receiver and establish new records for crystal reception. Experimenting with different crystals is not expensive and most chemical and radio supply houses can furnish them in any amount.

### High Frequency Resistance and Its Measurement by Means of the C. W. Oscillator

(Continued from page 1803)

requirement is met in practice by the use of very thin resistance wire having very high specific resistance. Experiment shows that wire such as manganin, German silver, etc., having high specific resistances and very small diameters, has practically constant resistance from direct current through the radio frequencies. The use of such wire as a standard will, therefore, permit of accurate measurements. A further advantage of a resistance standard having high specific resistance is that high resistances may thus be secured with very small lengths of wire.

There are a number of methods of measuring resistance at radio frequencies, each of which will be given with the necessary precautions to be observed to insure accuracy. In every case the C. W. oscillator described in the January, 1923, issue of RADIO NEWS will be used as the exciting source of oscillations to which the circuit to be measured is coupled. This C. W. oscillator will be represented as in Fig. 5.

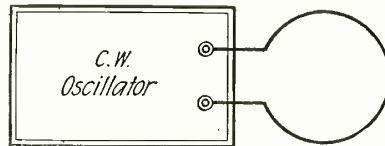

Fig. 5. The C.W. Oscillator as Referred to in This Article is Represented by This Symbol.

#### METHODS OF RESISTANCE MEASUREMENT

**Substitution Method.** In this method, the apparatus, the resistance of which is to be measured, is replaced by a standard resistance. Suppose it is desired to measure the resistance of a coil  $L_x$  at a given wave-length. Coil  $L_x$  is connected to a circuit as in Fig. 6. This circuit contains another inductance  $L$ , whose value need not be known, a variable condenser  $C$ , a milliammeter  $A$ . A double throw double pole switch is used to connect either the unknown coil  $L_x$  or the standard resistance  $R_1$  in circuit. The oscillator is adjusted to the required wave-length and loosely coupled to the measured circuit *only through coil L*. With the D. P. D. T. switch thrown so that unknown coil  $L_x$  is in circuit, tune circuit by means of the variable condenser  $C$  to resonance with the C. W. oscillator. Carefully note the reading on the R. F. milliammeter  $A$ , and call this reading  $I_1$ .

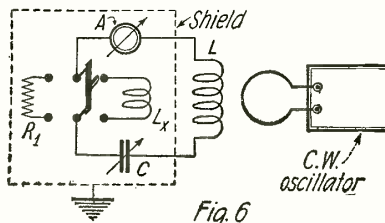

Fig. 6

Circuit of Apparatus Used for the Measurement of Resistance. In This Case a Standard Resistance is Employed.

# SOMETHING \$1.00 NEW

**SELECTIVITY AT LAST!**

The UNIVERNIER provides ultra-fine vernier adjustment.

**EASY TO INSTALL**

The UNIVERNIER is substituted for the ordinary knob in a few minutes on the shafts of Variometers, Vario-couplers, Variable Condensers, Rheostats, and Potentiometers.

**THE UNIVERNIER**

will add to the appearance of any radio set. It is an attractive knob inside of which is a simple mechanism so arranged that the knob rotates 12 times to one revolution of the shaft. By pressing lightly towards the panel, it functions as an ordinary knob, thus combining vernier and coarse adjustment in a single unit. DX results are surprising.

**THE UNIVERNIER \$1.00**

360° finely graduated silver-plated dial for use with the UNIVERNIER...25c extra

**COMPLETE \$1.25**

SEND NO MONEY—Mail us your order today for one or enough to equip your set—and pay the postman for each when delivered. Made in two sizes:  
No. 251 for 1/2 inch shaft.  
No. 188 for 3/16 inch shaft.

Dealers and Jobbers write for discounts.

**WALBERT MANUFACTURING CO.**  
935 Wrightwood Ave. Chicago, Ill.

# UNIVERNIER

## Wave Trap

TRADE MARK PATENT APPLIED FOR

**The Missing Link in RADIO**

**Stops Interference!**

Radio's latest wonder is ready for you. The Wave Trap will get you that elusive DX station through heavy interference. An attainment impossible heretofore. This remarkable little instrument will also greatly increase your range. We guarantee its satisfaction to you.

It is installed in a minute by changing only one connection, and is indispensable on any receiving set with any type of antenna. It is mounted on a formica panel in a handsome mahogany finished cabinet 6x5x6 and is a high grade instrument throughout. Write us for our circular.

**850** Perbend Electric Co.  
CHARGES PREPAID  
25 E. SOUTH WATER ST.  
**CHICAGO**

## KLOSNER RADIO PRODUCTS

Send for free literature.

KLOSNER IMPROVED APPARATUS CO.  
2024 BOSTON ROAD NEW YORK CITY



Then this current is given by the equation

$$I_1 = \frac{E}{R_x + R}$$

where E is the E. M. F. induced in coil L by the oscillator

R<sub>x</sub> is the resistance of the coil, which is to be found

R is the resistance of the rest of the circuit, which resistance is constant.

Now quickly throw the D. P. D. T. switch over so that the standard resistance is connected in place of the unknown inductance and vary condenser C until resonance is again secured with the C. W. oscillator. This is necessary since the elimination of coil L<sub>x</sub> has resulted in detuning the circuit. Adjust the standard resistance quickly until the same reading is secured on the milliammeter as before, namely I<sub>1</sub>. Let R<sub>1</sub> equal the value of the standard resistance inserted. Then

$$I_1 = \frac{E}{R_1 + R}$$

Since I<sub>1</sub>, E, and R are the same as in the above first equation it follows that the inserted resistance R<sub>1</sub> is the resistance of the coil L<sub>x</sub>. Since both measurements are carried out with the same current indicated by the ammeter, this method is sometimes called the "equal deflection" method.

**Errors and Precautions.** This method requires careful and detailed discussion in order that the reader may appreciate the difficulties encountered in accurate measurements. In the first place consider the factor R which is assumed to be constant in both measurements above. This factor R is the total resistance of condenser C, coil L and ammeter A with connections, at the wave-length used. Now since L and A are not varied we may properly assume that their resistances remain constant. However, condenser C is at a different setting in both measurements due to retuning the second time. Hence the assumption of constant resistance for C may or may not be correct, depending upon the type of condenser used. A loss-free condenser should, therefore, be used, having an air dielectric, in which case the above assumption of constant resistance is permissible.

In the second place the accuracy of the above measurement is based upon the assumption that the voltage induced in the measured circuit—factor E in the above equations—is constant in both measurements. It is permissible to assume that the C.W. oscillator generates a constant current. Hence, allowing constant coupling between the oscillator and coil L, the E. M. F., induced in coil L electromagnetically is constant. However, unless proper precautions are taken the oscillator may also induce voltages in coil L<sub>x</sub>, which is under measurement, and which is not present in the second measurement. Hence the E. M. F.'s induced will be different in both measurements and the accuracy will be worthless. To avoid this, coil L<sub>x</sub> should be removed as far as possible from the C.W. oscillator to prevent any such induction. Then again there is the great possibility that besides electro-magnetic induction there may be considerable electrostatic induction which may be different in both measurements, and especially on account of the absence of coil L<sub>x</sub> in the second measurement, would not be the same. Hence the assumption of equal induced voltages on which the accuracy of the measurement depends, would be invalid. In order to avoid this unequal induction of capacity voltages the best precaution to observe is to shield the entire circuit excluding the coil L, thus concentrating the inductive action on this coil only, since it is always in circuit during the measurements. As a further precaution the shield should be grounded as indicated in Fig. 6.



## Its Marvelous Sensitivity is Amazing the Entire Radio World

The WARE AD2 Receiver operates with any properly made loop intended for the broadcasting wave lengths

It receives local stations in any location, including steel buildings. In unshielded locations during fall, winter and spring, it brings in programs from 1000 to 3000 miles on small indoor loop.

It eliminates interference (static, in-

duction and interfering radio stations) to an extent that will prove a revelation.

It reproduces the broadcasted programs with absolutely perfect tone quality.

It requires no other knowledge to hook up and operate than is contained in the printed instructions which come with each set.

Ask Your Dealer—or Send for Descriptive Folder

Ask your dealer or send direct for descriptive folder. If we are not represented in your territory, order direct from factory. *Distributors and Dealers write for proposition.*

# WARE RADIO CORP'N

160-162 DUANE ST.  NEW YORK, N.Y.

### McTIGHE ALKALINE STORAGE "B" BATTERY

for RADIO OUTFITS



The McTighe Storage "B" Battery is now furnished in two sizes, the original 22 volt and a new 28 volt, battery, having 30 per cent more plate capacity. McTighe Batteries are absolutely noiseless, can be charged from any light socket, and are proof against damage by short circuit, overcharging or standing unused. They are furnished in oblong glass cases which nest neatly, each with its own size.

The McTighe Chemical Rectifier will charge one, two or three "B" Batteries at one time. Our Combination Magnetic Rectifier will charge 6 volt "A" Batteries or "B" Batteries up to 120 volts.

22 Volt Battery .....	\$5.00	Chemical Rectifier .....	\$1.50
28 Volt Battery .....	6.00	Magnetic Rectifier .....	20.00

F. O. B. Irwin, Pa.

**ECONOMIC APPLIANCE CO**  
IRWIN, PENNA.

Get a Handy Binder for your RADIO NEWS. Holds and preserves six issues, each of which can be inserted or removed at will. Price 65c. Experimenter Pub. Co., Inc., Book Dept., 53 Park Place, New York.

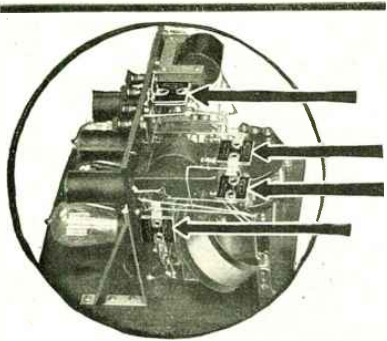

In this DeForest radio receiving set three Dubilier Micadons are used as a shunt across the transformers and one Dubilier Micadon as a grid-condenser. Dubilier Micadons are similarly used in other standard receiving sets.

### Why Dubilier Micadons are used in DeForest Sets

**P**ERFORMANCE (and therefore the reputation of a radio manufacturer) is so dependent on good condensers that in De Forest radio receiving sets and in others equally well known, Dubilier Micadons are the standard equipment.

Unless a radio receiver is fitted with Dubilier Micadons the broadcasting station is not heard at its best.

The list price of Dubilier Micadons varies from 35 cents to \$1.50 each, depending on the capacity.

Send for descriptive circular.

**DUBILIER CONDENSER AND RADIO CORPORATION**  
48-50 West Fourth St., New York

- BRANCH OFFICES**
- San Francisco, Cal., 709 Mission St.
  - Washington, D. C., Munsey Building
  - St. Louis, Mo., Syndicate Trust Bldg.
  - Chicago, Ill., 33 So. Clinton St.
  - Atlanta, Ga., Forsyth Building
  - Seattle, Wash., 1928 L. C. Smith Bldg.
  - Pittsburgh, Pa., 704 Granite Bldg.
  - Los Angeles, Cal., 337 South Western Ave.
  - Huntington, W. Va., 1028 Fourth Avenue
- Distributed in Canada by Canadian General Electric Company, Ltd., Toronto

**HYGRADE SPECIALS**

No. 763 Eveready Variable B. Battery	..... \$1.25
No. 768 Eveready Variable B. Battery	..... 2.25
No. 767 Eveready Variable B. Battery	..... 4.25
Skinderviken Transmitter Buttons	..... .95
2000-Ohm Murdock No. 56 Head Set	..... 4.49
3000-Ohm Murdock No. 56 Head Set	..... 4.98
Federal 2200-Ohm Head Set	..... 6.50
Western Electric Head Set	..... 9.75
6 Volt 20 Amp. Marke Storage Batteries	..... 8.95
6 Volt 50 Amp. are	..... 11.95
6 Volt 80 Amp. Guaranteed 2 Years	..... 15.45
6 Volt 110 Amp.	..... 18.95

All orders must include Parcel Post charges.  
**HYGRADE ELECTRICAL NOVELTY COMPANY**  
 41 West 125th St. New York, N. Y.

**UNIVERSAL  
& RESEARCH CO**

199 So. Fair Oaks Ave.  
**PASADENA CALIFORNIA**

In the above measurement we have assumed that the standard resistance necessary to produce equality of current in both measurements was available. This will be the case if the standard resistance is continuously variable, which it is not very likely to be, hence we have to consider the second case of the substitution method, namely, the case of unequal deflections.

The circuit is the same as in Fig. 6. Three observations are necessary (1). With only C, L and A in circuit, tune to the oscillator and observe the ammeter reading,  $I_1$ , which must be given by the equation

$$I_1 = \frac{E}{R}$$

where E is the constant E. M. F. induced in the circuit. R is the total circuit resistance of C, L and A.

(2) Insert coil Lx to be measured whose resistance (unknown) is Rx and again tune to the oscillator and note the ammeter reading  $I_2$ , which is given by

$$I_2 = \frac{E}{R_x + R}$$

(3) Substitute a known standard resistance Rs in place of the unknown coil Lx and again tune to the oscillator and note ammeter reading  $I_3$ , which is

$$I_3 = \frac{E}{R + R_s}$$

From these three equations, by eliminating the factors of E and R, we find that the unknown resistance Rx is given by the equation

$$R_x = \frac{I_1 - I_3}{I_3 - I_2} R$$

Thus from these three observations of current we can find the value of any unknown resistance. Since this method, in principle, is the same as the preceding method except that three readings are taken, the same precautions have to be observed as mentioned for the other method.

The method given above applies to any element of which the resistance might be desired. Thus if the resistance of condensers is to be measured, the same procedure is followed, substituting the unknown condenser for the inductance Lx.

The above substitution method is suitable if the resistance of single units is desired. However, if the resistance of a circuit is desired, as for example an antenna circuit, the following resistance variation method is used.

*Resistance Variation Method.* The cir-

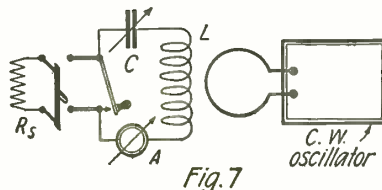

Another Method in Which the C.W. Oscillator is Used for the Measurement of Resistance

cuit used in this method is indicated in Fig. 7, in which L, A, C is the circuit whose resistance is to be found. Rs is a standard resistance whose value is known and which may be cut in and out of circuit at will by means of the single and double pole switch, as shown. The measurement is made as follows: With the standard resistance cut out of the circuit entirely, the oscillator being loosely coupled to the circuit, the variable condenser C is varied until the

Warren Radio Loop,  
Cut Away to Show  
Construction.

What  
You Can Do  
With the —

## Warren Radio Loop

**S**ELECT your stations, just by turning the loop in the direction of the station desired.

**M**AKE any set portable. This compact aerial can be packed right with the set.

**T**UNE on-ranges from 175 to 18,000 meters according to type loop.

**M**ANY other advantages described in Bulletin T-102.

If your dealer is out of Warren Radio Loops, send us your order, with his name.

*Sold by dealers who sell the best*

- Type-A-737 (300-700 meters) 6 inches square—non-directional .....\$10.
- Type-A-7236 (175-1000 meters) 6 inches square—non-directional .....\$12.
- Type-B-2537 (300-700 meters) 18 inches square—directional .....\$20.
- Type-BL-2520 (200-18,000 meters) with homecomb coil. 18 inches square—directional.....\$25.

**V-DE-CO RADIO MFG. CO.**

Asbury Park, N. J.  
Dept. N

## USE OUR FACTORY

Manufacturers and dealers who require wireless apparatus or parts can obtain quantity output and guaranteed delivery. We have over half a million dollars invested in special and automatic machinery. Wire and metal products our specialty. Send sample your product and receive our quotation on making.

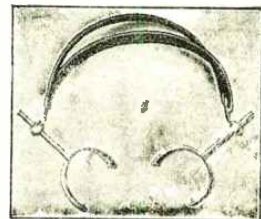

## HEADBANDS

You know this headband. We can make prompt shipment on your order. Get our prices.

**THE AUTOYRE COMPANY**  
Oakville, Conn.



circuit resonates with the oscillator. The reading of the ammeter A is then noted which reading we will call  $I_1$ . Then this current is given by

$$I_1 = \frac{E}{R_x}$$

where  $R_x$  is the resistance of the circuit which is under measurement. Now by means of the two switches the standard resistance is cut into the circuit, which standard we will call  $R_s$  and again the circuit is tuned to the oscillator. The ammeter reading is noted, which we will call  $I_2$ . This current will be given by the equation

$$I_2 = \frac{E}{R_x + R_s}$$

where E is the constant voltage induced in the circuit by means of the coupled oscillator. From the above two equations we find that

$$R_x = \frac{R_s}{\frac{I_1}{I_2} - 1}$$

from which the circuit resistance can be found. In this way the resistance of any circuit may be found, as, for example, a wavemeter, antenna, secondary circuit of a transmitter, etc.

**Errors and Precautions.** In this method, as in the previous substitution method, errors may arise due to unequal voltages being induced in both measurements, hence destroying the validity of the above calculations. To avoid this, shielding and grounding are resorted to as in the above method. Loose coupling between oscillator and circuit is absolutely essential; otherwise the introduction of resistance in the circuit may result in a different reaction on the oscillator than when the resistance is absent, in this way producing a different current in the oscillator and, therefore, changing the induced voltages. Very loose coupling will prevent any reactions between circuit and oscillator, regardless of the load in the circuit.

One of the very most important resistance measurements which ever have to be made is the measurement of antenna resistance. This measurement in practice is made almost daily, as the efficiency of any station is primarily dependent upon the resistance of antenna and ground. It is, therefore, desirable to give a special method for the measurement of antenna resistance which method has been found suitable in practice. Of course the resistance of an antenna may be measured by one of the methods above described, but the following is a special method worked out for antenna s and is called the artificial aerial method.

**Artificial Aerial Method.** The principle of this method is essentially as follows: Suppose a given voltage in the antenna under measurement produces a certain current. If we can substitute for this real antenna an artificial antenna whose constants are exactly identical with those of the real antenna and which constants are known, we should then be able to produce in this artificial antenna the same current with the same voltage, as with the real antenna. Knowing the constants we then have the resistance of our antenna. In practice, this method works out as follows:

The scheme of connections is shown in detail in Fig. 8. We have the antenna A and ground G whose total resistance is to be measured. This antenna is connected to an inductance coil  $L_1$  for coupling purposes to the oscillator, a loss-free air variable condenser  $C_1$  (zero resistance) for tuning the antenna to the wave-length at which the measurement is to be made, and a sensitive R. F. milliammeter A. On the other side of the two throw-over switches  $S_1$  and  $S_2$  we have an artificial antenna

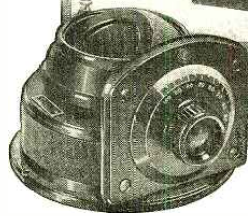
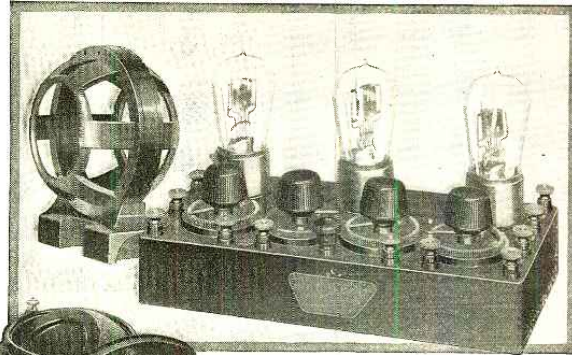

## Building Good Will with a Quality Material

The high quality of much of the Radio apparatus available today is due to the consistent policy of leading manufacturers in this field, who early adopted the phenolic resin material Bakelite, Condensite, and Redmanol, for their electrical insulation. Its uniformity assures them of a constant, unvarying standard. Its dielectric and mechanical strength, dependability, and fine finish, and its availability as a molding material, or in laminated sheets, rods, and tubes, or as varnishes and cements, have met the exacting needs of manufacture.

Write for a copy of Booklet B.

### BAKELITE CORPORATION

Address the Divisions

Bakelite, Condensite, and Redmanol are the trademark names for the phenolic resin materials manufactured by the several Divisions of the Bakelite Corporation. Each Division maintains a research laboratory which will gladly cooperate with manufacturers in the working out of new applications.

Divisions of  
**BAKELITE CORPORATION**

**BAKELITE**  
General Bakelite Co.  
8 West 40th St. New York

**Condensite**  
Condensite Co. of America  
Bloomfield, N. J.

**REDMANOL**  
Redmanol Chemical  
Products Co.  
636-678 West 22nd St.  
Chicago, Ill.

## The Material of a Thousand Uses



### CARTER "TU-WAY" Plugs and "HOLD-TITE" Jacks

Carter "TU-WAY" Plug takes ONE to FOUR phone sets at the same time. Connects with ANY kind of terminal. Price . . . . . \$1.50  
NEW CARTER VERNIER CONTROL RHEOSTAT with NICHROME wire and pigtail connection. Price . . . . . \$1.50  
NEW CARTER AUTOMATIC PLATE CIRCUIT CONTROL RHEOSTAT eliminates change-over switches, filament control jacks, and first and second stage jacks. Price . . . . . \$2.25

Sold by all good electrical and Radio Jobbers. Write for bulletin on these and other Carter products  
New Control Switches of all types.

CARTER RADIO CO. 209 S. State Street CHICAGO

Insure your copy reaching you each month. Subscribe to Radio News—\$2.50 a year. Experimenter Publishing Co., 53 Park Place, N. Y. C.

# Gould

## Radio "B" Battery

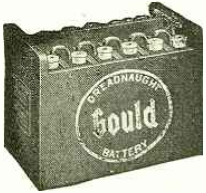

The compact Gould Radio "B" Battery, (patent applied for) is designed to prevent grounds between cells, thus doing away with noise in headset. 24 volts in variable 2-volt steps. Non-sloping hard rubber case. Will not detract from the appearance of the finest set. \$2.50 f. o. b. factory.

### Essential for Clear Reception

Noiseless operation is the goal of every radio enthusiast. Much of the noise attributed to static is actually developed in the "B" batteries. Especially is this true after the batteries have been in use for a period of time. The reason is due to the internal construction of the dry battery and other types of storage batteries not being properly designed to prevent external grounds between cells.

Freedom from noise of the Gould "B" battery is due to its internal construction and the external design of the case which makes grounding between cells practically impossible. (Patent applied for). By the use of the Gould "B" battery not only is noise eliminated, but its constant non-fluctuating voltage throughout the greater part of its discharge results in clearer reception and increased range. Costing but a few cents for recharging, the Gould Radio "B" battery is more economical and will give most satisfactory results.

On sale by Radio Dealers and over 3000 Gould Service Stations.

**GOULD STORAGE BATTERY CO.**

39 East 42nd St. New York

Plant: Depew, N. Y.

# Gould

## Radio "A" Battery



Gould Radio "A" Batteries are used by the various Radio Branches of the U. S. Government. Built for continuous service. Made in sizes from 50 A.H. to 160 A.H. \$18.00 to \$33.00, f.o.b. factory.

TRADE MARK



Galena Crystal, Mounted ..... 35c

Galena Crystal, Unmounted ..... 25c

IMMEDIATE DELIVERY

Manufacturers, Jobbers, Dealers, Write for quantity prices

**GALENA CRYSTAL MFG. CO.**  
2894 Fulton Street Brooklyn, N. Y.

Parts and Accessories for makers of radio apparatus



Details and Prices on request

**GENERAL RADIO CORPORATION**

First Quality Radio Equipment

including MUSIC MASTER RADIO AMPLIFIER

624-628 Market St. Philadelphia

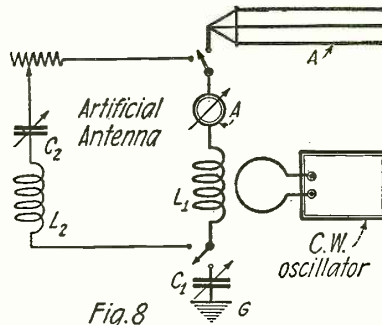

Fig. 8 System Used of the Measurement of Antenna Resistance.

composed of the following: An inductance  $L_2$ , which is equal in value to the inductance of the antenna; a variable air condenser  $C_2$  which is loss free (no resistance), and permits tuning to the required wave-length and brings the total capacity up to the total antenna capacity with  $C_1$  in series; and a variable resistance standard  $R_s$ . Thus we have in the artificial antenna the exact constants of the real antenna, except that the resistance of the antenna is concentrated in the standard  $R_s$ .

The throw over switches  $S_1$  and  $S_2$  are thrown so that the real antenna is connected in circuit. The oscillator is very loosely coupled to coil  $L_1$  and condenser  $C_1$  is adjusted so that the antenna tunes to the oscillator. The reading of the ammeter  $A$  is noted. Call it  $I$ . The throw over switches are now thrown over to the artificial antenna.  $C_2$  is now adjusted to tune to the oscillator, and the standard resistance  $R_s$  is adjusted until the ammeter  $A$  reads the same current as before, namely,  $I$ . The resistance at which this occurs is the resistance of the antenna and ground.

It will be observed that coil  $L_1$  and ammeter  $A$  are in both circuits, hence only the real antenna and ground are actually measured. Extremely loose coupling is essential in order that no reactions be produced on the oscillator. Both condensers  $C_1$  and  $C_2$  must be loss-free air condensers, otherwise their resistances will vitiate the accuracy of the measurements. There is only one possible error in this measurement, and that is the resistance of coil  $L_2$ , which is in place of the antenna inductance and which has been assumed to be zero. Actually the coil  $L_2$  has some resistance. It is neglected because the antenna generally has a very small inductance, say 20 microhenries and, therefore, a very few turns will suffice to reproduce this inductance. However, for absolutely accurate results it will be essential that the resistance of coil  $L_2$  be measured and added to the value of  $R_s$  to give the true antenna and ground resistance.

This covers in general the methods of resistance measurement. Of course there are other methods, but they depend upon the use of damped sources of oscillations, such as those produced by a buzzer and are fast coming into disuse due to uncertainty of buzzer operation, and to the superiority of C.W. oscillations for measurement purposes.

### A Super-Regenerator for Amateur C.W.

(Continued from page 1785)

$L_1$  and  $L_2$  are mounted on front of panel so that the coupling between the coils inserted therein may be varied by moving  $L_1$  to or from  $L_2$  in the regular "honeycomb" manner.

### It's the contact that counts

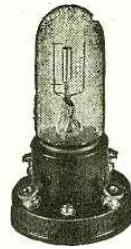

The special phosphor bronze clips of the Na-ald W. D. 11 Socket maintain perfect contact regardless of any variation in tube prongs and bases.

Moulded from genuine Condensite, these sockets are made for use with the famous W. D. 11 tubes, operated by a single cell battery.

The Na-ald De Luxe V. T. Socket is of highest quality throughout. Its laminated phosphor bronze strips press firmly with a side wipe action on the contact pins, keeping surface clean and insuring perfect contact.



Send stamp for dial, small-space socket, condenser and R.F. transformer circulars.

These sockets retail at 75c each

Alden Manufacturing Co. Formerly Alden-Napier Co. Dept. K 52 Willow Street Springfield, Mass.



## RHAMSTINE\*

Amplifying Transformer

for WD-11 Tubes

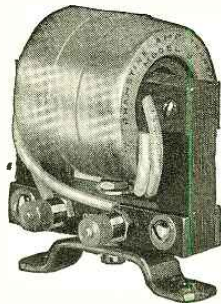

Model B

Price \$4.00

You are assured of the best results if you use the Rhamstine\* Model B Amplifying Transformers with the new dry cell tube, WD-11.

Each transformer is guaranteed to give satisfaction. Order yours today.

Dealers write for discounts.

Manufactured by

**J. THOS. RHAMSTINE\***  
2152 E. Larned St. Detroit, Mich.  
\*Maker of Radio Products

## CONQUEROR

One Knob Control Radio Receiving Set

Write

**LEWIS & DEROY RADIO CORP.**  
560 7th Ave., New York City

### "Use Copper"

In Bulletin No. 32, the U. S. Bureau of Standards says: For all wiring—antennae, grounds, etc.—use Copper.

**COPPER & BRASS**  
RESEARCH ASSOCIATION

15 Broadway • New York



L3 is also mounted on the front of the panel, but at right angles to L2.

L4 is mounted on the back of the panel in a horizontal position while L5 is mounted on back of panel in a vertical position. A regular D1-1,500 coil is used in mounting L4, while a regular D1-1,250 coil is used in mounting L5.

While the regular honeycomb type coils can be used at L1, L2 and L3, for the regenerative coils, they are not at all satisfactory for this class of work and it is advisable to make up four or five small single-layered coils for this purpose.

All regenerative coils should be wound on a form of 3" outside diameter. Bakelite is to be preferred. One cylinder should be 1 1/4" long, another 1 3/4" long, and the others 2 1/4" long. One No. 42 Remler panel plug should be purchased for each coil it is decided to make.

Each coil is then drilled in the center with a 9/64" drill with two holes 9/16" apart for the screws fixing the panel plug which is to be used as a coil plug on these coils. After winding the coil, each end is connected to one of the screw heads of the plug on the inside of the coil and the coil is complete. If desired, the whole winding may be covered with 1/64" bakelite sheeting and a nice job will result. In winding, a space approximately 1/4" is left in the center of each coil to allow for the wire to clear the plug bolts.

The 1/4" coil should be wound with 28 turns of No. 20 enameled wire.

The 1 3/4" coil should be wound with 42 turns of No. 20 enameled wire.

One 2 1/4" coil is wound with 56 turns of No. 20 enameled wire, while a second 2 1/4" cylinder is wound with 74 turns of No. 22 enameled wire.

These four coils will be sufficient to cover all waves-lengths from 175 meters up to well over 400 meters, although if desired to work at either shorter or longer wave-lengths, it is recommended that a cylinder 1 1/2" long be wound with 34 turns of No. 20 enameled wire, and another 2 1/4" long be wound with 92 turns of No. 24 enameled wire.

The 28-turn coil will be used in the primary (L1) for practically all wave-lengths up to 450 meters, the series parallel switch and large primary condenser (C1) taking care of the requirements of all ordinary amateur aerials.

The 56-turn coil must be used in the secondary (L2) and the 42-turn coil in the plate (L3) for all general amateur wave-lengths from 175 to 250 meters and may also be used on wave-lengths up to approximately 350 meters.

The wave-length reading of C2 will be approximately as follows, with these coils in service. (180-degree scale on condenser).

C2 Degrees	Wave-length
8	175
24	200
42	225
58	250
74	275
92	300
106	325
124	350
140	375

It is not advisable to carry C2 beyond this point.

The 74-turn coil should be used in the secondary and the 56-turn coil in the plate for wave-lengths between about 225 and 400 meters and they may be used for wave-lengths considerably higher.

With these coils in service the wave-length of C2 will now be approximately as follows:



Cat. No. 85

## An Improved RHEOSTAT another PACENT development

**SIMPLE — STURDY — FINELY ADJUSTABLE — EASY TO MOUNT**

You'll welcome the many advantages in the new PACENT RHEOSTAT. It is beautifully constructed, flawless in performance, the simplest to assemble or take apart when mounting. The turn of one screw separates the two units (as illustrated). Unit 1 consists of the pointer, knob and shaft moulded in one piece. Unit 2 remains intact when rheostat is separated, permitting the careful contact adjustment made at factory to remain undisturbed. Changing from panel to table mounting is simply a matter of

a few seconds. The wire element will safely carry 1 1/2 Amp. continuously. The base of the rheostat is heat-resisting and will not crack or warp. The rheostat turns with the smooth, "velvety" feel of precision instruments, making perfect control easy. Another instance of PACENT quality at reasonable cost.

The PACENT Potentiometer (same size and incorporating all the advantages of the PACENT rheostat) Catalogue No. 88, \$1.25.

WRITE FOR DESCRIPTIVE BULLETIN N-4

**DON'T IMPROVISE—"PACENTIZE"**

# PACENT ELECTRIC COMPANY

INCORPORATED

Executive Offices: 22 Park Place, New York, N. Y.

### BRANCH OFFICES

Chicago Washington, D. C.  
Philadelphia Minneapolis  
San Francisco St. Louis



Canadian and British Licensees:  
Colonial Radio, Ltd., Hamilton, Can.

Members, Radio Section, Association of Electrical Supplies

## RADIO BOXES AND CABINETS And Other Wood Products

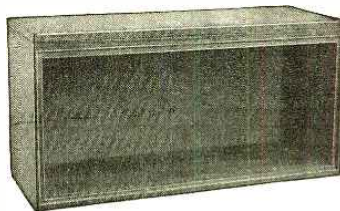

We solicit your inquiries for your Radio Box and Cabinet requirements. Will quote prices upon receipt of blue print or specifications of your special requirements.

**YOUNG MFG. CO.**  
725 SECOND ST., BELOIT, WIS., U. S. A.  
PHONE 1571



**KEEP  
A DAY AHEAD**

of the headlines of tomorrow's newspapers!

Don't be satisfied with the regular broadcasted programs! Get the most out of radiol! Hundreds of radio enthusiasts are doing it!

Equip your vacuum tube set with a  
**FINCH RADIO RELAY**

and you will automatically receive and at the same time have a permanent record of all the important and interesting news events of the world, whether or not you know the code.

Send Today for Booklet R 4

**FINCH RADIO MFG. CO.**  
303 FIFTH AVE. N.Y. CITY.



secondary winding. Number 36 D.C.C. permits 78 turns per inch. The secondary unit is to be wound in one pie in layers well insulated with thin empire cloth.\* Allowing three and one-half inches for the winding space we will be able to place 270 turns on each layer. (It figures 273 but the average winder will not be successful in putting that many on each layer—considering this in the light it should, I have allowed but 270 turns per layer.)

We must also take a middle tap from the secondary winding at 1,350 turns which is half of the total secondary winding of 2,700 turns. By dividing 1,350 by 270 we ascertain that it will require exactly five (5) layers for one-half of the secondary, and ten layers for the complete winding. Care should be exercised in winding the second secondary section to see that it is wound in the same direction as the first winding.

After the windings are placed on the core pieces and the end pieces are alternately fitted in so as to form the closed core type of transformer, the two end pieces (shown in figure 3) are slipped on and the bolts 3 are screwed down upon the lamination joints until they are as tight as it is possible to get them. These end pieces come with the phase-splitting transformer and aid materially in having the transformer perform at its greatest degree of efficiency. There are four end pieces protruding one from each side of each clamping piece. These are shown by No. 1 in Fig. 3. A piece of bakelite was cut to fit on each side of the transformer and binding posts were mounted as can be seen in the photograph. The primary winding and filament lighting source coming to one side of the transformer and all the secondary leads to the piece secured on the other side of the transformer.

Figure No. 4 shows the circuit at its best. To begin with, the middle tap of the secondary winding must be connected to the middle tap of the primary winding through a choke having a value of approximately 1.5 Henry.

In the secondary legs are two radio frequency chokes comprising ten turns No. 8 bare wire three inches in diameter—spaced one-eighth inch between turns. Two .001 condensers are connected in series and the middle tap connected to the antenna and top of inductance unit. The two ends of the secondary winding go to both sides of the condenser unit and to the two plates as shown. Both grids are in parallel and connect to the bottom end of the inductance unit through a .0005 mfd. condenser.

The 7.5-volt source is brought to the two filaments which are connected in parallel and the middle tap continues on to the bottom side of the variable condenser of .001 mfd. capacity which has its other side connected to the bottom of the tuning inductance.

For signalling a 5,000-ohm resistance was connected in series with a telegraph key—this in turn shunted across the grid-filament circuit. The radiation ammeter is connected in the ground lead. In order to further effect 100 per cent rectification and reduce the A.C. hum—two 1 mfd. condensers are connected across both the A.C. primary source and the filament lighting leads. The middle taps of the condensers are brought to ground as shown in the drawing.

**GENERAL CONSIDERATIONS**

If a separate lighting transformer was

\*The author had considerable trouble with various forms of windings. Pies are liable to break down every time and if the reader will take my advice obtained from hard work—performed in rewinding four or five secondaries in every shape and manner (and incidentally cutting several veins in my right arm on the fourth affair) he will follow the above directions out to the letter when building the secondary unit.

**W. R. C. on Radio Goods Stands for the Same as Sterling on Silver.**



**Dealers!**

Every article distributed by the Wintner Radio Corporation is subject to a rigid laboratory test.

We are manufacturers' distributors with sole rights in many states, and have available supplies for immediate delivery.

**Head Sets :: Tubes  
Variable Condensers**

- Fixed Condensers
- Variometers—Varicouplers
- Lightning Arresters
- Detectors—Sockets—Transformers
- Batteries and Battery Chargers.

**Complete assortments to start your Radio department at \$250 - \$500 - \$1000.**

**WINTNER RADIO CORPORATION**  
115 WEST 30th STREET NEW YORK CITY

Telephone 0373-0374 Watkins

**GALENA TESTED CRYSTALS — Wholesale Only**

Condensers—11—21—41 Pl. K. D. use these in your manufacturing and put them in your new catalog.

Binding posts—switch points—switches. Wireless phone tuners— all prices and types. 24-page catalog—10c.

**TRESCO - - Davenport, Pa.**

Licensed Under Armstrong Patent No. 1113149

**Newark Wireless Exchange**

We carry all makes of wireless Apparatus

Send 10 cents for catalogue

87 Halsey St., Newark, N. J.

THE crystal receiving set  
**PINK-A-TONE**  
DETECTOR of the air

Manufactured by  
PINKERTON ELECTRIC EQUIPMENT CO.  
National Service Co., General Sales Agent  
1834 Broadway, New York



### Compare These Prices

WHY PAY MORE WHEN YOU CAN GET ROCK BOTTOM PRICES FROM US

Just glance over our list and send us your Money Order. Twenty-four hours after receiving your order it is on its way to you.

LIST PRICE	OUR PRICE
\$ 5.00 Radiotrons UV-200	\$ 4.25
6.50 Radiotrons UV-201	5.75
16.00 Baldwin Phones, type C	12.00
7.75 Baldwin Units Loud Speakers	6.00
8.00 Federal 2200 Ohm Phones	6.00
8.00 Brandes Superior Phones	7.00
5.00 Acme Transformers	4.25
1.00 Double Jacks	.60
.70 Single Jacks	.50
2.50 Bull-Dog Plugs	1.25
Contact Points, per doz.	.15
Switch Levers, 1 1/2" radius	.25
45.00 Magnavox	38.00
1.50 100 ft. Stranded Aerial Wire	.60
.50 Aerial Insulators	.20
1.00 100 ft. Solid Aerial Wire	.40
75.00 Paragon RA-10 Set	68.00
25.00 90 ampere guaranteed Storage Battery	18.00
1.00 Rheostats	.75
1.00 Fada Rheostats	.75
1.00 Vacuum Tube Sockets	.65
18.50 Homchargers	15.50
3.50 B. Batteries volt meters 0-50 V.	2.75
55.00 Western Electric New Style Loud Speakers	42.75
.75 Rheostats	.60
3.00 B. Batteries	2.25
2.50 B. Batteries	2.00
1.75 B. Batteries	1.10
1.50 Dials	.75
1.00 Dials	.40
2.75 De Forest Detectors	1.95
.75 Sockets	.60
6.50 Westinghouse WD-11 Tubes, operated on 1 Dry Cell.	5.98
1.00 Westinghouse WD-11 Sockets	.65
4.50 Thordarson Transformers	3.75
2.00 Potentiometers	1.25
1/2 Megohm Grid Leaks	.60
1/2 Megohm Grid Leaks	.65
1.00 Grid Leak Holders	.65
1.00 Double Phone Cords	.60
.50 Single Phone Cords	.35
Duplex Phone Adapters, fits Edison, Victor or Columbia.	1.75
Genuine Bakelite Panels, per sq. in.	.02
Spaghetti, per ft.	.09
12.00 Genuine Western Electric Signal Corps V.T.-2 Tubes	9.00
112.00 De Forest type Honeycomb Set, special Mahogany Cabinet	65.00
3.00 Racony Electric Light Aerial	2.00
35.00 Audmix Loud Speakers	18.50
6.50 Turney 3,000 Ohm Phones	4.25
4.50 Diamond 2,000 Ohm Phones	3.75
5.00 Fischer Variometers	3.75
6.00 Fischer Variometers	4.75
5.00 Fischer VarioCouplers	3.75
6.00 Fischer VarioCouplers	4.75
8.00 Atwater-Kent Variometers	7.00
8.00 Atwater-Kent VarioCouplers	7.00
5.00 Pathe Variometers	3.75
14.00 Atwater-Kent Mounted VarioCouplers	11.75
16.00 Atwater-Kent 2-step amplifier	13.75
8.50 Everet Head Phones, 3,000 Ohms	4.95
1.50 Thordarson Rheostats	1.15
Bus Wire for wiring sets, per ft.	.02

Honeycomb coils, all sizes, 20% discount. Space being limited, we are obliged to omit many items.

Write for our Quotations

### Cut Rate Radio Co.

Dept. A Newark, N. J. P. O. Box 472

### Cardboard TUBES FOR Paper WIRELESS

2 1/2, 3, 3 1/4, 3 3/4 in. O. D. Per foot 30c  
4, 4 1/4, 4 1/2, 4 3/4 in. O. D. " " 35c  
5 and 5 1/2 in. Outside Diameter " " 40c  
6 in. Outside Diameter " " 50c

Postage Extra, Shipping Wt. 1 lb. per foot Dealers, write for special price list

BAEHM PAPER CO., INC. 219 FULTON STREET, NEW YORK

### VERNIER

CONDENSERS —Direct from manufacturers — capacity .0005, electrically and mechanically perfect—Guaranteed. Price with knob only \$2.50 Postpaid.

HEARWEL CO., Mfrs.

63 DEVONSHIRE STREET BOSTON, MASS.

C2 Degrees	Wave-length
8	225
16	250
26	275
36	300
46	325
56	350
66	375
76	400
87	425
98	450

The operation of the set is very simple and if the set has been laid out and assembled as instructed, no trouble should be experienced. The filament is lighted at approximately normal brilliancy and the "B" battery of 45 to 90 volts connected up. Neither are critical and time should not be wasted on them. C3 controls the oscillator circuit and with the "B" battery connected, the filament lighted and coils C2 and C3 in position, a faint AF hum should be heard in the phones as soon as it is advanced a little above the zero position. The further C3 is advanced the louder the hum will become, but for distance C3 must be used as close as possible to the point where the AF hum is first heard, just far enough above it to keep oscillations steady.

A little trouble may be experienced in this at first, due to the oscillator starting up with the regenerative coils and aerial circuit out of balance, which causes a big racket in the receivers. The noise will let up as soon as C1 and C2 are swung to balance each other at any wave-length. The approximate position for C3 is between 40 and 50 degrees with 45 volts "B" battery. With more battery or if the tube is not as hard as it should be, this position will be lower.

The moment the set clears up by adjusting C1 and C2, signals will begin to come in and the fine points of adjusting will be learned in a very short while. The coupling between primary and secondary plays an important part in selectivity, and it will be noted early that the higher the capacity of C2, the looser should be the coupling for best general results.

While this type of super regenerator is an excellent instrument of great sensitivity, it has its limitations and too much must not be expected of it, especially at first, as it takes a little while to fully learn its characteristics. While much more selective than the usual forms of super-regenerative circuits, it is not quite as selective as a standard regenerative set. It almost entirely rejects spark stations, only the strongest getting through at all, and these in a low cracky tone almost or entirely unreadable. It is highly influenced by the "mush" from a nearby high-power arc station and will be quite noisy under this kind of interference.

It can be used to advantage on small indoor aerials when interference or static makes operations unsatisfactory on a regular outdoor aerial, and will give some surprising results under favorable conditions from indoor aerials; several stations on the Pacific Coast, all well over 2,300 miles distant from here, have been recorded on this type of aerial at night.

By far the greatest benefit to be derived from super regeneration by the average amateur is from operating on a regular aerial in daylight and if only one day per week is available to operate in daylight it will amply repay you to build a set of this kind, especially for this service.

With your regenerative sets, you have no doubt listened to stations fade out one by one, shortly after sunrise. Sometimes you are able to hold a few of the distant ones for probably an hour or so, but finally all but the usual daylight bunch will have vanished and you wish for something just a bit more sensitive, something that will allow you to hold that distant station longer. In this type of "super" you have that wish granted, granted even better than you had wished for, as you can hold on to the re-

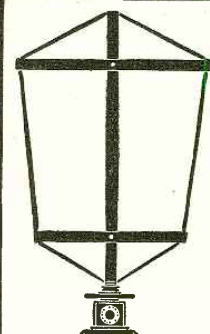

Eliminate the Aerial and Obtain Better Reception with the NASSAU



Pat. Pending  
Price \$35.00  
Jobbers and Dealers Write for Proposition

The Secret is in the Patented Winding 1500 MILES ON LOUD SPEAKER

With 2 stages radio and 2 stages audio frequency amplification.  
Write for Circular "R"

Manufactured by  
**NASSAU RADIO CO., Inc.**  
60 Court St., Brooklyn, N. Y.

### "SUPERLATIVE" AMPLIFICATION

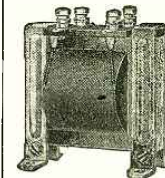

No. 41

You Can Increase Your Range Eliminate Howling and Distortion Bring Out the Full Clear Tone in Volume

### JEFFERSON Amplifying Transformers

Furnished in two types either mounted or unmounted. Coils specially wound with No. 40 and No. 44 wire on a core of the finest rolled Silicon steel.

SEND FOR RADIO BULLETIN Prompt Deliveries  
JEFFERSON ELECTRIC MFG. COMPANY  
424 S. Green St., CHICAGO

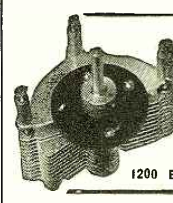

VARIABLE CONDENSERS  
3-Plate Vernier .....\$0.75  
23-Plate .0005 Mid. .... 1.75  
43-Plate .001 Mid. .... 2.25  
24-Plate Balanced Cond. 3.75  
44-Plate Balanced Cond. 4.75  
Aluminum Plates, accurate spacing. Please send 10¢ additional for postage.  
Money back if you are not satisfied.  
MONTROSE MFG. CO.  
1200 Bedford Ave., Brooklyn, N. Y.

### ENGRAVING MACHINES

For RADIO PANELS And Other Radio Engraving  
ENGRAVERS & PRINTERS MACHINERY CO.  
Sag Harbor, New York





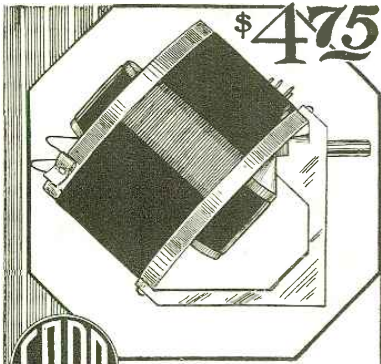

**Vario-Coupler**

The fastest selling vario-coupler on the market. Technically O. K. and the price is right.



**Inductance Switch**

A mighty fine switch. The knob matches Fada Rheostat knob.

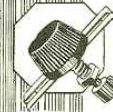

**Series-Parallel Switch**

Changes quickly from circuit to circuit. The handiest switch for experimenters.



**Power Rheostat**

Will control three or four radio frequency amplifier tubes.

Send 10¢ for Fada Handbook. Plumb full of radio facts.

**F. A. D. Andrea**

1581A Jerome Ave., N. Y. C.

**FADA RADIO PARTS**



So numerous have been the requests for Chi-Rad Handbooks that we are forced to make this small mailing charge.

The latest edition, just off the press, contains 48 pages of valuable information. It contains:

1. Technical descriptions of practically all standard radio equipment.
2. Detailed instructions complete with circuits and illustrations on "How to Build the Reinartz Receiver."
3. Radio definitions, wire tables, wireless codes, etc.

Wrap a dime up in this ad and mail it to us today—Handbooks will be mailed out in the order in which we receive requests.

**Chicago Radio Apparatus Co.**  
415 S. Dearborn Street  
Chicago

magnet type, but it will be understood that (except by introducing complications) the latter type of model motor is the simplest form to control, as it will be observed in subsequent articles (when I shall furnish a wiring diagram of the complete receiving apparatus) that the conductor, and outer rails of a model electric railway, will be simply connected to terminals Nos. 5 and 6 (Fig. 3).

(To be continued in the next issue)

**More from England**

(Continued from page 1801)

current, as it would repay me for the trouble of getting up at about 3 A.M.

Well, here are the stations: 1BD1, 1CVE, 1AD, 1CKR, 1ARY, 1BAS, 1BES, 1UN, 1GV, 1BYG, 1CRW, 1XM, 1ACK, 1KMR, 2GK, 2AWL, 2NR, 2ZK, 2CYZ, 2CYG, 1CZ, 2ZS, 2HW, 2ATS, 3CT, 3ARK, 3BFU, 8CK, 8AQO, 8XE, 8BEO, 8VE, 2AWP, NOF.

The aerial is about 40' high and the receiver is of the single circuit type with tickler feed back. I hope to be able to listen again during April and also hope that I will get some speech from the amateurs. I have already received speech and music from six different broadcasting stations.

C. W. GOYDER,

44 Hale Lane, Mill Hill,  
London, N. W. 7, England.

**Radio Shower Party**

(Continued from page 1789)

Phone Diagrams and Hook-ups of Crystal and Audion Receiving Circuits, Amplifier Circuits, Regenerative Circuits, Sending Circuits, with Key Chart of Symbols, and Pamphlet, How to Read Diagrams; 1 Fourteen Radio Formulae and Diagrams; 1 Complete and Detailed Instructions, How to Build and Install Every Known Aerial for the Amateur—Consolidated Radio Call Book

32. 1 Variometer—F. R. S. Radio Corp.
33. 1 Year's Subscription to SCIENCE & INVENTION—Experimenter Publishing Co.
34. 1 Year's Subscription to RADIO NEWS—Experimenter Publishing Co.
35. 1 A. C. H. Sharp Tuner Dial—A. C. Hayden Radio & Research Corp.
36. 1 A. C. H. Sharp Tuner Dial—A. C. Hayden Radio & Research Corp.
37. 1 Brach Lightning Arrester—L. S. Brach Mfg. Co.
38. 1 Formica Panel—The Formica Insulation Co.
39. 1 Year's Subscription to PRACTICAL ELECTRICS—Practical Electrics Co., Inc.
40. 1 Westwre Condenser—The Westwre Co.
41. 1 Bradleyometer—The Allen Bradley Co.
- 41.A 1 Antenna Plug—Chas. Freshman Co. Inc.
- 41.B 1 Variable Resistance Leak with .00025 Micon Condenser—Chas. Freshman Co. Inc.
42. 1 Memory Course—C. K. Dodge.
43. 1 Bradleystat—Allen Bradley Co.
44. 1 Klosner Model 200 Vernier Rheostat—Klosner Apparatus Co.
45. 1 Resistance Unit and Mountings—Daven Radio Co.
46. 1 Pair Bates Ear-Cushions for Head Sets—Bates & Company.
47. 1 Consolidated Radio Call Book—Consolidated Radio Call Book Co.
48. 1 Autostat—Automatic Electrical Devices Co.
49. 1 Autostat—Automatic Electrical Devices Co.
50. 1 Barkeley Four Phone Plug—The Barkeley Electric Mfg. Co.
51. 1 Shur Grip Plug—Martin-Copeland Co.
52. 1 Bradleyadapter—Allen Bradley Co.
53. 1 Bradleyswitch—Allen Bradley Co.
54. 1 Battery Testing Outfit—The Chaslyn Co.
55. 1 Saturn Perfect Jack—Saturn Mfg. & Sales.
56. 1 Radiogem Receiving Set—Radiogem Corp.
57. 1 Saturn Automatic Plug—Saturn Mfg. & Sales Co.
58. 1 Set Phone Clips—Star Mfg. Co.
59. 5 W. D. 11 Fuses—Radio Equipment Co.
60. 1 .006 Micon Condenser—Chas. Freshman Co. Inc.

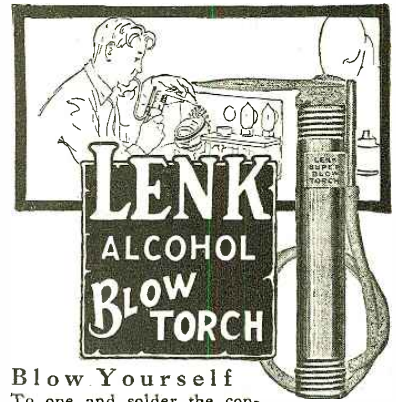

**Blow Yourself**

To one and solder the connections on your Radio set. Fine for close, careful work. Produces a 1400° needle-point flame instantly. Just the tool for fixing the wiring on your car, repairing electric fixtures, mending kitchen utensils.

Used by Electricians and Mechanics everywhere 60° coil self-fluxing (acid or rosin core) solder. 25c  
Lenk "Jumbo" ("Mouth Blow") torch ..... \$1.00  
Lenk Automatic (blows itself) Torch ..... 1.50  
Marvel Soldering Kit—one Lenk Automatic and one coil each of self-fluxing acid and rosin core solder, in neat leatherette case ..... 2.00  
If your local dealer cannot supply you, order direct.

**LENK MANUFACTURING CO.**  
38 PORTLAND ST. BOSTON, MASS.

**They Speak for Themselves**

**STANDARD RADIO HORNS**

Any make of receiver will fit patented attachment and base. Rubberoid black Enameled finish baked on.

**THREE SIZES**

- No. 114—14" Bell, 24" high, List ..... \$12.00
- No. 17—7" Bell, 19" high, List ..... \$7.50
- No. 15—5" Bell, 14" high, List ..... \$5.00

Also Gem—11" Bell, 14" high, 16" long, List ..... \$7.50

Write for particulars

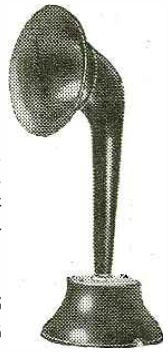

Manufacturers! Let us quote you prices on special horns to meet your requirements

**Standard Metal Mfg. Co.**

231 Chestnut St.

Newark N. J.

**TWO SUPERSENSITIVE CIRCUITS**

(Both Copyrighted)

My Highly Improved Reinartz brings in all important stations on both coasts and Mexican border, loud, clear and without distortion. We dance to music from Atlanta received on one loud Baldwin unit. Build one of these wonderful sets from my blueprints and specifications, price 50c, or with a perfect and complete double wound spiderweb coil, \$3.00 by mail. No other windings used. Photo of my set on a glass panel with every order.

My W. D. 11 Circuit is especially designed for use with the "Pickler" tube and brings out the full value of that little tube as no other circuit can. Stations 1000 miles away come in clearly on one tube. This set is small, complete, portable. For the man who wishes the highest efficiency this is the set to build. Price of blueprint and specifications \$1.00, or with complete and perfect windings \$5.00. Photo of set with every order. Either set is cheap and easy to build, easy to operate. Everything clearly shown.

S. A. Twitchell, 1927 Western Ave., Minneapolis, Minn.

**CUT RATE RADIO**

Standard apparatus only. Write for 54 Page Catalog of Bargains.

- Baldwin Type "O" Phones ..... \$10.25
- Brandes Superior Phones ..... 6.45
- Radiotron U V 200 Detector Tubes ..... 4.25
- Aene Audio Transformers ..... 4.45

Everything for Radio at less. Immediate Delivery.  
**Federal Radio Electric Co., Dept. A**  
1235 GRAND AVE. KANSAS CITY, MO.

**Zone No. 10**

Ohio, Kentucky, Indiana, Illinois, Michigan and Wisconsin

1. 1 Certified Radiotrician Course—National Radio Institute.
2. 1 RORN Tuned Radio Frequency Amplifier Unit—A. H. Grebe & Co., Inc.
3. 1 D412 Detector and Two Stage Amplifier—Acme Apparatus Co., and 1 W. T. 501 Peanut Tube and Adapter
4. 2 Rasla Radio Frequency Transformers and 2 Rasla Audio Frequency Transformers—Rasla Sales Corp., National Distributor of Radio Service Laboratories.
5. 1 Omnigraph Code Machine—The Omnigraph Co.
6. 1 National Airphone Crystal Set, Model "G"—National Airphone Co., and 1 W. T. 501 Peanut Tube and Adapter—Radio Research Guild.
7. 1 Ricohorn—Radio Industries Corp., and 1 Carter Two-way Plug—Carter Radio Co.
8. 1 Crystal Set—Standard Radio & Elec. Co., and 1 W. T. 501 Peanut Tube and Adapter—Radio Research Guild.
9. 4 No. 269 22½-Volt Variable "B" Batteries Novo Mfg. Co., Inc.
10. 1 Set Constructional Drawings of Ten Tube Super-Hetrodyne—Experimenters Information Service.
11. 1 Gould Radio "B" Battery—Gould Storage Battery Co.
12. 1 Dictograph 3000 Ohm Head Set—Dictograph Products Corp., and 1 Carter Two-way Plug—Carter Radio Co.
13. 1 300 A. General Amplifying Unit—General Radio Co.
14. 1 Trimm "Professional" 3000 Ohm Head Set—Trimm Radio Mfg. Co., and 1 Carter Two-way Plug—Carter Radio Co.
15. 1 Wood Horn Loud Speaker—Inter-Ocean Radio Corp., and 1 Carter Two-way Plug—Carter Radio Co.
16. 1 Marco Tuner—Martin-Copeland Co.
17. 1 Connecticut Variable Condenser—Connecticut Telephone & Electric Co.
18. 1 Goodman Wave Tuner—L. W. Goodman.
19. 1 Cole Audio Frequency Transformer—A. B. Cole Corp.
20. 1 Frost 3000 Ohm Head Set—Herbert H. Frost, and 1 No. 138 Multiple Fone Plug—Herbert H. Frost.
21. 1 Murdock Loud Speaker—Wm. J. Murdock Co., and 1 Carter Two-way Plug—Carter Radio Co.
22. 1 Murdock Head Set No. 56—Wm. J. Murdock Co., and 1 Carter Two-way Plug—Carter Radio Co.
23. 1 Double Head Set—Radio Industries Corp., and 1 Carter Two-way Plug—Carter Radio Co.
24. 1 Membership in The Radio Guild Co-operative Service Bureau—The Radio Guild.
25. 1 Audio Frequency Transformer—Connecticut Telephone & Electric Co.
26. 1 Pada Variocoupler—Frank A. D. Andrea.
27. 1 Large Type "B" Battery—Hipwell Mfg. Co.
28. 1 22½-Volt Defelco "B" Battery—Defelco Battery Corp.
29. 1 45-Volt "B" Battery—National Electrical Novelty Corp.
30. 1 WorkRite Variocoupler—WorkRite Mfg. Co.
31. 1 WorkRite Variometer—WorkRite Mfg. Co.
32. 1 No. 1 Complete Patterns, Diagrams & Instructions for Making Short Wave Regenerative Set; 1 No. 2 Complete Patterns, Diagrams & Instructions for Making Detector and Amplifier Radio Units; 1 No. 3 Complete Instructions and Blue Prints for Making Radiophone Crystal Set; 1 Twenty Radio Phone Diagrams and Hook-ups of Crystal and Audion Receiving Circuits, Amplifier Circuits, Regenerative Circuits, with Key Chart of Symbols and Pamphlet, How to Read Diagrams; 1 Fourteen Radio Formulae and Diagrams; 1 Complete and Detailed Instructions, How to Build and Install Every Known Aerial for the Amateur—Consolidated Radio Call Book Co.
33. 1 Variometer—F. R. S. Radio Corp.
34. 1 Year's Subscription to SCIENCE & INVENTION—Experimenter Publishing Co.
35. 1 Year's Subscription to RADIO NEWS—Experimenter Publishing Co.
36. 1 A. C. H. Sharp Tuner Dial—A. C. Hayden Radio & Research Corp.
37. 1 A. C. H. Sharp Tuner Dial—A. C. Hayden Radio & Research Corp.
38. 1 A. C. H. Sharp Tuner Dial—A. C. Hayden Radio & Research Corp.
39. 1 Brach Lightning Arrester—L. S. Brach Mfg. Co.
40. 1 Formica Panel—The Formica Insulation Co.
41. 1 Year's Subscription to PRACTICAL ELECTRICS—The Practical Electrics Co.
42. 1 Westwyre Condenser—The Westwyre Co.
43. 1 Bradleyometer—Allen Bradley Co.
44. 1 Memory Course—C. K. Dodge.
- 44.A 1 Antenna Plug—Chas. Freshman Co. Inc.
- 44.B 1 Variable Resistance Leak with .0025 Micon Condenser—Chas. Freshman Co. Inc.
45. 1 Bradlystat—Allen Bradley Co.
46. 1 Klossner Model 200 Vernier Rheostat—Klossner Improved Apparatus Co.
47. 1 Resistance Unit and Mountings—Daven Radio Co.
48. 1 Pair Bates Ear-Cushions for Head Sets—Bates & Company.

**Heard with A MU-RAD Receiver**  
**And A 2 Foot Loop Aerial**



(The MA-13)

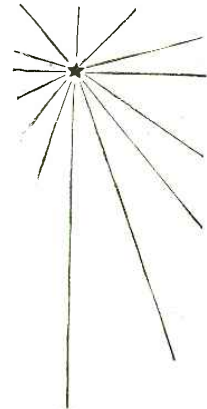

The New  
 Star in  
 the Radio  
 World

**From NEW YORK**

- Davenport 830 Miles
- Kansas City 1040 Miles
- Fort Worth 1285 Miles
- Havana 1567 Miles

**From ST. LOUIS**

- Manitoba 900 Miles
- Montreal 1000 Miles
- San Francisco 1820 Miles
- Honolulu 4278 Miles

**From CLEVELAND**

- Fort Worth 1530 Miles
- Denver 1200 Miles
- Salt Lake City 1530 Miles
- Havana 1671 Miles
- San Francisco 2180 Miles

**From CHICAGO**

- Havana 1621 Miles
- Los Angeles 1840 Miles
- San Francisco 1955 Miles

**From DETROIT**

- Fort Worth 1092 Miles
- Havana 1680 Miles
- Calgary 1667 Miles
- Forto Rico 2036 Miles
- San Diego 2070 Miles
- Los Angeles 2070 Miles
- San Francisco 2210 Miles

They copied all they could copy. But they could not copy our mind; We left them tearing and swearing A thousand miles behind.

—Kipling.



**Why MU-RAD Excels**

1. Unequalled Sensitivity—Exceeds the sensitivity of the average set many times. The above record demonstrates this.
2. Fine Selectivity—Permits differentiation of stations 1% off tune.
3. Simple Operation—All tuning can be done with one hand.
4. 1,000 Mile Reception—Guarantee goes with every set.
5. Distinctive Appearance—Solid mahogany cabinet, Radion panel, highly polished.

Ask for a Demonstration of MU-RAD Receivers

The MU-RAD dealer in your town will gladly let you listen in on either type MU-RAD receiver

Attractive Proposition for Dealers

**MU-RAD Laboratories, Inc.**

801 Fifth Avenue Asbury Park, N. J.

**Two Types MU-RAD SETS**

Type MA-12 3-Stage R-F and Detector \$128

Type MA-13 3-Stage R-F, Detector & 2 Stages A.F. \$160

**World Radio Batteries SAVE YOU 50%**

WRITTEN 2-YR. GUARANTEE

Direct factory to user sales methods save you 50%. Highest quality material insures you 100% service. Every battery backed by our written two-year guarantee. You take no risk. Batteries shipped express C. O. D. for your inspection. Mail your order today—at once.

**COMPARE THESE PRICES**

6 Volt 40 Amps. \$6.50	No other manufacturer offers such a high quality battery at such a low price. Save 50% on your next battery and get better and longer service—buy a World Storage Radio Battery. Write today.
6 Volt 60 Amps. 10.00	
6 Volt 80 Amps. 12.50	
6 Volt 100 Amps. 14.50	

World Battery Co., 1219 S. Wabash Ave., Dept. 1, Chicago

**Our Genuine Skinderviken Transmitter Button**



Used by thousands for Wireless, Loud Speakers, Amplifying and all sound transmission purposes.

**Price \$1.00**

POSTPAID with instructions **Free Literature**

15 PARK ROW

K. ELECTRIC CO.

NEW YORK



# 1000 MILES with a Crystal Set

A Needles California, radio fan writes:

"Using your M. P. M. Radio crystal, I picked up Los Angeles, San Francisco, Salt Lake, Denver and St. Louis. It is far superior to any crystal I have ever used."



The discovery of M. P. M. has revolutionized the possibilities of ordinary crystal sets. M. P. M. is super-sensitive—reproducing from every point on its surface. It increases audibility as well as radius, and makes the purchase of an expensive tube set unnecessary.

Send 25c and name of your Radio Dealer for a sample M. P. M. crystal—concert tested and guaranteed.

DEALERS: Write today for our attractive sales proposition.

## M. P. M. Sales Co.

Dept. N.

247 S. Central Ave., Los Angeles, Calif.

### RADIO MAILING LISTS

12,400 Radio Dealers, covering U.S. by States...	per. M. \$7.50
1,614 Radio Manufacturers, covering U.S. by States	per list 15.00
1,757 Radio Supply Jobbers, covering U.S. by States	per list 15.00
260 Radio Stations	per list 4.00
257 Mfrs., who make and assemble complete radio sets	per list 4.00
25,000 Radio Amateurs and Managers of Radio Stations	per M. 7.50

Ask for price list covering Canada and England. Above ready to send on receipt of remittance.

Trade Circular Addressing Co., 166 W. Adams St., Chicago

You can be quickly cured, if you

## STAMMER

Send 10 cents for 288-page book on Stammering and Stuttering. "Its Cause and Cure." It tells how I cured myself after stammering 20 yrs. B. N. Bogue, 885 Bogue Bldg., 1147 N. Ill. St., Indianapolis

Insure your copy reaching you each month. Subscribe to RADIO NEWS—\$2.50 a year. Experimenter Publishing Co., 53 Park Place, N. Y. C.

49. 1 Consolidated Radio Call Book—Consolidated Radio Call Book Co.
50. 1 Autostat—Automatic Electrical Devices Co.
51. 1 Autostat—Automatic Electrical Devices Co.
52. 1 Barkelew Lightning Arrester Switch—The Barkelew Elec. Mfg. Co.
53. 1 Aero Plug—Star Mfg. Co.
54. 1 Bradleyadapter—Allen Bradley Co.
55. 1 Bradleyswitch—Allen Bradley Co.
56. 1 Battery Testing Outfit—The Chaslyn Co.
57. 1 Saturn Perfect Jack—Saturn Mfg. & Sales
58. 1 Radiogram Receiving Set—The Radiogram Corp.
59. 1 Saturn Automatic Plug—Saturn Mfg. & Sales Co.
60. 1 Set Phone Clips—Star Mfg. Co.
61. 5 W. D. 11 Fuses—Radio Equipment Co.
62. 1 .006 Micon Condenser—Chas. Freshman Co. Inc.

### Zone No. V

Tennessee, North Carolina, South Carolina, Georgia, Alabama, Florida, Mississippi

1. W. D. 11 Detector and Two Stage Amplifier Complete—Bruno Radio Corp., and 1 W. T. 501 Peanut Tube and Adapter—Radio Research Guild.
2. 1 R O R N Tuned Radio Frequency Amplifier Unit—A. H. Grebe & Co., Inc.
3. 1 Vacuum Tube Receiver—Finch Radio Co., and 1 W. T. 501 Peanut Tube and Adapter—Radio Research Guild.
4. 2 Rasla Radio Frequency Transformers and Two Rasla Radio Frequency Transformers—Rasla Sales Corp., National Distributors for Radio Service Laboratories.
5. 1 National Airphone Crystal Set, Model G—National Airphone Corp., and 1 W. T. 501 Peanut Tube and Adapter—Radio Research Guild.
6. 1 Ricohorn—Radio Industries Corp., and 1 Carter Two-way Plug—Carter Radio Co.
7. 1 Crystal Set—Standard Radio & Elec. Co., and 1 W. T. 501 Peanut Tube and Adapter—Radio Research Guild.
8. 4 No. 269 2 1/2-Volt Variable "B" Batteries—Novo Mfg. Co., Inc.
9. 1 Gould Radio "B" Battery—Gould Storage Battery Co.
10. 1 Constructional Drawings of a Ten Tube Super-Heterodyne—Experimenter Information Service.
11. 1 Dictograph 3000 Ohm Head Set—Dictograph Products Corp., and 1 Carter Two-way Plug—Carter Radio Co.
12. 1 Trimm "Professional" 3000 Ohm Head Set—Trimm Radio Mfg. Co., and 1 Carter Two-way Plug—Carter Radio Co.
13. 1 Wood Horn Loud Speaker—Inter-Ocean Radio Corp., and 1 Carter Two-way Plug—Carter Radio Co.
- 13.A 1 "Signal" R-21 Loose Coupler—Signal Elec. Mfg. Co.
14. 1 Connecticut Variable Condenser—Connecticut Telephone & Electric Co.
15. 1 Goodman Wave Tuner—L. W. Goodman.
16. 1 Cole Audio Frequency Transformer—A. B. Cole, Inc.
17. 1 Frost 3000 Ohm Head Set—Herbert H. Frost, and 1 No. 138 Multiple Fone Plug—Herbert H. Frost.
18. 1 Murdock Loud Speaker—Wm. J. Murdock Co., and 1 Carter Two-way Plug—Carter Radio Co.
19. 1 Murdock Head Set No. 56—Wm. J. Murdock Co., and 1 Carter Two-way Plug—Carter Radio Co.
20. 1 Double Head Set—Radio Industries Corp., and 1 Carter Two-way Plug—Carter Radio Co.
21. 1 Membership in The Radio Guild Co-operative Service Bureau—The Radio Guild.
22. 1 Audio Frequency Transformer—Connecticut Telephone & Electric Co.
23. 1 Pada Variocoupler—Frank A. D. Andrea.
24. 1 Large Type "B" Battery—Hipwell Mfg.
25. 1 2 1/2-Volt Defelco "B" Battery—Defelco Battery Corp.
26. 1 45-Volt "B" Battery—National Electrical Novelty Co.
27. 1 WorkRite Variocoupler—WorkRite Mfg.
28. 1 WorkRite Variometer—WorkRite Mfg. Co.
29. 1 No. 1 Complete Patterns, Diagrams & Instructions for Making Short Wave Regenerative Sets; 1 No. 2 Complete Patterns, Diagrams & Instructions for Making Detector and Amplifier Radio Units; 1 No. 3 Complete Instructions and Blue Prints for Making Radiophone Crystal Sets; 1 Twenty Radio Phone Diagrams and Hook-ups of Crystal and Audion Receiving Circuits, Amplifier Circuits, Regenerative Circuits, Sending Circuits, with Key Chart and Pamphlet How to Rec. Diagrams; 1 Fourteen Radio Formulae and Diagrams; 1 Complete and Detailed Instructions, How to Build and Install Every Known Aerial for the Amateur—Consolidated Radio Call Book Co.
30. 1 Variometer—F. R. S. Radio Corp.
31. 1 Year's Subscription to SCIENCE & INVENTION—Experimenter Publishing Co.
32. 1 Year's Subscription to RADIO NEWS—Experimenter Publishing Co.
33. 1 A. C. H. Sharp Tuner Dial—A. C. Hayden Radio & Research Corp.
34. 1 A. C. H. Sharp Tuner Dial—A. C. Hayden Radio & Research Corp.
35. 1 Brach Lightning Arrester—L. S. Brach Mfg. Co.

## Dr. T. O'Connor Sloane Will Teach You CHEMISTRY Right In Your Own Home



DR. T. O'CONNOR SLOANE, A. B., A. M., Ph. D., Ed. D., Educational Director Chemical Institute of New York, formerly Treasurer American Chemical Society and a Practical Commercial chemist as well as a noted instructor.

Good chemists command high salaries. Industrial firms of all kinds pay tempting salaries to get the right men. Salaries of \$10,000 a year are not unusual for chemists of exceptional abilities. The work of the chemist is extremely interesting. If you are fond of experimenting, take up chemistry. If you want to earn more money, the way is open through our Course in Chemistry.

**You Can Learn at Home**  
Dr. Sloane will teach you Chemistry at home in a practical, intensely interesting way. Our Course is remarkably simple. No special education required—if you can read and write plain English you can thoroughly understand and master every lesson.

**Easy Monthly Payments**  
The price of our course is very low and the tuition includes everything, even the chemistry outfit—there are no extras to buy with our course. You can pay in small monthly amounts within the reach of everyone. Our plan places a chemical education within the reach of everyone.

**Experimental Equipment Given to Every Student**  
One special feature of our course is that we give to every student, without additional charge, the chemical equipment he will need for his studies, including forty-two pieces of laboratory apparatus and eighteen different chemicals and reagents. The fitted, heavy sized box serves as a carrying case for the equipment and as a laboratory accessory for performing experiments.

**SPECIAL 30-DAY OFFER**  
In addition we are making a special offer for a short time only. You owe it to yourself to find out about it. Mail the Coupon to-day for free book! Opportunities for Chemists, and details of our special offer. Act immediately before this offer is withdrawn.

—CUT HERE—

CHEMICAL INSTITUTE OF NEW YORK, Inc. (Home Ext. Division, 4-A, 140-R, Liberty St., N. Y. City)  
Without obligation or cost, send me your free book, "Opportunity for Chemists," and full particulars about the Experimental Equipment given to every student, and tell me about your plan of payment and special 30-day offer.

Name .....

Address .....

City ..... State .....

## WELSH PEANUT TUBE

W. T. 501

"The Tube That Cannot Squeal"  
Sold for experimental use as a detector only.

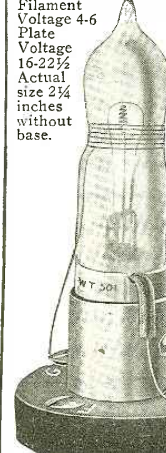

List Price  
**\$2.00**

at your dealer or from us by insured mail 10c. extra.

Can be used on 3 dry cells or regular 6-volt A Battery—Wiring diagram packed with each tube showing how to use the W. T. 501 with any crystal set. Nickel-plated socket, moulded base, double spring contacts, 40c. extra. Adaptor for standard V. T. Socket, 75c. extra for use in tube sets. Booklet giving complete constructional details of tube set using the W. T. 501 25c. extra. Jobs and dealers wire for merchandising plan Packed 10 in a carton, 10 cartons per case. Orders filled in rotation. Please do not ask us to open an account to ship sample tubes. Samples shipped only at list price which will be credited towards your first stock order.

RADIO RESEARCH GUILD  
9-15 Clinton Street P. O. Box 1 Newark, N. J.

## AMERICAN TIME CLOCK REPAIR & SUPPLY CO.

SECOND HAND TIME CLOCKS  
Bought, Sold, Repaired and Exchanged  
ALL WORK GUARANTEED  
We Carry a Full Line of Supplies  
489 Broadway, near Grand St., Phone, Canal 7951

- 36. 1 Formica Panel—The Formica Insulation Co.
- 37. 1 Year's Subscription to PRACTICAL ELECTRICS—Practical Electrics Co., Inc.
- 38. 1 Westwyr Condenser—The Westwyr Co.
- 39. 1 Bradleyometer—Allen Bradley Co.
- 40. 1 Memory Course—C. K. Dodge.
- 40.B.1 Variable Resistance Leak with .00025
- 40.B.2 Variable Resistance Leak with .00025 Micon Condenser—Chas. Freshman Co., Inc.
- 41. 1 Bradleystat—Allen Bradley Co.
- 42. 1 Klosner Model 200 Vernier Rheostat—Klosner Improved Apparatus Co.
- 43. 1 Resistance Unit and Mountings—Daven Radio Co.
- 44. 1 Pair Bates Ear-Cushions for Head Sets—Bates & Company.
- 45. 1 Consolidated Radio Call Book—Consolidated Radio Call Book Co.
- 46. 1 Autostat—Automatic Electrical Devices
- 47. 1 Autostat—Automatic Electrical Devices
- 48. 1 Barkelew Four Phone Plug—The Barkelew Electric Mfg. Co.
- 49. 1 Formica Variable Condenser—C. S. Cherpeck.
- 50. 1 Bradleyadapter—Allen Bradley Co.
- 51. 1 Bradleyswitch—Allen Bradley Co.
- 52. 1 Battery Testing Outfit—The Chaslyn Co.
- 53. 1 Saturn Perfect Jack—Saturn Mfg. & Sales
- 54. 1 Radiogem Receiving Set—Radiogem Corp.
- 55. 1 Saturn Automatic Plug—Saturn Mfg. & Sales Co.
- 56. 5 W. D. 11 Fuses—Radio Equipment Co.
- 57. 1 .006 Micon Condenser—Chas. Freshman Co., Inc.

**Zone No. VI**

- Minnesota, Iowa, Missouri, North Dakota, South Dakota, Nebraska, Kansas, Montana, Wyoming, Colorado
- 1. 1 D412 Detector and Two Stage Amplifier—Acme Apparatus Co., and 1 W. T. 501 Peanut Tube and Adapter—Radio Research Guild.
  - 2. 1 RORN Tuned Radio Frequency Amplifier Unit—A. H. Grebe & Co., Inc.
  - 3. 1 D4 Single Circuit Regenerative Set—Radiocraft Co., Inc., and 1 W. T. 501 Peanut Tube and Adapter—Radio Research Guild.
  - 4. 2 Rasla Radio Frequency Transformers and 2 Rasla Audio Frequency Transformers—Rasla Sales Corp., National Distributors for Radio Service Laboratories.
  - 5. 1 National Airphone Crystal Set, Model G—National Airphone Corp., and 1 W. T. 501 Peanut Tube and Adapter—Radio Research Guild.
  - 6. 1 Ricohorn—Radio Industries Corp., and 1 Carter Two-way Plug—Carter Radio Co.
  - 7. 1 Crystal Set—Standard Radio & Elec. Co., and 1 W. T. 501 Peanut Tube and Adapter—Radio Research Guild.
  - 8. 4 No. 269 22½-Volt Variable "B" Batteries Novo Mfg. Co., Inc.
  - 9. 1 Set Constructional Drawings of a 10 Tube Super-Heterodyne—Experimenters Information Service.
  - 10. 1 Gould Radio "B" Battery—Gould Storage Battery Co.
  - 11. 1 Dictograph 3000 Ohm Head Set—Dictograph Products Corp., and 1 Carter Two-way Plug—Carter Radio Co.
  - 12. 1 Trimm "Professional" 3000 Ohm Head Sets—Trimm Radio Mfg. Co. and 1 Carter Two-way Plug—Carter Radio Co.
  - 13. 1 Loud Speaker—Standard Metal Mfg. Co., and 1 Carter Two-way Plug—Carter Radio
  - 14. 1 Connecticut Variable Condenser—Connecticut Telephone & Electric Co.
  - 15. 1 Goodman Wave Tuner—L. W. Goodman.
  - 16. 1 Cole Audio Frequency Transformer—A. B. Cole, Inc.
  - 17. 1 Frost 3000 Ohm Head Set—Herbert H. Frost, and 1 Frost No. 138 Multiple Pone Plugs—Herbert H. Frost.
  - 18. 1 Murdock Loud Speaker—Wm. J. Murdock Co., and 1 Carter Two-way Plug—Carter Radio Co.
  - 19. 1 Murdock Head Set No. 56—Wm. J. Murdock Co., and 1 Carter Two-way Plug—Carter Radio Co.
  - 20. 1 Double Head Set—Radio Industries Corp., and 1 Carter Two-way Plug—Carter Radio
  - 21. 1 Membership in The Radio Guild Co-operative Service Bureau—The Radio Guild.
  - 22. 1 Audio Frequency Transformer—Connecticut Telephone & Electric Co.
  - 23. 1 Fada Variocoupler—Frank A. D. Andrea.
  - 24. 1 Large Type "B" Battery—Hipwell Mfg.
  - 25. 1 22½-Volt Defelco "B" Battery—Defelco Battery Corp.
  - 26. 1 45-Volt "B" Battery—National Electric Novelty Co.
  - 27. 1 WorkRite Variocoupler—WorkRite Mfg.
  - 28. 1 WorkRite Variometer—WorkRite Mfg. Co.
  - 29. 1 No. 1 Complete Patterns, Diagrams & Instructions for Making Short Wave Regenerative Set; 1 No. 2 Complete Patterns, Diagrams & Instructions for Making Detector and Amplifier Radio Units; 1 No. 3 Complete Instructions and Blue Prints for Making Phone Diagrams and Hook-ups of Crystal and Audion Receiving Circuits, Amplifier Circuits, Regenerative Circuits, Sending Circuits, with Key Chart of Symbols and Pamphlet, How to Read Diagrams; 1 Fourteen Radio Formulae and Diagrams; 1

**Don't Waste Money, Time and Patience on Cheap, Improperly Designed Radio Parts. Insist on Getting New York Coil Company's Products, Which Insures Entire Satisfaction. Honestly Priced, Scientifically Constructed and Engineered to Deliver the Maximum Results.**

**JOBBER AND DEALERS** get our complete literature and worthwhile discounts.

Our 180 degree Variocoupler is a masterpiece, suitable for use in any circuit. Most efficient and best constructed Coupler in existence. Price, \$4.50.

STANDARD 90 Degrees VARIOCOUPLER. Price \$3.50

Our Combination Mounted Variocoupler for table or back panel mounting has all taps connected and soldered, nothing else like it. Price, \$8.00.

MOUNTED 3 CIRCUIT TUNER. Exceptional selectivity and sharp tuning, makes the most easily constructed and highest efficiency Set known. Price without Dial \$6.00. With 3¾ Bakelite Dial \$7.00.

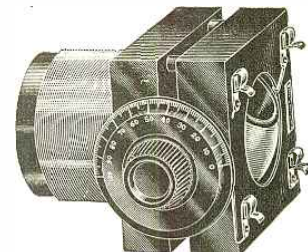

Our Variometers are full size precision instruments. They are not of the "competitive" type. Price \$4.00.

Our Audio Frequency Transformers are the choice to the leading manufacturers and radio engineers. Guaranteed to give high magnification, less distortion and better all around efficiency. No howling. Price \$4.00.

NEW YORK COIL COMPANY'S Variable Condensers are the standard by which others are judged, containing such features as all metal framework, adjustable bearings and positive electrical contact:

11 Plate.....	\$1.50	43 Plate.....	\$3.00
23 Plate.....	2.00	3 Plate.....	1.25

NEW YORK ENTERTAIN-A-PHONE RECEIVING SET NO. 2—Complete with detector and two stages of amplification, all in one cabinet. Contains a non-regenerative two circuit

hook-up with two stages audio amplification. Results are simply a revelation. It must be operated and heard to be appreciated. Workmanship and design and material of exceptional character throughout. Of unusual interest to the jobber. Price \$50.00 fully guaranteed.

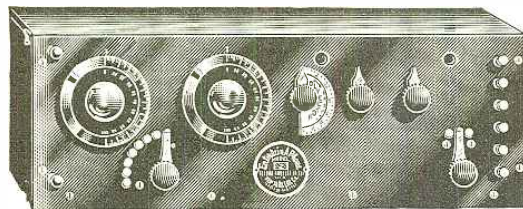

**NEW YORK COIL COMPANY, Inc.**  
338 Pearl Street New York City, N. Y.

**Super-Sensitiveness!**

THE crystal is the "bull's-eye" of your crystal receiving set. Unless it is super-sensitive you are wasting time and entertainment and cannot "hit" the combination for best results. Insist upon the genuine Original Arlington Tested NAA Detector Minerals. They are carefully selected from bulk stock, individually tested and guaranteed super-sensitive.

Galena, Silicon or Goldite price per crystal, 25c. Same mounted in brass cup, 40c. Obtainable at your dealer's or sent direct (post-paid) on receipt of price.

*The Newman-Stern Co.*  
Newman-Stern Building Cleveland

**SPAULDING Fibre PRODUCTS**

If you use Vulcanized Fibre in your Radio Outfits (and you should), get in touch with us. We can offer quick service and best quality.

Panels, washers, bushings and other specialties.

**J. SPAULDING & SONS CO., Inc.**  
484 Broome St. .... New York City  
141 North 4th St. .... Philadelphia  
15 Elkins St. .... Boston  
659 West Lake St. .... Chicago  
Tonawanda .... New York

**MONEY FOR YOU**—Add to your salary—Make extra pin money—Start a lucrative business of your own. Spend an hour each day taking subscriptions for the Radio News. We'll pay you well and you'll enjoy the work. Write for full particulars. Circulation Dept., RADIO NEWS, 53 Park Place, New York City.



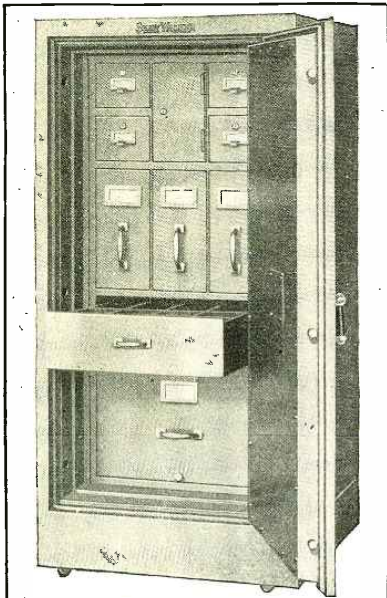

**SHAW-WALKER**

**PORTABLE VAULT**

These clauses appear in your Fire Insurance Policy:

"This Company shall not be liable for loss to accounts, bills, currency, deeds, evidence of debt, money, notes or securities."

"The Insured shall produce for examination all books of accounts, bills, invoices, and other vouchers, of certified copies thereof if originals are lost."

Consider what you would lose and what it would cost to replace your records if fire visited you tonight.

You cannot afford to be without the protection that our PORTABLE VAULT offers. It's low cost should enable every business, no matter how small, to give protection to those uninsurable records.

Price is \$100, slightly higher in South and West. Interior equipment is extra.

Branches in all principal cities.



Muskegon, Michigan.

- Complete and Detailed Instructions, How to Build and Install Every Known Aerial for the Amateur—Consolidated Radio Call Book
30. 1 Variometer—F. R. S. Radio Corp.
  31. 1 Year's Subscription to SCIENCE & INVENTION—Experimenter Publishing Co.
  32. 1 Year's Subscription to RADIO NEWS—Experimenter Publishing Co.
  33. 1 A. C. H. Sharp Tuner Dial—A. C. Hayden Radio & Research Corp.
  34. 1 A. C. H. Sharp Tuner Dial—A. C. Hayden Radio & Research Corp.
  35. 1 Brach Lightning Arrester—L. S. Brach Mfg. Co.
  36. 1 Formica Panel—The Formica Insulation Co.
  37. 1 Year's Subscription to PRACTICAL ELECTRICS—Practical Electrics Co., Inc.
  38. 1 Westwyre Condenser—The Westwyre Co.
  39. 1 Bradleyometer—Allen Bradley Co.
  40. 1 Memory Course—C. K. Dodge.
  - 40.A 1 Antenna Plug—Chas. Freshman Co. Inc.
  - 40.B 1 Variable Resistance Leak with .00025 Micon Condenser—Chas. Freshman Co. Inc.
  41. 1 Bradleystat—Allen Bradley Co.
  42. 1 Klosner Model 200 Vernier Rheostat—Klosner Improved Apparatus Co.
  43. 1 Resistance Unit and Mountings—Daven Radio Co.
  44. 1 Pair Bates Ear Cushions for Head Sets—Bates & Company.
  45. 1 Consolidated Radio Call Book—Consolidated Radio Call Book Co.
  46. 1 Autostat—Automatic Electric Devices Co.
  47. 1 Autostat—Automatic Electric Devices Co.
  48. 1 Barkelew Four Phone Plug—Barkelew Elec. Mfg. Co.
  49. 1 Jewel Detector—Star Mfg. Co.
  50. 1 Bradleyadapter—Allen Bradley Co.
  51. 1 Bradleyswitch—Allen Bradley Co.
  52. 1 Battery Testing Outfit—The Chaslyn Co.
  53. 1 Saturn Perfect Jack—Saturn Mfg. & Sales Corp.
  54. 1 Radiogem Receiving Set—The Radiogem Corp.
  55. 1 Saturn Automatic Plug—Saturn Mfg. & Sales Co.
  56. 3 W. D. 11 Fuses—Radio Equipment Co.
  57. 1 .006 Micon Condenser—Chas. Freshman Co. Inc.

**Zone No. VII**

Arkansas, Louisiana, Oklahoma, Texas and New Mexico

1. RORN Tuned Radio Frequency Amplifier Unit—A. H. Grebe & Co., Inc.
2. 1 D412 Detector and Two Stage Amplifier—Acme Apparatus Co., and 1 W. T. 501 Peanut Tube and Adapter—Radio Research Guild.
3. 1 Timmons Talker—J. S. Timmons Co., and 1 Carter Two-way Plug—Carter Radio Co.
4. 2 Rasla Radio Frequency Transformers and 2 Rasla Audio Frequency Transformers—Rasla Sales Corp., National Distributors for Radio Service Laboratories.
5. 1 National Airphone Crystal Set Model "G" National Airphone Corp., and 1 W. T. 501 Peanut Tube and Adapter—Radio Research Guild.
6. 1 Ricohorn—Radio Industries Corp., and 1 Carter Two-way Plug—Carter Radio Co.

**Ford Runs 57 Miles on Gallon of Gasoline**

A new automatic Vaporizer and De-carbonizer, which in actual test has increased the power and mileage of Fords from 25 to 50 per cent and at the same time removed every particle of carbon from the cylinders, is the proud achievement of John A. Stransky, 3481 South Main Street, Pukwana, South Dakota. A remarkable feature of this simple and inexpensive device is that its action is governed entirely by the motor. It is slipped between the carburetor and intake manifold and can be installed by anyone in five minutes without drilling or tapping. With it attached, Ford cars have made from 40 to 57 miles on one gallon of gasoline. Mr. Stransky wants to place a few of these devices on cars in this territory and has a very liberal offer to make to anyone who is able to handle the business which is sure to be created wherever this marvelous little device is demonstrated. If you want to try one entirely at his risk send him your name and address today.—Adv.

**LEARN ELECTRICITY IN 3 MONTHS**

IN THE GREAT SHOPS OF

Make this the most profitable and enjoyable summer of your life. Come to Chicago, the electrical center and the country's greatest summer resort city. Learn Electricity in America's oldest, largest and best equipped school. Earn your way, free employment department. If you come now we will pay your railroad fare and give you free a course in auto truck and tractor electricity, a course in radio, and a life scholarship in the great Coyne School. This is the greatest offer ever made by a school. Write at once for particulars as we cannot keep this offer open long.

**Write Today Coyne**

Trade and Engineering Schools  
1300-1310 W. Harrison St.,  
Dept. 5944 Chicago, Ill.

**Starting a Company?**

Save expenses and taxes by organizing on the popular, COMMON LAW plan under a pure DECLARATION OF TRUST. No experience required to fill in DEMAREE STANDARD FORMS, issue shares and begin doing business at once. Genuine DEMAREE FORMS are nationally known, approved by attorneys and utilized by successful concerns throughout the United States. Send for large, free pamphlet (C-40) containing valuable information that you may need. C. S. DEMAREE, legal blank publisher, 708 Walnut, Kansas City, Missouri.

**PATENTS Secured**

Prompt service. Avoid dangerous delays. Send for our "Record of Invention" form and Free Book telling How to Obtain a Patent. Send sketch or model for examination. Preliminary advice without charge. Highest References. Write TODAY, J. L. Jackson & Co., 414 Ouray Bldg., Washington, D. C.

**PATENTS** As one of the oldest patent firms in America we give inventors at lowest consistent charge a service noted for results, evidenced by many well known Patents of extraordinary value. Book, Patent-Sense, Free. Lacey & Lacey, 631 F St., Wash., D. C. Estab. 1869.

**OLD MONEY WANTED**

\$2 to \$500 EACH paid for hundreds of old or odd coins. Keep ALL old money, it may be VERY VALUABLE. Send 10 cents for New III's COIN VALUE BOOK, size 4x6. Get Posted. We pay Cash. CLARKE COIN CO., Ave. 79, Le Roy, New York

**A BETTER JOB NOW!**

Learn good trade in a few weeks. 12 million autos, trucks and tractors need service. Repairmen needed. Write today for FREE catalog giving full particulars. MICHIGAN STATE AUTOMOBILE SCHOOL 5344 Auto Bldg., Detroit, Mich.

Talk Number 2

**SIGNAL**

*Facts from the Factory*

At the SIGNAL plant we never forget that if we scrimp on material or slight our work then someone will surely be disappointed, and perhaps a despairing call for help may be made in vain.

So it is our joy to perform each operation, little or big with the utmost of conscientious precision, knowing, thus, that no life can ever be charged against defective SIGNAL apparatus.

Radio equipment bearing the name of SIGNAL may safely be depended upon for good honest service.

**SIGNAL Electric Mfg. Co.**

Factory and General Offices:  
1912 BROADWAY, MENOMINEE, MICH.

Atlanta Boston Chicago Cleveland Minneapolis Montreal  
New York Pittsburgh San Francisco St. Louis Toronto  
You'll find our local address in your Telephone Directory (2101)

**INFORMATION COUPON**

Signal Electric Mfg. Co.,  
1912 Broadway,  
Menominee, Mich.

Please send catalog and bulletins giving complete information about SIGNAL Radio equipment to name and address written in margin.

7. 1 Crystal Set—Standard Radio & Elec. Co., and 1 W. T. 501 Peanut Tube and Adapter—Radio Research Guild.
8. 4 No. 269 22½-Volt Variable "B" Batteries Novo Mfg. Co., Inc.
9. 1 Set Constructional Drawings of a 10 Tube Super Heterodyne—Experimenters Information Service.
10. 1 Gould Radio "B" Battery—Gould Storage Battery Co.
11. 1 Dictograph 3,000 Ohm Head Set—Dictograph Products Corp., and 1 Carter Two-way Plug—Carter Radio Co.
12. 1 Trimm "Professional" 3,000 Ohm Head Set—Trimm Radio Mfg. Co., and 1 Carter Two-way Plug—Carter Radio Co.
13. 1 Loud Speaker—Standard Metal Mfg. Co., and 1 Carter Two-way Plug—Carter Radio Co.
- 13.A 1 "Signal" 43 Plate Variable Condenser—Signal Elec. & Mfg. Co.
14. 1 Goodman Wave Tuner—L. W. Goodman.
15. 1 Cole Audio Frequency Transformer—A. B. Cole, Inc.
16. 1 Frost 3000 Ohm Head Set—Herbert H. Frost, and 1 Frost No. 138 Multiple Fone Plug—Herbert H. Frost.
17. 1 Murdock Loud Speaker—Wm. J. Murdock Co., and 1 Carter Two-way Plug—Carter Radio Co.
18. 1 Murdock Head Set No. 56—Wm. J. Murdock Co., and 1 Carter Two-way Plug—Carter Radio Co.
19. 1 Double Head Set—Radio Industries Corp., and 1 Carter Two-way Plug—Carter Radio Co.
20. 1 Membership in The Radio Co-Operative Service Bureau—The Radio Guild.
21. 1 Type 231 A General Amplifying Transformer—General Radio Co.
22. 1 Fada Variocoupler—Frank A. D. Andrea.
23. 1 Large Type "B" Battery—Hipwell Mfg.
24. 1 22½-Volt Defelco "B" Battery—Defelco Battery Co.
25. 1 WorkRite Variocoupler—WorkRite Mfg.
26. 1 WorkRite Variometer—WorkRite Mfg. Co.
27. 1 No. 1 Complete Patterns, Diagrams and Instructions for making Short Wave Regenerative Set; 1 No. 2 Complete Patterns Diagrams and Instructions for making Detector and Amplifier Radio Units; 1 No. 3 Complete Instructions and Blue Prints for making Radiophone Crystal Set; 1 Twenty Radio Phone Diagrams and Hook-ups of Crystal and Audion Receiving Circuits, Amplifier Circuits, Regenerative Circuits, Sending Circuits, with Key Chart of Symbols and Pamphlet How to Read Diagrams; 1 Fourteen Formulae and Diagrams; 1 Complete and Detailed Instructions—How to Build and Install Every Known Aerial for the Amateur—Consolidated Radio Call Book
28. 1 43 Plate Ames Variable Condenser—Picard Radio Corp.
29. 1 Year's Subscription to SCIENCE & INVENTION—Experimenter Publishing Co.
30. 1 Year's Subscription to RADIO NEWS—Experimenter Publishing Co.
31. 1 A. C. H. Sharp Tuner Dial—A. C. Hayden Radio & Research Corp.
32. 1 A. C. H. Sharp Tuner Dial—A. C. Hayden Radio & Research Corp.
33. 1 Brach Lightning Arrester—L. S. Brach Mfg. Co.
34. 1 Formica Panel—The Formica Insulation Co.
35. 1 Year's Subscription to PRACTICAL ELECTRICS—Practical Electric Co., Inc.
36. 1 Westvire Condenser—The Westvire Co.
37. 1 Bradleyometer—Allen Bradley Co.
38. 1 Memory Course—C. K. Dodge.
- 38.A 1 Antenna Plug—Chas. Freshman Co. Inc.
- 38.B 1 Variable Resistance Leak with .006 Micon Condenser—Chas. Freshman Co. Inc.
39. 1 Bradleystat—Allen Bradley Co.
40. 1 Klosner Model 200 Vernier Rheostat—Klosner Improved Apparatus Co.
41. 1 Resistance Unit and Mountings—Daven Radio Co.
42. 1 Pair Bates Ear Cushions for Head Sets—Bates & Company.
43. 1 Consolidated Radio Call Book—Consolidated Radio Call Book Co.
44. 1 Autostat—Automatic Electrical Devices
45. 1 Autostat—Automatic Electric Devices Co.
46. 1 Barkelew Four Phone Plug—The Barkelew Electric Mfg. Co.
47. 1 Bradleyadapter—Allen Bradley Co.
48. 1 Bradleyswitch—Allen Bradley Co.
49. 1 Battery Testing Outfit—The Chaslyn Co.
50. 1 Saturn Perfect Jack—Saturn Mfg. & Sales Co.
51. 1 Radiogram Receiving Set—Radiogram Corp.
52. 1 Saturn Automatic Plug—Saturn Mfg. & Sales Co.
53. 5 W. D. 11 Fuses—Radio Equipment Co.
54. 1 .006 Micon Condenser—Chas. Freshman Co. Inc.

**Zone No. VIII**

Washington, Oregon, California, Idaho, Nevada, Utah, and Arizona

1. 1 D412 Detector and Two Stage Amplifier—Acme Apparatus Co., and 1 W. T. 501 Peanut Tube and Adapter—Radio Research Guild.
2. 1 Rorn Tuned Radio Frequency Amplifier Unit—A. H. Grebe & Co., Inc.
3. 1 Certified Radiotrician Course—National Radio Institute.

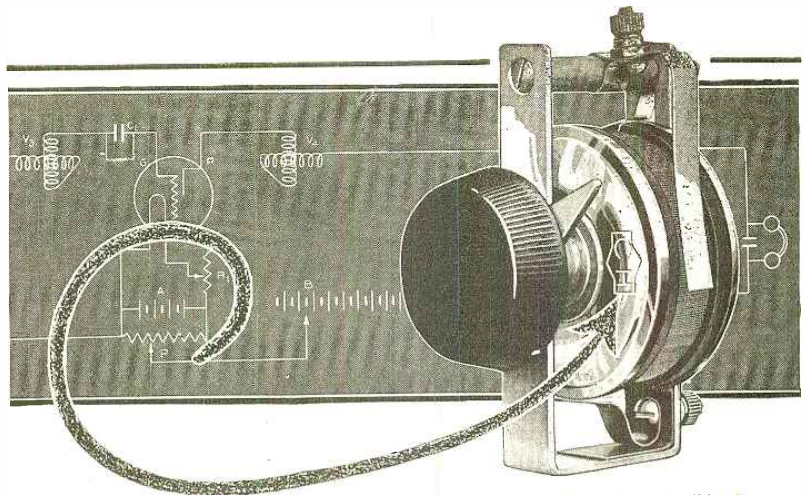

The C-H Radio "A" Battery Potentiometer.

## This Trade Mark On Your Potentiometer Assures Results

**Y**OUR receiving set will have increased signal strength and a greater range when equipped for fine control of the plate potential.

The C-H Radio "A" Battery Potentiometer gives you these better results without disturbing your existing circuits—it is easily mounted on your panel (template and screws are furnished) and the convenient binding posts facilitate wiring. Ask your dealer to show you this new instrument—and demand the C-H trade mark—it is essential where accuracy and reliability are required.

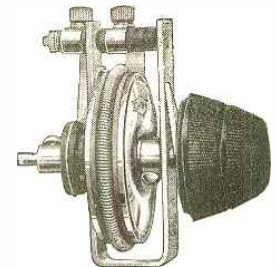

C-H Radio Rheostats built by rheostat builders. For precise filament control. Mechanically and electrically perfect-matched exactly in design and appearance by the new C-H potentiometer.

Type 11601-H1 (with vernier) \$1.50, for Detector Tube Control. Type 11601-H2 (without vernier) \$1.00, for Amplifier Tube Control.

**THE CUTLER-HAMMER MFG. CO.**

Member Radio Section, Associated Manufacturers of Electrical Supplies  
MILWAUKEE - WISCONSIN



Over a Quarter Million C-H Radio Rheostats Now in Use

# RADIO "A" BATTERY POTENTIOMETER

## PARTS

We manufacture them all—No matter what circuit you are going to use in that new set—we can supply the parts. Panels drilled and engraved to suit your own requirements. Special parts made if necessary but we have hundreds of stock parts, ready to mail, from which you can readily select a list to meet your needs. You can buy all your parts and supplies from us. Ten years experience in our line insures your results. Don't try to get good results from cheap inferior parts—IT CAN'T BE DONE. Buy WIRELESS SHOP PARTS and be sure of your results.

We are now preparing an interesting catalog of our products. Is your name on our mailing list? If not, write your name and address on the margin of this page, tear out our ad. and put it in the mail. It will mean money in your pocket because we sell everything direct by mail—YOU SAVE and get better goods.

**THE WIRELESS SHOP**

1202 W. SECOND ST.

A. J. EDGOMB

RN-4  
LOS ANGELES, CALIF

Get a Handy Binder for your RADIO NEWS. Holds and preserves six issues, each of which can be inserted or removed at will. Price 65c. Experimenter Pub. Co., Inc., Book Dept., 53 Park Place, New York.



# W. L. DOUGLAS

**\$5 \$6 \$7 \$8 & \$9 SHOES** FOR MEN AND WOMEN

**W. L. Douglas shoes are actually demanded year after year by more people than any other shoe in the world**

**BECAUSE** W. L. Douglas has been making surpassingly good shoes for forty-six years. This experience of nearly half a century in making shoes suitable for Men and Women in all walks of life should mean something to you when you need shoes and are looking for the best shoe values for your money.

**W. L. DOUGLAS** name and portrait is the best known shoe Trade Mark in the world. It stands for the highest standard of quality, style and workmanship at the lowest possible cost.

**No Matter Where You Live** shoe dealers can supply you with W. L. Douglas shoes. If not convenient to call at one of our 116 stores in the large cities, ask your shoe dealer for W. L. Douglas shoes. Protection against unreasonable profits is guaranteed by the name and price stamped on the sole of every pair before the shoes leave the factory. Refuse substitutes. The prices are the same everywhere.

If not for sale in your vicinity, write for catalog.

**TO MERCHANTS:** If no dealer in your town handles W. L. Douglas shoes, write today for exclusive rights to handle this quick selling, quick turn-over line.

*W. L. Douglas*  
President  
W. L. Douglas Shoe Co.  
172 Spark St., Brockton, Mass.

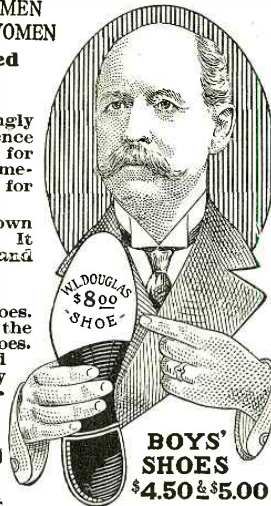

4. 2 Rasla Radio Frequency Transformers and 2 Rasla Audio Frequency Transformers—Rasla Sales Corp., National Distributors for Radio Service Laboratories.
5. 1 National Airphone Crystal Set, Model "G" National Airphone Corp., and 1 W. T. 501 Peanut Tube and Adapter—Radio Research Guild.
6. 1 Ricohorn—Radio Industries Corp., and 1 Carter Two-way Plug—Carter Radio Co.
7. 1 Crystal Set—Standard Radio & Elec. Co., and 1 W. T. 501 Peanut Tube and Adapter—Radio Research Guild.
8. 4 No. 269 22½-Volt Variable "B" Batteries—Novo Mfg. Co., Inc.
9. 1 Set Constructional Drawings of a 10 Tube Super-Heterodyne—Experimenters Information Service.
10. 1 Gould Radio "B" Battery—Gould Storage Battery Co.
11. 1 Dictograph 3000 Ohm Head Set—Dictograph Products Corp., and 1 Carter Two-way Plug—Carter Radio Co.
12. 1 Trimm "Professional" 3000 Ohm Head Set Trimm Radio Mfg. Co., and 1 Carter Two-way Plug—Carter Radio Co.
13. 1 Loud Speaker—Standard Metal Mfg. Co., and 1 Carter Two-way Plug—Carter Radio Co.
14. 1 Goodman Wave Tuner—L. W. Goodman.
15. 1 Cole Audio Frequency Transformer—A. B. Cole, Inc.
16. 1 Frost 3000 Ohm Head Set—Herbert H. Frost, and 1 Frost No. 138 Multiple Fone Plug—Herbert H. Frost.
17. 1 Murdock Loud Speaker—Wm. J. Murdock Co. and 1 Carter Two-way Plug—Carter Radio Co.
18. 1 Murdock Head Set No. 56—Wm. J. Murdock Co., and 1 Carter Two-way Plug—Carter Radio Co.
19. 1 Double Head Set—Radio Industries Corp., and 1 Carter Two-way Plug—Carter Radio Co.
20. 1 Membership in the Radio Guild Co-Operative Service Bureau—The Radio Guild.
21. 1 Fada Variocoupler—Frank A. D. Andrea.
22. 1 Large Type "B" Battery—Hipwell Mfg. Co.
23. 1 22½-Volt Defelco "B" Battery—Defelco Battery Corp.
24. 1 WorkRite Variocoupler—WorkRite Mfg. Co.
25. 1 WorkRite Variometer—WorkRite Mfg. Co.
26. 1 No. 1 Complete Patterns, Diagrams & Instructions for making Short Wave Regenerative Set; 1 No. 2 Complete Patterns, Diagrams & Instructions for making and Amplifier Radio Units; 1 No. 3 Complete Instructions and Blue Prints for making Radiophone Crystal Set; 1 Twenty Radio Phone Diagrams and Hook-ups of Audion Receiving Circuits, Amplifier Circuits, Regenerative Circuits, Sending Circuits, with Key Chart of Symbols and Pamphlet—How to Read Diagrams; 1 Fourteen Radio Formulae and Diagrams; 1 Complete and Detailed Instructions—How to Build and Install Every Known Aerial for the Amateur—Consolidated Radio Call Book Co.
27. 1 Year's Subscription to SCIENCE & INVENTION—Experimenter Publishing Co.
28. 1 Year's Subscription to RADIO NEWS—Experimenter Publishing Co.
29. 1 A. C. H. Sharp Tuner Dial—A. C. Hayden Radio & Research Corp.
30. 1 A. C. H. Sharp Tuner Dial—A. C. Hayden Radio & Research Corp.
31. 1 Brach Lightning Arrester—L. S. Brach Mfg. Co.
32. 1 Formica Panel—The Formica Insulation Co.
33. 1 Year's Subscription to PRACTICAL ELECTRICS—Practical Electrics Co., Inc.
34. 1 Westwre Condenser—The Westwre Co.
35. 1 Bradleyometer—Allen Bradley Co.
36. 1 Memory Course—C. K. Dodge.
- 36.A 1 Antenna Plug—Chas. Freshman Co. Inc.
- 36.B 1 Variable Resistance Leak with .006 Micon Condenser—Chas. Freshman Co. Inc.
37. 1 Bradleystat—Allen Bradley Co.
38. 1 Klosner Model 200 Vernier Rheostat—Klosner Improved Apparatus Co.
39. 1 Resistance Unit and Mountings—Daven Radio Co.
40. 1 Consolidated Radio Call Book—Consolidated Radio Call Book Co., Inc.
41. 1 Autostat—Automatic Electrical Devices Co.
42. 1 Autostat—Automatic Electrical Devices Co.
43. 1 Barkelew Four Phone Plug—The Barkelew Electric Mfg. Co.
44. 1 Bradleyadapter—Allen Bradley Co.
45. 1 Bradleyswitch—Allen Bradley Co.
46. 1 Battery Testing Outfit—The Chaslyn Co.
47. 1 Saturn Perfect Jack—Saturn Mfg. & Sales
48. 1 Radiogem Receiving Set—The Radiogem Corp.
49. 1 Saturn Automatic Plug—Saturn Mfg. & Sales Co.
50. 5 W. D. 11 Fuses—Radio Equipment Co.
51. 1 .006 Micon Condenser—Chas. Freshman Co. Inc.

## BROADCAST YOUR BUSINESS MESSAGES ON A REGAL REBUILT ROYAL

Regal Rebuilt Royal Typewriters are stripped to the base and thoroughly rebuilt by experts.

They carry the same kind of a guarantee as a new typewriter.

Cash or monthly payments.

For sale by all responsible typewriter dealers everywhere,—or

Write direct to



Genuine Regal carry this  Rebuilt Royals trade-mark.

### REGAL TYPEWRITER COMPANY, INC.,

359 Broadway, New York, N. Y.

Marcus Harwitz - - - General Manager

## PATENTS If You Have an Invention and Desire to Learn How to Secure a Patent

Send for our Free Guide Book, **HOW TO GET YOUR PATENT.** Tells our terms and methods. Send model or sketch and description of your invention and we will give our opinion as to patentable nature. Our documentary **PROOF OF INVENTION** is intended for your protection and will be sent you without charge. Write for it.

### RANDOLPH & CO.

Dept. 459 Washington, D. C.

NAME .....

STREET .....

CITY ..... STATE .....

## PATENTS

C. L. PARKER  
Formerly Member  
Examining Corps.  
U.S. Patent Office.  
PATENT - LAWYER  
McGill Bldg., Wash., D. C.

Patents, Trade Marks, Copyrights, Patent Litigation  
Handbook for Inventors, "Protecting, Exploiting and Selling Inventions," sent upon request.

## PATENTS

Procured. Send sketch or model today for examination, prompt report and advice. No charge for preliminary advice. Write for free Booklet and blank form on which to disclose your idea. Highest references. Promptness assured.

### CLARENCE A. O'BRIEN

Registered Patent Lawyer  
1051 Southern Building, Washington, D. C.

### Zone No. IX

Dominion of Canada

1. RORN Tuned Radio Frequency Amplifier Unit—A. H. Grebe & Co., Inc.
2. 1 D412 Detector and Two Stage Amplifier—Acme Apparatus Co., and 1 W. T. 501 Peanut Tube and Adapter—Radio Research Guild.

3. 1 Radiotrician Course—National Radio Institute.
4. 2 Rasla Radio Frequency Transformers and 2 Rasla Audio Frequency Transformers—Rasla Sales Corp., National Distributors for Radio Service Laboratories.
5. 1 National Airphone Crystal Set Model "G"—National Airphone Corp., and 1 W. T. Peanut Tube and Adapter—Radio Research Guild.
6. 1 Ricohorn—Radio Industries Corp., and 1 Carter Two-way Plug—Carter Radio Co.
7. 1 Crystal Set—Standard Radio & Elec. Co., and 1 W. T. 501 Peanut Tube and Adapter—Radio Research Guild.
8. 4 No. 269 22½-Volt Variable "B" Batteries—Novo Mfg. Co., Inc.
9. 1 Set Constructional Drawings of a 10 Tube Super-Heterodyne—Experimenters Information Service.
10. 1 Gould Radio "B" Battery—Gould Storage Battery Co.
11. 1 Dictograph 3000 Ohm Head Set—Dictograph Products Corp., and 1 Carter Two-way Plug—Carter Radio Co.
12. 1 Trimm "Professional" 3000 Ohm Head Set—Trimm Radio Mfg. Co., and 1 Carter Two-way Plug—Carter Radio Co.
13. 1 Loud Speaker—Standard Metal Mfg. Co., and 1 Carter Two-way Plug—Carter Radio Co.
14. 1 Goodman Wave Tuner—L. W. Goodman.
15. 1 Cole Audio Frequency Transformer—A. B. Cole, Inc.
16. 1 Frost 3000 Ohm Head Set—Herbert H. Frost, and 1 Frost No. 138 Multiple Fone Plug—Herbert H. Frost.
17. 1 Murdock Loud Speaker—Wm. J. Murdock Co., and 1 Carter Two-way Plug—Carter Radio Co.
18. 1 Murdock Head Set No. 56—Wm. J. Murdock Co., and 1 Carter Two-way Plug—Carter Radio Co.
19. 1 Double Head Set—Radio Industries Corp., and 1 Carter Two-way Plug—Carter Radio Co.
20. 1 Membership in the Radio Guild Co-operative Service Bureau—The Radio Guild.
21. 1 Fada Variocoupler—Frank A. D. Andrea.
22. 1 Large Type "B" Battery—Hipwell Mfg. Co.
23. 1 22½-Volt Defelco "B" Battery—Defelco Battery Corp.
24. 1 WorkRite Variocoupler—WorkRite Mfg. Co.
25. 1 WorkRite Variometer—WorkRite Mfg. Co.
26. 1 No. 1 Complete Patterns, Diagrams and Instructions for making Short Wave Regenerative Set; 1 No. 2 Complete Patterns, Diagrams and Instructions for making Detector and Amplifier Radio Units; 1 No. 3 Complete Instructions and Blue Prints for making Radio Phone Crystal Set; 1 Twenty Radio Phone Diagrams and Hook-ups for Crystal and Audion Receiving Circuits, Amplifier Circuits, Regenerative Circuits, Sending Circuits, with Key Chart of Symbols and Pamphlet—How to Read Diagrams; 1 Fourteen Radio Formulae and Diagrams; 1 Complete and Detailed Instructions—How to Build and Install Every Known Aerial for the Amateur—Consolidated Radio Call Book Co.
27. 1 Year's Subscription to SCIENCE & INVENTION—Experimenter Publishing Co.
28. 1 Year's Subscription to RADIO NEWS—Experimenter Publishing Co.
29. 1 A. C. H. Sharp Tuner Dial—A. C. Hayden Radio & Research Corp.
31. 1 A. C. H. Sharp Tuner Dial—A. C. Hayden Radio & Research Corp.
32. 1 Brach Lightning Arrester—L. S. Brach Mfg. Co.
33. 1 23 Plate Ames Variable Condenser—Picard Radio Corp.
34. 1 Formica Panel—The Formica Insulating Co.
35. 1 Year's Subscription to PRACTICAL ELECTRICS—The Practical Electric Co.
36. 1 Westwre Condenser—The Westwre Co.
37. 1 Bradleyometer—Allen Bradley Co.
38. 1 Memory Course—C. K. Dodge.
- 38.A 1 Antenna Plug—Chas. Freshman Co. Inc.
- 38.B 1 Variable Resistance Leak with .0025 Micon Condenser—Chas. Freshman Co. Inc.
39. 1 Bradleystat—Allen Bradley Co.
40. 1 Klosner Model 200 Vernier Rheostat—Klosner Improved Apparats Co.
41. 1 Pair Bates Ear Cushions for Head Set—Bates & Company.
42. 1 Consolidated Radio Call Book—Consolidated Radio Call Book Co., Inc.
43. 1 Autostat—Automatic Electrical Devices Co.
44. 1 Autostat—Automatic Electrical Devices Co.
45. 1 Berkeley Four Phone Plug—The Berkeley Electric Mfg. Co.
46. 1 Bradleyadapter—Allen Bradley Co.
47. 1 Bradleyswitch—Allen Bradley Co.
48. 1 Battery Testing Outfit—The Chaslyn Co.
49. 1 Saturn Perfect Jack—Saturn Mfg. & Sales Co.
50. 1 Radiogem Receiving Set—The Radiogem Corp.
51. 7 Saturn Automatic Plug—Saturn Mfg. & Sales Co.
52. 5 W. D. 11 Fuses—Radio Equipment Co.
53. 1 .006 Micon Condenser—Chas. Freshman Co. Inc.

**Zone No. X**

Mexico, Cuba, Panama Canal Zone and South America

1. 1 D412 Detector and Two Stage Amplifier—Acme Apparatus Co., and 1 W. T. 501 Pea-

# WEBSTER RADIO APPARATUS

Webster Radio Apparatus—both parts and assembled receiving sets—are built to typical Webster standards of perfection. Our line of parts includes everything from contact points and switch stops to Variometers and Variable Condensers—designed to function perfectly. When building your set, ask your dealer for Webster Apparatus. You are thus assured the utmost value, for Webster parts are designed to perform properly and are priced fairly. If your dealer does not carry Webster Radio Apparatus, write for our 24 page catalog and order direct.

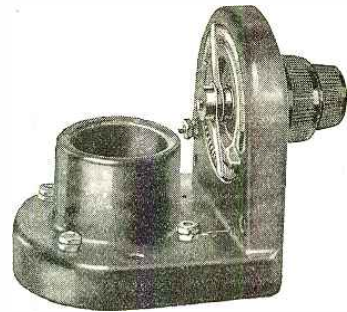

Webster Combination Socket and Rheostat

This unit combines both socket and rheostat together for either panel or table mounting. It is moulded porcelain finished in a brown glaze. Finished with or without vernier.

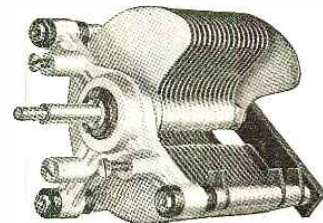

Webster Variable Condensers

The entire condenser is of improved design. Made of aluminum and accurately spaced. Bearings of ample size with threaded hard rubber bushing for adjustment. Insulated stops limit the arc of rotating plates to 180 degrees. Shaft extension ¼" diameter.

Webster R.-F. Transformer

Iron core type carefully tuned at the factory. Completely enclosed in attractive moulded case. Made in TYPES for 1st, 2nd, or 3d steps of amplification. Range 175-555 meter wave band. Moderately priced.

Other items of Webster Radio Apparatus include Head Sets, Variometers, Vario-couplers, A.-F. Transformers, Rheostats, etc.

Complete line of receiving sets at prices ranging from \$30.00 to \$119.00.

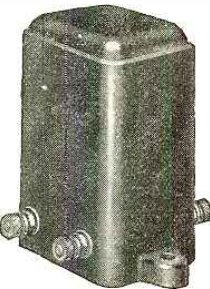

**WEBSTER ELECTRIC COMPANY**  
1904 Clark Street  
RACINE WISCONSIN U. S. A.

Manufacturers of Webster Magneto—over 750,000 in use.

**ATTENTION RADIOTICS**



If you use Amplifying Tubes you can make your Victor talking machine a **RADIO LOUD SPEAKER**, with a **"BEEKO"** Radio-Phone attachment. Sample by mail, 40c. Liberal Discount in Quantities

**J. H. Bunnell & Co.**  
Department X  
32 Park Place, New York

**Radio Supplies at Cut Prices**

Baldwin Headsets—Type C	\$10.50
Federal Headsets—2200 ohm	6.25
Brandes Headsets—Matched Tone	6.25
Thordarson Amplifying Transformers	3.49
Jefferson Amplifying Transformers	3.75
Acme Amplifying Transformers	3.98
Eveready Variable B Battery No. 763	1.25
Eveready Variable B Battery No. 766	2.00
Eveready Variable B Battery No. 767	3.58
Acme Amplifying Transformers	3.98
43 Plate Variable Condensers	2.00
23 Plate Variable Condensers	1.75
3½ inch Dials	.35
1 inch Electrose Dials	.98
001 Fixed Condensers	.25
002 Fixed Condensers	.25
005 Fixed Condensers	.50

Send money order and include postage.

**KENSINGTON RADIO SUPPLY CO.**  
4417 18th Ave., Brooklyn, N. Y.



## EASTERN CLASSIC RECEIVING SETS

Model 101—102

**MUSIC**, News Reports, Opera Concerts, Talks brought right to your home. All the above is yours through the Eastern. The Eastern Classic is constructed with the finest instruments made. Each set is enclosed in a solid mahogany cabinet of the utmost ruggedness and beauty.

**MODEL 101** is our improved detector unit tube type having a wave-length ranging from 200-1,500 meters. Its receiving capacity will bring the broadcasting from a distance approximately 125 miles. All sets equipped with the new type vernier rheostat, giving a much finer adjustment, which tends to eliminate distortion in the phones. Each set equipped with head phones and aerial equipment. List Price . . . . . **\$75.00**

Model 102—two stage amplifier unit. List Price . . . . . **\$125.00**

**EASTERN RADIO MANUFACTURING CO.**  
122-124 Fifth Ave. (Near 17th St.) New York City

## IMMEDIATE SHIPMENT



We can offer immediate shipment on orders for any of the items listed below. Postage must be included with all orders.

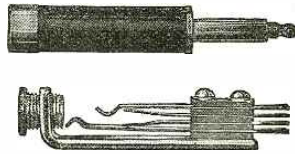

- Bakelite dials—drilled for 1/4 in. shafts . . . . . \$1.00
- Plugs and jacks as illustrated—complete . . . . . 1.50
- Plug only . . . . . .75
- Jack only . . . . . .85
- Socket as illustrated . . . . . 1.00
- 10 to 1 Ratio amplifying transformer—guaranteed . . . . . 4.50
- Binding Posts—black satin finish . . . . . .10
- Bakelite panel—1/4, 3-16 or 1/4—cut to size—runs 20 cubic inches to the lb—cutting charge, 35c per lb. . . . . 2.00
- De Forest condensers—panel mounting .0005 M.F. . . . . 4.50
- Mesco 1 K.W. keys—1/4 inch Sterling silver contacts . . . . . 2.75
- Trumbull-Vanderpoel antenna switches . . . . . 3.25
- Acme 1/2 K.W. fully mounted transformers, regular price \$30.00—Our Price . . . . . 17.50
- Beauging panel switch 1 1/2 in. radius . . . . . .60
- Skinderviken transmitter buttons . . . . . .70

Send 15c for complete literature.

## ELECTRICAL SPECIALTY COMPANY

48-50 South Front Street

COLUMBUS, OHIO



### SAVE MONEY ON STORAGE BATTERIES FOR WIRELESS USE

- 6 volts 40 amp. . . \$9.00
- 6 volts 60 amp. . . 13.00
- 6 volts 80-100 amp 19.50

Batteries shipped fully charged, ready for use. Guaranteed 18 Months on Adjustment. Distributors, Jobbers, Dealers—write for discounts. If your dealer can't supply you, send check or money order direct.

**LIBERTY BATTERY CO.**  
4241 Armitage Avenue, Chicago, Illinois

## AERIALS

A complete, two-wire Antenna Equipment, consisting of

- Two Adjustable Masts Insulators Guys
- Antenna Wire Spreaders Rope, etc.
- 20 ft., \$22.00 30 ft., \$26.00 40 ft., \$30.00

Shipped knocked down in sections—express Collect—with full directions for setting up.

Fits any slant roof—Easily set up. Write for descriptive circular to

**HUDSON ENGINEERING COMPANY**  
Radio Division OSWEGO, N. Y.  
SOLD EVERYWHERE

used the telegraph key could be connected directly in the primary side of the 500-volt power transformer.

### BEST TO USE SEPARATE LIGHTING TRANSFORMER

There is no doubt in my mind that a separate lighting transformer would be the proper way to operate C.W. sets from A.C. sources. When the tubes begin to oscillate it is absolutely necessary to watch the filaments because there is some action in the transformer itself which causes an overload to the filament. Contrary to the general belief—it is a fact that even though the windings are properly selected—there is a favorable chance of burning out filaments when the tube is oscillating. For this very reason the author placed a variable resistance in the filament circuit of the tubes to vary the supply to the filaments of the tubes—even though the filament supply source registered seven and one-half volts on an A.C. voltmeter during a considerable number of tests. Another thing to consider is the fluctuation of line voltage common to house lighting sources.

For most efficient operation it is absolutely necessary to use two transformers. I myself offer no good excuse for using the transformer as it stands, with the exception that this is the first chance I have had at a close up of the operating characteristics of such types of transformers.

### CONDENSERS

If you value the price of transmitting vacuum tubes be positive that all your condensers selected for operation in this particular circuit are of the best kind procurable. Faulty condensers may mean two tubes as fast as you put them in the socket. Two tubes went out of existence for me when the .001 mfd. condenser plates touched and the .0005 mfd. grid condenser punctured on the ends of a poorly constructed condenser of that type. This permitted the high voltage to jump between the grid and filament and it took but one jump in each tube to destroy the filaments. For the .0005 mfd. condenser it is recommended that one be built up from a sheet of 1/8th flint glass measuring 7" x 7" square—place the foil on each side with shellac, allowing one-half inch around the edges. The .001 mfd. condenser should be of the variable oil immersed type. Castor oil or oransil oil will do. It will be preferable to use the latter for the cost of castor oil has long been above our pocketbooks. *Take the former after burning out several good Radiotrons—especially the U.V. 203.*

The two .001 mfd. condensers connected in the plate circuit can be constructed as follows: For each condenser having a capacity of .001 plus, take two plates 1/8th inch in thickness by 7" x 7" square. Put foil on both sides as described above. Connect them in parallel. You will require four plates for the two condensers.

It is a very good idea to shunt a small .0005 variable condenser across the inductance unit so that the wave-length adjustments may be brought about more precisely. This is shown in the drawing by the dotted lines.

### HIGH VOLTAGE CONSIDERATIONS

The Radiotron U.V. 202's have held up on a 600-volt plate potential. On this voltage the tubes require less filament voltage. It is not the best thing to do and for those who desire a lower voltage than that given in the beginning of this article the following modifications are given. Letting the primary stand "as is" i.e., 270 turns

**PERFECT ELECTRIC CONTROL**

# RESIST-O-METER

TRADE MARK

Type A—  
Filament  
Price \$1.80

We manufacture the following:  
RESIST-O-METERS  
Type A—Filament  
Type B—"B" Battery  
Type C—Potentiometer  
TEST-RITE  
CONDENSERS  
in the following capacities:  
Phone .001 mfd.  
Grid .00025 mfd.  
Grid .0005 mfd.  
Grid  
Leak .0005 mfd. 1-meg.  
V. T. Sockets  
Engraved Binding Posts  
Accessory

The Resist-O-Meter is a super rheostat—for perfect electric control. Go to the nearest Radio Dealer and buy one for your set.

The "Resist-O-Meter"—a Scholes Product

- is a micrometer control and gives continuous variation between the extreme ranges of its ohmage.
- is non-inductive.
- is supplied with adjustable brackets for mounting, making new screw holes in panel unnecessary.
- is compact and convenient, and takes up very little space in standardized mounting.
- is made in models covering every requirement for radio use.
- possesses the lowest resistance at full compression (practically zero).
- the resistance material cannot pack.

The Scholes Radio & Manufacturing Corporation holds the sole license to manufacture this type of current control, under patents granted Mr. F. A. Rojas, Nos. 15478 and 1366945, other patents pending. It is sold only under trade name "Resist-O-Meter." Ask your dealer to supply you.

Write to Mr. H. L. Demuth

**The Scholes Radio & Manufacturing Corporation**  
32-36 West 18th Street  
New York City

## Moulded-RADIO-Accessories

*Manufactured of Approved Material*

Specifications Solicited

Knobs	Dials	Rotors
Couplers	Panels	Stators

---

### International Insulating Corporation

Radio Dept. 25 West 45th St. New York City	Factory Springfield, Mass.
--	----------------------------------

### Look At These Prices

Variable Condensers

Genuine Formica Panels  
Real Aluminum Plates

3 Plate	.....\$ .90	23 Plate	.....\$1.90
13 Plate	.....\$1.30	43 Plate	.....\$2.30

*Sent post paid on receipt of price.*

**American Governor Co.**  
Anderson, Ind.

## NOVO "B" BATTERIES

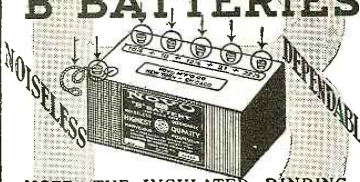

NOTE THE INSULATED BINDING POSTS AND TIN WIRE CONNECTOR

**NOVO MFG. CO.**  
424 W. 33rd St.      531 SO. DEARBORN ST.  
NEW YORK      CHICAGO

- nut Tube and Adapter—Radio Research Guild.
- 2. 1 RORN Tuned Radio Frequency Amplifier Unit—A. H. Grebe & Co., Inc.
- 3. 2 Rasla Radio Frequency Transformers and 2 Rasla Audio Frequency Transformers—Rasla Sales Corp., National Distributors for Radio Service Laboratories.
- 4. 1 Type A B Battery Charger—France Mfg.
- 5. 1 National Airphone Crystal Set Model "G"—National Airphone Corp., and 1 W. T. 501 Peanut Tube and Adapter—Radio Research Guild.
- 6. 1 Ricohorn—Radio Industries Corp., and 1 Carter Two-way Plug—Carter Radio Co.
- 7. 1 Crystal Set—Standard Radio & Elec. Co., and 1 W. T. 501 Peanut Tube and Adapter—Radio Research Guild.
- 8. 4 No. 269 22½-Volt Variable "B" Batteries Novo Mfg. Co., Inc.
- 9. 1 Set Constructional Drawings of a 10 Tube Super-Heterodyne—Experimenters Information Service.
- 10. 1 Gould Radio "B" Battery—Gould Storage Battery Co.
- 11. 1 Dictograph 3000 Ohm Head Set—Dictograph Products Corp., and 1 Carter Two-way Plug—Carter Radio Co.
- 12. 1 Trimm "Professional" 3000 Ohm Head Set Trimm Radio Mfg. Co., and 1 Carter Two-way Plug—Carter Radio Co.
- 13. 1 Loud Speaker—Standard Metal Mfg. Co., and 1 Carter Two-way Plug—Carter Radio Co.
- 14. 1 Goodman Wave Tuner—L. W. Goodman.
- 15. 1 Cole Audio Frequency Transformer—A. B. Cole, Inc.
- 16. 1 Frost 3000 Ohm Head Set—Herbert H. Frost, and 1 Frost No. 138 Multiple Fone Plug—Herbert H. Frost.
- 17. 1 Murdock Loud Speaker—Wm. J. Murdock Co., and 1 Carter Two-way Plug—Carter Radio Co.
- 18. 1 Murdock Head Set No. 56—Wm. J. Murdock Co., and 1 Carter Two-way Plug—Carter Radio Co.
- 19. 1 Double Headset—Radio Industries Corp., and 1 Carter Two-way Plug—Carter Radio Co.
- 20. 1 Membership in the Radio Guild Co-operative Service Bureau—The Radio Guild.
- 21. 1 Fada Variocoupler—Frank A. D. Andrea.
- 22. 1 Large Type "B" Battery—Hipwell Mfg.
- 23. 1 22½-Volt Defelco "B" Battery—Defelco Battery Corp.
- 24. 1 WorkRite Variocoupler—WorkRite Mfg.
- 25. 1 WorkRite Variometer—WorkRite Mfg. Co.
- 26. 1 No. 1 Complete Patterns, Diagrams and Instructions for making Short Wave Regenerative Set; 1 No. 2 Complete Patterns, Diagrams and Instructions for making Detector and Amplifier Radio Units; 1 No. 3 Complete Instructions and Blue Prints for making Radiophone Crystal Set; 1 Twenty Radio Phone Diagrams and Hook-ups of Crystal and Audion Receiving Circuits, Amplifier Circuits, Regenerative Circuits, Sending Circuits, with Key Chart of Symbols and Pamphlet How to Read Diagrams; 1 Fourteen Radio Formulas and Diagrams; 1 Complete and Detailed Instructions—How to Build and Install Every Known Aerial for the Amateur—Consolidated Radio Call Book Co.
- 27. 1 Year's Subscription to SCIENCE & INVENTION—Experimenter Publishing Co.
- 28. 1 Year's Subscription to RADIO NEWS—Experimenter Publishing Co.
- 29. 1 A. C. H. Sharp Tuner Dial—A. C. Hayden Radio & Research Corp.
- 30. 1 A. C. H. Sharp Tuner Dial—A. C. Hayden Radio & Research Corp.
- 31. 1 Brach Lightning Arrester—L. S. Brach Mfg. Co.
- 32. 1 Formica Panel—The Formica Insulation
- 33. 1 Year's Subscription to PRACTICAL ELECTRICS—The Practical Electric Co., Inc.
- 34. 1 Westwyre Condenser—The Westwyre Co.
- 35. 1 Bradleystat—Allen Bradley Co.
- 36. 1 Memory Course—C. K. Dodge.
- 36.A 1 Antenna Plug—Chas. Freshman Co. Inc.
- 36.B 1 Variable Resistance Leak with .006 Micon Condenser—Chas. Freshman Co. Inc.
- 37. 1 Bradleystat—Allen Bradley Co.
- 38. 1 Klosner Model 230 Vernier Rheostat—Klosner Improved Apparatus Co.
- 39. 1 Resistance Unit and Mountings—Daven Radio Co.
- 40. 1 Pair Bates Ear Cushions for Head Set—Bates & Company.
- 41. 1 Consolidated Radio Call Book—Consolidated Radio Call Book Co., Inc.
- 42. 1 Autostat—Automatic Electrical Devices Co.
- 43. 1 Autostat—Automatic Electrical Devices Co.
- 44. 1 Barkeley Four Phone Plug—The Barkeley Electric Mfg. Co.
- 45. 1 Bradleyadapter—Allen Bradley Co.
- 46. 1 Bradleyswitch—Allen Bradley Co.
- 47. 1 Battery Testing Outfit—The Chaslyn Co.
- 48. 1 Saturn Perfect Jack—Saturn Mfg. & Sales
- 49. 1 Radiogram Receiving Set—Radiogram Corp.
- 50. 1 Saturn Automatic Plug—Saturn Mfg. & Sales Co.
- 51. 5 W. D. 11 Fuses—Radio Equipment Co.
- 52. 1 .006 Micon Condenser—Chas. Freshman Co. Inc.

### Zone No. XI

England, France, Spain, Portugal and Mediterranean Cities

- 1. 1 RORN Tuned Radio Frequency Amplifier Unit—A. H. Grebe & Co., Inc.



2. 1 D412 Detector and Two Stage Amplifier—Acme Apparatus Co., and 1 W. T. 501 Peanut Tube and Adapter—Radio Research Guild.
3. 1 Type 215 General Two-Step Amplifier—General Radio Co., and 1 W. T. 501 Peanut Tube and Adapter—Radio Research Guild.
4. 1 Fremont Tuner and Detector—Fremont Radio Sales Co., and 1 W. T. 501 Peanut Tube and Adapter—Radio Research Guild.
5. 1 Home Charger—Automatic Electrical Devices Co.
6. 1 National Airphone Crystal Set Model "G"—National Airphone Corp., and 1 W. T. 501 Peanut Tube and Adapter—Radio Research Guild.
7. 1 Ricohorn—Radio Industries Corp., and 1 Carter Two-way Plug—Carter Radio Co.
8. 4 No. 269 22½-Volt Variable "B" Batteries Novo Mig. Co., Inc.
9. 1 Crystal Set—Standard Radio & Elec. Co., and 1 W. T. 501 Peanut Tube and Adapter—Radio Research Guild.
10. 1 Set Constructional Drawings of a 10 Tube Super-Heterodyne—Experimenters Information Service.
11. 1 Gould Radio "B" Battery—Gould Storage Battery Co.
12. 1 Dictograph 3000 Ohm Head Set—Dictograph Products Corp., and 1 Carter Two-way Plug—Carter Radio Co.
13. 1 Trimm "Professional" 3000 Ohm Head Set Trimm Radio Mig. Co., and 1 Carter Two-way Plug—Carter Radio Co.
14. 1 Loud Speaker—Standard Metal Mig. Co., and 1 Carter Two-way Plug—Carter Radio Co.
15. 1 Goodman Wave Tuner—L. W. Goodman.
16. 1 Cole Audio Frequency Transformer—A. B. Cole, Inc.
17. 1 Frost 3000 Ohm Head Set—Herbert H. Frost, and 1 Frost No. 138 Multiple Pone Plug—Herbert H. Frost.
18. 1 Murdock Loud Speaker—Wm. J. Murdock Co., and 1 Carter Two-way Plug—Carter Radio Co.
19. 1 Murdock Head Set No. 56—Wm. J. Murdock Co., and 1 Carter Two-way Plug—Carter Radio Co.
20. 1 Double Head Set—Radio Industries Corp., and 1 Carter Two-way Plug—Carter Radio Co.
21. 1 Membership in The Radio Guild Co-operative Service Bureau—The Radio Guild.
22. 1 Fada Variocoupler—Frank A. D. Andrea.
23. 1 Large Type "B" Battery—Hipwell Mig.
24. 1 22½-Volt Defelco "B" Battery—Defelco Battery Corp.
25. 1 WorkRite Variocoupler—WorkRite Mig.
26. 1 WorkRite Variometer—WorkRite Mig. Co.
27. 1 No. 1 Complete Patterns, Diagrams and Instructions for making Short Wave Regenerative Set; 1 No. 2 Complete Patterns, Diagrams and Instructions for making Detector and Amplifier Radio Units; 1 No. 3 Complete Instructions and Blue Prints for making Radio Phone Crystal Set; 1 Twenty Radio Phone Diagrams and Hook-ups of Crystal and Audion Receiving Circuits, Amplifier Circuits, Regenerative Circuits, Sending Circuits, with Key Chart of Symbols and Pamphlet How to Read Diagrams; 1 Fourteen Radio Formulae and Diagrams; 1 Complete and Detailed Instructions—How to Build and Install Every Known Aerial for the Amateur—Consolidated Radio Call Book
28. 1 Year's Subscription to SCIENCE & INVENTION—Experimenter Publishing Co.
29. 1 Year's Subscription to RADIO NEWS—Experimenter Publishing Co.
30. 1 A. C. H. Sharp Tuner Dial—A. C. Hayden Radio & Research Corp.
31. 1 A. C. H. Sharp Tuner Dial—A. C. Hayden Radio & Research Corp.
32. 1 Formica Panel—The Formica Insulation
33. 1 Year's Subscription to PRACTICAL ELECTRICS—Practical Electric Co., Inc.
34. 1 Westwre Condenser—The Westwre Co.
35. 1 Bradleyometer—Allen Bradley Co.
36. 1 Memory Course—C. K. Dodge.
- 36.A 1 Antenna Plug—Chas. Freshman Co. Inc.
- 36.B 1 Variable Resistance Leak with .006 Micon Condenser—Chas. Freshman Co. Inc.
37. 1 Bradleystat—Allen Bradley Co.
38. 1 Klosner Model 200 Vernier Rheostat—Klosner Improved Apparatus Co.
39. 1 Resistance Unit and Mountings—Daven Radio Co.
40. 1 Pair Bates Ear Cushions for Head Set—Bates & Company.
41. 1 Consolidated Radio Call Book—Consolidated Radio Call Book Co.
42. 1 Autostat—Automatic Electrical Devices Co.
43. 1 Autostat—Automatic Electrical Devices Co.
44. 1 Barkelew Four Phone Plug—The Barkelew Electric Mig. Co.
45. 1 Bradleyadapter—Allen Bradley Co.
46. 1 Bradleyswitch—Allen Bradley Co.
47. 1 Battery Testing Outfit—The Chaslyn Co.
48. 1 Saturn Perfect Jack—Saturn Mig. & Sales
49. 1 Radiogen Receiving Set—Radiogen Corp.
50. 1 Saturn Automatic Plug—Saturn Mig. & Sales Co.
51. 1 .006 Micon Condenser—Chas. Freshman Co. Inc.

**Zone No. XII**

Includes all other places not named in the other eleven zones and includes the "High Seas"

1. 1 D412 Detector and Two-Stage Amplifier—Acme Apparatus Co., and 1 W. T. 501



# RADIO

in

# Strong Hands

**N**OW, at last Radio sets and parts are offered by an independent corporation possessing large capital, a modern plant, and a staff of seasoned radio engineers and experts—a House that is in business to *stay*—whose *guarantee* offers complete and permanent protection



**SENIOR SET**

**Long Distance Wonder Workers**  
Sweep the country from coast to coast, giving their owners their pick of the daily and nightly programs broadcasted by the 500 stations in the United States and Canada.

THE "SENIOR SET" embodies both detection and amplification, and can be used with either headphones or loudspeakers, or both.

MICHIGAN ACCESSORIES includes variometers, grid variocouplers, variable condensers, all-wave couplers, vernier rheostats, plain rheostats, etc.

*Send for full information on both sets and parts.*

M. R. C.

Regenerative Radio Receiving Sets

are built under Armstrong License (U.S. Patent 1,113,149 and pending letters patent No. 807,388). This means that they embody the latest development in *Regeneration*—the soul of radio.



**JUNIOR SET**

THE "JUNIOR SET" a detector unit only is limited to headphone reception. It can however, be hooked up with the Michigan Amplifier unit, for loudspeaker reception.

## MICHIGAN RADIO CORPORATION

GRAND RAPIDS, MICHIGAN



### Loud Speaker for any Crystal Set

By using the STEINMETZ amplifier you can fill the whole room with music and can increase your range up to 1000 miles. \$8.50, remit by check or money order.

Specials for Limited Time Only  
Radiotron UV200 Detector tube, \$3.75. Amplifier tubes, \$4.75. 1½ volt dry cell tubes, \$4.75. Sockets for standard tubes 50c. Sockets for 1½ volt dry cell tubes, 50c. Standard 2000 ohm phones, \$3.50. 3600 ohm, \$1.30. SUPERIOR crystal sets, \$3.90. Nore 22½ volt "B" Batteries, \$1.50. Rheostats, 50c.

Complete instructive catalog 5c at your dealers or Steinmetz-Wireless Mig. Co., 5706 Penn Ave., Pittsburgh, Pa.

DEALERS:—

WE are Jobbers for

Grebe Receiving Sets  
Murdock Products  
Baldwin Phones  
Federal, Fada and  
Radio Shop Products

Write for Our Special Proposition A

The Radio Shop  
OF NEWARK

76 Springfield Ave., Newark, N. J.

# Each a Leader In Its Field

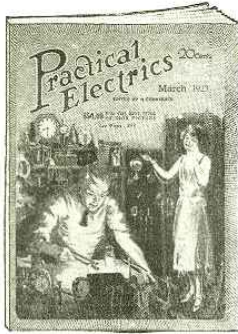

## Practical Electrics

Is the electrical magazine for every one. Its articles all cover electrics of a "practical" nature, and are written in such simple terms that they can readily be understood by all—whether they are beginners, students, laymen, experimenters, or engineers.

Every article is profusely illustrated and each issue contains hundreds of diagrams, patterns, and plans.

Special articles by students, experimenters and famous electricians.

Special department will answer your questions. Prize contests for beginners and students each month.

Sample Copy Sent Free.

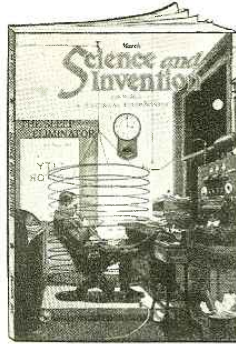

## Science & Invention

Is one of the most interesting magazines published. It is more interesting than fiction.

It is profusely illustrated and covers in word and picture the latest achievements in the sciences—in Invention, Astronomy, Physics, Chemistry, Electrics, Mechanics, etc.

It has a large section devoted exclusively to Radio.

SCIENCE & INVENTION has the distinction of being more often quoted than any other magazine in the world.

More than 100 large pages—with over 300 illustrations, drawings, etc.

Special prize contests are offered each month.

Sample copy will be sent Free.



## Radio News

"The 100 Per Cent Wireless Magazine"

The Largest Radio Magazine in the World.

Is read by more than a million Radio enthusiasts each month.

Its position as the leader of all Radio publications is universally recognized by dealers, radio manufacturers and every branch of the radio industry and its pages reflect their confidence.

RADIO NEWS contains more articles by Radio Experts—more specific information—detailed drawings—illustrations and news—than is published in any other magazine.

More than 200 large pages monthly. Profusely illustrated.

### Special Notice to Subscribers

If you are already a subscriber to either magazine—it is not too late to take advantage of these clubbing rates. Just check the club desired—and send us remittance covering the difference between the amount you have already paid and the clubbing price. Please give us the number of your present subscription.

## ONE YEAR CLUBS

- PRACTICAL ELECTRICS, one year (12 numbers)..... \$2.00
  - " " " and RADIO NEWS (12 numbers each) ..... 3.75
  - " " " and SCIENCE & INVENTION (12 numbers) ..... 3.75
  - " " " SCIENCE & INVENTION and RADIO NEWS (12 numbers each) ..... 5.75
  - RADIO NEWS and SCIENCE & INVENTION (12 numbers each) ..... 4.00
- (50 cents additional must be added to the cost of each magazine for Canada or Foreign).

## TWO YEAR CLUBS

- PRACTICAL ELECTRICS, two years (24 numbers)..... \$3.50
  - " " " and SCIENCE & INVENTION (24 numbers each) ..... 7.25
  - " " " and RADIO NEWS, each two years (24 numbers) ..... 7.25
  - " " " RADIO NEWS and SCIENCE & INVENTION, each two years (24 numbers) 10.50
  - SCIENCE & INVENTION, two years (24 numbers)..... 4.00
  - RADIO NEWS, two years (24 numbers)..... 4.00
  - RADIO NEWS and SCIENCE & INVENTION, each two years (24 numbers each) ..... 7.50
- \$1.00 additional must be added to the cost of each magazine for Canada or Foreign).

Send Your Remittance Today To

## THE EXPERIMENTER PUBLISHING CO.

53 PARK PLACE

NEW YORK CITY, N. Y.



- 1 Peanut Tube and Adapter—Radio Research Guild.
- 2. 1 RORN Tuned Radio Frequency Amplifier Unit—A. H. Grebe & Co., Inc.
- 3. 1 6-Volt 110 A. H. Marko Storage Battery Marko Storage Battery Co.
- 4. 1 Homecharger—Automatic Electrical Devices Co.
- 5. 1 National Airphone Crystal Set Model "G" National Airphone Corp., and 1 W. T. 501 Peanut Tube and Adapter—Radio Research Guild.
- 6. 1 Ricohorn—Radio Industries Corp., and 1 Carter Two-way Plug—Carter Radio Co.
- 7. 1 Crystal Set—Standard Radio & Elec. Co., and 1 W. T. 501 Peanut Tube and Adapter—Radio Research Guild.
- 8. 4 No. 269 2 1/2-Volt Variable "B" Batteries—Novo Mfg. Co., Inc.
- 9. 1 Set Constructional Drawings of a 10 Tube Super-Heterodyne—Experimenters Information Service.
- 10. 1 Gould Radio "B" Battery—Gould Storage Battery Co.
- 11. 1 Dictograph 3000 Ohm Head Set—Dictograph Products Corp., and 1 Carter Two-way Plug—Carter Radio Co.
- 12. 1 Trimm "Professional" 3000 Ohm Head Set—Trimm Radio Mfg. Co., and 1 Carter Two-way Plug—Carter Radio Co.
- 13. 1 Goodman Wave Tuner—L. W. Goodman.
- 14. 1 Ames Variocoupler—Picard Radio Corp.
- 15. 1 Cole Audio Frequency Transformer—A. B. Cole, Inc.
- 16. 1 Frost 3000 Ohm Head Set—Herbert H. Frost, and 1 Frost No. 138 Multiple Fone Plug—Herbert H. Frost.
- 17. 1 Murdock Loud Speaker—Wm. J. Murdock Co., and 1 Carter Two-way Plug—Carter Radio Co.
- 18. 1 Murdock Head Set—Wm. J. Murdock Co., and 1 Carter Two-way Plug—Carter Radio Co.
- 19. 1 Double Head Set—Radio Industries Corp., and 1 Carter Two-way Plug—Carter Radio Co.
- 20. 1 Membership to the Radio Guild Co-operative Service Bureau—The Radio Guild.
- 21. 1 Fada Variocoupler—Frank A. D. Andrea.
- 22. 1 Large Type "B" Battery—Hipwell Mfg.
- 23. 1 2 1/2-Volt Defelco "B" Battery—Defelco Battery Corp.
- 24. 1 Mahoganite Resistor Radion Panel—American Hard Rubber Co.
- 25. 1 WorkRite Variocoupler—WorkRite Mfg.
- 26. 1 WorkRite Variometer—WorkRite Mfg. Co.
- 27. 1 No. 1 Complete Patterns, Diagrams and Instructions for making Short Wave Regenerative Set; 1 No. 2 Complete Patterns, Diagrams and Instructions for making Detector and Amplifier Radio Units; 1 No. 3 Complete Instructions and Blue Prints for making Radio Phone Crystal Set; 1 Twenty Radio Phone Diagrams and Hook-ups of Crystal and Audion Receiving Circuits, Amplifier Circuits, Regenerative Circuits, Sending Circuits, with Key Chart of Symbols and Pamphlet How to Read Diagrams; 1 Fourteen Formulae and Diagrams; 1 Complete and Detailed Instructions—How to Build and Install Every Known Aerial for the Amateur—Consolidated Radio Call Book
- 28. 1 Year's Subscription to SCIENCE & INVENTION—Experimenter Publishing Co.
- 29. 1 Year's Subscription to RADIO NEWS—Experimenter Publishing Co.
- 30. 1 A. C. H. Sharp Tuner Dial—A. C. Hayden Radio & Research Corp.
- 31. 1 A. C. H. Sharp Tuner Dial—A. C. Hayden Radio & Research Corp.
- 32. 2 Formica Panel—The Formica Insulation Co.
- 33. 1 Year's Subscription to PRACTICAL ELECTRICS—Practical Electric Co., Inc.
- 34. 1 Westwre Condenser—The Westwre Co.
- 35. 1 Bradleyometer—Allen Bradley Co.
- 36. 1 Memory Course—C. K. Dodge.
- 36.A 1 Antenna Plug—Chas. Freshman Co. Inc.
- 36.B 1 Variable Resistance Leak with .006 Micon Condenser—Chas. Freshman Co. Inc.
- 37. 1 Bradleystat—Allen Bradley Co.
- 38. 1 Klosner Model 200 Vernier Rheostat—Klosner Improved Apparatus Co.
- 39. 1 Resistance Unit and Mountings—Daven Radio Co.
- 40. 1 Pair Bates Ear Cushions for Head Set—Bates & Company.
- 41. 1 Consolidated Radio Call Book—Consolidated Radio Call Book Co.
- 42. 1 Autostat—Automatic Electrical Devices Co.
- 43. 1 Autostat—Automatic Electrical Devices Co.
- 44. 1 Barkeley Four Phone Plug—The Barkeley Electric Mfg. Co.
- 45. 1 Bradleyadapter—Allen Bradley Co.
- 46. 1 Bradleystat—Allen Bradley Co.
- 47. 1 Battery Testing Outfit—The Chaslyn Co.
- 48. 1 Saturn Perfect Jack—Saturn Mfg. & Sales
- 49. 1 Radiogem Receiving Set—Radiogem Corp.
- 50. 1 Saturn Automatic Plug—Saturn Mfg. & Sales Co.
- 51. 1 .006 Micon Condenser—Chas. Freshman Co. Inc.

**SOMETIMES!**

A series of imitations on a harmonica was included in a program recently broadcast. With a good performer a harmonica gives at times a good imitation of music.

**ANSWERS ALL RADIO QUESTIONS**

GET A

**Radio Quiz Book**

and Get a Government License

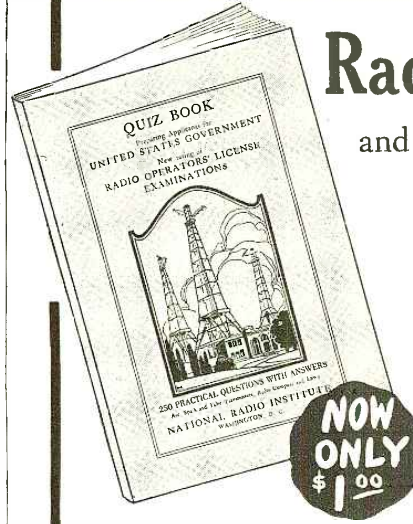

**NOW ONLY \$1.00**

What do you want to know about Radiophone Receiving Sets?—transmitting sets?—what problems are bothering you? The second edition of the Radio Quiz Book is what you need.

Popular Demand

The first edition of 10,000 was sold quickly—now the second edition is ready. The Radio Quiz Book, written by the experts of the National Radio Institute, America's greatest Radio Training School, answers all Radio questions and especially the ones usually asked in government license examinations. 260 common questions are answered in addition to explanations of all types of receiving and transmitting sets, storage batteries, radio symbols, technical terms defined, radio laws and regulations.

**CONTENTS**

- 106 pages.
- 260 common radio questions with answers.
- 92 illustrations.
- Definitions of Radio terms.
- Radio laws and regulations.
- Radio symbols.
- Helpful equations.
- Exhaustive explanations of all types of Receiving and Transmitting Sets.
- Complete list of broadcasting stations.

The Only Book of Its Kind

There are hundreds of books flooding the market, but there are none that can compare with the Radio Quiz Book in valuable information for the price.

Get Your Copy Today

National Radio Institute, Dept. Q  
1345 Pa. Ave., N. W., Washington, D. C.  
Gentlemen: Attached is \$1. Send me by return mail a copy of the second edition of your Radio Quiz Book.  
Name.....  
Address.....

The Only Authentic Book on the Construction and Operation of

**"The Armstrong Super-Regenerative Circuit"**

Described fully in 52 pages, including 21 photographs and Hook-Ups in simple non-technical radio language.

This set built by the author

George J. Eltz, Jr. E. E., A. I. E. E.

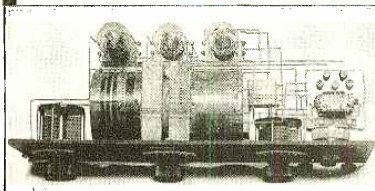

Complete Description of Each of the Three Circuits Invented by  
**MAJOR E. H. ARMSTRONG, E. E.**  
How to Change a Regenerative Circuit to a Super-Regenerative Circuit  
Price \$1.00 Per Copy

Mailed or at your dealer DO NOT SEND STAMPS  
**RADIO DIRECTORY and PUBLISHING CO.**  
47-A Vesey St. New York City

**Radio Dealers Tie Up With Ludwig Hommel & Co.**

- (1) Their discounts are liberal.
- (2) They wholesale to dealers exclusively and do not compete with their dealers by retailing.
- (3) They carry an enormous stock of sending and receiving material, insuring you quick shipment and a positive source of supply.
- (4) They maintain a Dealer's Service Department to help you with your problems. This service is free and cheerfully given.
- (5) They are distributors for the Radio Corporation of America and all the other leading manufacturers.
- (6) You can rely absolutely on Ludwig Hommel & Company apparatus. It is guaranteed by the manufacturers and by them.
- (7) They do more advertising than any other distributors of Radio Apparatus and refer to their dealers consumers' inquiries resulting from that advertising.
- (8) They have been wholesale distributors for 16 years and play square with everybody at all times.

Ask for Hommel's Encyclopedia of Radio Apparatus No. 225S and order your requirements now for immediate delivery.

**LUDWIG HOMMEL & CO**  
530-534 FERNANDO ST. PITTSBURGH, PENNA.

# OPPORTUNITY AD-LETS

Follow these advertisements every month. Reliable advertisers from all over the country offer their most attractive specials in these columns. Classified advertising rate fifteen cents a word for each insertion. Ten per cent discount for 6 issues, 20 per cent discount for 12 issues. Name and address must be included at the above rate. Cash should accompany all classified advertisements unless placed by an accredited advertising agency. No advertisement for less than 10 words accepted. Objectionable or misleading advertisements not accepted. Advertisements for the June issue must reach us not later than April 1st.

**THE CIRCULATION OF RADIO NEWS IS OVER 242,000**  
 EXPERIMENTER PUBLISHING CO., INC., 53 Park Place, New York, N. Y.

### Agents Wanted

Ambitious men, write today for attractive proposition, selling subscriptions to America's most popular automobile and sportsman's magazines. Quick Sales. Big profits. Pleasant work. Digest Pub. Co., 9528 Butler Bldg., Cincinnati.

Big Money and fast sales. Every owner buys gold initials for his auto. You charge \$1.50; make \$1.35. Ten orders daily easy. Write for particulars and free samples. American Monogram Co. Dept. 135, East Orange, N. J.

Amateur Agents Wanted in every city and town to sell radio apparatus. A few stocking agencies still open. Delfeco, 12 Meeting Street, Pawtucket, R. I.

We want Salesmen and Agents, either whole or side line, to sell our low priced radio books to the trade. Excellent proposition for live wires. The E. I. Company, Publishers, 233 Fulton Street, New York City.

We Wish Representatives in every community to secure subscriptions for Radio News, Science and Invention, and Practical Electric. This is a wonderful opportunity for Amateur Radio Enthusiasts to make big money quickly. Write Experimenter Publishing Co., Inc., 53 Park Place, New York City.

Amateur Agents wanted in every city and town to sell the Radioscope—the wonder crystal set. Write for information—The Radioscope Mfg. Co., 128 No. Main, Providence, R. I.

Tremendous Opportunity for ambitious agents. The indispensable, rapid selling Speedy Dish Washer. Price \$3.50. No competition. No investment. Easy selling plan. Convenient sample. Commission daily. Make application today—exclusive territory. Sheppard-Luth Mfg. Co., 16 Z Hudson St., New York.

Build Your Own Business—Renewing and drying rugs and carpets on floors of offices, hotels, homes. New Method. Big profits. \$10 Day easy. Write for full information. Tezply Company, 12-A, Somerville, N. J.

Agents Wanted in every city and town to sell standard radio apparatus. Attractive discounts given. If interested, write us at once stating age and radio experience. Wilmington Electrical Specialty Co., Inc., 912 Orange St., Wilmington, Delaware.

Free Book Start Little Mail Order business. Home employment evenings. Fler, Dept. 180-A, 74 Cortland St., N. Y.

Several territories open for live representatives to sell knockdown Radio Sets. Live leads furnished. Write or call for details. Fremont Radio Sales Co., Inc., 50 Church St., N. Y. C.

### American Made Toys

Manufacturers on Large Scale, also homeworkers, wanted to manufacture Metal Toys and Novelties. Millions needed of Barking Dogs, Wag Tail Pups, Wild Animals, Automobiles, Indians, Cowboys, Baseball Players, Cannons, Toy Soldiers, Crowing Roosters, Statues of Liberty, Miniature castings of Capitol, Bathing Girl Souvenirs and others. Unlimited possibilities. Guaranteed Casting forms furnished manufacturers at cost price from \$5.00 up, with complete outfit. No experience or tools necessary. Thousands made complete per hour. We buy goods all year and pay high prices for finished goods. Cash on delivery. Contract orders placed with manufacturers. Catalog and information free. Correspondence invited only if you mean business. Metal Cast Products Co., 1896 Boston Road, New York.

### Automobiles

Automobile owners, garagemen, mechanics, send today for free copy America's most popular motor magazine. Contains helpful articles on over-hauling, repairing, ignition, carburetors, batteries, etc. Automobile Digest, 528 Butler Bldg., Cincinnati.

### Business Opportunities

Become a Landscape Architect. Dignified, Exclusive Profession. Little competition. \$5,000.00 to \$10,000.00 income for experts. Easy by our method. Begin earning 3 weeks after you enroll. Write today. American Landscape School, 11R, Newark, N. Y.

\$400 clear each day, anybody can do that with our equipment, canvassing and experience unnecessary, send 30c in silver with reference for particulars. Triple Block Motor Works, Garfield, Wash.

Sell us your spare time. You can earn Fifteen to Fifty dollars weekly writing showcards at home. No canvassing, pleasant profitable profession easily, quickly learned by our simple graphic block system, artistic ability unnecessary, we instruct you and supply work. Wilson Methods, Limited, Dept. J, Toronto, Canada.

Growing Radio concern seeks active associate with \$4000 to increase its business. Opportunities big for right party. Write Box 105, Radio News.

### Correspondence Courses

Used Correspondence Courses Bought and Sold. Our plan will save you money. Educational Bureau, 1894 Collins, N. E., Grand Rapids, Michigan.

Dollars Saved—Used correspondence courses of all kinds sold, rented and exchanged. List free. (Courses bought.) Lee Mountain, Pisgah, Alabama.

### Books

"Lights, Colors, Tones and Nature's Finer Forces", including Vibrations, Electromagnetics, Inventions, Radio, Candles; illustrated; 250 pages; postpaid \$2.00; Catalogue Free; Stevens Publishers 212 Powell, San Francisco, California.

Sexology Books only for professional and advanced student readers. Forel, Krafft-Ebinger, Kisch, Hobbie, Ellis, Freud, Key and other authorities. The Modern Book Association, 4150 Santa Monica Blvd., Los Angeles, Calif.

How to Make Wireless Receiving Apparatus. 100 pages—38 illustrations. Only strictly modern radio apparatus are described in this book and the illustrations and descriptions are so clear and simple that no trouble will be experienced in making the instruments. Paper covered, 35c. postpaid. Experimenter Publishing Co., Book Dept., 53 Park Place, New York City.

How to Make Wireless Sending Apparatus. 100 Pages—38 Illustrations. Written and published entirely for the wireless enthusiast who wants to make his own radio apparatus. Contains more information on 'how to make it' than any other book we know of. Paper bound 35c. postpaid. Experimenter Publishing Co., Book Dept., 53 Park Place, New York City.

Experimental Electricity Course in 20 Lessons. By S. Gernsback and H. W. Secor, E. E. A course of the theory and practice of Electricity for the Experimenter. Every phase of experimental electricity is treated comprehensively in plain English. New experiments are described and explained in nearly every application of Electricity in modern life is given. 160 pages—400 illustrations. Flexible cloth cover, 75c. Postpaid. Stiff cloth cover, \$1.25 Postpaid. Experimenter Publishing Co., Book Dept., 53 Park Place, New York City.

Wireless Course in 20 Lessons. By S. Gernsback, A. Lescarboure and H. W. Secor, E. E. Tells you everything you want to know about "Wireless"—theory, practice and history. A clear, concise course on every phase of this subject. 160 pages—350 illustrations, 30 tables. Stiff cloth cover, \$1.75, postpaid. Experimenter Publishing Co., Book Dept., 53 Park Place, New York.

The How and Why of Radio Apparatus, by H. W. Secor, E. E. This newest book on radio matters fulfills a distinct gap in wireless literature. The treatment is made as understandable and as free from mathematics as possible, it at the same time incorporates a wealth of technique and instruction for the Radio Amateur—the Radio Operator—the Installation and Designing Expert—as well as teachers and students of the subject in general. A very broad field has been covered by the author, at the same time giving a great deal of information not found in other text books. If you are interested in any branch of the Radio or allied arts at all you will surely need this latest contribution to radio literature, which is destined to be found on every radio man's book shelf before long. A glance at the following list of chapters gives but a very scant idea of the extensive and useful radio knowledge provided in its text: The Induction Coil; The Alternating Current Transformer; Radio Transmitting Condensers; The Spark Gaps; Radio-Transmitting Inductances; Radio Receiving Tuners; Radio Receiving Condensers; Detectors; Telephone Receivers; Radio Amplifiers; Construction of a Direct Reading Wavemeter and Decimeter; Antenna Construction; The Calculation and Measurement of Inductances; Appendix containing very useful tables, covering all subjects treated in this very unusual book. This newest of Radio Works, cloth bound in Vellum de Luxe, Gold Stamped and Hand Sewed, has 160 pages. Size of book, 6x9 inches. The How and Why of Radio Apparatus. Postpaid, \$1.75. Experimenter Publishing Co., Book Dept., 53 Park Place, New York City.

### Batteries

Batteries. Edison Storage 'B' Battery Elements 5c per pair; 18 will make \$2.25 volt Battery. Gilman's Battery Shop, Chelsea Sq., Chelsea, Mass.

### Chemistry

Learn Chemistry at Home—Dr. T. O'Connor Sloane, noted educator and scientific authority, will teach you. Our home study correspondence course fits you to take a position as chemist. See our full page ad on page 1765 of this issue. Chemical Institute of New York, 140 Liberty Street, New York City.

### Ford Owners

Sport Cars, fast, saucy, hug the turns and stick to the road—make you glad you're a Ford owner. Can easily be built by aid of life-size "Red-Kut" patterns and picture instructions. The "Pat" system delivered complete with pressed metal streamlining all for \$6.40. Garage men make big money building them. Send 5-cent coin for prospectus on making sport cars—Jiffy Tops and Gosum Windshields. Kuempel Co., 316 Kuempel Bldg., Guttenberg, Iowa.

### Electric Supplies and Appliances

Electric Tattooing Outfits. Illustrated Catalogue, 10c. Waters Mfg., 1050 Randolph, Detroit.

### Exchange

For Sale—Two Western Electric VT-1's New—\$9.00 each. Lawton Bidde, 442 Bosart Ave., Indianapolis, Indiana.

Nearly new Standard Royal Typewriter. Want \$40.00. I need lathe, and shop equipment or binoculars. D. Davis, 301 E. Main St., Chillicothe, Ohio.

Amateur Agents wanted in every city and town to sell radio apparatus. A few stocking agencies still open. Delfeco, 12 Meeting Street, Pawtucket, R. I.

Edison Elements for Storage B Batteries. Six to ten cents per pair postpaid. (Depending solely on size of order). I handle strictly first grade elements only. A. J. Hanks, 608 Montgomery Street, Jersey City, N. J.

Omnigraph—15 Dial. First check \$15 takes it. L. E. Yoder, Fairmont, W. Va.

### For Inventors

Unpatented ideas can be sold. I tell you how and help you make the sale. Particulars free. Write W. A. Greene, 109 The Atlantic, Washington, D. C.

### Games and Entertainments

\$25 Nightly. Chalk-Talk Entertainments. Instructions \$1. Comic Art Studios, Owatonna, Minnesota.

### Health

Diseases and Their Innate Healer. Book 50c. Arthur J. Stevens, Wauseon, Ohio.

Tobacco or Snuff Habit Cured or no pay; \$1 if cured. Remedy sent on trial. Superba Co., S.B., Baltimore, Md.

### Help Wanted

We want Salesmen and Agents, either whole or side line, to sell our low priced radio books to the trade. Excellent proposition for live wires. The E. I. Company, Publishers, 233 Fulton Street, New York City.

Be a Mirror Expert. \$3-\$10 a day; spare time home at first; no capital; we train, start you making and silvering mirrors. French method. Free prospectus. W. R. Derr, Pres., 26 McKinley St., Baldwin, N. Y.

All men, women, boys, girls, 17 to 60, willing to accept Government Positions, \$117-\$190, traveling or stationary, write, Mr. Ozment, 251, St. Louis, immediately.

Earn \$25 Weekly, spare time, writing for newspapers, magazines. Experience unnecessary; details free. Press Syndicate, 5685, St. Louis, Mo.

Get posted for Spring—Good prices paid for butterflies, insects. See Sinclair display advertisement, page 1570.

### Insects Wanted

Get posted for Spring—Good prices paid for butterflies, insects. See Sinclair display advertisement, page 1570.

### Instruction

Learn Chemistry at Home—Dr. T. O'Connor Sloane, noted educator and scientific authority, will teach you. Our home study correspondence course fits you to take a position as chemist. See our full page ad on page 1765 of this issue. Chemical Institute of New York, 140 Liberty Street, New York City.

Used Correspondence Courses only one quarter original price. Free bargain price list 1000 courses. Courses bought: Students' Exchange, 45 West 42d St., New York.

Mouth-Organ Instructor, 25c. Play in one hour. Elsea Co., Bowling Green, Ohio.

### Languages

World-Romtic System. Masterkey to All Languages. Primers, 25 languages, \$1.94 each language: Arabic, Bohemian, Bulgarian, Cantonese, Chindua, Danish, Dutch, English, Scotch English, French, German, Hungarian, Italian, Japanese, Latin, Parsiabi, Polish, Portuguese, Rumanian, Russian, Szechuan, Spanish, Swedish, Pronunciation Tables, 94 languages, 30c each language. Languages Publishing Co., 8 West 40th Street, New York.

### Mail Order Business

Advertise. Newspapers, magazines. List on request. Pennell Company, Covington, Kentucky.



**Miscellaneous**

Get posted for Spring—Good prices paid for butterflies, insects. See Sinclair display advertisement, page 1870.

Send us Your Metal Work. We are equipped to do metal stamping power press work, soldering and plating, etc. Estimates furnished. T. E. Bennett Co., 7 Beverly Street, Providence, R. I.

Ferrets \$1.50, Imported Canaries, \$5.00, Parrots, Pigeons, Puppies, Kittens. Leroy E. Taylor, Minneapolis, Minn.

Questions Answered regarding your broadcast receiver—25c each. Devore, Gibson City, Ill.

Crystal Gazing. An art. Can you scry? Lessons 50c, Also Crystals. Crystal Gazing Company, 522 Station "B", Kansas City, Missouri.

**Motion Pictures—Motion Picture Plays**

\$35.00 Profit nightly. Small capital starts you. No experience needed. Our machines are used by government institutions. Catalog free. Atlas Moving Picture Company, 483 Morton Bldg., Chicago.

**Motorcycles—Bicycles**

Don't buy a Bicycle Motor Attachment until you get our catalog and prices. Shaw Mfg. Co., Dept. 6, Galena, Kansas.

**News Correspondents**

Earn \$25 Weekly, spare time, writing for newspapers, magazines. Experience unnecessary; details free. Press Syndicate, 505, St. Louis, Mo.

**Novelties**

Crystal Gazing, Book 75c. Also Crystals, Crystal Gazing Supply Co. 223 Station "B", Kansas City, Missouri.

**Office Devices**

Save half an office machines, equipment, addressers, Multigraphs, Duplicators, Dictaphones. Pruitt Company, 112 North Wells, Chicago.

**Old Money Wanted**

\$2 to \$500 Cash paid for hundreds of old or odd coins. Keep All Old Money, it may be very valuable. Send 10 cts. for new Illustrated Coin Value Book, 46c. Get posted. We pay cash. Clarke Coin Company, Ave. 80, LeRoy, N. Y.

**Patent Attorneys**

Inventors: Protect your invention through A. M. Wilson, Inc., Washington, D. C. Over 25 years of efficient, expert, confidential service. Skilled in Radio-Electrical, Chemical and Mechanical fields. Our new Illustrated Patent Book, giving much necessary and very useful information which every inventor should know, will be sent free upon request. Prompt and careful attention. Highest references. Moderate fees. Send sketch or model for our careful opinion and preliminary advice. Write today to A. M. Wilson, Inc., (Radio 3 ARH), 325 Victor Bldg., Washington, D. C.

Patents. Send drawing or model for examination and report as to patentability. Advice and booklet free. Highest references. Best results. Promptness assured. Watson E. Coleman, Patent Lawyer, 624 F Street, Washington, D. C.

Patents—Inventors should write for Free Guide Books and Record of Invention Blank before disclosing invention. Send model or sketch of your invention for our free opinion of its patentable nature. Radio Electrical, Chemical, Mechanical and Trade-Mark experts. Victor J. Evans & Co., 922 Ninth, Washington, D. C.

Patent. Electrical cases a specialty. Pre-war charges. B. P. Fishburne, 340 McGill Bldg., Washington, D. C.

Inventors! Patents procured. Trade-marks registered. prompt personal service. Fees reasonable, request free "Inventor's Guide" giving detailed information. Franklin H. Hough, Inc., 927 Washington Loan & Trust Bldg., Washington, D. C.

Herbert Janner, Patent Attorney and Mechanical Expert, 624 F Street, Washington, D. C. I report if Patent obtainable and exact cost. Send for circular.

Patents Secured. Prompt service. Avoid dangerous delays. Send for our "Record of Invention" form and Free Book telling How to Obtain a Patent. Send sketch or model for examination. Preliminary advice without charge. Highest References. Write today. J. L. Jackson & Co., 113 Ouray Bldg., Washington, D. C.

Patents—Send for form "Evidence of Conception" to be signed and witnessed. Form fee schedule, information free. Lancaster and Allwine, 269 Ouray Bldg., Washington, D. C.

Patent Sense. The Book the Inventor Keeps. Free. See lacy's ad page 1910.

Patents procured. Send sketch or model today for examination. Prompt report and advice. No charge for Preliminary advice. Write for free Booklet and blank form on which to disclose your idea. Highest references. Promptness assured. Clarence O'Brien, Registered Patent Lawyer, 751 Southern Building, Washington, D. C.

Patents Procured and Trade-Marks Registered. Advice and terms upon request. Robb, Robb & Hill, 1409 Hanna Building, Cleveland, Ohio, 948 McLachlen Bldg., Washington, D. C.

Patent application filed on partial payment plan. Trade-marks, copyrights, etc. Milo J. Stevens & Co., 592 F Street, Washington, D. C. Estab. 1884.

Millions spent annually for ideas. Hundreds now wanted! Patent yours and protect it. Write today for free book—tell how to protect yourself, how to invent, ideas wanted, how we help you sell, etc. 301 Patent Dept., American Industries, Inc., Washington, D. C.

**Patents**

Inventions Commercialized. Patented or unpatented. Write Adam Fisher & Co., 278, St. Louis, Mo.

**Personal**

Lonesome—Join our club—make acquaintances everywhere. Big illustrated book with descriptions and photos, sent in plain wrapper for ten cents. Bonadio Co., Dept. 58, Kansas City, Mo.

Exchange cheery letters with new friends. Betty Lee Inc., 4254 Broadway, New York City. Send stamp.

**Phonographic Supplies**

Build Your Own Phonograph. Big saving. Pleasant, instructive work. Complete instructions, blue-prints, etc., absolutely free. Write today. Associated Phonograph Co., Dept. AP-13, Cincinnati, Ohio.

**Scenery to Rent**

Settings for Opera, Plays, Minstrels. Plush Draps. Address Amelia Grain, Philadelphia.

**Stamps and Coins**

Free—Beautiful set of stamps to approval applicants. Postage 2c. Yonkers Exchange, Yonkers, N. Y.

Stamps, 50 Varieties, Africa, Brazil, Peru, Cuba, Mexico, etc., 10c. 50 different U. S. 25c; 1,000 mixed, 40c; 1,000 Kings, 10c. List free. C. Sterman, 5965 Cote Brillante, St. Louis, Mo.

**Telegraphy**

Wanted—Young men and women to learn Morse and Wireless Telegraphy. Railroad and Wireless Companies in great need of operators. We teach you quickly, and procure positions at big salaries. Great opportunities for advancement. All expenses low; can earn part. Write today for free catalog and 1874. Deddes Telegraph Institute, 27 Street, Valparaiso, Indiana.

**Ventriloquism**

Ventriloquism taught almost anyone at home. Small cost. Send 2c stamp today for particulars and proof. Geo. W. Smith, Room M-546, 125 N. Jefferson Ave., Peoria, Ill.

**Wanted to Buy**

Do You Want Extra Money—We will send you cash for any old Gold, Silver or Platinum Jewelry and Diamonds, Silverware, discarded false teeth. Gather up the old scraps and send to us by registered mail. Highest prices guaranteed. If not satisfactory return our check and we return shipment at our expense. Meyer Jewelry Co., Suite 300 Boley Bldg., Kansas City, Mo.

Cash for Old Gold, Platinum, Silver, Diamonds, Liberty Bonds, War, Thrift, Unused Postage Stamps, False Teeth, Magneto Points, Jobs, any valuables. Mail in today. Cash sent, return mail, goods returned in ten days if you're not satisfied. Ohio Smelting Co., 304 Hippodrome Bldg., Cleveland, Ohio.

Full value paid for old gold jewelry, watches, diamonds, crowns, bridges, dental gold, silver, platinum, gold or silver ore, magnets, pipe, war savings stamps, old false teeth. Packages held 4 to 12 days and returned if our offer is not satisfactory. United States Smelting Works (The Old Reliable), 120 So. State St., Dept. 16, Chicago, Ill.

**Wireless**

Switch Levers, 15c—Points, 1c—23 Plate Variocouplers, \$1.25—Receivers, 50c—U. V. 201 Amplifiers, Catalogue Free. Stewart Radio Supply Co., 3124 Cherokee, St. Louis, Mo.

200-20,000 Meter Receiver including Radiotron \$35.00. Two step Amplifier \$25.00. Box 205, Williamsport, Pa.

Variable Condensers—Capacity .0005, \$1.48 postpaid. Chercheck Company, 3123 Davlin, Chicago.

43 Plate Condenser with dial \$2.40. 14 Tap Variocouplers with dial \$2.00. Detector unit, \$3.50. Detector and one step, \$13.50. Detector and two step, \$23.50. Tube set, \$12.00. Radio News back issues 40c. 3000 ohm phones, \$5.00. T. Bates, Astoria Avenue and Kearney St., New York City.

Stremberg-Carlson Phones. The professional headset at the amateur's price. Super-sensitive, comfortable, durable. Impedance correct for phone work with modern vacuum tubes. Equipped with five-foot polarity indicating, moisture-proof silk cords. A real radio headset for \$7.50. Carrollton Radio Shop, Carrollton, Missouri.

Sockets for WD-11 dry cell tubes 50 cents. Franklin Radio Mfg. Co., 711 Penn Avenue, Wilkingsburg, Pa.

Fibre Panels cut any size ¼ inch thick, 3/16 inch square inch, delivered. With front and edges buffed and polished. ¾ inch extra. Ohio Comb Co., Orrville, Ohio.

Build your own electrolytic storage battery charger. Plates and complete instructions, \$1.00. Descriptive circular free. Peerless Electrical Parts Co., 105 Harris, Rochester, N. Y.

Big Price Reductions all radio supplies. Circular free. QST Radio Service, Williamsport, Penna.

Guaranteed Repairing and Wiring—all makes of radio apparatus. We can make any set work. Write for price. Repair Dept., Radio Panel Shop, Junction City, Kansas.

This is Real Service—Panels cut to order, smooth sawed edges. We cut them exactly to size and ship the same day your order is received. ¼-inch thick, 1½ per square inch; 5/16-inch thick, 2c; ¾-inch thick, 3c; 7/16-inch thick, 3½c; 1/2-inch thick, 4c; why pay more? These radio panels are made of the highest grade black fibro. This material possesses high dielectric strength, is inexpensive, unbreakable and easy to work. Our special offer. Radio panels 6x6½ inches 50c; 8x12¼ inches, \$1. We also carry a complete stock of the rod and tubes, the real thing for electrical insulation, special prices quoted upon application. We pay postage. Radio Instrument & Panel Co., Box 75, Cicero, Ill.

**Wireless—continued**

All Radio Experimenters League Members Wear a Radio Experimenters' Label Button (See ad on page 1923, this issue) identified as an alert and progressive radio enthusiast. Join the Radio Experimenters' League conducted by amateurs for amateurs. Any owner of a Radio set is eligible for membership. Every member receives one of these 14K gold plated label buttons, also a membership card and private identification code number. All members of the league are entitled to a 10 per cent discount on any approved standard receiving or transmitting radio apparatus. You may also have your choice of any one of the following: "Dopesheets" 1. Ten Super-Regenerative Circuit Diagrams every one designed by the famous Major Armstrong himself, together with a complete discussion of their operation by Major Armstrong reprinted by special permission from the Proceedings of the Institute of Radio Engineers. 2. Diagram of Armstrong Super Receiver with accurate panel layout. List of parts and where to get them, also three photos. This set actually works. 3. Diagram how to make a simple and inexpensive wave-trap to separate 360 and 400 meter waves and minimize interference. 4. Wiring diagram of the best transmitting set we have seen for C. W. voice or buzzer with accurate Panel layout. 5. Details of new "Reflex" circuit showing how to set two stages Radio frequency and two stages Audio frequency using only two bulbs. We always have the facts on the latest developments. If you have any hard nuts to crack or questions to ask, shoot them in; we will send a "dopesheet". We old timers are sincerely glad to lend a hand wherever possible. This is one of the most valuable features of membership. Send your name today. Enrollment and registration fee 50c, includes button, membership card, 10 per cent discount privilege, and choice of any one of the above "Dopesheets". Other "dopesheets" in the above list or special "dopesheets" answering questions, 50c each. Radio Experimenters' League, P. O. Box 1, Newark, N. J. More Radio clubs invited to affiliate. Limited number of tests, W. F. 501 Peanut tubes 80c each while supply lasts \$2.00 each. Sockets 40c extra—adapters 75c extra.

Astonishing Results Rokay Single Control Hook-up. Don't buy or build before writing information. Can Rebuild Receivers into Single Control cheaply. Rokay Electric Company, Incomat, Ohio.

For Immediate Delivery—Tubes, Magnavox, Westinghouse Receiving Sets, Phones, Condensers, Rheostats, Variometers, Couplers, Panels, Transformers, V. T. Sockets, Dials, Switch Points, and full line of Parts. R. B. Electric Co., Galva, Ill.

Build your own Radiophones. Instruction Book ten cents. Radio Service Institute, U. S. S. Bank Bldg., Washington, D. C.

Buy! Don't Overlook This. The "Rasco" Baby Detector. Greatest detector ever brought out with molded base. Fully adjustable. See former advertisements in this publication, or our catalog. Detector with Galena Crystal, complete 50c, the same detector with Ruscite Crystal, 75c prepaid. Send for yours today. Radio Specialty Company, 96-98 Park Place, New York City.

Attention!—50 Vacuum tube hook-ups. The greatest collection of vacuum tube circuits ever brought under two covers at such insignificant cost. These diagrams will be found in the great "Rasco" catalog, which contains all the latest materials and parts in a greater proportion than any other catalog. 15c in stamps, or coin, will bring the catalog to you. Radio Specialty Co., 96-98 Park Place, N. Y.

Dials 3 inch genuine hard rubber raised or depressed scale, white or gilt lettering drilled for ¼ and ½ inch shafts. One doz. 3 for \$1.50 postpaid. No stamps. Radio Sales Co., Box 1144, Bethlehem, Pa.

Miller audiotransformer eliminates howling. Entirely satisfactory on 3 stages. Price \$5.00 postpaid anywhere in U. S. Radio Sales Co., Box 1144, Bethlehem, Pa.

Bargains—New goods. \$45.00 Magnavox, \$36.00, U. V. 200 Detector Tubes, \$4.25. U. V. 201 Amplifier Tubes, \$5.40. W. D. 11 Detector Tubes, \$5.40. Brandes 2000 ohm Phones, \$6.00. Murdoch 2000 ohm Phones, \$4.00. Forduck 3000 ohm Phones, \$4.50. Wern Electric Phones, \$8.00. Westinghouse Battery Charger, \$15.50. Schock, 3832 N. Percy St., Philadelphia, Pa.

Wire Your Set with Copper Braid instead of solid wire. Extremely low resistance at Radio frequencies. Also many mechanical advantages. No. 16 contains 96 No. 36 bare wire. One doz. \$18 feet for \$1.50. Radio Panel Shop, Junction City, Kansas.

"Hearwell" detector radio sensation, eliminates crystal trouble, permanent sensitive. Guaranteed. Fits crystal cup. One doz. 30c. each. Hearwell Co., Box 4131, Boston, Mass.

Tube Renewals—Radiotron, Cunningham, DeForest, etc. at \$3.00. Detectors, \$3.50; Amplifiers V-T 1's, 2's, U. V. 202, W-D 11 at \$4.50. Prompt deliveries and satisfactory results guaranteed. S. Strobel & Co., 4101 N. 6, Philadelphia, Pa.

Use a C3 receiver, built for service. Cheney Radio Co., Cheney, Kansas.

Pacific Coast Stations are heard in Pittsburgh with variocoupler and 300 ohmeters Receiving Radiometers (condenser moulded variometers) Radiometers \$4.00 each postage paid. Rogers Radio Company, 5133 Woodworth St., Pittsburgh, Pa.

Wireless Course in 20 Lessons. By S. Gernsback, A. LeCarbours and H. W. Secor, E. E. Tells you everything you want to know about "Wireless"—theory, practice and history. A clear, concise course on every phase of this subject. 160 pages—350 illustrations, 30 tables. Stiff cloth cover, \$1.75 postpaid. Experimenter Publishing Co., Book Dept., 53 Park Place, New York City.

How to Make Wireless Receiving Apparatus. 100 pages—90 illustrations. Only strictly modern radio apparatus are described in this book and the illustrations and apparatus are so clear and simple that even those who have experienced in making the instruments. Paper covered, 50c. postpaid. Experimenter Publishing Co., Book Dept., 53 Park Place, New York City.

How to Make Wireless Sending Apparatus.—100 pages—88 illustrations. Written and published entirely for the wireless enthusiast who wants to make his own radio apparatus. Contains more information on "how to make it" than any other book we know of. Paper bound, 50c. postpaid. Experimenter Publishing Co., Book Dept., 53 Park Place, New York City.







# RICO PRODUCTS

## A Remarkable Phone

Here is the loud-speaker phone for which you have been waiting! For the first time you are now able to buy a single 2,000-ohm loud-speaker phone that has been planned by radio and acoustic engineers for one purpose, and one purpose only—namely, to reproduce sounds clear and loud through a horn.

Used in any standard horn, it will amplify the weakest of sounds so that the whole family can hear your radio all over the house. Furnished complete with a five-foot (5 ft.) cord. The RICO LOUD-SPEAKER PHONE will prove a revelation to you, if you have used regulation head receivers for loud talkers. We are so convinced that you will be enthusiastic about this phone that we make this

**SPECIAL OFFER:** Try this LOUD-SPEAKER PHONE for five days, and simply consider the money you are sending in to us as a deposit. If, at the end of five days, you are not convinced that it is the best loud-talker phone you have ever seen or heard, return it to us and your money will be promptly refunded.



FIBRE  
"RICOHORN"

**\$12.50**

No. 111  
COMPLETE  
With  
"RICO"  
Loud Speaker  
Phone

This horn stands 23" high, bell 10". Made entirely of fibre, metal base.

No. 11 Fibre "RICOHORN" only with base, but without Loud-Speaker Phone, height 23", bell 10", each \$10.00

**RADIO  
INDUSTRIES  
CORPORATION**

131 Duane Street  
NEW YORK CITY

California, Washington and Oregon Distributors: Western Agencies, Inc.  
711 Mission St. San Francisco, Cal.

## A Remarkable Price

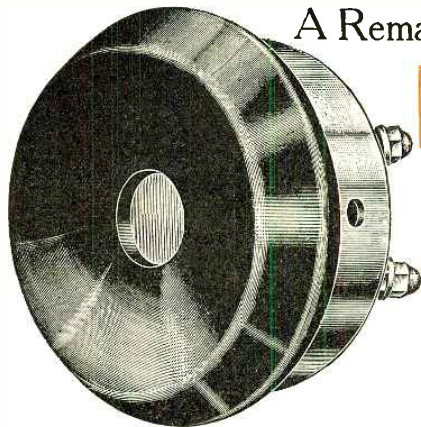

"RICO" Loud Speaker Phone With Cord

**\$4.50**

**SEND NO MONEY**

RICO Phones achieve remarkable results, due to the three poles. The only ones that have return circuit through the diaphragm, with the magnetic pole in the mathematical center of the diaphragm.

USE COUPON BELOW

Note: The RICO Loud-Speaker No. 25 'Phone must be used in connection with a 1- or 2-stage amplifier or more.

### "RICO" "Super-Sensitive" Phones

This 'Phone comprises two of our Loud-Speaker 'Phones, described above, with our stock headband and cord. The resistance is 4,000 ohms, and is made especially for use with vacuum tubes. Not suitable for crystal outfits. Note particularly that this set of receivers has the two receivers connected in parallel, not in series, as is usual with other receivers. The parallel connection gives double the intensity; this phone will surprise you with its extremely powerful volume of sound. No. 40, Super-Sensitive Double Headset, each **\$9.50**

**75c**



This adapter fits Columbia, Victor, and Sonora phonographs. Is made entirely of Pure rubber, with brass tube insert.

Fits any telephone receiver, as well as our LOUD-SPEAKER Phone.  
No. 131 "RICO" Phonodapter, each, prepaid, **\$.75**

### Phone Price List

Parcel Post—Paid Anywhere in North America	
No. 25 Special Loud-Speaker Phone with cord	\$4.50
No. 20 2000 ohms Double Head Set	5.00
No. 30 3000 ohms Double Head Set	5.50
No. 40 4000 ohms Double Head Set	9.50
No. 10 1000 ohms Single Head Set	3.50
No. 15 1500 ohms Single Head Set	3.25
No. 2 1000 ohms Receiver only	2.00
No. 3 1500 ohms Receiver only	2.25
No. 05 5 ohms Receiver only	2.00
No. 075 75 ohms Receiver only for Telephone work, not for radio	1.00

Mail your order at once, if your dealer can not supply you. Insist upon RICO Tri-pole. There is a very good reason why you should use RICO 'phones, and that is they are different—not merely Phones, but

**Phones built for Radio purposes.**



**\$5.00**

Rubber Head Band

Rico No. 20, 2000 ohm Double Head Set with pure rubber covering. Now \$5.00  
Rico No. 30, 3000 ohm Double Head Set with pure rubber covering. Now \$5.50

**SEND NO MONEY**

COUPON

R.N. 4

Radio Industries Corporation,  
131 Duane Street, New York

Gentlemen:

Please send me prepaid \_\_\_\_\_ for which I will pay the postman the amount advertised in these pages. (NOTE: "Phonoadapters," due to the very low price, cannot be sent C.O.D.) If within five days I do not find the phones all you claim for them, I may return same to you in good condition and you will refund the full purchase price.

NAME \_\_\_\_\_  
STREET AND NO. \_\_\_\_\_  
CITY \_\_\_\_\_ STATE \_\_\_\_\_

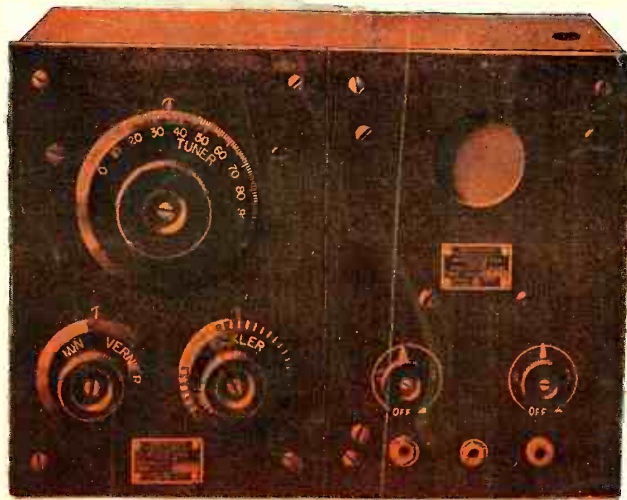

*In* **TRENTON**, he hears  
*stations 1500 miles away*  
 with **Radiola RC**

REG. U. S. PAT. OFF

J. T. K. Hudnut, Secretary and Treasurer of the Trenton Electric Supply Company, recently wrote and said about Radiola RC:

*"Just a line to tell you that Radiola RC has given perfect satisfaction. On Tuesday evening between 11:15 and 11:30 I picked up Chicago and Kansas City."*

This is but one of thousands of letters received in which owners of Radiola RC have commented on its remarkable range. Half the delight of radio lies in this ability to pick up the far stations.

Radiola RC is a compact, highly-sensitive, long-distance receiver that can be used with a loud-speaker to flood a room with music. Thousands of Radiola RCs are in use everywhere.

The price of Radiola RC is \$132.50. Examine it at any RCA dealer. If there is none near you, write to us and we shall put you in touch with one.



*To find out what Radiola will fit your needs and purse, write for free illustrated booklet "Radio Apparatus for Broadcast Reception."*



This symbol of quality  
 is your protection

**Radio**  **Corporation**  
*of America*

District Offices:

Sales Department, Suite 2065  
 233 Broadway, N. Y.

10 South LaSalle Street, Chicago, Ill.  
 433 California Street, San Francisco, Cal.