

CIRCULATION LARGER THAN THAT OF ANY OTHER RADIO PUBLICATION



RADIO NEWS

REG. U.S. PAT. OFF.

25 Cents

APRIL

Over 200
Illustrations

Edited by HUGO GERNSBACK

RADIO
OSCILLATOR
DETECTS
THIEVES

SEE PAGE 1408

EMPLOYEES EXIT

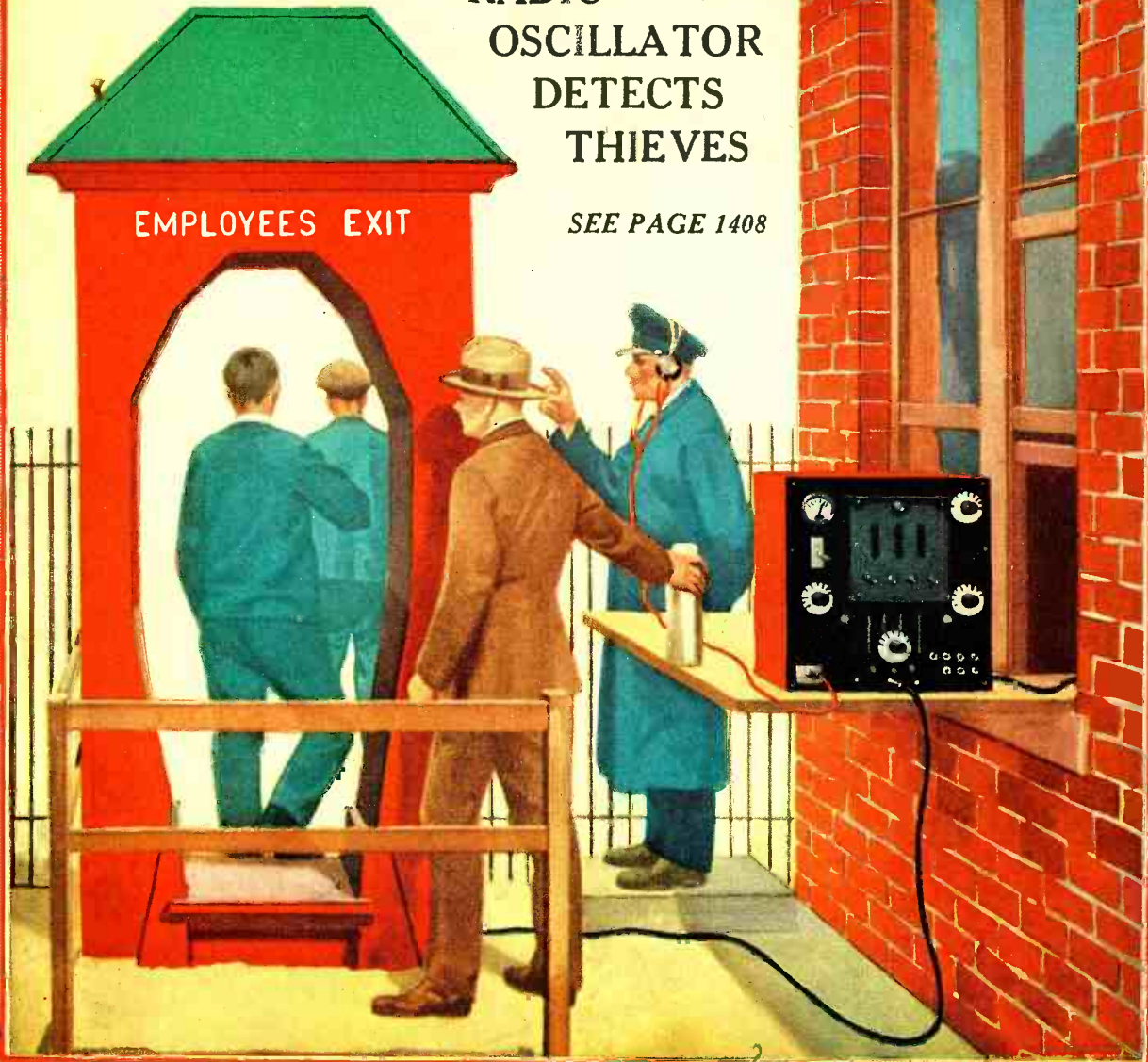

RADIO'S GREATEST MAGAZINE

EXPERIMENTER PUBLISHING COMPANY, NEW YORK, PUBLISHERS OF

SCIENCE and INVENTION RADIO REVIEW AMAZING STORIES RADIO INTERNACIONAL

Cunningham

RADIO TUBES



Confidence in a Name

KNOWLEDGE derived from his own experience soon convinces the radio recruit that all radio tubes are *not* alike--no matter how similar their appearance. And from his own experience he

reaches the conclusion of millions --that the best guarantee of hidden value and unseen protection in a radio tube is in the name Cunningham with a reputation zealously guarded since 1915.

E. J. Cunningham Inc.

Chicago

San Francisco

New York

Tower

REG. U.S.
PAT. OFF.

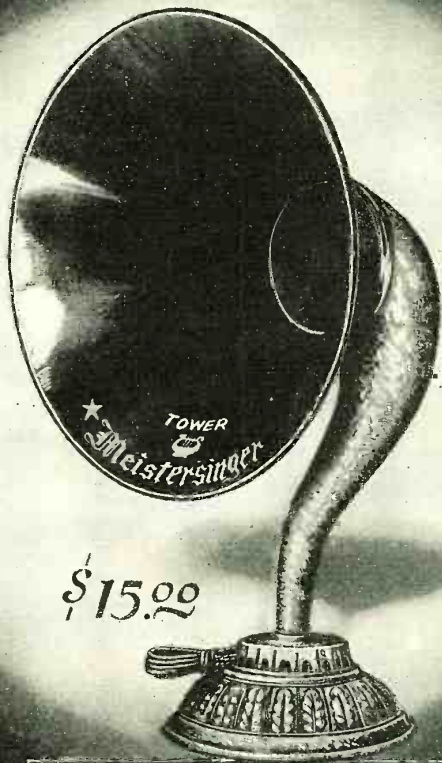

\$15.00

TOWER MFG CORP

BOSTON MASS.

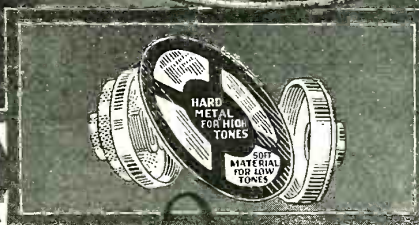

PATENTS PENDING

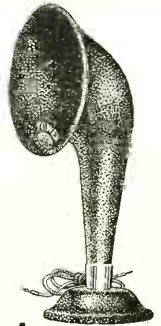

Tower Scientific
\$2.95

These Tower Products equipped with this New Diaphragm

Phonograph Attachment
\$3.95

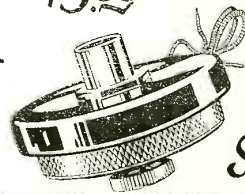

\$8.50 *Scientific*

Little Spitfire \$4.95

WORLD'S GREATEST SPEAKER VALUES

RADIO NEWS

Published by EXPERIMENTER PUBLISHING COMPANY, INC.
 Publishers of "Radio News," "Science and Invention,"
 "Radio Internacional," "Radio Review" and "Amazing Stories."
 Editorial and General Offices: 53 Park Pl., New York City
 H. GERNSBACK, President. S. GERNSBACK, Treasurer
 R. W. DEMOTT, Secretary.
 MEMBER: AUDIT BUREAU OF CIRCULATIONS
 RADIO MAGAZINE PUBLISHERS ASSOCIATION

VOLUME 7

CONTENTS APRIL, 1926

NUMBER 10

In Our Next Issue

A New and Convenient Method of Assembling Radio Sets,
 By Joseph Riley.

This article will bring out for the first time a novel method of radio construction, eliminating much of the drudgery of wiring and connecting, and obtaining superior results. Every constructor and experimenter should read this.

* * *

More About Vacuum Tubes,
 By Dr. Charles B. Bazzoni.

A continuation of this interesting series on laboratory methods, telling of the remarkably simple methods used to produce the high vacua, which have made possible radio as we know it.

* * *

Static Forecasts Forest Fires,
 By S. R. Winters.

An interesting article telling how Uncle Sam's foresters have made the static demon give warning of the "dry spells" which necessitate special vigilance over our National Forests.

* * *

Changes in the Polarization of Radio Waves,
 By Dr. Greenleaf W. Pickard.

An article on an interesting phenomenon which radio waves share with light waves, and its application to make radio transmission more effective for direction and distance.

In This Issue

The DX Listener 1395

By Hugo Gernsback

The Phantom Radio Dinner 1396

By G. C. B. Rowe

Radio Makes Isolated Lives Happy. By Mrs. Christine Frederick 1398

Radio Happenings of the Month Illustrated 1399

By George Wall

A 23-Control DX Receiver 1400

By Samuel Silverman

Music On Wheels 1401

By Joseph Riley

Work for New Radio Detective Car 1401

By George F. Paul

Short-Wave Radio on the Pacific 1402

By Capt. H. J. Adams and F.C. Ryan

\$75 Prize Winner in the Radio News Play Contest "The Fugitive" 1403

By James F. Conway

Radio Developments Shown in Pictures 1404

Views of the New Super-Power Station WJZ WRNY For New York Visitors 1405

By Charles D. Isaacson

"So's Your Old Ghost!" 1407

By Marius Logan

The Radio Watchman at The Gate 1408

By Dr. K. Schuett

International Radio 1409

All About "A" Batteries and Chargers 1410

By A. P. Peck

Round the World in a Radio-Equipped Lifeboat 1412

By A. Dinsdale

Radio Set Owners Information 1413

New Developments in Radio Apparatus 1414

By William J. Griffin

"Quo Vadis?" 1418

By Henry Dubois

A New Loud Speaker Diaphragm 1419

By G. S. Bennett

Thirty Years in the Dark Room 1420

The Passing of Canned Music 1422

By Major J. S. Hatcher

The Experimenter's Own T. R. F. Set 1424

By A. P. Peck

List of Broadcast Stations in the United States 1427

A New Radio Frequency Receiver 1428

By Edward Spiegler

A Balanced Tuned R. F. Receiver 1429

By John M. Kirkland

The Ghirard VIII Superheterodyne 1430

By Alfred A. Ghirardi

How to Construct the DX4 1432

By A. K. Laing

Five Minutes of Radio for a Nickel 1433

By Joseph Riley

The Doughnut Five 1434

By Ashur Van A. Sommers

A Duplex Crystal-Detector Hook-Up, Using Both Halves of the Wave 1435

All About Toroid Coils 1436

By Sylvan Harris

What Is "Distortion?" 1438

By Dr. A. E. Anderson

What Is Regeneration? 1440

By Kenneth W. Jarvis

Shielding Radio Receivers Gains Favor 1442

By Herndon Green

Radio Wrinkles Regarding Noises 1443

By Jack Milligram

Radiotics Correspondence From Readers 1448

Standard Hook-Ups 1449

Radio Set Directory 1451

RADIO NEWS LABORATORIES I Want to Know 1452

By Joseph Bernsley

Radio Book Reviews 1493

RADIO NEWS is published on the 10th of each preceding month. There are 12 numbers per year. Subscription price is \$2.50 a year in U. S. and possessions. Canada and foreign countries, \$3.00 a year. U. S. Coin as well as U. S. Stamps accepted (no foreign coins or stamps). Single copies, 25 cents each. A sample copy will be sent gratis on request. Checks and money orders should be drawn to order of EXPERIMENTER PUBLISHING CO., INC.

All communications and contributions to this journal should be addressed to Editor, RADIO NEWS, 53 Park Place, New York, N. Y. Unaccepted contributions cannot be returned unless full postage has been included. All accepted contributions are paid for on publication. A special rate is paid for novel experiments; good photographs accompanying them are highly desirable.

RADIO NEWS, Monthly. Entered as second class matter, July 12, 1924, at the Post Office at New York, N. Y., under the Act of March 3, 1879. Additional entry at Long Island City, N. Y., and San Francisco, Calif. Title registered U. S. Patent Office. Copyright, 1926, by The Experimenter Publishing Co., Inc., 53 Park Place, New York. The Contents of this magazine are copyrighted and must not be reproduced without giving full credit to the publication. Copyrighted in Germany. Reproduction of articles in Germany is reserved for Radio, Berlin 42. RADIO NEWS is for sale at all newsstands in the United States and Canada.

New York City
 General Advertising Dept.
 53 Park Place

Western Advertising Representatives
 Finnan & McGuire
 720 Cass St., Chicago, Ill.

New England Advertising Representative
 T. F. Magrane, Park Square Building, Boston, Mass.

and at Brouha's, Ave. de L'Opera, Paris, France. European agents: S. J. Wise Et Cie, 40 Place Verte, Antwerp, Belgium.

HOW TO SUBSCRIBE FOR RADIO NEWS. Send your name, address and remittance to Experimenter Publishing Co., 53 Park Place, New York. Mention the name of the magazine you are ordering. We also publish SCIENCE AND INVENTION RADIO INTERNACIONAL, RADIO REVIEW and AMAZING STORIES. Write clearly.

RATES AND TERMS. The subscription rate for RADIO NEWS is \$2.50 per year (12 numbers). When remitting do so by check, money order, or registered letter if cash is enclosed. Avoid sending cash through the mail if possible. Subscriptions for less than one year are not accepted. Subscription may be made in combination with SCIENCE & INVENTION, RADIO INTERNACIONAL, RADIO REVIEW and AMAZING STORIES.

POSTAGE. We prepay postage in all parts of the United States, Mexico and island possessions. For foreign or Canadian subscriptions we require 50 cents in addition to the subscription price for additional postage charges.

CHANGE OF ADDRESS. Notify us as far in advance as possible. It requires several weeks to make an address change on our records. Always write clearly. ON EXPIRATION of your subscription we enclose a renewal blank in our last number to you; we stop our delivery to you on expiration.

Pacific Coast Advertising Representatives
 A. J. Norris Hill Co.
 Hearst Bldg., San Francisco, Calif.
 Detwiler Bldg., Los Angeles, Calif.

Kansas City Advertising Representatives
 Davies and Dillon
 15 W. Tenth St., Kansas City, Mo.

Detroit Advertising Representative
 Roy Buell, Donovan Bldg., Detroit, Mich.

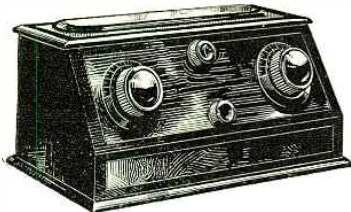

The Crosley 4-tube—4-29
in which the Crescendon is equal to one or more additional tubes of tuned radio frequency amplification . . . **\$29**



The Crescendon
—an amazing new volume control exclusive to Crosley sets. Hear it!

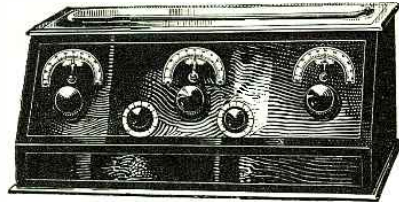

The Crosley 5-tube—5-38
All the volume, selectivity and purity of tone available in the best 5-tube set—plus the Crescendon . . . **\$38**

Widespread Popularity Marks Another Great Success

Spectacular as has been each stride in radio achieved by Powel Crosley, Jr., never before has a Crosley success received such prompt and widespread recognition. Here in the radio plant which has made more radios than any other factory in all the world, every man and machine is going at top speed, every hour is a crowded hour, every night a working day, as the result of orders for the four new Crosley sets.

Even the sweeping success of the Crosley Musicone did not match this merciless demand upon an organization tuned to mass production. With the first demonstrations by Crosley dealers, public approval was expressed in orders that have increased in volume day by day and show no inclination to relax.

This popularity is distributed quite evenly between the four new 4- and 5-tube sets. Thousands who had formerly believed that

worth while reception was exclusive to high priced sets, have found in Crosley 4-29 and 5-38 all that they could ask of radio. The accurate selectivity and pure tone of these instruments would be enough. That magnificent volume achieved through the *Crescendon* is the final touch.

And in Crosley "RFL" types there is a revelation for all. For here true cascade amplification makes its first appearance. Here what was considered *impossible* in expert opinion has been achieved by amplification closely approaching theoretical maximum efficiency per tube!

What a joy to find, and in a low priced set, rare beauty, rich tone, volume subject only to your desire, and no howling at any pitch by any mishandling under any conditions.

Each instrument delights the ear, fires the enthusiasm of the lay technician, converts the staunchest skeptic to love of radio.

See the new Crosley receiving sets at your dealer's or write Dept. 22 for descriptive catalog

Crosley manufactures radio receiving sets which are licensed under Armstrong U. S. Patent No. 1,113,149, or under patent applications of Radio Frequency Laboratories, Inc.

THE CROSLLEY RADIO CORPORATION, CINCINNATI, OHIO
 Powel Crosley, Jr., President

Owning and Operating WLW, first remote control super-power broadcasting station in America



The Crosley 5-tube—RFL-60
A set of marvelous performance and beautified by the artistic decorative panel **\$60**

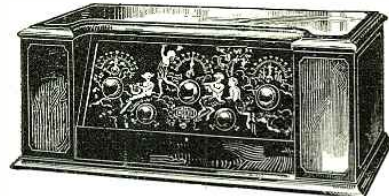

The Crosley 5-tube—RFL-75
Simplicity and speed in tuning, fidelity of tone and decorative beauty, enhanced by the art panel **\$75**

Add 10% to all prices west of the Rockies

CROSLLEY RADIO

BETTER—COSTS LESS

FOR THE ENTERTAINMENT CORNER

INDEX TO ADVERTISERS

INDEX TO ADVERTISERS

	Page		Page		Page
A					
Acme Apparatus Co.....	1465				
Aerovox Wireless Corp.....	1476				
Alden Mfg. Co.....	1458				
All-American Radio Corp.....	1484				
All Radio Co.....	1491				
Allen-Bradley Co.....	1512				
Ambassador Sales Co.....	1498				
Amhu Engineering Institute.....	1505				
American Electric Co.....	1507				
American Hard Rubber Co.....	1490				
American Radio Engineers.....	1495				
Amplion, Corp. of America, The	1508				
Amisco Products, Inc.....	1505				
Arrow Battery Co.....	1504				
Atwater Kent Mfg Co.....	1498				
B					
Bakelite Corporation.....	1463				
Baker-Smith Co., Inc.....	1490				
Barawik Company, The, 1484, 1488, 1495, 1501, 1505, 1508, 1509					
Barkelew Elec. Mfg. Co., The	1472				
Belden Mfg. Co.....	1467				
Benjamin Electric Mfg. Co.....	1509				
Bluebird Tube Co.....	1493				
Boice, W. B. & J. E.....	1501				
Bogue, B. N.....	1458				
Bradley Institute.....	1494				
Brady, John B.....	1511				
Brant Battery Co.....	1462				
Bremer-Tully Mfg. Co.....	1470				
Brownlie, Roland.....	1468				
Buescher Band Instrument Co.	1480				
Butts, Inc., C. W.....	1476				
C					
C. E. Mfg. Co., Inc.....	1472				
Camfield Radio Mfg. Co.....	1503				
Carborundum Company, The	1489				
Carter Radio Co.....	1497				
Chelsea Radio Co.....	1486				
Chemical Institute of N.Y., Inc.	1481				
Chicago Battery Works.....	1480				
Chicago Elec. Devices Co.....	1504				
Chicago Stock Gear Works.....	1476				
Christen Mfg. Co., J. C.....	1504				
Cole Radio Mfg. Corp.....	1490				
Conneway Electric Labs. Inside Back Cover Conrad Co., Inc., The 1392, 1506					
Coyne Electrical School.....	1508				
Crescent Radio Supply Co.....	1480				
Crosley Radio Corp., The.....	1387				
Culver-Stearns Mfg. Co.....	1486				
Cunningham, Inc., E. T. Inside Front Cover					
D					
Daven Radio Corp.....	1498				
DeWitt LaFrance Co.....	1476				
Distantone Radio, Inc.....	1389				
Dongan Electric Mfg. Co.....	1462				
Duke Radio Co.....	1494				
E					
Economy Radio Sales Co.....	1494				
Electrad, Inc.....	1470				
Electric Specialty Co.....	1468				
Electrical Engineers Equipment Co.....	1488				
Electrical Research Labs.....	1490				
Electro Thermal Co., The.....	1495				
Erie Fixture Supply Co.....	1495				
Evans & Company, Victor J.	1462				
F					
Fahnestock Electric Co.....	1507				
Fansteel Products Co., Inc.....	1461				
Ferbend Electric Co.....	1502, 1507				
Fishwick Radio Co.....	1504				
Fitzpatrick, Geo. J.....	1509				
Formica Insulation Co., The.....	1485				
Freshman Company, Inc., Chas.	1491				
G					
G-S Radio Research Lab.....	1502				
Gearhart-Schlueter Radio Corp.	1464				
Gem Tube Co.....	1511				
General Electric Co.....	1499				
General Merchandising Co.....	1494				
General Radio Co.....	1495				
General Winding Co., Inc.....	1487				
Golden Leutz, Inc.....	1493				
Gold Medal Radio.....	1508				
Goodrich Rubber Co., The B.F.	1470				
Gould Storage Battery Co., Inc., The.....	1497				
H					
Hammarlund Mfg. Co.....	1501				
Heath Radio & Electric Mfg. Co.....	1478				
Hommel & Co., Ludwig	1476, 1490				
I					
Indiana Mfg. & Elec. Co.....	1484				
International Correspondence Schools.....	1511				
Ivorylite Radio Panel Co.....	1486				
J					
Jewell Electrical Instrument Co.	1478				
K					
K. Electric Co.....	1508				
K & H Electric Co.....	1458				
L					
Lancaster & Allwine.....	1482				
M					
Mack Laboratories.....	1499				
Marko Storage Battery Co.....	1472				
Mason, Fenwick & Lawrence.....	1502				
Maxon, E. P.....	1493				
Midwest Radio Co.....	1458				
Miller Rubber Co. of N. Y., The	1498				
Morison Elec. Supply Co., Inc.....	1511				
Myers Radio Tube Corp.....	1502				
N					
National Carbon Co., Inc.....	1459				
National Company, Inc.....	1468				
National Radio Institute.....	1391				
Niagara Metal Stamping Corp.	1464				
Norden-Hauck, Inc.....	1484				
O					
Ohio Electric & Controller Co., The.....	1490				
Omnigraph Mfg. Co., The.....	1503				
Orr, T. V.....	1483				
Osborne-Kelsey Co.....	1474				
Owen, Richard B.....	1508				
P					
Parker, C. L.....	1508				
Pfanstiehl Radio Co.....	1475				
Phenix Radio Corp.....	1393, 1471				
Pilot Electric Mfg. Co., Inc.....	1473				
Powerola Radio Corp.....	1474				
Press Company, The.....	1464				
Press Guild.....	1464				
Prest-O-Lite Co., Inc., The.....	1469				
R					
Radial Company.....	1498				
Radio Association of America.....	1509				
Radio Corp. of America..Back Cover					
Radiogem Corp., The.....	1464, 1489				
Radio Parts Co.....	1499				
Radio Specialty Co.....	1479				
Randolph & Co.....	1498				
Randolph Radio Co.....	1511				
Ray Manufacturing Co.....	1490				
S					
S-C Merchandising Co.....	1469				
Scientific Radio Labs.....	1480				
Scott Radio Labs.....	1458				
Service Battery Co.....	1474				
Silver-Marshall, Inc.....	1490				
Smith, B. Hawley.....	1498				
Somerset Radio Corp.....	1477				
Southern Toy Co., Inc., The.....	1478				
Standard Radio Co.....	1472				
Starrett Mfg. Co.....	1468				
Sterling Mfg. Co. The.....	1476				
Super-Service Labs.....	1476				
Sylvania Products Co.....	1482				
T					
Telephone Maintenance Co.....	1460				
Thomas Battery Co.....	1466				
Thompson-Levering Co.....	1466				
Thordarson Electric Mfg. Co.....	1394				
Tower Mfg. Corp.....	1388				
Triangle Manufacturers.....	1491				
Twentieth Century Radio Co.....	1468				
U					
Union Radio Corp.....	1460				
U. S. Tool Co., Inc.....	1472				
Utility Radio Co.....	1491				
Utt-Williams Elec. Prod. Co.....	1480				
V					
Viking Tool & Machine Co., Inc.....	1489				
W					
Wagner Radio Co.....	1488				
Walbert Mfg. Co.....	1482				
Warshawsky & Co.....	1494				
Western Radio Mfg. Co.....	1460				
Weston Elec. Instrument Corp.	1488				
Willard Storage Battery Co.....	1457				
Wirt Company.....	1494				
Wizard Wire Winder Co.....	1486				
World Battery Co. 1482, 1504.	1508				
XYZ					
X-L Radio Laboratories.....	1494				
Y. M. C. A. Radio Institute.....	1488				
Yale Specialty Supply Co.....	1505				
Yaxley Mfg. Company.....	1486				



Five Tubes Single Control

DISTANTONE MODEL "C"

Here is Distantone's latest achievement, to meet the ever increasing demand for an efficient single control receiver at a moderate price. It is a product of the Distantone Laboratories, internationally known for their line of quality receivers. It is encased in a beautiful mahogany cabinet with sloping panel of genuine Bakelite, attractively engraved, and equipped with Marco dial. This new model is without a doubt, one of the biggest values in radio today, a wonder for selectivity, volume and purity of tone.

\$75

LIST PRICE
Without Accessories

Distantone

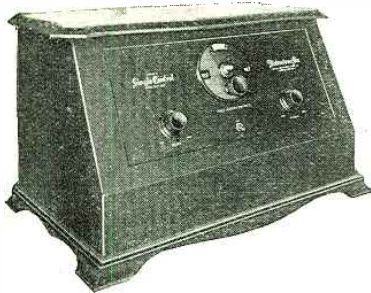

MODEL F — 6 Tubes — \$115.

A perfect single control receiver of great volume, sensitivity, and selectivity. Mahogany cabinet, engraved Bakelite panel.



MODEL E — 5 Tubes — \$55.

An efficient receiver of the two-dial type; two tone mahogany cabinet, sloping panel.



MODEL B — 5 Tubes — \$47.50

Light colored mahogany cabinet, ebony edges, three-ply veneer walnut front panel.

MODEL A—5 tubes—similar to MODEL B, only smaller. List price\$37.50

Distantone Radio is one of the fastest selling lines in the country today, because there is a model for every purse and every model represents the biggest value that can be obtained at the price.

The line includes five tube receivers of two and three dial control, and five and six tube sets with single dial control, all of the Tuned Radio Frequency type.

Any model of the Distantone line, as pictured and described here, will bring to any home, large or small, the fullest measure of radio enjoyment.

Attractive Proposition to Distributors.

Wherever Distantone receivers have been introduced, and they are sold throughout the world, they immediately jump to the front rank of fast sellers. We still have some unallotted territory, and have an attractive proposition for reliable and financially responsible distributors and jobbers. Write for full particulars.



Model D—Single Control 6 Tubes — — \$150.00

Here is a custom-built one-dial control receiver that is the last word in radio efficiency and beauty of cabinet. We receive continual reports of coast to coast reception. It is sensitive to the highest degree, and possesses hair-line selectivity. Its tonal quality is superb and its volume immense. In workmanship, efficiency and appearance, this is a real DeLuxe receiver.

PRICES SLIGHTLY HIGHER WEST OF DENVER

DISTANTONE RADIO, Inc., LYNBROOK, LONG ISLAND
NEW YORK

RADIO NEWS READERS' BUREAU

Time and Postage Saver

IN every issue of RADIO NEWS you undoubtedly see numerous articles advertised about which you would like to have further information. To sit down and write an individual letter to each of these respective concerns, regarding the article on which you desire information, would be quite a task.

As a special service to our readers, we will write the letters for you, thus saving your time and money.

Just write the names of the products about which you want information, and to avoid error the addresses of the manufacturers, on the coupon below and mail it to us.

If the advertiser requires any money or stamps to be sent to pay the mailing charges on his catalogue or descriptive literature, please be sure to enclose the correct amount with the coupon.

We will transmit to the various advertisers your request for information on their products.

This service will appear regularly every month on this same page in RADIO NEWS.

If there is any Manufacturer not advertising in this month's issue of RADIO NEWS, from whom you would like to receive literature, write his name, address and the product in the special section of the coupon below.

TEAR ALONG THIS LINE

READERS' SERVICE BUREAU,
 Experimenter Publishing Co., Inc., 53 Park Place, New York, N. Y.

RN-426

Please advise the firms listed below that I would like to receive detailed information on their product as advertised in the issue of RADIO NEWS.

DO NOT USE THIS COUPON FOR TECHNICAL QUESTIONS

NAME	ADDRESS (Street — City — State)	List here specific article on which you wish literature.	If Catalogue of complete line is wanted, check in this column
.....
.....
.....
.....
.....
.....
.....
.....

Use this space if you desire information from a manufacturer whose advertisement does not appear in this month's issue

NAME	ADDRESS (Street — City — State)
.....
.....
.....

Your name	Dealer's name
Your address	His address
<input type="checkbox"/> If you are dealer check here. City	City
State	State

FREE!



“MEN! Here's the 'dope' you've been looking for-

How TO GET INTO THE RADIO BUSINESS”

J.E.S.

\$50 to \$250 a Week in Work That is Almost Romance

If you're earning a penny less than \$50 a week, clip coupon now for FREE BOOK! New book, profusely illustrated, tells all about the Radio profession, thousands of openings—in work that is almost romance! YOU can learn quickly and easily at home, through our tested, improved methods, to take advantage of these great opportunities! Why go along at \$25 or \$35 or \$45 a week, when you can pleasantly and in a short time learn to be a Radio Expert, capable of holding the big jobs, paying \$50 to \$250 a week?

Clip Coupon for Free Book

Don't envy the other fellow who's pulling down the big cash! Our proven home-study training methods make it possible for you, too, to get ready for a better job, to earn enough money so you can enjoy all the good things of life. Most amazing book ever written on Radio tells how—thousands of interesting facts about this great field, and how we can prepare you, quickly and easily in your spare time at home, to step into a big-pay Radio job. You can do what thousands of others have done through our training. GET THIS NEW FREE BOOK. SEND COUPON TODAY.

J. E. SMITH, President
NATIONAL RADIO INSTITUTE
Dept. DW-1 WASHINGTON, D. C.

These Instruments FREE of Extra Cost

All instruments shown here and others—SIX BIG OUTFITS—sent to all our students free of extra cost under short-time special offer. Clip coupon now—find out all about this big unequalled offer while you still have time to take advantage of it. Our training is intensely practical—these instruments help you learn to do the practical work. Receiving sets, from simplest kind to thousand-mile receiver. Many other big features.



J. E. SMITH,
President

My Radio Training Is the Famous "Course That Pays For Itself"

Spare time earnings are easy in Radio when you know it the way we teach you. Increase your income almost from the start of your course thru practical knowledge we give you. We show you how to hold the job, then our big Free Employment Department helps you get one. Free book "Rich Rewards in Radio" tells how.

Howard B. Luce of Friedens, Pa., made \$320 in 7 weeks during his spare time. D. H. Suitt of Newport, Ark., writes, "While taking the course I earned in spare time work approximately \$900." Earl Wright of Omaha, reports making \$400 in a short time while taking his course—working at Radio in his spare time only! Sylvester Senso, 207 Elm Street, Kaukauna, Wis., made \$500.

And when your training is completed you're ready to step into a real big Radio job like C. C. Gielow, Chief Operator of the Great Lakes Radio Telegraph Company; E. W. Noy, Chief Operator of Station WRNY; Edward Stanke, Chief Operator of Station WGR; and hundreds of other N. R. I. Trained men. The National Radio Institute, oldest and largest Radio home-study school in the world today offers you the same opportunity these men had, under a bond that guarantees you full satisfaction or money refunded. It's your big chance to get into Radio—mail coupon for FREE Book and proof!

NOW!
Special
Short Time
Offer
6
BIG
COUPONS

Radio
Needs
Trained
Men

National
Radio Institute
Dept. DW1
Washington, D. C.

Dear Mr. Smith:
Without obligating me in any way, send me your big FREE BOOK, "Rich Rewards in Radio," and all information about your practical, home-study, Radio Course.







SEND THIS COUPON TODAY

Name..... Age.....
Address.....
Town..... State.....

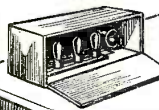
**SOLD AT ALL NEWSSTANDS
AND RADIO STORES**

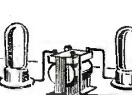

**25
CENTS**

<p>CHAPTERS Each of the six illustrations shown here represent the various general subjects covered by this handbook and illustrate its thoroughness.</p>	<p>GENERAL TROUBLES</p> 	<p>AERIAL TROUBLES</p> 	<p>TUNER FAULTS</p> 	<p>DETECTOR TROUBLES</p> 	<p>AMPLIFIER TROUBLES</p> 	<p>REPRODUCER TROUBLES</p> 
--	---	--	---	--	---	--

Trouble Finding and Correcting Simplified for Everyone

No matter how much or how little you know of your radio receiver, this new "Radio Trouble Finder" book is going to be a big help.

It explains the common and special faults of all the standard receivers of today; tells how to recognize instantly, by various sounds, where the trouble lies and also gives special simple tests by which you can determine what is wrong with your receiver. Then for each particular fault there is explained the proper procedure for correcting it.

All troubles and their remedies are arranged in simple charts so that even the most inexperienced radio user will have no trouble in keeping his set at all times in first class condition.

All parts of the radio set are illustrated to show the layman how to proceed in correcting faults.

THE PRICE OF THIS BIG BOOK IS ONLY 25c. Everyone can afford a copy. Keep one around the house for any emergency. Order today by using the coupon below, enclosing 25c.

**200
Illustrations
Size
6 x 9 Inches**

**Sold everywhere
on Newsstands
and Radio Dealers**

Published by The E. I. Company
Distributed by

The Consrad Co., Inc., 64 Church St., New York, N. Y.

CONSRAD CO., INC.,
64 Church St., New York, N. Y.
Gentlemen:—I am enclosing 25c. Kindly forward at once one copy of "The Radio Trouble Finder."
Name
Address
City, State

Mr. Everyman Says:

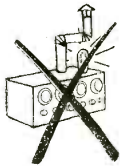

\$135.00

West of the Rocky Mountains \$140.00

In beautiful Console Model

\$175.00

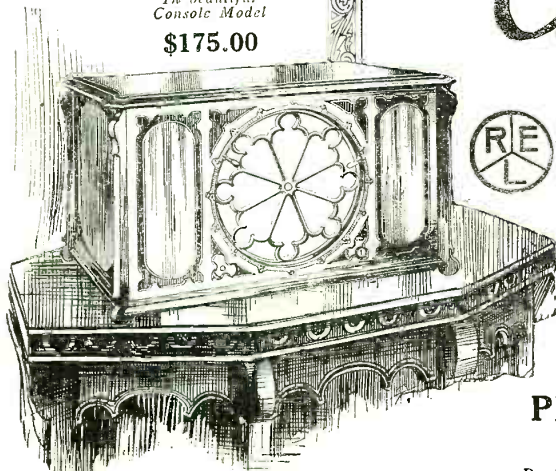

IF I WERE BUYING A RADIO SET
I'd want one with the machinery covered
Because
I'm not interested in machinery
But whatever gadgets had to show
I'd want done up pretty
Because
I'd want to put the set in the parlor,
Not in the garage.

ID WANT a set that was put together to stay together,
That worked when I wanted it to work,
That was loud enough and clear enough
And didn't run amuck,
Because I haven't the time to learn
How to make it do what it wouldn't do.

AND what is more, I'd want a set
That would run circles around my neighbor's
That would do its stuff when company was around,
That wouldn't balk at a grade,
Because
I'm no piker
And I wouldn't own a piker's set.

THIS set would have "Go" to it like my car
And I'd be sport enough to give it a fighting chance,
Because
Anything that will deliver the goods "when" and "as"
With the odds against it
Is likened to me and my fellowmen,
And I'm for it!

And if ever a set answered the voice of
Mr. Everyman, It's the

ULTRADYNE MODEL L-3



The Ultradyne Model L-3 is a six-tube receiver employing the fundamental principles of the best circuits greatly refined and simplified. No dials—no panel; just two inconspicuous levers that constitute a station selector.

The assembly lock bolts of all genuine Ultradyne Model L-3 Receivers carry Mr. R. E. La-cault's personal monogram seal.

Write for descriptive folder.

PHENIX RADIO CORPORATION
114 East 25th Street, New York City

Desirable Exclusive Territory still open for Authorized Dealers

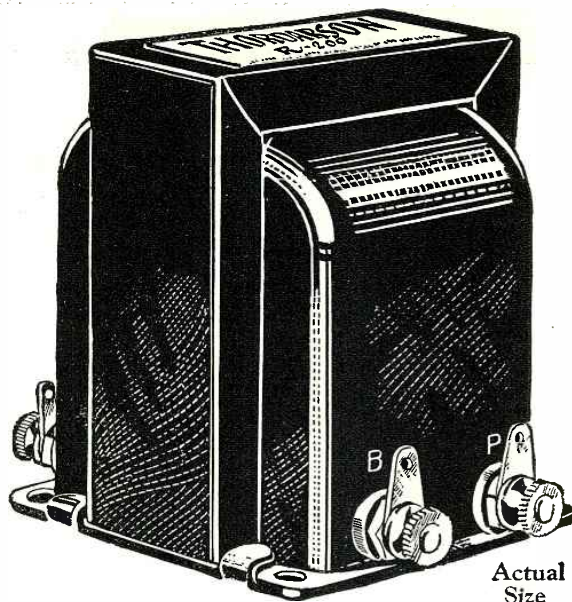

Actual Size

Here is the New
THORDARSON
R-200

used in the

Silver-Cockaday
Single Control
Receiver

described in Popular Radio, March

Price \$8 each

A Big New Audio Frequency Transformer—Guaranteed by Thordarson

THIS big new Thordarson R-200 contains a super-size layer-wound square coil. The much larger magnetic circuit, so provided, minimizes core losses (a leading cause of distortion in powerful receivers). If your present transformers distort voices and instruments when you desire full volume, if they blur the low notes, if they are lacking in genuine musical quality, replace them with a pair of these big new Thordarson R-200's. Ideally adapted for all two-stage amplifiers.

If dealer is not yet supplied, order from us. Write for fully descriptive literature.

Other Thordarson Transformers

Autoformers (All Frequency Amplifiers), \$5 each. Regular Super Audio Frequency Transformers in either sub-panel or top mounting type: 2-1, \$5; 3½-1, \$4; 6-1, \$4.50. Power Amplifying Transformers, \$13 the pair. Interstage Power Ampli-

fyng Transformers, \$8. For Raytheon B-eliminators: R-195 Transformer, \$7; R-196 Choke, \$5. All Thordarson products are unconditionally guaranteed. Shipped direct upon receipt of price, if dealer cannot supply.

THORDARSON ELECTRIC MANUFACTURING CO.
Transformer specialists since 1895
WORLD'S OLDEST AND LARGEST EXCLUSIVE TRANSFORMER MAKERS
Chicago, U.S.A.





RADIO NEWS

H. GERNSBACK, Editor and Publisher
SYLVAN HARRIS, Managing Editor

EDITORIAL AND GENERAL OFFICES, 53 PARK PLACE, NEW YORK

Vol. 7

APRIL, 1926

No. 10

The D X Listener

By HUGO GERNSBACK

In the whole annals of human endeavor, there has never before been a condition such as that in which most of humanity now finds itself. I speak of radio broadcasting and of the man who, although perhaps snowed-in somewhere in the hills, has the entire world laid open to him and, so to speak, at his beck and call. He turns a dial or two, adjusts a knob, and listens in to the President of the United States speaking from Washington; or, by moving the dials a fraction of an inch, he may hear a singer from the Metropolitan Opera; or, if his set is sensitive enough, another twist will bring in an English, or a Mexican station. This is the condition which we find, not only in this country, but in almost every other one on the globe, as well, where close parallels to it abound.

During the past year or so it has been asserted, rather vehemently in some quarters, that DX listening is rapidly passing out, and that people are relying upon only their local stations for amusement. While there is, of course, some truth in this, I find no general evidence that all listeners wish local programs only. At first the man who buys a ready-made set is, of course, not aware of the intricacies and delights of fishing for distant stations with his set; so he will be satisfied for some time to listen in to the various local stations or other nearby ones.

After a while, however, these begin to pall; and when his friends begin to tell him of this or that distant station which they have heard, he too will be bitten by the DX bug. Sooner or later he will fall victim to the ever-increasing radio wanderlust: for the army of DX listeners is increasing rather than decreasing, as an unprejudiced investigation will show.

For instance, every time *Radio News* publishes a description of a circuit or a set that is known to bring in the distance, we immediately become deluged with thousands of inquiries from readers who already have a set, but wish to get another more sensitive than their present receiver. This is not, by any means, an unusual occurrence, but is repeated continually, as every editor of a radio magazine or newspaper understands well.

Not only that, but actual investigation among some of the foremost stores has revealed that the male purchaser, when he comes to buy a set, insists that it must perform for DX, otherwise he does not want it. Radio dealers will tell you that, when sets are sent on approval, the male members of the household, before committing themselves to the purchase of the set, insist upon having a demonstration that the set can bring in the distant stations; and while the buyer may, possibly, not try to fish for DX stations every hour of the night, he will do so much more frequently than is suspected.

The studious young man, as well as the man with the investigating turn of mind, will sit before the set until the wee hours of the morning, filling up his log book with call letters of stations, hundreds and thousands of miles distant from his locality. I make bold to assert that, if any sets were to be placed upon the market, today, that could be guaranteed to bring in stations from the other side of the ocean, no manufacturer could make them fast enough to supply the demand; and if the truth were known, most of our manufacturers are always striving to attain that perfection. The sets to come out in the future will be more sensitive than anything that we have known up to today; because it really is possible to build sets to receive with fair regularity distances of 4,000 and 5,000 miles, and such sets will be built for the average customer in a not-too-distant future.

At present, DX listening must always be taken with a grain of salt. Stations that come in excellently one night may be heard the next night only above a whisper, or not at all. The

reason is, of course, that it is not the set that is at fault, but, rather, the vast ocean of ethereal disturbances which we term "atmospherics." This little-charted ocean changes from hour to hour and from minute to minute. Electrical stresses set up in the atmosphere are probably the reason for most of our poor DX reception. On a so-called good listening night, these electrical stresses are, probably, to a great extent neutralized, which makes the transmission of the electromagnetic radio waves much easier and, consequently, they will penetrate much further. Barometric fluctuations, electrical storms, snow storms, sudden changes of temperature, all reduce radio reception to a minimum; while the absence of these makes for better reception.

From this it can be seen that the best radio set may not be able to pull in the distant stations when such natural phenomena abound.

How can these effects be overcome in the future? In several manners. First, super-power will make it possible for the waves from a broadcast station to get through bad atmospherics, by sheer strength. On the other hand, receiving sets may be developed to a sensitivity so great that, even if the signals are very weak, they still may be received partly through the ground. It should always be remembered that, in all radio reception, the ground-wave is as important as the wave coming through the air.

As many broadcast listeners know, who own extremely sensitive sets, radio reception can be had by the ground lead alone; and if this is used DX reception is frequently excellent, even though with the ordinary aerial it may not be good at all. Mr. James Harris Rogers, of "underground-aerial" fame, demonstrated this sufficiently by burying his aerial underneath the ground; and by this means even radio's worst bugaboo, static, was eliminated to a very great extent.

Who knows, therefore, but that the coming radio receiver will be operated by the ground method entirely, without relying upon loops or aeriels? This would certainly be an improvement, because the aerial and loop pick up not only nature's static, but man-made static, which escapes from electrical insulators, power houses, all sorts of electrical appliances, etc.

As I have said before, DX reception is always a more or less unknown quantity; but even during the best "radio weather" a set may bring in a station loudly a thousand miles away, while a station much nearer, say two hundred miles, will not be heard at all. Many people are constantly puzzled as to this; but there is, as a rule, a simple remedy. The aerial commonly used in such cases is directional; that is, if your aerial runs in the direction of the station which you wish to receive, that station, as a rule, comes in best. If you wish to receive DX stations from all points of the compass, it would be best to have what is called an "umbrella aerial," which is simply a vertical mast from which single wires, thirty or forty feet long, radiate in all directions. A description of such an aerial can be found in all radio text books.

By means of an umbrella aerial it is possible to receive equally well from all directions; although this type has the disadvantage of causing some interference, particularly between stations close together in their wave-lengths.

After all is said and done, my sympathies are entirely with the DX listener; for I can not imagine any greater thrill than that which comes to me when I listen, as I often do, to a station thousands of miles away. It is the greatest triumph yet achieved by mind over matter; and it should certainly be utilized to the utmost extent.

Mr. Hugo Gernsback speaks every Monday night at 9 P. M. from Station WRNY on various radio and scientific subjects.

The Phantom Radio Dinner

By G. C. B. ROWE

The dinner described in this interesting article was unique in several ways. It was the first time in history that 20,000 people have sat down to the same banquet in sixty-seven cities, where the connecting link was radio. Photoradiograms were also used to make the occasion more joyous.



Vice-President Charles G. Dawes and Gen. James G. Harbord, who introduced him at the M. I. T. dinner. © Henry Miller News Service.

IN every period of history there have been feasts and dinners, the fame of which has been handed down to posterity.

There was the well known feast of Belshazzar, as related in the Bible; there was the great feast of Alexander, just before the burning of Persepolis; one of the many famous feasts of Nero was given in the palace gardens in Rome, when the scene was illuminated by human torches; there was the famous dinner that M. Fouquet gave in honor of the visit of Louis XIV to his estate outside of Paris; and on January 19 of the present year there was given the dinner which will be famous as the first one at which 20,000 people sat down.

Naturally this remarkable dinner was not held in the Yale Bowl or any such place as that; but the diners drew up their chairs to tables in sixty-seven cities that are scattered over the United States, Cuba, Canada, England and Hawaii. The diners for the most part were graduates of the Massachusetts Institute of Technology. In four of these sixty-seven cities speeches were made by men prominent in public life, and heard

by all the diners, by means of radio receivers in each banquet room.

When such an event as this dinner is announced in this day and age the mind at once jumps to radio. And it was indeed this wonder of modern science that formed the connecting links between these widespread cities. Seven stations were linked in a radiating chain. They were WJZ, New York; WRC, Washington; WGY, Schenectady; WBZ, Springfield; KDKA, Pittsburgh; KOA, Denver, and KFKX, Hastings.

The chief speaker of the evening was the Vice-President of the United States, Charles G. Dawes who, with Major-General James G. Harbord, President of the Radio Corporation of America, addressed the diners from Washington. George Eastman, of Kodak fame, made his address from Rochester, N. Y.; Dr. Samuel W. Stratton, President of the M. I. T., spoke from Cambridge, Mass.; and several other speeches were delivered from the Waldorf-Astoria Hotel in New York. In addition to the talks that were broadcast, there was musical enter-

Honolulu to New York
Technology Banquet
Waldorf-Astoria, N. Y.
Jan. 19, 1926

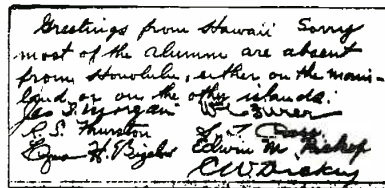

A facsimile of the message from Honolulu, as it was received in New York by the photoradiogram process.

tainment by some of the best talent in Manhattan, enjoyed by all the diners.

A PRODIGIOUS TASK

The seven stations that broadcast this

series of speeches were connected by land wires to the studios from the banquet rooms where speeches were made. The method of distribution is as follows: The microphone, into which the speaker talks, is connected

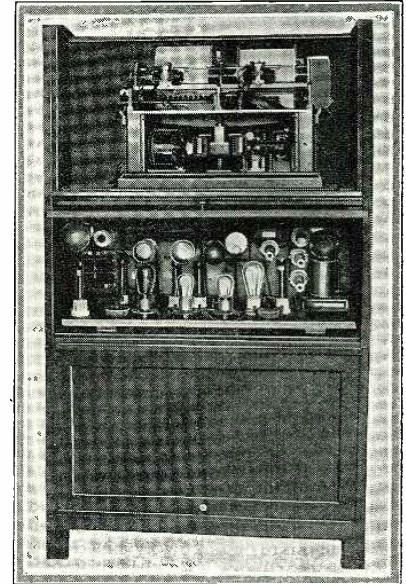

The illustration above shows the interior of the receiving apparatus used in the photoradiogram process for sending pictures by means of radio. On the top shelf is the printing apparatus, underneath which are the amplifier tubes.

with a specially-balanced telephone line. It is mentioned that the telephone lines are specially balanced, because it is quite necessary to eliminate all factors that might tend to distort the speech before it is put on the air. These telephone lines are connected with the studios of the various broadcast stations, so that the program is broadcast on the wave-length of each station that is connected in the chain. It can readily be seen what a gigantic task an interlinking of stations of this kind presents to the telephone engineers. Generally in a chain of stations the program has been broadcast from just one point, but in the case of the Phantom Dinner there were four different cities to be linked into the chain at different times.

Not alone is the selection of the long distance telephone lines to pick up the speeches from the different cities important; but there are problems of amplifying, and the elimination of static, cross talk and all the ills to which telephone lines are heir. Before such a program can be broadcast there is necessary an enormous amount of testing the circuits and providing emergency lines in case of a breakdown. About every 200 miles there are provided audio frequency amplifiers and filters; and these have to be carefully watched over. As there was a receiving set with loud speakers in each room in which the banquet was held, in order that every diner should hear the speeches, all this apparatus had to be tested thoroughly as well as the transmitting end.

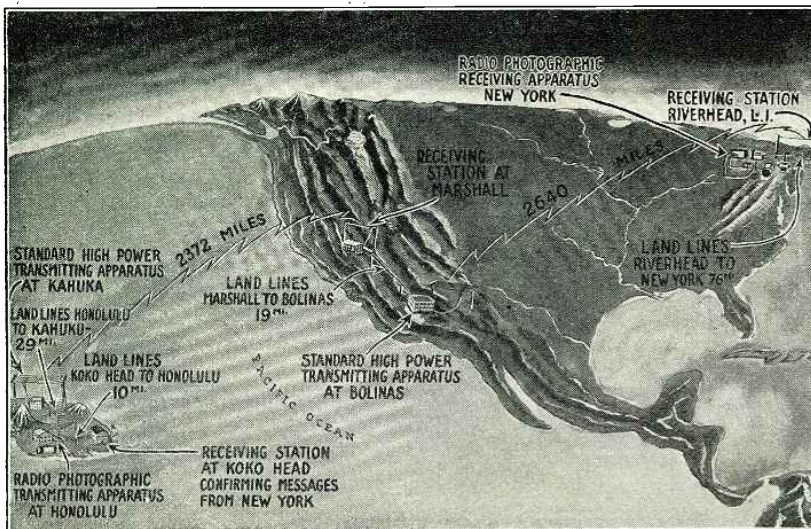

The above diagram shows the path travelled by the photoradiogram waves in their 5000-mile trip from Honolulu to New York City.



George Eastman of Rochester, N. Y., who addressed the diners by means of radio from that city. (This is a facsimile of a photograph sent by the photoradiogram process.)

RADIO PHONOGRAPH DEMONSTRATION

A feature of the dinner that was exclusive to the 700 diners at the Waldorf Hotel in New York was the showing of radio photographs of some of the speakers on a screen, while their words were being heard by means of radio. The photographs had been sent to New York from Washington and Cambridge, some days in advance, by the photoradiogram method. These same photographs were sent out during the dinner as sound waves from the R. C. A. broadcast station in the lower section of New York.

After being sent through the air, these waves were picked up at New Brunswick, N. J., and Riverhead, L. I., and sent by land wire to the dinner at the Waldorf. Here they were decoded and turned back into photographs by a special apparatus set up in the hotel. Here it took about twenty-five or thirty minutes to build up each picture from the transmitted waves, although the radio signals for each black and white space on the photographs were flashed through the air in the fraction of a second.

"These photoradiograms," predicted David

Sarnoff, who was toastmaster at the New York dinner-party, "carry promise of much greater achievement. From the present generation of electrical scientists may come the key to instantaneous visual communication by radio. When that time comes, as I confidently believe it will, radio television will be able to unite you, not only, in sound but in sight. You will be able, not only to hear, but also to see the speakers in action at your far-flung dinner."

cisco, to New York by means of the photoradiogram process. In order to have these copies in New York at the time of the dinner this method was employed as the quickest known. The process for the transmission of letters is the same as that for photographs, a small portion of each letter being sent at a time. In that way it was possible to send out to the diners photostat copies of the letters, so that the handwriting of old friends could be recognized.

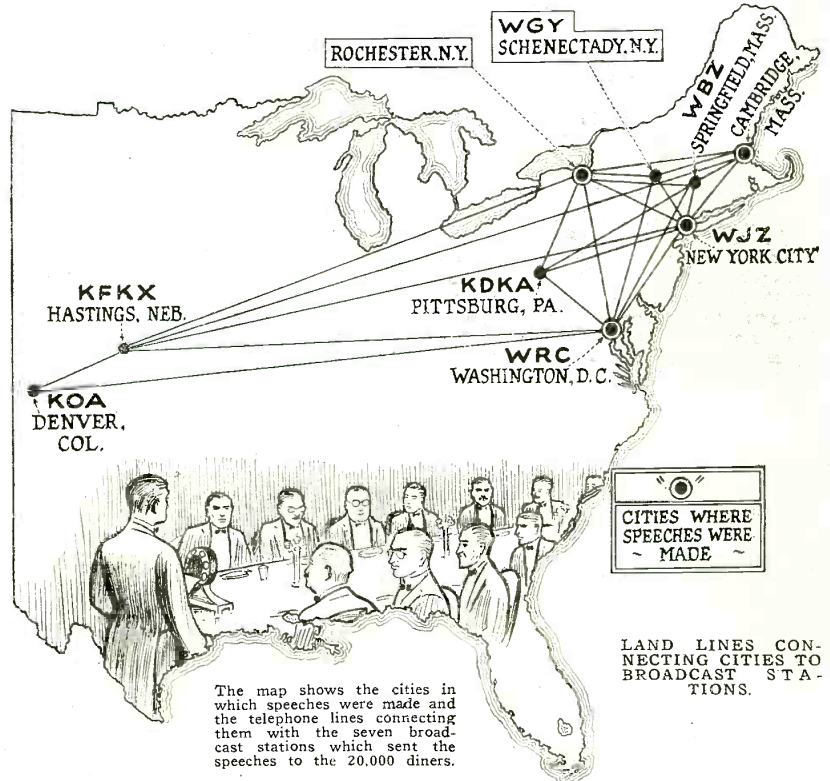

FAC-SIMILE LETTERS BY RADIO

All the diners who were within a twenty-four-hour mailing distance of New York received at their places at table photostat copies of messages that had been sent by alumni in Hawaii, England and San Fran-

Events such as this Phantom Radio Dinner bring home to us in no uncertain manner how rapid are the strides with which the science of radio is forging ahead. If our grandparents had been told, when they were young, that within their lifetime it would be possible to sit down to a banquet at which there were twenty thousand diners, separated by seven thousand miles of sea and land, surely it would have caused them to laugh. But in these days of the twentieth century such items as the above, when they appear in

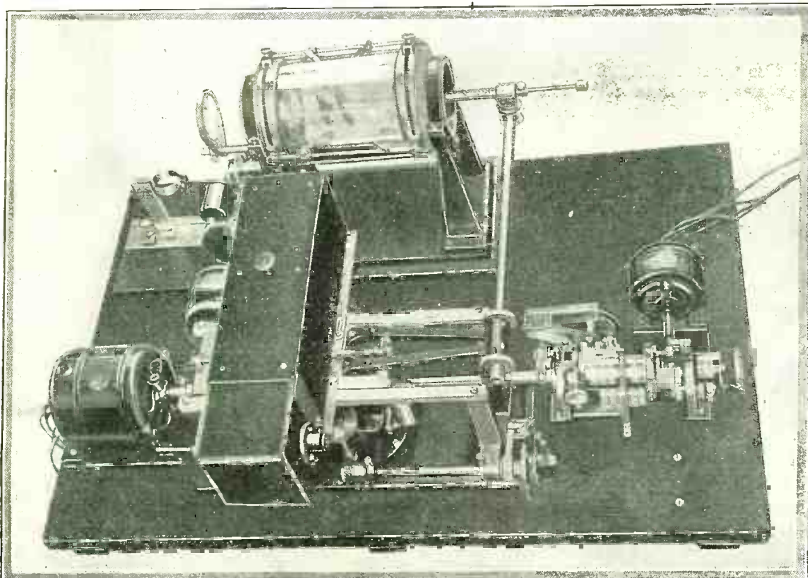

Photos in this article by courtesy of the Radio Corporation of America. Above is shown the transmitting apparatus for the broadcasting of photographs, maps, etc., by means of radio.

Greetings from
R. A. Chatterton
 President, Institution
 of Electrical Engineers
 London

These greetings were sent by radio across the Atlantic Ocean from London by the photoradiogram process.

the daily papers, cause no undue comment. However, it must be admitted that radio is certainly bringing greater numbers of people together in close union than any other medium hitherto known.

Radio Makes Isolated Lives Happy

By Mrs. CHRISTINE FREDERICK

In this interesting article, Mrs. Frederick tells just how much radio means to those who live far from towns and even those who, though they inhabit big cities, are confined in their work to the house. Radio is indeed to those an emancipation proclamation.

LAST summer the writer was out in the country for a vacation—far up in the hills on a farm. No first-class music had ever come within a hundred and fifty miles of it, except on a phonograph record. No great man had ever made a speech within the hearing of its natives. No first-class theatrical entertain-

home and were out of touch with modern life, they slumped back, due to the overpowering effect of their environment, which was fifty to a hundred years behind the times. In the *Atlantic Monthly*, recently, there was a pathetic article written by such a man who had been given by a philanthropist a boarding school education. He went back to his

tain farm! She went about her work singing. She was adjusted to her life; she had found the connecting link—the slender thread-like aerial that was strung up between the house and the great red barn. I looked at it often—it seemed like the sword of Damocles, literally hung upon a silken thread. If the aerial failed, the young girl was pushed back upon the small resources of that backward community. If it worked, she could gather all the wonders of civilization, energize, stimulate and cheer herself for her part in the world. I have never had such a forceful, concrete illustration of what radio is to mean to the future of America, for what that girl learns over the radio she will pass on to her sons and daughters, and so will millions of other young women now in isolated communities.

Every woman who is cut off from life and culture, either by distance, or close domestic duties, knows the deep marks on their souls and spirits made by their isolation and helplessness.

I have travelled on the Chautauqua circuit from Florida to Michigan—every day a new town—and met and talked with the women. I have lectured before Farmers' Institutes all the way out to Utah. As household editor of women's magazines, I have had great sacks of mail from women from every corner of the country, heart breaking letters many of them.

THE CARES OF LONELY HOMES

What has been their oft-repeated story? It has always been the same; imprisonment between four walls; long hours of exhausting work; very little money left from necessities for trips or travel, amusement, music or education. The only thing in the world that has held millions of such women to their hard tasks has been a desire to give to their children the things they couldn't have—mainly, music, education, lectures, amusement, contact with the world.

(Continued on page 1468)



To those folk living in isolated places, radio, more than any other recent invention, is bringing daily some of the joy of living. © Kadel & Herbert.

ment had ever been seen by those farm people.

But out under the old gnarled apple trees, near the house, (which had been hewn with the broad-axe from forest oak 150 years ago, and put together with oak pins), we sat one evening and listened to the New York Philharmonic orchestra play the Beethoven Fifth Symphony; and we heard Roxy and his gang put over a good show at the Capitol Theatre. The horny hands of the farm women, used to all labor and no amusement for the last half century, were still and awed. It was as though the Magic Carpet of Bagdad had come to life and transported them to Gotham.

The daughter in that household, who had gone to a normal school for a few years, had come home to the farm determined not to lose touch with the wonderful world her school had given her a glimpse of. She was continuing her studies by radio. She was getting inspiration, to keep up her music lessons alone without a teacher, by listening to piano music via radio. She was continuing to learn the more wholesome modern cookery from the cookery talks and lessons via radio. Radio, radio, radio—her thoughts were on it almost hourly; her contacts with the outside world were at least two or three a day, via radio.

Now mark you this: for that young woman, on that isolated farm, radio was the one life-preserver to which she clung to keep herself modern; to prevent herself from slipping back into her old place. The tragedy of education for isolated rural folk heretofore has been that, as soon as they got back

illiterate mountain folk and felt desperately the tragedy of his situation; educated to a modern world, and yet thrust back, completely cut off from that world.

But not my hopeful daughter of the moun-



"To the women radio is still more; it is a proclamation of emancipation from isolation." © Kadel & Herbert.

Radio Happenings of the Month Illustrated

By GEORGE WALL

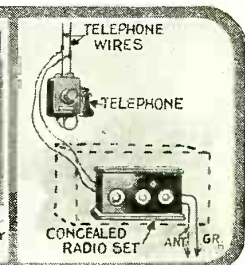
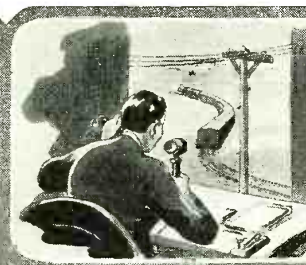
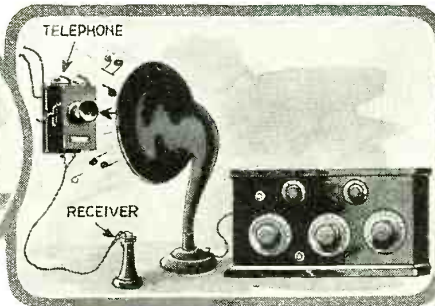

In a country district, where the local telephone exchange was closed after 9 P. M., a physician takes his telephone receiver off the hook and, by placing the horn of the loud speaker close to the transmitter of the phone, rebroadcasts radio concerts to the twenty-four parties on the same party line. All that is necessary, for any of the subscribers on the doctor's line to hear the music, is to lift their receiver from the hook and listen in.

A telegraph operator in Pennsylvania mystified radio experts for many months by saying that he received radio concerts from a distance over the telephone in the station, without the aid of any radio receiver. However, he recently admitted the whole thing to be a hoax, as he had connected a receiving set to the phone lines.

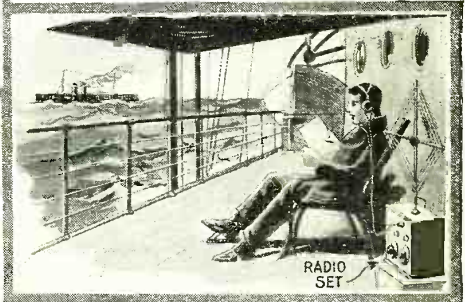
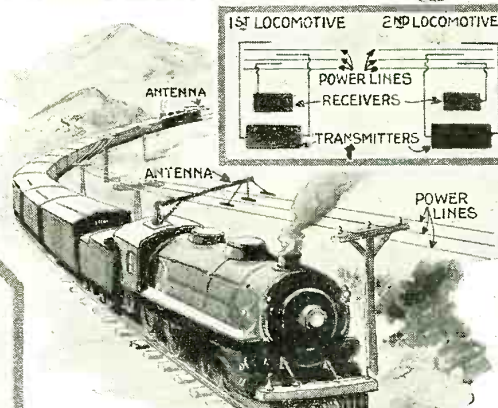

A new use for wired radio has been announced, in communication between the front and rear ends of long freight trains. Either code or voice may be used, although the latter is satisfactory only when the train is not in motion. Wave-lengths of 100 to 140 meters were used with 50 watts power, on a train half a mile long.

Darley Paskman, of WGBS, New York, took his own radio set with him and kept in touch with the station all the way down to Bermuda, where he also intends to listen in to certain of the features.



The latest converts to radio are the Eskimos. An explorer, who has just returned from Labrador, says they chuckle at jazz and solemnly listen to speeches, even though they cannot understand the language.

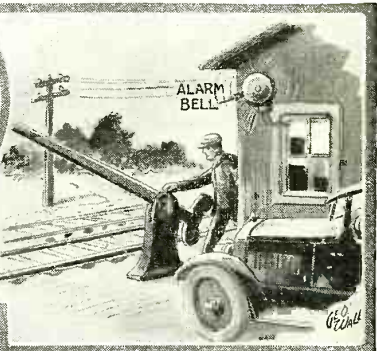

Because it was impossible for him to erect an antenna, a radio fan of Hillside, N. J., used a nearby railroad track instead of the usual wires. Reception was O. K., but every time the set was turned on the bell in the crossing watchman's hut rang, giving a false alarm of the arrival of a train. This system was not in use long.

A pet dog, who showed his dislike for radio programs by barking at the loud speaker, never barks during the Sunday sermons

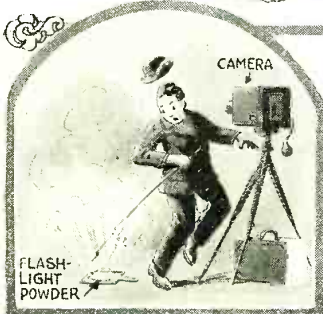

A photographer was about to take a picture, in a broadcast station using super-power, when a wire he was holding touched his pan of flashlight powder, which exploded. The wire in his hand had picked up enough energy, radiated from the antenna, to set off the powder.

At Sheffield, England, a mouse stopped transmission when it entered a microphone and chewed up a coil. At the high-powered station at Daventry, England, another mouse got stuck between the main condenser plates of the transmitter and was electrocuted, stopping broadcasting for twelve minutes.

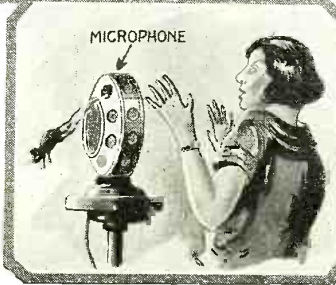

A 23-Control DX Receiver

By SAMUEL SILVERMAN

Daily there come to the editorial office of RADIO NEWS many letters telling of record DX reception. Mr. Silverman's receiver was so unique that it was considered to be of interest to our readers.

A QUESTION that is frequently asked by the radio fan, who is a confirmed seeker after the elusive DX, is "What will help to bring in far distant stations?"

The writer, after experimenting with a great number of different circuits, types of antenna and various apparatus, has found that the receiving equipment shown in the accompanying illustration gives the most consistent results. Although the number of controls seems to be excessive (in fact the number is 23), yet it takes only a comparatively short time to tune in any station. The antenna is one of the most important factors in bringing in the DX. After trying many types of aeriels, the writer uses a single-wire, No. 14 bare copper, stranded, with good porcelain insulators, two on each end. Length of aerial, 100 to 125 feet including lead-in up to receiving set. Use nothing less than No. 12 copper-covered wire for lead-in and ground. Keep the wire away from brick walls of building and insulate with brackets. The higher the aerial masts, the better. Pull wire tightly so as not to swing in the wind; a slack aerial has caused many DX stations to fade away. Use porcelain tubing for insulating lead-in of wire going through window to the set. Insulate wire coming through window to receiving set with porcelain insulators. (Lead-in is at No. 1). Use No. 12 copper-covered wire for "A" and "B" battery connections. Solder aerial and lead-in connection well.

Keep "A" battery fully charged and see that the "B" batteries show, by test with a voltmeter, not less than 40 volts on the 45-volt tap, and not less than 20 volts on the 22-volt tap. See that tubes are all in good condition. Last of all, buy the best of parts and equipment of well known manufacturers of tested apparatus.

CONSTRUCTION OF THE DX SET

My receiving outfit is a home-made 14-tube super-heterodyne. The wave-length range is 160 to 850 meters; there are 1 oscillator, 2 detectors, 3 stages of regenerative tuned radio frequency, 3 stages of tuned radio frequency amplifiers, 4 stages of audio frequency. The controls number 23. The average radio fan might despair of learning how to tune such a set, but once familiar with it, ten seconds only will be required to tune in on the stations desired. Referring to the illustration, No. 2 is a wave trap and filter, for cutting out code and interference. No. 3 is a regenerator, with one stage of tuned radio frequency. The amplification obtained is greater than that obtained by several stages of transformer coupled amplification, at short wave-lengths; it is equal to several stages of "neutralized" transformers, the "neutralized" circuit not being regenerative.

DOUBLE-CIRCUIT ADJUSTMENTS

No. 4 is a two-circuit antenna adapter, which consists of a low-loss series antenna condenser, a variable inductance of very low distributed capacity, with a fixed coupling to the secondary inductances. For wave-lengths of 160 to 480 meters, a small inductance

is used in the secondary circuit; for 400 to 850 meters a loading inductance is brought in through the wave-change switch. The secondary circuit wave-lengths are adjusted by the wave-length condenser in the super-heterodyne. This unit can also be used to convert any loop receiver over to antenna reception.

No. 5 is a regenerator, two stages of tuned radio frequency. When used with the super-heterodyne, the antenna adapter is

14-tube, 23-control sets are not very common these days. In presenting Mr. Silverman's article, we wish it to be understood that this is not a new-fangled set, but simply an aggregation of sets which were used by him for the trans-Atlantic tests. That such a scheme is practical is best proven by the fact that Mr. Silverman was actually able to receive a number of trans-Atlantic stations.

unnecessary, but as a wave trap it helps to cut out interference. No. 6 is a super-heterodyne with 1 oscillator, 2 detectors, 3 stages of tuned radio frequency and 2 stages of audio amplifiers.

No. 7 is an amplifier; No. 8 is a 3-tube single-circuit regenerative set used for local

KWSC, Pullman, Washington
WBAP, Fort Worth, Texas.
WFAA, Dallas, Texas.
KOA, Denver, Colorado.
KOB; State College, New Mexico
WNAD, Norman, Oklahoma.
KEMO, Fayetteville, and KTHS Hot Springs, Arkansas.
KFKB, Milford, Kansas.
WKAQ, Porto Rico.
PWX, Havana, Cuba.
CZE, Mexico City, Mexico.
CKY and CNRW, Winnipeg, Canada
GNRR, Regina, CNRS, Saskatoon, and CNRE, Edmonton, Canada.

During the International Radio tests held in January the writer, in New York, picked up station CZE, in Mexico City, Mexico. The station had been tuned in but a few moments when the announcer was heard to say, "If any Americans in the vicinity of New York City are listening to CZE will they extend our congratulations to Mr. Hugo Gernsback of WRNY on his new magazine *Radio Internacional*?" The writer at once called Mr. Gernsback on the phone and delivered the message.

It might be of interest to our readers to know that the Mexican station, CZE, mentioned in the above article, has been received by several broadcast listeners in the northeastern section of the country. Several letters have been received in the editorial office of RADIO NEWS reporting this fact and also forwarding to Mr. Gernsback the greetings that Mr. Silverman mentions in his article.

Following is a typical letter from one gentleman, who finds the Interflex circuit excellent for distant reception

MEXICO CITY ON LOUD SPEAKER

Editor, RADIO NEWS:

It may interest you to know of the results which I obtained on an Interflex Four during International Test Week. On both Tuesday and Wednesday night, about 11:30 P. M., I plainly heard (on the phones) a violin solo, but was prevented from hearing the announcements by "bloopers." According to my calculations, both stations were on a wave-length of between 362 and 378 meters. On Thursday, I received nothing after 10:00 P. M., but on Friday, at 11:40 I picked up Mexico City and succeeded in putting it on the speaker with such volume that it could be heard 30 feet away. The announcer would say, "This is CZE, Mexico City," and then repeat "Mexico" about 10 times.

I departed from the printed instructions somewhat by using a variocoupler in place of the special coil, rheostats in place of amperites, and an adjustable crystal. I am using a two-wire aerial, 50 feet long and 27 feet high, running east and west, with the lead-in on the west end, and a drain pipe for a ground.

Up to last Sunday, my DX record was WOAI, San Antonio, Texas, which was also received on the speaker, about a month ago

ROBERT L. SNYDER,
5 Clay St., Adams, N. Y.

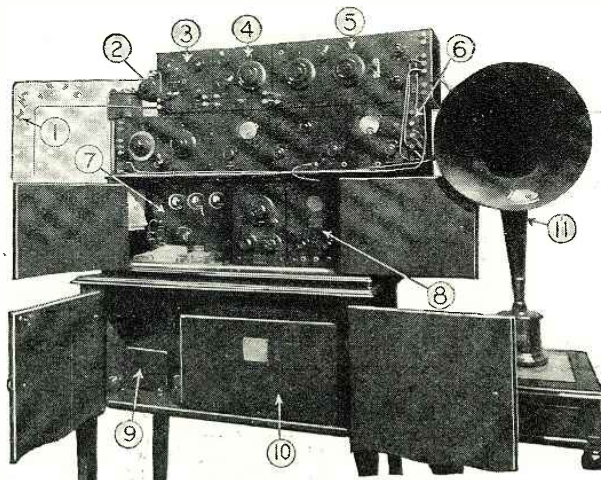

The 23-control radio set assembled by Mr. Silverman. The component parts are numbered in accordance with the text.

stations; 9 is a current supply set operating from an electric light socket of 110 volts A.C., supplying "A" and "B" power for No. 7. No. 10 is an 180-ampere-hour storage "A" battery to supply current for the different units. In the rear of the storage "A" battery, are two heavy duty "B" batteries. No. 11 is a power loud speaker.

COVERING ALL NORTH AMERICA

Following is a list of some of over 200 stations that the writer has heard with the receiver illustrated:

KFRC, KJBS, KPO, San Francisco, California.
KRE, Berkeley, Calif.
KHJ and KMTR, Los Angeles, California.
KFWB and KNX, Hollywood, California.
KOCAC, Corvallis, Oregon.

Music on Wheels

By JOSEPH RILEY

A few years ago an efficient portable receiver was a curiosity, and a rarity as well. Today the portable idea has been extended to transmitting stations of fairly high power. The two portable transmitters described on this page are not freaks. They may be relied upon to operate under all conditions; and one of them is used as a constant adjunct to a fixed broadcast station on the West Coast. The other is a "radio sleuth," as well as a portable transmitter, in government service.



Fig. 3. (Above). An interior view of the radio detective car, which has proved very useful in locating power leaks and other forms of interference, as well as in running down violators of the radio laws.

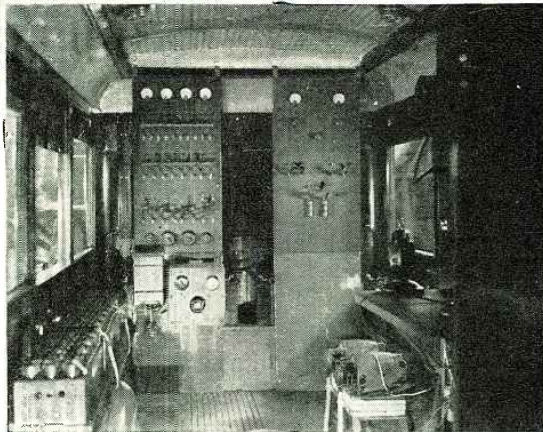

Fig. 2. At the right may be seen in interior view of the portable broadcast station, the exterior of which is shown at the bottom of the page. At the left are the battery racks. The two long panels control the generators and the transmitting tubes.

NCESSITY, the mother of invention, has caused the appearance, recently, of a number of portable broadcasting and trouble-shooting stations. These adopt the precept of Mohammed. If the star will not come to the broadcast station, the broadcast station will go to the star.

In Figs. 1 and 2 is illustrated the portable radio broadcast station of Warner Brothers' motion picture studio and radio, KFVB, the argest of its kind built to date. The Department of Commerce has issued call letters 6XBR on 108 meters, 250 watts of power.

The set has been operated under all conditions and has proven its reliability. It fills a long-felt want for a station on wheels. It can be run out and set up in a few minutes' notice; and can be made ready to send in less than fifteen minutes after reaching its destination.

The apparatus is mounted on a Morceland motor coach, which is 22 feet long, behind the dash, and gives ample room for the four panels and the transmitter.

The antenna system consists of two collapsible towers which fold down against the top of the truck, and when extended reach the height of 45 feet at the high end—25 feet at the low. The wires are brought down in a fan and fastened to the lead-in insulator. The counterpoise runs around the top edge of the truck, being left open in front. The transmitter is of 250 watts, using coupled Hartley circuit. A maximum amount of coupling is used to keep the wave steady and sharp. The antenna circuit is detuned 13 per cent. in order to keep the wave steady.

Constant current (Heising) system of modulation is used. A 50-watt acts as a speech amplifier for the 250-watt modulator. The speech amplifier is coupled to the modulator by the use

of transformers. This stage of amplification is very much like that of the ordinary receiving set, except that the transformers are built to carry 1,500 volts and the added volume of voice which is needed to modulate 250 watts.

The input panel uses two stages of power amplification, with a third stage when needed. These stages are impedance-coupled to give better and clearer amplification. This panel delivers about ten watts of energy to the 50-watt speech amplifier. A 500,000-ohm potentiometer controls the volume of the input panel. A jack and plug arrangement is used in all circuits to test the plate current. Two microphones may be used, and a switch is provided for changing from one to the other.

A separate panel controls the power for the generators. On this are mounted switches for changing from one generator to the other, or throwing the two in parallel.

On this panel are two volt meters, one for each generator. This enables the operator to read both generators separately, which is necessary when running them in parallel.

A fourth panel controls the entire power supply. When all switches are in the up position, the batteries are on discharge, when down all are on charge. Four hours of steady service is had from one charging of the batteries. Jelly batteries are used throughout, both for the generators and filament.

Particular care was taken to run all wires in the truck, whether from batteries to tubes, or from one panel to the other, in lead-covered cables, all of which are grounded. This keeps any radio frequency out of all the circuits.

Radio 6XBR was built for experimental purposes, and to tie up with KFVB on 252 meters. In testing this station out it was found that it reached a class of listeners-in that had been overlooked, the radio amateur and the BCL who make it a business to listen in on the low waves.

This portable truck will be used to broadcast all sport events, musical entertainments and programs from theatres using Warner Brothers' pictures. These will be put on the air on 108 meters, and picked up by Warner Brothers' station KFVB, whence they will be rebroadcast on 252 meters.

In the future, 6XBR will reverse operations and rebroadcast KFVB on 108 meters. On the first test, letters were received from as far east as Denver and north to Portland, from those who had heard it on that wavelength.

All equipment and mounting was built at the Warner Brothers' studios, under the supervision of Frank N. Murphy, electrical engineer of the studio, and radio station KFVB.

Work for New Radio Detective Car

By George F. Paul

LOCATING a leak in a power transmission line may sometimes prove a puzzling matter. This was shown recently when the new radio detective car, shown in Fig. 3, was called upon to make a special trip from Detroit to Charleston, W. Va. This leak had put all of the radio receivers in Charleston out of commission; and this fact had so influenced the local sale of radio sets that practically no business was being done.

This car contains all of the apparatus needed to locate radio interference or unlicensed stations, to test wave-lengths and to examine amateur operators.

There are three complete receiving sets, one for short-wave lengths down to 40 meters, one induction receiver to locate leak. (Cont'd on page 1484)



Fig. 1. The portable broadcast station shown below is used in conjunction with station KFVB. It is sent to places where events of special interest are about to occur, and puts them on the ether on 108 meters. KFVB rebroadcasts the programs on 252 meters. Many amateurs with short-wave sets listen in for the short-wave direct.

Short-Wave Radio on the Pacific

By CAPTAIN H. J. ADAMS and F. C. RYAN

Here are related some of the most interesting experiments and tests yet made on the wave-length of 40 meters. These tests were conducted between station FX1 in Hawaii and the yacht *Kaimoloo*, which was on a cruise in the Southern Pacific.

HONOLULU, the "Cross-Roads of the Pacific," famous for its ukuleles and hula-dancing girls, is now receiving prominence through its short-wave radio.

Honolulu has been very closely associated with the development of radio, beginning in the early days of sparks with the inter-island stations of the Mutual Telephone Company; followed by the linking of the islands to the mainland by the Poulsen arc system; and today the high-powered stations of the Radio Corporation and the Navy, relaying between the mainland and the Far East. Last, but not least, paving the way for a new era, the Army Signal Corps' experimental short-wave station FX1, on 40 meters, has carried the name of Honolulu by radio to Johannesburg, South Africa, to the MacMillan Expedition in the Far North, to the Philippines in the Far East, to our Anglo-Saxon brothers in Australasia, to our friends in Chile and the Argentine, and to amateurs throughout the continental United States.

The arrival of the Pacific fleet in these waters last April aroused the Signal Corps personnel at Honolulu to the great inherent possibilities of short-wave radio, so ably sponsored by Snell of N. R. R. L. fame. The result was station FX1, equipped with a transmitter of the type used by Ed Willis, 6TS, of Santa Monica, Calif., well known through his connection with the first trans-continental short-wave tests, and at that time a member of the Naval Reserve on duty with the fleet.

The receiver is of the Snell type, using detector and two steps of audio frequency amplification.

The aerial system is a single wire 60 feet long, suspended at an angle from an 80-foot mast, and is used in conjunction with a single-wire counterpoise 60 feet long. This radiating system has a natural wave-length of 120 meters. The third harmonic is utilized for 40 meters and the fifth harmonic for 20 meters. The antenna current is 2.2 amperes on 40 meters and 1.5 amperes on 20 meters, measured on the counterpoise side of the antenna leading coil. Further details will be found by a study of the accompanying illustrations.

HALF-WAY AROUND THE WORLD

Beginning operations early in July of last year, at first reaching amateurs on the Pacific Coast and in the Middle-West, and then gradually extending its sphere of operation

to all parts of the United States. Station FX1 was heard at night by Mr. Pleas, of Johannesburg, South Africa, a distance of 12,000 miles. He reported by card that our telegraph signals were so loud as to be heard throughout the room. His receiver consists of a detector and two audio frequency steps of amplification.

Two-way communication was established at night in August with the MacMillan Arctic Expedition, 12 degrees from the North Pole. Congratulatory messages were exchanged between Governor Farrington, of the Territory of Hawaii, and Commander MacMillan.

Last July the yacht *Kaimoloo*, carrying on board the owner, Medford R. Kellum, and party, of Honolulu, left that port on an extended trip into the South Seas.

Mr. Kellum, cognizant of the wonderful possibilities of short-wave radio telegraphy, had placed upon the *Kaimoloo* a 40-meter transmitter using two 250-watt tubes. The yacht also carries a spark transmitter operating on 600 meters. The aerial is a vertical

cege 60 feet in height. The antenna current is six-tenths of an ampere.

TESTING RECEPTION IN THE SOUTH SEAS

Fred Roebuck, the radio operator of the *Kaimoloo*, using the call letters KFUH, has been in nightly communication with Station FX1 in Honolulu on 40 meters. A great number of personal messages have been exchanged between Mr. Kellum and his friends in Honolulu, even though he was far in the South Seas.

Reporting on the signals from FX1, he states that, at night time, at a distance of 300 to 500 miles, the usual weak signals peculiar to short waves at close range were noted. From 500 miles out until his arrival at Fanning Island, 1,100 miles from Honolulu, the signal strength increased rapidly and became very loud. There was very little interference or static.

On several prearranged schedules two-way transmission was effected during the day, at 8:30 a.m., while the yacht was at Fanning Island. There was very little or no difference in the strength of the signals as compared with night communication.

Leaving Fanning Island, the yacht proceeded to Tongareva, or Penrhyn Island, 2,900 miles from Honolulu, located in lat. 9° S, lon. 158° W. It was observed that the signals retained the same strength, and nightly communication was carried on with perfect regularity.

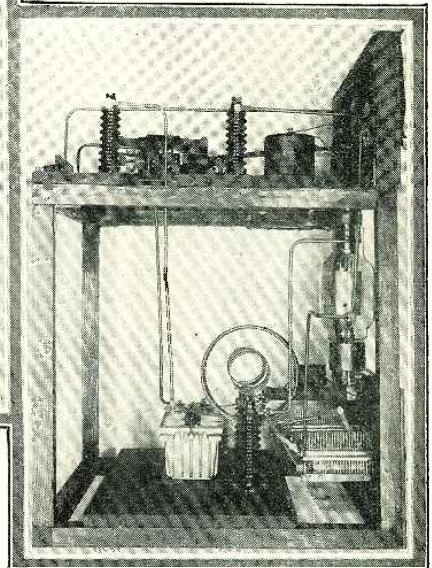
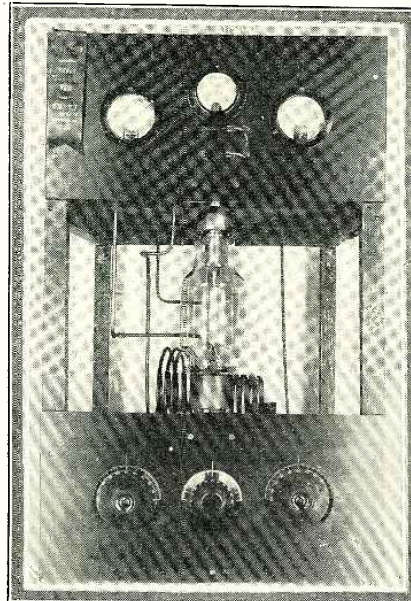

At the left are shown the panel and interior views of the receiver, which is of the Snell type, used at station FX1. The various inductance coils, which are shown on each side of the set, fit in the sockets provided for them in the upper left side of the receiver's baseboard.

The photographs above and on the right are front and side views, respectively, of the transmitter of short waves at station FX1. This station works on wave-lengths of 20 and 40 meters. Photos courtesy of Signal Corps, U. S. Army.

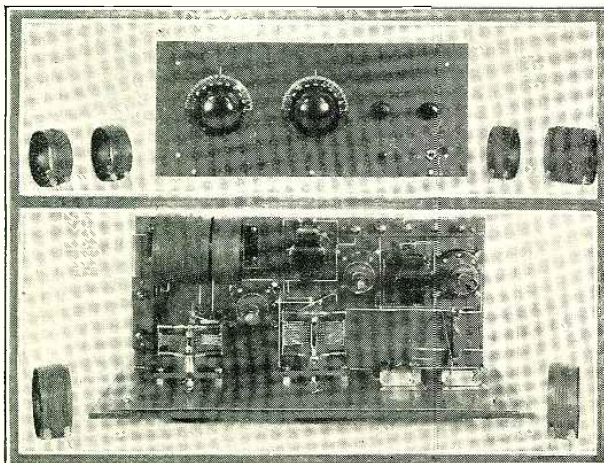

While the yacht was sailing from Penrhyn Island to Tahiti, and also when anchored in Papeete Harbor, 2,300 miles from Honolulu, the results remained the same.

Leaving the Society Islands, the boat sailed for Rarotonga, in 21° south latitude, Palmerston Island and Niue in lat. 19° S, lon. 169° 55' W. Roebuck reports FX1 signals as the strongest issuing from Honolulu, with practically no fading or swinging.

After a cruise in the Samoan Islands, the *Kaimoloo* will proceed to New Zealand, via Suva and the Fiji Islands. The operator expresses the opinion that there is not the slightest doubt but that communication will be maintained with FX1 throughout the remainder of this long South Pacific cruise.



"The Fugitive"—\$75.00 Prize Winner In the Radio News Play Contest

By JAMES F. CONWAY



CAST OF CHARACTERS

FRANK, a chauffeur. ALICE, his wife.
FRED, her brother.

ALICE (at telephone) Lintock 4-1-9-5, please. Yes, please. Is this Sarah? This is Alice. How do you do, Sarah? You didn't come in this afternoon, as you promised. Tomorrow afternoon surely, then. Sarah, has Frank come back to the house there? No! Well, I'm awfully nervous, you know he should have been back hours ago. You haven't seen him since he left at ten this morning? Yes, Sarah, I know he's a careful driver but there are so many machines on the road now. Yes, I know I shouldn't be nervous, but what in the world can be detaining him? He hasn't called on the phone. Yes? Yes? Yes? I'll give up my fears, but I wish he would come home. Supper has been cold for hours. My brother Fred is coming in this evening. I expect him now. (With catch in her voice) Oh, Sarah, I do hope nothing has happened. Yes, a Happy New Year to you.

(Sound of New Year's celebration outside.)

Yes, Sarah, the children are fine. I put them to bed long ago, but they keep asking for daddy. (Knocks at the door are heard.) Sarah, some one is at the door, and it is Fred, I think. I'll say good-bye now, yes, good-bye, Sarah.

FRED: I wish you a Happy New Year, Alice, and to Frank and the boys. The crowd delayed me, or I should have been here—

ALICE: A very Happy New Year to you, Fred, I'm very glad you came. I've been very lonesome all evening. I've been waiting for Frank for the last five hours.

FRED (cheerfully): Probably the crowd has detained him as it did me. But you are nervous. There is no need for that. Frank knows how to take care of himself.

ALICE: I know Fred, but five hours is a long time, and there are so many machines on the road now. People are celebrating too, and maybe driving a little less careful than usual. (Nervously) I do hope nothing has happened to him, he hasn't called up or anything.

FRED: Oh, he was driving then? Where did he go?

ALICE: He went to Lindsay at ten on some business for the boss. He should have been back here by six, and here it is after eleven. I get more afraid every minute. (Celebrators heard outside.) This is a poor New Year's Eve for me. Of all nights in the year for this to—

FRED: Why look at the worst side of it now? Brace up and enjoy the noise outside. Let's turn on the radio, and I'm sure Frank will be back here in a jiffy. The traffic has been heavy on the road and he couldn't make time, that's all.

ALICE: I wish I could brace up but I have a terrible feeling of dread somehow. Especially since the fortune teller told me to beware of accidents. (Crying) I wish I had never gone to her.

FRED: I told you not to place any faith in fortune tellers. You should never pay any attention to them. I'll tune in on the radio, that will be a little diversion. (Radio music is heard for a moment.)

Ge, that's swell music they are broadcasting tonight, isn't it? Listen to that jolly crowd outside.

ALICE: I can't enjoy it, my head is in a whirl. I'll go and make you some tea.

FRED: Not now, Alice, thanks. Listen to the program for a while. There, the announcer is on now. (Short pause). You

heard that? He says a dangerous criminal has escaped from prison, at Lindsay, has killed two men while trying to take their machines, and has wounded a third while escaping with his car! All towns should be on the lookout! (Music on the radio again.) What the matter? Alice, you look pale!

ALICE: He killed two men while trying to take their machines! He—he killed two (crying) men while trying to—to—take—their.—Oh Frank, Frank, Frank. Oh Frank, why did you go, why did—did—you—u-u-u go?

FRED: This is all uncalled for. There are thousands of men with machines. Why should it be Frank?

"THE FUGITIVE" will be broadcast on Monday, March 15, at 11 p. m., from WRNY, the RADIO NEWS station in New York, as enacted by a full cast of professional players.

Other prize winners in the RADIO NEWS Play Contest will be published in subsequent issues of this magazine and similarly broadcast by WRNY. The first prize winner, "The Hidden Witness," was broadcast on February 15 from WRNY, where it was performed by the Radio Theatre Players.

ALICE: Oh, Oh, Oh, it must be, it must be! (Celebration louder than ever outside.) Oh, Oh, I knew it when he didn't call up, when he did—did—didn't call me up, he—always did before.

FRED: You must not allow yourself to think that way! Why don't you forget it for a little while? There the announcer is on again; he is giving the names of the men—(a short pause)

You see he said Bailer and Bellews were the names of the two men that the convict got—letters and cards were found in their pockets, so the names must be correct.

ALICE: Oh, Oh, Oh, I'll die! He said Bailer, but he got it wrong, it's Taylor, it's (gasping) Frank! It must be Frank, Oh, Oh—

FRED: What's the matter Alice, don't—don't faint—there—there—she has fainted, there now rest on the sofa. (Nervous)

Bailer is pretty close to Taylor at that. I guess I'd better get her some water. (Noise outside slowly dies out.) She'll revive in a minute now, cold water is good. This has been a terrible evening for poor Alice, I—I wish Frank would come now. Alice—Alice—wake up dearest—gee—she's pale alright.

ALICE (now reviving) Oh—oh—Fred, has Frank come back yet?

FRED: He'll be here soon now, sis, don't fret any more, it isn't good. Have some of the water. (Radio music plays again.)

ALICE: Oh, my boys, my boys, are they safe, are they safe?

FRED: Don't rise now, Alice, rest awhile. The boys are sleeping.

ALICE (crying): I must see them—Oh I'm so weak. (going out.)

FRED: The radio sounds beautiful in contrast to the excitement inside and outside tonight—gee—I wish Frank would come home, she's fretting a lot. But—but—Bailer—Bailer—is mighty close to Taylor—I pray it isn't true. Hope should spring eternal.

ALICE (returning calmly): What were you saying, Fred?

FRED: Hope should spring eternal, again, any fear.

ALICE: I'm hoping, Fred, hoping (New Year's racket is heard faintly.)

FRED (exuberantly): I hear steps on the stairs outside! It's him—It's him—I'll open the door.

FRED: Why, hello, Frank! Where have you been keeping yourself?

ALICE (joyously): Frank, dear, I'm so glad you are safe!

FRANK: Happy New Year, Fred! I've been busy with a jailbird all evening!

FRED: Busy with a jailbird?

ALICE: I've been so worried about you—but I'm so glad nothing happened.

FRANK: I tried to call up but the line was busy. I've been busy too since five o'clock—I captured Rader the convict and turned him over to the Lindsay police!

FRED and ALICE (simultaneously): You captured Rader? But how?

(Continued on page 1476)

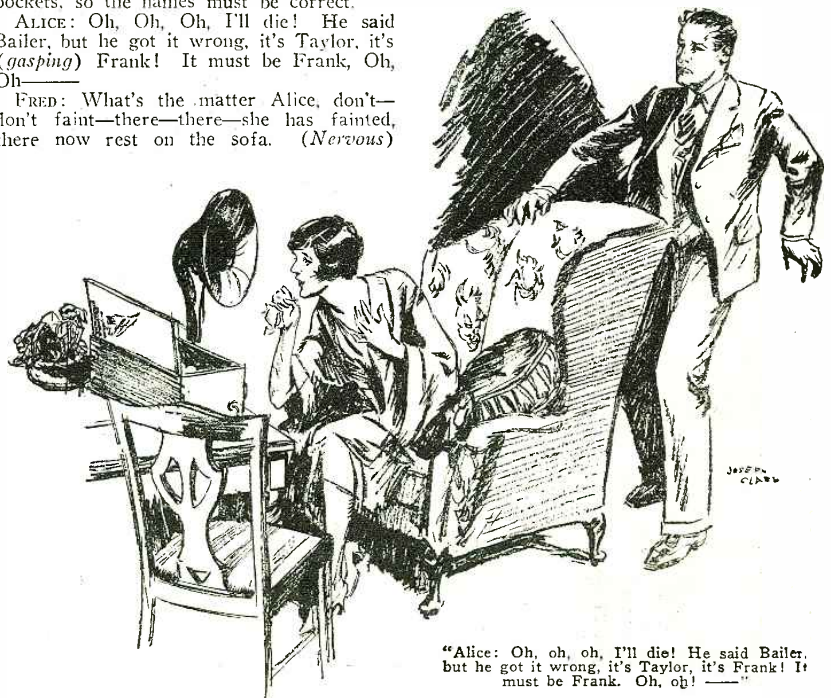

"Alice: Oh, oh, oh, I'll die! He said Bailer, but he got it wrong, it's Taylor, it's Frank! It must be Frank. Oh, oh!"

Radio Developments In Pictures



←←← **A SIGN OF THE TIMES**
 At the left is shown what is, perhaps, the only singing sign in existence, which advertises a radio company in Lima, Ohio. The case at the top of the sign encloses a loud speaker, which is connected to a set inside the store. "It speaks for itself," says the inventor, "even if this sign is a lyre."

NEW RADIO MAP OF THE UNITED STATES
 This map, prepared for the Radio Section of the Department of Commerce, shows at a glance the broadcast situation. The stars indicate high-powered stations of 5-kw. and over; the dots stations from 1/2-kw. up, and the light ones those of less than 500 watts. It is easy to see the congestion of stations in the more populous portions of the United States, and imagine the problems it brings in keeping open radio channels; while in the great western area, with its many isolated listeners, the stations are far apart. © Harris & Ewing.

RADIO TRAIN CONTROL
 This is a roadside unit, used in the system of train control pictured at the bottom of the page, to relay signals received from along the line. © Fotograms.

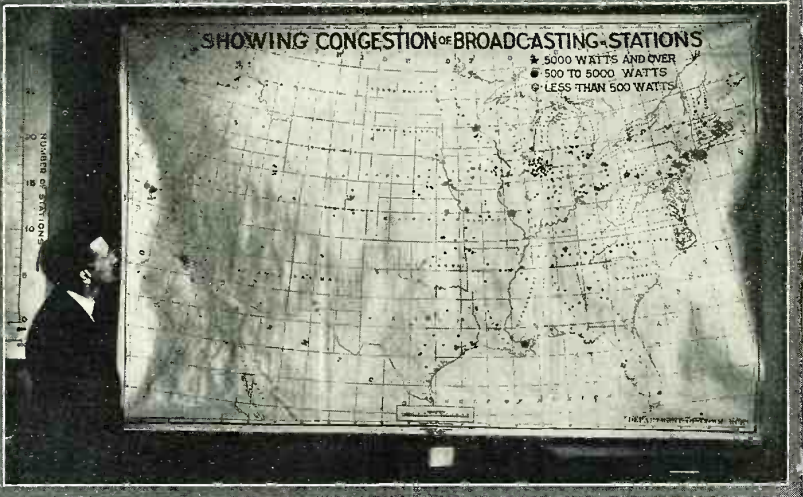
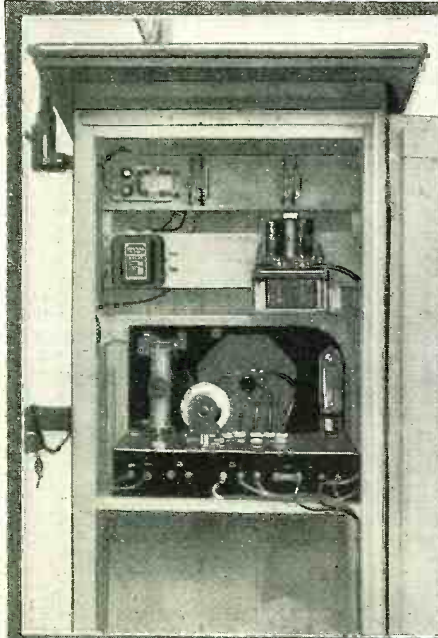

RADIO CONTROL TO AVERT POSSIBILITY OF TRAIN WRECKS
 The illustration at the lower left shows the speed governor which is attached to the pilot wheel of a locomotive, when equipped with a new radio safety device. Through a control circuit in the locomotive, this will cause the brakes to be applied when the speed exceeds that authorized by railroad regulations. The picture to the right shows one of the pick-up coils on the locomotive; two positions being used, one for clear track conditions and one when caution signals are received. Radio-frequency currents are sent out from oscillating units in roadside cabinets (such as that at the left above) and follow the rails to the pick-up coils beneath the locomotive. The oscillators act as a block system, showing the condition on the track ahead, whether clear, caution or danger. Signal lights in the cab convey the information to the engineer. © Fotograms.

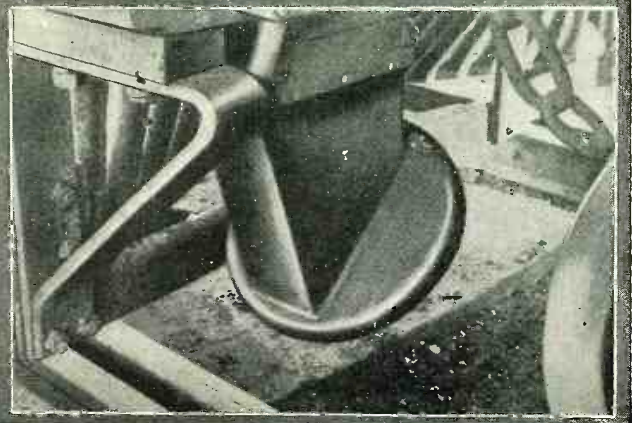
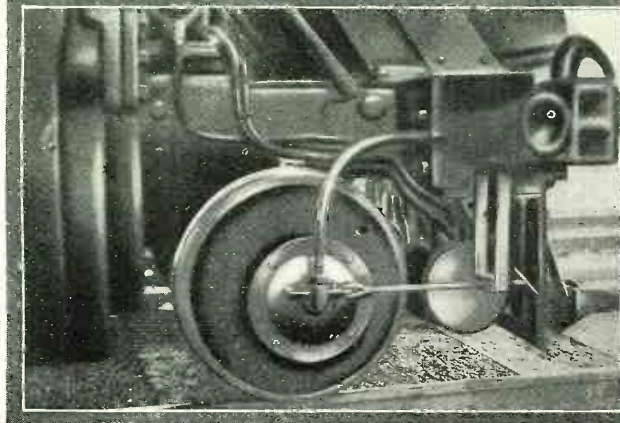

Views of the New Super-Power Station WJZ

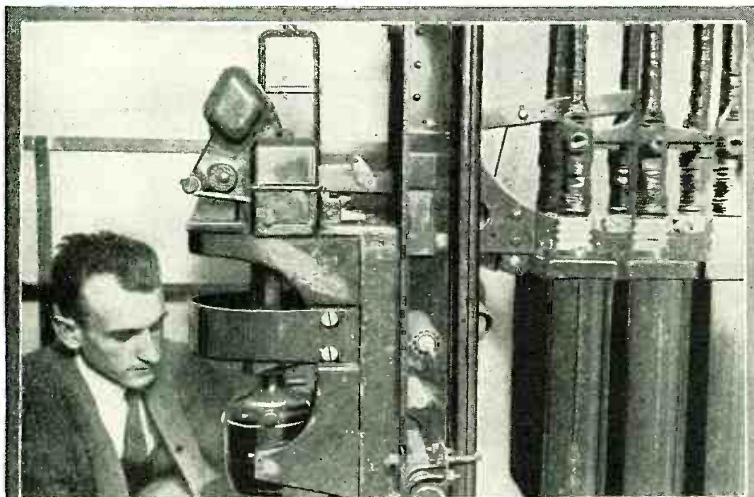

WATER COOLER FOR VACUUM TUBES. This huge water cooler, which is capable of cooling 100 gallons of water per minute, is used for the purpose of keeping the giant vacuum tubes used in the transmitter at an operating temperature. This is necessary because the great power which is needed to operate these tubes would ruin the comparatively delicate elements in a short time.

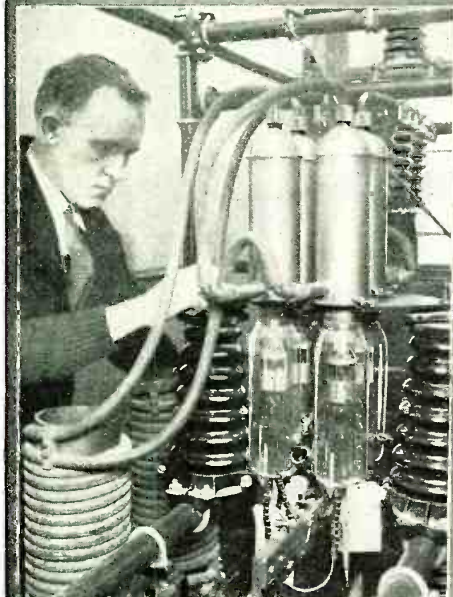

A MOTOR - OPERATED OIL SWITCH. Above is shown one of the largest switches, which is located in a house of its own and controlled from the central switch board. This switch is operated by a remote-control switch, which closes a circuit starting the motor shown at the bottom of the photograph. By running the motor in the opposite direction the switch is opened.

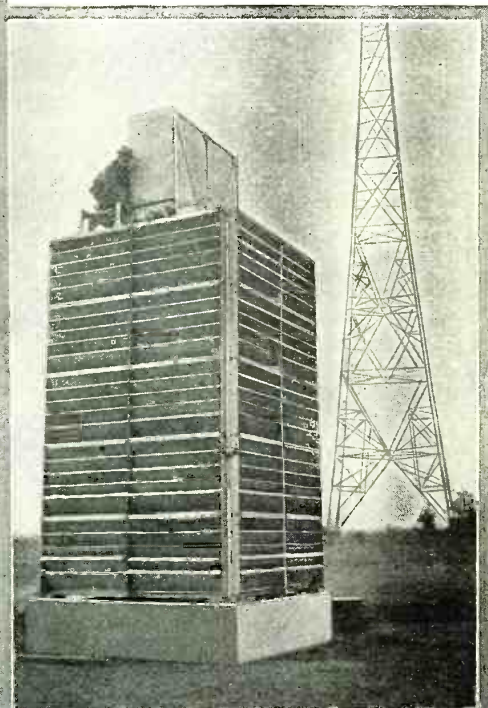

A CLOSE-UP OF THE 10-KW. TRANSMITTING TUBES. There are 64 of these tubes used in the broadcast station WJZ at Bound Brook, N. J. At the lower left may be seen the coiled pipe which carries the cooling water to the inlet of the tube's cooler. Notice the large insulators that are necessary for this type of vacuum tube.

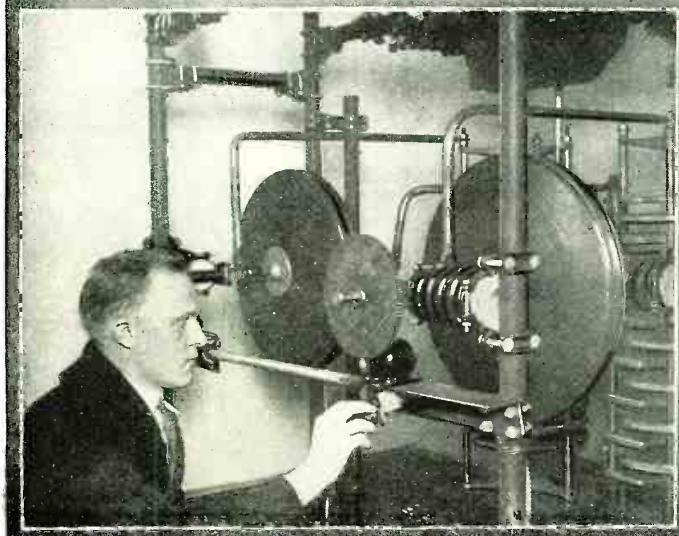

CONTROL PANEL OF WJZ. Every part of the complicated apparatus of the transmitting station is controlled from this one panel. The man on the right is holding one of the 10 kw. power tubes.

GIGANTIC VERNIER CONDENSERS. On the left is shown a pair of air condensers which are used for sharpening the tuning of WJZ. They operate by varying the separation between the plates and are verniers to the big condensers, the plates of which can be seen in the extreme right background. The verniers are operated electrically by small electric motors. Photos © Kadel & Herbert.

WRNY for New York Visitors

By CHARLES D. ISAACSON*



EMITO ORTEZ
Spanish prima donna, who has starred in opera in Italy and France, whose splendid soprano is heard often at WRNY.



PANCHO FUENTES
Who joins to her voice his rich baritone, in the romantic Spanish melodies which have thrilled thousands.



VERA SUNDELSON
Assistant program director, hostess for WRNY's artists and soother of artistic tempers.



JACK WHEATON
You have heard Jack Wheaton's orchestra from WRNY and enjoyed its strains of lively dance music.



Channing Pollock
Distinguished playwright, author of "The Fool" and "The Enemy," is a frequent visitor to WRNY.



Charlotte Trystman
This gifted little pianiste is but 11 years old, though you may find difficulty in believing it, after hearing her at WRNY.



Walter F. Gruening
You have heard him in "Harper's Magazine's" regular book reviews at WRNY.



KENYON CONGDON
Who recently made his debut in radio from WRNY. Mr. Congdon possesses a baritone voice of distinction.

ARE you coming to New York? Then let me invite you at once to visit the RADIO NEWS Station at The Roosevelt. You will find the hotel one of the most beautiful in the country; and there you will hear one of the very best hotel orchestras I have ever known—I refer to Orlando's Roosevelt Concert Orchestra, under the direction of Herbert Sohman. You have doubtless heard this orchestra play to you three times a week through WRNY. Here you will also see Ben Bernie, and dance to his syncopating tunes—that is if you stay at The Roosevelt, or dine here in the Grill Room. But quite apart from that, please take this as your invitation to visit the RADIO NEWS Station on the eighteenth floor, also the RADIO NEWS Transmission Room on the twentieth floor. We will be happy to meet you and to greet you. You will always find something happening, and always find many celebrities on hand. WRNY folks will be glad to write you at any time and give you any information you desire in preparing for a visit to this city.

FOR LOVERS OF DRAMA

By the way, are you listening in every night at 7.15 to the Radio Theatre Index? For visitors to New York, this list is invaluable. Everyone who comes to the metropolis, of course, plans to attend the theatre, and does not want to waste an evening on a production that is only fair. The Radio Theatre Index will give you the exact information that you want—about the plays you want to see—where they are playing, the members of the casts, the type of plays, what you can expect in the way of music, laughter, thrills, etc.

Out-of-towners are asked, at this point, to write to the Program Director and tell what this Index means to them, and how valuable it is proving.

THE SHOPPERS' ADVISER

Another feature at WRNY that is particularly valuable to visitors to New York is the Radio Sales Analysis.

Visitors to New York want to buy; they want to buy the best things that are offered, and get the best values; and every morning WRNY is now selecting the most interesting offerings of the better grade department stores and shops, for the benefit of the women particularly. This service will enable those who are planning to come to New York in the next few days to know just which stores to shop at, and which stores are offering the things that visitors are anxious to buy.

GUIDE TO THE CHURCHES

For those who seek religious information
(Continued on page 1488)

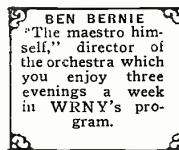

BEN BERNIE
"The maestro himself" director of the orchestra which you enjoy three evenings a week in WRNY's program.



FRANCINE VYDE
Whom you know perhaps better on WRNY's program as "The Coloratura Soprano."



Samuel Polonsky
Broadcasts through WRNY the finest and most soulful violin concert numbers. He is a pupil of Auer.



Henrietta Anustreich
Whose Piano Dances — not dance music, but concert selections based on dance themes you know.



Sergei Klitansky
A famous teacher of singers, who has instructed many eminent artists, is the conductor of a series at WRNY.



JOHN ADAM HUGO
Composer of "The Temple Dancer," is now preparing the first opera written for radio production.



ROMUALDO SAPIRO
The veteran operatic conductor of whom you will read more in this article, is now directing at WRNY.



Harry Finkel, M. D.
Whose talks on "Diet" are not the least interesting of WRNY's weekly features. He tells what foods suit you.

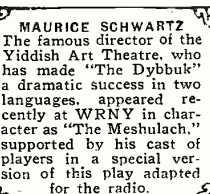

MAURICE SCHWARTZ
The famous director of the Yiddish Art Theatre, who has made "The Dybbuk" a dramatic success in two languages, appeared recently at WRNY in character as "The Meshulach," supported by his cast of players in a special version of this play adapted for the radio.



* Program Director of WRNY.

"So's Your Old Ghost"

By MARIUS LOGAN

"AND what's more, Buddy, you can take my word for it, that was the slickest game that ever was doped out."

"Is that so? Well, suppose you tell me all about it. Got the time?"

"Aw say, what yer tryin' to do—slip us the wise tongue? Lay off that stuff, guy, lay off it! I got nothin' to do and the whole night to do it in. Hey, Joe, make ours the same!"

This last was accompanied by a look of inquiry in my direction, which I as silently answered with a nod. Joe, the man of all work in Red Mike's saloon on Ninth Avenue, in the town known to the world in general as Manhattan, brought two glasses filled with something that Mr. Volstead would not consider "good" beer,—but we did.

It was this excellent beverage that had drawn me to the little back room of Mike's thirst parlor that rainy night. After my more or less arduous day's work on the paper downtown even my comfortable bachelor quarters had seemed to be lacking in something and I had braved the elements to seek relaxation—and refreshment—in Mike's. I had brought along a book and had read about an hour, when the door into the bar had opened and an ugly head with a battered cap had been thrust in.

At once my mind jumped back to a similar occurrence in 1918. I was then across the pond doing my bit with the Signal Corps as a radio operator, and had been located for some days in a sector that was, to say the least, just a bit lively. One night when everything possible had gone wrong, as it seemed, the shack door was jerked open and a head poked in with the "tin derby" cocked jauntily on one side.

"Hey, Buddy, I seen your light as we was passing and thought you'd like to know we was retirin'."

"The hell you say!"

He looked astonished—laughed—and vanished.

However that sentence had been a great help—a very great help in fact. My equipment had not been working well and messages were jammed and garbled, and I had received no orders as to the retirement. After destroying the necessary things in the shack, I left as quickly as I could and caught up with the retreating company.

Later on I looked up the little fellow who had really saved me—for a barrage had started soon after we had left—and found that he hailed from New York too. Pat McRosen had been born and raised in the neighborhood of Ninth Avenue and Twenty-third Street—and all the world knows what that means. Yes, he was hard-boiled, but like most ten-minute eggs his shell was the hardest part of him.

So when the door in Red Mike's opened and I recognized the same head, I said:

"The hell you say!"

Pat took a long look at me and then the rest of his poorly-clad body was dragged through the door. He was short, just an inch or two over five feet; with black hair, that at the moment needed the attentions of a barber; eyes that were never still and generally shifting nervously from place to place; one ear distinctly of the cauliflower type, and what learned professors of human nature would call a weak chin. His clothes were hand-me-downs and he seemed to be on his uppers.

"Sit down, Pat, and have one on me." I invited, "and tell me how the world's been treating you since I left you in Brest."

His story was like many others that have been heard all over the country since the close of the war. No work to be had—starvation just a step around the corner—so he had resorted to the only thing he knew how to do at all—the confidence game. And it was here that he seemed to take on new life when he started to tell me about "the slickest game that ever was doped out."

"Well, it was this way," he began, after sampling the glasses' contents, "after bum-

ming around the country for five years and not getting nowhere, I hunts up my old pal, Solly, the Egg, here in the old town. Solly was busier than I was doing nothing, so we scrapes our skulls to see if we couldn't pull something new.

"Solly had a skirt in tow that was one knockout, believe me, boy! She sure was the goods forty ways from the jack. Brains, my gawd, she sure had plenty. And there was a friend of Solly's named Mat Frankel, that was a classy boy with a smooth tongue and a swell line of society patter. When he worked, which wasn't any oftener than he had to, he was touring the country in vaudeville as a ventriloquist.

"Well, Mat and Solly had been playing with this here radio. They'd sit and fool around with the thing for hours when we should have been doping out something to collect us some jack. Mat had worked for a while, when the vaudeville business was sort of on the fritz, in some big radio factory, where he had been with a guy that had been playing with these here short waves, you know, down around five meters or so?"

"Where did you learn so much about it, Pat?" I interrupted.

"Aw, say, I ain't no dope-head. Playing around with those birds I picked up a lot about old kid radio. But listen and pipe down. These two bozos they finally get a set working—and working good, what I mean—on five meters, see? We used to send messages across the room and then we tried it from my room over to Solly's and it sure did work great.

"One night Solly's lady friend was there and she pulled the one grand little idea. We was to rent a place in a classy dump and fix it up like a spiritualist's dive—you know, hangings with stars on them—classy chairs—deep carpets—low lights and all the old bunk. Then we was to fix up the radio so that we could send and receive messages from there, the dope being that we could

(Continued on page 1458)

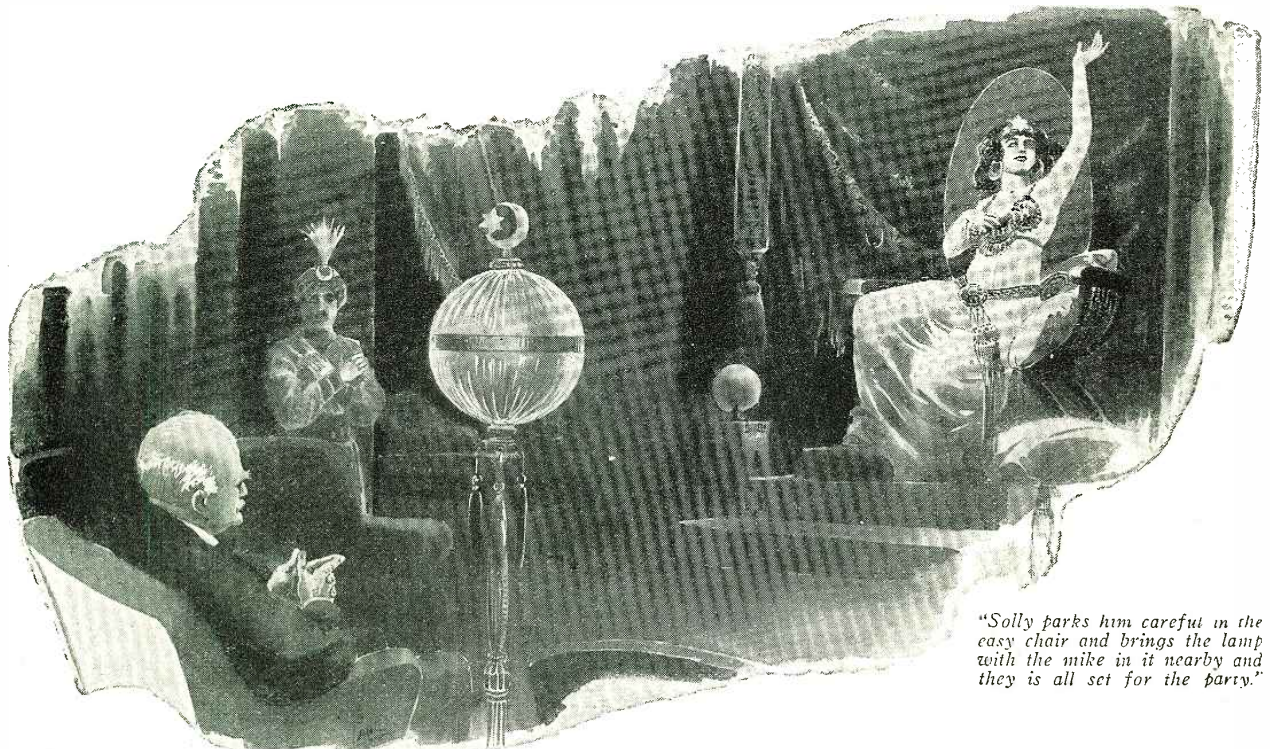

"Solly parks him careful in the easy chair and brings the lamp with the mike in it nearby and they is all set for the party."

The Radio Watchman at the Gate

By Dr. K. SCHUETT

In nearly every large manufacturing plant trouble has been experienced with employees carrying home small pieces of metal, instruments, etc. In Germany a large manufacturing plant has prevented this by installing a radio detective, as explained in this article.

DURING the past few years, and especially since the war, it has been found necessary by the management of many large factories to maintain a close inspection of their employees when the latter pass from work: as otherwise the dishonest element, always found among them, would be certain to seize the opportunity to carry away tools and valuable small articles of manufacture, either completed or partially so. It is obviously impossible, because of the time and labor which would be required to do so, to make a search by hand of the entire working force: and mechanical processes of examination ("frisking") although such can be devised, require apparatus entirely too expensive, and are ineffective to produce the desired certainty of results.

However, two German scientists, Drs. Geffchen and Richter, of Leipzig, have recently worked out the details of an electrical apparatus by means of which, without any physical contact, it is possible to make an effective search of every person leaving the premises; and to determine with certainty, and instantaneously, whether he is carrying with him any object of a metallic nature.

THE COIL AS A DETECTIVE

This examination is effected by the change of pitch in a telephone headset, which is worn by the person who is charged with the duty of carrying out the inspection. The workmen leave the factory grounds through a wicket gate; as shown in the illustration, which is taken from a photograph of the main exit of a German factory, where the apparatus described in this article is in successful operation. The wicket, or framework surrounding the gate, through which the workmen must pass in single file, is

constructed to enclose and support a coil of many turns of insulated copper wire—the "gate-coil" shown in the diagram of the circuit, on this page. A condenser, C₃ in the diagram, is so adapted to the coil that they form an oscillating circuit, inductively coupled to a circuit containing a generator of audio-frequency currents (No. 1). This circuit is brought to oscillation in the same manner that the carrier-waves, of radio broadcast stations, with their higher frequency, act upon a radio receiving set tuned to a critical point.

The number of oscillations per second (the frequency) in such a closed circuit depends upon: first, the size of the condenser and its consequent capacity; and second, upon the size of the coil, or more properly, upon its inductance. If the latter is increased by adding more turns the frequency is diminished, the oscillations will fall to a lower frequency, and consequently a telephone receiver connected in the oscillating circuit will give a note of proportionately lower pitch.

"MAGNIFYING" THE CHANGE IN PITCH

The inductance of the coil can also be increased if a piece of iron, steel, or other metal is introduced within it, because this makes an alteration in the lines of magnetic force emitted from the coil. This principle, the use of which in the construction of transformers is familiar to all constructors of radio sets, is utilized in the detecting apparatus connected to the gate coil, to learn whether those who pass through it have any metallic substance concealed on their persons.

It will be obvious that the change effected in the inductance of the coil by a piece of metal which is small in size, in comparison with the dimensions of the electrified wicket-gate, may be practically nil. It may be often

as small as one-hundredth of one per cent. The resulting change in the pitch of the note heard in the telephone set would in this case be entirely too small to be detected without the aid of some further electrical appliance. This, however, is provided in the following ingenious manner.

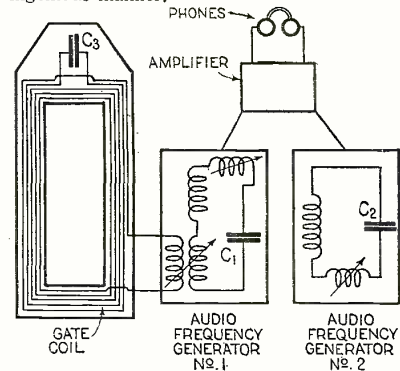

Above is shown a schematic diagram of the radio gate watchman, which is fully explained in the accompanying text.

In a second oscillating circuit, connected with another generator of audio-frequency impulses (No. 2), oscillations are brought about, having almost exactly the same frequency as those produced in the circuit connected to the gate coil. Now, if these two series of oscillations are caused to act simultaneously upon the telephone, with proper adjustment, a note is produced in the telephone, differing in pitch from both. It is a great deal lower. This phenomenon is akin to that produced by playing two organ notes of low pitch which do not harmonize; the "beats" resulting measuring the differences of their frequencies.

What happens is that a wave at one of its amplitudes (highest points) is weakened by the second sound wave, and at another amplitude is strengthened by it, so that the times at which the sound strikes most forcibly upon the ear occur at greater intervals; and this produces the effect of a greatly-lowered pitch. The periodicity of the beats, which constitutes their pitch, becomes of course highest as the frequencies of the two sound waves tend to become equal, and it falls with great rapidity when their difference is very slightly increased.

Thus, if we tune the two circuits of our detector apparatus to bring about a beat of definite pitch, and then introduce into the gate coil a piece of metal, the frequency of the gate-coil circuit is lowered. The result is that the beats heard in the telephone suddenly change in pitch: and they revert to the original sound only when the piece of metal is again removed from the field of the coil.

OPERATING THE RADIO DETECTIVE

In the illustration which accompanies this article, the apparatus with the amplifiers which produce the audio-frequency oscillations is shown at the right, standing on the window ledge. The attendant beside it wears the telephone headset, which is connected to the two circuits as described, and notes the change of sound, if any, as each man passes. The degree of sensitiveness to the presence of metal, attained by the use of this apparatus, is astonishing. Even watches and keys

(Continued on page 1493)

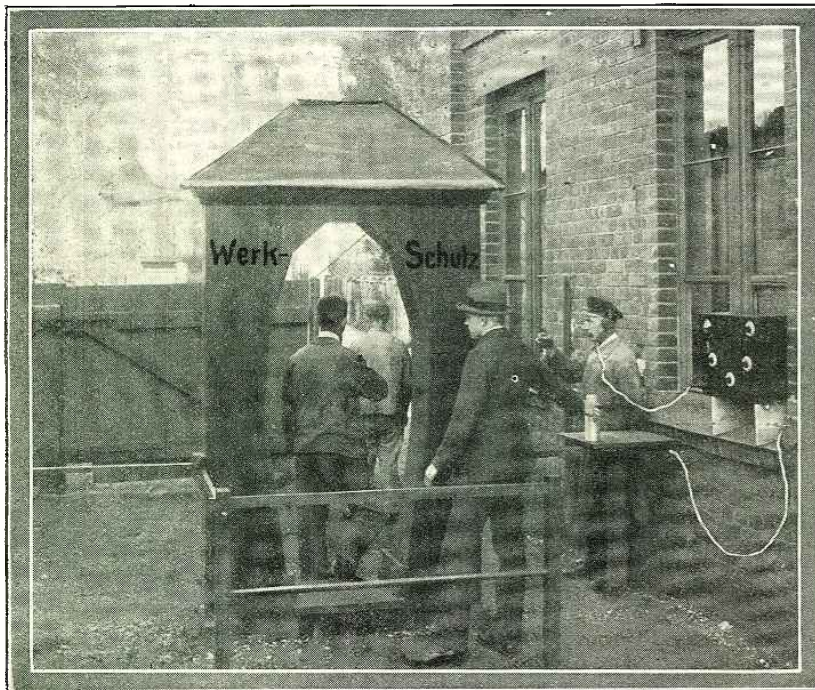

This illustration shows workmen passing through the "gate coil" of the radio detective, which indicates by a change of tone in the headset if any metal is passing through the coil's field.

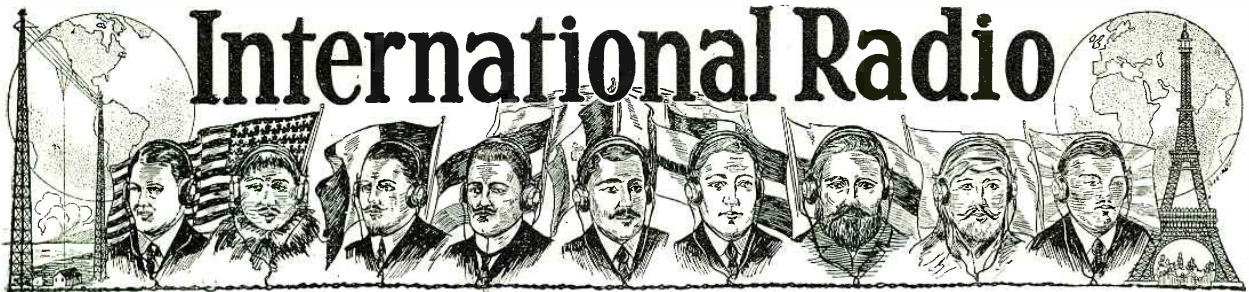

JAPAN

Starting the Young in the Right Path.

Broadcasting is seizing the imagination of Japan, and an effort is being made to cultivate the youthful Japanese mind in radio matters. The principal of the Taisho English School, in Tokio, is training his young pupils in the writing of prose and verse especially for radio broadcasting. He has formed a world radio league and wishes to broadcast "the world's dear children's literary articles for the Japanese children." The literary attempts will be transmitted in English from the Tokio Broadcasting station.

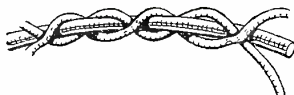

Above is shown a wire designed especially for coils that have to be space-wound. With ordinary wire this is rather difficult, for it is no easy matter to space every turn uniformly; so an English firm has used bare wire around which are wound two threads, in the manner shown above. This conductor, which may be obtained either stranded or solid, may be wound evenly on a tube with the proper spacing due to the thread.



ITALY

Electricity Supply Control by Radio

A concession has lately been granted by the Italian Government to a Milan company to establish six radio transmitting and receiving stations, in connection with electric power stations, and their transformer and local distributing stations. The purpose of the installations is to transmit by radio operating instructions to the engineers in charge at the different stations.

The concession, which is to run for a period of ten years, authorizes a wave-length of 1,000 meters for two of the installations and 1,750 meters for the others. Messages are to be only transmitted between certain hours, except in the case of emergencies. This is said to be the first installation of this kind in Italy.

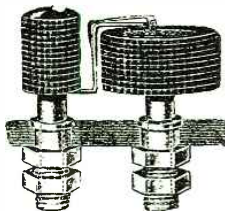

A new idea in crystal detectors is shown in the accompanying illustration. In the first place, the crystal element has a flat surface, composed of a number of very small crystals mounted together. It is stated that the great number of these makes the finding of sensitive points extremely easy. In place of the usual cat-whisker a small plate of resilient material is used. This detector may be mounted on the front of a panel; high efficiency is claimed for it.



GREAT BRITAIN

Increase of Listeners in 1925.

No fewer than 1,574,572 listeners now hold licenses in Great Britain, so that a recent estimate of ten million listeners to British programs seems less extravagant than it was at first supposed.

Flewelling with Radio News

RADIO NEWS announces the addition to its staff, as a contributing editor, of Mr. Edmund T. Flewelling, well known as the inventor of the Flewelling super-regenerative circuit. Mr. Flewelling was awarded a silver cup at the first Radio World's Fair in this city in 1924, for "constructive advancement shown in receiving-set design;" and another at Chicago, where he successfully opened the Radio Show by his short-wave transmitter, linking the show with A. R. R. L. headquarters in Hartford, Conn., at noon—one of the first successful short-wave transmissions effected from within a steel building.

Mr. Flewelling was one of the incorporators of the Radio Manufacturers' Association, and has served as technical adviser to many organizations. His articles will, among other things, tell of five years' tests of radio reception from an automobile throughout the eastern United States; and of the results of researches made during the past year at his laboratory in Michigan. He will explain exclusively in Radio News his method of building radio sets practically without wires, in a fraction of the time now necessary and also an entirely new method of securing radio frequency amplification, whose influence upon radio development is at the present time impossible to forecast.

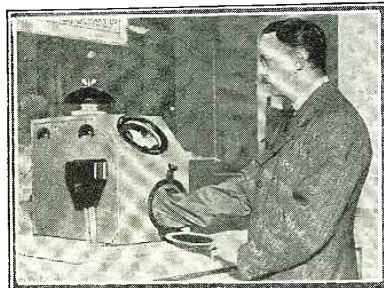

A waterproof radio set, designed especially for lifeboats in an emergency, is shown in the above illustration. This set was shown at the Shipping and Engineering Exhibit held in London. © Wide World Photos.



GERMANY

Street Cars and Interference

The disturbance of radio reception by street railways is being systematically studied in Germany. The Telegraphic Research Institute has investigated the matter more particularly in Berlin, and has found that it is not the driving current but the lighting current that is chiefly responsible. It was found that when the lighting current was increased, from 0.6 amperes to 2.5

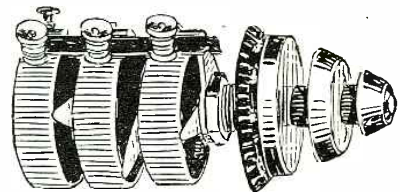

The triple rheostat, shown in the sketch above, is designed primarily as a space-saver on the panel. Each of the three resistances can be controlled separately from the front of the panel, by means of the three dials and two hollow shafts. Each shaft carries an arm, which slides over the resistance, the latter being wound on a fibre strip. But one hole in the panel is necessary for the mounting of this instrument.

amperes, the noises practically ceased, owing to the diminished voltage.

Another remedy, first tried at Halle, was to introduce condensers of large capacity (about 30 microfarads) in parallel with the lights. This was successful in both Halle and Berlin, where rolling contacts are used; but not in Frankfurt, Brandenburg or Karlsruhe, where aluminum sliding contacts are fixed to the cars. The Frankfort Corporation tried substituting carbon for aluminum, and found it beneficial, besides being cheaper. In Berlin fifty-five tram cars have been equipped with condensers to cut down interference.

"Radio as She Is Spoke."

The casual reader of the foreign radio journals may be disappointed in his search for noteworthy bargains, but he will be rewarded by the discovery of many literary gems in some of the sales talks, for the average European manufacturer pays the prospect the compliment of endeavoring to speak the latter's language, when he wishes to trade. What do you think of this?

"As specially I furnish my two apparatus types, thousands of which are used in Germany, best approved:

- DETECTOR RECEIVER with or without inductive coupling for all wave lengths
 - AUDION PRIMARY RECEIVER with foil regeneration
 - AUDION SECONDARY RECEIVER with fine tuning for wave lengths 200-900
- (Continued on page 1495)

The Radio Beginner

All About "A" Batteries and Chargers

By A. P. PECK, Assoc. I. R. E.*



Fig. 8. One of the low charging rate types, technically known as a "trickle charger." If constantly used, it gives perfect results.
Photo by courtesy of Pansteel Products Co.

WHILE preparing the material to be used in this article, and thinking about "A" batteries in general, the writer recalled the days when an "A" battery was more or less of a scarcity in the radio experimenter's laboratory. "When was this?" you ask. Along about the beginning of the World War, or a little prior to that time. Great was the astonishment of the various neighbors when they were ushered into an experimenter's laboratory, and were allowed to listen to the dots and dashes of the various commercial stations that were received on a crystal detector set. Usually the first question asked was: "Where does the electricity come from?" And then their astonishment was further in-

creased when they were informed that no electricity was used at that end of the "line," or rather that no local source of current was employed. This was because the greater part of the reception at that time was accomplished with crystal detectors, of the type just coming into prominence which did not require the use of batteries. These, of course, were the galena and silicon types.

Today, however, batteries are the most common sights to be found in experimental laboratories and, for that matter, in connection with the majority of radio sets that are in use. Generally speaking, there are three types of batteries, one of them being the "A" battery, and in this article we will deal with that source of current alone. Every set in general use today employing vacuum tubes, for the reception of radio signals or programs, uses an "A" battery to light the filaments of the tubes. This is its one and only function; but if it does not perform this properly, the action of the entire set is spoiled. In order to make a vacuum tube operate, that is the type of tube that is in general use, it is necessary that a very thin wire, sealed within the tube, be heated to incandescence, and this is accomplished by passing a current of electricity through it. The "A" battery furnishes this current and so enables the tube to operate. Of course, the other batteries are just as important as the "A"; but we will leave discussion of them to a future time. At the present, let us concern ourselves only with the items mentioned in the heading of this article.

When we consider the way in which a vacuum tube operates, as hitherto described in this department (RADIO NEWS for September, 1925—page 314), we find that the "A" battery, or the source of current for the filament of the tube or tubes, must be

very constant in operation, or otherwise the action of the set will suffer. Two separate and distinct types of batteries have been adopted for general use in radio reception or the purpose of supplying the current—dry cells and storage batteries.

DRY CELLS

Dry cells are in use today, mainly because they are convenient to use, are comparatively cheap in first cost and do not have to be recharged. When run down, they are thrown away and a new set installed. However, in the long run, a storage battery is often found far more satisfactory, because it is always on hand, can be charged readily and cheaply and delivers a very steady flow of current. However, in isolated localities where commercial electrical current is not available for charging storage batteries, dry



Fig. 5. The above illustration is a rear view of the charger shown at the lower left. The taps are for the purpose of varying the voltage, according to the battery to be charged.
Photos by courtesy of Gen. Electric Co.

cells are found to give very good satisfaction. You should always have a new set of dry cells on hand before the old ones are too far gone.

The principal way of testing a dry cell and in fact, the only practical way for the radio set operator is to measure the voltage across the terminals of each separate cell. Employ a low-reading voltmeter for this purpose. When a cell is new, it will be found to read slightly in excess of 1.5 volts. After it has been in use for some time this voltage will be found to have dropped off; and when it reaches approximately 1.2 volts, then is the time to buy a new set of batteries and have them on hand for service when necessary. Then, when the rheostats have to be turned up all the way in order to receive signals, and when you find that the signal strength falls off appreciably after the set has been in operation for a period of from fifteen minutes to one-half hour, you may know that the set of dry cells that are now being used for the "A" battery is very nearly exhausted. It will also be found by checking with the voltmeter that the voltage of each cell has probably dropped to 1 or 1.1 volts. Change them at this time.

Dry cells are suitable for use with UV-199 or C-299 tubes, as well as with WD-11

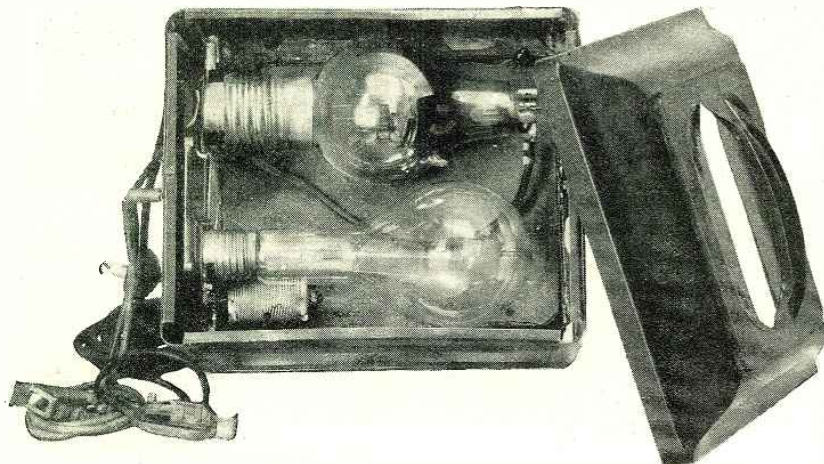

Fig. 6. Above is a view of the bulb type of charger, also illustrated in Fig. 5. Here the cover is removed to display the rectifier bulb and the incandescent light which regulates the rate of charge. With practically all chargers, full and complete directions for their operation are included by the makers.
Photos by courtesy of Gen. Electric Co.

* Radio Editor, SCIENCE AND INVENTION.

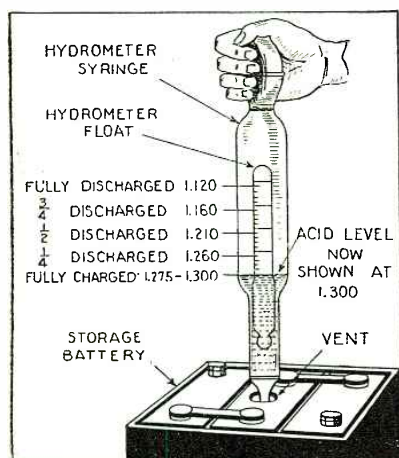

Fig. 1. How to test the specific gravity of the electrolyte in a storage battery. A hydrometer is used, and the float rises or falls according to the condition of charge.

and WD-12 tubes. In some cases, four of them, connected in series, are used for operating UV-201 tubes or C-301A tubes but this practice is not to be advocated. It would be far better to use WD-11 or WD-12 tubes and connect two or three dry cells in parallel to operate the filaments. This subject has been dealt with before in this department.

With regard to the care of dry cells, there is little to be said. Keep them in a dry place and free from dust. Do not place them near a radiator or in a warm place, as this tends to cause them to deteriorate more quickly than they will under normal conditions. Remove dust and other accumulations from between the terminals occasionally; so that there can be no chance of a partial short circuit between these two points, which would also tend to run down the cells and shorten their lives.

STORAGE BATTERIES

Let us now take up the consideration of storage batteries. These batteries are un-

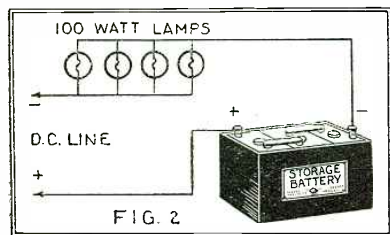

FIG. 2

Fig. 2. Charging a storage battery from a D.C. line is very simple, and the above circuit is all that is required.

oubtedly the most commonly-used; and since they all are similar in construction, we will not bother to deal with various types here. It will be sufficient to generalize.

The term storage battery is in fact a misnomer. A storage battery does not, technically speaking, store electricity in any form whatsoever. Just what does happen is that when electricity is fed into a storage battery, a chemical change takes place within it. This chemical change is of such a nature that when the two terminals of the battery are connected to an external circuit through which current can flow, a reverse chemical action takes place and a current of electricity is generated.

It is quite essential that a storage battery be chosen which is designed for the type of work that is encountered in radio reception; or in other words, the battery selected should be one that gives good service when used at a low discharge rate. Practically all automobile batteries, as well as those especially

designed for radio work, will give satisfaction. However, there are some radio batteries that will stand up a little better than those designed for automobile starting and lighting. In the long run, there is little choice between the two types. At the present time, the writer is using a standard type of automobile starting-battery which has been employed for operating various radio sets for a period of almost four years; the battery is still giving excellent service and in fact, does not show any signs of deterioration. This sort of service can only be obtained by proper care of the battery, and more will be said of this later on.

From the mention made of the chemical action taking place within a storage battery, it is quite obvious that some sort of arrangement must be used for introducing current into the battery so that the chemical change will take place; and so that the battery can later, after it is charged, be used for operating a radio set. Furthermore, there is one point that must be stressed here and that is, that the type of current, introduced into a storage battery when charging it, must be of the same general characteristics as the current to be delivered from the battery. In other words, direct current must be used.

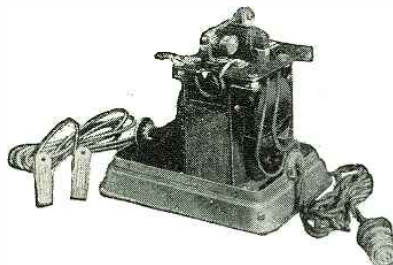

Fig. 4. The working parts of a very efficient type of vibrating rectifier are shown above. The case has been removed for this purpose.

It is impossible to charge a storage battery directly from alternating current such as is found in the majority of house lighting systems. Some device must be used between the house lighting circuit and the storage battery in order to change this current to a form suitable for charging the battery. Although a charged battery delivers a very smooth flow of direct current, still it can be charged with a pulsating current of the same nature. A pulsating current is one which varies in voltage between certain limits. However, it does not change its direction, as is the case with alternating current, and

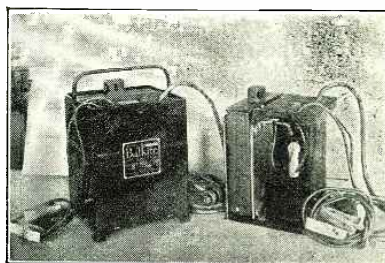

Fig. 7. Above (left) a standard type of electrolytic rectifier for charging; (right) the same type of instrument with the case cut away to show construction.

Photo by courtesy of Fansteel Products Co

therefore, is perfectly satisfactory for recharging any type of storage battery. The various chargers described further on in this article and illustrated in these pages will be found quite satisfactory for renewing your storage "A" battery for further service

CARE OF STORAGE BATTERIES

It is most essential that a storage battery of any type be given good care. Failure to do this will result in poor service and results unsatisfactory in all ways. A storage battery, even though it is very ruggedly constructed, is nevertheless a comparatively delicate part of your apparatus and must be treated accordingly. It should never be handled roughly or allowed to drop. If you do this, you are very liable to crack the cells that contain the liquid; as a result, this liquid or electrolyte will leak out, and since it contains acid, it will ruin almost everything that it touches. In view of the fact that batteries contain acid and that breakage is liable to take place at some time or other, a good many radio set users provide for such an emergency by placing their batteries in shallow glass or hard rubber trays. Then if an accident should take place, the tray will keep the acid from doing any damage.

Always keep the top of your storage battery clean. Do not allow water or moisture to collect upon it, and be sure to dust it off occasionally. After the dust has been removed, wipe off every part of the top very carefully with a cloth and then with another cloth moistened with ordinary household ammonia again go over the entire surface. Be sure you get in between the filler plugs and the connecting lead bars, as well as under the bars and all around them. Do not saturate this cloth with the

(Continued on page 1484)

Fig. 3, at the right, shows a completely assembled vibrating charger, the interior view of which is Fig. 4 above. This particular instrument is so constructed that it can be used for both "A" and "B" battery charging and in fact, one of these instruments is now in use in the writer's laboratory. For charging "B" batteries, the fuse plug is removed, a suitable-sized incandescent bulb inserted in the socket, the uppermost flexible lead connected to the correct binding post and the two lower binding posts connected to the battery.

Photos by courtesy of the Kodak Radio Corp.

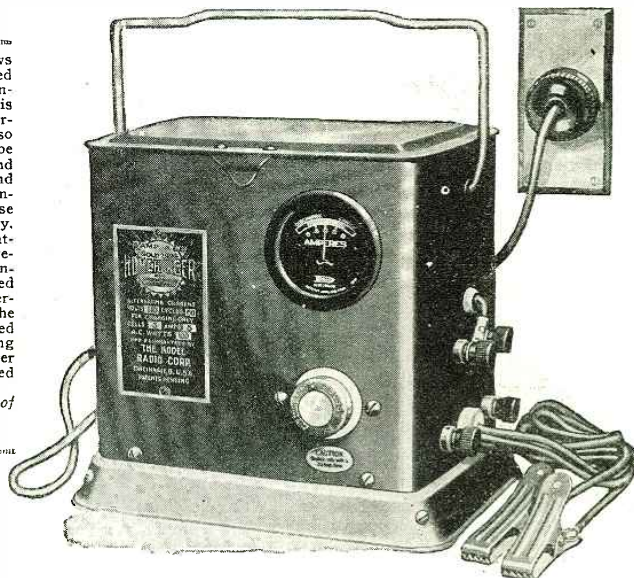

Round the World in a Radio Equipped Lifeboat

By A. DINSDALE*

Four Englishmen are going on a world-girdling cruise in a 40-foot motor life-boat to test out her seaworthiness, her radio equipment and general usefulness. The article below gives a description of the radio equipment of the "Elizabeth and Blanche."

THROUGHOUT the history of the human race, men have been found who are willing and ready to risk everything in the interests of science, discovery, and in search of means for making the world safer for their fellow men. Within the latter category fall Captain G. E. Hitchens and his three brave companions, who started from London about the end of November upon their adventurous 38,000-mile cruise around the world in a standard forty-foot motor lifeboat.

The radio apparatus aboard the "Elizabeth & Blanche" is the standard lifeboat equipment of the Marconi Company, and derives its power from a $\frac{1}{4}$ -H. P. air-cooled gasoline engine of particularly compact and efficient design. Directly coupled to this engine is a 500-cycle A.C. generator, the maximum output voltage of which is 200 volts. This power unit, when run at full speed, is capable of operating the $\frac{1}{4}$ -kw. quenched spark transmitter shown in the corner of the table in the interior view. On full power this transmitter produces an aerial current of about 2 amperes.

When run at reduced speed, so as to generate 110 volts, this same power unit is used to provide current for the illumination of the lifeboat; and for its searchlight, which is designed for signalling purposes at night, for picking up other boats, and to act as a mark to guide rescuing ships.

THE RECEIVING EQUIPMENT

The aerial is of the four-wire flat-topped variety, supported by two masts which are situated as far apart as possible, and specially designed for quick erection and dismantling. When a lifeboat is housed on the deck of a liner, these masts are let down

by a hinge, and kept stowed along the fore-and-aft line of the boat.

The standard lifeboat receiving equipment may comprise either a straight 2-tube receiver of non-directional properties, or a specially designed radio compass receiver, employing six tubes, which is used in conjunction with a loop antenna, such as shown in the interior illustration, just behind the operator. It is stowed in this position when not in use. Its location under service conditions can be seen in the exterior view of the boat, where it is visible in the centre of the boat, pointing athwartship.

Turning to the interior once more, the radio compass receiver is shown immediately in front of the operator. The tubes employed are of the well-known tubular V-24 type, the first four (top four in illustration) of which are R.F. tubes, the fifth the detector, and the sixth a stage of A.F. amplification. Immediately below the tubes are the controlling switches and tuning condensers. Between these condensers there is fitted a crystal detector, which acts as a stand-by, or alternative means of reception, so that "A" battery energy may be conserved when tube reception is not an absolute necessity.

Where a radio compass receiver is not desired, the alternative receiving equipment is not so elaborate, consisting merely of a detector and one stage of A.F., and also arranged for alternative crystal reception. This type of receiver must be mounted in the boat on strong elastic slings, so that violent movement of the boat, engine vibration, etc., shall not cause microphonic noises in the phones. Both these types of receiver, like the transmitter, are designed

for operation only in the immediate vicinity of the 600-meter wave-length. It is not necessary to provide for others, because all distress work at sea is carried out on 600 meters.

For the purpose of the voyage of the

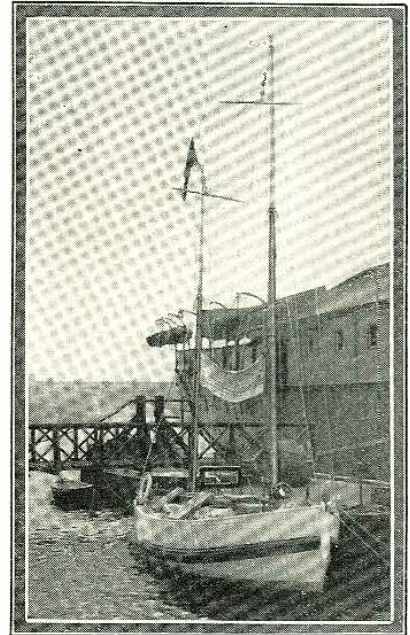

The 40-foot motor boat moored at her dock in London. Notice the main and loop antennas, the latter amidship, and the searchlight.

"Elizabeth & Blanche," however, a second receiver has been fitted, capable of covering all the commercial wave-lengths. It is a 2-tube outfit (det. and A.F.), fitted with alternative crystal detector. Its purpose aboard the "Elizabeth & Blanche" is to enable Captain Hitchens and his companions to receive time signals, meteorological reports, and news bulletins, all of which are sent out on the longer wave-lengths.

PROVISION FOR EMERGENCIES

The "A" battery power for the tube filaments is obtained from two 4-volt 40-ampere-hour storage batteries. One of these batteries is normally kept in the boat when the liner is at sea, and the other in the vessel's radio room, where it is charged. It is the duty of the chief operator of the liner to see that one full charged battery is always in the lifeboat.

The object of installing a separate power unit for the radio equipment, instead of driving the radio generator from the main engine of the lifeboat, is to make the radio independent of main engine breakdowns.

The range called for in the British regulations on the subject is 50 miles, when communicating with another ship fitted with a crystal receiver only. With tube reception at the other end, this range can be greatly exceeded, and in actual tests with the above described gear, transmitting to ship equipped with a tube receiver, ranges up to 175 miles have been obtained. Communication has also been maintained for an hour with a coast station, in daylight, at a range of 300 miles.

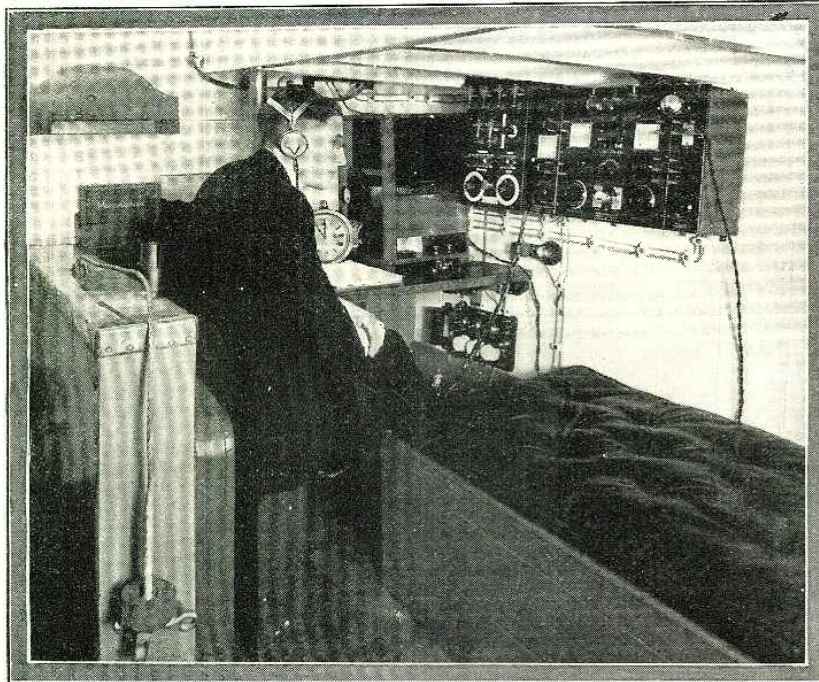

Interior of wireless cabin, showing Radio Operator Gilbert Moss, seated before his instruments. Behind him, on the deck, is the loop antenna, unshipped. In the corner of the bench is the $\frac{1}{4}$ K.W. quenched spark transmitter, and on the bulkhead in front of Mr. Moss is the 6-tube radio compass receiver and the 2-tube all-wave receiver, both fitted for alternative crystal operation. Photos © Marconi Wireless Telegraph Co., Ltd.

*Member of the Radio Society of Great Britain.

Radio Set Owner's Information

REMOVING BATTERY CORROSION

6. John H. Harbison of New York asks:

Ques.—The terminals of my storage battery get covered with a greenish paste. How can I get rid of this; as no matter how often I scrape them clean, in a day or so they are again covered?

Ans.—This is a form of corrosion that occurs in every storage battery, and may easily be removed with a solution of ordinary baking soda. Dissolve a tablespoonful of soda in three ounces of water, and apply it to the terminals with a rag. The cleansing is progressing satisfactorily, if a bubbling and hissing takes place where the

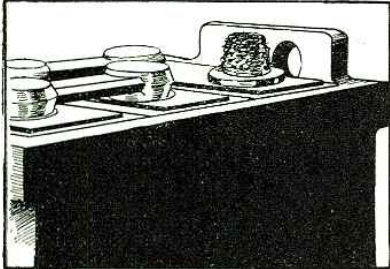

The copper sulphate corrosion that occurs on battery terminals may be easily removed by wiping with a soda solution.

copper sulphate (the greenish substance) and the soda solution come together. The terminals are wiped clean with another rag, as soon as this chemical action has ceased. The terminals of the battery should be smeared with a light coat of vaseline, which will in no way interfere with the proper functioning of the battery and prevent a recurrence of the accumulation.

This copper-sulphate corrosion on the terminals of storage batteries is caused by the solution inside the battery creeping up to the terminals by capillary attraction. However, the light coating of vaseline will be found to be a good remedy.

BUYING A LOUD SPEAKER

7. James T. McCullam of Houston, Texas, asks:

Ques.—I wish to purchase a new loud speaker to use with my five-tube tuned radio frequency receiver. Are there any set rules which you can give me which will give maximum results?

Ans.—The selection of a loud speaker is generally taken too lightly by the average fan. If a speaker gives a great volume of sound without too much distortion, the purchaser is in many cases satisfied. Then, after a few months' use, a new type of speaker is advertised in the papers and magazines; it is heard somewhere and the fan thinks seriously of discarding his own and getting a new one.

However, there are loud speakers on the market today which are just about as near perfection as can be expected; so that one might be purchased today without the fear that something which will make you jealous will appear on the market tomorrow. In many loud speakers there is a so-called "mellowness" of tone which is perhaps very pleasing to some people, but which also deceives many. It must be remembered that, in music, the same note can be played on a dozen instruments and yet there will be a distinct difference in the sound. For instance, play the note A above middle C on the piano, play the same note on a violin and then on a flute. The difference in quality will be unmistakable.

Just what causes these differences? It is simply a matter of overtones; there is in-

THIS page constitutes what is to be known as the SET OWNERS' INFORMATION department, and is to be conducted regularly each month in RADIO NEWS. The purpose of the department is to furnish assistance to those readers who have not yet acquired any extensive knowledge of radio, but who are the possessors of radio receivers and wish to know how to handle them.

There is always new blood coming into the fraternity of radio enthusiasts; and it is obviously unreasonable to expect that can intelligently read the articles which are written for the more experienced fans. Consequently this new department has been started for their benefit; and we invite anyone who desires to do so, to write an account of his troubles to the editor of this department. No letters will be answered by mail. The editor will select from the letters which he receives those queries that seem to be of most practical interest to all, and will answer them fully and in detail each month. There will be no charge for this service. Simply write to SET OWNERS' INFORMATION DEPARTMENT, RADIO NEWS, 53 Park Place, New York City.

sufficient space here to go into the theory, but the reader can ascertain for himself by consulting any good textbook on physics. In loud speakers, however, these overtones are sometimes sacrificed in order to get the bass notes, with the resultant effect that it is impossible to distinguish between a violin and a 'cello, for instance.

So, in the selection of a loud speaker, it would be well to listen to a small orchestra and see if the different instruments can be distinguished. Can the high notes of the flute be separated from those of the violin? Can the notes of the 'cello be distinguished from those of the oboe? It is safe to say that if a loud speaker will stand these tests, any other duties that are required of it will be satisfactorily fulfilled.

INSULATING THE AERIAL LEAD-IN

8. Samuel L. Linhart of Philadelphia, asks:

Ques.—Why is it necessary to keep the lead-in of an antenna away from the roof and the wall on its way down to the receiving set?

Ans.—It must be remembered, in connection with an antenna, that not only the wires that are stretched between the insulators on the roof, but the wires leading from these

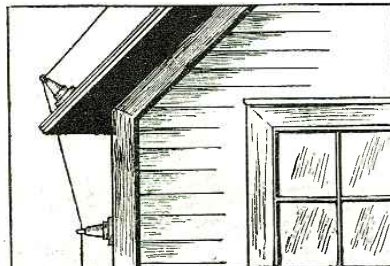

Keep the lead-in at least six inches from the roof and walls to insure good reception.

wires to the set itself, are at the same potential with respect to the earth, and the lead-in must be considered as part of the antenna. That is: when an incoming radio wave meets an antenna in its path, it induces a charge in the wire composing the antenna, and the wire that is connected to the receiver transmits this charge to the set. This radio wave is at high frequency and from the very nature of radio waves, very easily jumps from one medium to another at a lower potential. Now if the wire from the antenna, being at the same potential as the antenna, and therefore greatly different from the zero potential of the earth, is allowed to be within one or two inches of a grounded object, such as the roof or walls of the building, the charge will leak off the wire and the signals received at the set will be weak.

The wire that leads from the antenna to the receiver should be kept at least six inches from the roof or wall. Insulators may be had, one end of which may be attached to the wall, and the other end has an eye for the wire to pass through. The place where the lead-in wire passes into the house should be as well insulated as any other part of the stretch. A good method is to procure a 1/2-inch board, about four or five inches wide, of length equal to the width of the window through which the lead-in is to be brought. Drill a hole in this board at a slight angle to the horizontal, equal in diameter to that of a porcelain tube insulator, through which the wire will pass into the room. The insulator should slant with its lower end outside the window, so that rain will not enter the tube.

This board can be placed under the lower sash of the window and held in place by the sash.

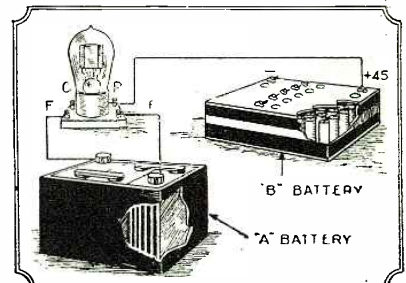

The main difference between "A" and "B" batteries is in the internal construction, as the former is for heavy duty and the latter for light.

WHY "A" AND "B" BATTERIES?

9. Frank V. Billings of Schenectady, N. Y., asks:

Ques.—Why are two separate batteries necessary to operate the ordinary vacuum tube in a radio receiver?

Ans.—In the first place the filament of the vacuum tube must be heated and this is done by the "A" battery, which is 1 1/2, 4 1/2 or 6 volts, depending on the style of the tube. When an object is heated, it throws off electrons; and some certain substances throw off more electrons than others, without destroying the object itself. For example, it has been ascertained that the electronic emission of thorium is very high and the filaments of vacuum tubes are coated with this substance. The heating by electricity is easily done, as one of the most efficient changes of electrical energy is into heat energy.

When the electrons are released from the filament by heating, they are free to fly in any direction. It should be remembered that electrons have a negative charge and if there

(Continued on page 1489)

New Developments in Radio Apparatus

By WILLIAM J. GRIFFIN



In this interesting survey of the radio market, Mr. Griffin discusses the products of several manufacturers who have departed in some ways from the standardized ideas of the industry, and have thereby created radio apparatus with unique, as well as valuable, features.



PROMINENT philosophers have been warning the public against too much standardization, because it tends to kill initiative and acts as a deterrent to progress. Although, in recent installments of this department, the tendencies toward mass movements of manufacturers toward a common goal have been remarked, there are some who refuse to "follow my leader," and who achieve success by the individuality of their products. It is upon such manufacturers that the industry is dependent for a great part of its advancement.

The apparatus described on the following pages is peculiarly typical of this phase of radio engineering.

A RECEIVER BALANCED BY AN ALL-CAPACITY BRIDGE

The broadcast receiver illustrated on this page may seem unusually complex in tuning, to those who have become accustomed to expect single-control in all of the newer sets. Yet it is one of the very latest to appear on the market. It is important, therefore, that we investigate the reasons for the multiple-control.

To start with fundamentals, a gain in any particular aspect of design in radio, as in any other field, must be expected to entail

will cut out very powerful locals and bring in distant stations through bad interference. The receiver is adjusted so that the dials read approximately the same at all wave-

An inspection of the wiring diagram shows that each of the radio frequency stages of this set forms a perfectly balanced Wheatstone's bridge, and furthermore, that the

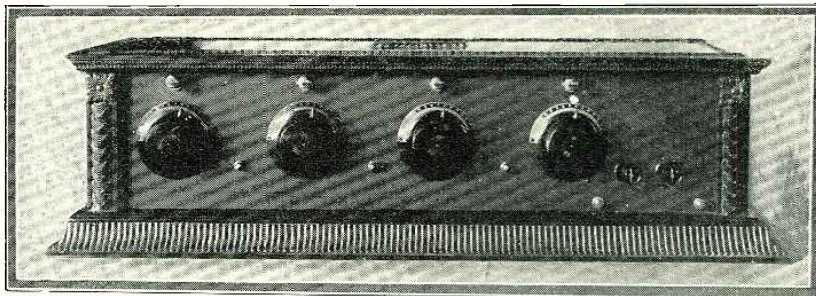

This cabinet is distinctive in design, but the circuit and instruments within are even more unusual. Notice the separate panel light above each dial. The four controls run in absolute synchronism, and do away with the necessity of single control.

Photos by courtesy of Walbert Mfg. Co.

lengths. On the average receiver the settings never vary more than a division or so of the dial. As human beings are supplied with two hands, there is little excuse for not using them. The four dials may be set accurately for any desired station; and the

tuning process does not tend to unbalance the bridge at any point in the wave-length range. Just how this is done has been told in detail, in articles appearing in former issues of RADIO NEWS (page 797 of the December 1925 issue and page 1152 of the February 1926 issue).

The small balancing condensers are not controlled by knobs of the usual type, as they need be set but once, when the tubes are installed, and need be changed only when new tubes are put in. The adjustments are made by means of a screwdriver, as the shafts of the minute balancing condensers bear slots much like the head of a screw. These are covered, after the adjustments are completed, by small metal caps which screw on and prevent accidental de-tuning.

A glance at any of the illustrations will show that the whole set is constructed in a fool-proof manner, and intended to last for many years. The variable condensers are protected by celluloid cases; and the coils are shielded in metal containers which remove the last possibility of feed-back and consequent oscillations. On page 1497 is shown the exact construction of the coils themselves. The relation of the coil to the shielding is such that the absorption losses are trifling.

The small panel lights are an important aid in tuning, especially as this set may be logged and will bring in a station at precisely the same setting night after night.

The bridge system, of course, suppresses all tendency to oscillate, and makes it as free from extraneous noises as any set can be made at the present time. The cabinet is distinctive, as its design is more elaborate than that of most. The carving is well exe-

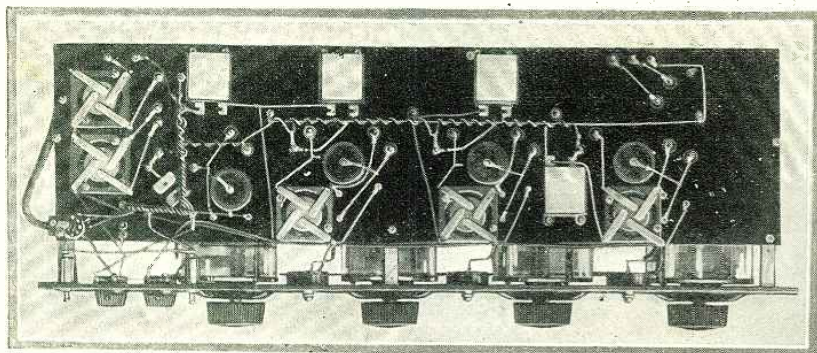

This bottom view shows the unusual method of wiring (which aids to suppress oscillations) and the small compensating condensers near the R.F. sockets. Three more are on the front panel (No. 9, below.)

some degree of loss in another aspect. Single-control is a commercial impossibility, if each of the several circuits operated by one knob tunes very sharply. Always it is to be had at some sacrifice of selectivity and sensitivity. The manufacturer of the receiver shown in the accompanying illustrations believes that selectivity and distance are characteristics of more importance than single-control. In consequence multiple-control is used; and the circuit is so designed that it

great amplification of which this set is capable makes "hunting" for stations unnecessary. Powerful stations within two thousand miles come in readily without searching. The lack of any auxiliary balancing controls which must be used in tuning, makes the receiver simpler in the long run than many which have fewer tuning controls, but a multitude of knobs controlling rheostats, potentiometers, compensating condensers, etc.

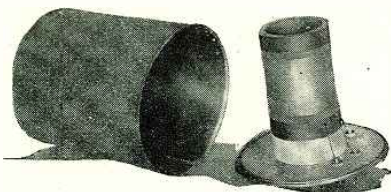

(Above) One of the R.F. transformers and its shielding "can." (Right) Top view: 1, R.F. amplifier sockets; 2, detector socket; 3, A.F. amplifier sockets; 4, double condensers; 5, detector tuning condenser; 6, coil "cans" for R.F. transformers; 7, A.F. transformers; 8, panel lights; 9, compensating condensers; 10, rheostats; 11, amperite, controlling A.F. amplifier.

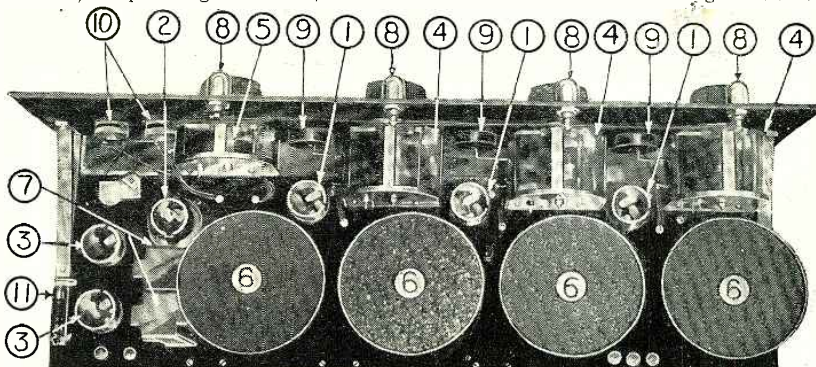

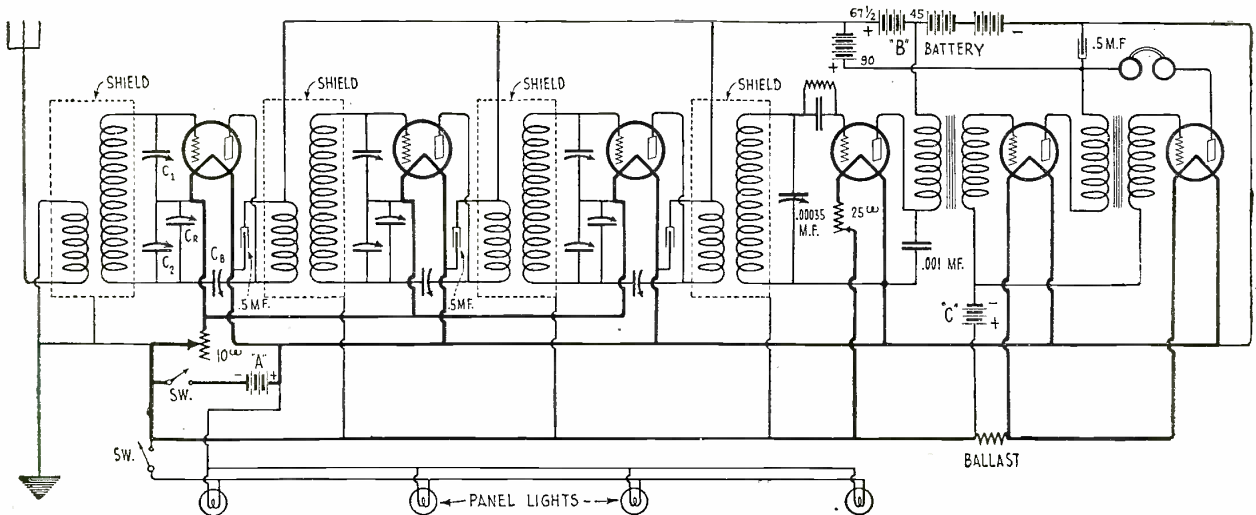

Wiring diagram of the receiver illustrated and described on the preceding page. Notice that the input and output circuits of each stage are kept at zero potential relation to each other by the Wheatstone's bridge arrangement of condensers. Cr compensates for the grid-filament tube capacitance and Cb for the grid-plate capacitance. A switch is provided to cut out the panel lights except when tuning, thus conserving the "A" battery

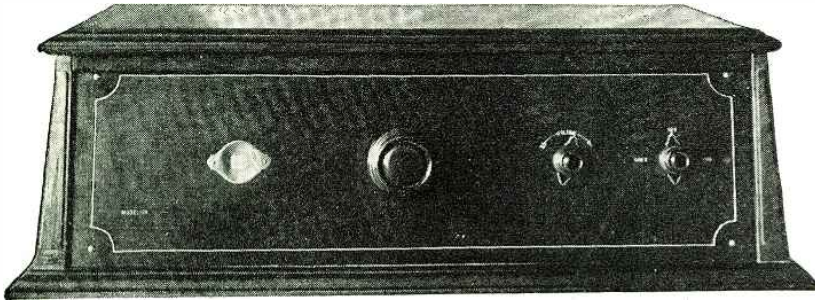

The receiver described below has an unusually harmonious appearance, as the front panel and knobs are made of wood to match the rest of cabinet. All metal work is lacquered brass. The dial is illuminated from the rear by a small bulb (shown as No. 7 below).

ated. The receiver, with its panel lights in operation, has an unusually attractive appearance.

HARMONY IN CABINET CONSTRUCTION

Radio buyers, who object to the "laboratory" appearance of many receivers, will find that the manufacturer of the one illustrated on this page has gone far in disguising the technical appearance, and in making all externals harmonize. The front panel is made of the same wood used in the cabinet, and the knobs are turned from solid wood blocks. All exterior metal parts are lacquered brass, which contrasts favorably with the wood finish, a light golden brown. The finish is completed by narrow striping in lacquer harmonizing with the brass work.

The appearance of the set in operation is further enhanced by the dial light. The dial of translucent celluloid, which is read through the small window at the left of the main tuning control, is illuminated from the

rear by a small bulb (which may be seen in the top view of the interior.)

This receiver is engineered for utmost simplicity in operation. There is but one

tuning control. No verniers whatever are used. Of the two smaller knobs, the left is a filament rheostat and the right a volume control, which cuts out the last stage of audio frequency amplification when loud signals are being received. It acts also as a filament switch.

The circuit employs tuned radio frequency amplification and a combination of transformer- and resistance-coupled audio frequency amplification. There are two stages of tuned radio frequency, using high ratio transformers and single-control cast condensers: the detector is a standard "hard" tube. The first stage of audio frequency amplification is transformer-coupled, and the last two resistance-coupled. The interesting method of making the three condensers run in synchronism is shown in the top and back views. The large celluloid dial acts as one of the friction gears, and translates the motion of the tuning knob to the condenser shafts. It meshes with a split pulley com-

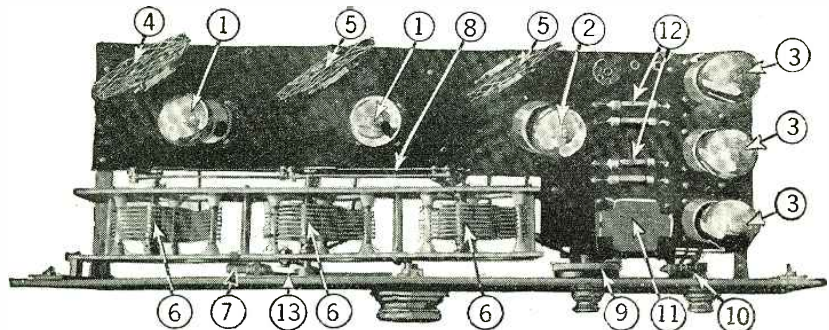

Top and rear views of the set described on this page: 1, R. F. Amplifiers; 2, Detector; 3, A. F. Amplifiers; 4, Antenna Coupler; 5, Interstage R. F. Transformers; 6, Tuning Condensers; 7, Dial Light; 8, Single-Control Mechanism; 9, Filament Rheostat; 10, Filament Switch and Volume Control; 11, Audio Frequency Transformer; 12, Resistance-Coupling Units for A. F. Amplifier; 13, Celluloid Dial. Photos by courtesy Pfanzstiel Radio Co.

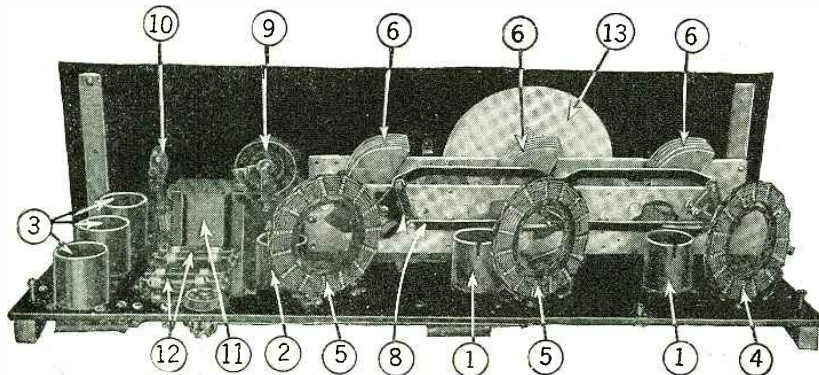

posed of two fibre washers which bear on both sides of the rim of the celluloid dial and maintain a constant friction grip. This eliminates backlash, or play, entirely.

As a hard tube is used for a detector, its socket is suspended on springs to reduce vibration and consequent microphonic noises, which are more bothersome in tubes with thin filaments.

As said before, the radio frequency transformers have a rather high ratio, about one to eight. This, and the losses intentionally

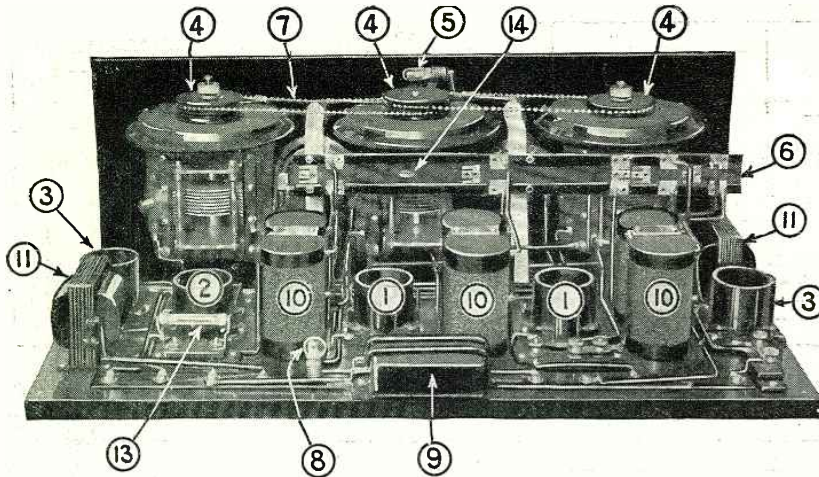

A receiver which employs beaded chains to move the three condensers in approximate synchronism, leaving the final adjustment to individual verniers. 1, R.F. Amplifier Sockets; 2, Detector Socket; 3, A.F. Amplifier Sockets; 4, Chain Gears; 5, Dial Light; 6, Automatic Wave-length Switch; 7, Beaded Chain Control Belt; 8, Pilot Light; 9, By-pass Condenser; 10, Binocular Coils; 11, A. F. Transformers; 13, Grid Leak-condenser; 14, Automatic Switch Lever.

introduced into the circuit by the use of "doped" spider-web coils, combine to suppress any tendency to oscillate; and broaden the tuning enough so that the three condensers may be used with a single control, without the necessity of auxiliary verniers. Yet the tuning is not broad enough to cause noticeable interference between stations near the same wave-length. Any loss in efficiency in the radio frequency stages is more than retrieved by the use of three stages of audio

frequency amplification, one of which may be cut out when it is not needed.

SINGLE CONTROL ON A DISTINCTIVE PANEL

The broadcast receiver illustrated in the accompanying half-tones has been engineered in a manner to make it the equal of the best five-tube sets on the market, internally; and, in addition, its front panel and method of single control are unique. Instead of placing the dials and verniers parallel to the panel, the usual practice, they are mounted at right angles and project through slots milled in the panel. Aside from giving the receiver a distinctive appearance, this feature has a great mechanical advantage, for it provides a simple means of mounting condensers with vertical shafts, which removes the necessity for counterweights to balance the plates, or the alternative, tight bearings. It makes the whole assembly as simple in operation as one could wish.

An inspection of the top and rear views of the interior will show the manner in which single-control is obtained. The central dial is bolted to the other two by means of two beaded link chains which are not taut. This allows about five degrees of play for the two vernier adjustments on the outside dial; but for large movements all three may be set simultaneously to an approximate position for any station by merely moving the central master control dial, or its vernier below. It

should be noticed that the edge of the upper dial is itself knurled and for large movements it should be moved directly with the thumb, instead of indirectly through the vernier below.

One of the most interesting feature of this set is the means provided for covering a dual band of wave-lengths. The upper band runs from 250 meters to 370; the lower from 160 meters to 325. Switching from one band to the other is accomplished automatically when the dial is turned past zero or past maximum. When the upper band is in use, a turn past zero switches to the lower range. When the lower band is in use, a turn past maximum switches back to the upper one.

The switching device may be seen in the two rear views. A long strip of insulating material (6) runs between the other strips. Metal contacts on the sliding member mesh with those secured to the stator. This compound switch is moved by a lever (14), which is in turn moved by the dial when it is turned past maximum or minimum. The metal bridging-pieces short-circuit a portion of the secondary of each radio frequency coupling transformer on the lower wave-lengths, as may be seen by inspecting the wiring diagram. In addition, another switch

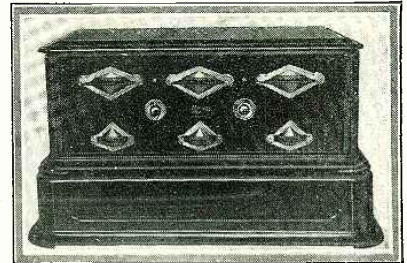

The front panel design of this receiver is unique. One of the small knobs controls the filament voltage. The other varies the "tone color," by means of a resistance and capacitance, in shunt with the primary of the second A. F. transformer.

Photos by courtesy of A. H. Grebe & Co.

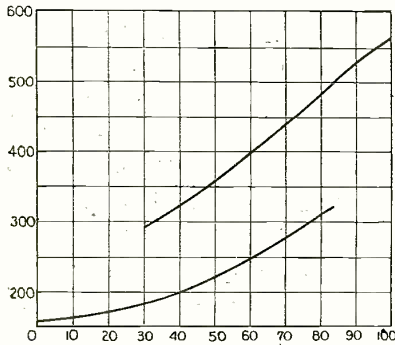

This graph shows the two wave-length ranges covered by the receiver illustrated in the adjacent half-tones. It will be seen that there is a liberal overlap between the two bands.

changes the antenna tap on the first coil at the same time that the secondary portions are shorted.

The coils, it will be noted, are of the confined field type, and in consequence no trouble arises from spray feed-back. The circuit is conventional in other respects, with the exception of the Tone Color control. This is a variable resistance in series with a condenser, both connected in parallel across the primary of the second audio frequency transformer.

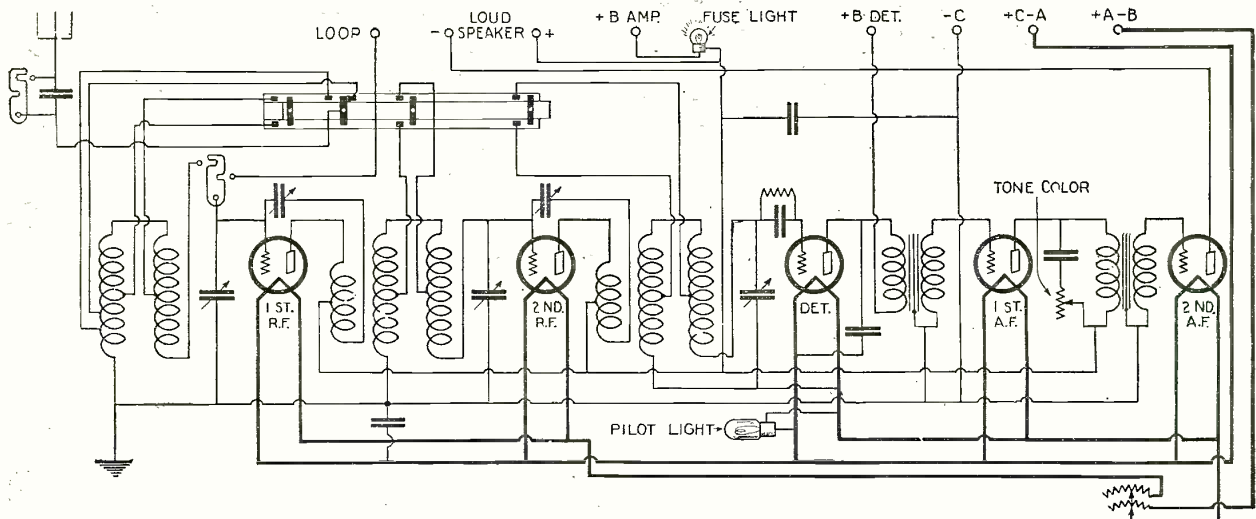

The unusual feature of this circuit is the means of changing the wave-length band. The long sliding switch, seen at the upper left, short circuits, in the short-wave position, a portion of the secondary of each R. F. transformer, and shifts the position of the antenna tap. Note the switches used to short the antenna condenser and to change from outdoor to loop antenna. Neutralizing condensers are shown above the two R.F. tubes.

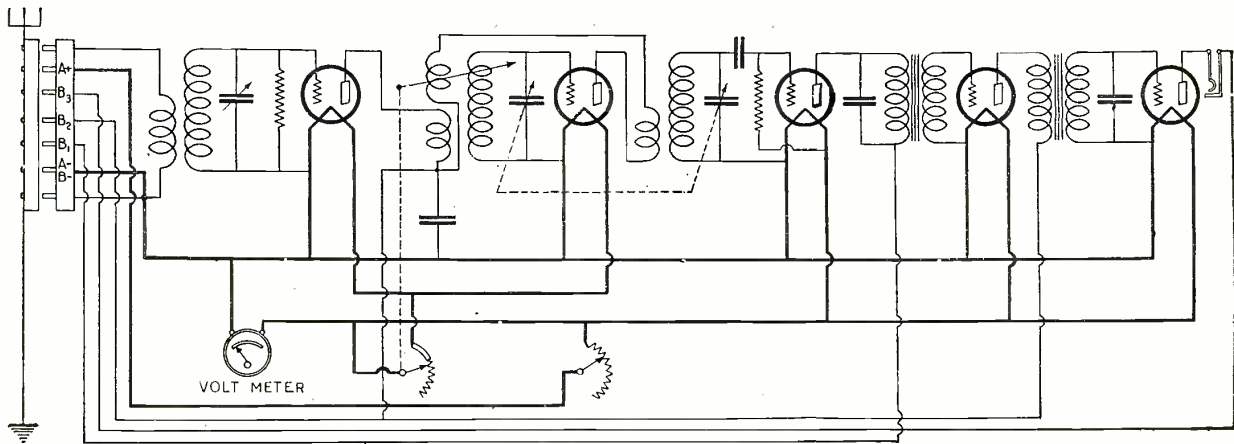

At the left of this diagram may be seen a conventionalized drawing of the round connection plug shown in the foreground of the half-tone at the bottom of the page. Observe that the filament voltage of the radio frequency amplifying tubes is varied simultaneously with the tickler coupling. This controls the tendency to oscillate. Two of the condensers are mounted on a common shaft.

A T.R.F. SET OF NOVEL DESIGN

A glance at the cabinet of the tuned radio frequency receiver illustrated in the accompanying half-tones is all that is necessary to indicate that radio designers are alive to the decorative possibilities of the new medium in which they are working. It has been said that all vigorous art is a product of economic necessity. The best example of

in various antennas make it difficult to keep the first stage in synchronism with the rest over the entire scale, although no difficulty is experienced in keeping the second and third in synchronism. This reduces the tuning controls to two, the proper quota for two hands. The two interior views show the sturdiness and efficiency which characterizes this receiver. In the bottom view may be seen the

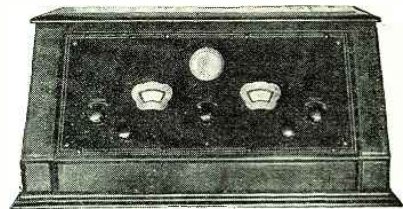

This cabinet is an excellent example of significant artistic form, expressing use in terms of design. The technical appearance is not disguised, but is made instead the basis of the decoration.

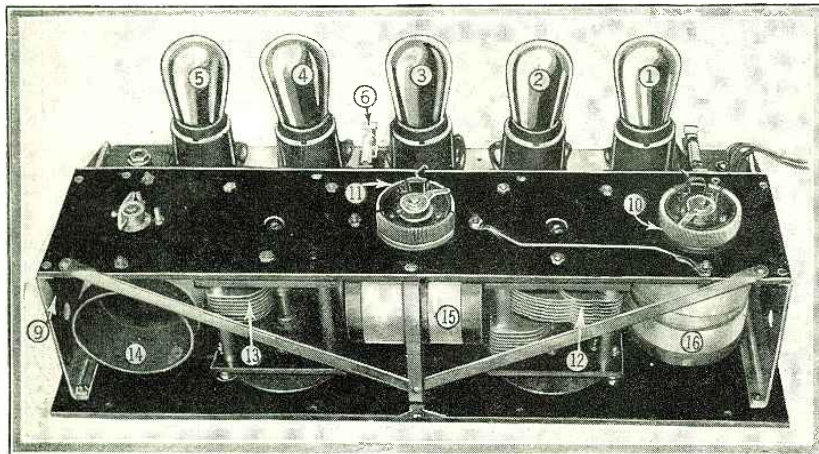

Bottom view of the receiver described on this page. Note that the tubes are mounted horizontally, when the set is in its normal position within the cabinet. The rheostat in the center of the sub-panel is on a common shaft with the tickler coil. The numbers are explained in the caption of the picture below.

positions of the three solenoids, each at right angles to the other two. It shows as well the double condenser at the right and the single one at the left.

Maximum radio frequency amplification is obtained by the use of regeneration in the second stage. An inspection of the wiring diagram shows that the tickler coil and the filament rheostat for the R.F. tubes move on the same shaft. Part of the rheostat "winding" is of solid metal, and does not vary the filament voltage until the tendency to oscillate becomes strong. When this happens resistance is cut in little by little. The whole makes a unique volume control. A voltmeter is provided on the panel to show at all time the condition of the batteries, as well as to aid in adjusting the filaments to the proper voltage by measurement instead of by guess. Normally the scale of this meter reads the "A" battery potential across all of the tubes. When the special rheostat on the volume control shaft is cut in, the voltage

(Continued on page 1497)

this is the sky-scraper architecture which has grown directly out of the limitations of the zoning laws. Architects have made a new type of design, within the restrictions legally imposed upon them.

Much the same thing is happening in radio. The scientific appearance is being transformed into a new type of decoration by men who understand its significance. The sloping panel and the use of metal plaques about the various controls and dials in this receiver result in an object unusually pleasing, yet representative of the function of the radio receiver itself.

The interior construction is also indicative of intelligent advancement. The manufacturer of this set believes that single control has not been developed as yet to a point that warrants a sacrifice in efficiency for its use. He realizes, however, that it has many advantages. For this reason a compromise has been made, and the customary three controls have been reduced to two. Two of the tuning circuits are combined and operated by one dial, while the first stage has a single control of its own. This is a very logical arrangement at present; as the discrepancies

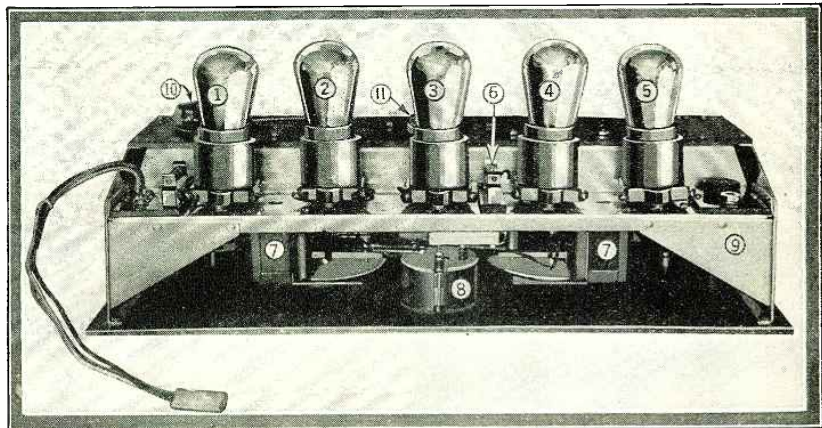

Top view, showing cushioned sockets: 1, Detector Tube; 2, R.F. Amplifier; 3, A.F. Amplifier; 4, R.F. Amplifier; 5, A.F. Amplifier; 6, Stabilizing Resistance; 7, Audio Frequency Transformers; 8, Voltmeter; 9, Shielding; 10, Main Filament Rheostat; 11, R.F. Filament Rheostat; 12, Dual Tuning Condenser; 13, Tuning Condenser, first stage; 14, Antenna Coupler; 15, First R.F. Transformer and Tickler; 16, Second R.F. Transformer. Photos by courtesy of Colin B. Kennedy Co.

Quo Vadis?

By HENRY DUBOIS

Being an interrogation on a few things which have come to pass in radio circles during the last two or three low-loss and straight-line epochs, and which add muchly to Ananias' reputation and Diogenes' perspicacity.

O H, Science! What deeds are committed in thy name! To what extremes must the purveyors and creators of radio components be driven to dispose of their wares? Has Diogenes become blind, like sightless Justice? Or has Ananias made a New Year's resolution, and has he kept it?

All these are mere conjectures, but so are some of the things I have been reading during my last year's rambles through the popular radio press. I have spent many years blinding my optics over engineering textbooks, and have wasted more patience than any one man ever possessed in wading through the technical journals; but never before this year, have I found that it was possible to accomplish the impossible. Let me elucidate

electrostatic field where the potentials are the least, and then attaching the insulating pieces at these points.

Well and good; the theory is correct. But here all correctness, accuracy, etc., cease to exist. The worthy gentleman forgot that the introduction of such a material object as a neon pencil into the electrified space would change the distribution of the field entirely, and make things look like what they ain't.

But enough of this. There are other and more immediate and astounding accomplishments which must be related. We cannot spend much time on each instance, but must be content with a mere synopsis of the wondrous deeds of our contemporaries.

The subject of coils, like that of condensers, was an alluring one; especially after a multitude of self-styled radio engineers had

have encyclopedias on missing linkages; but we have yet to find a reputable personage who has succeeded in measuring this field spray

The whole matter boils down to this—that there is a great deal of talking on these subjects, by those who have made no measurements. Things are glorified to the heavens, or damned to the realms of his satanic majesty, simply because of an idea. No attention is paid to its actual greatness or smallness. However (and with a deep sigh) it serves its purpose as "sales-talk."

There are many ill-advised concerns in the radio industry. There are manufacturers of coils who count the henries or microhenries as equivalent to so many turns of wire or to so many feet of wire. There are manufacturers of rheostats who never heard of resistances other than six or thirty. Or

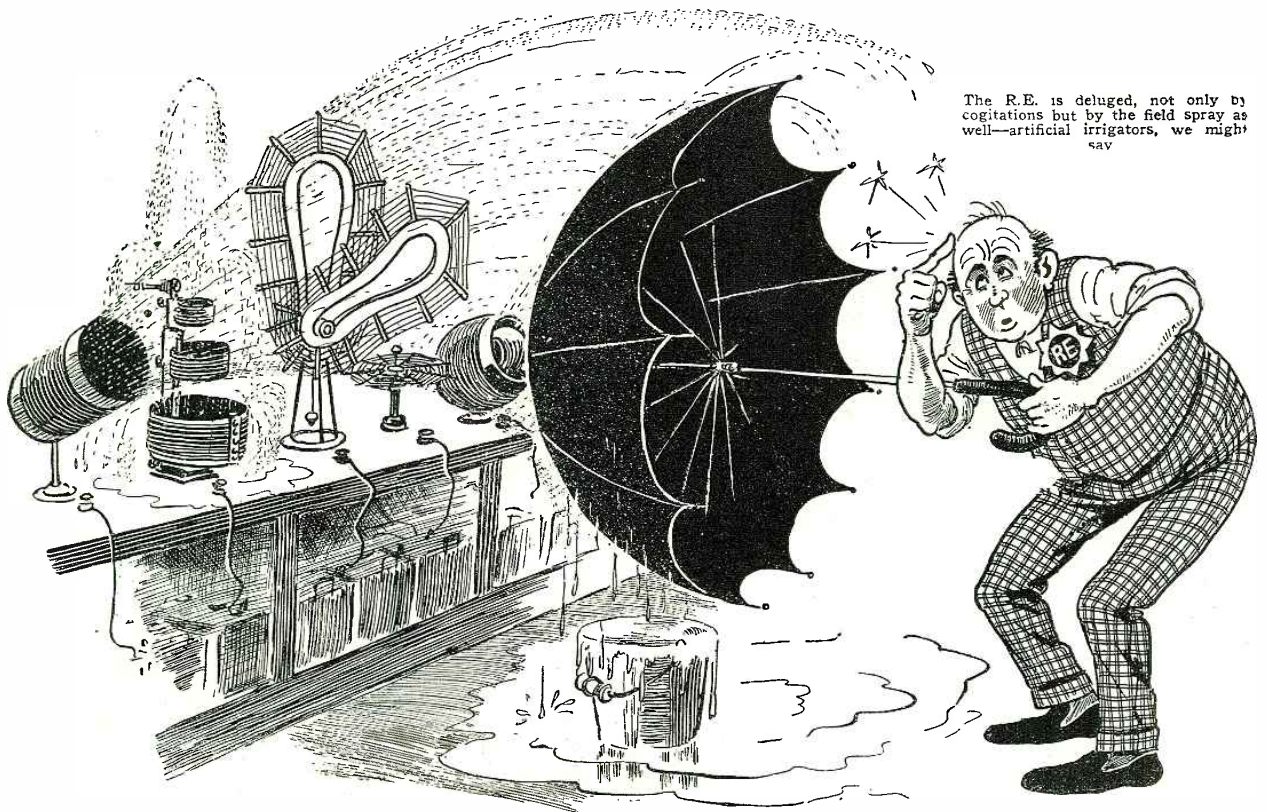

The R.E. is deluged, not only by cogitations but by the field spray as well—artificial irrigators, we might say

Not so long ago there was, as you will recall, if your memory is normal, a great ho-do, hullabaloo and ado, over the losses in condensers. During that belligerent period there came to my notice a thesis, written by a worthy gentleman, who related that he had passed sufficient high-frequency current through a condenser, and then explored the electrostatic field with a neon tube. The purpose of all this will be apparent in a moment.

It had often been thought that much of the losses in a condenser is due to leakage through, or across, the insulating material which is used to support the movable plates; and therefore that by using this material judiciously the losses could be reduced. The problem then resolved itself into finding the

decided that they had proved all self-oscillation in radio frequency amplifiers to be due to inter-stage coupling. The electromagnetic field, in and about an innocent coil of wire wound in a cylindrical fashion, was painfully and pathetically subjected to inspection, analysis and contempt.

No such things as neon tubes were used in looking over these fields; to tell the truth the man who wielded the neon tube in the condenser field is to be commended. At least he tried; that is more than can be said of those who bungled up the coil-ic ectoplasm, not on the sensitized surfaces of photographic plates, but in the vast insensitive cranial spaces.

We have much talk about field spray; we have volumes written on leakage flux; we

one or two megohms. Why, there is one case I know of, where the manufacturer's "engineer" actually placed a copper car around the coil to shield it while he was making measurements on it! The gods be praised! I always thought that the toroidal coil's chief attribute was that it possessed little, if any, external field. In the words of one who has been mentioned above, "The spray field is nil."

All in all, there is nothing like trying. We try to give credit where credit is due, and where no credit is due we generally say nothing; but there are cases where the attempts become ludicrous. We feel that a bit of space-filler like this supplements the purpose of a cartoon, and helps make the first hundred years more bearable.

A New Loud Speaker Diaphragm

By G. S. BENNETT

Many of the faults of radio reproduction, which have been for years blamed to the composition of the loud speaker, or its design, were really inherent in the rigidity of the little diaphragm which converts electricity into sound. A scientist whose specialty has been musical instruments, has effected a considerable improvement by the use of a new type of diaphragm which is freer to vibrate than those in use hitherto.

THERE is one problem with which designers of loud speakers have been confronted, ever since the thought of loud speakers was first conceived, and that is the correct design of the diaphragm. A great deal of the troubles of distortion have been blamed on the shape of the horn and the material of which it is constructed, when in reality the diaphragm itself is to blame.

Back in the early days of the radio era, say about 1920, loud speakers were designed with two shapes of horns: *i.e.*, straight and curved. These speakers, which employed a diaphragm of metal, gave anything but a faithful reproduction of the music that was transmitted, the music being harsh, "tin-panny" and generally badly distorted. Then came a time of experimentation with shapes of the horn and the results were many, weird and wonderful. There were horns with half a dozen twists and turns, the idea being to get a maximum length of horn in a small space. Then loud speakers were put on the market, which retreated from the twist-and-turn idea to that of reflected sound waves; and there were many

had perfected a new type of diaphragm for use with these instruments. He found that with the all-metal diaphragm, which had been in use for such a long time, there were

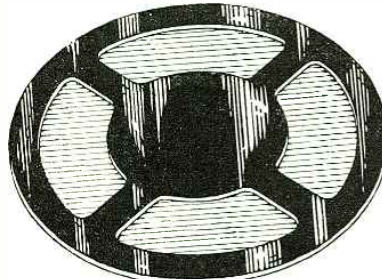

Fig. 1. A new compound diaphragm, which covers the whole gamut with less distortion than metallic ones. The center and rim are soft iron; the lighter parchment shows through the openings.

unequal stresses and strains, which detracted from good faithful reproduction in the loud speaker. After a great deal of experiment-

in somewhat the manner that the back of a violin has a center of thickness. On the proper placing of this center of metallic thickness in the diaphragm depends the tone reproduction vibrations of a loud speaker; and so in this new loud speaker the greatest mass of metal is in the center of the diaphragm, thus allowing the center to vibrate at maximum amplitude.

A diaphragm composed solely of parchment would, of course, combine great flexibility with a freedom from overtones much greater than that of an iron diaphragm, which is more resonant from its nature. Parchment, however, is non-magnetic; and a metallic element is therefore necessary to receive the electric audio-frequency impulses and transform them into sound.

The combination, therefore, of an interrupted metal diaphragm with a continuous parchment disk, cemented together and moving in unison, brings together the distinctly-advantageous features of both. When clamped between the rings (shown in the assembly of parts in Fig. 2), the combination diaphragm is free to respond to the signals as they come from the receiver.

The resultant output of the loud speaker using this diaphragm is said to be remarkably free from all distortion and to reproduce the lower notes of the scale faithfully. Many of the loud speakers that have preceded the present day have been woefully lacking in this last mentioned respect; and it is a well-known fact that it is exceedingly unpleasant to hear music in which there are no bass notes. Further, the full undistorted swing from low to high notes produces the rich natural depth of tone so much desired, assuring a new conception of naturalness in reproduction that has been long sought, but until now hardly believed possible.

Under actual tests in RADIO NEWS LABORATORIES it developed that when used in a telephone receiver, this diaphragm makes for greatest sensitivity. This was to be expected because it takes very much less energy to flex this diaphragm than the ordinary one.

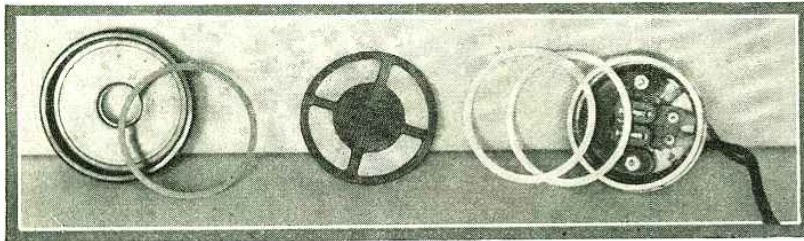

Fig. 2. This illustration shows the complete loud speaker unit disassembled. The metal-and-parchment diaphragm is suspended by means of several rings of fairly porous material, which allows maximum freedom of movement and further reduces any tendency toward resonant vibration. Photo courtesy of Tower Manufacturing Corp.

types of this kind. Finally the cone type of loud speaker was introduced to the long suffering radio public, and that was hailed as the ultimate and all the other superlatives.

However, many loud speakers that have been put on the market, have some more or less serious drawback. Some chattered badly when they were connected to a receiver having an output that was greater than usual; others distorted on no provocation at all; some were excellent reproducers of the human voice and absolutely worthless when it came to music. However, after all these various ideas had been tried, attention was once more turned to the diaphragm.

A HINT FROM STRADIVARIUS

About a year ago Dr. Herman Fisher startled the Paris Conservatory of Music and the entire musical world by producing violins, which not only rivaled the famous Stradivarius instruments in tone reproduction, but actually exceeded them. Dr. Fisher solved beyond any doubt the age-old secrets of the old violin craftsmen and brought to light the fact that the greatest thickness of wood in a Stradivarius is not in the geometrical center of the instrument, but directly under the foot of the sounding post rests.

On Dr. Fisher's arrival in America his attention was directed to the many problems that had yet to be solved in connection with the loud speaker, and a few months later he

ing, he found that the combination which gave consistent results was one of metal and a certain kind of parchment paper (See Fig. 1.) This composite diaphragm is therefore thicker in some portions than in others,

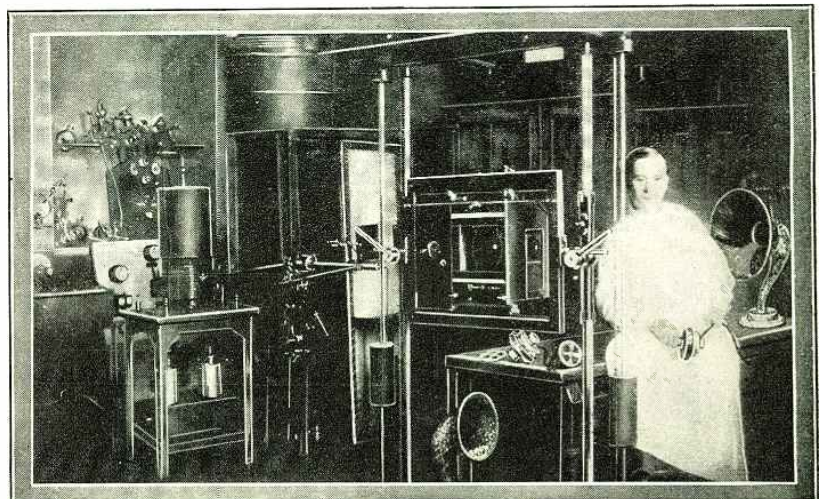

Dr. Herman Fisher, the eminent Russian scientist, in the laboratory where he developed the remarkable new diaphragm shown in the two illustrations above. Dr. Fisher has designed, as well, the finest of modern violins.

Thirty Years In the Dark Room

The Experiments of D. McFarlan Moore

The fifth installment of a biography written by A. K. Laing, of RADIO NEWS, continuing Moore's experiences to the point when his ideal, artificial daylight, was achieved.

MOST men measure the pathway to success by a record of their movements from one position to another, each representing some advance over the former one. D. McFarlan Moore has a different standard. The history of his achievements is divided into the periods of time which he spent in the succession of "dark rooms," in which most of the working hours of his life have been passed.

In his devotion to his great idea—providing the world with a more efficient form of illu-

THE FIRST SNAP-CONNECTOR
 Moore wanted some form of quickly-detachable connector. In the middle nineties elastic sleeve bands were unknown, and their forerunner consisted of a pair of clips with spring jaws, fastened together by a piece of cord or wire. Moore removed his sleeve shortener from his arm and used it for a snap-connector in his laboratory work. He showed his idea to others, and soon the spring-clip connector came into common use in all laboratories. Thus the present battery

newspaper all articles and news relative to this ideal, and now has on hand a file of many thousands of these.

Although Moore's ideal of service to mankind is his main memory of the early dark-room days, they are also connected with reminiscences of much overwork. At one



Fig. 2. (Right) The high-frequency generator which supplanted vacuum break vibrators, as a means of energizing the successful commercial installations of Moore tubes. It is the forerunner of the high-frequency alternators used in trans-Oceanic radio communication.

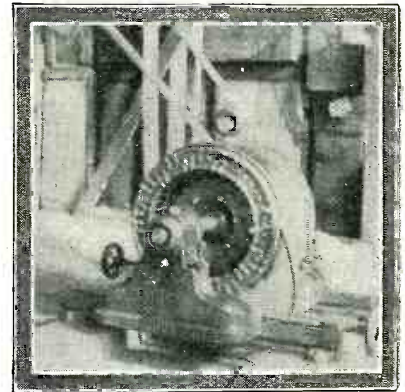

Fig. 3. (Left) The arrangement of Moore Light tubes used in an interior decoration exhibit at the Mechanics' fair in Boston. Note the manner in which the tubes themselves are made a part of the decoration.

time his doctor gave him only a few more months to live. It was at this period, however, that the young inventor married; and his physical rejuvenation in the years that followed must be laid largely to the care and practical good sense of his wife.

mination—he sentenced himself to voluntary imprisonment during the day as well as the night, in rooms completely screened from the rays of the sun. This, after all, was the best condition, the best stimulus, under which to produce artificial daylight.

It will be remembered that the light from his first experimental lamp was too faint to be seen at all in daylight. He had to demonstrate it in the vault of the Edison company, and that room he refers to as his first "dark room." His second was the photometer room of an abandoned electric lamp factory, in Harrison, N. J., whose exterior is shown in one of the accompanying illustrations. It was here that he made one of the minor inventions which has proved one of the greatest helps ever devised for laboratory workers all over the world.

clips and other similar connectors are the outgrowth of the sleeve fasteners in vogue in 1895.

At this early period in his career Moore was fired by a desire to aid in every way possible the cause of world peace and the political and social welfare of mankind. He began a life-long habit of clipping from each day's

PREDICTION OF RADIO TELEPHONY

In these early years Moore had already developed the power of prophecy which has characterized all of his ideals and all of his work. Some of his predictions and the manner in which they came true, were set down in the last installment of this biography. Another was his statement, made in 1896 be-

Fig. 5. (Right) Mr. Weidmann, the millionaire silk manufacturer, standing under an installation of color matching tubes.

Fig. 6. (Below) The first electrical script sign.



fore the work of Marconi, deForest, or Fleming had become known, which reads, in part: "Yes, with a vacuum tube no larger than a watch, and without wires, I will yet be able to talk to a man in China and see him face to face." Although his prophecy has not reached its full justification in practice, no one intimately connected with the radio industry of today would be bold enough to deny that it may shortly come about, just as he predicted. Already amateurs employing small five-watt transmitting tubes have communicated to more remote points than China; and television, or the telorama as Moore chooses to call it, is the sure development of tomorrow.

One day when Moore entered his laboratory he noticed that his lamp flashed on suddenly, and for no apparent reason. When he left the room it flashed off again. Investigation showed that it was due to "body capacity," a phenomenon familiar to all radio fans of today; and showed further that his tube was dependent to some extent upon tuning, identical with that now practised in radio. The slight capacity of his body had changed the frequency of the tuned circuit, which supplied power to the lamp, and caused the latter to light. This happened at least ten years before the problems of tuning were fully understood in wireless telegraphy.

BEGINNINGS OF "WIRELESS"

Late in the nineties the world was suddenly aroused by the investigations of Mar-

Fig. 7. The exterior of 321 Sussex Street, Harrison, N. J., where a dark room was located in which Moore spent the years of preparation for his great success.

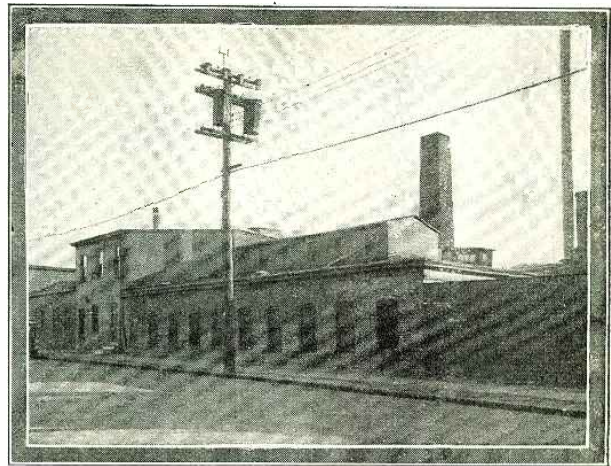

coni, and began to study the neglected data of the researches of Hertz. No inventor could resist the lure of this new field of endeavor; and Moore, like the rest, conducted investigations and drew up many patent specifications which he still has on file. These, however, were looked upon by his financial backers as impractical side issues, which would divert the inventor's time from the more immediately pressing problem of

"artificial daylight." For this reason they were never filed. Moore admits that they would have been of little financial use in any event, for there was no market for them. They included, however, specifications for tuned circuits, vacuum tubes as transmitters and receivers, perforated discs for sending intermittent impulses, selenium-cell recording devices, thermopiles, and many other features which later were incorporated into the field of radio.

Due to Moore's preoccupation with the field of light he often played the part of scientific philanthropist to workers in other fields of scientific investigation. He gave hints on high-frequency alternators, tuned circuits, arcs, and other features which were developed by other inventors.

For example, when W. J. Clark attempted to demonstrate Marconi's experiments at the Madison Square Garden Electrical show, it was Moore's vacuum-break, in his light exhibit, that supplied the energy to actuate the coherer, and not the nearby open-air spark which proved less reliable. This was a secret withheld both from the general public and from the promoters of the show. It was not, however, essentially a deceit, as the demonstration was pure wireless telegraphy; and Moore's vacuum-break and tubes which supplied the energy were located much further from the receiving apparatus than the actual spark transmitter supplied by Clark.

In 1901, when Marconi succeeded in sending the letter S across the Atlantic, and shortly afterwards appeared in New York City, Moore was one of the first to congratulate him on his achievement; and he evinced so much interest in, and knowledge of, the subject that the Marconi officials came to him with plans of a coalition between the two inventors for work on opposite sides of the Atlantic. But Moore's obligations to his financial backers, and his interest and faith in

(Continued on Page 1505)

GASEOUS CONDUCTOR TYPE OF MOORE LAMPS ~

1		20	
2		21	
3		22	
4		23	
5		24	
6		25	
7		26	
8		27	
9		28	
10		29	
11		30	PORTABLE WINDOWS WITH MAGNETIC FEED. TYPE D.
12		31	PORTABLE TRANSFORMER AND LAMP FOR NEON.
13		32	PORTABLE ELECTRO-CHEMICAL FEED. CO ₂ LAMP TYPE E.
14		33	LOW VOLTAGE CORONA LAMP. TWIN HELICES. NEGATIVE GLOW. TYPE F ₁
15		34	LOW VOLTAGE NEON TUNGSTEN ARC WITH HELICAL ELECTRODES. TYPE G
16		35	LOW VOLTAGE POSITIVE COLUMN WITH IONIZING GAPS. TYPE H.
17		36	LOW VOLTAGE "TUNED" LAMP
18		37	LOW VOLTAGE CORONA LAMP. STRAIGHT ELECTRODES. TYPE F ₂
19		38	LOW VOLTAGE CORONA LAMP. CAVITY ELECTRODES. TYPE F ₃ . TELORAMA.

Fig. 1 (Left) This chart shows the important stages in the development of the final commercial Moore tubes, shown at 29, and lists the further refinements of recent years as well.

Fig. 4 (Right) The magnetic mechanism of the "breathing tube." Its operation is described in detail in the accompanying article. By means of this ingenious device, minute quantities of air were admitted at intervals of one minute, to keep the pressure constant.

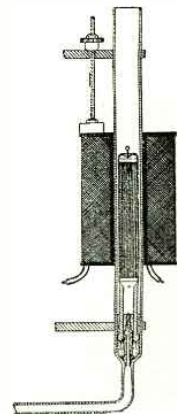

The Passing of "Canned Music"

By MAJOR J. S. HATCHER

Ever since the advent of radio, the reproduction of music has been the subject of a great deal of research. Major Hatcher, for many months, has been devoting his time to research work in audio frequency transformers and loud speaker horns, and tells of his findings in a most interesting manner.

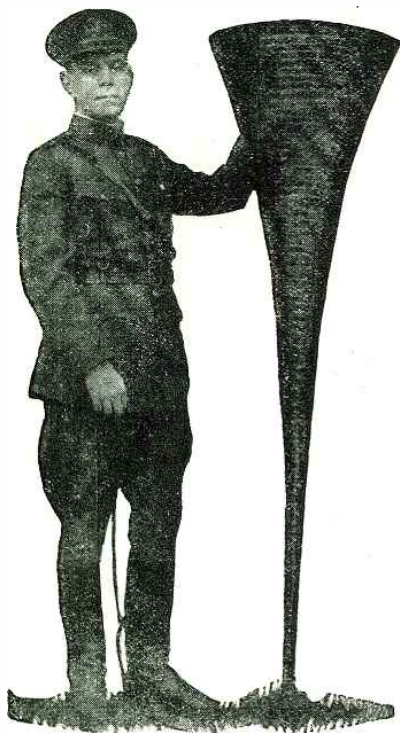

The author with a 6-foot exponential horn used for an experimental radio loud speaker.

DURING the past year there was presented to the public what amounts to a veritable revolution in the field of both the phonograph and the radio. At this writing it is possible to obtain either a radio set or a phonograph which will reproduce music with a fidelity and mellowness of tone destined to render obsolete the term of "canned music"—which has been applied with a considerable amount of justice to the radio and phonograph music of the past.

The change is principally due to the fact that the low, or bass, notes which have hitherto been absent from music of this nature, are reproduced fully by these new instruments. Doubtless the reader will recollect instances of having listened to pipe organ music, in which some of the notes were merely a deep rumble. In fact sometimes these notes are so low that they are practically *felt* more than they are heard.

Who can remember having heard such a note from a radio receiver or phonograph, and who can remember having heard the deepest bass of a piano on either one of these sound reproducers? It is now possible to hear the deepest organ notes, and the lowest bass of the piano perfectly reproduced.

The difference between one of these new instruments and the old type is simply indescribable, and must be heard to be appreciated. The best way to realize the difference is to switch the music from one of the new instruments to an old one. Tune in an orchestra program on one of the new radio instruments, and the hearer is enchanted with a tremendous volume of soft and mellow sound, containing all the full rounded tones of the bass as a background for the higher notes. Switch to one of the old instruments and the music changes suddenly to a strident volume of shrill metallic noise. The listener then realizes for the first time what has always been the matter with the phonograph music and radio music of the past. It is "canned music." Some metallic mockery of each note remains, but all the living, mellow tones have been filtered out.

DEVELOPMENT OF REPRODUCTION

Radio is somewhat similar to the phonograph in its general development. It was first announced to the public as a scientific curiosity, capable of sending signals without wires for a short distance. As it developed to a practical agent of communication, it was used for telegraphic code and the developments were all directed towards clarity in detecting dots and dashes. After the vacuum tube amplifier was invented, it was found necessary to have some device to couple each stage of amplification with the next one, and transformers were used for this purpose.

A transformer is essentially an inductance device, and therefore it depends on the frequency of the electrical impulses for its efficiency. In addition to its inductance, every transformer has capacity between the adjacent coils of its winding. This capacity, taken in conjunction with its inductance, will form a tuned circuit which will respond more strongly to some particular frequency to which it is tuned.

It was found by experience that the greatest audibility of code message was obtained when the transformers were made to respond most strongly at about one thousand cycles per second, and accordingly when broadcast speech and music first made its appearance, the transformers on the market were of the type giving a strong response, or peak of audibility, at this point. (See Fig. 1).

When radio first became a popular form

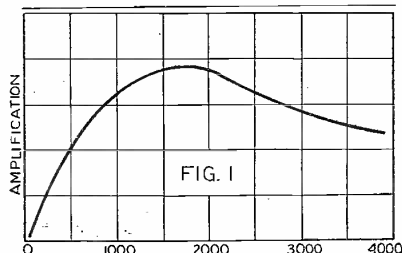

FIG. 1
TRANS. COUPLED AMPLIFIER WITH POORLY DESIGNED TRANS.

The above curve shows why some transformers produce distorted music in the loud speaker.

of entertainment, reproduced speech had a high-pitched nasal sound, and the music was more metallic than ever. Some makers of loud speakers attacked this defect by making mica diaphragms, or metallic diaphragms which were corrugated in order to break up the vibrations.

Some advertised a wooden horn to introduce a mellow tone. One maker advocated a copper horn, and covered the inside with a rough finish similar to the alcohol-proof finish used on microscopes and optical instruments; the theory being that this roughness would prevent undesirable reflections which would distort the tones.

However, at the beginning of the radio craze, tone quality was really a very secondary consideration, as most of the radio experimenters of several years ago were striving for distance as the most desirable qualification of the radio receiver.

IMPROVEMENTS IN TRANSFORMERS

Lately new audio frequency transformers have been placed on the market which have

been specially designed to reproduce the lowest audible frequencies. Several of these give very satisfactory reproductions of tones below one hundred cycles a second. (See Fig. 2.)

Some radio makers have sought to attain tone quality by using these improved transformers. Others have discarded transformers entirely, and are using resistance-coupled amplification, which has the advantage of giving a uniform response over almost the entire range of audible frequencies, but which has the disadvantage of giving less amplification per tube.

In spite of the fact that these improved types of amplifier were given a great deal of publicity in the radio magazines, and were tried by thousands of amateur builders, the improvement in tone quality was not as marked as had been hoped, and many people were disappointed by the improved amplifiers. The reason for this was that these were in most instances used with loud speakers which were not capable of reproducing the low notes, after they had been amplified by the radio set.

ELIMINATING THE HORN

However, the existence of amplifiers which made it possible to receive the lower audible frequencies, was an incentive to the development of improved types of loud speaker. Before these new amplifiers were produced there was really no point in getting a loud speaker which would produce the deepest bass notes, because these notes were not present in the radio set, and therefore all loud speakers sounded very much alike.

One of the earliest improved loud speakers is the now well known paper disc type. A sheet of brass has a given frequency at which it will vibrate if struck (that is, it has a given note of its own) but a sheet of paper has no such note or frequency to which it responds. The cone loud speakers consist of a sheet of paper or parchment to which a metallic pin is attached in the center and this to the armature of an electromagnet which is actuated by the electrical impulses from the radio receiver. The metallic pin moves in unison with the impulses which correspond to the sounds that it is desired to receive, and as the paper is fastened to the pin, it also moves at the same frequency and its large, flat surface being in contact with the air, sets up corresponding air waves which the ear receives as sound.

STUDYING THE HORN

The problem was also attacked in another direction, that of investigating the horn to

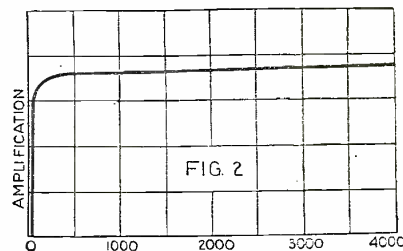
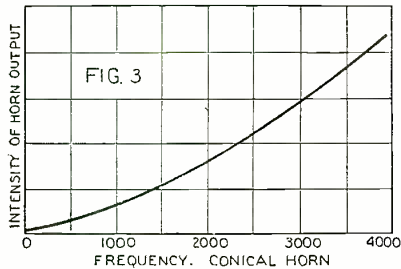

FIG. 2
RESISTANCE COUPLED AMPLIFIER

With a resistance-coupled amplifier the amplification curve is flat over a wider range of frequencies than that of a transformer-coupled amplifier.

sec if it could be made to transmit the deeper notes. Assuming that sound travels at approximately 1,120 feet per second, the lowest audible notes, which are around 30 cycles per second, have a wave-length of approximately 38 feet; whereas notes towards the higher end of the audibility range, say around 5,000 cycles per second, would have a wave-length of only about 3 inches. It will be readily understood that a wave 3 inches long will have time to undergo numerous reflections and re-enforcements in a horn of ordinary length, whereas a wave 38 feet long will not.

It was found that with our ordinary cone-shaped horn, the higher the frequency of the sound, the more strongly will it be transmit-



Compare this curve with Fig. 4 to see the difference in efficiency between the two types of horns.

ted. The low notes are transmitted so weakly that they are practically not heard at all; and this in itself is sufficient to account for the peculiar metallic quality of the radio and phonograph music of the past. This can be better illustrated by reference to the piano keyboard, with the statement that on the average radio or phonograph practically the whole left-hand third of the keyboard, comprising all of the deeper tones, is either omitted entirely, or very seriously slighted.

COMPLEXITIES OF SOUND

Practically no musical instrument gives pure tones in the physical sense, that is, none of the notes are composed entirely of vibrations of one frequency. Take for example, middle "C." This is supposed to represent a frequency of 256 vibrations per second. If this were strictly a pure tone, it would sound the same whether given off by a piano, violin, flute or harp; but as a matter of fact its sound varies greatly, depending upon what instrument produces it.

The reason is that instead of being a pure tone, it is accompanied by many harmonics and over-tones, the number, pitch and intensity of which are determined by the character of the instrument producing the original sound. The harmonics and over-tones determine the character of the various instruments, and if they are slighted or left out, the music sounds unnatural.

Psychological studies have indicated that it is very tiring to listen to music in which the lower tones are omitted. Instead of being reposeful, music of this character is actually a nervous irritant; though as is often the case with eye-strain and other such sources of irritation, the victim may not be conscious of it at the time.

The average radio loud speaker will not reproduce notes below about 300 cycles per second. The different investigators in this field have tried various-shaped horns, with a view to overcoming this difficulty. Among the curves tried are the parabola, hyperbola, etc.

SCIENCE IN HORN DESIGN

However, the most successful horn from the theoretical standpoint, is built on what is called the exponential curve. In the cone, as we leave the small end, the horn gradually expands. If, for example, the cone has an opening at the small end 1 inch wide and expands to double its width for the first foot of length, the width at that point will

then be 2 inches. At the end of the second foot the width will be 3 inches; at the third it will be 4 inches, and so on, getting an inch wider for every foot of added length.

On the other hand, an exponential horn having an original opening of 1 inch, and an expansion double this amount, or 2 inches at the end of the first foot, would again double, or have 4 inches at the end of the second foot, 8 inches at the end of the third foot, and so on; for each unit of length adding a given percentage, not of the original opening, but of the opening at the last measurement.

This exponential rate is sometimes called the "law of organic growth," as it is the rate at which plants, trees and other organic materials increase in size. If, for example, a tree increases ten per cent. in size every year, the amount added each year will be ten per cent. of the total size the year before.

In any phonograph or radio horn the sound waves generated at high pressure in the small end, are gradually expanded as they travel along the horn until, when they reach the large end, they are released into the room at atmospheric pressures.

By extensive calculations it has been demonstrated that, in order to amplify the different tones equally, there must be the same proportion of expansion for each unit of extension in length. The exponential horn fulfills these conditions, and gives a practically uniform amplification of all frequencies within the range for which it is designed.

LIMIT OF RANGE

It is found, however, that there is a certain point called the "cut-off," and the exponential horn will not reproduce frequencies below this point. The "cut-off" point, or lowest frequency at which the horn will reproduce, is dependent on the rate of expansion. The wider the conical angle, or the greater the rate of expansion, the higher will be the "cut-off" point. The horn illustrated will bring in notes as low as 29 cycles, and the result is that the music which it gives off creates the impression that a real orchestra,

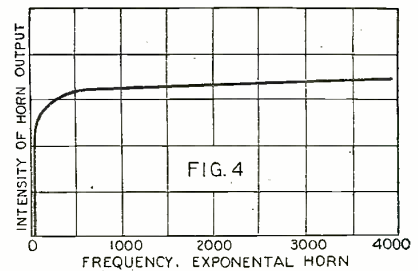

This curve shows that an Exponential horn gives maximum intensity over the greatest frequency range.

been put into the sound horn of the phonograph, and it is the most perfect loud speaker that can be obtained." A year ago an acoustic engineer said in my presence, when hearing this same remark: "I have to laugh every time I hear that. As a matter of fact the sound box of the phonograph is so poorly designed that its defects are apparent at a casual glance. Just the shape of the tone arm makes me shudder every time I look at it."

In time this newly acquired knowledge reached the phonograph makers in various ways. For example, in testing the different forms of horn it was not always possible to use radio music, as it was not always available. An easy substitute was to play a phonograph record electrically: that is, fit the needle to the armature of an electromagnet, so the motions of the needle would generate varying electrical impulses. These impulses were then fed through an amplifier and played on an experimental horn. It was soon found that the records themselves were defective. The low notes were not recorded on them at all.

NEW PHONOGRAPH METHODS

New methods of making the records by an electrical process were developed, which faithfully placed on the disc every note that actually existed in the air at the time the record was being made. The possibili-

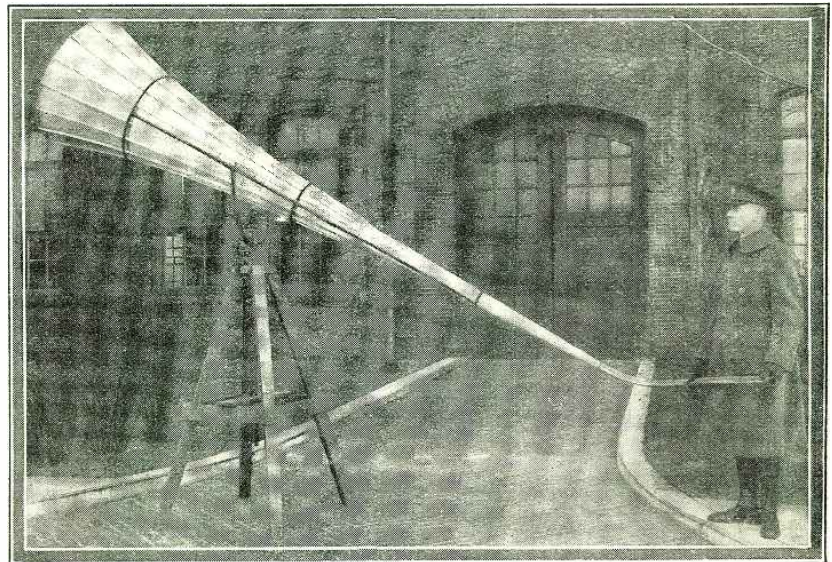

Capt. Hiram B. Ely, head of the Government Sound Laboratory at the Frankford Arsenal, Philadelphia, with experimental 12-foot Exponential horn, designed by him for use in sound investigation.

ties of the exponential horn being known, in every instance where a visitor has heard this outfit, the result has been an instant desire to obtain something similar.

During the early days of radio it was common to hear phonograph attachments recommended instead of the conventional loud speakers; because, as was frequently remarked, "Years of scientific research have

ties of the exponential horn being known, the next step was to adapt it to the phonograph by making a larger cabinet and building into it a horn which curved on itself, so as to get the greatest possible length inside the cabinet, and yet preserve the exponential expansion of area.

Two prominent phonograph companies (Continued on page 1468)

The Experimenter's Own T.R.F. Set

By A. P. PECK, Assoc. I.R.E.*

This receiver was developed only after several months' experimenting and, though but four tubes are used, it will be found to be the equal of sets using a greater number.

RECENTLY a well-known manufacturer of tuned radio frequency receivers placed on the market a very good and inexpensive kit designed to be used in constructing five-tube sets, employing two stages of tuned radio frequency amplification, a detector and two stages of audio frequency amplification. The kit, as sold, consists of three standard well-made variable condensers and three inductances, each containing both primaries and secondaries. In looking over one of these kits, the idea came to the writer's mind that it could, undoubtedly be used in some other way than in making up a standard type of tuned radio frequency receiver. Therefore, one of the kits was obtained and laid out with the usual tube sockets and other accessories in bread-board fashion; and experimental work was started to determine just what circuit would be best for use with these instruments.

After much experimental work, a hook-up incorporating one stage of tuned radio frequency amplification, a detector and two stages of audio was evolved. Two of the units included in the manufacturer's kit were connected in the detector circuit in a rather peculiar manner; and, by virtue of this fact, some unusual and interesting results were obtained.

ELIMINATING INTERFERENCE

The main and most noticeable feature of the finished receiver which is illustrated here is the fact that the unit connected in the plate circuit of the detector tube appears to act as a tuned filter circuit. With this set, the writer was able to tune out the experimental station of WJZ, 2XAR, when operating the set on an aerial 100 feet long and located at a point only approximately four miles distant from the above mentioned super-power station. Remember that this was done using only one stage of tuned radio frequency amplification, but still the selectivity was all that could possibly be desired.

With the connections that were employed, it was found possible to make the set oscillate or regenerate under certain conditions; but when stability was achieved with no os-

cillation, the set was found to act well and operate quite smoothly.

As will be noted in the diagram and in the various illustrations, one of the inductance and condenser units is used in the antenna circuit. An untuned primary is connected between the antenna and ground, and the secondary tunes the grid circuit of the first R.F. tube. Another of the units couples the R.F. tube to the detector; and in the grid return of the detector circuit, the primary of the third unit is connected. The secondary with its tuning condenser is in series with the plate circuit; and in order to make the set operate correctly, it was found necessary to connect a small condenser in series with the inductance and the tuning condenser as shown here. This fixed instrument should have a capacity of .00025 μ f..

IT is against the policy of RADIO NEWS to publish the names of manufacturers or of makes of instruments in connection with the apparatus described in these pages, but this information will be gladly given privately. If you are interested in any special instruments described here, address a letter to the I WANT TO KNOW DEPARTMENT, enclosing stamped return envelope. The names and addresses of the manufacturers will be given free of charge. —EDITOR.

be found necessary to reverse the connections to the primary of the third unit, or to the secondary or both. In any event, try the different combinations.

CONTROL SHOULD BE HANDY

In order to stabilize this set so that it

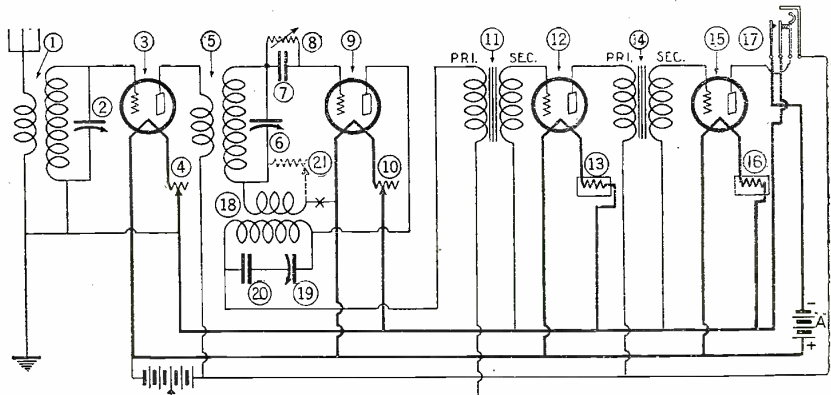

Fig. 1. The schematic circuit diagram of this novel, experimental tuned radio frequency receiver is shown above. Using standard units for tuning, this circuit gives exceptional results when it is properly balanced. The same numbers assigned to the various instruments in the diagram above are also placed on the illustrations on this and the next two pages.

making the effective tuning capacity for this unit in the vicinity of .000125 μ f.

After this set has been hooked up—and it should be done in bread-board fashion first, so that various changes can be made until the desired results are obtained—it may

be easily handled and so that its various effects can be studied, it becomes necessary to insert a resistance in series with the primary of the third unit and the filament circuit. For this work, it is absolutely necessary that a very finely-adjustable resistance be used, variable from 100 to 1,000 ohms. In tuning, it will be found that the adjustment of this resistor is most critical and it may be some time after you put the set in operation before you find the exact adjustment for it. Therefore, it should be mounted conveniently so that the control knob can be reached and so that it is constantly at hand. Two connections were tried for this control resistance; one of them is shown in dotted lines in Fig. 1, whereas the other connection is indicated by X. The first shows the resistance connected across the primary of the third, or regeneration, unit; while X shows where it is to be connected in series with the primary and filament circuit. Both these positions should be tried until the best one is ascertained.

When using this set, it will be found necessary to change the tubes about until the best detector is found. Then, the plate voltage of this latter tube should be critically varied. It will be found that a difference of only a few volts in the potential applied to this tube will make a very great difference in the results obtained.

The grid leak used in connection with the detector tube of this circuit is also a very critical part. It might be continuously variable throughout its range; and when the set

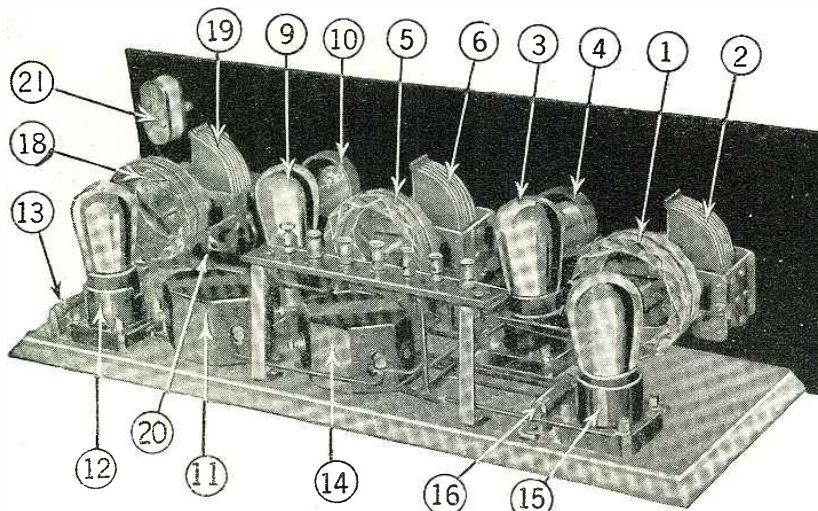
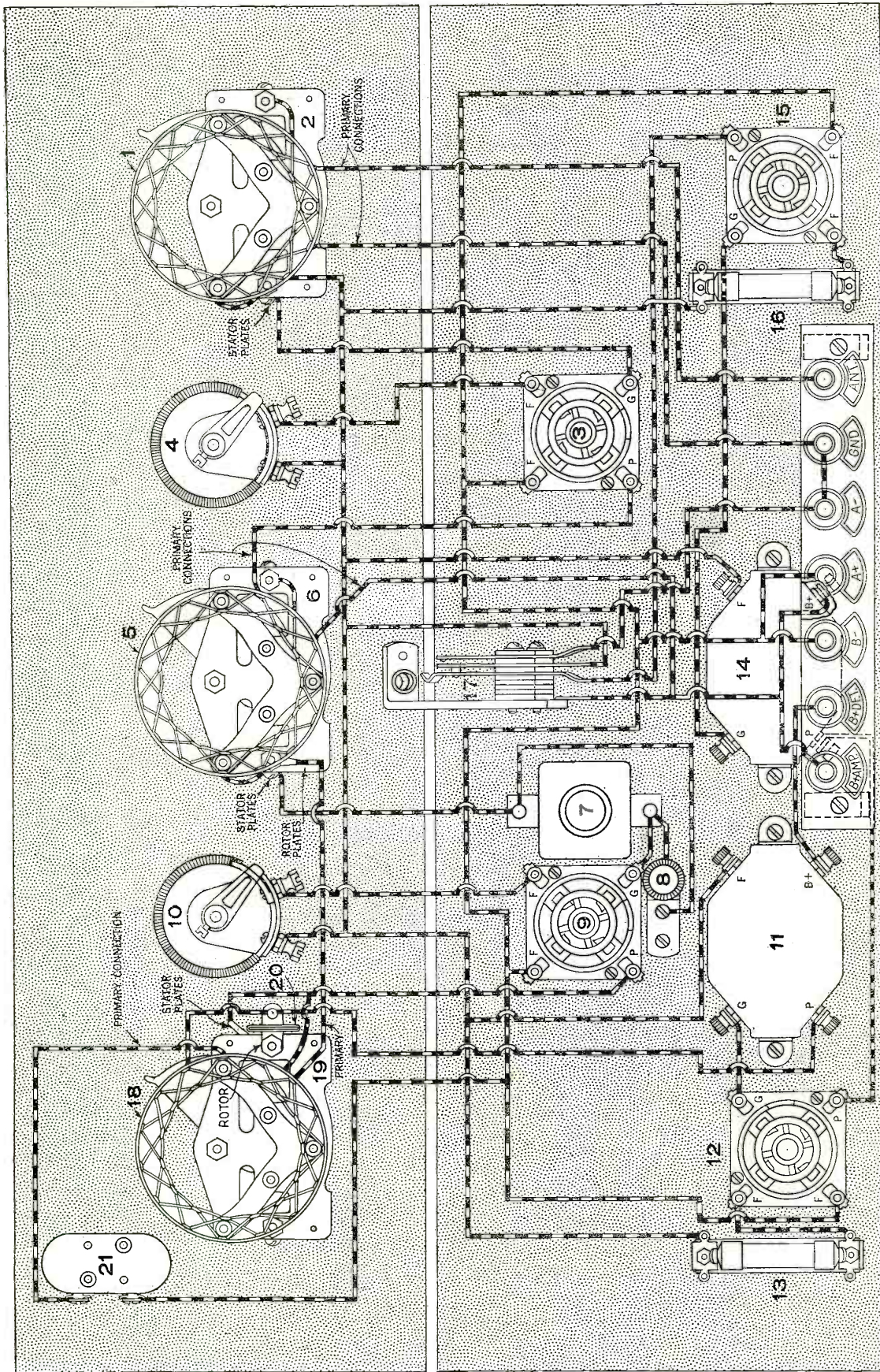

Fig. 2. In the photograph reproduced above, 1, 5 and 18 indicate standard tuned radio frequency transformers; 2, 5 and 19 are the variable condensers that tune the R. F. transformers; 3 is the R. F. amplifying tube; 4 is the amplifier rheostat; 9 is the detector tube; 10 is the detector rheostat; and 11 is the first audio frequency amplifying transformer.

Photo by courtesy of Chas. Freshman Co., Inc.



The Schematic Layout of the Experimenter's Own T.R.F. Receiver.—1, R.F. Coils (Primary and Secondary); 2, Variable Condenser for tuning same; 3, First R.F. Tube; 4, Rheostat for Controlling No. 3; 5, Detector Tuning Coil (Primary and Secondary); 6, Variable Condenser for tuning No. 5; 7, Grid Leak; 8, Grid Condenser; 9, Detector Tube; 10, Rheostat for controlling No. 9; 11, First A.F. Transformer; 12, First A.F. Tube; 13, Amperites; 14, Second A.F. Transformer; 15, Second A.F. Tube; 16, Amperite; 17, Double-Circuit Jack; 18, Feed-Back Coil (Primary and Secondary); 19, Condenser for tuning No. 18; 20, Small Fixed Condenser, in series with No. 19; 21, Shunt Resistance for controlling Feed-Back.

A Loss of \$5,560.00

2,224 lines of advertising offered for publication in this issue of RADIO NEWS were rejected and publication refused because of false or misleading statements, exaggerated claims, or because the article itself was without merit, in our opinion.

This represents more than five pages of advertising space, and a cash value of \$5,560.00.

RADIO NEWS will continue its established policy of protecting its readers as far as possible from advertisers who seek to mislead through false or exaggerated claims, and who try to sell radio sets, parts, or accessories, which do not attain the standard of quality set by RADIO NEWS Laboratories.

is in operation, a very minute change in this resistor will often be found conducive of much better results. This instrument is indicated by 8 in the circuit given and its shunt grid condenser by 7. The instruments employed are as follows: (See diagram.)

- 1st T.R.F. unit,
- 2nd T.R.F. unit,
- 3rd T.R.F. unit,
- .00025 μ f. fixed condenser,
- 100- to 1,000-ohm variable resistance,
- Amperite or rheostat,
- Carbon pile rheostat,
- Amperite or rheostat,
- Amperite or rheostat,
- Variable grid leak,
- .00025 μ f. fixed condenser,
- .001 μ f. by-pass condenser,
- First audio transformer,
- Second audio transformer,
- Single-circuit filament control jack.
- R.F. tube,
- Detector tube,
- First A.F. tube,
- Second A.F. tube.

AN INTERESTING APPARATUS

The type of receiver shown here is purely for the experimenter inasmuch as it will act in almost as many different ways as it is possible for a radio set to operate. With it you can get the effect of regeneration, and by different adjustments the unit 18-19 can be made to act as a tuned filter. This feature is most valuable for increasing selectivity.

Furthermore, in experimental work the writer is quite sure that the set often operated as a super-regenerator inasmuch as it gave all the symptoms of such a type of set. The well-known "variation frequency" could

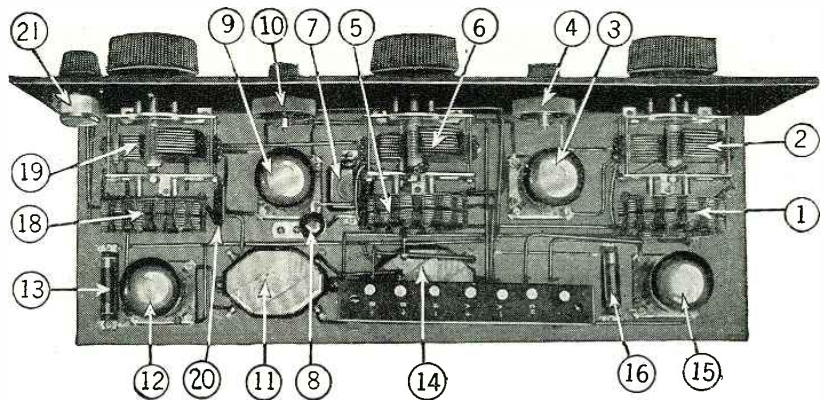

Fig. 3. 7 indicates the grid condenser, of .00025- μ f. capacity; 8 is a standard type of variable grid leak; 12 is the first audio frequency amplifier tube; 13 is the amperite controlling the filament of tube 12; 14 is the second audio frequency amplifying transformer; 15 is the second audio frequency amplifier tube; and 16 is its filament control resistance.

Photos courtesy Chas. Freshman Co., Inc.

often be heard and was controllable. Furthermore, when operating in this way, the set worked without an antenna and only the ground connection was necessary. It could be connected to either the antenna or ground binding posts of the receiver with equal results. Taken as a whole, this set is one of the most interesting that the writer has ever developed. Hour after hour can be

tained. The set is one that seems to offer great possibilities, particularly from an experimental viewpoint, and under certain operating conditions it has a kick that can be likened only to that of the proverbial army mule.

OPERATING INSTRUCTIONS

The following method of putting this set into operation seems to give the most satisfactory results, at least with the particular set that the writer built, and at any rate, it should be followed until you are familiar with the circuit. First, all the tube filaments are lighted by inserting the plug in the filament control jack, and the resistance of the grid leak, is increased until an audio frequency note is heard. Then decrease the resistance of this unit until the noise stops. This should be done with the resistance 21 at minimum setting. Then with the variable condenser 19 at its minimum capacity, turn the dials controlling the other two condensers simultaneously until some local station is heard. When it has been brought in at maximum volume with these two controls, see what effect the third tuning condenser has upon signal strength. Manipulate this together with the variable resistance 21 until the greatest possible volume is obtained. Then try small changes of the rheostat 4 as well as that one marked 10, providing a rheostat is used here instead of a fixed resistor. By using various combinations of settings of the tuning condenser 19 and the variable resistor 21, some most interesting results can be obtained.

ADJUSTMENTS MUST BE WORKED OUT

Do not forget that when operating this particular receiver, it is necessary that the exact adjustment of resistor 21 be found. A rotation of as little as 5° of the knob of this control may mean the difference between a very weak signal that is just audible and a volume of reproduced sound that will fill the entire house. Furthermore, this instrument will have to be slightly changed for differences in wave-length. However, after the operator becomes familiar with the operation of the various parts, he will find that the correct settings for the resistance can practically be learned by heart. On the higher wave-lengths, the resistance will be decreased, and on the short waves, the resistance will be increased. Usually, the variation is only through about one-quarter of a turn of the resistance control knob; and soon you will find that when tuning for the high wave-length stations, you can merely turn the knob to the right about one-quarter of a turn from the short wave position. Then when tuning below 320 meters, you only have to turn the knob in the opposite direction about the same distance to achieve maximum signal strength.

(Continued on page 1504)

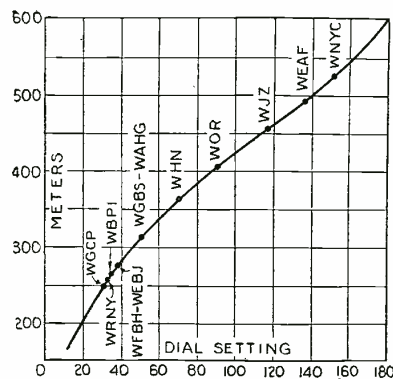

Fig. 5. This chart shows the tuning curve of this tuned radio frequency set, indicating the dial readings for various wave-lengths.

spent observing its operation and studying its action; and after you do this, you can evolve your own theory as to how it operates. Frankly, the writer is not yet sure of just what takes place in the receiver; and if any of the readers who built this set care to do so, the writer would appreciate it greatly if they will communicate with him and describe the results that they have ob-

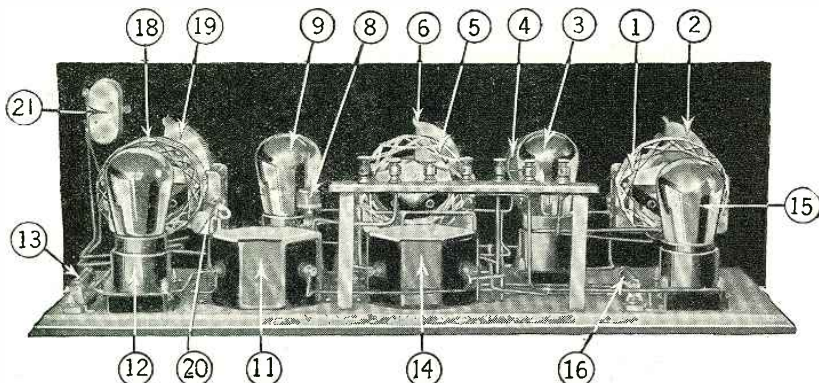

Fig. 4. 20 indicates the .00025- μ f. fixed condenser, which is connected in series with the tuning condenser of one of the tuned radio frequency units, in order to reduce the effective capacity of the circuit; 21 is the 100- to 1,000-ohm variable resistance, used for controlling oscillation in the circuit of the detector tube.

A New Radio Frequency Receiver

By EDWARD SPIEGLER*

In this article Mr. Spiegler tells how to construct a six-tube radio frequency receiving set that will bring in the DX stations with good volume. The reproduction is good, because of the design of the audio frequency amplifier.

THE fact is generally recognized, by radio constructors and experimenters, that a considerable portion of the oscillation trouble encountered in tuned radio frequency receivers is caused by direct magnetic feed-back of energy, from one R.F. stage to the preceding one. The effect is most appreciable in sets employing straight solenoid inductances (as such coils have the most widespread external magnetic fields) and is least noticeable in outfits using transformers of the confined-field variety.

In general, the best results are obtained from tuned R.F. circuits when the magnetic coupling between connected stages is at a minimum. Manufacturers have not been slow to realize this; and have either developed some efficient type of confined-field

the troubles with which a set is already afflicted.

Bearing the above facts in mind, the writer recently constructed a six-tube radio frequency receiver, involving two stage of R.F., detector, and one stage of transformer- and two stages of resistance-coupled A.F., yet operating with a simple two-dial control. For the radio frequency transformers, which, of course, are the most important single instruments, in almost any R.F. set, three coils were used, wound in the shape of a figure 8. They are known as "lemniscate" coils, taking their name from the shape of the mathematical curve, the "lemniscate."

WINDING THE COILS

Each of these coils consists of a 15-turn primary and a 103-turn secondary, both of

IT is against the policy of RADIO NEWS to publish the names of manufacturers or of makes of instruments in connection with the apparatus described in these pages, but this information will be gladly given privately. If you are interested in any special instruments described here, address a letter to the I WANT TO KNOW DEPARTMENT, enclosing stamped return envelope. The names and addresses of the manufacturers will be given free of charge. —EDITOR.

centers of exactly two inches. The wire is simply threaded in and around the posts, bound along the outer and inner edges with thin strips of adhesive plaster, and then slipped off.

The turns of wire are spaced a distance equivalent to about half the diameter of the wire, in order to reduce the inherent capacity of the winding. The smaller this capacity, the more sharply does any inductance tune when a variable condenser is connected across it.

There are produced two distinct magnetic fields of opposed respective poles. If the upper end of the right-hand section of the "hour-glass" form is a North pole, the adjacent left-hand end is a South pole; and as unlike poles attract, the magnetic lines of force flow together and form a strong, complete circuit directly within the axis of the inductances. The net result of the arrangement is such that few lines of force extend beyond the ends and sides of the coils themselves.

PARTS REQUIRED

Three of these "lemniscate" coils have been used in this receiver, and are found to work excellently. The following other parts are required:

- One panel, 7x24 inches,
- One sub-panel, 9x23 inches.
- Two micrometer dials,
- One battery switch.
- One low ratio audio transformer,
- One .00025- μ f. grid condenser and 2-meg-ohm leak,
- Two $\frac{1}{4}$ - and one $\frac{1}{2}$ -ampere ballast resistances,

(Continued on page 1499)

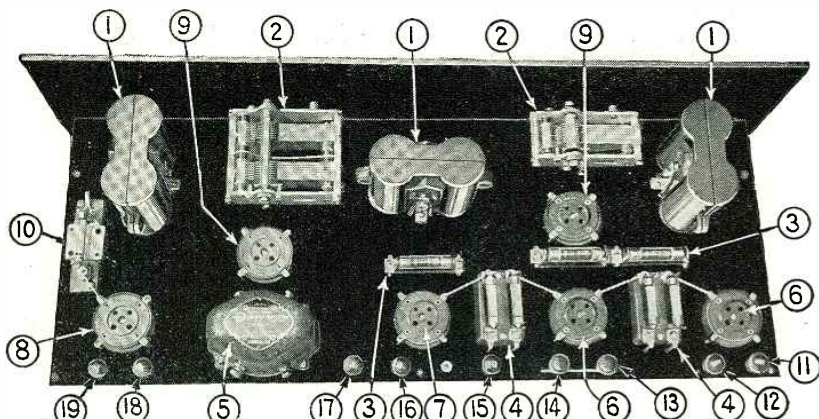

No. 1, R.F. transformers; 2, variable condensers; 3, automatic ballast resistances; 4, resistances for A.F. amplifier; 5, A.F. transformer; 6 and 7, A.F. tube sockets; 8, detector socket; 9, R.F. tube sockets; 10, grid leak and condenser; 11, antenna; 12, ground; 13, —"B"; 14, + "A"; 15, +135v.; 16, +90v.; 17, +22½v.; 18, —"A" and + "C"; and 19, —9v. "C."

Photos by courtesy of General Winding Co.

transformer or adopted some system of inter-stage shielding. From the home constructor's viewpoint, the confined-field unit is more conveniently incorporated into receivers than shielded open coils; for under some conditions the presence of shields may aggravate

No. 26 C.C. enamelled wire, wound in hour-glass shape to form an upright inductance, just three inches high. A simple winding form may be made by screwing two 4-inch pieces of round wood, 1 inch in diameter, to a plain board, with a separation between

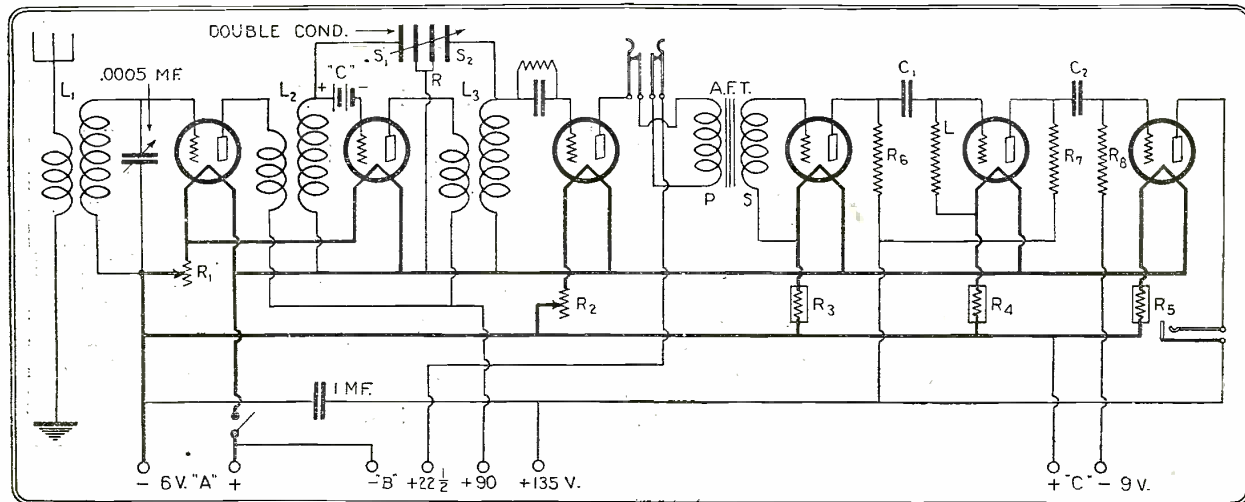

Above is shown the circuit diagram of this six-tube radio frequency receiver. The different values for the parts are given in the accompanying text.

*General Winding Company.

A Balanced Tuned R. F. Receiver

By JOHN M. KIRKLAND

The outstanding feature of this receiver is that oscillations are completely under control at all times. It will be found to be an excellent set for crowded districts as well as a great DX getter for less congested areas.



ONE of the greatest drawbacks of receivers employing one or more stages of tuned radio frequency amplification is the probability that in the middle of a top-hole program they will break into violent oscillation, with or without any apparent cause. There have been cries that rang to the blue heavens for a circuit that has tuned radio frequency amplification, but will not oscillate on any occasion, after it has once been instructed not to.

audio amplifier. However, the detector and radio frequency tubes' filaments are controlled by the usual rheostats, while there is another rheostat in series with the radio frequency tube, which serves as a control for the volume.

In the circuit as shown in the accompanying diagram. In the first stage of the audio frequency amplifier there might be substituted a 6:1 ratio transformer, instead of the 2:1 as indicated. This suggestion is for experimenters, who live at a considerable distance from a broadcast station and

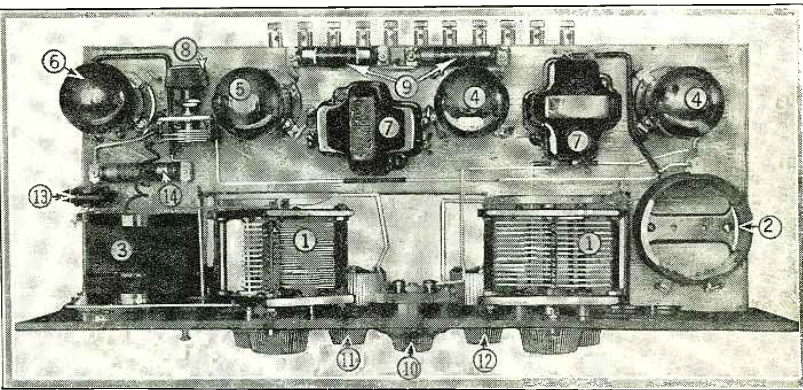

No. 1 indicates the variable condensers; 2, the R.F. transformer; 3, antenna coupler; 4, A.F. amplifier tubes; 5, detector tube; 6, R.F. tube; 7, A.F. transformers; 8, 5-plate condenser; 9, automatic filament controls; 10, high resistance rheostat; 11 and 12, filament rheostats; 13, grid condenser, and 14, grid leak.

IT is against the policy of RADIO NEWS to publish the names of manufacturers or of makes of instruments in connection with the apparatus described in these pages, but this information will be gladly given privately. If you are interested in any special instruments described here, address a letter to the I WANT TO KNOW DEPARTMENT, enclosing stamped return envelope. The names and addresses of the manufacturers will be given free of charge. —EDITOR.

In the receiver shown in the accompanying illustrations a circuit is used that more or less fills the bill in overcoming this disadvantage of tuned radio frequency circuits in general. A multitude of systems have been created for the elimination of oscillations in this type of receiver; all the way

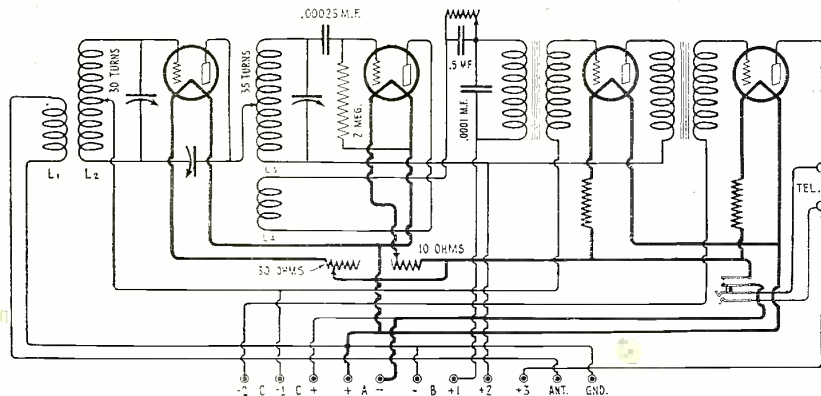

Above is shown the circuit diagram of the four tube receiver. It will be noticed that the terminals marked +1, +2 and +3 are those for plate voltages. The last two may be connected if 90 volts are used on both A.F. tubes.

who desire more than the usual volume from their set. If a tube of the UX-120 type is to be used in the last stage of the amplifier, this change is advisable, as this type of tube has a low amplification factor. If UV-199 tubes are to be used in both stages of the amplifier this change should not be made.

The other change that might be made in the diagram is the introduction of a double-circuit jack in the plate circuit of the first tube of the audio frequency amplifier. This is for fans who live in the vicinity of large cities where there are broadcast stations whose volume would be too great for the house.

CONSTRUCTION

From the front view of the panel and the other illustrations a good idea can be had of the position of the various instruments. The panel, which is 7 x 18 inches, is first drilled for the condensers and the three rheostats.

(Continued on page 1478)

from the old-fashioned potentiometer to the newest-fangled idea in left-handed gadgets; but most of them are fairly difficult to adjust and the tuning is rather complicated. However, in this circuit, there is but one slight adjustment to make for the elimination of the unwelcome oscillations, and that is the variation of the small five-plate condenser (No. 8 in the views.)

The circuit for this receiver has one stage of balanced tuned radio frequency amplification, a detector which is tuned and its sensitivity controlled by a resistance method, and two stages of transformed coupled audio frequency amplification. A feature of the set as built is that there are separate terminals for the last stage of the audio amplifier, so that the plate and grid bias voltages may be varied and the best results thereby obtained. Often, the experimenter will recollect, he has wished to try a different "B" or "C" voltage on the second stage than that used on the first; and these extra terminals are provided for this purpose. Instead of rheostats ballast resistances are used in the

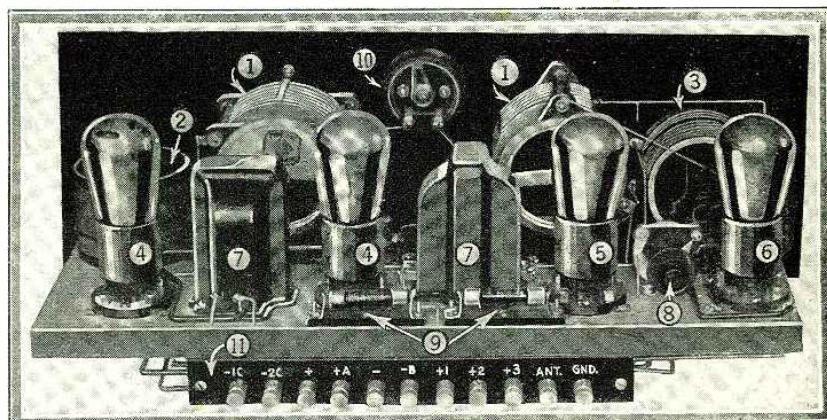

The rear view of the receiver: 1, the variable condensers; 2, the R.F. transformer; 3, the antenna coupler; 4, A.F. amplifier tubes; 5, detector; 6, R.F. tubes; 7, A. F. transformers; 8, compensating condenser; 9, automatic filament controls; 10, high-resistance rheostat; 11, terminal board.

Photos by courtesy of General Radio Company

The Ghirard 8 Super-Heterodyne

By ALFRED A. GHIRARD, Asso. A. I. E. E.*

A super-heterodyne receiver that will bring in distant stations on a 15-inch loop is a most desirable set to have, in the opinion of the majority of fans. We recommend this receiver as a good "super-het."



IT is against the policy of RADIO NEWS to publish the names of manufacturers or of makes of instruments in connection with the apparatus described in these pages, but this information will be gladly given privately. If you are interested in any special instruments described here, address a letter to the I WANT TO KNOW DEPARTMENT, enclosing stamped return envelope. The names and addresses of the manufacturers will be given free of charge. —EDITOR.

THE super-heterodyne method of radio reception has been the target for probably more unjust criticism than any other receiving system we have. Theoretically the system is sound; but practically it has not worked out in popular favor to a degree anywhere near commensurate with its real worth.

In the majority of cases when accepted theory and actual practice do not agree, there is something wrong with the actual practice. Either the theory has not been carried out faithfully in the construction, or it has not been applied correctly. In the case of the super-heterodyne, both reasons seem to apply: first, many sets offered to the public have been fostered by men who have had axes to grind; secondly, about 99 per cent. of the sets have been of the slap-up test-out variety. Other reasons are, the exaggerated claims made by the sponsors for distance and selectivity, which can never be duplicated by anyone building the set—leading to keen disappointment and discouragement on the part of the fan.

Lastly, most of the care and thought seems to be given to the electrical part of the set, the mechanical construction being left to take care of itself as best it can. For instance, what is the use of paying extra money for a set of efficient variable condensers, if the panels are made of a material which will warp and buckle under the strain of the weight of the instruments? Penny-wise and pound-foolish seems to be the rule, rather than the exception, in some radio construction.

The super-heterodyne should surpass all circuits for distance and selectivity. Distance features are obtained by the use of cascade R.F. amplification, selectivity is brought about by the use of a loop aerial. Loop reception is, of course, very desirable* for its convenience, portability and selectivity.

RESULTS WITH THE SET

The Ghirard VIII has been in the process of development for a period of four months. The second detector and audio frequency amplifier circuits were developed nearly six months ago in conjunction with M. B. Sleeper, during work on another type of set. Everything possible has been done to procure parts which are not only efficient electrically but up-to-date, small in size and able to stand up under long usage. The circuit is similar in some respects to that developed by R. W. Cotton.

At the writer's laboratory on the south shore of Staten Island (which is particularly bad for loop reception on account of large adjacent bodies of water) all of the local stations, all Chicago stations, Elgin, Illinois, WGY, KDKA, WRC, WPG, and Philadelphia stations can be brought in on the loud speaker, consistently any night, at any time during the hours of broadcasting.

The loop used is only 15 inches square, and absolutely no interference is encountered. Tuning is accomplished with the two main

ser. The first detector and oscillator tubes are coupled together by means of the oscillator coupler. The rotor coil of this coupler is adjustable, but when once set need never be touched again. The primary of the filter transformer is shunted by a 0.001- μ f. fixed condenser. This serves, not only to sharpen the tuning, but also as a by-pass for the frequency of the incoming wave. Energy from the plate of the first tube is fed back to the grid circuit loop by means of the 45- μ f. midget condenser.

By using a three-tap loop, with this scheme, we obtain regeneration in the first tube, resulting in increased sensitivity, sharper tuning of the loop condenser and marked directional properties in the loop. Following this we have three stages of intermediate frequency amplification at 3,000 meters, with a 400-ohm potentiometer to control oscillation. In the actual operation of the set it has never been found necessary to make the grids of these tubes positive (using 67½ volts on the plate), so that "B" battery consumption is reduced to a minimum.

The rest of the A.F. amplifier may perhaps seem to be built back end forward, having the first stage resistance-coupled and the second stage transformer-coupled. It is well known that for maximum efficiency in vacuum tube circuits, the impedance of the coupling device should be equal to that of the plate circuit of the tube it works in conjunction with. This allows the use of a stage of resistance-coupled amplification following the detector, using a 0.1-megohm coupling resistor.

The second stage of audio is transformer-coupled, with a transformer which has a flat amplification curve, preserving the fine quality of reproduction; the amplification of the transformer is unusually high, being nearly twenty. This combination gives us an A.F. amplifier working most efficiently with the detector tube, with a saving in cost of parts and increase in volume and clarity. By-pass condensers of the values shown are used.

The jack arrangement is unique. The jack permits plugging in of the phones after the first A.F. stage, and also controls the filament of the last tube. The loud speaker is permanently connected to the set at the rear by binding posts. This does away with unsightly plugs and cords at the front of the set when the speaker is used. When the phones are used, inserting the phone plug in the jack automatically disconnects the loud speaker and the filament of the last tube. This filament control feature does not introduce any difficulties in the wiring. 1- μ f. by-pass condensers are used to by-pass the R.F. currents from the I.F. (intermediate) stages and from the plate of the detector tube. This greatly improves the quality and stabilizes the set. Further by-passing is obtained by running all the filament leads parallel and close together.

CONTROLS

The left hand rheostat on the set has a resistance of 6 ohms and controls the oscillator and I.F. tubes. The center rheostat of 10 ohms controls the two detector tubes. The one on the right, 30 ohms, gives independent control for the last tube. The first A.F. tube is controlled by a 1-A amperite. This permits of cutting the last tube in and out without affecting the brilliancy of the one preceding it. Provision is made for the use of a "C" battery on the A.F. tubes. The set is built around the helical-wound

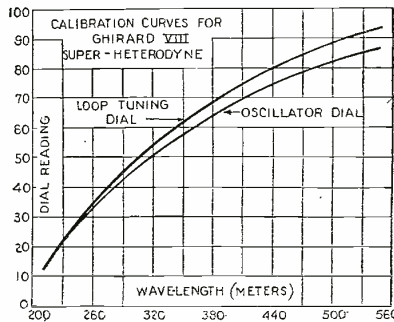

This pair of calibration curves indicate how simple a matter it is to log the Ghirard VIII. for tuning.

dials, auxiliary volume control being obtained by the use of the potentiometer—simplicity personified! The rheostats need be adjusted only occasionally to make up for changes in "A" battery voltages.

CONSTRUCTIONAL DETAILS

You will notice from the circuit diagram that eight tubes of the UV201-A type are employed. The loop is tuned by a 0.0005 μ f. straight-line frequency variable conden-

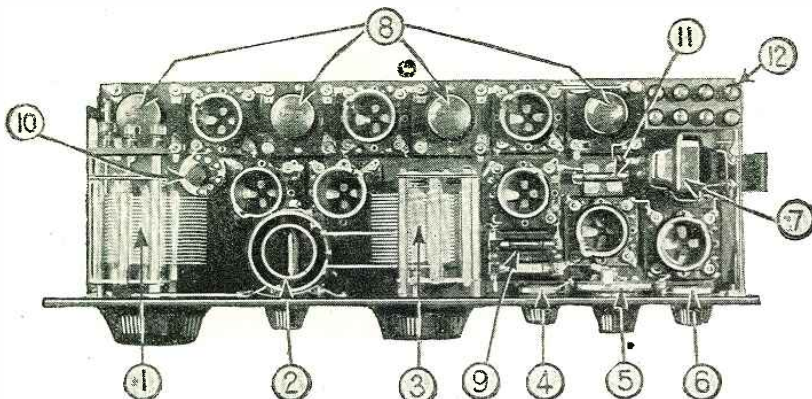

No. 1 is the antenna condenser; 2, coupler; 3, oscillator condenser; 4 and 6, rheostats; 5, potentiometer; 7, A.F. transformer; 8, intermediate transformers; 9, resistances; 10, .000045 mfd. condenser; 11, grid leak and condenser, and 12, terminal board.

* (Author's rights reserved)

transformers designed by Prof. Bowles. The intermediate frequency (3,000 meters) transformers are matched to one-twelfth kilocycle. They are primarily of the air-core type, with a very small quantity of iron in them. This broadens the peak sufficiently so that great amplification is obtained, without any cutting of the side bands to cause poor quality in the reception. The filter transformer is of the air-core type, tuned to a sharp peak by the use of a .001- μ f. fixed condenser across the primary winding. It is absolutely necessary to have this .001 condenser of the proper capacity.

The two 0.0005- μ f. straight-line frequency condensers are slightly larger in size than the usual .0005 condenser; but it was thought best to sacrifice space in this case, for sturdy mechanical construction and electrical efficiency, and the advantage of perfectly-balanced rotors. The rheostats are but 1 1/4 inches in diameter. The potentiometer is sturdily built, and operates with amazing smoothness. The filament lock switch enables the owner to lock the set when not in use, so that children or others cannot turn on the tubes.

The front panel measures 7 x 21 x 3/16 inches; the tube panel 7 x 20 x 3/16 inches; the main binding post panel 3 x 1 1/2 x 3/16 inches; and the loop binding post panel 2 1/2 x 1 x 3/16 inches. Hard rubber panels are not suitable for a set of this type, as hard rubber is not strong enough mechanically to carry the weight of the instruments without warping; one of the stronger insulating compositions must be used. The two panel support brackets serve to fasten the tube panel rigidly to the front panel. The weight at the center of the panel is supported by two small brass angle brackets. This method of construction results in a rigid outfit. The set can be grasped anywhere in one hand, so that its entire weight is suspended, without damage either to wiring or any of the parts or panels. This is a good mechanical test for any set.

ARRANGEMENT OF PARTS

You will notice that the tube sockets, transformers, and resisto-coupler unit are fastened to the tube panel. Practically all of the wiring is carried down under the tube panel. This is made possible by the use of No. 18 tinned copper wire, covered where necessary with varnished tubing. The filament wiring is kept bunched, in order to take advantage of the by-passing effect, resulting in improved quality. There is less wiring in this set than in the ordinary 5-tube tuned R.F. set; this has been accomplished by a very careful study of the relative location of parts and wiring.

A hasty glance at the bottom view of the tube panel might lead one to think there are exceedingly long leads, but closer inspection shows that practically all of this wiring is for the filament circuits, in which moderately long leads bunched together are advantageous rather than a detriment. It is important to note that the parts have been so arranged that the grid and plate leads between the tubes and I.F. amplifying transformers, on top of the tube panel, have been kept down to the unbelievable length of "one-quarter-inch."

Since each transformer is separated from the next by a tube socket (2 1/2 inches), there is no possibility of interaction due to stray fields. The first detector and oscillator grid condensers are fastened directly to the underside of the tube panel, by removing the grid terminal screws from the sockets and running longer screws through the terminals and panel. This makes the grid leads about 1/2 inch long, and simplifies the wiring. The oscillator coupler shaft is cut off flush with the brackets and the collars adjusted as shown. The brackets are flattened out somewhat so the coupler lies flat against the front panel. The panel is blind-drilled and tapped on the rear side so that the coupler



With but two controls, the Ghirard VIII is very easy to tune: the oscillator coupler adjustment is permanent. Rheostats (left to right) 6-, 10-, 30-ohm. Potentiometer knob in upper right.

man "building his own." The filament switch and jack are kept under the tube panel. The two 1- μ f. by-pass condensers and amperite are fastened under this panel with 1/2 inch 6-32 F. H. machine screws. The battery binding-post strip is supported by two nicked brass posts, 3/8 by 3 3/8 inches. This strip may be kept down lower, but the author prefers the high mounting, as it is very convenient to get at these terminals when the set is installed in a cabinet. The loop terminal strip is mounted directly on the loop tuning condenser, by means of two nicked brass rods, 5/16 x 3/4 inches, threaded to take 6-32 screws. The right-hand one also serves to connect the right-hand binding

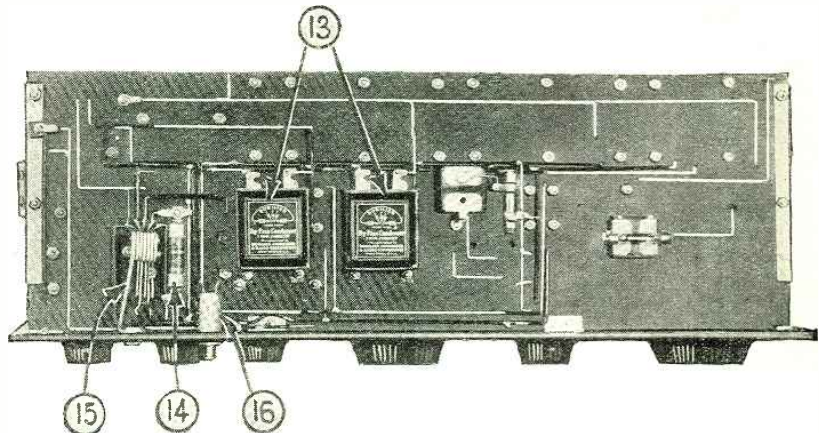

Here is the view beneath the sub-panel: No. 13, the by-pass condensers; 14, automatic filament control; 15, filament control jack; and 16, filament switch.

is fastened to the panel with 6-32 R. H. machine screws, without having them show on the front.

If you can possibly manage it, have the front panel grained, or "dull finished," and engraved. This gives a professional touch to the set which is always a satisfaction to a

post directly to the end plate and rotor of the condenser.

WIRING

An explanation of the connections to the five terminals of the oscillator coupler will (Continued on page 1503)

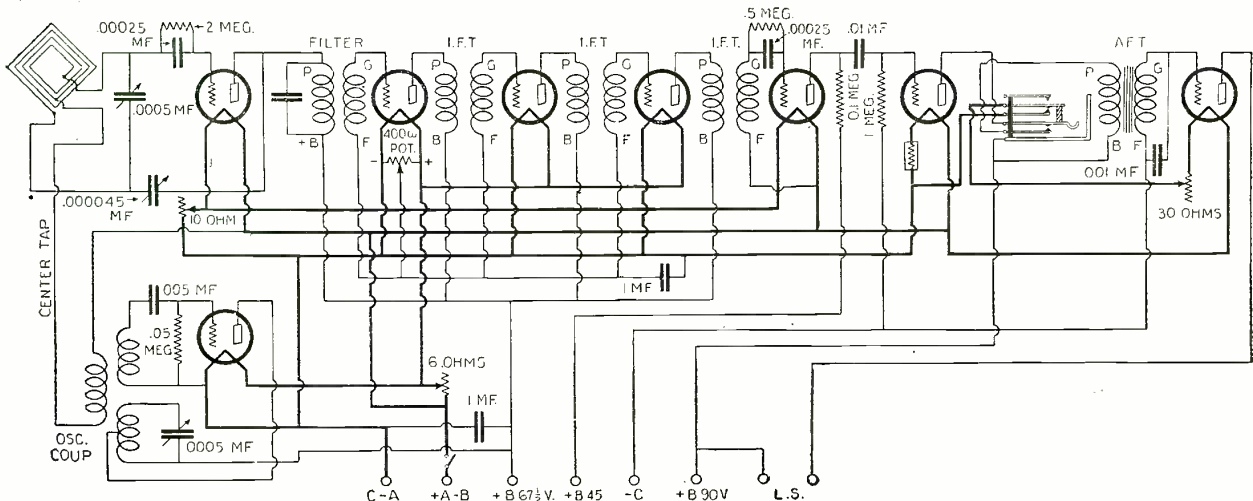

Above is shown the circuit diagram of the Ghirard VIII. The filament control jack controls also the last tube, which does not operate when the plug is in.

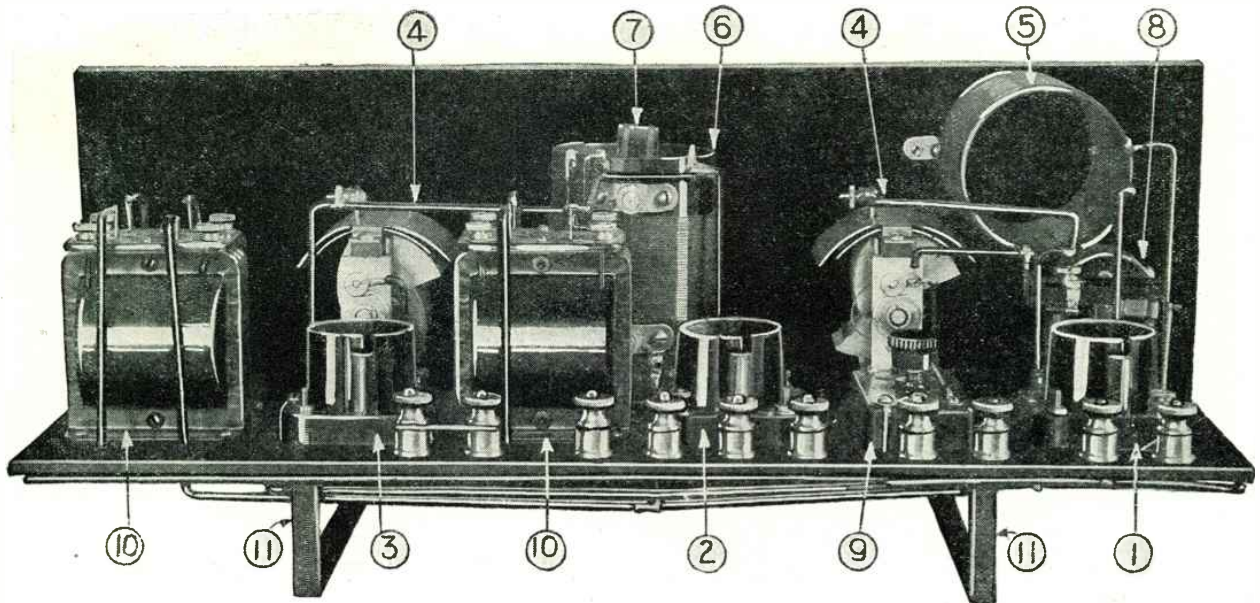

Photos courtesy of Samson Electric Co

No. 1 is the R.F. tube socket; 2, the detector tube socket; 3, one of the A.F. amplifier sockets; 4, variable condensers; 5, antenna inductance; 6, R.F. transformer; 7, tickler coil; 8, rheostat; 9, neutralizing condenser; 10, A.F. transformers; 11, baseboard supports.

How To Construct the DX4

By A. K. LAING

THE newer circuits designed for kit manufacturers show a decided trend toward fewer and more efficient stages of tuned radio frequency amplification. This is due, in part, to the difficulties in tuning presented by a three-dial set, and in part to general features of economy and simplicity in construction. Perhaps the most important reason for this change lies in the fact that the neutralizing or balancing methods used on many three-dial sets make them inefficient on the broadcast waves above 375 meters. It is a simple matter, on the other hand, to design a single stage of tuned, balanced radio frequency amplification which will have about the same efficiency on all wave-lengths within the range of the tuning controls.

The DX4 receiver, shown in the photographs reproduced on this page, was designed especially to bring in distant stations with good volume. For this reason low losses and sharpness are the features most

stressed. As only one stage of tuned radio frequency is used, it is unnecessary to introduce losses and broad tuning in order to control the tendency to oscillate. This makes the overall efficiency about equal to that of the usual five-tube receiver, and simplifies the tuning operation.

IT is against the policy of RADIO NEWS to publish the names of manufacturers or makes of instruments in connection with the apparatus described in these pages, but this information will be gladly given privately. If you are interested in any special instruments described here, address a letter to the I WANT TO KNOW DEPARTMENT, enclosing stamped return envelope. The names and addresses of the manufacturers will be given free of charge. —EDITOR.

THE CIRCUIT OF THE DX4

One stage of balanced tuned radio frequency amplification is followed, in the DX4,

by a regenerative detector and two stages of low-ratio transformer-coupled audio frequency amplification. Both the balancing system and the radio frequency transformer are unusual in design. The former employs a small variable condenser, a radio frequency choke coil, and a by-pass condenser in a novel arrangement which departs from the usual "Wheatstone's bridge." The radio frequency transformer has a provision for varying the coupling. The importance of this feature will best be realized by those who have read Mr. Harris's article on coupling in the December issue of RADIO NEWS.

Referring to the illustrations, the coil mounted at right angles to the front panel is the antenna coupler. It consists of an 18-turn primary and a 54-turn secondary wound at a distance of $\frac{1}{8}$ inch apart on a 2½-inch tube. In the center of the set, and at right angles to the sub-panel, may be seen the interstage transformer and tickler coil. The transformer secondary of 54 turns is wound on a tube identical with that of the antenna coupler. Within this tube revolve two 2-inch tubes; the top one bears the tickler winding of 16 turns of fine wire, the lower one the primary of 30 turns. These coils may be made by the builder, but it will be found most satisfactory in the long run to purchase them ready-made, as the construction of bearings for the vario-coupler is a particularly hard task.

COMPONENT PARTS REQUIRED

- 1 front panel, 7 x 18 x 3/16 inches.
- 1 base panel, 7 x 17 x 3/16 inches.
- 1 filament control jack,
- 1 rheostat, 30-ohm,
- 1 rheostat, 10-ohm.
- 2 variable condensers, S.I.F. .0005- μ f.,
- 1 interstage transformer and tickler,
- 1 antenna coupler.
- 4 sockets for UV-201A tubes.
- 2 low ratio audio frequency transformers,
- 1 fixed condenser, .00025- μ f.,

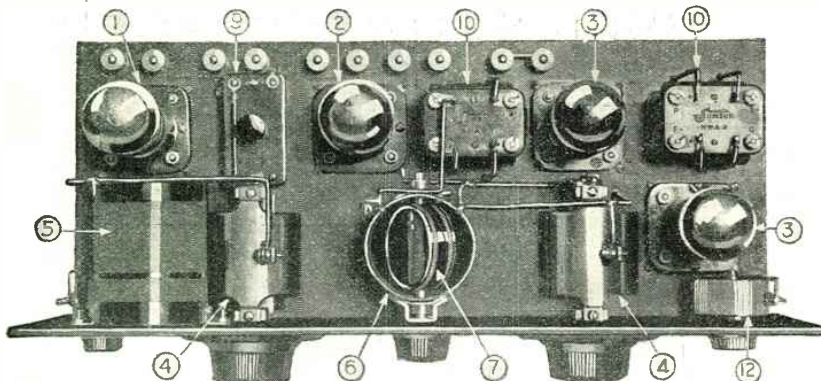

Top view of the DX4 receiver. No. 1 is the R.F. tube; 2, detector; 3, A.F. amplifiers; 4, variable condensers; 5, antenna inductance; 6, R.F. transformer; 7, tickler coil; 9, neutralizing condenser; 10, A.F. transformers; 12, rheostat.

- 1 fixed condenser, .0005- μ f. (with grid leak clips),
- 1 fixed condenser, .001- μ f.,
- 1 variable neutralizing condenser,
- 1 grid leak, 5-megohm,
- 1 radio frequency choke coil,

on a core $\frac{1}{2}$ inch in diameter. Directions for making a suitable choke will be found in Mr. Hatry's article in the February issue of RADIO NEWS, entitled "A Balanced Reflex."

ASSEMBLY

The top and rear views should give a

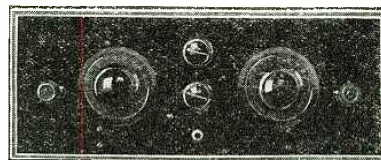

Panel view of DX4 receiver.

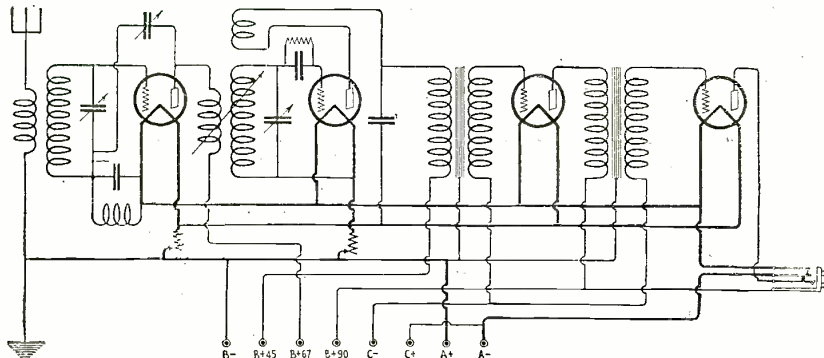

The four-tube, tuned radio frequency regenerative detector receiver called the DX4.

- 10 binding posts,
- 2 panel brackets.

The radio frequency choke coil mentioned above may be purchased with the complete kit if the builder desires, or it may be made at home. It should consist of several hundred turns of fine wire (No. 36 or smaller)

clear idea of the arrangement of parts. It is not necessary to follow rigidly the exact spacing shown, but the general scheme of the layout shown should be adhered to. Referring to the top view of the set, the socket at the left is for the radio frequency tube. Next comes the detector socket. The socket

at the right rear is in the first audio frequency stage, and the one near the panel at the right is the second audio.

The rheostat appearing at the left in the front panel view controls the detector tube only. Its resistance is thirty ohms. The one at the right controls the three amplifier tubes, and has a resistance of ten ohms.

The jack used has an auxiliary pair of contacts insulated from the two which make contact with the plug. These close the filament circuits of all the tubes when the plug is inserted.

The condensers used in the set made in the RADIO NEWS LABORATORIES are unique in the S.L.F. field for their compactness. Some S.L.F. condensers in the zero position take up six or more inches of lateral panel space, and as much as thirty square inches is needed to allow for the swing of the elongated rotor plates. The condensers used in this set take up a maximum lateral space of $3\frac{1}{2}$ inches and a total area of eight square inches on the panel.

(Continued on page 1491)

Five Minutes of Radio for a Nickel

By JOSEPH RILEY

ONE of the favorite pastimes of the American people is dropping coins in a slot. There are the familiar weighing machines in every railroad station, which for the sum of one cent will indicate your correct weight. There are machines scattered all over the country that dispense chewing gum, candy and other eatables for the same amount. If your boots need shining, there is no need to wait for the shoe-shine artist; go to the nearest shine machine and place your shoes in its care.

Not to be behind the trend of the times, the radio slot machine has made its appearance. If you forget to bring your pocket portable receiver with you, and there is a program on the air that you are particularly anxious to hear, just walk into a store that has one of these radio receiver slot machines, drop a nickel in the slot, set the two dials of the set—and your station will be heard from the loud speaker in the top of the machine.

HOW IT OPERATES

This slot machine made its appearance recently in Philadelphia and consists of a five-tube radio frequency receiver, having one stage tuned R.F., one stage of fixed R.F., detector and two stages of audio frequency amplification. There is also a timing mechanism which limits the reception to five minutes. On the side of the machine next to the slot in which the nickels are deposited, is a table showing the times when stations are broadcasting and also the necessary dial settings of the receiver.

The small knob below the slot is turned after the nickel is deposited. This starts the motor which operates the timing mechanism. After four minutes of music a red electric lamp lights in the front of the cabinet, warning the listener that if he wishes to continue the reception beyond the period of another minute another nickel must be dropped in the slot. This must be repeated every five minutes. The opening of the loud speaker horn is behind the grill work above the dials of the receiver, and the timing mechanism is under it.

Before long, it is possible these machines

will be as common a sight as the many different types of vending machines that are familiar to everybody today and then the

American boy and girl will have another slogan, "Papa, gimme a nickel I wanta hear some radio music!"



When a nickel is dropped in the slot, your favorite radio station can be tuned-in by the two dials on the front of the cabinet.

© Wide World Photos.

The Doughnut Five

By ASHUR VAN A. SOMMERS

The receiver described in this article takes its name from the type of coils used in the radio frequency transformers. It should prove an interesting receiver for the set builder.

IN radio, as in the automobile field, a stage has been reached at which no type or make can be called the best from every aspect. All sets manufactured by reputable companies, and all circuits designed by prominent radio men, are good, just as all automobiles are good. But, just

and sharpness there is no doubt whatever that a properly constructed solenoid is best. But solenoids are the most difficult coils to neutralize, or to stabilize. The field of the solenoid suitable for broadcast reception is large, and it interlinks with other coils and with the wiring of the set, causing all

IT is against the policy of RADIO NEWS to publish the names of manufacturers or of makes of instruments in connection with the apparatus described in these pages, but this information will be gladly given privately. If you are interested in any special instruments described here, address a letter to the I WANT TO KNOW DEPARTMENT, enclosing stamped return envelope. The names and addresses of the manufacturers will be given free of charge. —EDITOR.

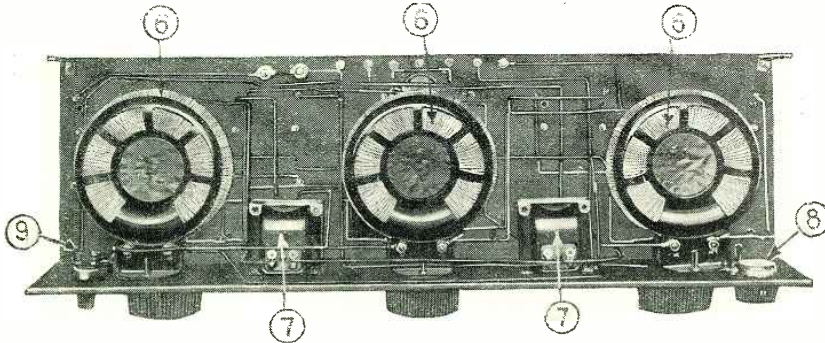

The view under the sub-panel: Nos. 6, the R. F. transformers; 7, the A. F. transformers; 8, the potentiometer, and 9, the filament switch.
Photos by courtesy of the Reichman Company

as different people choose different cars because they excel in some one feature, such as speed, or power, or simplicity, or economy, so different individuals choose different radio sets because they appeal in some particular feature.

The choice in the field of tuned radio frequency receivers comes down, largely, to a decision whether sharpness, sensitivity, or stability is most desired. No receiver now available presents the ultimate in all three characteristics. Many fans believe that stability is the most important feature of all, and prefer a set which is perfectly stable, even if sensitivity and sharpness are reduced a trifle.

The deciding feature in most radio frequency sets is the type of coil used in the inter-stage transformers. In the January issue of RADIO NEWS (page 986), an article was published entitled "Which Type of Coil Is Best?" This article brought out the fact that plain cylindrical single-layer coils have the lowest losses of any type. The writer of the article stated, however, that he considered the coils merely from the aspect of resistance at high frequencies. For volume

kinds of feed-back squeals unless great care is taken to insure zero coupling between all coils. Even when this is done, capacitance coupling will be enough to cause a good deal of trouble over part of the wave-length range.

So for those who wish to construct a set which will be as stable as possible, it will be found that the toroids are ideal. Actually, the difference in efficiency between solenoids and toroids is slight. When we consider that it is very often necessary to introduce losses into the circuit deliberately, in order to control oscillation, the difference in efficiency may be discounted entirely. Those who are interested in an exact evaluation of toroids are referred to an article entitled "All About Toroid Coils" in this issue.

CONSTRUCTIONAL DETAILS

No specific parts are recommended for the set, as meritorious apparatus of any make may be combined for this circuit. The complete list of components follows:

- 1 Toroidal antenna coupler coil,
- 2 Toroidal inter-stage coupling transformers,
- 3 Straight line frequency condensers, .0005- μ f.,

(Continued on page 1502)

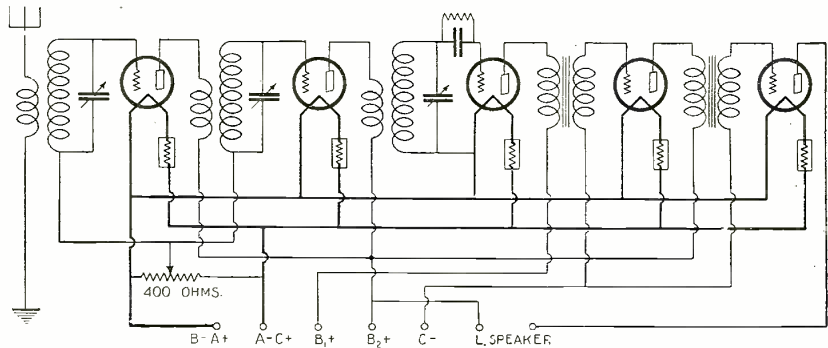

The circuit diagram of the Doughnut Five is shown above. The only adjustment, beside that of the three tuning condensers, is the potentiometer, for regulating the grid bias on the R. F. tubes.

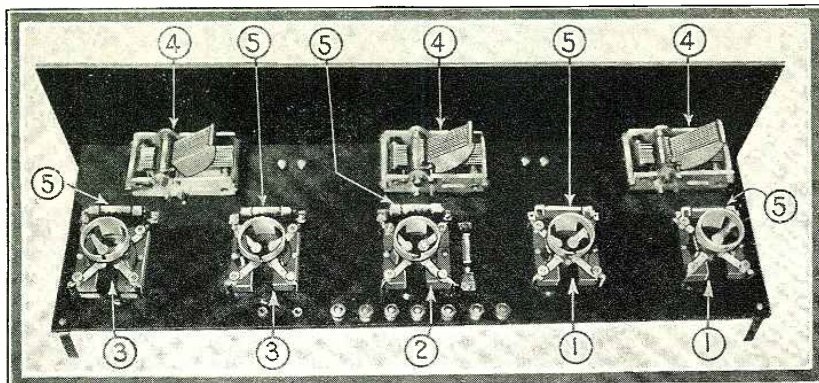

No. 1 indicates the R. F. tube sockets; 2, the detector socket; 3, the A. F. amplifier sockets; 4, the variable condensers, and 5, automatic filament adjusters.

AMAZING STORIES

The new scientific fiction magazine, issued by the publishers of this magazine, will be on sale the first of each month. The April issue will contain stories by Jules Verne, H. G. Wells, George Allen England, and many others.

Brim full of scientific fiction of the type you enjoy now in this magazine.

A big magazine, with a big new idea.

Edited by Hugo Gernsback.

For sale on all newsstands.

25c the copy.

A Duplex Crystal-Detector Hook-up

Utilizing Both Halves of the Wave*

This article will appeal to the experimenter who likes to work with crystal detectors. By using two crystal detectors it is possible to get maximum results with very little trouble in wiring changes.



THE majority of broadcast receiving sets (in Central Europe, where distances are short) use crystal detectors, which are popular because of their cheapness, simple construction and easy operation. This is especially true of broadcast listeners; for the beginner who wires his own set is apt to look on the simple crystal with contempt, and often hook it up to various tube circuits, getting less satisfaction in the end than a good crystal set would have afforded, under equally favorable conditions.

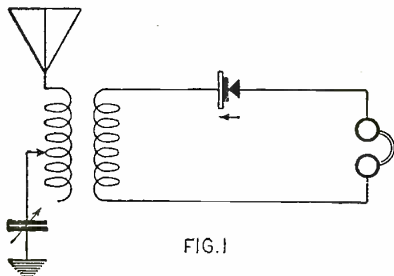

FIG. 1
The crystal detector hook-up shown above utilizes but one-half of the incoming radio wave, thereby wasting a great deal of energy.

It is true the crystal receiver can deliver no more energy to the phones than it receives from the antenna, less the necessary amount of loss. No amplification connections, (in "cascade") are possible from the crystal. But we can find out what is needful for satisfactory reception from local stations if we study one factor, economy of signal

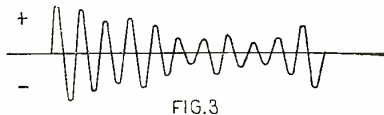

FIG. 3
A carried wave that is modulated, in which form it is received on an antenna.

energy, that is to say, obtaining the greatest amount of reproduction from the current received by the antenna.

The loss of energy in coils, condensers, crystal, etc., can be limited to a small amount by very careful selection of parts and highly insulated mounting. But many a radio beginner has met with a great deal of trouble, because the crystal in an ordinary hook-up, like Fig. 1, transmits to the headset only

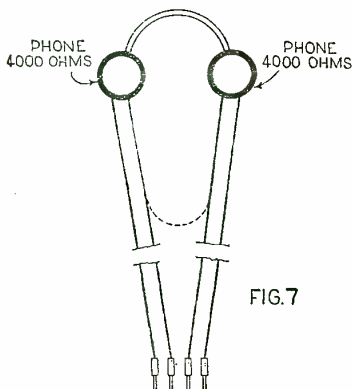

FIG. 7
Method of connecting head set for use with Duplex system of crystal detection.

one-half of the oscillations which it receives, and the other half of the signal energy is lost, so far as reproduction is concerned.

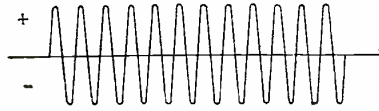

FIG. 2
A carrier wave before it is modulated at the broadcast station.

THE CRYSTAL TRANSMITS HALF-WAVES

As we all know, the action of a crystal receiver is, briefly, as follows: the waves modulated by voice or music at the broadcast station (Figs. 2 and 3), follow each other with a rapidity too great, or, as we say, with too high a frequency, to put the diaphragms of the head-phones into vibrations causing audible sound. They are therefore conducted through the crystal, which has the peculiarity (like the action of a valve) of letting half of the oscillation of the radio wave pass through it. (See Fig. 4). Accordingly the telephone receives only direct-current impulses of a low frequency, but to which the diaphragms respond, so that sound is transmitted to the ear.

The loudness of reception from the set

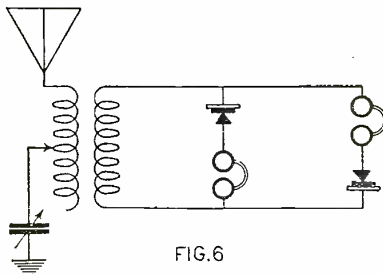

FIG. 6
By employing two crystal detectors and two head-phone sets as shown in the above diagram both halves of an incoming radio wave are rectified.

now depends upon the amplitude or height of radio waves (see A in Fig. 5) which is governed by the amount of incoming energy, by the size of the antenna, and several other factors. The incoming oscillations in the negative direction are held back from the phones by the detector (Fig. 4) and therefore half of the incoming energy is necessarily unused, independently of the unavoidable losses in the set. This reduces the loud-

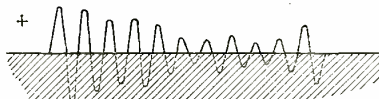

FIG. 4
Only one-half of the received modulated wave is passed to the rest of the circuit after rectification by the crystal detector.

ness of reception, and occasions loss which is unnecessary in a crystal set.

USING THE WASTED HALF-WAVE

It is possible, by the use of two oppositely-connected crystals, to utilize both halves of the wave, thus taking advantage of almost the entire energy received, and bringing up the reproduction to its maximum value in this receiver. Fig. 6 shows a hook-up which does this, by employing two separ-

ate head phones, each of which gives approximately the loudness of reception possible with a single phone on a single crystal-circuit. To concentrate this more efficient utilization of energy, in a single headset, two methods are available.

First, one may connect up a double headset, each of whose phones has 4,000 ohms resistance. Customarily the two are connected in series, but we change the leads so that each is connected individually (Fig. 7), and then complete the circuit as shown

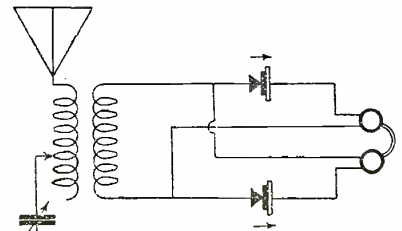

FIG. 8
How a single pair of phones can be connected in the Duplex circuit to get full-wave rectification.

in Fig. 8. In this the maximum amount of energy is brought to the phones, and thereby the loudest reception is obtained that is possible from an unamplified crystal set. The hook-up may be varied.

Secondly, the same end may be attained by the use of two transformers; that is, the amount of energy obtained from the two crystals is brought to a single headset. For this purpose two transformers with

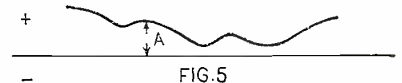

FIG. 5
The loudness of signals in the phones depends upon the amplitude, A, of the rectified radio wave.

a very low step-up ratio (1:2, or, at most, 1:3) are hooked up in accordance with Fig. 9. The correct polarity of the set must be kept, so that the currents in the secondary coils of the transformers shall not be working against each other.

This hook-up has the advantage that an ordinary headset can be used without change; but it is somewhat difficult to find two transformers exactly matched. Theoretically, to get the best results with a particular headset, the alternating current resistance of the primary windings of the transformers should be exactly equal to that of a 4,000-ohm headset; and that of the secondary windings

(Continued on page 1468)

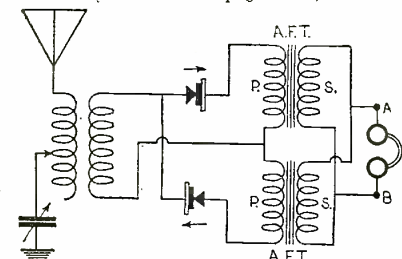
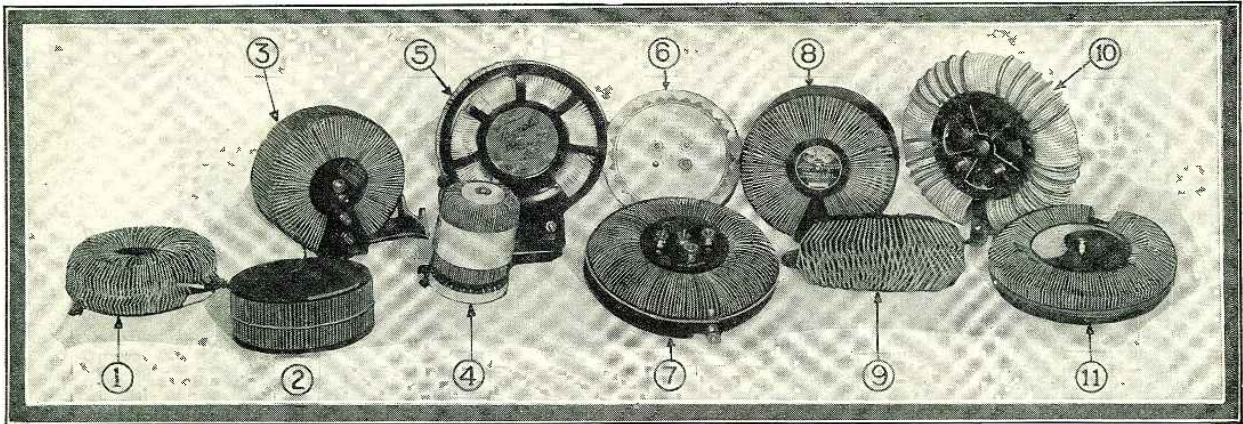

FIG. 9
By using two low ratio transformers, a head set connected in the usual way (in series) may be used.

* From Radio Amateur, Vienna.



Different commercial makes of toroids: 1, Orbit; 2, Nolte Circoids; 3, Bremer-Tully; 4, Radio Foundation Torocoil; 5, Thorola; 6, Summit; 7, Erla Circloids; 8, All-American; 9, Feri Coil; 10, Naxon; 11, Wybo Hexoids.

All About Toroid Coils

By SYLVAN HARRIS

There has been much ado about toroidal coils for the last several months; but strange to say, nothing of a quantitative nature was published about them until January, 1926, when RADIO NEWS took the initiative. In that issue appeared an article by Sylvan Harris on the resistance of various types of coils, which has caused considerable discussion, especially with regard to the data on toroids. This article, completes the subject from the standpoint of design.



THE toroidal coil has been used for a long time in various ways in laboratory work, and I believe, to some extent in telephone work. The shape of the toroid is that of an anchor-ring, by which name it was generally known until the recent enthusiasm in radio circles for that type of coil. In radio circles the coil is generally known by its mathematical name, in its various forms. The noun is "torus," the adjective is "toroidal" the form "toroid" is a substantive adjective. It is by this latter form that the type of coil shaped like the homely "doughnut" is generally known in radio circles.

In the January issue of Radio News an article was presented by the present writer, in which the high frequency resistance of coils of various types was discussed. In that article were included cylindrical coils, toroidal coils, and various other forms. The article avowedly dealt only with the resistance of coils; nevertheless some readers took exception to the fact that I was dealing with only one phase of the subject, for the reason that, as one correspondent states, "... your article lays undue stress on a point which, although important, is not paramount; that is, the inductance-resistance ratio. The primary inductance, mutual inductance and coupling coefficients have more

bearing on the actual operation than the points stressed in your article."

This correspondent was intimately interested in the manufacture of toroidal coils, the L/R ratio of which, it was shown in my article in the January issue of RADIO NEWS, is generally lower than the ratio for single-layer cylindrical coils. He goes on to state, "... It is true that it is not possible to keep the radio frequency resistance of a toroidal coil as low as that of an equivalent solenoid," which seems to be in agreement with the findings of the RADIO NEWS laboratories.

However, the point is, that it is impossible

to cover adequately all phases of any given subject in a single article in any magazine. Volumes may be written on the properties of coils. In the article referred to, the writer purposely omitted all considerations other than resistance, intending to leave the other phases of the subject until this present article. The reason for this is an important one.

Perhaps the most important difference between cylindrical and toroidal coils, seen from the radio viewpoint, lies in the fact that the toroidal coils have a confined magnetic field, whereas at the ends of the cylindrical coil the field spreads out; the intensity of this field may, when the length of the coil is not much greater than its diameter, be relatively great at some distance from the ends of the coil. There is opportunity then, for electromagnetic coupling to be established between the circuit containing this coil and any other circuits which may be linked by this spreading magnetic field. A general idea of the distribution of the magnetic fields of the two types of coil may be obtained from Fig. 1.

This property of the toroid has been so emphasized in the text and advertisements of radio publications that all other points seem to have been either forgotten or taken for granted. This is a peculiarity of the radio industry. No one item should ever be con-

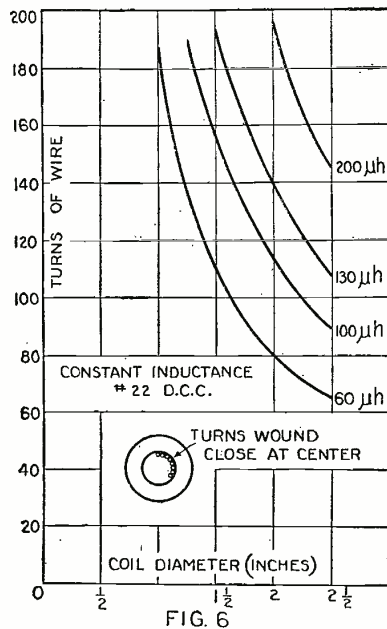
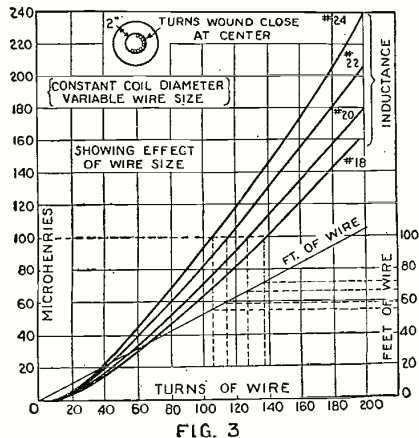

At the left it is shown how the inductance varies with the number of turns (wound touching at center); above, the relation between the coil diameter and the number of turns; and on the right the effect of varying the coil diameter. Note how slowly the inductance increases compared with the number of turns, for the small diameters.

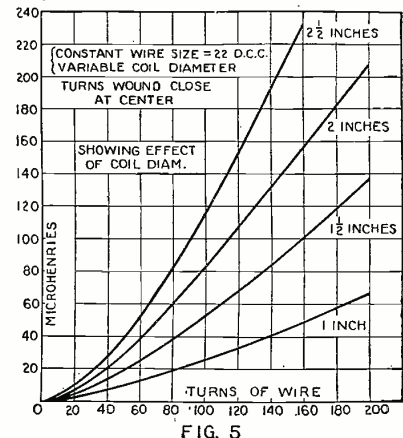

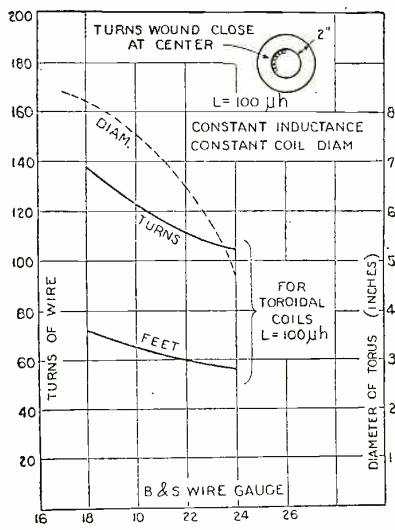

FIG. 4
This graph shows the large number of turns and length of wire required in these toroids to give an inductance of 100 microhenries.

sidered to the exclusion of all the others. In the case in point it was unnecessary to emphasize the excluded items, for this was one article balanced against the hundred others which emphasized and repeated the others. The importance assigned to a thing is not always inherent; the importance assigned to it depends not only on the inherent importance, but also the distance from which it is viewed. Betelgeuse is infinitely greater than our mighty sun, but can be studied only through a powerful telescope, merely because it is several thousand light-years away.

An ingenious method of explaining why the magnetic field of the toroid is confined, suggested by one manufacturer's advertisement, is illustrated in Fig. 2. Imagine a number of ordinary cylindrical coils connected in series and arranged in a circle. The windings of the coils are all the same, so that the N pole of each coil is adjacent to the S pole of the next coil. Since unlike poles attract, the separate magnetic fields of the different coils will be drawn in and combined, so that a continuous field around the circle will result, and the leakage field outside the coils will diminish. When sufficient coils are added and the circle completed, we will have the toroid with its confined field. There is some little leakage field from a toroid, which, however, is small compared with the spreading field of a cylindrical coil. It will be noted that the toroid has no poles. This is because (referring to the circle of coils in Fig. 2) the adjacent N and S poles combine to neutralize each other.

The toroidal coil, with its confined field, finds its most important application in radio frequency amplifiers, where it is desirable to prevent magnetic coupling between the various stages. If coupling exists between the input and output circuits of any stage or stages self-oscillation is likely to occur, or the amplification may be diminished, or both. Besides this, the linking of the spreading field of a cylindrical coil with pieces of metal, such as the plates of a condenser, or the casing of an A.F. transformer, is likely to cause perceptible losses in the system, with the attendant lack of sensitivity and broadness of tuning. There is no doubt that all these effects occur; there is considerable question, however, as to the magnitude of these effects, and as to whether it is not possible to keep them small no matter what kind of coil is used.

The toroidal coil, on account of its confined field, reduces considerably inter-stage coupling and losses due to absorption in adjacent metallic surfaces. There is no doubt

that considerable benefit arises in these directions from using toroids. The other question which must be considered, and to be fair we must consider all points, is whether these benefits are not annulled by the higher resistance of the toroid as compared with the cylindrical coil, and whether the same effects cannot be obtained by using a simple cylindrical coil of low resistance properly shielded.

It is possible to shield a cylindrical coil so that inter-stage coupling is prevented, yet without increasing the resistance inordinately. This can be done by allowing sufficient space between the shielding surfaces and the coil in question. These are some points in the argument to consider, but there are two other points which must not be forgotten. These are size and cost.

There must be considered the relative costs of shielding for cylindrical coils, and special winding methods and machinery for toroidal coils. There must be also considered the space occupied by a well-designed toroid as compared with the space which the shielding compartment of a cylindrical coil would occupy. This writer cannot at the present give any answers to these questions; the thoughts are presented for what they are worth, and it is believed that they have not occurred before this to many of our readers.

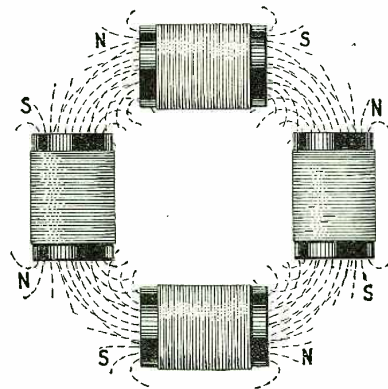

FIGURE 2
The nature of the toroid can be studied as an evolution from the cylindrical coil as shown by several of the latter arranged in a circle.

We have said above that the resistance of toroids is generally higher than the resistance of cylindrical coils. The reason for this is that in order to keep the overall dimensions of the coil within reasonable limits the coil diameter must be rather small. The coil diameter is to be distinguished from

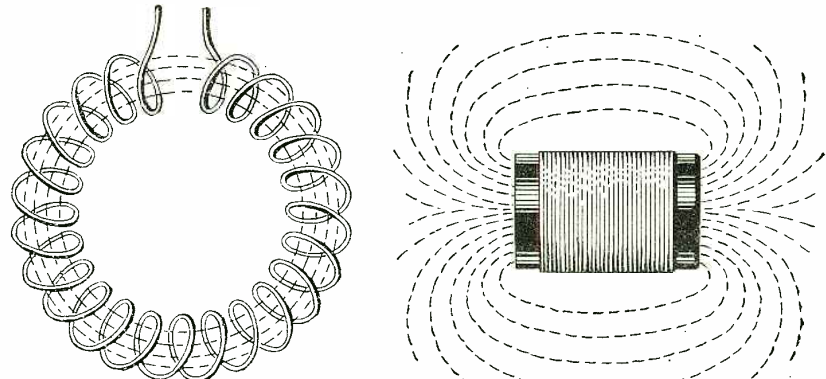

FIGURE 1

In this picture is shown how the magnetic field of the cylindrical coil sprays outward, while that of the toroid is confined within its windings.

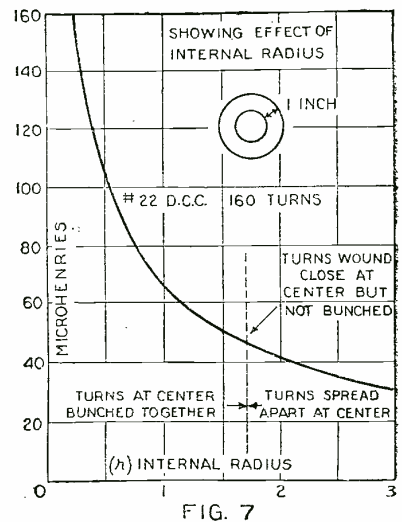

FIG. 7
It is seen from this chart that the greatest inductance can be obtained in a toroid for a given coil diameter, when the internal diameter is small, or when the turns are bunched at the middle.

the other, which I will call the ring diameter. This corresponds to the diameter of the hole of the doughnut. The small coil diameter makes it necessary to employ many more turns of wire to obtain the required inductance.

To investigate more thoroughly the toroidal coil and to understand what tendencies and paths to follow in their design, a number of calculations were made from formulas contained in Circular 74 of the Bureau of Standards. Curves obtained from these calculations are shown in the various diagrams on these pages.

First the effect of wire size was investigated. To make the calculations certain assumptions are required, and in this case it was assumed that the coil diameter was two inches. This is larger than is actually found in practice, but will be satisfactory for indicating the tendencies. At the center the diameter is so regulated that the turns just touch, without crowding or spacing. There is nothing out of the ordinary in this diagram excepting that it shows clearly that even with as large a coil diameter as two inches, a considerable number of turns is required in the coil to furnish the required inductances. For instance, 140 turns of No. 18 wire are required to give an inductance of 100 microhenries; and 162 turns of No. 24 D.C.C. wire are required for 180 microhenries.

(Continued on page 1472)

What Is "Distortion?"

By DR. A. E. ANDERSON*

In this article Dr. Anderson essays to analyze one of the most popular radio terms, "distortion" and establish the necessity of determining the type of distortion existing before the trouble can be remedied.

LAST season one of the most popular expressions in the radio vocabulary was "low-loss." In a similar way, this season "distortion" or "distortionless" bid fair to be the watchwords of the radio fan, and the battle cry of the manufacturer. The term "loss," of "low-loss" fame, has been proven to be a general term covering several kinds of losses—conductivity, eddy current, dielectric, leakage, etc. "Distortion" is even more indefinite because the reasons for the condition are far more numerous. The word should be used only in a general sense, and not as a description of a particular defect arising from a particular cause.

For example, it is correct to say, in commenting in general on a broadcast reproduction, "the music was undistorted" (or distorted, as the case may be), or "was distortionless." On the other hand the expressions, "my set distorts," "causes distortion," or "full of distortion," would not particularly enlighten a service man, who may be called upon to improve the quality. The natural consequence of such an assertion would be to provoke a question; such as, "What do you mean by distortion? Do you mean not clear, harsh, blastful, ragged, or an uneven amplification of all audio frequencies?" Wherefore the expression "distortion" must be refined, and qualified very materially, before any advice can be given for correcting the trouble.

As a pertinent word for expressing poor quality in a particular sense, "distortion" is entirely inadequate.

It is beyond the scope of this article to deal directly with the engineering design of the various instruments which constitute a receiving set, or to go deeply into methods of correcting the faults responsible for "distortion." Rather it is the writer's purpose to emphasize that "distortion" covers a multitude of sins, and to point out some of the most common types of "distortion."

Here is a list of some common troubles which make up "distortion":

- Wave deformity,
- Static,
- Microphonic tubes,
- Poor loud speakers,
- Poor contacts,
- Internal electrolytic action of "B" batteries,
- Poor broadcasting.

Of this list, wave deformity and poor loud speakers are most serious, and are themselves due to several contributing factors.

PREVENTION OF WAVE DEFORMITY

Wave deformity and its reasons are exceedingly complex. All in the above list are included, and the following faults also contribute: oscillation of both radio and audio circuits, or regeneration pressed too far; incorrect bias on grids of audio tubes; audio tubes of too small capacity; partial rectification by audio tubes; no grid leak for detector, or one of incorrect value; external heterodyne beats; tubes with irregular static curves; and poor audio amplifying transformers.

The effect of wave deformity is music or voice reproduction which is not clear, but difficult to understand, in which detail is lacking and extraneous noises are introduced. A slight deviation from true wave form is unavoidable, and barely noticeable; but greater wave perversion produces distortion to a greater degree.

"THE HEART OF THE RADIO SET"

The correction of wave distortion consists, of course, of removing the causes. Those enumerated suggest their own remedies; but, inasmuch as the audio amplifying transformer has been the centre of so much comment concerning distortion, it seems advisable to go into this particular cause in detail. The audio amplifying transformer can be called quite truthfully the heart of the receiving set. The signal quality is no better than the transformer will allow it to be. On the other hand, the transformers have been the butt of much undesired criticism.

The purpose of the audio amplifying transformer is to receive an input and deliver it to the grids of the succeeding amplifier tubes in exactly the same wave form as when received, but with a higher potential. If the exact characteristics of wave form are not preserved, "distortion" is to be expected. The tendency of most audio transformers is to raise the potential of the medium audio frequencies higher than those of the extremities. That is, frequencies between 250 and 3,500 cycles are favored, while frequencies below and above this range are slighted, so to speak. The result is a form of wave "distortion."

The better transformers very slightly favor the middle frequencies and do not neglect the extremes so much. The amplification curve of a good transformer will show only a slight gradual bend downward at the extremes. A poor transformer will have one or more peaks, and uneven amplification of

all audio frequencies is bound to ensue. A transformer combining a nearly straight amplification curve with one of high value requires a nicety of proportion and a careful selection of material. Coil dimensions, impedance, ratio and capacity must be kept closely within limits, and the size and permeability of the core must be accurately determined.

TRANSFORMERS UNJUSTLY BLAMED

It has been the author's experience to be told many times that a certain high grade transformer was "full of distortion"; when in reality the transformer was full only of carefully selected and shaped metals, sealed in wax. "Distortion" finally boiled down to "blastful," "weak" or "not clear." A few minutes of cross-examination generally

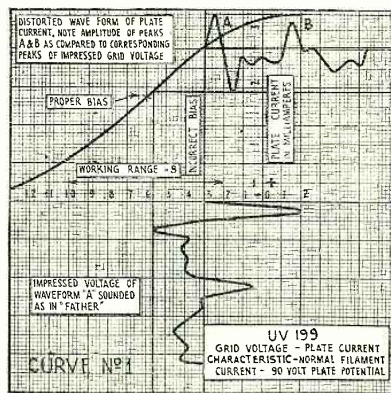

An ordinary static curve of the UV-199 tube, showing how an incorrect grid bias can cause severe distortion on strong signals. Note that the proper bias of -6 is higher than is commonly used with the UV-199. Since the working range is only 8 volts, larger grid fluctuations than this will overload the tube. Compare this curve to curve No. 2.

showed the trouble to exist in some other part of the set. This simply indicates how unjustly a transformer can be criticised; because, as a rule, it does its allotted work too well.

Whenever poor quality is received from an audio amplifier, it is well to be sure that the last-stage tube has sufficient capacity to carry the voltage impressed on it by the transformer without danger or becoming overloaded (which is the cause of "blasting"). It is quite easy to overload the small 199 tubes, or tubes of similar characteristics, especially on high power local stations. The 201-A will carry a greater grid voltage-change, but even this tube is sometimes too small for its function. A surprisingly large percentage of distortion in the audio amplifier, is due to tubes of too small capacity.

A receiving set constructed of all high-grade parts, and utilizing a good circuit, failed to give good quality on local stations but distant stations came in admirably clear and distinct. Substitution of the new UX 120 tube in the last stage (instead of the UV-199, which had been used throughout), cleared up the trouble immediately. Moral—don't send a boy on a man's errand.

STATIC

Everyone is familiar with the bugbear "static." While this form of "distortion" is transient, it is no less disagreeable. There is, at the present time, no known means for

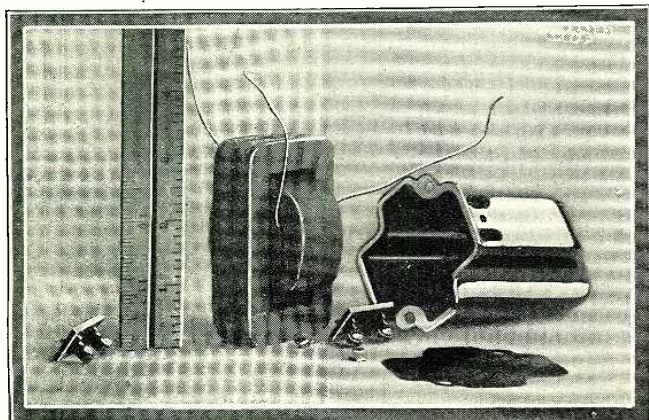

The inside view of an audio transformer of popular make showing the generous size of the cone and coil. Larger transformers are the result of improved design. As a general rule, a large audio transformer is necessary to incorporate the principles for achieving good quality.

* Chief Engineer, General Radio Co.

counteracting static completely. It can be reduced, however, by employing a small pick-up agency, such as a short, low antenna or a loop. Experiments with underground antennas indicate that static discharges are practically negligible. Unfortunately, the disadvantages of the underground antenna are such that its general adoption is impractical.

MICROPHONIC NOISES

Sustained audio oscillation, because of vibrating tube elements, is a particularly annoying phase of distortion. The small tubes, such as the 199, are very microphonic, and therefore should be mounted on some shock-absorbing material as, for instance, sponge rubber. Microphonic "distortion" is easily recognized because of the singing sound produced when the tubes are jarred. The sound-frequency is dependent on the mechanical size of the tube elements, which vibrate at their natural frequency when suddenly disturbed. The oscillation amplitude either gradually diminishes or else builds up to a height governed by the resistance of the circuit or the saturation point of the tubes. When the oscillation reaches its maximum strength it remains constant, until an outside influence disturbs the balance, after which it gradually dies away. The detector tube is usually the most troublesome, because the microphonic noises are amplified by the audio amplifier. The least microphonic tube should be used for the detector, the next best in the first audio stage, and so on. Radio frequency tubes do not amplify microphonic noises and therefore are least troublesome.

LOUD SPEAKERS

Loud speaker distortion is a subject for considerable comment and speculation, and as such cannot receive in this article all the attention that it deserves. However, a few of the major forms of loud speaker distortion will be touched upon.

Horn and diaphragm resonances are forms of "distortion" that affect quality very much in the same way, because one particular audio frequency is exaggerated in respect to others. The difference between the two types of resonance lies simply in the range of the frequencies they produce loudest. Diaphragm resonance occurs generally between 600 and 1,000 cycles, depending on the size of the diaphragm. Horn resonance, on the other hand, is usually below 500 cycles, depending on the size as well as the shape of the horn. Although horn resonance can be reduced and made to act broadly (as can also diaphragm resonance, to a lesser degree), it cannot be entirely eliminated. The metallic horn is fast disappearing because of its critical resonance-point; and wood, fibre or moulded composition, comparatively free from vibration, are taking its place. However, the recent appearance of the cone projectors shows that the trend is away from the horn type of loud speakers.

Diaphragm rattles, having a mechanical tone, are generally the outcome of a poor diaphragm adjustment. If the diaphragm is too closely adjusted to the pole pieces, vibration is restricted, and the diaphragm will strike the pole pieces if the loud speaker or

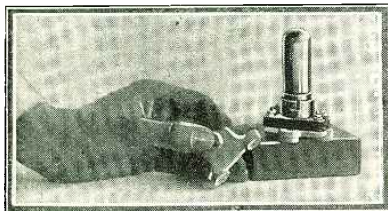

A soft, shock-absorbing cushion under the tube sockets will greatly reduce microphonic distortion. To avoid bracing the socket, small or flexible wire should be used in making socket connections.

telephones are energized to any great extent. This, of course, applies only to a reproducer constructed on the principle of the ordinary telephone headset. Those loud speakers employing a leverage mechanism to transmit the motion to the diaphragm are, as a rule, quite free from diaphragm rattles of this sort. All loud speakers having the disc type of diaphragm are subject to noises from diaphragms cracked or not rigidly clamped.

PROBLEMS OF DIAPHRAGM DESIGN

Diaphragm inertia is responsible for a non-uniform reproduction of all the audio frequencies. In this respect it is not unlike the effect of poor audio transformers. If a diaphragm is very small and light, its inertia is also small, and it can therefore respond more easily to the higher frequencies. Its disadvantage, however, lies in its inability to produce with equal volume the low tones. On the other hand, a larger, heavier diaphragm will act in the opposite manner; so that a compromise must be made on a size which will respond fairly uniformly to the best common audio range. The cone type of loud speaker has a type of diaphragm which automatically adapts itself to the energizing frequency. By this is meant that for the higher frequencies only the apex of the cone

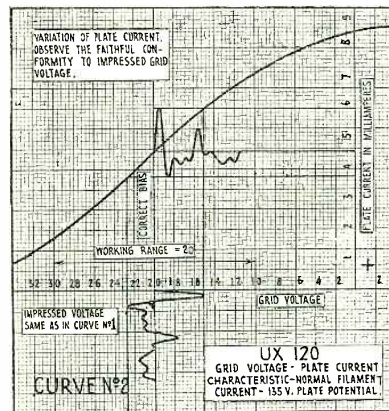

Static characteristic of the UX-120 tube. Note the high negative grid bias necessary. The large working range insures sufficient capacity to handle large grid voltage fluctuations without distortion.

is actuated, rather than its entire surface. As the frequency is reduced, the motion of the diaphragm covers a greater area; so that for the low frequencies, the whole cone is set in motion. Such an arrangement will reproduce more faithfully the great audio range of the full orchestra or an organ or piano.

BALANCING THE OUTPUT WITH THE LOUD SPEAKER

It has been definitely proven that for best quality and efficiency the loud speaker impedance should nearly equal that of the output circuit. Most loud speakers have an impedance in the vicinity of 15,000 ohms at 1,000 cycles, which is satisfactory for the output of the 201A tubes, or tubes of similar plate impedance. As the plate impedance varies nearly in inverse proportion to the plate voltage, it is a simple matter to adjust the plate impedance to match the loud speaker impedance. For loud speakers having a comparatively low impedance, this method is impractical, because saturation of the common types of tubes would be reached before the plate impedance would be reduced sufficiently. Therefore, either power tubes should be used in connection with low-impedance loud speakers, or else the loud speaker should be coupled to the output circuit through a compensating transformer. The use of power tubes insures a capacity large enough to carry, without blasting, the

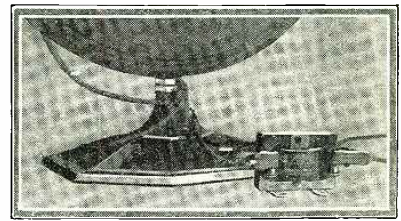

One type of adjusting transformer, designed to compensate for a known ratio of impedance between two circuits, shown in connection with a cone speaker.

voltage change in the last stage. Compensating transformers have the advantage of isolating the loud speaker from the plate current which tends to keep the diaphragm in a constant state of strain. Both power tubes and coupling transformers should be used, to attain both advantages; the coupling transformer should have an impedance ratio of one to one.

POOR CONTACTS AND OLD BATTERIES

Distortion from poor contacts is inexcusable, for it is one of the easiest forms to avoid, and its cure is self-evident. Sometimes the crackling and noisy quality of the reproduction suggests static. Should there be any doubt, the antenna may be disconnected and the quality then observed. This will check the set only. It should be made certain that the antenna is without loose connections and well insulated, so that no noises can be introduced from this source when reconnected again: the same also applies to the ground lead.

Quite commonly, when dry cell "B" batteries become old, the quality is impaired, due to a continual "frying" noise, which sometimes resembles loose connections or static. This form of distortion is due to the internal chemical action of the batteries, and the only remedy is substitution of a new supply. Susceptibility of the audio amplifier to howl is a form of distortion also made possible by the old dried-up "B" batteries. In this case the internal resistance of the batteries is excessive and a form of resistance coupling is brought about, causing an audio frequency feed-back. Storage "B" batteries of course, cannot cause distortion, provided that they are kept in good condition.

POOR BROADCASTING

Poor broadcasting is infrequent, but when it exists it is beyond the control of the listener. To determine whether or not the trouble is outside the set requires some experience and experimenting. The surest way to determine this question is to make a comparative test on other receiving sets. The majority of the broadcast stations, however, emit a wave much more pure and true than is ordinarily passed through the loud speaker cord or headset in the home of the listener. It is quite safe to say that there is a considerable gap to be closed, before reproduction will be of the same quality as the broadcast leaving the studio. In the meanwhile, study your set and make a careful analysis of the quality. Do not merely sum up bad quality as "distortion," but try to determine what is causing the distortion. If the technicalities are too great, do the best you can, by describing the trouble as clearly as possible to a capable man, who can probably end your difficulties with small expense, thereafter making your set a creator of pleasure instead of noise.

THE RADIO NOVEL

The radio may work all right for essays and historical treatises, but the novel—never! When hero and heroine quarrel, there simply must be a book so that one can turn to the last chapter immediately.

Baltimore Sun.

What Is Regeneration?

By KENNETH W. JARVIS*

Although there has been published, of late, much in condemnation of the regenerative circuits, nevertheless regeneration remains a most efficient method of increasing detection. This article is the first of two, forming a most interesting and readily-understood explanation of the theory and practice of regeneration.

ABOUT 1912 the circuits giving rise to the phenomena of regeneration were disclosed to the radio world. Since that date, the use of regeneration has been the biggest factor in the advance of radio communication. The advent of broadcasting popularized radio reception and created a demand for a cheap but efficient receiver. Regeneration enabled this demand to be satisfied—so much so that over half of the radio receivers used today are regenerative sets.

What does regeneration do to produce the wonderful amplification obtained in our radio receivers? How is regeneration affected by circuit conditions? What is the limit of regenerative amplification? Unfortunately, these, and many other questions relating to regeneration, were never satisfactorily answered until very recently. These answers have at last been obtained after many hours of research in one of the largest radio research laboratories in the world. It is the purpose of this article to present, in as non-technical a manner as possible, the reasons for regenerative amplification, and how we can make better use of regeneration by a better understanding of the principles involved.

Fundamentally, regeneration is possible only in a power amplifier. A crystal detector, as ordinarily connected, cannot be made to regenerate, as there is no power amplification. The crystal detector serves merely to rectify, not to amplify the radio signal. However, the vacuum tubes used in modern receivers are essentially power amplifiers, and so can be used as regenerators.

REGENERATION IS "FEEDING BACK"

Regeneration consists in taking a small portion of the output power from a tube and sending it back to the input side of the tube amplifier. This is shown diagrammatically in Fig. 1. The circle with the arrow inside represents the vacuum tube amplifier, and the arrow shows the direction in which the power is flowing. The incoming energy is represented by the stream A, a portion of the output power fed back is shown by B, while the power available for use in the headphones is shown by C.

There are many types of circuits making use of this feed-back, often masquerading under high-sounding trade names, but all can be reduced to a few fundamental circuits. A most important point is noted here. If properly constructed, the regenerative amplification with any one of these possible circuits is absolutely the same! None of the trick 'double-regeneration, or tuned plate-tickler combination methods will give a bit more signal than the simple tickler method, notwithstanding the claims for every new variation of regenerative amplification. This has been proven experimentally, and will be

evident from the very nature of regeneration as we proceed.

HOW THE "TICKLER" OPERATES

Fig. 2 shows the more common method of producing regeneration. This method is called the "tickler feed-back" method and is due to the inductive coupling between the plate and grid circuits. Any current flowing in the tickler coil produces a magnetic flux which links with the coil in the grid circuit and so transmits energy to the grid or input circuit.

Fig. 3 shows another method of power feed-back, this time by capacity coupling. As in Fig. 1, A represents the signal input, B the feed-back through the condenser, and C the available power output. This circuit is often called the Reinartz circuit.

Fig. 4 is another variation of capacity feed-back, and is known as the "tuned plate"

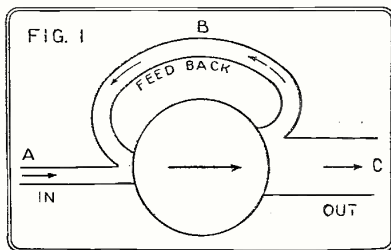

The above diagram shows how part of the output power is returned to the input, thus swelling the final volume of the output.

circuit. If a higher voltage is produced across the tuned circuit in the plate circuit of the tube than is impressed on the grid, a current will flow through the tube capacity between plate and grid. This current means that power is being transferred from the plate circuit to the grid circuit and regeneration is resulting.

This is the action taking place in the present day tuned radio frequency amplifiers. If a sufficiently large number of primary turns are used in the tuned transformer, a high voltage is built up across the primary which sends a current back through the tube capacity. This means regeneration and perhaps, oscillation.

ANALYSIS OF THE TICKLER

In explaining the action of regeneration some one of the possible methods of feed-back must be chosen. This is not due to the difference in the conclusions finally reached, for a consideration of any of the circuits mentioned produces the same results. For many reasons the tickler method of feed-back seems the best. A little closer analysis of this type of circuit is therefore desirable. The circuit has been redrawn in

Fig. 5, with one stage of neutrodyne radio frequency amplification ahead. This is done to eliminate the variables introduced by the antenna. The effect of the antenna will be considered later.

How is the power input to the grid circuit from the tickler obtained? It has been shown above that this is accomplished by the "cutting" of the turns in the grid inductance by the magnetic flux of the tickler. The relation of the tickler coil to the coil in the grid tuned circuit is exactly the same as that between the primary and secondary of a transformer. The action of the tickler, so far as power input to the grid circuit is concerned, can therefore be analyzed exactly as that of a transformer.

In calculations and explanations of transformers, the primary and secondary are resolved into what is called an "equivalent" circuit. In this circuit, the values of the secondary resistance and reactance are transferred to the primary and the combination analyzed as a simple series circuit. In the tube circuit, the secondary is "tuned" and consequently has no reactance. Thus, in this analysis, an "effective resistance" is transferred to the "primary" side of the transformer, i.e., the tickler side. The power lost in a resistance is equal to the current squared multiplied by the resistance. The power "lost" in the "effective resistance" of the tickler is the actual power transferred to the grid circuit to help the signal.

HOW REGENERATION VARIES

It is important here to show several quantitative relations. First, the "effective resistance" of the tickler increases as its coupling to the tuned circuit is increased. Second, the plate current (A.C.) varies almost directly as the grid voltage. (The plate current is nearly independent of the tickler's "effective resistance," as the plate-filament resistance of the tube is so large in comparison.) Therefore the power fed back (regenerated) into the grid circuit is directly proportional to the tickler coupling and almost so to the square of the grid voltage.

As is well known, both the coils and the condensers used in our radio receivers have resistance, which causes a power loss in the grid circuit. The loss in the tuned circuit, however, is not the only one, for one of the greatest sources of loss in a radio circuit is right in the grid-filament circuit of the tube itself. The power loss in these two places varies about as the square of the voltage on the grid. This grid voltage will be designated hereafter by the term E_g .

Now if the tickler coupling is increased until the feed-back of power is equal to the power lost, at some specific value of E_g on the grid, the tube will be capable of supplying all of its own losses and will begin to

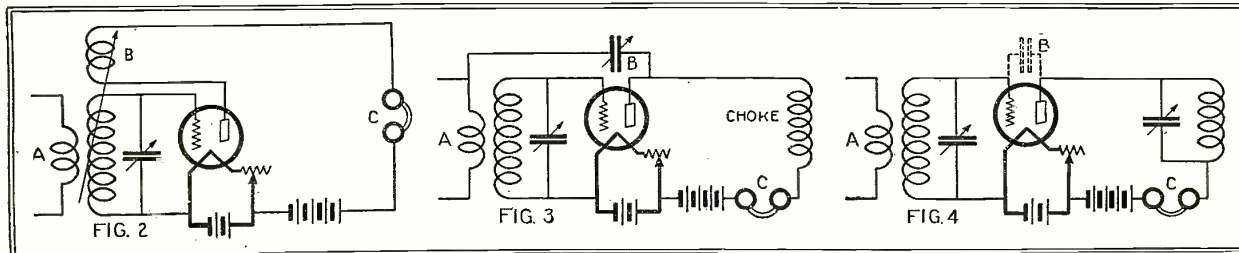

Fig. 2 is the common method, or "tickler-feed-back," of producing regeneration. Figs. 3 and 4 are two "capacity-feed-back" regenerative circuits, the latter being the "tuned-plate" system.

* Engineering Department, Crosley Radio Corp.

Shielding Radio Receivers Gains Favor

By HERNDON GREEN

THIS season has shown a tendency among the manufacturers of a radio receivers toward shielding either of the different radio stages or of the complete set. There are several methods used; some manufacturers shield each stage separately; others do not go to this extreme, but shield either the entire set, or the coils alone. Which is the better practice to follow has not yet been fully decided, although there is much to be said on either side.

The first thing to consider is why shielding is necessary, or whether it is necessary? In the past we have been able to make radio receivers operate very satisfactorily without shielding. Why then the recent advent of shielding?

There is no doubt that many times considerable inconvenience and difficulty has arisen because of body capacity, or inter-stage coupling, or both. Inter-stage coupling tends to reduce the over-all amplification

times did not prove satisfactory. At first, when the coils were shielded by placing them in cans, the absorption of energy (by reason of the eddy currents established in the metal

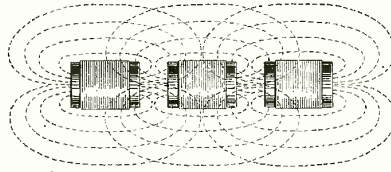

of which the cans were made) far over-balanced the advantages which were expected from the shielding. Later on it was found that shielding the entire set resulted in an improvement, in that the pick-up of signals by the coils and wiring in the receiver was eliminated. This is of special

stations a difficult and exasperating matter.

When the set as a whole is shielded, there is generally no difficulty experienced from absorption of energy by the shielding material. This is because the shielding is so far removed from the coils and condensers that, although there is actually some absorption, it is reduced to a very small amount.

Shielding the entire set, however, does not prevent inter-stage coupling, which results from one circuit linking the magnetic flux lines emanating from another circuit near it. The only way to prevent such inter-stage coupling is evidently to shield each stage separately. But the difficulty in doing this lies in the fact that there must be sufficient separation between the shielding and the apparatus which it shields; otherwise there results the absorption of energy to which I referred above. When individual shielding

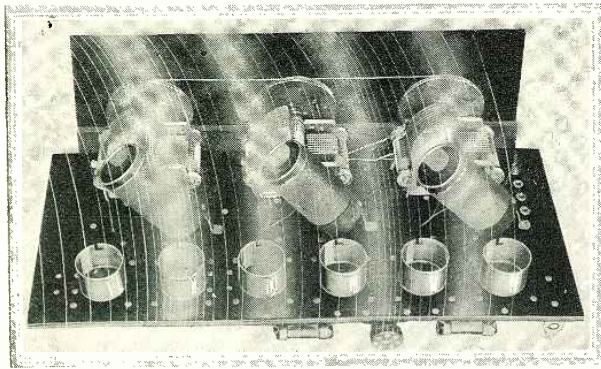

The diagram above shows, in exaggerated fashion, the manner in which R.F. coils produce feed-back due to inter-stage coupling. At the left it is indicated how the radio waves, passing over the coils and wiring of the set as well as over the antenna, influence materially the operation of the receiver. The waves picked up by the second stage obviously are not amplified in the first stage. Moreover, this is a common source of interference from locals, when tuning in distant stations.

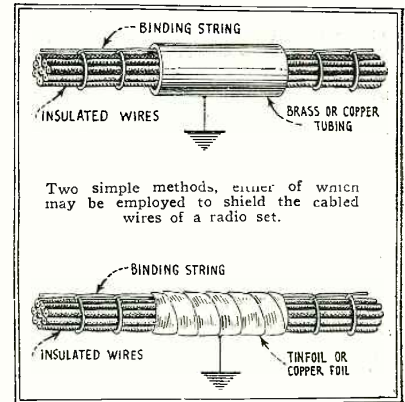

Two simple methods, either of which may be employed to shield the cabled wires of a radio set.

of the receiver, as well as to cause it to oscillate. When this tendency toward self-oscillation is present, special means must be employed to control it; and foremost among these methods is that of cutting down the coupling between the stages by reducing the number of turns on the primary of the tuned transformer.

This reduction of the number of primary turns is not always a good thing. In most cases it also reduces the energy transfer between the stages, so that the efficiency of the receiver is impaired considerably. This is perhaps one of the most potent reasons why so many of the tuned R.F. receivers are poor distance getters, and compare so poorly with the simple regenerative receiver, in spite of the fact that the former system generally uses five tubes and the latter three.

There is a certain optimum number of turns to use on the primary coil of the resonance transformer, in order to obtain the greatest energy transfer between the adjacent stages; and rather than cut down on this, the efforts of many investigators have been directed toward reducing the inter-stage coupling by other methods. One of the earliest of these attempts was made by mounting the coils at special angles to each other. Although this resulted in a little improvement, it did not prove entirely satisfactory. The main reason for this is that the exact angle was not known. The angle at which the coils must be set to obtain the least coupling between them depends on the geometry of the coils, that is to say their length, diameter, and the distance between them.

Later on shielding was tried, but many

advantage when the receiver is located in a city where there are a number of broadcast stations. There are no doubt many who are able to pick up the locals with their receiver when their antenna is disconnected. This is due to the wiring of the set, and may happen even when the tuned circuits are not in resonance with the local station. Evidently this must result in considerable interference, and make the tuning of distant

of the separate stages is used, then, either the shielding compartments must be rather large, or the coils and condensers rather small. Small coils must be made of fine wire, so that we are here between the devil and the deep blue sea, and must strike a compromise. The use of very fine wire may result in a high-resistance circuit, so that this may also counteract the good effects we expected from the shielding.

(Continued on page 1466)

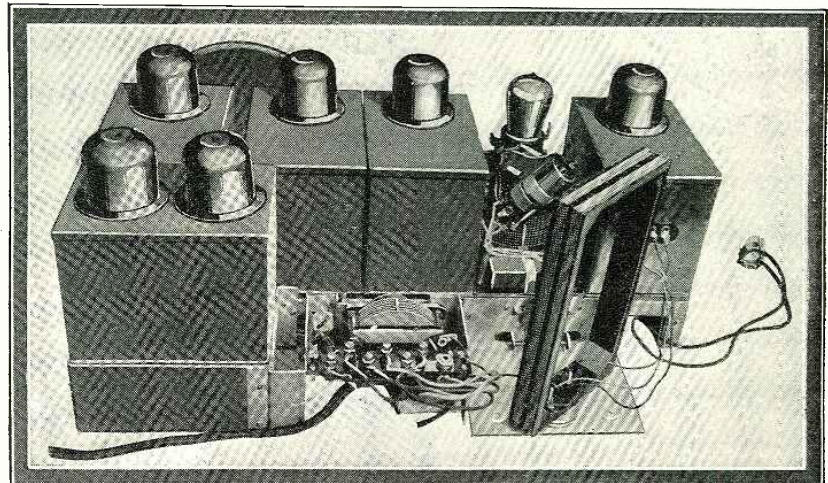

Here is a recent receiver in which the stages are separately shielded by metallic compartments, eliminating simultaneously coupling between stages, and the interference effect illustrated above.

Radio Wrinkles

MAXIMUM-MINIMUM STOPS FOR VARIABLE CONDENSERS

The only way to be certain that the dial of a radio receiver works in exact synchronism with the rotor plates, is to have maximum and minimum stops on the plates themselves, and not on the dial. Otherwise, when the dial reads zero the plates may be a bit above zero, and some of the tuning range will be lost.

Rigid metal stops are unsatisfactory, as an unintentional turn past the maximum or minimum position may bend the stop or, what is more serious, warp the plates.

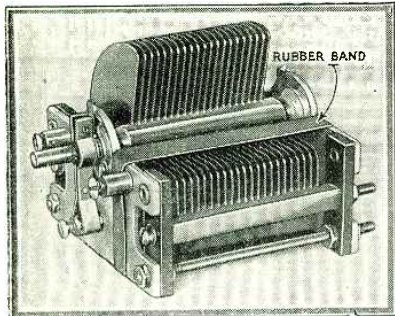

By using a heavy rubber band as a stop for the movable condenser plates much trouble will be saved.

A method of providing stops which does away with the above disadvantage is shown in the accompanying illustration. A rubber band is slipped over the stator plates in the manner indicated. This provides an exact stop at the maximum position; and in most condensers gives an accurate stop at the minimum position as well. This depends, however, upon the normal separation of the plates in the minimum position.

When a straight-line frequency condenser is used, it is necessary to locate the band quite near the shaft, if it is to be a minimum stop as well as a maximum.

One of the principal advantages of this scheme is the fact that, although the band tends to stop the plates at exactly the maximum position, no harm is done if the dial is turned past the last graduation, because of the flexibility of the rubber.

Contributed by Samuel Bond.

EASILY-MADE TUBE PROTECTOR

The writer has devised a little instrument which can be made by any fan at a very small cost. This tester shows if there is a short circuit in the receiving set.

The construction of this "tube saver" is

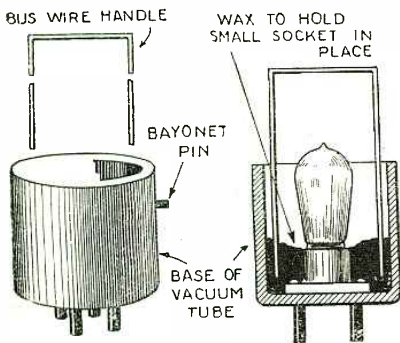

By using an old vacuum tube base, a miniature lamp and socket an efficient tube protector can be easily made.

very simple, as reference to the accompanying diagrams will show. The materials needed are:

- 1 piece of heavy bus wire, 5 inches long,
- 1 old "B" battery,
- 1 old vacuum tube,
- 1 8-volt flashlight lamp, with socket.

First of all the bus wire is bent in the shape of a "U" as shown in the drawing. The next thing is to take a burned-out vacuum tube and break the glass. The elements are then broken off until only the base remains. Locating the filament prongs is the next step. They are directly opposite the side where the "bayonet pin" is fastened. Wires from these two filament pins are run to a small flashlight socket. The plate and grid wires are removed. It will be found that a Christmas tree lamp socket will be very satisfactory. Solder all connections. The handle of the unit is placed in the base of the vacuum tube socket. A torch or other heat is used to melt pieces of sealing wax taken from an old "B" battery. As the wax melts, pour it into the vacuum tube socket, being careful, of course, not to pour any into the flashlight socket inside. Keep pouring until you have the old tube socket completely filled. The handle will be imbedded securely when the wax hardens.

When you want to use the tester, insert the small 8-volt flashlight lamp. Suppose you have just completed wiring a receiver. Before placing the vacuum tubes in their sockets insert the tester.

If by any chance you have the "B" batteries connected across the filaments, the small lamp will burn out. As these lamps are inexpensive, it is better to have this lamp burn out than the filament of a more expensive tube.

If you wish to use the tube saver only as a guard against connecting the "B" battery across the filaments, the 8-volt lamp will be the only one necessary. However, if you are not certain of your "A" battery voltage, a lamp which is rated at 1½ volts would serve to show whether your battery is correct, for a dry cell tube, such as the "WD-11." A 6-volt lamp could be used to show whether the voltage is right for the large 6-volt vacuum tubes.

Contributed by H. B. Closson, Jr.

VERNIER ADJUSTMENT FOR TAND-DEM CONDENSERS

Experimenters who have built receiving sets, incorporating tandem condensers have found it a very difficult task to make the two circuits controlled by the "siamese" actually synchronize over the whole scale. Even if the two capacitances are almost equal at all settings, it is a difficult job to construct two coils so identical that they too will balance up over the entire scale. In practice we must be prepared to face the probability that the two circuits will tune several kilocycles apart at certain portions of their range.

This is usually compensated for by using a vernier condenser in parallel with the one that has the lowest reading. But this system has one disadvantage. Assume that a station on 900 kilocycles is being tuned in. The tendency, if the circuits are 4 kilocycles out of synchronism, is for one to tune 2 kc. high, and the other 2 kc. low for maximum response on the original setting. This means that both the vernier and the master control must be juggled before both circuits are brought to 900 kc.

Tuning is much simplified if a vernier is used which increases one circuit's frequency and decreases the other simultaneously, and to the same degree. Thus, in the above case, if the vernier subtracts 2 kc. from one

and adds 2 kc. to the other, the complete tuning operation is done in two movements. First set the main dial for maximum response; then set the vernier for peak volume

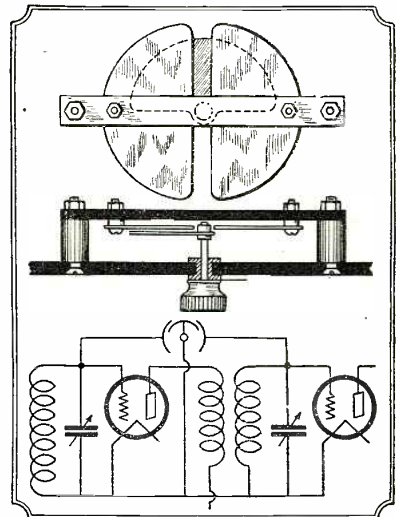

An excellent accessory can be made, as shown above, for the balancing of a radio frequency amplifier. Three condenser plates are necessary.

It will be found unnecessary to touch the main dial again, as is always necessary when the vernier controls only one of the circuits.

The construction and connection of such a vernier is shown in the accompanying sketches. As shown, it is mounted directly on the panel between the two condensers to which it is connected. The maximum effective capacitance may be varied to suit the needs of the specific circuit by varying the height of the two mounting posts.

Contributed by Elbert Fowler.

A SELF-RENEWING VARIABLE GRID LEAK

A disadvantage common to almost all variable grid leaks now on the market is the fact that the "slider," or variable contact

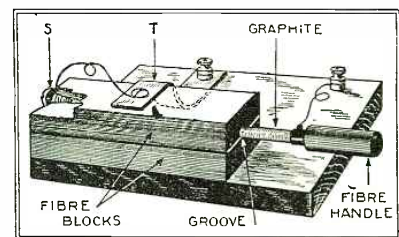

The parts for this excellent grid leak can be found around any work bench, and it will prove a satisfactory instrument.

member, of the leak gradually wears away the resistance strip, and causes the resistance to rise to a point which makes adjustment very difficult. As the resistance element consists in most cases of a thin coat of india ink, or of an even more fragile pencil mark, the reason for this wearing can be understood readily.

The accompanying illustration shows how an excellent grid leak may be made out of the graphite from an old pencil, some scraps of fibre, and a piece of spring brass. A groove is made in the base with a triangular file, and another in the upper piece of fibre.

The pencil lead from a heavy pencil runs in these grooves. At the start the upper groove should be well leaded, and contact made by flowing india ink over the end of the leaded portion and to the small brass screw S. This in turn is connected to the brass tension spring T by a small wire; and one binding post serves both to make final connection to the set and to hold the tension strip.

The other contact is made to the sliding rod direct. The easiest way to do this is to copper-plate one end of the graphite pencil lead by partially immersing it in copper sulphate, connecting it to the negative pole of a dry cell, and putting a copper wire from the positive pole into the solution as well). The resultant action will deposit a thin coat of copper in a few minutes. A flexible wire may be soldered to this and connected to the other post. The handle consists of a small bit of fibre rod drilled and cemented over the end of the pencil lead.

When in operation the graphite on the contact rod tends to rub off little by little and adhere to the contact piece, thus making the leak self-renewing.

Contributed by Will Griffin.

USES FOR DISCARDED FORD COIL VIBRATOR HOLDERS

When the platinum contact of a Ford spark coil vibrator burns off, a piece of stiff brass in the shape of a T is discarded. This piece, shown at Fig. 1, has many uses, a few of which follow:

1. *A Bushing for Varico-couplers.* Bend the whole piece in the shape of a "U," after drilling a 1/4-inch hole about 5/16 inches from the "T" end. The addition of a small coil spring makes a bushing almost identical with those used on a well-known commercial tuner. The method of assembly is shown in Fig. 2. This solves the most difficult problem in the construction of a home-made variocoupler.

2. *Coil Mounts.* Pieces bent in the same shape, but without the extra hole prescribed for the bushings described above, may be used to mount coils on the back of a variable condenser, or on the panel, as shown in Fig. 3.

3. *Mounts for Binding Post Strips.* Two such pieces, with the tops bent in a direction opposite to that prescribed above, may be used as supports for binding post strips at the back of the set. Fig. 4 shows the exact method of bending the strips.

4. *Bearings for Extension Shafts.* When instruments are located near the back of the set, to avoid hand capacity effects, or crowding, extension shafts must be used. These may be kept in alignment by means of bearings located midway, as shown in Fig. 5. This, it will be seen, requires no extra drilling whatever.

5. *Connectors for Dry Cells.* By cutting off one of the bottom lugs, as shown in Fig. 6, the brass vibrator pieces may be made into neat dry cell connectors.

7. *Grid Leak Clips.* The bottom portion alone may be cut off and bent to form an end mounting for a grid leak cartridge, as shown in Fig. 7.

Contributed by Alexander R. Appelman.

QUICKLY-MADE PANEL LIGHTS

Those who have radio receivers with tubes mounted on the front panel may make the tubes themselves serve as panel lights by the simple procedure of painting the top and end of each tube with black insulating varnish, or some similar substance: Due to the

DARK PAINT ON TOP OF TUBE

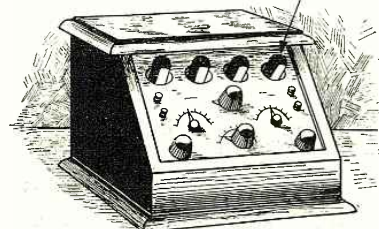

By painting exposed vacuum tubes with black insulating paint, leaving a small window unpainted in the lower side, panel lights are easily made.

fact that the top of the tube glows more brightly than the reflected light on the panel, the tubes in their normal condition make the dials harder instead of easier to read. But, with the direct glow screened

away, the panel light is quite satisfactory. The silvering on the inside of the tubes reflects the light, which would otherwise be blocked by the plate of the tube, back toward the base and then downward.

Contributed by Samuel Bond.

AN EASY METHOD OF "THREADING" SPAGHETTI

The home builder is well acquainted with the fact that spaghetti is apt to come just enough under size to make it very difficult to cover a long piece of bus bar without

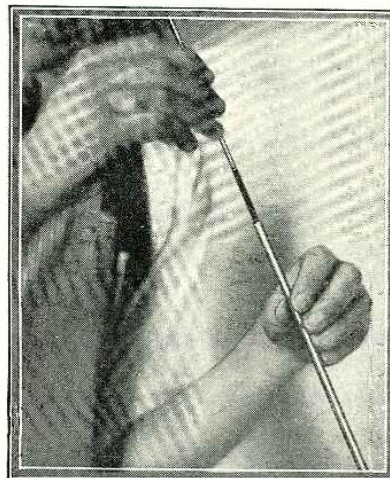

By using a piece of copper tubing, shown in the operator's left hand, spaghetti may be easily pushed over bus bar wire.

bending it badly out of shape, and wasting much time and patience. The usual method of forcing it on, a half inch at a time, becomes particularly irksome to the man who makes sets to order, or to the experimenter who changes his apparatus constantly.

I have found a very simple and useful method of getting the spaghetti over the wire. By using this method a complete length may be slipped on in ten or fifteen seconds, that by the usual push and pull method would take ten times as long.

Procure a length of copper tubing, 3/16 inches inside diameter, and as long as the pieces of bus wire in use. This will probably be 24 or 30 inches. Start the spaghetti over the end of the bus wire for an inch or so. Then slip the bus wire into the tube and the spaghetti may be pushed on rapidly, the tube serving as a guide and preventing the development of kinks.

The real advantages of this method can hardly be realized until it has been tried. It may sound unimportant on paper, but the best evidence of its use is the fact that on my suggestion it has been adopted by one of the foremost research laboratories in all its constructional work.

Contributed by Elbert Fowler.

AN INEXPENSIVE AUTOMATIC SWITCH

It is a well known fact that the life of a transmitting tube is reduced considerably when the filament and plate voltages are applied simultaneously. The high plate potential should be applied a fraction of a second after the filament is lighted. This would necessitate the throwing of two switches every time the transmitter is operated, a great nuisance.

At my station I use but one D.-P. D.-T. switch, one pole of which connects the antenna to the transmitter, while the other pole closes the circuit to the filaments and starts an automatic switch which applies the plate voltage a moment later.

The solenoid S of the automatic switch

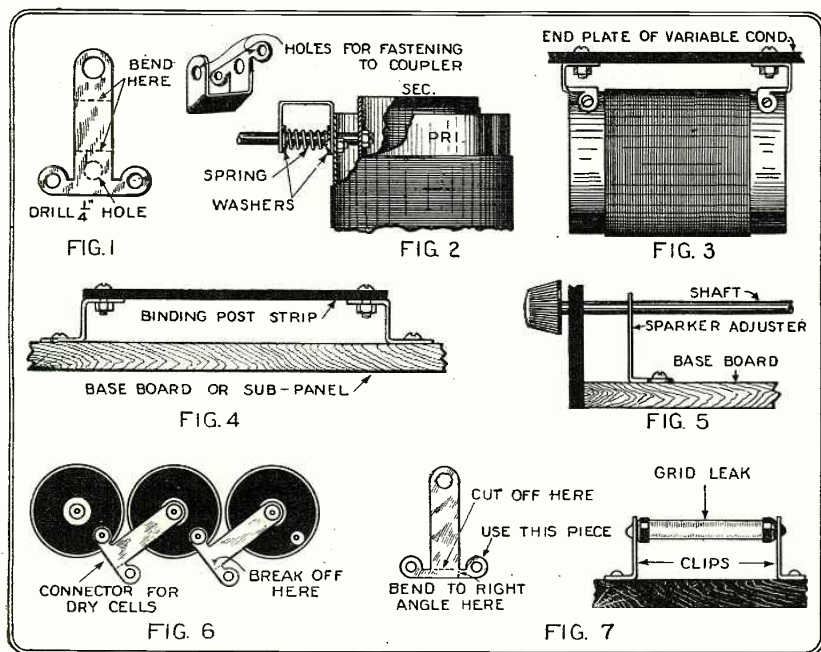

The above sketches show how radio parts can be made from discarded Ford coil-vibrator holders.

(Fig. 1) was made by soldering two metal washers to the ends of a brass tube and winding the tube full of wire from the secondary of an old Ford spark coil. The

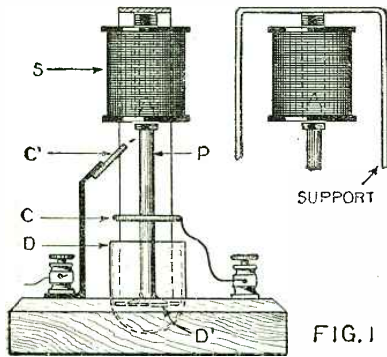

Detailed construction-drawing of the automatic switch, which is simple to build.

solenoid is mounted in a vertical position directly above the dash-pot D. This was made by filing off the end of a test tube and cementing it into the base. The plunger P is an iron spike with the disc D' soldered to its head and with its other end well insulated. In the center the silver coin C is

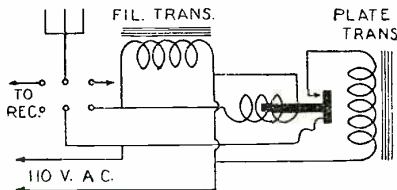

FIG. 2

How the automatic switch may be connected in the power supply circuit of a vacuum tube transmitter.

soldered together with the flexible connection.

When the current is turned on, the plunger rises so that the contact C meets the contact C', thus completing the plate circuit. The speed with which the switch acts depends upon the thickness of the oil used in the dash-pot, or it can be regulated by a resistance in series with the instrument. Connections for the switch are shown in Fig. 2.

Contributed by Edward Binns.

A METHOD OF CABINET CONSTRUCTION

As every home radio builder knows, the cabinet is the most difficult part to be constructed if a really decent-looking set is desired. A very efficient and simple method of building a cabinet is shown in the accompanying illustrations.

The corner posts are the keynote of this method of assembly. These, for the average set, will measure 1 1/2 x 1 1/2 x 7 inches. Oak, or some other wood which suits the particular taste, may be used. Grooves are cut as shown in Fig. 1. The width of these will depend upon the thickness of the veneer or panel material used. They should have a depth of about 5/16 of an inch. If you prefer to make a cabinet with space for "B" batteries the arrangement shown in Fig. 3 may be used. In this case six or eight posts will be needed instead of four. The space allowed for the "B" batteries would be at least 4 1/2 inches wide and seven or eight inches long. Its exact dimensions should really be planned to make a snug fit with the actual batteries used.

The back and ends of the cabinet, and the fronts of the battery compartments, may be made from thin wood veneer of any appropriate kind. This wood may be identical

with that of the posts, or it may be selected to form a pleasing contrast. The front panel may be of Bakelite, Formica, Radion, Celoron, or some other special insulating material; or it may be of wood or some non-magnetic metal. This choice depends upon the desires of the individual builder, as well as upon the instruments to be incorporated into the set.

The top and bottom may be formed of one-inch stock, cut with square edges or rabbeted, as desired. The upright posts should be fastened to the base by means of screws passing up from the bottom. The panels may be slipped into the slots and fastened in no other way; or they may be glued or screwed in place. It is advisable in all cases to leave the front panel free, so that it may be removed when necessary. The hinges for the top should be fastened to the corner posts rather than to the veneer.

Contributed by A. Douglas.

A CABLE CONNECTOR FOR "A" AND "B" BATTERIES

When one desires to use two or more radio sets on one set of batteries, or when it is necessary to move one set for any reason, a detachable connector which breaks all circuits in one operation is a great saver of time and error.

Such a connector can be made at home in the following manner: Take an old tube (the peanut size is handiest) and remove all glass and cement from the base. A metal base is not suitable; use a bakelite one if possible. Solder the wire from the detector,

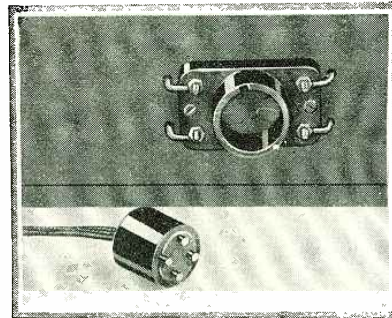

This illustration shows the vacuum tube base, to which is soldered the battery leads, and the tube socket on the set's rear panel.

or 22-volt contact of the "B" battery to the grid contact point of the base, passing the wire down through the base. Solder the

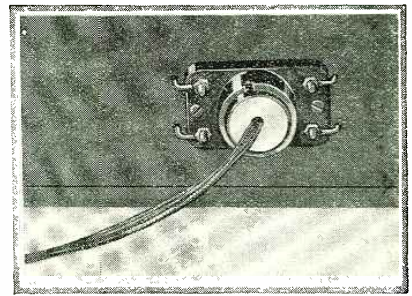

When the tube base is inserted in the socket the batteries are connected quickly and correctly to the receiver.

B — and A + wires to the plus filament contact of the base. The B + 90-volt wire goes to the plate prong, and the A — wire to the filament minus prong.

Fasten a vacuum tube socket to the back of each of your sets, and connect wires from the binding screws to the instruments within the set, or to the binding posts of the set if there are any. The A + and B — leads go to the positive filament post on the socket; the A — to the filament negative of the socket; the detector plate to the grid of the socket, and the plate leads of the amplifier tubes to the plate post of the socket.

The ground and aerial may be connected by an ordinary electric light plug of the "straight pull" type, such as are used on electric irons.

Contributed by John C. Hughes.

METHOD OF FIXED CONDENSER CONSTRUCTION

A bad fixed condenser is quite the easiest piece of radio apparatus that the fan can make. A good one is very difficult to construct. A condenser that does not form a rigid unit when completed will give rise to all kinds of microphonic noises, and will prove more of a drawback than a help. Yet a rigid one usually is a complicated instrument to make at home.

The illustration shows a method of constructing condensers which are both simple and highly efficient. It may be used for condensers of any capacitance desired, within reasonable limits, but is especially useful in making small ones for grid condensers, etc.

Procure a rod of some insulating material, two sheets of copper foil, and a sheet of mica. The foil and mica should be one (Continued on page 1499)

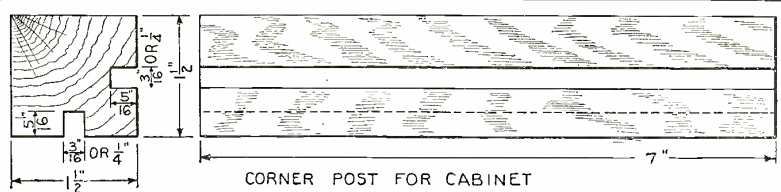

FIG. 1

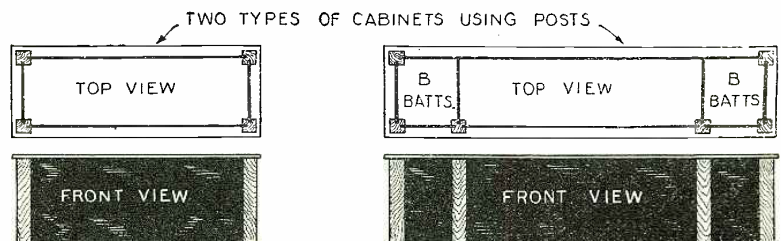

FIG. 2

FIG. 3

The cabinet housing a set is no unimportant factor, as it is "the part that shows." The above drawings should prove useful to the set constructor.



Regarding Noises

By JACK MILLIGRAM

LOOK at the title of this article again, fellows, and then think a minute. When we come to consider noises in general, don't we really find that we, ourselves, are causing a lot of them that are not only unnecessary, but detrimental to our own progress and to our own work? There certainly are a lot of noises on the air today—and they cannot be called any-

actually filters a little. The "Six" that you heard undoubtedly was using something on the order of a so-called brute-force filter (see Ballentine if you don't believe me). A filter of this type (refer to Fig. 1 here), will usually succeed in smoothing out some of the worst possible notes; and if it is used in connection with a properly tuned set, you will soon be surprising yourself by

at least 30-henry size or preferably a 40 or a 50. The condensers C and C₁ should be identical in size, and may consist of one or more capacities. If so, they are of course connected in parallel. The capacity of the two units, C and C₁, should be at least 2 μf. each; 4 μf. will probably be found better, and of course capacities between these two may also be employed. In any event, a filter consisting of a 30-henry choke and 8 μf. capacity will usually smooth out the most refractory note that it is possible to pull out of any rectifier in existence. In Fig. 1, no transformer or rectifier circuit is shown, because this is left up to you. You are probably using some type of rectifier at the present time, and so a filter system like the one shown can be added to your installation without any other changes.

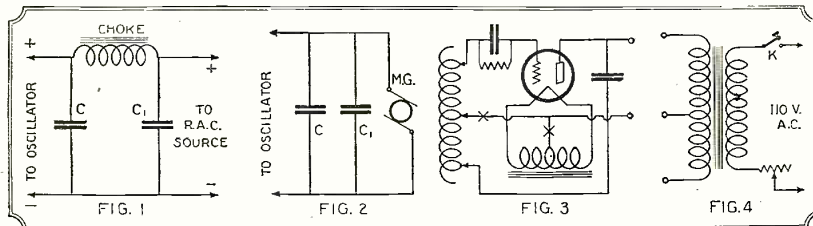

Fig. 1 above shows how to connect a filter to obtain that much desired D.C. note. Fig. 2 shows how to filter a motor generator. Fig. 3 indicates the two worst possible keying connections; while Fig. 4 shows the very best of any that can be used. If you use a good filter and key properly, you will get out better, and furthermore will not trouble the BCLs.

TAMING THE MOTOR GENERATOR

Motor generators are supposed to be the berries for a pure D.C. note, but how often is a note of this sort produced by a set using an M.G. without any filter? Darn seldom. The commutator ripple of an M.G. is just about as bad as an A.C. note, unless of course the machine is of a 500-cycle type. There are few of these in existence, however, and the majority of M.G.s. used pro-

thing but noises—that, with a little work and expenditure of time, could be eliminated to the benefit of all. The two noises I am going to rave about in this particular symposium are rotten notes and key clicks.

Let us take these up in the order that they are mentioned above, talk about them a little bit and decide on some remedies. If you do not believe that there are some terrible notes on the air, get your head under a headband and tuck a pair of cans up close to your ears, and listen in on any one of the ham bands. What do you hear? Occasionally a good strong, clear, whistling note pounds through like the proverbial ton of bricks; and, waiting for the signature, you find that it is a "Six" hitting the ether with so few watts input that if he were operating with the same power years ago, he wouldn't be heard as far as you can throw a power transformer.

Then fish around a little bit and pretty soon you will hear something that resembles a decrepit buzz saw in the last stages of asthma. He makes a lot of noise but the least little bit of static or QRM from some nearby station jams him so badly that he can hardly be read. He sounds as though he was using raw A.C. directly on the plates of his tubes, and in all probability he is. When he signs off you find that he is a "Three" or a "Four," and using a lot of power at that. Probably the brass pounder that you have just been listening to is sitting back in his shack and wondering why in heck he couldn't work some "DX." No wonder he can't! With a note that sounds like a cross between a thunder storm and a lion in distress, how can he expect anyone to copy a note through any of the QRM or QRN that is found in the ham bands?

A SURE-ENOUGH FILTER

What's the answer? Usually nothing more or less than the installation of a filter, that really does the job that it should, and

up a "DX" record that will give you writer's cramp to copy off when you want to send it into the "Calls Heard" column.

To operate properly a filter of this sort, the choke coil shown in Fig. 1 should be

(Continued on page 1474)

Here is a station that we are willing to bet, has a pure D.C. note. Usually workmanship of the type exhibited means a station that turns out the best possible kind of results. These results cannot be the best if the power supply is not pure and if the set is not properly tuned. Fellows, heed the advice given in this page and help others by helping yourselves at the same time. Your work will be conducive of good fellowship with other hams and with the BCLs. Let's go for better notes and keying.

Illustration of 1XZ. station of the Clark University Radio Club, Worcester, Mass.
© The Gilliams Service.



—RADIOTICS—

FOR THE BEAUTY PARLOR



Fashion note from QST for January. In the advertisement of the Randolph Radio Corp. there is mentioned a "Columbia Long WAVED Transformer." Can't you girls just hear Rosebud at the beauty parlor trying to persuade Miss Transformer to get a "permanent!" instead of bothering with a Marcel every week? Yes, girls, it's a tough world.

Contributed by Arthur Harrison

IN NOTHING FLAT

Latest battery-charging information from the Muskegon, Mich., Chronicle of Dec. 24, in an advertisement selling a "NON-TIME Battery charger." Believe me, you radio fans, that's the charger we have been on the trail of. Think of it, just throw the switch in and then yank it out—battery all nicely pepped up.



Contributed by A. D. Seaman

BELIEVE IT OR NOT



Advice dispensed by the Family Herald and Weekly Star, Montreal, Can., on Dec. 2: "Your PHOTOGRAPH will certainly not reproduce broadcast music unless the proper attachments are used." Well, well, here's a use at last for the tintype of dear old Grandpop. Just trim to size and use as the diaphragm of the loud speaker.

Contributed by K. M. Rayner

PARENTS PLEASE NOTE

Advice for the care of infants from the Newark Sunday Call, Jan. 3: "SHORTING TWINS in Arkay Radio Stops Squealing." We are sorry that we can't check up this information but the twins in our family are still conspicuous by their absence. Will someone let us know if the method is efficient.



Contributed by W. B. Morningstern

THUMBS DOWN ON THE MOUTH ORGAN

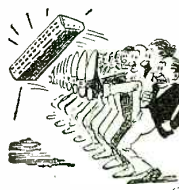

The Radio World of Jan. 2 carried the distressing news that "Stations Join Hands to Eliminate HARMONICAS." No longer, if these stations succeed in their plan, will the strains of "Little Annie Rooney" and other classics seep through our windows at night from the musical gang on the corner. We regret such a catastrophe.

Contributed by I. S. Zeluff, Jr.

FROM THE RUBBER TREE?

On Dec. 19 in the Peoria, Ill., Star appeared this pulling advertisement: "Radio Cabinet for sale. WILL FIT MOST ANY SET." Now who cares if they make a mistake in the layout of their panel or baseboard? Just use one of these Stretch Cabinets and make 'em fit. It's a cinch!

Contributed by R. S. Mandelkorn



RECEIVERS A LA SING-SING



New styles in sets as advertised by the Daily Oklahoman of Dec. 20: "STRIPED RECEIVERS. \$39.50 to \$115." Maybe these sets are modeled after the festive zebra or perhaps there is a new method of tuning, using stripes instead of wavebands. That's the trouble with some of these advertisements—they're rather indefinite.

Contributed by Albert O. Romine

GIDDAP, NAPOLEON!

On page 48 of the Radio Guide for December reference is made to a "magnet unit of the BI-POLO type." A team of hard-riding, hard-hitting magnet units ought to attract as many people to Meadowbrook as H.R.H. the Vagabond Prince, himself.

Contributed by Will Griffin

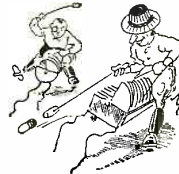

FOR BUCKING THE STRIKE



Household hint from an advertisement in the St. Louis Post-Dispatch of Dec. 6: "1926 model Kenmau, wonder of radios—2 TON cabinet." This evidently is for the lucky fellow who has some coal to store in his cellar. We suppose that the coal-man has to be entertained these days as he heaves it in.

Contributed by L. Harold Shelton

ELIMINATING THE MALE INTERFERENCE

In the Radio Review for December, 1925, is some information for the girls: "The first step to be taken in the elimination of the HIM is to pass the current through a filter." Now you more deadly of the species, try and find out what kind of a filter this is. Us guys has gotta stick together and I won't tell, believe me!

Contributed by Everett Brozov



If you happen to see any humorous misprints in the press we shall be glad to have you clip them out and send to us. No RADIOTIC will be accepted unless the printed original giving the name of the newspaper or magazine is submitted with date and page on which it appeared. We will pay \$1.00 for each RADIOTIC accepted and printed here. A few humorous lines from each correspondent should accompany each RADIOTIC. The most humorous ones will be printed. Address all RADIOTICS to

Editor RADIOTIC DEPARTMENT,
c/o Radio News.

THAT FOR YOU, MR. VOLSTEAD!



Instrument for strayers from the straight and narrow path as advertised in the Vancouver B. C., Sun of Dec. 10: "Straight line FREQUENTER \$2.00." We imagine that this is a combination gyroscope and radio set for those that the dry Mr. Volstead has driven to drink. We are sending in our order for one at once.

Contributed by Oliver Brind

WADDYA MEAN?

New radio instrument, as related in the Cincinnati, O., Enquirer of Dec. 6: "...including the Gold Seal NON-CHARGER, the first battery charger ever manufactured for use in the home." Somehow or other we think that there's stumpin' more or less fishy somewhere. We always had the idea that chargers were to put some pep in the old power house. Oh well, live and learn.

Contributed by Herman Korte

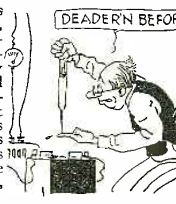

FOR FISHERMEN OR GIRLS?

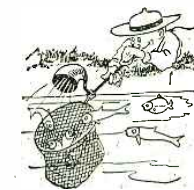

Advertisement from the Cleveland Plain Dealer of Dec. 12: "Radio equipment, SUPER NETS, custom built." If these be for the followers of Izaak Walton then there is doubtless some sort of radio bait for the fish. If they are of the hair-retaining variety then we have to throw ourselves on the mercy of the Court and ask—how come?

Contributed by Carl J. Klagge

TRY THIS ON YOUR LOUD SPEAKER

Idea received from an advertisement in the Dec. 13 St. Louis Post-Dispatch: "...console cabinet with FILLED-IN Loud Speaker." Get the idea? If you don't like the way your favorite DX station is coming in, fill up the horn with anything handy, such as pillows, old wagon wheels, a horse and buggy or what you will.

Contributed by C. M. Browning



HEY, FELLERS, SPRING HAS COME!



To increase the sale of coils the spring model for boys is advertised, as follows, in the Liberty Mini Order catalog: "This coil is wound with green silk wire over a fibre frame with 21 TOPS." Quite a cute little gadget, don't you think? Does anyone know how they keep all the tops spinning? We don't.

Contributed by Norman E. Isaacson

MY, MY, MY, ALSO OH DEAR!

The Radio World magazine of Dec. 12 in a list of parts for a rectifier specifies: "One AC 220 volts STEP-IN transformer." For the lova Mlike, what next? We thought that we were more or less familiar with most of these things, but here's something that none of us put over on us. Wadda you say?



Contributed by Leo Lades

SO BIG AND STRONG AND HANDSOME

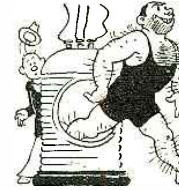

Fundamentalist gesture in the Simplex Catalog No. 65: "MALE transformer B eliminator." Just the thing for that great big set for the wide open spaces, where men are he-men and women are governors. Three routing cheers!

Contributed by A. R. Miller

FOR THE WINTER

Fashion note in an advertisement in the Berkshire County Eagle, Pittsfield, Mass., on Jan. 13: "Make your own set and let us build its Radio Cabinet's OVERCOAT made to order." Well, boys, wadda you say? Are you all set to get that snappy coat having a panel effect with a satin finish?



Contributed by W. G. Alurias

FOR THE DX HOUND



This from an advertisement in the Randolph Radio Corp. catalog: "Set... built into a beautiful walnut VERNIER 2-tone console." We can recommend this type of console to the man who simply must have distance. After a little practice the tuning is more or less simple.

Contributed by Lloyd Tufford

WE DON'T WANT IT

On Jan. 17 in the Cleveland Plain Dealer was the following head line: "Date on Radio DELINQUENCY unit." We have met in our travels many sets that were decidedly of this type, but this is the first time that we have seen them featured in this way, as there is a sub-head, "It Prompts Many Queries." We'll bet it does.



Contributed by D. E. Roberts

Correspondence from Readers

In this department the readers air their views on many important questions of the day. Comment is invited and an attempt is made to give equal weight to both sides of a controversy regardless of the magazine's policy.

FRENCH RADIO STATIONS

Editor RADIO NEWS:

We take the liberty of calling to your attention several inaccuracies, which we correct below, as far as concerns our company, in the December, 1925, number of RADIO NEWS, pages 821-822.

The short wave-length operations of the radio stations of the French transmitting companies, are now as follows:

1. Sainte-Assise station (Compagnie Radio-France)
Station call letters FW.
Wave-lengths 42 meters and 23 meters.
Operates commercially with Buenos Aires.
2. Sainte-Assise station.
Station call letters 8GB.
Wave-length 75 meters.
Transmission tests of the Societe Francaise Radioelectrique.
3. Clichy station (Suburb of Paris).
Trial station of the Societe Francaise Radioelectrique, set up in the building of the Compagnie Francaise de Radiophonie which conducts the broadcast station "Radio Paris."
Station call letters 8GA.
Approximate wave-length, 30 meters.
Also the station 8AJ of the laboratories of the Societe Francaise Radioelectrique at Levallois Perret (Suburb of Paris) is not now transmitting.
The call letters SFR are not used.
The wave-length of the broadcasting station, "Radio Paris," of the Compagnie Francaise de Radiophonie is now 1,750 meters and no longer 1,780 meters.
Société Française Radioélectrique.
79 Boulevard Hausmann, Paris (8).

INTERFLEX NOTES

Editor RADIO NEWS:

I have put up a Regenerative Interflex and I must say that this is the 3-tube set that I have been looking for. The quality of tone is as nearly perfect as I have heard; and while I use mine principally on locals, a friend who also made one has had everything in a thousand-mile radius and is tickled stiff with it.

I have found that many tubes that have been accidentally burned out can be resuscitated by tapping them smartly while the current is on the same as can be done with Mazda lamps. I got back three out of seven that way.

E. T. BIRDSALL, M. E.
2617 East 76th Street, Cleveland, Ohio.

Editor RADIO NEWS:

Allow me to thank you for and congratulate you upon the "Regenerative Interflex." Within fifteen minutes after completing my set, I had Atlanta, Ga., as fine as one could wish. Since then I have picked up all sections of the country. Here are some of the stations I've received: WGHB, Clearwater, Fla.; KFI, Los Angeles, Calif.; WSMB, New Orleans, La.; KOA, Denver, Colo.; CNRO, Ottawa, Canada; KWKH, Shreveport, La.; CHYC, Montreal, Canada; KTHS, Hot Springs, Ark. While writing this, I'm listening all over the country. I don't believe this can be beaten!

WILLIAM B. SHENK,
1425 Cedar Street, Milwaukee, Wis.

Editor RADIO NEWS:

This is to inform you I built a "Regenerative Interflex" set taken from the December RADIO NEWS. I am so well pleased with the

result that I am building two more sets for the visitors who have heard same. It is easier to get New York or Los Angeles, which is 1,500 miles from here, than it is to get Kansas City, 125 miles from here. Have visitors every evening and all say it is the best they ever heard for volume and clearness. It can not be beat. I am trying to get Havana, Cuba, and I will succeed, as I wish to have the laugh on some of my "teasers." I wish to thank you and staff for the good things you always have in the RADIO NEWS.

FRED L. KRUEGER
R. F. D. No. 1, Emporia, Kansas.

DX WITHOUT CONNECTIONS

Editor RADIO NEWS:

I have been reading in "Correspondence from Readers" in February's RADIO NEWS, the wonderful results obtained by Mr. Bachman, builder of a one-control regenerative interflex; and, by golly!, this that follows, I think is also worthy of being reproduced in your section "Correspondence from Readers."

I own a super-heterodyne, and really, I think there is nothing better. Of course, I do lots of talking among my radio friends, and my records got them going. The other night a few of them came to witness by themselves the performance of my set, and, all nervous, I set my receiver at work; but after turning the dials in all directions, nof a single signal was heard loud enough in the loud speaker. Finally, when they were all kidding me, I got KDKA with a tremendous volume and then WSAI, with a little less volume. I knew something was wrong somewhere and I started looking around to find out the cause. But what was my surprise and the same with all others present, when they saw that neither antenna nor ground was connected to the receiver! I never thought this could be possible, since I am 1,350 miles from Pittsburgh, and a few miles farther from Cincinnati. My friends are a whole lot more respectful now, when referring to my Super-Het. And I swear that this is honest truth!

A. J. CAROL,
Cardenas, Cuba.

DX AT CHRISTMAS

Editor RADIO NEWS:

After reading the article by Mr. Green in the January RADIO NEWS, I decided to write you about reception. Mr. Angel's record can be backed up, if it is at all necessary to do it. As for reception of California stations, I do not think it freakish. To date, seven California stations have been logged, KFON, KFVB, KTBI, KNX, KGO, KPO and KFI. The one most regularly heard is KFON, while KGO has the record for volume. These stations were heard on an ordinary home-made single-circuit "blooper," with one stage of A.F. amplification.

Perhaps you may put me down as a follower of Münchhausen, but here goes. In December, 1924 (the date I failed to write down), I tuned in a station at 9:00 o'clock, E. S. T., giving out market reports, which isn't usually common at that hour for an Eastern station. But the volume was so great that the station seemed as though it were east of the Mississippi. But no, the voice said "This is KGO, Oakland, California." This was on detector alone. If my amplifying transformer had not burnt out, KGO could have easily been heard on a loud speaker. I have not heard, before nor since, such reception as that.

For another good record, station WTEC, of Coldwater, Miss., operating on 10 watts, was heard on December 25, 1925, between 10 and 11 p. m., E. S. T. Previously, on December 25, 1924, a station from Mexico City was logged. Call letters I believe were CYB, but due to the similarity of sound between such letters as B, E, D, etc., it was hard to distinguish. I have listened late on December 25 for several years and find it excellent for DX reception.

I might add that the theoretical and the biographical articles are fine and are very educational. The last is the principal reason why I take RADIO NEWS.

LESLIE G. VAIL,
Orient, New York.

DESIRES CORRESPONDENTS

Editor RADIO NEWS:

I would like to get into communication with radio amateurs in other countries to exchange ideas. Will you please insert such a notice in your tophole magazine?

FRED IWATA,
Takigashira Machi, 30 Azahara, Yokohama, Japan.

THE INTERNATIONAL TESTS

Editor RADIO NEWS:

I have seven 201-A tubes going fine, every tube O. K., "A" battery full and a 110-volt storage "B" battery. East and west, also north and south antenna with a throw switch on my window sill; located on the fourth floor of a five-story apartment house on the hill section of Commonwealth Avenue, Boston. I usually can pull in on loud speaker on any night, any Mid-West station such as WOC, WSUI, or down in Texas, WOAI.

I've been "listening in" these two nights. What I received last night was a bedlam of static, howls, squeals and other unheard of noises, a mumble of words, a crash of a super-het, more static, half a bar of music, two or three words and then noise.

Tonight conditions were even worse, without a "smell" of music or speech of any sort. Forty minutes in the land of "bedlam" is sufficient and I've "signed off" to write you this letter of how I found "International Tests" the first two nights. My set is a six-tube (four separate units), and has three stages of radio frequency. Ahead of this I have a tuned R.F. unit; consequently four stages of R.F. This set tunes out the locals and worked perfectly before and after the test hour last night (Florida very fine on loud speaker). It is in perfect condition tonight—but when the "wilds" let loose at 11, it seemed worse than last evening. I get more out of this set than most friends do from any sets they have, so if this "seven-tuber" doesn't bring in the "bacon," I doubt if any will! A scattering word or two does not mean that "International Tests" are successful; but unless the "squealers" are legislated against and prohibited, the tuning in of foreign signals will never be satisfactory. Am I correct?

"RADIO TOURIST."

MORE INTERFLEX RECORDS!

Editor RADIO NEWS:

Have been operating the Interflex-4, and considering price I don't think any set can equal it. Look at a map and find Port Angelus, Washington, and then try and realize a 4-tube set getting such stations as WOAI, San Antonio, WGY, WGR, WSMB,

(Continued on page 1482)

STANDARD HOOK-UPS

EVERY month RADIO NEWS presents in this convenient form a selection of circuit diagrams, with constructional and other data, on standard hook-ups, which the editors have tried and found to give excellent results. Every radio experimenter should preserve these for their reference value, as they are selected to cover the complete range of radio apparatus, from the simplest to the largest and most complicated. Requests for special or additional advice and information should be addressed to the I WANT TO KNOW Department of RADIO NEWS. (A charge of 25 cents is made for answering each question which requires a reply by letter.)

Handy Reference Data for the Experimenter

LOOP ANTENNA TRANSMITTER

Circuit No. 153. For those who intend going to camp next summer, or contemplate week-end trips, this particular transmitter should be adaptable; since it has the popular characteristics necessary, such as portability, efficiency, ability to operate on a loop, etc. The advantage of the loop antenna in transmitting is that directional signals may be sent by simply pointing the loop in the desired direction.

An ordinary 5-watt tube should be used in this circuit. Plate voltage may be supplied by either "B" batteries, or a generator which may be coupled to the engine of the automobile, or a motor-generator whose motor runs on a single storage battery. Loop should consist of 3 turns of No. 10 wire wound on a wooden frame, about 3 feet square. Both variable condensers shown in the circuit should be of the transmitting type and able to withstand a fairly high voltage.

The radio frequency choke coil L_1 consists of 400 turns, wound on a 4-inch tube with No. 28 D.C.C. wire. L_2 consists of 300 turns wound on a 2-inch tube with No. 28 D.C.C. wire. The wave-length of the

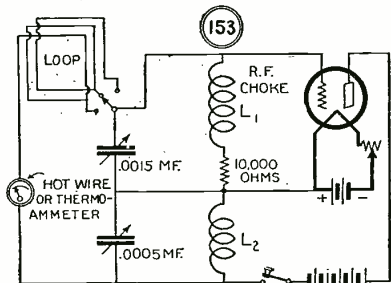

An efficient portable loop antenna transmitter that may be carried in a small suit case, which will safely accommodate all batteries necessary.

transmitter may be varied by changing the position of the switch lever on the various loop tap. When maximum deflection is obtained in the "radiation ammeter," the transmitter is operating at its maximum efficiency for that particular wave-length.

PHANTOM RECEIVER

Circuit No. 154. Here is a receiver that, when properly constructed, is capable of giving very good results. This receiver was extremely popular some short time back, but was lost in the rush of numerous so-called low-loss circuits. The receiver itself is extremely simple to build and operate, and may be constructed by any novice with very little radio experience.

The primary for stator winding consists of 120 turns of either No. 18 or 20 D.C.C. wire. This winding should be tapped every 10 turns, beginning with the 20th. The rotor winding has a similar number of turns; but is tapped every 10th turn, and the first tap made at the 40th turn. The grid leak should be preferably of the variable type, to obtain the proper grid bias.

Either dry cell type tube or storage battery type, such as the 201-A or 301-A, or the UV-200, or UV-300 may be used. If the soft (200 or 300) type is used best results will be obtained by varying the plate

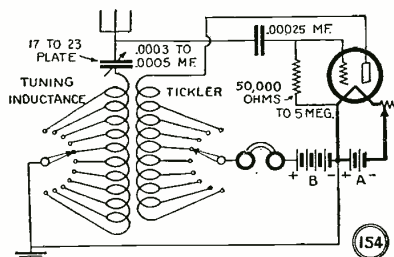

The results obtained by this receiver give a clear indication of why the title "phantom" is used. The efficiency obtained is unusual, though it seems almost unbelievable that one tube could produce so much.

voltage from $16\frac{1}{2}$ to $22\frac{1}{2}$. If the other type of tubes are used, about 45 volts would be best. All other constants necessary are clearly shown on the diagram.

COUNTER E.M.F. CIRCUIT

Circuit No. 155. The reason this circuit is called "counter E.M.F." is because three small tickler coils are used to produce a counter electro motive force so that oscillations are prevented; the results obtained are somewhat similar to those from the neutrodyne receiver. These coils are coupled to the grid circuit inductance coils as shown, so that the feed-back energy from the plate to the grid is in reverse or opposite phase; thus they neutralize the effect of the energy fed back through the tube capacities.

These coils may be adjusted so that neutralization is complete or partial, according to the degree or amount of sensitivity desired. The coupling should, therefore, be made variable, similar to that of the rotor coil employed in a three-circuit tuner. The antenna coil should have about 50 turns of No. 26 D.C.C. wire wound on a tube 3 inches in diameter and tapped every fifth turn. The other primaries have about 50 turns on the same size tube using the same size wire. The secondaries have about 80 turns, and may be wound on the same form

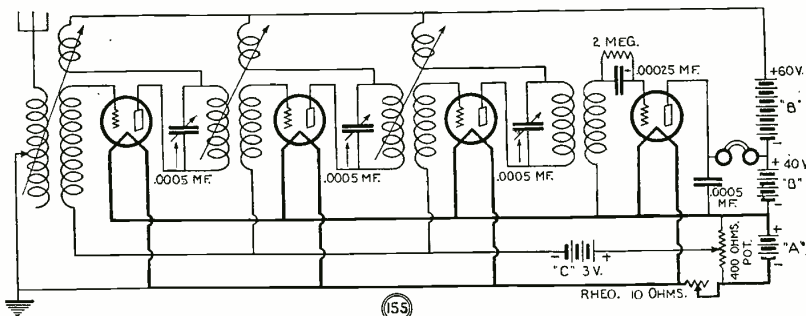

A new method of producing regeneration in, not only the detector stage, but the radio frequency stages as well. Regeneration is carried to such an extreme that unusual sensitivity, and thereby volume and distance, is obtained with this receiver. Cautious tuning is, however, required.

as the primary coil in each case. The separation between the primaries and secondaries should be about $\frac{1}{2}$ inch.

The ticklers consist of about 25 turns of No. 20 D.C.C. wire on a $2\frac{1}{2}$ -inch tube, and should be mounted near one end of each secondary, so that they may be turned through an angle of 180° . When using the regular antenna and ground the primary circuit is not tuned, but taps are provided in case it is desired to use a loop antenna. The antenna coil is then used for coupling.

SINGLE LOOP ANTENNA TRANSMITTER

Circuit No. 156. This type of loop transmitter requires still less equipment than is necessary in the first loop transmitter shown (Circuit No. 153). It is just as simple to build and operate and requires less adjustment.

An ordinary 5-watt tube or the new type $7\frac{1}{2}$ -watt tube may be used, with a minimum of 350 volts on the plate. The oscillating circuit consists of the inductance L_1 , which is the loop, and the tuning condenser, which is of .0005- μ f. capacity. The condenser should be of the transmitting type and able to withstand a fairly high voltage. The wave-length in this case is determined by the adjustment of the variable condenser, and the size of the loop used. The lead from the filament through the loop should be connected at approximately the center of the loop.

This circuit is so simple and efficient, considering that it operates from a loop, that any doubts that may arise in the constructor's mind in regards to its range will be offset by admiration for its effectiveness.

SPECIAL RADIO FREQUENCY AMPLIFIER

Circuit No. 157. This circuit illustrates another method of preventing oscillations in a radio frequency amplifier. In principle it is essentially the same as the neutrodyne, but the method of connecting the neutralizing condensers is different.

In this circuit a specially constructed, three-plate condenser is required to obtain neutralization. Two of the plates are stationary but insulated from each other. One of them is connected to the plate of the

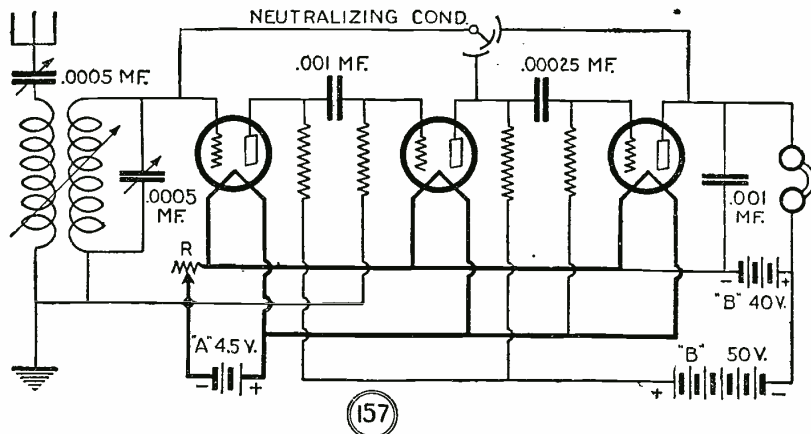

A novel receiving system in which resistance-coupled amplification and a neutralized stage of tuned radio frequency amplification are used, resulting in clear, undistorted signals that are very pleasing to the ear.

second tube and the other to the plate of the third. The movable plate is connected to the grid of the first tube. It is so mounted with respect to the two stationary plates that when it engages with one it disengages from the other. Therefore, the grid of the first tube may be coupled electrostatically to the plate of either the second or the third tube. Since the potentials of these two are in opposite phase, either a positive or a negative feed-back may be given to the first tube. Hence, oscillations may be controlled.

The tuning elements of this circuit may be like those of any other similar circuit already described. The rheostat R should be at least 10 ohms, when three UV-199 tubes are used. The coupling resistances used should be about 50,000 ohms. The detector battery "B" may have any value from 22½ to 40 volts. The voltage on the first two tubes should be much larger, because these two tubes are amplifiers and there is a large voltage drop across the coupling resistances. Hence the batteries should have values of about 40 and 90 volts, respectively.

The principle of this circuit may also be applied to other types of coupling. Tuned impedances may be used instead, in which case they should consist of a parallel combination of an inductance and a capacity of approximately the corresponding value. Or there may be used instead radio frequency choke coils, consisting of about 300 turns of No. 26 double cotton covered wire on a tube 2½ inches in diameter. If these two types of coupling are used the total "B" voltage need not be more than 40 to 60 volts.

This method of neutralization may be ap-

plied to transformer-coupled circuits, either tuned or radio frequency, provided care is taken that no leads are crossed; that is, that they are not so connected that the plates of the second and third tubes are in the same phase.

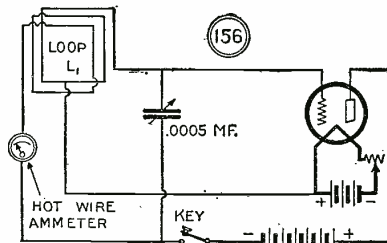

An extremely efficient and simple portable transmitter capable of signaling within the distance of 15 miles, using a loop in place of the conventional antenna.

RESISTANCE-COUPLED SUPER-HETERODYNE

Circuit No. 158. About the most sensitive and selective receiver that one could construct would be one employing the super-heterodyne principle. With the development of practical dry cell tubes, and low-current-consuming storage battery tubes this type of receiver is becoming more popular from day to day. However, the only

present objection is the amount of static and other interfering noises usually obtained with this type of receiver, and which are due to the enormous amplification and inherent transformer noises. These noises are done away with in the circuit shown below, as it is already a proven fact that resistance-coupled amplifiers produce the best quality of reception.

The small coupling coil, shown connected in the loop circuit, is optional; its use being dependent upon whether the loop has enough turns and can satisfactorily cover the broadcast range desired.

The values of the parts necessary are as follows:

- R = resistance of 50,000 ohms;
- R₂ = ½ megohm;
- R₃ = 2 megohms;
- L₂ = 40 turns No. 26 D.C.C., on a tube 3 inches in diameter with a tap at the middle turn;
- L₃ = from 5 to 10 turns of No. 22 D.C.C. on a 3-inch tube; being dependent as aforementioned on the wave-length range to be covered.

The capacities of the condensers are indicated in the diagram. The oscillator condensers, although shown variable, may be of the fixed type. The best adjustment is, however, obtained when each circuit is tuned separately, so that the filter circuit is adjusted to pass only the wave-length desired.

L₄ is a 300-turn honeycomb coil.
L₅ is a 500-turn honeycomb coil.

Although only one stage of audio frequency amplification is shown, additional stages may be added. It would be advisable to add three stages of the resistance type of audio amplification, and thus maintain the same system of amplification employed in each stage.

An additional advantage of this system of amplification is that the Super-Heterodyne may be made to operate at any intermediate wave-length desired, and without any changes in the intermediate amplifier, since resistance-coupled amplification works equally well at any frequency.

The necessary change would be in the oscillator design and filter transformer; the oscillator to heterodyne the incoming frequency to the new frequency desired. The filter transformer must be designed to pass only the wave-length or frequency desired, without too great a side band, and thus facilitate sharper tuning.

Some additional experimentation with the values of the resistances used in each stage, varying the values from one-tenth to one-half megohm, might result in increased efficiency of the receiver.

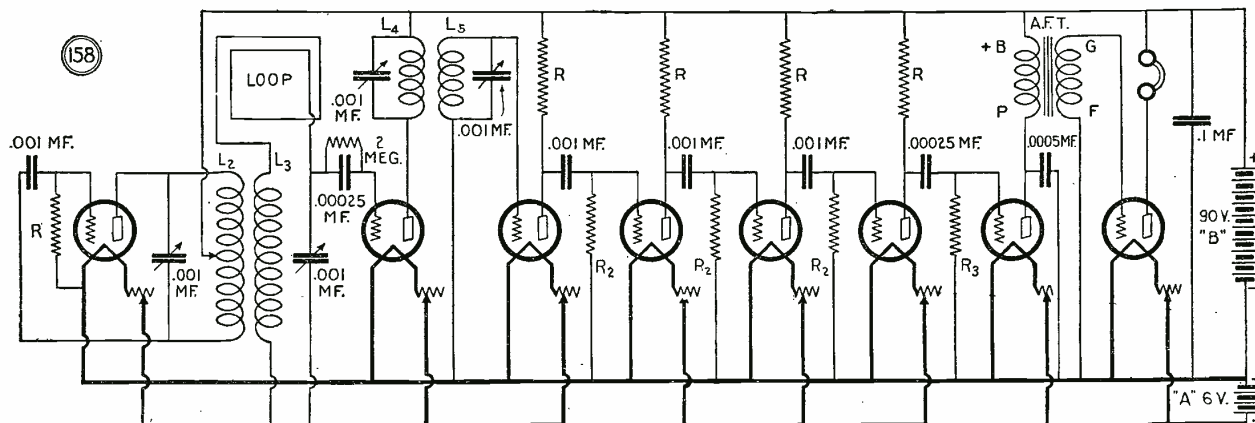

An exceptionally efficient and "quiet" Super-Heterodyne receiver, capable of producing unusual results with pure tonal quality due to the most efficient type of amplification known (as regards its capabilities of distortionless reproduction) that of the resistance-coupled type. The circuit is a very flexible one and may be made to operate at various intermediate frequencies, by simply changing the oscillator and filter-coil design.

RADIO SET DIRECTORY

RADIO has now arrived at the stage where receiving sets have become stabilized to a very high degree. Inasmuch as there is continuous discussion as to various features of sets produced in the United States, RADIO NEWS has taken the initiative to present month by month, a complete picture of the entire set industry.

In presenting the various sets in a directory of this kind, it is naturally only possible to touch the high points, and we have therefore listed all outfits under a simple classification that will, we hope, be of great service to the public, as well as to the trade. We have

attempted in this directory to list every set manufactured in this country, and although we have written a number of letters to all manufacturers, not all have replied. In order to make the directory complete, all sets manufactured by any one manufacturer listed have been included.

The Directory will be kept up to date, month by month. All manufacturers are invited to send monthly corrections as to the various features of the sets which they produce.

Manufacturer:
A-C ELECTRICAL MFG. CO.,
E. Fourth St., Dayton, Ohio
Trade Name: A-C Dayton XL-10
Circuit: Tuned radio frequency
Batteries: Dry cell or storage
Antenna: Outside
Loud Speaker: Separate
Controls: Three
List Price: \$115

Trade Name: A-C Dayton glass-encased
Circuit: Tuned radio frequency
Batteries: Dry cell or storage
Antenna: Outside
Loud Speaker: Separate
Controls: Three
List Price: \$125

Trade Name: A-C Dayton Phono-Set
Circuit: Tuned radio frequency
Batteries: Dry cell or storage
Antenna: Outside
Loud Speaker: Phonograph
Controls: Three
List Price: \$95

Trade Name: A-C Dayton XL-15 Console Model
Circuit: Tuned radio frequency
Batteries: Dry cell or storage
Antenna: Outside
Loud Speaker: Built-in
Controls: Three
List Price: \$185

Trade Name: A-C Dayton XL-5 Knock-Down Set
Circuit: Tuned radio frequency
Batteries: Dry cell or storage
Antenna: Outside
Loud Speaker: Separate
Controls: Three
List Price: \$72.50

Trade Name: A-C Dayton Consolette
Circuit: Tuned radio frequency
Batteries: Dry cell or storage
Antenna: Outside
Loud Speaker: Built in
List Price: \$135.00

Manufacturer: **AERIAL ELEC. CO.,**
128 West Kinzie St., Chicago, Ill.
Trade name: Crystal King
Circuit: Crystal detector Set
Antenna: Outside
Controls: Two
List Price: \$38.00

Trade name: Combination King-1
Circuit: Crystal Detector with A.F. amplifier tube
Batteries: Dry cell
Antenna: Outside
Controls: Two
List Price: \$10.95

Trade Name: Two Stage Amplifier
Circuit: Transformer coupled A.F.
Batteries: Dry cell

List Price: \$13.75

Trade Name: Combination King-3
Circuit: Crystal Detector and two stage A.F.
Batteries: Dry cell
Antenna: Outside
Controls: Two
List Price: \$19.50

Manufacturer: **AJAX ELEC. SPEC. CO.,**
1926 Chestnut St., St. Louis, Mo.
Trade Name: Marvel-tone
Circuit: Tuned radio frequency
Batteries: Storage recommended
Antenna: Outside recommended
Loud Speaker: None furnished
Controls: Three
List Price: \$60.00

Trade Name: Ajax-V.S. & L. Crystal Set
Circuit: Crystal
Batteries: None
Antenna: Outside or socket
Loud Speaker: None
Controls: One
List Price: \$2.50

Manufacturer: **ALADDIN MFG. CO.,**
Muncie, Indiana
Trade Name: Aladyne Plain Cabinet
Circuit: Non-oscillating tuned radio frequency
Batteries: Storage
Antenna: Outside
Loud Speaker: Separate
Controls: Two
List Price: \$60.00

Trade Name: Aladyne Semi-Console
Circuit: Non-oscillating tuned radio frequency
Batteries: Storage
Antenna: Outside
Loud Speaker: Built-in
Controls: Two
List Price: \$90.00

Manufacturer: **AMERICAN BOSCH MAGNETO CORP.,**
Springfield, Mass.
Trade Name: Amborola
Batteries: Storage "A"—Dry "B"
Antenna: Indoor or outdoor
Loud Speaker: Separate
Controls: 1 battery and 1 antenna (two internal indicators used for tuning)
List Price: \$145.00

Manufacturer: **ANDREWS RADIO COMPANY,**
1414 S. Wabash Ave., Chicago, Ill.
Trade Name: Andrews Deresadyne Model 11
Circuit: Deresadyne
Batteries: Storage
Antenna: Outdoor or indoor
Loud Speaker: Separate
Controls: Three
List Price: \$125.00

Trade Name: Andrews Deresadyne DeLuxe Model
Circuit: Deresadyne
Batteries: Storage
Antenna: Outdoor or indoor

Loud Speaker: Separate
Controls: Three
List Price: \$165.00

Trade Name: Andrews Circuit Deresadyne Model 111
Batteries: Built-in Bal-kite B eliminator with small storage A battery and built-in Bal-kite trickle charger
Antenna: Outdoor or indoor
Loud Speaker: Built-in
Controls: Three
List Price: \$285.00

Manufacturer: **APEX ELECTRIC MFG. CO.,**
1410 W. 59th Street, Chicago, Ill.
Trade Name: Apex Super Five
Circuit: Tuned radio frequency
Batteries: Storage
Antenna: Outside
Loud Speaker: Separate
Controls: Three
List Price: \$80 without accessories

Circuit: 1 stage untuned 2 transformer coupled radio freq.
Batteries: Direct from A.C. or D.C. current
Antenna: Outdoor or indoor
Loud Speaker: Built-in
Controls: Two
List Price: \$235

Trade Name: Argus Power Electric Radio Model 300
Circuit: 1 stage untuned 2 transformer-coupled radio freq.
Batteries: Direct from A.C. or D.C. current
Antenna: Outdoor or indoor
Loud Speaker: Built-in
Controls: Two
List Price: \$300

Manufacturer: **AUDIOLA RADIO CO.,**
430 So. Green Street, Chicago, Ill.
Trade Name: Audiola "Big Six"
Circuit: Tuned radio frequency

Manufacturer: **BALTIMORE HUB WHEEL & MFG. CO.,**
Fallsway at Gay Street, Baltimore, Md.
Trade Name: Hubco Baby Grand Model 100
Circuit: Tuned radio frequency
Batteries: Dry cell or storage
Antenna: Outside
Loud Speaker: Separate
Controls: Three
List Price: \$50.00

Trade Name: Hubco Baby Grand No. 101
Circuit: Tuned radio frequency
Batteries: Dry cell or storage
Antenna: Outside
Loud Speaker: Separate
Controls: Three
List Price: \$60.00

Trade Name: Hubco Baby Grand No. 102 DeLuxe Model
Circuit: Tuned radio frequency
Batteries: Dry cell or storage
Antenna: Outside
Loud Speaker: Separate
Controls: Three
List Price: \$65.00

Trade Name: Hubco Baby Grand No. 103
Circuit: Tuned radio frequency
Batteries: Dry cell or storage
Antenna: Outside
Loud Speaker: Built-in
Controls: Three
List Price: \$75.00

Trade Name: Hubco Baby Grand No. 104
Circuit: Tuned radio frequency
Batteries: Dry cell or storage
Antenna: Outside
Loud Speaker: Built-in
Controls: Three
List Price: \$100.00

Trade Name: Hubco Baby Grand No. 105 Console Model
Circuit: Tuned radio frequency
Batteries: Dry cell or storage
Antenna: Outside
Loud Speaker: Built-in
Controls: Three
List Price: \$100.00

Manufacturer: **BAKER-SMITH CO., Inc.,**
New Call Building, San Francisco, Calif.
Trade Name: Syllan
Circuit: Tuned radio frequency
Batteries: Storage
Antenna: Outdoor or indoor
Loud Speaker: Separate
Controls: Three
List Price: \$65.00
With built-in speaker, \$100.00

Manufacturer: **BATTERYLESS RADIO CORP.,**
116 W. 65th St., New York City

Trade Name: "No-Bat-Ry"
Circuit: Super-tuned radio frequency
Batteries: None; Electric current, D.C. or A.C.
Antenna: Outdoor or indoor
Loud Speaker: Separate
Controls: 3 tuning, 2 controls
List Price: D.C. current, \$140.00; A.C. current, \$200.00

Trade Name: "Bat-Ry-Les" Console Model
Circuit: Super-tuned radio frequency
Batteries: None; Electric current, D.C. or A.C.
Antenna: Outdoor or indoor
Loud Speaker: Built-in
Control: 3 tuning, 2 controls
List Price: \$350.00
(Can be used with either D.C. or A.C. current)

Manufacturer: **G. BOISSONNAULT CO., Inc.,**
365 Canal Place, New York
Trade Name: White-stone
Circuit: Tuned radio frequency
Batteries: Storage
Controls: Three
Loud Speaker: Separate
Antenna: Outdoor or indoor
List Price: \$35.00

Trade Name: White-stone DeLuxe
Circuit: Tuned Radio frequency
Batteries: Storage
Controls: Three
Loud Speaker: Separate
Antenna: Outdoor or indoor
List Price: \$37.50

Manufacturer: **CHAS. A. BRANSTON, Inc.,**
815 Main St., Buffalo, N. Y.
Trade Name: Branston Hetrola Cat. No. R45
Circuit: Tuned radio frequency
Batteries: Storage
Antenna: Outdoor
Loud Speaker: Not included
Controls: Two
List Price: \$55.00

Trade Name: Branston
Circuit: Tuned radio frequency
Batteries: Storage
Antenna: Outdoor
Loud Speaker: Not included
Controls: Two
List Price: \$75.00

Trade Name: Branston Hetrola Cat. No. R47
Circuit: Tuned Radio frequency
Batteries: Storage
Antenna: Outdoor
Loud Speaker: Built-in
Controls: Two
List Price: \$120.00
(To be continued in May RADIO NEWS)

Notice to Readers

Detailed information respecting the following sets, or any other receiving sets, may be had on inquiry by addressing a letter to the Editor of the Set Directory, RADIO NEWS.

Trade Name: Apex DeLuxe
Circuit: Tuned radio frequency
Batteries: Storage
Antenna: Outside
Loud Speaker: Built-in
Controls: Three
List Price: \$135.00

Trade Name: Apex Baby Grand Console
Circuit: Tuned radio frequency
Batteries: Storage
Antenna: Outside
Loud Speaker: Built-in
Controls: Three
List Price: \$225.00

Trade Name: Apartment Grand
Circuit: Tuned radio frequency
Batteries: Storage
Antenna: Outside
Loud Speaker: Built-in
Controls: Three
List Price: \$300.00

Manufacturer: **ARGUS RADIO CORP.,**
23 West 18th St., New York
Trade Name: Argus Power Electric Radio Standard
Circuit: One stage untuned, two transformer-coupled radio freq.
Batteries: Direct from A.C. or D.C. current
Antenna: Outdoor or indoor
Loud Speaker: Separate
Controls: Two
List Price: \$160

Trade Name: Argus Power Electric Radio Model 235
Batteries: Either (storage preferred)
List Price: \$90
Antenna: Outdoor
Loud Speaker: Separate
Controls: Three

Trade Name: Audiola "Midget"
Circuit: Special non-regenerative
Batteries: Dry cell WD-12
Antenna: Outdoor
Loud Speaker: Head-set separate
Controls: One
List Price: \$10

Trade Name: Audiola "Sealed Five"
Circuit: Tuned Radio Frequency
Batteries: Either (storage preferred)
Antenna: Outdoor
Loud Speaker: Separate
Controls: Three
List Price: \$60

Trade Name: Audiola "Console Six"
Circuit: Tuned Radio Frequency
Batteries: Storage
Antenna: Outdoor or indoor
Loud Speaker: Built-in
Controls: Three
List Price: \$160

Trade Name: Audiola "Console Five"
Circuit: Tuned Radio Frequency
Batteries: Storage
Antenna: Outdoor or indoor
Loud Speaker: Built-in
Controls: Three
List Price: \$135



RADIO NEWS LABORATORIES

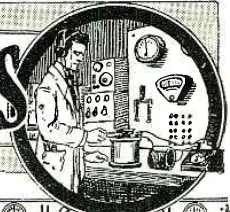

RADIO manufacturers are invited to send to RADIO NEWS LABORATORIES, samples of their products for test. It does not matter whether or not they advertise in RADIO NEWS, the RADIO NEWS LABORATORIES being an independent organization, with the improvement of radio apparatus as its aim. If, after being tested, the instruments submitted prove to be built according to modern radio engineering practice, they will each be awarded a certificate of merit, and a "write-up" such as those given below will appear in this department of RADIO NEWS. If the apparatus does not pass the Laboratory tests, it will be returned to the manufacturers with suggestions for improvements. No "write-ups" sent by manufacturers are published on these pages, and only apparatus which has been tested by the Laboratories and found to be of good mechanical and electrical construction is described. Inasmuch as the service of the RADIO NEWS LABORATORIES is free to all manufacturers whether they are advertisers or not, it is necessary that all goods to be tested be forwarded prepaid, otherwise they cannot be accepted by the Laboratories. Apparatus ready for the market or already on the market will be tested for manufacturers, as heretofore, free of charge. Apparatus in process of development will be tested at a charge of \$2.00 per hour required to do the work. The Laboratories will be glad to furnish readers with technical information available on all material listed here on receipt of a stamped envelope. The Laboratories can furnish resistances of the various instruments, amplification curves of transformers, losses in condensers, etc., and other technical information. Address all communications and all parcels to RADIO NEWS LABORATORIES, 53 Park Place, New York City.

LOUD SPEAKER

The loud speaker shown was submitted to the RADIO NEWS LABORATORIES for test, by The Goldsmith Corporation, 15 William St., New



York City. It is of unusual design and is capable of reproducing signals with unusually high quality. AWARDED THE RADIO NEWS LABORATORIES CERTIFICATE OF MERIT NO. 1213.

SOCKET

The socket shown was submitted to the RADIO NEWS LABORATORIES for test, by Hart & Hegeman, Hartford, Conn. It is of distinct low loss

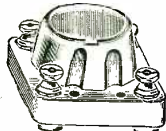

type and may be used in the construction of any radio receiving set. It is of the standard V. T. type. AWARDED THE RADIO NEWS LABORATORIES CERTIFICATE OF MERIT NO. 1226.

VOLTMETER

The voltmeter was submitted to the RADIO NEWS LABORATORIES for test, by the Weston Electrical Instrument Corp., Newark, N. J. It

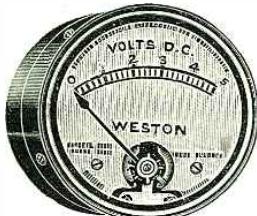

is of the highest grade construction possible, and can be used in connection with radio receivers to indicate storage battery voltage or amount of voltage used to light the filaments

of tubes after it is controlled by the rheostat.

AWARDED THE RADIO NEWS LABORATORIES CERTIFICATE OF MERIT NO. 1219.

COIL

This unusual plug-in coil was submitted to the Radio News Laboratories for test, by Silver-Marshall, Inc., 105 S. Wabash Ave., Chicago, Ill. It is designed to operate on short wave-lengths, particularly the amateur band. The coil is of special construction and plugs into a unique socket containing four terminals which are connected to primary and secondary windings. This feature makes possible changing from one range to another without any

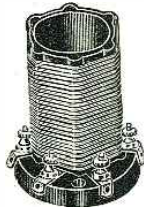

additional alterations or inconvenience.

AWARDED THE RADIO NEWS LABORATORIES CERTIFICATE OF MERIT NO. 1228.

LOW-LOSS COIL

This low-loss, tuned radio frequency coil was submitted to the RADIO NEWS LABORATORIES for test, by the Bodine Electric Co., Ohio St. and Oakley Blvd., Chicago, Ill. It is of the binocular type and may be satisfactorily used in the con-



struction of any radio receiver that requires a coil having the above characteristics.

AWARDED THE RADIO NEWS LABORATORIES CERTIFICATE OF MERIT NO. 1198.

MICA CONDENSER

The condenser shown in the illustration was submitted for test to



RADIO NEWS LABORATORIES, by the Magnus Electric & Radio Mfg. Corp., 797 East 138th Street, New

York City. This fixed condenser is designed for use in any radio receiver. Its capacity has been tested and found to be fairly accurate. It is of solid construction.

AWARDED THE RADIO NEWS LABORATORIES CERTIFICATE OF MERIT NO. 1120.

INSULATOR

The insulator shown was submitted to the RADIO NEWS LABORA-



TORIES for test, by Hart & Hegeman, Hartford, Conn. It may be used in the construction of antennas, having unusual properties as regards insulation, moisture-proof quality, construction, etc.

AWARDED THE RADIO NEWS LABORATORIES CERTIFICATE OF MERIT NO. 1227.

LOOP AERIAL

The unique loop aerial shown was submitted to the Radio News LAB-

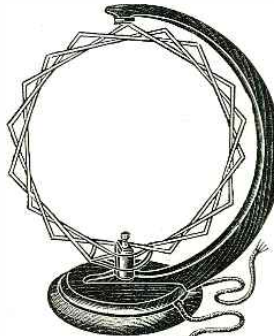

ORATORIES for test, by Eclipse Radio Laboratories, Rock Island, Ill. It is of special construction, being wound in the most approved low-loss, basket-weave form, thus giving a high degree of efficiency and enhanced directional property.

AWARDED THE RADIO NEWS LABORATORIES CERTIFICATE OF MERIT NO. 1172.

ADAPTOR

The adaptor shown was submitted to the RADIO NEWS LABORATORIES for test, by Alden Mfg. Co., Spring-



field, Mass. It is made of compressed bakelite and is of very rigid construction. It may be used to

adapt UX-199 and -120 tubes, etc. to the standard V.T. socket.

AWARDED THE RADIO NEWS LABORATORIES CERTIFICATE OF MERIT NO. 1206.

"B" ELIMINATOR

The "B" Eliminator shown was submitted to RADIO NEWS LABORATORIES for test, by Magnus Electric & Radio Corp., 797 E. 138th St., New York City, and found to be highly efficient and capable of working in conjunction with any radio receiver for supplying "B" battery current. It is operated from



an alternating current source and special provision is made for obtaining detector plate voltage.

AWARDED THE RADIO NEWS LABORATORIES CERTIFICATE OF MERIT NO. 1195.

ERLA TRANSFORMER

The transformer illustrated was submitted to the RADIO NEWS LABORATORIES for test, by the Electrical Research Laboratories, Inc., 2500 Cottage Grove Avenue, Chicago



Ill. This audio transformer is designed for use in an audio amplifier of any receiver. It is of solid and neat construction and reproduces the signals without any distortion. AWARDED THE RADIO NEWS LABORATORIES CERTIFICATE OF MERIT NO. 1118.

S. L. F. CONDENSER

The condenser shown in the illustration was submitted to the RADIO NEWS LABORATORIES for test, by Haig & Haig, Rochester, N. Y. This condenser is of the straight line frequency type and of solid unique construction. It is fairly accurate in regard to maximum and minimum capacity. It may be used

in conjunction with any coil in the building of radio receivers.

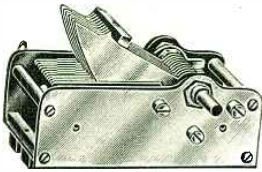

AWARDED THE RADIO NEWS LABORATORIES CERTIFICATE OF MERIT NO. 1114.

BATTERY CHARGER

The charging device illustrated was submitted to the Radio News Laboratories for test, by Liberty Electric Corporation, 342 Madison Ave., New York City, and has been



found satisfactory for charging both "A" and "B" batteries. The charging rate for the storage "A" battery is approximately 5 amperes. AWARDED THE RADIO NEWS LABORATORIES CERTIFICATE OF MERIT NO. 1163.

FIXED CONDENSER AND MOUNTING

This fixed condenser with grid leak mounting was submitted to the Radio News Laboratories for test, by the Micamold Radio Corp., 1087 Flushing Avenue, Brooklyn, N. Y.



It is designed for use in the detector circuit in any receiver. The condenser plates are entirely enclosed by some moulded material, which makes the condenser moisture-proof and therefore constant in capacity.

AWARDED THE RADIO NEWS LABORATORIES CERTIFICATE OF MERIT NO. 1115.

AUDIO TRANSFORMER

The audio transformer illustrated was submitted to the Radio News Laboratories for test, by Electrical Research Laboratories, Inc., 2510 Cottage Grove Ave., Chicago, Ill. It is of unusual design and capable of amplifying current of audio fre-



quency without noticeable distortion. It may be used satisfactorily in the construction of any radio receiver which employs transformer-coupled amplification.

AWARDED THE RADIO NEWS LABORATORIES CERTIFICATE OF MERIT NO. 1168.

SOCKET

The socket illustrated was submitted to the Radio News Laboratories for test, by Alden Mfg. Co., Springfield, Mass. It is made of moulded bakelite compressed to an

unusually high degree, so that the entire socket is exceptionally strong and rigid. Special prolongations of the terminal contacts are provided to facilitate connections to the socket.

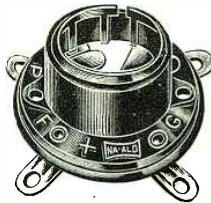

AWARDED THE RADIO NEWS LABORATORIES CERTIFICATE OF MERIT NO. 1116.

RECEIVING SET

The receiving set shown was submitted to the Radio News Laboratories for test, by Magnus Electric & Radio Mfg. Corp., 797 E. 138th St., New York City, and found to possess the qualifications required for a receiver as regards sensitivity, selectivity, design, etc.



AWARDED THE RADIO NEWS LABORATORIES CERTIFICATE OF MERIT NO. 1194.

WIRELESS TRANSFORMER

The transformer illustrated was submitted to the Radio News Lab-



oratories for test, by Forster Mfg. & Electric Co. It is of unusual design and capable of amplifying currents of audio frequency without noticeable distortion. It may be used satisfactorily in the construction of any radio receiver which employs transformer-coupled amplification.

AWARDED THE RADIO NEWS LABORATORIES CERTIFICATE OF MERIT NO. 1229.

MULTI-POINT PANEL CRYSTAL

The crystal shown in the illustration was submitted to the Radio News Laboratories for test, by the

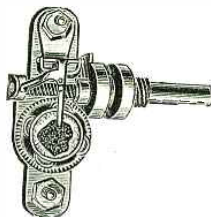

F. H. Noble Co., 29 East Madison Street, Chicago, Ill. This multi-point panel crystal detector was tested in conjunction with an ordinary crystal set and reflex receiver, and found to be satisfactory. It is of solid and efficient construction as the illustration shows and has a multi-point catwhisker.

AWARDED THE RADIO NEWS LABORATORIES CERTIFICATE OF MERIT NO. 1123.

LOG CHART

The radio log chart shown was submitted to the Radio News Laboratories for test, by the Pacific Radio Mfg. Co., Centralia, Wash. It can be used as a means of finding instantly the dial readings of your receiver for various stations. The dial readings should be jotted down first; and when the station is desired again the special construction

of this chart permits immediate location of the reading.



AWARDED THE RADIO NEWS LABORATORIES CERTIFICATE OF MERIT NO. 1211.

TRIGGER SWITCH

The switch shown in the illustration was submitted to Radio News Laboratories for test, by Hart & Hegeman, Hartford, Conn. This

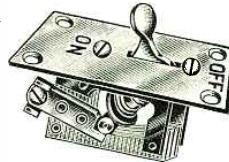

trigger switch is designed for use in any receiver to turn tubes on or off, each position being indicated on the switch. It is of neat and solid construction.

AWARDED THE RADIO NEWS LABORATORIES CERTIFICATE OF MERIT NO. 1121.

SUB-BASE BRACKET

The bracket illustrated was submitted to the Radio News Laboratories for test, by the Garfield Radio Mfg. Co., 64 Vesey Street, N. Y. C. This bracket was designed for use with sets where sub-base panels are used. It is moulded of radion material. It is extremely rigid and strong, being able to withstand an enormous pressure.



AWARDED THE RADIO NEWS LABORATORIES CERTIFICATE OF MERIT NO. 1119.

"B" ELIMINATOR

The "B" Eliminator shown was submitted to the Radio News Laboratories for test, by Radio Television Co., 9410 St. Catherine Ave., Cleveland, Ohio, and found to be unusually efficient and capable of working in conjunction with any radio receiver for supplying "B" battery current. It is operated from an alternating current source and special provision is made for obtaining detector plate voltage.

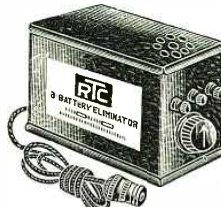

AWARDED THE RADIO NEWS LABORATORIES CERTIFICATE OF MERIT NO. 1166.

CONDENSER

This unique straight-line-frequency condenser was submitted to the Radio News Laboratories for test, by the Walbert Mfg. Co., 925 Wrightwood Ave., Chicago, Ill. It is of low-

loss design and is completely covered by a transparent case which serves

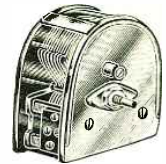

to keep out dust and makes the instrument of consistent values.

AWARDED THE RADIO NEWS LABORATORIES CERTIFICATE OF MERIT NO. 1217.

SOCKET

The socket shown was submitted to the Radio News Laboratories for test, by Bremer-Tully Mfg. Co., 532 S. Canal St., Chicago, Ill. It is made of moulded bakelite, with dull black finish, and is of unusually rigid construction. The socket accommodates two types of tubes. The special construction of the terminals leading to the prongs of the socket enable connections to be either soldered or bolted to the terminal.

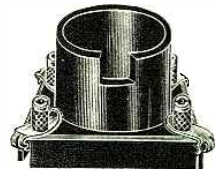

AWARDED THE RADIO NEWS LABORATORIES CERTIFICATE OF MERIT NO. 1230.

COIL

The low-loss coil herewith shown was submitted to the Radio News Laboratories for test, by the All-American Radio Corp., 4201 Belmont Ave., Chicago, Ill. It is of the toroidal type, its inherent characteristic



being, as a result of the method of winding it, that of preventing magnetic or field feed-back and thereby preventing self-oscillation.

AWARDED THE RADIO NEWS LABORATORIES CERTIFICATE OF MERIT NO. 1167.

SPAGHETTI TUBING

This spaghetti tubing was submitted to the Radio News Laboratories for test, by the Crescent Braid Co., 444 Wellington Ave.,



Providence, R. I. It may be used to cover the bus-wire, whenever crowded connections are made, to prevent short circuits. It is of unusual strength and neat appearance.

AWARDED THE RADIO NEWS LABORATORIES CERTIFICATE OF MERIT NO. 1214.

INDUCTANCE COIL

This spider-web inductance coil was submitted to the Radio News Laboratories for test, by the Ipswich Wireless Co., 260 St. Matthew's St., Ipswich, Mass. It may be used in the construction of any radio receiver; and includes both primary and secondary windings, so that it may be adapted to either

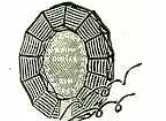

tuned radio frequency sets or wave traps, etc. AWARDED THE RADIO NEWS LABORATORIES CERTIFICATE OF MERIT NO. 1209.

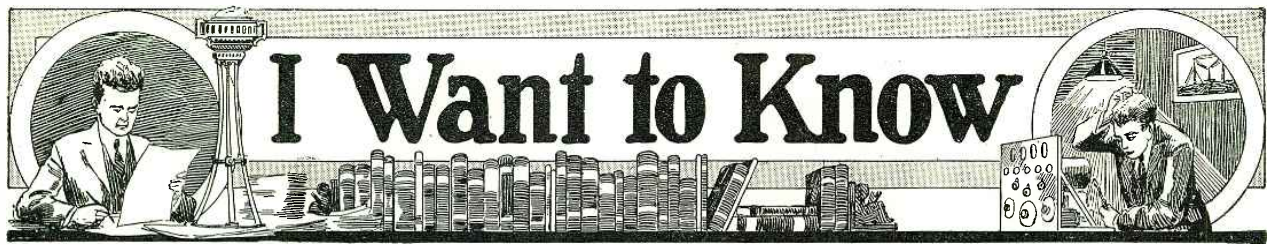

Conducted by Joseph Bernsley

THIS Department is conducted for the benefit of our Radio Experimenters. We shall be glad to answer here questions for the benefit of all, but we can publish only such matter as is of sufficient interest to all.

1. This Department cannot answer more than three questions for each correspondent. Please make these questions brief.
2. Only one side of the sheet should be written upon; all matter should be typewritten or else written in ink. No attention paid to penciled matter.
3. Sketches, diagrams, etc., must be on separate sheets. This Department does not answer questions by mail free of charge.
4. Our Editors will be glad to answer any letter, at the rate of 25c for each question. If, however, questions entail considerable research work, intricate calculations, patent research, etc., a special charge will be made. Before we answer such questions, correspondents will be informed as to the price charge.

Mr. Bernsley answers radio questions from WRNY every Thursday at 7:45 P. M.

OPERADIO PORTABLE RECEIVER

(2158) Mr. J. Groh, Washington, D. C., asks:
 Q. 1. I have an Operadio portable receiver which I carry around with me in my visits to several of the big cities throughout the country, my position being that of a traveling salesman. Some time back, however, an accident happened to the set, which necessitates complete rewiring. I wonder if you could furnish me with the diagram of this receiver. The receiver is the one which includes all batteries, and loud speaker within a folding case, the loop being of the folding type also, and also comprising the top cover of the case.

A. 1. The diagram you desire is shown in these columns (Fig. 2158-A). The model shown is the "1925 Operadio," which we believe is the model you describe. More complete information and data concerning this receiver may be obtained from the Operadio Corporation, 8 S. Dearborn St., Chicago, Ill.

25-B AMPLIFIER UNIT

Q. 2. Recently I had the pleasure of listening to a 25-B amplifier unit, constructed by the Western Electric Co., which was attached to an ordinary one-tube receiving set and operated from an alternating current lighting source. The volume and quality produced was perfect, in fact so much so that it has aroused a desire on my part to construct this unit. Any constructional data and diagram you can furnish me that will enable me to build this unit, will be sincerely appreciated.

A. 2. The following is all the data we could secure (and which we think will be necessary to build this unit) and which was obtained from a booklet which includes all the information for the care and operation of the 25-B amplifier, as published by the Western Electric Co.:

"A good loud speaking telephone requires more electrical energy for its proper functioning than most audio frequency amplifiers in common use are able to deliver without overloading the vacuum tube in the last stage. It is generally possible to secure ample volume with these amplifiers, but at the expense of the quality of reproduction, due to the distortion which results from this overloading. The No. 25-B amplifier is intended for use as an adjunct to a loud-speaking energy at audio frequencies, so that the loud-speaking telephone may function at maximum capability.

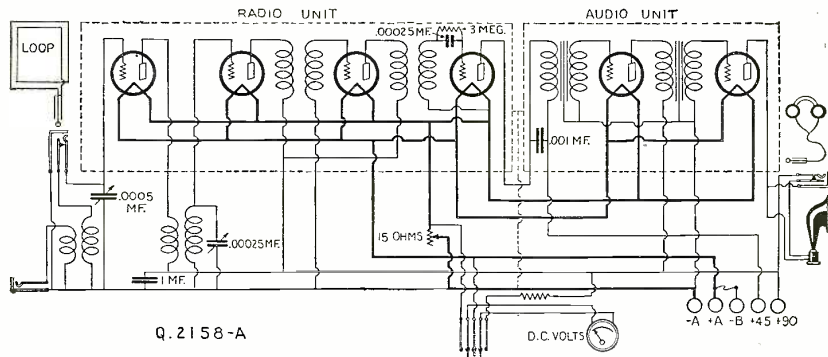

The circuit of the Operadio portable receiving set, with the exact connections used in the manufactured receiver. This receiver employs three stages of radio frequency amplification, tube detector, and two stages of audio frequency amplification, using the 199 type tubes throughout.

"It consists essentially of a single stage amplifier with a self-contained current supply set for both the vacuum tubes used in it. It employs two Western Electric No. 205-D vacuum tubes, one as an amplifier and the other as a rectifier. "No batteries are required for the operation of this amplifier. The only current supply necessary is the ordinary 110-volt 60-cycle A.C. house lighting current. No other form of house lighting supply can be used with this apparatus. The house lighting supply is transformed, rectified and filtered by the self-contained current supply set so as to properly energize the amplifier without the use of batteries. The amplifier consumes about 40 watts; that is it takes about the same power as a medium-sized incandescent bulb. "When used in conjunction with a radio receiving set, this amplifier is not intended to provide all the audio frequency amplification necessary for proper loud-speaking telephone operation; but only that portion of the amplification where there is

most likely to be overloading, that is, the last stage. Thus, if satisfactory volume is obtained in a headset from the detector tube of a radio receiving set, one stage of ordinary audio frequency amplification plus the No. 25-B amplifier will provide sufficient energy to operate a loud-speaking telephone so as to be audible throughout a good sized room. "The amplifier is equipped with a cord to connect it to a radio receiving set and also has a cord with a plug to connect it to the lighting circuit. A switch in the latter cord is furnished, to turn the power on or off, and is the only control on the amplifier. The apparatus is contained in a metal cabinet.

Operation

"The cord attached to the terminals marked "IN" should be connected to the radio receiving set. It is immaterial to which of the terminals the conductors are connected. For the best results, the amplifier should have one stage of ordinary audio frequency amplification between it and the detector tube of the radio receiving set.

If the radio receiving set contains no audio frequency amplification, one stage should be introduced between the radio receiving set and the amplifier. If the radio receiving set contains one stage of audio frequency amplification, the amplifier should be connected directly to its output.

"If the radio receiving set contains two or more stages of audio frequency amplification, the amplifier, for ordinary reception, should be connected to the output of the first audio frequency stage. On very weak signals, more volume may be obtained by using both audio frequency stages in the radio receiver, connecting the amplifier to the output of the second audio frequency stage. The quality of reception, however, is very likely to be impaired by the introduction of this additional audio frequency stage. This is not the best method of obtaining more volume on weak signals. The fact that two audio frequency stages are needed to give sufficient volume, indicates that the energy input from the detector tube of the radio receiving set is too small. The better remedy for this condition would be to increase the energy input to the detector tube by additional amplification ahead of the detector tube; increasing the coupling or whatever means the radio receiving set affords.

"Conversely, if too much volume is obtained with only one stage of audio frequency amplification between the detector tube and the amplifier, it indicates that the energy input to the detector tube is too large, and consequently the detector tube is probably overloaded and introducing distortion. The best remedy for this is to reduce the amplification ahead of the detector tube, decreasing the coupling, or whatever means the radio

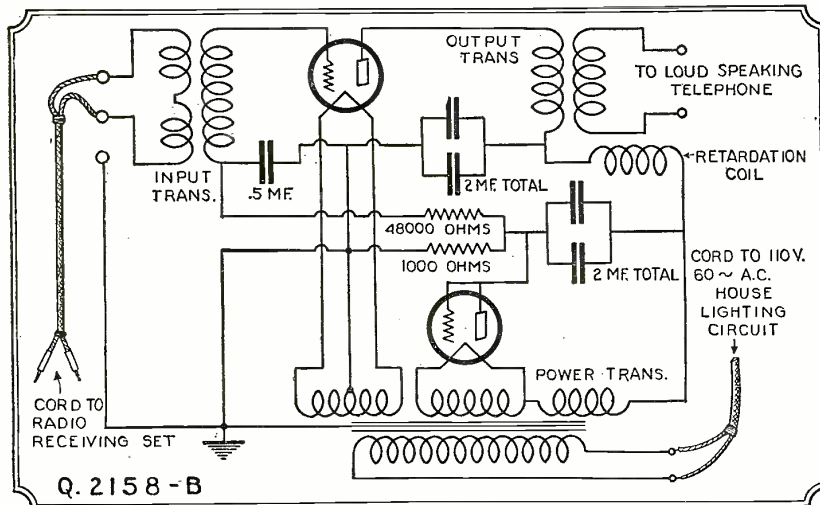

The Western Electric Type-B power amplifier unit which operates directly from an alternating current source, without any batteries required. The unit is very efficient.

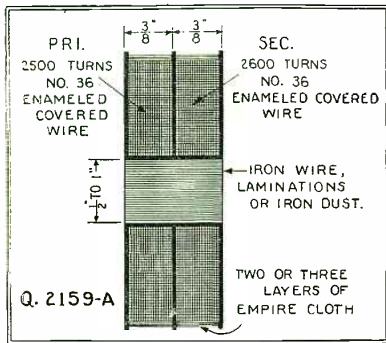

Design of an intermediate transformer which operates with maximum efficiency at 50 to 60 kilocycles. The correct amount of iron core must be determined experimentally.

receiving set affords. Do not eliminate the audio frequency stage of amplification between the detector tube and the amplifier. While this will reduce the volume, the detector tube will be overloaded and consequently the quality of reproduction will be impaired.

Other Connections

"Connect the cord of the loud-speaking telephone to the terminals marked 'OUT.' It is immaterial to which of the terminals the conductors are connected. Connect the terminals marked 'G' to a water pipe, radiator or other effective ground.

"Connect the cord with the plug to a 110-volt 60-cycle A.C. lighting circuit. To put the amplifier in operation, press the light colored button of the cord switch. To turn the amplifier off, press the black button of the cord switch.

"This apparatus will amplify without distortion the output of the radio receiving set to which it is connected. For this reason, if the output of the radio receiver is unsatisfactory in any way (that is, if there is 'howling,' interference, etc.), the amplifier will not correct matters; on the contrary it makes such interference or other disturbances more noticeable because of the amplification it effects.

"When the amplifier is not in use turn off the cord switch. This is important as it conserves the life of the vacuum tubes."

Values of the parts to be used in the construction of this unit are indicated on the diagram. (Fig. 2158-B.)

STUDIO-TYPE SUPER-HETERODYNE

(2159) Mr. J. Harrison, St. Louis, Mo., wants to know:

Q. 1. I am particularly interested in the Western Electric Super-Heterodyne receivers used so extensively in broadcast studios. The particular model I refer to is called Type 6004-C Radio Receiving Outfit. Any information concerning the construction of the parts, etc., circuit diagram, and any other data that will materially aid me in the construction of this receiver would be greatly appreciated. I intend building a receiver for my own private use and trust that there are no objections in furnishing this information for this purpose.

Ans. 1. The information you desire was obtained after a great deal of difficulty, and we are publishing as much data as is available. However, we would like to impress you with the fact that the Western Electric Co. does not offer this receiver for sale to any person that desires one, the

set being only sold to broadcasting stations. Neither can you obtain parts of this set from the Western Electric Co.; although, it may be possible to substitute parts of similar value. To aid you in the construction of this receiver, we are furnishing the characteristic data of each part. The number 6004-C Super-Heterodyne receiver, as designed by the Western Electric Co., operates over a frequency range of from 1,360 to 460 kilocycles, corresponding to a wave-length range of from 220 to 650 meters. The receiver uses the small peanut type "N" tube, although the 199 type may be substituted in its place.

The oscillator coil is of special design; consisting of three windings, two of which are wound on a 2-inch bakelite tube with 48 turns of No. 28 D.C.C. wire; the third is wound on a 1-inch tube with 40 turns of No. 28 D.C.C. wire.

The intermediate transformer may be of either the 50- or 60-ke. type, which use an iron core to broaden the peak of amplification of the transformer. The filter transformer is used in the output stage or last radio frequency stage, connecting to the detector tube, and to give the set the necessary selectivity. It would be advisable, when obtaining the intermediate R.F. transformers, to obtain the filter transformer that is designed to be used with that particular type.

Details for the construction of an intermediate

should you so desire. Also, the original receiver uses only one stage of audio frequency amplification, as it is intended to be used in conjunction with a power amplifier. In our modification of the circuit, we show two stages of audio frequency amplification, so that loud speaker volume may be obtained without the addition of any other amplifiers.

The parts necessary are as follows:

- 1 oscillator coil, as per specifications,
- 2 50- or 60-K.C. iron core intermediate frequency transformers,
- 2 .0005 μ f. variable condensers, preferably of the straight-line-frequency type,
- 1 filter transformer,
- 1 midget variable condenser, range from 2 to 30 μ mf.
- 2 double-circuit jacks,
- 1 single-circuit jack,
- 1 filament switch,
- 1 15-ohm rheostat,
- 1 0- to 50,000-ohm variable resistance,
- 1 7 x 21 bakelite panel,
- Shielding screws, bolts, etc., including all other necessary miscellaneous material.

It would be advisable to shield completely the receiver and units, especially the intermediate transformers. Shielding the receiver will be of considerable aid in eliminating interference and obtain-

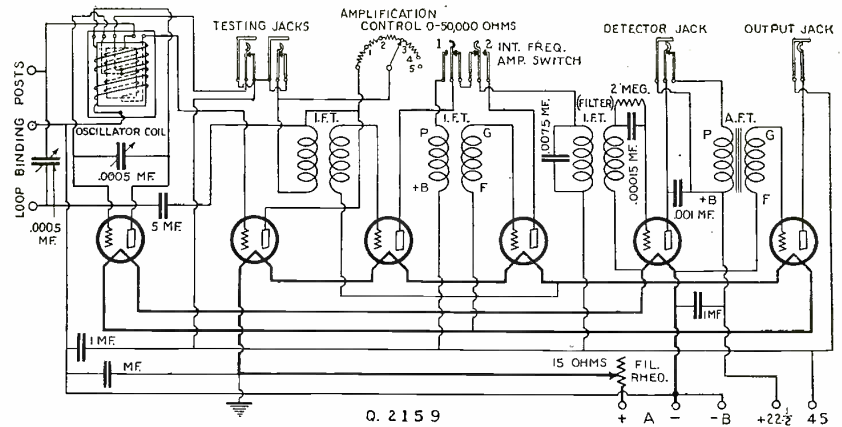

The original circuit used by the Western Electric Company in their type 6004-C radio receiving outfit. The oscillator coil design and connections are included in the diagram; the two 48-turn windings being placed on a 2-inch tube; the 40-turn winding on a 1-inch tube mounted within the 2-inch tube coil.

transformer that has the necessary characteristics to enable it to be used in conjunction with the "N" tubes are also shown in Fig. 2159-A. The filter transformer characteristics are somewhat similar to those of the intermediate transformer, with the exception that no iron core is used.

Construction of the Receiver

Please note that the diagrams accompanying the answer to your question are two; Fig. 2159 being the original as used in the Western Electric Super, and Fig. 2159-C a modification to simplify wiring and eliminate some testing jacks incorporated in the original receiver to facilitate testing and repairing of the set by the maker. These we think to be unnecessary in an ordinary amateur constructed receiver, although you may use them

ing selectivity when local stations broadcast, also to prevent body capacity effects. The loop used in conjunction with the receiver must have three binding posts or terminal connections; one each for the beginning and end of the loop binding, and one which is connected to the center tap of the loop. The filaments of each tube in the original diagram (Fig. 2159) are connected in series, which necessitates the use of an 8-volt storage battery, although a single Peanut tube requires a little more than one volt. When 199 type tubes are used in the modified circuit shown (Fig. 2159-C) only a 4-volt storage battery is required because the filaments are wired in parallel and a special means of obtaining the proper grid bias is provided; a potentiometer being used for this purpose which should be of the 400-ohm type.

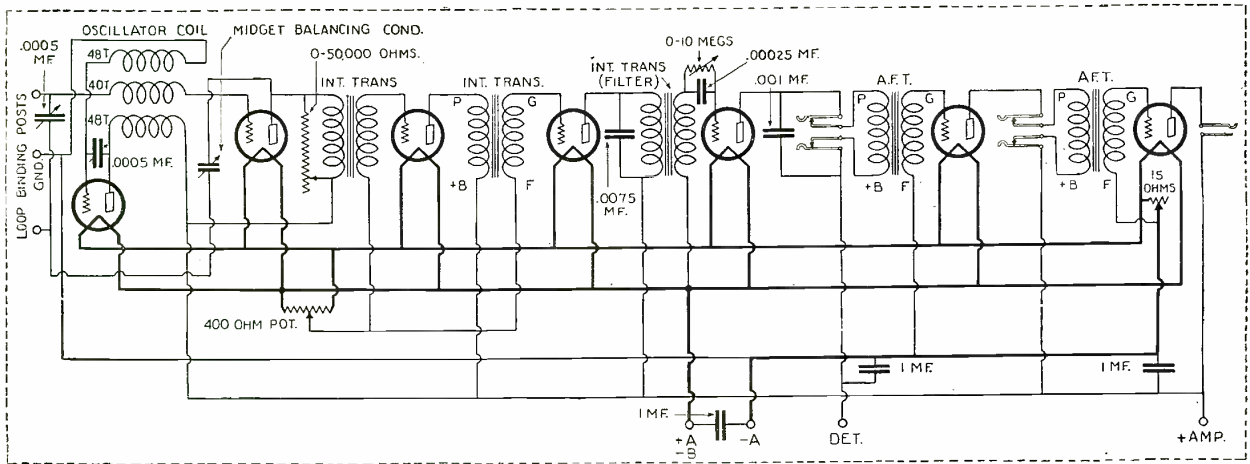

A modification of the original circuit of Fig. Q-2159, in which the potentiometer method of controlling the grid bias on the intermediate radio frequency stages is used. Two stages of audio amplification are used instead of one, as in the original. The 0 to 50,000-ohm variable resistance, which is used as a volume control, may be eliminated.

The following are instructions furnished by the Western Electric Co. in a booklet supplied with the Super-Heterodyne receiver. These instructions should be used only providing the original circuit diagram is used without any modification, although most of the details are applicable to the modified receiver.

Filament Control

To put the radio receiver in operation, open the panel (by pressing the buttons on the sides of the cabinet near the top) sufficiently to view the vacuum tubes and turn the filament rheostat knob from the "OFF" position in the direction indi-

densers. This is important if good quality is desired. Do not attempt to reduce the volume by manipulation of the condensers. This will throw the receiver out of tune and impair the quality of the reception. The radio receiver should always be tuned as accurately as possible, and the volume controlled as explained below.

The operator is advised to keep a record of the various stations received, together with the various dial settings, in order to facilitate returning to these stations.

Volume Control

The volume may be controlled by varying the intermediate frequency amplification, or by cutting in or out the stage of audio frequency amplification. One or two stages of intermediate frequency amplification may be employed as desired by setting the "Intermediate Frequency Amplifier Switch" at "1" or "2" (see Fig. 2159). With the switch set at "2," the volume will be considerably greater than with the switch set at "1," but the quality of reception may not be as good on strong signals. A finer regulation of volume can be obtained by adjustment of the "Amplification Control." This finer regulation operates when employing either one or two stages of intermediate frequency amplification.

The headset is provided with a cord and a plug which may be inserted either in the detector jack or the output jack (see Fig. 2159). If the plug is inserted in the former, the stage of audio frequency amplification is cut out and the volume of sound will be considerably less than if the plug is inserted in the output jack.

When a loud-speaking telephone outfit is used in conjunction with the radio receiver, two general means of controlling the volume will be available; i. e., those provided in the radio receiver and those in the loud-speaking telephone outfit. To obtain a given volume of reception with this combination it will generally be preferable to utilize all of the amplification available from the loud-speaking telephone outfit and only a portion of that available from the radio receiver, rather than utilize only a portion of the amplification available in the radio receiver and all the amplification available in the radio receiver. This method of operation improves the quality of reception, as it prevents needless "overloading" of the detector and places the heavy load on that portion of the combination designed to carry it.

Maintenance

A gradual decrease in the volume of reception indicates that the filament "A" or plate "B" batteries are becoming exhausted. Examine the vacuum tubes. If the filaments of the vacuum tubes cannot be made to glow at a yellowish-red color by adjustment of the rheostat, the decreased volume is caused by an exhausted filament battery, and this battery should be recharged. If the filaments can be made to glow at the above brilliancy and the volume of reception is still unsatisfactory, the "B" batteries are probably exhausted and should be replaced.

A sudden cessation of reception probably indicates that a vacuum tube has been burned out. Examine them. The filaments of the tubes are connected in series and if one is burned out all the tubes will fail to light. To determine which tube is burned out, test each in succession by replacing it with a new one and noting whether all the tubes then light.

If difficulties other than those mentioned above are experienced, examine the power cord, the wiring to the batteries, and the connections between the radio receiver, the tuning unit and the filter for loose or broken connections.

FENWAY SUPER-HETERODYNE

(2160) Mr. P. Cherubini, Waterloo, Iowa, wants to know:

Q. 1. A New York friend of mine recently wrote me concerning a new and supposedly very

efficient Super-Heterodyne receiver, which is becoming very popular with east coast fans, the circuit being called "The Fenway Super-Heterodyne." Can you furnish me with any information relative to its efficiency, constructional data, circuit diagram, and any other additional detail which you might think worth mentioning?

A. 1. This receiver was developed by Mr. L. Fenway and all information which follows was secured from the November 23 Radio Section of the New York Sun. We regret that we cannot give the names of the manufacturers whose parts may be used in the construction of this receiver; but will mention the characteristic and type of each part, so that you may use any good instrument that you think will work satisfactorily.

The parts necessary are as follows:

- 3 intermediate frequency transformers, 30-kc. iron core type,
- 1 filter transformer designed to operate in conjunction with the above,
- 2 .00025 μ f. fixed condensers (omit if tuned R.F. transformers are used),
- 8 tube sockets,
- 1 rheostat, 6-ohm,
- 1 potentiometer, 400-ohm,
- 1 high resistance, 0-5000-ohm,
- 1 single-circuit filament control jack,
- 1 voltmeter switch,
- 1 grid condenser, .00025 μ f. capacity, with clips,
- 1 by-pass condenser, .005- μ f.

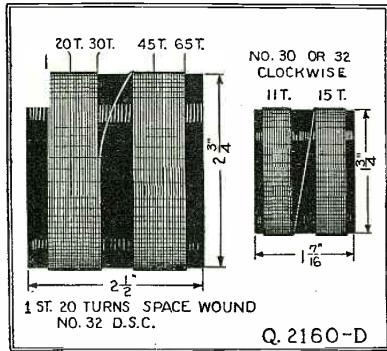

Construction of the tuned radio frequency coil. The large coil, (left) is L2 and the smaller L1. (See diagram below.)

cated to increase the current. The rheostat should be turned only far enough so that the filaments of the tubes light to a yellowish red. Close the panel and proceed with the tuning.

After the radio receiver is in operation and the reception is satisfactory, the filament rheostat should be turned counter-clockwise as far as possible without causing a material decrease in the volume of sound received; that is, it is preferable to operate the filaments at a dull red rather than a yellowish red, if sufficient volume is obtained. The vacuum tubes should never be allowed to become more brilliant than a yellowish red, or reception will not be improved and the life of the vacuum tubes will be considerably reduced.

When the outfit is not in use, turn the filament rheostat knob to the "OFF" position in order to conserve the life of the batteries and vacuum tubes.

Tuning

To tune the radio receiver to a particular station, set the "Intermediate Frequency Amplifier Switch" at "2" and the "Amplification Control" at "5" (see Fig. 2159). Turn the two-point switch on the tuning unit to the contact marked "A" for the antenna unit. This makes the primary circuit aperiodic. Then set the coupling knob at maximum and turn the tuning and oscillator condensers of the receiver slowly. The tuning condenser should be turned so that the pointer advances only a few graduations at a time. For every setting of the tuning condenser, the oscillator condenser should be turned so that the pointer passes over a considerable number of graduations, in order to find both settings of the oscillator condenser. After the signal has been obtained, turn the switch on the tuning unit to the contact marked "T," and turn the primary tuning knob on the unit until maximum signal intensity is obtained. Now reduce the coupling, as this improves the selectivity and the tuning may be refined by readjusting all three con-

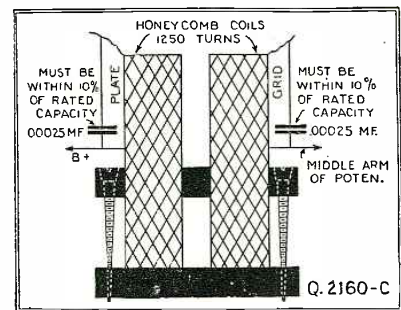

The design of the filter or in-put transformer. Although these coils may be wound similarly to ordinary transformers, ordinary honeycomb coils may be used with the same efficiency.

- 1 by-pass condenser, .001- μ f.
 - 2 by-pass condensers, .5- μ f.
 - 1 double-reading voltmeter (large size),
 - 1 milliammeter, 0 to 50 (large size),
 - 1 5-meg. grid leak,
 - 8 standard vacuum tubes with porcelain bases.
- The set will work, however, with composition based tubes.

The construction of the oscillator coils is as follows:

Two pieces of tubing are necessary, one 3 inches long and 2 inches in diameter, the other 1 inch in diameter and about 1 inch in length, and wound after the windings are completed, so that the 1-inch coil may be rotated similar to a 3-circuit tuner. The grid coil of the oscillator coupler should have 70 turns, the plate coil 24 turns and the pick-up coil from 6 to 15 turns, the wire being No. 30 D.S.C. The pick-up and oscillator windings are wound on a 1 3/4-inch tube, the plate coil on a 3/4-inch tube which is placed within the larger tube, like the radio frequency coil shown.

(Continued on page 1476)

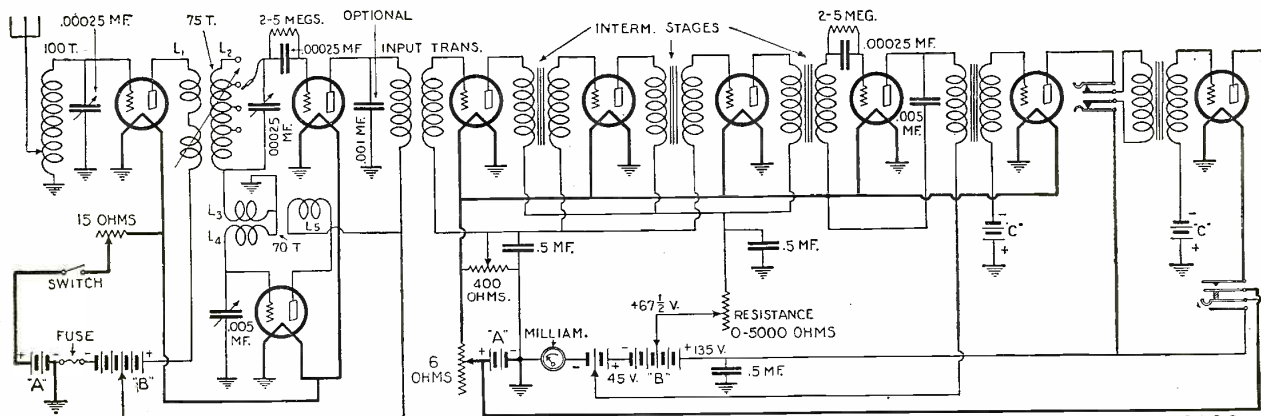

Q. 2160

The complete schematic diagram of the Fenway Super-heterodyne. We do not advise any radical changes, although the milliammeter may be omitted, and three stages of resistance-coupled audio amplification substituted for the transformer type, to enhance the quality. A loop may be substituted for the antenna and ground, by omitting the 130-turn coil and connecting the loop to the variable condenser. The various ground indications represent connections to the shielding, which should be grounded to prevent body-capacity.

ENDORSEMENT

Two hundred and six leading broadcasting stations depend on the steady current of Willard Radio Batteries to amplify voice and music sent out on their programs.

WILLARD

RADIO

BATTERIES

Our advertising tells your customers why these stations prefer Willards, and how the amplifying job of the broadcaster is identical with the amplifying job on their own radio sets.

Mentioning this point will help you to sell more Willard Radio Batteries. You know, too, that you can depend on *them* to give better results and to save the customer money, for Willards are built for Radio and *they last for years.*

WILLARD STORAGE BATTERY CO.
CLEVELAND, OHIO

The Right Selling Plan for Radio Dealers

Your local Willard Service Station will act as your jobber on Willard Radio Batteries.

This means a quick source of supply of strictly fresh, well-charged batteries which you can turn over to your customers in the pink of condition.

No servicing problems for you. Your local Willard Service Station assumes the responsibility for service.

Months of operation have proved that this plan is effective, and profitable for all concerned.

Willard Radio Batteries are being advertised more extensively than ever.

Have your local Willard Service Station show you this advertising and explain the details of this practical plan for selling radio storage batteries. The advertisements are signed:

Sales and Service through
The Willard Battery men
and their
Authorized Radio Dealers

Appropriate signs and window cards will identify you as an Authorized Dealer. Booklets and other valuable selling helps are also furnished.

Your Nearest Willard Service Station is Your Nearest Willard Jobber

and now more stations Come in distinctly

A UX Power Tube will increase volume and clarity in YOUR set

REWIRING UNNECESSARY

Note: The UX-120 tube for dry battery sets and the UX-112 for storage battery sets reproduce more perfectly the excellent broadcasting of today. These tubes handle the powerful signals of nearby stations so that the quality of the tone is preserved without distortion. You can easily obtain this increase in clarity without rewiring your set. A complete line of Na-Ald Adapters and Connectors have been made to meet this purpose. Their scientific design insures a nicety of operation. Below are given three efficient and easily made applications of the new power tubes. For complete details covering these and other applications of the new tube, mail the coupon below.



No. 920 Connectorald

How to improve storage battery sets

Clarity and Volume can be increased in storage battery sets by using the UX-112 tube in the last stage. Easily fitted to the UV-201A socket by means of the Na-Ald No. 112 Connectorald which provides cables for attaching necessary extra B and C batteries. Price, \$1.25. Mail coupon below for complete adapter information covering use of new tubes in all sets.

How to improve sets equipped with UV-199 tubes

To increase volume and clarity in sets using UV-199 tubes, use the UX-120 tube in the last stage. Easily fitted to the UV-199 socket with a Na-Ald No. 920 Connectorald which also provides cables for attaching necessary extra 45 volts B battery and 22½ volts C battery required for the UX tube. Price, \$1.25

How to switch to dry batteries without sacrificing volume or quality.

The combination of a UX-120 tube for the last stage with UX-199 tubes in the other sockets provides with dry cells, results previously obtained only with storage batteries. Fit UX-120 tube to the UV-201A Socket with Na-Ald Connectorald No. 120. Cables provided for attaching extra B and C batteries. Fit UX-199 tubes in all other sockets with Na-Ald No. 419-X adapters. Price, No. 120 Connectorald, \$1.25; No. 419-X Adapters, 35c.



No. 120 Connectorald

ALDEN MANUFACTURING COMPANY
Dept. K18 Springfield, Mass.
All Na-Ald Sockets, Dials and Adapters are protected by patents. Many patents pending.



ALDEN MFG. CO., Dept. K18, Springfield, Mass.
Please send me complete information on how to increase volume and clarity in any set by the use of the new tubes.

Name
Address
City State

"So's Your Old Ghost"

(Continued from page 1407)

get folks there and slip them messages from the dead and answer questions, all by radio. See the line?"

I nodded, "Go on, it sounds good."
"Whaddya mean, 'sounds good'? It was good! Well, anyhow we sits right down and dopes out the lay. Sadie was to be the medium, Solly the grand keeper of the mystic gate, Mat was the come-on artist and the voices from the great beyond and I was to learn the gentle art of working the radio at the classy dump end. Mat said that he could raise enough jack to start things going and me and Solly was to work on the radio.

"We doped out the neatest little outfit that ever Old Man Radio dreamed of. We got us a couple of tubes that would oscillate on those low meters, some special radio freak coils that Mat and Solly had hatched between them, some copper strips and rods for antennas and things, and we was all set. Then we doped out some amplifiers to be used in the mystic chamber with the loud speakers. I was to be able to control the works by throwing a switch or two. See?"

"In a couple of days Mat showed up with the coin and said that he had found a couple of places that was just our meat. They was uptown and in one grand, classy neighborhood. Where the medium was to pull her stuff was in a small apartment house. There were two rooms, one of them a great big one that could be fixed up swell as the mystic chamber and the other was for the suckers to wait in. The other place was in a rooming house about two blocks away and we was to set up the other end of the radio outfit there.

"Well, we finally got the two places fixed up and believe me that spiritual dive was sure the goods. We had the walls of the mystic chamber hung with black velvet, with pretty tinsel stars and moons and things on them; classy lights that could be made real dim; a swell big chair for Sadie to park in when the spirits was to be brought around for afternoon tea.

"And the radio? Now keep your shirt on. That was the best of all. Between the hangings and the wall in three places we put these here new cone speakers and from the little closet where we put the radio works, I could throw any or all of them in the circuit at once and you never could tell where the voices were coming from. I could sit back there in my dugout and hear and see everything that was being pulled off in that room and they never knew that I was among those present.

"How did we work it? Well, here's the lay. We had gathered one of these new mikes that picks up a fly's footsteps, and parked it in the middle of one of those big standing lamps, that folks have alongside of pianos. You know? Well, we'd just park that thing near the person hankering after some dead soul and of course Sadie would tell them to ask their questions loud and clear. Well, I'd send the question over the bounding ether to Mat, who had the same kind of an outfit as I did, which I should have told you was rigged for both sending and receiving. When the question was asked I'd throw the switch to the getting side and that threw in some audio amplifier tubes and shoot Mat on to the loud speaker. I'd let one loud speaker work for a while and then I'd switch on another, just to keep the boobs guessing.

"Mat was sure the berries on raising the dead. If some poor nut came in and wanted to know what his dear departed wife thought of some trip that he was going to take, if

Build the Set That Holds 4 World's Records



The receiver that brought in stations 6,000 to 8,000 miles distant with loud speaker volume night after night. All records fully verified.

Holds World's Records For

- (1) Longest distance ever received on a loop aerial—8,375 miles.
- (2) Most consistent reception of stations 6,000 to 8,000 miles distant—117 programs in three months.
- (3) Brought in 6 different stations in 2½ hours—all over 6,000 miles.

PRICE

Complete Set of Parts.....\$89.00
(Includes all parts necessary to make an exact duplicate of this wonderful receiver, together with blue prints and complete building instructions.)

Story of development and proofs of records sent on receipt of stamped and addressed envelope.

Scott Radio Laboratories

39 S. Dearborn St. Chicago
Dealers and set builders write for discounts

MUSIKTRON

RADIO TUBE

PRICE ONLY

\$1.50

Better Results

Here's a tube that gives better results and at a new low price. Try it in your set as a detector or amplifier. The quality materials used in its sturdy construction give longer life, clearer reproduction and greater distance. Regular types KH-001A, -012 and 099—\$1.50 each. Resistance coupled amplifier tubes \$3. Power tubes all types \$4.

Sold on money back guarantee. Sent direct by mail, C.O.D. or money-order with order. We pay postage. Send for yours TODAY.

K. & H. ELECTRIC CO.
43 Commercial Street
Newark, New Jersey

LATEST "COAST TO COAST" FULLY GUARANTEED RADIO'S—10 DAYS FREE TRIAL! SAVE 1/2 TO 3/4

Use us everywhere report Miraco Radios get programs coast to coast on loud speaker; outperform sets three times as costly. Many hear foreign countries. Radio a most amazing values in unconditionally guaranteed, factory-built low distance sets—let testimony of users convince you.

MIRACO RADIO
GETS 'EM COAST TO COAST

Powerful New Multi-tube Miraco gets long distance on loud speaker. Set, ONLY \$27.35 retail.

FREE! Literature on latest improved 12.5 tube models, new low prices, testimony of users and SPECIAL OFFER. Write: **MIDWEST RADIO CORP'**
Pioneer Builders of Sets
404 W. E. 8th St. Cincinnati O.

AGENT USERS WANTED Write for discounts.

You can be quickly cured if you

STAMMER

Send 10 cents for 288-page book on Stammering and Stuttering, "Its Cause and Cure." It tells how I cured myself after stammering 20 yrs. B. N. Bogue, 534 Bogue Bldg., 1147 N. Ill. St. Indianapolis.

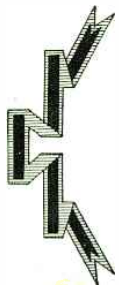

*“Your radio is always top notch.
What do you do to keep it so full
of pep?”*

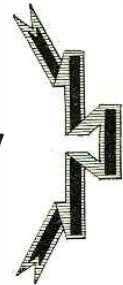

KEEPING your “B” batteries full of pep, without frequent renewals, is simply a matter of using the right size Evereadys for your particular set with a “C” battery*.

The rule which determines the right size “B” batteries to use is so simple no one can make a mistake, and once learned it definitely settles the question of “B” battery service and economy.

On 1 to 3 tubes — Use Eveready No. 772.

On 4 or more tubes — Use the Heavy Duty “B” Batteries, either No. 770, or the even longer-lived Eveready Layerbilt No. 486.

On all but single tube sets — Use a “C” battery.

When following these rules, No. 772, on 1 to 3 tube sets, will last for a year or more, and Heavy Duties on sets of 4 or more tubes, for 8 months or longer.

These life figures are based on the established fact that the average year-round use of a set is 2 hours a day.

A pair of Eveready No. 772's for a 5-tube set

instead of 2 Eveready No. 770's or 2 Eveready Layerbilts No. 486—looks at first glance like an economy because of lower first cost. But in a few months the 772's will be exhausted and have to be replaced. After the same length of time the Eveready No. 770's or the Eveready Layerbilts No. 486 will still be good for many more months of service.

We have prepared for your individual use a new booklet, “Choosing and Using the Right Radio Batteries,” which we will be glad to send you upon request. This booklet also tells about the proper battery equipment for use with the new power tubes.

*NOTE: In addition to the increased life which an Eveready “C” Battery gives to your “B” batteries, it will add a quality of reception unobtainable without it.

Manufactured and guaranteed by
NATIONAL CARBON CO., Inc.
New York San Francisco
Canadian National Carbon Co., Limited
Toronto, Ontario



LEFT—No. 486.
for 4, 5 or more
tubes. \$5.50.



RIGHT—Eveready Dry Cell Radio “A” Battery, 1½ volts.

EVEREADY

Radio Batteries

—they last longer

Tuesday night means Eveready Hour—9 P. M., Eastern Standard Time, through the following stations:

- | | |
|------------------|------------------|
| WEAF—New York | WSAI—Cincinnati |
| WJAR—Providence | WEAR—Cleveland |
| WEEL—Boston | WWJ—Detroit |
| WTAG—Worcester | WGN—Chicago |
| WFI—Philadelphia | WOC—Des Moines |
| WGR—Buffalo | WCCO—Minneapolis |
| WCBE—Pittsburgh | WCCO—St. Paul |

KSD—St. Louis
Pacific Coast, Eveready Program,
KGO—San Francisco, 8 to 9 P. M.

UNION RADIO TIP JACKS

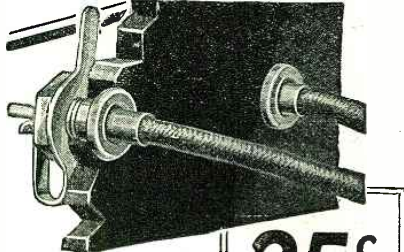

Can be quickly and easily connected and disconnected. They give perfect temporary or permanent connections.

25¢
A PAIR

YOU'LL find them quicker and easier to connect, more convenient, surer and better than binding posts. They lock fast to the panel and never loosen. No tops or parts to lose—hold the battery lead wires or phone tips securely, release easily, save time and trouble. Set builders and owners realize their advantages in maintaining perfect electrical contacts.

Firmly grip all wires from No. 11 to No. 24 B & S gauge. Three sizes for all panels. TYPE A (Standard) for 3/16" to 3/4" panels. TYPE B (Special) for panels, cabinet walls and partitions from 5/16" to 3/4" thick. TYPE C (Special) for panels up to 3/4" thick. HEAVILY NICKEL PLATED.

The Engineers and Designers of the

HAMMARLUND-ROBERTS RECEIVER

Specify the Use of Union Radio Tip Jacks

for their convenience, and ease of connecting and disconnecting all the input lead wires. This compact, efficient and highly recognized receiver employs only the finest of standard parts. Union Radio Tip Jacks are also used as standard equipment in many of the finest receivers on the market.

Other Guaranteed Radio Products

VERNIER DIAL ADJUSTERS — Handy for finer tuning. Price 60c.



IDENTIFICATION TAGS — Hard, red fibre ovals with stamped designations. Thread them on your wires—they save time in tracing leads. COMPLETE SET OF 9 TAGS ONLY 10c.

Ask your dealer for Union Radio Tip Jacks and other guaranteed products or write to us for illustrated and descriptive circular "C."

TO ALL BRANCHES OF THE TRADE

Send for literature and samples of our reasonably priced Guaranteed Radio Products. Get details of our attractive proposition.

UNION RADIO CORPORATION
124 S SUSSEX AVENUE, NEWARK, N.J.
NEW YORK OFFICE 116 WEST 32ND STREET

he was an old guy, a nice sweet old lady's voice would come tottering in over the air. When there was a young, spry fellow that wanted his wife, the voice would sound just as sweet as a Paul Whiteman fox-trot. Yes, indeed, Mat could do his stuff.

"The seekers after the dead one would show up on the minute and Solly, all dolled up in a hot-dog fancy bath-robe, and turban and brown stuff smeared on his face, would open the door and shut 'em in the waiting room. We had bright lights in there so as to make it all the harder to see when they got into Sadie. Then after we had let them cool their heels in the waiting room for a while, Solly would show 'em in to Sadie with a salaam that was a knockout.

"Then Sadie would do her stuff and she could, too, what I mean. Mat had given her the low-down on the line she was to sling and after a week or so of practising you would never think that she had talked any other way. Oh, boy, it was sure a treat to hear her moan out, 'Who that is weary comes to seek consolation of the Great Beyond?'—and Pat chuckled at the recollection.

"Sadie was all dolled up like the Queen of Sheba and she made a hit, especially with the men. Men? You can just bet your bottom yen that we had 'em. They were just as bad as the dames when it came to hunting for information from the goners. As I was saying, Sadie looked great in her scenery and we always had a baby-spot on her when she was parked on her throne, so that she was always smack in the middle of the picture.

"Well, we were doing a nice little business and our pickings off the gang of suckers always gave me cigarette money, you can bet on that. But Solly and Mat they had it all doped out that the jack ought to be coming in faster, so they dopes out a lay to give some phony tips on the stock market and things like that, Mat knowing some bird downtown that has a bucket-shop.

"Gosh, the way we worked that was the old-time pipe. Some of these poor bozos used to ask their dead folks if they should buy different stocks at certain times and when they should sell them to get the fattest profit. Mat got all the dope from his friend and then for a while they would give 'em good steers and then Mat would do his stuff and Brother Sucker would be out some jack and we would be in."

"But I don't see . . ." I interrupted. "What don't you see?" Pat asked with a pained expression.

"How did you and the rest of the gang make money from that?"

The pained expression became more so. "Listen now. If these birds would ask their dead grandmas what stock they should buy, Mat would tell them two or three times to buy something that his friend had told him would be pretty sure to do the balloon act. Well, they would be tickled pink if they made some coin and back they'd come for more. Then when they was ripe for a killin' Mat would slip 'em the word to buy lots of some stock that his friend knew was on the toboggan. Well, instead of ever buying the stock, the bucket-shop boy would just send around a receipt for so many shares and then when the stock would fall we would split the margin. Oh, that was slick stuff.

"Of course, it was risky, but most of the suckers had to have several doses of it before they found that Grandma or Cousin Abner didn't know so much about gambling on Wall Street as they played it these days. See now?"

I nodded. "Well everything was going along all jake for a long time. One day the door slams open and Mat bounces in, all happy as a hop-head loaded up with snow. He grabbed up Sadie from where she was parked

AMPLION

For Better Radio Reproduction

Hear this World-Wide Favorite

Creation of Alfred Graham & Co., England, 38 years experienced in producing loud speaking devices. Amplions lead in sales throughout the world. Hear an Amplion—in comparison! Six models, including phonograph units, equipped with cords and plugs, \$12 up. Write for "Amplion Pedigree."

THE AMPLION CORPORATION OF AMERICA

Suite S, 250 Madison Avenue, New York
Chicago Branch: 27-29 No. Morgan St.
Burndep of Canada, Ltd., Toronto

The Famous Truly Portable TELMACO P-1 Receiver

Four Tubes Do the Work of Seven

The peer of portables in size, weight, ease of tuning, selectivity, distance, volume, workmanship and price. Aerial, loud speaker and batteries self contained. Complete with tubes and batteries, \$125.00 \$141.50. Receiver only . . .

P-1 Kit Saves You Money!

Our offer of the Telmaco P-1 Receiver in kit form has met with enthusiastic reception. This contains all parts, as built by us, including case, drilled and engraved panel, and illustrated instructions. \$80.00 Complete kit . . .

Ask your dealer or write us. Descriptive folder free.

Radio Division:
Telephone Maintenance Co.
20 So. Wells St. Dept. B Chicago, Ill.

TELMACO

Quality Radio Exclusively Established 1918

RADIO CATALOG

Dealers! Send for new 1925-1926 Catalog. Contains nationally advertised high quality sets, kits and parts. Use your letterhead.

Western Radio Co. MFG
134-136 W. Lake St. Chicago, Ill.

RADIO AGENTS WANTED

5 Tube Demonstrator FREE!

Earn \$25 to \$100 a week, part or full time. Every-one a prospect. Complete line standard sets and accessories, \$5.00 to \$90.00. Write today for illustrated catalog and exclusive selling plan for live dealers and community agents. 20TH CENTURY RADIO CO., 1001 Coca Cola Bldg., Kansas City, Mo.

*Unfailing
radio power
from the*
LIGHT SOCKET



with

Balkite Radio Power Units

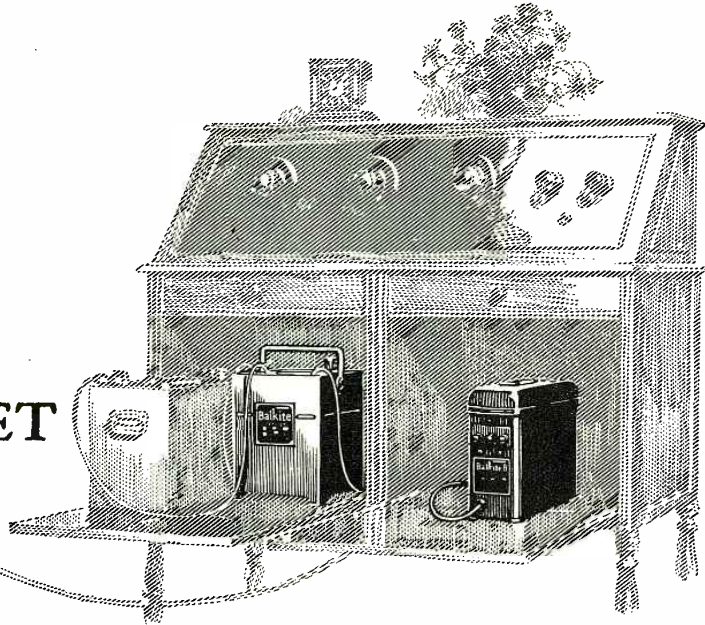

Balkite Radio Power Units give unfailing, uniform current for both circuits from the light socket. One very popular Balkite installation, especially for heavy duty sets where reserve "A" power is required is with the Balkite Battery Charger and Balkite "B." Here the noiseless, high-rate Balkite Battery Charger is ideal. If your battery should be low, you merely turn on the charger and operate the set. Balkite "B" eliminates "B" batteries entirely and supplies plate current from the light socket.

Balkite light socket equipment

Another very popular Balkite installation is with the Balkite Trickle Charger and Balkite "B." The Balkite Trickle Charger converts your "A" battery into an automatic "A" power unit that provides "A" current from the light socket, so that both circuits operate from the lighting circuit. This installation enables you to convert your present receiver into a light socket set.

Noiseless — No bulbs — Permanent

All Balkite Radio Power Units are permanent pieces of equipment, entirely noiseless, have no bulbs, nothing to break, replace or get out of order. Their current consumption is very low. All operate from 110-120 volt AC current, with models for 50, 60 and other cycles. *All are tested and listed as standard by the Underwriters' Laboratories.*

[The Balkite Railway Signal Rectifier is now standard equipment on over 50 leading American and Canadian Railroads]

FANSTEEL
Balkite
Radio Power Units

MANUFACTURED BY FANSTEEL PRODUCTS COMPANY, INC., NORTH CHICAGO, ILLINOIS

SOLE LICENSEES IN THE UNITED KINGDOM: MESSRS. RADIO ACCESSORIES LTD., 9-13 HYTHE RD., WILLESDEN, LONDON, N. W. 10



Balkite Trickle Charger

Converts any 6-volt "A" battery of 30 ampere hours capacity or more into an automatic "A" power unit that furnishes "A" current from the light socket. With 4-volt and smaller 6-volt batteries may be used either as an intermittent charger or a trickle charger. \$10. West of Rockies, \$10.50. In Canada, \$15.

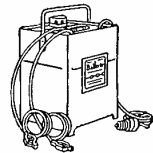

Balkite Battery Charger

The popular rapid charger for 6-volt "A" batteries. Noiseless. Can be used during operation. Special model for 25-40 cycles. \$19.50. West of Rockies, \$20. In Canada, \$27.50.



Balkite "B"

Eliminates "B" batteries and supplies plate current from the light socket. For sets of 6 tubes and less. \$35. In Canada, \$49.50.

Balkite "B" II

Supplies plate current from the light socket. Will serve any standard set. Especially adapted to sets of 6 tubes or more. \$55. In Canada, \$75.

Send for this
New Hookup



Four-Tube Receiver

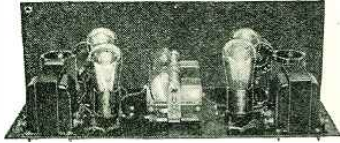

The outstanding receiver development of the season, in which is combined the genius of two of the most distinguished radio engineers. A receiver for the home builder that will represent for several seasons to come a far greater value than any other design available.

Several outstanding features place the design in a position far in advance of anything available or contemplated. Unlimited wavelength range, with interchangeable antenna and detector coils; marvelously improved audio transformers; a special self-contained wiring harness; but one tuning or station selector control, are special features.

Over-all design is rugged and solid. Adapted to practically any standard cabinet, any standard tube, any battery or eliminator source of supply, outdoor antenna or loop.

Only a screw driver and pair of pliers necessary. The set can be built at an extremely low cost and parts are readily available at all radio dealers.

Represented Manufacturers:

- Belden Mfg. Co.—S-C Wiring Harness
- Central Radio Laboratories—Centralab Resistance
- Polymet Mfg. Corporation—Fixed Condensers, Leak and Leak Clips
- Poster & Co.—Drilled and Processed Front Panel and Drilled Sub-Panel
- Silver-Marshall, Inc.—Variable Condensers, Coil Sockets, Coils, Tube Sockets, Vernier Dial, Mounting Brackets
- Thordarson Elec. Mfg. Co.—R200 Power Transformers
- Yaxley Mfg. Co.—Rheostat, Jacks, Switch

Get the hand-book at your radio dealer's, or clip the coupon and send with 25c to
S-C MERCHANDISING CO.
110 So. Wabash Avenue, Chicago

S-C MERCHANDISING COMPANY
110 So. Wabash Avenue, Chicago
Herewith please find 25 cents for which send me the hand-book of the new S-C Four-Tube Receiver.

Name

Address

careless-like on the grand throne and did a wild and woolly hotsy-totsy all over the place. "When he finally came down to earth we asked him why all the merry-merry?" "Guess what we have coming to us?" he asks, real classy. "Someone gave you the keys to the Treasury?" this from Sadie. "I suggested that some dead grandpa that he'd been imitating, had left us all a few grand. "No, you're all wrong—all of you," Mat says. "But it sure means jack and plenty of it."

"Finally, he spilled the dope. He had met an old guy at one of these flossy clubs who started in asking him about Madame Stella, which was what we called Sadie in front of strangers and those that paid our rent. Mat slung him the old line of chatter and he ate it all up—strong. It seems his sister had died about a year before and had left a wad of jack for her 17-year-old son, making the old guy keeper of the cash. Well, the old boy, being like most of us—short of kale—decides to do some speculating and using this money to do it with and not telling a word to the kid.

"Mat said that he had found out that he was a superstitious old duck and thought he ought to find out from his dead sister, if it was O. K. to start action. Mat told him that Madame Stella could do the trick and, the old fellow asked for all the dope including the address. This all sounded like old stuff to the rest of us, and then it was that Mat spilled the real news. The old buzzard had just five hundred grand that he was going to play with. That's all—just half a million!

"Did we feel like a gang of kids on Christmas morning after Santa Claus had been good and filled every stocking in sight? Oh, I guess we did. We were every bit as happy as Mat and told him so.

"In the morning there was a letter from George B. Strong inviting himself over to play in our back yard. It being the first piece of real change we'd come anywhere near, we set aside all the next afternoon for George himself, so he could have a good long talk with Sis. Mat and I went over that radio set, just as if there had been something wrong with it, to see that everything was set all nice and pretty for our little tea party. Mat did some practising with his old-lady voice, putting on all the frills that he could think of and Sadie was going over her scenery, like it was the most important thing in the whole place, and Solly was making the dump in general shine like a new 201-A.

"Well, right when the old Ingersoll told the world that it was two bells the door buzzer did its stuff and Solly nearly broke his neck getting to it and salaaming old George B. into the reception room. George was a gray-haired old party and if ever anybody on earth smelt of ready kale, he did. Solly parked him in the most comfortable chair in the room and then pulled this line:

"Worshipful and honorable sir, I crave thy permission to inquire if Madame Stella will receive you?"

"George looked sort of dazed, but told Solly to go to it, or words to that effect.

"Solly made his usual graceful exit into the mystic chamber and then Sadie got the idea that it would be a good thing to make the old party wait awhile, which we did. Then Solly goes back again and begs his pardon for keeping him waiting, but Madame Stella was taking her mid-day refreshments and could not be disturbed. Then the honorable George looked more interested than he had before.

"What does she eat?" says he. "That was a poser for Solly, because Sadie's favorite refreshment consists of ham and cabbage and lots of Murphys on the side



A Year From Today In Radio

Sets will get their B-Power from the light socket—much smoother and more dependable reception will result.

Build your own B-Eliminator using Dongan B-Power Units and the Raytheon Tube, endorsed by the leading engineers and already operating faithfully for thousands of fans.

Complete information and diagrams upon request. If your dealer cannot supply you send money order direct



B-POWER UNITS

for Building

Raytheon Tube B-Eliminators

TRANSFORMERS
509 Full Wave
\$7.00 List



Also Transformers and Chokes for R.C.A. and Cunningham Tubes.

CHOKES
514 20 Henry
\$5.00 List



Raytheon Tubes
\$6.00 List

Set Manufacturers—we can furnish you with unmounted transformers and chokes in any style and quantity. Our engineering department is at the service of Receiver and B-Eliminator Mfrs.

DONGAN ELECTRIC MANUFACTURING Co.
2977-3001 Franklin Street, Detroit, Mich.



BRANT

Unfailing "B" Power

GUARANTEED

TWO YEARS

Stops all worry about "B" Battery supply. Makes your set work better and more powerful—100 Volts and more. Clean, compact unit.

WRITE TODAY FOR OUR
BIG CIRCULAR "R"

BRANT BATTERY CO.
1622 W. 16th St., Los Angeles, Cal.

PATENTS WRITE for our Four Guide Books and "REC-ORD OF INVENTION BLANK" before disclosing inventions. Send model or sketch and description of your invention for our **INSPECTION** and **INSTRUCTIONS FREE. TERMS REASONABLE.** Electrical and Radio Cases a specialty.

VICTOR J. EVANS & CO.
919 NINTH ST., WASHINGTON, D. C.



Univernier
Walbert Mfg. Co.



Adapter
Herbert H. Frost, Inc.

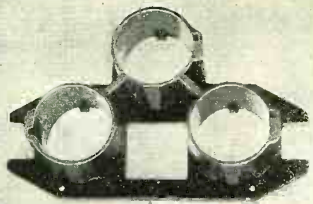

Tube Socket Assembly
Colonial Radio Corp.

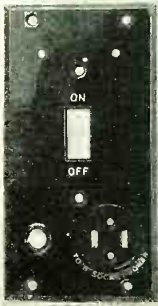

Switch Panel
Philon Socket Power 'B'
Philadelphian Storage Battery Co.



Potentiometer
Herbert H. Frost, Inc.



Tube Base
Supertron Mfg. Co.

Health and happiness through radio

Each morning, young and old everywhere are adding to their store of health by doing the setting-up exercises broadcasted from many stations. Each evening radio adds to their pleasure and happiness through the dance programs.



In developing receiving sets that make the benefits of radio broadcast reception practical for everyone, radio engineers have found Bakelite to be superior for a great variety of radio parts—particularly those that are vital to clear reception and true tonal quality.



Bakelite is the preferred material for panels, dials, knobs, condensers, tube sockets and tube bases,

plugs, rheostats and for other radio devices including speakers. In fact, 95% of radio set and parts manufacturers use Bakelite as they have found that its permanently high insulation value, its strength, its lasting color and finish, its immunity to injury through exposure to heat or moisture, make it superior for radio use.



It is always best to make sure that the radio set or parts that you buy are Bakelite insulated.

Write for Booklet 24

BAKELITE CORPORATION
247 Park Ave., New York, N. Y.
Chicago Office: 636 West 22nd St.

BAKELITE CORPORATION OF CANADA, Ltd.
163 Dufferin Street, Toronto, Ontario, Canada



BAKELITE

REGISTERED



U. S. PAT. OFF.

THE MATERIAL OF A THOUSAND USES

"The registered Trade Mark and Symbol shown above may be used only on products made from materials manufactured by Bakelite Corporation. Under the capital "B" is the numerical sign for infinity, or unlimited quantity. It symbolizes the infinite number of present and future uses of Bakelite Corporation's products."

How to Make Your Own SPEECH AMPLIFIER

MICROPHONE Transmitter Buttons have been used for a number of years to make powerful sound transmitting elements. These very sensitive amplifiers offer every "Radio Fan" the means of building his own powerful speech amplifier. We offer here-with to the constructor these special Amplifier Units.

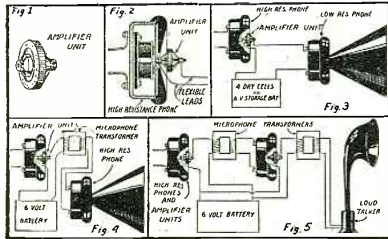

Fig. 1 shows the amplifier unit.

Fig. 2, shows how the unit is attached to a telephone receiver. The first procedure is to mount the unit on the diaphragm of a telephone receiver, which usually is a high resistance telephone, either 1,000 or 1,500 ohms.

Next we select the loud speaking telephone. If a low resistance telephone is available, it should have for maximum efficiency an impedance equal to the resistance of the amplifier unit, or about 10 ohms; it is connected up as shown in Figure 3. A 5 ohm telephone receiver is used in this circuit with a 6-volt storage battery.

Two telephones taken from a good double headset of 2,000 to 3,000 ohms which do not rattle on strong currents, are employed in Fig. 4, one at the receiving end, the other as loud talker. In this hook-up there is one instrument which must absolutely be used with this combination, the transformer. As stated before in connection with Fig. 3, the impedance of the telephone, if used in direct connection, should equal the resistance of the unit. But as the impedance of the telephone in Fig. 4 is much higher than the resistance of the unit, it may be 200 times as great, a transformer having a step-up ratio is used to match up the resistance of the unit with the impedance of the loud speaking telephone. In other words, the primary coil of the transformer should have an impedance (which is sometimes called "A. C. resistance") equal to the resistance of the unit, or about 10 ohms, and the secondary coil should have an impedance equal to the impedance of the high resistance telephone. This transformer may be purchased in any Radio Store and is called a microphone transformer or modulation transformer, designed primarily to use in radio transmitting sets. A 6-volt battery gives the best results. The current passing through the unit will vary from .1 to .25 amper.

Fig. 5 shows a circuit for further increasing the volume of sound. This is simply two of the circuits, such as shown in Fig. 4, linked together. This arrangement is highly sensitive and the telephones on which the units are mounted should be packed in a box of cotton, as the slightest vibration or sound in the room will be picked up and heard in the loud talker. Any sensitive radio loud talker may be used in this particular circuit.

THESE and innumerable other interesting experiments are possible with these amplifiers. Every amateur should have at least one or two in his "Lab" or workshop. A four-page instruction pamphlet is sent with every unit.

SPECIALLY PRICED
While they last **85¢** Per Unit
OR TWO FOR \$1.50

PRESS GUILD,
66-R W. Broadway, New York City, N. Y.

Enclosed find 85¢—\$1.50 for which send me postpaid one—two amplifier units as advertised.

Name

Address

Town..... State.....

and that didn't sound like the kind of a meal that dealers in dead spirits ought to have. Solly did some fast brain work and blats out that Stella usually ate a peach or an apple or a few grapes for luncheon.

"But to get on with the story. Old Georgie comes slow into the mystic room following the salaaming Solly and from my dugout he looks as if he was properly impressed with the whole works. Solly parks him careful in the easy chair and brings the lamp with the mike in it near by and they is all set for the party.

"With whom do you wish to communicate?" says Sadie as a starter.

"With my sister, who died a year ago," answers George, as though he was just calling her on the phone.

"Then to make it look hard, Sadie does a lot of heavy breathing and moaning and carrying-on generally and George looks more impressed than ever. Finally I shoots on the receiver and Mat starts in to do his stuff.

"I'm not going to try to tell you all that went back and forth over the air that afternoon, but you can take my word for it, it was the original hot-dog stuff. Mat did better than he knew how that afternoon and George asked his sister more questions about this and that than you could think of. The old radio set sure did behave pretty all the while, and when George got up to leave he had the dope to buy some stock that Mat's friend said just couldn't help but skyrocket, for he wanted to give him lots of confidence in us and then make the grand killing.

"Well, for a week or so we just didn't have the heart to do much of anything except wait for the George to turn up again. And he did. Just three weeks later we gets another letter asking Madame Stella for another date with Sis and of course we're big-hearted and slips him a date as per invitation. He comes right on time, as he did before and Stella don't keep him waiting none this trip. No, sir, Solly shows him right in for we were all set to do the dirt without further waiting.

"Mat in his answer what stock he should buy this time, as he had made a nice fat profit out of the other deal, told George to buy and buy heavy of a stock that we had the dope was due to go down past the bottom of the sea, if not further. George is all excited and is on pins and needles to get out, but Mat keeps on spiling on how much of the stock to buy and where to go and all about it. He talks so that I can't shut him off without gumming the whole works and I saw that George wanted to beat it. And let me say here and now that that was what sent the whole thing flooy.

"In the middle of a sentence the door buzzer busts in, real insistent. Inside we heard Solly trying to shut somebody up, but then we heard a nice heavy voice like a bull saying, 'Well, young fellow, you'll let me in!' Then I *did* shut off the radio, just before the door into the waiting room opens and there's Solly trying to hold back a wild-eyed young fellow and TWO COPS!

"There was lots of talk and as soon as George B. Strong sees the young fellow he goes a real nice lemon shade around the gills.

"Walter," says he, 'what are you doing here?'

"Walter comes back with the old one, 'Speak for yourself, Uncle George.'

"Well, to make a long story short this young bozo Walter is a radio bug and the same as us has been playing around with waves four and five meters long. He had been listening in the first time Uncle Georgie had been talking to his mamma and had heard the whole thing. Of course, he was right interested for he had been told that there was no money for him for a long time and here was George speculating wild and merry. When he hears Unkie coming back

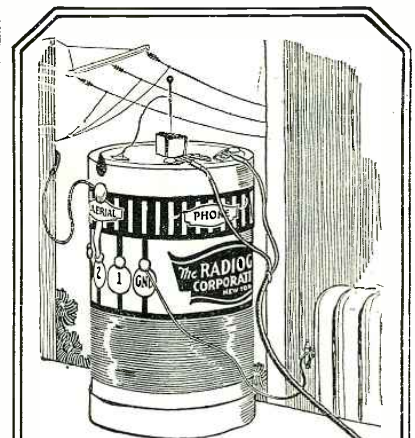

THE SIMPLEST PRACTICAL
RADIO SET MADE

\$1.00

The **RADIOGEM**

The simplest radio outfit made—yet as practical as the most expensive. A crystal receiving set that you can operate and enjoy even though you know absolutely nothing about radio. You receive the RADIOGEM unassembled, together with a clearly written instruction book, which shows you how to quickly and easily construct the set, using only your hands and a scissors. The outfit comprises all the necessary wire, contact points, detector mineral, tube on which to wind the coil, etc., etc. The instruction book explains simply and completely the principles of radio and its graphic illustrations make the assembling of the RADIOGEM real fun.

THE RADIOGEM CORP.
66-R W. Broadway New York City

MORE PROFITS for the Professional SET BUILDER

We have an unusually interesting proposition to make to the man who is now building (or has the ability to build) radio receiving sets for resale.

This is a real opportunity. Write today for full information.

Gearhart-Schlueter Radio Corp.,
715 Voorman Avenue
Fresno, California

RADIO RENCH
Five strong little wrenches and a handy screw-driver fitting every nut and bolt on your radio. All held together by a patented device so none will be lost but easily detached for use.
Nagara Metal Stamping Corporation
Dept. 602 Niagara Falls, N.Y.
Folded Free
15¢
See Patent Free
Prepay Your
Order

Print Your Own
Cards, Stationery, Circulars, Paper, etc. Save money. Print for others, big profit. Complete outfits \$8.85. Job press \$12.35. Rotary \$15. All easy, time-saving. Write for catalog presses type etc. THE PRESS CO., Y-72, Meriden, Conn.

The Last word in audio amplification

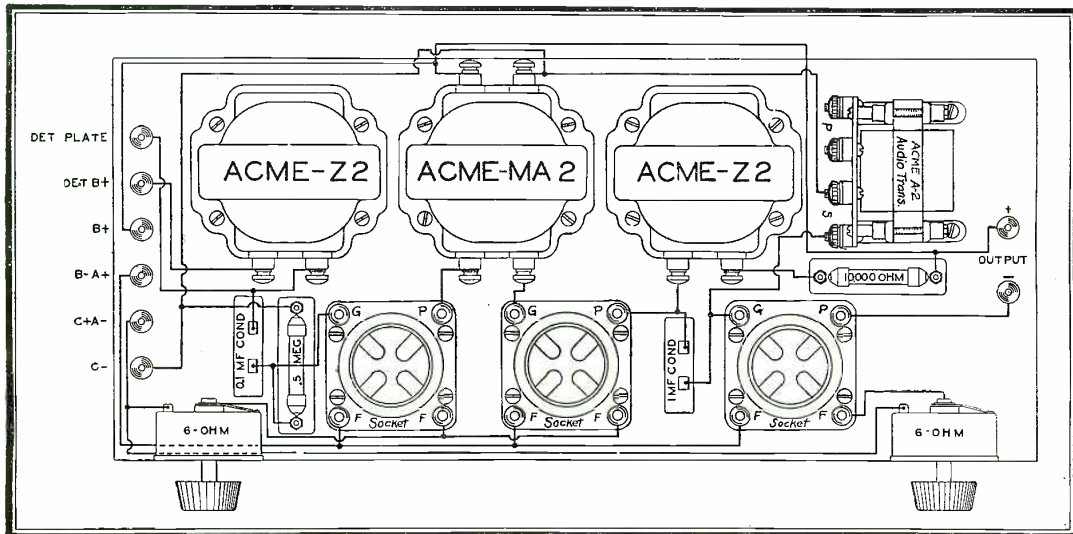

Impedance : Transformer : Impedance

THE diagram above will give you some idea of the very latest step in audio amplification. This is the outgrowth of nearly 7 years of experience in working on proper amplification—the problem of “How well you can hear.”

Whether you want to get a distant station or one right around the corner, the main thing is “How well you can hear.” Today’s broadcasting demands clear, understandable, full-noted music and voice. All the greatest artists are on the air; the greatest men talk to us. We don’t want to miss a note or word, nor do we want this music or these speeches distorted in any way.

You will probably remember the football game or the prize fights which was spoiled for you right in the most exciting part simply because you couldn’t understand the announcements or they were so muffled you had to strain to hear.

Acme research work has been confined to audio amplification and reproduction and here you find the latest result. An audio amplifier using the combination of impedance and transformer coupling with over-

all amplification greater than two transformers, and far superior in quality, no matter what the type of transformer used. Whatever set you have, just add this amplifier to your detector and notice the difference.

Send for wiring diagram

A complete working diagram of the above chart will be sent you for 25c in stamps or coin. It is easier to follow than the plainest road map. With this chart we shall be glad to send you free a copy of “Amplification without Distortion,” a famous radio book over 300,000 radio fans have found helpful. It tells the whole story of distortion and how it can be overcome. In it also is complete information on the famous line of Acme products including radio and audio transformers, amplifying impedance, the new Acme “double free-edge cone” loud speaker, the new Acme B-eliminator. Use coupon below for convenience. Acme Apparatus Company, pioneer radio and transformer engineers and manufacturers, Dept. K14, Cambridge, Mass., U.S.A.



Illustration above shows the Acme MA-2 Transformer, price \$5, and the Acme Z-2, amplifying impedance, price \$4. Both look alike, yet both serve a separate purpose. You need them both.

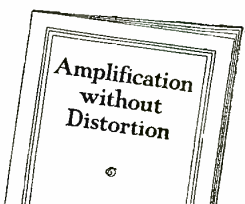

ACME

~for amplification

ACME APPARATUS CO.,
Dept. K14, Cambridge, Mass.

Gentlemen: Enclosed find 25c (stamps) (coin) for which please send me full diagram as shown above and a copy of “Amplification Without Distortion.”

Name

Street

City State

A Scientific Instrument House of International reputation offers for the first time direct to the public an improved *S.L.F. Variable Air Dielectric Condenser*

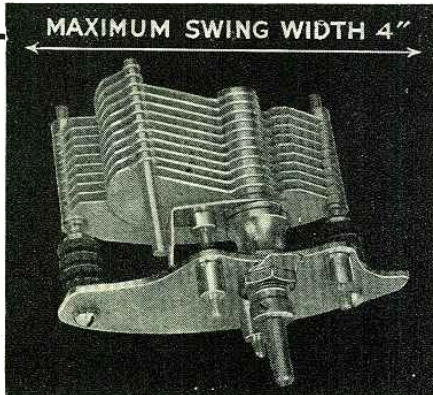

Made of the best materials obtainable, the highest grade of aluminum and the best grade of brass. Besides the materials used, the workmanship is that of instrument makers rather than ordinary mechanics and several features of decided merit are embodied in this Condenser, among them being the improved calibration curve.

The S. L. F. Condenser that takes no more room than old types

The popular "straight-line frequency" calibration gives too rapid a capacity variation near maximum capacity to permit convenient tuning for the longer-wave-lengths. This will be appreciated by radio fans, who appreciate the nicely balanced compromise, such as has been obtained by equal spacing of broadcasting stations and equal facilities of tuning over the entire frequency band. Its compactness is appreciated, due to the fact that most of the

present-day "straight-line frequency condensers" have narrow, pointed rotor plates of small area, which require a large number of plates and give rise to an extravagant rotor sweep, so as seriously to crowd the other parts of the set. In our Condenser the eccentric semi-circular plates, which gives the improved calibration curve, has a substantial area and only a moderate sweep.

Special Features

Low Minimum Capacity, reaching down to 200 meters. Negligible Losses. Individually fitted bearings, allowing no side or end play. Highly developed crimping process insures good bonding between plates. All plates centered, due to rigid assembly and inspection tests. General sturdiness of construction and clean workmanship. Our enormous production for set manufacturers enables us to make this extremely fine price offer to the public. Sold only on a cash with order basis, money returned if you are not more than satisfied that they are exactly what you want and equalled electrically or mechanically.

Price \$2.75 each Set of three, \$8.00

Sent by paid parcel post anywhere in U. S. A.

THOMPSON-LEVERING COMPANY—Radio Division
353-357 NORTH 57th STREET PHILADELPHIA, PENNA.

Trade Mark Registered

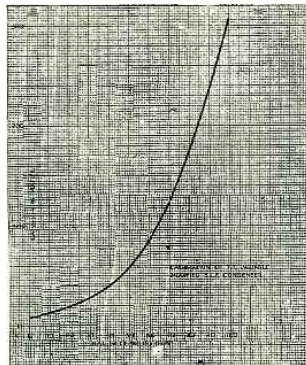

for more tips, he starts to trace us down with the help of a little direction-finder that he had rigged up. They only lived about three blocks from us and it didn't take him very long to find out just where we were and then he got a couple of 'the finest' to come along as persuaders in case they were needed.

"Do I need to tell you any more?" asked Pat.

"No, I think I can finish that story myself. Only tell me one thing, how long did you stay in the coop?"

Pat laughed. "You sure do like to ask funny questions. Who was going to appear against us? We fixed the cops with a good line and of course Strong wouldn't say anything and the kid was shut up by the old man, who didn't want to be the laughing stock of the clubs he belonged to. Oh, we skipped out of that all rightee, but the only trouble was that we didn't have a chance to get some of the old man's five hundred grand. Oh, gosh, it's a tough life, ain't it? How's chances for another scuttle of suds?"

Shielding Radio Receivers Gains Favor

(Continued from page 1442)

During the last year the toroidal coil has been developed so that it is now possible to prevent inter-stage coupling, or at least reduce it considerably, without having to shield the stages separately. At the same time, toroidal coils do not couple readily with outside systems, so that there is not much likelihood of a receiver using toroidal coils picking up the locals without an antenna—at least if the receiver be situated a couple of miles from the transmitting station.

But it seems that there is nothing perfect in this universe. Although the toroidal coil has these advantages, it has the disadvantage of higher resistance than the ordinary cylindrical coil, and also that of having the high and low potential ends of the coil close together.

In making a choice of methods for reducing interference and inter-stage coupling, all these facts should be weighed, one against the other. There are no set rules to follow, except that good judgment should always be exercised.

An interesting method of shielding has recently been introduced in which only the coils of the receiver are shielded, large copper cans being used for the purpose. The can is rather large compared with the size of the coil, so that it seems that there is a considerable amount of wasted space in the receiver. With the proper distribution of the parts in the receiver, however, crowding can be avoided; but the resulting set is likely to be a little larger than the general run of radio receivers.

It is oftentimes a mistake to shield some parts and neglect others. Many times the wiring from the batteries, at some distance from the receiver, will have an antenna effect and pick up signals from local stations. It is advisable to shield the battery cords, as well as the other parts of the receiver. This may be done by bunching all the battery wires into a cable, and then slipping the cable into a brass or copper tube. Another and a cheaper way of doing this is to wrap the cable with copper foil or tin foil, tying it tight at intervals with string or fine wire. The shielding should always be grounded, otherwise its effect may be lost.

It seems to the writer that the days of complete shielding are at hand. This season some of the sets built by manufacturers are shielded; next season, or at least the one



100 AMP. RADIO BATTERY

6 Volt Rubber Case

TWO-YEAR Written Guarantee by THOMAS WITHERBEE

Storage Battery Pioneer for 28 Years.

Shipped direct from factory to you. No middlemen's profit—no delays—no grief.

Send No Money

This is an actual 100 amp. Radio Storage Battery honestly built of purest materials by real battery builders. Solid Rubber Compartment cases—not wood (non-leakable)—will outlast the battery itself. Lead coated carrying handle. Wing binding posts. Will operate the average 5 tube radio set from three to four hours daily for a month to six weeks.

NO DEPOSIT or Advance Payment Required

Simply order—and we will ship by express and you can examine battery at your express office to your heart's content. If you agree with us that it's the biggest offer ever made—pay the expression \$9.98 plus express charges.

If you prefer to remit with order—deduct 50c. You run no risk as we replace any defective battery during two years.

THOMAS BATTERY CORP., 511 West 50th St., New York, N.Y.



for DISTANCE Use a Beldenamtel Aerial

Interesting Facts About Beldenamtel Aerial Wire

Made in 100 and 150 feet lengths to avoid splicing for lead-in wire.

Furnished in distinctive striped carton that is a safeguard against substitution.

Endorsed by leading radio engineers as the best and most efficient aerial.

THE reason for the unusual efficiency of a Beldenamtel Aerial is the great care exercised in its construction. Beldenamtel Aerial Wire is made of several strands of pure copper, each coated with many layers of baked Beldenamtel. The enamel coating prevents corrosion of the wire surface, and thereby offers a low resistance to the antenna current.

Ordinary bare copper aerials corrode, and the volume and range of the set decreases. A Beldenamtel Aerial never corrodes, and therefore the volume and range are not diminished by corrosion. Try a Beldenamtel Aerial, in place of your old aerial, and hear the difference.



*Mail the Conpon
for Free Illustrated
Booklet*

BELDEN MANUFACTURING CO.
2314M South Western Ave., Chicago

Please send me your booklet entitled "Helpful Hints for Radio Fans."

Name.....

Address.....

Belden

NATIONAL Velvet Vernier DIAL Type B, Variable (Patent Pending)

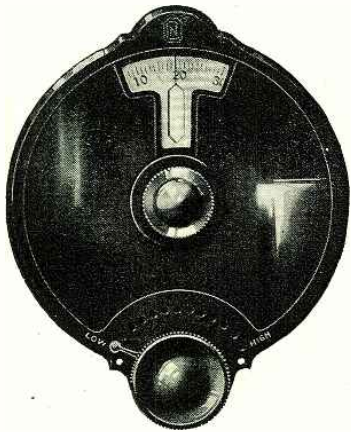

Positive Control—Easily Mounted

YOU control the reduction ratio with this new NATIONAL Type B, Velvet Vernier Dial. And what a difference in the tuning of your set! You'll be astonished.

Easily mounted on the 1-4 in. shaft of any standard type of variable condenser. A screw driver is the only tool you need.

It has the same velvety smoothness, the same freedom from backlash, the same mechanical drive as the NATIONAL's famous Type A dial.

Write for Bulletin 109RN

NATIONAL COMPANY, Inc.

W. A. READY, President

110 Brookline Street, Cambridge, Mass.

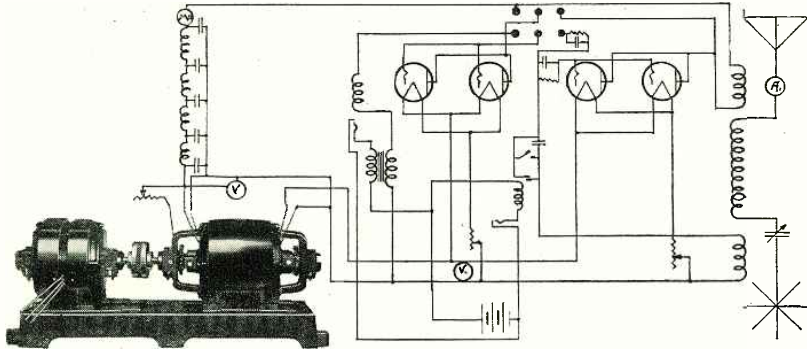

There is no question about the Miles per Watt with ESCO—it is the maximum. Item 35. Two unit four bearing set. Furnished with ring oiled or ball bearing Motor to suit local supply. This "ESCO" set delivers 1000 volts, 300 watts for plate supply and 12 volts, 150 watts for filament supply. This set driving two 50 watters will make a good consistent station.

ELECTRIC SPECIALTY COMPANY

Manufacturers of Motors, Generators. Motor-Generator Sets, Dynamotors and Rotary Convertors for all radio purposes. Have you got your copy of Bulletin 237B and ESCO Filter facts? If not, write for them.

TRADE "ESCO" MARK

211 South Street

Stamford, Conn.

Get an "ESCO" Maximum Miles per Watt POWER supply and you'll need a globe for your records.

RADIO PANELS OF GENUINE BAKELITE

Cut, drilled and engraved to order. Send rough sketch for estimate. Our New Catalog on Panels, Tubes and Rods—all of genuine Bakelite—mailed on request.

STARRETT MFG. CO.
520 S. GREEN ST. CHICAGO

YOU CAN GET

Greater reflex or crystal set reception if you use the

BROWNIE VERNIER DETECTOR

\$2.00 At your dealer or Direct.
ROLAND BROWNIE & CO.
20 Saunders St. Medford, Mass.

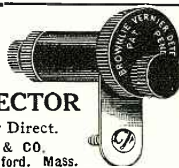

after that, may see all the factory-built sets shielded. It is desirable that this be done, not only to facilitate proper design and uniformity in the receivers, but for the purpose of simplifying and improving the operation. Inter-stage coupling, body effects, critical tuning, interference from locals, and many other evils will be corrected by the proper application of shielding.

The Passing of Canned Music

(Continued from page 1423)

have recently announced improved instruments of this type. In addition to the changes made in the record and the horn, there has also been produced a new and greatly improved type of diaphragm to which the needle is attached. The result is almost unbelievable.

The music obtained from these two new instruments is no longer "canned music," but contains all of the notes just as they are heard by the ear when the original music is played.

This marked improvement in the quality of music which can be reproduced in the home, is an important instance of the way in which pure science can be applied so as to benefit the public at large.

A Duplex Crystal Detector Hook-up

(Continued from page 1435)

should be twice as great, and connected in parallel. Furthermore, the hook-up shown has the advantage that the phone terminals A and B can be connected to an ordinary audio frequency amplifier.

In closing, it may be said that in Austria experiments to increase the efficiency of the crystal set have been carried out to an extent far too limited, and it is to be hoped that more radio amateurs will work along this line. It will be of great value to the public to discover improvements, previously unknown or insufficiently tried.

Radio Makes Isolated Lives Happy

(Continued from page 1398)

Truly, I believe that the above mentioned values have been those most eagerly sought after in the United States. We are seeing the results now, as millions of young people are crowding the schools and colleges, concerts, etc., and the automobiles are bringing millions of people to the small town for the movies.

America is a very hard-working country; both men and women on farms and in small towns labor very constantly and even exhaustively. They need and develop an almost violent appetite for amusement. If they didn't, they wouldn't be able to stand the pace. It is well known that for a period of fifty years or more before the era of the automobile, an alarming number of cases of insanity occurred on middle-western isolated farms, especially among the women. The life of dreary labor and isolation was almost unendurable. Even in the early pioneering days there had been excitement, danger and adventure—yes, and travel, in the covered wagons, etc.

IN GREAT CITIES TOO

I am drawing a picture of this situation on the farm and in the small town. But many women in the large cities have also their

Light to see— power to hear

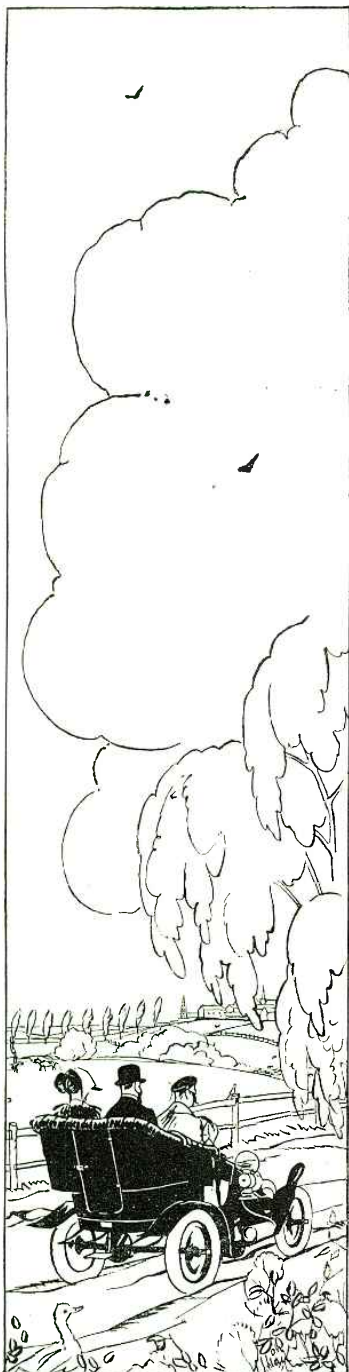

WHEN you buy a Prest-O-Lite Storage "A" or "B" Battery for your set, you are not only saving money because they cost less, but you are buying radio batteries that are made by a company with over twenty years of manufacturing experience.

Prest-O-Lite maintains the world's largest electro-chemical research laboratories. From these laboratories have come the wonderfully efficient Prest-O-Lite Radio Batteries. Made especially for radio, they deliver their rated capacities at full power.

Ask for Prest-O-Lite Radio Batteries. They may be purchased from \$4.75 up. It is no longer necessary to take chances with batteries of unknown make. You will find Prest-O-Lite dealers within earshot of your own loud speaker.

THE PREST-O-LITE CO., INC.
INDIANAPOLIS, IND.

New York San Francisco

In Canada: Prest-O-Lite Company of Canada, Ltd.
Toronto, Ontario

Send for free booklet

"What every owner of a radio should know about storage batteries" is a little booklet which every radio fan will find interesting and helpful. It is crammed full of hints that will bring surprising radio results—and save you money. It's yours for the asking—without obligation.



Designed especially for radio

Prest-O-Lite

STORAGE BATTERIES FOR
MOTOR-CARS AND RADIO



COUNTERPHASE SIX

Judge It by RESULTS

Results only determine the popularity of a receiver. To say that the Counterphase is popular is putting it mildly. A comparatively short time ago the Counterphase was unknown. Its introduction with Bremer-Tully's word that it was better than the famous Nameless, was enough for the progressive American radio fan. It became popular over night because it did what B-T said it would—

and WHY SHOULDN'T IT

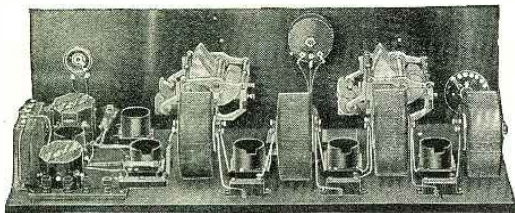

3 stages radio frequency
—circuits balanced by
B-T patented method.

Last word in selectivity.

May be used with 15-foot indoor aerial.

Only two tuning controls.

Thousands of testimonial letters attest its right to leadership—Essential parts are available in kit form—

- No. 6 kit for 6 tube sets.....\$38.00
- No. 5 kit for 5 tube sets..... 28.50

"BETTER TUNING"

an interesting booklet containing 68 pages of straight-to-the-point radio facts. Don't miss the 9th edition—just out! Price 10c—Circulars free.

BREMER-TULLY MFG. CO.

532 So. Canal St.

Chicago, Ill.

Goodrich Silvertown Radio Panels



For greatest range and selectivity

- 1 Easier to drill and machine.
- 2 Better color, lasting lustre.
- 3 Lower free sulphur—no discoloration.
- 4 Higher softening point—no warping.

Goodrich V. T. Sockets
Radiophone Ear Cushions

Spaghetti Tubing
Battery Mats

Hard Rubber Tubes for Coils

The B. F. Goodrich Rubber Company
Established 1870 Akron, Ohio

\$1.50 FOR YOUR OLD RADIO TUBES

regardless make or condition, toward purchase of each new standard \$2.50 tube. Positively guaranteed. We do not sell re-built or bootleg tubes. AGENTS WANTED.

SUPER-SERVICE LABORATORIES, Dept. 55
Room 58, 39 West Adams Chicago, Ill.

ELECTRAD
Certified Radio Parts

problem. Without servants, imprisoned in small—sometimes almost intolerably small—apartments, with babies and small children to care for, these women have known loneliness and isolation, even in the midst of the seething mob.

The plain, blunt truth is that until radio came, the average woman with children, the woman living in the country or the small town, found that her isolation nearly broke her spirit and pushed her into mental inferiority. What else can happen when there is lack of opportunity for education, contact, music, amusement? A woman with small children is a self-imprisoned slave to her offspring, and no amount of fine theory can dispute it. She is limited very largely to such pleasures and benefits as she can get in her own home.

All our theories of helping this woman—up to the time of the coming of radio—were based on getting the isolated people to where the music, education, etc., was located.

MEN'S TOY AND WOMEN'S HELPER

A great many people, therefore, have not grasped the enormous significance which the radio has for the women without advantages, both in city, small town and rural section. It is performing the miracle, previously thought quite impossible, of taking right into the private confines of the home—no matter how humble, or where located—the best that the country affords in education, music and amusement. To men it has meant largely the thrill of invention: to women—who accept invention more as a matter of course—it has been something quite different. That is why at first men were the radio "fans"; they loved the scientific marvel of the instrument; their passion for DX thrill kept it up; and the broadcasting material grew and improved.

Then came woman's turn. Caring little for distant stations, she—always the practical and utilitarian—began to notice radio—began to make radio into what is its great destiny; a re-shaper of family outlook and individual growth; a lifter-up of middle class standards; a provider of middle class opportunity on a colossal scale.

Rich people know radio as another luxury, another amusement and marvel. But average people know radio for what it really is—a changing of the horizons of life—a harvest of treasure that has been denied them.

To the women it is still more; it is a proclamation of emancipation from isolation. The telephone was supposed to have been such an emancipation, but it never has been, except for emergency. The phonograph was also supposed to be an emancipation, and it has been so only by proxy. The automobile, above all, was supposed to be such an emancipation, and it has gone a long distance in that direction; but when you come right down to cases it simply permitted farm folks to go to the nearest small town, and small town folk to go to the nearest larger town, for what such centers had to offer—which is a ghastly little indeed—of the really high-grade education, amusement, music afforded by this great country.

There isn't the slightest possible real comparison between these other "emancipations," and that which radio affords.

RADIO A CREATOR OF TRADE

It is worth while, too, to note what radio is doing for the business world, in relation to average women. As every student of business knows, it is not money, but desire for things, which makes trade. Misers make no trade; nor do people work to earn money who have no desires. Desires do not grow naturally; they are stimulated. Mail order catalogs used to do a lot of such stimulating in isolated communities; one mail order house does quite a lot of business with the Esquimaux of Alaska, because wants are stimulated by the catalog.

Radio is stimulating desire and enlarging



A New Development Insures Remarkable Radio Reception

**The only Eliminator
with a variable control
on Radio Frequency**

One Variable Control for de-
tection from 0 to 65 volts.
One Variable Control for R.
F. Tubes from 40 to 120 volts.
One Power Control for Audio
Tubes from 90 to 180 volts.

**Desirable Exclusive
Territory Still Open
for Authorized Dealers**

R. E. Lacault, our chief engineer, has had a real-honest-to-goodness "B" Battery Eliminator developed to meet his own exacting requirements and he has authorized us to guarantee this Eliminator without any reservations.

Here is a "B" Battery Eliminator—a real Eliminator—Endorsed by one of the foremost Radio Engineers of United States and France. And, it is sold on a money-back guarantee basis.

It will deliver ample "B" Battery current supply to operate any radio set from one to ten tubes; and is particularly efficient when applied to neutrodynes, 8 and 10 tube super-heterodynes and Ultradynes L-1, L-2 and L-3.

It puts new pep in your set!

No Hum	No Leaky Cells	No Battery Replacements
No Acid	No Spoiled Rugs	No Fuss
No Recharging		No Bother

Remember your first cost is the only cost and your "B" Battery troubles are banished forever. Nothing to wear out. The unit is compact and of rigid construction. Just plug into your electric light socket and you have top-notch "B" Power at your service. The current consumption is negligible; but the receptive qualities of your receiver will be improved to a marked degree.

Don't just take Mr. Lacault's word for this—as this Eliminator is sold on a money back basis—Simply send us your order and we will forward the Eliminator by express C. O. D. Test it for five days and if it does not do all we claim—return it to us and your money will be cheerfully refunded, without question.

This new "B" Eliminator will save you money—save your temper—and will give you much pleasure in the efficient way it operates. Clip the coupon—Don't delay.

5 DAYS FREE TRIAL

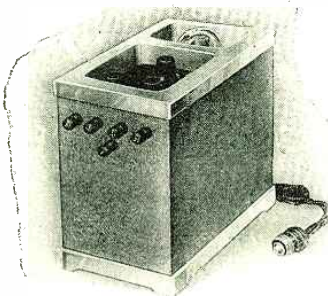

PHENIX RADIO CORPORATION
114 East 25th St., New York, N. Y.

Gentlemen:—Please send me C. O. D. plus shipping charges, one "B" Battery Eliminator, approved by Mr. R. E. Lacault.

110 Volts, alternating current, 60 cycles, complete \$55.00

It is agreed and understood that if the eliminator after it is received by me, is not satisfactory, I will return it within five (5) days, and my money will be refunded without question.
(Or) I enclose full remittance herewith and you are to prepay express charges.

SIGNED:

STREET:

CITY: STATE:

"B" Eliminator for D.C. Current is \$25.00

Check Eliminator Desired

BARKELEW Lightning Arresters

LIGHTNING ARRESTER SWITCH

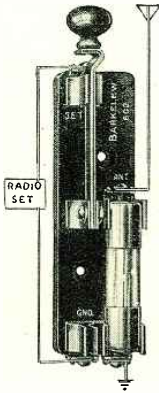

No. 602 Price \$2.50

OUR No. 602 Lightning Arrester Switch is universally recognized as the only device on the market which combines on one base all those functions essential for maximum protection.

The Vacuum tube arrester is permanently in the circuit from antenna to ground, ready to "spill" any overcharge. With the switch blade the antenna may be disconnected from the radio set and thrown directly on ground.

It meets not only the requirements but also the additional recommendations of the National Electric Code.

Our No. 606 Vacuum Tube Lightning Arrester is less expensive but it meets all the actual requirements of the National Electric Code.

Both are Approved by the Underwriters' Laboratories.

See our Radio Catalog at your Dealer.
If he hasn't his copy, we have one for him.

The Barkeley Electric Mfg., Co.
Middletown, Ohio, U. S. A.

NEW YORK, 157 Chambers St.
BOSTON, 31 Bedford St.
WASHINGTON, D. C., Mills Bldg.
ATLANTA, GA., 180 Spring St.

CHICAGO, 15 S. Clinton St.
DENVER, Denham Bldg.
MINNEAPOLIS, 1017 Lumber Ex.
SEATTLE, 1041 Sixth Ave. S.

SAN FRANCISCO, 75 Fremont St.
LOS ANGELES, 443 S. San Pedro St.
TORONTO, 20 Bloor St. W.
MONTREAL, 296 St. Paul St. W.

LIGHTNING ARRESTER Vacuum Tube Type

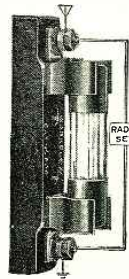

No 606 Price \$1.50

mental horizons, which always means enlarging the desire for possessions. Pianos and musical instruments, books, new foods, more sanitary facilities, different clothes, more education—all these and more are being bought to a larger degree by women who hear what is being said over the radio. The standard of living is being raised everywhere—which means more work and more prosperity.

And women are happier, healthier, and more up-to-date; that is the biggest item of all.

All About Toroid Coils

(Continued from page 1437)

From this chart the number of feet of wire required to furnish a given amount of inductance can be obtained. The straight line shown indicates the number of feet of wire required in this coil to furnish an inductance of 100 microhenries, when wound with various sizes of wire. These figures are taken from the curves of Fig. 3 and plotted in Fig. 4. The broken curve of Fig. 4 indicates the overall diameter of the coil. It must not be forgotten that all this applies to coils having a coil diameter of two inches, and the turns are wound closely at the center. It does not apply to coils of other dimensions, although as I have said before, the curves can be used as a rough guide in studying the coils. As a manner of "getting his bearings," the reader may compare these curves with those shown in the January and February, 1925, issues of RADIO NEWS. See the articles on "High Frequency Resistance," dealing with cylindrical coils.

In Fig. 5 we have shown the effect of varying the coil diameter, at the same time keeping the turns close at the center, without crowding or spacing, and in Fig. 6 are curves showing the turns required in toroids, having different coil diameters to furnish given amounts of inductance.

In Fig. 7 we have a very interesting effect shown, the effect of the internal diameter (or ring diameter) on the inductance of toroidal coils, all the coils being wound of 160 turns of No. 22 wire, and having a constant coil diameter of 1/2 inch, shown by the curve. It will be noted that the smaller the internal (or ring) diameter, the greater is the inductance, for a given number of turns, wire size, and coil diameter. As a matter of interest, the broken line indicates the internal diameter at which there is no crowding or spacing, or at which the turns just touch each other. To the right of this line the turns are spaced; to the left they are bunched together.

it's in the TUBE

YOUR receiving set can be no better than its tubes. CeCo Tubes give maximum results in clarity of tone, rich volume and long life.

Our charted tests (results confirmed by laboratories of national reputation) PROVE CECO TUBES' SUPERIORITY—as detectors, as amplifiers.

Buy CeCo Tubes whether your set takes one tube or eight.

Now ready! CeCo Tubes with new type Long PRONG BASES. Also, power amplifier tubes, E (Dry Cell Type), F (Storage Battery), for last stage of Audio Frequency. Ask your radio dealer.

C. E. MFG. CO., INC.
702 Eddy Street Providence, R. I.

CECO TUBES



3 TYPES—ONE QUALITY,
THE BEST

	"A"	"B"	"C"
Filament Volts.....	5.0	3.0	3.0
Filament Current....	0.25	.08	.06
Plate Voltage	20 to 120	20 to 80	20 to 80



U. S. TOOL S.L.F. CONDENSERS

work with a smoothness that prevents skipping by any station. Equally efficient under all conditions.

U. S. TOOL COMPANY, INC.
AMPERE, N. J.

MARKO

RADIO BATTERIES

are
ALWAYS DEPENDABLE
MARKO STORAGE BATTERY CO.
Brooklyn, New York

BUILDING A SET?

You must have rheostats of correct ohmage. Insist on the genuine

KLOSNER RHEOSTATS
Made by pioneer makers of the vernier. FREE.—Send for valuable Rheostat Chart and information on the care and operation of vacuum tubes. Mention dealer's name.
KLOSNER RADIO CORPORATION
1024 East 178th St. Rheostat Specialists, N. Y. C.



LATEST WHOLESALE RADIO CATALOG

FREE Simply send name TODAY for big 64-page book explaining liberal proposition paying agents \$60 to \$100 a week, and how to get latest radio goods at wholesale. Live dealers and agents wanted.
Standard Radio Co., 1408 Walnut, Kansas City, Mo.

Station
WRNY
NEW YORK

258.5 Meters - 1160 kilocycles
is owned and operated by the
publishers of this magazine
Our Editors will talk to you
several times every week—
See your Newspaper
for details
**TUNE IN ON
WRNY**

Again Pilot shows the way

\$ 1.00



**TRIPLE
CAPACIGRAD**

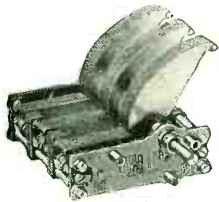

NEUTROGRAD

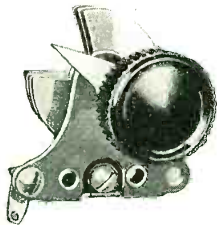

NEW CAPACIGRAD

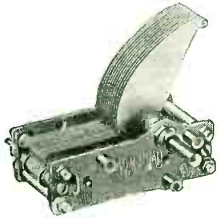

**FITALL
UNIVERSAL SOCKET**



PILOT JACK



PILOT RHEOSTAT



A Master Improved Vernier *dial for finest tuning*

Once again PILOT has achieved a master production for radio set builders and users—a new, improved vernier dial (ratio 10 to 1) which makes fine tuning not only possible, but simple. Readings are marked for both degrees and kilocycles. Made of genuine bakelite that is moulded in the Bakelite Department of the great PILOT plant where everything is made from Raw Materials—the world's greatest parts manufacturer.

This beautiful, sharp-tuning dial can be purchased at all S. S. Kresge stores.

If there is none near just send one dollar by postal money order and we will mail you a KILOGRAD direct.

Pilot Electric Manufacturing Co., Inc.
323 Berry Street
Brooklyn, New York

PITTS' UNDERGROUND ANTENNA

Successful Thru Performance Filters Reception

\$14⁵⁰

Results Guaranteed



Radio Reception through the ground eliminates Static and Power Line interferences you are now picking up on a loop or outside aerial. Your set is more selective cutting out powerful local stations that are interfering with distance—Plenty of Volume—is not Directional. Thousands of enthusiastic owners—easier to install than an outside aerial—works on all circuits. Mail coupon today for Pitts' Under Ground Antenna with full directions and Written Guarantee.

DEALERS, JOBBERS, WRITE FOR PROPOSITION!
Ernest Walker Sawyer—Factory Representative

OSBORNE-KELSEY CO., 1915A Santa Fe Ave
Los Angeles, Calif.

Gentlemen:
Enclosed is money order (or check) for \$4.50—send one Pitts' Under Ground Antenna with full directions and Written Guarantee, for which I will pay \$10 (balance of cost) upon receipt.

Name.....
Address..... City..... State.....

Regarding Noises

(Continued from page 1446)

duce something that sounds more like a 100-cycle note than anything else. However, an M.G. set can and should be filtered. In this case, the apparatus necessary is not quite so complicated as that used for filtering A.C. In fact, all it consists of is a few high-capacity condensers shunted across the output of the M.G., as in Fig. 2. We show two capacities, C and C₁. They may be 1- or 2- μ f. each, and sometimes a single 1- or 2- μ f. shunted across the output will be found of ample size. Try different capacities until you find out just which will work best on your particular installation.

Before we leave the subject of notes in general, let us mention that no matter what kind of a filter system you use, you will not get that desired pure D.C. tone unless your set is properly tuned. The best brute-force filter will not help you, if you do not fuss around with the oscillation transformer clips until the very best operating position is ascertained. Therefore, see to it that your transmitter has the two following requisites: a good filter and a properly-tuned oscillatory circuit. Then you can step out and get that well-known grand and glorious feeling. Incidentally, you will start to acquire new wall paper faster than ever.

WHERE KEY CLICKS ORIGINATE

Now let us find out something about these key clicks that the neighbors complain about every once in a while. Probably there are more key clicks turned loose around the various sections of this country by the methods illustrated at X in Fig. 3 than in any other way. If you want to raise bedlam in general around your particular locality, just put your key in series with the filament center tap, as shown in Fig. 3, and go to it. You will soon hear some insidious rumors about the BCLs that somebody must be operating a pneumatic concrete breaker in the immediate proximity of their residences. The truth must be told, however; and the imitation of the said pneumatic concrete breaker is caused by nothing more or less than your very innocent keying in the center tap. Cut it out fellows, or the BCLs are liable to cut you out. There are other and far better ways of keying than by the center tap or grid methods. Leave them alone and, among other things, you will find that your oscillator tubes will last longer.

Any method of keying that allows the high voltage current to remain applied to the plate, during the entire operating period, is to be looked upon with disfavor. Probably this is the cause of more tubes running hot than anything else. Even though your circuit is properly tuned, and you are not applying more than 100 per cent. excess plate voltage to the plate (which is usually considered normal in this country), your plates will run red, and even white hot if the high voltage is applied regardless of the position of the operating key. If you are keying in any other way than that shown in Fig. 4, yank your key out of the circuit now and insert it in series with the primary of the plate supply transformer, as shown. Your key clicks will be killed and the BCLs will once more be happy. When the key is up, there will be no high voltage on the oscillators and your tubes will get a chance to cool off. Incidentally, of course, they will last longer.

Some folks are going around, and seemingly trying to scare hams out of the practice of using primary keying, by saying that if you do so and are using good brute-force filter

MAKE YOUR SET BATTERYLESS

We will tell you how to make any set operate perfectly without A, B, or C Batteries for

You can now make an Electric Light Socket Radio Receiver out of any battery operated set, radio circuit or parts, and eliminate forever all A, B and C batteries, chemicals, chargers, continuous trouble, upkeep expense, disappointments and save easily \$75 a year.

Anyone—you, your battery-charging, electrical and radio service man or dealer—can make it in short time at reasonable expense. Thousands are now doing it and thousands are now in the homes.

It will be as good as POWEROLA, the famous 5-tube no-battery electric radio (universal for A. C. or D. C.) now demonstrated and sold thru the New York Edison Co., your local electric light company, radio, electrical or music dealer, and

tested and endorsed by Popular Radio, Radio Broadcast, Radio News and all highest and leading authorities, and engineers, as being powerful, practical, perfect, dependable and constant in performance.

REMEMBER YOU DON'T HAVE TO JUNK OR THROW AWAY YOUR OLD SET OR PARTS. THEY CAN NOW BE MADE INTO AN UP-TO-DATE ELECTRIC RADIO, THE LATEST AND BEST IN RADIO PERFECTION AND PLEASURE.

Send \$1.00 and we will mail you booklet containing 29 new and hitherto unpublished diagrams, information and literature, showing how to transform any old or new radio set, circuit and parts into an Electric Radio.

POWEROLA RADIO CORP. (Dept. R.N.) 1845 BROADWAY NEW YORK

100 Volt Storage "B" Battery for \$1000!

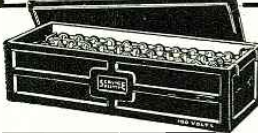

Everybody can now enjoy the benefits of Storage "B" Batteries—more power, quieter reception, greater economy. Rubber case prevents leakage or shorting. Easy to recharge. Will last for years with ordinary care.

SERVICE Rechargeable "B" Batteries in all-rubber cases

50 VOLTS	\$5.50
100 VOLTS	\$10.00
125 VOLTS	\$12.50
50 VOLTS	\$7.75

Prices in Canada

100 VOLT	\$14.50	125 VOLT	\$17.00
----------	---------	----------	---------

SERVICE Double-Duty CHARGER

Charges 6-volt "A" or Auto Batteries or up to 125 volts of "B" Battery IN SERIES. Noiseless in operation. Extremely economical. The height of convenience.



Complete with Bulb \$14.50

SERVICE BATTERY CO. of Canada, 137 Roncesvalles Ave. Toronto, Ontario

SERVICE BATTERY CO.

704 East 102nd Street Cleveland, Ohio

Insure your copy reaching you each month. Subscribe to Radio News—
\$2.50 a year. Experimenter Publishing Co., 53 Park Place, N. Y. C.

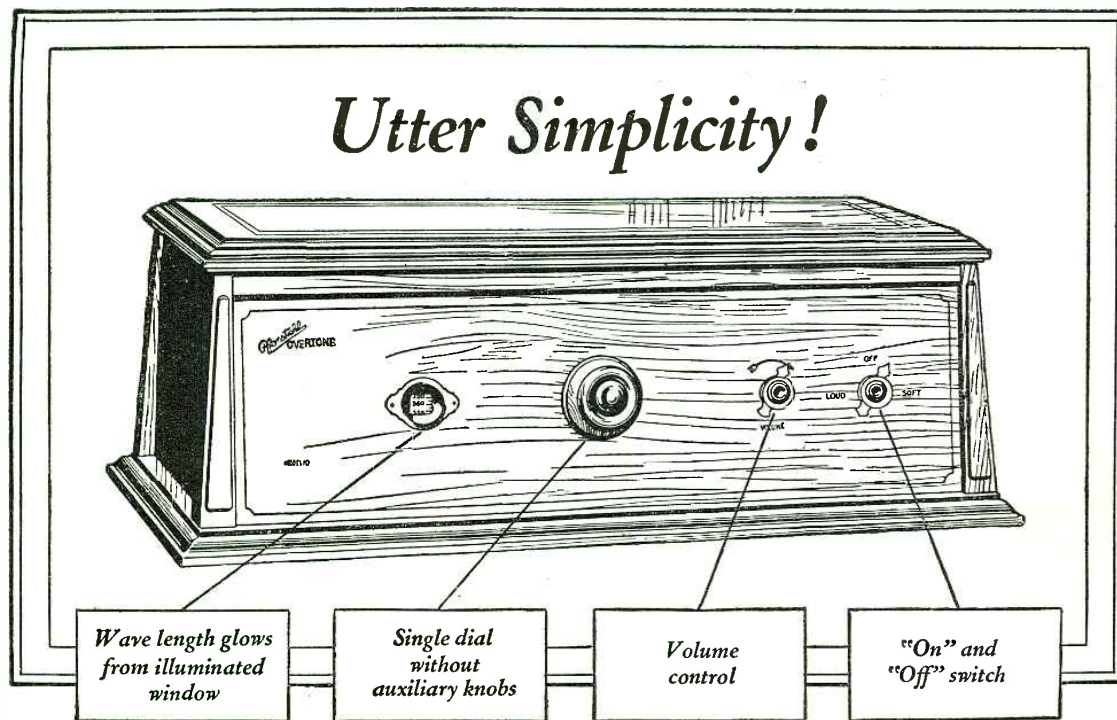

How free from complications is this radio panel. It has but one tuning dial, a volume control and a switch for "on" and "off." The merest amateur can tune as accurately and as quickly as an expert. He does not have to grope around adjusting dials. He turns IMMEDIATELY to the wave length desired. It is ILLUMINATED; you can read it in the dark.

The Real Secret of Tone Beauty

(It Is All in the Overtones)

ANYBODY can build a complicated radio receiver. The market is full of them. Simplicity is the secret of everything most desirable in a radio set—TONE QUALITY above all. The more devices and adjusters employed, the more interference there is with the delicate flow of radio energy in and between circuits. The least disturbance of the vibrations which make overtones blurs the tone.

The tone beauty of the PFANSTIEHL "OVERTONE" receiver is due to its ultra simple design, its freedom from electrical errors and from the devices necessary to adjust them. Music or human speech is received and reproduced exactly as transmitted, with all of the tone color which invests them with individuality and charm.

The same freedom from extra dials or adjusters also enables a very graceful looking panel to be designed. There is nothing to clutter it. The inside is just as clean-swept as the outside; there are no hidden adjusters or extra wiring to complicate operation.

Hence you get
Matchless tone—single dial tuning—graceful design in the

Pfanstiehl

"OVERTONE" RECEIVER
Perfectly Reproducing the Overtones



MODEL 100—A complete 6-Tube Single-dial Console Overtone Receiver with Overtone Speaker, Control Board, Battery Charger and Compartments for Battery built in. Price \$450.00 (less tubes and batteries).



MODEL 108—Overtone Single-dial 6-Tube Receiving Set with demountable Console Stand, Overtone Speaker built in. Price \$200.00 (less tubes and batteries).

Other 5-Tube Models \$85 to \$135
Exclusive Dealer Franchise

GOOD RECEPTION!



Will you get it from now on?

WEAK or sluggish radio reception is usually the fault of tube filaments. Run down tubes used night after night are bound to give poor results—and even a new tube may not be up to standard.

You can now measure tube strength!

The Sterling R-403 Tube Reactivator rebuilds the tube filament strength. The meter on this reactivator permits you to know instantly the strength of any thoriated filament tube before and after treatment. You are not guessing. The process can be repeated over and over.

Read the Meter

Test your tubes often and reactivate them only when they need it. That's the Sterling "metered" way. Be ready for the best this summer. **Ask your dealer—for a STERLING!**
Its price is only \$12.50 (50-60 cycle)
\$14.00 (25-40 cycle)

Sterling

TUBE REACTIVATOR
RENEW'S YOUR TUBES, and TESTS THEM, TOO

THE STERLING MANUFACTURING COMPANY
Cleveland Ohio Dept. H.

when
you have done everything
to your set and yet you
don't get Results - try



AEROVOX

FIXED CONDENSERS

Tested and approved by M. I. T., Yale, Radio News, Popular Radio and Popular Science. Used by over 200 of America's leading set manufacturers.

Made in all capacities. Also manufacturers of Grid Leaks, Resistors, Resistofomers and Rheostats.

Accuracy plus Quality
Results

AEROVOX WIRELESS CORPORATION
489-491-493 Broome St., New York City

Branch Offices:
Chicago, Ill.
53 W. Jackson Blvd.
Cincinnati, Ohio,
304 Palace Theatre Bldg.
Boston, Mass.
104 Portland St.
Los Angeles, Cal.
324 No. San Pedro St.

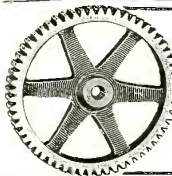

GEARS
All Kinds—Small
The most accurate made and prices reasonable. We carry a complete line of gears in stock for immediate shipment. Can also quote on special gears of all kinds. Send us your inquiries. Write for Catalogue 40
Chicago Stock Gear Works
105 South Jefferson St., Chicago



EUREKA DIAL POINTERS
10c EACH
Polished Nickel or Gilt.
D-X Owl Pointer:
Nickel 10c Gold Plated 15c
Send price in stamps or money order for quantity wanted.
C. W. BUTTS, INC.
42 HEDDEN PLACE
EAST ORANGE, N. J.

Have your tubes tested on the
Superadio-Dynameter

MODEL 5 RECEIVER \$56 WATCH FOR THE B and C BATTERY ELIMINATOR
De Witt-La France Co., Cambridge, Mass.

Immediate Shipment from Stock
HAVE MERCHANDISE WHEN YOU NEED IT
Catalog 466'S is free to dealers

WHOLESALE EXCLUSIVELY
LUDWIG HOMMEL & CO
929 PENN AVENUE PITTSBURGH, PA.

Insure your copy reaching you each month. Subscribe to Radio News—\$2.50 a year
Experimenter Publishing Co., 53 Park Place, N. Y. C.

your sigs will acquire little tails, that will make them hard to read. True enough, these little tails will be found under certain conditions; but these conditions are very easy to eliminate and once this is done, you can key in the primary and use a brute-force filter without any trouble whatsoever. The method of eliminating the tails is to tune your set properly. It will be found that this can be done, in a way to eliminate entirely the little tails, and the results will be all that can be desired.

And so fellows, here is some dope for you. Go to it, and see if you can't stop some of the noise that some of you have been creating. We hope that those who read this, and are not creators of noise, will not take offense. The dope is given in the spirit of helpfulness; and if it accomplishes its purpose of removing some of the bum notes and bad key clicks from the air, we will all offer up thanks and be glad.

The Fugitive

(Continued from page 1403)

FRANK: He held me up and tried to take my car—he turned for a moment. I knocked him out with a wrench and turned back to Lindsay with him. There they told me that he had killed two already today—I've been through red tape ever since.

ALICE: And weren't you afraid?

FRANK: Yes, I was afraid he'd take the car.

FRED: You know there is a reward of one thousand dollars? You'll get that of course?

FRANK: I get that tomorrow—they took my picture for the morning papers, too.

ALICE: And you get a thousand dollars, Frank, dear? (Celebrations heard again; music stops on radio.)

FRED: The announcer is on—listen—(a short pause)

FRED: Hear that, Frank! The announcer says the criminal Rader has been captured single-handed by Frank Taylor of this city. This entitles Mr. Taylor to the State's one thousand dollar reward, and to the additional five hundred offered by the Radio Association! (music goes on again.)

ALICE: Frank, you're the most wonderful—but you must be hungry—I'll have supper ready in a minute for you boys.

FRANK: Alright dear, I'm hungry, alright.

FRED: Gosh, Frank you're sure starting the new year right! Listen to that jolly racket outside—everybody's happy tonight alright. By the way—what are you going to do with the additional five hundred?

FRANK: New hats for Alice, toys for the boys, and a bigger radio for the house.

ALICE: Come boys, sit down, I'll have your supper in a hurry.

FRED: Ha! ha! ha! Then, Frank, we certainly can hope for a Happy, a Prosperous, and a Radio New Year.

THE END

I Want To Know

(Continued from page 1456)

The filter coupler may consist of two 1,250-turn honeycomb coils, mounted as shown in Fig. 2160-C. The R.F. coil consists of a tube 2 3/4 inches in diameter and 2 1/4 inches in length. L-2 is the winding on this tube and consists of 75 turns of No. 32 D.S.C. or D.C.C. wire, tapped at the 20th, 30th, 50th and 75th turns. The rotor coil is placed within this and measures 1 3/4 inches in diameter and 1 7/16 inches in length. The method of winding and assembling this coil is shown in Fig. 2160-D. The antenna coil consists of 100 turns of No. 26 or 28 D.S.C. or D.C.C.

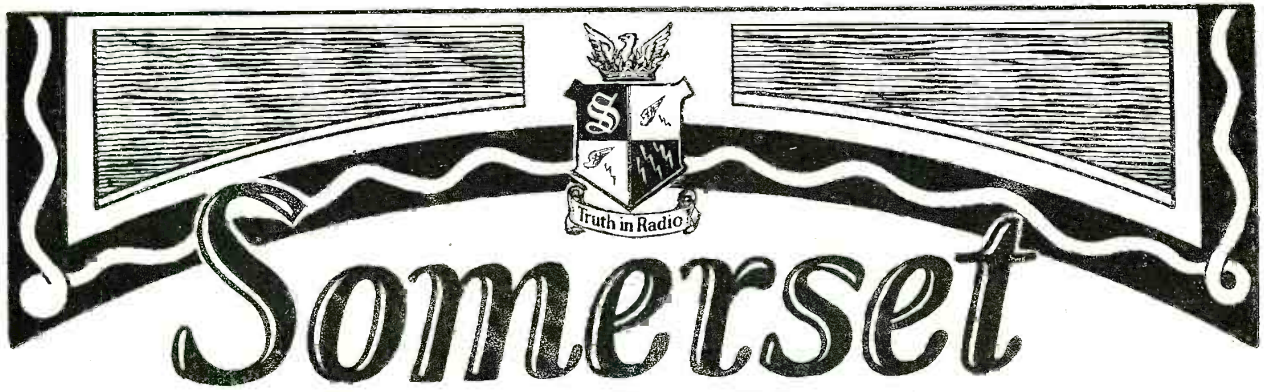

Somerset

STANDISH MODEL 4-C



"TRUTH IN RADIO"

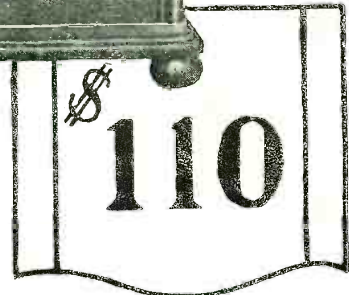

Synchronized, Single Master Control Gives Greatest Simplicity of Operation

Ever since SOMERSET Radio made its appearance two years ago, these beautiful sets have endeared themselves to the public on account of absence of extravagant claims.

SOMERSET Standish Model 4C achieves absolute simplicity in operation. One synchronized control takes care of all major tuning for local stations. A vernier control underneath the large dial is used only when listening to distant stations.

This is a 4-tube set entirely enclosed in an antique mahogany, two-tone, beautifully inlaid cabinet, with built-in Utah Loud Speaker, the best that money can buy. There is space for both "A" and "B" batteries in this large cabinet. Not just a cabinet, but a perfect piece of furni-

ture. The total size of the cabinet is 28½" x 13" x 13½".

Storage batteries or dry cells can be used. Standish Model 4C operates from 200 to 600 meters. There is an automatic filament control, eliminating chances of burning tubes too brightly and does away with extra controls.

Straightline Frequency condensers of the latest type do away with crowding of the short-wave stations.

This receiver is the best and most pleasing model of the SOMERSET line of modern radio receivers. It is handsome, powerful, and practical throughout—built by men who have been in the radio business since 1908.

Special Dealer FRANCHISE

Extra valuable dealer franchises for the SOMERSET line are still open to some dealers who are interested in the better model receivers that are ready for quick installing, backed by a liberal advertising campaign in your own territory. Write for complete plan. Wire for your territory or use this coupon, as we are closing all territory rapidly.

SOMERSET RADIO CORPORATION
113-119 Broadway Brooklyn, N. Y.

SOMERSET RADIO CORP.,
113-119 Broadway, Brooklyn, N. Y.

4-26

Gentlemen: Kindly send me at once details as to Special Dealer franchise.

Name

Address

City, State

HEATH "RAD. ANT"

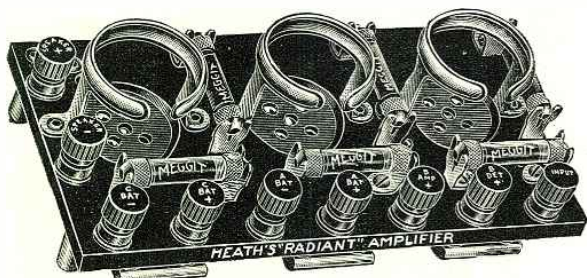

3 Stage Resistance Coupled Amplifier Gives Natural Tone Quality

The Heath 3 stage Resistance Coupled Amplifier is the highest type of audio amplification. It supplies pure, undistorted tone to your loud speaker and gives a high quality of reception you never thought possible. Accommodates either UV or UX type tubes. Suitable wherever Resistance Coupled Amplification is required. Unit complete with Laboratory Tested "Meggit's"; completely assembled and wired; ready to install in your set, is priced at \$10.00.

If your dealer can't supply you, order direct from our factory.

Write for literature.

Made by Makers of Heath "Radiant" Condensers.

HEATH RADIO & ELECTRIC MFG. CO.

206-208-210 FIRST ST.

NEWARK, N. J.

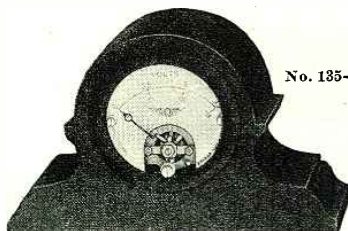

No. 135-C

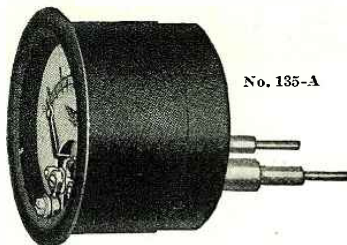

No. 135-A

Control
the
Filament
of your
Tubes

Send for Jewell Circulars Nos. 735
and 739 describing these two new in-
struments designed for new Radiola,
Victor and Brunswick Sets.

Order from Dealer

JEWELL ELECTRICAL INSTRUMENT CO.

1650 Walnut St. - Chicago

"26 years making good instruments"

You Will Make a Big Mistake

If you buy a radio cabinet without first getting our free catalogue. Made in hardwood mahogany finish or solid black walnut. Choice of 7½ or 10 inch depth same price. Full length piano hinge and lid support, both nickel plated. Baseboard free. Beautiful cabinets in rubbed finish. We sell Loud Speaker cabinets complete with grille and silk ready for your favorite unit.

The Southern Toy Company, Inc.

Dept. N

Hickory, North Carolina

Insure your copy reaching you each month. Subscribe to Radio News—
\$2.50 a year. Experimenter Publishing Co., 53 Park Place, N. Y. C.

40 Non-Technical Radio Articles

every month for the beginner, the layman and those who like radio from the non-technical side.

SCIENCE & INVENTION, which can be bought at any newsstand, contains the largest and most interesting section of radio articles of any non-radio magazine in existence.

Plenty of "How To Make It" radio articles and plenty of simplified hook-ups for the layman and experimenter. The radio section of SCIENCE & INVENTION is so good that many RADIO NEWS readers buy it solely for this feature.

List of Radio Articles Appearing in the April Issue of "Science and Invention"

Latest Radio Broadcast News.

The Radio Constructor—How to Build a Real "B" Eliminator.

By A. P. Peck, Assoc. I. R. E.

A Highly Efficient Six-Tube Receiver,

By L. Abrams

Five Tubes With Regeneration.

Radio Oracle.

Radio Wrinkles.

wire wound on a 2- or 2½-inch tube and tapped every 2 turns for the first 15 turns at one end.

The coils described in the article ought to cover a wave-band of from 550 to 220 meters.

An antenna coil that will register from 380 to 175 meters can be made by space-winding 70 turns with a tap at the sixth turn; 240 meters to 100 meters, 50 turns, tapped at seventh turn; 120 meters to 50 meters, 30 turns, tapped at the tenth turn. The windings for the oscillator coupler, to cover the same wave-bands, are as follows: 380 to 175 meters, L-3, 4 turns; L-4, 50; L-5, 35; 240 to 100 meters, L-3, 4 turns; L-4, 40 turns; L-5, 25 turns; 120 to 50 meters, L-3, 3 turns; L-4, 22 turns; and L-5, 15 turns. It will not be possible to space-wind the oscillator coils as much as the antenna coils, but they can be spaced a little. Naturally, none of these coils are bank-wound. In fact, the coils to cover the band between 550 and 220 meters need not be banked if there is room enough for all wires on the form.

A loop may be used, satisfactorily, by simply substituting the two connections from the loop for the two connections of the antenna coils, which must be disconnected. The loop connections go directly to the rotor and stator plates of the first variable condenser shown.

A Balanced Tuned R. F. Receiver

(Continued from page 1429)

stats. Then the wooden baseboard is prepared by cutting out the section immediately under the two variable condensers. The baseboard is 7 x 17 x ½ inches and the cut-out section is 11 x 3 inches, allowing 3 inches at each end of the baseboard for the two inductances as shown. The apparatus is placed temporarily in position on the baseboard, and then holes of a diameter that will permit bus bar wire to enter are drilled through the board, to permit ease in wiring and to shorten the length of the leads to the various instruments. It should be noticed that the two inductances are placed at right angles to each other, as are the two audio frequency transformers.

The two inductances are wound with No. 24 D.S.C. wire on tubes of insulation, which are about 2¼ inches long and 2¾ inches in diameter. On these tubes first wind 59 turns of the wire, with a tap at the 30th turn in one case and at the 35th in the other. The latter is the secondary of the radio frequency transformer; and the primary consists of 15 turns wound on a thin strip of insulation and slipped over one end of the secondary. This is all the construction. The inductance which has its secondary tapped at the 30th turn is placed in the antenna

BUILD YOUR OWN RADIO SET!

FREE THIS VALUABLE 64-PAGE BOOK

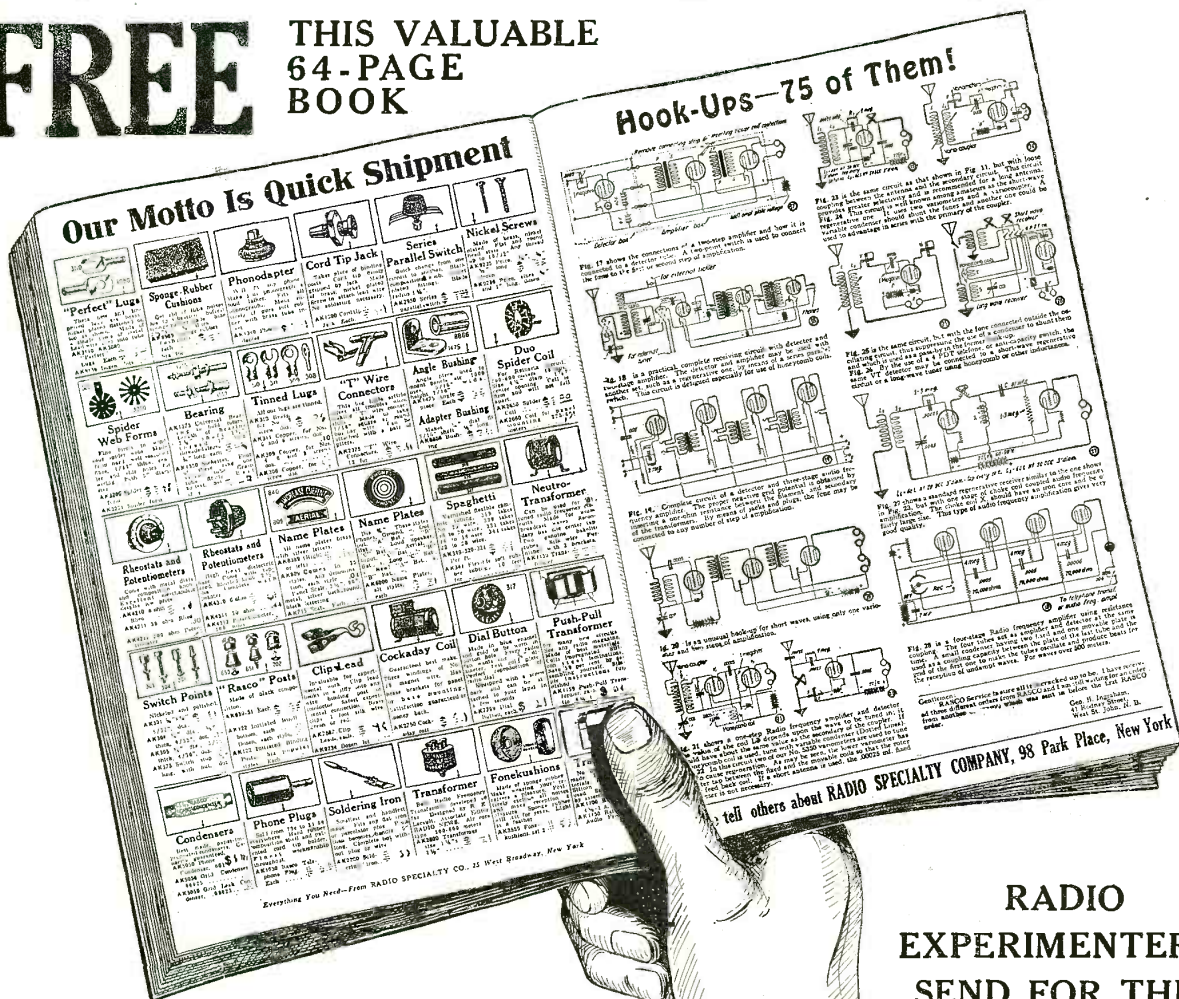

NEW 1926 SPRING CATALOGUE
No. 16 JUST OUT
64 Pages—600 Illustrations

Buy from Radio's oldest Mail Order House

THE NEW RASCO CATALOG No. 16

Contains the Following Hookups.

All Armstrong Circuits: These important circuits are explained clearly, all values having been given, leaving out nothing that could puzzle you. Just to name a few of the Vacuum Tube circuits: The V.T. as a detector and one-step amplifier; Super Regenerator; one-step radio frequency amplifier and detector; three-stage audio frequency amplifier; short wave regenerative circuits; 4-stage radio frequency amplifier; radio and audio frequency amplifier; inductively coupled amplifier; all Reflex Circuits.

This catalog is crammed full of small parts and radio findings, literally thousands of them. In addition there is much useful information contained herein.

WE are the oldest established, exclusive radio mail order house in the country. Our motto is "Quick Shipment." All orders are shipped within 24 hours. Quick, prompt, courteous service. We carry a larger variety of radio parts and findings than any other radio house in the country.

"RASCO HAS IT"

If you are in need of certain small radio parts that other radio and mail order houses do not bother to carry, get the Rasco parts catalog, and you will find them there, anything from a screw to copper ribbon and telephone diaphragms, as well as thou-

sands of other small radio findings. Just to mention a few:

Lugs, nuts, dials, vernier dials, jacks, plugs, every kind of knob, cords, panels, screws, sliders, washers, selenium, tinfoil, switches, crystals, cap nuts, Litz wire, cord tips, brass rods, resistances, name plates, spring binding posts, switch parts, metal ribbon, carbon balls, binding posts, all types, switch points, switch levers, lock washers, carbon grains, ground clamps, metal pointers, insulated tubing, low melting metal, antenna connectors, bus bar wire, as well as thousands of others.

WE CARRY THE LARGEST VARIETY OF SMALL RADIO PARTS IN THE WORLD.

If you will paste this coupon on a post card and mail today, we will be pleased to send you our new Catalog at once.

RADIO SPECIALTY CO.
98 Park Place **New York City**

RADIO SPECIALTY CO., 98 Park Place, New York R.N.-426
 You may send me, without charge or obligation, your NEW CATALOG No. 16. (Write on margin if you desire.)

Name

Street

P. O. State

RADIO EXPERIMENTERS. SEND FOR THIS FREE BOOK TODAY

... tell others about RADIO SPECIALTY COMPANY, 98 Park Place, New York

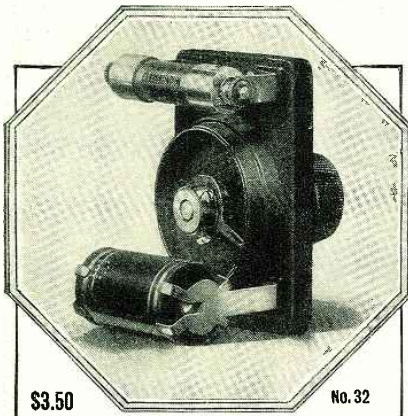

\$3.50
IN U. S.
(WITHOUT DRY CELL)

No. 32

Banish Detector Troubles with The Carborundum Stabilizing Detector Unit

BY a turn of the knob on the stabilizer you adjust the detector impedance to best suit operating conditions.

You can materially reduce the detector circuit damping, thus giving increased selectivity—sharper tuning.

With this stabilizing unit you get the most efficient rectification—resulting in increased sensitivity—greater volume.

It's a simple device that solves all detector troubles.

Comes equipped with genuine, fixed Carborundum Detector. An ordinary flash-light cell for booster voltage completes the unit.

You can get the fixed, permanent Carborundum Detector alone for \$1.50

YOUR DEALER OR DIRECT
Send for Descriptive Circular Showing Hookups

THE CARBORUNDUM COMPANY
NIAGARA FALLS, N. Y.

New York Chicago Boston Philadelphia
Cleveland Detroit Cincinnati
Pittsburgh Milwaukee Grand Rapids



AERO-LOOP--

\$12.50 A loop plus an antenna.

THE SCOTT SALES COMPANY
449 S. San Pedro St., Los Angeles, Cal.
Man. by UTT-WILLIAMS, SANTA ANA, CAL.

A Laboratory Product



CRESCENT LAVIZE RESISTANCES

For Distortionless Amplifications
Used on the U. S. A. Dirigibles. Made all capacities 12,000 ohms and up. List price \$1.50. Special sizes to order. Write today. Discounts to dealers.

Crescent Radio Supply Co., 1-5 Liberty St., Jamaica, N. Y.

circuit, and the other is used as the radio frequency transformer.

THE OPERATION

As mentioned above, there are separate binding posts provided for the "B" and "C" connections of the audio frequency amplifier tubes. The proper voltage to use in these two places cannot be considered as too important; for many times this spells the difference between good and mediocre reception and quality. It is suggested that the experimenter read over carefully the data furnished with his tubes and try different potentials at these points, in order to get the maximum results from his receiver. The "B" battery terminals are numbered 1, 2, and 3, each with a plus sign.

It should be noted that the "B" battery terminals are marked + 1, + 2, and + 3; + 1 is the detector; + 2 is the terminal for the R.F. tube and the first stage of the amplifier, and + 3 is the terminal for the last stage of the amplifier. It will be unnecessary to have a separate wire to this last-mentioned terminal if, for instance, 90 volts are used on the plates of the two tubes in the amplifier. It will suffice merely to short terminals + 2 and + 3. The "C" battery terminals are marked in the same manner. C-2 is connected to the secondary of the audio frequency transformer in the last stage, in case a power tube is used in that position and a greater voltage bias is desired. In case tubes of the same type are used in both stages of the amplifier; then the terminals, as mentioned above, may be shorted.

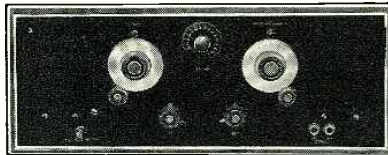

The panel view of the tuned R.F. receiver. There are only two tuning controls, making it a simple matter to pick up stations.

Outside of the usual tuning operations, there is but one adjustment to be made on the completed receiver, and that is the fixing of the small five-plate variable condenser. This adjustment is made as follows: a broadcast station, the wave-length of which is in the neighborhood of 300 meters, should be tuned in with the detector in oscillation. The condenser shunted across the secondary of the R.F. transformer should be varied until the whistle is quite loud, and then the antenna condenser should be tuned. It will be noticed that the whistle will change in pitch as this last-mentioned condenser is varied. Then the balancing condenser should be adjusted until the antenna condenser change effects no difference in the pitch of the whistle. This indicates a balanced condition in the receiver. It is important that the balancing condenser be varied very little at a time, each time noting the change in pitch of the whistle. On one side of the balancing point the whistle will be found to fall in pitch, and to rise on the other.

When a station is to be tuned in, the high resistance in series with the primary of the R.F. transformer is varied until the carrier waves of the stations are heard as the condenser dials are rotated. When a station is selected the tuning dials are adjusted and the resistance again varied until the whistle entirely disappears.

PARTS REQUIRED

- Following is the list of parts required for constructing the receiver:
- 2 coils (see specifications above),
 - 4 vacuum tube sockets,
 - 1 five-plate condenser,
 - 2 variable condensers (.0005 mf.),
 - 1 rheostat, 10-ohm,
 - 1 rheostat, 30-ohm.

Make Your Own Cone Speaker - and Save \$25

(All Parts Supplied)

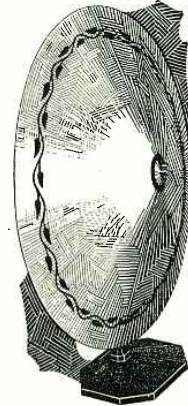

Why pay \$35 or more for a cone speaker when you can easily assemble a splendid super-sensitive one with the complete parts we send you—and save \$25?

We include a special cone unit, blue print and simplified directions for assembling. Directions are so clear anyone can easily set it up in a few hours. It's a big cone, eighteen inches high, complete in every detail. Unmatched for beauty, and reproduces music and voice with faultless accuracy. The cost is amazing-

low—only \$10 complete for the most approved form of loud speaker known. Big saving is due to elimination of labor in assembling and packing and because we save jobbers' and dealers' profits.

Send No Money

Simply send name and address for the complete outfit. When postman brings package, deposit only \$10.00 in full payment. If not entirely satisfied return parts within ten days and your money will be instantly refunded. Never before has a better radio bargain been offered. Write at once.

SCIENTIFIC RADIO LABORATORIES
254 W. 34th St., Dept. 44, New York City

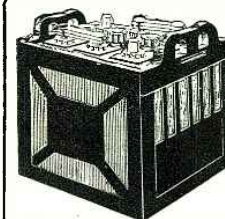

CHICAGO RADIO BATTERIES AUTO

Solid One Piece Rubber Containers

GUARANTEED FOR 2 YEARS

FAMOUS for unexcelled quality, guaranteed long-lived service and unvarying dependability. Chicago Batteries offer the Radio fan an "A" Power that is backed by years of experience and master workmanship with the finest materials available. Endorsed and approved by leading Radio and Automotive authorities. Chicago Batteries in their new non-leak, solid rubber cases represent an amazing value at lowest cost.

PRICES
Solid Rubber Case
RADIO Batteries
6 volts, 100 amps. . . \$ 8.79
6 volts, 120 amps. . . 10.79
6 volts, 140 amps. . . 13.50

SAVE MONEY—ORDER DIRECT
Buy Chicago Batteries direct from the manufacturer. Batteries you order will be shipped the same day. Express C O D or 5% discount cash with order.

CHICAGO BATTERY WORKS
1210 Peoria St. Chicago, Ill.

Bethe Jazz King Of Your Town!

Be popular. In demand everywhere. Have fun. Earn your welcome. Charm your friends with your

BUESCHER
True Tone

SAXOPHONE

Teach yourself, 3 free lessons give you quick easy start. Try any instrument in your own home 6 days free. See what you can do. Easy terms if you decide to buy. Send now for beautiful free literature. A postal brings details.

Buescher Band Instrument Co. (4)
1228 Buescher Block Elkhart, Indiana

Insure your copy reaching you each month. Subscribe to RADIO NEWS—\$2.50 a year. Experimenter Publishing Co., 53 Park Pl., N.Y.C.



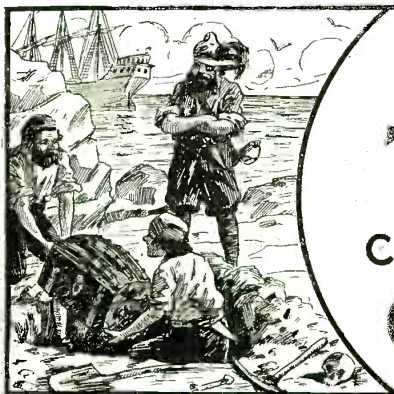

BURIED TREASURE can still be found in CHEMISTRY



Good Chemists Command High Salaries

and you can make yourself independent for life by unearthing one of chemistry's yet undiscovered secrets.



T. O'CONOR SLOANE,
A.B., A.M., LL.D., Ph.D.
Noted Instructor, Lecturer and Author. Formerly Treasurer American Chemical Society and a practical chemist with many well known achievements to his credit. Not only has Dr. Sloane taught chemistry for years but he was for many years, engaged in commercial chemistry work.

Do you remember how the tales of pirate gold used to fire your imagination and make you want to sail the uncharted seas in search of treasure and adventure? And then you would regret that such things were no longer done. But that is a mistake. They *are* done—today and everyday—not on desert islands, but in the chemical laboratories throughout your own country. Quietly, systematically, the chemist works. His work is difficult, but more adventurous than the blood-curdling deeds of the Spanish Main. Instead of meeting an early and violent death on some forgotten shore, he gathers wealth and honor through his invaluable contributions to humanity. Alfred Nobel, the Swedish chemist who invented dynamite, made so many millions that the income alone from his bequests provides five \$40,000 prizes every year for the advancement of science and peace. C. M. Hall, the chemist who discovered how to manufacture aluminum made millions through this discovery. F. G. Cottrell, who devised a valuable process for recovering the waste from flue gases, James Gayley, who showed how to save enormous losses in steel manufacture, L. H. Baekeland, who invented Bakelite—these are only a few of the men to whom fortunes have come through their chemical achievements.

What Some of Our Students Say of This Course:

I have not written since I received the big set. I can still say that it far exceeded my anticipations. Since I have been studying with your school I have been appointed chemist for the Scranton Coal Co. testing all the coal and ash by proximate analysis. The lessons are helping me wonderfully, and the interesting way in which they are written makes me wait patiently for each lesson.—**MORLAIS COUZENS.**

I wish to express my appreciation of your prompt reply to my letter and to the recommendation to the General Electric Co. I intend to start the student engineering course at the works. This is somewhat along electrical lines, but the fact that I had a recommendation from a reliable school no doubt had considerable influence in helping me to secure the job.—**H. VAN BENTHUYSEN.**

So far I've been more than pleased with your course and am still doing nicely. I hope to be your honor graduate this year.—**J. M. NORRIS, JR.**

I find your course excellent and your instruction, truthfully, the clearest and best assembled I have ever taken, and you are the fifth one I've studied.—**JAMES J. KELLY.**

From the time I was having Chemistry it has never been thus explained to me as it is now. I am recommending you highly to my friends, and urging them to become members of such an organization.—**CHARLES WYNJAMIN.**

I shall always recommend your school to my friends and let them know how simple your lessons are.—**C. J. AMDAHL.**

I am more than pleased. You dig right in from the start. I am going to get somewhere with this course. I am so glad that I found you.—**A. A. CAMERON.**

I use your lessons constantly as I find it more thorough than most text books I can secure.—**W. M. H. THIBBS.**

Thanking you for your lessons, which I find not only clear and concise, but wonderfully interesting. I am—**ROBT. H. TRAYLOR.**

I received employment in the Consolidated Gas Co. I appreciate very much the good service of the school when recommendation was asked for.—**JOS. DECKER.**

Now Is the Time to Study Chemistry

Not only are there boundless opportunities for amassing wealth in Chemistry, but the profession affords congenial employment at good salaries to hundreds of thousands who merely follow out its present applications. These applications are innumerable, touching intimately every business and every product in the world. The work of the chemist can hardly be called work at all. It is the keenest and most enjoyable kind of pleasure. The days in a chemical laboratory are filled with thrilling and delightful experimentation, with the alluring prospect of a discovery that may spell Fortune always at hand to spur your enthusiasm.

You Can Learn at Home

To qualify for this remarkable calling requires elaborate specialized training. Formerly it was necessary to attend a university for several years to acquire that training, but thanks to our highly perfected and thorough system of instruction, you can now stay at home, keep your position, and let us educate you in Chemistry during your spare time. Even with only common schooling you can take our course and equip yourself for immediate practical work in a chemical laboratory. Dr. Sloane gives every one of his students the same careful, personal supervision that made him celebrated throughout his long career as a college professor. Your instruction from the very beginning is made interesting and practical, and we supply you with apparatus and chemicals for performing the fascinating analyses and experimental work that plays such a large part in our method of teaching, and you are awarded the Institute's official diploma after you have satisfactorily completed the course.

Easy Monthly Payments

You don't have to have even the small price of the course to start. You can pay for it in small monthly amounts—so small that you won't feel them. The cost of our course is very low, and includes everything, even the laboratory outfit—there are no extras to buy with our course. Our plan of monthly payments places a chemical education within the reach of everyone. Write us and let us explain our plan in full—give us the opportunity of showing you how you can qualify for a highly trained technical position without even giving up your present employment.

Special 30 Day Offer

Besides furnishing the student with his Experimental Equipment, we are making an additional special offer for a short while only. You owe it to yourself to find out about it. Write to us for full information and free book "Opportunities for Chemists." Send the coupon right now while it is fresh in your mind. Or just write your name and address on a postal and mail it to us. But whatever you do, act today before this offer is withdrawn.

DON'T WAIT—MAIL COUPON NOW!

CHEMICAL INSTITUTE OF NEW YORK
Home Extension Division 4
66-R—West Broadway
New York City

Please send me at once, without any obligation on my part, your free book "Opportunities for Chemists," and full particulars about the Experimental Equipment given to every student. Also please tell me about your plan of payment and your special 30 day offer.

NAME

ADDRESS

CITY..... STATE.....

R. N.—Apr. '26.

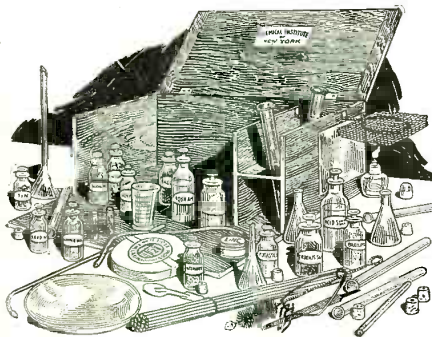

Experimental Equipment Furnished to Every Student

We give to every student without additional charge this chemical equipment, including forty-nine pieces of laboratory apparatus and supplies, and forty different chemicals and reagents. These comprise the apparatus and chemicals used for the experimental work of the course. The fitted heavy wooden box serves not only as a case for the outfit but also as a useful laboratory accessory for performing countless experiments.

CHEMICAL INSTITUTE OF NEW YORK, Inc.

HOME EXTENSION DIVISION 4

66-R—WEST BROADWAY

NEW YORK CITY



12-Cell-24-Volt Storage "B" Battery

Positively given Free with each purchase of a WORLD "A" Storage Battery. You must send this ad with your order. World Storage "B" Batteries give you economy and performance unheard of before. They deliver unflinching power that is clear, pure and quiet. Tested and Approved by Leading Authorities.

Radiocast Station
WSBC

Set your Radio Dials at 210 meters for the 1000-watt World Storage Battery Station, WSBC, Chicago. On the air nightly, between 6:30 P. M. and 8:30 P. M. and 10:00 P. M. and 1:00 A. M., with intensely interesting programs for your approval and enjoyment.

You save 50%

WORLD "A" Batteries are famous for their guaranteed quality and service. Backed by years of successful manufacture—thousands of satisfied users. Built of finest materials possible to obtain from raw material producers of national reputation. Equipped with solid rubber one-piece containers, an insurance against acid leakage and breakage. You save fifty per cent and get a



2-Yr. Guarantee Bond in Writing with each Radio "A" and Auto Battery. WORLD Battery owners "tell their friends." That's our best proof of performance and is chiefly responsible for the tremendous growth of the Company. Compare these prices—then send your order in TODAY.

2-Yr. Guarantee Bond in Writing with each Radio "A" and Auto Battery. WORLD Battery owners "tell their friends." That's our best proof of performance and is chiefly responsible for the tremendous growth of the Company. Compare these prices—then send your order in TODAY.

Solid Rubber Case Radio Batteries	Solid Rubber Case Auto Batteries
6-Volt, 100-Amperes . \$11.25	6-Volt, 11-Plate . . \$11.25
6-Volt, 120-Amperes . 13.25	6-Volt, 13-Plate . . 13.25
6-Volt, 140-Amperes . 14.00	12-Volt, 7-Plate . . 16.00

SEND NO MONEY!
Just state battery wanted and we will ship day order is received, by Express, C. O. D., subject to your examination, on arrival. FREE "B" Battery is included.
EXTRA OFFER—Five per cent discount for cash in full with order. Buy NOW and get a guaranteed battery at fifty per cent saving to you.

WORLD BATTERY COMPANY
1219 S. Wabash Ave., Dept. 10, Chicago

World Batteries for Radio

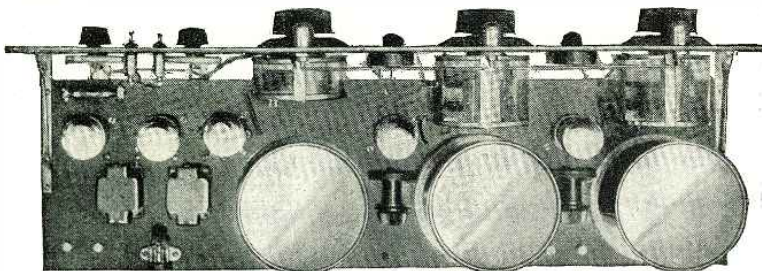

WITH THIS KIT AMATEUR SET MAKERS CAN ACHIEVE ISOFARAD

The Isofarad Circuit is the culmination of three years intensive laboratory work by Walbert engineers. Each problem was attacked from the standpoint of fundamentals and completely solved—First, greater amplification was secured, then oscillation prevention was achieved, next a coil was developed of the highest possible efficiency and finally the layout and minor circuit details were arranged to produce a receiver of uniformly excellent qualities. The practical result is a receiver possessing a hitherto unattainable degree of sensitivity, selectivity and tone quality.

- Issofarad five-tube Kit, completely assembled (but not wired) including wire and instruction book..... \$ 75
 - Issofarad five-tube receiver complete..... 125
 - Issofarad six-tube receiver complete..... 165
- Send \$.25 for booklet—"Issofarad Revealed"

WALBERT MANUFACTURING COMPANY

923 Wrightwood Avenue

CHICAGO

- 2 audio frequency transformers, ratio 2:1.
- 1 plug and single-circuit jack,
- 1 fixed condenser (.05 mf.),
- 11 binding posts,
- 2 dials,
- 1 fixed condenser (.0001 mf.),
- 1 fixed condenser (.00025 mf.),
- 1 grid leak (2-megohm) and mounting.
- 2 automatic filament controls,
- 1 variable resistance (500-50,000-ohm),
- 1 panel 7 x 18 x 3/16 inches,
- 1 baseboard (wood) 7 x 17 x 1/2 inches,
- 1 terminal strip 9 3/4 x 1 1/4 x 3/16 inches.
- 1 filament switch.

Correspondence From Readers

Continued from page 1448)

WLIB, WOK, WEBH, WSAI, KDKA WJZ, WORD, WCCO, WMAK, and ninety others all on loud speaker, as I haven't any phones and wouldn't use them if I had them I placed a switch in place of phone jack, added a "C" battery and doubled the volume
GEORGE W. COWAN,
2nd and Chase Sts., Port Angelus, Wash

Editor, RADIO NEWS:
I sit here listening to a Regenerative Interflex as I write. It is the clearest and best set for tone quality I have ever heard regardless of make or price. Many of my friends who have heard it say the same thing. New Orleans (WSMB), the greatest distance I have yet had, came in nicely on a low-priced horn.
LEON M. SEE,
Auburn Heights, Mich
December 16, 1925.

BALANCED INTERFLEX RECORD

Editor RADIO NEWS:
I am glad to say that, with the Balanced Interflex made recently, and using my own parts to make the set, I have been able to log the following stations:

Station	Wave-length	Dial	City
WNYC	526	54	New York
WEAF	492	50	New York
WJZ	455	45	New York
WJY	405	39	New York
WOR	405	38	Newark
WMCA	341	32	New York
WAHG	316	29	Richmond Hill
WHN	361	34	New York
WAAM	263	..	Newark
WGCP	252	34	Newark
WBRR	273	..	Rossville, N.Y.
WGBS	316	29	New York
WIP	508	52	Philadelphia
WGBB	244	..	Freeport, N.Y.
WLIT	395	..	Philadelphia
WRNY	258	11	New York
WORD	Chicago
WMBF	284	37	Miami Beach
WGBU	Miami Beach
WOC	484	47	Davenport
WHAZ	380	38	Troy, N. Y.
WGN	370	..	Chicago
WDAF	366	..	Kansas City
WTAM	389	..	Cleveland
WSAI	326	..	Mason, Ohio
WOO	509	52	Philadelphia
WHAP	240	14	Brooklyn
KDKA	309	28 1/2	Pittsburgh
KYW	535	54	Chicago
WPG	300	26	Atlantic City
WRC	469	46	Washington
WEBJ	273	15	New York
WFBH	273	14	New York
WCCO	416	35	Minneapolis
WGY	380	36	Schenectady
WLW	422	41	Cincinnati

J. SCHUTZ,
98 Parkville Avenue,
Brooklyn, N. Y.

PATENTS
DON'T LOSE YOUR RIGHTS
Before disclosing your invention to anyone send for free blank form "EVIDENCE OF CONCEPTION" to be signed and witnessed.
LANCASTER & ALLWINE
Reg. Pat. Attys. in U. S. and Canada
270 Ouray Bldg., Washington, D. C.
Originators of the form "Evidence of Conception"

FOR REAL SATISFACTION AND PERFORMANCE!
Sylvania Tubes
SYLVANIA PRODUCTS CO. EMPORIUM, PA.

Villa Tasso

NORTHWEST FLORIDA

*The Most Beautiful
Homeland in America*

BUY An Ideal Homesite

In Florida's most Beautiful Section

VILLA TASSO

On Bluffs Overlooking Choctawhatchie Bay

Northwest Florida is just being discovered. In this glorious spot, Florida's most beautiful section—50 miles East of Pensacola, on bluffs overlooking the beautiful Choctawhatchie Bay—lies Villa Tasso with its delightful Homesites.

A newly discovered Florida dreamland abounding in opportunities—Healthful, Invigorating climate with pure soft water all year round. In the shadow of Magnolia, Pine, Oak, Holly and Palmetto trees, and adjoining national forest, and looping the old Spanish trail giving all the delights of safe bathing beach, hunting, fishing, boating, riding, golf, etc. Freight and Passenger Steamer Service. Beautiful Appalachian scenic highway leads directly to Pensacola, one of Florida's most magnificent cities.

Lots average 50 x 150, average elevation 16 feet, guaranteed high, desirable for building. Now offered for three hundred to two thousand dollars with perfect title. Prices have quadrupled in 3 years and values are rapidly advancing. Reasonable terms.

These prices are a fraction of the cost of other Florida property. Buy now for a homesite or for investment. Write immediately for information to T. V. Orr, Villa Tasso Lodge, Temporary Post Office, Bolton, Florida.



*An Ideal for You
In Undiscovered Florida*

Work for New Radio Detective Car

(Continued from page 1401)

in power transmission lines, and one super heterodyne covering 50 to 3,500 meters, designed and built by the Bureau of Commerce. The transmitter, of 100 watts on 80 meters, will broadcast over a range of 200 to 300 miles. There are 24 cells of 155 ampere-hour storage batteries. These are designed to charge from a rectifier when in the garage, or from the regular generator on the car when in motion. Because of the great weight of the storage batteries and other special equipment, the car weighs 6,300 pounds and requires special springs.

This car is used by the supervisor of radio in the Eighth District, with headquarters at Detroit. His district embraces western New York and Pennsylvania, West Virginia, Ohio and the lower peninsula of Michigan.

The Radio Beginner

(Continued from page 1411)

ammonia, but merely moisten it, so that the battery can be cleaned more readily. After this has been accomplished, cover the connection terminals with a very thin coat of vaseline. This will prevent corrosion from taking place; but if such has already occurred, remove the corrosion before applying the grease.

Regarding the location of storage batteries, do not place them near radiators or hot-air registers. If you do this, it will cause the electrolyte or liquid within the cells to evaporate very quickly and you will have to add distilled water more often than is necessary. Also, do not place the battery where it will be in the way or where anyone is liable to stumble over it. A storage battery is a heavy proposition and is not the most pleasant thing in the world for your feet to encounter, particularly when it is not expected. Some radio set owners dispose of the rather unsightly storage battery, by placing it in the cellar of their homes some where nearly under the radio set, and drilling a hole in the floor so that the wires between the set and the battery can be run as directly as possible. This is a very good scheme if a convenient location can be found in the cellar.

THE ELECTROLYTE

The electrolyte in the storage battery cells consists of a mixture of sulphuric acid and water in certain proportions. When a battery is in use, the amount of electrolyte in the cells diminishes; but this merely because

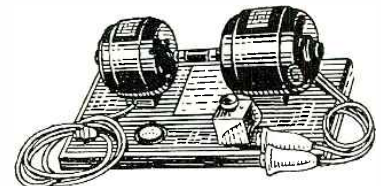

Fig. 9. Motor generator chargers are efficient and are often desirable. Here is a small, compact type.

Illus. courtesy Ohio Elec. & Controller Co.

water has evaporated and not because any of the acid has been lost. Therefore, in order to make up for this evaporation, it is only necessary to add pure distilled water. Never add acid. The distilled water can be purchased from any garage or storage battery supply station. Be sure that you get pure water and never attempt to fill your battery cells with water obtained from the tap. Water that has not been distilled contains certain mineral elements that will be detrimental to the action of the storage bat-

CASE RADIO APPARATUS

Formerly INDIANA HYPERDYNE RADIO

Meets Every Demand!



\$65.00
LESS BATTERIES AND TUBES

MODEL 500

A DeLuxe five tube long distance tuned Radio Frequency Receiver, placed in 3/4" solid mahogany cabinet with sloping crystal lacquer aluminum panel. Very best materials throughout. Each set thoroughly tested. All parts and set complete built in modern plant. Made in two styles of cabinets. Model 500, table type \$65.00. Model 702, console type \$160.00.

\$85.00
LESS BATTERIES AND TUBES

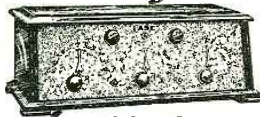

MODEL 503

A six tube multi-power receiver of precision. Has four degrees of power controlled from front panel giving superior reception at all times. Positive vernier controlled silver pointers, calibrations on panel marked regularly and in meters. Beautiful hand rubbed mahogany cabinet. The radio buy for Spring and Summer use. Made in two styles of cabinets. Model 503, table type \$85.00. Model 701, console type \$180.00.

6 Popular Models 6 Popular Prices

\$65.00	\$160.00
75.00	170.00
85.00	180.00

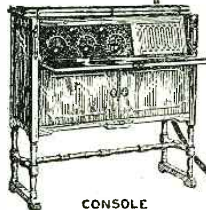

CONSOLE MODEL 703

"What's Under the Hood"



Write Today for Full Information

Quality Radio Sets are Manufactured Complete in Our Large Modern Plant—

INDIANA MFG. & ELEC. CO.

600 CASE BLOCK, MARION, INDIANA

CASE RADIO APPARATUS

Hear Europe with the Universal Plio-6

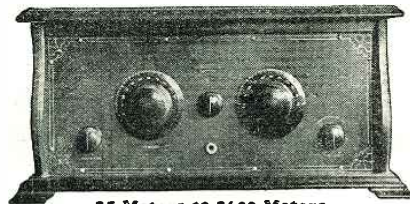

35 Meters to 3600 Meters

A new broadcast receiver representing the highest type of efficiency obtainable in point of extreme range, tremendous audibility and remarkable selectivity.

Maximum Efficiency—Inexpensive

Parts or Completely Constructed

Write for information today

NORDEN-HAUCK, Inc.
Engineers

1617 Chestnut Street, Philadelphia, Pa.

No Batteries

are required even to operate the powerful receiver pictured above, if you use the new laboratory type

Model A Power Unit

FREE RADIO GUIDE

NEWEST 1926 EDITION

Shows the latest circuits, the newest developments in radio at startlingly low prices. Get the parts you want here and save money. The best in parts, kits, sets and supplies. Orders filled same day received. Write for free copy NOW; also please send names of one or more radio fans.
BARAWIK CO., 102-145 So Canal St., Chicago, U. S. A.



Radio Built for the Years to Come

tery and if continually used will eventually cause the battery's ruin.

The water may be added to the battery with the aid of an ordinary hydrometer, an instrument which may be purchased at the same place that you buy your distilled water. This instrument is made for the purpose of testing storage batteries to show how nearly they are fully charged. You will find that the hydrometer consists merely of a syringe-like arrangement such as that shown in Fig. 1, arranged with a float inside the tubular part. On squeezing the rubber bulb, placing the rubber tube in the hole provided in the top of a cell or a storage battery and releasing the bulb, it will be found that a quantity of the electrolyte will be drawn up into the cylinder. The float will start to rise; and when it is completely off the bottom of the cylinder, it will be found that one of the graduations on the scale of the float will be at the top level of the liquid. This scale division denotes the condition of the battery.

Ordinarily, and generally speaking, when the scale reading is in the neighborhood of 1.175, the battery is nearly discharged, and should be recharged. Fully charged values

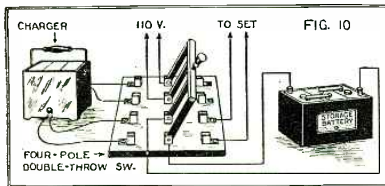

Fig. 10. By using a four-pole double-throw switch, the battery and charger can be automatically connected and disconnected and thus the use of flexible leads and clips is eliminated.

vary from 1.250 to 1.300, but it is rare that a battery is charged until it reads more than 1.275. This will be found to be a quite satisfactory limit for all ordinary purposes. By occasionally checking the condition of your battery with the hydrometer, going over every cell at each test, you can determine just about when it is necessary to charge it. It will not do the least bit of harm to put the battery on charge when the hydrometer reads 1.200. Let it charge until its condition is such that the reading is between 1.260 and 1.275; and if you do this regularly, your battery will give the best possible service throughout its entire life. This life will be long if you follow the other rules for the care of storage batteries that were given above.

DIRECT CURRENT CHARGERS

Although alternating current is the most common type available, still for the benefit of those who have direct current (D.C.) in their homes, the following hints are given for charging batteries from their supply. The radio set owner who has D.C. in his home can congratulate himself, because it is far easier and cheaper to charge from direct current. This is because it is not necessary to change the current from alternating to direct; and all that the owner has to do is to connect his battery to the lighting circuit with some suitable resistance in series to control the rate of charging. For all ordinary purposes, and for charging at a rate of approximately 4 amperes or slightly less, four 100-watt lamps are connected in parallel as shown in Fig. 2. Make the other connections to the battery and lighting circuit as shown. Leave the battery on charge until a hydrometer test shows that the battery is fully charged. Be sure that the polarities are correct as shown.

To determine the polarity of your house lighting current when D.C. is employed, the following method is probably the simplest. Place a very weak salt solution in a cup and dip the bared ends of wires connected to the lighting circuit in this solution, being sure not to touch the ends together as blown



Complete Radio Panels in the Most Attractive Designs

DESIGNS and decoration in any art style may be applied to Formica panels by the Veri-Chrome process. This year you will see the introduction of new decoration of remarkable attractiveness.

The Veri-Chrome process, patented and controlled by the Formica Insulation Company is proving so much more adaptable from the production point of view; it is producing panels of so much finer appearance, that it promises to supercede other methods of panel decoration and marking.

Because of its permanent finish and immunity to atmospheric and other conditions Formica provides the most lasting and desirable front for a radio set. It is evidence of the highest quality.

Completely decorated panels are offered amateur set builders who put together certain well known kits: Bremer Tully, Counterphase, Nameless and No. 1; Best's Superheterodyne in two sizes, 7x20 and 7x26, Browning Drake kit of the National Co., and the Marco Browning Drake, General Radio Broadcast Receiver Cockaday L. C. 26, and Victoreen Superheterodyne.

Write for prices and literature.

THE FORMICA INSULATION COMPANY
4618 Springrove Avenue Cincinnati, O.



FORMICA

Made from Anhydrous Bakelite Resins
SHEETS TUBES RODS

CHELSEA

Super-Five

\$50

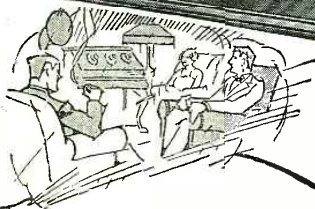
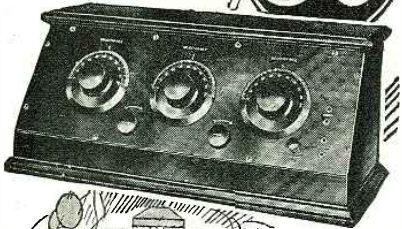

EVERYwhere— Winning New Friends

THAT'S exactly what the new Chelsea Super-Five is doing because it offers supreme performance at a popular price. Each Super-Five is housed in a beautiful mahogany-finish cabinet with graceful sloping panel and large over-size dials for easy tuning. Dust-proof, fool-proof inside panel to protect the "vitals." Hand soldered connections. Rugged bus-wiring throughout. Convenient cord leads for making all connections.

See these Chelsea features at
★ Your Dealers. Write Us
for Folders.

CHELSEA RADIO COMPANY
CHELSEA, MASS.

YAXLEY

Approved
Radio Products

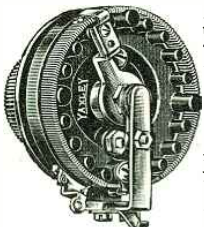

are Vital Parts of
the Most Popular Sets
of Leading Radio
Manufacturers. The
Wonder

AIR-COOLED RHEOSTAT

Along with Yaxley
Jacks, Jack Switches
and Midget Battery
Switches is the choice
of careful factory and
home set builders.

at Radio Dealers
YAXLEY MANUFACTURING CO.

Dept. N. - Chicago
217 N. Desplaines St.

fuses will result. Holds the ends about one inch apart in the solution and you will notice a quantity of bubbles forming around each one of them. The negative wire will be found to have twice as many bubbles around it as are present at the positive wire and, therefore, the polarity is easily determined and you will be sure of connecting your battery to the circuit correctly. Failure to ascertain the direction of flow of the current and connecting the lighting wires to the battery incorrectly will result in discharging the latter. It is a good idea to mark the particular pair of wires used for charging the battery, so that at any future date you can go right ahead and charge it, without having to repeat the above described process.

ALTERNATING CURRENT RECTIFIERS

When we come to consider the use of alternating current (A.C.) for battery charging, we have an entirely different and more complicated problem. It becomes necessary to change the current, as mentioned before; and in order to do this, any one of four main types of instruments may be used. First, what is known as a vibrating rectifier may be connected, so that when alternating current is applied to the input circuit, a pulsating direct current will be delivered by the output. This current is then used for charging. The second type to be considered is that using a vacuum tube for rectifying the alternating current. The third is the electrolytic variety, wherein two plates of dissimilar metals are immersed in a solution and the entire arrangement is so made that current can only pass through in one direction, whereby a rectifying action is obtained. The fourth, and last, general type is that where an electric motor is run on the alternating current and used to drive a generator which delivers direct current.

Let us now consider these four types of chargers, or rectifiers as they are often called, in detail. They are all illustrated in these columns. In Figs. 3 and 4, we have the vibrating type of rectifier or charger. As Fig. 3 shows, the apparatus is very simple in appearance and it is only necessary to insert the plug in a wall socket and connect the two convenient clips to the "A" battery. Be sure that the polarity is correct. The terminals of the "A" battery are usually marked plus and minus, and often the positive or plus (+) pole is painted red. The clips connected to the charger are also marked, or one of them is painted red, and this one should be connected to the positive pole. The other one of course goes to the negative pole. With the particular type of charger shown in Fig. 3, it becomes possible to charge both "A" and "B" storage batteries with the same unit. The other illustration of the vibrating type of charger, Fig. 4, shows the internal construction of this instrument. The vibrator is located at the top and in a convenient position for adjustment. However, with a well-made charger of this variety it is not necessary to make any adjustments of the vibrator, except after long periods of use. A well-made vibrator will retain its adjustments quite well; and after the initial ones have been made, the charger itself can practically be forgotten for quite some time and only need be thought of when it is to be used for reviving a dying storage battery.

BULB CHARGER

The second type of charger mentioned above, that using a bulb for rectification, is shown in Figs. 5 and 6. This particular instrument can be used for charging both "A" and "B" batteries. By referring to Fig. 6, the internal construction of the instrument can be seen. The 100-watt incandescent bulb, located beside the rectifying bulb, is there for the purpose of regulating the charge when the instrument is used for "B" batteries. With this, as with other types of manufactured chargers, complete op-

Sent Prepaid Anywhere in the U. S.
SPACES PERFECTLY \$7.50

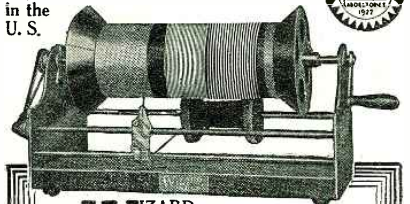

WIZARD WIRE WINDER

eliminates the most trying and difficult job in building sets. Saves hours in time and waste! Winds automatically and uniformly any thickness of silk, cotton and enameled wire into practically any style coil from 1/8 in. to 1/2 in. diam. and up to 10 1/2' long. Full instructions with each machine. Ready for instant use. Nickel plated throughout, strongly built.

SEND NO MONEY we'll send your WIZARD C.O.D. or enclose \$7.50 with your order—either way we pay the postage.

Wizard Wire Winder Co.

3814 Central Ave.
Los Angeles, Calif.
Dealers! Investigate!

Sold on an Absolute Money Back Guarantee

22 1/2
VOLT
unacid
everlasting
rechargeable
"B"

**STORAGE
BATTERY**
\$2.95

Includes chemical



45 volts, \$5.25; 90 volts, \$10.00; 112 1/2 volts, \$12.50; 135 volts, \$14.75; 157 1/2 volts, \$16.50. Truly the biggest buy today. Easily charged on any current including 22 volt systems. Any special detector plate voltage had. Tested and approved by leading authorities such as Popular Radio laboratories. Over 3 years sold on a non-red tape 30-day trial offer with complete refund if not thoroughly satisfied. Further guaranteed 2 years. Knock-down kits at greater savings. Complete "Hawley" Battery Charger \$2.75. Sample cell 35c. Order direct—send no money—simply pay the expressman cost on delivery. Or write for my free literature, testimonials and guarantee. Same day shipments.

B. HAWLEY SMITH

314 Washington Ave.

Danbury, Conn.

Rubber Covered Insulators



Actual Size

Neat and efficient. For antenna, ground and for lead in wires. Small screw starts readily and makes finished job. Great improvement over ordinary large, unsightly insulators. They keep the wires in place and out of the way. Packed 10 in a box, 25c at your dealers or direct from us.

CULVER-STEARN'S MFG. CO.
Worcester, Mass., U. S. A.

IVORY RADIO PANEL

Write for FREE sample and complete description of Ivory Lite, the most beautiful radio panel on the market. Ivory Lite is a pure white ivory 3/16" thick and unequalled in beauty and workability, cut any size, 3c sq. inch. Shipped anywhere prepaid or C.O.D. Also Ivory dials and knobs. **IVORYLITE RADIO PANEL CO.** 3222 Avenue F, Dept. N. - Fort Worth, Texas

erating specifications are available when the charger is purchased and these should be followed implicitly. Failure to do so may result in trouble.

The third type of charger, known as the electrolytic type, is shown in Fig. 7. The two illustrations here show one of the chargers completely assembled and the other is a cut-away view showing the internal construction. This charger is absolutely silent in operation as there are no moving parts. On the other hand, however, it is necessary to add water to it just as regularly as you do to your storage battery; but this should be no detriment to its use, because of the fact that the user of a storage battery will always have distilled water on hand for renewing the solution of the battery and, therefore, can just as readily put a little of it in the electrolytic charger.

There is another type of electrolytic charger available on the market today, known as the trickle charger. This supplies a very low amperage current to the storage battery, and, therefore, it is necessary to extend the charge over long periods of time. However, this particular unit is designed to be connected to the "A" battery at all times when the radio set is not in actual use. By doing this, the battery is always kept at its best operating point, and there need never be any fear of its failing just when it is most needed. This type of trickle charger is shown in Fig. 8.

MOTOR GENERATORS

Motor generators, the fourth type of battery charger mentioned above, are not in very wide use today but there is at least one available on the market. This particular type is shown in Fig. 9. Motor generators are quite efficient forms of converters and give very good satisfaction. They are expensive in first cost; but will operate over long periods of time without any attention and without giving trouble, and will probably last longer than any other available type of charger.

On the other hand, all of the chargers described here, and in fact practically all of those available on the market today, are strongly constructed; and the average buyer need not be afraid that he will get some inferior product when purchasing an instrument of this type. The particular form of charger that you purchase will rest with your own desires and the initial investment that you wish to make. The choice is entirely up to you.

A word as to the care of chargers will not be amiss here. Treat them just as well as you do your "A" battery, and do not subject them to unnecessary abuses.

In Fig. 10 is given a circuit diagram showing how a storage battery and charger of any type whatsoever can be connected to a four-pole double-throw switch. If such an installation as this is made, you can connect permanently to the house lighting circuit; and merely by throwing the switch to one side or the other, connect your battery to the charger and the charger to the house lighting circuit, or disconnect the charger and connect the battery directly to the radio receiving set. By using this system, all clips and other more or less makeshift connections are done away with. No matter what type of battery or charging device you are using, it will repay you in convenience to make an installation such as that shown in Fig. 10.

COLORED STATIC

Mrs. Johnson: Ah thought you-all said you was gwine to name your new baby "Victrola," but Ah hears you-all done make a change.

Mrs. Moses: Yes. Ah expected it would be a girl, and Ah had decided to name her "Victrola," but she turned out to be a boy, so Ah done name him "Radio."

Christian Advocate.

GEN-WIN LEMNIS-COIL

SCIENTIFICALLY—the BEST COIL for YOUR SET—HERE'S the PROOF

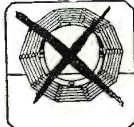

"LOW-LOSS"

The term "low-loss" is a misnomer as applied to this type of coil. These inductances are so called because their self-supporting feature reduces electric losses. However, the frequent and sharp bends in the wire increase their resistance, especially at radio frequencies.

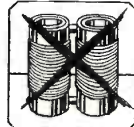

"DUAL"

Dual coils consist essentially of two small solenoid coils, wound in opposite directions and mounted side by side. Their magnetic fields are somewhat confined by this arrangement, but the turns on which the wire is wound introduce electric losses. Their resistance is comparatively high due to the small diameter of the individual windings.

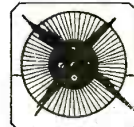

"FIELDLESS"

These coils have almost completely confined magnetic fields, but possess inherently high resistance. All small diameter coils have this serious defect, which cuts down both volume and selectivity.



"SOLENOID"

Solenoid coils have the lowest resistance of all, but this advantage is more than counterbalanced by the fact that their fields are entirely unconfined. Unless the utmost care is used in shielding the coils, in placing them in the correct angular relationship, or in balancing the circuit, the set in which they are used will invariably squeal and whistle.



THE GEN-WIN LEMNIS-COILS

LEMNIS-COILS are wound with an elongated reverse curve, the extraordinary length of which makes them closely approach the solenoid coils in low resistance. They are wound on air, the turns being spaced. This reduces absorption losses to a minimum. The form of winding effectively confines the magnetic field, as the two halves that comprise a whole unit have opposite polarities. This feature overcomes interstage coupling and obviates the necessity for special angular placement. It also makes unnecessary the use of neutralizing condensers, potentiometers and resistances to stop oscillation.

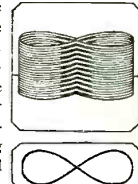

GET ALL THESE FEATURES

1. Lemnis-Coils confine the electro-magnetic field and neutralize the tendency toward oscillation; Avoiding the resistance usually encountered in small diameter coils.
2. Lemnis-Coils have no "peak". They afford high uniform amplification on all broadcast wavelengths. (They do not cause distortion).
3. Lemnis-Coils amplify only what is received from the preceding stage. Their non-pick-up qualities reduce the annoyance of static and other interference.
4. Lemnis-Coils are kept free from dust with sealed Bakelite cases, retaining full efficiency.
5. Lemnis-Coils are individually tested in the laboratories of the General Winding Company and are then packed in kits of three matched coils. These laboratory tests assure simplified tuning and uniform dial readings.

Study these essential features. Buy a kit of three Lemnis-Coils from your dealer. Build a handsome five- or six-tube set easily, in a few hours. Or, if you already have a radio receiver, replace its coils with Lemnis-Coils and get greatly improved reception.

Kit of Three Lemnis-Coils with wiring diagram \$12

Designed for use with .00035 mfd. variable condensers—(Wavelength range 200-600 meters).

CHICAGO and AMERICAN
 J. C. Keogh, Inc. at CHICAGO
 Bach-Harris Company, 322 South Michigan Avenue, Chicago.
 Jan. 5, 1926
 Subject: Lemnis-Coils
 Gentlemen: I hooked up a five-tube RF set constructed with your General Radio Winding Lemnis Coils and a group of other miscellaneous parts.
 Selectivity and volume were excellent and the distance range, from California to New York and New Orleans to Canada.
 A valuable feature of these coils would appear to be the very small energy pick-up when antenna and ground wires are disconnected. Located but two blocks from a 1000-watt station on 447 meters it was possible to tune this station out on two degrees either side on all three dials.
 Very much pleased indeed with the performance of this equipment.
 Very truly yours,
 J. C. Keogh
 emb.

GENERAL WINDING CO., Inc.
 214 FULTON STREET, NEW YORK, N. Y.
 You may send me, postpaid, one guaranteed Kit of three GEN-WIN Lemnis-Coils, complete with blueprint, showing detail of hook-up.
 Enclosed is money-order for \$12.
 Ship C. O. D.
 It is understood that these coils are guaranteed to afford the utmost in radio reception.
 Name.....
 Street and No.....
 City..... State.....

A UNIQUE WESTON radio panel combination

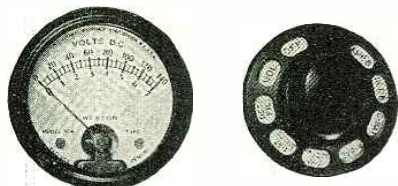

Model 506 Voltmeter and Weston Universal Bi-Polar Switch

FOR UNUSUAL RADIO results, for economy and for positive set control we announce this unique Weston combination of Panel Voltmeter and Switch.

Just a twist of the Bi-Polar Switch and you instantly and accurately make a complete electrical check on any type of radio set!

Obvious operation advantages lie in quick and positive knowledge of all voltage conditions as read on this double scale (140/7 volts) Voltmeter.

By placing a Weston Model 506 Voltmeter and a Multi-Point Switch on the panel of your set you insure the use of tubes at proper filament voltages, you can constantly check battery conditions and get the best results from your set.

Typical of its value is its use on a five-tube neodyne—you can regulate the filament voltages of the Radio Frequency Tubes, Detector Tube, the First and Second Audio Frequency Tubes, and check the voltages of the "A" and "C" Batteries, the Detector "B" and Amplifier "B" Batteries.

Weston quality Radio Instruments lead in this new field as they do in every other electrical outlet in commerce, industry, research. For further information on this device write for Circular "N".

WESTON
ELECTRICAL INSTRUMENT CORPORATION
173 Weston Ave., Newark, N. J.



Make Radio Pay You--He Does!



Vito Chico has an interesting, well-paid and pleasant job as a Chief Radio Operator in the U. S. Coast Guard Service. Since graduating from the "Y" institute five years ago, he has made rapid progress. Radio offers these opportunities for you, too.

Learn Radio At Home in Spare Time or at our big school in New York City. Courses for Radio Operators, Mechanics, Broadcasting, Dealers.

Write NOW for free booklet "Opportunities in Radio"
Y. M. C. A. RADIO INSTITUTE
158 East 86th St. New York City

Insure your copy reaching you each month. Subscribe to RADIO NEWS — \$2.50 a year. Experimenter Publishing Co., 53 Park Pl., N. Y. C.

WRNY for New York Visitors

(Continued from page 1406)

WRNY carries a Church Index. Every Sunday morning the services at churches of all creeds are announced. Of course, in addition, Dr. Christian F. Reisner preaches. Service are broadcast from Temple Emanuel, and other religious bodies are heard from. There are Protestant, Jewish and Catholic circles, which are of interest to all faiths. We have as well our "Music of All Religions" period each Sunday afternoon.

Also in addition to the Radio Theatre Index, which tells you which plays to see, there is the *Musical Courier* which tells you about the concerts that are going on. There are book reviews by *Harper's Magazine*, which advise you which books to buy, and many other features of especial interest to visitors to New York.

NOTABLE RECENT PROGRAMS

Now, I should like to tell you some of the big things that have happened during the month of January. WRNY, of course, co-operated in the International tests and had some very remarkable reports from different points of the globe.

The "Music of All Religions" gathering at The Roosevelt, brought together Arabs, Buddhists, Christians, Hindus, Jews, Chinese and representatives of other faiths. It was one of the most colorful things I have ever seen. These weekly gatherings are bringing together all religions. The Catholic Circle brought Daniel Tobin, James J. Walsh and Father Finn. The Jewish Circle brought Dr. Harold Korn, Mrs. Alexander Kohut and Dr. Isaac Landman. Each of these people had something interesting to say to people of all religions.

An interesting night was that when Jesse Straus, of R. H. Macy & Co., and Charles K. Woodbridge, president of the Associated Advertising Clubs of the World, spoke on "Thrift."

A big night was that when the whole company of "The Taming of the Shrew" appeared in the "Up and Down Broadway Review."

I wonder if out-of-towners were with us at the back-stage broadcasting of "Earl Carroll's Vanities," when all the beautiful girls and comedians spoke into the microphone. Frank Tinney was there and told the people he was a lecturer and not a comedian; that he had lectured on the sex of cantaloupes that very afternoon.

We have had with us Baron Ireland, Percy Crosby, Arthur Guiterman and Robert Benchley, all of "Life's" editorial staff.

A VETERAN OF THE BATON

Did you listen in that night when Romualdo Sapio conducted an operatic period with Louise Stallings, the famous American soprano? Romualdo Sapio was at one time conductor of the Metropolitan Opera House: was on tour as conductor for Patti and for Calve. While he was at the studio, I showed him an old autograph album of my aunt, Kate Brand, who was second leading woman in the Patti company. In this is a page which bears an autograph from Romualdo Sapio to Kate Brand, written in Boston in 1865, so Sapio added "Still Alive and Kicking in 1926."

The Charles D. Isaacson Sunday night concerts continue to be of extreme interest, and are probably the distinctive musical events of our program. For visitors to New York, the invitation is ever extended.

Perfect Reproduction



Now Possible by the Use of Wagner Audio Frequency Transformers

List \$7⁰⁰

These transformers are tuned and matched by an ENTIRELY NEW LABORATORY PROCESS. They are scientifically designed. Made of specially selected materials and are truly a quality product.

Tested and approved by The Chicago Daily News, Evening Post, Amours Institute, Everybody's Weekly, and carrier the SEAL OF MERIT issued by the Radio News.

A pair of these transformers will be submitted to recognized set manufacturers for tests without cost, on request.



If Your Dealer Cannot Supply You, We Will

Three "E" Straight Line Rheostat

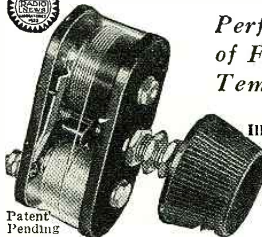

Perfect Control of Filament Temperature

6-15-30 Ohms
Illustration 1/2 Size

Master Engineer in Precision and Skill now offer you the utmost in Rheostats.

Patent Pending

Designed and produced by one of the largest manufacturers of electrical power equipment. Used by those who demand the best results. Perfect Reception depends on a fine, smooth, dependable variation of filament temperature in the detector tube. For there is only one temperature at which efficient reception is obtained and this point is very critical.

The THREE "E" STRAIGHT LINE RHEOSTAT finds this critical point as no other can. It gives straight line variation, runs smoothly, is absolutely NOISELESS and once set "stays put!" By all means secure this precision instrument at once. Ask your Dealer or order direct, giving us his name.

Price \$2.30—Postpaid

ELECTRICAL ENGINEERS EQUIPMENT CO

Radio Division
708 W Madison St., Dept. 6,
Chicago, Ill.

Circulars on Request



The Aristocrat of Rheostats

Trade CHICAGO, U.S.A. MARK

FREE RADIO GUIDE

NEWEST 1926 EDITION

Shows the latest circuits, the newest developments in radio at startlingly low prices. Get the parts you want here and save money. The best in parts, kits, sets and supplies. Orders filled same day received. Write for free copy NOW; also please send names of one or more radio fans.

BARAWIK CO., 102-145 So Canal St., Chicago, U. S. A.

DON'T MISS THIS BOOK.
"RADIO WRINKLES"
JUST OUT!

Ask your Newsdealer.
THE CONSRAD CO., INC.,
64 Church St., New York City

that you make it your business to be our guests at these concerts, which are held in De Witt Clinton Hall, at 59th Street and Tenth Avenue.

We broadcast also a card party which was held in The Roosevelt by the Federated Women's City Clubs. There were 1,900 women present. The feature of the afternoon was the grand march of the four hundred presidents of city clubs, and each president spoke a few words into the microphone.

I hope I may meet you all, face to face, soon.

What Is Regeneration?

(Continued from page 1441)

means that E_s may (and in practice, always will) increase to a value greater than E_p , and reverses the direction of current in R_s . In other words, in the practical operation of a regenerative set, the tuned circuit takes no energy from the applied signal, but actually supplies power to the signal!

To the majority of readers the previous paragraph will seem rather confusing. This is due in main, not to the method of stating facts, but in the revolutionary ideas there presented. You may be sure that these statements were proven beyond a shadow of a doubt before being so positively stated.

OSCILLATION IS REGENERATION

We are now in a position to define regeneration. We have seen that the signal voltage does not supply energy to the regenerated grid circuit. The applied signal merely prevents a certain loss from occurring. The tickler supplies all of the energy required to maintain a voltage E_s on the grid. If this condition were maintained in an independent circuit, without a signal input, we would say the tube was oscillating. We can do no different now. Quoting from a previous paper on this same subject*: "When a certain voltage E_p at a frequency f_1 is introduced into a circuit tuned to f_1 (as shown in Fig. 7) the losses occurring in that circuit will be sufficiently lowered to allow the electron tube to oscillate at a frequency f_1 . In so oscillating, it builds up and maintains a stable value of voltage E_s on the grid. Regeneration and oscillation are one and the same thing."

(To be continued in May RADIO NEWS.)

*"An Analysis of Regenerative Amplification," V. D. Landon & K. W. Jarvis. Proceedings of The Institute of Radio Engineers. December, 1925.

Set Owner's Information

(Continued from page 1413)

is an object having a positive charge in the neighborhood of the free electrons, they will rush towards it. This is done in a vacuum tube. The plate of the tube is charged positively with respect to the filament, anywhere from 16 to 135 volts, depending on the use to which the tube is being put. This voltage must be supplied by another battery, called the "B" battery.

The "A" and "B" batteries are of a different construction, due to the fact that the former must be capable of delivering more power than the latter. The average tube in use today draws .25 amperes at 6 volts and it is because of this heavy drain from the battery, that a storage type must be used. In the case of the "B" batteries, it is only necessary that they be capable of supplying a few milliamperes per tube, so their internal construction need not be so heavy. In fact "B" batteries are usually made from a group of dry cells, connected in series, thus adding their voltage output. These dry cells are of relatively small internal capac-

SAVE TIME AND MONEY

We have radio Tools of every description for every conceivable set building purpose

You will be astonished at the remarkable tools we have for your work and delighted at our low prices

NO. 202



COMBINATION PLIER

Combination Plier, Wire Cutter, Wire Former and Wrench. Drop forged, slender but exceptionally strong. 6 inches long. No. 202—Combination Plier, Wire Cutter, Wire Former and Wrench.....75c



RADIO TOOL SET

This is the handiest set of tools ever made for Radio Work by the makers of the famous "YANKEE" Tools. It contains the following: 1 Ratchet Screw-driver, 6 1/2 in. long holding all attachments; 1 Blade, 5 1/2 x 3-16; 1 Blade, 3 1/2 x 1/8; 1 Blade 2 1/2 x 1/4; 1 Countersink; 2 Socket Wrenches for all small nuts; 1 Reamer to enlarge holes in panel from 1/8 to 1/2; 1 Wrench, one end 5-16" square or hex. for jack, other 1/2" hex., etc.

PRICE per set—No. 701.....\$3.00

NO. 701

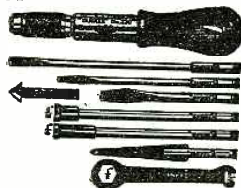

SIDE CUTTING NIPPER, LAP JOINT

For cutting all kinds of wire. Jaws hardened and oil tempered. Natural steel finish with polished jaws. Length 6 inches.

PRICE—No. 201.....75c

NO. 201



CIRCLE CUTTER

Especially designed for the Radio Constructor. Made of the finest material and equipped with the highest grade high steel cutting bits. It does three things at once. It drills its own pilot, cuts out plug and puts bead or scroll around the hole in one operation. Cuts holes 3/4 to 4 in. in diam.

PRICE—No. 402.....\$3.00

Nos. 401 & 402



NO. 304

401. Same tool but smaller and not fitted with bead or scroll in one operation.

PRICE—No. 401.....\$2.00

SCREW STARTER and DRIVER

Holds any screw by its slot with a firm grip, makes it easy to place and start screws in difficult places. Just the tool for the Radio Constructor. All parts heavily nicked and polished.

PRICE—No. 304.....\$1.00

NO. 800



ELECTRIC SOLDERING IRON

A perfect tool for Radio Work. Operates either on 110-volt A.C. or D.C. The heat element is of Nichrome, which prevents overheating and assures the desired even temperature. Size of Iron, 10 1/2 in. long. A 4-ft. cord and plug is furnished.

PRICE No. 800.....\$2.00

NO. 302

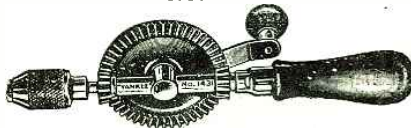

HAND DRILL

Especially designed for Radio Work by the makers of the famous "Yankee" Tools. A beautiful balanced, small, powerful drill with 4 to 1 ratio of gears for speed. Special chuck 9-32" capacity, to take largest drill, mostly furnished with drill or tool sets. Length over all, 9 1/2 in. Weight 1 1/2 lbs.

PRICE—No. 302.....\$2.75

Order all tools by order number. All goods are shipped free of transportation charges to all parts of the United States and possessions the same day as the order is received.

MONEY REFUND GUARANTEE

If you are not satisfied money will be refunded on return of goods.

THE RADIOGEM CORPORATION

66-R West Broadway

New York, N. Y.

Radion serves manufacturers

The great desirability of Radion insulation — and the great factory facilities of the organization that produces it—are widely appreciated by manufacturers of sets and parts.

That is why Radion is so extensively used as insulation for

- Condensers
- Coils
- Jacks
- Batteries
- Head Phones
- Sockets
- Tubes
- Panels
- Base Panels
- Binding Post Strips

Easy to machine, accurate when moulded, Radion simplifies the problems of production and assembly. From the tiniest bushing to the largest panel, Radion serves the radio industry efficiently and economically.

Manufacturers are invited to consult us freely and to ask for experimental and test samples of Radion—"The Supreme Insulation."

AMERICAN HARD RUBBER COMPANY
Dept. A16,
11 Mercer St., New York City



OHIO Motor Generator CHARGER

A real Motor Generator with no bulbs to break—no chemicals to renew—no contacts to burn or fuse. Charges in one-third the usual time or several batteries in parallel. Capacity 3 to 18 amps. at 6 to 10 volts. Also made up to 250 volts. Merely hook to light socket. Fully automatic. Lasts a lifetime.
SATISFACTION GUARANTEED OR MONEY BACK

THE OHIO ELECTRIC & CONTROLLER CO.
3907 MAURICE AVENUE ~ CLEVELAND, OHIO.

FREE RADIO BOOK

Science has invented a new kind of coil. Now have it on your present set. Gives 4 great advantages otherwise impossible. Write for new book just published showing many new ideas. Also 8 new circloid circuits. Address Electrical Research Laboratories, Dept. 17-D, 2500 Cottage Grove Ave., Chicago, Ill.

ity, but it is sufficient for the needs of the plate circuit of the tubes.

ADVANTAGES OF STRANDED WIRE

10. Henry Clements of New York City, asks:

Ques.—Why is stranded wire better to use for antennas than solid wire?

Ans.—The electrical currents that flow in the antenna are of high frequency; and as they represent the only available energy to reproduce the signals in the receiver, it is most essential that as easy a path as possible be provided for them. It is characteristic of high frequency currents (sometimes referred to as radio frequency currents), that they do not penetrate very deep into a wire, when they travel along it. This is just the opposite of the current from a direct current source, as that type of current completely covers the cross-section of a wire.

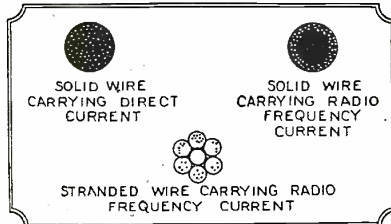

These cross-sections of wires illustrate how different currents behave in different wires.

In order to have as free a path as possible, therefore, the antenna wire should have as great a surface as is possible and so stranded wire is used. If a solid wire which had a large surface area were used, a large proportion of the metal would be wasted, and at the same time it would be extremely heavy to hang between two posts. By using several strands of wire twisted together, the surface area is made large, while the amount of metal in the wire is kept at a reasonable minimum.

Radio Wrinkles

(Continued from page 1445)

inch narrower than the length of the rod. Lay the foil and mica as shown at A, and roll them up tightly on the rod. The unit should then appear as at B. Brass strips bent around the ends and clamped by small binding posts will hold the plates firmly in place. The middle section should be taped tightly. The capacitance will depend both upon the size of the plates and the thickness of the mica. The latter should be the thin-

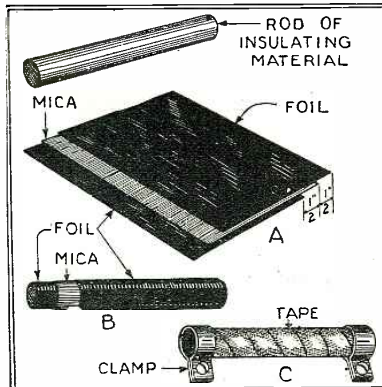

The above illustration shows a simple method of constructing a fixed condenser by wrapping the foil and mica about a rod.

NEW

Universal Vernier Dial

Composed of black bakelite dial housing enclosing reversible, celluloid-finished indicator plate marked off to half-degree divisions. Ratio. 14.5 to 1. Absolutely without backlash due to automatic friction take-up. Fits any condenser—left or right—half or full turn movement.
Price \$2.50



SM 210 and 211 Transformers



Designed so that maximum amplification will be obtained at 60 kilocycles. Both types in bakelite housings, hermetically sealed. No. 210 is ironcore type while No. 211 is of the aircore type, and is supplied with measured tuning condenser. Each transformer is furnished with individual laboratory curve chart.

Price: Both Types, ea. \$6.00

SEE SM PRODUCTS AT YOUR DEALERS OR SEND FOR CIRCULARS

SILVER-MARSHALL, Inc.
116 S. Wabash Ave., Chicago, Ill.

IMPROVE YOUR RADIO SET WITH A

Ray "Low-Loss" Ground

(Patent Pending)

Reduces Power Hum and Static
Greatly Improves Tuning
Clarity, Distance
and Volume

Not a trick device, but Designed and Constructed by an Electrical Engineer.

Price \$6.00

At Your Dealer's, or by Mail or Express

RAY MANUFACTURING CO.
REDLANDS, CALIFORNIA

VEST POCKET RADIO

\$1.50 SELLER

Not a toy. 30 miles tuning. No batteries. No tubes. Biggest radio sensation of the year. Sample \$1.00. One Dozen \$8.50. It astounds radio fans with its remarkable clearness.

TRIANGLE MANUFACTURERS,
506 W. 45th St. Chicago

Sylfan

"RADIOMATES"

Receivers - Reproducers - Tubes

BAKER-SMITH CO., INC., San Francisco
Branches in Principal Cities



This Booklet
**Resistance Coupled
Amplifiers**
IN THEORY
AND
PRACTICE

By Arthur B. Cole R.E.
sent post-paid on receipt of 10¢
in stamps or coin
COLE RADIO MFG. CORP.
BLOOMFIELD, NEW JERSEY

WHOLESALE EXCLUSIVELY
LUDWIG HOMMEL & CO.
1929 PENN AVENUE PITTSBURGH, PA.
**SATISFIED DEALERS
BECAUSE
WE HELP THEM ~**
Catalog 466-S is free to Dealers

nest obtainable. Otherwise it will be apt to crack. A condenser made of one complete turn of all three elements on a 1/2-inch rod 3 inches long will be suitable for the grid condenser in the average set. A half-dozen turns should be used for a by-pass. This, again, depends upon the thickness of mica used.

Contributed by Will Griffin.

How to Construct the DX4

(Continued from page 1433)

It is important in this set that low-ratio audio frequency transformers be used. 3:1 was the ratio selected for the set shown in the accompanying illustrations.

The grid condenser and leak, and the two by-pass condensers, are mounted below the sub-panel.

WIRING

An inspection of the illustrations will show that most of the wiring is confined to the space below the sub-panel. This is a good precedent for the builder to follow. It makes all parts of the assembly completely accessible, and lessens the possibility of short circuits. It is best to wire the grid circuits of the radio frequency amplifier and detector first; then the plate circuits of the same two tubes. These parts of the circuit deserve the most direct wiring. When they are completed the rest of the wiring may be done, taking care to keep all wires carrying high frequency separated as much as possible. A few minutes spent studying the wiring diagram should serve to show the best method of arranging the various leads. It is advisable to use spaghetti, at least in the filament and plate circuits.

NEUTRALIZING

The set is neutralized in the customary manner. After all connections have been made to antenna, ground, and batteries, tune in some strong local station. The set will probably oscillate strongly, making it impossible to hear the program clearly. Now set the regeneration control at zero coupling and the variable primary of the interstage R.F. coupler at maximum. Remove the first tube and place a bit of paper over one of the filament prongs. Then re-insert it in the socket. The paper, if properly located, will keep the tube from lighting. The signals will still be audible, although in a reduced degree. Now vary the small neutralizing condenser until the signals show a minimum strength, or fade out entirely. In this condition the set is perfectly neutralized, and should not oscillate when the paper is removed from the tube prong and the tube re-inserted.

OPERATION

The operation of the set is identical with that of an ordinary three-circuit regenerative receiver, with the exception of the added tuning control in the radio frequency stage. This dial follows approximately in its settings that of the condenser in the detector circuit. The coupling control in the interstage transformer serves to regulate sharpness and volume; when one is increased the other is reduced. The tickler coil also controls volume and quality in a like fashion. Both together form a means of getting almost any kind of results from the DX4; distance when distance is wanted, quality when that is desired, hair-splitting sharpness to cut through locals. It is one of the most flexible circuits available, and range of operating conditions of which it is capable makes it suitable for a wide variety of individual tastes.

It's Easy to Build A Powerful Set!

Using the New and Improved FRESHMAN "TRF" Low Loss Kit



These are the identical units which have made the FRESHMAN MASTERPIECE factory built Receivers the World's Greatest Radio Sets. **\$9.50**

Straight Line Wave Length Condensers With Low Loss Self Balanced Coils

Complete instructions for building this powerful five tube receiver, written in plain everyday English, together with actual size schematic wiring diagram, are furnished with every FRESHMAN "TRF" KIT.

Sold by Authorized Freshman Dealers Only!

CHAS. FRESHMAN COMPANY, Inc.

Freshman Building 2626 W. Washington New York Blvd., Chicago

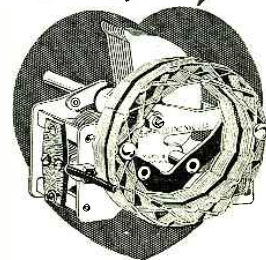

BUILD IT WITH KELBRACKETS!

Only \$1.50 Per Pair

Make a sturdy, efficient, good-looking set. Kelbracket Booklet shows how, giving actual size and many uses. Mailed Free.

KELLERADIO, Inc.
821 Market Street, San Francisco, Calif.

Wade Square Law Condenser and Dial

All sizes, complete with 4-inch vernier dial, for:

Capacity .000125 mfd.	\$8.00
Capacity .00025 mfd.	6.25
Capacity .00035 mfd.	6.35
Capacity .0005 mfd.	6.50

At your dealers, otherwise send purchase price and you will be supplied postpaid.

THE VIKING TOOL AND MACHINE CO., Inc.
747 65th Street, Brooklyn, N. Y.

EVERYTHING IN RADIO AT ATTRACTIVE PRICES SETS OR PARTS

Mail order only

ALL RADIO COMPANY, 417 North Clark St., Chicago

RADIO AMATEURS—Improve your set with a Faradon Mica Condenser, Model UC 1015, made expressly for Radio Corporation. Only \$1.25. Originally listed \$3.25. Capacity range .0002 to .001 mfd. All brand new and packed in original containers. Instruction sheet enclosed. Send your order in now! Postage*Prepaid Anywhere in the U. S.

UTILITY RADIO CO., 58 North 6th Street, Newark, N. J.

INTRODUCING

AMAZING STORIES

THE
NEWEST
STORY
MAGAZINE

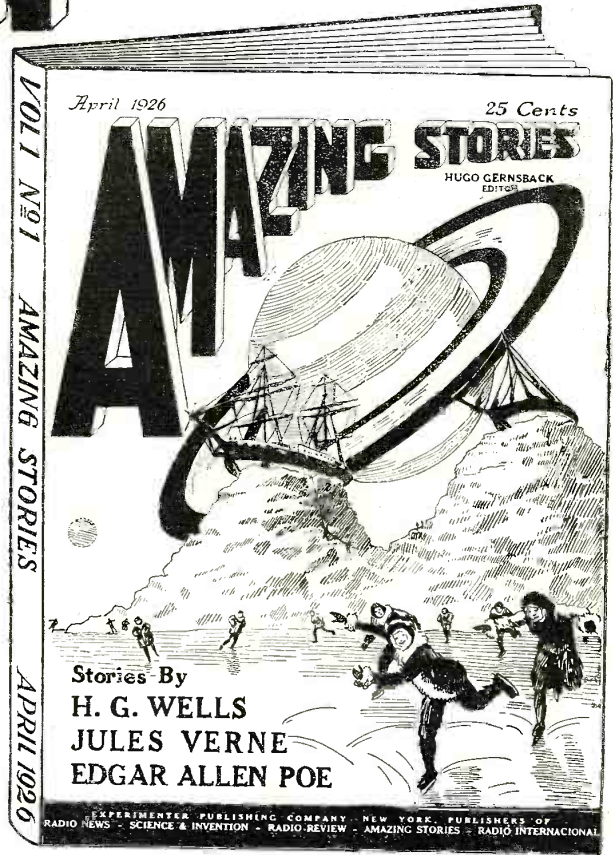

25^c

EVERYWHERE

100

PAGES
ILLUSTRATED

Stories by

H. G. WELLS

JULES VERNE

EDGAR ALLEN POE

and other great writers

Big, Smashing Stories of the Future, Educational, Absorbing

You are familiar with some of the brilliant works of Jules Verne, the master of imagination, H. G. Wells, with his equally daring imagination, and other authors of the imaginative school.

Never before was there a magazine that contained stories of this type exclusively. AMAZING STORIES, published by the publishers of SCIENCE and INVENTION and RADIO NEWS, and edited by Hugo Gernsback, himself an author of imaginative stories, will bring to you from month to month the most amazing stories of the world's greatest scientific fiction.

GREAT NEWS

The publishers of AMAZING STORIES have contracted for the entire 15 volumes of Jules Verne stories—each and every story that Jules Verne ever wrote. Many of these stories have never appeared in print before in America, except in one expensive library edition, while most of Jules Verne's stories have never been available to the public at large in

America. AMAZING STORIES has all of them and will publish them for several years to come.

The publishers of the new magazine are scouring the world for stories of this type, and have already secured English, French, and German works, all of which will be published in forthcoming editions.

In the very first issue, one of the finest bits of imagination of Jules Verne, "Off on a Comet" is published. There also appears stories by H. G. Wells, Ray Cummings, Edgar Allen Poe, and others.

Interesting, startling, and amazing from cover to cover. Every story illustrated. Don't miss the first issue, buy your copy today and watch for the next issue, or you can receive your copy every month by sending \$2.50. Your dealer will have single copies for sale at 25c each. The magazine being advertised widely, there will be a tremendous demand for it, so place your order today.

Amazing Stories is published every month, contains 100 big pages, illustrated, large size, 8 x 11 inches. A great big book. Do not miss it.

READ AMAZING STORIES

SOLD EVERYWHERE, OR IF YOUR DEALER CANNOT SUPPLY YOU
WRITE DIRECT TO

Experimenter Publishing Co., Inc., 53 Park Pl., New York

The Radio Watchman at the Gate

(Continued from page 1408)

can be detected with certainty; in practice the apparatus would be set to an adjustment a little less than critical, so that the smaller bits of metal need not cause signals in the phones. In order to prevent the purpose of the detector being defeated by the presence of lunch cans, thermos flasks, or other property of the workmen, a shelf is provided at the side of the wicket, as shown. The employe leaves any metal articles before passing through the wicket; and then returns to get them, before leaving through the main gate.

If the detector shows the presence of an undue amount of metal on a person passing through the gate, he may be then searched with more care. A small "searching coil" is provided for this purpose, which acts on a similar principle to the larger circuit. By moving this coil over the body of the person searched, the location of any piece of metal is determined accurately in an instant. This auxiliary coil may be made so sensitive that it will respond with certainty not only to coins in the pockets, but also to the presence of a stick-pin in the cravat or of metal fillings in the teeth; and that without actually coming in contact with the person thus searched.

Book Reviews

TUNING COILS AND METHODS OF TUNING. By W. James, Assistant Editor of *Wireless World* and *Radio Review*. Stiff paper cover, size 5½ x 8½ inches. 75 pictures and explanatory sketches. 128 pages. Published by Iliffe & Sons, Ltd. Price 2/6 (with postage, this comes to about 70c).

An extract from the author's preface states: "Formulas and examples of their use will be given only when they are essential for correct understanding of the subject." We find this decision to be well carried out.

This is probably the most complete book available on the one subject of inductances, practically every form taken by inductance being mentioned.

One very noticeable exception is the toroid. This form of winding is coming into more general use in the United States and is worthy of treatment. "Astaire" and "binocular" coils are not described, either. However, this deficiency may be compensated for by a study of the article on inductance appearing in the February, 1925, issue of *THE EXPERIMENTER* magazine, where these three forms of winding are pictured and described.

"Inductance" is treated mathematically, theoretically and practically.

"Spade" tuning is described at considerable length. We do not believe this form of varying the inductance of a coil by placing a metal plate in variable relation to the coil has been used in American receivers since the "Mignon" line of apparatus entered and left the American market some years prior to the advent of broadcasting. A tuner of English manufacture using the principle appears on page 43 of the July, 1925, issue of this magazine.

The author's paragraph, "Spade tuning introduces no serious losses, provided the spade is carefully designed," should cause experimenters to invent many new ways of adapting our present and multitudinous circuits to include this form of inductance variation as a possible solution of some unsolved problems.

The text is so written that anyone can readily understand it.

Not being an ephemeral book, it is certainly worth binding in more permanent form.

THE HOME CONSTRUCTOR'S WIRELESS SETS. By F. H. Haynes, Assistant Editor of *Wireless World* and *Radio Review* magazine. Counting postage, the price is about 50c.

The contents page lists complete constructional details for a Simple Crystal Set, Single Valve Set, a Note Magnifier (Audio Frequency Amplifier), High-frequency Amplifier and Detector Set and a Power Amplifier. This seems to cover the range of essential units in more general use. British Post Office regulations prohibiting the

The Mystery Receiver

CHARLES LEUTZ'S LATEST EPIC

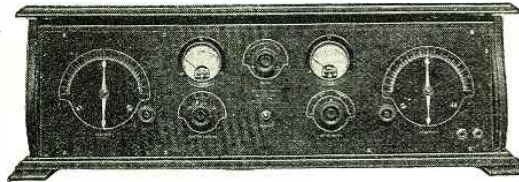

THE UNIVERSAL SUPER-8

LICENSED UNDER HOGAN PAT. 1,014,002

Tunes all Wavelengths from 35 Meters to 3600 Meters

The Universal Super 8, "The Mystery Receiver," is an improved design of the Universal Plio 6, but does not by any means supersede the Universal Plio 6, which is still continued and which is the leading broadcast receiver in its sphere. The Universal Super 8, however, is an advancement in that while it retains all the salient features of the Universal Plio 6, adds some new desirable features, making it the highest grade set possible to produce.

- (1) Meters are provided to read the battery voltages.
- (2) A special antenna coupling circuit is provided to reduce interference and static.
- (3) Geared verniers are provided on the tuning controls.
- (4) Metallic shieldings provided at points deemed advisable.
- (5) Seven tubes are used to give still greater volume and fine tone musical reproduction.
- (6) All the important component parts are encased in a metal container, and factory sealed to prevent any damage and to prevent competitors from copying the new features.
- (7) We believe it is impossible to trace the circuit and design by taking this receiver apart outside of our factory.

The exact function of the seven tubes of the Universal Super 8 is not revealed at this time as the manufacturers desire to keep all details a secret until full patent protection is afforded. Full operating instructions are supplied with each Universal Super 8, however. Patents are applied for covering some of the features of the Universal Super 8.

Either the old or the new type tubes are used in the Universal Super 8, and special provision is made for bias batteries, specified by some tube manufacturers.

Obviously this receiver will not be made on a large production scale, due to the time needed in building each one individually. Orders are now being taken on a custom-made basis as each set is laboratory tested in Long Island by an expert radio engineer to insure its perfection.

It is believed that the new design embodied in the Universal Super 8 gives the finest musical reproduction, tune, selectivity, audibility and maximum range that can be obtained by any receiver using seven tubes. Judging from the interest in our other multiple tube receivers, we believe the demand for this new design is going to tax our capacity the year around, and, as above stated, orders are now being taken in rotation. Prices quoted on application.

This receiver is not regenerative and is not a super-heterodyne.

WRITE OR WIRE

GOLDEN-LEUTZ INC.

VAMOS BUILDING

6th & Washington Aves., Long Island City, N. Y.

Cables "Experinfo"



BLUEBIRD RADIO TUBES

are powerful—sensitive for distance, give clear volume and long service.

GUARANTEED

to work in Radio Frequency, Neutrodyne, Super Heterodyne and Reflex.

WITH BAKELITE BASE

Type 401A \$2.00 All Standard Types

Type 400
Type 499
Type 412

Also 499A with Standard Base 202-5 Watt Transmitter \$3.00

When ordering mention types Shipped Parcel Post C.O.D. BLUEBIRD TUBE CO. 200 Broadway Dept. N New York

The Saw for Every Use

Cuts wood, iron and bakelite. Especially designed for radio set builders. Highly tempered steel blades. Sold by radio dealers and hardware stores or sent by mail, postpaid, with six blades..... \$1.00

Dealers and others write for circular and full information.



F. P. MAXSON
1033 Newport Av.
CHICAGO
Telephone
Lakeview 1403

Insure your copy reaching you each month. Subscribe to Radio News—\$2.50 a year
Experimenter Publishing Co., 53 Park Place, N. Y. C.

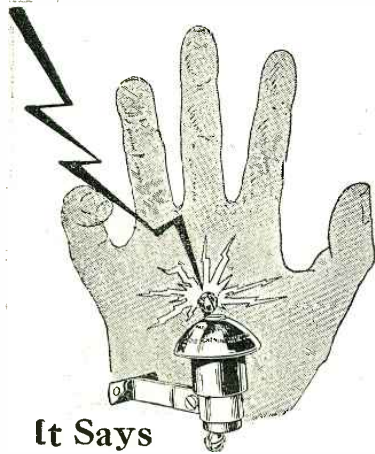

**It Says
"STOP"
and Lightning Won't
Harm Your Set**

The National Board of Fire Underwriters specify that an approved Radio Lightning Arrester must be used with all out-door aerial installations. Protection is easy. Insure your insurance and save your set with a WIRT LIGHTNING ARRESTER (listed as standard by the Underwriters Laboratories). The cost is a trifle.

The WIRT LIGHTNING ARRESTER is an approved air gap type, made of bakelite giving ample insulation, with brass terminals moulded in bakelite, far enough apart so that there is no leakage. A "petticoat" of bakelite shields the arrester from water and dust. Handsome and rigid. Lasts a lifetime. Easy to install. Full directions on box.

THE WIRT LIGHTNING ARRESTER IS LISTED AS STANDARD BY THE UNDERWRITERS LABORATORIES

Wirt Lightning Arrester...\$1.00
Wirt Insulator35

When you install your WIRT LIGHTNING ARRESTER get a WIRT INSULATOR and prevent leakage along your lead-in wires. It keeps the wire at the proper distance, provides perfect insulation; and prevents wear and tear on the wire by preventing sagging and swaying.

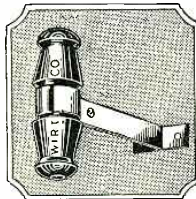

Sold by Leading Radio Dealers

WIRT COMPANY
PHILADELPHIA PENNSYLVANIA
Makers of Dim-A-Lite

\$138 U. S. ARMY \$39.65
Aeroplane Radio

Greatest Set ever offered to public. Quality unsurpassed—Cost government \$138. Lives depended on reliability. Rubber cushioned and insulated throughout. No vibration or distortion—reduces static. Ideal for home, auto, boat or clubhouse. RECEIVES AND BROADCASTS Receives on 190 to 600 Meters. Transmits on 200 to 500—Slight change needed to use assigned amateur wave lengths. Made by Western Electric Company—uses standard equipment.

WRITE QUICK! Don't Wait. Get complete details today. Only 100 Sets at this low price—\$39.65.

WARSHAWSKY & COMPANY
1915 So. State Street, Div. RN-4 Chicago

Learn Watchwork, Jewelrywork and Engraving A fine trade commanding a good salary, and your services always in demand. Address Horological, Dept. 5, Bradley Institute, PEORIA, ILLINOIS, for our latest catalog.

use of regenerative receivers, because of their inclination to oscillate and thus radiate an interfering wave, are generally known (this ruling has not been enforced to the full extent, because of the sudden advance of interest in radio, and a tacit understanding of the extreme desirability of a non-oscillating but regenerative receiver), and therefore a brave effort to qualify construction data on a standard regenerative receiver was particularly noticeable, the author stating: "All types of receivers making use of reaction (regeneration) energize the aerial circuit to a more or less extent in the process of tuning, and this is also true in most cases where straightforward high frequency amplification is employed." And then: "For this reason" (referring to the use of only one tube in the oscillating condition, when it is possible to receive local stations with a fair degree of quality) "do not let the receiver oscillate unless this condition is essential to bringing in the required signals. (The italics are ours.)" "Frequent adjustment of the set during broadcasting hours is the principal cause of interference, and when once set to the desired transmission, the tuning controls should be left alone." The construction descriptions are detailed and complete, making the book of particular interest to anyone desiring a handy reference to construction data on common sets.

WIRELESS VALVE RECEIVERS IN PRINCIPLE AND PRACTICE. By R. D. Bangay and N. Ashbridge. Stiff paper cover. 116 pages. Size 5½ x 8½ inches. Published by Iliffe & Sons, Ltd. 75 diagrams, sketches and curves. Price 2/6 (about 70c).

R. D. Bangay is well known to the radio fraternity as a writer capable of making technical matter understandable to the most inexperienced. His "Wireless Valve Receivers and Circuits" (or, as we would understand it, "Radio Tube Sets and Circuits") should be read in conjunction with his "The Oscillation Valve." One is a complement of the other. Having read the latter, one is better prepared to benefit by a reading of the former.

About one-half the book is given over to a theoretical treatment of the subject, the remainder being more in the nature of practical data.

Considerable space is devoted to the little-understood grid leak action under the caption, "Grid Leak Rectification." Regeneration is not described at sufficient length in the chapter on "The Use of Reaction."

"Characteristic curves" are so well described and explained that no one, after studying the text and sketches, need say they cannot comprehend such curves and lines.

"Supersonic" (or, as we call it, "super-heterodyne") reception is dealt with only slightly, just sufficient to show the genesis of the name.

The book should appeal to anyone short of an engineer.

"Valve," "supersonic," "frames," "reaction," "magnifier" and a host of other words of that ilk cause us to ask when an international convention may be expected to decide upon one standard radio nomenclature.

SIMPLICITY OF RADIO is the name of an 80-page booklet written by Powel Crosley, Jr., and published by The Crosley Publishing Co., Cincinnati, Ohio. Complimentary copies may be obtained by writing to this company.

The cover is in three tones of blue, and the booklet is called "The Blue Book of Radio."

While devoted to the one objective of increasing public interest in Crosley products, this booklet will be found of interest to anyone desiring a somewhat deeper understanding of radio than can be secured merely by gazing at the necessary parts or the completed set.

How to read diagrams, where to look for trouble in sets, why the vacuum tube functions, the how and why of the broadcast stations from which programs emanate and similar subjects are treated in this booklet.

The well-used but ever helpful "water analogy" is called upon once again to explain the action of radio instruments and circuits.

RADIODYNAMICS, The Wireless Control of Torpedoes and Other Mechanism. By B. F. Miessner. Hard covers. 5½" x 8½". 211 pages. Published by D. Van Nostrand Co., New York. \$2.00.

This book is an excellent, practical and comprehensive treatise, without being too technical, on this branch of the science of telemechanics, or the control of apparatus at a distance from the operator. It is devoted to explanation and description of the systems and mechanisms to accomplish this through the four media, ether, air, earth and water. The treatment is scholarly and complete, without being pedantic, and the style is lucid.

Readers who have found interest in the article, "Controlling Power and Motion by Radio," appearing in the March issue of Radio News, will be able to follow this subject systematically through Mr. Miessner's book, to which the author of that article is indebted for much valuable material and for illustrations.

**Dealers!
REAL PRICES**

We carry in stock at all times the following merchandise—

- | | |
|---------------------|---------------------|
| Electrical Supplies | China ware |
| Furniture | Hardware |
| Radio | Musical Instruments |
| Automotive | Leather Goods |
| Equipment | Sporting Goods |
| Aluminum Ware | Jewelry |
| Novelties | |

FREE! 1926 complete illustrated catalog just off press. Write for a copy at once. Supply limited.

General Merchandising Co.
Incorporated

818 Walnut St., Philadelphia, Pa.

**SEE THAT
SCREW**



A Screw-Driver adjusts an X-L in crowded places

X-L VARIO DENSER

Results in easier tuning, more distance, volume and clarity—greater stability. Indorsed by leading radio authorities.

MODEL "N"—A slight turn obtains correct tube oscillation on all tuned radio frequency circuits. Neutrodyne, Roberts two tube, Brownlux-Drake, McMurdio Silver's Knockout, etc. Capacity range 1.8 to 20 micro-micro farads. **PRICE \$1.00**

MODEL "G"—with grid clips obtains the proper grip capacity on Cockaday circuits, filter and intermediate frequency tuning in heterodyne and positive grid bias in all sets. Capacity range .0016 to .00055 and .0003 to .001 micro farads. **PRICE \$1.50**

X-L PUSH POST—Push it down with your thumb, insert wire, remove pressure and wire is firmly held. Releases instantly. **PRICE 15c**

X-L RADIO LABORATORIES
2426 Lincoln Avenue, Chicago, Ill.



1926 RADIO CATALOG & LOG BOOK

Get Our 1926 Beautiful Illustrated Catalog!

Which contains all latest STANDARD RADIO MERCHANDISE and up to date Log Book. It will pay you to buy from us. We carry one of the largest lines of Radio in the East. Don't miss the wonderful opportunity to participate in this Great Sale. Rush your request at once.

To cover the cost of mailing enclose 10c. **ECONOMY RADIO SALES COMPANY** 288 6th Ave. Dept. F. New York DEAL DIRECT AND SAVE REAL MONEY (No Dealers)

5-TUBE SET = \$28 = LATEST DESIGN

This wonderful value made possible because practically everything is manufactured in our own factory. We supply chassis completely wired with cushioned sockets, S. L. F. Condensers, Verrier Diodes, Low Loss Coils, no cabinet. Dimensions of set 7x18 in. Latest design. Express extra; weight 13 lbs. Money refunded if unsatisfactory in 3 days. Remit cash, Money order or Express. Dealers write for special proposition. **Duke Radio Co., 326 W. Madison St., Chicago, Ill.**

Insure your copy reaching you each month. Subscribe to **RADIO NEWS**—\$2.50 a year. Experimenter Publishing Co., 53 Park Pl., N.Y.C.

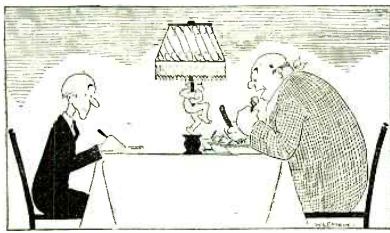

"Variable Capacity"

International Radio

(Continued from page 1409)

LOW-FREQUENCY AMPLIFIER
with distort onless transformers for single and double amplification

TWO AND FOUR VALVE APPARATUS

with fixed and setting in spoolcoupling for all wave-lengths.

My drawingcards in components are

STRONG SOUNDING HEAD SETS
with or without fine insertion of the acoustic **RADIO LOW-FREQUENCY TRANSFORMER**

distortionless in steel armatures 6 : 1 4 : 1 3 : 1

VARIABLE CONDENSERS

Plates, brass, dielectric hard ruther with fine insertion"

The radio fan with some skill in crossword puzzles will not be long in solving the references to "foil-regeneration and fine tanning." Though "hard ruther" may prove somewhat harder to translate, it is satisfactory to notice from a recent foreign advertisement that this material (insulation) is not without a satisfactory substitute, for we read:

"All insulating parts for the weak current and radio industry made of the easily worked up and highly superior artificial material 'TROLIT' in all colors.

"Heares, handles, scale discs for condensers, buttons of every description. Vulkan fibre in plates, rods and tubes as also all figured parts. Specialty: bows (unbreakable) for head hearers, of fibre, supplied."

Fortunately this advertisement is in three languages, so that the radio dealer may discover, by the exercise of a little ingenuity, that "hearers" are the circular ear-pieces for headphones; while the buttons are intended, not for his pants but for his receiver's panel.

A. J. Smith.

NOW ACCORDING TO THE BOOK ALL I NEED TO COMPLETE THIS SET IS A CATWHISKER



When Pussy Needs a Friend.

The UNIVERSAL Standards of Quality



Type 277-D
Coupling Coil
Price \$1.50

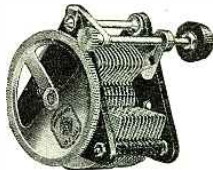

Type 247-H
Geared Condenser
Price \$5.00

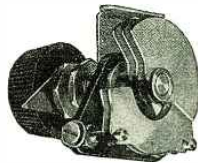

Type 368
Micro-Condenser
Price \$1.25



Type 285
Audio Transformer
6 to 1 and 2 to 1
Price \$6.00



Type 349
UX-Tube Socket
Price 50c



Type 301
Rheostat
Price \$1.25

In building a radio receiver remember that its performance depends primarily upon two things; an efficient circuit, and the use of good parts.

Wherever you find a popular circuit you will invariably find General Radio parts.

The General Radio Company has contributed more in scientific apparatus for laboratory use than any other one Company in the history of radio.

The same outstanding craftsmanship and materials are embodied in General Radio parts for use in the construction of broadcast receivers.

Through the merits of design, performance, and price, General Radio instruments for the scientist or set-builder are universally recognized as the Standards of Quality.

Every instrument made by the General Radio Company is thoroughly guaranteed.

Write for our latest parts catalog 923-N.

GENERAL RADIO CO
Cambridge 39, Mass.

GENERAL RADIO INSTRUMENTS

"Behind the Panels of Better Built Sets"

Free to Men Past 40

What is prostate gland disorder? Why does it come to two-thirds of all men past middle age? Why does it cause loss of vitality, sciatica, aching feet, back and legs? Amazing book, written by well known American Scientist, answers these questions and tells how 20,000 men have found relief without drugs, surgery, lessons. Simply send name and address for copy, no obligation. Address the **ELECTRO THERMAL CO.**, 615 1/2 Main St., Steubenville, Ohio. West Office: Dpt. 6V, 711 Van Nuys Bldg., Los Angeles Cal.

RADIO STUDY AT HOME

RADIO EXPERT

Radio, the wonder of all ages, has grown with gigantic strides. Radio experts are needed to keep pace with the growth. Thousands of good-paying positions are open to trained men. money—travel—get into the limelight. There's romance, power and fortune ahead for men with vision now just as there was when Henry Ford got started on his auto. The great opportunity is here.

YOU EARN WHILE YOU LEARN

Our home-study course in practical radio can be mastered by you in 3 months. Become a radio engineer. Write for free booklet, "Millions Unemployed." **FREE TWIN** if you enroll now. Send letter or postal to **RADIO SET**, 1-1, Mendota—learn how to make \$100 wk. **AMERICAN RADIO ENGINEERS**, Dept. 407 Hearst Bldg., Chicago, U. S. A.

"Lighting Fixtures" READY TO HANG

(Direct from Manufacturer)
Completely wired including glassware
Send for new Catalogue No. 27
(Just reduced prices)
Special Proposition to Dealers
ERIE FIXTURE SUPPLY CO.
STATION R ERIE, PA.

FREE RADIO GUIDE

NEWEST 1926 EDITION

Shows the latest circuits, the newest developments in radio at startlingly low prices. Get the parts you want here and save money. The best in parts, kits, sets and supplies. Orders filled same day received. Write for free copy NOW; also please send names of one or more radio fans.

RARAWIK CO., 102-145 So Canal St., Chicago, U. S. A.

Insure your copy reaching you each month. Subscribe to Radio News—\$2.50 a year
Experimenter Publishing Co., 53 Park Place, N. Y. C.

The New

RADIO NEWS

Sold on All Newsstands

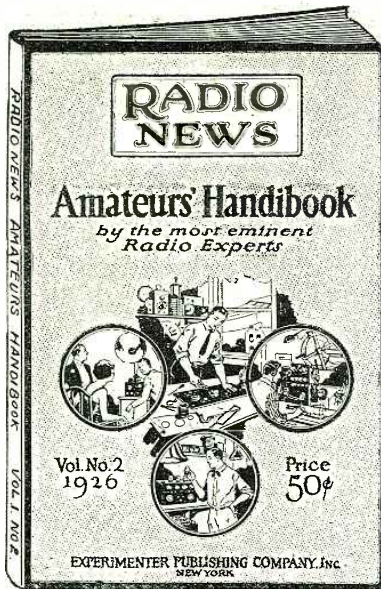

AMATEURS' HANDIBOOK
118 Hookups : Over 300 Illustrations

Any electrician will tell you that his Electrical Handbook is his most valuable reference—so also, the builder, the mason, the carpenter, all use a handy reference book no matter what the job may be. It is as important as the tools they use to work with. EVERY MAN SHOULD HAVE A RADIO HANDBOOK, the real, concise, yet comprehensive book on everything of reference value to anyone interested in radio whether he builds his own set or is engaged in professional radio activity.

All information for this book has been carefully culled from the pages of no less authority than Radio's Greatest Magazine, Radio News. Radio men in constant touch with all radio material have selected the most valuable articles.

The RADIO NEWS AMATEURS' HANDIBOOK contains a complete resume of every phase of radio. It is the first book of its kind, a veritable gold mine of radio information.

Published in the large size 9 x 12 inches, contains 128 pages, illustrated.

Published and Distributed by

The Experimenter Pub. Co., Inc.
53 Park Place, New York, N. Y.

New, Enlarged 2nd Edition

Size 9 by 12 inches

50c the Copy

Romance, Mystery, Intrigue-700 Years Hence

by

Hugo Gernsback

Editor of SCIENCE & INVENTION,
AMAZING STORIES, RADIO NEWS,
AND RADIO INTERNACIONAL

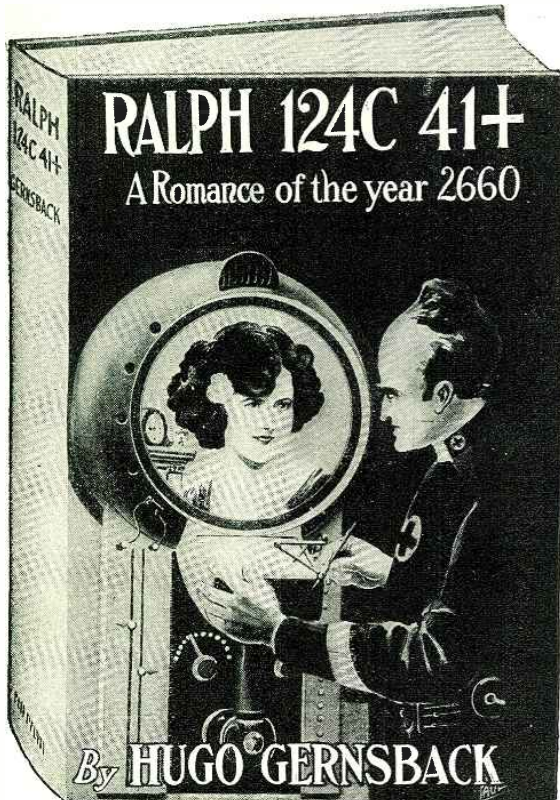

IN 1908, Mr. Hugo Gernsback, Editor of RADIO NEWS and other publications, published the first radio magazine the world had ever seen—"Modern Electrics." In one of these volumes he ran a story entitled "Ralph 124C 41+ A Romance of the Year 2660." This story, although written many years ago, proved more valuable as the years went by, because many of the prophecies made in this book gradually came true.

This was in the days before broadcasting had even been thought of, and before we had the radio telephone, yet all of this is faithfully chronicled in this story.

Old-time readers of "Modern Electrics" probably remember the story and now have a chance to get the complete book.

A pioneer in the electrical and radio field, Mr. Gernsback has a profound knowledge of the subjects, coupled with a finely trained and highly imaginative mind.

This unusual combination has enabled him to foreshadow with almost unbelievable accuracy some of the more recent developments. His earlier predictions, which have appeared from time to time during the past decade in many newspapers and magazines, are now realities. Every prophecy is based on accurate scientific knowledge. His ideas are no more fantastic than the realities and commonplaces of our everyday life would have been to our great-grandfathers.

THE STRATFORD CO., Publishers

For Sale by

The Experimenter Pub. Co., 53 Park Pl., N. Y.

Just fill out this coupon, enclose \$2.15 and we will send you a copy—at once Post-Paid.

ORDER BLANK

EXPERIMENTER PUBLISHING CO.,
53 Park Place, New York City.

Gentlemen:—
Enclosed find \$..... for which please send me
..... copies of "RALPH 124C 41+,"
by Hugo Gernsback.

Name

Address

PRICE \$2.15 POSTPAID RN-4

New Developments in Radio Apparatus

(Continued from page 1417)

is still measured across the terminals of the detector and audio frequency tubes, but read across both the R.F. filaments and the resistor in series. Thus the voltage on the R.F. filaments is always known to be the same as or less than the meter reading.

As an aid to clarity, the primary of the first audio frequency transformer and the secondary of the second are shunted by condensers. All of the leads are brought in by means of a combination plug, which is shown diagrammatically in the wiring sketch, and is pictured in the top view of the interior.

The tubes, it will be noticed, are mounted horizontally, instead of vertically, the more usual practice. The sockets are supported by springs, and the whole assembly is practically non-microphonic.

The appearance of the entire exterior is pleasing and harmonious, as the tones of the cabinet, metal work, and panel have been blended by a skilled artist.



This new kind of "A" POWER pays for itself over and over again

THE first cost of Unipower is moderate—and the first cost is the last.

When you also consider that Unipower banishes the cost and inconvenience of dry "A" battery renewals, or the bother of charging a storage battery, increases the life of your tubes and, in addition, gives you the finest kind of continuous, un-failing "A" power, you see how economical Unipower really is.

pays for itself over and over again. It costs but a few cents a month to operate. Write for booklet, "Unipower—a triumph in radio power".

THE GOULD STORAGE BATTERY CO. Inc.
250 Park Avenue, New York

Unipower contains a Balkite charging unit of special design.

4 volt model, \$35—60 cycles, 110-125 volt A. C. Designed for radio sets using 199 tubes or equivalent.

6 volt model, \$40—60 cycles, 110-125 volt A. C. Designed for radio sets using 201-A tubes or equivalent.

Prices west of the Rockies slightly higher. Special models, 25-50 cycles are available.

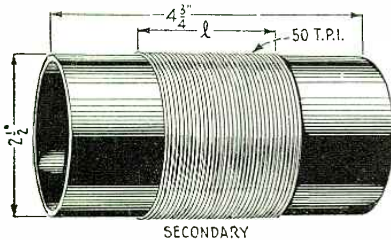

SECONDARY

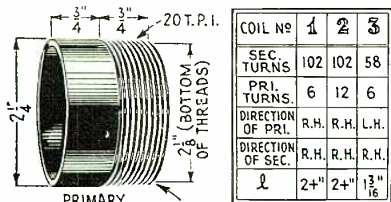

COIL No	1	2	3
SEC. TURNS	102	102	58
PR. TURNS	6	12	6
DIRECTION OF PRI.	R.H.	R.H.	L.H.
DIRECTION OF SEC.	R.H.	R.H.	R.H.
	2 1/4"	2 1/4"	1 3/16"

PRIMARY
INSERTED AT END OF SECONDARY OPPOSITE GRID CONNECTION.
START WINDING AT THIS END.

This illustration gives data on the construction of the "canned coils" of the receiver illustrated on page 1414.

A TESTER WHICH CHECKS ALL TUBE FUNCTIONS AT ONCE

Tube testers which employ meters in the various circuits, if a complete test of all functions is desired, are prohibitively expensive. It requires half a dozen accurate meters to test a tube and really know its operating condition. One manufacturer has discarded the meter method entirely, and produced a tester which checks simultaneously

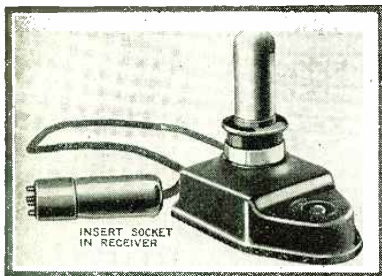

This compact instrument gives a quick, qualitative test of tube functions which would require half a dozen accurate meters to duplicate quantitatively.

Photo by courtesy of Morrison Radio Co.

\$1.75
"DIALITE"
Complete with Lamp

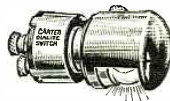

Half Size

Any dealer can supply

CARTER

Illuminates dials and front of panels. Provided with extra terminal to be used as filament switch when desired. Complete with 6-Volt Lamp.

Current consumption negligible.

In Canada: Carter Radio Co., Limited, Toronto



"IMP" Pilot Switch \$1.50

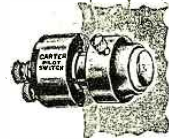

Half Size

Write us for Catalog

Insure your copy reaching you each month. Subscribe to Radio News—\$2.50 a year. Experimenter Publishing Co., 53 Park Place, N. Y. C.

Special Horns to fit Special Cabinets

Although we make 45 different amplifying horns for use inside and outside the cabinet, it is possible, Mr. Manufacturer, that you will need

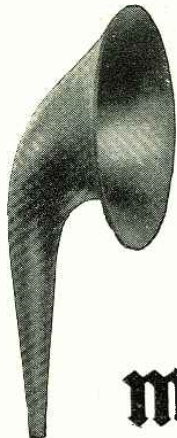

A
Horn of
Special
Size to
Fit Your
New
Model
Miller

Radio horns are installed in many of the highest class radio sets manufactured. If we may have your cabinet specifications, we will gladly design and quote you on a horn, developed on the best scientific principles, which will fit your set.

Miller horns, through experience and knowledge, are designed on the soundest acoustic principles. They are *inert*, and will not split, crack, dry up, swell or rattle.

Let us figure with you on a more satisfactory horn for your models, old or new.

The Miller Rubber Co.
of N. Y.
AKRON OHIO

PATENTS

If you have an invention and desire to secure a patent, send for our Evidence of Invention Blank and free guide book, "HOW TO GET YOUR PATENT." Tells our Terms, Methods, etc. Send model or sketch and description of your invention for INSPECTION and INSTRUCTIONS.

No Charge for the Above Information

RANDOLPH & CO., Dept. 459 Washington, D. C.

ATWATER KENT RADIO

all of the functions which could be tested, ordinarily, by the most expensive meter method.

The instrument shown in the accompanying half-tone is simplicity itself in operation. A tube is removed from the receiver and placed in the socket of the tester, the plug of the tester is put in the socket in the set. When the rheostats of the receiver are set for normal operation the small glow lamp in the base of the tester will light brightly, if the tube is good, but will fail to light at all if it is inoperative. Various stages of brilliancy between these two extremes will show the comparative efficiency of any tube.

The small bulb is not connected in the circuit directly. It is coupled electromagnetically to a grid coil and lights due to the radio frequency energy generated by the radio tube in an oscillating condition. Any factor, such as weak filament emission, low amplification factor, low conductivity, etc., will decrease the amount of energy generated and the small lamp will glow less brightly. With dry-cell tubes the maximum brilliancy is always less than with storage-battery tubes. This should be remembered in testing the two types.

Thus, by one simple operation, this tester checks all of the important characteristics of a tube, and supplants apparatus of many times its cost. The older style of meters will still be used for quantitative tests, of course, and remain the laboratory standard, but this one brings a reliable means of checking tubes within the abilities and funds of the average experimenter and small dealer.

A TABLE WHICH CONVERTS THE SMALL SET INTO A CONSOLE

The average small set which has no interior partition for batteries, and is used with a separate loud speaker, usually calls down the wrath of the housewife because of the bat-



This table gives to the ordinary radio set all of the conveniences of a console. Compartments are provided for "A", "B", and "C" batteries, charger, loudspeaker, etc., and a drawer for small tools, log books, and other accessories which the radio fan finds convenient to have at hand.

tery leads and the antiquated phonograph appearance of the horn. For this reason the table console illustrated in the two accompanying half-tones will be welcomed by many, as a means of doing away with the unsightliness of the usual small set, yet without the expense of buying a complete console.

The horizontal table portion in front is long and deep enough to hold any standard set of the usual shape. In the rear, right and left, compartments are provided for "B" batteries, "A" batteries, and charger, or for eliminators, and passages for the battery cables. A grilled opening, semi-circular in shape, is cut in the wood, behind which the loud speaker horn or cone is located. It rests upon an adjustable foot, which may be varied in height to bring the throat of the horn



Today
-in every
good set!

100% Value
From Each Tube

Offers precision regulation—automatically
No hand rheostats to regulate.

Used As Standard Equipment In

GEN-WIN
LEMNIS
RECEIVER

Price \$1.10 complete with mounting
Write for free hook-ups

Radiall Company

Dept. RN-4, 50 Franklin St., N. Y. City

AMPERITE
REG. U.S. PAT. OFF.
The "SELF-ADJUSTING" Rheostat

TRUTH

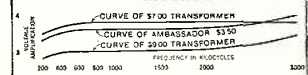

AMBASSADOR

Perfect Radio

TRANSFORMERS

By the most careful laboratory tests give as good or better results than transformers costing two and three times as much. Test them in your set and be convinced of the TRUTH.

FREE Four page booklet in colors, "The Truth About Transformers" and hook-ups.

AMBASSADOR SALES CO.
110 Greenwich St., Dept. 450 New York

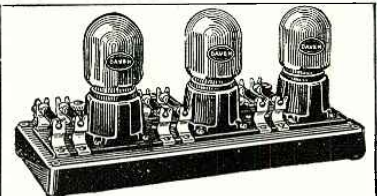

The Daven Super-Amplifier
for volume and tone quality
3 STAGES RESISTANCE COUPLED
ECONOMICAL DISTORTIONLESS
Easily added to any set
Saves Several Hours' Assembly
For Sale by All Good Dealers

or the center of the cone in the best position behind the grilled opening.

A drawer is provided in front for the call book, dial log, small tools, and other accessories.

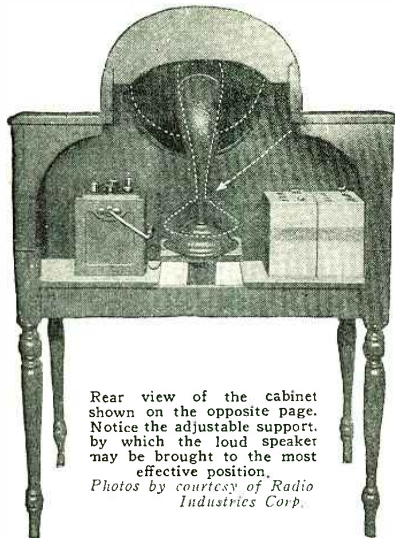

Rear view of the cabinet shown on the opposite page. Notice the adjustable support by which the loud speaker may be brought to the most effective position.
Photos by courtesy of Radio Industries Corp.

A New Radio Frequency Receiver

(Continued from page 1428)

Two resisto-couplers, with associated resistances,

- One single .00035- μ f. S.L.F. condenser.
- One double condenser, consisting of two 00035- μ f. sections,
- One 10-ohm rheostat,
- One 30-ohm rheostat,
- One single closed- and one single open-circuit telephone jacks,
- Six UX-type tube sockets,
- Ten binding posts.

On the 7x24 panel are mounted: the single condenser, in the left-hand center section; the double condenser, in the corresponding right-hand center section; the open circuit jack and the 10-ohm rheostat, in the lower left-hand corner; the closed-circuit jack and the 30-ohm rheostat, in the lower right-hand corner; and the battery switch, in the exact lower center.

POSITION OF THE PARTS

The sub-panel is supported in the rear of the front panel by the heavy frames of the phone jacks and a small "L" shaped brass bracket fastened just above the battery switch. As can be plainly seen in the illustration, the sub-panel holds the rest of the apparatus.

One coil is mounted on the left side of the single condenser, the two being connected to act as the aerial tuning and first-stage R.F. components. Another goes on the left side of the double condenser, and couples the first tube to the second. The third fits on the right side of the double condenser, which tunes together the second and third coils, representing the second R.F. and detector stages.

The placement of the various sockets and the audio amplifier components is quite simple, and will present no difficulties to the average constructor. The socket behind the single condenser is for the first R.F. tube; the one behind the double condenser for the second R.F. tube; and the one in the right-hand corner for the detector. The grid-condenser-and-leak unit is screwed down conveniently in the place between the last socket and the right-hand coil, and will

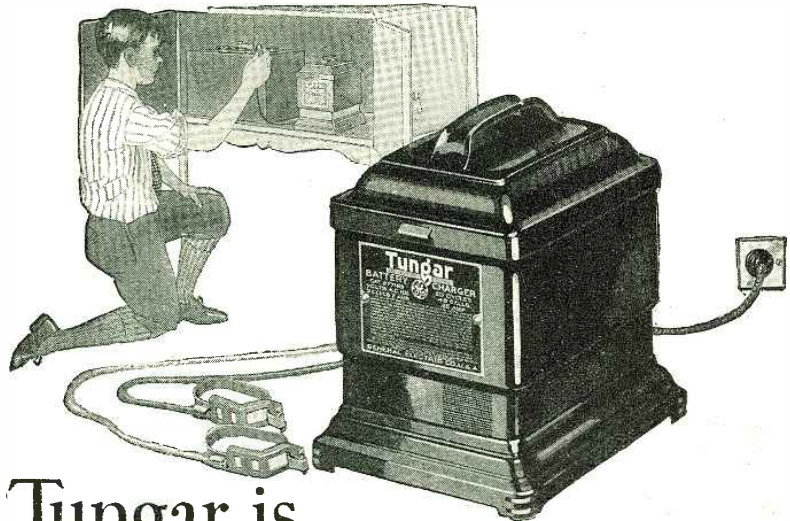

Tungar is the easy-to-use charger

Anyone can clip a Tungar to a battery and plug it in on the house current. That's all there is to it.

Attach a Tungar at night—and have snappy batteries in the morning. It will not blow out Radiotrons.

It needs little attention. Only a dime's worth of current consumed for a charge. No wonder "Tungar" is fast becoming the word for battery charger.



Tungar is the original bulb charger. It is a G-E product developed in the Research Laboratories of General Electric.

The new Tungar charges 2, 4 and 6 volt "A" batteries, 24 to 96 volt "B" batteries, in series; and auto batteries, too. No extra attachments needed.

East of Rockies
Two ampere size \$18.00
Five ampere size \$28.00
60 cycles . . . 110 volts

Merchandise Department
General Electric Company
Bridgeport, Connecticut

Tungar
REG. U.S. PAT. OFF.
BATTERY CHARGER

Tungar—a registered trademark—is found only on the genuine. Look for it on the name plate.

GENERAL ELECTRIC

Save Money on Your Raytheon-B-Eliminator



Complete Parts with RAYTHEON Tube and full Instructions
NOW ONLY \$28.95

Your opportunity to purchase at a great saving, complete set of parts and directions for building your own "B" Eliminator. Genuine Raytheon Tube, Thorndarson Chokes and Transformers. Only nationally advertised parts. Operates any number tubes, no hum. Money back guarantee. Save one half cost by building. Plug in any 110 V. A.C. socket and your "B" Battery troubles are over.

FREE Send immediately for Free Instructions and Particulars
MACK LABORATORIES

725 Cass Street Chicago, Ill.

Build the Radio Broadcast UNIVERSAL Four Tube Receiver

ENDORSED by Radio Engineers as the best of over 200 circuits tested. . . . Incorporates all the latest improvements in receiver design. . . . truly universal in wave-length range.

COMPLETE KIT of approved parts including drilled and engraved panel, baseboard, binding post strip, wire, etc. . . . \$46.50

WRITE for free booklet containing complete instructions and templates for building.

RADIO PARTS CO., LABS.
8 South Austin Boulevard Oak Park, Ill.

Insure your copy reaching you each month. Subscribe to Radio News—\$2.50 a year. Experimenter Publishing Co., 53 Park Place, N. Y. C.

RADIO NEWS
IN SPANISH

RADIO INTERNACIONAL

RADIO NEWS
IN SPANISH

ARGENTINA
BOLIVIA
BRAZIL
COLOMBIA
CUBA
ECUADOR
CHILE
VENEZUELA
GUATEMALA
SALVADOR
COSTA RICA

Radio's International Magazine
The largest Radio Magazine printed in Spanish

Circulates in 22 Spanish-Speaking Countries

1—RADIO INTERNACIONAL is RADIO NEWS in Spanish, carrying 96 pages monthly of the latest radio developments—the best articles from RADIO NEWS translated into Spanish and to fit foreign conditions.

2—As it is the best Spanish radio magazine, it is read and studied with eagerness alike by amateurs, broadcast listeners, and dealers throughout all Spanish countries.

3—140,000,000 is the population of these twenty-two countries—a larger audience than the United States.

4—They are now taking to radio with the same enthusiasm that marked the beginning of broadcasting in this country.

5—They are big and active buyers—mostly of American goods, because they are recognized as the best suited to Spanish American requirements.

6—When it is Summer in the United States—Mid-winter holds south at the Equator—it is their big Radio Season.

For General Information Write

Experimenter Pub. Co. Inc.,
53 Park Place, New York, N. Y.

MEXICO
HONDURAS
GUIANA
PORTUGAL
NICARAGUA
PORTO RICO
PARAGUAY
PHILIPPINES
PANAMA
SPAIN
URUGUAY

require only two very short connecting wires.

The audio transformer and the resistance-coupling units then follow in natural order around the back edge of the sub-panel. The last A.F. tube is in the left-hand corner, where it connects easily with the phone jack on the front panel. The positions of the amperites are plain. The binding posts are distributed along the extreme back edge.

WIRING DIRECTIONS

It is a good idea to drill and assemble the front panel and sub-panel as individual units, and to put them together after as much work as possible has been done on each. Much of the wiring on the sub-panel, for instance, can be done most easily with the front panel out of the way.

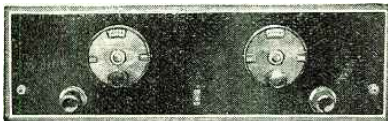

Panel view of this radio frequency receiver. Note the simplicity of controls.

The wiring diagram will be recognized by many as a more or less orthodox circuit, without fancy frills or unnecessary embellishments. It is highly stable and dependable, as the results obtained from it will conclusively demonstrate.

The filament wiring should be treated first. The 10-ohm rheostat, R1, controls the first two R.F. tubes; the 30-ohm one, R2, the detector alone. One 1/4-ampere ballast resistance R3 maintains the filament of the first audio bulb; a second (R4), that of the second audio bulb; while R5, which regulates the last tube alone, is 1/2-ampere size, because it is connected to a UX-112 tube, which draws that much current.

The primary of the first lennis coil, L1, goes straight to the aerial and ground posts; while its secondary is bridged by the single .00035-μf condenser. The primaries of the other two coils, L2 and L3, are wired to the plate circuits of the first and second tubes, respectively, and then to the 90-volt "B" post. The secondaries lead to the grids of the second and third bulbs—direct to the former and through the grid condenser to the latter.

The connections of the double condenser must be carefully watched. As the rotors (R) comprise one common set of plates, one wire is led from them to the plus side of the "A" circuit. The front set of fixed plates, S1, is then connected to the G post of the second socket; while the back set, S2, leads similarly to the grid condenser at the third receptacle.

The audio amplifier embodies the best features of two systems by employing a transformer for the first stage and resistance for the last two. The arrangement furnishes signals of great volume and impeccable clarity. Condensers C1 and C2 are the usual blocking capacities, while resistances R5, R6, and R7 are all 100,000 ohms, and L 500,000 ohms.

The first five tubes are standard UX-201-As, the last one a UX-112 power bulb. The latter is quite essential, as a regular 201A in this position is capable neither of remaining under-saturated nor of providing the proper plate circuit impedance characteristics to match a cone loud speaker. The battery requirements are the usual ones; 6-volt storage "A", and 135-volt "B."

OH, LADY, LADY!

Watts: "Why does he always speak of his wife as Old High Tension?"

Mike O. Henry: "Because she has a high frequency for charging everything."

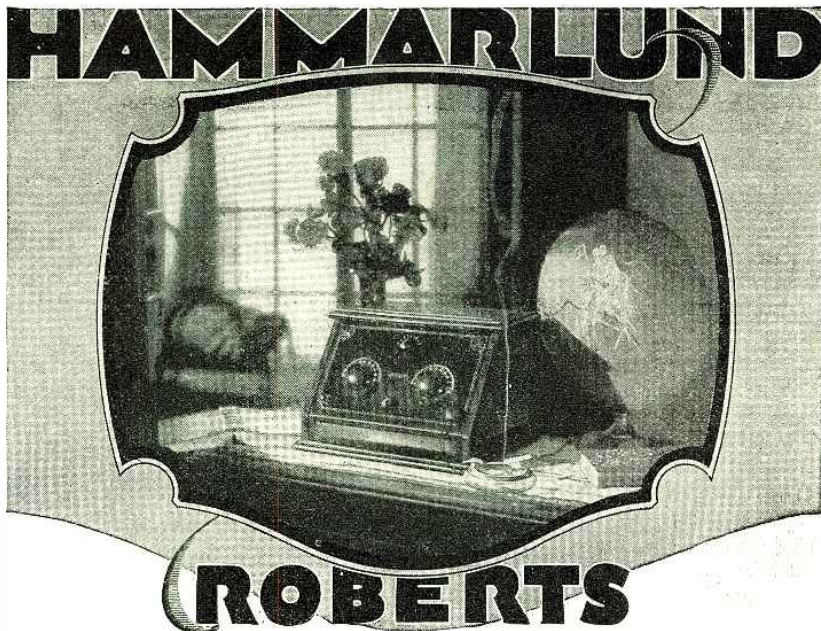

FOR a long time to come, there will not be evolved a more efficient circuit than that in the new Hammarlund-Roberts Receiver.

Ten leading radio engineers devised it as their composite ideal. The result is a receiver, operating on only five tubes, which possesses the sensitivity of a standard eight-tube receiver, plus a high degree of selectivity which minimizes interference.

Timing is simplicity itself. The volume and tone are exceptional, the receiver being designed to operate on the cone type of speaker.

And best of all, you can construct it yourself, from the finest parts known to radio, with results worthy of any professional builder.

The cost, \$60.80 (cabinet extra), is only about one-third of the price of a factory-built receiver of similar quality.

Your dealer sells the famous Hammarlund parts for this receiver and can supply you with all the other parts specified in the "How to Build" book, which will be mailed on receipt of 25 cents.

HAMMARLUND MFG. CO.

UNIT 2 — "Hammarlund, Jr." The Precision Midget Condenser.

UNIT 3 — The New Hammarlund Straight-Line Frequency Condenser.

UNIT 4 — The New Hammarlund Low-Loss, Space-Wound Coils.

For Better Radio PRODUCTS

424-438 W. 33 St., New York

FOUNDATION UNIT

The Foundation Unit contains all special parts needed to build the Hammarlund-Roberts Receiver, including drilled and engraved panels, brackets, wire, screws, etc \$7.90, at your dealers.

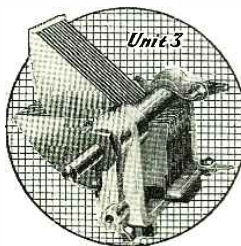

BUILD STYLE INTO YOUR RADIO!

Make your Radio a beautiful piece of furniture by building a handsome cabinet with a BOICE-CRANE JUNIOR BENCH SAW

Make money building for others. Easy to do the whole job on a Junior Bench Saw. Does ripping, mitering, grooving, rabbeting, sanding, grinding, and many other operations with ease and accuracy. Special blades cut Bakelite. Saves 2 1/2" stock. Table 10" x 12". Driven by 1/2 or 1/3 h.p. motor attached to light socket. Write for illustrated booklet on bench saws, hand saws, jig saws, lathes and jointers. All sold on money-back guarantee.

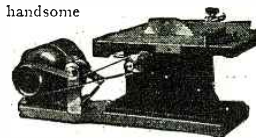

W. B. & J. E. BOICE Dept. 804-B, TOLEDO, OHIO

9 Circuits-1 Tuning Dial!

A Separate Circuit for each 40 Meter Wavelength Band. A single tuning dial, yet greater selectivity. Let our nearest dealer show you the great Kellogg.

KELLOGG WAVE MASTER

Or write for complete descriptive folder No. 1-D today. KELLOGG SWITCHBOARD & SUPPLY COMPANY 1041 W. Adams Street :: :: :: Chicago, Ill.

FREE RADIO GUIDE

NEWEST 1926 EDITION

Shows the latest circuits, the newest developments in radio at startlingly low prices. Get the parts you want here and save money. The best in parts, kits, sets and supplies. Orders filled same day received. Write for free copy NOW; also please send names of one or more radio fans. BARAWIK CO., 102-145 So Canal St., Chicago, U. S. A.

Insure your copy reaching you each month. Subscribe to Radio News—\$2.50 a year. Experimenter Publishing Co., 53 Park Place, N. Y. C.

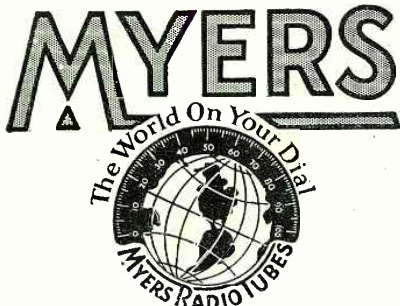

Seven Years of Superiority

KNOWN as the original HI-MU tubes before the days of BCL;

Preferred by amateurs and experts before the first popular receiving set was sold;

Progressively improved in construction and performance;

Made in the newest and best equipped plant in America.

Get the World on Your Dial With Myers Tubes

Low impedance, high amplification constant, high mutual conductance. Best results in any circuit—impedance, resistance or transformer coupled.

At Your Dealer's
Myers Radio Tube Corporation
Cleveland, Ohio

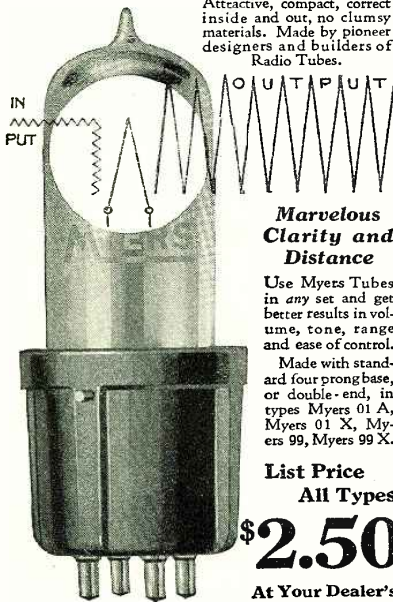

Attractive, compact, correct inside and out, no clumsy materials. Made by pioneer designers and builders of Radio Tubes.

Marvelous Clarity and Distance

Use Myers Tubes in any set and get better results in volume, tone, range and ease of control.

Made with standard four prong base, or double-end, in types Myers 01 A, Myers 01 X, Myers 99, Myers 99 X.

List Price All Types

\$2.50

At Your Dealer's

RADIO INVENTIONS

Protected by U. S. and Foreign Patents,
MASON, FENWICK & LAWRENCE
Patent and Trade Mark Lawyers,
Washington, D. C., New York, Chicago

Established Over Sixty Years

References: Life Savers, Inc., Port Chester, N. Y.; Stephen F. Whitman & Son, Philadelphia; Pacific Coast Biscuit Co., Seattle, Wash.; Loft, Inc., New York City; Siraque Warner & Co., Chicago; The Warren Co., Atlanta, Ga.; K. Baldwin Co., New Orleans, La.; Joseph Burnett Co., Boston.

Send Description and Sketch.

Insure your copy reaching you each month. Subscribe to RADIO NEWS—\$2.50 a year. Experimenter Publishing Co., 53 Park Pl., N.Y.C.

The Doughnut Five

(Continued from page 1434)

- 3 Vernier dials,
- 5 Tube sockets,
- 5 Amperites (1A),
- 1 Potentiometer 300- or 400-ohm,
- 1 Grid leak and mounting (2-megohm),
- 1 Grid condenser,
- 2 By-pass condensers, .0005- μ f.,
- 1 Battery switch,
- 7 Binding posts,
- 2 Phone tip jacks,
- 1 Panel, 7x24x3/16 inches,
- 1 Sub-panel 7x23x3/16 inches,
- 18 inches of brass strip, $\frac{1}{8}$ x $\frac{3}{8}$ inches,
- Bus bar, spaghetti, machine screws, etc.

The sub-panel is secured to the main panel by means of angles made from pieces of the brass strip $4\frac{1}{2}$ inches long, bent at a point 2 inches from one end. Two holes should be drilled in each side of the angle; if the coils shown in the accompanying illustrations are used, the holes in the 2-inch sides should correspond to those in the mounting foot of the toroid; and both may be secured to the main panel with the same two screws.

The sub-panel is situated two inches above the bottom of the cabinet. Two brass feet are fastened at the back corners, as shown in the rear view.

The audio frequency transformers are situated between the toroids. These may be secured to the main panel or to the sub-panel, depending upon the size and method of mounting provided by the make selected. Those used in the set illustrated are fastened to the sub-panel by the bolts and thumb-screws which may be seen in the top view.

The tube sockets are next mounted, spaced at equal distances from one another. The

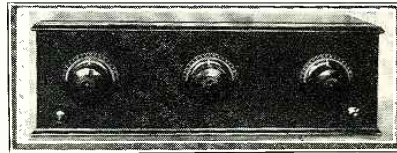

A view of the front of the Doughnut Five receiver. Notice there are three condenser dials to adjust, making the tuning of the set relatively simple.

grid and plate terminals should be at the rear. The five amperites are mounted directly in front of the sockets. The main panel bears nothing but the three condensers, the potentiometer, and the filament switch. The screws supporting the sub-panel may be located in such a manner that they will be hidden by the dials.

For the sake of neatness, and to minimize the chance of a short circuit due to some metal object accidentally getting into the set, it is best to locate all wiring under the sub-panel. As all of the parts are arranged in standard sequence, following the arrangement of the wiring diagram, the wiring itself is comparatively simple.

It is best to start by wiring the coils to the condensers, and then to the grid circuits of the radio frequency tubes, as the leads of this portion of the set should be made as short as possible, and should be spaced at a maximum distance from one another. Next wire the plate circuits of the radio frequency stages. The rest of the wiring may then be completed, without needing particular care to keep the leads separated. A careful inspection of the wiring diagram should be sufficient guide in arranging the wires.

OPERATION OF THE DOUGHNUT FIVE

This set is tuned in the same manner as any standard neutrodyne or tuned radio frequency set. If the first dial does not read

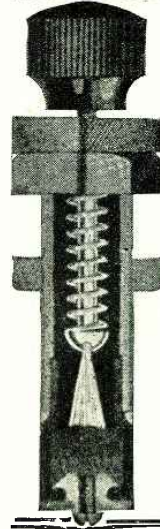

SEVENTY WHISKERS!

Don't let tube capacity stop you from crystal-detector clear reception.

Seventy "Whiskers"—silk core construction—spring tension and tinsel cushions insure perfect satisfaction.

Nothing like it. Won't burn out. Will last for years. Buy today from your dealer, or write us.

(Price \$2.00)

SCOTT SALES CO.,
International Distributors
439 S. San Pedro St.,
Los Angeles, Cal.
Manufactured by
G-S RADIO RESEARCH LAB.
LOS ANGELES, CAL.

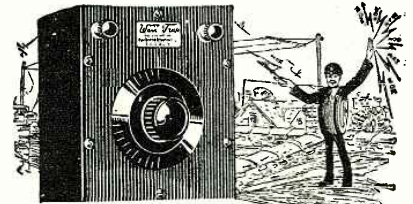

The Traffic Cop of the Air

Add a Ferbend Wave Trap to your Radio Set and "Police" your reception. Regulate traffic! Guaranteed to tune out interfering station. Widely imitated but never equalled. Not a "toy"—quality, material, workmanship equal to that of the finest receiving sets.

The original and only successful WAVE TRAP. Now in its fourth year. Sent postpaid upon receipt of \$8.50 or C.O.D. plus postage. Send for Free Booklet.

Ferbend Electric Co.
425 W. Superior St., Chicago
See the new Ferbend "B" Eliminator announcement on page 1507

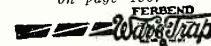

U. S. Post Office, Billings, Mont.

"Ferbend Electric Co. Gentlemen:

With my Fada Neutrodyne and Ferbend Wave Trap I received the address of Free City, Nebraska, on a special wave length. Many fans tried to get it but failed. Also the base-bulb World Series from W.O.A.W. and K.M.A. Sennott, Iowa. Had W.E.A.F. New York, loud enough to carry across the street. Will put my Set and Wave Trap up against any in the city regardless of price.

(Signed) J. A. Thompson, Supt. of Mails."

DON'T MISS THIS BOOK

RADIO WRINKLES

ON SALE MARCH 1st

A complete book full of helps, wrinkles, shortcuts to better reception. Hints on how to build good sets, how to get the most from them. 96 pages, 500 illustrations, large size 9 x 12 inches.

PRICE 50 CENTS

Sold Everywhere

If Your Dealer Cannot Supply You Write Direct to

THE CONSRAD CO., Inc.
64 Church St. New York, N.Y.

at approximately the same figure as the others, try a different antenna tap. Leave the set on the tap which brings the dials most nearly into synchronism.

The set may be found to oscillate at certain portions of the wave-length range. In this case the potentiometer should be varied to control the voltage on the grids of the radio frequency tubes. This potentiometer will be found to serve as a volume control as well.

If the set does not give satisfactory amplification in the first test, try reversing the terminals of the doughnut coil primaries.

The values given for by-pass condensers, grid condenser, and grid leak are arbitrary, and will vary with the tubes used. If the results obtained with the original assembly are not perfectly satisfactory, try other values for these.

The Ghirard VIII Super-Heterodyne

(Continued from page 1431)

probably be helpful here. The top lug nearest the front panel is connected to the stator terminal of the oscillator condenser. The connection to the middle lug goes through the tube panel to the plate terminal of the oscillator tube. The rear lug goes to the rotor of the condenser. The front lug, at the lower end of the coupler, goes to the A-bus wire; the rear lower lug to the 0.005- μ f. oscillator grid condenser.

After the parts have been assembled on the tube and front panels, do as much of the wiring on these panels as possible before finally fastening them together. Have the soldering iron hot enough to make the solder flow freely; and be sure to make the joints strong mechanically. The best mechanical design in any set is worthless if the connections are not properly made. Shape the wire carefully, so as to make a neat job. Wipe all the excess soldering paste from each joint with a clean cloth, after soldering.

The wiring diagram (page 1431) represents the connections of the set in the final form adopted. When the wiring is completed, check it over carefully at least twice for in a set of this type it is very easy to forget one or two connections.

TESTING AND OPERATING

When the set is ready for testing, set the oscillator coupler at full-coupling position. Set the midjet condenser at minimum capacity. Connect the "A" battery first. Insert the tubes and see that they light properly, when the filament switch is pulled half way out. (The phone plug must be inserted to light the last tube). Now connect the "C" battery (4½ volts). If everything seems all right, connect the "B" batteries to the set. Start with 90 volts on the A.F. amplifier; about 67½ volts on the intermediate frequency stages; and around 45 volts on the detectors. Connect the speaker or phones, being sure that a loud click is heard.

You are now ready to connect the loop. It must have a center tap, and should cover the broadcast range of wave-lengths when used with the 0.0005- μ f. condenser. The loop used by the author for testing consists of 13 turns of wire, spaced ¼ inch apart, and wound in a square pancake form with a mean side length of 15 inches. A center tap is provided. Connect the loop to the set. Reception for any station will be found at a maximum when the plane of the loop points in the direction of the station received.

Now turn the two detector tubes up about three-fourths of the way. Turn the oscillator and I.F. amplifier tubes up to about half of full brilliancy. The last A.F. tube may also be turned up about 75 per cent.

Amazing Success of Camfield DUODYNE! CIRCUIT
Built with Camfield Parts!

Never before has such widespread endorsement been given any new radio circuit in so short a time! From all parts of the country letters are pouring in telling of the wonderful results obtained with the new Camfield DUODYNE CIRCUIT,—a circuit which prevents oscillation.

Build It Yourself with Camfield Parts—Save \$5000

The following Camfield Parts are essential for use in building the Famous DUODYNE CIRCUIT:

- 1 Type 22K Camfield Duoformer Kit.....\$10.00
 (Containing Three Duodyne Transformers.)
- 3 Type 886 Camfield Straight Line Variable Condensers, each \$6.00
- 5 Type 11 Camfield Bull Dog Grip Sockets, each .65

Write Today for Your Copy of Complete FREE Descriptive Story

telling about the DUODYNE CIRCUIT and Camfield Parts—and how simply and easily you can build this set which is bringing such remarkable results everywhere! Send us the name of your radio dealer.

Dealers!

Write today for complete information about the DUODYNE CIRCUIT and Camfield Parts. Give us the name of your jobber.

CAMFIELD RADIO MANUFACTURING CO.
 329 HARRISON ST. OAKLAND, CALIFORNIA

LEARN THE CODE AT HOME WITH THE OMNIGRAPH

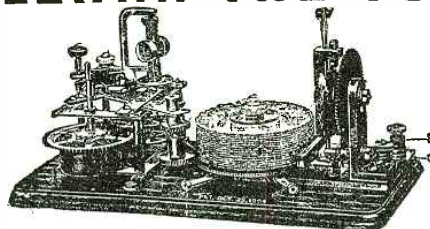

THE OMNIGRAPH Automatic Transmitter will teach you both the Wireless and Morse Codes—right in your own home—quickly, easily and inexpensively. Connected with Buzzer, Buzzer and Phone or to Sounder, it will send you unlimited messages, at any speed, from 5 to 50 words a minute.

THE OMNIGRAPH is not an experiment. For more than 15 years, it has been sold all over the world with a money back guarantee. The OMNIGRAPH is used by several Dep'ts. of the U.S. Gov't.—in fact, the Dept. of Commerce uses the OMNIGRAPH to test all applicants applying for a Radio license. The OMNIGRAPH has been successfully adopted by the leading Universities, Colleges and Radio Schools.

Send for FREE Catalog describing three models. DO IT TODAY.
THE OMNIGRAPH MFG. CO., 15 HUDSON STREET, NEW YORK CITY
 If you own a Radio Phone set and don't know the code—you are missing most of the fun

Insure your copy reaching you each month. Subscribe to Radio News—\$2.50 a year. Experimenter Publishing Co., 53 Park Place, N. Y. C.



\$2.75
C.O.D. **World**
Storage "B" Battery

12 Cells, 24 Volt units. Equipped with **Solid Rubber Case**, an insurance against acid and leakage. Extra heavy glass jars. Heavy rugged plates. Built with the same care and precision as the famous World Radio "A" Batteries.

Lasts Indefinitely-- Pays for Itself

Economy and performance unheard of before! Recharged at a negligible cost. Delivers unflinching power that is clear, pure and quiet. Tube plate (B) voltage is best served by storage battery power. It is, above all, constant, unvarying, dependable and efficient. Radio tubes are far too critical to subject them to power less efficient than that coming from a good storage "B" battery. Your set demands the best!

Tested and Approved by Leading Authorities

The following qualified institutions of merit have tested and approved World Storage "B" Batteries: Radio News Laboratories, Popular Science Institute of Standards, Popular Radio Laboratories, Radio Broadcast Laboratories, Radio Age Laboratories, Lefax, Inc., and others equally important. You can depend on a tried and proven article when you decide on a World Storage "B" Battery. Thousands in use. Order yours today!

SEND NO MONEY

Just state number of batteries wanted and we will ship day order is received. **Extra Offer:** 4 batteries in series (96 volts), \$10.50. Pay expressman after examining batteries. 5 percent discount for cash with order. Save 50 percent—get a tried and proven battery of merit, by mailing your order in NOW!

WORLD BATTERY COMPANY
1219 So. Wabash Ave., Dept. 75 Chicago, Ill.
Makers of the Famous World Radio "A" Storage Battery!
Prices: 6-volt, 100 Amp. \$11.25; 120 Amp. \$13.25; 140 Amp. \$14.00.
All equipped with Solid Rubber Case.

World STORAGE BATTERIES
RDKA • WFAF • WGN • WJLS • KHJ • KGO • KFAF • WJW • KOP
Set your Radio Dials at 210 meters for the new 1000 watt World Storage Battery Station, WSBG, Chicago. Watch for announcements.

Are Your Variable Condensers Dusty?



You will not get satisfactory results if you allow dust to collect between the plates of your variable condensers. You can thoroughly, quickly, safely and easily remove the dust in your set with the

LITTLE MARVEL RADIO BELLOWS

Special rubber tip prevents damage from contact. Frequent use of the LITTLE MARVEL keeps your set at its highest efficiency.

Sent Postpaid anywhere in U. S. upon receipt of \$1.50. Money refunded if not satisfactory.

J. C. CHRISTEN MFG. CO.
121 Dock St. - St. Louis, Mo.

TO JOBBERS AND DEALERS: WRITE FOR OUR PROPOSITION

Insure your copy reaching you each month. Subscribe to **RADIO NEWS**—\$2.50 a year. Experimenter Publishing Co., 53 Park Pl., N.Y.C.

Set the potentiometer at mid position. By turning this to the right you should hear a strong click as the I.F. tubes go into oscillation. Slowly rotate the oscillator dial; if whistles are heard, the oscillator is performing correctly. Turn the potentiometer to the left until a click is heard, showing that the I.F. amplifier has gone out of oscillation. Rotate the loop tuning condenser dial very slowly, one division at a time, and for each position rotate the oscillator dial over an arc of about 30 degrees in the vicinity of the setting of the first dial. It will be found that the two dial settings are very nearly alike for any station on both dials.

When a station is brought in, adjust the tubes to their best operating point and move the potentiometer to the right within a short distance of the oscillation point. The potentiometer and rheostat dials need be changed very rarely when once set. Now adjust the oscillator rotor to the minimum coupling position consistent with no decrease in signal strength. Increase regeneration by means of the midget condenser until the set is working just below oscillation. These two parts need never be touched when once set. However, if a new oscillator tube is used, the coupler setting may have to be varied somewhat.

Now vary the various "B" voltages until the best combination is found. The author has found that distant stations can be pulled in very easily if the second detector tube is turned down quite low, and the loop is rotated very slowly while tuning. A calibration curve for the two dials, using the loop specified, is given on page 1430.

The Experimenter's Own T. R. F. Set

(Continued from page 1426)

When under certain conditions this set is made to operate as a regenerator, the adjustment of the grid leak, S, will be found critical. In fact, under all conditions, this leak must be adjusted to suit the tube that is used as detector; but under regeneration conditions, the adjustment will be found most critical. Change the value of the grid leak until it is found that the set goes into oscillation with a soft hiss rather than with the usual bang. When the detector circuit is in this condition, the circuit can be brought closer to the point of oscillation and hence, the detector circuit will be at its most sensitive point without spilling over into oscillation just when this condition is not desired.

When you build this set, do not expect to get the best of results immediately. It may take hours of adjusting and experimental work before you hear good signals, but when you do finally get the set adjusted, we are quite sure that you will be more than pleased with its peculiar action. Operating this set will give you what might almost be called a course in radio, because of the various features that you will find prominent in connection with it.



"SPARK INTERFERENCE"

Eliminate Interference

WITH THE



Effarsee
ANTENNAE
REG. U. S. TRADE MARK
PATENT PENDING

SWEETENS RECEPTION INCREASES SELECTIVITY CUTS DOWN STATIC

80% of all reception troubles are due to faulty outdoor aerials. The improved EFFARSEE is a scientifically designed antenna that gives maximum signal power, still eliminates electrical and other interference. Gives sweeter, clearer reception, cuts down summer static, and enables you to separate stations that ordinarily interfere with one another.

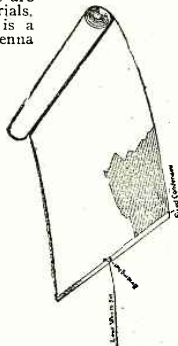

Can Be Used Anywhere—Indoors or Out!

The EFFARSEE consists of 100 strands of copper wire, insulated from one another and from moisture, covered with parchment and equipped with special fixed condensers. Can be used indoors or out, hung on walls, hidden under rugs, or rolled up in some corner. Eliminate the interferences that handicap reception—give your set a chance to do its best. Write for testimonials of enthusiastic users.

Type IXL (large) . . . \$4.00
Type BXL (small) . . . 2.50
At any radio dealer—or write direct.

FISHWICK RADIO CO.
131 CENTRAL PARKWAY, CINCINNATI, O.

WRITTEN 2-YEAR GUARANTEE

ARROW BATTERY

Battery Prices SMASHED!

To Consumers Only
Here is a real battery quality guaranteed to you at prices that will astound the entire battery-buying public. **Order Direct From Factory.** Put the Dealer's Profit in your own pocket. You actually save much more than half, and so that you can be convinced of true quality and performance, we give a **Written 2-Year Guarantee.** Here is your protection! No need to take a chance. Our battery is right—and the price is lowest ever made. Convince yourself. Read the prices!

Auto Batteries Radio Batteries
6 Volt, 11 Plate, \$8.50 6 Volt, 100 Amp. \$8.50
6 Volt, 13 Plate, \$10.25 6 Volt, 120 Amp. \$10.25
12 Volt, 7 Plate, \$11.75 6 Volt, 140 Amp. \$11.75

Buy Direct—Send No Money
We ask no deposit. Simply send name and address and style wanted. Battery will be shipped same day we receive your order. Express C.O.D. subject to your examination on arrival. Our guarantee accompanies each battery. We allow 5% discount for cash in full with order. You cannot lose! Send your order today—NOW!

ARROW BATTERY CO.
Dept. 6 1215 So. Wabash Ave., Chicago

RADIO TUBES

Repaired—Exchanged—Sold
Send broken or burned out tubes to us. We repair and return them good as new, \$1.00 each for common types. Or—we exchange one of your present tubes for another type, for your tube and \$1. Send for price list on special types that list for more than \$2.50. Send no money. We ship all tubes C. O. D.

We Operate Our Own Laboratory
You are assured perfect tube performance with our repairs because we operate our own tube laboratory. Don't take chances. Send your tubes to us—one of the oldest high frequency laboratories in the country.

CHICAGO ELECTRIC DEVICES CO.
70 E. 22nd Street, Dept. 34, Chicago, Ill.
Established—1920

Thirty Years in the Dark Room

(Continued from page 1421)

he dream of artificial daylight kept him from accepting. By this time wireless telegraphy had become practical in a sense and was recognized as a permanent addition to and advance in the field of communication. Moore was much interested in the work of Duddell, an Englishman, in superimposing a telephone circuit on a D.C. arc in a gas jet, because Moore himself had discovered a system for his light consisting of a low-voltage circuit superimposed upon a high-voltage one.

Contemplating wireless telegraphy and the current advances in this field caused Moore to revert at times to his earlier dream of seeing electrically, and he recorded details, very interesting today, of how it might be accomplished. Again, however, his backers refused to spend money on patents.

DEVELOPMENT OF THE MOORE LAMP

In experimenting with vacuum-tube lighting it was necessary to make literally thousands of models of all shapes and sizes. In consequence there was much popular confusion about what the "Moore Light" really was. Some referred to it as the largest single lamp ever made, 250 feet in length, and others as the smallest. Fig. 1 shows or describes only thirty-eight of these models, in various stages of development. Some of these are drawn schematically, and do not indicate the dimensions of the lamps to which they refer. Some which might appear to be a foot or two in length, from the drawing, actually were a hundred times as long.

Moore was the first to utilize the hitherto-neglected, as worthless, negative-glow of the Geissler tube, develop it into a light source, and place it in an ordinary incandescent-lamp bulb. Some of the lamps developed before 1895 were supplied with a large plate electrode and a small wire one. Moore noticed that these caused rectification of the alternating current supplied, but as he was interested in light, not rectification, he did not attempt to put this feature to practical use. It is remarkable, however, that he thus anticipated not only the Fleming valve, but the modern filamentless rectifier tubes as well.

The vacuum vibrator method of supplying peak potentials to the carbon dioxide gas in the tubes was simpler and more effective than either the induction coil or the transformer methods, when alternating current was the source. But Moore discovered that when A.C. was used in a tube with two-plate electrodes both became luminous, an obvious advantage. He soon set about the task of making a tube to run directly from alternating current.

From the point of view of the radio public, it is interesting to find in Moore's notes the statement that current flows more freely from hot electrodes, and that these are quickest to disintegrate. He had discovered the features of electron flow in vacuum tubes, now utilized in radio.

Moore made use of the fact, that hot electrodes in his tube would disintegrate, to produce intense pure white light for a few seconds or minutes. The record-breaking photograph of Chauncey Depew, which appeared in the March issue of RADIO NEWS, was made in 1898 by the use of a tube with small platinum electrodes which vaporized in the process.

In 1904 a carbon filament was combined with a large cup-electrode (see Fig. 1, No. 17). This circuit became one of more than one hundred patents issued to Moore, and is the foundation upon which all present day radio tubes, rectifiers, and low voltage X-ray tubes are based.

Previous to 1905 it had been commonly

Bigger Radio Bargains Than Ever Before

New 1926 Radio Guide Free A Message for Radio News Readers

SOMETHING new has happened in the radio world. Readers of RADIO NEWS, Popular Radio, Radio Broadcast and other radio magazines know now that the revolution that has taken place in radio is a silent one, but nevertheless a decided one. The changes as represented by the new circuits, are really radical, despite the fact that they have not been heralded from the housetops. Hook-ups that represent the last word in long range, selectivity and tone clarity can now be built by anyone, so simple are these newer ideas. One dial control, one condenser, one changeable coil, with from four to six tubes, the most simple hook-ups imaginable, will give you radio reception such as you have only dreamed of but never heretofore realized

The New 1926 Barawik Radio Guide (just out) will give you valuable and authentic information on the new developments. It will put before you radio's newest ideas and permit you to experiment and build the circuits that are now "the thing". To keep up with radio's newest ideas, you will need this new Barawik Radio Guide.

RADIO'S NEWEST IDEAS

A free copy of this remarkable book is yours for the asking.

Not only are these newer ideas explained and illustrated, but you are given the opportunity of securing these standard guaranteed supplies at tremendous price reductions, at prices that represent huge savings to you in the construction, up-keep and perfection of your own radio set and those that you will build.

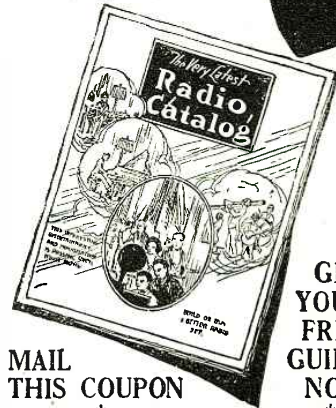

GET YOUR FREE GUIDE NOW

MAIL THIS COUPON

Fill in the Coupon Now for Your Free Copy

All that we ask is that you write us a letter or postal, or better yet, fill in the handy coupon at right with your name and address and, if possible, the name and address of one or more radio fans who would be interested. Free copy will be sent you and your friends at once. Write today—NOW.

BARAWIK CO., 102-142A So. Canal St., Chicago
Send me my copy of your new Radio Catalog and Builder's Guide.

Name
Address
Friend
Address

The Barawik Co.

102-142A SO. CANAL ST., CHICAGO, ILL.

\$60. to \$100. Weekly Selling 40 to 550 Meter Set

Spare Time Profits—No Capital

Public wants this Amazing New Set. Coast-to-coast reception. Receives all waves, 40 to 550 meters. Shot sub-panel makes assembly quick and easy. We need distributors everywhere. Demonstration sells. No carry stock. Set sells at half store prices. \$60 to \$100 weekly easily made.

FIVE TUBE DEMONSTRATOR FREE with RADIO TRAINING
Our Special Plan trains you in Radio—gives you a Free Demonstrator Set and appoints you as distributor.

The entire cost is less than regular dealer's price for Set alone. Hundreds are making big money in spare time. Get started now while territory is still open. Write Today! Don't miss this opportunity to make a fortune in Radio. Get complete training and sales plan Free! **AMBU ENGINEERING INSTITUTE**
2632 Prairie Avenue Div. 25-D Chicago, Illinois

RICHARDSON RADIO RECEIVERS

"Bring long distance home"

Write for folder
RICHARDSON RADIO INC.
LONG ISLAND CITY NEW YORK

Yale GROUND HOG

The Perfect Groundhog
DOUBLES POWER AND DISTANCE
Marvelous newly-invented ground gives 100% improved reception. Doubles power and distance. Stops leakage. Reduces static. Stops jangling even in mid-summer. Results never before equalled.

THE PERFECT GROUND—Proven absolutely essential to clear, powerful distance reception. Draws and holds moisture indefinitely. Highly sensitive to radio energy. No wave resistance.

SEND NO MONEY—To introduce, we offer to those who act at once, regular \$5.00 size for only \$2.00. Send name today and pay \$2.00 plus 17c postage on delivery. Or send only \$2.00 with order and save postage. Satisfaction guaranteed.

FREE—Full description of Ground Hog and big money making agent's offer on request—write today.
Yale Specialty Supply Co.
1807 Grand Ave., Kansas City



Write for Booklet
AMSCO PRODUCTS Inc.
Broome and Lafayette Sts.
New York City

Two Great Radio Books In One

HOOKUPS

Plenty of new and practical hook-ups, illustrated and explained in a constructional and non-technical manner. For the radio set builder and amateur.

RADIO ENCYCLOPEDIA

Every issue contains an instalment of S. Gernsback's Radio Encyclopaedia. The first complete, authentic work of its kind. Valuable to everyone interested in radio.

CALL BOOK

This is a very valuable reference, a complete list of Broadcast stations, Canadian stations and foreign broadcast stations. The most complete list of its kind. Each list arranged for logging stations with dial setting record blanks.

RADIO LISTENERS INFORMATION

This section gives many hints and ideas on the care and operation of a receiving set, together with practical information on radio from the listener's point of view.

200 PAGES—300 ILLUSTRATIONS

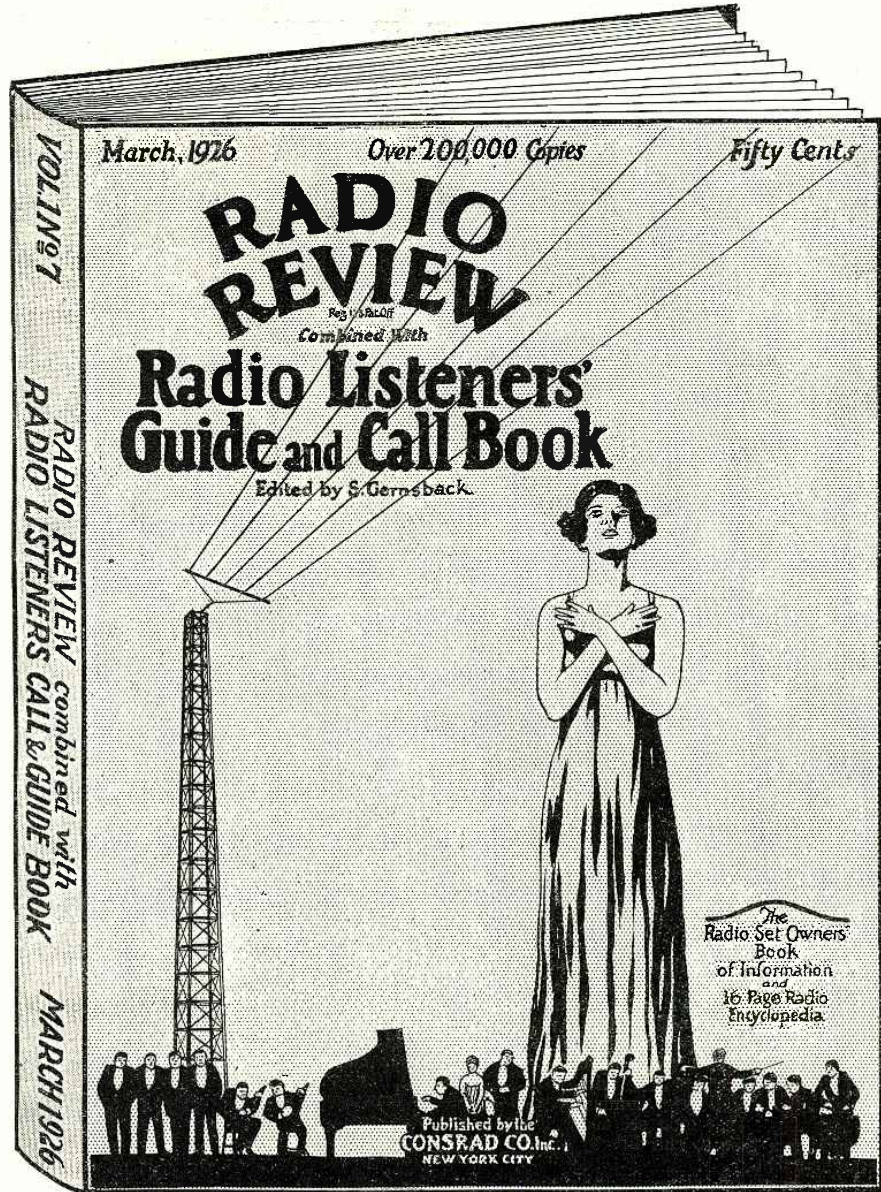

The Most Valuable Radio Book of its kind—for Beginners, Broadcast Listeners and Amateurs

SOLD ON ALL NEWSSTANDS

Now the RADIO LISTENERS' GUIDE and CALL BOOK is combined with RADIO REVIEW and will be issued four times a year in one great complete volume.

Each issue of this great new book contains a complete digest of practical radio hook-ups culled from radio press throughout the world, S. Gernsback's well known radio encyclopedia, in installments, an international radio press digest of news and information, a complete accurate list of Broadcast station call letters, and a valuable section replete with information for the Broadcast listener.

Published in the large Magazine size, contains 200 pages and more than 300 illustrations ALL FOR 50c the COPY. Watch for the first issue on all newsstands and all radio stores beginning February 1st. You will buy the biggest value in wealth of radio reference material ever printed for the radio broadcast listener, amateur or professional.

Published and Distributed by

The Consrad Co. Inc. 64 Church St. New York, N.Y.

50^c
PER
COPY

supposed that the ideal of cold light would be achieved by the use of some unique form of E.M.F. wave, caused by rapid current interruptions. After working with this idea for years, Moore was finally convinced that he was on the wrong track. He had produced by far the most practical means of obtaining rapid breaks with his vacuum vibrator, but the results were not satisfactory. So he determined to change his whole method, and try the effect of unaltered dynamic current. In six months he began to get positive results.

PROVING ITS PRACTICABILITY

The third dark room was the vault of the United States Patent Office, where he had to demonstrate his light before the examiners would grant him a patent. The fourth was one about 12 feet square, which became the first room in the world to be lighted to normal daylight brilliance with "artificial daylight." But lighting with dynamic currents demanded a much larger dark room, the fifth. It was 22 feet wide and 75 feet long. A large number of vacuum tubes, each 3/4 inches in diameter and 7 feet 7 inches long were distributed over its ceiling. This room was on the fourth floor of the Power building in Newark. The third floor was also lighted by these tubes, as were the halls and steps leading down to the first floor. It was the most elaborate display of vacuum-tube lighting the world had ever known.

Moore installed in the basement of this building a high-frequency alternator, shown in Fig. 2. This was the forerunner of the alternators which were to replace spark and arc in high-power trans-oceanic wireless telegraphy. The current from each pole passed through half a dozen large inductance coils, and then to the tubes distributed over the building. These were connected in parallel. Each had two external caps of metal at the ends, about a foot in length. It will be seen that they formed condensers; and that in combination with the inductances each tube constituted a resonant circuit which would have to be tuned for best results. No transformer was used, and the generator was designed for one million crests per minute. Thus it could have been used in radio to deliver a wave of about 36,000 meters. Indeed, Moore advised several prominent radio inventors, who called upon him at the laboratory for information about vacuum vibrators, to discard the idea as he had done, and take up the high-frequency alternator for radio work.

The necessity of keeping his work before the public caused Moore to exhibit at the Mechanic's Fair in Boston. Fig. 3 shows the model parlor and its lighting arrangement. Compared with the ornate fixtures that were the rule in ordinary carbon lamp lighting at the time, this room makes an unusually pleasing appearance.

By 1906 other inventors had learned of the occasional marvelous sensitivity of small vacuum tubes. Moore had repeatedly suggested the possibility of their use in wireless. One of the objections, most frequently raised against his suggestion, was the supposed necessity of keeping the gas at a constant critical pressure. Moore had struggled for a long time with the problem from his own point of view and interest, light. Finally he solved the difficulty for large tubes by means of the "auto-magnetic feed valve."

THE "BREATHING TUBE"

Fig. 4 shows the mechanism of the valve, which is designed to keep the pressure in tubes, some hundreds of feet in length, constant within one one-hundred-thousandth of an atmosphere! It consists of a block of carbon welded into the wall of the tube, and porous enough to admit gas slowly. Normally this is covered by mercury and admits no gas, but when the current flowing through the tube changes from the normal value, indicating a change in gas pressure,

Within Reach of All

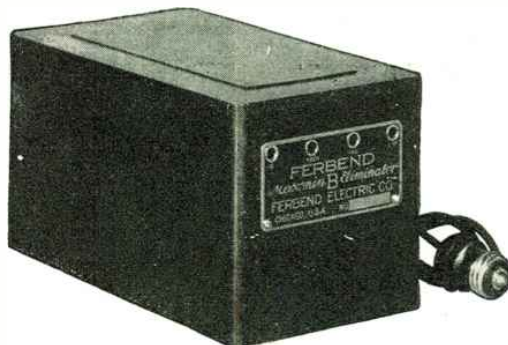

Unconditionally Guaranteed to be equal or superior to any Eliminator on the market, regardless of price.

\$12.50

Complete, nothing else to buy. Supplied in two models, one for Direct and the other for Alternating Current.
A. C. Model, price \$12.50
D. C. Model, price \$ 9.75

FERBEND "B" ELIMINATOR

Superior Results!

FERBEND Wave Trap
This company also manufactures the famous Ferbend WAVE TRAP—the instrument which has been widely imitated but never equalled. It is the only original and genuine.

Now you can get permanent and efficient "B" current supply direct from your electric light socket at a price scarcely higher than new "B" batteries. Ferbend has succeeded in combining results with first-cost economy, for your benefit. Equip your set NOW with this wonderful new instrument and be convinced.

Ask Your Dealer or Send Direct

If you prefer, we will make shipment direct to you upon receipt of price, or C.O.D. if desired. Remember, *superior results are guaranteed or your money back.* USE THE COUPON NOW!

FERBEND ELECTRIC CO.
425 W. Superior St., Chicago, Ill.

Ferbend Maxmin "B" Eliminator

Operates at a maximum efficiency at all times. Noiseless—no hum. Taps at 22½—45—90 volts.

Maximum voltage, 100. (for 135 volts, simply add a 45 volt "B" battery.)

A. C. model gives *Full Wave Rectification*. Cost of operation less than 50c a year. Lasts indefinitely.

All parts are specially designed and manufactured by us for this purpose only.

Unconditionally Guaranteed to be equal or superior to any Eliminator on the market, regardless of price.

Ferbend Electric Co.
425 W. Superior St., Chicago

- Send at once. Payment enclosed.
- Send C. O. D. Send Literature.
- Send A. C. Model. Send D. C. Model.

Name.....
Address.....
City.....
State.....

FAHNESTOCK CLIPS



"Popular Wherever Radio Is Used."
FAHNESTOCK Connectors are used by nearly every manufacturer of standard radios and manufacturers of high grade "A" and "B" Batteries. FAHNESTOCK makes connectors for every radio purpose.

"THE IDEAL CONNECTOR"
Catalog sent upon request
FAHNESTOCK ELECTRIC COMPANY
Long Island City, New York

"They Satisfy"

Loud pleasing tone.
Handsome material.
Distinctive design.

Horns \$22.50 to \$30.00
Units \$10.00 to \$12.00

Manufacturers



American Electric Co.
State & 64th Sts. - Chicago

Insure your copy reaching you each month. Subscribe to Radio News—
\$2.50 a year. Experimenter Publishing Co., 53 Park Place, N. Y. C.

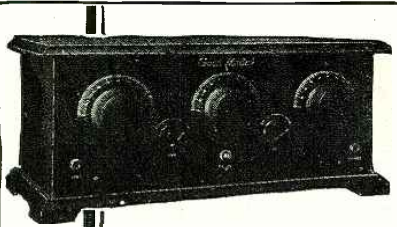

In
7 x 18"
Beautiful
Wooden
Cabinet

**It's
a
5-Tube
GOLD MEDAL
TUNED
RADIO FREQUENCY
RECEIVER**

Was \$60

NOW \$25

without accessories

Satisfaction Guaranteed

Delivered free anywhere
in the United States

Agents, Dealers, Distributors
Wanted

GOLD MEDAL RADIO
1032 Longwood Avenue
New York City



**6-Volt
Storage
Radio "A"
Battery**

Most amazing battery value
ever offered! A genuine World
6-Volt Radio "A" Battery with
30 ampere capacity for only
\$5.00! Just the thing for Trickle
Charger. Famous World Quality
assured. Equipped with

\$5.00
C. O. D.
Send No
Money

Solid Rubber Case

an assurance against acid and leakage. Order Now. We
ship same day - by express C. O. D. subject to your examina-
tion on arrival. Extra Offer: 5% discount for cash in full
with order. ACT TODAY!

World WORLD BATTERY CO.
Dept. 110,
STORAGE BATTERIES 1219 S. Wabash Ave., Chicago
KDKA - WFAA - WGN - WJS - KHJ - KGO - KFAF - WJY - KOP

FREE RADIO GUIDE

NEWEST 1926 EDITION

Shows the latest circuits, the newest develop-
ments in radio at startlingly low prices. Get
the parts you want here and save money.
The best in parts, kits, sets and supplies.
Orders filled same day received. Write
for free copy NOW; also please send names of one or more
radio fans.
BARAWIK CO., 102-145 So Canal St., Chicago, U. S. A.

the electro-magnet is energized, lowering the surface of the mercury and causing the carbon block to be exposed for a few moments until enough gas is absorbed to bring the pressure back to normal. This process continues at definite intervals, of about a minute for the average tube, and caused some wag to call it "the breathing tube." The title is an apt one, as the tube breathes in a manner quite comparable to that of animals.

Moore installed such a tube in the lobby of Madison Square Garden, where it remained for many years. While conversing with Stanford White under its brilliance. Moore recalled the wisp of light which both had witnessed about twelve years before, in the first demonstration in the vault of the Edison company. An insignificant beginning, by faith, had grown into a notable scientific and economic achievement.

The next day an interview between the two men resulted in Moore's making, and presenting to de Forest as a matter of professional courtesy, several tubes for radio use, controlled by a similar vacuum feed, or "breathing" device: de Forest was still working at the time with his famous "inverted tomato can" over a gas flame. He soon found that the vacuum regulator was unnecessary in his work.

The great tube which Moore had installed in the Garden was 186 feet in length, and gave a brilliant white light much more powerful than the old carbon lamps. Yet the monthly current bill was only one-fifth what it had been. It was the most triumphant demonstration to date of the value of the unique lighting system.

Just before Moore addressed the National Electric Light Association in 1896, he had discovered that impurities in the alcohol used to rinse out the tubes had been the cause of the light in his early models. This had led to years of research and experimentation in chemistry to find suitable materials to increase the light. Many solids and gases were tried, but in the end ordinary air was found to be the most practical gas combination for use in the large tubes; and this alone was used in the one in Madison Square Garden.

THE LONG TUBE COMMERCIALIZED

This tube marked the entry of a practical commercial model. All vibrators had been eliminated. The tube was operated direct from a high potential transformer housed in a steel box. Both of the terminal electrodes of the large tube were concealed within the box, so that no possible danger could result from accidentally touching the tube. The instant it was broken the current would cease, so the installation was practical and fool-proof in every way.

Soon the long-tube installations became commonplace. One could ride on a Broadway car from the Battery to Central Park in the evening, and have at least one long tube in sight all the way. The combined length of these installations would have provided a tube four miles in length, giving brilliant white light at a fraction of the cost of unsatisfactory yellow light from the old carbon filament lamps.

Some amusing incidents are part of the history of long-tube installations. During a circus in the Garden, for example, a giraffe was greatly entranced by the sight of the tube, thought it good to eat, and proceeded to take a bite. The resulting explosion was startling, and caused confusion among the animals, and the circus-goers as well. An under-water tube in the million-dollar pier aquarium at Atlantic City cast a similar spell over an unwary shark, who also took a bite, with about the same results.

When such tubes were filled with carbon dioxide and placed on the ceilings of the color-matching rooms of the great textile plants of the country, they emancipated own-

PATENTS

To the Man with an Idea
I offer a comprehensive, experienced, efficient service for his prompt, legal protection and the development of his proposition. Sends sketch, or model and description, for advice as to cost, search through prior United States patents, etc. Preliminary advice gladly furnished without charge. My experience and familiarity with various arts frequently enable me to accurately advise clients as to probable patentability before they go to any expense. Booklet of valuable information and form for properly disclosing your idea free on request. Write today.

RICHARD B. OWEN
PATENT LAWYER
2 Owen Building, Washington, D. C.
41A Park Row, New York City

**SEND FOR YOUR FREE COPY
TESTED HOOK-UPS**



Submitted By Users of Our

Wonderful transmitter Button for loud speakers. Amplification and experiments.

Price \$1.00 Postpaid with Instructions

K. Electric Co., 15 Park Row, New York

PATENTS

C. L. PARKER
Formerly Member
Examining Corps,
U. S. Patent Office.
PATENT - LAWYER
McGill Bldg., Wash., D. C.

Patents, Trade Marks, Copyrights, Patent Litigation
Handbook for Inventors, "Protecting, Exploiting
and Selling Inventions," sent upon request.

**Learn
ELECTRICITY**
in Great Shops of
COYNE

All practical, personal training. No books or useless theory. You don't need education or experience. Earn while you learn. Electrical Experts Earn \$60 to \$200 a Week. Complete course in 3 months. Send for Big FREE BOOK of 151 electrical photos. Ask about 2 Big Special FREE Courses.
Dept. 5944 COYNE ELECTRICAL SCHOOL
1300-10 W. Harrison Street, Chicago

Ask for Special Free R. R. Fare Offer - NOW

AMAZING STORIES

AMAZING

The New Magazine
of Novels and Stories
with a Scientific
Touch

See Full Page
Ad This Issue

ers forever from the tyranny of night and of dark days. The world at last had a standard of color values, and the Moore tube has reigned supreme ever since for this purpose. The creation of this lamp gave Moore much satisfaction, for he remembered an early day in the Edison plant, years before, when he had confided to the great inventor his dream of producing, some day, a light that would be equivalent of daylight. "What's the matter with my light?" Edison asked. "It's too small, too red, and too hot," Moore replied impulsively. Now his criticism was justified and his dream had come true.

Fig. 5 shows one of the earliest color-matching installations, in the plant of the Weidmann Silk Company, at Paterson, N. J. In the illustration Mr. Weidmann, the eccentric millionaire, is shown wearing the wooden shoes which he persisted in affecting during his whole lifetime.

SUCCESS ATTAINED

Much of Moore's success was due to leadership. He was able to hold the admiration of his employes, and many of them remained with him for years, later achieving their own reputations as scientists. To Messrs. Warner and Porter, Moore gives special praise and commendation.

The Madison Square Garden installation started a period of financial success and expansion which continued for some time. Offices were opened in New York City, and were visited by the foremost engineers and many public figures of the day. Edison, Westinghouse, Colonel Harvey, and Joseph Leiter were among the visitors. Moore was so pressed with invitations to speak at various gatherings that he had to decline most of them. He published several epochal scientific papers; and after addressing the Franklin Institute in Philadelphia was awarded the John Scott Medal.

Moore soon extended his early idea of electric writing to electric script, using his long, narrow tubes. Broadway was soon flanked with a double line of signs, such as that shown in the accompanying illustration of the front of the World building.

The success of the American installations caused the formation of many foreign companies for the development of the Moore light, and created an international demand for "glass plumbers." Over a dozen were sent abroad to educate the foreign workers.

Thus was reached the height of development of this particular invention, Moore's first great ideal. It has since taken its place in the history of scientific development, and has been superseded by the smaller and handier tungsten filament lamp for everyday use. It is still invaluable as a source of pure white light; and is widely used in plants where color is an important factor in manufacturing. Furthermore it seems almost certain that in the future some form of the Moore lamp will again come forward, as the scientific search for cold light progresses. The present efficiency of tungsten lamps is still low in comparison with the ideal light and the luminosity of gases seems to offer a promising path for future experiment.

An article entitled "Controlling Power and Motion by Radio" appeared in the March issue of RADIO NEWS.

Due to an unfortunate error, an acknowledgment which should have been published in that issue was omitted. Much of the material in our article was based upon Mr. B. F. Meissner's book "Radiodynamics," the standard treatise on the subject.

The Editor regrets the omission and takes this opportunity to acknowledge the source from which many of the facts presented in our article were drawn.



**The Benjamin
A REAL
Straight-Line Frequency Condenser**

Logs evenly over the sweep of the dial in exact ratio with the broadcasting frequency steps. Eliminates bunching of stations and increases selectivity and sensitivity. No body capacity effects and no absorption losses. A beautiful instrument in unpolished silver plate, made with the precision of a watch, to last a lifetime.

Patents Pending

Patented
July 26, 1925
May 2, 1911



**Benjamin
Cle-Ra-Tone Sockets**

Stop tube noises by preventing the transmission of outside vibrations into microphonic disturbances. Four springs support the socket—"float" it above the base and absorb all shocks and jars. The new "Push" type Cle-Ra-Tone Sockets are for standard UX and WX tubes.



**Benjamin Tuned Radio
Frequency Transformers**

Improvement in tone, volume and selectivity. Low Resistance. Low Distributed Capacity. Space wound, air core; double green silk insulation—the nearest approach to an all-air dielectric construction. The highest type of inductance. Singly and in sets of three.



Sold through Radio Jobbers and Dealers Everywhere

Send for full information on these and other Benjamin Radio Products. Address our nearest office

Benjamin Electric Mfg. Co.

120-128 S. Sangamon Street, Chicago

247 West 17th Street, New York

448 Bryant Street, San Francisco

Manufactured in Canada by the Benjamin Electric Mfg. Co., of Canada, Ltd., Toronto, Ontario

LEARN RADIO

Become a big-pay man in the greatest industry of all time. Quickly, easily and right at home, you can fit yourself for highest salary positions, or you can cash in on your spare time. The call is urgent for mechanics, operators, designers, inspectors. Unlimited, fascinating opportunities on land or sea

I WILL TRAIN YOU AT HOME TO BE A RADIO EXPERT

Under my practical, easy to understand, instruction—you qualify in an amazingly short time. No previous experience is necessary. Every branch of radio becomes an open book to you. You learn how to design, construct, operate, repair, maintain and sell all forms of Radio apparatus. My methods are the latest and most modern in existence.

FREE Wonderful home construction tube receiving set of the latest design. **Write Today** "Radio Facts" **FREE**

A. G. Mohaupt, Radio Engineer, RADIO ASSOCIATION OF AMERICA, Dept. 5944 4513 Ravenswood Ave., Chicago

REJUVENATE reflex or crystal set with THIS DETECTOR trouble eliminator—ALWAYS LIVE



CRYSTAL DETEX DETECTOR \$1

"ROLL THE PERFECT" Unmounted Crystal on 368 GOLD catwhiskers—100% CONTACT \$1. COMPLETE with Crystal—Dealers or Direct. G. FITZPATRICK, 5560 Jackson Blvd., Chicago

FREE RADIO GUIDE

NEWEST 1926 EDITION

Shows the latest circuits, the newest developments in radio at startlingly low prices. Get the parts you want here and save money. The best in parts, kits, sets and supplies. Orders filled same day received. Write for free copy NOW; also please send names of one or more radio fans. BARAWIK CO., 102-145 So Canal St., Chicago, U. S. A.

Insure your copy reaching you each month. Subscribe to Radio News—\$2.50 a year
Experimenter Publishing Co., 53 Park Place, N. Y. C.

Step into the limelight!

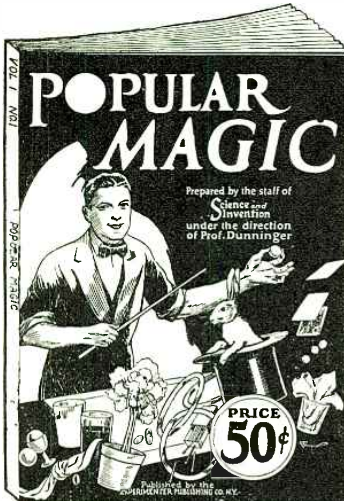

Surprise your friends with a Mastery of Mystery

Be the popular man in your circle of friends. You can entertain them and hold their attention with a thousand surprises and novelties.

POPULAR MAGIC contains thousands of simple, entertaining parlor tricks, as many puzzling magical stunts and a whole book full of mystic spirit novelties that you can entertain your friends with. A new set of tricks for every day of the year. Compiled from the great magazine "SCIENCE AND INVENTION."

GET THIS GREAT BOOK TODAY. Chock full of tricks, Novelties, Mystic performances, Master sleights-of-hand, Gags, Disappearing acts. All kinds of fun. Buy a copy or order direct.

PRICE 50c

Compiled by the Staff of
SCIENCE AND INVENTION
under the direction of

Prof. DUNNINGER

the man who mystified the Prince of Wales, Ex-Presidents Harding, Taft, Roosevelt, President Coolidge and other celebrities.

Large Size Book 9x12 inches. 112 Pages—Hundreds of Illustrations

Sold by All Newsdealers

Published and Distributed by
EXPERIMENTER PUBLISHING Co., Inc.

53 Park Place New York, N. Y.

Salesmen Wanted (Continued)

Wonder fluid charges batteries instantly. Chance to make fortune selling to garages and dealers. Gallon free to agents. F. & M. Sales Co. 2069 Eastern Ave., Cincinnati.

Scenery to Rent

Settings for Opera, Plays, Minstrels, Plush Dréps. Address: Amelia Graln, Philadelphia.

School of Electricity

Electricity—Short day or evening courses in Electricity, Drafting, Engineering, and Architecture. In Chicago earn while you learn. Part Time positions pay expenses. Faculty of experts. Special short courses. Diplomas in 2 years. B.S. Degree in 3 years. Small classes, individual instruction. 23 year old institution with thousands of successful graduates. Enter any time. Employment bureau. Moderate tuition—monthly payments. New College building—all athletics. All details in 72 page "Blue Book." A copy will be sent to you free. Write today. Chicago Technical College, Dept. 27, 113 E. 26th St., Chicago, Ill.

Song Poems

Song Writers—Successful Composer has proposition, Box 801, Dept. H, Cincinnati, Ohio.

Song Writers

Songwriters: Let me furnish the music for your songs, guaranteeing you absolute satisfaction. Copyrights secured. Submit your serinits for estimate and free advice. Walter W. Newcomer, 1674 Broadway, New York.

Song Poem Writers—For wonderful melodies to your songs, write, Francis Couover, (Composer), Avon, N. J.

Song Poems Wanted. Radio Publicity Bureau R, 21 Times Square Station, New York.

Stammering

Stop Stammering. All speech defects successfully corrected. Samuel Robbins, 399 Boylston St., Boston.

Telegraphy

Telegraphy—Both Morse and Wireless taught thoroughly. Big salaries. Wonderful opportunities. Expenses low; chance to earn part. School established fifty years. Catalog free. Lodge's Institute, Cour St., Valparaiso, Ind.

Wanted to Buy

Full Value Paid for Old Gold, Jewelry, Watches, Diamonds, crowns, bridges, dental gold, silver, platinum, gold or silver ore; magneto points, old false teeth. Packages returned if our offer is not satisfactory. United States Smelting Works (The Old Reliable) 39 So. State St., Dept. 16, Chicago, Ill.



GEM TUBE

A Guaranteed Radio Tube
Within Reach of All

Every tube guaranteed. A tube for a dollar of \$3 value. A trial order will convince you as it has thousands of others. Send your orders at once.

Orders sent C.O.D. parcel post.

Type.....401A	\$1.00
Type.....400	
Type.....499	
Type.....499A	1 EACH

(with standard base)
Dealers. Write for Discounts

GEM TUBE CO.

Dept. N. 200 B'way, N. Y. City
220 So. State St., Chicago, Ill.
Lafayette Bldg., Detroit, Mich.

Special Library of Information on RADIO PATENTS and TRADE MARKS

JOHN B. BRADY

Patent Lawyer

Ouray Building Washington, D. C.

Cable address: **RADIOPAT** Telephone: **Main 4806**

Just Out! Silver-Cockaday S-C Receiver

Described in March "Popular Radio"

Single Control—4 Tubes—Most Up-to-Date
of All Circuits. Completely Assembled
Harness Assures Easy Wiring.

The Specified Parts

2 S-M No. 316 .00035 Condensers @ \$5.75.....	\$11.50
2 " " No. 515 Coil Sockets @ \$1.00.....	2.00
1 " " No. 801 Vernier Dial.....	2.50
1 " " No. 110A Coil.....	2.50
1 " " No. 114A Coil.....	2.50
4 " " No. 510 Tube Sockets @ 50c.....	2.00
1 " " No. 340 Condenser—.00025.....	1.50
1 " " No. 540 Mounting Brackets (pr.).....	.70
1 Yaxley No. 16K 6 ohm Rheostat.....	1.35
1 " " No. 1 Jack.....	.50
1 " " No. 2 Jack.....	.60
1 " " No. 10 Switch.....	.50
1 Polymet .00015 Condenser with grid leak clips..	.45
1 " " .002 Condenser.....	.40
1 " " .005 Condenser.....	.60
1 " " 2 megohm leak.....	.25
2 Thoradars @ \$8.00.....	16.00
1 Centralab Resistance No. 25 M. S. R.....	2.00
1 Drilled and Engraved Front Panel.....	4.50
1 Drilled and Engraved Sub-panel.....	2.50
1 S-C Wiring Harness.....	4.00

TOTAL \$58.85

1 Screw Assortment.....\$ 15

Send for "The Key to The Silver-Cockaday Receiver." Price 25c postpaid.

WHOLESALE RETAIL



15 East 40th Street, New York City

Every Radio Fan should have this book

JUST OUT—514 PAGES



Compiled by
HARRY F. DART, E.E.
Formerly with the Western
Electric Co., and U. S. Army
Instructor of Radio.
Technically edited by
F. H. Doane

NO MORE need you turn from book to book, hoping to find what you want. It is all here, in 514 pages crammed full of every possible radio detail. Written in plain language, by engineers for laymen. 100,000 sold.

IT EXPLAINS: Electrical terms and circuits, antennas, batteries, generators and motors, electron (vacuum) tubes, many receiving hook-ups, radio and audio frequency amplification, broadcast and commercial transmitters and receivers, super-regeneration, codes, etc.

Send \$1 today and get this 514-page I. C. S. Radio Handbook—the biggest value in radio today.

International Correspondence Schools
Box 8283-G, Scranton, Penna.

I enclose One Dollar. Please send me—post-paid—the 514-page I. C. S. Radio Handbook. It is understood that if I am not entirely satisfied I may return this book within five days and you will refund my money.

Name.....

Address.....

Check here and enclose \$1.50 if you wish the edition bound in Leatheroid.

**64 Illustrated Pages
of Radio Bargains!
Write for Catalog Today**

RANDOLPH RADIO CORP.
159 N. UNION AV. Dept. 2 CHICAGO, ILL.

The Bradleyohm is used as standard equipment on the Acme B-Power Supply and most other B-Battery eliminators provided with voltage control. Silent voltage control is thereby assured.

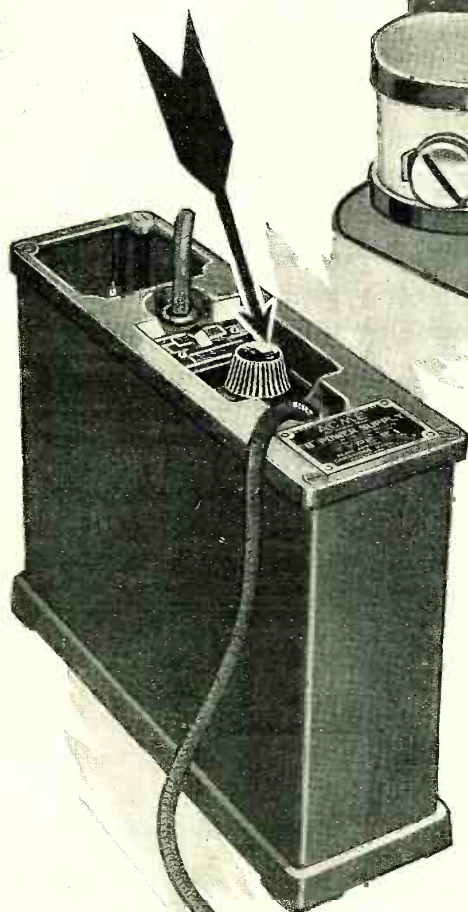

Insist on
Genuine Allen-Bradley Products
Sold in Checkered Cartons

How to Get Extra Voltage Taps from Your B-Eliminator

MANY radio receivers are provided with several B-battery terminals for detector, amplifier and radio frequency tubes. To provide the extra voltage taps from B-battery eliminators, such as the Acme B-Power Supply unit, is a simple matter. The diagram below shows the method of connecting the necessary Bradleyohms and condensers.

A Bradleyohm No. 10 for the 67-volt connection and a Bradleyohm No. 5 for the 90-volt connection provide marvelously smooth control over a wide range for these terminals. The condensers may be larger if desired, especially when used with audio-frequency taps. The standard Bradleyohm in the eliminator gives sufficient range for the detector plate voltage. Your dealer can supply you with Bradleyohms and condensers. Try these connections tonight and improve your receiving set.

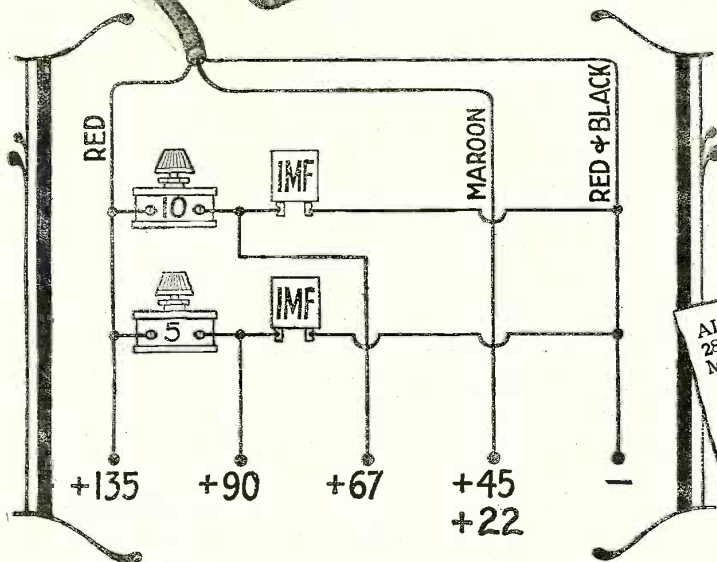

Mail the Coupon
for Literature

ALLEN-BRADLEY COMPANY
287 Greenfield Avenue
Milwaukee, Wisconsin

Please send me literature on Allen-Bradley radio products including the Bradleyohm.

Name

Address

your radio's best friend!



PUT a Magnatron into every socket of your radio set. Your set will know the difference — and you'll notice it, too, by the thrill that comes with truly lifelike radio reproduction. Clearer music, greater distance, longer life; all these Magnatrons will give you. Quickly you will agree that Magnatrons are the best friends your set could have.

The most modern laboratory methods and equipment, the finest materials and painstaking precision enter into the making of every Magnatron.

The DC-201A, the DC-199 (large or small base), the DC-120 (a dry cell power tube), and the Rex (for B eliminators) sell for only \$2.50. By the way, write the Connewey Electric Laboratories, Magnatron Building, Hoboken, N. J. for your free copy of "Pot Pourri—a snappy review of mirth and music".

New! The DC-112, a super-volume tube that delivers unusually great volume without distortion. Up to usual high Magnatron standards.

\$6.50

Complete factory stock for Pacific Coast carried at Pacific Radio Labs. 236 So. Los Angeles St., Los Angeles, Calif.



MAGNATRONS



\$35

RCA
Loudspeaker
MODEL
100

Get the boom of bass notes. Get the clear sweetness of high overtones. Give your set rare tone quality with this RCA Loudspeaker. It is particularly adapted to sets that use the new power Radiotrons.

Radio Corporation of America
New York Chicago San Francisco

RCA Loudspeaker

M A D E B Y T H E M A K E R S O F R A D I O L A S