

CIRCULATION LARGER THAN THAT OF ANY OTHER RADIO PUBLICATION

RADIO NEWS

REC. U.S. PAT. OFF

AUGUST
25 Cents

Over 200
Illustrations



Edited by HUGO GERNERACK

WHAT
CIRCUIT CAN
YOU DESIGN
FROM THESE PARTS?
\$300.00
IN PRIZES
SEE PAGE 106

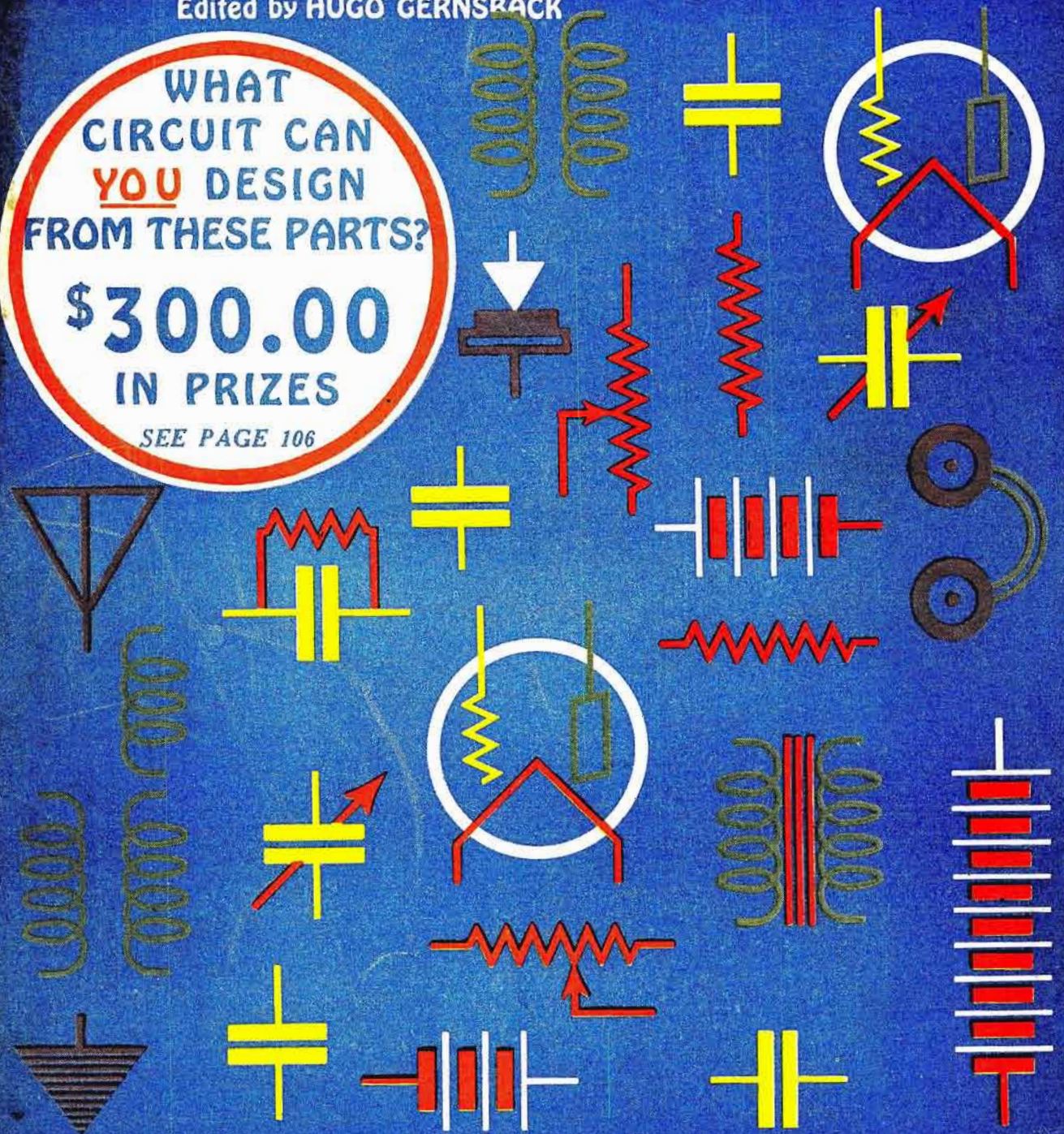

RADIO'S GREATEST MAGAZINE

EXPERIMENTER PUBLISHING COMPANY, NEW YORK, PUBLISHERS OF
SCIENCE and INVENTION RADIO REVIEW AMAZING STORIES RADIO INTERNACIONAL

Cunningham

RADIO TUBES

Since 1915—
Standard for all Sets

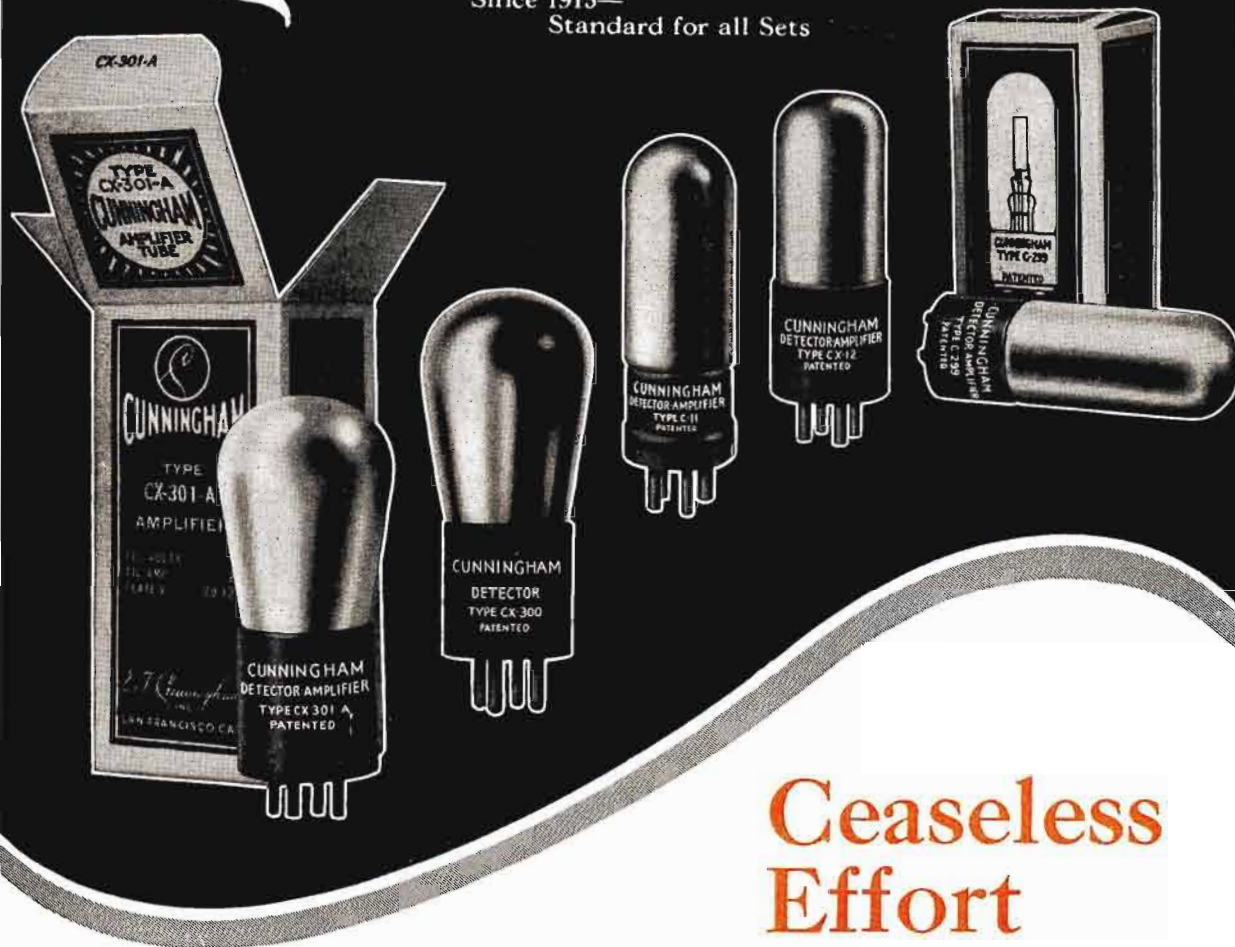

Ceaseless Effort

to improve the quality of radio reception has had one sure result. Today—thanks to this effort—Cunningham Radio Tubes have won a reputation and a confidence which are reflected in their popularity. "Since 1915—Standard for all Sets," is far more than a slogan; it is a clear statement of absolute fact.

All Types C-&CX---

In the Orange and Blue Carton

E. J. Cunningham Inc.

New York

Chicago

San Francisco

Manufactured and sold under rights, patents and inventions owned and/or controlled by Radio Corporation of America.

Novelties In Radio



LIFE ON THE OCEAN WAVE

is civilized by radio for the cadets on the New York State schoolship "Newport." This airy perch is the best place, so they say, on the ship for DX reception. © HERBERT PHOTOS.

A REALLY PORTABLE ANTENNA

The lady shown above is carrying, not an umbrella, but a new type in portable antennae, with its twelve metallic loops. It is said to be quite efficient for reception; and if the weather demands, a bit of cloth will make it a sunshade or an umbrella. © HERBERT PHOTOS.



HEARING THROUGH THE FINGERS

Helen Keller, deaf and blind since birth, is shown enjoying a radio program through the sense of touch, feeling with her marvellously delicate fingers the vibration of the horn. © HERBERT PHOTOS.



WHEN THE HURDY-GURDY PLAYS BY RADIO

The Radio Hurdy-Gurdy man of Berlin is evidently prospering, by the looks of his equipment. He also is using an umbrella-shaped antenna. The radio receiver is slung from his belt and the speaker is in his left hand. What next? © HERBERT PHOTOS.



UNDER THE STARS WITH A PORTABLE

These campers at Bear Mountain, above the Hudson River, are listening to a bedtime story—or something—over the radio, before they lie down in the open air to enjoy a cool night's sleep. They have the right idea. © Foto Topics.



Whatever may be the full explanation, each "alpha" or "beta" particle acts as a "trigger" to produce a discharge from the Leyden jar, which amounts to a minute momentary current. This is far too small to be detected by ordinary means, so it is run into a three-stage amplifier, with 10:1-ratio transformers. Of course, the distortion from this amplifier would be fearful for radio work, but for our purpose it was immaterial. This amplifies something like 70,000 times, making the total ratio of amplification 7,000,000,000,000 (seven thousand billion).

SEPARATING THE ATOMS

To get the electrons, uncontaminated with "alpha" particles, we placed a piece of non-radioactive nickel plate above the cell, and bombarded the under side of it with "alpha" particles from polonium. Whenever an "alpha" particle struck the nickel, several electrons were ejected into the cell. The electrons so ejected are known as "delta rays," being released from the nickel plate on the bombardment of the latter by the alpha particles.

To get the "gamma" rays uncontaminated, we put a shield of lead, one-eighth inch thick, between the radium and the cell to absorb all the other rays. It is surprising that "gamma" rays, which are electromagnetic waves similar to light waves, but of much shorter wave-length, should be detected as separate bursts of sound; until one remembers that each atomic explosion which gives rise to the "gamma" rays produces a train of these waves, and that what we hear are the individual trains.

As a source of "alpha" particles, although not entirely free from electrons and "gamma" rays, we used a thin deposit of polonium on lead. The numbers on a radiolite clock also served as an abundant source of "alpha" particles, also, however, not free from other rays.

DETECTOR OF RADIOACTIVE MATERIAL

With an Atomophone, ore can be instantly tested for radioactive constituents. A piece of ordinary rock held over the Atomophone produces no sounds. If, however, a piece of radioactive ore, such as carnotite or pitchblende, be held over the cell, the loud

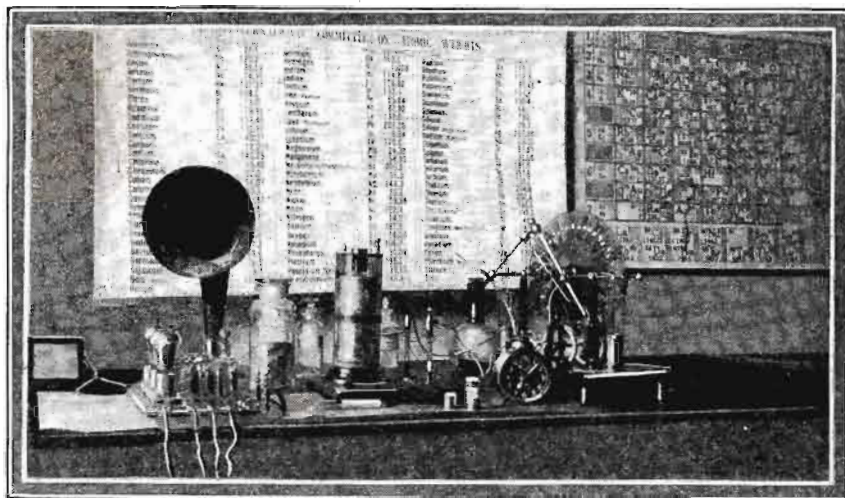

A photo of the complete atomophone. The amplifier can be seen in front of the loud speaker. The static machine is on the extreme right of the board and the Leyden jar in the center.

speaker belches forth a clatter in testimony of its radio-activity. Although an ordinary limestone rock does not give evidences of radio-activity when tested in this way, it can be made to show the minute quantity of radioactive gas, "radon," that is within it as well as all other rocks. If the same rock, which gave no evidence of radio-activity when held over the cell, be treated with acid and the carbon dioxide gas given off passed through potassium hydroxide solution (to absorb the greater part of the carbon dioxide) then it may be shown to be radioactive. Pass the gas into the cell, and the loud speaker tells whenever one of the atoms of radon has "exploded."

If a plate of nickel be hung over a radium solution and charged to a negative potential of about one hundred volts it will soon become quite radioactive, due to a deposit of "Radium C" on its surface. If a plate of aluminum, of such thickness as to absorb all the "alpha" particles given off by this "Radium C," be placed over the cell and the nickel plate laid on this, there will be quite regular outbursts from the loud speaker.

These are due to atoms of hydrogen with one positive charge, which are expelled from the aluminum with very high velocities. These charged hydrogen atoms, or "protons" as they are called, have energies forty per cent. greater than the energies of the alpha particles which produce them. This suggests that aluminum is a potentially radioactive substance, needing only some such agent as an "alpha" particle to detonate it and make it actually radioactive.

But the fact that, on the average, a million "alpha" particles have to be shot at aluminum before one hits just right to cause the disintegration of the aluminum atom, shows that the "forty percent. profit," after all, isn't profit.

The idea of making an atom or an electron, the tiniest thing in the universe, audible over great distances appealed strongly to our imagination, and led to the successful attempt to broadcast these experiments. Reports so far received indicate that an atom's audibility covered an area of more than a million square miles.

Radio In Serbia

By Z. KITTICH

WAY down home at Aleksinac I hooked up my own regenerative double circuit tuner and hung the aerial between the chimney and a willow tree. For some reason it didn't work. After two days investigating the trouble I tied the other end of the aerial to a plum tree and for some reason or other the set *did* work. Of course my folks were puzzled about everything concerning it, but the main feature of all this is the conclusion arrived at by my mother, who never saw an electric wire in her life, let alone a radio. Putting it in English, her explanation sounded something like this: "Son, it is because the plum tree bears fruit and the willow tree doesn't!"

In these parts government post offices are handling all postal, telegraph and telephone business. The fellow in my home town who brings the mail couldn't understand how I could listen to something that they, down at the post office, could not. He also expressed the belief that there were no underground wires between the post office and my home.

Obtaining a permit to possess a receiving set is a very complicated process here. I tried to secure a temporary permit from the authorities; but so many questions were raised and so many doubts expressed that I

found it more advisable to wait than run the risk of having my apparatus confiscated. Again, when you do buy a manufactured set you must assure the fellows in charge about the hook-up or, at their polite request, you have to trundle it to headquarters for inspection. One can easily understand the risk he is running as all the better and patented sets are usually sealed and breaking the seal results in the cancelling of the guarantee. At least two sets that I know of which were handed over to the officials of this department could not be repaired by them after inspection. In another case a set was tampered with in such a manner that it was impossible to get it working again.

My father was scared to death of my storage battery (I brought it with me from Washington, D. C., fully charged), after I had put it through some tricks, such as running a toy motor and producing sparks. As to the receiving set; after hesitating a while he tried on the ear phones, but suddenly took them off and begged me to throw the whole thing in the river; for, as he put it, no good could come from such a devilish contraption that nobody in the town had yet seen or heard.

The red tape, \$8 yearly government tax,

high duty and no literature on the subject in our language makes radio's entry into Jugoslavia very difficult. The Belgrade radio station cannot be heard outside of Belgrade, though it has an output of 2 kw. Where this power goes to I do not know, nor do I think those in the station know. Another thing about this station—and the worse for us who pay and do not hear it—is its 1,650-meter wave-length. The people cannot afford the price of the coil or coils to cover this high wave-length. For the cost of one you can buy half a dozen fine chickens or ten quarts of the best red wine. So, far as I know, nobody listens to our own station, yet it continues to broadcast for half an hour three days a week. No program bulletins are issued; those in the station broadcast what they please and evidently entirely for their own amusement. If you raise your voice against this foolishness you are met with that killing Balkanian "*Oh, laissez faire, laissez passer!*"

However, there is fine music all over Europe and one can fish for it to his heart's content with a single-tube regenerative set. The tubes must be American-made; or you

(Continued on page 177)

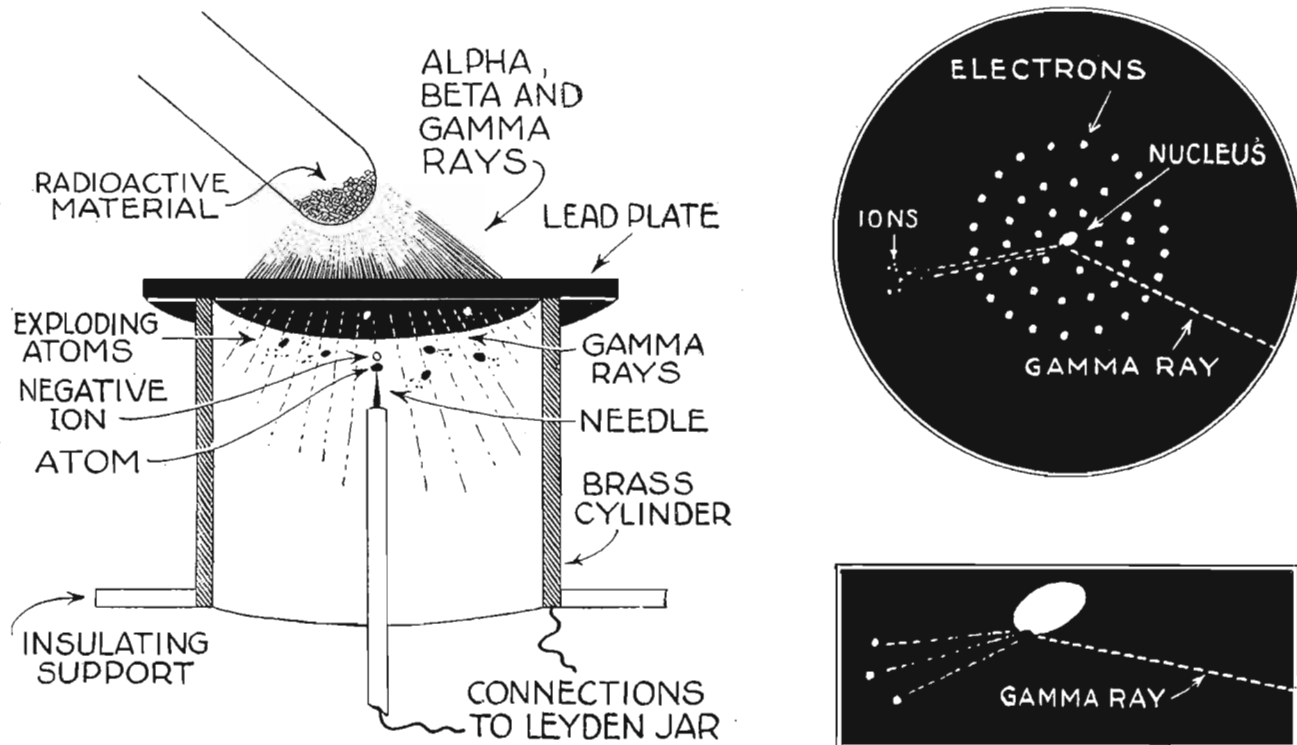

The above diagram serves to convey an idea as to what takes place in the Atomophone. The radioactive material emits "Alpha," "Beta" and "Gamma" rays. However, the lead plate over the top of the ionizing chamber allows only the "Gamma" rays to pass into the chamber. The high potential difference, existing between the needle and the chamber wall, ionizes the air. The "Gamma" rays bombard the atoms and break off a number of ions from the nuclei or "protons". The action is shown in the sketch at the upper right: here a "gamma" ray has knocked a number of ions off a nucleus. The surrounding electrons are not affected. The lower sketch is an enlarged view of the "proton" alone, which illustrates the "collision" more effectively.

Broadcasting the Sounds of Atoms

By H. P. CADY and JOHN STRONG*

ON the evening of May 20 last the "voice of the atom" was broadcast from station KFKU at the University of Kansas for the first time in the history of radio. The apparatus employed, which has been named the "Atomophone," is the joint development of a number of scientists.

The complete arrangement consists of an ordinary static machine, a Leyden jar, a special cell into which the atoms are shot, and a three-stage audio-frequency amplifier with loud speaker. The "atom cell" is a polished brass cylinder inside which is supported the point of an ordinary phonograph needle, as shown in the accompanying diagram. The Leyden jar is charged by the static machine, and serves as an accumulator to charge the needle, on which a negative charge of 4,000 volts is impressed by connecting it to the inside coating of the jar. The brass cylinder is insulated by a hard rubber support, and connected to the outside coating of the Leyden jar through the primary winding of the first audio-frequency transformer.

To operate the apparatus, the Leyden jar is connected to the static machine by closing the switch (SW) and charged until a brush discharge occurs at the needle point. The switch is then opened, thus disconnecting the static machine; and sufficient time given the charge on the jar to fall to a potential just insufficient to cause a discharge. If a piece of radioactive material, which gives off "alpha," "beta" or "gamma" rays, be held above the

cell, there will occur an immediate outburst of sound from the loud speaker.

SIZE AND SPEED OF ATOMS

The "alpha" particles are atoms of helium carrying a positive charge and traveling at a very high velocity, *ten to fourteen thousand miles per second*. The "beta" particles are "atoms" of electricity, or *electrons*, traveling at a still higher velocity.

The following may serve to give an idea of the minuteness of an atom: If a granule of sugar be divided into a *billion* parts and one of these parts again divided into a *billion* parts, one of these last will weigh as much as *twenty helium atoms*. The mass of an "atom" of electricity or electron is about *one seven-thousandth* of that of a helium atom. It is quite remarkable that one should get a distinct sound from the effects of such unimaginably minute particles. The sound caused by these atoms is similar to that of a bell that has been struck and quickly silenced. Their sequence is ir-

regular, but can be regulated (by the use of a lead screen with a small perforation) to resemble the sound of a pan of corn vigorously popping. Not all atoms may be heard in the Atomophone, but only those which "explode" or those which are thrown off by the radioactive "explosions."

AMPLIFIED SEVEN TRILLION TIMES

The theory explaining just what happens in the chamber, when an atom enters, is not as yet complete, but in part it is as follows: When the "alpha" or "beta" particles enter the chamber, they produce, from the millions of molecules in the air within the chamber, some *ions*. These ions, being in an intense electric field, instantly start to move with a very high velocity, high enough to produce new ions from the molecules of air with which they collide, and these in turn multiply themselves by the same process; and all this takes place in the thousandth part of a second. This theory is very satisfactory except for one thing: the amplification is ten- to one-hundred-million times, which is larger than can be calculated on the basis of the known facts. This indicates that some additional unknown factor is in operation.

(The charge of an electron is estimated by scientists at 10^{-19} x .159 coulombs; that is to say, one ampere of current requires the passage of no less than 6,280,000,000,000,000,000 electrons per second. It will be seen how much amplification is needed, of the charge of one electron, to produce audible signals.—EDITOR.)

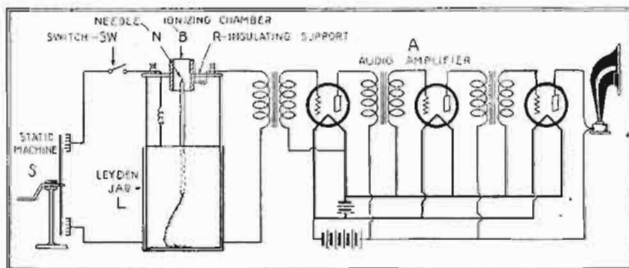

The circuit diagram of the Atomophone. The input of the three-stage A.F. amplifier connects to the ionizing chamber B and the outside coating of the Leyden jar L, which is charged by the static machine S.

*University of Kansas.

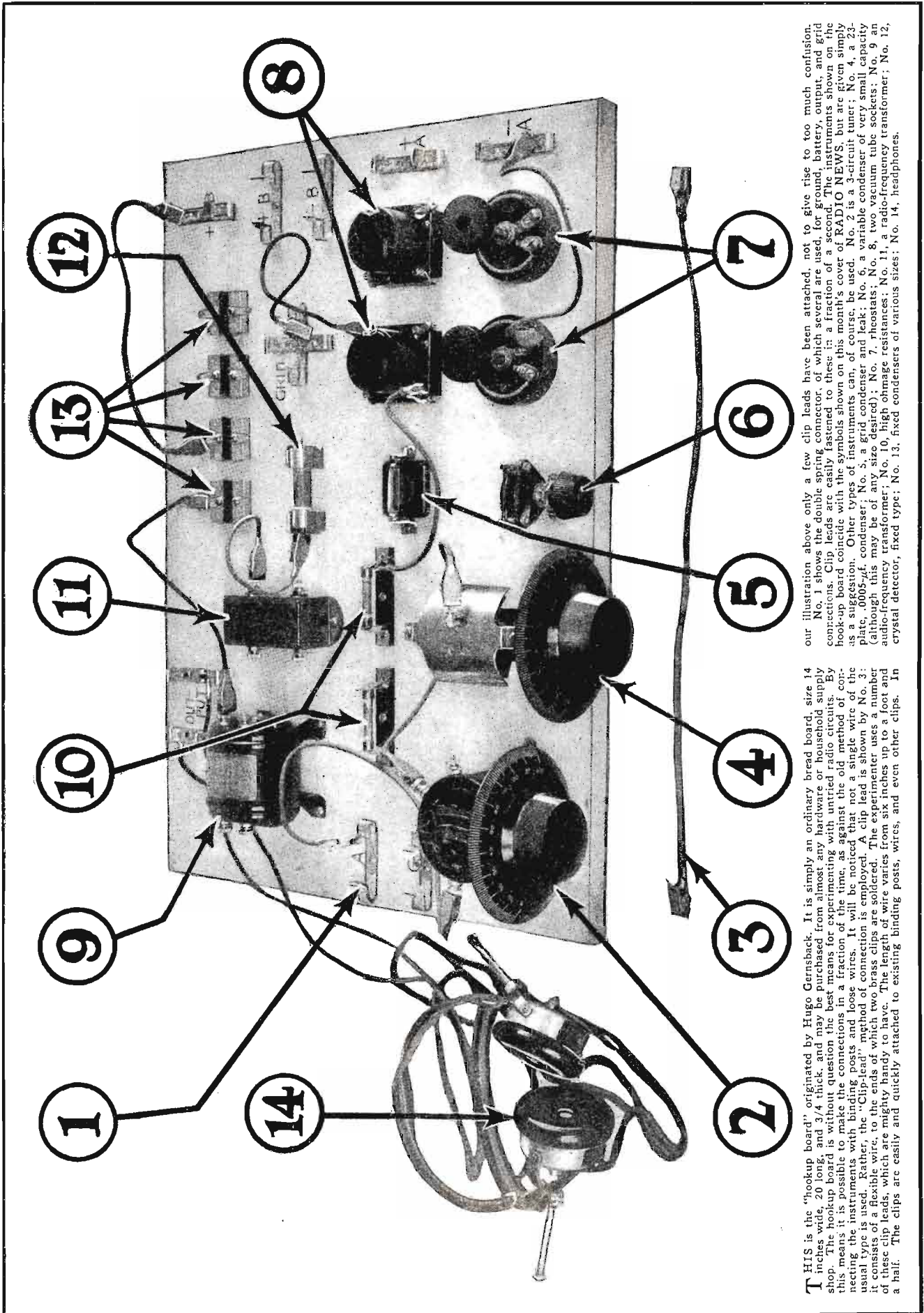

our illustration above only a few clip leads have been attached, not to give rise to too much confusion. No. 1 shows the double spring connector, of which several are used, for ground, battery, output, and grid connections. Clip leads are easily fastened to these in a fraction of a second. The instruments shown on the hook-up board coincide with the symbols shown on this month's cover of RADIO NEWS, but are given simply as a suggestion. Other types of instruments can, of course, be used. No. 2 is a 3-circuit tuner; No. 4, a 23-plate, .0005- μ f. condenser; No. 5, a grid condenser and leak; No. 6, a variable condenser of very small capacity (although this may be of any size desired); No. 7, picostats; No. 8, two vacuum tube sockets; No. 9 an audio-frequency transformer; No. 10, high ohmage resistances; No. 11, a radio-frequency transformer; No. 12, crystal detector, fixed type; No. 13, fixed condensers of various sizes; No. 14, headphones.

THIS is the "hookup board" originated by Hugo Gernsback. It is simply an ordinary bread board, size 14 inches wide, 20 long, and 3/4 thick, and may be purchased from almost any hardware or household supply shop. The hookup board is without question the best means for experimenting with untried radio circuits. By this means it is possible to make the connections in a fraction of the time, as against the old method of connecting the instruments with binding posts and loose wires. It will be noticed that not a single wire of the usual type is used. Rather, the "clip-lead" method of connection is employed. A clip lead is shown by No. 3: it consists of a flexible wire, to the ends of which two brass clips are soldered. The experimenter uses a number of these clip leads, which are mighty handy to have. The length of wire varies from six inches up to a foot and a half. The clips are easily and quickly attached to existing binding posts, wires, and even other clips. In

\$300 Prize Set Design Contest

What Circuit Can You Design from These Parts?

IN some quarters the impression seems to prevail that hook-ups and new circuits are doomed and that there is no further interest in them. We are confident, however, that RADIO NEWS, perhaps more accurately than any other agency, knows what is going on in radio circles; and that there is proof abundant that, rather than dying out, radio experimenting in this country is steadily forging ahead. The minute we let up on publishing hook-ups and constructional radio articles in RADIO NEWS, we are inundated with a storm of protesting letters. Every time we publish a new hook-up, literally thousands upon thousands of letters for more information and details come to our desks; and instead of a decline, it has become necessary for us to put additional people on our technical staff in order to cope with the situation.

It is true that no revolutionary circuits have come out during the last year or so, and there is a prevalent feeling that no new circuit will be developed soon. We ourselves do not share this view at all, and we assuredly do not believe that the last word has been said in hook-ups and new circuits. If you take a chessboard, you can make literally hundreds of trillions of combinations that seemingly are inexhaustible; There are thirty-two chessmen on the board; and if it is possible with these few pieces to make billions upon billions of combinations, it should be possible to get millions of various combinations with a few radio parts or components.

Of course this simile does not hold absolutely good, for the reason that you can not interchange radio components as you can interchange, for instance, the pawns on a chessboard; but, just the same, we all know that millions of combinations in radio circuits and hook-ups are possible.

WANTED, A BETTER COMBINATION

We believe that somewhere there are some experimenters who have hook-ups that are different, which perform better than others now known. It is our duty, and the duty of these experimenters, to make such circuits known to the world. Sometimes by slightly changing a part entirely new effects are created. For instance, when the Neutrodyne circuit came out a few years ago, no new components or parts were used. It was simply a new combination. A little later some one came along and did a similar thing by fastening a coil near the back plate of a condenser in order to introduce losses. Again no new apparatus, but entirely new and surprising results. Not so long ago the Editor of this publication stuck a crystal in the grid leak, which resulted in the Interflex principle. No new instruments here—simply a new adaptation of old ones. And so it goes.

This prize contest, then, is nothing but an incentive to busy experimenters to develop a circuit that has qualities not known before, if that is possible. We want something that is different, something that will set our fellow experimenters to work with new zest, and yes—we want an improvement. Exactly what we want is shown in the rules of the contest, which should be read carefully. *So do not jump to any conclusions of what is wanted, but carefully read the Rules of the Contest.*

WE WILL PAY FOR YOUR PATENT

Now it may seem to you that a first prize, even for \$100.00, would be a small recompense for hitting upon a really excellent circuit. That is certainly true, but in no case does RADIO NEWS, by awarding a prize, acquire the rights to the circuit. Quite the contrary. It should be known to would-be inventors that the publication of any circuit in RADIO NEWS is the best possible patent reference that can be had. If the circuit and description is published in RADIO NEWS, the inventor has two years in which to file a patent application, and thus he gets the best protection that he could possibly get.

Furthermore, as an added incentive to the inventor, always providing the circuit is patentable, RADIO NEWS hereby agrees to take out a patent in the inven-

tor's name, paying the entire patent fees; and the patent, if issued by the U. S. Patent Office, will belong, of course, to the inventor in whose name it will be taken out.

These clip leads are about a foot long, having spring clips at each end, which can be clipped to any binding post or wire; so that connections can thus be made more quickly than by any other method. (Upon receipt of a stamped, self-addressed envelope, the Editors will be glad to send the addresses of a number of manufacturers who supply clips and spring binding posts of the type used on the hook-up board.)

A complete hook-up can be effected by this method in less than ten minutes, and if it does not work out right, a different hook-up can be made almost as quickly. There is, of course, no soldering and no loose wires, and a maximum of hook-ups and connections can thus be tried out in a minimum of time.

CONDITIONS AND RULES OF HOOK-UP CONTEST

The instruments placed upon the hook-up board in our illustration were selected at random, but the constructor of the new circuit can, of course, use any instrument to his liking, within the list of permissible parts.

- Antenna } (Or loop)
- Ground }
- One three-circuit tuner
- One grid leak and condenser.
- Two variable condensers
- Two vacuum tubes and sockets
- Four fixed condensers
- Two fixed resistances
- Two rheostats
- One R.F. transformer
- One A.F. transformer
- One crystal detector
- One head-set
- "A", "B", and "C" batteries

- (1) Any or all of the parts listed and shown may be used, but parts not listed here must not be used.
- (2) Variable condensers are shown, and one may be the regular type, .0005, .00035, .00025, or any other capacity, and the other may be a vernier, or both may be verniers, or both may be large size. This option as to values of parts used is good throughout the entire contest. If special coils are needed these can be constructed, as long as the classification falls within the list given above.
- (3) No circuit shall be entitled to a prize if it radiates. This is essentially a non-radiating hook-up contest. Bear this in mind.
- (4) No one shall be eligible for a prize unless the set has actually been built and constructed.
- (5) No sets are to be sent to RADIO NEWS unless the judges of the contest deem it necessary, in which case they will notify the builder of the set. You must be prepared to send the set within 48 hours if called upon by the judges to do so. Transportation charges for the set will be paid both ways by RADIO NEWS.
- (6) The parts used in contestant's set may be standard parts obtainable on the market, or they may be home-made. It is, however, preferable to use standard parts.
- (7) Contestants must submit a complete wiring diagram drawn in ink on white paper, 8½x11 inches, on which the diagram of the

(Continued on page 164)

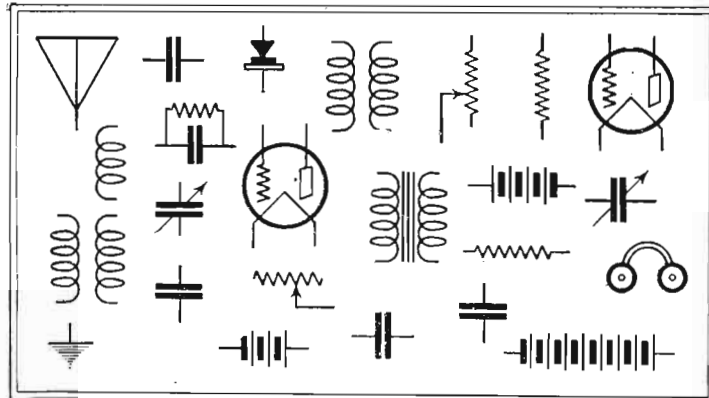

These 23 conventional symbols, universally standard in circuit diagrams, indicate the pieces of apparatus, out of which sets entered in this contest must be built by suitable connections. Can you build an efficient receiver, with a new or improved circuit, out of them?

PRIZES

First Prize	\$100.00
Second Prize	75.00
Third Prize	50.00
Fourth Prize	25.00
Fifth Prize	15.00
Sixth Prize	10.00
7th, 8th, 9th, 10th, and 11th Prizes, \$5.00 each	25.00
	\$300.00

the inventor in whose name it will be taken out.

We believe this is a contest in which every one should join, and we feel quite sanguine that some new and better circuits will result, which will benefit the entire radio fraternity, and perhaps help the radio industry at large.

MAKING EXPERIMENTING EASY

We have shown in our photographic illustration the so-called "Gernsback Hook-up Board," which was developed by the Editor of RADIO NEWS some time ago. This hook-up board makes experimenting a joy and a pleasure. The instruments, it will be noted, are screwed to an ordinary bread board, which is provided with a number of binding-post clips, all of which can be connected in any combination desired by means of the flexible so-called "clip leads."

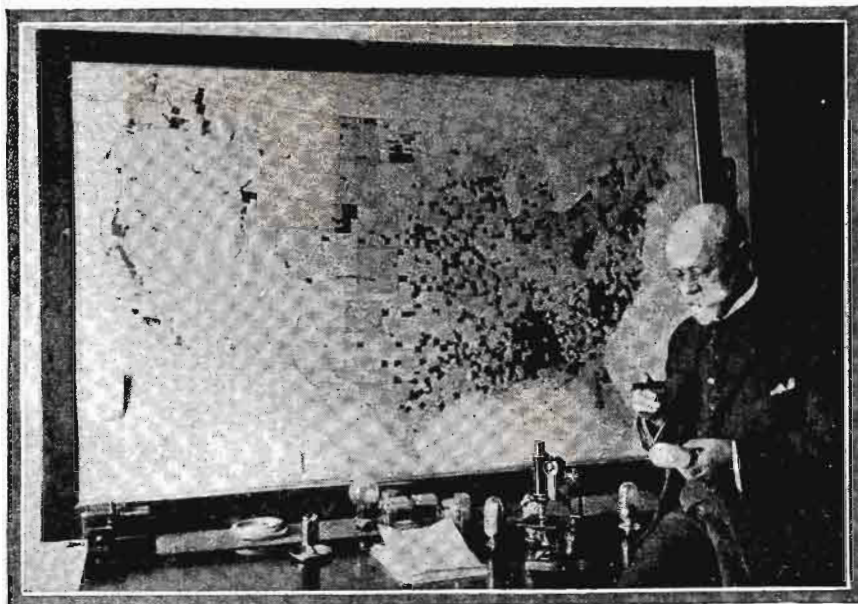

Dr. Milton Whitney, Chief of the Bureau of Soils, who will grant Radio School Certificates for Proficiency in Study of Soils.

has been made to reach a million farmers in a nation-wide school of the air, is not without a precedent, at least, on a small scale. The first "College of the Air" was organized and conducted by KSAC, broadcasting station of the Kansas State Agricultural College, which unique institution had an enrollment of 5,000 Kansas farmers—bona fide students. Sam Pickard was the organizer and director of this pioneer "College of the Air," and, fortunately, the United States Department of Agriculture has the benefit of his experience in the formulation of plans and operation of the "U. S. Radio Farm School." He is Chief of Radio Service, and in this capacity will direct the enlarged plans for making the laboratories and grounds of the Department of Agriculture, in Washington, co-extensive with the entire nation.

FARM AND HOME

"Radio—a Farm and Domestic Utility," is the happy phrase used by Mr. Pickard, in announcing the tentative plans of this national university of the air. The schedule of courses suggests the operation of a school without the usual vacation period; that is, the year is divided into four quarters and information suitable to the respective farming seasons will be spread by radio throughout the twelve months. The subject of livestock, for example, includes brief lectures on the feeding and management of the four principal kinds of domestic animals, namely, hogs, sheep, cattle, and horses. Courses in poultry, also represented by a time division of four quarters during the year, are to be given in accordance with seasonal requirements of poultry raising.

Crops and horticulture, and poultry and livestock, are the general classifications—well-nigh covering the range of agriculture—under which subject matter will be prepared and presented by the "U. S. Radio Farm School." The subjects of crops and horticulture will be treated by a specialist assigned to perform this task; whereas, another specialist will devote his time to the popular treatment of topics relating to poultry and livestock. Working immediately under the supervision of Mr. Pickard, Chief of Radio Service, will be a radio program specialist, an appointee yet to be determined by the United States Civil Service Commission. Material suitable for broadcasting to this farm school, potentially numbering a million students, will be dramatized.

A CHAIN OF STATIONS

Plans for the actual broadcasting of the vast fund of information emanating from the "U. S. Radio Farm School" have not been perfected. Tentative arrangements, to which Mr. Pickard is now committed, call for the use of ten or twelve important and strategically located broadcasting stations. Another plan afoot, negotiations being under way, is the sponsoring of a farm program by A. Atwater Kent, the radio manufacturer, of Philadelphia.

Despite his pleasing slogan "A Million Farmers are Picking Dollars Out of the Air," Mr. Pickard is keenly mindful of the requirements that popular presentation, even to the point of dramatization, and brevity, must characterize agricultural information, if it is to make a successful bid for sweeping reception and use through the medium of radio. Old-time fiddling, Hawaiian music, and songs of the long ago, need no artificial stimulus for arresting and sustaining the interest of rural folk. Informative material, however, must compete with these programs of entertainment; and if the farmer is to share his radio listening periods with such subjects as freshening cows, sour soils, and

infant mortality of livestock, this information must be appealing as well as instructive.

Sam Pickard, in freely engaging the facilities of about sixty-five commercial broadcasting stations for the dissemination of his "Fifty Farm Flashes," has well learned the lessons of popular presentation during the past two or three months. Testimonials from about fifty broadcasting stations, scattered in widely separated geographical sections of the country, are generous in their comments on an informative service that has successfully shared time with entertainment with the vast invisible audience, commonly believed to be in a rage over jazzy music.

FEELING OUT THE FARMER

These and many other favorable comments, it would seem, should suffice to prove to the Radio Service of the Department of Agriculture that the vein which it has chosen in the presentation of farm facts, is a most happy and pleasing one. Not content, however, with these generous letters of approval, Mr. Pickard has started on a nationwide tour, beginning May 25, to ferret out the needs of directors of broadcasting stations as they relate to their invisible rural audiences. Their opinions will be carefully weighed and checked against the expressions of farmers, with whom he will come in contact on this country-wide automobile tour. During his three-months' absence from Washington, Mr. Pickard will exchange views with at least a thousand dirt farmers; and from a cross-section of this compendium of opinions he will be well prepared to conduct the "U. S. Radio Farm School," fully assured that the information thus broadcast will be both pleasing and informative.

George Washington, who had a vision of a national university, in his most far-sighted moments, never dreamed of a "U. S. Radio Farm School," reaching into a million or more isolated farm homes. Now, farmers will not have to depend altogether upon the R.F.D. service for agricultural information, contained within the covers of unattractive farmers' bulletins. Instead, with timeliness and continuity as factors in imparting information, radio will act as a hurry-up messenger between Uncle Sam's national farming bureau and the rural population. Brevity, speed, and a pleasing manner of presentation, will characterize the service of the "U. S. Radio Farm School"—more details on a diversity of subjects will follow by mail, upon request to the department by the farmer who is interested in following up any special subject.



Sam Pickard, Chief of the Radio Service of the U. S. Department of Agriculture. © Harris & Ewing.

One Million Farmers to Study by Radio

By S. R. WINTERS

One of Uncle Sam's latest plans to aid the farmer in developing himself and his land, is by means of the U. S. Radio Farm School. Mr. Winters gives a clear idea of how this project will function in this interesting article.

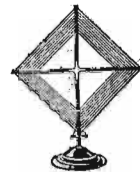
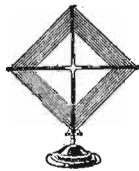

"Radio, the newest of inventions, is proving of great and increasing usefulness to agriculture, the oldest of the occupations of civilized man. Not only is it supplying accurate information in time for the farmer to use it, but it is giving the rest of the population an understanding of the problems and needs of farming. Everywhere farming and the farmer need clear-headed sympathetic understanding on the part of the population as a whole. Nowhere in the world can we have a permanently prosperous civilization, if agriculture is unsuccessful and rural life unsatisfactory.

"In our complex modern life, all groups in the population must in the last analysis stand or fall together. Co-operation, not conflict, is essential to steady progress. I am confident that all elements in the population will co-operate for the permanent betterment of agriculture, once they understand what is necessary.

"To this end the radio will contribute much. This may be made a potent means of stimulating understanding, good-will and co-operation."—W. M. Jardine, Secretary of Agriculture.

Agriculture to carry its scientific knowledge, derived from research laboratories and experiment farms, directly to a million American farms. The farm will be considered the student's laboratory, and assignments will be given, necessitating practical work.

The chief of a bureau in the Department of Agriculture, who formerly confined the results of laboratory findings to the pages of a bulletin or circular, will prepare timely and concise talks for delivery to the microphone, for instantaneous broadcasting to farms. The farmer who may be doing his fall plowing or wrestling with the problem of a litter of pigs, will apply the information from Washington to a proper adjustment of his farming practices. Thus, "for the land's sake," lecture courses from Uncle Sam's national farming bureau will dovetail with the daily farm work; and each farm thereby becomes a practical laboratory. Radio instruction will be supplemented with a file of bulletins dealing with the subject matter broadcast.

courses are to be given by the "U. S. Radio Farm School," and like students within academic walls, who receive diplomas for a completion of required studies, these tillers of the soil who demonstrate proficiency in a majority of the courses taught are to be granted certificates in scientific agriculture. These are to be signed by the chiefs of the respective bureaus and countersigned by Secretary Jardine.

Or, to give an illustration, let us use this

RADIO AGRICULTURAL COURSES Systematic lecture

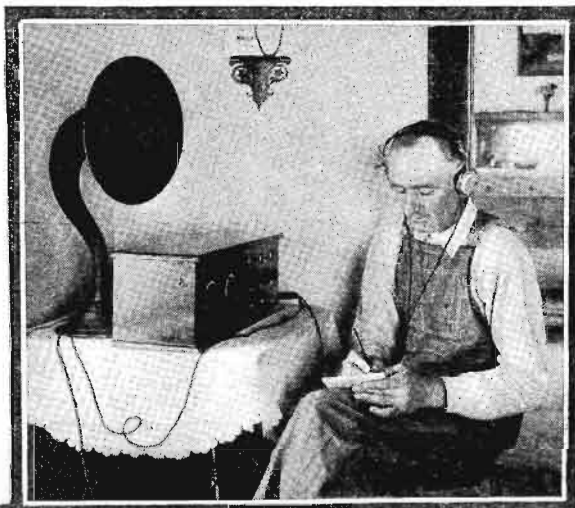

ONE million farmers are going to school, by proxy, at the Department of Agriculture in Washington!

Farms are to be transformed into scientific laboratories, and college certificates in agriculture are to be issued to farmers, without requiring them to leave the land which they till.

The summer, during which farmers were formerly attracted to the extension courses of the state agricultural colleges, may soon find these same farmers remaining at home and pursuing courses of study in the "U. S. Radio Farm School." The most revolutionary departure in the use of radio as a medium for imparting information is the plan of the United States Department of



The farmer gets great value from the daily broadcasting of grain, livestock and produce prices. Iver Peterson of Morris Co., Kansas taking down the day's quotations.

reasonable supposition: "This is station WRNY, New York: we will now broadcast a lecture by Dr. L. O. Howard, Chief of the Bureau of Entomology, United States Department of Agriculture, on the subject, 'The Busy Bee as a Loafer.' Please stand by." Meanwhile, the beekeepers of New York State

or others interested in bee culture, adjust their head telephones or loud speakers and prepare to absorb information which is calculated to upset the dictum "busy as a bee." Then Dr. Howard proceeds to disclose results developed at the Government experiment bee farm, at Somerset, Maryland, which are somewhat startling in that bees are represented as idlers. The beekeeper, in his apiary in New York State, can apply this new theory in studying the activities of his hives of bees as they go on their nectar-sucking errands.

The "U. S. Radio Farm School," a radical innovation, because heretofore no attempt

After the work of the day is over, the farmer and his family find enjoyment and recreation in radio.

Above, Charles Ostrand, farmer boy of Shawnee Co., Kansas, with the three-tube set he built. Left, Perry Brown and family, of Sherman Co., Kansas, enjoying the broadcast program.

Photos by courtesy of the United States Department of Agriculture





RADIO NEWS

H. GERNSBACK, Editor and Publisher
SYLVAN HARRIS, Managing Editor

EDITORIAL AND GENERAL OFFICES, 53 PARK PLACE, NEW YORK

Vol. 8

AUGUST, 1926

No. 2

THE DOUBLE-GRID TUBE

By HUGO GERNSBACK

ONE of the greatest advances in radio was the invention of the double-grid tube. This type of tube has for years enjoyed a tremendous popularity in Europe, but, strange to say, it has been sadly neglected in this country.

For the experimenter and the hook-up fan, for the set builder, and for even the set manufacturer, there is nothing more interesting and more efficient than the double-grid tube. There are so many great advantages in such a tube, that it is a mystery why it has not come into use much more than it has up to the present.

The double-grid tube has been described for years in the pages of RADIO NEWS, and it is—theoretically at least—well known to most of our readers. But how many have actually experimented with this excellent tube? It is not very much more expensive than the regular tube; but instead of having four connections, as does the single-grid tube, it has either five prongs or the usual four prongs, to fit any socket, plus an extra binding post attached to the metallic shell of the tube.

Now that we here in America are beginning to use the European type of pin socket, which has no supporting sleeve, it becomes simple to use the double-grid tube with the extra connection on the shell. Perhaps this has been one of the difficulties considered insuperable up to now, but it certainly should be overcome immediately.

In our August, 1924, issue, we described an excellent circuit in connection with a double-grid tube, the *Solodyne*, which makes it possible to use a vacuum tube without a "B" battery. There are, however, many other excellent circuits that can be used with such a tube; and I sincerely hope that our tube manufacturers will take advantage of the tremendous demand that must be awaiting their product, once the experimenters and set manufacturers begin to see the great advantages of such a tube.

The present-day three-element tube, the one which we have used up to now, while a wonderful piece of apparatus, is yet very poor when compared to the double-grid type. The ordinary three-element tube on the market now amplifies about six or seven times, whereas the double-grid tube has an amplification factor of twenty or more, almost three times as much, and that without an increase in the internal output impedance. That, in plain English, means that the double-grid tube is therefore suitable as a power tube. Putting it in another way, one double-grid tube is almost as good as three of the present type.

One of the most injurious defects of the vacuum tube is a result of the capacity effect between the plate and the grid. For that reason it has not been possible to construct really efficient radio-frequency amplifiers that will cover the broadcast wave-lengths. This defect can be overcome readily by means of the double-grid tube. Also, if our tube manufacturers were to turn out a good two-grid tube of the three-volt type, our experimenters would have the ideal tube for portable sets.

Furthermore, the demand in this country at the present time is for sets that may be operated on the house-lighting current. Great advantages are claimed for such sets, but most of them, up to now, have not worked out very well. The two-grid tube gives us an advantage here, because it becomes a rather simple matter to filter out or neutralize the hum, by means already known to the experimenter and set constructor.

Aside from this, the two-grid tube is very much more economical than the single-grid tube; and I am certain that as we go along,

many new advantages and many new excellent circuits will be discovered by our experimenters.

The tube holds out excellent promise for double-regeneration circuits, certain types of reflex, and especially in Super-Heterodyne work. For instance, Dr. Langmuir has discovered a circuit where the double-grid tube is used for simultaneous oscillation and modulation, both in a single tube.

It may even be possible, though we can not be too sure about this, that by means of the double-grid tube some progress can be made toward the elimination or partial suppression of static.

There is hardly a circuit now known that cannot be improved or bettered by means of the double-grid tube, and I am certain, as well, that many hitherto undreamt-of circuits will be found in the future, when employing the double-grid tube.

As far as we are aware now, we have reached about the ultimate in circuits. There are only five or six circuits to begin with, all the others being variations, but I am certain that

by means of the double-grid tubes we shall in the future have circuits which in sensitivity and efficiency will outdistance anything that we think possible today. It will be possible to use a one-tube set with a crystal combination and without a "B" battery, to operate a loud speaker for short distances.

That this sadly-neglected tube offers great possibilities can best be demonstrated by the fact that tubes that give an amplification factor actually above 900 have been constructed for laboratory purposes; which, when compared to our present-day tubes, giving only six- or seven-fold amplification, seems to be a tremendous improvement.

There is, in short, no reason today why double-grid tubes should not be used by every experimenter, nor why they should not be adopted by set manufacturers as well. As I mentioned above, such tubes can be made to fit any existing socket, and only slight changes are necessary to adapt the tube even

to an existing set.

There is another important phase in the possibilities of the multi-grid tubes of which nobody seems to have taken sufficient cognizance; and that is their adaptation to the purposes of power amplification. In spite of all the work that has been done in the development of these tubes, they have so far been made only to operate on plate voltages somewhat lower than we are accustomed to use with the single-grid tubes. Nowadays, a slight saving in "B" current is of little account, especially in view of the growing use of "B" battery eliminators. It would seem, therefore, that by making these two-grid tubes to operate on the higher plate voltages now in general use, and similarly as to the "A" voltages, it should be possible to produce amplifiers of power far excelling anything we have hitherto seen.

The ideas expressed above are only a few of the thoughts aroused by the possibilities of the multiple-grid principle in vacuum tubes. There is no telling what progress may be attained by further research work and practical development; and I suggest to our experimentalist readers that here is an open and little-crowded field in which to put forth their best endeavors.

At the present time double-grid tubes are not manufactured commercially in this country, but if experimenters of the country and the set manufacturers require such a tube, it will be made quickly enough. The trouble is that its great advantages and utility have not been sufficiently known; but it is high time that we woke up and got out of our present stagnation.

... wherein the Editor calls attention to the sadly-neglected double-grid tube—why, with the advent of the pin-type socket, this tube should now rapidly become popular—how the single-grid tube amplifies six or seven times, and the two-grid tube twenty times—why entirely new and more sensitive hook-ups are possible with the double-grid tube—why it is particularly interesting for power amplification—and why you will get such tubes if you really want them.

Mr. Hugo Gernsback speaks every Monday night at 9 P. M. from Station WRNY on various radio and scientific subjects.

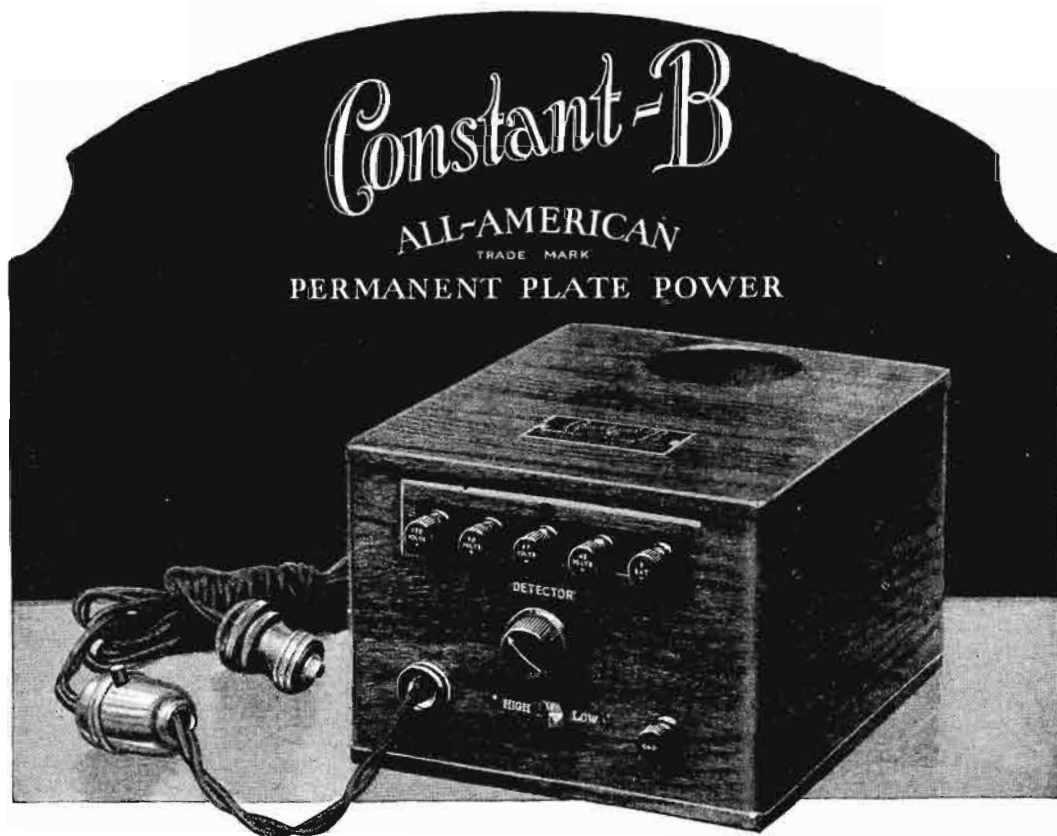

Steady "B" power without batteries

Pure full tone is possible only with "B" voltage kept constantly up to standard; All-American "Constant-B" gives it to you

YOU'VE had your "B" battery troubles; everybody has. Here's a permanent end to them—install an All-American "Constant-B," attach it to a light socket, and turn on the switch. You get a dependable, permanent supply of uniform, constant plate current; insuring full, pure tone.

There's no acid to ruin things; no annoying hum. And all inside units are permanently sealed against atmospheric conditions.

"Constant-B" has taps for 135, 90 and 67½ volts; and a 10 to 60 volt tap varied in output by a "Detector" control.

The "High-low" switch insures uniform voltage, regardless of the number of tubes used; "Low" for 2 to 5 tube sets, "High" for sets with 6 tubes or more.

"Constant-B," after passing the highest laboratory tests, carries the seal of approval of the Popular Science Institute of Standards and other testing laboratories. It measures up in every way to All-American's high standards of painstaking workmanship and satisfying performance.

[PRICE]
\$45
 Complete with
 Raytheon Tube]

Descriptive folder and interesting booklet showing how to build a "B" Power Supply similar to "Constant-B" sent free on request. Specify bulletin B-82.

ALL-AMERICAN RADIO CORPORATION

4209 BELMONT AVE., CHICAGO, U. S. A.

Station WENR—266 Meters—is owned and operated by the All-American Radio Corporation

Tune them out and KEEP them out
 with *Filtrola* STATION
 ELIMINATOR

This attractive compact unit, complete in itself, makes it a simple matter to tune out interfering stations you don't want—even the most powerful. No tubes, batteries or other units to install. A typical All-American product in its precision and quality of workmanship.



Price \$15



I Will Train You At Home To Fill a Big Pay Radio Job



"I give you all this apparatus so you can learn quickly at home the Practical Way"

J.E.S.
FREE OF EXTRA COST

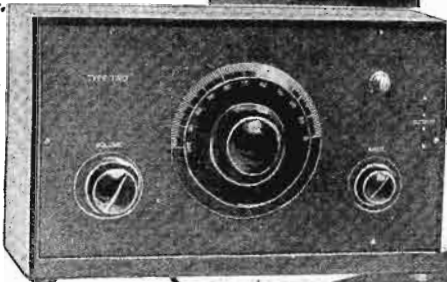

You Get All of This

All instruments shown here and others sent to all my students free of extra cost under short time special offer. Clip coupon now—find out all about this big unequalled offer while you still have time to take advantage of it. This training is intensely practical—these instruments help you do the practical work. You learn workmanship and get added confidence in your ability.



\$70 in One Day For T. M. Wilcox

"I am in business for myself and RECENTLY MADE \$70 in ONE DAY. I was an electrician of rich experience, occupying a splendid position as telephone superintendent when I enrolled with you believing it would open up greater opportunities—have not been disappointed. Estimate Radio will be worth tens of thousands of dollars to me in next few years." T. M. Wilcox, Belle Island, Newfoundland.

World Famous Training That "Pays for Itself"

My Radio course World-Famous as the training that "pays for itself." Make more money QUICK when you take up this practical course. Work on millions of antennas, receiving sets, offers you big chance to make spare time cash while you're learning. I'll show you how—teach you the latest "dope," furnish you with business cards, show you how to get the business and make it pay. My students don't wait a year to increase their income—they report QUICK INCREASES as a result of this course—often two or three weeks after starting. Howard Luce, Friedens, Pa., made \$320 in 7 weeks during spare time. D. H. Suit Newport, Ark., writes, "While taking the course I earned in spare time work about \$900." Earl Wright, Omaha, reports making \$400 in a short time while taking course—working at Radio in spare time! Sylvester Senso, Kaukauna, Wis., made \$500. These records not unusual—these men a few of hundreds.

Your Satisfaction Guaranteed

We who know the results this practical tested training gets—the increased earnings it has brought to men everywhere—stand behind it all the way with a signed guarantee bond that we give you when you enroll. On completion if you're not entirely satisfied in every way, you get back every cent you've paid us. No strings to this offer—you yourself are the only judge. Get started today! It's your big chance for one of the bigger Radio jobs—mail coupon NOW for my Big FREE BOOK and proof! No obligation.

If you're earning a penny less than \$50 a week, clip coupon now. Send for AMAZING FREE BOOK, "Rich Rewards in Radio." Why go along at \$25 or \$35 or \$45 a week, when you could earn \$50 to \$250 in the same six days, as a Radio Expert? Hundreds of N. R. I. trained men are doing it—why can't you?

Earn \$50 to \$250 a Week—

RADIO EXPERTS IN BIG DEMAND

Radio needs trained men. Get into this new live-wire profession of quick success. It's the trained man, the Radio Expert, who gets the big jobs of this profession—paying \$75, \$100, \$200 a week and up. Every day N. R. I. trained men are taking good places in the Radio field—men just like you—their only advantage is TRAINING. You can prepare just as they did, by new practical methods. Our tested clear training makes it easy for you. Big Free Book contains all the proof.

You Learn Quickly In Spare Time

So sure am I that I can train you successfully for a better future in this new Big-Pay profession, that I guarantee your training with a money-back bond. Lack of experience or education won't hold you back—common schooling all you need to start. You can stay home, hold your job, and learn quickly and pleasantly in your spare time. My practical, helpful methods enable you to start RIGHT AWAY toward one of the bigger Radio jobs paying \$50 to \$250 a week. No delay, no losing time from work—no scrimping or scraping to get your training.



Operates WMAQ

"Accepted a position with the Chicago Daily News Station WMAQ. MY INCOME PRACTICALLY DOUBLED, thanks to you. I handle all consultation, also do operating. Your course taught me not only the theoretical but also the practical knowledge that makes my work easy for me." Keith Kirnbay, Station WMAQ, Chicago, Ill.

Get This FREE BOOK

Most amazing book on Radio ever written—full of facts and pictures—tells all about the great new Radio field, how we prepare you and help you start. You can do what others have done—GET THIS BOOK. Send coupon today—no obligation.

J. E. SMITH, President
NATIONAL RADIO INSTITUTE
Dept. HW1, Washington, D. C.



J. E. SMITH, President
NATIONAL RADIO INSTITUTE
Dept. HW1, Washington, D. C.

Dear Mr. Smith—Without obligating me in any way, send me your free book, "Rich Rewards in Radio" and all information about your practical, home-study Radio Course.

Name..... Age.....
Street Address.....
Town..... State.....

EMPLOYMENT SERVICE TO ALL GRADUATES

Originators of Radio Home-Study Training



INDEX TO ADVERTISERS

A	D	J	R
Page	Page	Page	Page
Acme Apparatus Co.192	Daven Radio Corp.177	Jewell Electrical Instrument Co. 182	Radiall Company174
Acme Electric & Mfg. Co., The 189	Deutschmann Company, Tohe ..178		Radio Association of America ...186
Aerovox Wireless Corp.186	Distantone Radios, Inc.184	K	Radio Corp. of America Back Cover
Alden Mfg. Co.179	Donle-Bristol Corp., The188		Radio Specialty Co.167
All-American Radio Corp.102		Karas Electric Co.179	Randolph & Co.187
All Radio Co.179	E	Kellogg Switchboard & Supply Co.181	Randolph Radio Corp.188
Allen-Bradley Co.162		Kennilworth Inn183	
Amplion Corp. of America, The 181		Klosner Radio Corp.179	S
Amsco Products, Inc.184	Easton Coil Co.182	Konite Corp., Tac178	
Arrow Battery Co.166	Electrad, Inc.168		Scott Radio Labs.181
Atwater Kent Mfg. Co.186	Electric Specialty Co.184	L	Seminole Co.182
Autostrop Safety Razor Co.173	Electrical Research Labs.184	Lancaster & Allwine185	Service Battery Co.188
	Erie Fixture Supply Co.189	Liberty Bell Mfg. Co.170	Silver-Marshall, Inc.189
B	Evans & Co., Victor J.174	Luxor Radio Co.170	Smith, B. Hawley175
Bakelite Corp.183		Lynch, Inc., Arthur H.160	Southern Toy Company, Inc., The191
Barawik Company, The184	F		Starrett Mfg. Co.189
Birnback Radio Co.170		M	Steinite Laboratories182
Boguse, B. N.166	Ferbend Electric Co.187	Marko Storage Battery Co.184	Sterling Mfg. Co., The174
Bosworth Elec. Mfg. Co., The 185	Ferguson, Inc., J. B.175	Massachusetts Radio & Telegraph School181	Supertron Mfg. Co., Inc.166
Bradley Institute174	Fishwick Radio Co.184	Midwest Radio Corp.166	
Brady, John B.191	Formica Insulation Co., The ..171	Miller Rubber Co. of N. Y., The 168	T
Brant Battery Co.188	Freshman Company, Inc., Chas. 174		Thomas Battery Co.187
Bremer-Tully Mfg. Co.188		N	Tower Mfg. Corp.97
C	G	National Carbon Co.159	
C. E. Manufacturing Co.181	G-S Radio Research Lab.185	National Radio Institute101	V
Camfield Radio Mfg. Co.178	Gearhart-Schlueter Radio Corp. 177	Norden-Hanck, Inc.183	Van Horne Company, The165
Carter Radio Co.185	Gem Tube Co.185		
Central Radio Labs.184	Gold Medal Radio Corp.175	O	W
Chemical Institute of N. Y., Inc. 169	Golien-Leutz, Inc.181	Onnigraph Mfg. Co., The183	Williams, A. F.183
Chicago Radio Apparatus Co.187	Goold Storage Battery Co., Inc., The179		World Battery Co.168, 170, 171
Chicago Salvage Stock Stores 168-182		P	
Churchill Hall168	H	Pacent Electric Co.163	
Columbia Print161	Hawkeye Radio Co.191	Parker, C. L.186	XYZ
Consrad Co., Inc., The 164, 172, 186	Heath Radio & Elec. Mfg. Corp. 179	Plymouth Rock Squab Co.166	N-L Radio Laboratories170
Coyne Electrical School177	Hommel & Company, Ludwig 179, 181	Press Guild, The164	Yaxley Manufacturing Co.166
Crescent Radio Supply Co.183			
Crosley Radio Corp., The99			
Culver-Stearns Mfg. Co.170-191			
Cunningham, Inc., E. T.188			
Inside Front Cover			

RADIO NEWS READERS' BUREAU

TEAR ALONG THIS LINE

Time and Postage Saver

IN every issue of RADIO NEWS you undoubtedly see numerous articles advertised about which you would like to have further information.

To sit down and write an individual letter to each of these respective concerns, regarding the article on which you desire information, would be quite a task.

As a special service to our readers, we will write the letters for you, thus saving your time and money.

Just write the names of the products about which you want in-

formation, and to avoid error the addresses of the manufacturers, on the coupon below and mail it to us.

If the advertiser requires any money or stamps to be sent to pay the mailing charges on his catalog or descriptive literature, please be sure to enclose the correct amount with the coupon. We will transmit to the various advertisers your request for information on their products.

This service will appear regularly every month on this same page in RADIO NEWS.

RN 8 26

TO: READERS' SERVICE BUREAU,
Experimenter Publishing Co., Inc., 53 Park Place, New York, N. Y.

FROM WRITE YOUR NAME and ADDRESS HERE:
NAME
ADDRESS CITY, STATE.....

Gentlemen: Please advise the firms listed below that I would like to receive detailed information on their product as advertised in theissue of RADIO NEWS.

<p> This form should not be used for technical questions</p> <p>NAME</p>	<p>ADDRESS (Street — City — State)</p>	<p>List here specific article on which you wish literature.</p>

Check here if you are a dealer
 Your Dealer's Name
Address

CROSLLEY



On June 8 and 9, the fourth Annual Convention of the Crosley Distributors was held in Cincinnati.

Powel Crosley, Jr., announced the most startling line of radio receiving sets in the history of the industry.

Every lover of radio is urged to get the story from his nearest Crosley dealer immediately.

RADIO

Better - Costs Less

RADIO NEWS

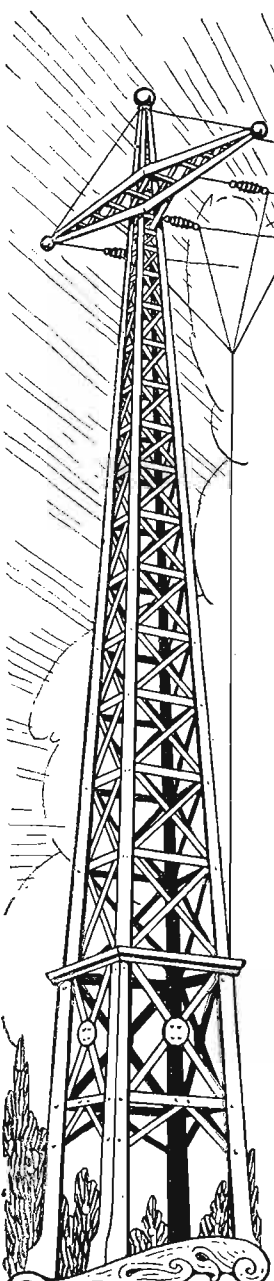

Published by EXPERIMENTER PUBLISHING COMPANY, Inc., Publishers of "Radio News," "Science and Invention," "Radio Internacional," "Radio Review" and "Amazing Stories."
 Editorial and General Offices: 53 Park Pl., New York City
 H. GERNSBACK, President. S. GERNSBACK, Treasurer. R. W. DEMOTT, Secretary
 Member: Audit Bureau of Circulations Radio Magazine Publishers Association

VOLUME 8

AUGUST, 1926

NUMBER 2

Contents of This Issue:

The Double-Grid Tube, By Hugo Gernsback	103	List of Broadcast Stations in the United States,	129
One Million Farmers to Study by Radio, By S. R. Winters	104	A Batteryless Receiver, By Joseph Bernsley	130
\$300 Prize Set Design Contest, Broadcasting the Sounds of Atoms, By H. P. Cady and John Strong	106 108	New Developments in Radio Apparatus, By G. C. B. Rowe	133
Radio in Serbia, By Z. Kittich	109	Relaying Radio Messages from the Polar Regions, By George W. Linn, Jr., 2CJE	135
Novelties in Radio, Recent Radio Inventions, "Now If You'll Take My Advice—," By George A. Ludwig	110 111 112	A Handy, Light Vacation Set, By Joseph Bernsley	136
Radio Weather, "Good and Bad," By Eugene Van Cleef	113	An Inverse Duplex Receiver for the Home Constructor, By Florian J. Fox	138
Radio News for the Month Illustrated, By George Wall	114	A Transoceanic Broadcast Receiver, By Charles R. Leutz	140
Budge Puts It Through, By Armstrong Perry	115	More About Receivers Without Wires, By Edmund T. Flewelling	141
Radio Set Owners' Information, About "Cavalleria" and WRNY, By Charles D. Isaacson	116 117	More About Audio-Frequency Amplifiers, By Sylvan Harris	142
The Radio Beginner—Are Portable Sets Really Practical? By A. P. Peck	118	Chemical Condensers of Large Capacity, By Clyde J. Fitch	144
Vacuum Tubes and Their Uses, By M. L. Muhleman	120	Results of Co-operative Measurements of Radio Fading, By Dr. J. H. Dellinger, Dr. C. B. Joliffe and T. Parkinson	146
Making a Business of Inventions, By L. T. Parker	124	Tip-Jack Voltmeters for Filament Regulation, By Ernest E. Stolp	146
Radio and the C. M. T. C., By Capt. John L. Autrey	125	Correspondence from Readers, Radio Set Directory,	147 148
The Broadcasting of Pictures, By Dr. Walter Friedel	126	Radio Wrinkles	149
International Radio,	127	Radiotics,	150
Manufacture of Modern Radio Receivers,	128	Standard Hook-Ups,	151
		The Radio Amateur—Let's Use Ultra-Short Waves, By Henry Lamonte	153
		RADIO NEWS LABORATORIES,	154
		I Want to Know, By Joseph Bernsley	156

In Our Next Issue

Kits of Parts for the Radio Set Constructor, By M. L. Muhleman.	Efficiency of Audio-Frequency Amplifying Devices, By Sylvan Harris.	A Circuit for the Double-Grid Tube, By the Staff of RADIO NEWS.
--	--	--

RADIO NEWS is published on the 10th of each preceding month. There are 12 numbers per year. Subscription price is \$2.50 a year in U. S. and possessions, Canada and foreign countries, \$3.00 a year. U. S. Coin as well as U. S. Stamps accepted (no foreign coins or stamps). Single copies, 25 cents each. Checks and money orders should be drawn to order of EXPERIMENTER PUBLISHING CO., INC.

All communications and contributions to this journal should be addressed to Editor, RADIO NEWS, 53 Park Place, New York, N. Y. Unaccepted contributions cannot be returned unless full postage has been included. All accepted contributions are paid for on publication. A special rate is paid for novel experiments; good photographs accompanying them are highly desirable.

RADIO NEWS, Monthly. Entered as second class matter, July 12, 1924, at the Post Office at New York, N. Y., under the Act of March 3, 1879. Additional entry at Long Island City, N. Y. and San Francisco, Calif. Title registered U. S. Patent Office. Copyright, 1926, by The Experimenter Publishing Co., Inc., 53 Park Place, New York. The contents of this magazine are copyrighted and must not be reproduced without giving full credit to the publication. Copyrighted in Germany. Reproduction of articles in Germany is reserved for Radio, Berlin 42. RADIO NEWS is for sale at all newsstands in the United States and Canada.

and at Brentano's, Ave de L'Opera, Paris, France. European agents: S. J. Wise Et Cie, 40 Place Verte, Antwerp, Belgium.

HOW TO SUBSCRIBE FOR RADIO NEWS. Send your name, address and remittance to Experimenter Publishing Co., 53 Park Place, New York. Mention the name of the magazine you are ordering. We also publish SCIENCE AND INVENTION, RADIO INTERNACIONAL, RADIO REVIEW and AMAZING STORIES. Write clearly.

RATES AND TERMS. The subscription rate for RADIO NEWS is \$2.50 per year. (12 numbers). When remitting do so by check, money order, or registered letter if cash is enclosed. Avoid sending cash through the mail if possible. Subscriptions for less than one year are not accepted. Subscription may be made in combination with SCIENCE & INVENTION, RADIO INTERNACIONAL, RADIO REVIEW and AMAZING STORIES.

POSTAGE. We prepay postage in all parts of the United States, Mexico and Island possessions. For foreign or Canadian subscriptions we require 50 cents in addition to the subscription price for additional postage charges.

CHANGE OF ADDRESS. Notify us as far in advance as possible. It requires several weeks to make an address change on our records. Always write clearly.

ON EXPIRATION of your subscription we enclose a renewal blank in our last number to you; we stop our delivery to you on expiration.

General Advertising Dept., 53 Park Place, New York City.

Western Advertising Representatives
Finucan & McClure
720 Cass St., Chicago, Ill.

Pacific Coast Advertising Representatives
A. J. Norris Hill Co.
5 Third St., San Francisco, Calif.
412 West 6th St., Los Angeles, Calif.

Kansas City Advertising Representatives
Davies and Dillon
15 W. Tenth St., Kansas City, Mo.

New England Advertising Representative
T. F. Magrane, Park Square Building, Boston, Mass.

Detroit Advertising Representative
Roy Buell, Donovan Bldg., Detroit, Mich.

The new Tower Cone

LEADS THE FIELD

OUT-DISTANCING, out-performing—the new Tower Cone sweeps ahead as the first choice of thousands. Such public preferment can mean but one thing—an infinitely finer quality of reproduction, an unequalled superiority in all those attributes most essential in a Cone Speaker. It will cost you nothing to see and hear this outstanding achievement in radio acoustics. Ask your Dealer *today!*

\$ 9.50

The exclusive features—found only in the new Tower Cone—have established its acknowledged prestige.

On Sale from Coast to Coast

TOWER MFG. CORP.,
BOSTON, — MASS.

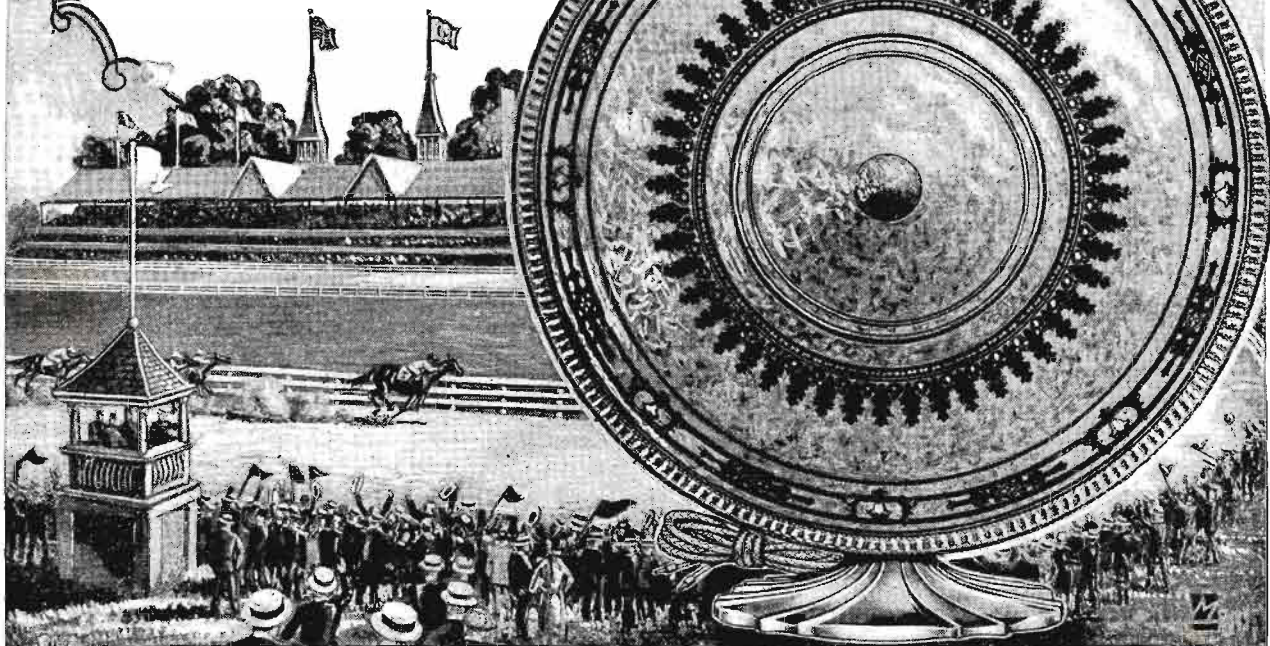

AMERICA'S MOST POPULAR CONE SPEAKER

Recent Radio Inventions

LATEST MARINE RADIO EQUIPMENT INSTALLATION

The receiving set carried by the liner "Hamburg" will operate anywhere on the waveband between 200 and 3,000 meters. Among its novel features are the square bakelite jackets in which the coils are contained, and the airtight cases which protect the condensers from the effects of the atmosphere. The "Hamburg" has a 1-kw. transmitter, which can be used for either phone or code work. © HERBERT PHOTOS.

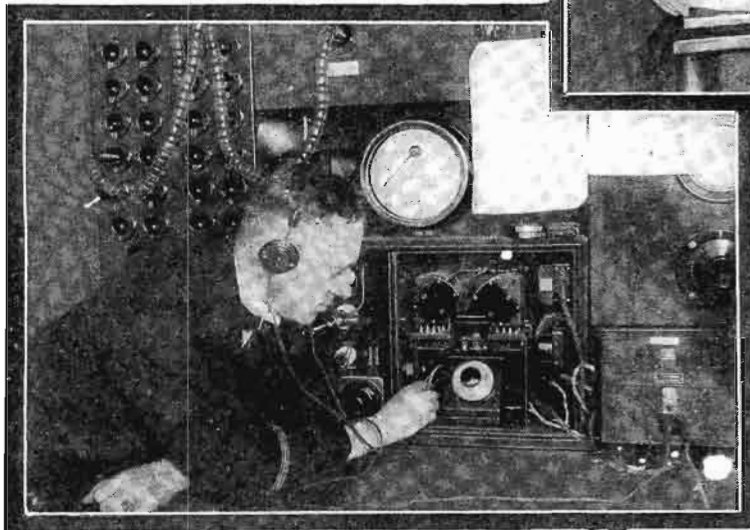

TRANSOCEANIC RADIOPHOTOGRAPHY APPARATUS

Commercial transmission of photographs by radio across the Atlantic has now passed the stage of a nine days' wonder. This illustration, showing the transmitting apparatus, was taken at the first public demonstration. Dr. E. F. W. Alexanderson, Richard H. Ranger, developer of the system employed, and Charles H. Taylor are shown (from left to right) at the instrument. © HERBERT PHOTOS.

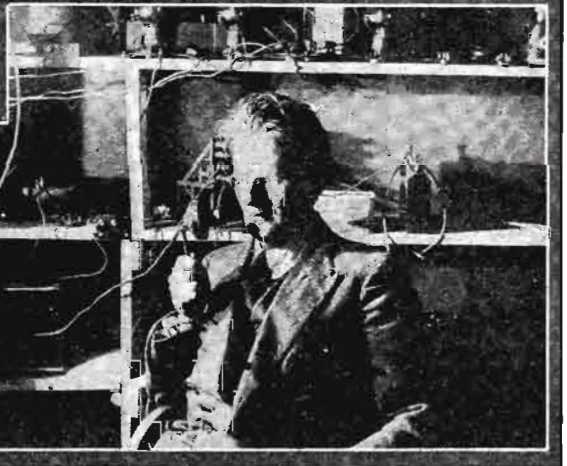

SUCCESSFUL WORKER WITH TELEVISION

John L. Baird, a canny Scot, of Glasgow, has brought television to the point of success. He is shown demonstrating his equipment. Both his voice and his image, as he sits in front of the television "window," are being clearly reproduced in an adjoining room. He hopes to broadcast before long the Derby, Great Britain's great sporting event. © WIDE WORLD PHOTOS.



HOW FAR TO SEA BED?

R. T. Russell, of the Washington Navy Yard radio testing section, is shown with a device which measures, by microphone, the distance from a ship's keel to the sea bottom beneath. © INTERNATIONAL NEWSREEL.



TELEVISION RECEIVERS FOR ALL LISTENERS

Mr. Baird predicts that his television receivers can be sold for about \$150; as in the system which he has developed, it is not necessary to employ costly special lenses. The Baird receiver is designed for attachment to the ordinary radio sets in present use. An article describing the Baird apparatus will appear in RADIO NEWS for September. Above, the inventor is shown transmitting the image of the dummy head which he holds. © WIDE WORLD PHOTOS.



"Now If You'll Take My Advice—"

By GEORGE A. LUDWIG

Here is a little story from which every radio fan can gain something. Read and heed!



If there is anything in this big wide world that I like—far, far away, as the song has it—it is some fat-headed bozo that dispenses advice to all and everybody whether they want it or not. Do you want to tune in on my sad, sad tale of woe? Well, give the old dials a twirl, get comfortable on the back of your neck and learn what advice did for me.

Perhaps I ought to announce my call-letters before starting this program. In case you have never met me before I am just plain John Smithe, spelt with an E on the tail-end of my name. Why the family ever started that high-hat stuff with the extra letter is over my dome, but it is there and so I have to use it. Well, now that we know each other, I'll tell you about my erstwhile friend, Billy Hoffman.

This guy Billy knew everything in the world that there was to know about the gentle art of yanking in sweet music over the radio route. He admitted it. And not only did he admit he was good (I suppose that I really ought to spell "good" with a capital), but he told the world all about Old Man Radio. In a very few words, my friend Billy was what is known hereabouts as belonging to the genus *radiopests*.

Yes, Billy liked to hear his mouth flap, and, if there was one thing on the footstool that he liked to warble about, it was vacuum tubes. That subject was one on which he could never be beaten or cornered. To hear him broadcast to his friends about a pressure of 2.76½ mm. of mercury inside a tube was really wonderful. He actually sounded as though he knew what he was talking about.

I got acquainted with Billy coming in on the train mornings. He would be eagerly lapping up the radio sections in all the morning papers; and one morning when I just had caught the train by the smallest possible margin and did not have time to buy a paper, he took pity on me and offered me one of his. That was the beginning. After that, as soon as he had found fault with the editors of all the radio sections for not running better stuff, he started to do his little act. He would pan everything in sight and then switch off on to what wonderful reception he had enjoyed the night before.

Being more or less of a firm believer in human nature and not knowing Billy at that time, I listened to him and believed some of the stuff that he told me. Then my wife having a birthday and having talked about how much she wanted a radio set, I made the biggest mistake of my young and hitherto blameless life—I asked Billy for some advice about a radio receiver.

He told me the only set that was even worth thinking about was a super-reflex-heterodyne having nine tubes. That set, according to Billy, would bring in any station that had ever been heard of and lots that weren't—and of course everything came in on the loud speaker. Sure! He told me to go see a fellow downtown that sold him all his radio supplies, and that he would fix me up cheap if I told him that Billy was my friend.

Well, that noon I slipped down to see this baby in the radio store and told him I was a great friend of Billy's. He seemed

glad to see me and invited me into his office and gave me a dubious looking cigar, which—praises be to Allah—did not draw very well. We chewed the fat awhile and then came down to the point—what sort of a set did I want; I got out the slip of paper that I had written the name of the set Billy told me and handed it to the gent of the shop. He looked pleased and then dragged me into a room where there was a gang of sets all rarin' to go. He approached with reverence and care the big overgrown cabinet with many dials and started in twiddling them and in a minute or two music poured forth from the loud speaker. It sounded pretty good to this kid and after some dickering there was a nice big slice cut out of my bankroll, and I was the proud possessor of a super-reflex-heterodyne receiver. The near relation of Jesse James promised to send me out everything that was needed and I left the store poorer but happy in my ignorance.

I met Billy on the 5:17 that night and told him about my purchase and then the fun began. Billy started spreading advice so thick that it looked like my garden in the early spring, and then I pulled another bone-head play. I asked him to come over to the house that evening and help me rig up the outfit.

Mind you, I had never heard Billy's set working, so you see I was perfectly innocent. I just wanted to get that straight in your

ing our work my wife sprung this little joke:

"Now that you've got up the antenna, tell me how does the music get to the set?"

Billy looked at me and I returned the compliment. We did not answer my ball and chain for the very simple reason that there was no answer. We had merely forgotten to put any lead-in from the antenna to the house. That's all. When we got up on the roof again and unbuttoned the antenna and tied on the lead-in wire in the latest approved style—according to Billy—I began to have a sneaking suspicion that maybe Billy wasn't all he cracked himself up to be. However, as I'm more or less of a gentleman, I didn't tell him all my thoughts and so we got the antenna up as it should be. Anyhow it looked all right to me.

We then went down to the living room and Billy had lots of fun scattering excelsior and paper all over the floor. Soon we had unearthed the monster with its attendant flock of tubes, wires, batteries and all the necessary and unnecessary junk in the world. Billy started in hooking wires to binding posts and looking awfully wise and going ahead just as though he knew what he was doing, when I happened to think of the antenna episode.

Says I, "Billy, if you don't mind, would you care an awful lot if we consulted the book of directions?"

"Really quite unnecessary," says he, "but if you want to—"

Well, just to please me, we followed some directions that the manufacturer had kindly included with the price of admission and so in a little while, we were pulling in some local music and my better 9/10 and I liked it. But did Billy think it was good reception? Not he. No, indeed. There was more wrong with that radio set than any other radio set just then born or unborn.

My wife, who is of a kindly nature, said to me when I didn't register any great amount of enthusiasm over Billy's suggestion. "Why don't you let Mr. Hoffman fix the radio machine, John, he knows more than you do about it?"

Now I ask you, what could a poor guy do? The way I figured the only reason that the old set was perking at all was because I had kept Billy at more or less of a distance from it. Anyhow after this little song and dance number by the wife, Billy went a-

the set without further urging and then I had that well-known feeling—Life's Darkest Minute. First he took off his coat to get plenty of freedom and I prepared to say bye-bye to the nice new radio set.

And were my expectations fulfilled? Yes, they were. And here's how.

Billy, first of all while rolling up his sleeves, announces that there don't seem to be enough voltage on the batteries. Then he sticks his hands in the innards of the set and starts undoing wires. There were a couple of sounds like some cats that were mad at each other, but Billy passes them off as if he had never heard them. I wasn't very much pleased, for I have a car and I know what it sounds like when you short a storage battery and also know that it is not particularly good for the battery either.

(Continued on page 182)



"He pulled out the filament switch and the tubes lit up—oh, they lit up beautifully—"

mind before I went on with the rest of the story.

Well, after dinner Billy showed up and when he saw the mess of boxes and cartons that littered up our living room his eyes lit up with an unearthly gleam. Due to the fact that we were running on Plus and Minus time (called by some folks daylight saving), there was light enough for us to find the way to the roof and near kill ourselves erecting an aerial. My wife parked herself in the yard where she had a good view of the proceedings and dispensed a very good grade of advice; which—as we are still alive—we did not follow.

We finally got a nice shiny copper wire strung between the pole that we rigged to the chimney and another pole on the roof of the garage. After we had it all fixed up nicely and were standing in the yard admir-

Radio Weather—"Good" and "Bad"

By Eugene Van Cleef

The weather has a great deal to do with radio reception and in this article Mr. Van Cleef has analyzed the conditions of the atmosphere which make good radio weather—or favor (?) us with static and fading.

PROBABLY no radio listener has failed to associate the clarity of reception of an evening's program with the weather. Strike up a conversation with any fan, or overhear discussions of last night's radio program by street-car passengers, store clerks or experts in the radio field, and rare indeed will be the omission of any reference to the weather. However, the exact manner in which radio transmission or reception is affected still remains largely in the realm of uncertainty. The popular belief that "bad weather" means poor reception, and fair weather good reception, is correct in principle but frequently wrong in specific application.

These general notions with regard to a particular kind of radio weather impressed the writer; first, because he had devoted a number of years to meteorological studies, and secondly, because after purchasing a 5-tube neutrodyne set and checking up on some of these weather comments he found them grossly inaccurate. It seemed, however, that there might be a relationship between the general atmospheric conditions accompanying a given kind of weather and the interference with reception usually referred to as static; so observations were made to determine whether any correlation existed between static and the passing high and low pressure areas. The results were striking.

THE WEATHER MAP

Before detailing them, it will be worth while to review briefly just what the "highs" (anti-cyclones) and the "lows" (cyclones) are. On the accompanying weather map they appear as bull's-eye affairs in alternating sequence. As they move across the country, no two highs or two lows follow in immediate succession, but always a high and a low make up a pair. Just what their origin is, we do not know, although much is known about their movements.

The most impressive relation between reception and the atmosphere is the fact that whenever the radio waves, or whatever the form of transmission may be, travel along a route at right angles to the isobars, (the heavy curves of equal barometric or atmospheric pressure) reception is clearest and strongest. This is as true for low-pressure areas as for highs, although reception tends to be weaker. Reception is weaker when waves pass from one pressure area across another, than when they are confined to a single area. Static is most frequent when the waves travel across areas of little difference in air pressure.

So far as the state of the weather is concerned, one may obtain as good results on a night when it is raining or snowing and blowing as when the skies are clear. All that is necessary is the right distribution of pressure.

COLD AND WARM AIR

Listeners generally recognize the fact that programs come in better on clear, cold evenings than evenings with moderate temperatures. This is due, it seems, to a lower percentage of atmospheric moisture when nights are cool than when they are warm. But it must be remembered that a cool or cold wave accompanies an intensive high pressure, in which the isobars are close together, so again we fall back upon pressure distribution. One exception, however, may be noted; namely, the condition of the summer atmosphere, which may be one of a relatively high moisture-content even in a high pressure area. Hence static is more common in summer than in winter. This high frequency of static may be further attributed to the greater number of low-pressure areas passing across the country, the consequent setting up of more "convection currents" and eddies in the summer air than in winter, and the occurrence of numerous thunderstorms, which are the expressions of a highly-electrified atmosphere.

These observations, then, indicate that the local weather does not determine the degree of clarity of reception or the intensity of static, but rather that quality of reception depends upon the locations of the receiving instrument and the broadcasting station with respect to the pressure distribution.

One more phenomenon of wide interest seems to be associated with pressures, namely fading. When the waves travel in a path parallel to the isobars fading occurs.

A FIELD FOR RESEARCH

The experiments have hardly proceeded far enough to allow of rigid conclusions, but observers who have checked against the statements made, have, on the whole, corroborated them. In fact one newspaper uses them as the basis for forecasting, for its readers, the probable clarity of reception on given nights. We need more observers in various parts of the country. If these preliminary qualitative records point toward a common conclusion, then certainly quantitative experiments along the same lines will be eminently worth while. The U. S. Bureau of Standards and some university physics laboratories have conducted tests in this field, but not as yet in any extensive manner, for the specific purpose of determining quantitatively the relation between atmospheric pressure and static. The results of these limited observations can not be looked upon as in any sense conclusive.

WEATHER OBSERVATIONS BY RADIO

Also, if we can show that static, fading

and associated phenomena arise from certain atmospheric conditions, then we may in turn acquire information relative to the circulation of the atmosphere itself. Such findings may prove of tremendous assistance in weather forecasting. While the U. S. Weather Bureau pays for itself many times, in terms of the savings to the public effected through its forecasts, its efficiency is still subject to improvement. Among other things it is desirous of improving and extending its long-range forecasts; but to accomplish this we must possess more exact data pertaining to the circulation of the air in the high and low pressure areas and the factors which affect their movement across the country.

Dr. C. G. Abbott, supported by the Smithsonian Institution and the National Geographic Society, is conducting a series of observations upon the variability in solar radiation and correlating these with daily temperatures on the earth in the hope of determining a definite relationship between the two, and to unravel the "mystery" of the behavior of the lower atmosphere. The work of Clayton in Argentina, where he successfully forecast the weather a week in advance by the aid of daily observations of solar variability, gave the stimulus to Abbott's plans. Reference is made here to this work in order to emphasize the desirability for continued study of the relation between radio reception, transmission and the atmospheric circulation, in order to improve, not only our radio technique, but also our understanding of the atmosphere in which we live and which so vitally affects us.

HOW TO CO-OPERATE

If any reader of this discussion should be tempted to conduct observations along the lines indicated, then perhaps a suggestion as to the kind of observations to make will be in order. The temperature, the state of the weather (that is rain, snow, fogs, clouds or a clear sky, the humidity and the pressure

(Continued on page 184)

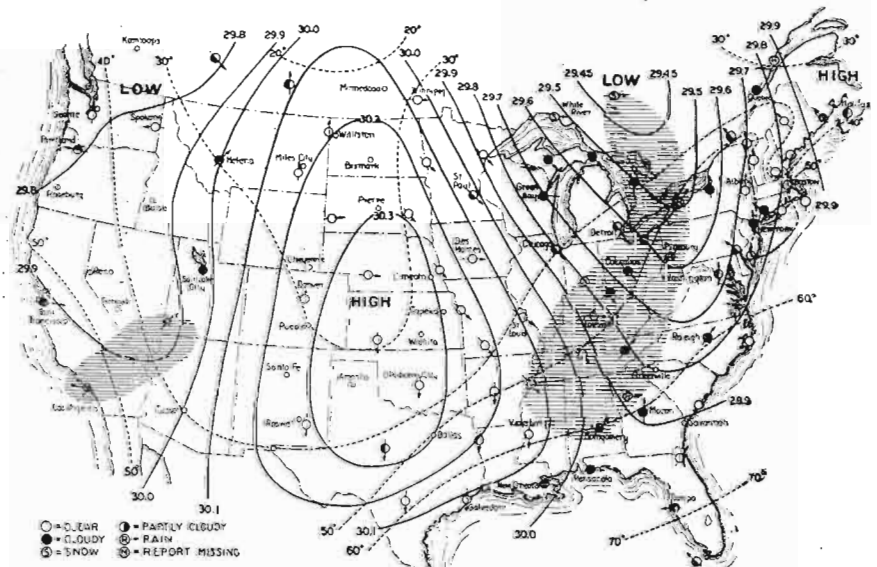

A weather map showing "isobars" close together. Reception at Kansas City from broadcasting stations in Chicago will be strong and without static under these conditions. It will be much better than, for example, at Duluth, Minn., where fading is indicated, because the transmission follows along an isobar. It should be understood, of course, that this statement applies to the conditions portrayed on this map and not at all times.

Radio News of the Month Illustrated

By GEORGE WALL

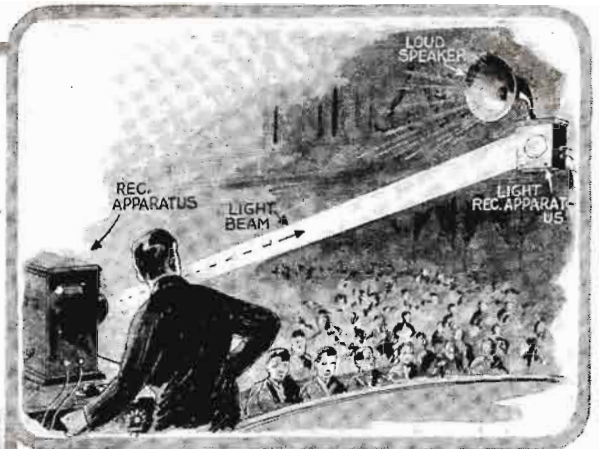
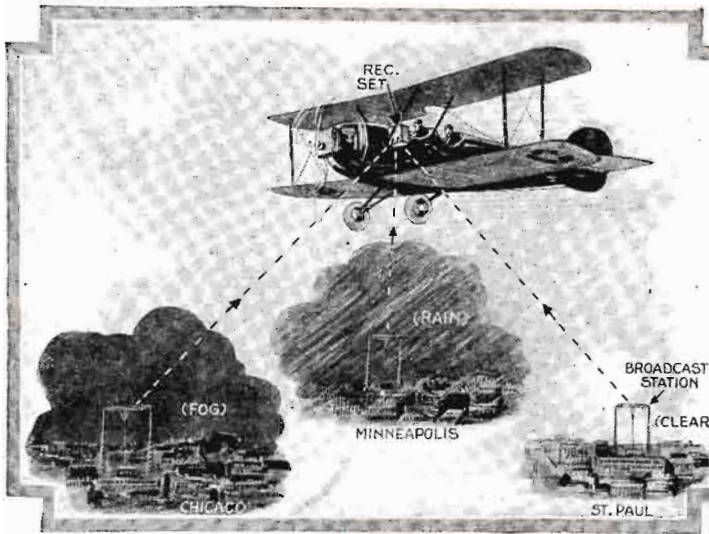

A recent public demonstration at Salem, Mass., of the electrical conductivity of a beam of ultra-violet light, replacing a wire in a receiver.

Airplanes carrying mail on the new Twin-Cities-Chicago route have receiving sets by which the pilots are informed of the weather conditions to be encountered by them. The reports are broadcast every fifteen minutes.



This shows the relay stations in the course over which the Norge's report of its flight to the pole were reported to Washington.

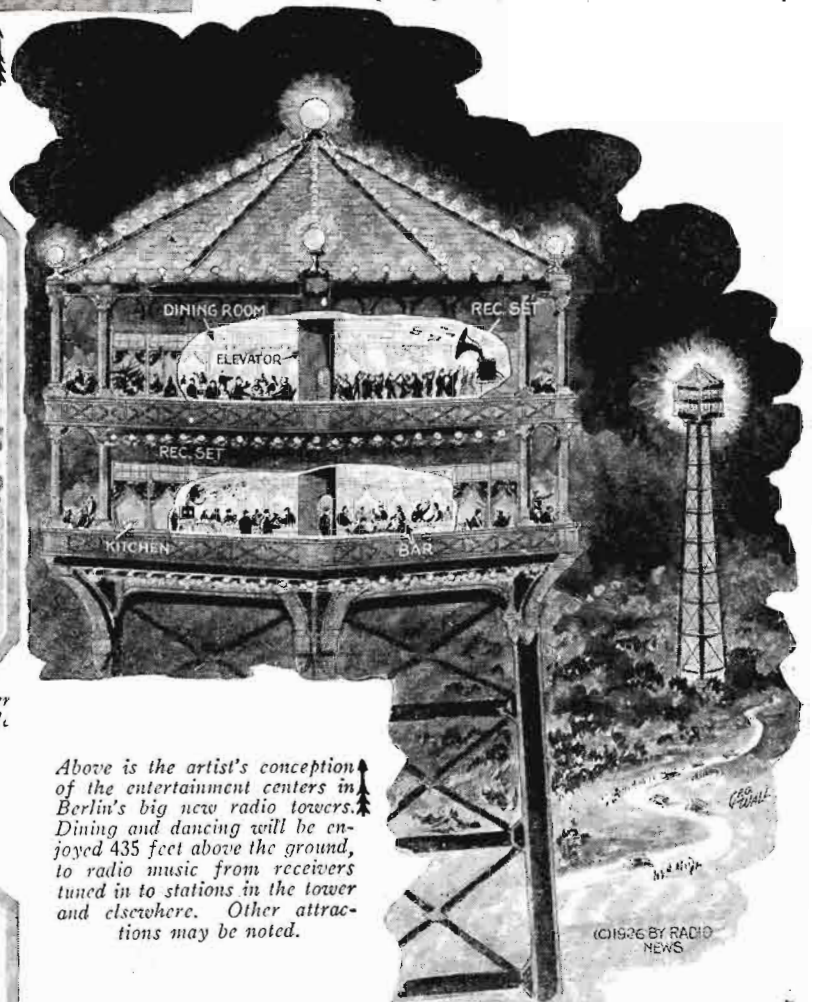

Above is the artist's conception of the entertainment centers in Berlin's big new radio towers. Dining and dancing will be enjoyed 435 feet above the ground, to radio music from receivers tuned in to stations in the tower and elsewhere. Other attractions may be noted.

(C)1926 BY RADIO NEWS



Radio fans say it with other things than flowers and postcards. Here are some of the gifts showered by them on the announcers at one mid-western station.



An enterprising "taxicabby" in Chicago attracts fares by furnishing free radio entertainment for them during the ride. Perhaps it takes their minds off the meter.

Budge Puts It Through

By ARMSTRONG PERRY



THE wind was howling and the snow swirling around the cozy cottage. A fire of logs leapt and roared in the huge fireplace that filled the living room with warmth and radiance.

Mrs. Horton sat darning a thick, woollen sock. Her sixteen-year-old son, commonly called Budge, was soldering connections on one home-made radio outfit while another poured forth a lively dance number that was being played by an orchestra out-of-doors in a far away state where, the announcer said, there were moonbeams and balmy air.

At that moment, a big car reached the top of the sharp incline that was the end of the road. A blinding flash from its powerful lights swept one window of the cottage after another, then the car stopped. The next instant a man came through the door that Mrs. Horton opened hospitably. In his great fur overcoat and cap he looked as big as a huge grizzly.

"I beg your pardon, Madam," he said, "we have lost our way. It is very important that I should be where I can keep in touch with my business associates for the next few hours. Have you a phone?"

"Yes, we have," Mrs. Horton answered, "come right in."

Budge slipped out without waiting to put on a cap, for the chauffeur was opening the hood and a sight of the big engine was not to be missed. A few minutes later he returned, with the chauffeur. They went over to the radio set and, after a brief inspection, disconnected the storage battery and carried it out.

"We've been having battery troubles, among others," explained the stranger, who introduced himself as Mr. Phelps. "I must send John, my chauffeur, out to look for a garage. He will come back for me as soon as the repairs are made. I see he has borrowed your boy's battery. Will you be able to get along without the broadcasts for one evening?"

"Get along without them!" exclaimed Mrs. Horton, "it will be a relief. That boy nearly drives me mad with his radio. It's all right when he is off in the woods, or around doing his chores. Then I can bring in a program I want and listen to it, but when he is here he will not leave the receiver alone. As soon as anything begins to come in as it should, he tunes that out and tries for something else, and he is everlastingly pulling his sets apart and making them over."

Mr. Phelps laughed. "That's the boy of it," he said. "I guess they are all like that. Mine is."

The chauffeur returned, followed by Budge. "She's working fairly well now, sir," he reported. "Budge here has let me take his battery and the starter works all right. Shall I start now, sir? I couldn't say how far I can get in this snow, but I'll do the best I can."

Mr. Phelps looked at the wet snow clinging to the chauffeur's fur coat, then peered out into the driving storm. Mrs. Horton went to get a cup of coffee and a trio of fat, sugar-covered doughnuts for the delectation of the chauffeur before he bucked the storm again.

Mr. Phelps turned back to John. "Get the car fixed as soon as you can and come back for me," he said. "Call me up when you start—what is the number here, Mrs. —"

"Mrs. Horton," his hostess informed him. "Our number is J-53, ring six."

"Yes, sir," said John, between doughnuts.

Having disposed of the doughnuts and two cups of coffee, John drove down the hill, stepped on the gas as he climbed the rise to

the next ridge and was soon out of sight and sound. Mr. Phelps glanced at his watch. "Six o'clock," he soliloquized. "That report on the merger ought to be announced soon."

"It's a terrible night to be out," said Mrs. Horton from the door of the kitchen, where she was busy preparing a chicken for the frying pan.

"I don't mind the weather when the car is all right," responded her guest. "I rather enjoy a storm in the country and I don't mind being snowed in, if I have time for it, but I should not have taken a chance just at this time when it is so vitally important for me to keep in touch with business. You may have read of the proposed railroad merger, and the government decision that is expected today?"

"I did," said Budge, "but I couldn't tell what it was all about."

Mr. Phelps glanced at his watch and went to the phone. Not receiving a response from Central at once, he turned the crank around and around with increasing vigor. "Is anything the matter with the 'phone?" he asked.

"We haven't used it today," Budge answered, "but we have been hearing other subscribers' rings on it as usual. Come to think of it, though, it hasn't rung once the last hour or two."

Mr. Phelps tried to ring again, then hung up the receiver. "Dead!" he said. "What a fool I was not to find out before the car left. But after all, I might better be here than stalled somewhere in a drift. Somehow I never thought of the possibility of being cut off from communication."

He turned to Budge. "This is serious," he said. "I can't be cut off from the world now! There's too much depending on my being in touch if anything goes wrong."

"The news broadcast ought to carry such news, hadn't it?" asked Budge. "WEAF comes in at eight." And then, after a moment's hesitation: "But I loaned my battery to your chauffeur!"

Mr. Phelps was walking back and forth before the fireplace his head drooping thoughtfully. Budge put on his cap, mackinaw and arctics and slipped out of the door. When he returned, Mr. Phelps was eating his mother's fried chicken but with an appetite less keen than he would have had if his mind were at ease.

"I thought there might be some break in the telephone wire that I could fix," Budge

reported, "but the snow has frozen on the wire and it is down for at least a half mile." He shook off the snow and warmed himself before the fire.

Mr. Phelps looked up at the incandescent lamp over his head. "The electric light wires are all right," he remarked.

"Yes, sir, they are heavier and they are put up stronger," Budge assented.

"Isn't there some way that they hook a radio set to the light wires?" asked Mr. Phelps.

Budge, who had been feeling helpless and anxious over the plight of his guest, suddenly saw possibilities. "Yes, sir, there is a way!" he exclaimed as he grabbed a well-worn radio handbook and began to search the index. "Let's see, a battery substitute has to reduce the light-line current—that means you've got to have a transformer or a lot of resistance. Then, the A.C. has to be changed to D.C., that takes a rectifier. And if you want to hear good you've got to filter out the 60-cycle hum. I believe I could build a battery substitute, Mr. Phelps."

Mr. Phelps looked at his watch. "In an hour?" he asked, doubtfully.

"Whew!" Budge whistled. "Well, maybe, if you will help."

* * *

Working feverishly, they completed the home-made rectifier just as the hands of Mr. Phelps' watch showed eight o'clock. "I hope the report on the merger won't be the first thing on the schedule," said Budge, as he hastily connected the rectifier to the improvised lamp board and the proper binding posts on his set.

He turned the button that admitted the line current to his hastily-constructed battery substitute, put phones to Mr. Phelps' ears and his own, and slowly turned the rheostat knob. The filament of the detector bulb lighted at once. Unfortunately, he did not notice that it glowed with an unwonted brilliancy—he was too busy trying to adjust his controls to eliminate the 60-cycle hum that drowned out most of what the announcer on WEAF's wave was saying:

"The following comes from Washington, D. C.—"

Just then there came a sudden and sepulchral silence in the radio receiver. The detector tube had burned out.

Mr. Phelps settled back with keen disappointment, which for the lad's sake he tried

(Continued on page 160)

"There's Chicago—He is on at eight. We can catch him yet. Eight o'clock there is nine here."

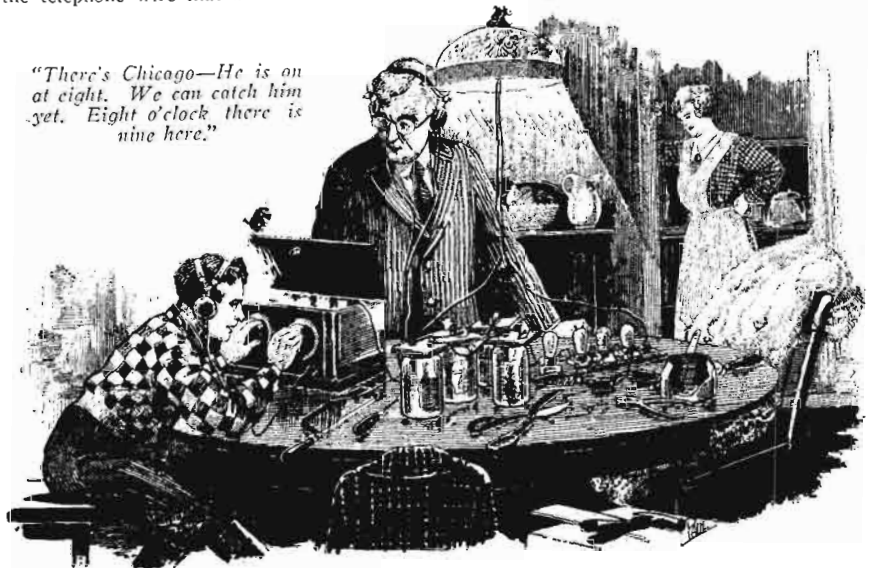

Radio Set Owners' Information

THE USE OF A COUNTERPOISE

(22) Waldo Pearce, of Hartford, Conn., asks:

Ques.—I have heard a lot about counterpoises lately, and have wondered whether the use of one in connection with my receiving set would improve conditions any; and if so, in what respect?

Ans.—Generally, a counterpoise is employed for transmission purposes, not for reception. However, they have been, and are being, used for reception; and in many instances have proven superior to a common ground connection. The use of a counterpoise in conjunction with an aerial will in-

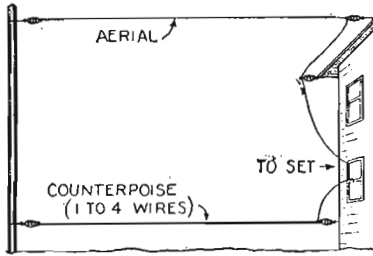

Showing one method of erecting a counterpoise. This is for use with a receiving set.

crease the selectivity of the antenna circuit; and in some cases may allow the use of direct coupling, without making the receiver excessively broad in tuning. Many reports have been received, to the effect that greater distances can be covered when using a counterpoise in place of a ground connection. Since the utilization of a counterpoise considerably decreases the resistance of the antenna circuit, it is possible that the above statement is sometimes correct.

The accompanying sketch shows a typical aerial and counterpoise. It should be noted that the counterpoise is strung directly beneath the aerial. The counterpoise should be from three to ten feet above the earth and, preferably, have two or three wires.

DRY CELLS FOR HEAVY DUTY

(23) Don C. Woodward, of Truxton, New York, asks:

Ques.—I have a radio set that uses four UV201-A vacuum tubes. There is no electric current in this vicinity, so I am forced to use four dry cells for lighting the tubes. I have found this to be a very expensive proposition, as the dry cells don't last any time. Have you any suggestions as to what I might do to cut down the operating expense.

Ans.—We would suggest that you use a bank of eight dry cells connected in series-

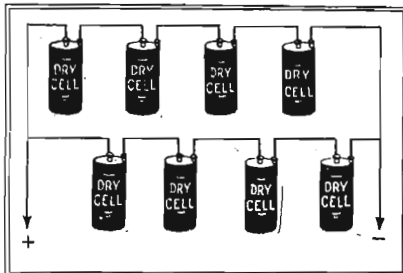

If dry cells are used for lighting vacuum tubes of the 201-A type, a great economy is effected by employing eight of them, connected in the manner shown above.

parallel as shown in the accompanying sketch. The eight cells used in this manner will last a good deal longer than two single sets of four as the current drain on each cell is much less. The process of deterioration is, in consequence, much slower.

THIS page constitutes what is to be known as the SET OWNERS' INFORMATION department, and is to be conducted regularly each month in RADIO NEWS. The purpose of the department is to furnish assistance to those readers who have not yet acquired any extensive knowledge of radio, but who are the possessors of radio receivers and wish to know how to handle them.

There is always new blood coming into the fraternity of radio enthusiasts; and it is obviously unreasonable to expect that they can intelligently read the articles which are written for the more experienced fans. Consequently this new department has been started for their benefit; and we invite anyone who desires to do so, to write an account of his troubles to the editor of this department. No letters will be answered by mail. The editor will select from the letters which he receives those queries that seem to be of most practical interest to all, and will answer them fully and in detail each month. There will be no charge for this service. Simply write to SET OWNERS' INFORMATION DEPARTMENT, RADIO NEWS, 53 Park Place, New York City.

AUDIO-AMPLIFIER TROUBLE

(24) Jos. Otott, of Bethlehem, Pa., asks:

Ques.—I recently completed a five-tube tuned radio-frequency set using CX-299 tubes. The volume was not sufficient so I added another stage of audio-frequency amplification and used a UX-120 power tube. The set works all right with the loud speaker on two stages; but when I plug it into the third stage I don't get anything much but a loud humming noise. Please tell me how I can get rid of this.

Ans.—The best way to get rid of the hum is to get rid of the last stage of audio-frequency amplification. Even though other means were taken to eliminate the hum, you would never get what one could call good quality of reproduction. Three stages of audio-frequency amplification is impracticable, unless it be of the resistance- or impedance-coupled type, neither of which will necessarily give you any more volume.

We suggest that you employ but two stages and use the UX-120 tube in the second stage. If the proper "B" and "C" battery voltages are employed on each of

the audio-frequency tubes, you should not only get good volume but good quality as well.

The accompanying diagram shows how the amplifier should be connected up. The approximate voltages for the "B" and "C" batteries are given.

REVERSED DIAL READINGS

(25) M. Klinger, of Brooklyn, N. Y., asks:

Ques.—I built a dual-regeneration set on a test panel and was very well satisfied with the results. Then I rebuilt the same circuit into a cabinet and am at a loss to understand why the broadcast wave-band operates the reverse of what it ordinarily should, on the dials of the set. For example, WEAF is received around 70 to 75 on most any set, whereas my set receives this station at 25. This reversal of form is true throughout the entire wave-length range of the set. Can you enlighten me as to what corrections are necessary to overcome this defect?

Ans.—The trouble you make reference to is due to either the variable condensers or the dials. There are two types of variable

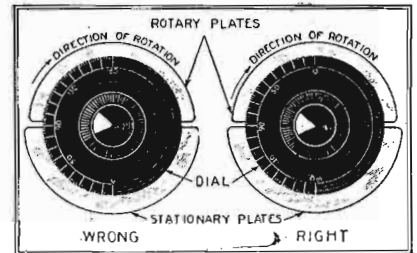

Be sure and get the right type of dials for your variable condensers if you want them to register correctly; and set each at zero with the condenser plates out, as shown.

condensers and dials, clockwise and anti-clockwise. The capacity (and consequently the wave-length adjustment) of a clockwise variable condenser increases as the shaft is turned towards the right. The capacity of an anti-clockwise condenser is increased as the shaft is turned towards the left. In either case the capacity increases as the rotary plates extend further into the space between the stationary plates.

Either you are using clockwise dials with anti-clockwise variable condensers, or vice-versa. No doubt your dials read zero when the plates of the condensers are completely intermeshed.

It may be that you have just overlooked the little matter of setting both dials at zero with the rotary plates of the condensers all the way out. The accompanying sketch illustrates just what we mean.



Circuit diagram of a two-stage audio-frequency amplifier, using 4½ volt dry-cell tubes. The tube in the last stage is a power amplifier and should give sufficient volume under most conditions.

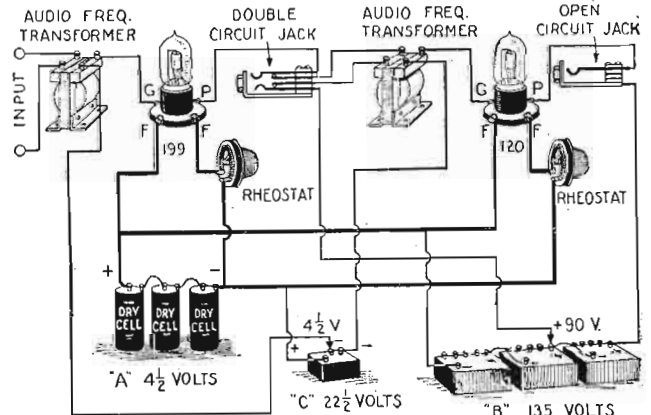

About "Cavalleria" and WRNY

By CHARLES D. ISAACSON, Program Director WRNY



"LA MOINEAU"
The Sparrow, from Montmartre, France—the wildest who ever went on the air over WRNY.



DR. FELIX ADLER
Founder of Ethical Culture, who made his first radio address on its Golden Anniversary through WRNY.



VIOLA BLANCHEY
Fine coloratura soprano, who is frequently heard over WRNY.



Clarence Bloemker
The St. Louis tenor, has a fresh, rich voice. You will hear him often at WRNY.



EVA SOBLE
Petite prima donna of the Music Box, whose oriental songs are heard over WRNY.



RENE FONCK
French ace of aces, who is flying from New York to Paris, spoke at WRNY, coming and going.



JUDSON HOUSE
who starred in "Cavalleria Rusticana" during the Edison Hour at WRNY.



MONA MORGAN
Gave Shakespearian interpretations at WRNY. She has starred lately with Walter Hampden.

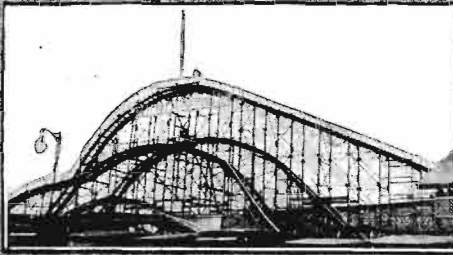

THE THRILLING "THUNDERBOLT"
The roar of this Coney Island attraction went on the air over WRNY.

INTERMEZZO from Cavalleria Rusticana—requests come again and again for that famous melody to WRNY. Hand organs grind it out and everybody sings it. And so Mascagni's fame goes on and on. Recently we included a whole scene from "Cavalleria" in the Edison Hour, when the Edison Ensemble, Maude Morgan, harpist, and Judson House, American tenor, gave it over the air. So I am going to tell you something about this famous opera. It has only one act, but it brought immortality to its composer overnight.

Pietro Mascagni, a disappointed dreamer, eking out a mere existence teaching music, heard of a contest for one-act operas. Urged on by his ever hopeful wife, Mascagni, a failure, determined to try again. He rushed out the score, and knowing that it was his greatest effort, he dared to imagine he might win. And he did. Heard at Rome, "Cavalleria" was acclaimed by the Italian public. "Rustic Chivalry" (the English translation), was heard all over the world; and little Mascagni found his name alongside Verdi, Beethoven, Mozart. While Mascagni has written many operas since, he has never equalled "Cavalleria." But his fame will endure through this true masterpiece of genius.

STORY OF THE OPERA

The scene is laid in Sicily on an Easter morning. Facing the cathedral is the inn of
(Continued on page 178)

FRANCE AND AMERICA MEET AT WRNY
WRNY's radio ambassador, Georgette Nyrielle, with France's consul-general, Maxime Mogendre, and Mt. Isaacson.

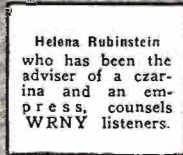

Helena Rubinstein
who has been the adviser of a czarina and an empress, counsels WRNY listeners.



Hon. Joab B. Banton
District attorney of New York, who delivered an address on the constitution in WRNY's legal series.



Berton Churchill
"Alias the Deacon." is a delight to WRNY fans in his interesting character sketches.



Ferruccio Corradetti
Veteran singer and instructor, who retains a youthful voice at 65, a regular at WRNY.



Vladimir Graffman
Genius of the violin, and his artist students, are a fortnightly treat broadcast by WRN. Y.



MARCELLA GEON
Well known for her fine accompaniments and instruction, is directing a concert series at WRNY



Will Irwin, the famous author, with the Man of Mystery, before WRNY's microphone at the McClure's dinner.

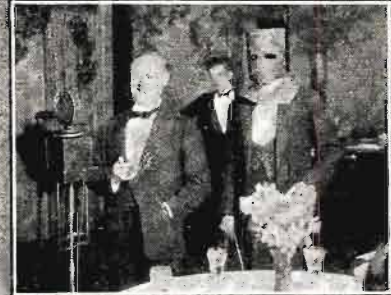



The Radio Beginner



Are Portable Sets Really Practical?

By A. P. PECK

ABOUT this time of the year, the really enthusiastic radio fan often propounds the above question. The answer today is, emphatically, Yes! Three, or even two years ago, such an answer could not be made definitely without quite a lot of qualification; but the advancement of radio in the past two years has been so great that today portable sets are entirely practical and can be made in various sizes, shapes and styles, to answer any purpose. We shall show the radio fan how portable sets can be made even more practical, and how they can be used to the greatest advantage; home-made sets and other details of importance will be touched upon. If you are at all interested in taking a set away with you on your vacation, or want to have a useful set on week-end trips, read on.

When considering users of portable receivers, three distinct classes must be taken into consideration. First, we have the person who travels by automobile; he is the most fortunate because with him weight does not have to be considered, and any desired type of set can be employed, if it is of reasonable proportions. The second is the "hiker," or person who travels by foot, who must economize every ounce of weight and cubic inch of space. His problem is exactly opposite to that of the automobilist. The third is the person who travels by train or other public conveyance, whose problem may be likened somewhat to that of the hiker, although the two cases are not absolutely alike. Therefore, before considering the type of portable receiver to buy or to construct, let us decide in just what way it will be transported.

If the automobile is to be the conveyance,

you can take along any type from a simple crystal receiver up to the largest of super-heterodynes. If you are going to travel by foot, a very small and compact crystal receiver together with a portable aerial, will be quite satisfactory. Obviously the hiker will not travel very far from the large cities, and therefore will always be near to broadcast stations. A crystal set will serve his purposes nicely. The vacuum-tube fan will undoubtedly want to build a small set using one or two tubes and dry-cell power supply.

For the traveler who uses public conveyances, a three-tube set of small and compact dimensions will be found quite satisfactory; and by judiciously selecting the apparatus, tubes and batteries to be used, the smallest possible amount of weight will be added to the traveling equipment.

The portable radio sets illustrated here will give the reader a very good idea of the type of receivers in general use today. It is exceedingly difficult for one not acquainted with the specific conditions and individual requirements to advise exactly the type of set that must be used. Only general suggestions can be given.

IMPROVISING A PORTABLE ANTENNA

The writer once heard a story of an absent-minded but resourceful radio fan which is well worth passing on. It seems that this fan spent several weeks prior to a trip into the mountains in his car, in designing and constructing a portable receiver. Joyfully he tried it out at home and found it to work to perfection. Accordingly it was bundled into the car and he started off in high spirits. The site of the camp for the first

evening was duly reached and, as soon as preparations for supper were under way, the portable set was unpacked. It was a beautiful affair, using a three-tube circuit and very compact. When it came to the actual setting up of the set, he found that no aerial and ground equipment had been provided. He was many miles from the nearest town and it looked as though no radio entertainment would be available that evening.

However, even though this fan was absent-minded he was somewhat ingenious. On searching through his tool box, he discovered several lengths of wire. He fastened one end of a length under a bolt head on the body of the car and clamped it firmly in position, making good contact with the metal. The other end of the wire was fastened to the antenna binding post of the set. Another piece of wire was fastened to the ground binding post and its other end, bared for a space of three or four inches, was thrust into a moist spot in the ground. If necessary, he could have poured several pails of water over the ground. However, with this makeshift antenna and ground he soon had the radio set working and enjoyed a pleasant evening.

This demonstrates graphically, how a little ingenuity will aid you in operating a portable set. It does not require a very great stretch of imagination to suppose that the above mentioned fan always "forgot" his antenna in the future and employed the body of the car in this capacity. However, while a crude antenna system will give fairly good results, it is much better to be equipped with one that is really good and that will deliver

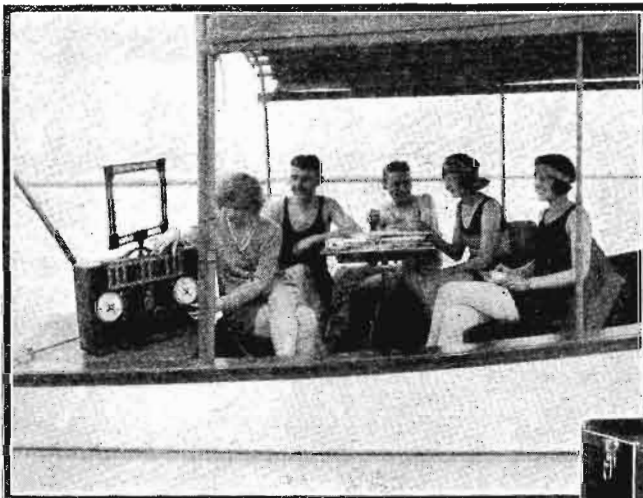
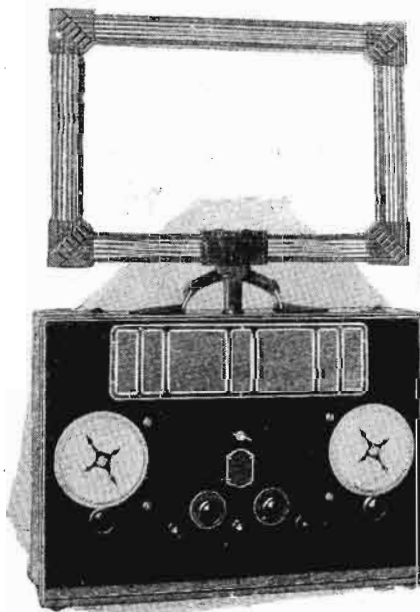

Boating or swimming to the strains of a jazz-band, brought to the spot by a portable receiver, is a mighty pleasant way to spend a summer's day.

Photos courtesy of Radio Corp. of America and Operadio Corp.

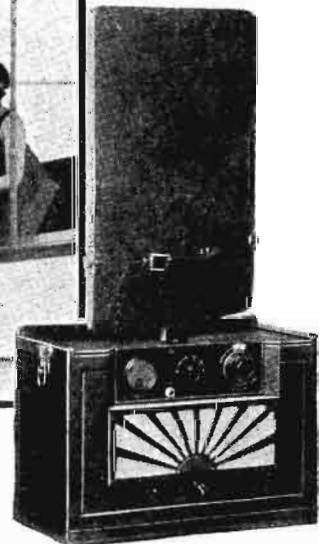



A portable receiver which has a built-in speaker and is easily carried on a trip. Photo courtesy of Ozarka, Inc.

the best results. If you have such you can even amuse yourself, during the later hours of the evening, by trying your hand at tuning in DX. An excellent type of antenna for portable receivers is made by pressing into service a metal tape of the type that winds up on a drum and so takes up but little space, together with a couple of insulators for suspending the two ends. You can undoubtedly find a nearby high spot, such as a tree, to fasten one end; and the other can then be brought down to a point near the set. A short piece of flexible wire with a clip on one end provides a lead to the set.

In case you are one of those radio enthusiasts who like to have everything of the very best, you can make up your own portable antenna by procuring about one hundred feet of $\frac{1}{2}$ -inch brass ribbon, about No. 20 gauge, and winding it on a spool similar to that used for a cloth or steel tape measure. Such a portable antenna will give the best of results, and furthermore, it will not rust, which is a big advantage, particularly as a portable antenna is to be used under all kinds of climatic conditions.

However, brass ribbon or surveyor's steel tape costs more than ordinary copper wire. Therefore, if you want to exercise a little economy, you can do so at the expense of convenience by merely carrying a 100-foot roll of No. 16 or 18 bare copper wire. This can be strung up between any two convenient points. The small wire is advised because it will not have to stand the stresses that are part of the everyday life of the ordinary permanent antenna, and will provide a smaller and lighter roll. Again, provide two small insulators as part of your equipment so that your antenna can be properly strung. With the bare copper wire it will usually be found possible to lead your wire directly to the set, eliminating the flexible lead with the clip mentioned above.

CONVENIENT GROUND CONNECTIONS

One make-shift ground has been described, but others can be used. Provide two feet of $\frac{1}{4}$ -inch copper or brass rod, sharpened at one end: a short length of flexible wire should be soldered to the blunt end of this rod, with the other end scraped of its insulation and connected to the ground binding post on the radio set. With a good sharp point on the rod, no trouble should be experienced in thrusting it for its full length into the ground. Thus a far better contact will be established than is the case with only a few inches of comparatively small wire.

If you are going to use your portable set at the sea-shore or near a lake or stream, you have an ideal location for a ground connection. The rod just mentioned can be laid in the water resting on the bottom, and it will give a good ground connection; or any old piece of metal, such as a tin can, can be used for making ground connection in water. Twist the wire leading from the set to the ground firmly around some projecting portion of the can, and sink the can to the bottom. This makes an effective

ground connection when used in salt water, or even in fresh water lakes and streams.

LIGHTING-WIRE CONNECTIONS

While the above described make-shift antennae and grounds are quite satisfactory from the standpoint of the person who is traveling by automobile or by foot, the radio fan who is going to spend his vacation at hotels will find few of them suited to his needs. However, in all but the smallest of small-town hotels, electricity is used for lighting purposes, and the traveler can use the electric light circuit in the room for providing his antenna. The condenser plugs used as antennae give quite satisfactory results; by merely twisting a piece of wire around a projecting portion of one of the light fixtures and connecting the other end of the wire to the antenna binding post of the set, a substitute antenna is obtained which will give surprising results. The writer has used one in his own home several times for testing out sets, and finds it to be good, but not quite as efficient as a well-made outside antenna of the permanent type.

As to the ground connection for use indoors in hotels and similar locations, it will usually be found that a water pipe is available. For the purpose of making a ground connection the traveler should provide a piece of flexible insulated wire, at least twenty feet long, and fasten a large battery clip to one end of it. It is then a very simple matter to scrape a little of the paint from an available water pipe and fix the clip firmly to the portion so exposed. This procedure can also be carried out with a steam or hot water radiator, fastening the clip to any convenient part of the system.

TUBES AND BATTERIES

While a small radio set in itself does not weigh very much and is not a particu-

larly great burden, still when it is fully equipped with the necessary tubes, batteries and some type of loud speaker, the weight is greatly increased. It is of course necessary to exercise judgment in the selection of these parts, so that the weight and volume will not be increased beyond the limits set by convenience.

The automobilist can disregard the "A" battery when equipping his set, because the storage battery in the car may readily be employed for furnishing the "A" current. It is necessary only to provide a pair of flexible leads, of length sufficient to reach from the set to the car battery, with a large battery clip fastened to each. These clips are then employed for making good firm contact with the battery terminals. Most cars in operation today employ standard 6-volt batteries; and therefore, such a current supply can be employed for operating UX-201A tubes or 6-volt power tubes. In the case of a 12-volt storage battery, one of the clips can be fastened to the end terminal, and the other clip to the terminal of the third cell up from that end, thus supplying 6 volts. If UX-199 tubes are used, the storage battery of the car can again be employed, with only two of the cells connected in the circuit. For $1\frac{1}{2}$ -volt dry cell tubes, one cell of the car battery can be used; but care must be taken not to advance the rheostat too far, as otherwise the tubes may be burned out. This is also true when using UX-199 tubes on the 4-volt source of supply.

As to "B" batteries for the automobilist, the size is not so important as the weight and need not be given very great consideration. Of course, the larger size of "B" battery will give longer and more satisfactory service under all operating conditions.

For the hiker or the traveler who must carry his set for comparatively great distances, UX-199 tubes are by far the most de-

(Continued on page 186)

When packing the camping equipment, remember that a portable radio set with a convenient loop will provide amusement and entertainment, as well as keep you in touch with the world.

Photos courtesy of Radio Corp. of America



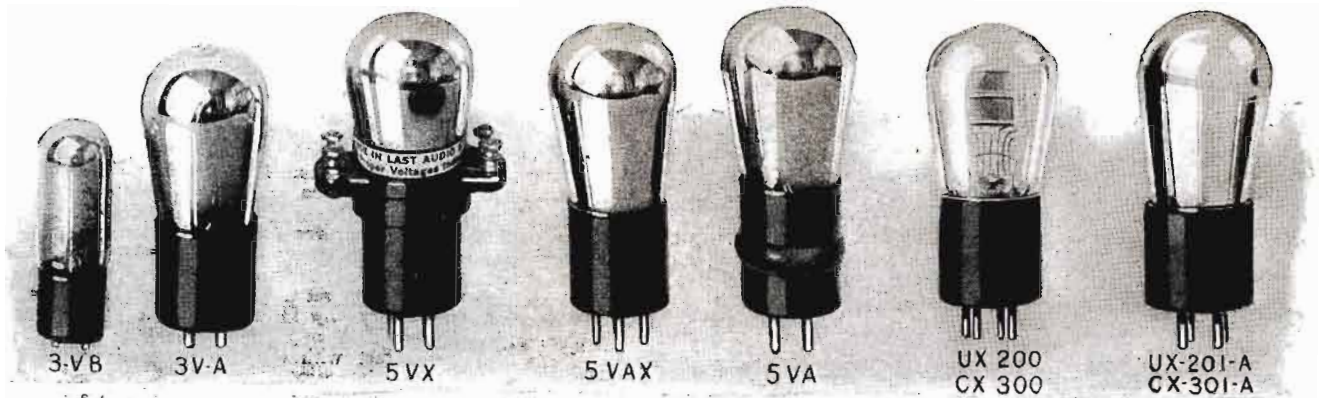

The characteristics of these vacuum tubes are given in the vacuum tube chart on page 122. The first tube is of the dry-cell type, requiring a 4½-volt "A" battery for lighting the filament. 3V-A is a standard 5-volt tube. 5VX is a power amplifier which can be used in the last stage of any audio-frequency amplifier. There is no necessity of changing any of the wiring in the set for the addition of more "B" battery, as binding posts are included on the tube itself. 5VA has a sponge rubber ring included as a part of the base which tends to absorb all vibrations which might otherwise cause the tube to become noisy. The next type of tube is for use as a detector only. The last is the well-known 201-A type, which can be employed as a detector or an amplifier.

Vacuum Tubes and Their Uses

By M. L. Muhleman

We believe this article on vacuum tubes to be of particular value at this time when so many changes and improvements have been made in receiving circuits and especially audio frequency amplifiers. Mr. Muhleman has included a non-technical explanation of the operation of the vacuum tube which should be of considerable interest to the layman.



MANY years ago Thomas A. Edison discovered that the filament of an ordinary electric light bulb emits a steady stream of "electrons" when in a state of incandescence. To put it more clearly, exceedingly minute electrified particles of the filament are thrown off into the evacuated space within the bulb and bombard the glass enclosure. This is known as the "Edison effect."

Dr. J. A. Fleming, an Englishman, found a very important use for the Edison effect. He invented the two-element vacuum tube, commonly known as the "Fleming Valve." This device is nothing much more than a specially-constructed electric light bulb with a thin metal electrode placed near the filament. There are three wires on the outside of the bulb, the two filament leads and the one from the metal electrode, which today is called the "Plate" in America and the "Anode" in Europe, where the filament is known as the "Cathode."

The theory of the operation of the Fleming Valve is comparatively simple. An electron stream is conductive, that is to say it forms a very good path for an electric current. Since the metal square or plate is bombarded by the electrons from the fila-

ment, if we connect the positive terminal of a battery to the plate and the negative

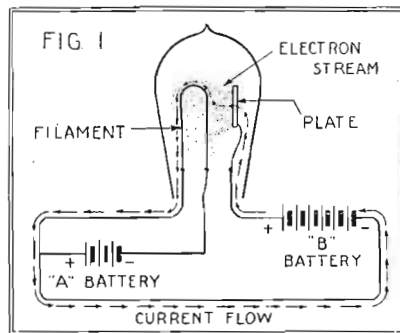

A sketch demonstrating the action of the original Fleming two-element vacuum tube. The electron stream from the lighted filament bombards the "plate" and provides a path for the flow of current from the "B" battery. This was the first and simplest form of vacuum tube. The above circuit diagram as well as others in this article, shows the flow of "B" battery current from plate to filament, or, from positive to negative, in the conventional manner. As a matter of fact, the flow is from the filament to the plate, or from negative to positive.

terminal to one of the filament wires, two things will happen: first, the major portion of the electron stream will be directed towards the plate as the positive voltage of the battery attracts it; and second, a current will flow. Fig. 1 serves to illustrate the action. Every time the filament is lighted by the current of the "A" battery, current will flow from the "B" battery, as a complete circuit is provided by the electron stream.

It is unfortunate that the terms "negative" and "positive" were confused in earlier days. It was formerly assumed that the flow of a current was from positive to negative. Actually, the flow is from negative to positive, as can well be understood if it is remembered that electrons are negative charges of electricity. Thus, the presence of a large number of electrons creates a high negative potential. It is apparent then that a positive potential is nothing more than a relatively smaller number of negative electrons. The high pressure side then is always negative and consequently the flow of current is toward the positive pole or low-pressure side. Enough for the basic action of the Fleming Valve.

THE THREE-ELEMENT VACUUM TUBE

Some years later Dr. Lee de Forest added another element called the "Grid." Thus was born the three-element tube or "triode" named by de Forest, the Audion. With the addition of the Grid in the vacuum tube, things started to happen. The underlying theory as applied by Edison and Fleming remained the same. The tube functioned in the same way; but the Grid, a little wire mesh interposed between the filament and plate, made possible increased control of the current flowing from the "B" battery.

Let us consider the action. Fig. 2 shows the three-element vacuum tube connected up in the conventional manner. Assume that the filament is lighted. We know, then, that current is flowing out of the "B" battery as it is evident that the open-work grid does not materially obstruct the stream of electrons. However, if we connect the *negative* terminal of another battery to the grid lead the electrons will be repelled by the grid so that comparatively few will manage to reach the plate. Consequently the path of the electrons is less conductive, and

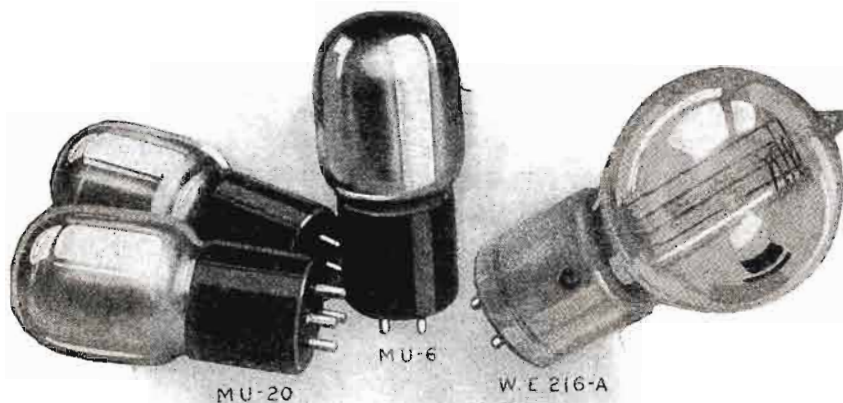

The MU-20 tubes shown above are designed specifically for use in resistance- or impedance-coupled A.F. amplifiers. They have an exceptionally high amplification factor and a high output impedance. Both the MU-6 and the W.E. 216-A are power amplifiers for use in the last stage of any type of A.F. amplifier. They both have a low output impedance.

less current can flow from the "B" battery. If we connect the positive terminal of the "C" battery to the grid, however, the electrons will be attracted by it, in the same manner as they are by the plate, and the stream will be increased. In this case the grid assists the plate in the work of attracting the electrons, and as a result a greater current can flow from the "B" battery. The extent to which the electron stream is affected is dependent upon, first, the voltage of the "B" battery and, secondly, on the positive or negative voltage of the "C" battery.

Now let us apply the Audion or three-element tube to a radio receiving circuit, so that we may review briefly the fundamental operation. We will leave out many details, as we wish only to describe the simple functions of the three elements. Let us turn our attention to the circuit diagram of Fig. 3. We have relieved ourselves of the "C" battery for the time being and connected the grid of the tube directly to the antenna circuit. The filament is lighted and a steady current is flowing out of the "B" battery. Until a voltage is impressed on the grid, there will be no variation or fluctuation of the "B" current, and consequently no sound in the head-phones, which are connected in the plate circuit. However, as soon as the antenna system picks up energy from a passing radio wave, the energy is impressed on the grid as an alternating voltage. Immediately the electron stream is affected, which in turn causes the current from the "B" battery to fluctuate. For every little change of voltage on the grid there is a large variation of the "B" battery current or "plate current" as we call it. Since the current induced in a radio receiving circuit, from a radio wave, is constantly changing its direction of flow, the voltage impressed on the grid is at one instant negative and at the next instant positive. Therefore, the flow of plate current is less at one instant than it is the next. The flow of plate current never changes its direction, it changes in degree only as indicated; yet it is always a faithful reproduction of the variation of the original radio wave.

THE THREE FUNCTIONS OF THE TUBES

If the vacuum tube is functioning as a radio-frequency amplifier (that is, increasing the strength of the radio currents before they have been made audible) the plate current produced will resemble the original impulses in form, as shown in Fig. 4A, and will be dissimilar only to the extent that all current variations will be positive.

If the tube is functioning as an audio-frequency amplifier (that is, increasing the strength of the currents after they have been made audible) the plate current variations

These power amplifier tubes are designed for use in the last stage of an audio frequency amplifier. On the left is a dry cell tube which requires a 4½-volt "A" battery. The center tube employs exceptionally high "B" battery voltage, and is usually employed with an amplifier that operates from the house current. This tube can also be used for transmitting purposes. The right-hand tube is of the storage battery type and has a very rugged filament. It makes an excellent detector tube as well as a power amplifier.

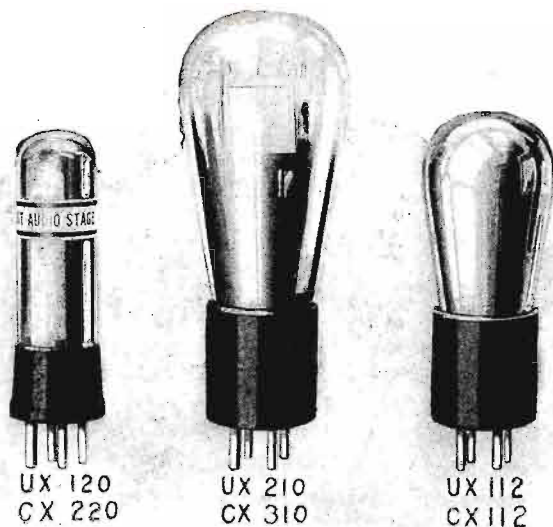

will be exactly the same as the grid variations but much larger in amplitude. Fig. 4A again serves as an illustration. In this case all voltage variations impressed on the grid are positive and not an alternation from positive to negative as in the case of the radio-frequency voltages.

circuit gives response to positive voltage variations only, so in effect, the negative half of each cycle of the radio-frequency current eliminated. Fig. 4B shows the result.

PRESENT-DAY VACUUM TUBES

Present-day vacuum tubes operate on exactly the same principle as the original Audion. They have, however, been greatly improved in construction. The elements are made of better materials and their designs have been made more efficient. Furthermore, the process of evacuation, which in the past was one of the most difficult problems, is now quite simple and far more effective. The devices employed in modern vacuum-tube factories insure nearly a perfect vacuum, which is so important a factor in the operation of the vacuum tube. Filaments have also been improved and present types take less current to light and supply a greater electron emission.

Through diligent research work, engineers have found that a "one design" vacuum tube cannot be the most suitable for all purposes. Today we have special tubes for radio-frequency amplification, for detection, and for audio-frequency amplification, including some of large size to which higher power may be applied. Though most of them look quite the same, they have different "characteristics." The size and the shape of the elements and the distance between them have more to do in determining the characteristics of the tube than anything else.

If you want the best of results from your receiving set it is important that you know "what is what" in the way of tubes.

"CHARACTERISTICS"

The average radio fan loses courage as soon as he is confronted by the word "char-

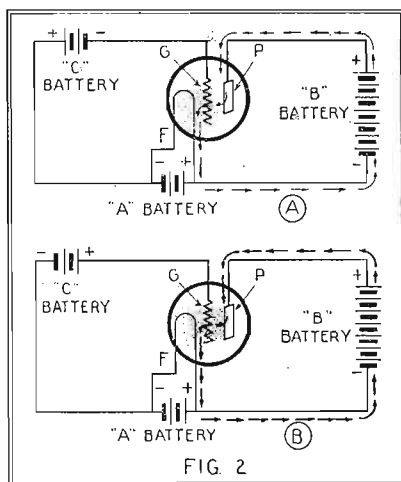

FIG. 2

Illustrating the effects of a positive and a negative "C" battery voltages on the grid of a vacuum tube. When the voltage is negative, as shown at A, the "B" current flow is low, as the flow of electrons to the plate is greatly reduced. When the grid voltage is positive, however, as shown at B, the electron stream is increased and consequently the flow of "B" current is greater. This explains why the use of a "C" battery lengthens the life of "B" batteries.

The action of a vacuum tube employed as a detector is a bit different. It is known that before anything can be heard in the head-phones or loud speaker the radio-frequency currents must be "rectified." In order to actuate the diaphragm of the phone or the speaker there must be a series of impulses or fluctuations in the plate circuit of the detector tube. To obtain these it is necessary to block out or eliminate every other half cycle of the alternation of the radio-frequency current. This is accomplished by maintaining the grid at a negative voltage, in one manner or another, so that all negative variations of the radio wave cut the flow of plate current practically to zero. To elucidate: since the grid is already negative, a negative voltage variation will make it more negative, thus reducing the electron stream to the plate. A positive voltage variation, however, will tend to decrease the negative value on the grid, thus increasing the electron stream and the flow of plate current. It is seen, then, that the plate cir-

A new storage-battery type power amplifier tube, for use in the last stage audio amplifier only. This tube takes the same filament voltage and filament current as the No. 112 tube shown above, but employs a "B" voltage of 180 and a 40½-volt "C" battery. Special means should be provided for handling its heavy output. Two arrangements are shown in Fig. 6.



A new type of detector tube which has greater sensitivity than former types, due to the use of an alkaline vapor. It can be used as a detector in any type of receiving circuit.



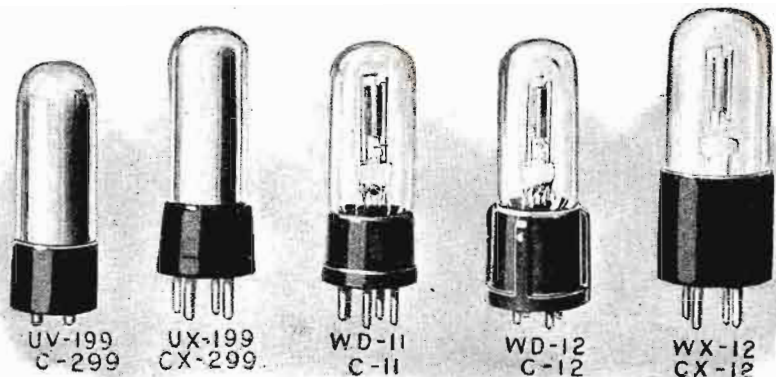

A group of dry-cell vacuum tubes. The first two differ only as to the type of base; both are intended to be operated from a 4½-volt "A" battery, that is, three dry-cells connected in series. The filaments draw very little current, as can be determined from the chart. The last three tubes also have identical characteristics, but are designed to fit different types of sockets. These tubes operate from a single 1½-volt dry cell and draw approximately ¼ ampere of current. The filaments are oxide-coated and very rugged.

The 4½-volt tube is the more economical of the two, as it requires less filament current than the 1½-volt type. Though it has not the high-amplification characteristics of the larger type storage-battery tubes, it is a most excellent detector and radio-frequency amplifier and a fair audio amplifier. Included in this class is a recent arrival, also a 4½-volt tube but which draws only ¼-ampere of current for the filament; it is designed for use in the last stage of audio-frequency amplification. It is virtually a power amplifier. The use of one will relieve the difficulty experienced in obtaining good volume without a loss in quality when employing the regular type of 4½-volt tube.

The second class includes all the common forms of tubes designed to operate from a storage battery. Most of them have thoriated filaments and require only ¼-ampere of current. The exceptions are those with oxide-coated filaments, drawing usually ½-ampere of current, which are designed for use as power amplifiers. The characteristics of the latter type are such that they make

acteristics," for he fears that directly follow- that there are two distinct classes of vacuum

Making a Business of Inventions

By L. T. PARKER*

The advice set forth herein, by a man who knows the various pitfalls that inventors are liable to encounter, should be well digested by anyone who does or may do serious experimental work.

THE old saying, "There is money in almost anything—if the business is operated properly" is worth considering deeply by persons who desire to accumulate money from patented inventions.

A general knowledge of the patent laws is not so difficult to acquire as the average man seems to think. Such knowledge will enable inventors to distinguish the proper procedure of making patents pay.

Unfortunately, most of them today do not know the fundamental principles of determining whether, for instance, a particular device may be patented, or whether one invention infringes upon another. Yet no great amount of study is required.

Familiarity with the patent laws would have benefited many of those individuals who have overlooked opportunities of protecting profitable things. No doubt many present-day radio experimenters have vague ideas of what things are patentable; perhaps some of them have discovered valuable things but failed to secure the protection which they are justified in obtaining through the patent laws. Persons who actually discover and invent some advantageous things, injure not only themselves by failing to obtain patents, for the public often is deprived of the benefits of the uses of such things.

WHAT IS PATENTABLE?

The most common question among inventors is "can I obtain a patent on my invention?" It is not difficult to answer such a question, at least with fair certainty of correctness. Is the invention new and useful? If so, generally a patent can be obtained. It does not matter if the parts are old, provided they are arranged in a new and beneficial manner.

Sometimes merely changing the material of a well-known article will produce far superior results.

A patent can be obtained on a combination of old elements; the main requirement is that the old elements must operate together to produce a new and useful result, different from those obtained by their separate use.

large one. Altogether, the outcome depends upon many things. The main thing for the average inventor to remember is not to overlook the simple ideas. If the invention is new and useful, the chances are, it is patentable.

PROTECTION OF PATENTS

The matter of infringement is another subject of importance to inventors. The important thing to remember is that the courts are in favor of giving the decision to the inventor, when it is possible to do so. Of course, there are numerous hearsay cases of which it is said inventors are robbed of their inventions, but when these instances are investigated, it will usually be learned that the patent itself was not sufficiently strong to justify the courts in upholding it.

It is not a simple matter to avoid the infringement of a valid patent, provided it is a strong one, properly worded. The long and well-known litigation between Drs. de Forest and Fleming relative to the audion patent is a fair example of the assertion that the courts are partial to inventors who are deserving. Although Dr. de Forest actually improved the usefulness of the audion to a

vention. And this is true even though adding to it is a material improvement of the original patented article. The law permits persons to make identically the same patented device if a part is eliminated, but it will not permit other inventors to make the patented thing plus one or more additional parts. There is no question that the Super-Heterodyne is an improvement on the Heterodyne, but nevertheless the former is considered an infringement of the latter. And this is a fact even though the Heterodyne was not originally intended to cover concert reception.

All of these things are very important for inventors to know. The business of inventing things has been very profitable to many folks. But in a sense, it is a business and to succeed in any business requires knowledge of certain important principles. An experienced inventor realizes the necessity of knowing the fundamental principles of the business without having to consult a patent attorney in every instance.

NECESSITY OF KEEPING RECORDS

Marconi has made a very complete study of the patent laws, and he is able to distinguish whether or not a thing is likely to withstand patent litigation. This knowledge is very evident when a history of the wireless invention is given consideration. Furthermore, he won his case in the face of heavy odds, simply because he had carried on the work of invention in the proper way and made records of every experiment, so that these were at hand to convince the courts as to the earliest time when the invention was conceived.

That is another very important thing for all inventors to remember. Never make an experiment without keeping a complete record of every thing that is done; and then follow it up with a detailed description of the results which are accomplished. Then

these records should be signed by a few reliable friends, as proof that the dates are positive, and not faked. Not only are records a good thing to have for the purpose of proving priority, but many times an experi-



An important thing for inventors to remember is to keep records of every experiment performed and have them witnessed at the time.

great extent, yet his use of it was declared to be an infringement of the Fleming

Radio and the C. M. T. C.

By CAPT. JOHN L. AUTREY*

Every young man who reads these words is interested in radio—and in this article is told how you can get instructions from the best teacher in the country, Uncle Sam.

THE Citizens' Military Training Camps this summer offer to qualified radio fans an exceptional opportunity to learn, at no personal expense, something about modern receiving and transmitting equipment. The great Signal Corps school at Fort Monmouth, N. J., where the Army's radio laboratories are located, will be open to interested young men between the ages of 17 and 24, for thirty days beginning August 6. In other parts of the country, too, are camps devoted to the various phases of military communication, including radio's companion subjects, telegraphy and telephony.

The most advanced of the courses, however, will be held at Fort Monmouth, the

and in many instances has actually led the field. New circuits and new sets are constantly being built or experimented with, in an effort to bring radio into as perfect a state as possible; and amateurs attending the camps are willingly given the benefits of these studies.

The majority of amateur transmitters already know that they have a decided friend in the Signal Corps. Accordingly, they are eagerly working hand in hand with the army in forming a communication net extending over the entire country. Such a plan was approved by the War Department a year ago, and the affiliation of civilian amateur transmitters with the Signal Corps has gone forward apace.

be mobilized with the greatest possible dispatch in time of war or other national emergency.

(c) To provide a reservoir of radio operators trained in army methods and in the basic principles of the army's methods of using radio in the field.

The agencies employed in this undertaking are the Regular Army, the National Guard, the organized reserves and the transmitting radio amateurs. The work is decentralized, and controlled by the corps area signal officers. The following is a general outline of the plan of action:

ORGANIZATION OF THE NETS

There will be organized in each Corps Area three radio nets, with amateur stations representing each military unit concerned:

(1) A corps area net, comprising the headquarters of each of its organized reserve divisions, the office of the governor of each state within the corps area, and a headquarters acting as the net control station.

(2) A net for the National Guard of each state to be known as the governor's net, which will comprise all of the National Guard units of that state, grouped into brigade, regimental and such other nets as are necessary to properly provide radio communication.

(3) A divisional net for each of the reserve divisions, with appropriate brigade and regimental nets under its jurisdiction.

The services of the amateur are purely voluntary and do not imply any military obligations. He is not asked to enlist or enroll in any way; merely to signify his desire to participate. Upon designation of his station as an "Army Amateur Radio Station," he is given a certificate by the corps area signal officer which remains in effect for a period of two years.

At the Citizens' Military Training Camps interested radio fans are given the opportunity to familiarize themselves with this plan, and to join the movement if they care to do so. Should sufficient amateurs who attend the camps desire to take the commercial and amateur radio operator's examination, arrangements will gladly be made with the district radio inspector and the examinations held while the camp is in session.

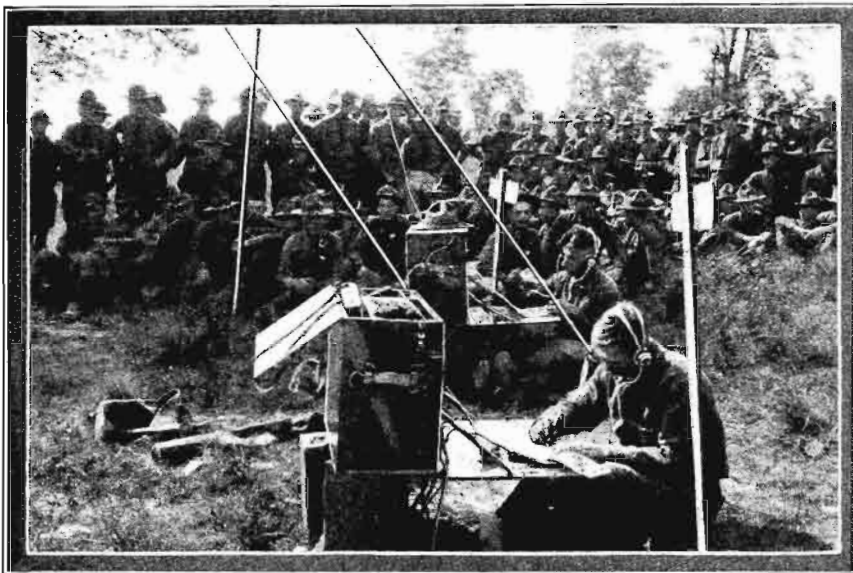

A radio class in the C. M. T. C. at Camp Meade, Maryland.

equipment there being much more up to date and the facilities greater than at other posts. Students will be taught to operate the different kinds of army sets, especially the short-wave loop set operating on the band from 68 to 75 meters. In addition, all amateur transmitters who hold a commercial first grade operator's license will be permitted to handle traffic at 2CXL, the Army amateur radio net-control station.

Complete receiving and transmitting stations will be set up and dismantled in the field, and communication nets will be formed just as they would in time of war. So efficient are army methods, developed through years of experimentation and practice, that field stations can be set up and begin transmitting within ten minutes.

Interesting features of the Fort Monmouth encampment will be the establishment of a radio net for an entire army division in the field, and a visit to the big station of the Radio Corporation of America, WJZ.

SIGNAL CORPS AMATEUR RESERVE

Transmitting amateurs who attend the Signal Corps camps in any part of the country will find the training they receive of great value to them when they return to their own stations. The army has always kept abreast of new developments in radio science,

The most salient features of the plan are:

(a) To provide channels of communication throughout the United States for use in emergencies when ordinary means of communication, such as telegraph and telephone lines, are destroyed by flood, fire, earthquake, tornado or other natural causes.

(b) To provide channels of communication for the civilian components of the United States Army—the National Guard and the organized reserves—so that they can

Receiving practical radio instruction at the Citizens' Training Camps.
Photos by courtesy of U. S. Army Signal Corps.

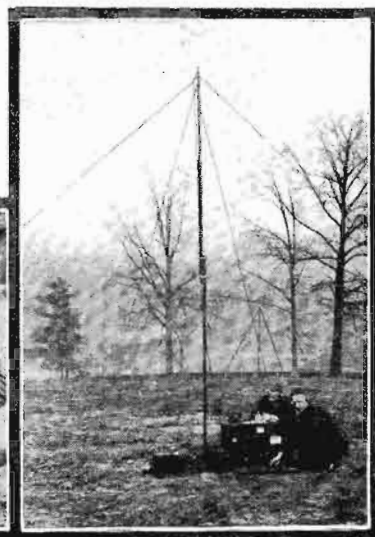

*Signal Corps, U. S. A.

The Broadcasting of Pictures

By Dr. WALTER FRIEDEL

Soon the transmission of photographs and sketches by radio will be no more of a novelty than radio broadcasting of speech and music is today. Dr. Friedel tells of the apparatus he has perfected for the transmission and reception of pictures.



WHILE recent publicity has been given most especially to the problems of electric television, it would be undesirable that we should neglect the progress already made in the broadcasting of pictures. We are in a position to construct comparatively simple and cheap apparatus for the reception of these by radio. Even the transmission of simple drawings will be of advantage. Weather maps will be of the greatest value to farmers, business men and navigators. The value of pictorial broadcast service to the police need not be described.

In addition to this, many things may better be conveyed in graphic form than by the ear. Numbers, as in quotations on the exchanges, are more trustworthy in black and white; many events may be best explained by means of curves and diagrams. With the general introduction of radio-picture receivers, these will become available; and the possibility of transmitting illustrations of educational radio lectures will multiply their value many times. The radio advertiser should find very valuable possibilities along this line.

It will be impossible to prevent the general introduction of picture-broadcasting, and this will help to prevent the saturation of the radio market for new apparatus. If there should be a surplus of the old-type receivers in the market, the manufacturers looking for new markets will produce in large quantities simple, cheap and practical picture reception apparatus.

In their manufacture, contrary to the case with the usual broadcasting, while the transmitting apparatus may be very expensive and complicated, the radio-picture receivers for the public must be inexpensive and easy to operate. This indicates that we should return to the simple methods of picture reception which were invented in the nineteenth century.

CHEMICAL AND ELECTRICAL RECORDERS

The first method employed in connection with the electric telegraph was electrochemical reception of signals: the incoming impulses pass from a metal stylus to a revolving metal cylinder over which a specially-prepared paper is stretched, causing a mark during the duration of the effective current. The use for impregnating purposes of a solution of potassium ferrocyanide (K₄ Fe C₆ N₆) and sodium nitrate (Na NO₃) results in a bright blue ("Prussian blue") mark at the point of contact formed by the passage of a current of 20 to 30 mil-

liamperes. If potassium iodide (KI) made into a paste with starch and perhaps a little calcium chloride (CaCl₂) are employed, a blue or bluish-black color is obtained with the passage of 40 milliamperes of current, and about three hundred signals may be recorded in a second. These markings, however, fade with the evaporation of the liberated iodine.

The disadvantage of this system, however, lies in the friction between the stylus and the moving paper, which prevents the latter from moving at an even speed. This is overcome by using a stylus which is not in actual contact with the paper.

Fig. 1 is a diagram of the amplifying system, relay and recording cylinder of the apparatus last mentioned. The amplified current operates the relay M, which closes the AC circuit and causes the electric stylus, S, to function. It is caused to travel back and forth across the width of the paper on the cylinder, and at each signal impulse a spark jumps from the stylus to the cylinder and

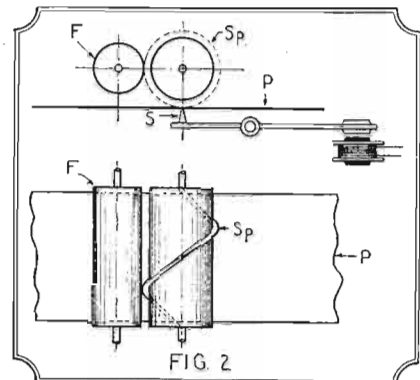

A cylindrical roller with a spiral edge, S_p, is used instead of a stylus in later models.

colored film and a dot of ink is left on the paper beneath.

The mechanical construction of this receiver is not very complicated, resembling that of the old type of talking machines which uses cylindrical records; the cylinder may be driven by a small motor or by clockwork. However, since the cylinder is small and the paper must be changed frequently, it is more desirable to employ a continuous roll of paper fed to the cylinder, so that the apparatus will be always ready for reception.

AN IMPROVED ROLL-FEED RECEIVER

Fig. 2 shows the latter type of construction. In place of the stylus we have a spiral edge, S_p, fitted to a cylindrical roller at a wide angle to the axis. It revolves once for each sixteenth of an inch that the paper advances. The edge is kept inked by the roller F. At every incoming signal, the paper strip P, which is constantly unrolling from one spindle to another, is pressed against the blackened spiral edge S_p at its point of contact with the edge S, which is parallel with the axis and extends across the full width of this paper. By means of this device a picture composed of perfectly straight rows of dots may be obtained, though all the parts of the apparatus are constantly moving. A great advantage is that the picture can always be easily inspected; and this is of value, because a guide line may be transmitted in order to check up on the synchronism. There are many methods of keeping the receiver in exact synchronism with the transmitter, though this is usually considered to present the principal difficulty. Different methods of synchronizing will be dealt with later.

TRANSMISSION OF MOVING PICTURES

In the transmission of actual moving scenes, the difficulty is to obtain a sufficient amount of light from any one point. The light which is received from one spot of a scene is reflected light, while that employed in the transmission of photographs, for instance, is concentrated light; so that in the latter case the result received may be made as strong as the original. We have the same condition, in principle, when from the transmission of a single picture we advance to that of a series of pictures to give the optical effect of motion. This result from the transmission of moving pictures we may call Telecinematography.

(Continued on page 184)

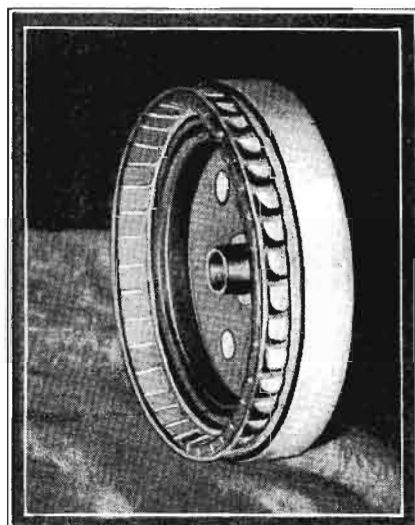

The rotating ring lens, which is a great aid to the efficient reproduction of pictures at the receiving end.

perforates the paper. The picture is formed by the series of perforations thus made.

Dieckmann has improved this method by placing over the paper wound on the cylinder, a thin sheet of suitable typewriter carbon paper. The heat of each spark melts the

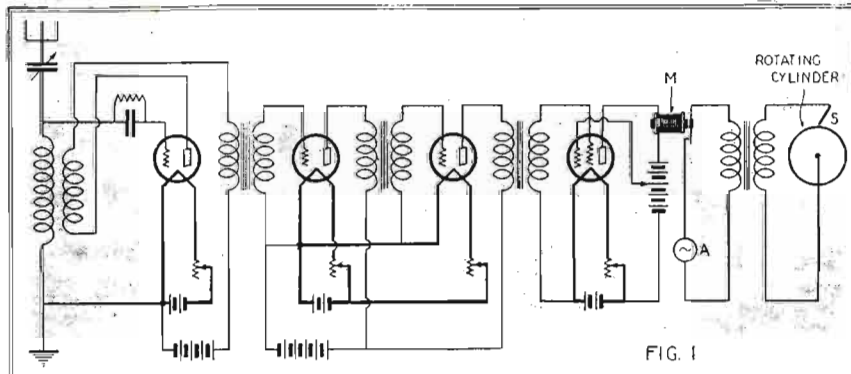

The circuit diagram of the amplifier, relay and recording cylinder of a receiving outfit, of simple construction, utilizing well-known methods.

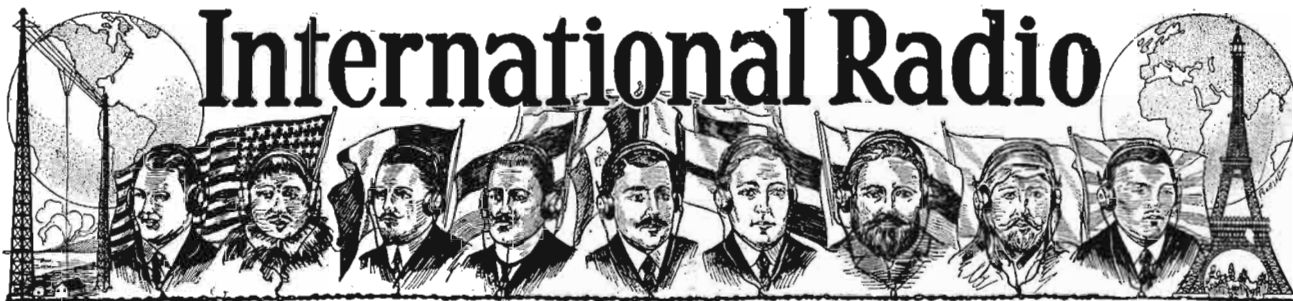

GREAT BRITAIN

A Friction-Drive-Dial Condenser

A new straight-line-frequency condenser with several novel features has recently appeared on the market in England, and is becoming increasingly popular with British B.C.L.s and short-wave hams. The accompanying sketch shows the instrument in detail. It is a thorough engineering job throughout, one of the leading features being that the rotor is mounted in ball bearings.

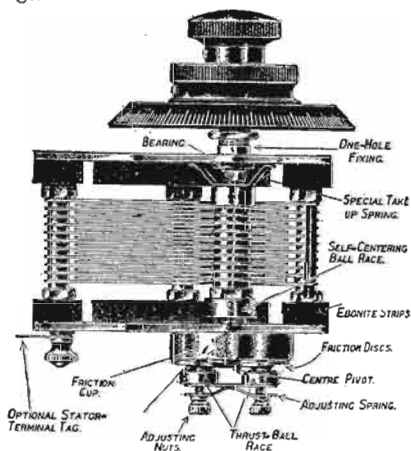

The English friction-drive variable condenser.

Besides the ordinary dial, there is a central knob which controls an excellent slow-motion drive. No gears are employed, the movement being obtained solely by friction, which is absolutely silent and smooth in action. Provision is made for the adjustment of the tension applied to the drive, and this also allows for the taking up of wear.

The three ball-bearings in the instrument are self-adjusting. The rotor is grounded through steel balls under high pressure. The 55-to-1 ratio of the drive is high enough for the finest tuning, yet low enough for easy searching. A direct-drive dial also is provided for rough setting.

This condenser, made by a concern in London, is an exceedingly well-made and well-finished article, selling at a popular price.—A. Dinsdale.

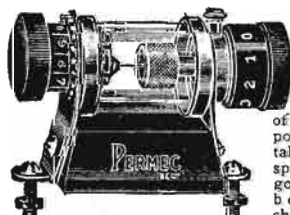

One of the greatest disadvantages that users have experienced with crystal detectors is the loss of the sensitive points in the crystal. If there is a spot through which good signals can be rectified, the chances are very large that it will be almost impossible to find again, once the catwhisker is displaced. The crystal detector shown in the accompanying illustration is so calibrated that once a spot is found, its position can be logged, and therefore can again be located. This is an English invention.



SWITZERLAND

European Radio Conference

An important conference of the various European radiophonic organizations was held at the Palace of the Nations, in Geneva, on March 25 and the following days, to fix the lengths of waves in emissions from the various stations; as at present overlapping is causing confusion, many stations being too close together in wave-length.

In view of the tremendous number of subscribers to wireless centres, some ruling of this kind is necessary. Germany has a million, Austria two hundred thousand, Switzerland thirty-two thousand; and the number of this silent but interested public is growing daily. —L. Reid.

When a portable receiver is constructed which is powerful enough to operate a loud speaker, the selection of this accessory is a great problem. An English firm has placed upon the market a small loud speaker which is only six inches in height and which will therefore fit in the average portable set.



Geneva to Be Radio Switch-board

It is proposed to make Geneva a kind of European centre of wireless, by a switchboard to be established in that city, so that concerts and lectures from various parts of Europe can be turned on to other parts, at request. For instance, London might want to have half an hour of Viennese music, while Berlin might like the Paris Bourse quotations. By centraliz-

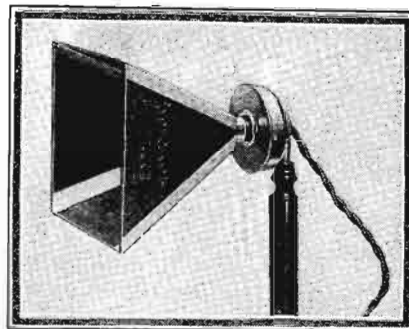

The microphone used by Dame Nellie Melba, world-famous opera diva, in the first important concert broadcast in the world, at Chelmsford, England, June 15, 1920, was improvised out of an ordinary carbon microphone and a cigar box. It now reposes in the museum of the Marconi Company. © Kadel & Herbert

ing everything on Geneva, this kind of broadcasting would be greatly facilitated; as Geneva is establishing communications with every capital in Europe, on account of the needs of the League of Nations in this respect. The same organization would serve, as the League requires it during the daytime; while most wireless transmission services for private persons or for broadcasting generally are rendered much later.

There is considerable hope of an increase in the feeling of fraternity and a spread of internationalism through wireless. Everywhere in Europe children are learning foreign tongues through listening in. The lessons are naturally gratis for all who have radio. If the lesson gets tired. (Continued on page 183)

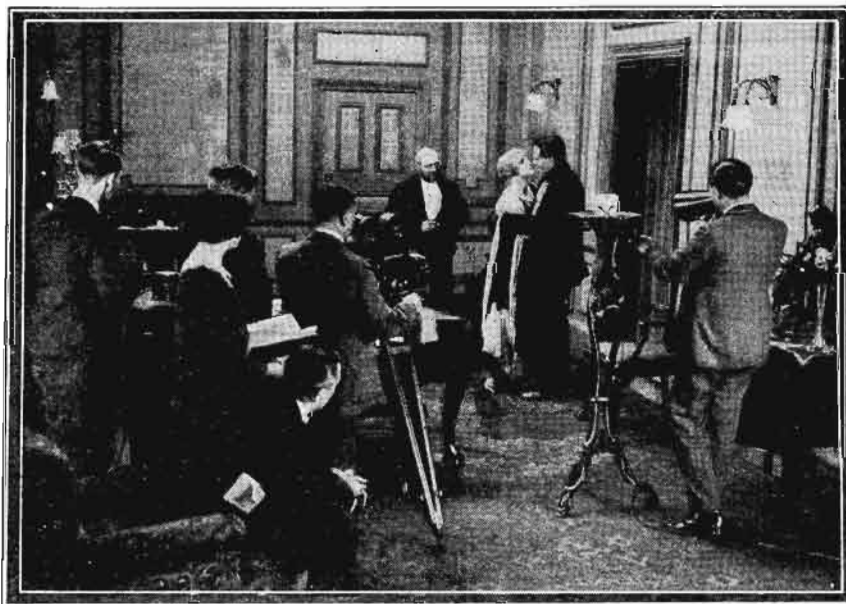

In order to give radio fans an idea of the sounds in a movie studio during the filming of a picture, such an event was put on the air by an English station. © Wide World Photos.

The Manufacture of Modern Radio Receivers

The recent trend in radio set manufacture has been toward making all the component parts, as well as the receiver itself, under one roof.



Above we see a big assembly room, where the units of parts from the various stamping, reeling, and other machines are brought together, and united into complete apparatus by deft operators. Long stretches of benches can be seen in well-lighted rooms, where one operation follows another in quick succession. The suitable routing of assembly work is one of the greatest factors in high-quality and low-cost manufacture today.

Below, a typical punch press department, where stampings are made of all sizes, up to receiver frames and shields.

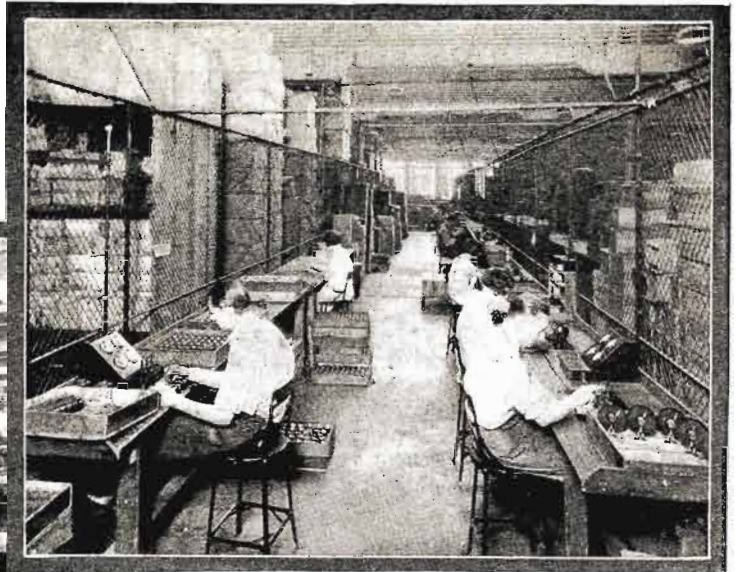
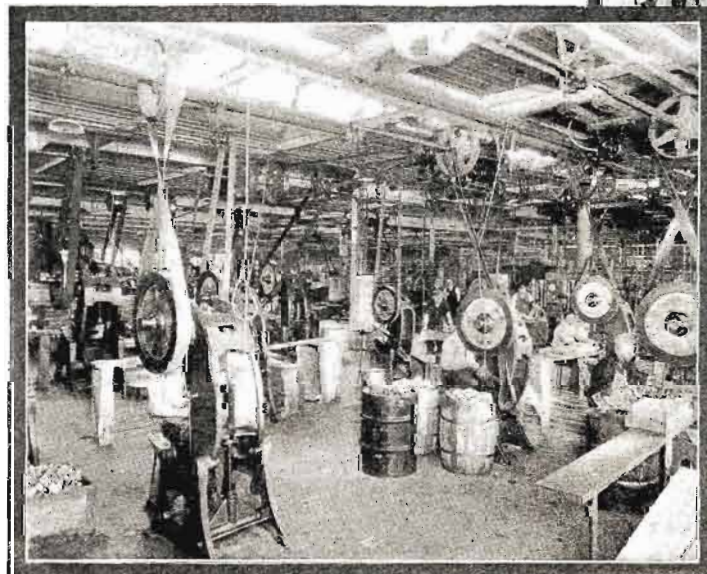

Above is a "testing lane" in one large Western factory. Every coil, condenser, transformer, etc., must undergo a series of rigid tests before it is selected as suitable for incorporation in a receiver.



At the left is shown a testing room for completed receivers. Each set, after it is assembled, must be tested over the broadcast range wave-lengths; actual local and distant reception is obtained to assure that it has suitable sensitivity and volume for distance getting.

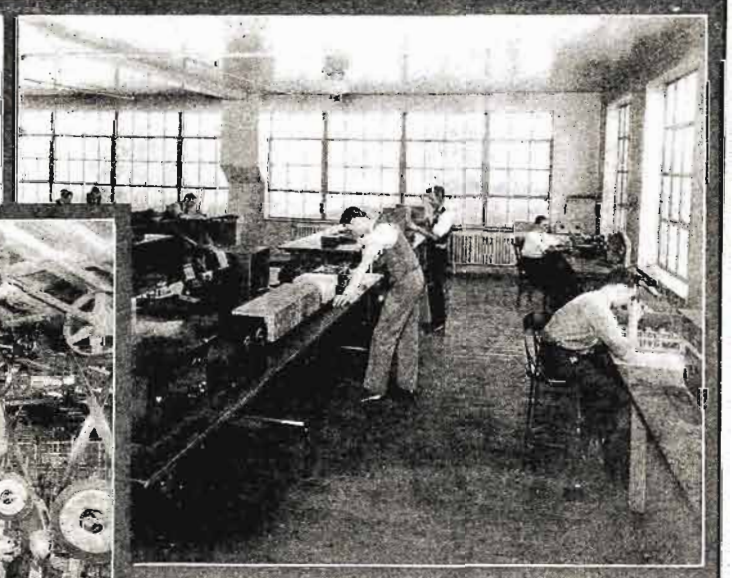

Every modern manufacturer must maintain an experimental laboratory with a corps of radio engineers, to carry on development work, improve old models in the light of the latest scientific discoveries, and bring out new ones. Much more effective research can be done now than was the case a few years ago; when, in many cases, the engineering department was able only to combine commercial parts, which afforded very limited choice.

Photos by courtesy of All-American Radio Corporation.

A Batteryless Receiver

By JOSEPH BERNSLEY

This receiver, constructed in the RADIO NEWS Laboratories, presents a novel and ingenious solution of the problem of battery elimination, which is today in the minds of set constructors. The same unit supplies "A" and "B" current economically.



THE unique arrangement upon which this receiver depends for its power supply involves a departure from the usual hook-up of vacuum-tube filaments. However, a decided advantage in operation and increased simplicity are gained by this innovation, which is sufficient reason for adopting it.

The trend of the past few months has shown an increasing popular demand for self-contained sets, deriving their power from the house-lighting current, simple to operate and giving the owner the least amount of trouble and outlay for maintenance. The receiver described in this article points the way toward the ultimate solution of this problem; and with the advance in tube design toward greater economy is a step toward lower operating costs.

Our readers will find its fundamental principle an excellent one to test out in their own construction and experiments.

NOT so very long ago we all looked forward to the day when it would be a simple matter to construct a receiver capable of operating directly from the house lighting current, without the enormous complications that made the problem then seem so difficult. Although there are at the present time numerous receiving sets which operate from the light-socket, the accessories required are complicated, bulky, and very expensive especially to maintain.

With the above disadvantages in mind,

the writer proceeded to gather together whatever information was available relative to battery elimination. A review of some of the more practical methods has been published in the January, 1926, issue of RADIO NEWS, headed, "Methods of Battery Elimination." Readers of that article will note that the problem of "A" battery elimination requires a considerable amount of material of a special nature; that is, rectifying tubes of a special type are necessary, and choke coils which are of necessity wound with heavier wire to pass safely, without heating, approximately 2 amperes.

Although there are many eliminators constructed in unit form, which may be connected to any receiver, the advantage obtained, that of an easily-made installation, is offset by the fact that two separate units, "A" and "B", are required. This, of course, results in a high first cost, besides the enormous dissipation of energy which must result from two such units, of which the final outcome is a good-sized bill for electric current.

ALTERNATIVE METHODS

Let us first review the various methods which might be employed in constructing this Batteryless Receiver, before giving the reasons why the particular method decided upon appears to be most practical and least complicated. The problem of "B" battery elimination we all know to be very simple at this time, due to the strides made in the commercial production of apparatus, employed in "B" battery substitutes. We have now various types of rectifier tubes which can be used for this particular purpose, the most popular of which are of two classes; one commonly known as "helium-tube" rectifiers, the other type depending upon the "valve action" obtained by an unusually heavy flow of electrons from a large filament to a plate element. Both types are

made so that half-wave and full-wave rectification can be obtained, separate tubes being used for each effect. These tubes, however, can be employed only for supplying the plate voltage and current necessary for a receiver; as the plate current used by a receiving set is usually small and these tubes will safely rectify only small currents. Step-up transformers, choke coils, and filter condensers designed to operate in conjunction with these rectifying tubes can easily be obtained and are commonly known as "B"-battery eliminator parts. The construction of such a device is exceedingly simple, and it usually works without the complications that usually set in some few years back, when the experimenter tried to build a battery substitute and the necessary parts, that made up the device.

"A" battery eliminator devices require bulky, expensive rectifying tubes somewhat similar to those employed in storage-battery charging devices. These tubes consume considerable filament current, a disadvantage sufficient to make the tube unsatisfactory for the purpose.

THE METHOD USED, AND WHY

Those familiar with the elementary principles of electricity, will recall that when we connect cells in *series* the current available from the cells remains the same but the voltage increases; when we connect cells in parallel, the voltage remains the same but the available current is greater. The principle holds true in the consumption of electrical energy; when we place two or more "electrical loads," resistances, or whatever else consumes electric energy, in *series*, the voltage required to operate or make these "loads" perform their necessary functions is higher than that needed when they are connected in *parallel*. The current in the first case is small, in the second case larger, being the total power taken by all the branches together.

Now, if we wire the filaments of all tubes employed in the receiver in parallel, we determine the current necessary to operate them by simply multiplying the current required for each tube by the number of tubes employed in the receiver, assuming that all the tubes are exactly similar. For example, if five tubes are employed in a receiver and the filaments wired in parallel, the total current (for the 201-A type) would be five times one-quarter of an ampere or 1 1/4 amperes. The voltage required for each tube is 6, and therefore this particular system requires 6 volts for all the five tubes. But if we connect five tubes of the 201-A type in *series* the current through all the five tubes is the same, that is one-quarter of an ampere. The voltage required, however, increases to five times that required for a single tube, or, as in this particular case, 30 volts.

The current delivered by the conventional "B" eliminator device is approximately, under normal conditions, 60 milliamperes. If we design a receiving set which will take approximately 15 milliamperes plate current, and wire the filaments in *series*, we can design a power unit which will supply both "A" and "B" battery current. This is made still simpler by the use of tubes whose filament-current is very low; *i.e.*, the 199-tube which draws only .06-ampere.

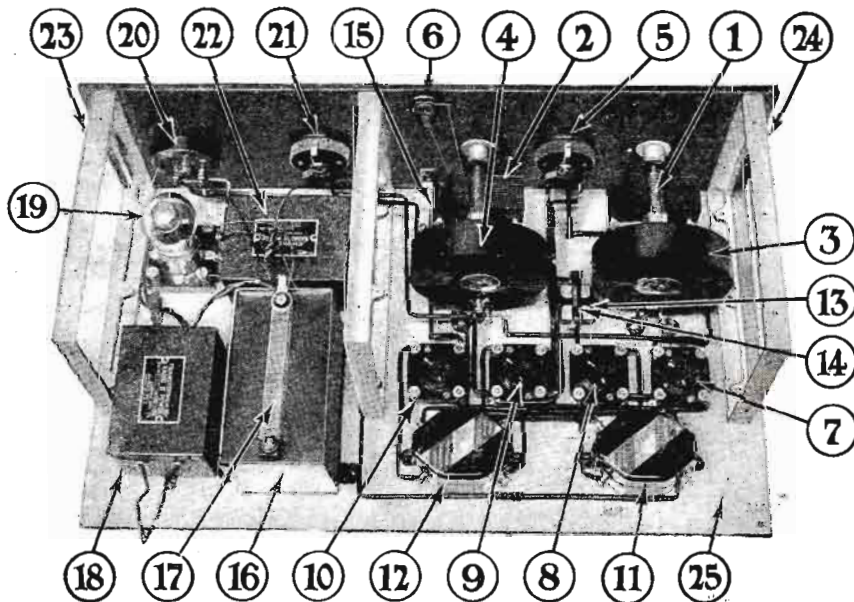

(Fig. A) The interior of the Batteryless Receiver. The three square aluminum brackets serve as a foundation for both the receiver and the shielding, which has been removed to show the various parts. The instruments to which the numbers refer can be easily identified on the large picture diagram opposite this page, except that here 24 indicates the position of the shielding when in place, and 25 the baseboard.

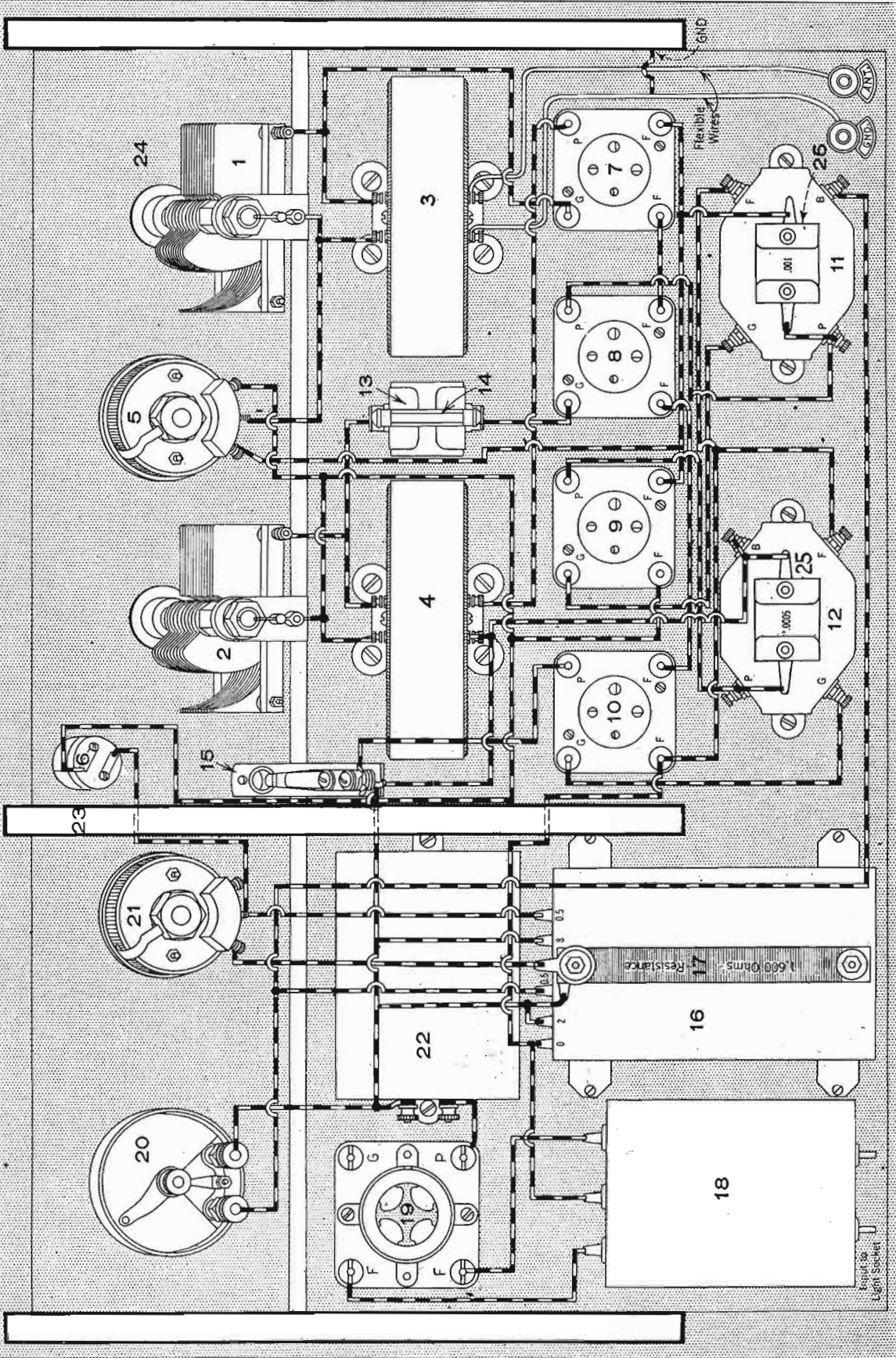

This picture wiring-diagram will help those who are constructing the Batteryless Receiver. Nos. 1 and 2 indicate 00035-ohm variable condensers; 3 and 4, toroid coils; 5, a 400-ohm potentiometer; 6, filament switch; 7, 8, 9 and 10 are UX tube sockets; 11 and 12, audio-frequency transformers, low-ratio type; 13, .00025- μ f. grid condenser; 14, 2, megohm grid leak; 15, single circuit jack; 16, "sp" eliminator filter-condenser unit; 17, 1600-ohm fixed resistance; 18, step-up transformer; 19, socket for rectifier tube; 20, 500- to 50-

000-ohm resistance; 21, 400-ohm variable resistance; 22, "B" eliminator choke coil; 23, aluminum frame bracket; 24, metal shielding of panel; 25, .0005- μ f. fixed condenser; 26, .001- μ f. fixed condenser.

1,600 Ohms Resistance
17
0 2 3 0.5

The Batteryless Receiver here described employs four 199 tubes, whose filaments are wired in series. A power unit, whose design practically coincides with that of a "B" battery eliminator device, is incorporated in the receiver. The schematic diagram illustrates the connections for the receiver and the power unit included with it, as shown in Fig. 3.

The receiving circuit employed is a simple, practical affair, which has proven time and again to be easy to tune, sensitive and fairly selective. One stage of tuned-radio-frequency amplification is employed. A 400-ohm potentiometer controls oscillation in the R.F. stage.

THE POWER UNIT

The only unique feature of this particular receiver is that an ordinary "B" battery eliminator, which employs in this case a helium-tube rectifier, is used for supplying both "A" and "B" current. To eliminate any possibility of an A.C. hum being induced in the instruments within the receiver, the power unit is completely shielded and enclosed.

THE RECEIVER

The toroidal type of coils is employed in this receiver, to take advantage of the restricted magnetic field, reducing the pick-up by the coils of the 60-cycle hum. The receiver unit also is completely shielded and separated from the power unit; each being placed in a separate compartment, so that a metal wall separates them.

The material used in the construction of this receiver must be of good quality. Do not stint by attempting to use old apparatus, unless the instruments are in perfect condition.

FINAL ADJUSTMENTS

If there should be a slight hum during reception, the only remedy is the addition of a choke coil connected between the points indicated as "X" and "Y," and a by-pass condenser connected as shown by the dotted lines near these points. The receiver itself will need no critical adjustment, as the circuit employed is simple and easy to operate, having proven itself to be a good DX-getter.

As a final precaution, a 5-ampere line-fuse may be connected in series with the input wires leading into the step-up transformer. Do not attempt to use the 201-A or storage-battery tubes in this receiver, as the output of the power unit will not be sufficient to operate them. The 400-ohm resistance, which is variable, should be completely in the circuit when the current is

(Fig. B) The front appearance of the Batteryless Receiver. The two knobs at the right of the receiver control the detector plate voltage and the filament voltage from the rectifier.

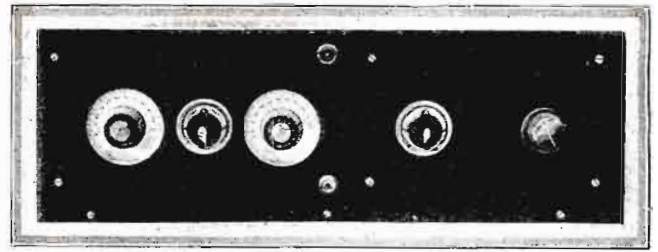

turned on for the first time. This resistance should then be decreased slowly until the tubes light up to their proper brilliancy and the receiver functions correctly. The 50,000-ohm variable resistance regulates the detector plate voltage. Its correct position is dependent upon the characteristics of the tube employed in the detector circuit. This resistance should be varied until the receiver seems to operate normally; that is, oscillates properly, has normal volume, is not critical, etc.

Do not forget to ground the shielding as this helps to prevent any possible 60-cycle hum from being transferred from the power unit to the receiver. If the power unit seems to function incorrectly, check the instruments employed in this unit. Test the transformer windings for complete circuit (by means of battery and head-set), also test the choke coil in the same manner for complete circuit. Make sure the by-pass condensers used in this eliminator are of the high voltage type and are not short-circuited.

BATTERYLESS FEATURE IN OTHER RECEIVERS

This Batteryless feature may be employed in other circuits as long as the 199-type tubes are used throughout. In the Super-Heterodyne circuit it will be found necessary to use two helium-tube rectifiers in parallel; the current output so produced will be sufficient to operate this receiver, even though 8 or 9 tubes are employed. Additional receivers of various types, employing a power unit of a similar nature to this one, will be described in future issues of RADIO NEWS.

It may prove of considerable advantage if set constructors and manufacturers seriously consider the feature of wiring filament circuits in series instead of the conventional parallel method. This will facilitate the adaptation of an "A" battery eliminator to the receiver. Where the designer doubts the capability of the power unit to supply sufficient current, an additional rectifying tube

placed in parallel will easily overcome that particular problem.

This particular method cannot as yet be adapted to receivers that employ the 6-volt, or storage battery type of tubes which consume 1/4-ampere or more. When a rectifying tube is developed capable of furnishing one-quarter of an ampere or more, then the solution of "A" battery elimination for large tubes will be attained.

It is easy to see the convenience to be obtained from a power unit supplying both "A" and "B" current; and this simple solution of the problem, by wiring the filament circuits in series, should prove popular with constructors.

LIST OF PARTS REQUIRED

POWER UNIT

- Step-up "B"-eliminator type transformer;
- Choke coil designed for "B" eliminator service;
- Helium-tube rectifier;
- Variable-Capacity filter condenser, tapped at 8, 2, and 0.5- μ f.;
- Variable resistance, 500 to 50,000 ohms;
- Fixed resistance, 1,600 ohms (can be made by connecting four 400-ohm resistances in series);
- Potentiometer, 400-ohm, or variable resistance;
- Standard VT socket, 6-volt type.

RECEIVER

- Two Variable Condensers, .00035- μ f., preferably S. L. F.;
- Two Toroid Coils;
- Four UX-type Sockets;
- Two Audio-Frequency Transformers, low-ratio type;
- Single-circuit Jack;
- Filament Switch;
- Panel, composition, 7x21, and Baseboard, 10x21;
- Three Brackets, square aluminum frame;
- Grid Condenser, .00025- μ f.;
- Grid Leak, 2-megohm;
- Fixed Condenser, .001- μ f.;
- Potentiometer, 400-ohm;
- Miscellaneous, wood screws, and machine screws, hexagonal bolts, etc., etc.;
- Also sufficient aluminum, brass, or nickel-silver sheet metal, No. 20 gauge, to shield receiver completely. The entire cost (not including tubes, loud speaker), should not exceed \$60.00.

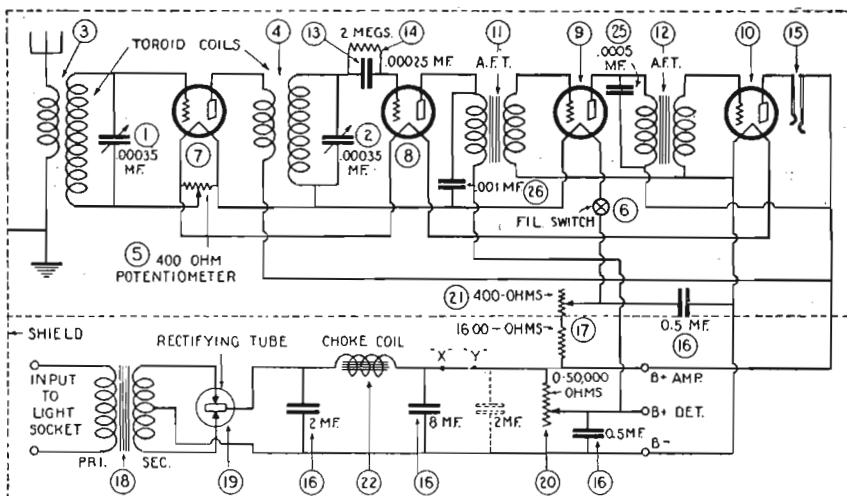

(Fig. C) The schematic wiring diagram of the batteryless receiver which incorporates a conventional tuned R.F. stage, detector, and two stages of audio-frequency amplification. The power unit which supplies both "A" and "B" current is illustrated directly below the receiver's connections. Instruments are designated by numbers which correspond to those on the large picture diagram.

IT is against the policy of RADIO NEWS to publish the names of manufacturers or makes of instruments in connection with the apparatus described in these pages. But this information will be gladly given privately. If you are interested in any special instruments described here, address a letter to the I WANT TO KNOW DEPARTMENT, enclosing stamped return envelope. The names and addresses of the manufacturers will be given free of charge. —EDITOR.

New Developments in Radio Apparatus

By G. C. B. ROWE



In the following article are described several new receivers and accessories which should be of great interest to radio enthusiasts, who wish to remain abreast of the times.



THOSE radio fans who have been playing the game since it first became a popular indoor sport around 1921, will doubtless remember that in the good old days, every time a new set was announced or someone described a new circuit, there appeared in all the papers and periodicals great splurges. Do you recollect the great fuss made when Armstrong told the world that he had a circuit that would operate a loud speaker, using only one tube? And do you remember how you scraped all your spare cash together and rushed to the nearest radio store and bought the big honeycomb coils that were necessary?

And should we continue these recollections with similar thoughts of the Flewelling circuit, that promised wonders, and the Auto-plex circuit, which was stripped of all unnecessary apparatus? Surely these circuits and times are reminiscences that are mighty nice to call up; and yet the days of 1926 will seem just as eventful several years hence. We have heard it said that radio today is more or less at a standstill. Don't you believe it for a minute! Every day there are new sets, and better ones, being placed on the market; and a glance at the pages showing the apparatus tested in the

market which have but two controls, and several have appeared with but one tuning adjustment.

As has been clearly shown by the great number of radio fans who sent in answers to the Ideal Set Contest, recently conducted by RADIO NEWS, the number of tuning controls should be reduced as much as possible, in fact to the minimum of one. Of course, with some circuits this is quite impossible, but there are many excellent ones that can be easily and efficiently controlled with but

this page. This five-tube receiver is one of interest primarily from its method of manufacture. A glance at the illustration of the rear of the set will show that every piece of apparatus is reduced to its fundamental parts. For instance, the sockets for the vacuum tubes are stamped out of the metal sub-panel, and the prongs are mounted in place by means of the circular fiber discs.

The variable condensers which are mounted on the front panel of the set, are shielded by thin metal plates (grounded) and shunted

Comparatively few radio fans outside of the "ham" fraternity realize the value of a first-class wavemeter. Usually there are several scales on the condenser dial, corresponding to the wave-lengths covered by the coils, but in this instrument, there is but one scale, the different readings being cared for by a set of curves.

Photo courtesy of General Radio Company

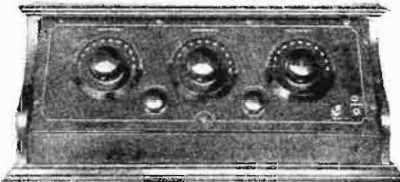
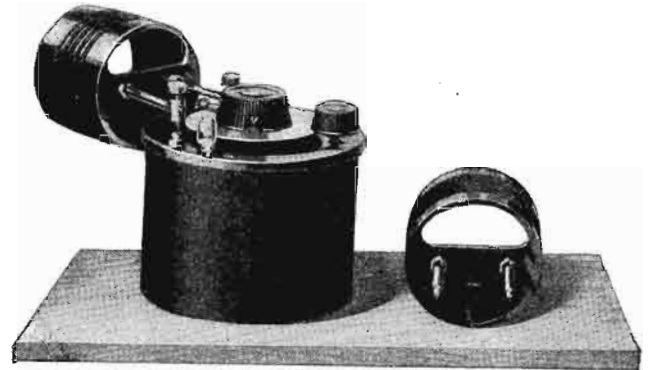

The three tuning dials of the receiver shown below have identical readings for the same station, so tuning is very simple.
Photo courtesy of Chelsea Radio Co.

RADIO NEWS Laboratories will give some indication of the amount of accessories that are being developed.

The tendency of manufacturers today is to place on the market receivers with as few controls as possible. This statement may seem to be untrue when some sets are considered, with three or four controls on their panels, but it will be noticed that the words "as few as possible" are used in the previous sentence. For some types of receivers three or four tuning controls are absolutely necessary, but there are many, many sets on the

one adjustment. However, the receivers that will appear on the market this fall will perhaps meet this demand of the fans for fewer controls.

EXTREME SIMPLICITY OF CONSTRUCTION

Manufacturers have seen that, in order to place receivers on the market at a maximum profit to themselves and a minimum cost to the consumer, there must be an improvement in the methods of production. Here is a great problem, for in mass production there is sometimes a tendency towards lowering the standards of electrical efficiency. Naturally this is a factor that is all important in the manufacturing of radio receivers; and the manufacturers who are turning out sets at the present time in imitation of Henry Ford's well-known methods, have kept the electrical efficiency of their products unusually high.

A receiving set that at once attracts the attention is shown in the illustrations on

across the three spider-web coils. These coils are mounted on a wooden strip hung from the metal sub-panel, and are placed so that the leads to them from the condensers are very short.

The metal sub-panel is riveted to a piece of metal which is attached to the top of the wooden front panel, and so bent that it completely covers the condensers and coils. The fiber bottoms of the tube sockets, the fixed condensers and the audio-frequency transformers are fastened beneath the sub-panel.

The circuit used in this receiver is of the tuned-radio-frequency type, having two stages of R.F. amplification, detector and two stages of A.F. amplification. Radio fans familiar with the several types of possible circuits will readily realize that it is to this one that nearly everyone turns, when a receiver is desired that will give volume, as well as quality and the ability to bring in distant stations.

As we have stated above, the various parts of this receiver are so made that there is no excess material anywhere in the set. Notice the two rheostats that are shown in the rear view of the set. Instead of being placed in a round piece of insulation, the resistance wire is wound on a strip, which is mounted directly on the front panel. In short, this tuned radio-frequency receiver, to which the battery cable is soldered in place, can be said to be reduced to fundamentals in every sense of the word.

A SIX-TUBE RECEIVER OF ATTRACTIVE DESIGN

A receiver, in which are combined excellence in design and workmanship, is the six-tube set shown in the illustrations on the next page. The circuit employed has two stages of tuned-radio-frequency amplification, detector and three stages of resistance-coupled audio-frequency amplification.

The three inductances, which are shown

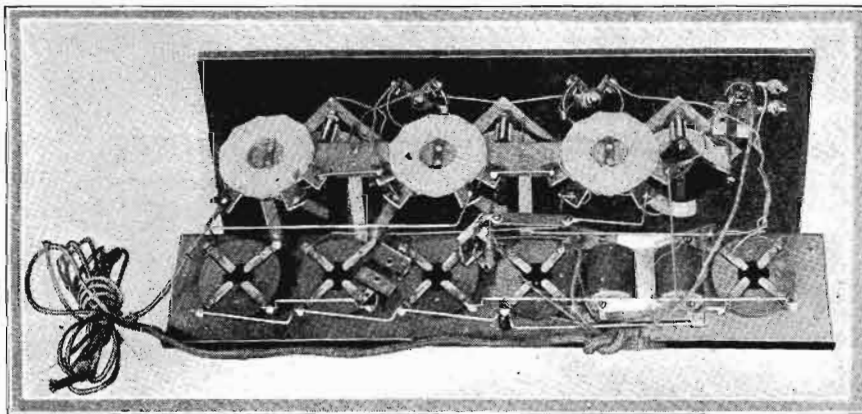

An estimate of the compactness of this five-tube receiver may be made from the above illustration. Note especially the arrangement of the apparatus.
Photo by courtesy of Chelsea Radio Co.

mounted on the bakelite sub-panel, are of the D-coil type. Coils of this type, which have been described in former issues of *RADIO NEWS*, are excellent for a set of this design, because they have a minimum of stray fields. The vacuum tube sockets are so made that they are an integral part of the sub-panel; *i.e.*, the cylinder supporting the base of the tube is screwed upon the top of the sub-panel, while the contacts are mounted beneath. This method, while saving space, also conserves wiring; as all leads to the sockets are run out of sight under the sub-panel.

The three variable condensers, which are of the straight-line-wave-length type, are mounted on a framework, which supports also the horizontal and vertical sub-panels. Two of these condensers are operated by the dial on the right, while the left dial controls but one. The dial controlling the two condensers operates a system of levers which is attached to both and so arranged that any variations can be compensated by a very simple adjustment.

The metal panel has in it two small windows through which can be seen the rotating scales that are attached to the condensers' dials. There is a volume control on the

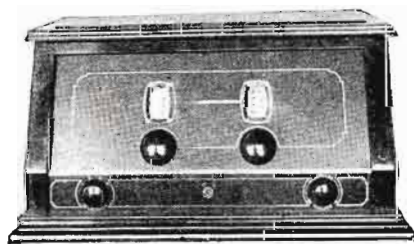

The two tuning controls of this receiver give a very pleasing appearance to the cabinet, the panel being of metal.

Photo by courtesy of A. F. Henninger Corp.

right side of the panel; and on the left a switch which permits variation of the inductance in the antenna primary circuit. This method of control increases the selectivity of the receiver.

The resistances and condensers used in the audio-frequency amplifier, as well as the automatic controls for the filaments of the vacuum tubes, are placed on the vertical sub-panel. On this is placed also a plug receptacle to which the battery connections of the set are made, thus eliminating the usual jumble of unsightly wires. Provision is also made for the application of higher plate-voltage on the last of the audio-frequency amplifiers, in case a power amplifier tube is employed. This is done by merely removing the jumper between the two binding posts at the rear of the sub-panel, and connecting the desired voltage at this point.

A WAVEMETER FOR AMATEURS

One of the most valuable pieces of apparatus that the amateur can have, in his transmitting equipment, is a reliable wavemeter, for it is to this instrument that he turns when he wishes to ascertain on which wave he is operating. Heretofore only wavemeters covering wave-lengths above 200 meters have been generally manufactured; and the amateur has been left without one of these instruments, or he has had to build one himself. Although these meters are not particularly difficult of construction, yet the coils used and the several calibrations necessary require very fine work and almost expert skill if they are to be anywhere near correct.

The wavemeter shown in the illustration on the previous page is simplicity itself. It has four inductances, of the type shown, and these four coils cover a wave-length range from 14 to 240 meters, which is exactly what

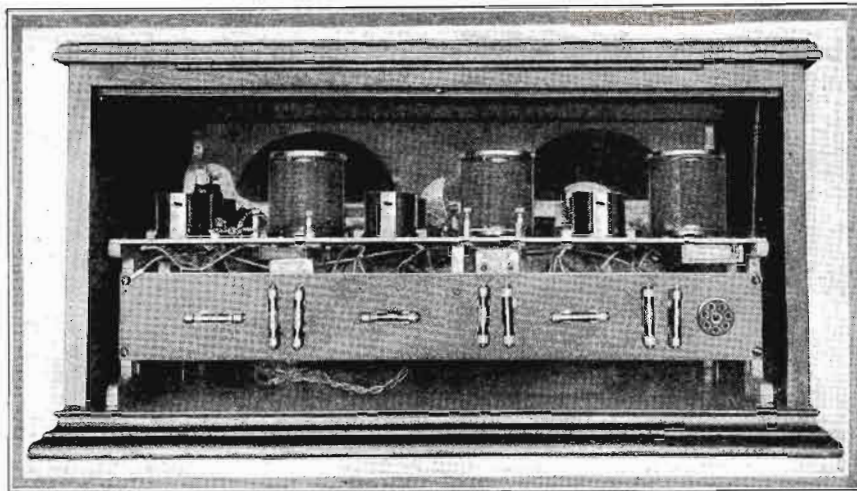

Although there are six tubes in this set, the apparatus is arranged so that there is no crowding.
Photo by courtesy of A. F. Henninger Corp.

the average amateur today wants his meter to do. Instead of the multiple-range dial, such as have been provided hitherto with most wavemeters, this instrument has only a single dial; while with every meter comes a set of calibration curves giving the wave-length reading for each setting of the dial.

There is a small electric lamp provided, to be connected between the condenser and the coil; the lighting of the lamp indicates resonance. A short-circuiting device is inserted, so that when the lamp is removed from its socket, the circuit is closed and the reactive method of checking resonance may be used.

A NEW LOUD SPEAKER

One of the greatest problems with which the radio designing engineer has had to contend in the past few years, is that of loud speakers. The era of horn speakers only, with their many different shapes and sizes, will be remembered and also the following enthusiasm for cone speakers.

It is usual, after the first crude attempts at design have been passed, that refinements always appear. This has been true in the case of the cone type of loud speakers. Last fall there appeared on the market another speaker, which had as its diaphragm a paper cone, but with a decided change in the design. Instead of two cones with their circumferences attached, there was but one whose edge was fastened in place by means of a sheet of very thin rubber. This arrangement, it was claimed, suspended the cone virtually free in space, while it was actuated by a rod connecting the apex and the unit.

This design was looked upon with much favor and the output of this loud speaker was described as everything that it should be. The loud speaker, which is shown in the accompanying illustrations, utilizes the

same principle, but with a different unit and another method of suspending the cone.

It will be noted from the illustration that the paper cone is fully protected by a metal covering, the latter supporting both the edge of the cone and the actuating unit at the rear.

Unlike many previous types of cone speakers this one acts more like a piston than like a vibrating unit; that is, the cone itself merely pushes a column of air. Due to the fact that a loose leather supporting-ring is employed, the forward and backward motion is in no way restricted; as a matter of fact, the cone can move a quarter of an inch.

It was found that the rubber which was used for attaching the paper cone to the front panel, or "baffle," as it is called, would not give satisfactory service under all kinds of climatic conditions, and so another medium of suspension was sought. It has been found that very thin leather is just about as flexible as the more elastic rubber and will answer the purpose very well. This, then, has been incorporated in the loud speaker shown with excellent results.

The large wooden ring to which the cone and unit is attached is an important factor in the operation of the speaker. In one sense it acts as a sounding board; similar to the wooden slats in the horn of a phonograph, but what is probably more important is its functioning as a "baffle." If a properly proportioned baffle were not employed, the sound waves leaving the rear of the cone would be reflected, thus reacting upon the sound waves emitted from the front with the possible result of distressing beat notes.

The cone and unit can be detached from the wooden ring and stand and are adaptable to console sets or special speaker cabinets in which case the rear of the cabinet acts as a satisfactory baffle



The front and rear views of the loud speaker described above.

Photo by courtesy of The Rola Company.



Relaying Radio Messages from the Polar Regions

By **GEORGE W. LINN, Jr., 2CJE**

Everyone has read of Com. Byrd's thrilling flight by airplane over the North Pole. Here is an account of how radio communication was established with the United States, and constructional details of the set used in New York City.

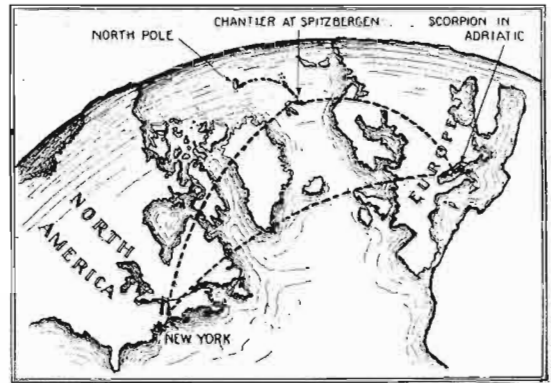

This map will give the relative positions of the two ships, which were worked by station 2CJE.

Not only is the necessity of radio as an aid to scientific exploration shown by the recent achievements in the far North, as Mr. Linn observes in his article, but also the priceless service which the amateurs of the world are rendering to the cause of radio development and communication.

The surprise and delight of the astronomer beholding a new inhabitant of the heavens, and of the explorer looking upon a new world, have been celebrated; but to them we can compare the pleasure and gratification of the amateur who finds that he has become, as may happen at any moment, the voice and the ear of his countrymen while history is being made. The idea is inspiring in the extreme.

Mr. Linn's short-wave transmitter and receiver served most effectively as a link between the Byrd North Polar Expedition, whose successful flight is known to all, and the Navy Department at Washington, to whom its reports were made. Here he tells the readers of RADIO NEWS how he did it, and how he constructed the equipment which gave this splendid performance. Illustrations of the equipment and flight of the Byrd expedition will be found in RADIO NEWS and in SCIENCE AND INVENTION for July.—EDITOR.

Messages from Commander Byrd. The messages originating on the *Chantier*, Byrd expedition's base ship, KEGK, at Spitzbergen, were sent to the *Scorpion*, to be relayed to the U. S. Due to severe QRN only five of the six messages were received and acknowledged that night; but a schedule was made for each succeeding evening at 11 o'clock. Communication was maintained with the *Scorpion* each night thereafter up to and including Saturday, May 22. In that time nineteen messages were received and

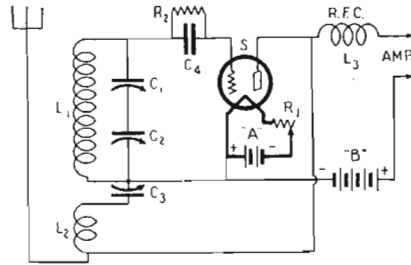

The schematic diagram of the receiving set which picked up Byrd's ship, the "Chantier."

BUILDING A GOOD DX TRANSMITTER

There are, no doubt, many readers who desire to build or know more about the transmitter and receiver used by the writer at his station, 2CJE, New York. Before going into the description of the various parts, a few words regarding the qualities of a transmitter and receiver for consistent work will be necessary. The following list, containing only a few of the essentials, gives the factors that will result in a good station.

The transmitter must have: a steady wave; a good note (DC or at least good RAC); and a wave that will remain constant from day to day in order that other stations may log your signals.

The receiver must have: freedom from body or hand capacity; freedom from tube and battery noises and all other disturbances occurring in the receiver itself; and a good dialing system so that stations once received can be readily received at some further time.

The transmitter here described was constructed with the above outlined qualities in mind to assure a consistent working range. A wave-length of 40 meters was decided upon, as this seemed to be the best all-around wave assigned for amateur use. A 50-watt tube at its normal input seemed to be sufficient to cover any distance desired with favorable conditions. The choice of a transmitting circuit was given due consideration; and the Hartley circuit, which is certainly the most popular circuit in use on the short waves, was selected because of its ease of construction and simplicity in tuning. The bread-board type of assembly was used, as this method facilitates changing of apparatus and wiring without in any way marring the finished set. Particular care was taken in insulating the apparatus from the baseboard. Porcelain stand-off insulators were

(Continued on page 166)

IN step with the development of aircraft as a means of exploring the uncharted polar regions, is the use of wireless telegraphy as a means of communication with the outer world. This year radio was an important part of the Amundsen and Byrd projects, and results have shown that radio is a necessity, not a luxury, in the north.

Having had no radio experience with the Amundsen flight, there is nothing of value or interest the writer can say regarding this venture, but he was fortunate to play a small part in the communication service of the Byrd Expedition.

On Monday evening, May 17, at approximately 11 o'clock, Eastern Daylight Saving Time, he called and raised NTT, the U. S. destroyer *Scorpion*, stationed in the Adriatic Sea. The *Scorpion* is equipped with a short-wave receiver and transmitter, beside the usual long-wave navy equipment. After reports were exchanged, the writer was ready to take the *Scorpion's* traffic, which, to his great surprise, consisted of six mes-

sages transmitted. A great deal of credit is due Operators Bailey and Shockley of the *Scorpion* for the way they handled their traffic and relayed it to the States. The *Chantier*, KEGK, was worked directly Saturday night and again on Monday night, and ten messages were received. On Wednesday KEGK was again raised and three messages addressed to Commander Byrd were transmitted. This closed the writer's communication with both the *Chantier* and the *Scorpion*. The total of twenty-nine messages from Commander Byrd received here, were forwarded to their destination by the U. S. Navy Communications Department at New York City, thus insuring quick delivery.

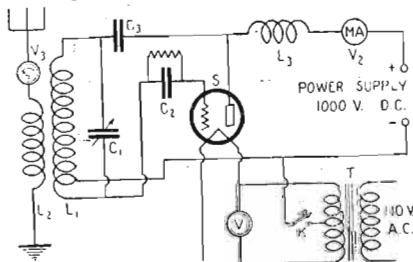

The schematic diagram of the short-wave transmitter at 2CJE, which was used in communicating with the "Chantier."

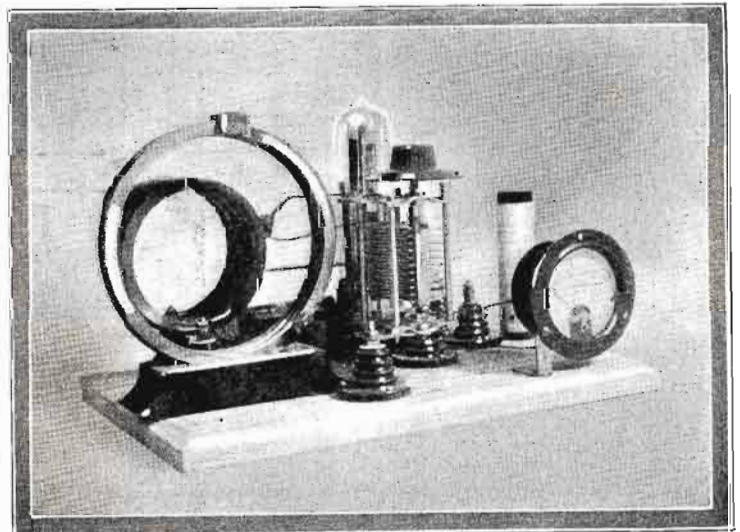

The transmitter at 2 CJE. The copper strip coils at the left are L1 and L2; the tall variable condenser in the center is C1; the upright inductance at the right is L3; and the condenser, C3, appears through the loop of the larger inductance. L2. Notice the size of the insulators used and their disposition on the baseboard.

A Handy, Light Vacation Set

By JOSEPH BERNSLEY

This light, but powerful receiver is of quality suitable for the home; but it is also built so lightly and compactly that it may conveniently be carried in a small car or boat, as well as by hand, providing a very entertaining companion for a week or a week-end in the open.

WITH the approach of hot weather and contemplated week-end trips, to say nothing of the anticipated usual summer vacation, the increasing interest in portable radio receivers, as the means of providing entertainment, brings forth considerable discussion as to the most efficient and convenient design of such a receiver, the type of circuit and tubes, whether to employ loop or portable antenna and ground, etc. To those who desire to construct such a receiver, this article offers constructional details of a set which was designed for the above mentioned purpose, but may be constructed to be mounted in an ordinary cabinet and used as a conventional living-room radio receiver.

The receiver is entirely self-contained; that is, batteries, both "A" and "B," are within the cabinet. The loop antenna, which is used in place of the usual antenna and ground, is mounted on the inside of the cover, thus making the receiver one compact unit, whose overall weight is approximately twenty-five pounds. Its compactness and portability are very well illustrated in the views designated as Figs. A and B.

Regarding its efficiency: due to the fact that the reflex principle is employed, loop reception is possible. Three stages of radio-frequency amplification are used, one stage tuned and two untuned; a crystal detector for rectification; and two stages of reflexed audio-frequency amplification. Using the loop alone (in New York City) it was possible to obtain loud speaker reception on all the local stations, and two stations in Philadelphia with fair volume. On headphones, 15 distant stations were logged in two evenings, although no strenuous attempt was made to get them. The unusual purity of tone obtained, due to the crystal rectification, makes the receiver well worth building. To increase its receptive range, an antenna and ground system may be employed, and connected to the binding posts at the left of the receiver, shown in the illustrations. This connection

will also increase the signal strength of the stations obtained on the loop, although the

and size desired; but should, however, be approximately the above mentioned, so that the set, which is built in unit form, may fit within the cabinet, thus enabling the constructor to adapt a similar lay-out.

COIL CONSTRUCTION

The coils may be constructed, as some little difficulty may be experienced in obtaining basket-weave coils to operate in conjunction with .0005- μ f. variable condensers. To economize in space, the constructor should wind them in either basket-weave or spider-web fashion. Using the basket-weave method, a 44-turn secondary is required, for both antenna and radio-frequency coils. The primary winding for the antenna coil should consist of 10 turns, and the primary winding for the radio-frequency coil has 15 turns. All windings are of No. 22 DSC or DCC wire.

This will give selectivity when the antenna and ground are used in place of the loop and still permit the receiver to oscillate on all wave-lengths. The radio-frequency transformers (untuned type) cannot be constructed at home as elaborate facilities are required. The loop, which is mounted on the inner side of the cabinet cover, consists of 21 turns of loop wire.

PRINCIPLE OF THE RECEIVER

As mentioned before, the receiver operates on the reflex principle, having three stages of radio-frequency amplification, crystal detector and two stages of audio. The three tubes first function as the radio-frequency amplifiers, and the output is delivered to the crystal detector which rectifies the radio-frequency impulses. The audio-frequency currents are then transferred back to the second tube, which functions as the first audio-frequency amplifier, and are then still further super-imposed on the third tube and amplified. The output of this tube is then delivered to the headphones or loud speaker, by means of the single circuit jack into which the plug is placed.



Fig. A. The Vacation Set ready for operation. Two dry cells are used for 199 type tubes, and four for the 6-volt 1/4-ampere type. 67 1/2 to 90 volts of "B" battery is required.

tuning will not be as sharp, and some additional atmospheric noises are introduced.

The cabinet dimensions are: 14 1/2 inches (inside specification) in length, by 14 1/2 inches in width and five inches in depth. These dimensions are not exact, as the cabinet may be constructed in any form or shape

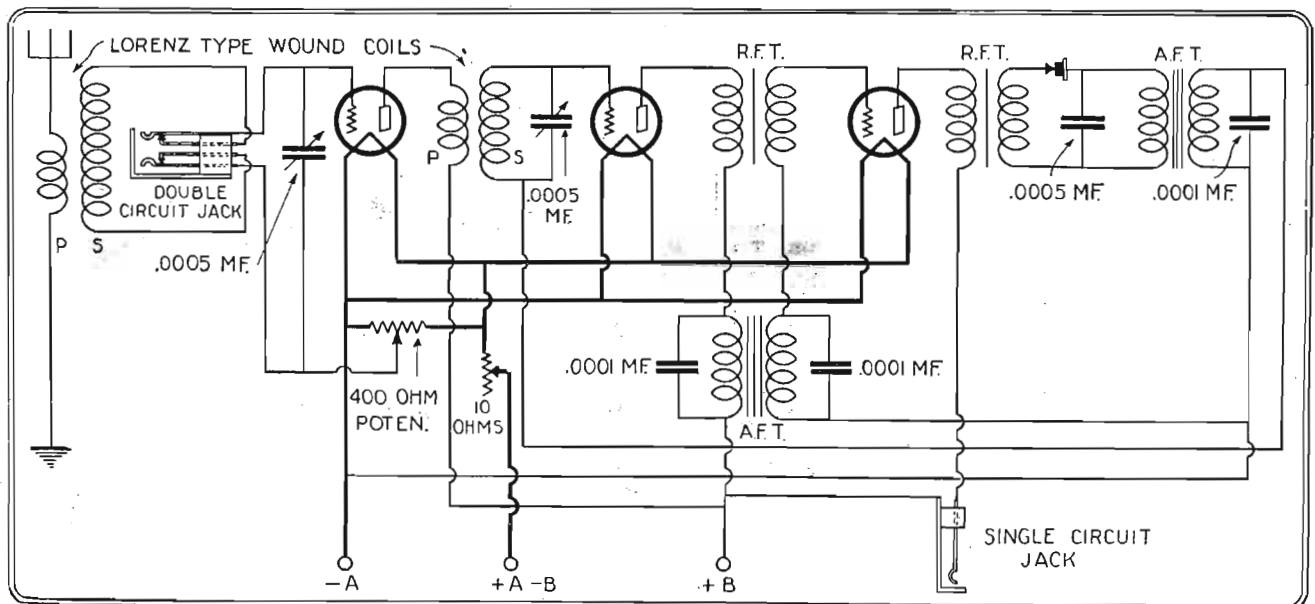

Fig. C. Schematic wiring diagram of the Vacation Set. Either antenna and ground or loop may be used. When a loop is desired for providing the incoming radio impulses to the receiver, it should be connected to a plug and placed in the D.C. jack as shown in Fig. A. The set is automatically ready for antenna and ground when the plug is removed.



Fig. B. The Vacation Set closed for carrying. It is of handy shape and size and weighs not over twenty-five pounds.

Note that across the respective windings of these audio-transformers are connected various small fixed by-pass condensers. These are so placed for the purpose of allowing any stray radio-frequency currents to be by-passed across the winding of the transformer, and back into the radio-frequency circuit through the batteries. The values of these condensers are somewhat critical, as too small a condenser will not by-pass all of the R.F. energy in the audio circuit; and too large a capacity will not only by-pass the R.F., but also allow some of the audio-frequency currents to escape, thus decreasing the efficiency of the receiver.

TUNING-IN

It must be remembered that this receiver was designed primarily for loop reception, although provision has been made so that it may be used in conjunction with an antenna and ground. Greatest selectivity will be obtained when the loop antenna is employed, as this instrument has been found to be very directional when performing its function. Thus, if a certain station is desired, for best reception it is advisable to point the loop in the direction of the broadcast station. If a particular local station causes considerable interference and is difficult to tune out, then by simply rotating the loop to a different direction this interference may be cut down to a minimum. To facilitate even sharper

tuning, a stage of tuned radio-frequency amplification is used, instead of the usual untuned type. The potentiometer is used for controlling oscillation and volume, but also affects the sensitivity of the receiver; as it is advisable to put the receiver in an oscillating condition (by bringing the potentiometer arm to the negative side of the potentiometer resistance), and tune in a distant station by means of "carrier-wave" reception. The receiver may be called practically a two-control receiver, as the potentiometer control is seldom used for local reception.

FINAL ADJUSTMENTS

If the receiver does not prove selective enough when used with an antenna and ground, the defect may be easily remedied by simply reducing the number of primary turns on the antenna coil. The exact number of turns that must be taken off must be determined by the "cut and try" method until the desired selectivity is obtained. Should the variable condenser that tunes the secondary circuit of the radio frequency coil tune too broadly, then, by simply reducing the number of turns on this coil the selectivity of this stage may be increased. If, during the tuning in, the potentiometer, when turned towards the negative side of the resistance, forces the receiver into noisy oscillations, or concisely speaking, into a "squawk", then incorrect size by-pass condensers have been used. The crystal detector may be of the fixed type, and it is advisable that several crystals be tried, until one is found with which efficient and stable results are obtained.

The carborundum fixed crystal detector was used in this receiver because it has been found to be unusually stable, while practically as sensitive as the variable-point type of crystal, whose adjustment is so critical.

The two condensers may be made to read alike, or very nearly so. The correct dial readings for a station with a wave-length around 450 meters should be between 80 and 85. If there should be a wide difference in the dial settings for the various stations received, remove turns from the secondary winding whose condenser shows the lowest reading, until the proper dial-setting for that wave-length is obtained. The number of turns removed will depend on the difference or variation from the proper reading found

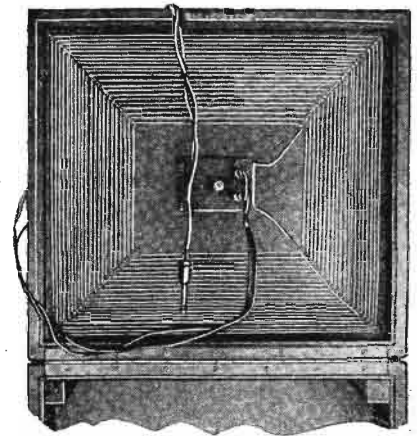

Fig. D. Illustrating the construction of the loop. It is tacked within the cover of the case, which is 13 inches square inside. Twenty turns of loop wire are sufficient to cover the broadcast range.

on first trial. It is best to remove a turn or two at a time, and then check the variation carefully. If a condenser reading is too high (i.e., 90 or 95 for 450 meters) then the remedy is in increasing the number of secondary turns until the reading is reduced to the desired figure.

A lighter receiver may be built in a portable typewriter case; and results obtained similar to those described above, if the electric specifications given are adopted. This circuit is very commonly used in reflex sets, especially of the portable type, and has proven itself unusually efficient, time and time again.

IT is against the policy of RADIO NEWS to publish the names of manufacturers or of makes of instruments in connection with the apparatus described in these pages, but this information will be gladly given privately. If you are interested in any special instruments described here, address a letter to the I WANT TO KNOW DEPARTMENT, enclosing stamped return envelope. The names and addresses of the manufacturers will be given free of charge. —EDITOR.

LIST OF PARTS

- 2—Variable condensers, .0005- μ f. each, preferably of the S.L.F. type;
 - 2—Dials;
 - 3—Sockets;
 - 2—Audio-Frequency Transformers, $3\frac{1}{2}$:1 ratio;
 - 2—Radio-Frequency Transformers, untuned type covering the wave-length range of from 200 to 550 meters;
 - 1—Fixed Crystal Detector;
 - 2—Lorenz type or basket-weave Coils, designed for .0005- μ f. condensers with primary winding;
 - 1—Insulating Panel, $7 \times 14\frac{1}{2}$ inches;
 - 1—Sub-Panel 4×12 inches;
 - 1—Single Circuit Jack;
 - 1—Combination Potentiometer and Rheostat; potentiometer 300- or 400-ohm, rheostat approximately 10-ohm;
 - 1—Double-Circuit Jack;
 - 4—Fixed By-pass Condensers, 3 .0001- μ f. 1 .0005- μ f.;
 - Miscellaneous, such as binding posts, screws, bus wire, etc.
- Approximate cost, \$30.

Fig. E. Illustrating the instrumental layout of the Vacation Set. No. 1 is the potentiometer-rheostat; 2 and 3 the .0005- μ f. condensers; 4 and 5 the basket-

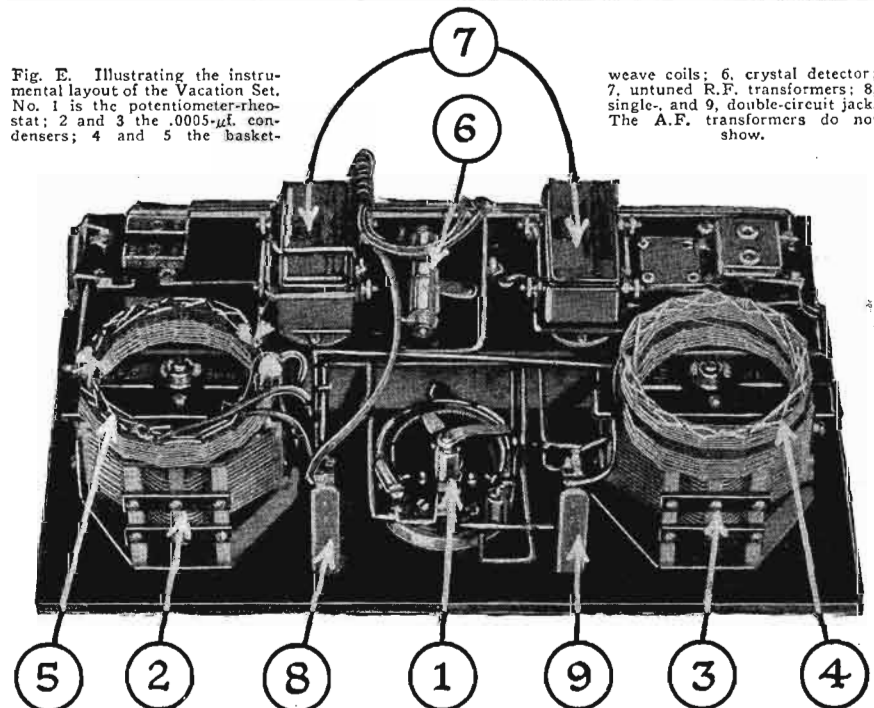

weave coils; 6. crystal detector; 7. untuned R.F. transformers; 8, single-, and 9, double-circuit jack. The A.F. transformers do not show.

An Inverse Duplex Receiver for the Home Constructor

By FLORIAN J. FOX

In this article are set forth complete details for the construction of a most interesting receiver. We recommend it to set builders.

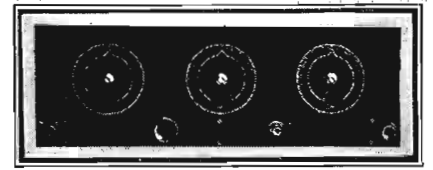

The operation of this receiver is very simple, as the three dials have approximately the same reading for a station.

MOST experimenters have found it difficult to reflex more than one tube in a receiver. The trouble is due, not to any flaw in the theory of reflexing, but usually to lack of information on the subject. Provided the tubes are not overloaded, it can easily be shown that a tube can amplify, simultaneously, both radio and audio frequency voltages. However, if the design is poor, reflexing more than one stage will cause instability due to either radio frequency feed-back by way of the audio channels, or audio frequency overload. It is obvious that if radio frequency currents get into the audio channels, they will be impressed on the radio amplifiers again, thus setting up a good radio feedback circuit. Such a feed-back link will set up radio frequency oscillations. On the other hand, if the reflexed tubes are seriously overloaded with audio voltages, modulation of the incoming signals will take place and cause what we term "Overload Howl."

The problem, then, is one of design. The energy levels in the reflexed tubes must be kept reasonably low, and the radio and audio frequency currents must be kept in their respective channels.

AVOIDS OVERLOADING AND NOISES

The Grimes inverse duplex system is the most stable of the reflex systems, because radio feed-back links never contain more than one radio amplifier. In the case of a straight reflex receiver two or more amplifiers may be contained in such a feed-back circuit. Inverse duplexing also tends to equalize the energy levels in the various tubes, as shown in Fig 1 and 1A, where we assume that each tube has an amplification of one unit. The sum of the R.F. and A.F. units in any one tube will represent the total load carried by that tube.

The economy of such a system is obvious. This is a vital point if the set is to be used in connection with dry cells for filament current. The total plate current of the receiver is about 7 milliamperes. The filament current, using dry cell tubes (3UX-199's and a UX-120 in the last stage) is only .3 amperes. Six No. 6 dry cells, connected in series parallel, should last about three months, under average conditions.

BUILDING THE SET
Fig. 2 shows the wiring diagram of one of the latest laboratory models of dry-battery-operated inverse duplex receivers.

In any case, first procure all the necessary parts, (listed at the end of this article) and then lay them out in a neat and logical manner. That is, place all the parts on the sub-panel or sub-base, that will eventually go there. By a process of arranging and re-arranging, a satisfactory lay-out will be found. Each tube should be placed close to its tuning condenser, and each audio trans-

sub-base and mount. Any good layout for a tuned radio frequency receiver or neutrodyne may be copied.

PROBLEMS OF AMPLIFICATION

To insure good results only good parts should be used. Low ratio audio transformers (between 1½-to-1 and 2-to-1) should be used in the reflexed stages. This will insure good quality of reproduction and greater freedom from difficulties arising from the overloading of the reflexed stages. The last audio transformer should have a

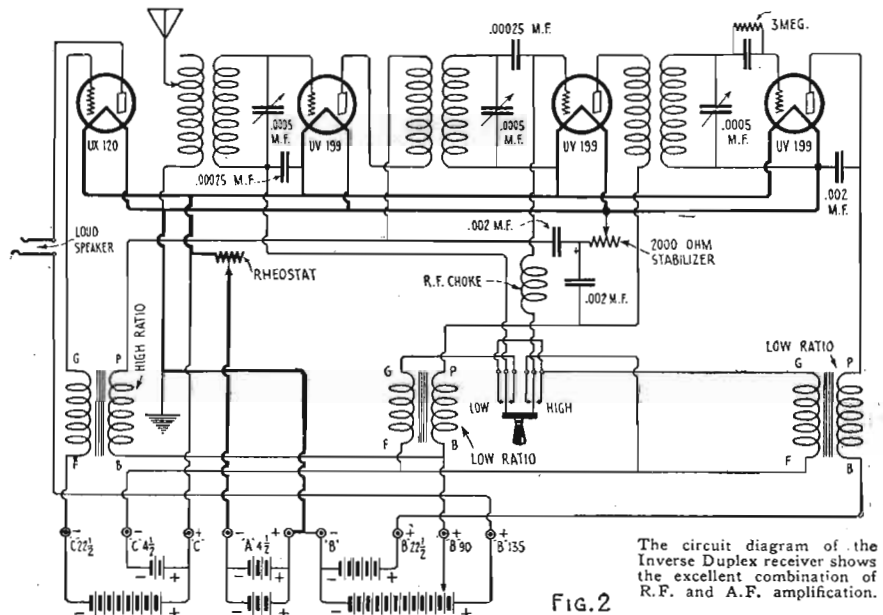

The circuit diagram of the Inverse Duplex receiver shows the excellent combination of R.F. and A.F. amplification.

FIG. 2

former should be placed reasonably close to its input tube. Fig. 3 will serve to show what is meant. In order to minimize radio feed-back the tuning condensers and the radio coils should be kept as far apart as possible. When a satisfactory arrangement has been found, measure off the necessary dimensions, mark them off on the sub-panel or

high step-up ratio, 6-to-1 being quite satisfactory.

Whenever three stages of audio frequency amplifications are used some special precautions must be taken. The detector grid leak and condenser should be mounted as close as possible to the grid post of the detector socket. Do not allow the output, or loud speaker wires of the last audio stage to get close to the detector tube or its grid leak or condenser. Wherever possible, in wiring the audio circuits, keep each wire close to, or twist it with, its return wire. The negative "C" or negative filament wire is the return for the grid wire, and the positive "B" wire is the return for the plate wire to an audio transformer.

Note that the last audio or power amplifier tube is placed as far away from the detector tube as possible. Ordinarily the detector tube is placed at the extreme right end of the receiver, and the power amplifier at the extreme left end of the set. Therefore, if convenient, the loud speaker jack should be mounted near the left end of the panel.

Due to the internal resistance of dry "B" batteries, audio feed-back is usually encountered when all tubes are operated from a single set of "B" batteries. This usually results in a high-pitched whistle. The use of by-pass condensers across the "B" batteries is usually a rather expensive preventive; because in order to overcome the difficulty a large capacity is necessary. It is

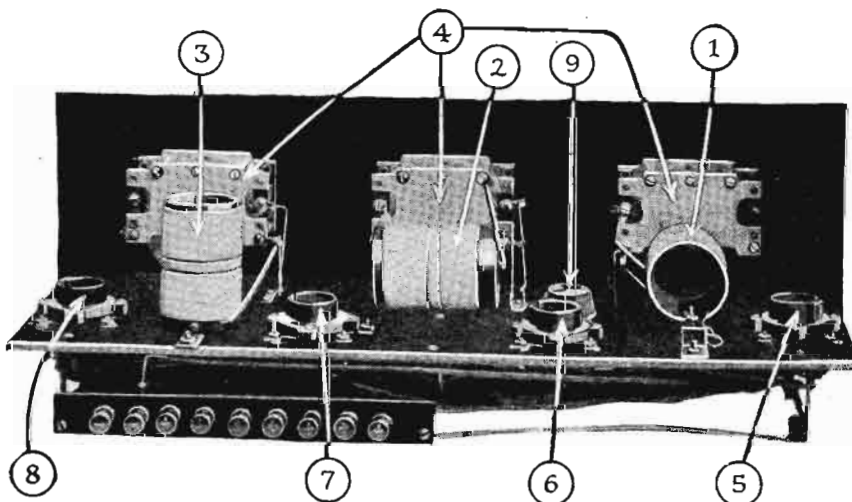

Nos. 1, 2 and 3 are the R.F. transformers; 4, tuning S.L.F. condensers; 5, 3rd A.F. tube; 6, 1st R.F. and 2nd A.F. tube; 7, 2nd R.F. and 1st A.F. tube; 8, detector; 9, 2000-ohm stabilizing rheostat.

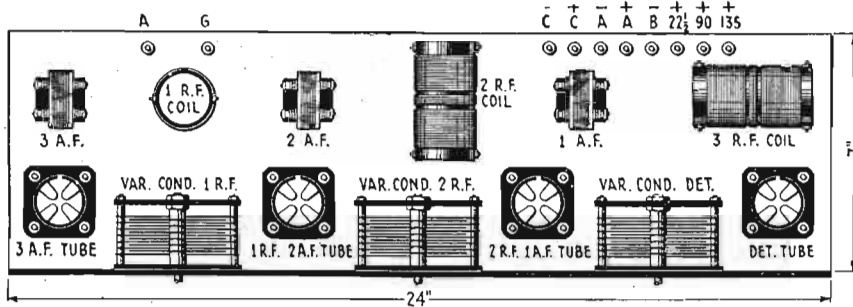

FIG. 3

This sketch gives a suggestion of the best way to place the apparatus on the base-board.

more economical to use a small separate 22½ volt battery for the detector tube. (See wiring diagram).

The radio frequency coils, as stated before, should be mounted as far apart as practicable. In addition they should be mounted at right angles to each other. This will minimize the setting up of radio frequency oscillations due to magnetic coupling between the coils.

VOLUME AND OSCILLATION CONTROL

A variable 2000-ohm stabilizing resistance is used to control the tendency for oscillation at the lower dial settings. Ordinarily this resistance is mounted inside the receiver. The resistance is increased by small steps until the set does not oscillate at the lowest wavelength it is desired to receive. However, this resistance may be mounted on the panel of the receiver, where it will serve as an oscillation and volume control. For the proper operation of this stabilizer it is absolutely necessary that the connections to the primary winding of the second radio frequency coil be reversed. Assuming that the primary and secondary of a coil are wound in the same direction, a coil is connected normally when the top of the secondary winding is connected to grid and the top of the primary winding is connected to plate.

The double-pole double-throw switch shown in the wiring diagram is a panel-mount jack switch. Its purpose is to change the set from 5-tube to 6-tube operation. The "Low" or 5-tube position is for local reception and the "High" or 6-tube position is to be used for weak and distant signals.

The antenna tap switch serves both as a volume and selectivity control. As the antenna turns are decreased, the volume decreases and the selectivity increases. At the higher wave-lengths a marked increase in volume is obtained by increasing the number of turns in the antenna circuit.

USE OF CHOKE COIL

When the secondaries of the radio and audio coils were connected in series, as in the early reflex circuits, trouble was experienced from so called "hand hum." That is, when the hand approached the tuning control of the tube which was the first reflexed-audio stage, a loud induction hum was obtained. On the inverse duplex set this hum occurred on the second dial. This trouble was due to the fact that the second variable condenser was connected to the grid side of the first audio transformer. On a three-stage audio amplifier the detector and first audio grids are quite susceptible to such induction. The trouble was remedied by the connection shown in the wiring diagram. The rotor of the condenser in question is connected to filament or ground, and the audio voltage is led to the grid of the tube through an efficient radio frequency choke coil. In order that this choke coil should introduce no loss or appreciable tuning error into the radio circuit, it must be made with some care. Details of the construction of such a choke coil will be given. (See Fig. 4.)

The winding form consists of a piece of

hardwood, fiber, hard rubber, or bakelite, 3 inches long and about ½-inch in diameter. If the builder has no lathe, he can have the form made in any machine shop. Slots 1-16 of an inch wide are cut to a depth of ⅜-inch. The slots are spaced 1-16-inch apart. This will enable the cutting of about 20 slots altogether. The exact number is not critical.

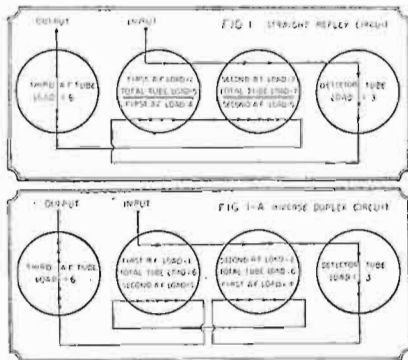

A comparison between the ordinary reflex circuit (above) and the Inverse Duplex (below), showing the more even distribution of the tube loads in the latter.

A saw cut is now made along the form parallel to its axis. This will be used for leading the wire from a filled slot to the next empty one. Fill each slot with No. 36 D.C.C. wire. The ends of the wire may be soldered later to lugs which can be screwed to the ends of the form. An easy way to wind a choke coil is to drill into the dead center of one end of the form for a distance of about an inch and leave the form on the drill. Then clamp the breastdrill in a vise in a horizontal position. By turning the crank with one hand and leading the wire with the other hand, the winding may be put on very rapidly.

If it is impossible to obtain the above form, some make-shifts may be devised. A dowel could be used, and the windings sepa-

rated by means of heavy card board washers. Fair results might be obtained by using a long thin thread spool filled with wire. Fill the spool up as the winding advances, that is, scramble-wind. Do not wind in layers, because the capacity of such a winding would be too great. Mounting brackets may be made for the choke coil if desired.

CHOOSING R.F. TRANSFORMERS

We now come to the question of radio frequency transformers. If these are to be purchased, some care must be exercised in choosing them. We prefer a coil with a cylindrical winding, either self-supporting or wound on a bakelite tube. Choose a coil of relatively small diameter, say not more than two inches. Large-diameter coils usually have large magnetic fields which make it very difficult to control radio frequency feedback, and oscillation.

For the benefit of those readers who may wish to build their own coils, we shall describe some which we have found to be very satisfactory from all angles. The coils described are for use in connection with .0005-µf. variable condensers. We have never been able to prove experimentally that a larger coil with a smaller condenser is more efficient, although theoretically it should be.

The winding form (See Fig. 5) is a bakelite or formica tube, 3½ inches long and 1¾ inches in diameter. A ½-inch space is left in the center of the secondary winding. In this space the primary is wound in the same direction as the secondary. Before winding, drill all the necessary holes for mounting brackets, terminals, and anchor holes for the ends of the windings. Then make a saw cut in the middle of the tube and at an angle of about 45 degrees to the axis of the coil. Now begin the secondary winding in such a direction that this saw cut can be used for leading the winding across the ½-inch space reserved for the primary. This will eliminate the necessity of cutting the secondary winding and soldering the ends later, although this may be done if it appeals to the builder. The secondary is wound with No. 28 D.C.C. wire. The total winding length is 2¼ inches, or the equivalent of 90 turns. Now wind the primary. This consists of 15 turns of No. 32 or 34 D.C.C. wire. Two such coils are made. The third, or antenna coil, has a primary of 25 turns (same size wire as the other primaries) tapped as follows: 2 turns, 4 turns, 8 turns, 15 turns, and 25 turns. The beginning of this winding is connected to ground, and the taps are connected to points on the inductance switch.

BUILDING A POWER AMPLIFIER

Of course an ingenious builder may modify the receiver if he so desires. For instance, if he desires more volume than can be ob-

(Continued on page 189)

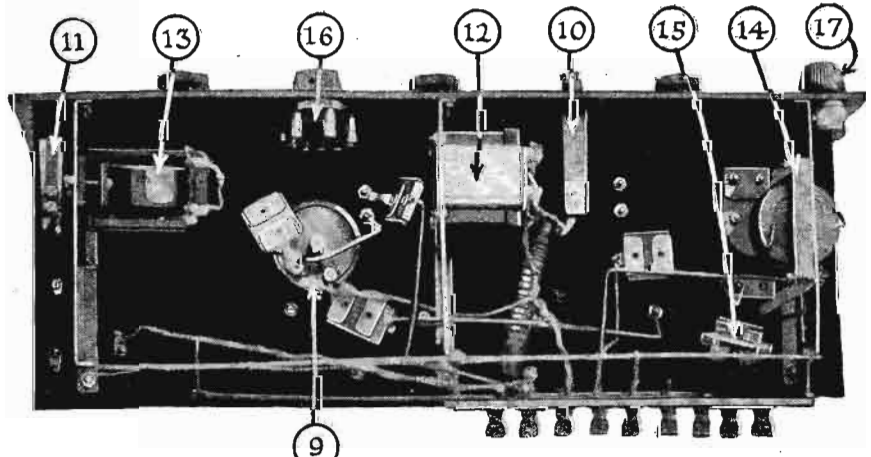

No. 9 shows the stabilizer; 10 and 11, jacks; 12, 13, and 14, A.F. transformers; 15, grid condenser and leak; 16, jack switch; 17, filament rheostat.

A Transoceanic Broadcast Receiver

By CHAS. R. LEUTZ

Four tuned stages of radio-frequency amplification—truly this receiver should bring in stations across the ocean and with loud speaker reproduction too.



ONLY a few years ago transcontinental reception of broadcast reception was new and unusual. Now, during favorable weather conditions thousands of receivers in the East receive regularly from the West Coast stations. In addition a few "listeners-in," here and there who have time in the afternoon, are receiving European stations. It must be remembered that there is a five-hour time difference. 11:00 p. m. in London is about 6:00 p. m. in the eastern section of the United States.

Furthermore, a large percentage of the foreign broadcasting stations use wave-lengths higher than used in the United States; for example, Daventry, England, employs 1,500 meters and Eiffel Tower 2,600 meters. While receivers have been designed to cover these wide wave-length ranges, and also using several stages of radio-frequency amplification, they are not well known, as they have not come into general use yet.

The super-sensitive broadcast receiver described in this article is a very late development.

RECENT research work has revealed the fact that more than two stages of tuned radio-frequency amplification can be used successfully, providing a few precautions are taken in the design of the set which is to contain them. To speak broadly, the most necessary precaution is complete isolation of each stage of radio-frequency amplification from the

amplification and to use total shielding in the full sense of the word. As a step further; each stage has its own A and B supply, the only exception being the audio-frequency amplifier stages which are combined on common batteries.

COVERS FOREIGN BROADCAST RANGE

Another important feature of this set is the plug-in coil arrangement which provides reception on wave-lengths ranging from 35 meters to 3,600 meters. Though plug-in coils are by no means new, this system has never before been carried into the field of tuned-radio-frequency amplifiers. Present day tuned-radio-frequency sets are not capable of covering more than the American broadcast wave-lengths; consequently, the construction of this receiver has again gained a point in originality.

The receiver was designed and constructed specifically for the 1925 Foreign Broadcast tests, and the object was to have a set more sensitive than any type previously built and at the same time exceptionally selective without the usual loss in quality of reproduction. The accompanying illustration shows the receiver set up for operation. It will be noted that the set is divided into six separate containers. These are made of sheet zinc with brass angles to insure rigidity. The zinc covering provides complete electrostatic shielding between each unit.

The first four cases contain the four tuned-radio-frequency amplifiers; the fifth case the detector and the last case the entire four stages of audio-frequency amplification.

It will be noted from the picture that the six units are separated by a few inches from each other. This is done to prevent the field

SEPARATELY-SHIELDED CONDENSERS

In addition to having all the component parts of one stage within one case, the variable condenser used in each stage is individually shielded, so that the electrostatic field of the condenser cannot affect or interact upon the field of the radio-frequency transformer with which it is employed.

It has been found in this receiver that the use of specially wound toroidal coils to restrict the field within a limited area does not permit the designing of a radio-frequency transformer efficient in other respects. That is, while toroidal windings do restrict the field and prevent intercoupling, the resultant winding has an excess of distributed capacity, high-frequency resistance and, in consequence, a poor amplification factor and a low degree of selectivity. The superior method is to use cylindrical windings and allow liberal space between them and the sides of the metal casings employed as the shields. If care is taken in the design, four stages of tuned-radio-frequency amplification without regeneration can be used successfully, and a high amplification factor expected from each stage.

It is well known that each stage of radio-frequency amplification added to a cascade, increases the selectivity four-fold. The degree of selectivity obtained with this receiver is actually about fifteen times as great as with a good selective receiver having two stages of tuned-radio-frequency amplification. If two stations are separated by 10,000 cycles, it is usually possible to select either one without any trace of interference from the other, regardless of their relative signal strength.

The radio-frequency transformers are placed on bases with plug-in contacts, so that they may be readily removed and a different size inserted. It is impossible to design one transformer to cover the wave-length range of 35 to 3,600 meters and expect any reasonable efficiency. Accordingly, to secure high and uniform efficiency under these requirements, five different sizes of transformers are used, covering the following ranges: No. 1, 35 to 90 meters; No. 2, 80 to 210 meters; No. 3, 200 to 550 meters; No. 4, 500 to 1,500; and No. 5, 1,200 to 3,600 meters. It will be noted that an overlap is provided between the ranges of the transformers.

DETAILS OF THE HOOK-UP

Referring to the circuit diagram, the related action of the six units is as follows: the first radio-frequency stage is tuned to the desired station by the main tuning condenser C1. The antenna series condenser C and selector switch SW are then adjusted to provide the proper degree of selectivity; points 1, 2 and 3 of the switch allowing for

(Continued on page 162)

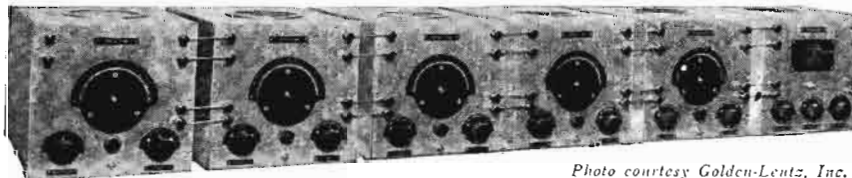

Photo courtesy Golden-Lentz, Inc.

Although there are many dials to be adjusted in tuning this receiver, the results obtained are worth any trouble.

others, in order that there may be no interaction between the adjacent circuits.

The utilization of metal shields has provided the solution to the problem. The coils, the condenser, the tube and the wiring for each stage are entirely enclosed in a separate metal case. It is only the connecting wires from one stage to the next that issue from the enclosures.

The experimental receiver described in this article is original as well as radical in many features. It is the first receiver designed to employ four stages of tuned radio frequency

of a radio-frequency transformer from extending from one shield to another, and thence to an adjacent radio-frequency transformer, in which case there would be interaction between two or more stages. If shielding is improperly employed it will defeat the purpose it has been intended for, and actually present a path for the radio-frequency currents instead of a blockade. This is particularly true if the radio-frequency transformers, grid leaks, plate leads or sockets are too close to the shielding.

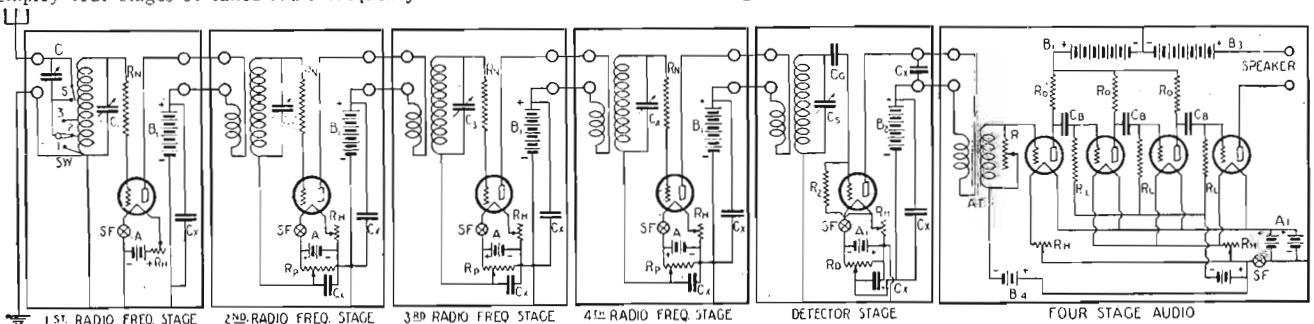

The circuit diagram of the 9-tube Transoceanic receiver, showing how the different stages are shielded completely, and how each incorporates its own current supply.

More About Receivers Without Wires

By EDMUND T. FLEWELLING

Herewith is the fourth of Mr. Flewelling's interesting articles on radio receivers, in which he tells of a new idea in connecting leads, employing the capacity which exists between them.



THE article of last month presented an introduction to a method of building radio receivers or transmitters, the use of which would greatly simplify the construction of radio sets and enable the manufacturer, experimenter or amateur to construct receivers with far more certainty as to the results than is possible with methods now in use. As in that article, it again becomes necessary here to reserve all patent rights to the author.

There is a vital need for reducing the mechanical construction of receivers to a point where use may be made of mathematics with their accuracy and certainty, as shown by the numerous attempts to build receivers of unit parts, or what might be called standardization. Standardization, up to now, would have had ill effects because of its tendency to make difficult the introduction of new ideas and devices. This will also hold true for some time in the future; and for this reason the writer wishes to impress on your minds that no constructive good can come, as yet, from building receivers without wires if only certain apparatus can be used.

On the other hand, great and constructive good can come from a design that allows radio sets to be built with a minimum amount of wire, yet include any part or component that may be considered good practice. If such a design is achieved (and the writer believes it has been) then the punch press and modern production methods will come into their own in the building of radio sets and the man who makes his own receiver will have a bit of guarantee that his receiver is going to work as its designer intended it should. Simplification of construction, without any attendant loss because of its use, is very sorely needed. The old days of a thousand dials per receiver are memories now, yet our modern receivers are better than ever because of their clean-cut simplicity. The use of a jack for the detector and one for the first stage besides the regular last-stage jack, or of several units, such as power amplifiers, loud speakers, etc., should be frowned upon. Receivers must eventually come to the entirely self-contained type and we should all work to this end—the modern-production-method receiver which is mathematically and mechanically correct, may be operated by anyone, and is entirely self-contained. We are a long way along the road to this, and I propose to show one way by which the road may be shortened.

MORE DIRECT CONNECTIONS

No matter what types of receivers using tubes, one might wish to consider, it will be found that all have several things in common. Let us point out a few of them in a general way. Every receiver has two connections, "+A" and "-A", to its filament. Most receivers have rheostats in the "-A" lead. Every grid is connected to a coil, or transformer, and the other end of this coil is always connected to the "A" lead, and most of the time to "-A". If a tap for neutralizing, etc., is taken off these or the plate coils, it seldom does much to upset our generalities. The plate of the tube leads to its coil, etc., and invariably ends up at "+B". Tuning condensers are usually connected to the grid and their rotary plates to the filament, either directly or eventually. The grounded point in receivers is on a common footing with one

side of the coils, condensers, batteries, shielding, rheostats and potentiometers. It is rather surprising to note how many ways exist for running a wire around a radio set, only to end up at "-A", and with a positive ignorance as to the harm done by this wire after it left the coil or condenser.

If we could connect our coils directly to the grid or plate and have no other end of the connection to complete, if we could confine the radio-frequency potentials to only the tubes and their coils and condensers, if we could wipe these radio-frequency potentials entirely out of our receivers as soon as they had done their work, we would be taking a long step toward our goal. We would then absolutely know that feedbacks existed only in the tubes, between the tubes, and between the coils and condensers. Four places for feedbacks, and one is eliminated by spacing the tubes far enough apart.

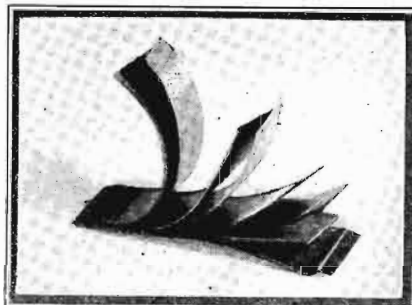

One of the "capacity-strip" connectors opened, showing the various leads and the insulators.

Surely if we know that troublesome or helpful feedbacks exist only in three places we have made a tremendous gain, because in present receivers the best guesser in the world can not tell where these feedbacks occur.

USE OF CAPACITY STRIPS

Supposing, after every coil or condenser had passed the R.F., that as the R.F. left the terminals of this coil it was fed into a mammoth tank condenser it would not have much opportunity for effect on the set, would it? If every current-carrying lead in the receiver, both the D.C. battery potentials and the A.C. potentials, R.F. and A.F., were carried in this tank condenser, then we would have a condition of extreme value to us in a number of ways. Such a condenser, to be of service, must be available for use in practically any part of the receiver; that is, we cannot run leads to the condenser for they would operate against the desired effect. The condenser must be at any point at which we may desire to use it. Such is the result accomplished by the capacity strip shown in last month's article and shown more clearly in this article. The long illustration shows a strip which may be used for any of the common popular or

commercial circuits, by cutting it off for the proper number of tubes. It will be noticed that there are rows of tabs or terminals along each side of the strip. On one side they run in pairs, for "+A" and "-A"; on the other side they run to correspond to "B 45", "B 90", "-A", and "C". The "B 45" and "B 90" are mounted, one on the other, and so show as one. "B 45" is but little used, so we tear off all "B 45" tabs not used, and the "B 90" tabs where "B 45" is used. The strip shown is being used in an effort to determine the minimum safe spacing of tubes; for R.F. and A.F. amplification work, and for 8-tube super-heterodyne work.

The other illustration shows a section of such a strip, opened up to illustrate the interleaving of the metal conducting plates and the dielectric material. It has been said that "-A" has a terminal on both sides of the strip; in other words there are two "-A" strips and might be any number for each of the various conducting strips. This fact, combined with the use of a suitable dielectric, and high pressure with proper materials gives a condenser of any practical capacity at our service right at the terminals of every tube, coil and condenser in our set; to say nothing of having it directly across all batteries or current-supply devices.

IMPROVEMENT OF SHIELDING

Rheostats and potentiometers may be placed at will, and practically any type of coil and transformer may be used to obtain any desired hook-up, with practically very little need for connecting wires. I have pointed out that shielding is common with the "A" battery, and the grounded side of coils and condensers. To secure the maximum good from shielding it must be "watertight," so to speak. Present methods spoil this "watertight" effect by running wires through multitudinous holes in the shielding. A capacity strip run through the shielding greatly simplifies this by its compactness and even more so when the strip is so shaped as to form one side of the shielding.

Again we must remember that almost invariably one side of the tuning condenser is common to the shielding and the "A" battery and that the strip may be used to form this side of the condenser, somewhat after the idea of the book type condenser, but not quite so crude. A little reference work shows that this type of condenser is far superior to the interleaving-plate type. It may be more efficient (lower-loss) and certainly has a much smaller external field, one reason for its efficiency. When properly designed, these condensers have an extremely small external field and their use would tend to cut our three places for feedback down to two.

I have mentioned that there may be more than one strip for "B 45" or "+A", etc., and for this reason might call your attention

(Continued on page 182)

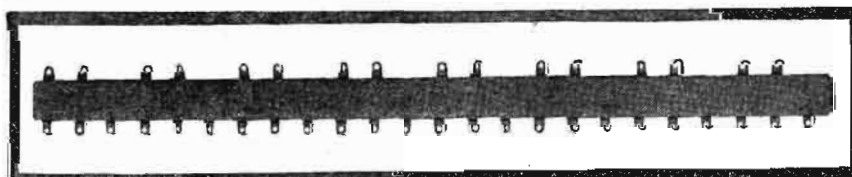

The "capacity-strip" connector. The tabs are lugs for the different strips of metal and are used for the various battery leads, as explained above.

More About Audio-Frequency Amplifiers

By SYLVAN HARRIS

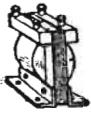

This, the third of Mr. Harris' series on A.F. amplifiers, deals with their performance from the hearers' standpoint. The first article was devoted to general requirements, and the second to graphic methods of representing characteristics.

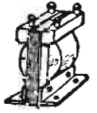

THE study of audio amplifiers, which we are making month by month in *RADIO NEWS*, is becoming very fascinating; for it has led, and is leading, to many important considerations which are quite new to us. Although it might be supposed, without careful reflection, that the study of amplifiers is a purely electrical subject, enough has already been brought out in these articles to show that the fact is otherwise. The two previous discussions in this series contained very little about transformers or other coupling devices, considered as electrical apparatus; but dealt with matters of the utmost importance as regards their *output*, which must be judged from an acoustical standpoint.

The first article described, in some detail, the nature of overtones as well as fundamental tones, explaining their importance and the necessity of preserving them, and showing the effects of imperfect amplification on the reproduced voice and speech. The second of the series showed how the characteristics of an amplifier are best plotted in graph form, in order to express the physiological phenomena of reproduced sound in the manner most readily comprehended by the sight.

This article continues the discussion begun in those preceding it, and deals with the requirements which successful transformers must satisfy. As the principles which we have already set forth apply with equal force to all types of amplifier coupling devices, we will not confine this series to transformers, as first planned; but extend its scope to include other types of coupling, resistances, impedances, etc.

As said at the conclusion of the previous article, we must deal only with *practical* requirements for amplifiers. It is obvious that no apparatus is perfect or can be made to function perfectly. For practical purposes, however, it may often be made to operate so well that the human senses cannot perceive any lack of perfection.

WHAT TOLERANCE IS PERMISSIBLE?

To make this observation appropriate to our discussion, and explain our meaning, let

us consider the characteristic curve of a specific, actual amplifier, and compare it with that of the imaginary, perfect amplifier. The question to be answered is, how far may the actual characteristic depart from the line of perfection before any distortion in the reproduced speech or music can be detected by the human ear?

As Fig. 1 shows, the perfect amplifier would deliver a voltage amplified at a uniform ratio at all frequencies; no matter what the pitch of the tone amplified, its strength would always be equally increased. In other words, the voltage output of the amplifier would *always* be the same number, say twenty, times the input voltage.

But, as we see from the characteristic curve of the actual amplifier, and as explained in detail in the previous articles, in practice the amount of voltage amplification drops rapidly at the lower frequencies. To find out the amount of this drop which is permissible, we must set up standards based on the phenomena of *audition* or hearing, as they have been determined by experiment.

In other words, we must answer two questions: first, "What is the lowest frequency we may ever want to pass through the amplifier?" and second, "At this frequency, to what extent may the voltage ratio drop before the effect is noticeable by the human ear?"

The correct answer to these questions will enable us to set the standards by which transformers may be judged. At the present time it is unnecessary to know more than this about amplifiers. In the past more would have been required, for a few years ago there were serious defects in amplifiers, causing decided humps in the characteristic curves anywhere along their length—even in the middle. But in the past year or so manufacturers have learned how to smooth out these humps, and have produced transformers with virtually flat curves up to six or seven thousand cycles, which is fairly near the upper-frequency limit of audibility.

The most important part of the curve, therefore, is the low-frequency end, to which we will confine our attention for the present.

It is well known that the lower-frequency limit of audibility is in the neighborhood of 32 cycles per second, and for some ears even higher than this. Certainly there are very few persons who can perceive tones having frequencies lower than this, which is that of the lowest note on the piano. The bass viol goes only as low as 40 per second.

DO WE NEED THE LOWEST TONES?

If those readers who are pianists will reflect for a moment on the number of times they strike a note in the last octave, they will agree with me that these are extremely

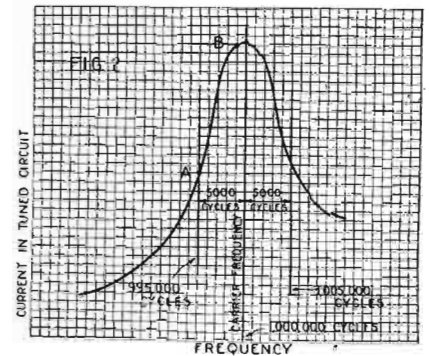

One cause of distortion in radio receivers: when the tuning of the R.F. stages is too sharp, or too much regeneration is used, the bands on either side of the carrier frequency, which correspond to the voice or musical frequencies, are cut off, so that the quality of reception is impaired.

few. Furthermore, it is doubtful whether the bass viol player uses his lowest note, the open E, except on rare occasions; and even the two notes above this are seldom played.

In view of this, let us assume arbitrarily that the lowest frequency we expect our amplifier to reproduce is 50 cycles per second, which is low enough for all practical purposes. This eliminates only the three lowest tones of the bass viol and the six lowest of the piano. With regard to the organ, there are certain of its longest pipes which will not be heard; but we must be reasonable, for prohibitive costs may not be incurred solely to take care of the notes down to 32 cycles.

Incidentally, it must not be thought that any of the amplifiers now in general use will reproduce the very low frequencies under all conditions. It will be seen, later on, that even the resistance-coupled amplifier will slight the low tones, unless it is carefully designed. Furthermore, it must be kept in mind that the loud speaker may be a source of serious distortion; as well as the radio-frequency amplifier with its regeneration. Defects in these should not be blamed on the audio amplifier; but, although this series of articles is devoted to the latter only, we shall show that in some cases it may be possible to *compensate* in some degree for the defects of the former.

Having decided that 50 cycles per second is the lower-frequency limit for our discussion, let us find out how much the voltage ratio may be permitted to drop at this frequency before our ears discover the effect; or, in other words, how small a change in sound intensity is noticeable. In some cases the effects are detected at once in the out-

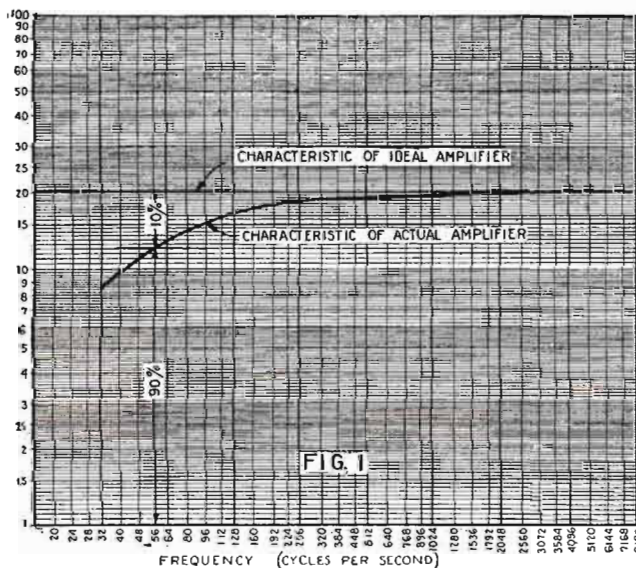

The ideal amplifier would amplify equally well at any frequency, as indicated by the straight horizontal "curve" in this chart; but the voltage ratio of the actual amplifier drops with increasing frequency, as indicated by the lower curve. There is a limited drop of voltage ratio which is permissible, depending upon the ability of the human ear to detect changes of sound volume. Change of sound-volume in the loud speaker depends considerably upon the change of voltage-ratio; so that the amplifier should be considered, as we do here, from the audition view-point.

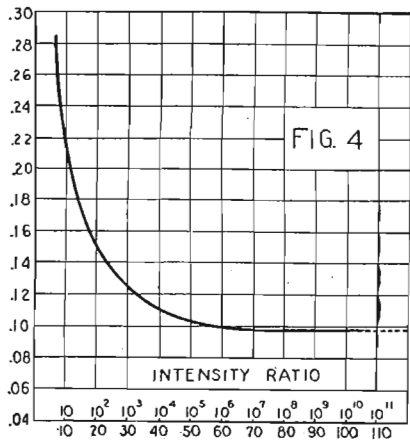

The vertical scale represents fractional change of energy in the sound wave. This curve shows the faculty of the human ear to perceive a change of sound intensity.

put of the loud speaker; we have heard people say that a certain loud speaker "has a high pitch," or "a low pitch." This is an inaccurate way of putting it, as the loud speaker does not, or should not, have a pitch of its own. What is meant by the expression is that the speaker reproduces the high tones well but neglects the low tones, or vice versa.

MATCHING THE AMPLIFIER WITH A LOUD SPEAKER

A part of this effect is often caused by the amplifier, and it may well happen that a "high-pitched" amplifier connected to a "low-pitched" loud speaker may produce very satisfactory results. For instance, if our amplifier is weak on the low tones and strong on the high ones, we might advantageously use a loud speaker which has an opposite or "complementary" characteristic, so that it will reproduce the low tones strongly and the high tones somewhat more weakly. On the other hand, if the amplifier is as strong on the low frequencies (down to 50 cycles) as it is on the higher ones—in other words, if it has a "flat" characteristic—then we should use a loud speaker which has also a flat characteristic. The proper selection of the combination introduces the "compensation" of which we have previously spoken.

There is another important consideration—that of the "side-bands" of the carrier wave transmitted by the broadcast station. It is possible that the tuning of the transmitter and of the R.F. amplifier of the receiver may be so sharp as virtually to cut off some of these side bands. This is especially possible with a regenerative receiver. The effect is illustrated in Fig. 2, which shows how the current in the tuned R.F. circuit varies with the setting of the condenser, when tuning to the carrier wave of a particular frequency. The side bands, which are produced by modulating the carrier wave with vocal or musical frequencies, extend about 5,000 cycles higher and lower than the carrier frequency. A carrier wave of 300 meters (1,000 kilocycles), for instance, modulated by musical frequencies up to 5,000 cycles, would include all frequencies between 995,000 and 1,005,000 cycles; although in a small band of 50 cycles on each side of the carrier frequency the tones would be inaudible.

It is obvious from Fig. 2 that the current in the tuned circuit of the receiver, when a tone of 5,000 cycles modulates the carrier wave (as shown at A), is less than that when a tone of 1,000 cycles is being received. As a consequence, we may expect that the high-frequency tones will be impressed on the audio amplifier at a lower voltage than the low-frequency tones. If this is the case, it may be advisable to use an amplifier with

a rising characteristic, such as that shown in Fig. 3, to bring back the high notes to their full strength. All this, of course, is only in case we use a loud speaker which has a flat characteristic. If the loud speaker, on the contrary, is strong on the high notes, we can use an amplifier with a flat characteristic, for the loud speaker will do the compensating. If the loud speaker is weak on the high notes and a flat-characteristic amplifier is used, the effect will be accentuated, and we may find the violin sounding like a 'cello, as explained in the first article of this series.

However, we will assume for the present that we have a loud speaker with a flat characteristic; if such a one is not available at the present time, it will be very shortly. We will assume also that the R.F. stages do not cut the side bands appreciably, for, if properly designed and operated, they will not do so. In this case what we require is an amplifier with a characteristic curve as nearly flat as possible.

SENSITIVITY OF THE HUMAN EAR

How flat should this be? This question may be answered by consideration of the results of the research into audition which has been made by Mr. V. O. Knudsen (Phys. Rev. xxi, No. 1, Jan., 1923). Some of this work is summarized graphically in a chart (Fig. 4), here reproduced by permission from the Bell System Technical Journal, in which it illustrated a paper by Dr. Harvey Fletcher (Oct., 1923). Without going too deeply into the analysis of this chart, it represents on the vertical scale the fractional change (called the "Fechner ratio"), in sound energy which is just perceptible to the ear. Thus, if E represents the intensity of a tone, and this is increased to an amount represented by ΔE , the ratio of the increase to the initial intensity, E , is the Fechner ratio. The horizontal scale represents simply the values of the intensity E. In other words, Fig. 4 shows how the least perceptible percentage of change in the loudness of tone varies with the loudness.

For tones above a certain intensity, as the chart shows, the fractional change in their loudness that is just perceptible is very constant, and has a value of 0.1; in other words, between very wide limits of intensity, we can perceive a change of ten per cent. in the loudness of a sound. Also, this means that we can tolerate a drop of voltage, at the output of our audio amplifier, of about 10 per cent. Note that the word *output* is emphasized. The amount of voltage drop tolerable in each stage of the amplifier depends upon the number of stages. If we use two stages, as in transformer-coupled amplifiers, the voltage amplification available at 50 cycles must be 94.9 per cent. (or the square root of .90 — for $.949 \times .949$

= .90) of that which is available at the higher frequencies. If there are three stages of A.F. amplification, as in resistance- or impedance-coupled amplifiers, each stage must supply at 50 cycles 96.6 per cent. of the voltage amplification available at the high frequencies (for $.966 \times .966 \times .966 = .90$).

To sum up, then, in two-stage A.F. amplifiers, the falling off of the curve, at 50 cycles, from the value at the higher frequencies should not be more than 5 per cent.; and in three-stage amplifiers, not more than 3.5 per cent. How near to these values the amplifiers now on the market approximate it is difficult to say; but at least they come considerably nearer to them than did the amplifiers available a year or so ago.

SOURCES OF DISTORTION

This article has become sufficiently long at this point, so that we can go no further this month into the subject; but we have at least established a criterion by which to judge the efficiency of amplifiers and to guide in their design. We will consider its application to particular cases in the subsequent numbers of this series.

Thus far we have considered amplifier coupling devices solely with regard to the frequencies transmitted by them. There is yet another important item which has been very much neglected by other writers and investigators; but which is of such importance that an amplifier which has a perfectly flat frequency characteristic may yet introduce serious distortion into the reproduction.

What I am referring to is the response of the amplifier under signals of various strengths. That of the electron tube is limited by the charge, which collects upon the grid and under certain conditions becomes sufficiently great as to introduce considerable distortion. But if the input circuit of the tube is designed to have relatively low resistance, no fear need be felt on this score, excepting in so far as the overall amplification is reduced.

Assuming that no such overloading of the grid occurs, there is yet another cause of distortion, which occurs especially in transformers, where the voltage ratio changes with the signal strength. Under some conditions, and since these coupling devices are generally designed to transmit very little power, their voltage regulation is very poor; and when the signal strength exceeds a certain limit the voltage ratio may fall considerably. This is another phase of the amplifier problem, which will be considered in detail in the next article of this series.

In this forthcoming article, also, we shall give in graphic form the results of some of the measurements which have been made on various types of coupling devices, in the Radio News Laboratories during the past few months.

An A.F. amplifier with a rising frequency-characteristic can be used to advantage in many cases, especially where the R.F. amplifier is tuned so sharply as to cut off some of the side frequencies, or at least to reduce them in intensity. The increased voltage step-up in the coupling device, as the frequency becomes higher, will compensate for the weakening of the high notes on account of the very sharp tuning. Also a loud speaker which is full on the low tones, but weak on the high ones, will act better with an amplifier having a characteristic like this.

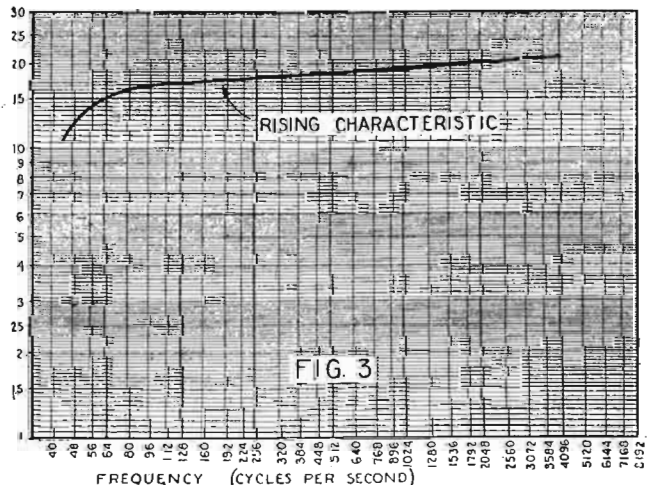

Chemical Condensers of Large Capacity

By CLYDE J. FITCH

"B" Battery eliminators require fixed condensers of several microfarads capacity for filtering purposes. In this article some interesting chemical condensers of large capacity are described.

THE extensive use of "A" and "B" battery eliminators for the radio set has created an enormous demand for filter condensers, of several microfarads capacity and capable of withstanding test voltages up to 500, which are usually made of sheets of tin foil separated by waxed paper. Such condensers were used in telephone circuits long before radio broadcasting started; but before machinery was perfected for manufacturing waxed paper condensers, chemical condensers were used, having been brought to a high state of perfection in the early days of telephony.

Due to lack of proper constructional data, experimenters have had little success with their use in filter circuits of "B" eliminators; but when properly made one will give surprisingly good results. While its use may not be practical in a commercial "B" eliminator, the chemical condenser may be highly recommended to the experimenter who builds his own and is familiar with its care and operation.

Certain metals, such as aluminum, magnesium, and tantalum, when immersed in an electrolyte, possess the property of allowing electricity to flow in one direction and not in the other, provided a certain critical voltage is not exceeded. Two electrodes of this kind practically prevent all flow of electricity and constitute what is known as an electrolytic or chemical condenser. This phenomenon was discovered by Wheatstone in 1855.

THE "RECTIFYING" ACTION

If an aluminum plate and a lead plate, in a solution of borax in water, are connected to an alternating current line (Fig. 1), an oxide or hydroxide film, covered by a thin gas layer, will gradually form on the aluminum plate. This film is an insulator of electricity, and when the aluminum is the anode or positive plate, current will not pass through it. It may be observed, however, that myriads of fine electric sparks dance all over the surface of the aluminum anode; these are caused by electricity jumping through small "pin-holes" in the film, the instant the aluminum plate becomes positive, forming what is called the "leakage current." Its flow almost instantly builds up the film which stops further flow of electricity. The leakage current therefore flows only at the beginning of each positive cycle.

When the lead plate is the anode, current flows from the lead plate, through the electrolyte and through the pin-holes in the film, to the aluminum plate. When the current flows in this direction, instead of sealing

up the holes, it decomposes the film around them, and they open up wider, like a camera shutter, and allow more current to pass. The pin-holes thus act like small valves, opening up when the current flows from the electrolyte to the aluminum, and closing when it flows from the aluminum to the electrolyte. The device therefore serves as a rectifier, possessing a greater resistance to electricity in one direction than in the other. Its use as a rectifier has been limited commercially, partly on account of the loss of energy due to the leakage current mentioned above.

It has been determined that the greatest frequency, of the opening and closing of the pin-holes in the film, is in the neighborhood of 1/1100 of a second. Consequently an electrolytic rectifier will not function in a radio-frequency circuit. It cannot be used as a detector.

USE AS A CONDENSER

When the electrolytic cell (Fig. 1) is connected to a D.C. line with the aluminum plate as anode (Fig. 2) a uniform film, without pin-holes, is formed over the entire submerged surface of the aluminum plate, and reduces the current flow to almost zero. There is no leakage current caused by sparking, as when the cell is used for a rectifier.

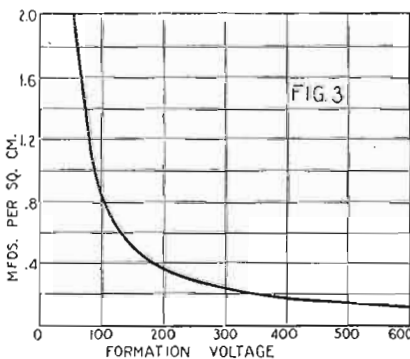

Curve showing the variation of capacity with formation-voltage of a chemical condenser, using aluminum plates.

A small leakage current flows from the aluminum plate at its contact with the surface of the electrolyte, but this can be reduced to a negligible amount by making the surface line very short and insulating the aluminum plate where it enters the liquid. When so constructed the cell forms a very good condenser. The film acts as the di-

electric. If worked below the critical voltage the film will not puncture. If the film is accidentally punctured, it immediately heals up again.

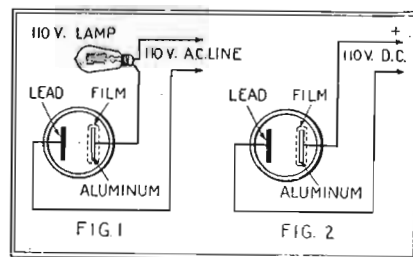

Fig. 1, connections of an electrolytic rectifier to an A.C. line. A lamp is used to limit the current flow. Fig. 2 shows the rectifier connected to a D.C. line.

The critical voltages for aluminum plates in electrolytes formed by 1 per cent. solutions of various chemicals, tested after 24-hour formation of the film, are as follows:

Sodium Sulphate (Na ₂ SO ₄)	40
Potassium Permanganate (KMnO ₄)	112
Ammonium Chromate ((NH ₄) ₂ CrO ₄)	122
Potassium Cyanide (KCN)	293
Ammonium Bicarbonate (NH ₄ HCO ₃)	423
Sodium Silicate (Na ₂ SiO ₃)	445
Ammonium Phosphate (NH ₄ H ₂ PO ₄)	460
Ammonium Citrate (C ₆ H ₅ OH[CO ₂ NH ₄] ₃)	470
Sodium Borate, "Borax" (Na ₂ B ₄ O ₇)	480

To obtain the large capacities required for "B" battery eliminator circuits, we must use very large plates or a very thin dielectric. The electrolytic condenser, on account of its extremely thin gas-film dielectric, has an enormous capacity when only small plates are used. C. I. Zimmerman found that the thickness of the film is between 1/50,000 and 1/500,000 of an inch, depending upon the formation-voltage. The dielectric constant of the film is about 10, so that a capacity of 1/4- to 1/2-mfd. per square inch of electrode surface is easily obtained.

The capacity of the electrolytic condenser depends only upon the voltage of formation and the material of the anode, and is independent of the nature of the electrolyte. Fig. 3 shows the variation of capacity with formation-voltage when using an aluminum anode. Note that the lower the formation-voltage the greater the capacity. A low formation-voltage produces a thin film and high capacity; a high formation-voltage produces a thick film and low capacity. In passing from a low to a high formation-voltage, the thickness of the layer increases and assumes its new value in a few minutes; in passing back to a lower voltage, it requires months before the gas layer assumes its former thinness.

BUILDING A LARGE CONDENSER

Dr. Gunther Schulze describes an interesting electrolytic condenser in the *Electrochemical and Metallurgical Industry*, Vol. VII, page 216. The condenser is made up of ten aluminum plates 3 13/16x6 1/2x1/25 inches, cut as shown in Fig. 4 and the lugs bent up (Fig. 5) to form the connections. The lugs and about half an inch of the top of the plates were placed in a saturated solution of ammonium borate, and a thick film formed at 500 volts, as indicated by the shaded area in Fig. 5. The purpose of this film is to help insulate the plate where it meets the surface of the electrolyte in the

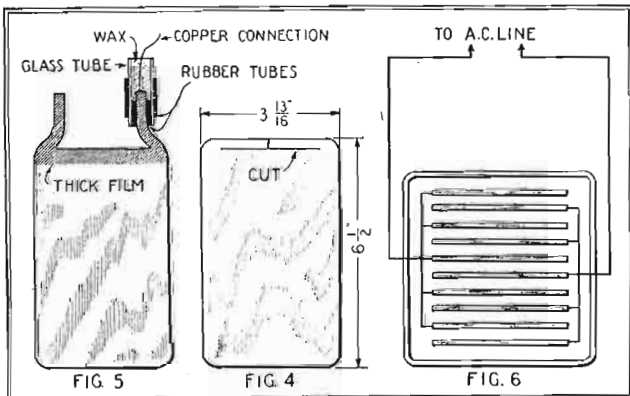

Constructional details of a chemical condenser. Fig. 4 shows how the aluminum plate is cut and bent up to form lugs, as in Fig. 5. Fig. 6 shows the connections of the finished condenser, for use in an A.C. circuit.

finished cell. Small copper connecting wires are fastened to the ends of the lugs. A rubber insulating tube is placed over the lug, over which is placed a glass tube, and the space between is filled with sealing wax. Another rubber tube is then placed over the whole.

The total effective area of the ten plates is 503 square inches, and the length of the boundary lines 3 inches. The residual current, or leakage current, at 110 volts was .0005 amperes, which leaked through the insulation at the boundary line. The distance between the plates was about 3/16 of an inch. In this condenser, five plates were used for each side of the circuit; and as each set of plates is of aluminum, it makes no difference which way the condenser is connected in the circuit. The following table shows the measured capacities with different formation-voltages:

Formation-voltage	μf. Capacity
40.....	147.7
80.....	73.1
132.....	44.0
160.....	37.7

Dr. Schulze's condenser is made up of ten plates, five for each side of the line, as shown in Fig. 6. This type of condenser is required for alternating current circuits. For filter circuits in "B" eliminators, where the current is not alternating but pulsating direct, we can connect all of the plates to the positive side of the line, and the electrolyte to the negative side by means of a small strip of lead dipping into it, as clearly shown in Fig. 7. This arrangement will give twice the capacity obtained with five plates on each side of the line. Therefore, instead of 147.7 microfarads at a formation-voltage of 40, the capacity is 295.4 microfarads.

It seems inconceivable that such a small device should give a capacity of nearly 300 microfarads. Think what it would cost to build a waxed-paper condenser of 300 microfarads—almost one dollar per microfarad.

UTILIZING THE CHEMICAL CONDENSER

Of course this capacity is obtained only provided the condenser is not used on voltages higher than 40—the forming voltage. If formed on 20 volts or less the capacity will be considerably greater; the condenser would then probably be suitable for filtering current in "A" eliminator circuits, where the voltage is not over 10. A capacity of 600 to 700 microfarads can be obtained at this low formation-voltage.

Extensive tests were made on the condenser described above; and it was found that for maximum efficiency the voltage at which the condenser is used should not exceed 90.

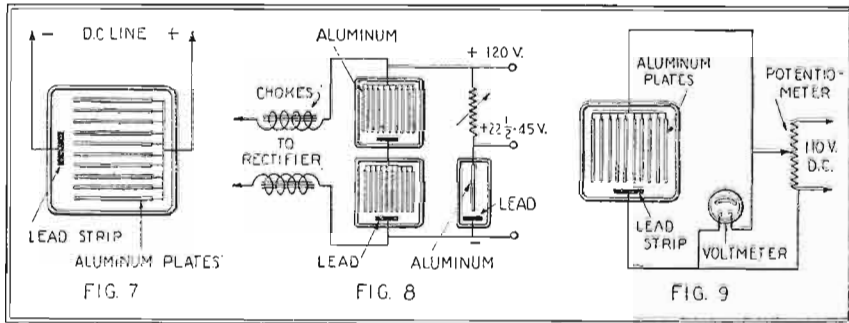

Fig. 7 indicates the connections of the chemical condenser for a D.C. circuit. A lead strip is used for the cathode. Fig. 8 shows the connections of a "B" eliminator filter circuit and Fig. 9 the connections for "forming" the plates.

For higher voltages two or more condensers should be connected in series. In "B" eliminator circuits the voltage seldom exceeds 150. Therefore two of these condensers should be used, connected in series. If the film on each condenser is formed at 75 volts, each will have a capacity of about 160 μf. Connecting them in series, the total capacity across the two will be about 80 μf., much greater than is necessary for a "B" filter circuit. The connections of the two condensers in series are shown in Fig. 8, with a complete filter circuit.

The experimenter who desires to build an electrolytic condenser should select a pure grade of commercial aluminum, either extra pure or No. 1, which is about 99.55 per cent pure, with a slight amount of silicon and iron. The plates should be cut as shown in Figs. 4 and 5, and thoroughly cleansed in hot water. For the electrolyte a saturated solution of borax, to which a small amount of glycerine is added, may be used. The negative terminal of the condenser may be a strip of lead dipping into the electrolyte, and the whole placed in a glass storage battery jar. As aluminum cannot be soldered with the ordinary low-temperature lead solders, connections may be made to the plates by means of small screws and nuts. By taking extra care to insulate the aluminum lugs at the surface line of the electrolyte the leakage current will be reduced to a minimum and the efficiency will be very high. The condensers will not draw a heavy load from the rectifier tubes.

To form the film on the plates, the connections shown in Fig. 9 should be used. The voltage at which the condenser is to be used should first be determined, and the forming-voltage should be a little greater; if the condenser is to be used on an A.C. circuit,

it should be greater than the maximum value of the A.C. voltage. If the 110-volt D.C. line is not available, a set of "B" batteries may be used to form the film. The current consumption is low and will not ruin the batteries. It is best to leave the forming-voltage on about ten hours. When using a 110-volt D.C. lighting line, a 400- or 500-ohm potentiometer and a voltmeter are desirable, as shown in the figure. By starting with the potentiometer arm at the bottom, at zero voltage, and gradually swinging it up until the proper voltage is applied, the film will slowly thicken as the voltage increases, and a minimum amount of current will be drawn from the line.

One of the main reasons why chemical condensers and electrolytic rectifiers have not been more popular is the sloppiness of the liquid electrolyte. Perhaps some experimenters may overcome this disadvantage by using some form of jelly or fused electrolyte. Fused sodium phosphate has been used for the electrolyte of an aluminum cell rectifier with very good results. It would seem that much better efficiency would be obtained when using the rectifier for "B" eliminators, because the current used is much less than for charging batteries.

Storage batteries with jelly electrolyte have been made to give fairly good results. The experimenter who wishes to work along these lines may use sodium silicate, commonly known as water glass, for making the jelly electrolyte, to which the acid may be added. However, it shrinks away from the plates and of course increases the internal resistance of the cell, which may become entirely open-circuited.

We should be pleased to hear from experimenters who have had any great success with solid electrolytes.

LIST OF BROADCAST STATIONS IN THE UNITED STATES

(Continued from page 129)

Radio Call Letter	BROADCAST STA. Location	Wave (Meters)	Power (Watts)	Radio Call Letter	BROADCAST STA. Location	Wave (Meters)	Power (Watts)	Radio Call Letter	BROADCAST STA. Location	Wave (Meters)	Power (Watts)
WLTS	Chicago, Ill.	258	100	WQAW	Omaha, Neb.	225	1000	WRAK	Evansville, Mich.	266.3	100
WLW	Harrison, Ohio	422.3	500-5000	WQAX	Trenton, N. J.	240	500	WRAM	Galveston, Ill.	211	100
WLWC	New York, N. Y.	284.3	3500	WQBC	Davenport, Iowa	185.8	5000	WRAP	Yellow Springs, Ohio	265	100
WMAZ	Canton, N. Y.	273	100	WQCL	Jacksonson, N. J.	275.2	15	WRAX	Reading, Pa.	238	10
WMAF	Dartmouth, Mass.	440.9	1000	WQDA	Patterson, N. J.	224	250	WRBC	Gloucester City, N. J.	268	500
WMAK	Lockport, N. Y.	296	500	WQEI	Ames, Iowa	273	750	WRCC	Valparaiso, Ind.	275	500
WMAJ	Washington, D. C.	212.4	100	WQFK	Homewood, Ill.	277.3	5000	WRD	Washington, D. C.	468.5	1000
WMAN	Columbus, Ohio	278	50	WQKO	New York, N. Y.	233	50	WRCE	Raleigh, N. C.	352	100
WMAQ	Chicago, Ill.	247.3	1000	WQLO	Philadelphia, Pa.	558.2	500	WREC	Coldwater, Miss.	254	10
WMAZ	St. Louis, Mo.	218	100	WQOD	Grand Rapids, Mich.	222	500	WREO	Lansing, Mich.	285.5	500
WMAZ	Macon, Ga.	251	500	WQOQ	Kansas City, Mo.	275	1000	WRHF	Washington, D. C.	250	50
WMBB	Chicago, Ill.	253	500	WQOR	Newark, N. J.	405.2	500	WRHM	Minneapolis, Minn.	252	50
WMBF	Detroit, Mich.	256.4	100	WQSD	Davosville, Ill.	275	5000	WRK	Hamilton, Ohio	270	100
WMC	Memphis, Tenn.	331.1	500	WQWL	New Orleans, La.	273	10	WRM	Ghana, Ill.	273	500
WMCB	Hoboken, N. J.	319.7	500	WQWO	New Orleans, La.	292	500	WRN	Richmond Hill, N. Y.	235	100
WMD	New York, N. Y.	217.9	500	WPAK	Agricultural Col., N. Dak.	275	50	WRNY	New York, N. Y.	258.9	500
WMAZ	Houston, Mass.	270	100	WPCC	Chicago, Ill.	258	500	WRN	Dallas, Tex.	240	250
WNAK	Roston, Mass.	289.2	200	WPDC	Buffalo, N. Y.	267.4	50	WRST	Bay Shore, N. Y.	215.7	250
WNAK	Omaha, Neb.	268	50	WPDQ	Atlantic City, N. J.	269.8	500	WRAV	Richmond, Va.	254	1000
WNAK	New Bedford, Mass.	248	100	WPRC	Harrisburg, Pa.	215.7	100	WSAL	Tarboro, N. Y.	273	500
WNJ	Newark, N. J.	292	150	WPSC	State College, Penna.	251	500	WSAL	Mason, Ohio	322.9	500
WNOC	Knoxville, Tenn.	268	100	WQAA	Parkeburg, Pa.	231	500	WSAN	Albion, Pa.	229	100
WNRC	Greensboro, N. C.	224	10	WQAC	Amherst, Tex.	234.2	100	WSAP	Fall River, Mass.	274	100
WNYC	New York, N. Y.	524	1000	WQAE	Scranton, Pa.	246	50	WSAX	Chicago, Ill.	268	100
WQAI	San Antonio, Tex.	394.5	2000	WQAM	Miami, Fla.	263	100	WSAZ	Pemeyoc, Ohio	414	50
WQAN	Lawrenceburg, Tenn.	282.8	500	WQAO	Saratoga, Pa.	253	100	WSS	Atlanta, Ga.	438.3	1000
				WQAO	New York, N. Y.	389	100	WSBC	Chicago, Ill.	249.7	1000
				WQCI	Chicago, Ill.	447.5	500	WSBF	St. Louis, Mo.	274	250
				WRAF	Laporte, Ind.	224	100	WSBT	South Bend, Ind.	273	250
								WSDA	New York, N. Y.	263	250
								WSKG	Bay City, Mich.	261	100
								WSM	Nashville, Tenn.	282.8	1000
								WSMB	New Orleans, La.	310	500
								WSMH	Oaxaca, Mich.	240	20
								WSMK	Dayton, Ohio	272	50
								WSOE	Madison, Wis.	240	300
								WSRO	Hamilton, Ohio	252	100
								WSSH	Boston, Mass.	261	100
								WSUJ	Iowa City, Iowa	289.5	500
								WSVS	Buffalo, N. Y.	218.8	50
								WSVS	Waukegan, Ill.	275	100
								WTAB	Fall River, Mass.	250	100
								WTAB	Carthage, Mo.	234	50
								WTAG	Worcester, Mass.	264	500
								WTAL	Toledo, Ohio	252	10
								WTAM	Cleveland, Ohio	380.0	3500
								WTAP	Cambelton, Ill.	242	50
								WTAP	Evansville, Ind.	264	100
								WTAR	Norfolk, Va.	261	100
								WTAW	Cotago Station, Texas	370	500
								WTAX	Streator, Ill.	231	50
								WTAT	Lambertville, N. J.	261	150
								WTIC	Hartford, Conn.	475.0	500
								WWAE	Plainfield, Ill.	242	500
								WWAO	Houghton, Mich.	247	250
								WWJ	Dearborn, Mich.	266	500
								WWJ	Detroit, Mich.	372.7	1000
								WWL	New Orleans, La.	273	100

Results of Cooperative Measurements of Radio Fading

By DR. J. H. DELLINGER, DR. C. B. JOLLIFFE and T. PARKINSON

During the last year and a half the Radio Laboratory of the Bureau of Standards has been studying the fading of radio signals. Herewith is a resumé of the findings.

AT the beginning of 1925, the Bureau of Standards invited a number of qualified laboratories to participate in the beginning of a co-operative program of measurements of the several quantities: field intensity, fading, direction variations, polarization, and atmospheric. In 1925 the work was largely confined to fading measurements, because the apparatus

receiving set, of any type, plus a sensitive direct-current galvanometer used with a detector in such a way as to measure variations in the received carrier-wave current. Records were in some cases made by visual observation of galvanometer deflections, but automatic continuous records were obtained in most of the work. These were easier for the observer, and showed up the smaller

The several sunset tests showed a similar decrease followed by an increase; superposed, however, on a marked general increase of signal intensity in the transition from daytime to night-time conditions. The time required for transition from normal daytime field intensity to normal night-time field intensity, at the particular frequencies used, is two or three hours, half before and half following sunset. The observations lead to the following general conclusions:

1. Short-period fading (periods of a few seconds to 8 or 10 minutes) is not the same on records made simultaneously, even at short distances.
2. The same is true of long-period changes (10 minutes to several hours).
3. Records of the same transmission made on successive days at the same receiving point bear little resemblance.
4. There is no correlation between intensity and fluctuation changes.
5. There is no consistent correlation between good reception and the relation of the transmission path to the direction of isobars or isotherms, as shown on weather maps covering the test periods.
6. Averaging a number of sunset records, made over a period of two weeks, shows a rise of intensity starting over an hour previous to sunset; a drop or lessening of the rate of increase before or during sunset at the receiving point; and a rise during or after sunset to a night-time value reached an hour or two hours after sunset. This value is not necessarily the night maximum which may occur much later. In the case of north-to-south transmission, the increase of intensity during the sunset period is continuous.
7. The average shows, in general, greater fluctuation at night than during daylight; the daylight value often being close to zero, while the night value, in rare instances, mounts to 3.5 times the mean intensity.
8. On the KDKA average records there is a consistent correlation between the ratio of day-to-night intensity and distance from the transmitting station. A correlation also between the ratio of day-to-night fluctuation and distance appears.
9. On a single set of 24-hour tests the maximum intensity appears at about the same time, the four hours preceding sunrise, for observers within 622 miles of the transmitting station.
10. Measurements of directional shifts during some of the tests indicate that they are, in general, accompanied by fading of the short-period type.

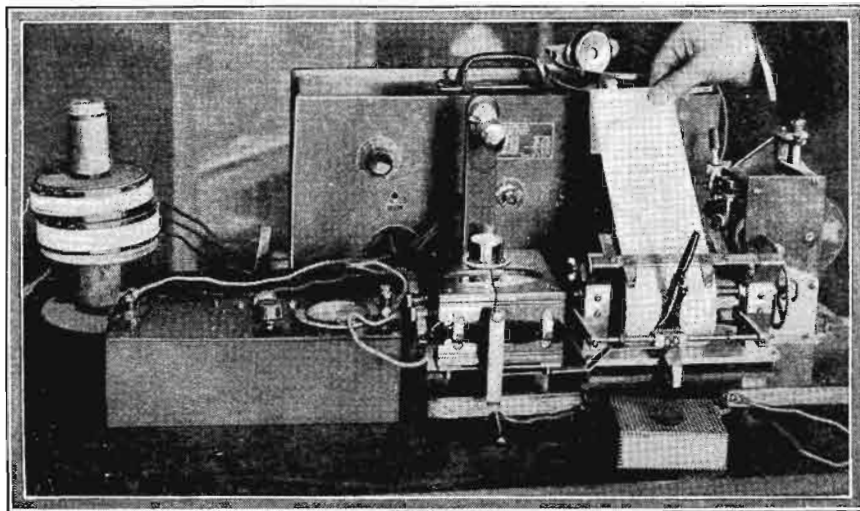

The apparatus assembled by Mr. Parkinson, of the Radio Laboratory of the Bureau of Standards, for making observations relative to the fading of radio signals

required is relatively simple and because fading phenomena promise to shed the most light on the wave characteristics.

The work was mainly at the broadcast frequencies because transmissions with an uninterrupted carrier-wave are not so readily available in other parts of the frequency spectrum. Results at other than broadcast frequencies, and field intensity and directional observations are therefore considered as incidental to the study of fading phenomena in the broadcast range.

The general plan of the work was the arrangement by which a certain station transmitted continuously during a specified period, and graphic records were made simultaneously by the observing laboratories. The observing method is that described in the pioneer paper, "Short-period Variations in Radio Reception," by G. W. Pickard. Proc. I.R.E., 12 p. 119; 1924.

The method of measurement utilized a

fluctuations which sometimes proved significant. A number of records made during some of the sunset fading tests, for instance, show a rapid periodic swing starting about fifteen minutes after the local sunsets at the observing points and lasting approximately a half hour.

RESULTS OF RESEARCH

The series of measurements on fading were devoted to a study of effects during the eclipse of January 24, the fading effects during sunset, and the fading variations throughout a 24-hour day.

The observations during the eclipse showed, as expected, a condition intermediate between daytime and night-time transmission. The perceptible variation lasted about an hour, consisting of a decrease in the field intensity to a minimum, followed by an increase to a maximum and then a subsidence to normal.

Tip-Jack Voltmeters for Filament Regulation

By ERNEST E. STOLP*

ATTENTION has been called to the use of filament voltmeters for controlling the application of voltage to vacuum tubes by the use of pin jacks in the panel of radio receivers.

Multitudes of tubes have gone to the rejuvenator or to the junk heap many moons sooner than they should, because of careless handling of the filament rheostat. The remedy lies in the use of a voltmeter, which, if connected in the filament circuit will give true readings of the voltage under varying battery conditions.

Receivers which are provided with pin jacks for easy application of a voltmeter have called forth small and exceedingly accurate meters, equipped with extended prods or terminals which will fit the pin jacks. These meters must be well made, with high-resistance movements, and have sturdy construction of the prods, which should also be adjustable to allow for slight inaccuracies in spacing of the pin jacks.

Zero adjusters, the same as used on the "big brother" or switchboard meters, should be provided so that deviations from the

zero mark, due to rough handling or shipment, may be corrected. For convenience the scale must have a special mark at three or five volts to permit of easy visibility.

Many tubes which have become inactive from excessive filament voltages will be replaced by tubes which will be controlled by the filament voltmeter; and in the near future many disappointments due to defunct tubes and run-down batteries will be forgotten in a new and added security of operation.

* Jewell Electrical Instrument Company

Correspondence from Readers

In this department the readers air their views on many important questions of the day. Comment is invited and an attempt is made to give equal weight to both sides of a controversy regardless of the magazine's policy.

FROM A FRIEND IN ENGLAND

Editor RADIO NEWS:

Yours is the only American radio magazine which has any sale to speak of over here, and our office copy is in continual demand by our regular customers of the ham fraternity when they drop in to "talk shop." I have taken it ever since I left Erie to take up my present job, and it keeps me wise as to what's new in radio in the United States.

A fair number of American sets are selling over here now, and people are buying them because they are more selective than British commercial receivers. Due to the Marconi patent royalties, however, which amount to \$3 per tube on sets bought, most of the B.C.L.'s hook up their own sets, and it is surprising what good results they get. They mostly use de Forest plug-mounting coils, and the most popular type of hook-up seems to be a four-tube with one stage tuned-plate R.F., detector, and two stages of transformer A.F. with switching for the last tube; though many are not switching the first A.F. which generally has an unsuitable amplification ratio for the position in front of the horn. A tickler coil couples the plate of the detector to the grid of the R.F. tube, and the trap circuit is placed in the antenna lead to cut out any local station that may interfere.

I have noticed that many of the British fans, after trying American hook-ups, come back to what are known here as "straight circuits," and think that Americans might get fine results from the old-fashioned layouts with the improved fixings now available. I built a radio last week on the lines indicated in the last paragraph, using Remler condensers, a Bradleyleak, Amperites, Thordarson transformers and Cleartron tubes. I have already had Rome, Madrid, Barcelona, San Sebastian, Prague, Berlin, Geneva, Oslo, Moscow, Hilversum, Hamburg, Breslau, Stuttgart, Frankfurt, Paris, Toulouse, all the British stations except Dundee, Aberdeen and Plymouth, and WBZ, WGY and KDKA. I hope to get more American stations next fall, but it is too late in the year to hope to do much at present. With regard to selectivity, I can hear Glasgow, 300 miles away, through Birmingham's transmission. The Birmingham station is just over a mile away, and both stations are emitting $1\frac{1}{2}$ kilowatts. On Swansea, 10 meters above Birmingham, I get interference, but am able to follow the program.

HENRY T. VOGEL,
Birmingham, England.

THE IMPROMPTU LOUD SPEAKER

Editor, RADIO NEWS:

With reference to Mr. Ralph Bailey's letter in the May RADIO NEWS, in which he states that his set acts as an impromptu loud speaker, it is undoubtedly the transformer, which he uses as a choke, causing the trouble. A reader of the London *Wireless World* had a similar experience, and I give, word for word, the explanation in the issue of March 31.

"Since, in order to propagate sound, it is necessary that some object be set into a state of mechanical vibration, it is obvious that some portion of your receiver must be vibrating in step with the audio-frequency electrical impulses present in your A.F. amplifier. The most likely source of this trouble is to be found in the laminations of

your transformer, which in all probability have become somewhat loose. Since these laminations are, of course, directly in the path of the varying magnetic field associated with the transformers, they will, if at all loose, tend to vibrate in the same manner as the diaphragms of the head phones, and so feebly reproduce any strong signals that are received. Steps should be taken to remedy this trouble, since it does, of course, definitely represent so much energy loss in the receiver."

This, I think, puts the thing in a large nut shell.

G. O. KERR,

6 Langley Road, Beckenham, Kent, England.

PLEASING THE MULTITUDE

Editor, RADIO NEWS:

The other evening I had some new receiving apparatus on test. Started listening in around ten o'clock and hoped to pick up a few DX stations. Possibly I did. Possibly I didn't. The point is I would have given a lot to know. The trouble, of course, was local interference. What I wanted more than anything else at the time was some distant station to conduct my tests on. And I remember wishing that WRNY was miles and miles away from me. Because I could have known it by the familiar, swinging tune of the Staccatone, and not had to rely on my imagination as to the call letters announced.

From any one else's standpoint it would have been unimportant whether or no I managed to pick up a distant station and through its transmission complete my tests. Contrarily, it is of prime importance to the DX hound that he know whence comes the feeble voice he is straining his ears to gather a few words from.

Complaints come from all parts of the globe relative to the failure of station an-

nouncers to give the call letters during the intervals between active transmission. Replies pour in to the effect that DXing days have passed and that, furthermore, the continual announcing of the stations' call letters is very bothersome to those listeners interested in the programs only. To say that the DX hound is passing is so much applesauce. But the incessant announcing of call letters is rather annoying at times.

Since broadcast stations strive to please all listeners why don't they follow in the steps of WRNY and employ some form of distinctive signal, to operate during the "silent periods," that the listeners might know from where the transmission is coming. Certainly there are enough "characteristic" noises to go around; chimes, gongs, bells, mechanical noises and so on. Thus would the DX hound be pleased; and though those composing the audience might not share the same emotion, certainly they would not find the sound of chimes, etc., as hard on their nerves as the monotonous repetition of "call letters."

HAROLD CLEAVE,
White Plains, N. Y.

ANOTHER SUBMERGED ANTENNA

Editor, RADIO NEWS:

We have an Atwater-Kent set through which we hear lovely concerts from all different parts of the world.

Static was very bad recently, so we decided to find a way to eliminate it. We removed the aerial and stood a big fish bowl full of water, and seven gold fish on the top of the cabinet. Then we attached a short piece of wire to the aerial binding post on the set and put the free end into the fish bowl; so that was all the aerial we had. To our surprise, we had lovely music out of the fish bowl. If you don't believe, try it.

MRS. J. W. CHERBONNEAUX,
Box 525, St. Petersburg, Fla.



In Wolverhampton, England, the curriculum of the schools includes weekly lectures delivered by means of radio. © International Newsreel.

— RADIO SET DIRECTORY —

Manufacturer: AIR-WAY ELECTRIC APPLIANCE CORP., 618 Broadway, Toledo, Ohio
Trade Name: Air-Way Model 61
Circuit: Tuned radio frequency; 4 stages resistance-coupled audio
Batteries: Storage
Antenna: Outdoor
Loud Speaker: Separate
Controls: Two
List Price: \$98.50

Trade Name: Air-Way Model 62
Loud Speaker: Built-in
List Price: \$137.50

Trade Name: Air-Way Model 63
Loud Speaker: Built-in
List Price: \$197.50

Trade Name: Air-Way Model 61-D
Batteries: Dry cell
Loud Speaker: Separate
List Price: \$98.50

Trade Name: Air-Way Model 62-D
Batteries: Dry cell
Loud Speaker: Built-in
List Price: \$137.50

Trade Name: Air-Way Model 63-D
Batteries: Dry cell
Loud Speaker: Built-in
List Price: \$197.50

Manufacturer: THE AMRAD CORPORATION, Medford Hillside, Mass.
Trade Name: Amrad Model S-522
Circuit: Neutrodyne
Batteries: Storage
Antenna: Outside
Loud Speaker: Separate
Controls: Three
List Price: \$60.00

Manufacturer: MAGNUS ELECTRIC & RADIO MFG. CO., 787-797 East 138th St., New York City
Trade Name: Magnutrol Open Wiring
Circuit: Tuned compensated radio freq.
Batteries: Storage
Antenna: Outdoor
Loud Speaker: Separate
Controls: Three
List Price: \$60.00

Trade Name: Magnutrol Sub-Panel Type
Batteries: Storage
Antenna: Outdoor
Loud Speaker: Separate
Controls: Three
List Price: \$60.00

Trade Name: Magnutrol De Luxe Type
Batteries: Storage
Antenna: Outdoor
Loud Speaker: Separate
Controls: Three
List Price: \$75.00

Trade Name: Magnutrol Magnus Phonograph Panel
Batteries: Storage
Antenna: Outdoor
Loud Speaker: With phonograph
Controls: Three
List Price: \$75.00

Trade Name: Magnutrol Magnus Console
Batteries: Dry cell or storage
Antenna: Outdoor
Loud Speaker: Built-in

Controls: Three
List Price: \$150.00

Manufacturer: MAZDA RADIO MFG. CO., 3405 Perkin Ave., Cleveland, Ohio
Trade Name: Consello Grand—Ten tubes
Circuit: Radio frequency
Batteries: Storage
Antenna: Loop
Loud Speaker: Built-in
Controls: Two
List Price: \$500

Trade Name: Consello—Eight tubes
Circuit: Radio frequency
Batteries: Storage
Antenna: Loop
Loud Speaker: Separate
Controls: Two
List Price: \$175

Trade Name: Consello Junior—Five tubes
Circuit: Reflex
Batteries: Storage
Antenna: Outdoor
Loud Speaker: Separate
Controls: Two
List Price: \$75

Trade Name: Consello Portable
Circuit: Radio frequency
Batteries: Dry cell
Antenna: Loop
Loud Speaker: Built-in
Controls: Two
List Price: \$225

Trade Name: Consello Special Ten Tubes
Circuit: Radio frequency
Batteries: Storage
Antenna: Loop
Loud Speaker: Built-in
Controls: Two
List Price: \$275.00

Manufacturer: MURAD RADIO CORPORATION, Asbury Park, N. J.
Trade Name: Model A
Circuit: Tuned radio frequency
Batteries: Storage
Antenna: Outdoor
Loud Speaker: Separate
Controls: One
List Price: \$155

Trade Name: Model B
Circuit: Tuned radio frequency
Batteries: Storage
Antenna: Outdoor
Loud Speaker: Separate
Controls: One
List Price: \$125

Manufacturer: THE OPERADIO CORP., 8 South Dearborn St., Chicago, Ill.
Trade Name: Operadio Consolette
Circuit: Tuned radio frequency
Batteries: Both
Controls: One
Loud Speaker: Built-in
Antenna: Indoors
Price: \$180

Trade Name: Operadio Portable
Circuit: Tuned radio frequency
Batteries: Both
Controls: One
Loud Speaker: Built-in
Antenna: Indoors
Price: \$160

Manufacturer: PFANSTIEHL RADIO CO., 11 So. La Salle St., Chicago, Ill.
Trade Name: Pfanstiehl Model 8
Circuit: Pfanstiehl non-oscillating system of tuned radio frequency
Batteries: Storage
Antenna: Outdoor
Loud Speaker: Separate
Controls: Two
List Price: \$85

Trade Name: Pfanstiehl Model 10 Single Dial Six Overtone Receiver
Circuit: Pfanstiehl non-oscillating system of tuned radio frequency
Batteries: Storage
Antenna: Outdoor
Loud Speaker: Separate
Controls: One
List Price: \$155

Trade Name: Pfanstiehl Model 8-E Console
Circuit: Pfanstiehl non-oscillating system of tuned radio frequency
Batteries: Storage
Antenna: Outdoor
Loud Speaker: Built-in

Controls: Two
List Price: \$135

Trade Name: Pfanstiehl Single Dial Six Overtone Receiver—Model 10 S—Double Duty Console
Circuit: Pfanstiehl non-oscillating system of tuned radio frequency
Batteries: Storage
Antenna: Outdoor
Loud Speaker: Built-in
Controls: One
List Price: \$200

Trade Name: Pfanstiehl Single Dial Six Overtone Receiver—Model 10-C—Console Complete
Circuit: Pfanstiehl non-oscillating system of tuned radio frequency
Batteries: Storage
Antenna: Outdoor
Loud Speaker: Built-in
Controls: One
List Price: \$450

Manufacturer: PRIESS RADIO CORP., 693 Broadway, New York City
Trade Name: Priess Straight Eight Model P.R. 4—Table
Circuit: Priess
Batteries: Storage
Antenna: Loop
Loud Speaker: Separate
Controls: Two, one for wave length
List Price: \$175

Trade Name: Priess Straight Eight Model P. R. 6 Console
Circuit: Priess
Batteries: Storage
Antenna: Loop, Built-in

Loud Speaker: Amplion Unit with built-in horn
Controls: Two, one for wave-length
List Price: \$285

Manufacturer: RADIO MASTER CORPORATION OF AMERICA, Bay City, Mich.
Trade Name: "Simplified" No. 10 Phono-Radio Combination
Circuit: Transformed radio frequency
Batteries: Dry cell or storage
Antenna: Outdoor
Loud Speaker: Built-in
Controls: Two
List Price: \$200

Trade Name: "Simplified" No. 11 Phono-Radio Combination
Circuit: Transformed radio frequency
Batteries: Dry cell or storage
Antenna: Outdoor
Loud Speaker: Built-in
Controls: Two
List Price: \$200

Trade Name: "Simplified" No. 12 Phono-Radio Combination
Circuit: Transformed radio frequency

Batteries: Dry cell or storage
Antenna: Outdoor
Loud Speaker: Built-in
Controls: Two
List Price: \$210

Trade Name: "Simplified" 5T-1 Table Model
Circuit: Compensated tuned radio frequency
Batteries: Dry cell or storage
Antenna: Outdoor
Loud Speaker: Built-in
Controls: Three
List Price: \$85

Trade Name: "Simplified" 5T-14 Console
Circuit: Compensated tuned radio frequency
Batteries: Dry cell or storage
Antenna: Outdoor
Loud Speaker: Built-in
Controls: Three
List Price: \$125

Manufacturer: REICH-MANN CO., 1725 West 74th St., Chicago, Ill.
Trade Name: No. 55 Thorola Isodyne
Circuit: Tuned radio frequency
Batteries: Dry cell or storage
Antenna: Loop and Outdoor
Loud Speaker: Separate
Controls: Three
List Price: \$100

Trade Name: No. 50 Thorola Isodyne
Circuit: Tuned radio frequency
Batteries: Dry cell or storage
Antenna: Loop and Outdoor

Loud Speaker: Separate
Controls: Three
List Price: \$85

Trade Name: No. 51 Thorola Isodyne
Circuit: Tuned radio frequency
Batteries: Dry cell or storage
Antenna: Loop or outdoor
Loud Speaker: Separate
Controls: Three
List Price: \$85

Trade Name: No. 52 Thorola Isodyne
Circuit: Tuned radio frequency
Batteries: Dry cell or storage
Antenna: Loop and outdoor
Loud Speaker: Built-in
Controls: Three
List Price: \$225

Manufacturer: SLEEPER RADIO CORP., 438 Washington Ave., Long Island City, N. Y.
Trade Name: Super Symphonetic (59)
Type of Circuit: Tuned radio frequency
Batteries: Storage
Antenna: Outdoor
Loud Speaker: Built-in
Tuning Controls: Two
List Price: \$150

Trade Name: Troubador (model No. 56)
Type of circuit: tuned radio frequency
Batteries: Storage "A", any type "B"
Loud Speaker: Separate
Antenna: Outside
Tubes: Five
Tuning Controls: Two
List Price: \$65

Trade Name: Scout (model No. 57)
Type of Circuit: Tuned radio frequency
Batteries: Storage "A" any type "B"
Loud Speaker: Separate
Antenna: Outside
Tubes: Five
Tuning Controls: Two
List Price: \$90

Trade Name: Serenader
Type of Circuit: Tuned radio frequency
Batteries: Storage "A", any type "B"
Loud Speaker: Built-in
Antenna: Outside
Tubes: Five
Tuning Controls: Two
List Price: \$115

Manufacturer: SONORA PHONOGRAPH CO., INC., 279 Broadway, New York City
Trade Name: Sonora Model C Receiver
Type of Circuit: Tuned radio frequency
Batteries: Storage
Antenna: Outside
Loud Speaker: Separate
Tuning Controls: Three
List Price: \$90

Trade Name: Sonora Model C Highboy
Type of Circuit: Tuned radio frequency
Batteries: Storage
Antenna: Outside
Loud Speaker: Built-in
Tuning Controls: Three
List Price: \$200

Manufacturer: SPIELMAN ELECTRIC CO., 311 West 99th St., New York
Trade Name: Air Pilot

Batteries: Storage
Antenna: Both
Loud Speaker: Separate
Controls: Three
List Price: \$60

Manufacturer: SPLITDORF ELECTRICAL COMPANY, 392 High St., Newark, N. J.
Trade Name: Splifdorf Polonaise
Type of Circuit: Tuned radio frequency
Batteries: Storage
Antenna: Both
Loud Speaker: Separate
Tuning Controls: Three
List Price: \$75

Trade Name: Splifdorf Nocturne
Loud Speaker: Built-in
List Price: \$150

Trade Name: Splifdorf Geisha
Loud Speaker: Separate
List Price: \$110

Trade Name: Splifdorf Rhapsody
Loud Speaker: Built-in
List Price: \$410

Trade Name: Splifdorf Mikado
Loud Speaker: Built-in
List Price: \$425

Manufacturer: STEWART-WARNER SPEEDOMETER CORP., 1825 Diversey Parkway, Chicago, Ill.
Trade Name: Stewart-Warner Model 300
Circuit: Tuned radio frequency
Batteries: Storage
Antenna: Indoor or Outdoor
Loud Speaker: Separate
Controls: Three
List Price: \$65.00

Trade Name: Stewart-Warner Model 330
Batteries: Dry cell
Loud Speaker: Separate
List Price: \$65.00

Trade Name: Stewart-Warner Model 305
Batteries: Storage
Loud Speaker: Separate
List Price: \$115

Trade Name: Stewart-Warner Model 325
Batteries: Storage
Loud Speaker: Separate
List Price: \$80

Trade Name: Stewart-Warner Model 310
Batteries: Storage
Loud Speaker: Built-in
List Price: \$175.

Trade Name: Stewart-Warner Model 315
Batteries: Storage
Loud Speaker: Built-in
List Price: \$285

Trade Name: Stewart-Warner Model 320 Console
Batteries: Storage
Loud Speaker: Built-in
List Price: \$450

STEINITE LABORATORIES, Atchison, Kansas
Trade Name: Steinite
Type of circuit: Crystal
Batteries: None
Antenna: Outside
Loud Speaker: None
Tuning Control: One
List Price: \$6

(Continued on page 173)

Notice to Readers

Detailed information respecting the following sets, or any other receiving sets, may be had on inquiry by addressing a letter to the Editor of the Set Directory, RADIO NEWS.



CONSTRUCTION OF PANEL BRACKETS

In present types of home-constructed sets brackets are usually needed for supporting the panel. It is not always possible to obtain just the right size or shape for the set you intend building. Therefore, why not make them yourself and have them exactly as you want them?

Excellent panel brackets can be made out of hard maple wood. The accompanying illustrations show two different types, one type for straight panels and the other for sloping panels. The wood should be about half an inch thick.

The machine screws employed for fastening the panel to the brackets should be at least an inch long. The holes, A, which allow space for the bolts, should be drilled first. Be sure that you place them near enough to the fore part of the board so that the ends of the machine screws will protrude far enough to take the bolts.

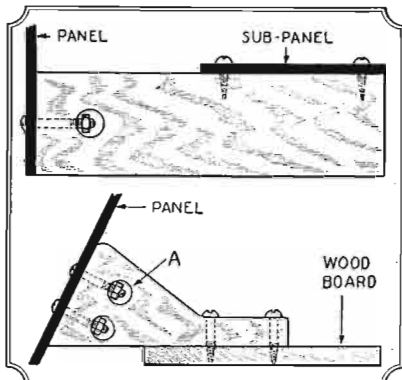

Good panel brackets can be made from hard wood. The sketch above shows two types, one for a sloping panel.

If wood screws are used to fasten the sub-panel to the brackets, be sure to drill holes for them, smaller in diameter than that of the screws of course, so that there will be no possibility of the wood splitting.

Contributed by Walter Lyon.

WAVE-CHANGING SWITCH

The switch to be described is comparatively simple in construction, the only requisites being a double-circuit jack, a knob with a pointer and shaft, and a fiber cam.

The advantages of the switch are numerous. It takes but a single hole to mount it on the panel; since a jack and cam are utilized, it is quiet in operation; it may be used in conjunction with either a two- or a three-circuit tuner and it is readily adaptable to other forms of circuits for the control of—well, what you wish, since it has four operating positions. However, its use as a wave-changing switch only is described here.

In the accompanying sketch it is shown connected up to a two-circuit tuner, with either a tuned or untuned primary, wherein it controls the inductances of the primary and secondary windings. The fiber cam is so cut that the two contacts of the jack are made and broken independently of each

other, instead of simultaneous as usual.

When the pointer is on PSL, sections of both the primary and secondary windings are shorted, thus allowing the reception of shorter waves. With pointer on PSH all of the primary is used, but the same section of the secondary winding remains shorted. In this position there would be less selectivity, but a greater transfer of energy from the primary to the secondary winding. With the pointer on PSH all of the windings of both primary and secondary are in circuit, thus allowing the reception of the longer waves. Moving the pointer to PLSH shorts a section of the primary winding only, thus giving added selectivity on the longer waves when desired.

The dotted lines show the position in which the cam should be when the pointer is on PSL.

No dimensions are given for the shaft or the fiber cam, as jacks are not of uniform construction. You will have to make them conform to the jack you have.

Contributed by H. J. DeAngelis.

AN EASILY CONSTRUCTED TUBE SOCKET

Since the advent of the UX tube, sockets have been put on the market to accommodate both the dry-cell and storage-battery types of tubes. The construction of most of these sockets is rather simple, and suggestive of a method whereby anyone at the expenditure of a few cents and a little time can easily make one.

A piece of 3/16-inch insulating composition is cut to the dimensions given in the accompanying drawing. Four holes are drilled to receive the prongs of the tube; those for the two large filament terminals are 5/32-inch in diameter and those for the small terminals 1/8-inch. The holes should be drilled for a rather loose fit, and care should be taken to drill them accurately. 6-32 machine screws are used to hold the spring contacts, which should protrude beyond the holes about 1/32-inch, or enough to make a good contact, but not cause the tube prongs to bind when the tube is taken out. Holes "A" and "B" are drilled and countersunk for flat-head wood screws,

which, together with bushings, hold the socket in place.

Large-sized Falmestock clips are used for spring contacts with this socket, as shown in Figs. 2 and 3. Connections are made right to the clips. Battery clips, or spring contacts made for this purpose, may also be used, but will probably necessitate a change of the holes from the dimensions given in Fig. 1.

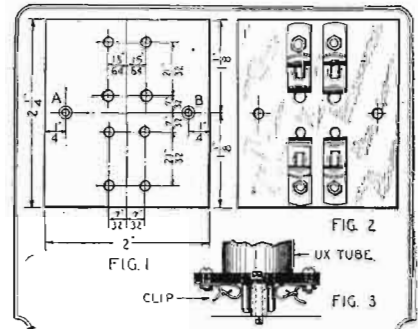

This simple tube socket is made from a square of insulating material and four battery clips. All the dimensions are given.

When adjusting the clips for proper spring contact, a piece of wire should be inserted in each clip before adjusting.

This type of tube receptacle affords a particularly neat, simple, and efficient socket arrangement, when used with a multi-tube set, and a sub-panel. The same idea may be carried out with a baseboard mounted set, however, using a long insulating strip.

When this tube-socket arrangement is used with a multi-tube set a saving of probably two or three dollars can be made on this item of expense.

Contributed by Edwin Flodquist.

REMOVING ENAMEL FROM WIRE

For the benefit of experimenters I wish to offer the following information relative to the removal of enamel from fine wires, such as those composing a strand of Litz cable. I have seen directions to heat the ends in a flame and plunge them while hot into alcohol.

(Continued on page 185)

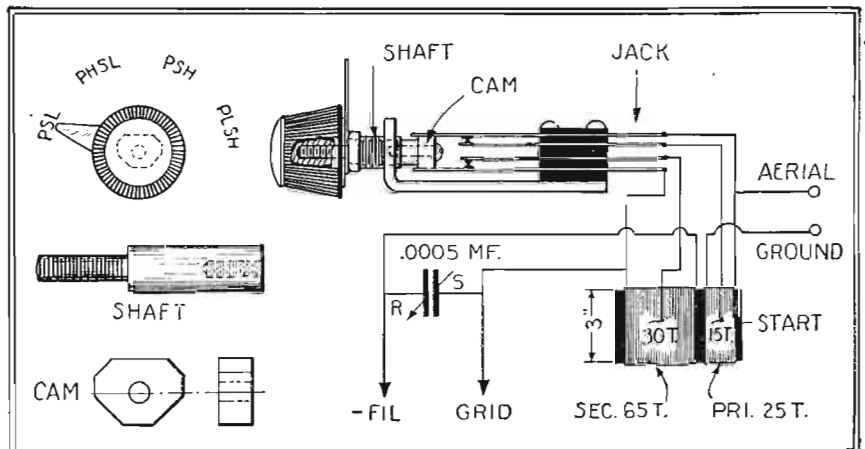

Constructional details and circuit diagram for the wave-changing switch which is made from a double-circuit phone jack and a rheostat knob. The brass shaft and fiber cam are easily made.

Radiotics

ANOTHER FOR THE BOOTLEGGER



Aid for the thirsty, as advertised in the May issue of *Radio News*—grid clips obtain the proper GRIP capacity on Cockaday circuits." Now that the radio manufacturers have turned their attention to the great problem of thirst, perhaps Congress will hurry up and alleviate the drought.

Contributed by E. J. Pullen.

ONE GREAT BIG MIKE



Description of a gigantic microphone in the April 17 issue of *Popular Wireless*, London: "Another type of microphone—consists of two metal sheets separated by a distance of only two or three MILES." Think that over, only two or three miles! They must have some whoppers over there in England.

Contributed by W. A. Agnew.

MUST BE A WARM BABY



Superheated announcement from the Rochester, N. Y., *Democrat and Chronicle* of April 29: "Wendell Hall, the RED-HEATED music maker, is now in Texas." Does this mean that the Lone Star State is going to be in for a hot old time, when this fellow goes on the air?

Contributed by Fred A. Meissel.

UNAFFECTED BY THE COAL STRIKE

Revelation of a secret by the Toledo, O., *News Bee* of April 19: "Next Friday will be sixteen years since the Marconi Trans-Atlantic FIRELESS service was opened." If Europe has been hiding this method of broadcasting heat waves all this time, we think something should be done about it.



Contributed by D. B. Wright.

DANGEROUS TO BE SAFE

From the "Storm King" advertisement in the New York *Sun* radio section of May 15: "While being confined to a hospital undergoing an operation, my AERIAL was struck by lightning." The Hospital for Sick and Crippled Aerials should install feather beds for them; it is hard enough for a healthy aerial to dodge lightning.



Contributed by W. R. Smith.

PAGE VINCENT LOPEZ!

Excellent suggestion from the Cincinnati *Enquirer* of March 21: "KGO, very good on phones but mushy on speaker with THREE TUBE JAZZ ORCHES. TRA from California hotel." Now we have at last found some use for our old tubes. Give them some music lessons and have your own jazz band. Hooray!



Contributed by Paul K. Jordan.

A VOICE FROM THE GREAT BEYOND

Spiritualistic item from the Pittsburgh *Press* of April 19, 1926: "Program from convention of the D. A. R. at Washington, including address by PRESIDENT ROOSEVELT and music by U. S. Marine Band." Apparently Sir Oliver Lodge and Conan Doyle have the right messages for us, and when combined with radio—honestly, ain't science wonderful?



Contributed by T. M. Chaney.

YOO HOO, NIZE BABY!

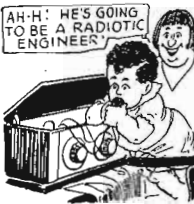

Milt Grossian gesture from the Radio Questions column of the San Francisco *Examiner* for April 18: "Your trouble is in your FIST audio-transformer. FT a new one." Nize baby, dunt et de fist transformer. For cutting de teeth it is insted witt de baby's fist.

Contributed by Winston Bull.

IF you happen to see any humorous misprints in the press we shall be glad to have you clip them out and send to us. No RADIOTIC will be accepted unless the printed original giving the name of the newspaper or magazine is submitted with date and page on which it appeared. We will pay \$1.00 for each RADIOTIC accepted and printed here. A few humorous lines from each correspondent should accompany each RADIOTIC. The most humorous ones will be printed. Address all RADIOTICS to

Editor RADIOTIC DEPARTMENT, c/o Radio News.

RADIO SET ACCESSORY

New accessory for a radio set as advertised in the Minneapolis *Tribune* of April 18: "This is the model 30 receiving set including battery CABLE WITH ONLY ONE DIAL." Well, we should think that the dials on the set were enough without putting one more on the cable.



Contributed by Albin Keays.

OSCAR, GET THE GLUE

Non-adhesive item from the April issue of *QST Magazine*: "a surprising thing—the POWER has entirely failed to stick together even under a pressure of 25 tons per square inch." We recommend that some experiments be tried with glue in getting the power to behave properly.

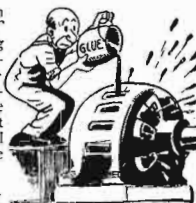

Contributed by J. E. Hays, RM2/C

FOR USE ON TRAINS?

A radio receiver useful for the traveller is mentioned in the Cleveland *Press* of April 2: "When your TUNNEL radio-frequency receiver oscillates—" This set will most likely function in great style in mountainous country and especially on railroads. Toot-toot! Look out for the hand-car!

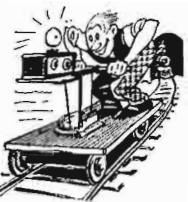

Contributed by C. E. Carlson.

THE SHANGHAIED STATION



Deep sea mystery hinted at by the New York *Sun* of May 15: "About a month ago the mate heard WEAF, then nearly 3000 MILES OFF THE COAST of America." Did the waves of the Pacific dampen the transmission—and who pushed WEAF off the dock, anyway?

Contributed by Pierson Brush.

GOOD HEFTY CURRENTS

Something about the strength of currents as related in the Rochester, N. Y., *Times-Union* of April 22: "An electric current will carry FATHER with larger wires." Perhaps this is some new manifestation of transmitting material objects over the bounding ether waves, using a network of larger wires.

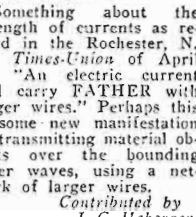

Contributed by J. C. Heberger.

ARE THE CATWHISKERS USED TOO?

Feline yowl from the May 19 issue of the Grand Rapids, Mich., *Press*: "Homewood station experimenting with 5,000 and 2,000 watt BROADCASTS." Believe me, the transmitting power of some pussies in our neighborhood would make these 5,000 watt broadcasts seem as if they had only 199-type tubes in their circuits.

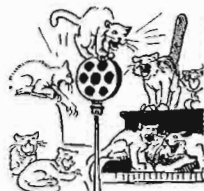

Contributed by Clement Dereyinski.

LOOKING FOR A PLACE TO HAPPEN

The following appeared in the New York *Daily News* of May 5: "Cook's entertainment from WIZ included several Southern readings. Whether the ACCIDENT was natural we don't know but it sounded genuine at any rate." Just what is a genuine accident, please?



Contributed by Jack Teller.

DO THEY JUMP OR RUN?

Write-up of an interesting musical program from the Toronto *Weekly Star* of April 24, in which mention is made of "the Harvard FLEE Club." Since this club is a regular feature on broadcast programs they must be those who sing and flee, and live to sing another day.



Contributed by C. L. G. Davies.

DO THREATENED BATTERIES LIVE LONG?

Ominous note in modern set construction from the New York *Sun*, June 5: "Standard color designation for cords is as follows: tracer THREAT—" How would you like to be a poor little "A" battery and have a ferocious and threatening tracer pursuing you? Help! Help! Take my juice, but spare my plates!



Contributed by Miles Martin.

STANDARD HOOK-UPS

EVERY month RADIO NEWS presents in this convenient form a selection of circuit diagrams, with constructional and other data, on standard hook-ups, which the editors have tried and found to give excellent results. Every radio experimenter should preserve these for their reference value, as they are selected to cover the complete range of radio apparatus, from the simplest to the largest and most complicated. Requests for special or additional advice and information should be addressed to the I WANT TO KNOW Department of RADIO NEWS. (A charge of 25 cents is made for answering each question which requires a reply by letter.)

Handy Reference Data for the Experimenter

AN INEXPENSIVE POWER AMPLIFIER

Circuit No. 175. This is a novel, efficient and inexpensive impedance-coupled power stage of audio amplification, which is suggested for the consideration of the experimenter or set constructor who would like a little more volume from his receiver; but wishes to avoid distorting the signal in any way, or incurring any of the other usual audio-frequency troubles that may arise when a third stage of audio is added.

The parts necessary are very few, as can be readily seen from the schematic wiring diagram explaining the circuit, which ap-

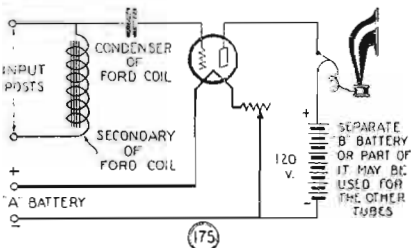

(175.) The connections for a one-tube power audio amplifier, which may be connected to any receiver where additional amplification of this type is required. Material for this amplifier can be very easily obtained.

pears on this page, and shows the value of all of them. The principal item is the power tube, which may be either a CX- or UX-112, CX- or UX-210, a W.E. 216-A or VT-2. The rest of the material required includes a socket, a rheostat, and the secondary winding and condenser of a Ford spark coil, which need not be removed from its casing, if the constructor understands the wiring and internal connections.

A coil and condenser, the former under the trade name of "audio impedance," and the latter a rated 1.0- μ f. capacity, may be readily purchased for this purpose.

The best results will be obtained when at least 120 volts of "B" battery is used; if greater volume is desired, it may be necessary to increase the plate voltage even above this figure.

EASILY-BUILT LOW-POWER TRANSMITTER

Circuit No. 176. Many "hams" and would-be amateurs hesitate to incur the cost of a transmitting set, because of both the initial outlay and the upkeep. The price of the plate-voltage transformer or motor generator persuades the student constructor that the time is not right for him to break into the game, unless he has a "rating" in the financial registers.

Here we offer the circuit diagram and specifications for the construction of a low-power transmitter whose various necessary parts should be found on the shelf. It is in the truest sense "low-power," as a 199 tube is employed for the generation of the R.F. currents, together with an ordinary 6:1-ratio A.F. transformer (any ratio down to 3:1 may be employed.) The primary of the

transformer is supplied from the 110-volt A.C. lighting current, the voltage induced in the secondary being dependent upon the step-up ratio of the transformer.

Thus, if the transformer is of the 3:1 type somewhere in the neighborhood of 330 volts should be the secondary output; if 5:1, somewhere around 550. These figures are only rough estimates, as the transformer is not designed for this duty; but the very small current which it can deliver will nevertheless be ample to operate the dry-cell tube.

The parts necessary are indicated in the diagram:

One special inductance, wound on a three-inch tube. The secondary is 20 turns of No. 20 DCC wire, tapped at the tenth turn; the primary is 5 or 6 turns of the same wire, wound 1-4 to 3-8-inch away from L2.

One variable resistance, 10,000-100,000-ohm, for grid leak;

Two variable condensers, .0005- μ f.;

Two fixed condensers, .002- μ f.;

One radiation ammeter, 0-0.5 scale;

One transformer for filament current, such as are used to operate toys or for bell-ringing purposes. If it delivers 6 volts, there should be used with it

One rheostat, 30-ohm;

One 199 or 299 tube, and socket;

One key;

One R.F. choke, which may be constructed of 200 turns of No. 26 DSC or DCC wire on a one-inch tube.

The range of this receiver will be of course limited, being somewhat dependent on the efficiency of its construction, its antenna and ground or counterpoise system, tube, etc. However, the average range which may be expected from it will be ten to fifteen miles; though freak conditions may at times permit the usual range of two to five hundred miles.

The note generated will be of the continuous-wave type, being either 60 cycles or 25, depending on the A.C. frequency which is utilized for the input to the transformer which supplies the plate current.

The note generated will be of the continuous-wave type, being either 60 cycles or 25, depending on the A.C. frequency which is utilized for the input to the transformer which supplies the plate current.

A SPARK COIL C. W. SET

Circuit No. 177 is that of another very simple and efficient transmitter which can be constructed by any experimenter, in spite of either limited experience or the lack of wherewithal to purchase the apparatus for a big modern station equipment. It must be kept in mind, however, that although the substitutes described here will give practical and satisfactory service over a range narrowly limited (unless freak conditions arise) the best results will be obtained from a transmitter in which efficient transmitting tubes—UX-210 or 203A type—are used with sufficient plate voltage, supplied either by a

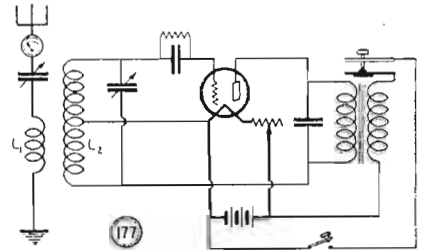

(177.) Another very inexpensive and simple transmitter. A Ford spark coil is employed to furnish the plate voltage. The "note" of the signal is dependent upon the adjustment of the buzzer, or vibrator, on the spark coil.

power transformer operating from alternating current mains and connected to an efficient rectifying system, or by a motor generator set.

This entire set may be operated by a 6-volt storage battery with the necessary filament as well as plate voltage supplied from this source. A Ford spark coil steps up the voltage so that the 6-volts is transformed into sufficient potential to supply the high-voltage plate current necessary for the tubes. The signals sent out by the set are, of course, of the I.C.W. variety; but they have a very agreeable musical note which may be varied by changing the adjustment of the spark coil vibrator. Such signals can be

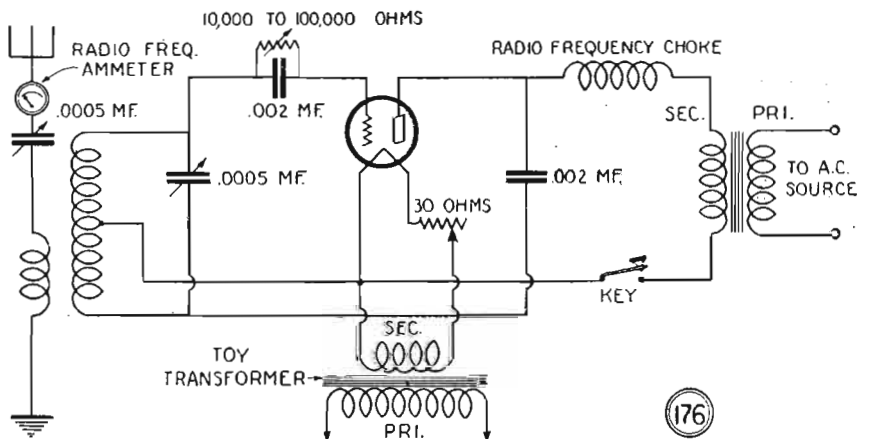

(176.) A novel and inexpensive, low-power transmitter. The parts necessary for this device can be easily found on the shelf of any experimenter. Distances up to 15 miles or more can be easily covered, even though only a small 199 tube is employed.

picked up on a crystal receiver, which is not possible with a pure C.W. transmitter.

The parts necessary for the construction of this transmitter are as follows:

One special coupler, L1, L2, the latter inductance having 45 turns of either No. 14 or 16 DCC wire wound on a 3½- or 4-inch tube with a tap taken at every 3rd turn. The other inductance, L-1, consists of 12 turns of the same size wire wound on a tube slightly smaller in diameter, to permit a variation in coupling.

Two variable condensers, .0005- μ f.; the series variable condenser is a provision for a long antenna to permit tuning down to the amateur wave-length, should the fundamental wave of the antenna be too high;

One fixed condenser .002- μ f. (in grid circuit);

One power tube, either W.E. VT-2 or 216-A or the new UX-210 type;

One power rheostat;

One key;

One radiation ammeter, 0 to 1 scale;

One Ford spark coil;

One condenser, glass-plate, large capacity spark transmitter type.

The advantage of such a set is that it combines the simplicity of a spark-coil transmitter with the sharpness of wave-length and distance-covering ability possessed only by a vacuum tube set. To the amateur who hasn't a great deal of money to invest in equipment, the spark-coil type of I.C.W. set certainly offers a splendid means of overcoming the high-voltage plate-supply problem at very little cost.

AN ALL-WAVE RECEIVER

Circuit No. 178. Despite the fact that there are many new kinds of receiving sets, hundreds of radio listeners are still using the three-honeycomb-coil type which was very popular in the earlier days of radio broadcasting. With this it is possible to do many things which cannot be accomplished with the newer receivers.

The ideal receiver for broadcast reception should be capable of selective tuning, consistent duplication of reception, undistorted loud speaker operation, and non-radiation. A tuner which complies with all these conditions and in addition provides features which enable sufficient reception over a wide range of wave-lengths, is herewith described.

A list of the necessary parts and apparatus is given below, and the constructor should have no difficulty in obtaining suitable apparatus of standard makes from almost any radio supply store.

One cabinet, standard with 7x18-inch in-

duating panel and 7x17 baseboard, seasoned wood;

One triple-honeycomb-coil mounting, preferably geared;

One variable condenser, 43 plates (.001- μ f.);

One variable condenser, 23 plates, (.0005- μ f.) preferably vernier type;

Two dials, 3-inch;

Three honeycomb coils, 50, 75 and 100 turns as indicated;

One fixed condenser, .001- μ f.;

One grid condenser, .00025- μ f., with grid-leak mounting clips and grid leak, 2-meg.;

One standard socket;

One rheostat;

Set of seven binding posts;

Four lengths of spaghetti tubing, and 10 feet of bus-bar wire.

Other honeycomb coils, of various sizes for different wave-lengths may be added when desired, as explained later.

This type of receiver is particularly adapted for the reception of all wave-lengths from 150 to 25,000 meters. For the experimenter who desires to copy high-power wireless telegraph stations working on long wave-lengths, this type of receiver is ideal. The various ranges are covered by means of honeycomb coils of different numbers of turns, which are plugged into the mounting and make possible tuning over various bands of wave-lengths by means of the variable condensers which are used in conjunction with them. A great advantage of these coils is that there is no dead-end effect; that is, the whole inductance is in the circuit all the time and there are no unused turns absorbing energy. As indicated in the wiring diagram, the primary, secondary and tickler coil are shown from left to right. The antenna to be used with such a set may consist of a single wire between 100 and 150 feet long.

When using various sizes of coils, it is advisable to buy or make a special rack to support those which are not being used; as if they are piled on their sides, the insulation of the wire is easily scratched and the efficiency of the coils considerably reduced. The rack may consist of a piece of board with holes drilled to accommodate the protruding plugs used to connect the coils into the table and the unused coils kept plugged on this special board.

Below is a table showing the ranges of wave-lengths covered by the various honeycomb coils when shunted by a .001- μ f. variable condenser. For short waves, the tickler coil should be of about the same value as

the secondary; and in some cases the primary is also of the same number of turns. For medium and long wave-lengths, the tickler coil is generally smaller than the secondary. This is to be found by experiment when tuning in stations.

Size of Honeycomb coils	Approximate wave-length with .001- μ f. condenser in shunt (meters)
25 Turns	375
35 "	515
50 "	730
75 "	1030
100 "	1460
150 "	2200
200 "	2850
250 "	4000
300 "	4800
400 "	6300
500 "	8500
600 "	12000
750 "	15000
1000 "	19000
1250 "	21000
1500 "	25000

The wave-length range in meters, when using a .0005- μ f. condenser in shunt with the given sizes of honeycomb coils, may be determined approximately by dividing the figures above by two.

This receiver, and other very efficient types, are completely described in a book titled "How to Make Practical Radio Receiving Sets," issued by the Conrad Publishing Co., 64 Church Street, New York City.

SIMPLE SELECTIVE RECEIVER

Circuit No. 179. A novel one-tube set is herewith diagramed and may be very easily constructed by those who desire simplicity in both the construction of the set and its tuning. An unusual tuning system is employed, which results in a multi-circuit

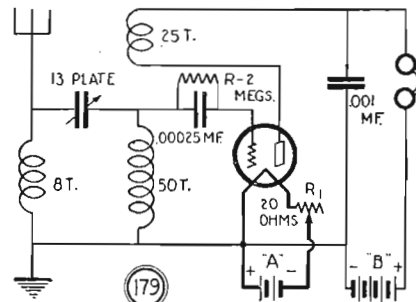

(179) A novel, simple one-tube receiver with which gratifying results are obtained. An ordinary 3-circuit tuner may be employed for the necessary primary, secondary, and rotor windings. The receiver is of the regenerative type.

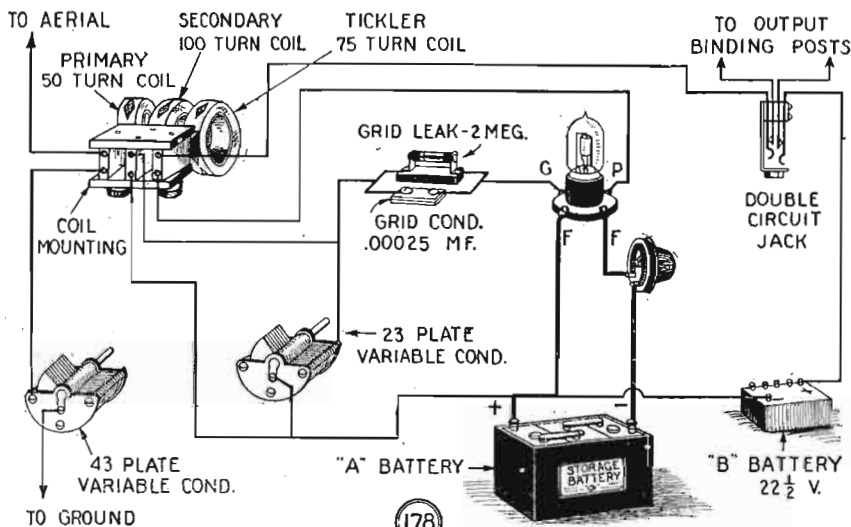

(178) A standard, very efficient, and most adaptable receiving set, "The Three-Honeycomb-Coil Receiver." A variable wave-length range of from 150 to 25,000 meters may be covered with this receiver. Plug-in honeycomb type coils are employed, which facilitate the changing over of the receiver from one wave-length range to another.

receiver that is capable of tuning through bothersome local stations and reaching those further distant.

An ordinary 3-circuit tuner may be employed for the tuning instrument, the plate coil being the rotor winding of this piece of apparatus. If the experimenter desires to construct this tuner, it may be made in the following manner: Obtain a piece of tubing 3 inches in diameter and approximately 4 inches in length; one-half of an inch away from the end of the tube wind 50 turns of No. 22 D.S.C. or D.C.C. wire. Three-eighths of an inch away from this winding, which is the secondary, wind the primary, which consists of 8 turns of the same sized wire. The plate, or rotor coil is wound on a piece of tube 2¼ inches in diameter and approximately 1½ inches in length, and consists of 25 turns of No. 26 or 28 D.S.C. wire.

Stations are obtained by simply rotating the variable condenser, as well as the plate or rotor coil winding to control regeneration, thereby regulating volume. The conventional two-stage audio amplifier may be added to this receiver to obtain loud speaker volume.

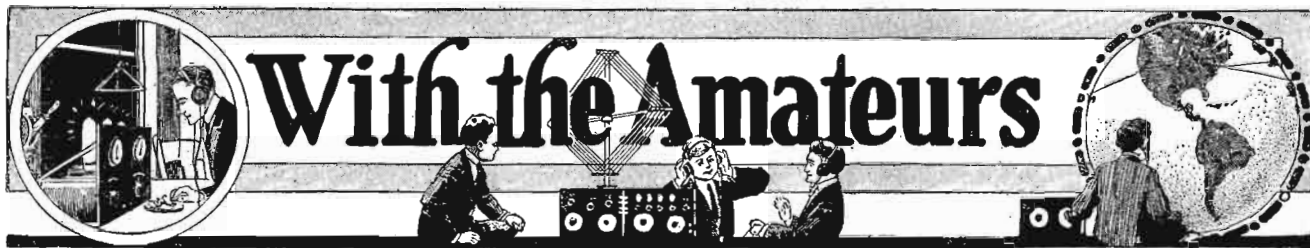

Let's Use Ultra-Short Waves

By HENRY LA MONTE

WELL, gang, in these days when old Sol is doing his best to make the mercury break the top off the thermometer, about the only thing that most of the boys want to do is nothing—and blamed little of that. However, the other day we met a couple of ham friends, who were all pepped-up over some work that they were doing on the ultra-short waves, and their dope certainly is worth while.

Did you know that it is now possible for hams to work on wavebands that are next door to nothing? Whether you did or did not, it is true all the same. The band from 4.69 to 5.35 meters has been opened for CW and the band from 0.7477 to 0.7496 meters has been released for beam transmission.

It has been our experience that the majority of hams do not realize just how much pleasure and experimental value can be pried out of these waves down at the bottom of the scale. The power required to send signals an enormous distance is startlingly small, when the longer waves are considered in comparison. Then, too, the apparatus needed is nowhere nearly as elaborate as that used for the wavebands around 100 or 150 meters. For instance, all the apparatus that is needed for a short wave outfit is a variable condenser, a couple of coils, some copper strips and a 201-A or 199 tube. That does not sound very difficult, does it?

Down in this neck of the woods there is a great field for *directional* work. Remember only a very small reflector is used, and this may easily be erected in the ham's shack, with little more trouble than the construction and installation of a loop antenna. There is nothing needed like the big reflectors that they employ over in England and up in Canada which were recently shown in RADIO NEWS. This sort of directional work is really in swaddling clothes and there are all the chances in the world that some experimenting ham might hit on one whopping big discovery. And why not let that fellow be you?

A CHEAP PLAYTHING

If you are a new-comer in the ham fraternity and many of the hard-earned shekels have rolled away for new apparatus, there is no need for you to say, "This 5-meter stuff will have to wait awhile." Just shunt that idea out of your head right away. In the vernacular. "It don't mean *nothing!*" We would be willing to bet that there isn't a ham who is reading this, who

has not at this very minute 90% of the necessary equipment in his junk box for a bang-up short wave outfit.

At this point there is most likely a howl arising from ham readers along these lines: "Where does that guy get that stuff about me having all that stuff in *my* junk box?" Well, of course, we don't know, but surely there are a few lengths of bell wire; an old variable condenser, that can be stripped down to two plates; a 201-A or 199 tube, and a few odds and ends that just *have* to be in the box. Now for the power end of the argument. For a 201-A or 199 tube all that is necessary are some dry cells and ordinary "B" batteries, or if the dry cells are not handy, use "B" and "C" batteries throughout. This is no bunk and you will

range for a proper filtering system. But once more, this is not a great difficulty.

A NEW LOW-LOSS IDEA

One of the first things that hams who are thinking of playing with the ultra-short waves should remember is, that at these high frequencies the dielectric losses increase enormously when compared with the corresponding losses at a longer wave-length. It is for this reason that in all ultra-short wave transmitters and receivers there should always be used as little insulation as possible. In many cases the base of the vacuum tube is removed and the leads to the filament, grid and plate are soldered directly to the wires running through the glass of the tube itself. The removal of vacuum tube bases is another comparatively simple task, although a certain amount of care must be exercised that the glass shall not be cracked. First unsolder the wires leading down to the prongs of the tube by holding a soldering iron against the prong. Then heat a stiff piece of fairly heavy wire and run around the junction of the glass and the base. This will melt the wax and the glass can be lifted from the base. In some makes of tubes, however, there is a cement used instead of wax and here the tube, after the leads to the prongs have been unsoldered, is placed in hot water, which will soon permit the base to be worked loose. Some of the new tubes have bakelite bases and in many cases it is unnecessary to remove them, because the losses are negligible.

Another source of loss at these high frequencies is in the insulation used for supporting coils, condensers, etc. Now one piece of insulation that can be eliminated—and which heretofore, very seldom has been—is the table on which the apparatus rests. Now there are most likely murmurs from the readers "Skyhooks, eh?" and the answer is. "Yes, more or less." Read on a little further and you will find the idea is not altogether unworthy of consideration.

The means of support which is before the jury is nothing more alarming than ordinary good strong string. Get the drift? Procure some small screw-eyes, urge them into the ceiling of the shack, or a framework, and suspend your apparatus by the above-mentioned string from them—and there you are! There is not a great amount of apparatus that has to be slung in this fashion and for the trouble that you take with it you will certainly be repaid by the results.

The antenna system is simplicity itself.
(Continued on page 191)



"The means of support which is before the jury is nothing more alarming than ordinary good strong string."

be surprised at the results. Also when you use batteries of this type, you will not have to bother with any filtering system for the simple reason that there is nothing to eliminate of a humming nature.

However, if the ham is fortunate enough to have 110-volt house current and wishes to use this on the plate of the tube, nothing could be simpler and more efficient. Of course, in case you employ this source of 110 volts—which by the way, is the maximum potential that you should apply to the plate of your tube—it will be necessary to ar-



RADIO NEWS LABORATORIES



RADIO manufacturers are invited to send to RADIO NEWS LABORATORIES, samples of their products for test. It does not matter whether or not they advertise in RADIO NEWS, the RADIO NEWS LABORATORIES being an independent organization, with the improvement of radio apparatus as its aim. If, after being tested, the instruments submitted prove to be built according to modern radio engineering practice, they will each be awarded a certificate of merit, and a "write-up" such as those given below will appear in this department of RADIO NEWS. If the apparatus does not pass the Laboratory tests, it will be returned to the manufacturer with suggestions for improvements. No "write-ups" sent by manufacturers are published on these pages, and only apparatus which has been tested by the Laboratories and found to be of good mechanical and electrical construction is described. Inasmuch as the service of the RADIO NEWS LABORATORIES is free to all manufacturers whether they are advertisers or not, it is necessary that all goods to be tested be forwarded prepaid, otherwise they cannot be accepted by the Laboratories. Apparatus ready for the market or already on the market will be tested for manufacturers, as heretofore, free of charge. Apparatus in process of development will be tested at a charge of \$2.00 per hour required to do the work. Address all communications and all parcels to RADIO NEWS LABORATORIES, 53 Park Place, New York City.

B-ELIMINATOR

The "Super-Ducon" B-Eliminator shown was submitted to the RADIO NEWS LABORATORIES for test, by the Dubilier Condenser & Radio Corporation, 4377 Bronx Boulevard, New York City. It was put through a

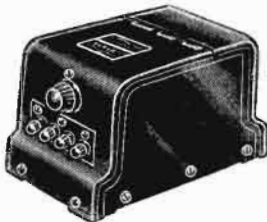

rigid test and found to pass no hum. It supplies sufficient current for the normal operation of six- and eight-tube sets.

AWARDED THE RADIO NEWS LABORATORIES CERTIFICATE OF MERIT NO. 1322.

VERNIER DIAL

The "Dialier" shown was submitted to the Radio News Laboratories for test, by W. F. Loughman, Inc., Boston, Mass. It has both clockwise and counter-clockwise readings, so



that it can be employed with any type of variable condenser or adjustable inductance. A small window is provided for the insertion of station calls.

AWARDED THE RADIO NEWS LABORATORIES CERTIFICATE OF MERIT NO. 1365.

LOUD SPEAKER HORN

The goose-neck horn shown was submitted to the Radio News Laboratories for test, by the Miller Rubber Co. of New York, Akron, Ohio. It is moulded of hard rubber and has



excellent tonal qualities when employed with a good grade of unit.

AWARDED THE RADIO NEWS LABORATORIES CERTIFICATE OF MERIT NO. 1224.

CRYSTAL

The "H-Wave" Radio Crystal was submitted to the RADIO NEWS LABORATORIES for test, by E. J. Mil-



ton, 951 Navajo St., Denver, Colorado. It was tested in a number of reflex circuits, as well as in a standard crystal circuit, and found to be both rugged and sensitive.

AWARDED THE RADIO NEWS LABORATORIES CERTIFICATE OF MERIT NO. 1235.

LOUD SPEAKER HORN

The panel horn shown was submitted to the RADIO NEWS LABORATORIES



for test, by the Miller Rubber Co. of New York, Akron, Ohio. Because of its unique construction it requires but little space and can be easily installed in a console set. It gives very good reproduction.

AWARDED THE RADIO NEWS LABORATORIES CERTIFICATE OF MERIT NO. 1221.

A.F. TRANSFORMER

This audio-frequency transformer was submitted to the Radio News Laboratories for test, by the Wagner



Radio Co., 643 West Washington St., Chicago, Ill. It gave excellent results under test, and showed itself particularly adapted to the amplification of low frequencies.

AWARDED THE RADIO NEWS LABORATORIES CERTIFICATE OF MERIT NO. 1222.

LEAD-IN TUBE

The "Rushton Plug-In Lead-In Tube" was submitted to the Radio News Laboratories for test, by J. Nicklin & Co., Ltd., 166, Great



Charles Street, Birmingham, England. It is used as a connector for phone tips. Two large contacts are

provided which give pressure on both sides of the tip.

AWARDED THE RADIO NEWS LABORATORIES CERTIFICATE OF MERIT NO. 1324.

A.F. TRANSFORMER

This audio-frequency transformer was submitted to the Radio News Laboratories for test, by the Perry Wire Works, Yonkers, N. Y. It is



well designed and has good amplifying characteristics.

AWARDED THE RADIO NEWS LABORATORIES CERTIFICATE OF MERIT NO. 1258.

BATTERY CORD

The "Unicord" shown was submitted to the Radio News Laboratories for test, by the Walnut Electric Mfg. Company, 308 South Green Street, Chicago, Ill. It simplifies the external wiring of a receiver and tends to increase the over-all effici-



ency of operation. All battery leads are included in the one cable.

AWARDED THE RADIO NEWS LABORATORIES CERTIFICATE OF MERIT NO. 1258.

AUDIO TRANSFORMER

The audio transformer shown was submitted to the Radio News Laboratories for test, by the Jefferson Electric Mfg. Company, 501 South Green Street, Chicago, Ill. It was

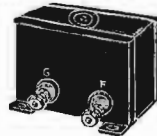

found to be a very good amplifier of low as well as high audio frequencies.

AWARDED THE RADIO NEWS LABORATORIES CERTIFICATE OF MERIT NO. 1408.

"A" FILTER

The Joyce Bros. "A" Filter was submitted to the Radio News Laboratories for test, by Helios, Inc., P. O. Box 3259, Boston, Mass. It is designed to be used in conjunction with an "A" battery charger or rectifier to supply filament current for the vacuum tubes, and has been found to be very efficient in operation.

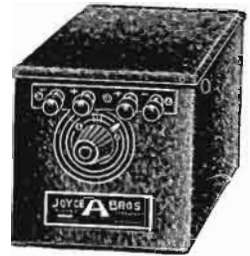

AWARDED THE RADIO NEWS LABORATORIES CERTIFICATE OF MERIT NO. 1426.

PANEL BRACKET

The "Kelbraker" shown was submitted to the RADIO NEWS LABORA-

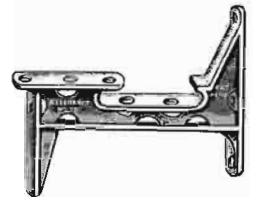

TORIES for test, by Kelleradio, Inc., 321 Market Street, San Francisco, Cal. It is of cast aluminum and found to have exceptional strength.

AWARDED THE RADIO NEWS LABORATORIES CERTIFICATE OF MERIT NO. 1425.

A.F. TRANSFORMER

This new type audio transformer was submitted to the Radio News Laboratories for test, by the Thordarson Electric Mfg. Co., Chicago, Ill.



It has a large iron core and a high impedance primary winding. It is an excellent amplifier of both low and high audio frequencies.

AWARDED THE RADIO NEWS LABORATORIES CERTIFICATE OF MERIT NO. 1417.

ONE-DIAL-CONTROL ATTACHMENT

This unique, one-dial-control was submitted to the RADIO NEWS LABORA-



TORIES for test, by the Henry G. Boselli Mfg. Co., 118 E. 2nd Street, Clifton, N. J. It can be adapted to any of the present type three-control receivers, and permits the adjustment of all controls in a single operation.

AWARDED THE RADIO NEWS LABORATORIES CERTIFICATE OF MERIT NO. 1271.

A.F. TRANSFORMER

The Amertran De Luxe audio transformer was submitted to the

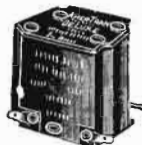

RADIO NEWS LABORATORIES for test, by the American Transformer Co., 178 Emmet St., Newark, N. J. It is of fine construction and successfully amplifies the low as well as the high frequency notes.

AWARDED THE RADIO NEWS LABORATORIES CERTIFICATE OF MERIT NO. 1409.

FIXED CONDENSER

The fixed condenser shown was submitted to the RADIO NEWS LABORATORIES for test, by Hart & Hege-



man, Hartford, Conn., and found to be of excellent construction. It is manufactured in a number of different low capacities.

AWARDED THE RADIO NEWS LABORATORIES CERTIFICATE OF MERIT NO. 1355.

TUBE SOCKET

This socket was submitted to the RADIO NEWS LABORATORIES for test, by Silver-Marshall, Inc., 848 W. Jackson Blvd., Chicago, Ill. It is de-



signed to take all types of UX tubes now on the market. It is moulded from a very good grade of material.

AWARDED THE RADIO NEWS LABORATORIES CERTIFICATE OF MERIT NO. 1318.

A.F. TRANSFORMER

The audio-frequency transformer shown was submitted to the RADIO NEWS LABORATORIES for test, by the Modern Electric Mfg. Company, 1231 Summit St., Toledo, Ohio. It was



found to have very good characteristics, being well constructed and adaptable to any type of receiving set.

AWARDED THE RADIO NEWS LABORATORIES CERTIFICATE OF MERIT NO. 1281.

CORD TIP JACKS

These small jacks were submitted to the RADIO NEWS LABORATORIES for test, by King Quality Products, Inc., 254 Rano Street, Buffalo, N. Y. They are of good construction and



can be easily mounted on any panel employed for radio sets. A good contact with the phone tip is insured.

AWARDED THE RADIO NEWS LABORATORIES CERTIFICATE OF MERIT NO. 1325.

VARIABLE CONDENSER

This variable condenser was submitted to the RADIO NEWS LABORATORIES for test, by the Standard

Products Mfg. Company, Wilmington, Del. It is of the straight-line-frequency type. The mechanical and electrical design is very good.



AWARDED THE RADIO NEWS LABORATORIES CERTIFICATE OF MERIT NO. 1326.

A.F. TRANSFORMER

The audio transformer shown was submitted to the RADIO NEWS LABORA-



TORIES for test, by the Acme Apparatus Co., Cambridge, Mass. It has an exceptionally large primary winding and a heavy iron core, which make it responsive to the amplification of both low and high frequency notes.

AWARDED THE RADIO NEWS LABORATORIES CERTIFICATE OF MERIT NO. 1419.

A.F. TRANSFORMER

The Supertran shielded audio transformer was submitted to the



RADIO NEWS LABORATORIES for test, by the Ford Radio & Mica Corporation, 111 Bleecker St., New York City. It is of very good construction and was found on test to be an efficient amplifier.

AWARDED THE RADIO NEWS LABORATORIES CERTIFICATE OF MERIT NO. 1418.

A.F. TUBE REVIVER

The "Socket" tube reviver shown was submitted to the RADIO NEWS LABORATORIES for test, by the International Resistance Co., Philadelphia, Pa. It is well made and so designed that anyone can operate it with little chance of trouble. It has been found to serve its purpose well.

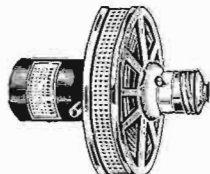

AWARDED THE RADIO NEWS LABORATORIES CERTIFICATE OF MERIT NO. 1283.

VALLEY BATTERY CLIP

The battery clip shown was submitted to the RADIO NEWS LABORATORIES for test, by the Valley Electric Co., 3257 So. King's Highway, St. Louis, Mo., and found to be of good construction. It has a strong spring which insures a firm grip of the clip on a terminal.



AWARDED THE RADIO NEWS LABORATORIES CERTIFICATE OF MERIT NO. 1462.

POWLR TUBE ADAPTER

The "Na-Aid No. 120 Connector-aid Adapter" was submitted to the RADIO NEWS LABORATORIES for test, by the Alden Mfg. Company, Springfield, Mass. It permits the use of a UX-120 power tube in any set without the necessity of rewiring the last audio stage.



AWARDED THE RADIO NEWS LABORATORIES CERTIFICATE OF MERIT NO. 1349.

POWER TUBE ADAPTER

The No. 112 Connector-aid was submitted to the RADIO NEWS LABORATORIES for test, by the Alden Mfg. Co., Springfield, Mass. It permits the use of a UX-112 type power tube in any

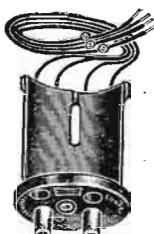

receiving set without the necessity of rewiring the last audio stage.

AWARDED THE RADIO NEWS LABORATORIES CERTIFICATE OF MERIT NO. 1434.

WALL-ART LOUD SPEAKER

The "Wall-Art Loud Speaker" was submitted to the RADIO NEWS LABORATORIES for test, by the P & G Mfg. Company, Maywood, Illinois. It is of unique design, the speaker itself being mounted behind an attractive



tapestry picture. The speaker gives very good reproduction.

AWARDED THE RADIO NEWS LABORATORIES CERTIFICATE OF MERIT NO. 1352.

BALANCING CONDENSER

This balancing condenser was submitted to the RADIO NEWS LABORATORIES for test, by the Walbert Mfg. Co., 925 Wrightwood Ave., Chicago, Ill. It is of unique construction. The capacity can be varied by turning a



small slotted nut on the top with a screwdriver.

AWARDED THE RADIO NEWS LABORATORIES CERTIFICATE OF MERIT NO. 1428.

FIXED-RESISTANCE UNIT

The fixed-resistance unit shown here was submitted to the RADIO NEWS LABORATORIES for test, by the Continental Carbon Co., West Park, Cleveland, Ohio. It has a high current-carrying capacity and is particu-

larly adaptable for use in "B" eliminator circuits.



AWARDED THE RADIO NEWS LABORATORIES CERTIFICATE OF MERIT NO. 1439.

BY-PASS CONDENSER

The by-pass condenser shown was submitted to the Radio News Laboratories for test, by the Potter Mfg. Co., Inc., North Chicago, Ill. It withstood all tests given it. These condensers are manufactured in various capacities from 0.5- μ f. upward.



AWARDED THE RADIO NEWS LABORATORIES CERTIFICATE OF MERIT NO. 1390.

A. F. AMPLIFIER UNIT

The "Radiant" amplifier shown was submitted to the Radio News Laboratories for test, by the Heath Radio & Electric Mfg. Co., 206 First St., Newark, N. J. It is of the resistance-coupled type, having three stages. It gave excellent results on test.



AWARDED THE RADIO NEWS LABORATORIES CERTIFICATE OF MERIT NO. 1218.

DETECTOR-AMPLIFIER UNIT

The "Radiant" resistance-coupled detector-amplifier, was submitted to



the RADIO NEWS LABORATORIES for test, by the Heath Radio & Electric Mfg. Co., 206 First St., Newark, N. J. It is identical to the "Radiant" amplifier unit, but with the addition of a detector-tube socket. It gave excellent results on test.

AWARDED THE RADIO NEWS LABORATORIES CERTIFICATE OF MERIT NO. 1432.

RECORDING DIAL

The "Acuratune" recording dial was submitted to the RADIO NEWS LABORATORIES for test, by the Mydar Radio Co., 9 Campbell St., Newark, N. J. It is of striking appear-



ance and good construction. It has a ratio of 12:1. Space is provided for listing station calls.

AWARDED THE RADIO NEWS LABORATORIES CERTIFICATE OF MERIT NO. 1406.

A.F. TRANSFORMER

The "Hedgehog" audio-frequency transformer was submitted to the RADIO NEWS LABORATORIES for test, by the Premier Electric Co., Grace &



Ravenwood Aves., Chicago, Ill. It gave excellent results under test.

AWARDED THE RADIO NEWS LABORATORIES CERTIFICATE OF MERIT NO. 1423.



Conducted by Joseph Bernsley

THIS Department is conducted for the benefit of our Radio Experimenters. We shall be glad to answer here questions for the benefit of all, but we can publish only such matter as is of sufficient interest to all.

1. This Department cannot answer more than three questions for each correspondent. Please make these questions brief.
2. Only one side of the sheet should be written upon; all matter should be typewritten or else written in ink. No attention paid to penciled matter.
3. Sketches, diagrams, etc., must be on separate sheets. This Department does not answer questions by mail free of charge.
4. Our Editors will be glad to answer any letter, at the rate of 25c. for each question. If, however, questions entail considerable research work, intricate calculations, patent research, etc., a special charge will be made. Before we answer such questions, correspondents will be informed as to the price charge.

Mr. Bernsley answers radio questions from WRNY every Thursday at 8:15 P. M.

The I Want to Know Department can not undertake to supply picture diagrams of circuits; the schematic diagrams, which are standard in their use of symbols, are made as plain as possible and full information is given with them. When a picture diagram of a given circuit is available elsewhere, we will supply this information on request.

SILVER SIX RECEIVER

(2180) Mr. N. R. Evans, South Bend, Ind., asks as follows:

1. Can you supply me with the constructional data and schematic wiring diagram of the Silver Six receiver about which I have heard much? The set, as I understand it, employs the desirable feature of plug-in coils, thus enabling a variable wave-length range to be covered. This characteristic is something that I have sought for a long time, as I am very much interested in short-wave reception. The honeycomb coil receiver lacks flexibility, that is, it is impossible to add radio-frequency amplification to it without complications. May I expect this information in your "I Want to Know" columns very shortly?

A. 1. The following is the description of the Silver Six receiver which you desire.

"The 'Silver Six' is a six-tube broadcast receiver of advanced design, using either loop or outdoor antenna for the reception of broadcasting programs on any wave-length. It is of the tuned-radio-frequency type, embodying several features which render it extremely sensitive and selective, that are not found in standard equipment.

"The circuit employed includes two stages of tuned-radio-frequency amplification, a detector, and three stages of resistance-coupled audio amplification.

"The radio-frequency amplifier uses a new type of inductance, plugging into special sockets, which permits the interchanging of coils for various wave-length ranges. The R.F. transformers are of special design, so built that while their losses are extremely low, any tendency toward undesirable oscillation is very slight, and where present, easily controlled. The antenna coupler is provided with a small adjustable rotor winding, which allows the receiver to be adjusted to suit any particular antenna conditions for each wave-length band it is desired to cover.

"The 'gain control' system employed, inaugurates a new departure in R.F. amplifier design, for it permits perfect control of oscillation and volume without in any way distorting the operating characteristics or selectivity of the circuits, as done

by methods heretofore employed, such as grid bias, potentiometers, etc.

"Straight-line-frequency condensers insure maximum selectivity and ease of tuning, since stations will be found separated by a given number of kilocycles per dial degree (approximately ten, or one transmission channel, per degree) instead of by wave-length as heretofore.

"The detector tube, contrary to the customary practice, rectifies by virtue of a negative grid potential, causing it to operate upon the 'knee' of its $E_c I_p$ characteristic curve. This insures maximum handling capacity without distortion, as well as lower detector-circuit losses than would be obtained with a grid-condenser-leak combination."

ASSEMBLY

The assembly of the receiver is quite simple. All necessary parts to build it are listed below, and can be obtained in kit form.

- Three variable condensers, .00035- μ f., S.L.F.;
- Three dials, 4-inch;
- One set of three plug-in inductances and sockets, designed especially for this receiver;
- Six UX-tube sockets;
- One rheostat, 3-ohm;
- One variable resistance, 1/2-megohm;
- One kit of resistance-couplings, designed for this circuit;
- One filament switch;

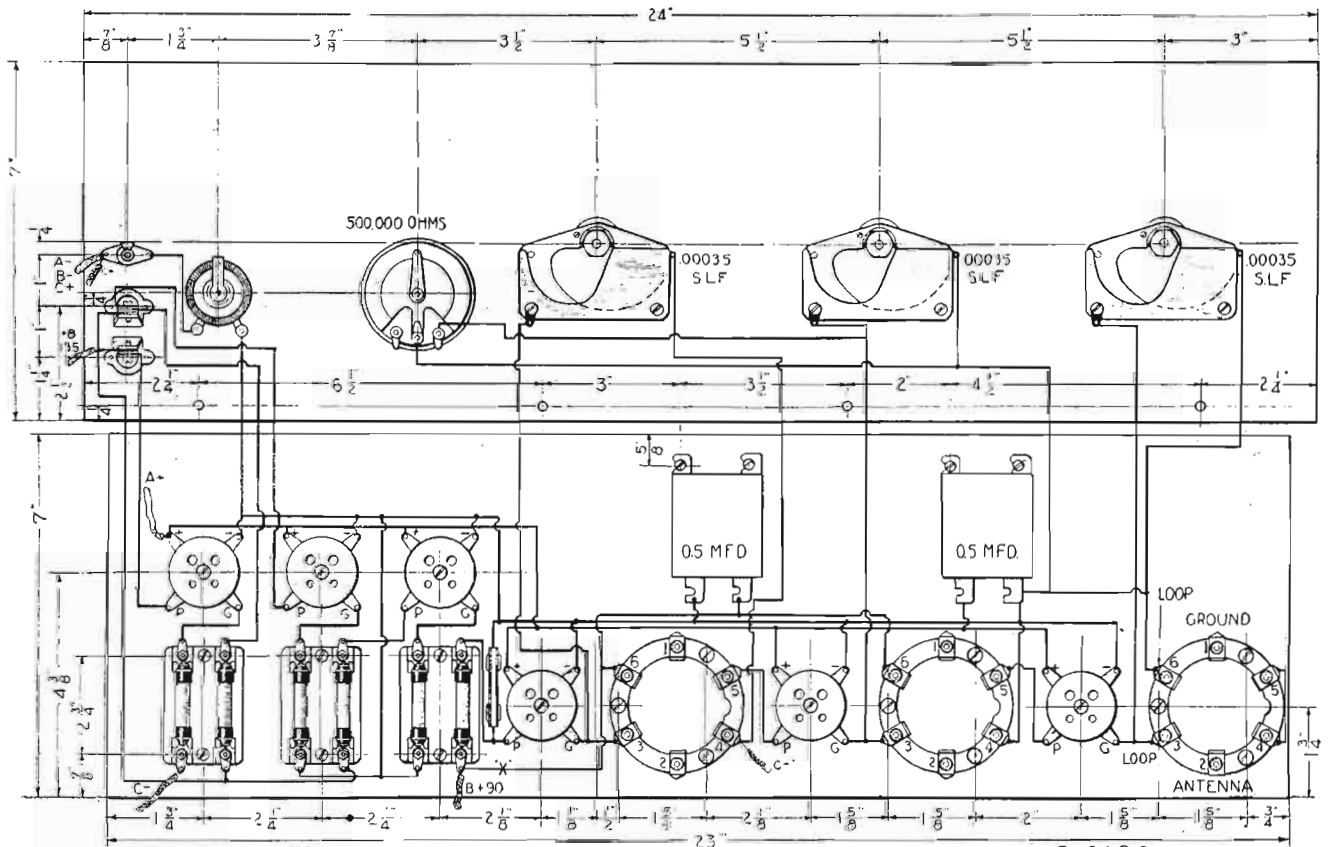

Q. 2180

Wiring diagram of the Silver Six receiver; two stages of tuned R.F., detector and three stages of resistance-coupled audio. A special means of controlling oscillations in the R.F. stages is provided. Plug-in inductance coils are used, so that a wave-length range from approximately 50 to 600 meters may be covered.

finished cell. Small copper connecting wires are fastened to the ends of the lugs. A rubber insulating tube is placed over the lug, over which is placed a glass tube, and the space between is filled with sealing wax. Another rubber tube is then placed over the whole.

The total effective area of the ten plates is 503 square inches, and the length of the boundary lines 3 inches. The residual current, or leakage current, at 110 volts was .0005 amperes, which leaked through the insulation at the boundary line. The distance between the plates was about 3/16 of an inch. In this condenser, five plates were used for each side of the circuit; and as each set of plates is of aluminum, it makes no difference which way the condenser is connected in the circuit. The following table shows the measured capacities with different formation-voltages:

Formation-voltage	μf. Capacity
40.....	147.7
80.....	73.1
132.....	44.0
160.....	37.7

Dr. Schulze's condenser is made up of ten plates, five for each side of the line, as shown in Fig. 6. This type of condenser is required for alternating current circuits. For filter circuits in "B" eliminators, where the current is not alternating but pulsating direct, we can connect all of the plates to the positive side of the line, and the electrolyte to the negative side by means of a small strip of lead dipping into it, as clearly shown in Fig. 7. This arrangement will give twice the capacity obtained with five plates on each side of the line. Therefore, instead of 147.7 microfarads at a formation-voltage of 40, the capacity is 295.4 microfarads.

It seems inconceivable that such a small device should give a capacity of nearly 300 microfarads. Think what it would cost to build a waxed-paper condenser of 300 microfarads—almost one dollar per microfarad.

UTILIZING THE CHEMICAL CONDENSER

Of course this capacity is obtained only provided the condenser is not used on voltages higher than 40—the forming voltage. If formed on 20 volts or less the capacity will be considerably greater; the condenser would then probably be suitable for filtering current in "A" eliminator circuits, where the voltage is not over 10. A capacity of 600 to 700 microfarads can be obtained at this low formation-voltage.

Extensive tests were made on the condenser described above; and it was found that for maximum efficiency the voltage at which the condenser is used should not exceed 90.

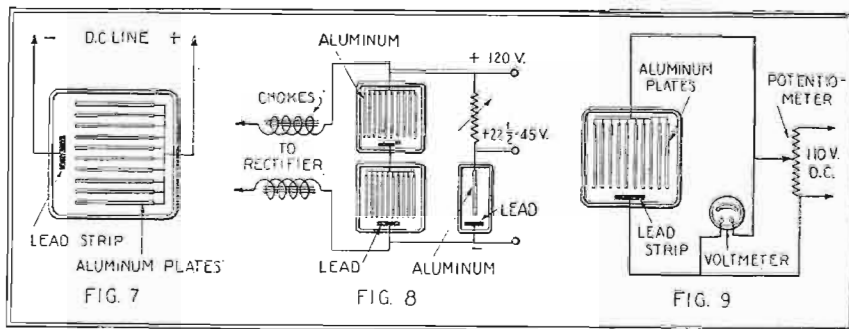

Fig. 7 indicates the connections of the chemical condenser for a D.C. circuit. A lead strip is used for the cathode. Fig. 8 shows the connections of a "B" eliminator filter circuit and Fig. 9 the connections for "forming" the plates.

For higher voltages two or more condensers should be connected in series. In "B" eliminator circuits the voltage seldom exceeds 150. Therefore two of these condensers should be used, connected in series. If the film on each condenser is formed at 75 volts, each will have a capacity of about 160 μf. Connecting them in series, the total capacity across the two will be about 80 μf., much greater than is necessary for a "B" filter circuit. The connections of the two condensers in series are shown in Fig. 8, with a complete filter circuit.

The experimenter who desires to build an electrolytic condenser should select a pure grade of commercial aluminum, either extra pure or No. 1, which is about 99.55 per cent. pure, with a slight amount of silicon and iron. The plates should be cut as shown in Figs. 4 and 5, and thoroughly cleaned in hot water. For the electrolyte a saturated solution of borax, to which a small amount of glycerine is added, may be used. The negative terminal of the condenser may be a strip of lead dipping into the electrolyte, and the whole placed in a glass storage battery jar. As aluminum cannot be soldered with the ordinary low-temperature lead solders, connections may be made to the plates by means of small screws and nuts. By taking extra care to insulate the aluminum lugs at the surface line of the electrolyte the leakage current will be reduced to a minimum and the efficiency will be very high. The condensers will not draw a heavy load from the rectifier tubes.

To form the film on the plates, the connections shown in Fig. 9 should be used. The voltage at which the condenser is to be used should first be determined, and the forming-voltage should be a little greater; if the condenser is to be used on an A.C. circuit,

it should be greater than the maximum-value of the A.C. voltage. If the 110-volt D.C. line is not available, a set of "B" batteries may be used to form the film. The current consumption is low and will not ruin the batteries. It is best to leave the forming-voltage on about ten hours. When using a 110-volt D.C. lighting line, a 400- or 500-potentiometer and a voltmeter are desirable, as shown in the figure. By starting with the potentiometer arm at the bottom, at zero voltage, and gradually swinging it up until the proper voltage is applied, the film will slowly thicken as the voltage increases, and a minimum amount of current will be drawn from the line.

One of the main reasons why chemical condensers and electrolytic rectifiers have not been more popular is the sloppiness of the liquid electrolyte. Perhaps some experimenters may overcome this disadvantage by using some form of jelly or fused electrolyte. Fused sodium phosphate has been used for the electrolyte of an aluminum cell rectifier with very good results. It would seem that much better efficiency would be obtained when using the rectifier for "B" eliminators, because the current used is much less than for charging batteries.

Storage batteries with jelly electrolyte have been made to give fairly good results. The experimenter who wishes to work along these lines may use sodium silicate, commonly known as water glass, for making the jelly electrolyte, to which the acid may be added. However, it shrinks away from the plates and of course increases the internal resistance of the cell, which may become entirely open-circuited.

We should be pleased to hear from experimenters who have had any great success with solid electrolytes.

LIST OF BROADCAST STATIONS IN THE UNITED STATES

(Continued from page 129)

Radio Call Letter	BROADCAST STA. Location	Wave (Meters)	Power (Watts)	Radio Call Letter	BROADCAST STA. Location	Wave (Meters)	Power (Watts)	Radio Call Letter	BROADCAST STA. Location	Wave (Meters)	Power (Watts)	Radio Call Letter	BROADCAST STA. Location	Wave (Meters)	Power (Watts)
WLTS	Chicago, Ill.	254	1000	WOAW	Omaha, Neb.	323	1000	WRAC	Essex, Mich.	254	500	WSDA	New York, N. Y.	263	250
WLW	Harrison, Ohio	122.3	500	WOAX	Trenton, N. J.	240	500	WRAM	Galesburg, Ill.	244	100	WSKC	Bay City, Mich.	263	1000
WLWL	New York, N. Y.	248.3	3750	WOC	Davenport, Iowa	183.6	5000	WRAY	Yellow Springs, Ohio	263	100	WSM	Nashville, Tenn.	282.3	1000
WMAO	Cazenovia, N. Y.	273	100	WOCL	Timonstown, N. J.	375.2	15	WRAX	Reading, Pa.	238	10	WSMB	New Orleans, La.	310	500
WMAF	Dartmouth, Mass.	440.9	1000	WOD	Paterson, N. J.	324	250	WRAC	Gloacaster City, N. J.	249	500	WSMH	Owosso, Mich.	240	20
WMAK	Leekport, N. Y.	254	500	WOK	Ames, Iowa	370	750	WRAC	Walparaiso, Ind.	375	500	WSMK	Detroit, Mich.	275	500
WMAJ	Washington, D. C.	212.6	100	WOK	Homewood, Ill.	217	5000	WRAC	Washington, D. C.	168.7	1500	WSDE	Milwaukee, Wis.	246	500
WMAN	Columbus, Ohio	278	50	WOKO	New York, N. Y.	233	50	WRAC	Washington, D. C.	274	10	WSRO	Hamilton, Ohio	253	100
WMAQ	Chicago, Ill.	447.5	1000	WOD	Philadelphia, Pa.	508.2	500	WRAC	Washington, D. C.	274	10	WSRH	Boston, Mass.	361	100
WMAV	St. Louis, Mo.	243	100	WOOD	Grand Rapids, Mich.	249	500	WRAC	Washington, D. C.	274	10	WSUL	Rocky City, Iowa	482.5	500
WMAZ	Macon, Ga.	261	500	WOQ	Kansas City, Mo.	378	1000	WRAC	Washington, D. C.	287.5	500	WSVS	Buffalo, N. Y.	218.3	50
WMBB	Chicago, Ill.	250	500	WOR	Newark, N. J.	405.2	500	WRAC	Washington, D. C.	250	50	WSVS	Buffalo, N. Y.	218.3	50
WMBC	Detroit, Mich.	256.1	130	WORD	Batavia, Ill.	275	5000	WRAC	Washington, D. C.	250	50	WSVS	Buffalo, N. Y.	218.3	50
WMBF	Miami Beach, Fla.	244.1	500	WOS	Jefferson City, Mo.	400.9	500	WRAC	Washington, D. C.	250	50	WSVS	Buffalo, N. Y.	218.3	50
WMCI	Memphis, Tenn.	289.7	500	WOVL	New Orleans, La.	270	10	WRAC	Washington, D. C.	250	50	WSVS	Buffalo, N. Y.	218.3	50
WMCA	Hoboken, N. J.	249.7	500	WOVA	Pope Wayne, Ind.	227	500	WRAC	Washington, D. C.	250	50	WSVS	Buffalo, N. Y.	218.3	50
WMSS	New York, N. Y.	214.6	500	WPAK	Agricultural Col., N. Dak.	275	50	WRAC	Washington, D. C.	250	50	WSVS	Buffalo, N. Y.	218.3	50
WMAB	Boston, Mass.	250	100	WPCC	Chicago, Ill.	253	500	WRAC	Washington, D. C.	250	50	WSVS	Buffalo, N. Y.	218.3	50
WMAC	Boston, Mass.	280.2	500	WPQ	Buffalo, N. Y.	265.4	50	WRAC	Washington, D. C.	250	50	WSVS	Buffalo, N. Y.	218.3	50
WMAD	Norman, Okla.	254	500	WPD	Atlantic City, N. J.	300.8	500	WRAC	Washington, D. C.	250	50	WSVS	Buffalo, N. Y.	218.3	50
WMAL	Omaha, Neb.	278	50	WPCC	Harrisburg, Pa.	216.7	100	WRAC	Washington, D. C.	250	50	WSVS	Buffalo, N. Y.	218.3	50
WMAT	Philadelphia, Pa.	250	100	WPSC	State College, Penna.	341	500	WRAC	Washington, D. C.	250	50	WSVS	Buffalo, N. Y.	218.3	50
WMAX	Yankee, S. Dak.	244	100	WQAA	Parkersburg, Pa.	224	500	WRAC	Washington, D. C.	250	50	WSVS	Buffalo, N. Y.	218.3	50
WMBH	New Bedford, Mass.	231	100	WQAC	Asheville, Tex.	224.2	500	WRAC	Washington, D. C.	250	50	WSVS	Buffalo, N. Y.	218.3	50
WMJ	Newark, N. J.	252	150	WQAE	Springfield, Vt.	214	50	WRAC	Washington, D. C.	250	50	WSVS	Buffalo, N. Y.	218.3	50
WMOX	Knoxville, Tenn.	268	100	WQAM	Miami, Fla.	243	100	WRAC	Washington, D. C.	250	50	WSVS	Buffalo, N. Y.	218.3	50
WMRC	Greensboro, N. C.	234	10	WQAN	Savannah, Pa.	251	100	WRAC	Washington, D. C.	250	50	WSVS	Buffalo, N. Y.	218.3	50
WMYC	New York, N. Y.	536	1000	WQAO	New York, N. Y.	360	100	WRAC	Washington, D. C.	250	50	WSVS	Buffalo, N. Y.	218.3	50
WOAI	San Antonio, Tex.	294.5	2000	WQJ	Chicago, Ill.	417.5	500	WRAC	Washington, D. C.	250	50	WSVS	Buffalo, N. Y.	218.3	50
WOAN	Lawrenceburg, Tenn.	283.8	300	WRAF	Laporte, Ind.	221	100	WRAC	Washington, D. C.	250	50	WSVS	Buffalo, N. Y.	218.3	50

Results of Cooperative Measurements of Radio Fading

By DR. J. H. DELLINGER, DR. C. B. JOLLIFFE and T. PARKINSON

During the last year and a half the Radio Laboratory of the Bureau of Standards has been studying the fading of radio signals. Herewith is a resumé of the findings.

AT the beginning of 1925, the Bureau of Standards invited a number of qualified laboratories to participate in the beginning of a co-operative program of measurements of the several quantities: field intensity, fading, direction variations, polarization, and atmospheric effects. In 1925 the work was largely confined to fading measurements, because the apparatus

receiving set, of any type, plus a sensitive direct-current galvanometer used with a detector in such a way as to measure variations in the received carrier-wave current. Records were in some cases made by visual observation of galvanometer deflections, but automatic continuous records were obtained in most of the work. These were easier for the observer, and showed up the smaller

The several sunset tests showed a similar decrease followed by an increase; superposed, however, on a marked general increase of signal intensity in the transition from daytime to night-time conditions. The time required for transition from normal daytime field intensity to normal night-time field intensity, at the particular frequencies used, is two or three hours, half before and half following sunset. The observations lead to the following general conclusions:

1. Short-period fading (periods of a few seconds to 8 or 10 minutes) is not the same on records made simultaneously, even at short distances.

2. The same is true of long-period changes (10 minutes to several hours).

3. Records of the same transmission made on successive days at the same receiving point bear little resemblance.

4. There is no correlation between intensity and fluctuation changes.

5. There is no consistent correlation between good reception and the relation of the transmission path to the direction of isobars or isotherms, as shown on weather maps covering the test periods.

6. Averaging a number of sunset records, made over a period of two weeks, shows a rise of intensity starting over an hour previous to sunset; a drop or lessening of the rate of increase before or during sunset at the receiving point; and a rise during or after sunset to a night-time value reached an hour or two hours after sunset. This value is not necessarily the night maximum which may occur much later. In the case of north-to-south transmission, the increase of intensity during the sunset period is continuous.

7. The average shows, in general, greater fluctuation at night than during daylight; the daylight value often being close to zero, while the night value, in rare instances, mounts to 3.5 times the mean intensity.

8. On the KDKA average records there is a consistent correlation between the ratio of day-to-night intensity and distance from the transmitting station. A correlation also between the ratio of day-to-night fluctuation and distance appears.

9. On a single set of 24-hour tests the maximum intensity appears at about the same time, the four hours preceding sunrise, for observers within 622 miles of the transmitting station.

10. Measurements of directional shifts during some of the tests indicate that they are, in general, accompanied by fading of the short-period type.

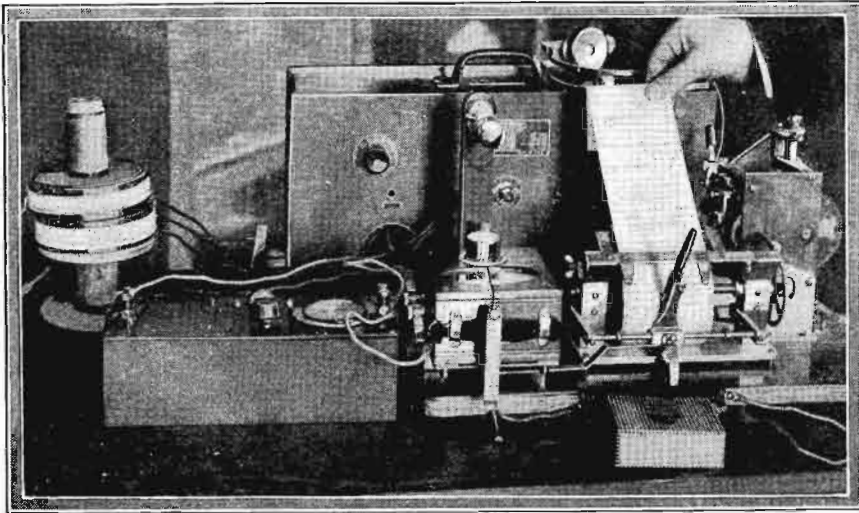

The apparatus assembled by Mr. Parkinson, of the Radio Laboratory of the Bureau of Standards, for making observations relative to the fading of radio signals

required is relatively simple and because fading phenomena promise to shed the most light on the wave characteristics.

The work was mainly at the broadcast frequencies because transmissions with an uninterrupted carrier-wave are not so readily available in other parts of the frequency spectrum. Results at other than broadcast frequencies, and field intensity and directional observations are therefore considered as incidental to the study of fading phenomena in the broadcast range.

The general plan of the work was the arrangement by which a certain station transmitted continuously during a specified period, and graphic records were made simultaneously by the observing laboratories. The observing method is that described in the pioneer paper, "Short-period Variations in Radio Reception," by G. W. Pickard. Proc. I.R.E., 12 p. 119; 1924.

The method of measurement utilized a

fluctuations which sometimes proved significant. A number of records made during some of the sunset fading tests, for instance, show a rapid periodic swing starting about fifteen minutes after the local sunsets at the observing points and lasting approximately a half hour.

RESULTS OF RESEARCH

The series of measurements on fading were devoted to a study of effects during the eclipse of January 24, the fading effects during sunset, and the fading variations throughout a 24-hour day.

The observations during the eclipse showed, as expected, a condition intermediate between daytime and night-time transmission. The perceptible variation lasted about an hour, consisting of a decrease in the field intensity to a minimum, followed by an increase to a maximum and then a subsidence to normal.

Tip-Jack Voltmeters for Filament Regulation

By ERNEST E. STOLP*

ATTENTION has been called to the use of filament voltmeters for controlling the application of voltage to vacuum tubes by the use of pin jacks in the panel of radio receivers.

Multitudes of tubes have gone to the rejuvenator or to the junk heap many moons sooner than they should, because of careless handling of the filament rheostat. The remedy lies in the use of a voltmeter, which, if connected in the filament circuit will give true readings of the voltage under varying battery conditions.

Receivers which are provided with pin jacks for easy application of a voltmeter have called forth small and exceedingly accurate meters, equipped with extended prods or terminals which will fit the pin jacks. These meters must be well made, with high-resistance movements, and have sturdy construction of the prods, which should also be adjustable to allow for slight inaccuracies in spacing of the pin jacks.

Zero adjusters, the same as used on the "big brother" or switchboard meters, should be provided so that deviations from the

zero mark, due to rough handling or shipment, may be corrected. For convenience the scale must have a special mark at three or five volts to permit of easy visibility.

Many tubes which have become inactive from excessive filament voltages will be replaced by tubes which will be controlled by the filament voltmeter; and in the near future many disappointments due to defunct tubes and run-down batteries will be forgotten in a new and added security of operation.

* Jewell Electrical Instrument Company

- Two jacks, one open, one closed-circuit;
- Two by-pass condensers, $\frac{1}{2}$ - μ f.;
- One fixed condenser, .002- μ f.;
- One baseboard 7x24, busbar, screws, etc.;
- One wiring cable, colored.

"The cable is included to simplify the wiring; as any ordinary layman with no practical experience can solder the various connections by simply following the color scheme furnished along with the cable, which is especially designed for this receiver. Bus-wire connections may be used instead, if so desired.

"With the tubes in place, pull out the filament switch, and rotate the rheostat from left to right until it is almost all the way around—say within one-quarter inch of the full-on position. The tubes should then be lighted fairly brightly. A plug connected to a pair of headphones should be inserted in the jack, and the grid posts of all tube sockets touched with the fingers. Clicks or squeals will be heard if the receiver is functioning properly.

"The volume control should be turned all the way to the right, or clock-wise, and the three dials set at about fifty degrees. If either end dial is varied over a range of two or three degrees, a click will be heard, possibly followed by a squeal or series of squeals, the pitch of which may be varied by rotating the dials slightly. The volume rheostat should be turned so that its arrow points straight to the right, and the small rotor coil in the antenna inductance slowly turned in so that its axis will coincide with that of the stator coil, until rotating the dials near approximately similar settings fails to cause clicks, squeals, etc. If for any reason, setting this rotor entirely in does not eliminate squealing, then this can easily be done by retarding the volume control to the left until it ceases.

"Tuning in local stations will be an easy matter, and is accomplished by setting all dials at five degrees, then at ten degrees, and so on up their scales in three- to five-degree steps. Once a station is

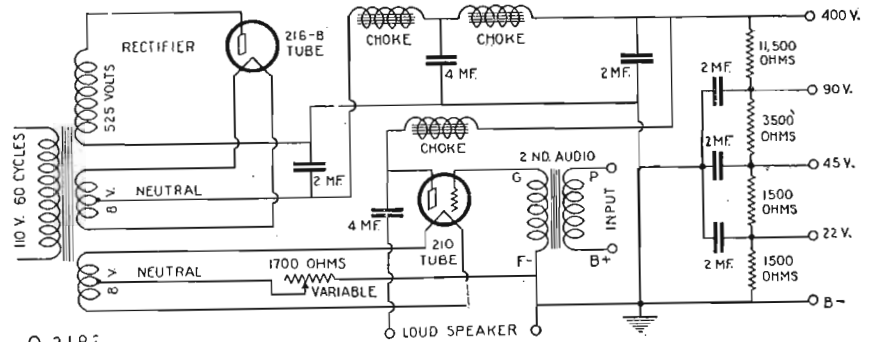

Q. 2182

A one-stage power audio amplifier, operating direct from the A.C. lighting socket, which supplies both A and B current for this particular unit. There is also a sufficient remainder to supply "B" current for the receiver.

Wave-Length Ranges

The wave-length range of this receiver includes both the amateur and broadcast bands, that is, 50 to 500 or 600 meters. The constructional data for these coils were published in an article titled "An Improved Laboratory Super-Heterodyne Receiver," in the January, 1926, issue of RADIO NEWS. The dimensions specified in that article for the antenna coupler for various wave-length ranges will be entirely satisfactory for the construction of these coils. These coils in their various sizes may also be purchased, if so desired.

"In some cases, the receiver may be too unstable on the lower ranges. Should this be the case, the

six standard dry cells must be used, connected in series parallel. This means that three cells must first be connected in series—the center post of one to the outside post of the next, and so to the third. The other three cells are similarly connected. This will then give two groups of three cells in series. The unconnected center posts of each series should be joined and led to the "+A" lead. The unconnected outside posts of the cells on the other ends of the groups then connect together and go to the "-A" lead. Using UX-199 tubes, the rheostat should be barely turned on—not further than when its arrow points straight to the left. Dry-cell tubes will give about 10 per cent. less volume than storage-battery tubes.

"The last audio tube, or right hand one, may well be a power tube for maximum volume. For use with UV-201-A's, its type number would be UX-112 or UX-171; for UX-199's the proper type is UX-120. With either style it will be necessary to turn the rheostat slightly further on than when standard tubes are used, and to supply the proper "C" battery voltage."

THE LEMNIS RECEIVER

(2181) Mr. C. N. Howard, Essex Junction, Vermont, asks as follows:

Q. 1. I would like to construct a receiver capable of unusual reproduction, its quality to be comparable with that obtained from a phonograph. I have the Lemnis Binocular coils on hand, and wonder if you could furnish me with the necessary constructional data and schematic wiring diagram of a receiver which you think will be entirely satisfactory as regards the above-mentioned characteristics?

A. 1. The diagram you request, is shown in Fig. Q.2181. We also include the illustration of a receiver incorporating the coils you mention, which was especially designed to reproduce musical notes faithfully. This advantage is largely due to the special amplifier incorporated. It consists of three stages of what is known as "autoformer coupling," resembling that of the impedance-coupled type of audio amplification. Six tubes are used in this receiver, two as tuned radio-frequency amplifiers, a detector stage, and the three stages of audio amplification. A 400-ohm potentiometer is used for controlling oscillations in the radio-frequency stages.

The parts necessary for the construction of this receiver are as follows:

- Three variable condensers, .00035- μ f., preferably S.L.F.; and dials;
- Three Lemniscate coils, L₁, L₂, L₃;
- Three Autoformers; A₁, A₂, A₃;
- One potentiometer, 400-ohm;
- Six automatic filament adjusters;
- Three by-pass condensers, 1.0- μ f.;

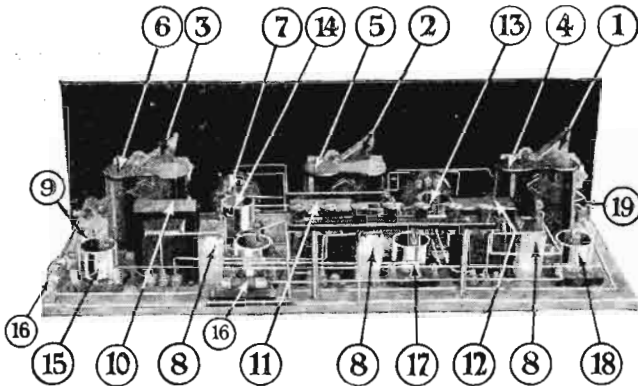

(Q. 2181B) The Lemnis Receiver. Nos. 1, 2, and 3 refer to .00035- μ f. SLF condensers; 4, 5 and 6, binocular coils; 7, 400-ohm potentiometer; 8, by-pass condensers; 10, 11 and 12, Autoformers; 13, first R.F.; 14, second R.F.; 15, detector; 17, second A.F.; 18, Automatic resistors; 19, grid leak and condenser.

Photo courtesy of General Winding Co.

heard it can be brought in to maximum volume by adjusting each dial carefully. However, if the volume control is too far to the right, distortion will be bad and the receiver unstable. Therefore, the volume control should always be operated to the left of the point where distortion begins to occur.

"If the receiver is logged, it will be found that all three dials will remain substantially an even number of degrees apart over their entire scales. This may be overcome, and all three made to read alike by loosening two, holding the condenser plates in position, and shifting the dials only on the condenser shafts so that their readings coincide with the third dial's before tightening them again.

remedy is to remove one or two turns from the small (5 to 6) winding of each No. 112 coil covering the troublesome range. In cases when the receiver will not operate on the higher wave-lengths, it may be necessary to add rather than remove turns from the R.F. coils. This is due to variation in tube characteristics.

Dry Cell Tubes

"It is perfectly feasible to use dry-cell tubes in the 'Six.' They should be of the UX-199 type throughout. No change in the design or wiring of the receiver is necessary for these tubes. The same batteries will be required as for UX 201-A tubes, except the storage battery, in place of which

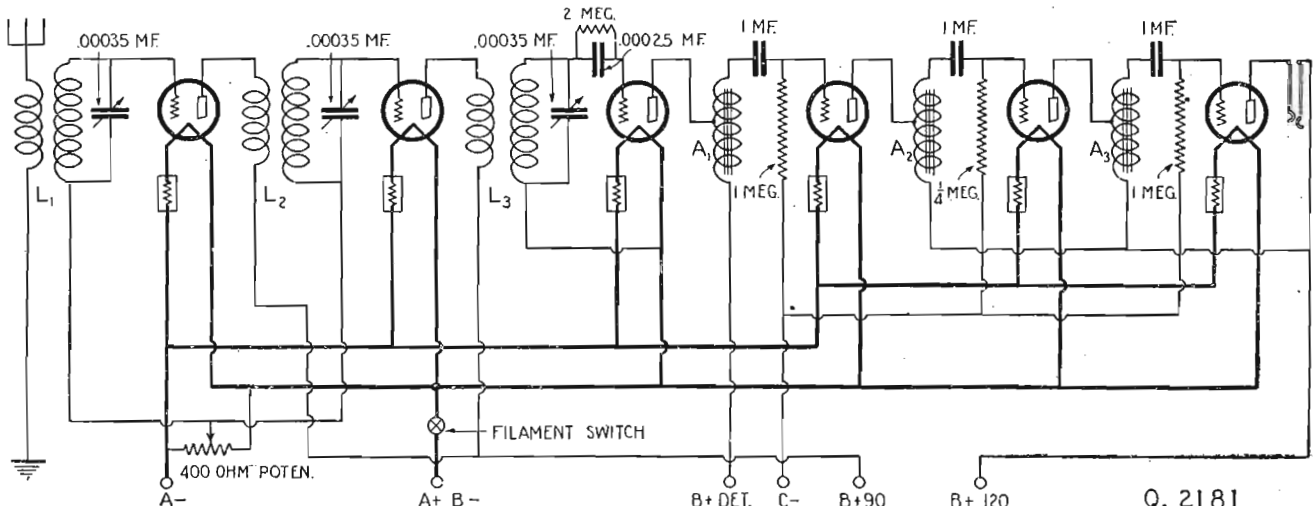

A standard six-tube receiver designed especially to amplify musical notes without distortion. What are known as "autoformers" are used in place of the conventional audio transformers to couple the audio stages.

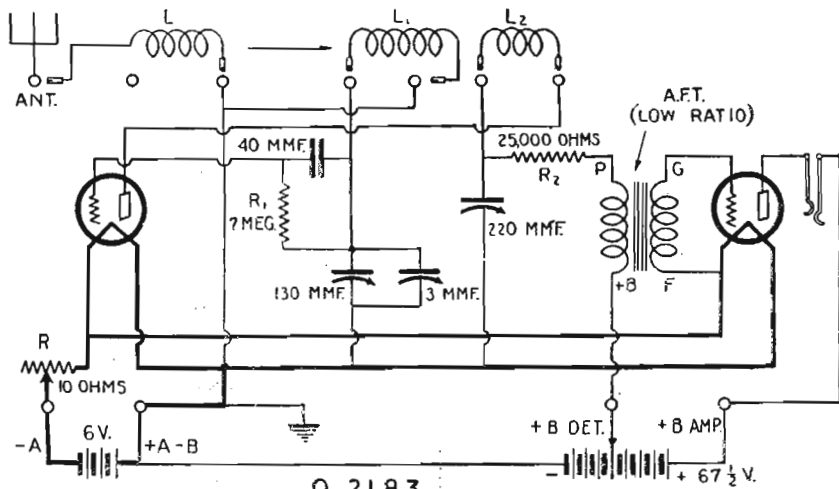

Q. 2183

The Grebe Short-Wave receiver (CR-18), employs plug-in coil inductances, by which a variable wave-length range of from approximately 8.52 to 216 meters may be covered. Constructional data for the receiver are given.

- Six sockets;
- One panel, 7x21, and baseboard, 7x21x $\frac{1}{2}$;
- Two resistors, 1.0-meg.;
- One resistor, $\frac{1}{4}$ -meg.;
- One terminal strip;
- Miscellaneous, such as wood-screws, nuts, bolts, etc.

In the assembly and construction of this receiver, try to duplicate the layout as illustrated. The parts shown here are symmetrically and efficiently placed. When tuning the set, the potentiometer should be turned over to the negative side, and the three dials rotated "in step," until a whistle or squeal is heard, which is an indication that a station has been obtained. The potentiometer should then be turned slowly back towards the positive side, until the whistle clears up and the station is heard.

BATTERYLESS POWER STAGE

(2182) Mr. F. C. Becker, Providence, R. I., asks as follows:

Q. 1. Can you furnish me with any practical information relative to the construction of a power stage unit, which I can add to my present two-tube Crosley receiver so that sufficient volume may be obtained from a loud speaker to be heard approximately 100 feet away? I have heard that such a unit can be constructed to operate direct from an alternating current source, which feature I would desire very much to combine with the aforementioned power stage.

A. 1. The schematic wiring diagram of a unit such as you desire, is shown in Fig. Q. 2182. The unit operates from a 60-cycle A.C. source and, besides furnishing plate and filament current for the power amplifier stage, furnishes additional "B" current for a receiver.

The parts necessary for the construction of this unit are as follows:

- Three choke coils, 10 henry;
- One step-up power transformer, having four windings; one primary winding and three secondaries consisting of the step-up winding (output 525 volts) and two 8-volt filament windings;
- Six by-pass condensers, 2.0 μ f.;
- Two by-pass condensers, 4.0 μ f.;
- Two standard sockets;
- One 216-B tube;
- One UX-210 or CX-310 tube;
- One A.P. transformer;
- One variable resistance, 0- to 5,000-ohm;
- Two fixed resistances, 1500-ohm;
- One fixed resistance, 3500-ohm;
- One fixed resistance, 11,500-ohm;
- Eleven binding posts, and baseboard 12x24x $\frac{1}{2}$;
- Miscellaneous.

Two special input binding posts are provided for, to which the output of the receiving set is connected. The output of the unit, indicated as "loud speaker," connects to the loud speaker. More than sufficient plate voltage is delivered by this power unit, and it will operate practically any type of receiving set.

GREBE SHORT-WAVE RECEIVER

(2183) Mr. B. P. Deverest, Ottawa, Can., asks as follows:

Q. 1. I am informed that A. H. Grebe has developed a new short-wave receiver, "CR-18" I think. Can you furnish me with any constructional information concerning same, as I am very much interested in short-wave sets?

A. 1. All the available information on the Grebe CR-18 short-wave receiver, is obtained from their booklet "Instruction and Operating Manual." All the necessary data which we think you might need, contained in that booklet, are herewith reprinted.

Short-Wave Receiver Design

"In designing a receiver for short-wave reception, many problems are encountered which are not met with when dealing with the higher wave-lengths. Radio frequency amplification does not seem to offer any particular advantages, and more complex cir-

cuits using multi-stage amplifiers are either unstable or have too many operating controls to be of any practical use.

The adjustable-tickler-coil circuit, for example, is inferior at very short wave-lengths, because a change in regeneration produces so great a change in wave-length that the transmitting station cannot be received with any degree of certainty. On the other hand, the capacity feed-back coupling method generally used results in stray-capacity effect so great that tuning is destroyed and the receiver becomes difficult to operate. While a few receivers have been designed, using the above mentioned circuits, generally the wave-length range of such sets is small and they can only be used to cover a limited band.

In order to receive continuous-wave stations to the best advantage, the circuit should be such that the point of oscillation is practically constant over the entire tuning range. For reception of broadcasting on the high frequencies, however, the regeneration control should operate in such a manner that the change from oscillating to non-oscillating condition is gradual rather than sudden.

The CR-18 receiver has been designed with all these points in mind, and a study of the circuit will reveal that variable electro-magnetic coupling between the antenna and secondary circuit is employed, contrary to the usual practice of using a small coupling condenser. This coupling coil permits a greater transfer of energy without affecting the wave-length calibration, and affords greater selectivity, reduces interference and induction noise and makes possible the use of harmonic tuning when using a large antenna.

Interchangeable Coils

"In order that tuning shall not be too critical the receiver is provided with five different coils which cover wave-length ranges, as shown above. The winding indicated as "L₁" may be approximately 8 turns. Coupling is varied by changing its position or proximity to the other windings.

These coils are fitted with plugs and are mounted outside of the cabinet, in order to reduce all losses and permit the coils to be interchanged without delay or difficulty. (No. 16 or 18 DCC wire will be satisfactory for winding these coils). Although each coil covers only a small wave-length range, the frequency-range is very large; and for this reason the beat-frequency control, consisting of a small variable air condenser, is incorporated in the receiver. This condenser permits one to discriminate between stations separated by only a fraction of a kilocycle and makes it possible to hold a station which is swinging or changing its frequency.

In place of a choke-coil in the plate circuit, the CR-18 employs a resistance. This resistance eliminates non-oscillating points in the tuning range which frequently occur when a choke-coil is used. Cushion sockets are used to eliminate all vibration and microphonic disturbances, which seriously affect the operation of a short-wave receiver.

Coil No.	Wave-length range-Meters	L ₁ turns	Space	L ₂ turns	Frequency range-Mega-cycles
1	8.5-18	1	1	2	16.6-3.5
2	15.8-31	3	1	2	9.7-1.9
3	29-62	8	1	4	4.85-1.3
4	56-112	18	2	6	2.68-.835
5	107-216	49	1	18	1.38-.28

Operating Instructions

"The CR-18 is designed to operate with 201-A, 5-volt, $\frac{1}{4}$ -ampere, X-type-base vacuum tubes. It is some times advisable to reverse the tubes in order to obtain the most desirable results. A storage battery should be used for filament supply.

"At least 90 volts of 'B' battery is necessary. A clip should be provided on the detector lead, so that variation of detector plate-voltage may be easily secured, as certain coils require more voltage than others.

"The antenna should consist of a single wire, approximately 75 or 100 feet in length including the lead-in, and should be well insulated. Good results may be obtained with an antenna as short as 25 feet, or even an indoor antenna may be resorted to. Connection to the ground should be made securely by means of a ground clamp fastened to a water pipe or radiator system. Care should be exercised in making all connections, as loose connections are more detrimental on short waves than on the higher wave-lengths.

"Set the wave-length dial on '0,' and starting at '0' on the regeneration dial slowly increase the reading to 25 or as far as necessary to cause indications of oscillation to be heard in the telephones. This point is usually 40 but will be subject to slight variations. When the point on the regeneration dial at which oscillations occur has been determined, move the dial 5 points higher. The receiver should now be in an oscillating condition over the entire wave-length range covered by the wave-length dial. A simple test to determine whether the receiver is oscillating or not is to touch the left-hand screw on the secondary coil; if a click is heard in the telephones the receiver is oscillating.

"Insert the antenna coupling coil and connect the antenna to the binding post provided. Adjust the antenna coil so that there is a separation of two inches between the top of this coil and the top of the secondary. Note again whether oscillations take place; if they have stopped, increase the regeneration dial 10 degrees and if this is not sufficient to cause oscillations, further separate the antenna coil from the secondary coil. Starting at '0,' move the wave-length dial to 100; and if points are found where the receiver stops oscillating, it indicates that the antenna circuit or a harmonic of it is in tune with the secondary circuit.

"If in later experience it is found that these non-oscillating points fall directly in the most generally used wave-length ranges, the points may be shifted by either lengthening or shortening the aerial. It will be impossible under certain conditions to eliminate all these points, regardless of the treatment of the antenna; but when these points appear, moving the antenna coil further away from the secondary coil will again permit oscillation to be maintained. Moving the regeneration dial to a higher point will also accomplish this, but it is preferable to utilize the antenna coupling coil for this purpose.

Use of Antenna Condenser

"With further reference to the occurrence of non-oscillating points on the wave-length dial, some may

(Continued on page 162)

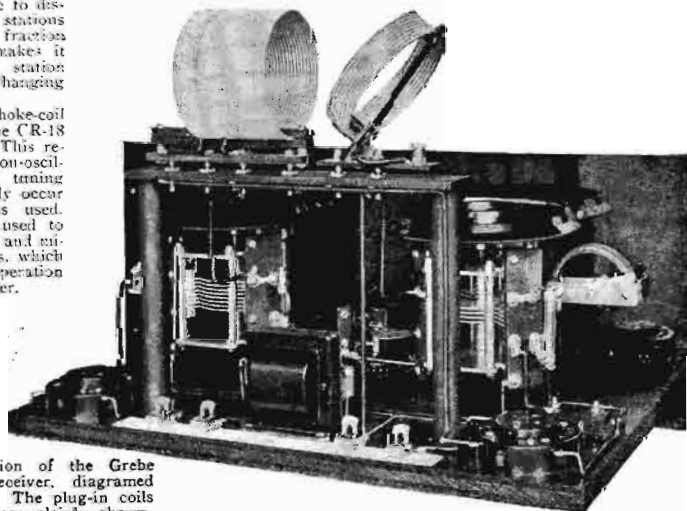

Q. 2183 B. Illustration of the Grebe CR-18 short-wave receiver, diagramed above and described. The plug-in coils and horizontal dials are plainly shown.

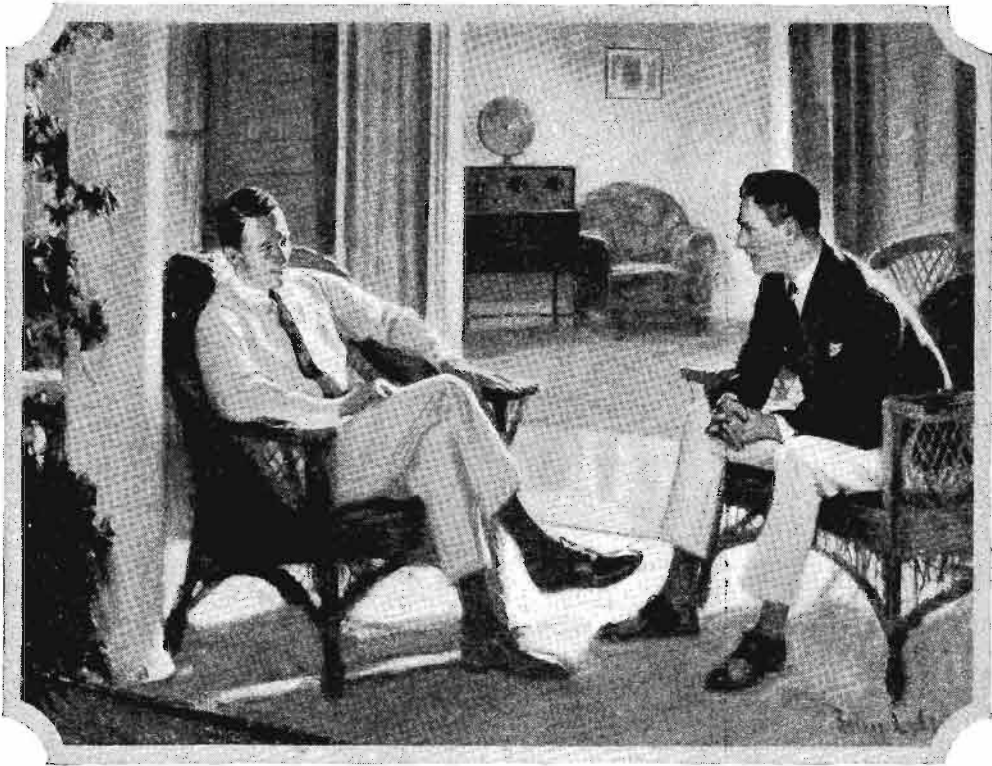

"My wife insists on getting a radio set exactly like yours. Where did you get it?"

"THE Radio Shop put it in for me, Jim. I've never had anything that was less trouble or expense, or that gave us all so much pleasure. We don't see how we ever got along without it."

"How about batteries? I've heard you have to give them a lot of attention."

"Not if you get good ones, Jim. The service man from The Radio Shop who installed my set said that the Evereadys he was supplying were exactly the right size for the receiver and should last eight months or longer. I've had the set six months now, and as far as I can tell, the 'B' batteries are as good as new."

That's the experience of those who follow these simple rules in choosing the right "B" batteries for their receivers:

On all but single tube sets—connect a "C" battery.* The length of service given here is based on its use.

On 1 to 3 tubes—Use Eveready No. 772. Listening in on the average of 2 hours daily, it will last a year or more.

On 4 or more tubes—Use the Heavy-Duty "B" Batteries, either No. 770 or the even longer-lived Eveready Layerbilt No. 486. Used on the average of 2 hours daily, these will last 8 months or longer.

Follow these rules and you, too, will find that Eveready



LEFT—No. 486, for 4, 5 or more tubes, \$5.50.

RIGHT—Eveready Dry Cell Radio "A" Battery, 1½ volts.



EVEREADY

Radio Batteries

—they last longer

Radio Batteries offer a most economical, reliable and satisfactory source of radio power. How long they last, of course, depends on usage; so if you listen less you can count on their lasting longer, and if you listen more, they will not last quite so long.

Send for booklet, "Choosing and Using the Right Radio Batteries," sent free on request. There is an Eveready dealer nearby.

*NOTE: A "C" battery greatly increases the life of your "B" batteries and gives a quality of reception unobtainable without it. Radio sets may easily be changed by any competent radio service man to permit the use of a "C" battery.

Manufactured and guaranteed by
NATIONAL CARBON CO., Inc.
 New York San Francisco
 Canadian National Carbon Co., Limited
 Toronto, Ontario

Tuesday night means Eveready Hour — 8 P. M., Eastern Standard Time, through the following stations:

- | | |
|------------------|------------------|
| WEAF—New York | WSAI—Cincinnati |
| WJAR—Providence | WTAM—Cleveland |
| WEHI—Boston | WWJ—Detroit |
| WTAG—Worcester | WCN—Chicago |
| WFI—Philadelphia | WOC—Davenport |
| WGR—Buffalo | WCCO—Minneapolis |
| WCAP—Pittsburgh | WCCO—St. Paul |
| | KSD—St. Louis |

LYNCH METALLIZED FIXED RESISTOR

WARRANTED—

*Absolutely Noiseless
Permanently Accurate
Dependable!*

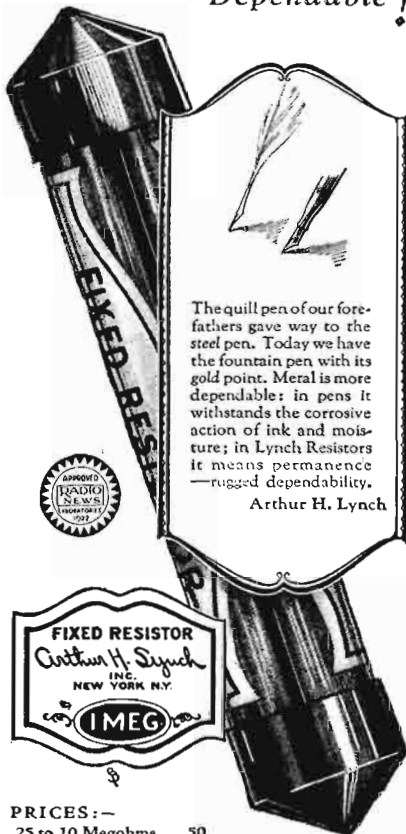

The quill pen of our forefathers gave way to the steel pen. Today we have the fountain pen with its gold point. Meral is more dependable: in pens it withstands the corrosive action of ink and moisture; in Lynch Resistors it means permanence—rugged dependability.

Arthur H. Lynch



PRICES:—
 .25 to 10 Megohms .50
 above .01 to .24 .75
 .001 to .01 " \$1.00 Single Mounting .35

METAL long has been recognized as the best of electrical conductors. The LYNCH METALLIZED RESISTOR, comprising a concentrated metallized deposit one-thousandth of an inch thick upon a glass core, gives *conductive, non-arcing* resistance that wins in the exacting tests of time and service.

Endorsed by leading engineers, experimenters and test laboratories, this LYNCH better-built product marks as great an advance as did the tungsten lamp over its predecessor—the carbon incandescent bulb.

If your dealer cannot supply you, it will pay you to wait for the mail—we ship postpaid, and Lynch products are sold on a money-back guarantee.

Dealers—Write us!

ARTHUR H. LYNCH, Inc.
 Manufacturers of Radio Devices
 Fisk Bldg., Broadway & 57th Street
 New York, N.Y.

Budge Puts It Through

(Continued from page 115)

to conceal, Budge's face flushed angrily but the wave of choler that swept him seemed to put lightning speed into his fingers. His fighting blood was up. He turned off the rheostat and snatched the dead tube from its socket with his right hand while he unscrewed one of the bulbs on his lamp board with his left, to cut down the current. Another twist or two of his wrist and the last amplifier tube was in the detector socket and the phone plug was shifted to the first amplifier.

"We will now continue our musical program with"—

Mr. Phelps and Budge both took off their phones, realizing that swift as the operator's movements had been, time had slipped away even more rapidly and the announcement they wanted to hear had been made. "Too bad, boy," said Mr. Phelps, "but it wasn't your fault. You did your best. Accidents will happen."

"It was my fault!" declared Budge, glancing furtively toward his mother, whose kitchenware seemed to have been wasted after all. "I ought to have protected the tube against too high voltage."

"Honest confession is good for the soul," quoth Mr. Phelps. "but there are few who give their souls the benefit of it."

But Budge was not licked yet. "Didn't I see a newspaper in the pocket of your overcoat, Mr. Phelps?" he asked.

"I believe I did bring an afternoon edition with me," Mr. Phelps replied. "Why?"

"See if it has a list of today's programs, quick!" directed Budge. "Maybe we can catch the report about the merger from another station."

Mr. Phelps acted on the suggestion with alacrity, while Budge took a spare tube from a new container and placed it in position in the set. Before he turned on the juice, he inserted an additional rheostat between the rectifier and the receiver.

"Here's the Town Crier, in Chicago," reported Mr. Phelps. "He was on at eight; let's see when he will be on again."

"Chicago—that's on central time!" cried Budge. "We can catch him yet. Eight o'clock there is nine here."

Rapidly, Budge fished the ether for WGN. Mr. Phelps strained his ears also. They had forty-five minutes before the Town Crier would broadcast the news, but they needed it all, perhaps, for testing.

Faintly they heard music, and the call letters, but try as he would, Budge could not bring in the signals with sufficient strength to guarantee success in hearing the all-important bit of information above the hum of the 60-cycle current that was supplying his filaments.

"I've got to have a filter," he told Mr. Phelps, and suddenly leaped from his chair and dashed for the door. "I know where I can get those twenty henries, or a lot anyhow," he shouted as he ran, "out of Lightning Lizzie."

He came back in a few minutes with the spark coil from his flivver, dangling wires showing that the device had been torn from its moorings without ceremony. Frantically he took the box apart and delved for a coil and a condenser.

It was 8:55 when the hastily constructed filter was connected between the rectifier and the receiving set. Five minutes later, the Town Crier in Chicago, in tones not too clear but still understandable, informed Mr. Phelps that the merger plans had not been approved by the government.

The square jaw of the capitalist set hard. "After permitting you to wreck your kitchen and car on my behalf, I seem to be in as bad a fix as ever," he said. "What the bears will

do to us when the stock exchange opens in the morning will be plenty. If there were only some way to get in touch with my office!"—

Budge suddenly came out of a trance into which he had fallen when his well-earned success failed to help his guest out of his difficulty. "If it will work on the receiver it will on the transmitter," he said, half aloud. "Hot dog! For once in my life I'm going to have all the juice I want on my plate! Write down your messages, Mr. Phelps, just as though you were going to send them by telegraph!"

"Have you a sending outfit!" exclaimed Mr. Phelps, surprised.

"If there is anything he hasn't got up in that den of his I don't know what it could be," broke in Mrs. Horton, who had been looking on, interestedly but unobtrusively. "He has to take the junk off his bed when he goes to bed, and reach down in the morning to pick up enough to make room for his feet before he can get out of bed."

Budge silenced his mother with a look of offended genius. "I have the parts, and I have an amateur license," he said. "I have been making over the set to get down to the short waves. I'll connect up the set, hook it to the light line with this battery substitute we made, and try to put your traffic through, Mr. Phelps. 'What's your address?'"

Mr. Phelps gave him the address. "Any chance of getting replies?" he asked.

"I'll have to get a QSL or I won't know that I've raised anybody," Budge answered, "and if any ham QSL's I can get anything else he sends. If I can make this thing work with my bottle, I'll raise some ham if I have to CQ by the hour. If I can raise one that can get me QSA I'll get him to QSR your traffic to your office, landline or phone, and QSR their traffic back. Maybe I can raise 2GX. I've worked him. He's a thirty-word brass pounder. Uses a bug. Boiled owl, too."

Mr. Phelps turned dazedly to Mrs. Horton as Budge tore up the stairs with the improvised battery substitute. "Is that some foreign language your son speaks, or is the lad breaking under the strain?" he said.

Mrs. Horton laughed until the tears came into her eyes. "Its radio lingo," she answered. "They seem to know what it means, but I don't."

Presently they tiptoed up the stairs. Surrounded by a tangle of wires and apparatus that seemed as hopelessly mixed as a ball of yarn after playing with a kitten, Budge was working a telegraph key.

A few minutes later, he threw a switch, moved some dials on a crude-looking receiver a degree or two, and began pounding an ancient typewriter. After writing two or three lines he passed the sheet over his shoulder to Mr. Phelps, hastily put in another and banged away some more.

Mr. Phelps, reading the message, looked incredulous, then absorbed, then jubilant. "By George, there's no mistake. Nobody but Sanger of our office could have sent that message."

Another sheet of paper came over Budge's shoulder. Mr. Phelps digested that, and another and another followed. Suddenly he ordered, sternly:

"Stop!"

"Just a minute—I'll QRX 2GX," said Budge, pounding out a few signals with his key.

"Who is this you're sending your messages through?" demanded Mr. Phelps. "This last one shows plainly that someone besides my own officials is getting confidential information. If the messages that I have entrusted to you are leaking out to some of our rivals, it may mean a loss of millions!"

"I don't think you quite understand, Mr. Phelps," said Budge with dignity. "Every radio operator, amateur or professional, is

1927 MODEL *The Newest Up-to-the-Minute Radio Set* —It Has Never Been on a Dealer's Shelf

SOLD ON A GUARANTEE OF SATISFACTION OR MONEY BACK

BST-6

*Volume
Control
180 to 550
Meters
Perfect
Calibration*



*B-Beauty
S-Selectivity
T-Tone purity
6-6 tubes*

THIS marvelous six-tube tuned radio frequency receiver is Self-Equalized and built of low-loss materials throughout. Its clear, rich tone of astonishing volume is a revelation. The circuit consists of two stages of tuned radio frequency, tube detector and three stages of balanced audio amplification. Air cooled rheostats and universal sockets are used.

Modified straight line frequency variable condensers are employed, insuring separation of the low wave length stations. **PERFECT CALIBRATION—STATIONS ONCE TUNED IN CAN ALWAYS BE LOGGED AT THE SAME DIAL POINT.**

The balanced amplifier gives absolutely natural reproduction of all overtones. The universal sockets permit the use of all the popular tubes, either dry cell or storage. The set does not oscillate, thereby preventing the reradiation of signals and reducing interference to a minimum.

Specifications

Bakelite Panel, Walnut Finish—
With Etch-O-Gravure and Gold Decorations—
Bakelite Sub-Base—
Kurz-Kasch Bakelite-Walnut Pointers; Gold-filled, to Match—
Kurz-Kasch Bakelite Gold-filled Rheostat Knobs—
Lubree Straight Line Frequency Condensers—
Special Coils; Double Silk Solenoids—
Shore Audio Transformers—
Caswell-Runyan Two-tone Walnut-Finished Cabinet.

LOG OF BST-6

Taken on a Fifteen Foot Aerial in One-half Hour by
Al. Kraus, 996 Aldus Street, New York City.

WSBC, Chicago, Ill. . . . 10	WGY, Schenectady, N.Y. 50
WBBR, Rossville, N. Y. . 16	WMAK, Lockport, N.Y. 51
WEBH, Chicago, Ill. . . . 49	WMSG, New York City 11
WHT, Deerfield, Ill. . . . 55	WOC, Devenpost, Ia. 85
WCCO, St. Paul, Minn. . 61	WFAA, Dallas, Texas . . 78
WSB, Atlanta, Ga. . . . 66	

SELECTIVITY

I live within four blocks of WLWL, and since the opening of this station have had great difficulty in choking them off my old set. Even after employing a wave trap I could still hear WLWL around the entire dial and was told by several friends that living so near this powerful station it would be impossible to entirely cut them out with anything less than a super-het. It was a very agreeable surprise, therefore, when I installed my new BST-6, to find that while WLWL came in on 25 I could tune in WRNY on 21 and entirely cut out WLWL. **This is certainly real selectivity.**—F. S. Clark, 350 West 55th Street, New York City.

Guarantee

Satisfaction or Money Back

Each receiver is tested and retested, boxed and inspected before leaving factory, and guaranteed to reach you direct in perfect condition. Workmanship throughout guaranteed the best. Assembled by experts.

Immediate Delivery

Direct from factory to you **\$40.00**
Immediate Delivery

SAFETY FIRST!—Why buy obsolete models, or radio failures at department store "bargain sales" when a BST-6, the latest achievement in radio, can be bought direct from the factory with no department store profit added? Here is a real bargain, sold you with a guarantee of satisfaction or money back.

Send Check or P. O. or Express Money Order to

RADIO DIVISION, COLUMBIA PRINT
141 West 45th St., New York City



Bradleystat

PERFECT FILAMENT CONTROL

FOR noiseless filament control and maximum range, ask your dealer for the Bradleystat. This graphite disc rheostat can be used for all tubes without change of connections. The bakelite knob is removable if desired. The one-hole mounting and small size make the Bradleystat easily adaptable to any radio set.

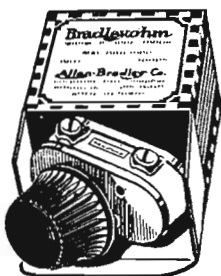

Bradleyohm

PERFECT VARIABLE RESISTOR

This ideal variable resistance unit is offered in several ranges as, for instance, from 10,000 to 100,000 ohms. These units are recommended by radio engineers for B-battery eliminators and solve the problem of obtaining variable voltage control from the B-eliminator. For fixed resistance units, always specify the Bradleyunit.

ALLEN-BRADLEY COMPANY
287 Greenfield Ave., Milwaukee, Wis.

Please send me your literature on the Allen-Bradley line of perfect radio devices.

Name.....

Address.....

under oath to keep secret the messages he handles or hears. He swears when he receives his license that he will not divulge the contents of any message to anyone except the person to whom it is addressed."

"But this message, which you would not be able to interpret because some of it is in a private code, indicates plainly to me that someone besides the men to whom I have sent my messages is in possession of them and, what is more, understands them."

"You can look up 2GX, the ham I am working, here's the call book," said Budge with a suspicious innocence. "Look in District 2, and you will find the call letters arranged alphabetically, with the names of the owners of the stations."

Mr. Phelps thumbed the book. A square forefinger followed a column down the page. It came to a sudden halt and an expression of mixed emotions overspread the capitalist's face. "It's on me, Budge," he said as he laid a confiding hand on the operator's shoulder. "2GX is my own boy."

"That's just what he said," Budge answered. "He wants to know if you don't think he ought to have that one-kilowatt bottle he asked you for a while back."

After a moment of wistful thinking, Mr. Phelps said: "Go ahead with the messages, while I code one for Jim." Taking a leather-covered book from an inside pocket, he constructed a message from the cryptical words it contained.

Budge took it and hammered it out, letter for letter: He turned to the typewriter and waited for the reply. When it came, he typed the first few words, then stopped and listened, while the veins in his neck swelled with suppressed excitement. Then he sprang from his chair with a whoop that brought a startled squeal from his mother. He grabbed the hand of their guest, babbling inarticulately as words tumbled over each other seeking expression.

"Mother!" he cried, as soon as he could control his feelings. "Mr. Phelps told 2GX to arrange for the two of us to go on one if his slips down the coast, through the Panama Canal, down the west coast of South America, across to Australia, around the Cape of Good Hope, home by way of China, India, the Suez Canal and Europe—around the world!—and we are to be the regular operators, 2GX and me, with the regular salaries and everything!"

The phones were still on Budge's head. He wheeled back to his apparatus suddenly and they saw that he was listening to another message. Then he threw his switch to the sending position and was busy at his key for a few moments.

"In plain English, just what was that you were saying to my boy?" asked Mr. Phelps.

"I said: 'So's your old man!'" Budge replied.

A Transoceanic Broadcast Receiver

(Continued from page 140)

this regulation. For maximum selectivity the selector switch SW is placed on point 1 and the condenser C cut into the circuit by opening the switch S.

The signal now passes to the second radio-frequency amplifier, which is tuned to the proper wave by condenser C2, and is further amplified. Passing to the third unit, the signal is tuned by condenser C3 and still further amplified. Transferring to the fourth radio-frequency amplifier the signal is again tuned, with condenser C4, this completing the radio-frequency amplification, approximately 10,000 times the strength of the original signal.

The signal now passes on to the detector, whose input circuit is tuned to the correct

wave by condenser C5, and is rectified and thus changed to audible frequencies.

From the detector stage the rectified currents are directed to the four-stage audio frequency amplifier where they gain sufficient strength to provide more than enough volume for any size room. The volume from this amplifier can be controlled by adjusting the variable resistor R.

The radio-frequency amplifiers are stabilized by the resistors RN in series with the grids. The amplification characteristics of the second, third and fourth R.F. amplifiers are controlled by the potentiometers RP. The potentiometer RD in the detector stage is employed for adjusting the "B" battery voltage on this tube. All high-resistance paths, such as the "B" batteries and the potentiometers are by-passed by 0.5- μ f. fixed condensers CX.

Each tube, with the exception of the last three audio tubes, has its own rheostat (RH) for controlling the filament current and a switch SF for disconnecting the A battery. As was mentioned before, separate A batteries are used for each tube, with the exception of the audio tubes, and since the current drain is very low, dry cells are employed.

The audio-frequency amplifier consists of one transformer-coupled and three resistance-coupled stages. The resistors RO and RL have a value of 30,000 ohms and have a high current-carrying capacity. The isolating condensers CB are of 1.0- μ f. capacity.

I Want to Know

(Continued from page 158)

prefer to use a third method of shifting or eliminating such points. It may be accomplished by connecting a small variable condenser with a capacity of .00035- or .0005- μ f. between the aerial and the antenna binding post on the receiver. By tuning this external condenser, a point will be found where the receiver stops oscillating; and by adjusting the condenser, above or below this point, stable operation will again be restored.

"It is important for the operator to appreciate fully the advantages that may be gained by harmonic tuning. This can be accomplished by using a small variable condenser connected in series with the antenna and the coupling coil. The effects are most noted on wave-lengths in which the fundamental period of the antenna is some multiple of the received wave-length.

"For example, if the length of the antenna is such that, when it is connected to the antenna coupling coil, it has a natural period of 300 meters, the following harmonics would occur; second harmonic at 150 meters; third at 100 meters; fourth at 75 meters; fifth at 60 meters, etc. If the antenna coil is close to the secondary coil, the receiver will stop oscillating at these wave-lengths. However, if oscillations are again restored by any of the previously-mentioned methods, stronger signals will be obtained at these points than on other wave-lengths in the tuning range. It is therefore, possible to adjust any antenna so that some harmonic falls on approximately the wave-length one desires to receive. The advantage of this method is that a long antenna may be used, which naturally will have better pick-up qualities.

"It is important for the operator to realize at the outset that the frequency band included in a single wave-length dial division is sufficient to accommodate as many as fifteen stations; and while very fine tuning can be secured with the tangent wheel, many of the stations will be passed over unless use is made of the beat-frequency control. The tuning values of the main wave-length condenser and the beat-frequency control are so proportioned that, whereas approximately fifteen stations will be found in one degree of the wave-length dial (one notch of the tangent wheel) each station may be separated by approximately one notch of the beat-frequency control wheel. With this in mind, the operator will soon become familiar with the tuning capabilities of this receiver.

Reception of Code

"When receiving C.W. or I.C.W. code signals, the regeneration dial should be reduced to the lowest reading possible, where oscillations are just maintained. This will result in weak signals being received with greater intensity. In other words, the weaker the signal, the weaker the oscillations in the receiver should be for maximum intensity in the telephones. However, where signals are easily readable, stronger oscillations may be used and are helpful in reducing noises and low-frequency interference.

"In order to receive broadcasting or speech it is necessary to keep the receiver in a non-oscillating condition. Maximum strength of reception will be obtained when the regeneration dial is set just below the oscillating point. A final critical adjustment can be made by using the filament rheostat."



Know Radio Reception as it should be!

Pacents Super Audio- former

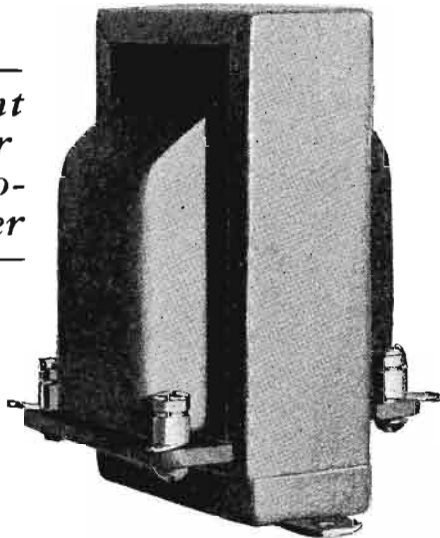

Pacents

Pacents No. 83 "Universal"
Cushion Socket



Here is a new Pacents engineering achievement, a Genuine bakelite socket, with real spring suspensions. The special phosphor bronze solder tab and spring members are all in one piece. This unique spring design insures positive non-microphonic cushion effect. Push contact seats tube prongs properly and effects reliable positive contact. It is "Universal", accommodating all UX or CX type of tubes as well as standard UV or CV types.

MANUFACTURERS
Special design manufactured for direct subpanel mounting. Let us quote for your requirements.

PRICE 65c

YOU will know radio reception as it should be after installing one or a pair of these shielded Superaudioformers. It is big and husky (as it should be) to give pure, natural and full tonal quality.

READ THIS LIST OF IMPORTANT FEATURES

- 1—Completely shielded.
- 2—Laminations securely clamped together by one-piece frame.
- 3—Possibility of laminations vibrating further guarded against by filling with a special wax compound.
- 4—Tested for its ability to amplify under actual working conditions.
- 5—Tested for breakdown at 1500 volts D. C.
- 6—All leads covered with high grade spaghetti. They terminate at both binding posts and solder tabs and are separated by a Bakelite Strip. Connections can be made by soldering or by means of the binding posts.
- 7—Terminals are plainly marked in a conspicuous place.
- 8—Terminals placed so as to be protected from damage in transit.
- 9—Simple two hole mounting in upright position or on either side by means of special clamp.
- 10—Special iron in core, a correctly designed coil and rugged mechanical assembly make for true tone quality.
- 11—Handsome finished in dull bronze—a beautiful transformer for the finest Receivers.

Input—Cat. No. 27A	Output—Cat. No. 27B	Choke—Cat. No. 29
Shielded—Price \$7.50	\$7.50	\$6.50
Unshielded—Price \$6.00	6.00	5.00

Manufacturers let us quote for your requirements.

PACENT ELECTRIC CO.

91 SEVENTH AVE., NEW YORK, N. Y.

Sales Agents: Chicago, Minneapolis, Buffalo, Boston, Philadelphia, Washington, D. C., Pittsburgh, San Francisco, St. Louis, Jacksonville, Cleveland, Canadian Licensed
 Manufacturer: White Radio, Ltd., Hamilton, Ont.,
 Licensed Manufacturer for Gr. Britain and
 Ireland: Igranic Elec. Co., Ltd., London and Bedford, England.



Pacents

"Megostat"
The Ideal Variable High
Resistance



This new addition to the Pacents line is an improved volume control giving a continuous variation of resistance from zero to maximum. Adaptable to every circuit for control of oscillation and volume. No highly porous impregnated paper used. Does not absorb moisture and resistance values are permanent and unchanging. The improved Pacents lever and banjo construction insures smooth riding, positive contact at all times. One hole mounting and two unit factory adjusted construction for ease in mounting.

Pacents "Megostat"

2,000, 25,000, 50,000, 100,000, 200,000, 500,000 ohms.
 Potentiometer type — three terminals—400, 200,000, 500,000 ohms.

PRICE

Megostat Cat. No. 191... \$1.25
 Potentiometer Type, Cat. No. 193... \$1.50

Thousands Use These Ingenious TRANSMITTER UNITS

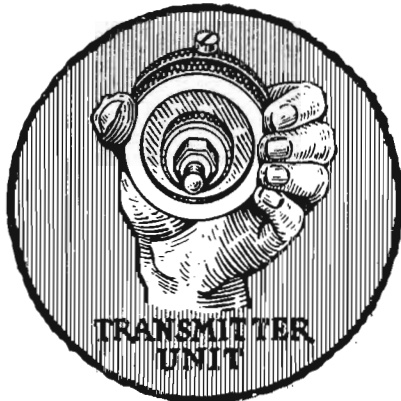

Here's a marvel of Engineering design—a practical miniature transmitter, used by thousands of radio fans and experimenters for amplification purposes. It is a most novel unit, having hundreds of uses. Every amateur should have two or three of these amplifiers in his laboratory.

A FEW USES FOR THESE UNITS

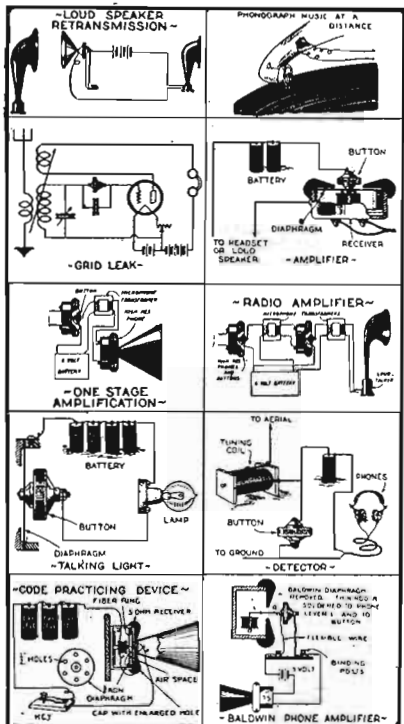

With each unit is mailed an eight-page instruction pamphlet containing suggestions for innumerable uses. Our supply is limited; avoid disappointment by ordering today. The coupon below is for your special convenience.

SPECIALLY PRICED
While they last— **95c**
(or Two for \$1.75) per unit

THE PRESS GUILD,
66-R West Broadway, New York, N. Y.
Enclosed find 95c/\$1.75 for which send me postpaid one/two amplifier units as advertised.

Name
Address
City, State

\$300 Prize Set Design Contest

(Continued from page 106)

parts must be distinctly marked and the correct values given, as, for instance, number of turns, wire size, diameter of coil, capacity of condensers, etc. On the reverse side of the wiring diagram, a description of the set is to be typed or written in ink in not more than 300 words. The judges are particularly interested in how this set performs, what DX it brings in, ease of tuning, etc.

(8) One at least, and not more than four, photographs of the set must also be submitted at the same time. The size of the photograph must not be less than 5x7 inches.

(9) Bind all papers and photographs firmly together so they can not be separated, and note that on every sheet of paper and every photograph entrant's name and address must be clearly printed.

(10) No penciled matter can be considered. Use either typewriter or pen and ink.

(11) Rolled manuscripts and photographs are excluded from this contest. All photographs and manuscripts must be submitted flat. Use a photomailer wherever possible, obtainable at all stationery stores.

(12) Any one is eligible to enter this contest, with the exception of employees of the Experimenter Publishing Company and their relatives.

(13) This contest closes September 20, 1926, at noon, by which time all answers must have been received at this office. Announcement of the prize winners will be made in the December, 1926, issue of RADIO NEWS, upon the publication of which the prizes will be awarded.

(14) Address all entries to Editor Hook-up Contest, 53 Park Place, New York City.

The prizes of this contest will be awarded to those persons submitting the most novel and interesting radio circuits, in the opinion of the judges. The matter of workmanship does not primarily enter into the contest, except insofar as it may assist the judges in deciding upon the relative merits of different sets. The prizes, therefore, will be awarded, not so much on the appearance of the sets, as upon the electrical and radio features incorporated in the circuits.

The Judges of the Contest will be a board comprised of editors of RADIO NEWS, the editors of SCIENCE AND INVENTION, and the editors of RADIO INTERNACIONAL. Their findings will be final.

In case of a tie, identical prize-winning answers being submitted by different contestants, identical prizes will be awarded to those so tying for the prizes.

A RADIOPTIMIST



BIG SUMMER OFFER

\$2 VALUE \$1 ..FOR..

This is the biggest opportunity of the year.

To the readers of RADIO NEWS we have arranged to offer a big reduction in the famous Conrad Pattern's and E. I. Co. Books; millions of these have been bought by Radio Fans. They are recognized, and sold by the best Radio stores and Newsdealers.

We offer any \$2.00 worth of these books and patterns you may select for \$1.

Think of it \$2 for \$1. Just check \$2 worth from the list below and send \$1 with the coupon and we will mail you the materials at once.

LARGE ORDERS ACCEPTABLE IN THE SAME PROPORTION.

MAIL THIS COUPON NOW!

THE CONRAD CO., Inc.,
64 Church St., New York, N. Y.
Gentlemen:—I enclose \$1, please send me the items checked below. (Items checked not to exceed \$2 worth.)

- E. I. BOOKS, regular price 25c
- No. 1. Tips for the Radio Constructor.
 - No. 2. How to Make Practical Radio Receivers.
 - No. 3. Radio Questions Answered.
 - No. 5. Loud Talkers and How to Build Them.
 - No. 6. How to Tune Your Radio Set.
 - No. 7. One Hundred Radio Hook-ups.
 - No. 8. All About Radio Parts.
 - No. 9. History and Operation of Vacuum Tubes.
 - No. 10. The Neutrodyne and All About It.
 - No. 11. How Radio is Received.
 - No. 13. Reflex Radio Receivers.
 - No. 14. The Super-Heterodyne, Theory and Construction.
- CONRAD PATTERNS, regular price 50c
- No. 2. How to Make a Two-Stage Amplifier.
 - No. 4. How to Make a Reinartz Receiver.
 - No. 5. How to Make a Reflex Receiver.
 - No. 6. How to Make a Cockaday Receiver.
 - No. 9. How to make the S. T. 100 Receiver.
 - No. 11. How to Make a Five-Tube Cockaday Receiver.
 - No. 12. How to Make a Portable Receiver.
 - No. 13. How to Make a Harkness Receiver.
 - No. 15. How to Make a Low Loss Receiver.
 - No. 16. How to Make the Tropadyne Super-radio.
 - A. Radio Map of the U. S. on Cloth.
 - B. 20 Radio Diagrams and Hook-ups.
 - C. All About Aerials and Their Construction.
 - D. Radio Amateurs' Practical Design Data.

NAME
ADDRESS
CITY, STATE

Check Vibration Stop Howling!

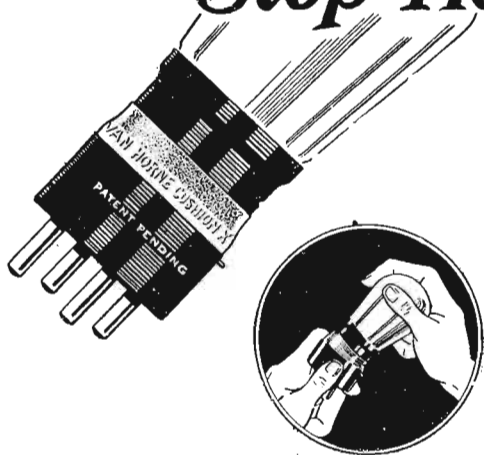

The rubber cushion absorbs vibration and eliminates microphonic noises

There is hardly a radio fan who does not fully appreciate the trouble that microphonic tubes and vibration cause in reception.

In the base of the CUSHION BASE tube is a soft sponge rubber cushion upon which the tube floats entirely protected against vibration.

A surprising softness of tone, the absence of harshness with clear natural reproduction of voice or instrumental music results when CUSHION BASE tubes are used.

Fans everywhere are discarding their old tubes and are putting in their place Van Horne CUSHION BASE tubes for they realize that much of tone distortion and loss of natural reproduction is caused by tube vibration.

Your set deserves the advantage this new tube will give. Get yours from your dealer or clip and mail the coupon.

These tubes are Van Horne developments and are manufactured exclusively by the Van Horne Company under patents pending to J. S. Van Horne

The set user knows the improvement that a power tube in the last audio stage will give—that roundness of tone and clear-cut reproduction of voice and music that is lost when an ordinary tube of insufficient capacity is used.

However, he has been reluctant to make the complicated changes in set wiring, for the addition of extra voltages, that all power tubes require.

On the ADAPTED MOGUL 5 VCX provision has been made for the addition of the extra voltages to the tube itself, making the tube as simple to use as an ordinary tube.

Your dealer will supply you with this tube that improves your reception by the elimination of distortion and overloading and by generally increasing speaker volume—or clip and mail the coupon.

The Van Horne Company manufactures a variety of tube types in both the Van Horne Selected and Certified brands for all receiving purposes, all of which are unconditionally guaranteed. Descriptive matter sent on request.

THE VAN HORNE CO
FRANKLIN, OHIO

No Change in Wiring with the adapted Mogul 5 VCX Power Tube

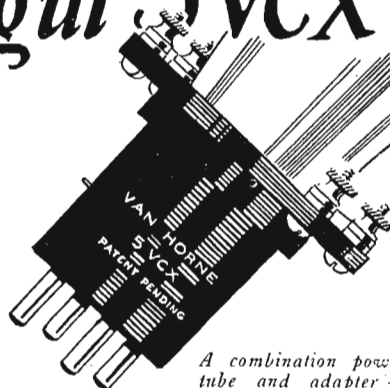

A combination power tube and adapter—An exclusive Van Horne Development.

SEE YOUR DEALER OR CLIP THE COUPON

THE VAN HORNE CO., Franklin, Ohio
Please send C. O. D. post prepaid:

- Cushion Base 5 VAX Tubes (corresponding to 201A) at\$3.00 each
- Adapted Mogul 5 VCX Tubes at..... 5.75 each

Name

Address

Dealer's Name

It is understood that the above tubes are returnable within ten days if not satisfactory.

THE TUBE WITH THE SENSIBLE GUARANTEE

Definite Quality!



Vibrationless Uniform and Good

When You Buy Ordinary Tubes You Are Buying Doubtful Quality

Tubes may leave a factory in good condition but whether they reach you that way is "Doubtful." Because it is commonly known that ordinary constructed tubes may be disqualified in handling—Therefore if they are good after you receive them, its just "luck," and even Luck is doubtful.

When You Buy New Supertrons You Are Buying Definite Quality

Supertrons are internally re-enforced—so that the three elements are tied into one unit. They are vibrationless—Uniform and Oh Boy! what quality—DEFINITE QUALITY.

Guaranteed by serial number—to assure a refund if they are not better

Supertron Mfg. Co.

INC. HOBOKEN, NEW JERSEY

Chicago Office 30 N. Dearborn Street
Export Dep't. 220 Broadway, N. Y. C.

SUPERTRON

THE FOREMOST INDEPENDENT TUBE MANUFACTURER

SENT YOU ON 10 DAYS FREE TRIAL

5 TUBE GUARANTEED RADIO **BIG POWERFUL MIRACO**

Users everywhere report it gets programs coast to coast, Canada to Gulf, loud and clear on speaker, output from \$100 to \$250 wms. Many \$59.50

FACTORY PRICES—SAVE **MIRACO RADIO GETS EM COAST TO COAST**
1/3 to 1/2. Smaller Sets \$13.75 up, retail. FREE Literature on latest 1 to 5 tube models. (Agents new low prices and Dealers) SPECIAL OFFER Write to MIDWEST RADIO CORPORATION Pioneer Builders of Sets 404-B-E 8th St., Cincinnati, Ohio

You can be quickly cured if you

STAMMER

Send 10 cents for 288-page book on Stammering and Stuttering, "Its Cause and Cure." It tells how I cured myself after stammering 20 yrs. B. N. Bogue, 6958 Bogue Bldg., 1147 N. III. St. Indianapolis.

Relaying Messages from the Polar Regions

(Continued from page 135)

used; and in the case of the grid condenser and the plate blocking condenser, a small piece of glass was used.

LIST OF PARTS—TRANSMITTER

- L-1. Primary—6 turns of edgewise-wound copper ribbon 5 inches in diameter.
 - L-2. Secondary—4 turns of edgewise-wound copper ribbon, 8 inches in diameter.
 - L-3. Radio-Frequency Choke—150 turns number 30 wire on a one and one-quarter-inch bakelite tube.
 - C-1. Primary Condenser—Double-spaced .001- μ f. receiving condenser making a capacity of .00025- μ f. approximately.
 - C-2. Grid Condenser—.002- μ f. mica condenser, 3,000 volts breakdown.
 - C-3. Plate Blocking Condenser, same size as C-2.
 - R. Grid Leak—5,000-ohm resistance.
 - S. Socket—50-watt tube socket.
 - K. Key.
 - V-1. Filament Voltmeter.
 - V-2. Plate Milliammeter.
 - V-3. Radio-Frequency Ammeter.
 - T. Filament transformer, 110 volt to 10-volt stepdown.
 - P. Plate Supply.
- Total approximate cost, \$86.00.

The high voltage (2,200 volts A.C.) is supplied by a 1 1/2-kw. pole transformer working from the city mains. This voltage is rectified by two "S" tubes and filtered with two 2- μ f. condensers on either side of a large choke. The actual voltage on the tube, with a load of 130 milliamperes, is exactly 1,000 volts. The filament is supplied by a step-down transformer, also working from the city mains, delivering 10 volts, which is the proper voltage for the tube used.

REGULATING CAPACITY IN THE RECEIVER

The receiver, which is built entirely of standard parts, uses a modification of the Hartley circuit with a two-step A.F. amplifier. The 20-, 40- and 80-meter bands are covered with three sets of coils; and by using the two condensers in series, as shown, the tuning ranges of 37.5 to 42.8 meters, and 75 to 85 meters, are spread over 100 degrees of the dial.

The same rules of construction used in building any low-loss receiver have been applied with special attention to the placing of the controls and coils. The former were placed at the point best located for tuning and the latter so placed that the controls could be manipulated without having to place the hand within the fields of the coils. Some care was also given to the way the set started oscillating. A set that goes into oscillation with a sound that is barely audible, is highly desirable in the reception of C.W. signals. This was accomplished in my receiver by the use of a grid leak of 8 megohms. Various other values were tried but 8 megohms produced the desired result. A great many methods of coupling the antenna to the set were given a fair trial, but it was finally decided to use the method shown in the diagram. This method did not call either for the use of a third coil or a ground but it had, however, one disadvantage. It was necessary to use an an-

YAXLEY

APPROVED RADIO PRODUCTS

JUNIOR

Jacks and Jack Switches

in all Spring Combinations

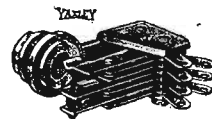

No. 704

Interstage Jack - - - - - 80c

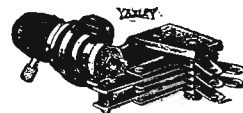

No. 745

Five Spring Jack Switch - - \$1.15

Compact—Dependable—Absolutely the same in every exclusive feature of design and construction as Yaxley standard jacks and jack switches. One nut mounting. Genuine phosphor bronze springs. Pure silver, self cleaning contact rivets. Pressure assembly assures permanent alignment. Spring terminals tinned for soldering.

Ask your dealer, or send his name with your order to

Yaxley Mfg. Co.

9 So. Clinton St., Dept. N., Chicago, Ill.

WRITTEN 2-YEAR GUARANTEE

ARROW BATTERY

Battery Prices SMASHED!

To Consumers Only

Here is a real battery quality, guaranteed to you at prices that will astound the entire battery-buying public. Order Direct From Factory. Put the Dealer's Profit in your own pocket. You actually save much more than half, and so that you can be convinced of true quality and performance, we give a **Written 2-Year Guarantee**. Here is your protection! No need to take a chance. Our battery is right—and the price is lowest ever made. Convince yourself. Read the prices!

Auto Batteries **Radio Batteries**
 6 Volt, 11 Plate, \$8.50 6 Volt, 100 Amp. \$8.50
 6 Volt, 12 Plate, \$10.25 6 Volt, 120 Amp. \$10.25
 12 Volt, 7 Plate, \$11.75 6 Volt, 140 Amp. \$11.75

Buy Direct—Send No Money

We ask no deposit. Simply send name and address and style wanted. Battery will be shipped same day we receive your order Express C.O.D. subject to your examination on arrival. Our guarantee accompanies each battery. We allow 5% discount for cash in full with order. You cannot lose! Send your order today

NOW!

ARROW BATTERY CO.
 Dept. G 1215 So. Wabash Ave., Chicago

ARROW BATTERY

SQUAB BOOK FREE

Breed squabs and make money. Sold by millions. Write at once for free 40-page book beautifully printed in colors telling how to do it. You will be surprised. **PLYMOUTH ROCK SQUAB CO.** 156 H St., Melrose Highlands, Mass.

BUILD YOUR OWN RADIO SET!

FREE

THIS VALUABLE 68-PAGE BOOK

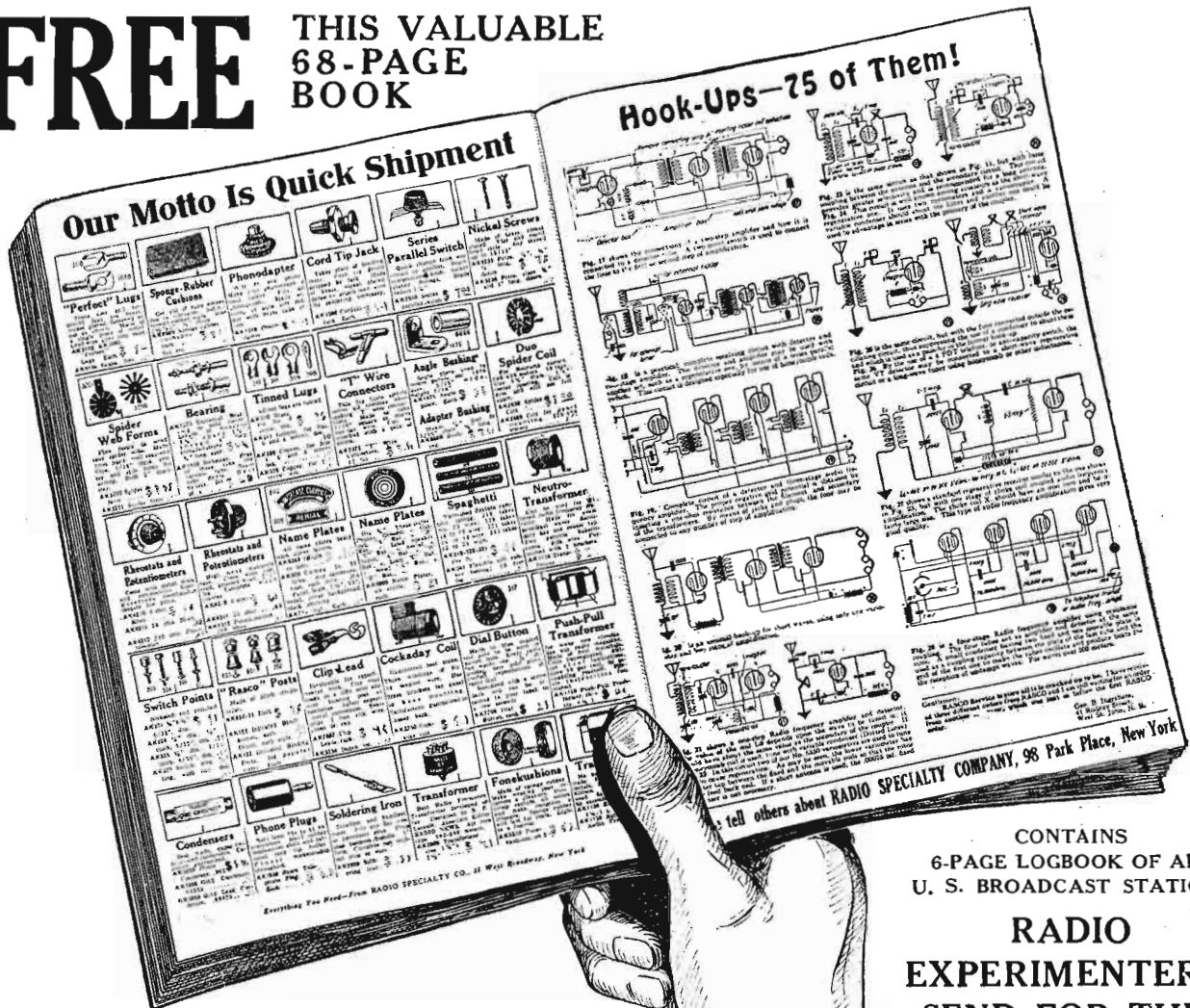

**THE BIG 1926 SPRING
CATALOGUE No. 16
68 Pages—600 Illustrations**

CONTAINS
6-PAGE LOGBOOK OF ALL
U. S. BROADCAST STATIONS
**RADIO
EXPERIMENTERS,
SEND FOR THIS
FREE BOOK
TODAY**

Buy from Radio's Oldest Mail Order House

**THE NEW RASCO
CATALOG No. 16**

Contains the Following Hookups.

All Armstrong Circuits: These important circuits are explained clearly; all values having been given. Just to name a few of the Vacuum Tube circuits: The V.T. as a detector and one-step amplifier; Super Regenerator; one-step radio frequency amplifier and detector; three-stage audio frequency amplifier; short wave regenerative circuits; 4-stage radio frequency amplifier; radio and audio frequency amplifier; inductively coupled amplifier; all Reflex Circuits.

This catalog is crammed full of small parts and radio findings. Literally thousands of them. In addition there is much useful information contained herein.

WE are the oldest established, exclusive radio mail order house in the country. Our motto is "Quick Shipment." All orders are shipped within 24 hours. Quick, prompt, courteous service. We carry a larger variety of radio parts and findings than any other radio house in the country.

"RASCO HAS IT"

If you are in need of certain small radio parts that other radio and mail order houses do not bother to carry, get the Rasco parts catalog, and you will find them there, anything from a screw to copper ribbon and telephone diaphragms, as well as thou-

sands of other small radio findings. Just to mention a few:

Lugs, nuts, dials, vernier dials, jacks, plugs; every kind of knob, cords, panels, screws, sliders, washers, selenium, tinfoil, switches, crystals, cap nuts, Litz wire, cord tips, brass rods, resistances, name plates, spring binding posts, switch parts, metal ribbon, carbon balls, binding posts, all types, switch points, switch levers, lock washers, carbon grains, ground clamps, metal pointers, insulated tubing, low melting metal, antenna connectors, bus bar wire, as well as thousands of others.

WE CARRY THE LARGEST VARIETY OF SMALL RADIO PARTS IN THE WORLD.

If you will paste this coupon on a post card and mail today, we will be pleased to send you our new Catalog at once.

RADIO SPECIALTY CO., 98 Park Place, New York R. N. 8-25
 You may send me, without charge or obligation, your NEW CATALOG No. 16. (Write on margin if you desire).
 Name
 Street
 P. O. State.....

RADIO SPECIALTY CO.
 98 Park Place New York City

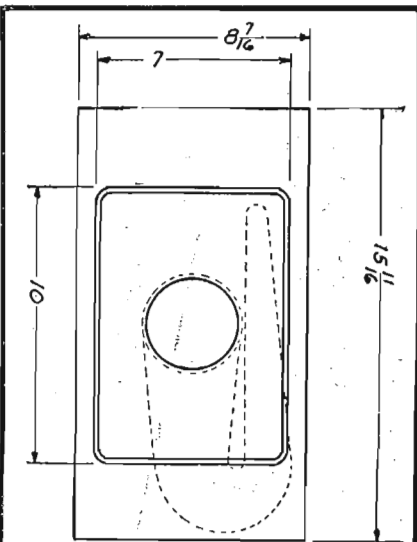

"Give Us Good Reproduction"

Now, more than ever before, radio owners are demanding faithful reproduction—clear, life-like tone quality. "DX" reception, of course,—fine tuning, to be sure, but they know that even the costliest set can be rendered harsh, jangling, discordant by an amplifying horn that is poorly designed, or imperfectly balanced with the speaker unit.

Miller

audio engineers have brought the amplifying horn to the highest pitch of perfection. Applying the Miller principle of SYNCHRONIZED AMPLIFICATION they have developed horns of truly remarkable acoustic properties—horns whose long air columns have just the right exponential curve to reproduce notes of both high and low frequencies with extreme evenness of amplitude, full volume and superb color. And there's no distortion, no vibration with Miller horns, for they are made of a rubber composition that is practically inert—a material, too, that can be molded into any shape or size.

Your data will have our prompt attention. Our engineers are at your service.

The MILLER RUBBER CO.
of N. Y.
AKRON, OHIO U. S. A.

STAMFORD IN THE CATSKILLS

The Joy of Trampers, Golfers and Fishermen

Rexmere Club Hotel
In Connection With

Churchill Hall
Stamford, N. Y.

Two Hotels With a Selected Clientele
Booklet With Pictures Sent Free
H. H. MASE, Managing Director
WILLIAM J. LOWE, Associate Manager

tenna with a fundamental, such that its harmonics would not fall within the wave-length range to be covered. The correct size of antenna was readily found by experiment.

The diagram on page 135 shows clearly the circuit and arrangement of parts. The list of apparatus required is given, with the specifications used by the writer.

LIST OF PARTS—RECEIVER

- L-1. Secondary—3 inches in diameter wound with No. 16 bare wire on 4 celluloid strips 1/4" wide, spaced the width of a turn. For 40 meters 7 turns are used and for 80 meters 15 turns are used.
 - L-2. Tickler—Constructed same as L-1, for 40 meters 4 turns and for 80 meters 8 turns are used.
 - L-3. Radio-Frequency Choke—100 turns of No. 30 wire wound on a 1" bakelite tube.
 - C-1. .00025- μ f. Variable Condenser.
 - C-2. .0003- μ f. Variable Condenser. (This condenser greatly reduces the capacity of C-1, thus making the change in C-1 very small over 100° of the dial. A 2-plate condenser could be used, but this would not be sufficient capacity to cover the 80-meter band. The method used gives ample flexibility on all waves.)
 - C-3. .00025- μ f. Variable Condenser.
 - C-4. .00025- μ f. Fixed Condenser.
 - R-1. 30-ohm Rheostat.
 - R-2. 8-megohm Grid Leak.
 - S. UX Tube Socket.
- Approximate total cost, \$14.25.

It is unnecessary to describe the amplifier used, as such information can be readily obtained from back issues of RADIO NEWS.

In the six months this transmitter has been in operation, stations in Australia, New Zealand, England, France, Italy, Belgium, Portugal and Mexico have been worked. The fact that communication was held with the U. S. S. *Scorpion* for six consecutive nights, and that traffic was cleared each night, is sufficient proof that both transmitter and receiver fulfill the qualities described as requisites at the beginning of the article.

AMAZING STORIES

August, 1926

ISSUE:

"STATION X," by G. McLeod Winsor. A wonderful radio serial describing in vivid language a titanic struggle between Lunarians and Martians. (Part II).

"THE TALKING BRAIN," by M. H. Hasta, a powerful story propounding new thoughts as to how a human brain can live detached from its body.

"THE MOON HOAX," by Richard Adams Locke, is the greatest scientific hoax that was ever perpetrated upon a credulous public.

"BLASPHEMER'S PLATEAU," by Alexander Snyder, a powerful and gripping story.

"THE TELEPATHIC PICK-UP," by Samuel M. Sargent, Jr. It is gruesome and thrilling.

"THE LORD OF THE WINDS," by Augusto Bissiri, wherein is shown the devastating ruin effected by the misuse of a marvelous apparatus.

"DR. OX'S EXPERIMENT," by Jules Verne. A little-known but amazing scientific story.

"THE SCIENTIFIC ADVENTURES OF MR. FOSDICK," by Jacque Morgan.

PRICE 25c PER COPY
AT ALL NEWSSTANDS

ELECTRAD

New!



ELECTRAD Heavy Duty Metallic Resistor

Specially developed for B eliminators and power supply units.

Special Features Are:

- 1—High current-carrying capacity.
- 2—Non-inductive. Accurate calibration.
- 3—Low temperature coefficient.
- 4—Resistance element fused to inside of Lavoque tube.
- 5—All standard high resistance sizes.

Price \$1.00; in Canada \$1.40
Ask Your Dealer For Detailed Circular

ELECTRAD New York City Inc.

FREE RADIO CATALOG



JUST off the press! Our special Summer Bargain Bulletin. Pages of parts, accessories, kits and sets—all the best and the last. A \$1,000,000.00 Radio Stock to choose from. A copy of this unusual catalog is yours for the asking. Just drop us a line—now.

CHICAGO SALVAGE STOCK STORE
Dept. R. N. 6 509 S. State St., Chicago, U.S.A.



6-Volt Storage Radio "A" Battery

Most amazing battery value ever offered! A genuine World 6-Volt Radio "A" Battery with 25 ampere capacity for only \$5.00! Just the thing for Trickle Charger. Famous World Quality assured. Equipped with

\$5.00
C. O. D.
Send No Money

Solid Rubber Case
an assurance against acid and leakage. Order Now. We ship same day—by express C. O. D. subject to your examination on arrival. Extra Offer: 5% discount for cash in full with order. ACT TODAY!

World WORLD BATTERY CO.
Dept. 110,
STORAGE BATTERIES 1219S. Wabash Ave., Chicago
RDKA—WEAF—WGN—WJS—KH—KGO—KRF—WJY—KOB

Chemistry paves the road to Success!

Some people measure success in terms of money and others in degree of knowledge and culture. Chemistry is the one uncrowded profession today that offers both. America, always a land of amazing opportunities, is especially so now in the field of applied Chemistry. Industries have developed within eight years more rapidly than the output of trained men to conduct them. Every big industry needs chemists and there is a real demand for them immediately.

Earn a Bigger Salary from now on—

Good Chemists Command High Salaries; you can make yourself independent for life by unearthing one of Chemistry's undiscovered secrets!

Do you remember how the tales of pirate gold used to fire your imagination and make you want to sail the uncharted seas in search of treasure and adventure? And then you would regret that such things were no longer done. But that is a mistake. They *are* done—today and every day—not on desert islands, but in the chemical laboratories throughout your own country. Quietly, systematically, the chemist works. His work is difficult, but more adventurous than the blood-curdling deeds of the Spanish Main. Instead of meeting an early and violent death on some forgotten shore, he gathers wealth and honor through his invaluable contributions to humanity. Alfred Nobel, the Swedish chemist who invented dynamite, made so many millions that the income alone from his bequests provides five \$40,000 prizes every year for the advancement of science and peace. Herman Frasch, who showed how to extract sulphur built up a huge fortune. C. M. Hall, the chemist who discovered how to manufacture aluminum made millions through this discovery. F. G. Cottrell, who devised a valuable process for recovering the waste from the flue gases, James Gayley, who showed how to save enormous losses in steel manufacture, L. H. Baekeland, who invented Bakelite—these are only a few of the men to whom fortunes have come through their chemical achievements.

NOW IS THE TIME TO STUDY CHEMISRTY

Not only are there boundless opportunities for amassing wealth in Chemistry, but the profession affords congenial employment at good salaries to hundreds of thousands who merely follow out its present applications. These applications are innumerable, touching intimately every business and every product in the world. The work of the chemist can hardly be called work at all. It is the keenest and most enjoyable kind of pleasure. The days in a chemical laboratory are filled with thrilling and delightful experimentation, with the alluring prospect of a discovery that may spell Fortune always at hand to spur your enthusiasm.

YOU CAN LEARN AT HOME

To qualify for this remarkable calling requires elaborate specialized training. Formerly it was necessary to attend a university for several years to acquire that training, but thanks to our highly perfected and thorough system of instruction, you can now stay at home, keep your position, and let us educate you in Chemistry during your spare time. Even with only common schooling you can take our course and equip yourself for immediate practical work in a chemical laboratory.

EASY MONTHLY PAYMENTS

You don't have to have even the small price of the course to start. You can pay for it in small monthly amounts—so small that you won't feel them. The cost of our course is very low, and includes everything, even the chemistry outfit—there are no extras to buy with our course. Our plan of monthly payments places a chemical education within the reach of everyone.

SPECIAL 30 DAY OFFER

Besides furnishing the student with his Experimental Equipment, we are making an additional special offer for a short while only. You owe it to yourself to find out about it. Write today for full information and free book "Opportunities for Chemists." Send the coupon right now while it is fresh in your mind. Or just write your name and address on a postal and mail it to us. But whatever you do, act today before this offer is withdrawn.

DON'T WAIT—MAIL COUPON NOW!

CHEMICAL INSTITUTE OF NEW YORK, Inc.

Home Extension Division 8

66-R West Broadway

New York City



LETTERS From Students Who Have Taken This Course

You will probably be pleased to learn one of the lessons gave me an idea to turn my chemical knowledge to profitable account. I am now making a varnish and paint which undersells the other type products by \$2.00 a gallon. In some cases more. Have been receiving gallon orders from painters during past week which has netted me a profit of \$12.50 for my "spare-time chemical industry." Many thanks for your training thus far.

J. J. KELLY.

I am but half way through your course and am certain that I have saved my Company many times the cost of the course and raised myself in the Share Holders estimation. The knowledge obtained has its immediate practical application and I do not hesitate in saying your course and the personal attention you give is invaluable to the practical man in any business where chemistry plays a part. You may use this letter and my name and address to the furtherance of your good work.

JOHN WALTER.

I have not written since I received the big set. I can still say that it far exceeded my anticipations. Since I have been studying with your school I have been appointed chemist for the Scranton Coal Co., testing all the coal and ash by proximate analysis. The lessons are helping me wonderfully, and the interesting way in which they are written makes me wait patiently for each lesson.

MORLAIS COUZENS.



T. O'CONOR SLOANE, A.B., A.M., LL.D., Ph.D.

Noted Instructor, Lecturer and Author. Formerly Treasurer American Chemical Society and a practical chemist with many well known achievements to his credit. Not only has Dr. Sloane taught chemistry for years but he was for many years engaged in commercial chemistry work.

EXPERIMENTAL EQUIPMENT FURNISHED TO EVERY STUDENT

We give to every student without additional charge this chemical equipment, including forty-nine pieces of laboratory apparatus and supplies, and forty different chemicals and reagents. These comprise the apparatus and chemicals used for the experimental work of the course. The fitted heavy wooden box serves not only as a case for the outfit but also as a useful laboratory accessory for performing countless experiments.

CHEMICAL INSTITUTE OF NEW YORK, INC.

Home Extension Division 8
66-R—West Broadway, New York City

Please send me at once, without any obligation on my part, your free Book "Opportunities for Chemists," and full particulars about the Experimental Equipment given to every student. Also please tell me about your plan of payment and your special 30 day offer.

NAME

ADDRESS

CITY STATE

R.N. Aug. 1926

Forget to turn off your "B" ELIMINATOR

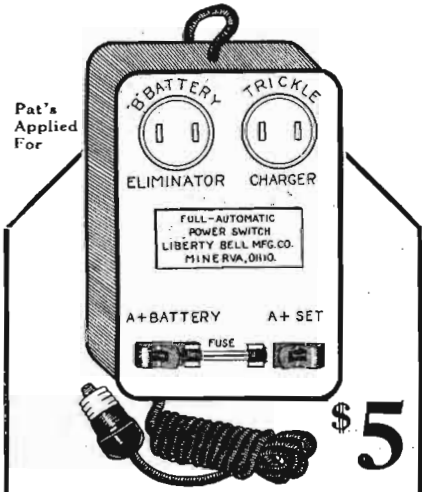

Let the Full Automatic Power Switch do it for you

100% AUTOMATIC CONTROL OF "B" ELIMINATOR AND TRICKLE CHARGER

When you snap off your set "FULL AUTOMATIC" turns off your "B" Eliminator for you—and of course when you snap on your set—turns it on again.

The Trickle Charger is also disconnected automatically when you are using your set, and is connected again when you turn the set off. Eliminates the HUM and regulates the charging. This switch can be used for either or both operations.

The Fire Underwriters now require that the "A" Battery circuit of EVERY RADIO SET be protected by a fuse. This feature is built into the FULL-AUTOMATIC switch.

DEALERS—sell this Power Switch with every "B" Eliminator. Let us tell you about it.

SOLD BY THE BETTER RADIO STORES
Manufactured and Guaranteed by
LIBERTY BELL MFG. CO., Inc.
MINERVA OHIO

\$15 for your old Loud Speaker!
Famous \$25 ADLER-ROYAL
Now only **\$10.00**

Your old loud speaker, regardless of make, condition or original cost, and only \$10 buys this famous \$25 Adler-Royal loud speaker. The Adler-Royal not only gives loud volume, but reflects delicate tones with perfect sweetness. Adjustable unit. Life-like reproduction. Executive piano finish cabinet. Operates with any radio receiver using loud speaker. Fully guaranteed. Absolutely new. Shipped in original factory cases. Send us your old speaker, prepaid, NOW, and only \$10, and get this newest, finest cabinet model reproducer. Send for bulletin of other bargains in nationally advertised radio apparatus.

LUXOR RADIO CO., 38 Wooster Street, Dept. 3, New York, N. Y.

Insure your copy reaching you each month. Subscribe to RADIO NEWS — \$2.50 a year. Experimenter Publishing Co., 53 Park Pl., N.Y.C.

Radio Set Directory

(Continued from page 148)

- | | |
|---|---|
| Trade Name: Steinite
Type of Circuit: Tuned R.F.
Batteries: Storage
Antenna: Outside
Loud Speaker: Separate
Tuning Controls: Three
List Price: \$39.50 | Loud Speaker: Separate
List Price: \$125.00 |
| Manufacturer: U-S-L RADIO, Inc., Niagara Falls, N. Y.
Trade Name: U S L
Broadcast Receiver
Circuit: Tuned radio frequency with resistance coupled amplification
Batteries: Storage or dry cell
Antenna: Outdoor
Loud Speaker: Separate
Controls: Two
List Price: \$80.00; | Trade Name: Work-Rite Aristocrat Six
Loud Speaker: Built-in
List Price: \$275.00 |
| Manufacturer: WALBERT MFG. CO., 925-41 Wrightwood Ave., Chicago, Ill.
Trade Name: Isolard VI
Type of Circuit: Balanced capacity bridge
Batteries: Storage
Antenna: Outdoor
Loud Speaker: Separate
Tuning Controls: 2 and 4
List Price: \$200 and \$165 | Manufacturer: ZENITH RADIO CORP., 310 S. Michigan Ave., Chicago, Ill.
Trade Name: Zenith 3R
Circuit: Non-radiating regenerative
Batteries: Dry Cell and storage
Antenna: Outdoor
Loud Speaker: Separate
Controls: Two
List Price: \$175.00 |
| Trade Name: Isolard V
Type of Circuit: Balanced capacity bridge
Batteries: Storage
Antenna: Outdoor
Loud Speaker: Separate
Tuning Controls: Three
List Price: \$125 | Trade Name: Zenith 4R
List Price: \$100.00 |
| Manufacturer: WORK-RITE MFG. CO., 1812 East 30th St., Cleveland, Ohio
Trade Name: Work-Rite Winner Five
Circuit: Neutrodyne
Batteries: Dry cell or storage
Antenna: Outdoor
Loud Speaker: Separate
Controls: Three
List Price: \$80.00 | Trade Name: Super-Zenith VII
Circuit: Special Zenith
Batteries: Dry cell or storage
Antenna: Outdoor or ground
List Price: \$240.00 |
| Trade Name: Work-Rite Air Master Five
Loud Speaker: Separate
List Price: \$120.00 | Trade Name: Super-Zenith VIII
List Price: \$260.00 |
| Trade Name: Work-Rite Air Master Six | Trade Name: Super-Zenith IX
Batteries: Dry cell and storage
Loud Speaker: Built-in
List Price: \$355.00 |
| | Trade Name: Zenith De-Luxe Colonial Model
Batteries: Dry cell, storage or Eliminators.
Loud Speaker: Zenith Dual twin speakers, built-in.
Controls: One
List Price: \$650.00 |
| | Trade Name: Zenith De-Luxe English Model.
List Price: \$890.00. |
| | Trade Name: Zenith De-Luxe Italian Model.
List Price: \$1,250.00. |
| | Trade Name: Zenith De-Luxe Chinese Model.
Controls: One
List Price: \$1,700.00. |
| | Trade Name: Zenith De-Luxe Spanish Model. |



"Why do you use such a low aerial?"
"So I can get the low-wave stations better."

FREE!

To Each Purchaser of a **WORLD 6 V. Auto or Radio BATTERY**

12-Cell — 24-Volt Storage 'B' Battery

Positively given free with each purchase of a WORLD "A" Storage Battery. You must send this ad with your order. WORLD Batteries are famous for their guaranteed quality and service. Backed by years of successful manufacture and thousands of satisfied users. Equipped with *Solid Rubber Case*, an insurance against acid leakage. You save 60 per cent and get a **2-Year Guarantee**

Bond in Writing "tell their friends." That's our best proof of performance. Send your order in today.

Solid Rubber Case Radio Batteries
6-Volt, 100-Amperes \$12.25
6-Volt, 120-Amperes 13.25
6-Volt, 140-Amperes 14.00

Solid Rubber Case Auto Batteries
6-Volt, 11-Plate \$11.25
6-Volt, 13-Plate 12.25
12-Volt, 7-Plate 16.00

Send No Money Just state battery wanted and we will ship day order is received, by Express C. O. D. subject to your examination on arrival. **FREE "B" Battery** included. **Extra Offer:** 5 per cent discount for each in full with order. Buy now and get a guaranteed battery at 60 per cent saving to you.

WORLD BATTERY COMPANY
1219 So. Wabash Ave., Dept. CHICAGO, ILL.

Set your dial to 1219 at 210 meters for the new 1000 w. World Storage Battery Station WSBM, Chicago. Watch for announcements.

World STORAGE BATTERIES
KOKA - WEAR - WGN - WJS - KHI - KGO - KRAL - WLY - KOP

SEE THAT SCREW

A Screw-Driver adjusts an X-L in crowded places

X-L VARIO DENSER

Results in easier tuning, more distance, volume and clarity—greater stability. Indorsed by leading radio authorities.

MODEL "N"—A slight turn obtains correct tube oscillation on all tuned radio frequency circuits. Neutrodyne, Roberts two tube, Browning-Drake, McMurdo Silver's Knockout, etc. Capacity range 1.5 to 20 micro-micro farads. **PRICE \$1.00**

MODEL "G"—with grid elms obtains the proper grid capacity on Cockaday circuits, filter and intermediate frequency tuning in heterodyne and positive grid bias in all sets. Capacity range .00016 to .00055 and .0003 to .001 micro farads. **PRICE \$1.50**

X-L PUSH POST—Push it down with your thumb, insert wire, remove pressure and wire is firmly held. Releases instantly. **PRICE 15c**

X-L RADIO LABORATORIES
2426 Lincoln Ave. N., Chicago, Ill.

A NEW RADIO PLUG

Simple to use, gives perfect electrical contact with any style tip.

Simply push cord tip through plug, loop cord and push tip back into plug.

Sent postpaid on receipt of 50c
CULVER-STEARNS MFG. CO.
Worcester, Mass.

don't move your set

BIRNBACH EXTENSION CORD

will move your speaker from room to room or to porch and lawn

20 FEET COMPLETE WITH CONNECTOR \$1.00
30 FEET COMPLETE \$1.25
50 FEET COMPLETE \$1.85

BIRNBACH RADIO CO.
370 SEVENTH AVE. N.Y. N.Y. CITY

Vacuum Tubes and Their Uses

(Continued from page 123)

and "C" voltages recommended by the manufacturer are applied.

Most of the power-amplifier tubes, with the exception of the dry-cell power tubes heretofore mentioned, operate from a 6-volt storage battery and draw approximately 1/2-ampere of current. Likewise, most of them have oxide-coated filaments which are very sturdy. These tubes use exceptionally high "B" and "C" voltages; one type uses 180 volts "B" battery and 40 1/2 volts "C" battery, and are for use in the last stage only, as indicated on the vacuum tube chart. It should be pointed out that they have a comparatively low "output impedance" and so will not give the best results with a high-impedance loud speaker unless an "impedance-matching transformer" or a choke coil is employed in the output circuit. Fig. 6 shows how to connect up the output circuit with one or the other of these devices.

TRANSMITTER TUBES

Most of the power tubes have suitable characteristics for use as *oscillators* or *transmitting tubes*. Naturally, they are adaptable to low-power sets only and cannot be safely overloaded. It is not advisable to employ a plate potential greater than 200 volts. However, very good work can be done with these tubes, particularly if the transmitter is operated on a short wavelength; we mean any wave below 100 meters.

A UNIQUE "IDEAL SET"

An entry in the Ideal Set Contest, which is on its face rather more humorous than

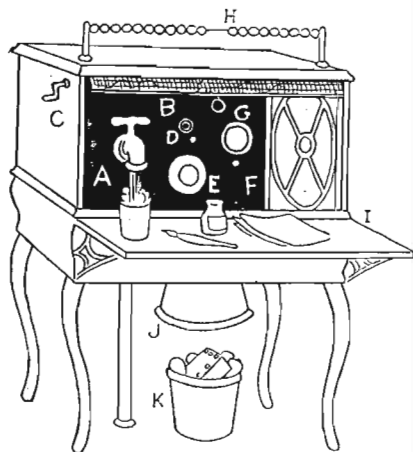

serious, was contributed by William G. Mortimer, of London, Canada. Mr. Mortimer thus explains the drawing:

- A. Handy tap, saves many steps, and also serves as ground.
- B. Radio map, wound up by C.
- D. Hole which squirts stream of water every time operator makes set whistle.
- E. Tuning dial.
- F. Loud speaker.
- G. Hole which emits piercing scream when button beneath is pushed. This informs other members of the family that a DX station has been tuned in.
- H. Rack on which to tally stations tuned in.
- I. Flat desk surface for writing.
- J. Run-down batteries, burnt-out tubes, etc., automatically drop through here into K.

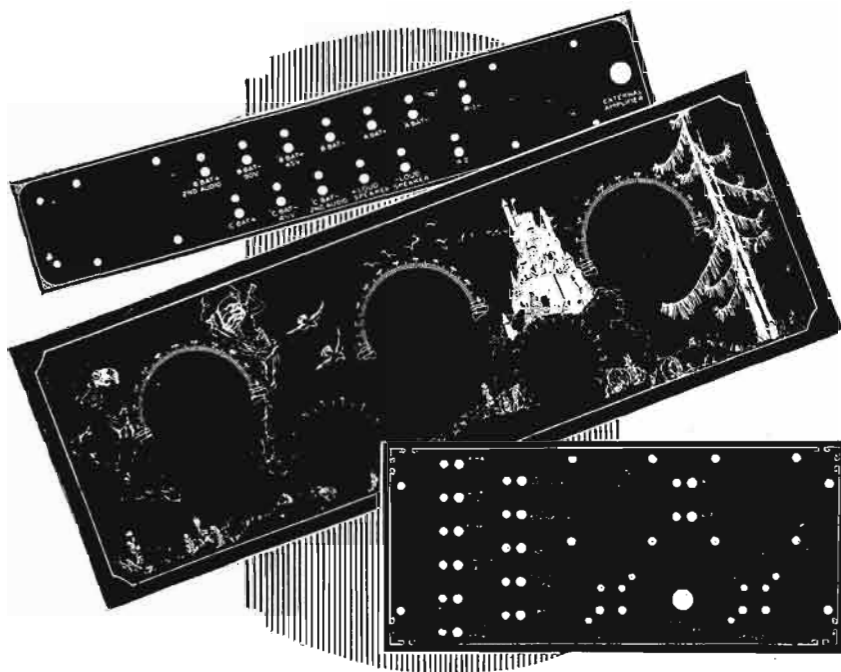

Punched and Veri Chromed Formica Base Panels

ON high-grade sets this year punched Formica base panels marked in gold by the Veri Chrome process will be very widely used. These panels have a very attractive appearance and give the interior of the set a finished appearance.

The panels may be had in either high gloss or mat finishes. The markings may be either gold or silver. For front panels Veri Chrome decoration in much greater variety of effects is now available. Some sets will have elaborate pictures. Others simple severe decoration. Dull satin finished wood effects are available.

FORMICA PANELS FOR KITS

Veri Chrome decoration has been applied to panels for numerous well-known kits. These include: Madison-Moore Superheterodyne; Victoreen Superheterodyne; Bremer-Tully Counterphase 5 and 6; Browning-Drake National; General Radio Universal Receiver; and L. C. 26 Cockaday.

Panels in standard sizes are sold in neat trade-marked envelopes. Special sizes may be had on order.

THE FORMICA INSULATION COMPANY

4618 Spring Grove Avenue Cincinnati, O.



FORMICA

Made from Anhydrous Bakelite Resins

SHEETS TUBES RODS

Radio's biggest, finest Call Book—and more

PRICE
50¢

JUNE
NUMBER

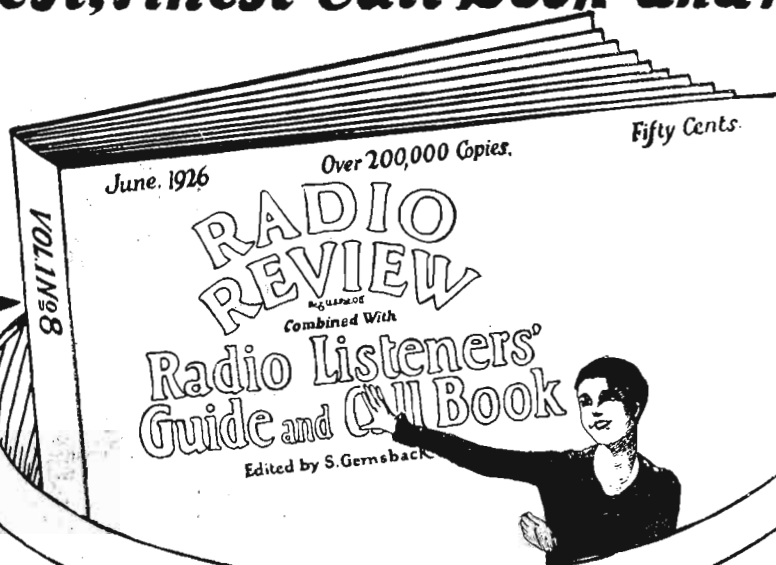

A Whole Barrellful of Useful, Valuable Information for Set Users

Don't operate your Radio Set in the dark. Here's a big magazine that gives you the name, the call letters, the power, the wave length, etc., of every Broadcast Station in the United States—and the hours they operate too. It gives plenty of new hookup information, General Radio information and carries in every issue a supplement of S. Gernsback's Radio Encyclopedia.

It is divided into four parts, each complete, authentic and up-to-the-minute.

The first part contains the finest and most up-to-date list of Broadcast stations obtainable—listed by Call Letters, Wave Length and cities, together with the broadcast schedule of each station for every day of the week. The book also lists all Canadian and Foreign Broadcast stations.

The second part of the magazine is devoted to articles of interest to the Radio Set Owner, giving him information on all subjects he ought to know, to

better understand the operation of his Radio Set.

The third part contains a great number of constructional articles to delight the fancy of the hookup fan on many modern receivers.

The fourth part contains a new supplement of S. Gernsback's Radio Encyclopedia, profusely illustrated and complete in every respect.

In all a tremendously valuable book to have on hand by every user of a radio receiver. The *Call Book* for ready reference to stations received. The *constructional articles* for data on your new set. The *Encyclopedia* for an intimate and authentic knowledge of Radio and the *Listeners information* for first hand knowledge on how to care for your set and operate it properly.

This big June issue is now sold everywhere by 60,000 newsdealers and radio dealers. *Buy a copy NOW.*

Published and Distributed by

The CONSRAD COMPANY, Inc.

64 Church Street
New York, N. Y.

50¢—SOLD ON ALL NEWSSTANDS

CALL LIST OF
CANADIAN, CUBAN AND MEXICAN
BROADCAST STATIONS
Arranged by Wave-Lengths

Call	Location	W.-L. Meters	Power Watts
2TW	Havana, Cuba	230	20
2LR	Havana, Cuba	235	50
CFKC	Thorold, Ont.	247.8	75
8BY	Santiago, Cuba	250	100
2BB	Havana, Cuba	255	15
6BY	Cienfuegos, Cuba	260	200
2UF	Havana, Cuba	265	10
CYF	Oaxaca, Mexico	265	100
CFRC	Kingston, Ontario	267.7	500
CYMC	Kingston, Ont.	267.7	20
CYB	Mexico City, Mex.	275	500
CYM	Monterey, Mex.	275	100
6JK	Santa Clara, Cuba	275	100
	Guadalajara, Mex.	280	10
2MG	Havana, Cuba	280	20
CFXC	New Westminster, B. C.	291.1	20
CJYC	Scarboro, Ontario	291.1	500
CNRV	Vancouver, B. C.	291.1	500
2OL	Havana, Cuba	300	100
CYA	Mexico City, Mex.	300	100
2RK	Havana, Cuba	310	20
CYU	Puebla, Mexico	312	100
CYCY	Charlottetown, P. E. I.	312.3	50
CNRA	Moneton, N. B.	312.3	500
CKCK	Regina, Sask.	312.3	500
CNRR	Regina, Sask.	312.3	500
2CX	Havana, Cuba	320	10
CYQ	Tampico, Mex.	322	100
CZE	Chihuahua, Mex.	325	250
CYX	Mexico City, Mex.	325	500
KCW	Burlington, Ont.	329.5	5000
CJGC	London, Ont.	329.5	500
CHUC	Saskatoon, Sask.	329.5	500
CJWC	Saskatoon, Sask.	329.5	250
CFQC	Saskatoon, Sask.	329.5	500
CNRS	Saskatoon, Sask.	329.5	500
CFCT	Victoria, B. C.	329.5	500
6KW	Santa Clara, Cuba	340	100
CHCS	Hamilton, Ont.	340.7	10
CFCU	Hamilton, Ont.	340.7	500
CKOC	Hamilton, Ont.	340.7	50
CZE	Mexico City, Mex.	350	500
2EP	Havana, Cuba	355	400
CFCA	Toronto, Ont.	356.9	840
CHIC	Toronto, Ont.	356.9	500
CHNC	Toronto, Ont.	356.9	500
CJBC	Toronto, Ont.	356.9	500
CJSC	Toronto, Ont.	356.9	500
CJCD	Toronto, Ont.	356.9	500
CKCL	Toronto, Ont.	356.9	500
CKNC	Toronto, Ont.	356.9	500
CNRT	Toronto, Ont.	356.9	500
CHSC	Unity, Sask.	356.9	250
CYH	Mexico City, Mex.	375	100
CKY	Winnipeg, Manitoba	384.4	500
CNRW	Winnipeg, Man.	384.4	500
CYL	Mexico City, Mex.	400	500
PWX	Havana, Cuba	400	500
CFCF	Montreal, Quebec	410.7	1650
CHYC	Montreal, Que.	410.7	850
CKAC	Montreal, Que.	410.7	1200
CNRM	Montreal, Que.	410.7	1000-1650
CFQC	Vancouver, B. C.	410.7	50
CFDC	Vancouver, B. C.	410.7	10
CFKC	Vancouver, B. C.	410.7	50
CFYC	Vancouver, B. C.	410.7	500
CJCK	Vancouver, B. C.	410.7	500
CKCD	Vancouver, B. C.	410.7	1000
CYO	Mexico City, Mex.	425	100
CFAC	Calgary, Alta	434.5	500
CFCN	Calgary, Alta	434.5	750
CNRC	Calgary, Alta	434.5	750
CHXC	Ottawa, Ontario	434.5	250
CKCO	Ottawa, Ont.	434.5	100
CNRO	Ottawa, Ont.	434.5	500
CYR	Mazatlan, Mex.	475	250
FAM	Guadalajara, Mex.	490	1000
CFCH	Iroquois Falls, Ont.	499.7	250
CFCK	Edmonton, Alta.	516.9	100
CJCA	Edmonton, Alta.	516.9	500
CNRE	Edmonton, Alta.	516.9	500
CYY	Merida, Mexico	548	100
	Tampico, Mexico	548	10
	Tampico, Mex.	548	100



Men relate

this simple way to get

a new thrill in shaving

Men the nation over are awakening to the fact that there is a general switch to the Valet AutoStrop Razor.

Its sales have pyramided in an astounding manner.

All because men are discovering that a sharp blade for every shave is a genuine luxury.

The Valet AutoStrop is the only razor that sharpens its own blades. A few strokes on its strop restore a blade to new-like keenness.

Sharpen it, then shave, then clean—all in a jiffy, and without removing the blade from the holder.

This is a different principle. The blade doesn't get duller and duller until it must be thrown away.

Every shave can be with a blade of super-keenness.

Have you fallen into a habit? Do you continue your old way of shaving?

Then join the thousands upon thousands who have turned to a new and better way and whose enthusiasm never wanes.

A speedy, comfortable shave every time—uniformly perfect. An end to "pulling." An end to wasting time.

"There's no shave like it," men say. Why miss this supreme improvement?

Valet Auto-Strop Razor

REG. U. S. PAT. OFF.

\$5 to \$25
Other sets
at \$1

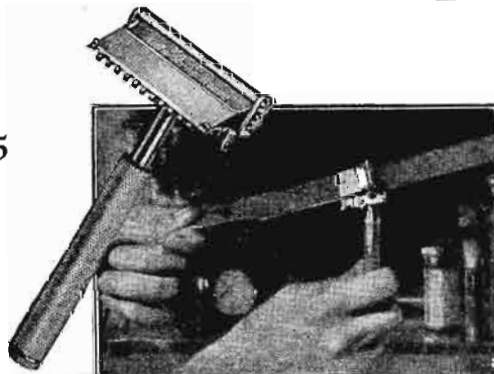

The RAZOR
That
Sharpens
Itself

AN EFFECTIVE LEAD-IN



AUTOSTROP SAFETY RAZOR CO., 656 First Avenue, New York City

Charge Indicator



Sterling NECESSITIES

For Your "A" Battery

The Clean Way to Test Wet Batteries is to use the Sterling Charge Indicator which plainly shows at a glance when battery needs recharging and when battery on charge has been charged enough.

PRICE \$2.00
A New Bulb Type Charger. Meter-Equipped made according to the very latest battery charging requirements. Quiet, sturdy, thorough in its work.

PRICE \$14.00
Ask your dealer for Sterling Radio Quality

THE STERLING MFG. COMPANY - CLEVELAND, O.

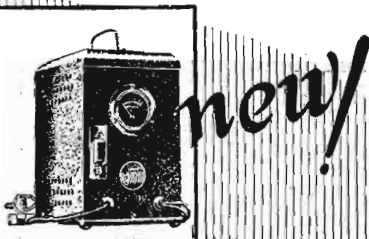

new!

BULB TYPE BATTERY CHARGER

FOR CLEAR, QUIET "B" POWER



RADIO Storage "B" Battery

12 Cells 24 Volts Lasts Indefinitely—Pays for Itself Economy and performance unheard of before. Recharged at a negligible cost. Delivers 2 amperes power that is clear, pure and quiet. Approved and listed as Standard by leading Radio Authorities, including Pop. Radio Laboratories, Pop. Sect. Inst. Standards, Radio News Lab., Lefax, Inc. and other important institutions. Equipped with Solid Rubber Case, an insurance against acid and leakage. Extra heavy glass jars. Heavy rugged plates. Order yours today!

SEND NO MONEY wanted and we will ship day order to received. Extra offers 4 batteries in series (36 volts), \$10.50 Pay expression after examining batteries. 5 per cent discount for cash with order. Mail your order now!

WORLD BATTERY COMPANY
1219 So. Wabash Ave., Dept. 75 Chicago, Ill.
Makers of the Famous World Radio "A" Storage Battery
Prices: 6-volt, 100 Amp. \$11.25; 120 Amp. \$12.50; 140 Amp. \$15.00.
All equipped with Solid Rubber Case.

World STORAGE BATTERIES
Set your Radio Dials at 210 meters for the new 1000 watt World Storage Battery Station, W5BC, Chicago. Watch for announcements.

KDKA • WEAZ • WGN • WJZ • KJL • KGO • KFA • WJY • KOP

Insure your copy reaching you each month. Subscribe to RADIO NEWS—\$2.50 a year. Experimenter Publishing Co., 53 Park Pl., N.Y.C.

Calls Heard

KFUH—YACHT "KAIMOLOA," OF HONOLULU, FRED ROEBUCK, RADIO OPERATOR. (See page 1402, RADIO NEWS for APRIL)

Heard and worked July 28th to August 8th, 1925, while anchored in lagoon at Fanning Island, 1000 miles south of Honolulu, 40 meters only.

(1pl), 1ux, 1anq, 1cmf, 2gk, 2afn, 2mu, 2ij, 2bbx, 2agb, 2hnm, (2hwi), 3bwi, 3ckg, (4sa), 4tn, 4km, (5uk), 5adz, 5ih, 5nq, 5agn, 5nj, 5ew, 5akz, 5zai, 5kc, 5ox, 5aj, (6awt), (6ip), (6fcl), (6cbb), (6aif), (6huc), (6zbn), (6cgo), (6ad), (6csl), (6aiv), (6csw), (6zau), (6cfl), 6uf, 6rn, 6hde, 6vc, 6clz, 6dh, 6mmw, 6js, 6crs, 6ur, 6aji, 6dal, 6hhz, 6rv, 6agk, 6hvy, 6hur, 6aij, 6han, 6sh, 6hcl, 6btm, 6bap, 6hgo, 6aai, 6cto, 6bke, 6bij, 6km, (7av), (7uz), (7uv), (7ack), 7fd, 7ay, 7ji, 7ch, 7nt, 7gb, 7it, (8ay), 8aj, 2ckm, 8pl, 8nk, 8bi, (9uq), (9cxx), (9uon), 9bht, 9hpb, 9xn, 9ado, 9akf, 9dvl.

AUSTRALIAN: 2yi, 2bb, 2ij, 3bd.
NEW ZEALAND: (Sac), 1ax, 2ac, 4ar, 1ao, 4al, 2ae, 2xa.

CHILE: (leg).

CANADIAN: (9ck), 5ef, 4aa.

ARGENTINA: Ba-1.

MEXICAN: 1b, 1x.

NAVY: (nve), (npu), (npm), (naj), (nrll), nkl, npg, npu, nas, nirx, namg, npo, nsx, nedj.

COMMERCIAL: (kdid), wap, wiz, wqn.

PHILIPPINE ISLANDS: 1hr.

August 8, to October 15, 1925. (35 to 40 meters). Stations heard and worked by KFUH while at Penrhyn Island; between Penrhyn Island and Papeete, Tahiti, and during time spent in Papeete Harbor, Papetaoi Bay, Moorea and other islands of the Society group.

1cmp, 1bes, 1pl, 1anq, 1yh, 1zi, 1ck, 1awe, 2hu, 2mm, 2xaf, 2mu, 2cpa, 2ckg, 2blm, 2ahm, 2bk, 2cxl, 2aum, 2aim, 2cjj, 3ckg, 3aao, 3lw, 3bva, 3hg, 3ekl, (4do), (4si), 4io, 4tv, 4rl, 4oa, 4ig, 4rm, 4bu, 4cu, 4ll, (5ado), (5lg), (5aid), (5oq), 5ew, 5nk, 5zai, 5sd, 5akn, 5ox, 5bg, 5he, 5va, 5wi, 5amw, 5adz, 5nq, 5aj, 5aua, 5aab, 5agn, 5atv, 5amk, 5afn, 5aj, 5akz, 5it, (6awt), (6ip), (6dg), (6def), (6cfl), (6zd), (6xad), (6ih), (6uf), (6cfe), (6aiv), (6aak), (6ea), (6che), (6ac), (6gk), (6amm), (6ahp), (6oi), (6bvs), (6si), (6cmh), (6bnr), (6tc), (6hip), (6cmq), (6cto), (6huc), (6asr), (6zbi), (6csw), 6chs, 6ct, 6vr, 6bij, 6hmw, 6ia, 6km, 6abg, 6aij, 6cix, 6cnc, 6hgv, 6hbm, 6aqp, 6dah, 6gbg, 6apk, 6aff, 6hil, 6cvc, 6cor, 6aig, 6aum, 6nx, 6ase, 6ajm, 6qu, 6cs, 6dab, 6wt, 6eah, 6ih, 6ake, 6dam, 6rv, 6aea, 6cv, 6zh, 6cz, 6alv, 6aai, 6ta, 6cc, 6dax, 6ake, 6cgv, 6cqa, 6eb, 6cmd, 6cft, 6hjd, 6ml, 6bkb, 6hvv, 6bon, (7de), (7ek), (7aek), 7ly, 7uz, 7ar, 7an, 7to, 7it, 7nz, 7af, (8gz), (8rv), Sac, Seg, (8hnl), (8cz), (8pl), (8qz), 7ot, 7eo, 7cs, (8bce), (8hnl), (8cz), (8pl), (8qz), (8rv), Sac, Seg, 8aly, 8cvi, 8bf, 8er, 8ix, 8es, 8gq, 8hau, 8se, 8pk, 8xk, 8cau, (9ded), (9uq), (9ef), (9yav), (9zt), 9xn, 9bht, 9dvr, 9ek, 9qr, 9cay, 9cht, 9hpy, 9wo, 9ij, 9eis, 9zk, 9dpx, 9eky, 9ff, 9hib, 9cun, 9cxx, 9hwh, 9dmj, 9co, 9ark, 9cvi, 9cvi, 9hwo, 9ird, 9dwb, 9zd, 9akf, 9cld, 9eez, 9aod.

CANADIAN: (5ba), (5go), 5bf, 5hp, 5ef, 4aa, 4gt, 3aa, 3kp, (9ck).

MEXICAN: 1af, 1b, 1k, 1x, 9a.

NEW ZEALAND: 1ao, 1ax, 1xa, 2ac, 2ae, 2bl, (3am), 3ao, (4ag), 4al, 4as, 4aa, 4ar, 4ak, 5da.

AUSTRALIAN: (2ij), (2gq), 2hs, 2cm, 2ip, 2hb, 2xa, 2jw, 2sw, 2hk, 2tm, 2yh, (3ei), 3lp, 3bu, 3bd, 4cm, 4an, 5bg, 5kn, 5da, 6ag.

ARGENTINA: (bal), afl, db2, de3, pa2, cb8, fg4, hb5, aa8.

BRAZIL: (bzlab), bz1ax.

PHILIPPINE ISLANDS: (pilhr).

CHILE: (leg).

CUBA: q2mk.

JAPAN: j1aa.

ENGLAND: g2cc, g2nm.

U. S. NAVY: (nrll), (nas), (numm), (nir), (nisv), (nqw), nedj, nkl, (npm), npg, npu, npo, npp, nve, naj, nsf, najd, nqg, (nqg-1), nqg-2, nijr, nisv, nix.

COMMERCIAL: (wap), (vng), wiz, wir, wvy, idg, wqo, ftj, kel, wvz, fw, whv, kudg, (gdvb), vit, anc, aq.

A RADIOPTIMIST

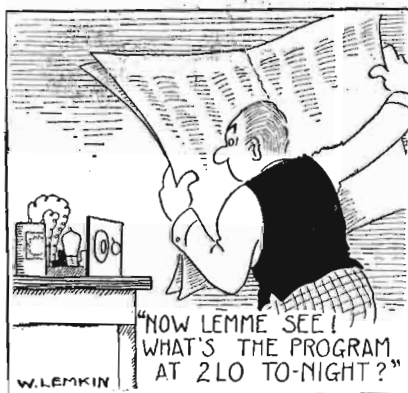

A Powerful LOUD SPEAKER!

\$10

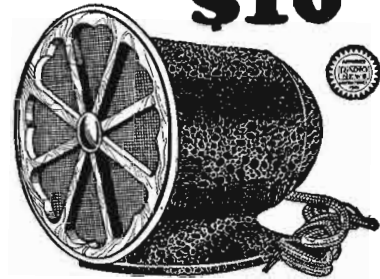

FRESHMAN MASTER SPEAKER

Only 6 inches in size, artistic in appearance, the Freshman Master Speaker is an ornament for any room.

A triple reflex speaker with powerful unit, it has volume equivalent to a 24 inch upright horn and tone quality unexcelled by speakers costing many times as much.

Sold by Authorized Freshman Dealers Only

CHAS. FRESHMAN CO., Inc.

Freshman Building New York
2626 W. Washington Blvd. Chicago



Fool Proof

AMPERITE—the perfect filament control. Takes the guess out of tube control. No knobs to turn. Makes tubes last longer. Makes any novice a master operator. Specified in all popular construction sets. \$1.10.

Radiall Company

Dept.-R.N.-8 50 Franklin Street, New York City



AMPERITE

The "SELF-ADJUSTING" Rheostat

WRITE for our Four Guide Books and "REC. ORD OF INVENTION" before disclosing inventions. Send model or sketch and description of your invention for our INSPECTION and INSTRUCTIONS FREE. TERMS REASONABLE. Electrical and Radio Cases a specialty.

VICTOR J. EVANS & CO.
919 NINTH ST., WASHINGTON, D. C.

Learn Watchwork, Jewelrywork and Engraving A fine trade commanding a good salary, and your services always in demand. Address Horological, Dept. 5, Bradley Institute, PEORIA, ILLINOIS, for our latest catalog.

The Set Owner's Progress

(As told by "K.C.B." in his lively column, "Ye Town Gossip," in the New York American.)

I KNEW very well.
 IF WE ever sent.
 FOR THE radio man.
 TO COME back again.
 THAT HE'D say to us.
 WE COULDN'T hope.
 TO GET any distance.
 WITH THE set we had.
 AND THAT'S what he said.
 BUT HE also said.
 THAT IF we liked.
 HE'D SEND us up.
 A LARGER set.
 JUST AS a loan.
 AND HE didn't want.
 THAT WE should think.
 THAT HE expected.
 TO SELL it to us.
 AND THE children said.
 WHEN HE had gone.
 THAT THEY never had seen.
 SUCH A lovely man.
 OFFERING TO loan us.
 A RADIO set.
 AND NOT wanting to sell it.
 AND ANYWAY.
 THE SET came up.
 AND THE little old set.
 THAT HAD intermittently.
 SERVED US well.
 WAS PUT aside.
 AND THE new big set.
 WAS ALL hooked up.
 AND FIRST thing we knew.
 WE CROSSED the country.
 TWO THOUSAND miles.
 AND NONE of us breathed.
 AS WE heard the news.
 AND NOW our home.
 HAS NOTHING in it.
 BUT DISTANT sounds.
 AND IF it happens.
 WE STUMBLE across.
 A PLEASING program.
 CLOSE AT home.
 AND I want to sit.
 AND SMOKE and listen.
 SOMEBODY SAYS.
 "BUT, DADDY dear.
 "THAT'S A local station."
 AND AWAY they go.
 OUT INTO the ether.
 AND ALL at once.
 THE MANIPULATOR.
 OF THE little buttons.
 WILL RAISE a hand.
 AND SHISH at us.
 AND BREATHLESSLY.
 WE'LL SIT and wait.
 HEARING FAINTLY.
 A DISTANT sound.
 THAT MIGHT be music.
 AND WHOEVER it is.
 WHO IS turning the knobs.
 WILL STIFFEN up.
 AND THEN relax.
 AND WHISPER to us.
 "I THINK he said Pittsburgh!"
 AND WE'LL clap our hands.
 AND TRY again.
 FOR STILL further away.
 I THANK you.

TOO LATE!

A woman's shrill scream, the sharp crack of a pistol, a brutal, mocking laugh, then silence.

The younger man jumped to his feet, but the great detective calmly removed his pipe from his mouth and remarked:

"No use, Watson. It's all over."

As usual, he was right. The next instant came the announcement: "This is Station WRNY signing off. Good night."

—Contributed by W. F. Hammond.

Ferguson

J. B. INCORPORATED

The Gold Standard of Radio Receivers

MODEL TEN

One Tuning Control—
Calibrated in Meters!

Simply select your program from the newspaper, turn up its wavelength and in comes your station.



This precision-built FERGUSON, with its resistance-coupled amplifier, delivers all of the music exactly as broadcast. From the silvery strains of the soprano to the deep boom! boom! of the bass drum—each note comes through in perfect timbre and with all the countless delicate overtones and shadings that give music its greatest charm. Complete shielding of all tuning elements gives this Receiver its great selectivity. Write us!

J. B. FERGUSON, INC.
 225 West 57th Street
 New York, N. Y.

Sold by
**Authorized Ferguson
 Dealers**

A 6-TUBE RECEIVER



\$110 00

No Seasonal Models—
 Continually Developing
 Refinements.

22½ VOLT

unacid
 everlasting
 rechargeable
 "B"
 STORAGE
 BATTERY

\$2.95

Includes
 chemical



45 volts, \$5.25; 90 volts, \$10.00; 112½ volts, \$12.50; 135 volts, \$14.75; 157½ volts, \$16.50. Truly the biggest buy today. Easily charged on any current including 32 volt systems. Any special detector plate voltage land. Tested and approved by leading authorities such as Popular Radio Laboratories. Over 3 years sold on a non-refund 30-day trial offer with complete refund if not thoroughly satisfied. Further guaranteed 2 years. Knock-down kits at greater savings. Complete "Hawley" 21" Battery Charger \$2.75. Sample cell 55c. Order direct—send no money—simply pay the expressman cost on delivery. Or write for my free literature, testimonials and guarantee. Same day shipments.

B. HAWLEY SMITH
 314 Washington Ave. Danbury, Conn.

For the

Season 1926-27

At a price
 for the home
 of moderate means

GOLD-MEDAL

RECEIVERS CONSOLES "B" ELIMINATORS

Distributors, Agents and Dealers
 Write for Territory.

GOLD MEDAL RADIO CORPORATION
 1038½ Longwood Ave., New York, N. Y.

Insure your copy reaching you each month. Subscribe to Radio News—\$2.50 a year. Experimenter Publishing Co., 53 Park Place, N. Y. C.



YOU NEED THESE BOOKS

Every Owner or Builder of Radio Receivers should know how they operate and how to care for essential parts. These books make it easy!

Compiled
-by the Staff of **RADIO NEWS**

Meet your radio problems and beat them

Radio Engineers Spent Seven Months to Give You This Valuable Book

A brand new book filled to the brim with a priceless array of selected Questions and Answers that are necessary to everyone in the construction, care and maintenance of modern sets, including information on hundreds of simple and complex circuits in common use today.

The staff of Radio News feels that it has created a book in which appears the cream of every radio man's problems and the best method of coping with them. There is contained invaluable information on every phase of radio. Information on hundreds of simple and complex hookups is given in clear and concise language. Information on practically every type of receiving set, manufactured receivers, vacuum tubes, miscellaneous circuits, and in short just what the radio enthusiast needs as an unerring guide and aid.

Contains 116 Pages, 300 Illustrations and is published in the large Magazine Size 9 x 12 inches.

PRICE
50¢

Read the best in radio!

116 Pages of Selected Radio Articles by the Most Eminent Radio Engineers

The "RADIO NEWS" Amateurs' Handibook is a large 116 page magazine size book containing a wide, varied and carefully selected array of the finest and most helpful radio articles that have appeared in the pages of Radio's Greatest Magazine, RADIO NEWS.

The cream of practical, up-to-the-minute, circuits and miscellaneous information and data is culled from RADIO NEWS and presented in compact form in this book. It embraces every phase of radio, but particularly the new and more practical receivers and circuits developed for modern reception.

Contains 116 Pages, Illustrated

PRICE
50¢

Get more from your receiver

Use This Big Bookful of Shortcuts, Hints and Practical Ideas

A big book full of short cuts, hints and practical ideas. The 500 RADIO WRINKLES BOOK is a very comprehensive compilation of the best time and money saving hints that can be effected. Under fifteen separate and distinct headings, the entire field of radio apparatus and instruments has been covered in simple, understandable language. It is divided into sections covering Antennae, Batteries, Coil Mountings, Condensers, Crystal Detectors, Inductances, Lightning Protectors, Loop Antennae, Loud Speakers, Resistances, Sockets, Switches, Transformers, Vernier Dials. There are no ifs nor buts to complicate directions. The Beginner as well as the more advanced radio man will soon find that this book contains a veritable storehouse of practical, inexpensive hints toward improving his radio apparatus.

Large Size 9 x 12 inches, 100 Pages Illustrated

PRICE
50¢

AT ALL NEWSSTANDS

IF YOUR DEALER CANNOT SUPPLY YOU, OR IF THERE IS NONE NEAR YOU, ORDER DIRECT.
THE EXPERIMENTER PUBLISHING COMPANY, Inc., - - 53 Park Place, New York

ANSWER TO CROSS-WORD PUZZLE
Which Appeared in July RADIO NEWS.

K	M	O		K	F	I		W	N	A	X	
G			W	L	W		K	T	A	B		K
Y		K	N	X		W	F	A	A		W	D
	W	Q	J		K	F	B	L		W	J	Y
K	G	W		W	T	A	L		W	B	A	L
S	N		W	R	A	V		K	W	C	R	
O		W	T	A	B		W	O	A	N		W
	W	B	A	K		W	C	C	O		W	O
W	B	B	M		W	D	A	H		W	H	O
W	R	R		W	L	B	L		K	O	A	
G	C		W	Q	A	O		K	H	Q		W
L		W	H	A	P		W	Q	J			J
	W	F	B	M		W	E	W		W	B	Z

Radio In Serbia

(Continued from page 109)

may soon light your room with others and wonder what your thoriums have fled through. And as soon as you embark on the waves you feel you are in a mad-house—the Tower of Babel has nothing on it. Every type of language you hated in school so much comes to your ears, every kind of propaganda relative to the problems that concern European nations, attractions of every description, talks on the cure of tuberculosis, Locarno and post-Locarno issues and divers what-nots. Budapest gives the Hungarian Rhapsody No. 2 and the Dances No. 5 and 6 with a rendition beyond comparison. Then comes Vienna with surprises; read the programs as much as you like and be prepared for the unexpected. Their modulation—or carrier wave or whatever you call it—is really fine, and they do give good music. Next is Rome with her lady announcer in a pleasant soprano. The first time I realized there may be music in somebody's voice was when I heard *her* talk. One must hear an Italian opera in Italy, by Italians in Italian, to fully appreciate the excellence of the Italian composers of old. Thus does the Milano station talk to us.

As you fish around one of the strongest whistles is that of Berlin.

The fellow with little patience had better put down the dial readings for the different stations for it is a rule, to which only English stations make some exception, that European announcers are too silent about their stations and programs. Some of them have distinguishable noises. Vienna for instance, lets you listen for intervals of 5 or 10 minutes to the ticking of a clock; Budapest has some peculiar sounding instrument.

At times it happens that, after tuning to the wave of a strong station and waiting for the coming number, someone breaks in in Swiss, French, Esperanto or nasal German—something which after you have recovered enough you make out to be "wait 15 minutes please" . . . and again you start roaming through the three continents. There is Toulouse, France. Somebody is cursing, swearing his head off, or just talking about the fall of the franc.

The center of this melting pot of languages is Prague, from whence they announce in every kind of language and dialect, I guess. Even now I am never sure I am listening to Prague without looking at the reading of the dial and the inductance switch to find whether I am on the 550 or 1,200 wave-length, the latter being Moscow. The Russian station is further away from me than Daventry, England, which uses a 24 kw., while Moscow uses only one-fifth of

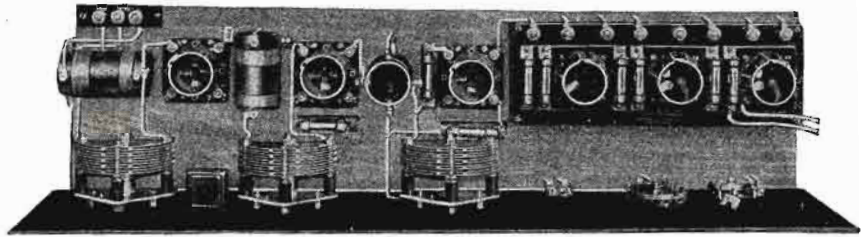

Daven Bass Note Circuit Demonstration Set Seen from above

Build NEXT Year's Sensational Set NOW

THE sensation of the coming season will unquestionably be the Daven Bass Note Circuit. Already it is a sensation with the limited number of fans who have had a chance to hear it.

Build it NOW—and yours will be the most talked of radio set in your locality. All your friends will be copying it.

The Daven Bass Note Circuit is just what its name implies. It transmits, completely and perfectly, all the low notes in the music, with the same clarity and beauty that characterize the higher vibrations. This is something no hook up has hitherto been able to do.

The Daven Bass Note Circuit was developed at the request of the fan. We had innumerable demands for a RADIO Amplification end that would be as good as the AUDIO Amplification end represented by the popular Daven Super Amplifier; one that would perfect detection, eliminate noises and losses, and be easy to assemble.

The Daven Bass Note Circuit, built of the famous Daven parts, is easy to assemble and to operate, because built on a straight line.

Go to the Authorized Daven Service Dealer in your locality. He will be glad to demonstrate the new quality of reception which the Daven Bass Note Circuit brings, and supply you with the necessary, Daven units for putting together this important new type of receiver.

Free literature describing the Daven Bass Note Circuit and the Daven Family of Radio Accessories sent on request.



BASS NOTE CIRCUIT

MADE UP OF THESE DAVEN UNITS

- 1 Set D. R. F. Coils
- 1 Daven Super-Amplifier
- 3 Daven Mu-20 Tubes
- 1 Daven Mu-8 Power Tube
- 1 Daven Leakandenser No. 22
- 1 Daven 1/2 Ampere Bal-last
- 1 Daven 1/2 Ampere Bal-last
- 1 Daven Special Type "A" Condenser

The Sine of Acoil
DAVEN RADIO CORPORATION
Resistor Specialists
Reg. U. S. Pat. Off.

159 Summit St., Newark, N. J.

RESISTOR HANDBOOK

Complete, Authoritative.
From your dealer, 25c or Sent by mail 30c. Daven Catalog Free!



Learn Electricity
by practical, personal training in the great shops of **COYNE**

You don't need education or experience. COYNE-trained men earn \$60 to \$200 a Week

COMPLETE ELECTRICAL TRAINING in Twelve Happy Weeks

Get my special offer of free fare to Chicago, also FREE courses in Radio and Auto Truck and Tractor Electricity. Ask for Big, Handsome FREE BOOK containing 151 actual photos of electrical methods and operations in Big Shops

COYNE ELECTRICAL SCHOOL
Dept. C-595 1300 West Harrison Street, CHICAGO, ILLINOIS

MORE PROFITS for the Professional SET BUILDER

We have an unusually interesting proposition to make to the man who is now building (or has the ability to build) radio receiving sets for resale.

This is a real opportunity. Write today for full information.

Gearhart Schlueter Radio Corp.
715 Voorman Ave., Fresno, California

Insure your copy reaching you each month. Subscribe to Radio News—\$2.50 a year
Experimenter Publishing Co., 53 Park Place, N. Y. C.

TOBE Now --
"A Better Resistor!"



VACUUM TIPON
LOEWE-LEAK

The new Resistor in a glass tube which is pumped out to a high vacuum and sealed. Look for the sealing TIPON the leak,—proof of the vacuum within. No moisture can reach it. No oxidation can take place.

In all sizes from 10,000 to 10,000,000 ohms. Permanent and noiseless. Sold in individual sealed, silvered packages as benefits a quality product.

PRICES

10,000 ohms ... \$1.00	1 megohm \$.50
50,000 ohms75	2 megohms50
1/10 megohm .. .75	4 megohms50
1/4 megohm .. .50	8 megohms75
1/2 megohm .. .50	10 megohms 1.00

We have tried to make it possible for you to get "TOBE" apparatus at your dealer's. Ask him first,—if it happens that he is not get stocked, we will be glad to forward your order on receipt of check or money-order.

Tobe Deutschmann Co.
 BOSTON, MASS. CORNHILL

Reserved for the
CAMFIELD RADIO MFG. CO.
 829 Harrison Street
 Oakland California

this power; yet the signals are very strong and the words distinct; due, maybe, to the peculiarity of Russian in having long words and many sharp consonants. We up here have safely and quickly negotiated the turbulent waters of bolshevism; so listening to this station, which now gives fine music, is an entertainment. And I tell you, it is SOME thrill to turn the dial about 1/5 of an inch and jump from Daventry to Moscow on a single tube and a wire 30 meters long stretched between two windows.

But the main thing of interest to you, maybe, is my attempts to hear America. Though I have not much to say, I devote a special paragraph to this point.

One evening around Christmas, while listening to something in dance music, I switched to 1,600 meters and heard the girl who laughs so sweetly in the programs of the Capitol Theatre in New York. I am not sure, but just conjecture it was Daventry or Koenigswusterhausen re-broadcasting an American program. Roxy and his gang heard here in the land of no sidewalks, no pavements, bad electricity, badly-managed movies, high inefficiency in every respect and European programs that lack American spirit! These programs are too solemn, you listen to them and think of funerals. The announcers and performers speak to us or sing to us from above. They will not lower themselves to the level of us mortals. They do us a favor when letting us listen to them. That is why Europe has no Roxy. She is too old and lacks humor.

There are some peculiar languages and programs I have heard that give me the feeling that I have visited Asia. If so, this will be nothing in comparison to the tests I want to put on with my new Roberts, in hearing America direct. I'll cajole it, or choke it; but it must bring me the land of its originator. Then I shall let you know how and what I heard.

(We are sure that RADIO NEWS' readers will enjoy letters like this from listeners in other countries as much as we do. We hope to receive many more good ones.—EDITOR)

About Cavalleria and WRNY
 (Continued from page 117)

Mamma Lucia. Turridu, her son, has been absent ostensibly to buy grapes at Brancofonte, but in truth making love to Lola, the wife of Alfio, the teamster. Santuzza, who loves Turridu, alone understands. While the peasants pour into the church and the organ peals, Santuzza weeps out her heart to Mamma Lucia and tells of her woe. For this is her story: Turridu and Lola once were lovers, but when Turridu went away, Lola married Alfio. Broken-hearted, Turridu returned and Santuzza comforted him and won his love. She gave her all. Now, Lola, jealous and angry, had won Turridu back to her side and in secrecy steals him from Santuzza and gives of the love, which belongs to Alfio. When Turridu appears, Santuzza pleads with him, but brazenly he throws her aside and enters the church with the shameless Lola. Vengefully, cruelly, Santuzza tells Alfio the truth, and after the service, Alfio challenges Turridu to a duel and kills him.

The action is tense, quick, close, and the music is passionate, beautiful, unforgettable. The Intermezzo is laid in the period after Santuzza has informed Alfio, while the church service is going on. The things to remember are: Lola's ditty, Turridu's serenade, Santuzza's story, Alfio's teamster song and the teamsters' chorus, the beautiful choruses from the church and the drinking song.

RADIO DRAMA AT WRNY

The Edison Ensemble did full justice to the Prologue, and Judson House to Turridu's serenade. This great weekly feature at WRNY holds high place in the musical life of the air. Speaking of the Edison Hour, reminds me that you probably heard the Edison prize play "The Return of Diogenes." You may recall that Arthur Williams, of the New York Edison Company, offered prizes for the best radio play devoted to the surprising changes of the world through electricity. The first prize effort was given

\$12.00

Ready to plug into light socket.

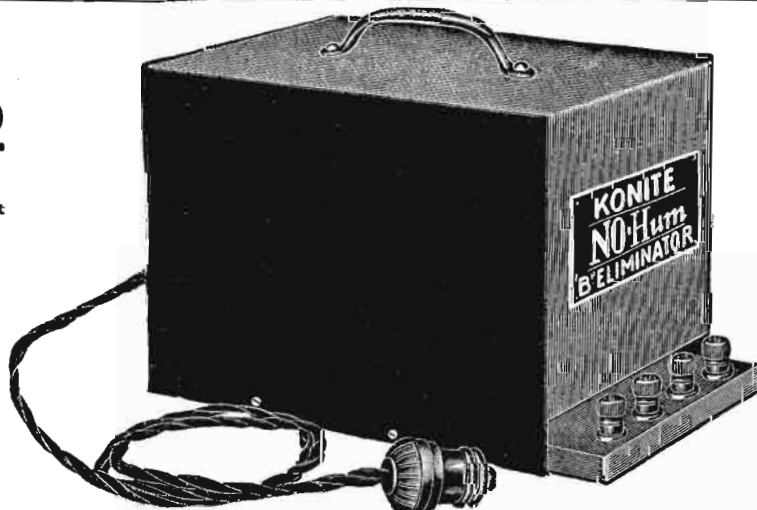

\$10.50

Knock down parts un-assembled.

Improve Your Reception! with the NEW
DEALERS
KONITE "NO-HUM" B ELIMINATOR

We have an excellent proposition for those who desire to handle our line. Write or wire for territory.

The Konite Corporation, 8-26
 25-27 W. Broadway, New York City
 Gentlemen: Please send to me at once:
 1 No. 100 Konite "No-Hum" "B" Eliminator, as advertised, all parts, but unassembled \$10.50 ; 1 No. 101 Konite "No-Hum" "B" Eliminator, assembled complete, ready to work \$12.00 ; Payment enclosed ; Send C. O. D.

Name
 Address
 City State

Utilizing many new improvements in full wave rectification. Ninety per cent of set owners who complain of poor reception are informed by the radio "doctor" that their trouble is due to run down batteries. The B battery is no different than a human being. No man can work efficiently when he is run down—why expect the B battery to act differently?

Even without use, the B battery deteriorates. With the popular priced KONITE "NO-HUM" B ELIMINATOR you are assured of a constant B supply from AC current at maximum efficiency at all times and it costs you less than \$1.00 per year for the electric current. All B batteries are eliminated.

NO NOISE, NO HUM, NO PARTS TO BE REPLACED

Three taps for 90, 45 and 22½ volts. Maximum voltage 100 volts. Operates either on 60 or 25 cycle AC current.

The KONITE CORP., 25-27 WEST BROADWAY
NEW YORK, N.Y.

over WRNY by the Radio Theatre Players, directed by Alfred Rigali (the same organization which has broadcast through WRNY for nearly a year). The big surprise was the engagement of Grant Mitchell, star of "One of the Family" and formerly with the "Tailor-Made Man"—an engagement which sets a new precedent in broadcasting. Mr. Mitchell played the role of "Diogenes" and gave verisimilitude to the old searcher for the honest man, returned to earth. Others in the cast were Mr. Rigali and Miss Isabel Dawn, then leading woman in "The Bells." Of course it is too late to notify you, but Alice Brady is to be the guest star in the second prize play, and Olive Wyndham and Louise Closser Hale in the third play. The success of "Diogenes" was tremendous, and not the least credit was given to the noises—which were real. In the studio were washing machines, vacuum cleaners, electric fans, vibrators, street car gong, police whistles, automobile motors and horns, etc.

The most exciting thing which has happened during the month probably was the appearance of Norman Thomas. This famous radical had been invited by most of the metropolitan stations, but mysteriously cancelled at the last minute. Thomas pleaded for freedom of speech on the air. WRNY invited him to speak and, as programed, he did speak. Introducing him I said: "Right or wrong, we concede to Mr. Thomas and others the right to address themselves to the radio public." After Mr. Thomas finished, Hugo Gernsback did some eloquent work in answering two of his most serious accusations.

And did you listen in on that famous night when Mona Morgan recited from Shakespeare, Marguerite Namara sang, Virginia Howell of "Alias the Deacon" read the verses of John B. Hymer and the whole cast of "One of the Family" had a party, with Grant Mitchell, Louise Closser Hale and the rest; and folks from "Pinafore" and others, and others, and others all joined hands.

CONCERTS FROM THE ROOSEVELT

Do you ever come to New York? Be here on a Wednesday, and then you can come to the Roosevelt Hotel and in an entirely informal manner make yourself at home in the Grand Ball Room while listening to the free concerts.

If you can't come, you can easily listen in through WRNY.

JEST AND EARNEST

Things I remember especially in recent programs:

Johnny Hines acting as master of ceremonies and doing it wonderfully; that funny man, Harry Hirshfield, telling us all about his famous character, Abie Kabibble, gave dialect stories which caused us aches in the side.

One evening the Hon. Joab H. Banton, District Attorney of New York, came over to speak on the Constitution. He proved to be a real fan of radio, knows all sorts of things only the amateurs are supposed to know, and listens for DX all the time. A few days after Mr. Banton broadcast, he wrote: "They heard my speech clearly in Houston, Texas, and Hot Springs, Arkansas." The very same night Mr. Banton came over, we had the whole cast of "Cherry Pie," and let me rise to observe that Harry Wagstaff Gribble never did a better job, and that all lyricists will have to look to their laurels.

We had lots of fun the nights we did the RADIO NEWS poem "Degenerative Sets," (it appeared in the June issue), which raised Cain with the heterodyners and others. So we gave an actual demonstration, all the noises included, until dozens of people wondered what had happened to the ether.

Clearer . . . Finer hot weather reception

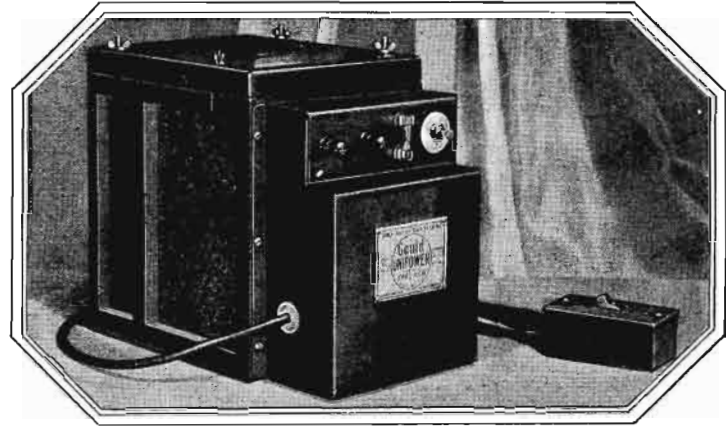

A SOFT, lilting waltz—a sensitive string solo with delicate tone cadence—the gracefully interlaced harmony of piano and voice. Suddenly a buzz—a rattle—the grating crash of static! Illusion and mood together are shattered—completely lost.

The mind topples from its world of fancy. It becomes practical. "Let's put the darn thing away for the summer. There's no getting away from hot weather static."

But with the radio shut up, long summer evenings are bound to drag. Try to calm that impossible racket. It is difficult to eliminate it totally during warm days but it can be toned down. Unipower is proving that to a great many fans.

Unipower is not merely the pioneer "A" power unit—it is a basic improvement in radio. It improves tone quality. It furnishes unflinching power. It is the only unit employing the trickle charge principle that also provides for rapid charging. It gives fool-proof, automatic control of both set and power supply, regardless of the type of "B" power used.

Unipower contains a Balkite charging unit of special design.

6 volt model, \$40—60 cycles, 110-125 volt A. C. Designed for radio sets using 201-A tubes or equivalent.

4 volt model, \$35—60 cycles, 110-125 volt A. C. Designed for radio sets using 199 tubes or equivalent.

Prices west of the Rockies slightly higher. Special models, 25-50 cycles, are available.

THE GOULD STORAGE BATTERY CO., INC.
250 Park Avenue, New York

Unipower

Off when it's on ~ On when it's off

HEATH
CONDENSERS
For Real Radio Reception
Write for Literature
HEATH RADIO & ELECTRIC MFG. CO.,
206 First St., Newark, N. J.

Immediate Shipment from Stock
HAVE MERCHANDISE
WHEN YOU NEED IT
Catalog 466-S is free to dealers

WHOLESALE EXCLUSIVELY
LUDWIG HOMMEL & CO.
929 PENN AVENUE PITTSBURGH, PA.

Alden Processed
NA-ALO
Sockets and Dials
ALDEN MANUFACTURING COMPANY
Springfield, Mass.

For "UV" or UX Type Tubes
NEW KLOSNER UNIVERSAL SOCKET
Hexagonal slanted holes for large prongs, spring grip terminal lugs, and ease in mounting make it the socket leader for 1926.
KLOSNER RADIO CORPORATION
1022 East 178th Street - New York

MARVELOUS NEW AUDIO TRANSFORMER adds a musical quality to any set far beyond anything you ever heard before. **KARAS HARMONIK** Amplifies low, middle and high tones—all to the same big volume, thus eliminating distortion. Brings out the vital harmonics and overtones of music. Price \$7.00. Write: Karas Elec. Co., 1020 Ass'n. Bldg. Chicago

EVERYTHING IN RADIO
AT ATTRACTIVE PRICES
SETS OR PARTS
Mail order only
ALL RADIO COMPANY, 417 North Clark St., Chicago

"NOVELTIES"

How to Make Them

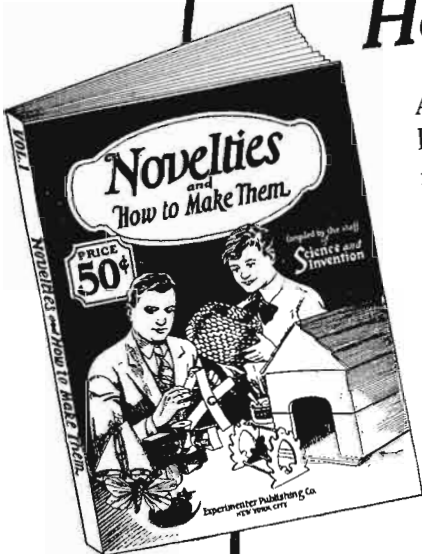

Almost every home has an old clock around— Do you know that a great many surprising, fun making, and useful novelties can be made just from the old springs, the gears, etc.

NOVELTIES, the new book, compiled by the staff of SCIENCE & INVENTION shows you how to make hundreds of wonderful Novelties, mostly out of old scrap things laying around the house. 116 Pages, in this book, show pictures, diagrams and explanations of remarkable, interesting things to make in your spare time.

Every page has a big, wonderful surprise for you. There is no end to the simple, magical things you can make at home.

It is sold on all newsstands. Buy your copy now. If your dealer cannot supply you use the special coupon below.

PRICE
50
CENTS

NOVELTIES, contains 116 Pages, hundreds of illustrations and is published in the big magazine size 9x12 inches

PER COPY



MAKE HUNDREDS OF USEFUL THINGS AT HOME WITH "HOW TO MAKE IT"

Building your own home furniture, cameras, radio cabinets, sport devices, etc., is easy if you know what materials you need, and have an illustrated explanation on how to proceed. Then, too, you can save a good deal of money by making these valuable things yourself.

"How to make it" a big book compiled from the great magazine "Science and Invention," is full to the brim with hundreds of up-to-date things to make at home. Things that can be made by any man with only a few simple tools.

Contains 116 Pages, 300 Illustrations. Large Size 9x12 Inches. PRICE 50c

SURPRISE YOUR FRIENDS MASTER MYSTERY Read "POPULAR MAGIC"



POPULAR MAGIC contains thousands of simple, entertaining parlor tricks, as many puzzling magical stunts and a whole book full of mystic spirit novelties. A new set of tricks for every day of the year. Compiled from the great magazine "Science and Invention."

GET THIS GREAT BOOK TODAY. Check full of Tricks, Novelties, Mystic performances, Master sleights-of-hands, Gags, Disappearing acts. All kinds of fun. Buy a copy or order direct. PRICE 50c.

Contains 116 Pages of Tricks, Hundreds of Illustrations, Size 9x12 Inches

EXPERIMENTER PUB. CO., Inc.,
53 PARK PLACE, NEW YORK
Gentlemen: I am enclosing \$..... for one copy of NOVELTIES; HOW TO MAKE IT; POPULAR MAGIC
NAME
ADDRESS
CITY, STATE
(Check Books Desired)

SOLD ON ALL NEWSSTANDS

IF YOUR DEALER CANNOT SUPPLY YOU USE COUPON

Experimenter Publishing Co., Inc.
53 Park Place New York, N. Y.

TO PANDEMONIUM ITSELF!

And speaking of noises, there was the Novelty Night feature, "The Inferno." First time any remote-control line was ever instituted from Satan's domain. Other stations may claim to have been the first to have been anywhere on earth, but WRNY holds the record for getting to hell. North Pole next! The Irvine Players helped and did beautifully; Dante also helped (with apologies for his lines.)

And here let me record with reverence, that we broadcast the Fiftieth Anniversary of the founding of Ethical Culture, and that Dr. Felix Adler, its founder and leader, at the age of seventy-five, made his first radio address. Dr. Stephen S. Wise also spoke that night.

There have been many famous speakers at WRNY this last month. At the Police Dinner of the Legion of Honor, Mayor Walker of New York and Police Commissioner McLaughlin were installed via WRNY. At the Postal Supervisors' dinner, Governor Bartlett, First Assistant Postmaster General, spoke; so did John J. Kiely, Postmaster of New York; Sir Gilbert Parker, the Canadian romantic novelist, and other celebrities.

History in music was made the night Pauline Watson played the new Morse violin, the first revolutionary change in the king of instruments since the days of Stradivarius.

The most beautiful ensemble ever to be broadcast, came to the studio one night recently, when Helene Romanoff appeared with Kathleen Karr, Miss Schweinert and others, all recruited from the Follies, Vanities, etc. They are stars in the making, vocally. I recommend that you urge Mr. Gernsback to rush this television machine which will enable you to see them next time.

Lots of information about camps went out this month over the air through the help of the American Schools Association, and Coney Island's opening was celebrated with the Thunderbolt over WNRV. Did you hear it? The Thunderbolt is the newest, wildest, thrillingest ride at the Island.

Did you know that May is the worst month in the year for catching cold? K. A. Hughes, of Salicon fame, brought forth the amazing figures. And so on; we have not space to record the things a single month found on WRNY's program.

DISCOVERING MANY COMING STARS

Along with all of these were the regular features of popular, classical and semi-classical music, brought by WRNY's favorite ensemble, Ben Bernie's Orchestra, Herbert Soman's Orlando's Roosevelt Orchestra, Johnny Camp's boys, and all the rest.

For the sake of history, I'd like you to note these new fine artists who have been heard over WRNY:

David Putterman, youngest cantor and wonderful tenor; Hans Merx, great Wagnerian baritone; Rose Black, soprano; Frances Sper, "pop" singer de luxe; Hardman Male Quartette, destined to fame; Dickie Hughes, one of the best singing ukelele stars on the air; Winthrop Wayne, actress of the Irvine Players; Edith Pollack, gifted member of the Drawing Room Players; La Verne Ellsworth, marvelous contralto; Marta Elizabeth Klein, prize-winning organist; Wilma Fekete, who plays violin and piano, with one even better than the other; Clarence Bloemker, the brilliant new tenor from St. Louis; Mary Howard, the unforgettable soprano from San Antonio; George Magis, the French lyric tenor; Adolph Martin, the cantor; Eva Soble, the diminutive prima donna; and so I might go on for pages and pages more.

See you next month! What would you like to have me tell you about? Just suggest it, and I'll try to follow your idea.

"MOST POWERFUL IN THE WORLD"

**Navy Model
UNIVERSAL TRANSOCEANIC**

Design by
CHAS. R. LEUTZ

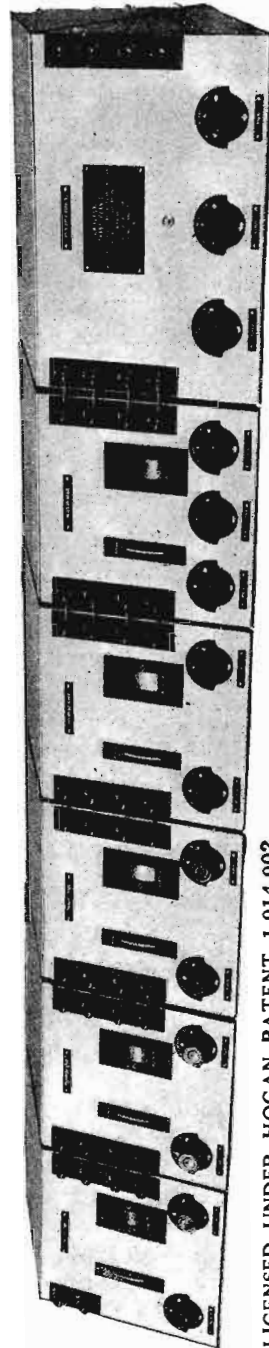

LICENSED UNDER HOGAN PATENT 1,014,002

Wavelength Range 35 Meters to 3600 Meters

Full details are given in our 88 Page Catalog Free.
Wire or write for your copy today.

MANUFACTURED BY

GOLDEN-LEUTZ, Inc., Sixth & Washington Aves., Long Island City, N. Y.

CABLE "EXPERINFO"

The Universal Transoceanic is supplied completely constructed and laboratory tested and is also supplied in Kit form, all parts ready for assembly. The complete set of Constructional Blue Prints covering all mechanical, electrical assembly details, wiring diagrams and instructions will be mailed upon receipt of \$5.00 net.

Make any Good Receiver BETTER

CC TUBES

C.E. MFG. CO.
Providence R.I.



WHOLESALE **LUDWIG HOMMEL & CO.** RETAILERS
929 PENN. AVENUE PITTSBURGH, PA.
SATISFIED DEALERS BECAUSE WE HELP THEM
Catalog 466-S is free to Dealers

AMPLION

FOR BETTER RADIO REPRODUCTION

RADIO SCHOOL

Send for Catalogue
MASSACHUSETTS RADIO and TELEGRAPH SCHOOL
NEW TERM SEPT. 13
18 Boylston St. Boston, Mass.

9 Circuits-1 Tuning Dial!

A Separate Circuit for each 40 Meter Wavelength Band. A single tuning dial, yet greater selectivity. Let our nearest dealer show you the great Kellogg.

WAVE MASTER
SWITCHBOARD & SUPPLY CO.

Or write for complete descriptive folder No. 1-H today.
KELLOGG SWITCHBOARD & SUPPLY COMPANY
1041 W. Adams Street Chicago, Ill.

WORLD'S RECORD SUPER 9

Holds world's record for most consistent reception of stations 6000 miles or more distant. Full sized Blue Prints and Instructions tell how to build Laboratory Models. Write for full details. Scott Radio Labs., Crilly Bldg., Chicago, Ill.

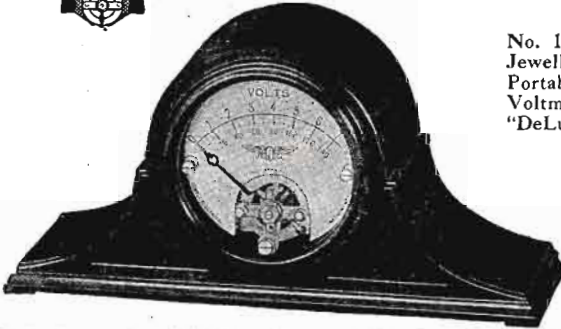
No. 117
Jewell
Portable
Voltmeter
"DeLuxe"

This is the most beautiful high resistance portable voltmeter manufactured. The case is of genuine black bakelite.

Tube manufacturers recommend the use of a voltmeter for filament control. Manufacturers are supplying pin jacks on the panels of their sets into which cords with phone tips are plugged. This instrument can be used to check batteries and for filament control on any set.

Send for circular No. 739

Jewell Electrical Instrument Co.
1650 Walnut St. - Chicago
"26 Years Making Good Instruments"

More About Receivers Without Wires

(Continued from page 141)

again to the bottom illustration, where a little imagination will show that there really is nothing to stop the use of tubes on each side of the strip. That is, sixteen tubes with their coils and condensers might conceivably be connected by means of the strip, with proper tube spacing, by-passing, shielding, and yet less wire than the average three-tube receiver.

"Now, If You'll Take My Advice—"

(Continued from page 112)

However, I managed to keep my mouth shut during this demonstration.

In a couple of minutes Billy pipes up, "Now, we'll have some real music!" and we did. He pulled out the filament switch and the tubes lit up—oh, they lit up beautifully, the only catch being that they didn't stay lit. Billy said that was funny and started hunting around for the reason, when I happened to touch one of the wires leading from the battery. I didn't touch it long as it was very, very hot.

I then invited my wife to leave the room and forgot that I had ever been a gentleman; for I told Billy that the only kind of a tube set he should be playing around with was one that had no tubes at all. And I also told him lots of other things that now are neither here nor there, but at that time they were very important. He said he was very sorry that he had spoiled my reception for that evening, but I was sorrier about the nine tubes that were permanently out. They represented real hard-earned cash.

After I cooled off a little I told him that I was going down and see his friend the next day and get another flock of tubes. Then he pulls his usual line:

"If you'll take my advice, I would get Robin Redbreast Tubes, if I were you." I won't bore you with all the technical reasons he gave me why I should get those tubes, but you see even yet, I did not know him well, for I followed his advice. The next day when I came home to put the Robin Redbreast tubes in the set, after I had rearranged the wiring according to the book of instructions, and they lit. Yes, they lit all right, but there wasn't an awful flood of melody running around the room from the loud speaker. I thought it was sort of funny, for the fellow in the store had said they were fine tubes. I took them back the next day and as they still lit I got my money back and then I went to a store where they sold regular tubes that I had seen advertised in all radio magazines. When I put them in the set, they worked and worked pretty.

That evening one of my friends came in with his wife and when he saw the latest acquisition he asked me if I knew Billy Hoffman. I admitted it and he started to laugh.

"Why the jolly ha-ha?" I asks him. "Did you fall for Billy's line too!" he chirps.

My wife not having sense enough to keep her mouth closed blats out how much Billy had helped me in getting my set together. Then this bird he laughs some more and said it was a great joke.

"Why is it a joke? Would you think it funny if he burnt out nine of your tubes?" I asks, sort of peevish.



Steinite Low Loss
Interference Eliminator
No Radio Set Complete Without It

Select stations at will. With music and voices crowding the air the average set fails to bring in the desired stations properly. The **Steinite Interference Eliminator** shuts out local and other interference. You get one station at a time, the one you want, and tune in loud and clear. Operates on any set—attach to aerial wire and to set—no changes—no extra tubes or batteries. Greatest Dollar Value in Radio Today.

OVER 300,000 SOLD



Improved Results With Tube or Crystal Try entirely at my risk the wonderful improvement this inexpensive little device will make in the reception of your set. Improves results on both crystal and tube sets that use any kind of aerial except loop antenna. Clears up reception wonderfully, increases volume, and partially absorbs static. **MONEY-BACK GUARANTEE.**

Mrs. Famous 1,500-Mi. Steinite 1-Tube set \$6. Long distance Crystal Set, \$6. Steinite Crystals, 50c—3 for \$1. Write for complete illustrated literature on all Steinite Radio Products.

Put this interference eliminator on your set and note amazing improvement. No tools needed—install in a moments time. Connect with set and follow simple instructions. Money back promptly if not delighted. \$1.00 postpaid anywhere in U. S. when cash with order.

References: Exchange National Bank, Atehison Savings Bank. Order today—a dollar bill will do.

STEINITE LABORATORIES, 129 Radio Bldg., ATCHISON, KANSAS

FREE Radio Catalog

Just off the press. Our second catalog for 1926. 160 pages of parts, accessories, kits and sets—all the best and the latest. A copy is yours for the asking. Just drop us a line—do it today!

CHICAGO SALVAGE STOCK STORE
Dept. R.N. 509 S. State St., Chicago, U.S.A.

COIL WINDINGS

Audio-B, Eliminator—Bell Ringing Trans
TELEPHONE RINGER—CHOKO—
IGNITION—CONTROLLER & SPECIAL
SOLENOID WINDINGS

Easton Coil Co. P. O. Box 237
Easton, Pa.

RADIO—5-tube Set \$22.50 Delivered

Think of it! A well known five tube Radio receiver only \$22.50 delivered. Tremendous range, clear powerful volume and simple tuning. Literature free. Radio Tubes, all types 95c postpaid.



SEMINOLE CO., Dept. N.,
427 East 16th St., New York
Agents and Dealers Wanted

READ
"AMAZING STORIES"
THE MAGAZINE OF SCIENTIFICATION
25c
ON ALL NEWSSTANDS

Insure your copy reaching you each month. Subscribe to Radio News—\$2.50 a year. Experimenter Publishing Co., 53 Park Place, N. Y. C.

Then this wild man laughs some more till I was nearly ready to throttle him. Finally he spills the dope between gasps that Billy Hoffman's chief object in life since the present radio era has been spreading advice, especially to those poor mortals, who admit that they don't know much about the so-called art. He has been one of Billy's victims, just like I was and that's why he enjoyed my discomfort.

And did I hear you ask what I said to Billy the next time I saw him? Well may you ask. I said nothing but dodged him every time I saw him coming; for the moral of this little tale is

ASK THE MAN WHO KNOWS—NOT THE FELLOW WHO HAS GOT ONE.

International Radio

(Continued from page 127)

some, it can be turned off, one of the great advantages, with other things besides communications in strange tongues. Cultivation of musical taste is also easy by this means, as there is a great choice of various kinds of entertainment.

One interest in Europe that is not satisfied with the great strides made by wireless, is the daily press. The interest in the latest news, hot from the printing press, which used to lead to the sale of hundreds of thousands of evening papers, for instance, is dead, killed by wireless and the cinema. For everyone knows the news already, having heard it broadcast, or seen it thrown on the screen. Thus newspapers are becoming more and more like magazines. Everywhere this change is being witnessed, the German papers being the most changed. Some print long "feuilletons" or interesting sketches, without news value; other short articles of very general interest. The space devoted to telegrams is getting smaller and smaller. —L. Reid.

NEW QRA's

20H, Lyman F. Barry, has moved from old QRA to 529 West 158th Street, New York, N. Y., operating on 40-meter band. QSL all crds.

5ALX, Edgar Woodfin, Kosciusko, Mississippi; 5 watts on 40 and 80 meters.

40 Non-Technical Radio Articles

every month for the beginner, the layman and those who like radio from the non-technical side.

SCIENCE & INVENTION, which can be bought at any newsstand, contains the largest and most interesting section of radio articles of any non-radio magazine in existence.

Plenty of "How To Make It" radio articles and plenty of simplified hook-ups for the layman and experimenter. The radio section of SCIENCE & INVENTION is so good that many RADIO NEWS readers buy it solely for this feature.

Radio Articles Appearing in the August Issue of "Science and Invention" Magazine.

- How to Build a Box Loop of Latest Type By Herbert Hayden
- Radio Hints—Illustrated With Photographs By Raymond B. Wailes
- A Study of Reflex Circuits
- The King of Super-Heterodynes Below 100 Meters
- The Radio Fan's Own Page



Panel Size: 36"x9x1-4"

Weight: 55 lbs.

**A New and Advanced Model—
Norden-Hauck
Super-10**

Highest Class Receiver in the World

THE NORDEN-HAUCK SUPER-10 is an entirely new and advanced design of Receiver, representing what we believe to be the finest expression of Modern Radio Research Engineering. It is the product of years of experience devoted exclusively to the attainment of an ideal Broadcast Receiver—regardless of cost.

Results obtained in every respect will upset all your previous ideas of good radio reception.

Here are only a few of the host of features that place the NORDEN-HAUCK SUPER-10 far in advance of competition:

- 10 tubes employed to give perfect reproduction with unlimited range and volume power.
- Super selectivity on all wave lengths.
- Built to Navy Standards.
- Wide wave length range without change of coils, etc. (Adaptable 35 meters to 3600 meters if desired.)
- Use Loop or Antenna.
- Simple to operate, having only two major tuning controls.
- No Harmonics. Signals are received only at one point.
- Special Power Audio Amplifier, operating any loudspeaker and eliminates necessity of external amplifier.
- Can be operated directly from house current if used with NORDEN-HAUCK POWER UNIT AB-2. Special.

The NORDEN-HAUCK SUPER-10 is available completely constructed and laboratory tested, or we shall be glad to supply the complete engineering data, construction blue prints, etc., for those desiring to build their own receiver.

UPON REQUEST a complete catalog, attractively illustrated, will be gladly mailed without charge, or full size constructional blue prints, showing all electrical and mechanical data, will be promptly mailed postpaid upon receipt of \$2.00.

Write, Telegraph or Cable Direct to

Norden-Hauck, Inc.

Engineers

Marine Building, Philadelphia, U. S. A.

TEAR OFF AND MAIL TODAY

NORDEN-HAUCK, Inc.
Philadelphia, U. S. A.

Gentlemen:—

Please send me without cost or obligation on my part, attractive illustrated literature describing the new Norden-Hauck Super-10.

I enclose \$2.00 for which please send me, postpaid, complete full size constructional drawings and all data for building the Super-10.

Name

Address

**KENILWORTH INN
ASHEVILLE, N. C.**

Comfortable Rooms—Best Sports—Excellent Food—
REASONABLE RATES—Write for Booklet
ROSCOE A. MARVEL, Manager
THE HOME OF HOSPITALITY
in the land of the sky

RADIO MAILING LISTS

26887 Retail Dealers Per M. \$7.50
2254 Radio Mfrs. Per List 20.00
2534 Radio Jobbers Per List 22.50
Ask for price list all other Radio lists, all 98% correct.
A. F. WILLIAMS, List Dept.
166 W. Adams St. Chicago

BAKELITE SOCKETS

AID CLEAR RECEPTION

Write for Booklet 24

BAKELITE CORPORATION
247 Park Avenue, New York, N. Y.
Chicago Office: 636 West 22nd St.
BAKELITE CORPORATION OF CANADA, Ltd.,
163 Dufferin St., Toronto, Ontario, Canada

A Laboratory Product

**CRESCENT
LAVITE
RESISTANCES**

For Distortionless Amplification
Used on the U. S. A. Dirigibles. Made all capacities 12,000 ohms and up. List price \$1.50.
Special sizes to order. Write today. Discounts to dealers.
Crescent Radio Supply Co., 1-5 Liberty St., Jamaica, N. Y.

Insure your copy reaching you each month. Subscribe to Radio News—
\$2.50 a year. Experimenter Publishing Co., 53 Park Place, N. Y. C.

Outstanding Example of Value!

Five Tubes
Two Dials **\$60**

This two-dial control receiver is an outstanding example of Distantone value. It employs two stages of radio frequency, a detector and two stages of matched audio amplification and challenges comparison with any other receiver for volume and performance. Richly finished two-tone cabinet with a control-board panel harmonizing with the balance of the cabinet. Wave length range 180 to 550 meters.

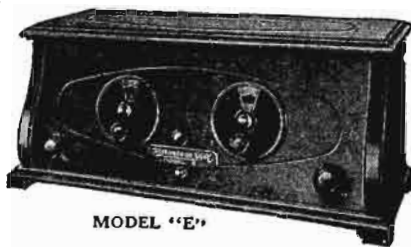

MODEL "E"

Distantone

Built By Craftsmen

TO DISTRIBUTORS

The Distantone line is one of the few real profit lines in radio. For reliable and financially responsible distributors and jobbers, we have an exceedingly attractive proposition for the coming season. Write or wire today for full particulars or samples.

Other Models from \$37.50 to \$150

The Distantone line includes five tube receivers of two and three dial control and five and six tube sets with single dial control; all Tuned Radio Frequency type. Every model a superior value for the price.

DISTANTONE RADIOS, Inc., LYNBROOK, LONG ISLAND, NEW YORK

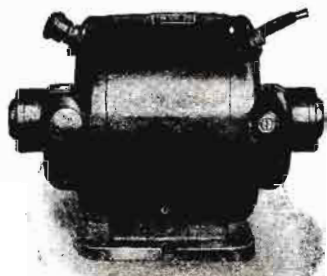

Byrd Crosses the Pole!

Commander and Pilot
Make Round Trip In
14 Hrs. 13 Min.

Oslo, Norway, May 10.—Lieut. Commander Richard E. Byrd and his pilot, Floyd Bennet, returned to King's Bay, Spitzbergen, at 6.30 p. m., and declared they had flown over the north pole in the Byrd expedition's monoplane, according to advices from King's Bay.

AGAIN ARCTIC EXPLORERS DEPEND UPON "ESCO"

The S. S. Chantier which Byrd used as a base was equipped with an "ESCO" dynamotor. This is the second time that an Arctic explorer has depended upon "ESCO" equipment for communication with the rest of the world.

ELECTRIC SPECIALTY COMPANY

211 South Street TRADE "ESCO" MARK Stamford, Conn.
Manufacturers of Motors, Generators, Motor-Generators and Dynamotors.

Effarsee Makes Summer Radio Reception a Pleasure
ANTENNAE PATENT PENDING
It gives a maximum of volume, minimum of static and sharper tuning. Place it anywhere—even under the carpet. Sent prepaid for \$4. Write for complete information.
FISHWICK RADIO COMPANY
131 Central Parkway & Elm, Cincinnati, O.

Centralab Radios, Modulators, Potentiometers or Rheostats are standard on 69 leading radio sets. Ask your dealer, or write for descriptive literature.

Central Radio Laboratories
19 Keefe Avenue Milwaukee, Wis.



MARKO
RADIO BATTERIES

are ALWAYS DEPENDABLE

MARKO STORAGE BATTERY CO.
Brooklyn, New York



Write for Booklet
AMSCO PRODUCTS Inc.
Broome and Lafayette Sts.
New York City

Radio Weather "Good" and "Bad"

(Continued from page 113)

of the air) should be recorded. In the absence of instruments, these elements, excepting the pressure, can be noted in descriptive terms. For example, one can easily determine whether it is humid or not by the general "feel" of the air. The approximate pressure may be determined from the daily weather map issued from numerous Weather Bureau stations in the larger cities. Certain broadcasting stations should be selected, preferably one in each of the four cardinal directions (north, south, east, west), and these should be observed regularly. The observations ought to be made at about the same hour, making allowances as the season advances for the increasing length of the day. We know that transmission during sunlight differs in character very frequently from transmission at night. Since most listeners have no recording devices for quantitative measurements of the sound intensities, it will be necessary to train the ear to sounds of similar intensities and then record the reception of programs as strong, moderate or weak. A series of records, correlated with the highs and lows described in the early part of this article, will quickly point to any relationship between the strength of reception, clarity, that is absence of static, and the direction of transmission with respect to isobars. The observer should keep his batteries at as nearly constant strength as possible.

The Broadcasting of Pictures

(Continued from page 126)

Figs. 3 and 4 show diagrammatically the methods which the writer has devised for the transmission and reception of moving pictures by radio. Fig. 3 is the transmitter, shown in schematic section. The film F is run smoothly, not intermittently as in ordinary projection, in front of the selenium cell, S_e; or a photo-electric cell such as the Luminotron (described in the October, 1925, issue of RADIO NEWS) may be used. The active surface of the cell must be as long as the film strip is wide.

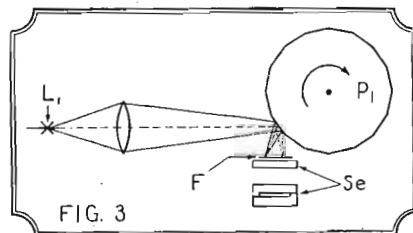

A schematic diagram of the author's machine for the transmission of pictures

In order to illuminate all the points of a line in the picture, from the light source L₁, the rotating polygonal mirror P₁ is placed so that it will reflect the rays of light through the film. Its rotation causes the spot of light to travel across the width of the film; and as the strip moves forward, all the points of the picture will successively be illuminated. (See RADIO NEWS of July, 1926, for illustrations diagramming similar action). This light passing through the film sets up current vibrations of varying strength in the light-sensitive cell, which serve, after sufficient amplification, to modulate the carrier wave of the transmitting station.

1926 FREE RADIO GUIDE
NEWEST 1926 EDITION
Shows the latest circuits, the newest developments in radio at startlingly low prices. Get the parts you want here and save money. The best in parts, kits, sets and supplies. Orders filled same day received. Write for free copy NOW; also please send names of one or more radio friends.
BARAWIK CO., 102-145 So. Canal St., Chicago, U. S. A.
FREE RADIO BOOK
Science has invented a new kind of coil. Now have it on your present set. Gives a great advantage otherwise impossible. Write for new book just published showing many new ideas. Also 8 new circuit circuits. Address Electrical Research Laboratories, Dept. 178, 2500 Cottage Grove Ave., Chicago, Ill.

THE PICTURE RECEIVING APPARATUS

Fig. 4 shows the construction of the receiver, which is more complicated. The light emanating from the source L_2 is varied in intensity in direct proportion to the incoming signal impulses, and passes through the Kerr cell, K , with its two Nicol prisms, N_1 and N_2 . The insertion of the rotating polygonal mirror, P_2 , causes the luminous ray to traverse the lines indicated by the arrows, thus reconstituting the picture in every line and point into which it was decomposed at the transmitting station.

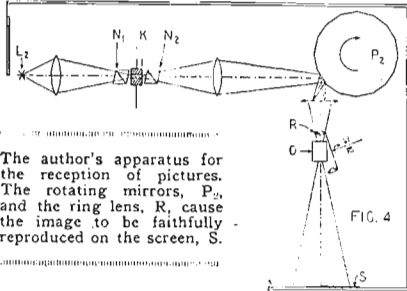

The author's apparatus for the reception of pictures. The rotating mirrors, P_2 , and the ring lens, R , cause the image to be faithfully reproduced on the screen, S .

It is necessary, however, to add still another device, the rotating ring-lens R , which redistributes the lines of the picture into a whole, and causes each successive picture to appear in the same position on the screen. This device, invented by Mr. Büchner, who has employed it successfully in his motion picture projector, is illustrated in the photo-engraving. The objective lens, O , then throws the final reproduced picture on the projection screen, which has a phosphorescent light-receiving surface.

Radio Wrinkles

(Continued from page 149)

I have found this to be quite impractical in cases of wire as fine as No. 35 or 40, as the wire itself is apt to melt. But it can be done by dipping the end in fused potash or soda. A little crucible can be made from a one-piece tin screw cap, from a bottle or can, and a twisted wire used as a handle. A few grains of concentrated lye should be placed in the crucible and melted over a small flame. Caution should be exercised in doing this; for if the lye is heated too rapidly it will spatter. The wire is wound into a small coil and dipped for a minute into the liquid alkali and then immersed in water until all the alkali is dissolved away. The wire should then be straightened out. The remaining enamel is readily rubbed off with a block of soft wood.

Contributed by Charles E. Parker.

Station
WRNY
NEW YORK
258.5 Meters - 1160 kilocycles
is owned and operated by the publishers of this magazine
Our Editors will talk to you several times every week.
See your Newspaper for details
TUNE IN ON WRNY



APPROVED.....
by the most critical eye

Look at the Bosworth, and you will sense an inborn dependability.

Those who actually use it, either as expert radio technicians or ardent broadcast listeners, place their further stamp of approval upon it.

The fan, because he finds that Bosworth Radio gives him good, clear, consistent, dependable reception, night after night, from a multitude of stations.

The technical man, because he recognizes a correctness of construction and engineering which makes these results possible.

Thus it is inevitable that those who know radio, from either angle, are recommending Bosworth to those who are still uncertain.

Two Bosworth models, a six tube set at \$155, and a five tube set at \$115. Write for booklet "A", "The Spirits of Entertainment". Address The Bosworth Electric Mfg. Co., 3750 Montgomery Ave., Cincinnati, Ohio.

BOSWORTH RADIO



GEM TUBE

A Guaranteed Radio Tube Within Reach of All

A tube for a dollar of \$3 value. A trial order will convince you as it has thousands of others. (Blue or Silver with Halobrite Base). Send your orders at once. Orders sent C.O.D. or parcel post.

Types \$1
401A Each
499
499A Each

With Stand and Base All Tubes with UV or UX Bases

Dealers, Write for Discounts

GEM TUBE CO.

(Dept. N.) 200 B'way, N. Y. City
220 So. State St., Chicago, Ill.
Lafayette Bldg., Detroit, Mich.

CARTER
"HI-OHM" Universal Volume Control

\$2

A simple — accurate volume control with unvarying electric characteristics. Contact arm slides on protecting wires covering moisture proof resistance wire. "HI-PO" same size and resistance, with third terminal, \$2.25. Write for illustrated folder and circuit suggestions.

Any dealer can supply

In Canada: Carter Radio Co., Limited, Toronto

Carter Radio Co.
300 S. MICHIGAN AVENUE
CHICAGO, ILL. U.S.A.

PATENTS

DON'T LOSE YOUR RIGHTS
Before disclosing your invention to anyone send for free blank form "EVIDENCE OF CONCEPTION" to be signed and witnessed.

LANCASTER & ALLWINE
Reg. Pat. Atlys. in U. S. and Canada
278 Quay Bldg., Washington, D. C.
Originators of the form "Evidence of Conception"

G-S SILK CORE CRYSTAL DETECTOR

PRICE \$1.50

Write for new descriptive folder.

Man'd by G-S Radio Res. Lab., 1269 Cochran Ave., Los Angeles

Distributors: Scott Sales Co., 443 S. San Pedro St., Los Angeles

OPPORTUNITY AD-LETS

Follow these advertisements every month. Reliable advertisers from all over the country offer their most attractive specials in these columns.

Classified advertising rate twenty-two cents a word for each insertion. Ten per cent discount for 6 issues, 20 per cent discount for 12 issues. Name and address must be included at the above rate. Cash should accompany all classified advertisements unless placed by an accredited advertising agency. No advertisement for less than 10 words accepted.

Objectionable or misleading advertisements not accepted. Advertisements for the October issue must reach us not later than August 1st.

CIRCULATION LARGER THAN THAT OF ANY OTHER RADIO PUBLICATION

EXPERIMENTER PUBLISHING CO., INC., 53 Park Place, New York, N. Y.

Agents Wanted

Big Money and fast sales. Every owner buys gold initials for his auto. You charge \$1.50; make \$1.35. Ten orders daily easy. Write for particulars and free samples. American Monogram Co., Dept. 133, East Orange, N. J.

Guaranteed Genuine Gold Leaf Letters anyone can put on store windows. Large profits, enormous demand. Free samples. Metallite Letter Co., 422 N. Clark, Chicago.

Agents—our super embossed display signs for all stores are tremendous sellers. \$75 to \$100 per week easily made. Write now for details. Artistic Signs, 799-O Broadway, New York.

Radio Catalog sent free on request. Agents wanted to sell 5-Tube Radio set. Radio Specialty Shop, 525 Park Ave., Kent, Ohio.

Amazing Large Cash Commissions introducing beautiful \$2.95 and \$1.95 Fit-to-measure guaranteed shoes. Actual samples furnished. Write for your territory. Style Arch Shoe Co., Dept. 151 I Cincinnati, Ohio.

Aviation

Learn to Fly! Write for booklet, Robertson Aircraft Corporation, Anglum, Mo.

Business Opportunities

Free Book. Start little Mail Order Business. Pier. 996 Cortland Street, N. Y.

Responsible manufacturer wants competent men to manage office and salesmen. \$300 to \$1,500 necessary; will allow expenses to Trenton if you qualify. Address Manager, 556 Forst Richey Bldg., Trenton, N. J.

Chemistry

Learn Chemistry at Home. Dr. T. O'Connor Sloane, noted educator and scientific authority, will teach you. Our home study correspondence course fits you to take a position as chemist. See our full page ad on page 168 of this issue. Chemical Institute of New York, 65 W. Broadway, New York City.

Correspondence Courses

Successful Speaking and reading by famous Robert Downie (Shakespeare Actor). Complete course reduced from ten to five dollars cash. Limited Time. Dietz Press, Richmond, Virginia.

For Sale

Meyer's Tubes Cartridge Type \$1.49. Schedler, 925 Cortland St., North Bergen, N. J.

For Sale: Watchmaker's Lathe at a bargain. R. Jaccardmann, 5815 Easton Ave., St. Louis, Mo.

Help Wanted

Detectives Needed Everywhere. Travel. Experience unnecessary. Write, George Wagner, former Government Detective, 1968 Broadway, N. Y.

Incorporations

Delaware Incorporator, Charters; Fees Small; Forms. Chas. G. Guyer, 901 Orange St., Wilmington, Del.

Instruction

Learn Chemistry at Home. Dr. T. O'Connor Sloane noted educator and scientific authority, will teach you. Our home study correspondence course fits you to take a position as chemist. See our full page ad on page 169 of this issue. Chemical Institute of New York, 65 W. Broadway, New York City.

Miscellaneous

I Catch from 45 to 60 Foxes in from 4 to 5 weeks' time, can teach any reader of this magazine how to get them. Just drop me a card for particulars. W. A. Hadley, Stanstead, Quebec, Canada.

Mr. Manufacturer, laymen or veteran—Slide Dump Scramer Hoist, loads wagons, does dishing. E. B. Hawkins, Applegate, Oregon.

Three Collection Letters That Actually Collect: "padding", 23 years' experience, \$2.50. Address J. A. Hillsman, Lynchburg, Va.

Art Photos 4 \$1.00. Names, Cuts. GPO Box 471, N. Y.

Motorcycles, Bicycles

Don't Buy a Bicycle Motor Attachment until you get our catalog and prices. Shaw Mfg. Co., Dept. 6, Galesburg, Kansas.

Old Coins

German Gov't Bond 5,000,000 Mk. 1921, \$1.50. 2,000,000 Mk Bond 1923, \$5.00. 500,000 Mk. Bill and Catalogue, 10c. Norman Shultz, Colorado Springs, Colo.

California Gold Tokens—Quarter Size 27 cents; half dollar size 53 cents. Catalogue and 500,000 German Mark Bill 10 cents. Alexis Mengelle, Colorado Springs, Colorado.

Old Money Wanted

\$2 to \$500 each paid for hundreds of Old or Odd Coins. Keep all old money, it may be very valuable. Send 10c for New Illustrated Coin Values Book, 4x6. Guaranteed prices. Get posted. We pay Cash. Clarke Coin Company, 14 Street, LeRoy, N. Y.

Patent Attorneys

Inventors—Should write for our Free Guide Books and "Record of Invention Blank" before disclosing inventions. Send model or sketch of your invention for our Free Inspection and Instructions. Radio, Electrical, Chemical, Mechanical and Trademark experts. Terms reasonable. Victor J. Evans & Co., 922 Ninth, Washington, D. C.

Patents. Send drawing or model for examination and report as to patentability. Advice and booklet free. Highest references. Best results. Promptness assured. Watson E. Coleman, Patent Lawyer, 644 G Street, N. W., Washington, D. C.

Patents—Send for form "Evidence of Conception" to be signed and witnessed. Form, fee schedule, information free. Lancaster and Allwine, Registered Patent Attorneys in United States and Canada, 269 Outray Bldg., Washington, D. C.

Patent-Sense—As one of the oldest firms in America we give inventors, at lowest consistent charge, a service not for results, evidenced by many well-known Patents of extraordinary value. Book, Patent-Sense, free. Lacey & Lacey, 644 F St., Washington, D. C. Estab. 1869.

Patents

Inventions Commercialized. Patented or unpatented. Write Adam Fisher Mfg. Co., 278 Enright, St. Louis, Mo.

Patents For Sale

Mr. Inventor. If you have a patent or invention for sale. Write Hartley, 38 Court St., Bangor, Me.

Printing Outfits and Supplies

Print your own cards, stationery, circulars, paper, etc. Complete outfits \$3.85; Job Presses \$12, \$35; Rotary \$150. Print for others, big profit. All easy, rules sent. Write for catalog presses, type, paper, etc. Press Company, A-13, Meriden Conn.

Radio

Amateurs Handbook, contains best radio articles from "Radio News", 128 pages, size 9x12 inches, valuable, instructive. Price 70c. Sold everywhere. Experimenter Pub. Co., Inc., 53 Park Place, N. Y.

500 Radio Wrinkles. Just off the Press. Hints, helps for every Radio User. 100 pages, illustrated, size 9x12 inches. Price 50c. Sold everywhere. Experimenter Pub. Co., Inc., 53 Park Place, N. Y.

Build a Lifetime "B" battery from my better Edison Elements. With welded connections, 7c pair. Sample cell 10c. Paul Mills, Woodburn, Oregon.

Boys! Don't Overlook This. The "Rasco" Baby Detector. Greatest detector ever brought out with molded base. Fully adjustable. See former advertisements in this publication, or our catalog. Detector with Galea Crystal, complete 50c, the same detector with Radiocite Crystal, 75c prepaid. Send for yours today. Radio Specialty Company, 56-98 Park Place, New York City.

Radio (Continued)

Attention!—50 Vacuum tube hook-ups. The greatest collection of vacuum tube circuits ever brought under two covers at such insignificant cost. These diagrams will be found in the great "Rasco" catalog, which contains raw materials and parts in a greater profusion than any other catalog. 15c in stamps, or coin, will bring the catalog to you. Radio Specialty Co., 96-98 Park Place, New York City.

New Broadcasting Generators, 500 volt \$15.00 each. Jawitz Company, 137 Centre Street, N. Y.

Free a sample of Ivorylite, the new ivory radio panel. It's the finest, most beautiful panel made. And LOOK it can be cut any size you want and only costs 3c square inch. Write today for FREE sample and complete description. Ivorylite Radio Panel Co., 8222 Ave. F, Fort Worth, Texas.

"Cape Antenna Spreaders" for sale. Full particulars upon request. Charles F. Jacobs, 279 Park Place, Brooklyn, N. Y.

A Two Dollar bill will bring you a 50H-60MA Filter (Cable Cull). Write for list. Radio Parts Sales Co., Box 24, Orange, N. J.

Construction of Broadcast and Amateur Transmitters a specialty. Short Wave Tuners or Wavemeters. Get our Prices. Strobel & Co., 3923 N. Sixth St., Phila., Pa.

Salesmen Wanted

A Salesman wanted in every town or city within 25 miles of a broadcasting station to sell Radiogem, the complete radio receiving set that retails for \$2.50. With Radiogem there is nothing else to buy—the outfit includes the Radiogem receiving apparatus, 1,000 ohm phone, and aerial outfit. The cheapest radio outfit on the market—yet as practical as the most expensive. Big money to the right men. Send \$2.00 for sample outfit. The Radiogem Corp., 66-B West Broadway, New York City.

Scenery to Rent

Settings for Opera, Plays, Minstrels. Plush Drops. Address Amelia Grain, Philadelphia.

School of Electricity

Electricity—Short day or evening courses in Electricity, Drafting, Engineering, and Architecture. In Chicago earn while you learn. Part Time positions pay expenses. Faculty of experts. Special short courses. Diplomas in 2 years. B.S. Degree in 3 years. Small classes, individual instruction. 22 year old institution with thousands of successful graduates. Enter any time. Employment bureau. Moderate tuition—monthly payments. New College building—all athletics. All details in 72 page "Blue Book." A copy will be sent to you free. Write today. Chicago Technical College, Dept. 27, 113 E. 29th St., Chicago, Ill.

Song Writers

Songwriters: Let me furnish the music for your songs, guaranteeing you absolute satisfaction. Copyrights secured. Submit your scripts for estimate and free advice. Walter W. Newcomer, 1674 Broadway, New York.

Stammering

Stop Stammering, increase salary. Descriptive booklet free. Samuel Robinson, 309 Boylston St., Boston.

St-tut-t-tering and stammering cured at home. Instructive booklet free. Walter McDonnell, 121 Arcade, 1126 Grandville Avenue, Chicago, Ill.

Stamps and Coins

Newfoundland Stamps on approval. None better—none cheaper. Send want list and references. Rev. Butler, St. Georges, Newfoundland.

Telegraphy

Telegraphy—Both Morse and Wireless taught thoroughly. Big salaries. Wonderful opportunities. Expenses low. chance to earn part. School established fifty years. Catalog free. Dodge's Institute, Cour St., Valparaiso, Ind.

Wanted to Buy

Full Value Paid for Old Gold, Jewelry, Watches, Diamonds, crowns, bridges, dental gold, silver, platinum, gold or silver ore; magnetite points, old false teeth. Packages returned if our offer is not satisfactory. United States Smelting Works (The Old Reliable) 39 So. State St., Dept. 16, Chicago, Ill.

user to employ any type of tube; that is, UX-199 with UX-120 in the last audio stage, or UX-201-A with UX-112 in the last stage.

PARTS REQUIRED FOR INVERSE-DUPLEX

- 3 Variable condensers, .0005- μ f.,
 - 3 Vernier Dials, 4-inch,
 - 3 R.F. Transformers,
 - 1 high-ratio A.F. Transformer, 5-to-1,
 - 2 low-ratio A.F. Transformers, 2-to-1
 - 1 panel, 7x24 inches,
 - 1 sub-panel, 7x23 inches,
 - 3 or 4 shelf-supporting brackets,
 - 1 open-circuit phone jack,
 - 1 inductance switch,
 - 1 rheostat, 10-ohm,
 - 1 D.P.D.T. Jack Switch,
 - 3 Fixed Condensers, .00025- μ f.,
 - 3 Fixed Condensers, .002- μ f.,
 - 1 Grid-Leak, 3-megohm.
 - 3 Sockets, UX-199,
 - 1 Socket, UX type,
 - 1 R.F. Choke Coil,
 - 1 non-inductive Variable Resistance, 2,000-ohm,
 - 1 Cabinet,
 - Wire, binding posts, solder, screws, nuts, etc.
- Estimated cost, not over \$40.00.

**A Radio Cabinet of Beauty and Elegance
Direct to You at
Lowest Cost**



Lid splined both ends to prevent warping
Nickel-plated piano hinge—Full length.
Nickel-plated lid support of artistic design.
Anti-vibration cushion feet (not visible in cut).

Edges of lid moulded to match bottom.
Shipped securely packed in strong carton.
Prompt shipment. Big stock for holidays.

	Hard-wood Solid	Rubbed Black	Mahog-Artic-ony Iron	Finish Walnut
7x18x7 1/2 or 10 in. deep	\$3.50	\$3.00		
7x21x7 1/2 or 10 in. deep	3.75	5.25		
7x24x7 1/2 or 10 in. deep	4.00	5.50		
7x26x7 1/2 or 10 in. deep	4.75	6.25		
7x28x7 1/2 or 10 in. deep	5.50	7.00		
7x30x7 1/2 or 10 in. deep	6.00	8.00		

Add 25c for "E-Z" Phone Plug.

Cash with Order or C.O.D. if 1/4 of price is sent with order. Prices F.O.B. Hickory, N.C. Order express shipment, often cheaper than mail and much safer from damage. Free with Each Cabinet a glued-up stock non-warping 3/4-inch baseboard. Free Catalogue.

THE SOUTHERN TOY COMPANY, INC., Dept. N., HICKORY, NORTH CAROLINA

Let's Use Ultra-Short Waves

(Continued from page 153)

Two copper rods, about 1/4-inch, are used, one for the antenna and one for the counterpoise. These are brought fairly near each other and the lead-ins taken from the ends that are adjacent. The length of these rods depends upon the wave-length used.

It has been mentioned above that the wave-band in the 0.75-meter neighborhood is for beam transmission and this brings us to the subject of reflectors. These reflectors should be parabolic in shape and their length should be one-fourth longer than the combined length of the antenna and counterpoise. However this length is very approximate, and it will be necessary to experiment before satisfactory transmission can be obtained.

As the main feature of beam transmission is its directional property, and as the average ham does not want all his transmission to go in one direction, it is recommended that some sort of a rotatable base be arranged, so that the sigs will go out to any point of the compass the ham may wish.

There have been many circuits for ultra-short wave transmitters and receivers published heretofore; and the ham is urged to experiment with a standard hook-up before venturing out on his own. After transmission on a "true and tried" circuit has been successfully accomplished, then will come the time when the real sport will start for the ham. There has been mighty little experimenting done down in these low-wave channels by the ham circles, so why not give it a whirl yourself? You can never tell what circuit or arrangement of apparatus you might stumble on which will repay you many, many times for the time and trouble that you have spent in its development. For further information on short wave transmitters and receivers see the March, 1925, issue of RADIO NEWS.

TIGHT!

The report that the Scotch use only close coupling has not yet been verified.
—Contributed by William G. Mortimer.

Quickly demonstrate your sets in apartments, houses, hotels, offices, hospitals, etc.

APPROVED RADIO NEWS SEPTEMBER 1926

POPULAR RADIO BROADCAST

Campers, tourists, resorters, fishermen, picnickers! Just what you are looking for!

**REEL OUT the Aerial---
PULL IN the Programs---
REEL IN when Through!**

No more hours wasted putting up or taking down antennas. No lead-ins to solder. No holes to drill. No tangle of wire. Carry a 21-ounce REEL AERIAL in pocket and put up a 100% efficient aerial in a few moments—any time, any place—outdoors, indoors. Its hard drawn PLAT copper wire (3/4-in. wide) can be fed in under or over window or door which can be closed tight without harm to wire. Aerial can be reeled out or in to any desired length up to 100 ft. Unused portion in case does not cause dead-end losses. Place case on or near set and connect with cord which plugs into center of Reel Aerial. Order today. Satisfaction Guaranteed. DEALERS, JOBBERS? Write for attractive literature and proposition. Use Reel Aerials in making free trial demonstrations. Sell Reel Aerials to people going away on vacations, to experimenters, etc.

SEND NO MONEY, JUST MAIL COUPON

HAWKEYE RADIO CO. Division of Hawkeye Lighting Rod Co., Dept. 1408, Cedar Rapids, Iowa.

Ship me—on your MONEY BACK GUARANTEE—one Reel Aerial C.O.D. I will pay postman \$5 plus few cents postage (postage prepaid when money accompanies order).

NAME

ADDRESS

You are dealing with an old reliable firm. SEND THE COUPON NOW!

Illustration is 1/2 size. Reel Aerial weighs only 21 oz. Nickel case, 4 1/4 in. dia. Fits pocket. Contains 100 ft. 3/4-in. flat copper wire—best antenna known.

Fasten long cord with weight on it to insulator on REEL AERIAL. Throw weight over limb of tree. Reel out as long an aerial as you wish and attach to set with cord which plugs into center of REEL AERIAL.

For indoor aeri-als—can be put up around walls or reeled out on floor.

For use in halls, theatres, laboratories, schools, clubs, on trains, at fairs, etc.

Special Library of Information
on
RADIO PATENTS
and
TRADE MARKS

JOHN B. BRADY
Patent Lawyer

Ouray Building Washington, D. C.

Cable address: RADIOPAT Telephone: Main 4806

Rubber Covered Insulators

Actual Size

Neat and efficient. For antenna, ground and for lead in wires. Small screw starts readily and makes finished job. Great improvement over ordinary large, unsightly insulators. They keep the wires in place and out of the way. Packed 10 in a box, 25c at your dealers or direct from us.

CULVER-STEARN'S MFG. CO.
Worcester, Mass., U. S. A.

Insure your copy reaching you each month. Subscribe to Radio News—\$2.50 a year
Experimenter Publishing Co., 53 Park Place, N. Y. C.

Contents of ACME B-Eliminator Kit

Wiring Diagrams with complete instructions Baseboard.

- 1 Acme B-4-Transformer
- 2 Acme B-2-30 Henry Chokes
- 1 Acme Condenser Block
- 1 Bradleyohm
- 1 Raytheon Tube and Socket
- Wire

PRICE \$39.50

Photo at right—Acme B-Eliminator, assembled from kit.

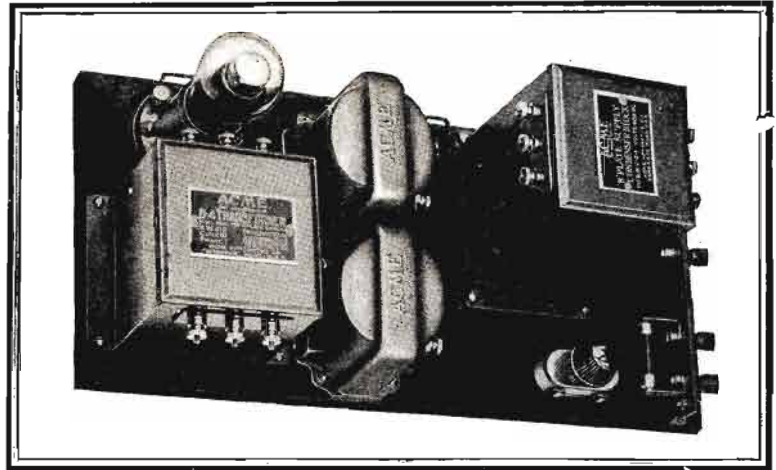

Photo below of factory-made Acme B-Eliminator Type E-1—110 Volts, 60 cycle. Type E-2—110 Volts, DC, \$20.



PRICE
\$50.00

You can easily make this Acme B-Eliminator yourself

The New Acme B-Eliminator Kit contains complete instructions and all parts

GET one of the new Acme B-Eliminator Kits—take it home and lay out the full size diagrams on the table in front of you. It only takes a few minutes to fasten the parts to the baseboard and connect them up. All the parts are there and the baseboard too, and easily-followed instructions that explain each step. It's as easy as rolling off a log. You fellows who have tinkered with radio will do it in less time than it would take to tell about it.

Then you'll have an Acme B-Eliminator and save the difference between the cost of the Kit and a factory-built Acme B-Eliminator.

Advantages of the Acme B-Eliminator

You get better quality and more distance, more volume, and no hum and no distortion. You can be sure of that. Also the Acme B-Eliminator maintains its voltage at all times

and you get voltages up to 180 volts which prevents any chance of over-loading. It will supply sets using up to 10 tubes.

A permanent B-Supply

When you invest in an Acme B-Eliminator you get a permanent B-Supply. No more running out to get new B Batteries. There's nothing to wear out—the Raytheon Tube used has no filament to burn out and will last for thousands of hours—the current cost is practically nothing.

Send coupon for both booklet and circular

Send 10c for our booklet, "Amplification without Distortion," which will tell you some things about improving the quality of your radio reception, together with special free circular on the B-Eliminator Kit, or ask us to mail the free circular. Check the coupon.

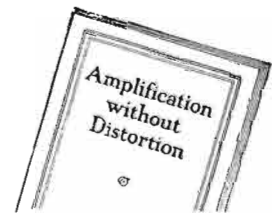

ACME

~ for amplification

ACME APPARATUS COMPANY,
Dept. K17, Cambridge, Mass.

- () I enclose 10c for copy of your booklet, "Amplification without Distortion" and circular on the B-Eliminator Kit.
- () Please send only free circular on B-Eliminator Kit.

Name

Street

City State

THE PICTURE RECEIVING APPARATUS

Fig. 4 shows the construction of the receiver, which is more complicated. The light emanating from the source L_2 is varied in intensity in direct proportion to the incoming signal impulses, and passes through the Kerr cell, K , with its two Nicol prisms, N_1 and N_2 . The insertion of the rotating polygonal mirror, P_2 , causes the luminous ray to traverse the lines indicated by the arrows, thus reconstituting the picture in every line and point into which it was decomposed at the transmitting station.

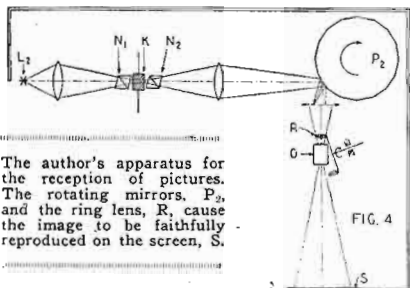

The author's apparatus for the reception of pictures. The rotating mirrors, P_2 , and the ring lens, R , cause the image to be faithfully reproduced on the screen, S .

It is necessary, however, to add still another device, the rotating ring-lens R , which redistributes the lines of the picture into a whole, and causes each successive picture to appear in the same position on the screen. This device, invented by Mr. Büchner, who has employed it successfully in his motion picture projector, is illustrated in the photo-engraving. The objective lens, O , then throws the final reproduced picture on the projection screen, which has a phosphorescent light-receiving surface.

Radio Wrinkles

(Continued from page 149)

I have found this to be quite impractical in cases of wire as fine as No. 35 or 40, as the wire itself is apt to melt. But it can be done by dipping the end in fused potash or soda. A little crucible can be made from a one-piece tin screw cap, from a bottle or can, and a twisted wire used as a handle. A few grains of concentrated lye should be placed in the crucible and melted over a small flame. Caution should be exercised in doing this; for if the lye is heated too rapidly it will spatter. The wire is wound into a small coil and dipped for a minute into the liquid alkali and then immersed in water until all the alkali is dissolved away. The wire should then be straightened out. The remaining enamel is readily rubbed off with a block of soft wood.

Contributed by Charles E. Parker.

Station
WRNY
NEW YORK
258.5 Meters - 1160 kilocycles
is owned and operated by the
publishers of this magazine
Our Editors will talk to you
several times every week.
See your Newspaper
for details
TUNE IN ON
WRNY



APPROVED.....
by the most critical eye

Look at the Bosworth, and you will sense an inborn dependability.

Those who actually use it, either as expert radio technicians or ardent broadcast listeners, place their further stamp of approval upon it.

The fan, because he finds that Bosworth Radio gives him good, clear, consistent, dependable reception, night after night, from a multitude of stations.

The technical man, because he recognizes a correctness of construction and engineering which makes these results possible.

Thus it is inevitable that those who know radio, from either angle, are recommending Bosworth to those who are still uncertain.

Two Bosworth models, a six tube set at \$155, and a five tube set at \$115. Write for booklet "A", "The Spirits of Entertainment". Address The Bosworth Electric Mfg. Co., 3750 Montgomery Ave., Cincinnati, Ohio.

BOSWORTH
RADIO



GEM TUBE

A Guaranteed Radio Tube Within Reach of All

A tube for a dollar of \$3 value. A trial order will convince you as it has thousands of others. (Blue or Silver with Bakelite Base). Send your orders at once. Orders sent C.O.D. with UV. or parcel post	Types \$1 401A 400 499 499A Each With Stand-ard Base All Tubes with UV. or UX Bases
--	---

Dealers, Write for Discounts

GEM TUBE CO.

(Dept. N.) 200 B'way, N. Y. City
220 So. State St., Chicago, Ill.
Lafayette Bldg., Detroit, Mich.

CARTER
"HI-OHM" Universal Volume Control

\$2

A simple - accurate volume control with unvarying electric characteristics. Contact arm slides on protecting wires covering moisture proof resistance wire. "HI-POT" same size and resistance, with third terminal, \$2.25. Write for illustrated folder and circuit suggestions. Any dealer can supply

In Canada: Carter Radio Co., Limited, Toronto

Carter Radio Co.
700 & 800 EAGLE AVENUE
CHICAGO, ILL. U.S.A.

EVIDENCE OF CONCEPTION

PATENTS

DON'T LOSE YOUR RIGHTS
Before disclosing your invention to anyone send for free blank form "EVIDENCE OF CONCEPTION" to be stored and witnessed.

LANCASTER & ALLWINE
Reg. Pat. Attys. in U. S. and Canada
270 Durray Bldg., Washington, D. C.
Originators of the form "Evidence of Conception"

G-S SILK CORE
CRYSTAL DETECTOR

PRICE \$1.50

Write for new descriptive folder.

Man'fd by G-S Radio Res. Lab., 1269 Cochran Ave., Los Angeles

Distributors: Scott Sales Co., 443 S. San Pedro St., Los Angeles

\$75 A WEEK
BUILDING RADIO SETS
In Your Spare Time

Join the Radio Association of America. Learn how to build and repair sets. The Association will train you—start you out in business, if you wish. Be the radio "doctor" of your community. \$3 an hour upwards easily made.

EARN \$500 IN SPARE HOURS

"I have at last found myself," writes Lyle Follick, Lansing, Mich. "I have already made over \$500." Werner Eichler, Rochester, N. Y., writes, "... have made over \$50 a week in my spare time." Our members are starting radio stores, increasing their salaries, securing better positions, passing radio operator examinations, earning big money in spare time.

JOIN ASSOCIATION NOW!

Are you interested in Radio for pleasure or profit? Join now because we have a Special Plan whereby your membership need not cost you a cent. Only limited number of these memberships acceptable. Write now for details—before it is too late.

Mail This Coupon

Radio Association of America,
 Dept. 138, 4513 Ravenswood Ave., Chicago
 Send me details of your Special Radio Association Membership Plan.
 Name
 Address
 City State

ATWATER KENT
RADIO

Are Portable Sets Really Practical?

(Continued from page 119)

sirable and practical. Three of these can be operated for some time from an ordinary 3-cell flashlight battery. If greater length of operation on one set of batteries is desired, connect two such batteries in parallel. For a "B" battery on a set of this nature, use the very smallest size available. For the hiker's set employing only a single tube, one 22½-volt "B" battery block will be found quite satisfactory for all-around use.

In order to get the best operation, it is wise to try out several of the UX-199 tubes in order to determine which one operates best as a detector on the low plate voltage. When it has been determined, take good care of this particular tube.

Although great advances have been made in current-supply devices operating from house lighting circuits, not one of them is practical in connection with portable receivers. Furthermore, such supply devices will probably never be perfected so that they can be used with portable receivers, because they are inherently bulky and heavy.

CIRCUIT TO BE USED

One question often asked of radio editors is "What type of circuit should I use for building a portable receiver, using so and so many tubes?" This is a question that the propounder could very easily answer for himself, if he would only stop and consider the situation for a moment. There is no circuit that can be designated as a "portable circuit." Any standard hook-up can be applied to the building of a portable set. For the constructor the following hints will be of value.

First determine the number of tubes you are going to employ. Then build the set



AEROVox
"Built Better"
LAVITE RESISTANCES
 Used by over 200 of America's leading set manufacturers. AEROVox Fixed Mica Condensers have been approved by M. I. T., Yale, Radio News, Popular Radio and Popular Science.
AEROVox WIRELESS CORP.
 489-491-493 Broome St., New York
Branch Offices:
 St. Louis, Mo., Syndicate Trust Building
 Cincinnati, O., 304 Palace Theatre Bldg.
 Chicago, Ill., 53 W. Jackson Boulevard
 Boston, Mass., 94 Portland Street
 Los Angeles, Cal., 324 N. San Pedro St.

PATENTS C. L. PARKER
 Formerly Member
 Examining Corps,
 U. S. Patent Office.
 PATENT - LAWYER
 McGill Bldg., Wash., D. C.
Patents, Trade Marks, Copyrights, Patent Litigation
 Handbook for Inventors, "Protecting, Exploiting and Selling Inventions," sent upon request.

150 Radio Hookups!

NEW!

The choicest selection of modern circuits obtainable

WHAT more could you ask?—150 of the very finest, selected hook-ups most popular today. Each one completely explained and fully illustrated so that complete receiver can be constructed at home. No out-of-date Hookups—all the finest and best in common use today.

It is compiled by the staff of RADIO NEWS.
 The book contains 64 Pages, all illustrated, and is printed in the large size 6 x 9 inches.
 Don't miss this opportunity—All Radio and News dealers have fresh copies Now. If there is no dealer near write us direct enclosing 25 cents.

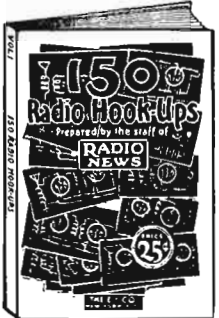

Published by the
E. I. COMPANY, Inc.

Distributed by
 The Consrad Company, Inc., 64 Church St., New York, N. Y.

25¢ ON ALL NEWSSTANDS

Consrad
 THE LARGEST PUBLISHERS OF RADIO BOOKS AND PATTERNS

using your own particular pet circuit; or if you do not have such a thing on your mind, stick to a standard circuit of any type. For a three-tube set, probably the best arrangement is to employ a standard regenerative tuner and two stages of A.F. amplification. If four tubes are to be employed, use one stage of tuned R.F. amplification, a regenerative detector, and two stages of audio. For five or six tubes, a standard circuit in which the antenna and detector circuits are tuned and the intermediate stage or stages are untuned, will be found quite satisfactory.

Although the term super-heterodyne is usually associated in the mind of the layman with a large receiver resembling a coffin in size, still several recent magazine articles have described portable super-heterodyne receivers (see page 46, RADIO NEWS for July, 1926.) It may be necessary for you to change slightly the mechanical construction in order to make the set fit some particular case that you may have on hand; but, in general, any compact layout can be followed.

Aside from home-made portable sets there are commercially manufactured receivers to be considered. Most of these are satisfactory only from the standpoint of the automobilist. Although they are termed portable, and are entirely self-contained, still they certainly require an automobile for transportation where the distance to be covered exceeds two ordinary city blocks. There are, however, some excellent portable receivers on the market, such as those illustrated in this article. The science of making a good single-control set has been carefully studied and the results have been employed in several portable sets.

One of those shown weighs 53 pounds complete with all accessories and with built-in loud speaker. It has several noteworthy features, such as a meter for reading both "A" and "B" battery voltages. Although it is equipped with a loop contained in the fold of the cover, it is also supplied with an antenna coil by which the set can be adapted to an outside aerial and ground. This particular receiver employs five UX-199 tubes, and one UX-120 tube in the last stage of audio. The tubes are all run on dry cells contained within the cabinet.

A good loop receiver is, without a doubt, the best for all-around work where a portable set is wanted; but unless it is really good, it is useless. Therefore, we would not advise any embryo radio fan of little or no radio constructional experience to try to build such a set. Better stick to the conventional types of sets with fewer tubes and put up with the small inconvenience of having to erect an aerial or use a makeshift. On the other hand, if you want to buy a radio set ready built, you cannot go wrong in buying one that is made by a reliable concern.

The subject of loud speakers to be used in connection with portable sets cannot be treated in great detail, because there is not much room inside such a set for the placement of a speaker. When you are going to use a portable receiving set, you cannot be too particular about the quality of music that is furnished by it. A very small horn will usually give fairly satisfactory results, and some horns made of moulded material on the market today are especially suitable for portable set use. You can very readily use one of these horns with a standard reproducing unit. Then, too, there are some good little cabinet speakers on the market today, which can be built into a portable set cabinet or carrying case. There is also a loud speaker only five inches high that can be tucked easily in one corner of the cabinet and brought out when you desire to use it. Considering its small size, this speaker gives surprising results and accomplishes the main object of any small loud speaker, which is to make the reproduced sounds directional.

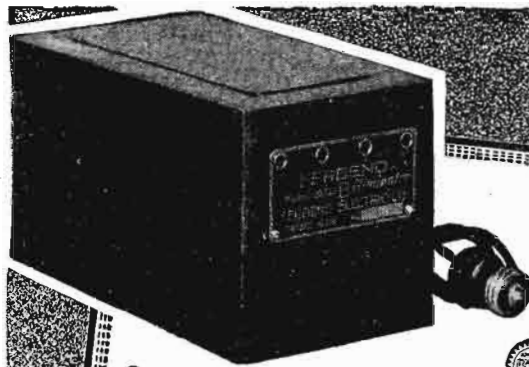

COMPLETE nothing else to buy
Replaces "B" Batteries. Operates Direct from Electric Light Socket, A. C. Power.

\$12.50

FERBEND "B" ELIMINATOR

Superior Results!

Costs scarcely more than new "B" Batteries. You get results combined with first-cost economy.

Operates at maximum efficiency at all times. Noiseless — no hum. Gives FULL WAVE RECTIFICATION. Taps at 22½—45—90 volts. Maximum voltage, 100. (Add "B" Battery for higher voltage.) Cost of operation less than 50¢ a year. Lasts indefinitely. Manufactured, not assembled. Order yours today.

Ask Your Dealer or Send Direct

If you prefer, we will make shipment direct to you upon receipt of price, or C. O. D., if desired. Use for 10 days to convince yourself — if unsatisfactory, write us within that time and your money will be refunded. Use the coupon now.

FERBEND ELECTRIC CO.
425 W. Superior St., Chicago, Ill.

FERBEND Wave Trap

This Company also manufactures the famous Ferbend WAVE TRAP — the instrument which has been widely imitated but never equalled. It is the only original and genuine. Priced at

\$8.50

FERBEND ELECTRIC CO., 425 W. Superior St., Chicago

Send at once. Payment enclosed.
 Send C. O. D. Send Literature.

Name.....
Address.....
City..... State.....

What Users Say:

"246 Florence Ave., Highland Park, Mich. Ferbend Electric Co., April 26, 1926
Gentlemen: My reception is greatly enhanced at least 50% since the installation of the Ferbend Eliminator and, incidentally, I am a very enthusiastic and satisfied customer. Performance is far in excess of excellence that I have ever before experienced with the use of batteries. I am using a tube R. F. (Frankman (Frank)) employing a "C" battery and an at a loss to know how I can at all improve it also using your "B" battery. In fact, I am so pleased that I solicit inquiries from such as may be your prospective customers. I have compared the performance of the "Maxim" with others of the far greater price and find that none produce the clarity of reception as does your instrument.
(Signed) Wilson E. Rogers"

"San Francisco, Calif. April 20, 1926
Ferbend Electric Co.
Dear Sirs: I have been using my "B" Eliminator steadily since I received it, and must say that it lives up to all the claims you make for it. This letter is to thank you for the same.
(Signed) Philip A. Reilly, 1467 Valencia St."

"17 Sewall St., Framingham, Mass. April 12, 1926
Ferbend Electric Co.
Dear Sirs: I have tried the "B" battery Eliminator which I purchased some time ago and find it works satisfactorily in every way. I have recommended this to several radio friends in this locality. I have had it on three different sets of 5 tubes each. Two of these sets are the latest radio frequency and the other is an eight-tube Ferbend set fully neutralized.
(Signed) Edw. A. Browning"

100 AMP. \$10.50 RADIO BATTERY

SEND NO MONEY
2 Yr. Guarantee by Thomas Witherbee
THOMAS BATTERY CORP.
511 W. 50th St., New York, N.Y.

PATENTS

If you have an invention and desire to secure a patent, send for our Evidence of Invention Blank and free guide book, "HOW TO GET YOUR PATENT." Tells our Terms, Methods, etc. Send model or sketch and description of your invention for INSPECTION and INSTRUCTIONS.

No Charge for the Above Information

RANDOLPH & CO., Dept. 459 Washington, D. C.

FREE! — Radio Catalogue

Radio Parts of the Best Quality

1. Right Prices
2. Quick Delivery
3. Dealer Cooperation
4. Complete Stock
5. National Advertising

CHICAGO RADIO APPARATUS
415 South Dearborn Street, Chicago
Dept. RN

Do you know what the B-6 Detector will do for your set?

If not, send for this booklet

B-6 DETECTOR . . . \$5

Manufactured and Sold by
The Donle-Bristol Corporation
 Tremont Street
MERIDEN . CONNECTICUT

Making a Business of Inventions

(Continued from page 124)

tor. Both were carrying on experiments separately unknown to each other, and applied for patents on the same thing. Quite naturally there was difficulty in proving who was the first inventor. All of the records of the experiments of both men were carefully examined by the courts in determining which was actually the first inventor. Of course, all experienced inventors are well informed as to the necessity of careful records, but the average inexperienced worker fails to protect himself in this manner as he should.

A United States patent is issued to the inventor who first invents the particular device. The patent is not issued, as many people believe, to the inventor who first files an application for a patent. This is the rule in some foreign countries, but here, of course, there is a limit on the time allowed to file an application for a patent. The safe plan is to file it as soon as the invention is sufficiently perfected to establish an advantageous and desirable date in the Patent Office records.

A very peculiar incident happened when Alexander Graham Bell filed his application for a patent on the telephone. Another inventor also filed an application for practically the same invention on the same day, only a few hours after Dr. Bell's application was registered. At that time there was a provision for inventors to file a record ("caveat") of their inventions previous to perfecting them and this is what Dr. Bell's rival filed. Therefore, after considerable litigation the patent rights to this valuable invention (which netted the inventor \$50,000,000) were awarded to Dr. Bell, who displayed records and other evidence which convinced the courts that he really preceded his rival in perfecting the invention.

Many other similar cases could be recited where knowledge of the patent laws has been especially advantageous to inventors. It does not pay to undertake any business blindly and without information on the subject. So it is with the patent business or the business of invention. A close study should be made of the different angles of the situation, so that you may know what to do at the proper time. It means increased profits from patents, and not only that but it may make the difference between success and failure.

100 Volt Storage "B" Battery \$10

Everybody can now enjoy the benefits of Storage "B" Batteries—more power, quieter reception, greater economy. Rubber case prevents leakage or shorting. Easy to recharge. Lasts years with ordinary care.



SERVICE "A" AND "B" CHARGER

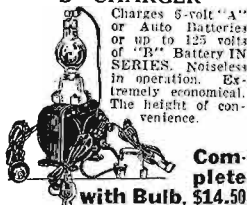

Charges 5-volt "A" or Auto Batteries or up to 125 volts of "B" Battery IN SERIES. Noiseless in operation. Extremely economical. The height of convenience.

Complete with Bulb, \$14.50

SERVICE STORAGE "B" BATTERIES IN ALL RUBBER CASES

50 Volts	\$5.50	100 Volts	\$10.00	125 Volts	\$12.50
Prices in Canada					
50 Volts	\$7.75	100 Volts	\$14.50	125 Volts	\$17.00

SERVICE "A" BATTERIES

Indestructible rubber case. Two year guarantee
 6 Volt 100 Amp. hr. \$14.00, 6 Volt, 120 Amp. hr. \$16.00

SERVICE BATTERY CO. of Canada 137 Roncesvalles Ave. Toronto, Ontario

SERVICE BATTERY CO.

704 EAST 102nd STREET CLEVELAND, OHIO

LEARN THE CODE AT HOME

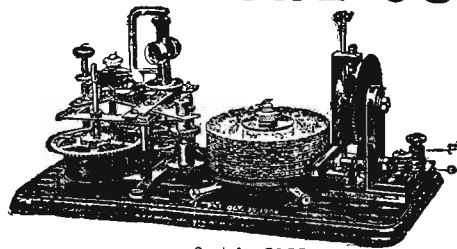

WITH THE OMNIGRAPH

THE OMNIGRAPH Automatic Transmitter will teach you both the Wireless and Morse Codes—right in your own home—quickly, easily and inexpensively. Connected with Buzzer, Buzzer and Phone or to Scammer, it will send you unlimited messages at any speed, from 5 to 50 words a minute.

THE OMNIGRAPH is not an experiment. For more than 13 years, it has been sold all over the world with a money back guarantee. The OMNIGRAPH is used by several DEPTS. of the U.S. Gov.—in fact, the Dept. of Commerce uses the OMNIGRAPH to test all applicants applying for a Radio license. The OMNIGRAPH has been successfully adopted by the leading Universities, Colleges and Radio Schools.

Send for FREE Catalog. **DO IT TODAY.**
THE OMNIGRAPH MFG. CO., 15 HUDSON STREET, NEW YORK CITY
 If you own a Radio Phone set and don't know the code—you are missing most of the fun

BRANT BATTERY COMPANY
 Manufacturers of the
BRANT CHARGEABLE BATTERIES
 1622 W. Venice Blvd., Los Angeles Cal.

64 Illustrated Pages of Radio Bargains!
 Write for Catalog Today
RANDOLPH RADIO CORP.
 159 N. UNION AV. Dept. 2 CHICAGO, ILL.

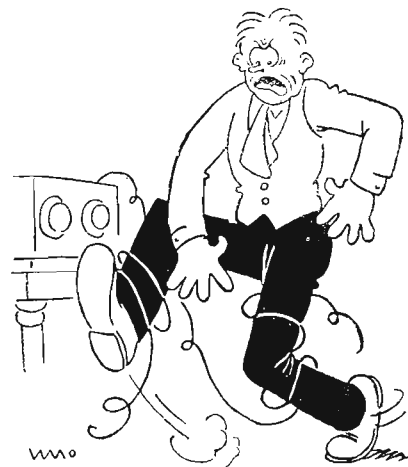

"Now I know why they quit calling it wireless and call it Radio!"

Insure your copy reaching you each month. Subscribe to Radio News—\$2.50 a year. Experimenter Publishing Co., 53 Park Place, N. Y. C.

An Inverse-Duplex Receiver for the Home Constructor

(Continued from page 139)

tained from a UX-120 tube, he may use a UX-112 tube with its filament operating from the A.C. house mains. This can be done by using an ordinary 8-volt bell-ringing transformer as shown in Fig. 6. A 400-ohm potentiometer is used to obtain the electrical midpoint of the filament. This balances out the A.C. hum which would be obtained otherwise. Due to the fact that the "C" battery is connected to the "neutral" point instead of to the negative side of the

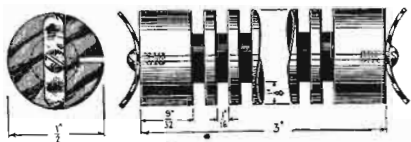

Dimensions are here given for the choke coil.

filament, 3 to 4½ volts of "C" battery must be added to the usual amount used. Thus for 90 volts of "B" battery use a 9-volt "C" battery; and for 135 volts of "B" battery use 12 volts of "C" battery.

If the prospective builder of the receiver already has a storage battery and charger he

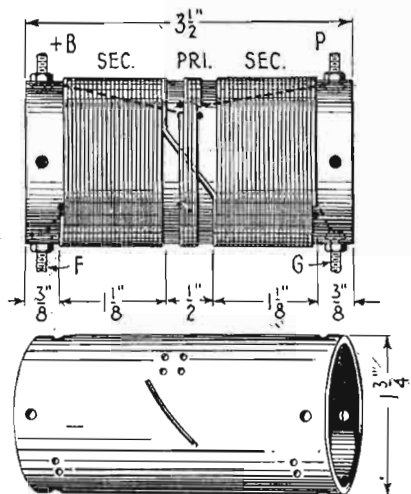

FIG. 5

The dimensions and method of winding the R.F. transformers

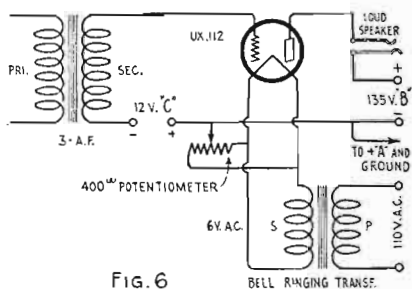
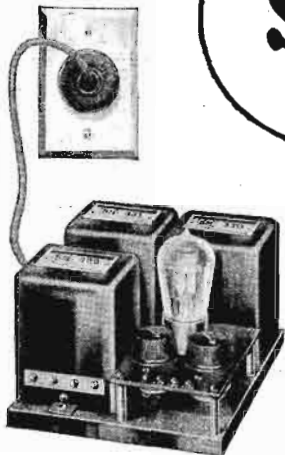

FIG. 6

The circuit diagram for the A.F. power amplifier operating from a source of 110-volt A.C. current.

may use storage battery tubes. In any case it might be a good idea to equip the set with the new UX sockets. This will enable the

SM "PLUG-IN-B"



The Silver-Marshall type 650-B gives the highest power, the best regulation (constant output) regardless of number of tubes used, and greatest freedom from hum of any power supply you can buy. It will supply from 25 milliamperes at 300 volts to 90 milliamperes at 190 volts—more than enough for the largest set. In it is incorporated the S-M 331 Unichoke—probably the greatest single advance made in "B" eliminator design since the Raytheon tube.

The S-M "Plug-In B" will operate any type of set, no matter what it is. It will handle the largest power tubes (especially the new UX171 soon due), and it will supply "A" and "C" power for audio amplifier tubes, too.

The "Plug-In B" never runs down, never is noisy—and will give constant, ample power long after you've spent three or four times its cost for dry cells. It is completely assembled, and requires the connection of a few wires, using only a screw-driver, to put it in operation.

Price, with genuine guaranteed Raytheon tube, \$35.00.

THE 220 and 221 AUDIO TRANSFORMERS

A Silver-Marshall audio transformer with a guarantee!—nothing less than a promise that it's better than anything you've ever heard—bar nothing.

The 220 audio, and 221 output transformers, are designed for the new power tubes as well as present day tubes.

Big, husky, solid—they usher in a new principle in audio equipment—the falling high frequency characteristic that means no hiss or noise—and quality such as you've simply never heard.

A pair of 220's and a 221 put into your present set will convince you of what radio reception can be. And remember, these transformers are unconditionally guaranteed to give better quality than any audio amplifier you've ever heard—resistance, impedance, any type at all. \$6.00.

"THE SECRET OF QUALITY"

Have you your copy of "The Secret of Quality?" This book tells you simply and concisely, how to get the most out of your audio amplifier—how to get real quality. It contains laboratory data never before available even to many manufacturers. It is the only authoritative treatise on all types of audio amplification written in non-technical language ever published.

It's free! Ask your dealer for a copy or write for it.

SILVER-MARSHALL, Inc.

848 West Jackson Blvd.

CHICAGO, U. S. A.



Chargers



Acme Dreadnought Type A. D.-6, capacity six-6 volt batteries, charging rate 5 amperes. Transformer type. Automatically restarts on line interruption. Sheet steel case finished in black lacquer. Very efficient and economical to use. Price—\$59 complete with bulb—\$66. West of the Rockies.



Acme Trickle Charger Type AT-1 delivers a charging current of 1/2 to 3/4 amperes and consumes 25 to 40 watts of energy. Uses a two ampere bulb. Has a specially designed transformer with independent windings. Enclosed in a sturdy, attractive case of sheet steel, finished with crystallized lacquer and mounted on rubber feet. Price with cord attachment and without bulb only \$6.00. 2 ampere bulb \$4.00 extra.

Acme Chargers are the only quality chargers on the market selling at such low popular prices. Ideal for the home and the radio shop. Built on the principle advised by leading battery authorities which the Acme proves to be Best By Test.

Delivers maximum charging current with minimum current consumption.

Order today. Satisfaction guaranteed.

We offer Jobbers an interesting proposition.

The Acme Electric & Manufacturing Co. *Manufacturing for Ten Years*

1412 Hamilton Avenue Cleveland, Ohio

Send me without obligation full information on your complete line of Acme Chargers.

Name

Address

Town..... State.....



"Lighting Fixtures"

READY TO HANG

(Direct from Manufacturer) Completely wired including glassware Send for new Catalogue No. 27 (Just reduced prices)

Special Proposition to Dealers ERIE FIXTURE SUPPLY CO. STATION R ERIE, PA.

RADIO PANELS OF GENUINE BAKELITE

Cut, drilled and engraved to order. Send rough sketch for estimate. Our New Catalog on Panels, Tubes and Rods—all of genuine Bakelite—mailed on request.

STARRETT MFG. CO. 520 S. GREEN ST. CHICAGO

OPPORTUNITY AD-LETS

Follow these advertisements every month. Reliable advertisers from all over the country offer their most attractive specials in these columns.

Classified advertising rate twenty-two cents a word for each insertion. Ten per cent discount for 6 issues, 20 per cent discount for 12 issues. Name and address must be included at the above rate. Cash should accompany all classified advertisements unless placed by an accredited advertising agency. No advertisement for less than 10 words accepted.

Objectionable or misleading advertisements not accepted. Advertisements for the October issue must reach us not later than August 1st.

CIRCULATION LARGER THAN THAT OF ANY OTHER RADIO PUBLICATION

EXPERIMENTER PUBLISHING CO., INC., 53 Park Place, New York, N. Y.

Agents Wanted

Big Money and fast sales. Every owner buys gold initials for his auto. You charge \$1.50; make \$1.35. Ten orders daily easy. Write for particulars and free samples. American Monogram Co., Dept. 133, East Grange, N. J.

Guaranteed Genuine Gold Leaf Letters anyone can put on store windows. Large profits, enormous demand. Free samples. Metallic Letter Co., 422 N. Clark, Chicago.

Agents—our super embossed display signs for all stores are tremendous sellers. \$75 to \$100 per week easily made. Write now for details. Artistic Signs, 799-O Broadway, New York.

Radio Catalog sent free on request. Agents wanted to sell 5-Tube Radio set. Radio Specialty Shop, 525 Park Ave., Kent, Ohio.

Amazing Large Cash Commissions introducing beautiful \$3.95 and \$4.95 fit-to-measure guaranteed shoes. Actual samples furnished. Write for your territory. Style Arch Shoe Co., Dept. 131 Cincinnati, Ohio.

Aviation

Learn to Fly! Write for booklet. Robertson Aircraft Corporation, Anglham, Mo.

Business Opportunities

Free Book. Start little Mail Order Business. Pier, 995 Cortland Street, N. Y.

Responsible manufacturer wants competent men to manage office and salesmen. \$300 to \$1500 necessary, will allow expenses to Trenton if you qualify. Address Manager, 536 Forst Richey Bldg., Trenton, N. J.

Chemistry

Learn Chemistry at Home. Dr. T. O'Connor Sloane, noted educator and scientific authority, will teach you. Our home study correspondence course fits you to take a position as chemist. See our full page ad on page 189 of this issue. Chemical Institute of New York, 98 W. Broadway, New York City.

Correspondence Courses

Successful Speaking and reading by famous Robert Downing Shakespeare Actor. Complete course reduced from ten to five dollars cash. Limited Time. Dietz Press, Richmond, Virginia.

For Sale

Meyer's Tubes Cartridge Type \$1.49. Schedler, 925 Cortland St., North Bergen, N. J.

For Sale: Watchmaker's Lathe at a bargain. R. Jaegermann, 5813 Easton Ave., St. Louis, Mo.

Help Wanted

Detectives Needed Everywhere. Travel. Experience unnecessary. Write, George Wagner, former Government Detective, 1963 Broadway, N. Y.

Incorporations

Delaware Incorporator, Charters; Fees Small; forms. Chas. G. Guyer, 901 Orange St., Wilmington, Del.

Instruction

Learn Chemistry at Home. Dr. T. O'Connor Sloane noted educator and scientific authority, will teach you. Our home study correspondence course fits you to take a position as chemist. See our full page ad on page 189 of this issue. Chemical Institute of New York, 98 W. Broadway, New York City.

Miscellaneous

I Catch from 45 to 60 Foxes in from 4 to 5 weeks' time, can teach any reader of this magazine how to get them. Just drop me a card for particulars. W. A. Badley, Stanstead, Quebec, Canada.

Mr. Manufacturer, laymen or veteran—Side Dumin Scrap or Holst, loads wagons, does ditching. E. B. Hawkins, Appleton, Oregon.

Three Collection Letters That Actually Collect product, 23 years' experience. \$2.50. Address J. A. Hillman, Lynchburg, Va.

Art Photos 4 \$1.00. Names, cuts. GPO Box 471, N. Y.

Motorcycles, Bicycles

Don't Buy a Bicycle Motor Attachment until you get our catalog and prices. Shaw Mfg. Co., Dept. 6, Galveston, Kansas.

Old Coins

German Gov't Bond 5,000,000 Mk. 1924, \$1.50, 2,000,000 Mk Bond 1923, \$5.00, 500,000 Mk. Bill and Catalogue, 10c. Norman Shultz, Colorado Springs, Colo.

California Gold Tokens—Quarter Size 27 cents; half dollar size 53 cents. Catalogue and 500,000 German Mark Bill 10 cents. Alexis Mengelle, Colorado Springs, Colorado.

Old Money Wanted

\$2 to \$500 each paid for hundreds of Old or Odd Coins. Keep all old money, it may be very valuable. Send 10c for New Illustrated Coin Values Book, 4x8. Guaranteed prices. Get posted. We pay Cash. Clarke Coin Company, 11 Street, LeRoy, N. Y.

Patent Attorneys

Inventors—Should write for our Free Guide Books and "Record of Invention Blank" before disclosing inventions. Send model or sketch of your invention for our Free Inspection and Instructions. Radio, Electrical, Chemical, Mechanical and Trademark experts. Terms reasonable. Victor J. Evans & Co., 922 Ninth, Washington, D. C.

Patents. Send drawing or model for examination and report as to patentability. Advice and booklet free. Highest references. Best results. Promptness assured. Watson E. Coleman, Patent Lawyer, 644 G Street, N. W., Washington, D. C.

Patents—Send for form "Evidence of Conception" to be signed and witnessed. Form, fee schedule, information free. Lancaster and Allwine, Registered Patent Attorneys in United States and Canada, 209 Ouray Bldg., Washington, D. C.

Patent-Sense—As one of the oldest firms in America we give inventors, at lowest consistent charge, a service noted for results, evidenced by many well-known Patents of extraordinary value. Book, Patent-Sense, free. Laeey & Laeey, 844 F St., Washington, D. C. Estab. 1869.

Patents

Inventions Commercialized. Patented or unpatented. Write Adam Fisher Mfg. Co., 278 Enright, St. Louis, Mo.

Patents For Sale

Mr. Inventor. If you have a patent or invention for sale. Write Bartley, 38 Court St., Bangor, Me.

Printing Outfits and Supplies

Print your own cards, stationery, circulars, paper, etc. Complete outfits \$8.85; Job Presses \$12, \$35; Rotary \$150. Print for others, big profit. All easy, rules sent. Write for catalog presses, type, paper, etc. Press Company, A-13, Meriden Conn.

Radio

Amateurs Handbook, contains best radio articles from "Radio News". 128 pages, size 9x12 inches, valuable, instructive. Price 50c. Sold everywhere. Experimenter Pub. Co., Inc., 53 Park Place, N. Y.

500 Radio Wrinkles. Just off the Press. Hints, helps for every Radio User. 100 pages, illustrated, size 9x12 inches. Price 50c. Sold everywhere. Experimenter Pub. Co., Inc., 53 Park Place, N. Y.

Build a Lifetime "B" battery from my better Edison Elements. With welded connections 7c pair. Sample cell 10c. Paul Mills, Woodburn, Oregon.

Boys! Don't Overlook This. The "Raseco" Baby Detector. Greatest detector ever brought out with molded base. Fully adjustable. See former advertisements in this publication, or our catalog. Detector with Galepa Crystal, complete 50c, the same detector with Radiolite Crystal, 75c pre-paid. Send for yours today. Radio Specialty Company, 90-98 Park Place, New York City.

Radio (Continued)

Attention!—50 Vacuum tube hook-ups. The greatest collection of vacuum tube circuits ever brought under two covers at such insignificant cost. These diagrams will be found in the great "Raseco" catalog, which contains raw materials and parts in a greater profusion than any other catalog. Use tin stamps, or coin, will bring the catalog to you. Radio Specialty Co., 90-98 Park Place, New York City.

New Broadcasting Generators, 500 volt \$15.00 each. Javitz Company, 137 Centre Street, N. Y.

Free a sample of Ivorylite, the new ivory radio panel. It's the finest, most beautiful panel made. And LOOK it can be cut any size you want and only costs 3c square inch. Write today for FREE sample and complete description. Ivorylite Radio Panel Co., 2222 Ave. F, Fort Worth, Texas.

"Cage Antenna Spreaders" for sale. Full particulars upon request. Charles F. Jacobs, 270 Park Place, Brooklyn, N. Y.

A Two Dollar bill will bring you a 50H-60MA Filter Check Coil. Write for list. Radio Parts Sales Co., Box 24, Orange, N. J.

Construction of Broadcast and Amateur Transmitters a specialty. Short Wave Tuners or Wavemeters. Get our Prices. Strubel & Co., 3023 N. Sixth St., Phila., Pa.

Salesmen Wanted

A Salesman wanted in every town or city within 25 miles of a broadcasting station to sell Radiogem, the complete radio receiving set that retails for \$2.50. With Radiogem there is nothing else to buy—the outfit includes the Radiogem receiving apparatus, 1,000 ohm phone, and aerial outfit. The cheapest radio outfit on the market—set as practical as the most expensive. Big money to the right men. Send \$2.00 for sample outfit. The Radiogem Corp., 68-R West Broadway, New York City.

Scenery to Rent

Settings for Opera, Plays, Minstrels. Plush Drops. Address Amelia Grain, Philadelphia.

School of Electricity

Electricity—Short day or evening courses in Electricity, Drafting, Engineering, and Architecture. In Chicago earn while you learn. Part Time positions pay expenses. Faculty of experts. Special short courses. Diplomas in 2 years. B.S. Degree in 3 years. Small classes, individual instruction. 23 years' old institution with thousands of successful graduates. Enter any time. Employment bureau. Moderate tuition—monthly payments. New College building—all athletics. All details in 72 page "Blue Book." A copy will be sent to you free. Write today. Chicago Technical College, Dept. 27, 118 E. 29th St., Chicago, Ill.

Song Writers

Songwriters: Let me furnish the music for your songs, guaranteeing you absolute satisfaction. Copyrights secured. Submit your scripts for estimate and free advice. Walter W. Newcomer, 1674 Broadway, New York.

Stammering

Stop Stammering. Increase salary. Descriptive booklet free. Samuel Robbins, 399 Boylston St., Boston.

St-tut-t-tering and stammering cured at home. Instructive booklet free. Walter McDonnell, 121 Arcade, 1126 Granville Avenue, Chicago, Ill.

Stamps and Coins

Newfoundland Stamps on approval. None better—none cheaper. Send want list and references. Rev. Butler, St. Georges, Newfoundland.

Telegraphy

Telegraphy—Both Morse and Wireless taught thoroughly. Big salaries. Wonderful opportunities. Expenses low, chance to earn part. School established fifty years. Catalog free. Dodge's Institute, Cour St., Valparaiso, Ind.

Wanted to Buy

Full Value Paid for Old Gold, Jewelry, Watches, Diamonds, crowns, bridges, dental gold, silver, platinum, gold or silver ore; magnet points, old false teeth. Packages returned if our offer is not satisfactory. United States Smelting Works (The Old Reliable) 39 So. State St., Dept. 16, Chicago, Ill.

AMBITIONS REALIZED



In the New B-T COUNTERPHASE

You will find the accomplishment of years' of effort to perfect a permanent type of radio receiver.

The radio public well knows B-T ability in technical design, mechanical refinements and most exacting workmanship,—and these things have never been exemplified to better advantage than in the Counterphase Eight and the new Counterphase Six.

Entirely New Accomplishments

It is impossible here to even touch upon all of the many features that distinguish these first B-T double shielded permanent models.

We have achieved our ambition to secure thru *Counterphase* methods uniform sensitivity across the scale without an oscillation control.

We have accomplished a degree of super-selectivity never before attained,—and that also without the difficulties usually attending fine tuning.

We offer a new patented exclusively B-T Visual Indicator that permits absolutely accurate calibration of all station wave lengths.



Radio frequency unit and micro-mike condenser used in new Counterphase shielded stages.

We have provided for absolute simplicity of control with only a single station selector.

"Straight Line Selectivity" is accomplished with the new S-L-S Condensers,—both product and these descriptive terms being exclusively B-T developments and registered as such.

You owe it to yourselves to investigate these and many other details before you choose your next receiver.

Eliminate Guesswork with the New B-T B Power Unit



It was designed to fulfill the requirements of an absolutely dependable unit that we could recommend for use with our own receiver, but it delivers the voltages required on any set of two to seven tubes.

Designed for the utmost in efficiency it is built so that the user knows exactly what to expect.

There is no other like it in design or operation and it would not be on the market if B-T did not believe that there is likewise none other that will deliver equal results.

Investigate this new product.

DEALERS

Counterphase sets are sold only thru B-T authorized dealers. There is a demand in your town for receivers of B-T quality. If you have not received your appointment write or wire your application.

Circulars on request covering all B-T products.

"Better Tuning" 10th edition ready about July 15th will give you a wealth of information on what's new in Radio,—you can hardly afford to miss it. Sent postpaid for 10c.



532 So. Canal St., Chicago, Ill.

bring your radio set up to date

for greater distance
for bigger volume—
for finer tone ~ ~

*N*EW RADIOTRONS—new performance—better radio! By keeping up with the progress of the Radiotron laboratories, you can get new results with your old set—keep it up to date. If you have a storage battery set, here is the way to equip it now, to make it many times better:

1. Distance! Take out the detector tube and put the new RCA Radiotron UX-200-A in the socket. This newest development of RCA research means greater sensitivity—longer distance reach.
2. Quality! Put all genuine RCA Radiotrons UX-211-A in the radio frequency sockets, and the first audio stage.
3. Volume, and finer tone! Use either power tube Radiotron UX-112 or Radiotron UX-171 in the last audio stage, for volume—full, clear-toned volume.

With the laboratories of RCA, General Electric and Westinghouse steadily at work to develop Radiotrons, radio reception is being improved year by year. Many of these improvements can be made right in your old set. Keep pace with Radiotrons. And, for your own protection, always look for the RCA mark on the base and inside the glass of every tube you buy.

RADIO CORPORATION OF AMERICA
New York Chicago San Francisco

RADIOTRON
UX-200-A—
special detector
tube for storage
battery sets.



RCA ~ Radiotron

MADE BY THE MAKERS OF THE RADIOLA