

RADIO AMATEUR NEWS

REG. U.S. PAT. OFF.

15 Cents
DECEMBER
1919
OVER 100
ILLUSTRATIONS
Edited by
H. Gernsback

"The 100% Wireless Magazine"

UNDERGROUND RADIO
FOR AMATEURS
-SEE PAGE 274



In This

UNDERGROUND RADIO MADE POSSIBLE FOR THE AMATEUR
By E. T. Jones
THE CONSTRUCTION OF VACUUM TUBES

FOREIGN RADIO APPARATUS
By Fred M. Gill
THE PRIEST LOOP SET

RADIO AMATEUR NEWS



CONTENTS

FOR DECEMBER

	PAGE		PAGE
"Developing the Radiophone"		"Hand Wound Honeycomb Coils"	
By H. Gernsback, Editor	269	By C. R. Dunn	285
"The Priess Loop Set"		"A Quenched Gap for Spark Coils"	
By Walter J. Henry	270	By Henry Bentman	286
"German Radio War Instruments".....	271	"Triple Coil Receiving Transformer"	
"Characteristics of Mica Transmitting Condensers".....By L. R. Jewett	272	By H. E. Parsons	289
"Underground Radio Made Possible for the Amateur".....By E. T. Jones	274	"Radio Digest".....	292
"The New Brunswick Radio Station"....	276	"A New Radio Dynamic Control System"	
"Radio 'Phone \$100 Prize Contest".....	277	By Lieut. W. R. Coventry, R. A. F.	293
"The Construction of Vacuum Tubes"		"Correspondence".....	294
By R. S. Hawkins	278	"Radio Experiences on the R-34"	
"Third Prize Award—Radio Contest"....	280	By Lieut. R. F. Durrant, R. A. F.	295
"Experiments with Loop Antennae"		"Amateur Ethics"	
By Fred M. Gill	282	By Pierre H. Boucheron	296
"Experiments with Loop Antennae"		"With the Amateurs".....	297
By C. L. Whitney	283	"Club Gossip".....	298
"The Construction of an Audion Cabinet"		"Junior Radio Course"	
By Gifford L. Weston	284	By W. A. Heppner, Associate Editor	300
		"New Radio Patents".....	302
		"I Want to Know".....	303
		"Buzzer-Phone".....By V. Denison	323

RADIO AMATEUR NEWS is published on the 25th of each month at 233 Fulton Street, New York. There are 12 numbers per year. Subscription price is \$1.50 a year in U. S. and possessions. Canada and foreign countries, \$2.00 a year. U. S. coin as well as U. S. stamps accepted (no foreign coins or stamps). Single copies, 15 cents each. A sample copy will be sent gratis on request. Checks and money orders should be drawn to order of EXPERIMENTER PUBLISHING CO., INC. If you should change your address notify us promptly, in order that copies be not miscarried or lost. A red wrapper indicates expiration. No copies sent after expiration.

All communications and contributions to this journal should be addressed to: Editor, RADIO AMATEUR NEWS, 233 Fulton Street, New York. Unaccepted contributions cannot be returned unless full postage was included.

included. ALL accepted contributions are paid for on publication. A special rate is paid for novel experiments; good photographs accompanying them are highly desirable.

RADIO AMATEUR NEWS, Monthly. Entered as second-class matter June 6th, 1919, at the Post Office at New York, N. Y., under the Act of March 3, 1879. Title registered U. S. Patent Office. Copyright, 1919, by E. P. Co., Inc., New York. The Experimenter Publishing Co., 233 Fulton Street, N. Y., N. Y. The Contents of this magazine are copyrighted and must not be reproduced without giving full credit to the publication.

RADIO AMATEUR NEWS is for sale at all newsstands in the United States and Canada; also at Brentano's, 37 Avenue de l'Opera, Paris.

H. GERNSBACK, President

S. GERNSBACK, Treasurer

R. W. DE MOTT, Secretary

AMPLIFY YOUR RADIO SIGNALS

One of the greatest drawbacks since the invention of wireless telegraphy is the receiving of weak signals at the receiving station. Many devices were proposed to improve this condition, but without success, on account of the mechanical difficulties encountered in these amplifying devices.

However, this was recently solved by the introduction of an exceedingly sensitive microphone transmitter, which is known to detect sound waves with great accuracy and magnify them through an intermediate telephone circuit.

By the employment of the new DETECTAGRAPH-TRANSMITTER, the amateur can amplify the

radio signals to such an intensity that he can hear the signals about his station without the need of the telephone head set.

By the addition of a loud talking telephone he is able to hear the messages many feet away from the instrument. He is also able to demonstrate the operation of his wireless apparatus to his friends.

The super-sensitive DETECTAGRAPH-TRANSMITTER herewith shown is two and three-eighths inches in diameter, five-eighths of an inch thick and weighs less than three ounces. It is the most sensitive sound detecting device ever brought before the public.

The manner in which the amplifying process is attained is by attaching with tape the DETECTAGRAPH-TRANSMITTER to the regular wireless receiver as indicated in the diagram.

SUPER-SENSITIVE
Detectograph
MICROPHONE DEVICES

Practical Instruments for Commercial and Scientific Purposes.

NOTICE
Although prices of raw material and labor have increased greatly in the last four years, we have continued selling our instruments at the pre-war prices, due to the fact that we had a large stock of material on hand. That material is now almost exhausted and we will be compelled to renew our stock at an increase in price, but for a limited time you can still get the benefit of the present low prices.



Our Super-Sensitive Detectograph Transmitter. Price, \$7.00 Complete

Other Uses

Not only is this instrument applicable for amplifying radio signals, but it can be used with equal satisfaction for magnifying other sounds. Phonograph music can be transmitted from one place to another by means of this instrument, and those who are afflicted with deafness will find enormous benefit by using this transmitter.



Adjusted Model "B" Horn, with No. 20 high grade Loud Talking Receiver. Cord Plugs and Desk Stand Base. Price, \$12.00 Complete



Our Special No. 25 Loud Talking Receiver Price, \$4.50 Complete

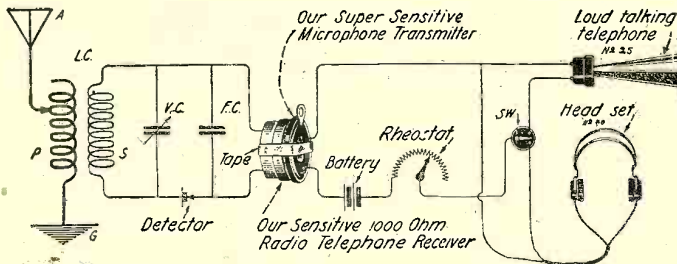

It is the greatest device for building your own loud talking telephone, detectograph and other devices. Can be used for any purpose where a sensitive detecting instrument is required.

Adjusted Model "C" Horn, with No. 20 high grade Loud Talking Wall Receiver. Price, \$12.00 Complete

DETECTAGRAPHS

FOR THE EXPERIMENTER

FOR DETECTIVES

FOR THE DEAF

DETECTAGRAPH

This detecting instrument of marvelous sensitivity can be used for detecting secret conversations. Outfit consists of Sensitive Transmitter, 25-ft. Black Cord, Receiver, Headband, Case and Battery.

\$15.00
Complete

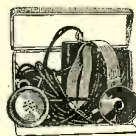

DETECTAGRAPH JUNIOR DEAF-PHONE

The outfit consists of a Super-Sensitive Transmitter, with a cord connector; Super-Sensitive Ear Piece with small black cord; Black Single Headband; Black Case and two small Batteries. Transmitter 2 3/8 inches in diameter, 5/8 of an inch thick, and weighs less than three ounces.

\$15.00
Complete

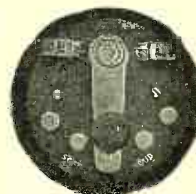

Detectograph Rheostat, especially made for amplifying circuits. Complete **\$2.00**



Super Sensitive No. 40 Receivers to be used in connection with Detectograph Transmitters. **\$10.50**

Order direct from ad. Or write for free descriptive circular. For your convenience use the coupon.

G. BOISSONNAULT COMPANY
25 CHURCH ST. NEW YORK CITY

NAME _____
ADDRESS _____

G. Boissonnault CO., 25 Church St., N. Y. C.

As per your advertisement please send me free circulars and full particulars about your Detectograph devices.

Audio Frequency Transformer

TYPE P

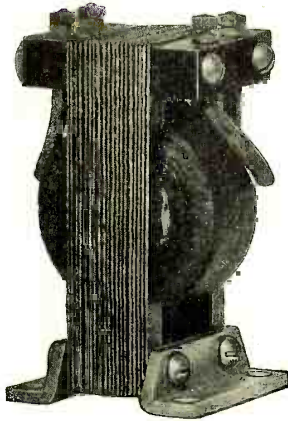

PRICE \$7.00
Postpaid
**IMMEDIATE
DELIVERY**

Standard Vacuum
Tubes \$7.00 each.

Due to its operation on the principle of voltage amplification through resonance this transformer provides a maximum of low frequency amplification and is superior to all others. Permits reliable daylight reception from European stations. Establishes new amateur long distance records. Renders remarkable amplification of all signals. May be used with the Marconi and all standard tubes.

Vacuum Tube Socket

TYPE TRIODE F

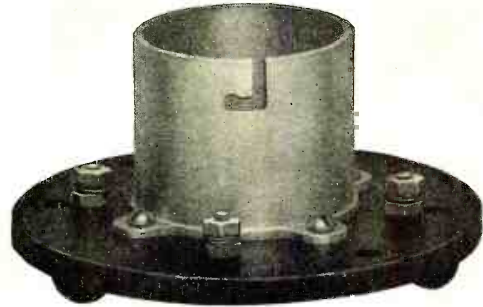

Price \$1.25 Postpaid

The base of this socket is bakelite dielecto and will not crack and break like the moulded material of the usual socket. Contact springs are stamped with identifying letters. Base is provided with three rubber feet and four countersunk holes for panel mounting.

We also manufacture:

Eaton Oscillators Two Step Amplifiers
Grid Leaks Damped and Undamped Receivers

FARADON MICA TRANSMITTING CONDENSERS
Standard and Special Radio
Equipment of Every Description

~~~~~

**Wireless Specialty Apparatus Co.,** ENGINEERS, DESIGNERS, MANUFACTURERS  
BOSTON, MASS, U. S. A.

## HIGH SPARK FREQUENCY FOR TRANSMITTING

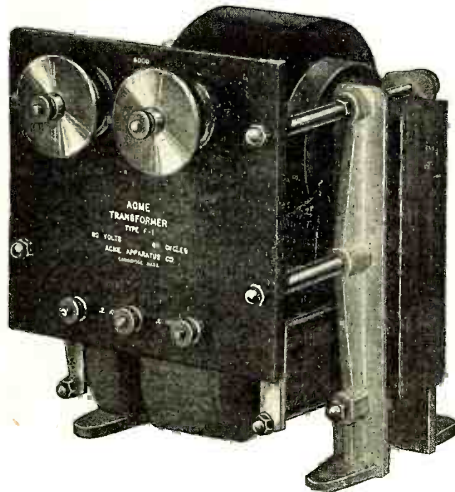

Can be obtained by the Average Amateur  
only by using Non Synchronous Rotary Gaps

THE BEST TRANSFORMER for use with rotary gap should be of the close-coupled non-resonance type.

The working principle of a transformer, condenser, and gap is similar to that of a swinging pendulum. A resonance circuit, like a comparatively heavy pendulum, is best adapted to a swing or condenser discharge of once per half-cycle or 120 times per second. The non-resonance type can be compared with a higher pendulum capable of swinging or discharging much faster, as would be required with rotary gaps, say from 500 to 1,000 times per second.

Our transformers are of the higher period type, designed solely for rotary gap work, and, unlike most transformers, they draw full rated power on a condenser, small enough to allow ample coupling for 200 meter work.

| Type      | Watts<br>Full Power | Amperes<br>Full Power | Secondary<br>Voltage | Net<br>Weight | Price   |
|-----------|---------------------|-----------------------|----------------------|---------------|---------|
| D-1 ..... | 250                 | 3                     | 7,000                | 13            | \$19.00 |
| F-1 ..... | 500                 | 6                     | 11,000               | 26            | 25.00   |
| H-1 ..... | 1,000               | 13                    | 15,000               | 48            | 38.00   |

The above prices are for 60 Cycle only. The prices for other frequencies on application. The power and current readings of this table are average values when using Condenser .007 and Murdock Rotary Gap.

**ACME APPARATUS COMPANY** - - 25 Windsor Street  
CAMBRIDGE, MASS.

# THE HEART OF THE WIRELESS

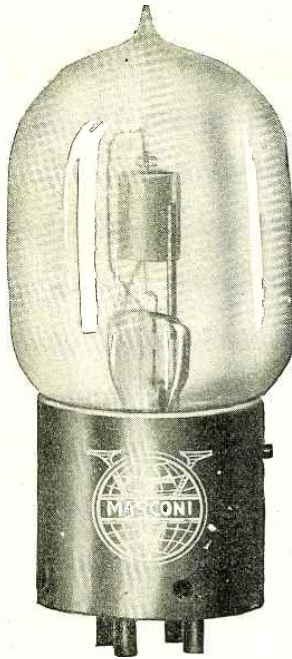

Fleming Pat. No. 803684  
De Forest Pat. Nos. 841387-879532

*An Amateur Station  
Without a Vacuum Tube  
is Years Behind the Times*

## MARCONI V.T

### \$7.00 each

Under agreements recently effected the Marconi V. T. is the only vacuum tube, or audion, which may be sold to amateurs, laboratories, schools of instruction and experimenters.

The approximate operating life of the MARCONI V. T. is 1,500 hours.

### FEDERAL-AUDIO FREQUENCY TRANSFORMER

Designed for use with the Marconi V. T.

**\$7.10**

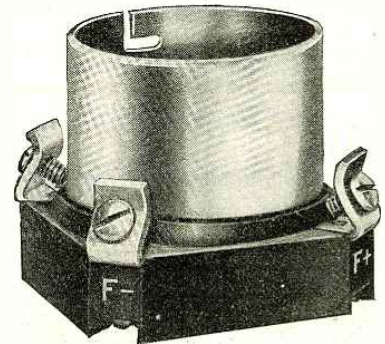

Standardized Socket \$1.50 additional

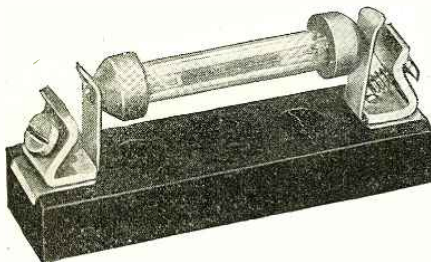

Standard Resistance, Complete \$1.00

The Marconi Resistance, connected in the circuit between the grid and the filament of the Marconi V. T., is made in the following standard sizes:

½ megohm, 1 megohm, 2 megohms, 4 megohms, 6 megohms.

Resistances of any special fractional values up to 6 megohms can be supplied.

Send all remittances with order to COMMERCIAL DEPARTMENT

## MARCONI WIRELESS TELEGRAPH CO. OF AMERICA

225 BROADWAY, NEW YORK

Retail Office and Exhibition Rooms—25 Elm St., New York

Sole Distributors for De Forest Radio Telephone & Telegraph Co.

BRANCH OFFICES:

Schofield Bldg., Cleveland, Ohio  
American Bldg., Baltimore, Md.

Insurance Exch. Bldg., San Francisco, Cal.  
136 Federal St., Boston, Mass.

301 Commercial Bank Annex, New Orleans, La.  
109 South 2nd St., Philadelphia, Pa.

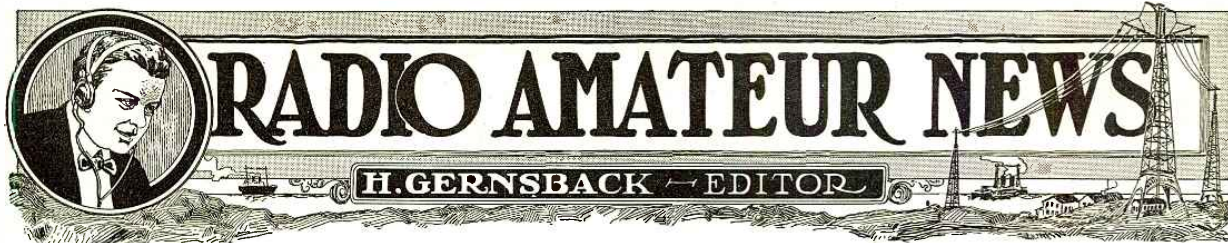

Vol. 1.

DECEMBER, 1919

No. 6

## Developing the Radiophone

**O**NE of the most fruitful branches of development in the Radio Art, no doubt lies at present in the radio telephone. The R. T. is nearer to the heart of every radio amateur than any other single thing in wireless, and rightfully so.

As I have often pointed out in the past, R. T. will be the amateur's salvation; it is the one great thing that will put American Radio Amateurism in a safe and respected position. The R. T. will lift the now—in many quarters despised—art into the great position it deserves.

Up to now Radio has been more or less a plaything, a sport, a sort of diversion for young boys from sixteen to seventy years old. Due to the always present irresponsible element within our midst, radio has often fallen into disrepute, and for this reason new radio bills just now are thicker than flies in the summer. Already radio inspectors are issuing warnings to those amateurs who are again hogging the ether, just as before the war—see this issue for details. What then will happen to us three or five years from now when fifty thousand more of us insist in tapping the key. Simply this: *Amateur Radio will be closed down tight by legislation.* And there will be no comeback this time, either. If it happens, we will only have to thank ourselves for it. Now, I do not wish to appear as an alarmist, but you will grant that, having had to do more with radio amateurism and radio legislation, than perhaps anyone else in this country since 1904, I ought to see clear and know whereof I speak.

As the situation now looks to me, our only salvation lies in the R. T. Once we get this firmly implanted into our minds we will have gone a long way towards the ultimate goal. I need not recite here all the advantages of the R. T. As far as the amateur is concerned—three are sufficient: First, no code need be learned or used; second, a radio phone message takes but a fraction of the time to send compared to a radio telegraph message; third, and most important, the R. T. does away with most of the now dreaded interference.

We must therefore devote all our energies in developing the R. T. We must leave no stone untouched to secure results. We must experiment every day till the goal is achieved. And, in passing, the amateur who invents a workable, practical, R. T. outfit that works on six dry

cells, will have a fabulous gold mine. Some of our big electric companies will pay a king's ransom for the patent, this very minute.

Using the audion as a generator for undamp waves and as a R. T. transmitter is of course a great accomplishment in itself. And the device works well,—better than anything else, so far. But it is not the ultimate goal. Vacuum tubes of the audion type are tricky as yet, and not too practical. Unless you use special tubes—and you can't just now, due to a complicated patent situation—the speech is not always clear, and far from satisfactory. At the critical period, the tubes often "go bluey" and refuse to "talk."

Amateurs therefore should look for substitutes of vacuum tubes, or devise other tubes, employing entirely different principles. The writer years ago, experimented with a sort of quenched gap, in a vacuum, also gaps enclosed in different gases. The results, however, were not too encouraging.

Trials should be made with plate gaps in various solutions, and effects noted. As a test the microphone can be connected in series with the primary and battery of a spark coil, or transformer. Many vacuum tubes, not necessarily using the Edison effect, could be tried. Tubes with mercury vapor—affording a "sparkless" discharge across an enclosed gap, should be worth while experimenting with. Quenched gaps made of unusual and untried metals or other materials, might unearth unknown and surprising qualities. Has anyone ever tried a spark gap made with ceric iron—the stuff that is used to make cigar lighters?

Then, if you do not wish to experiment with any of these, you can fall back upon the arc as a source of undamp waves. Perhaps you can find some materials other than carbon that give a satisfactory arc at a low voltage. Did you know that *you can maintain a microscopic arc at about 8 volts with two carbons as thin as pencil-leads.* I tried this stunt years ago and it works well. Now if you can impress the voice currents on such an arc and step up your voltage to about 10,000 in order to radiate from your aerial, you will have a fine radio telephone. It should not be impossible to do this.

There are a thousand other fascinating stunts that you may try out. Each one may prove to be the "missing link."

H. GERNSBACK.

# The Priess Loop Set

*I. Why and How the Portable Loop Set Was Developed*

By **WALTER J. HENRY\***

On a certain day about the middle of June, 1918, a telegraph wire which formed part of the ground telegraphy system, developed by the French Signal Corps, and in use in the A. E. F. at that time, suffered, during

lently forward on a zig-zag course across his eight lines. The wires were, of course, ground into an unrecognizable mass of copper. Resort was necessarily made to runners, but the appalling losses and the uncertainty of message delivery rendered

While many officers favored an undamped system of transmission, Lieut. Priess pointed out that "reception of undamped waves of these high frequencies by any of the familiar heterodyne circuits is an impractical proposition for field service, as the swaying of note due to normal minute changes in the receiving and transmitting antenna incident to operation, will be sufficiently great to cause the heterodyne frequency to swing through to inaudible frequencies." He also reasoned correctly that, "It is a fallacy to claim secrecy for a system that involves as much difficulty for your own reception as it does for the enemy. The importance of the secrecy factor varies directly as the military importance of the communication to the first line. First line communication has simply a local and immediate importance such as the direction of a local barrage and the reporting of battalion positions. It must, however, be 100% reliable as other wire communication alternatives are entirely absent here in an engagement. Code sending is used in all cases and it is adequate secrecy, since the information has lost its value to the enemy, by the time he has succeeded in having it decoded by his intelligence system."

For this reason and because of the greater ruggedness and reliability of spark apparatus Lieut. Priess decided to use a damped system. By July 14, 1918, two sets had been developed by salvaging parts from available radio equipment; and combining and co-ordinating these units and other available facilities as Yankee ingenuity dictated. For example, the bakelite dielecto used was sawed from the panel of a \$1,600 airplane transmitter that had proven too excessive in power for army use. The buzzer was the donation of the French Signal Corps, who in turn had more or less politely requisitioned it from the Boches, who had specialized in buzzer manufacture.

The two sets were first tested at Chatillons being placed above ground and five kilometers apart. Excellent results were obtained. The wavelengths used varied from 66 to 180 meters. Similar tests were made with one set in a dugout with about ten feet of earth and stone separating it  
(Continued on page 308)

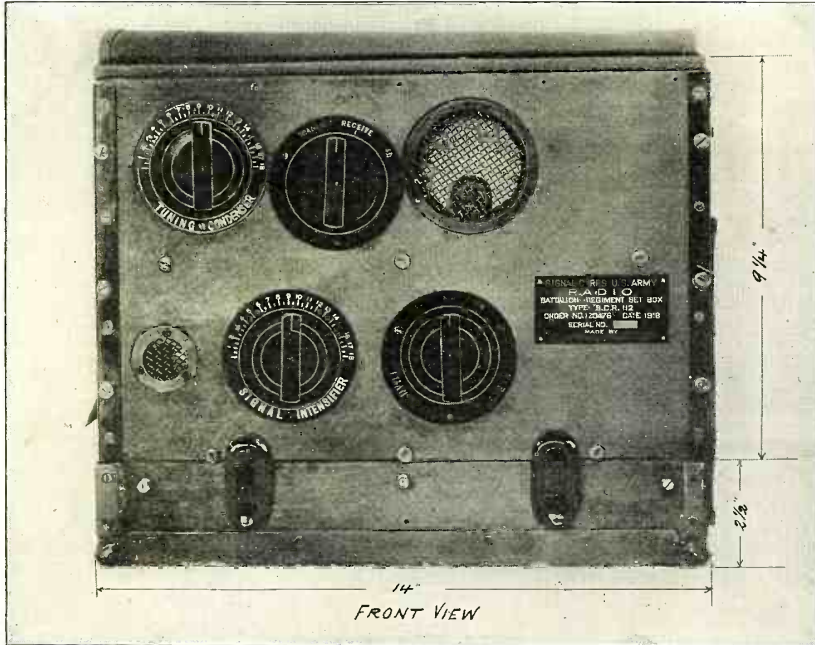

The Priess Transmitter and Receiver Combined in a Single Unit for Communicating on Three Wavelengths, Using the Same Loop for Transmission and Reception, and Operating from a Ten-Volt Storage Battery.

a single barrage at Soissons, 350 shell breaks on a length of 1,000 yards. About that time the long drawn-out trench warfare was abandoned in favor of open tactics, and the constantly shifting movement of men, machines and artillery proved extremely detrimental by causing havoc with ground communication systems. It became practically impossible to maintain telegraph wires forward of regiment as was found out by a certain signal officer who laid eight parallel lines between two points to insure

this method of communication disheartening, to say the least.

An increasing number of incidents of this kind made it rapidly evident that the direction and co-ordination of front-line troops must take place through the medium of a compact, portable and shell proof radio set. The now famous incident of the "lost battalion" also indicated the extreme desirability of a radio direction finder. The problem was placed before Lieut. William H. Priess,† who was in charge of the A. E. F. field radio forward of brigade. Lieut. Priess recognized that a successful system along the lines desired must necessarily be based upon the direction finder loop patented by Mr. Greenleaf W. Pickard in 1908. He proposed to design a set that could be easily carried by one man and which could be completely contained within a dugout or shell hole. The British had already experimented to some extent with a loop one meter square but had used this only for transmission, supplementing it with the usual type of wire antenna with a 2-Step Amplifier for receiving. The British equipment could hardly be called successful, however, inasmuch as the range was only about 1,600 yards and the system was complicated by the necessity of using four separate and different units for each wavelength. Lieut. Priess decided to attempt the construction of a single unit capable of two-way communication on three wavelengths, using the same loop for transmission and reception, and operating from a small ten-volt storage battery.

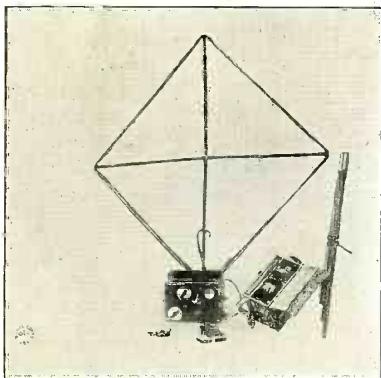

Showing the Complete Loop Set Connected Up Ready for Use.

the working of at least one line. As the engagement developed he saw, much to his horror, one of their own tanks pressing re-

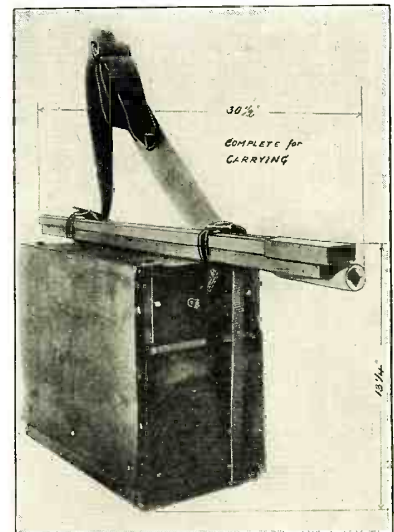

The Set Disassembled and Packed for Carrying.

\* Sales Manager, Wireless Specialty Apparatus Co

† Chief Engineer, Wireless Specialty Apparatus Co.

# German Radio War Instruments

A two-step Amplifier, a Crystal Detector and a H. F. Buzzer of clever Design.

**D**URING the war, vacuum tube amplifiers of every description were used, by both the Allies and Germans, in order to make the most feeble signals audible. Perhaps the most common in use was the two-step amplifier, due to its efficiency, compactness and size. In the trenches it was popular for close range work, such as picking up ground telegraph and telephone signals. In the submarine, an amplifier of this type proved very efficient when used in connection with listening devices.

It is easily apparent from the photographs that the design of this type of German amplifier was copied from apparatus picked up in a retreat of the Allies. While the arrangement of the various parts of the set are original, the circuit and design are attempts at improving upon the French apparatus.

In Fig. 1, the photograph shows the front view of the two-step amplifier. The hinged cover which forms the top, the upper half of the front and part of the sides, has been removed. Perhaps our attention is first drawn to the tubes. They

A general idea of the internal construction may be obtained from Fig. 2. This photograph was taken with the back of the amplifier removed. It is apparent that

impedance of 37,000 Ohms. A feature of this amplifying coil is the iron casing which surrounds it. Evidently this was used to form a path for the magnetic flux. In addition there is a casing of copper over the iron one. This is to prevent magnetic reaction which if present in such a compact set would reduce its efficiency. There are no binding posts on the outside of the set whatsoever, as the connections to the detector are made thru wires passing thru a hole in the side of the box. Fig. 3 shows the wiring diagram of the amplifier. This amplifier was tried out with a detector of American make and was found to be very efficient.

No doubt our readers will be interested in knowing what a German crystal detector looks like. Fig. 4 shows a unit type with the cover removed. The contact wire is fastened by a small machine screw and is manipulated by the fingers. The crystal is mounted in a small rotating member which has a knurled edge, the thumb being used to do the rotating. The unit is plugged into the receiver, thus doing away with leads and binding posts.

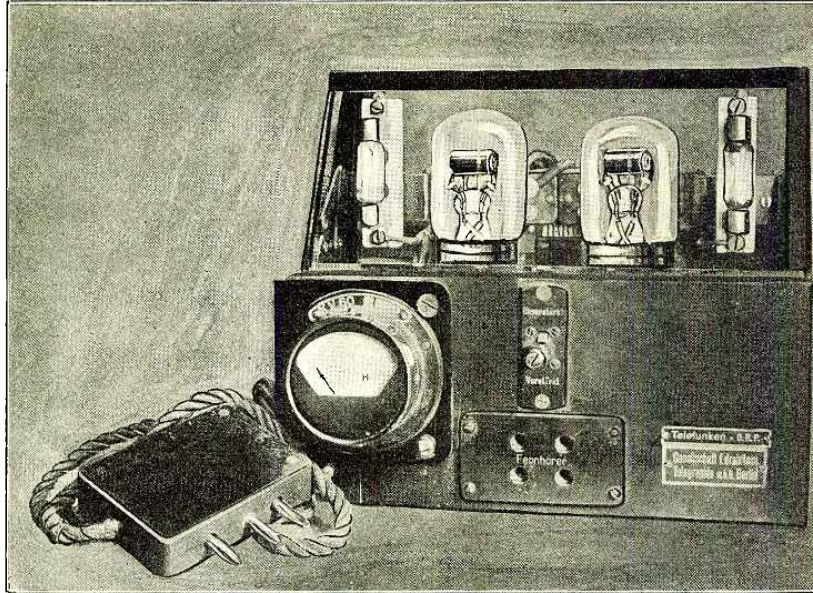

Front View of a German Two-Step Amplifier. The "A" and "B" Battery Voltages Are Indicated by the Meter at the Left.

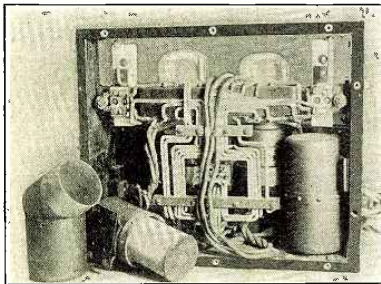

Rear View of the Amplifier Showing the Internal Arrangement.

are of the ordinary German type, one of which was described in the last month's issue of the RADIO AMATEUR NEWS. The glass covered fuses, mounted on the porcelain receptacles to the left and right of the tubes, are connected in the filament circuit, so as to protect the filaments. The voltmeter mounted at the lower left hand corner of the panel indicates both the "A" battery voltage and the "B" battery voltage. The key switch in the center throws the amplifier in or out of the circuit as desired. When the switch handle is in the "up" position only the detector is in use; when in the "down" position, the amplifier is connected. The holes below the key switch are for the phone cord plugs. The connecting block at the left of the amplifier is used to connect the "A" and "B" batteries.

expert workmanship was used in wiring; in fact it seems that an attempt was made to wire the set, so that the enemy would have difficulty in tracing the circuit.

Mounted at the back of the fuse blocks are small porcelain blocks, each being a connecting terminal for a tiny resistance coil. These resistance coils are used instead of the adjustable rheostats, found in use on most of the amateur sets. From this it appears that the German type of vacuum tube is not very critical in operation. At the lower left and right hand corners the amplifying coils are mounted. The one at the left has been taken apart to show the internal construction. It is somewhat similar in design to the open core type, formerly used in this country. The primary is wound on a laminated core of very fine iron wire and has an impedance of 5,300 Ohms. The secondary is wound in regular layer fashion and has an

impedance of 37,000 Ohms. A feature of this amplifying coil is the iron casing which surrounds it. Evidently this was used to form a path for the magnetic flux. In addition there is a casing of copper over the iron one. This is to prevent magnetic reaction which if present in such a compact set would reduce its efficiency. There are no binding posts on the outside of the set whatsoever, as the connections to the detector are made thru wires passing thru a hole in the side of the box. Fig. 3 shows the wiring diagram of the amplifier. This amplifier was tried out with a detector of American make and was found to be very efficient.

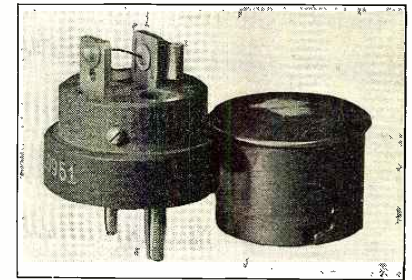

This is a Unit Crystal Detector Which is Very Rugged, Yet Efficient.

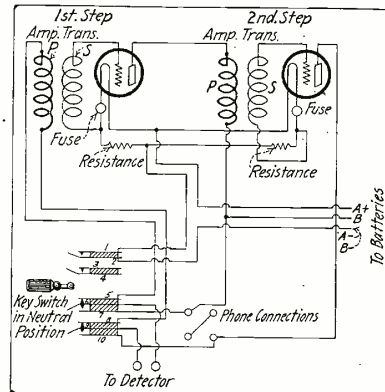

Wiring Diagram of the Amplifier.

A very ingenious high frequency buzzer shown in Fig. 5, when tested out, gave a beautiful 600-cycle note, scarcely audible when held six inches from the ear. The knob at the right controls the tension of the vibrator while the knob on top varies the pressure of the contact screw. The iron element of the vibrator is square in form and the platinum contact wire is fastened diagonally across it. For the amateurs, who are desirous of constructing a buzzer of this type, a detailed drawing is shown in Fig. 6.

The case is made of wood about 1/4 of an inch thick, so that when it is closed absolutely no sound will come from the buzzer. The magnets are wound with No. 28 enameled. The cores of the magnets are 3/16 of an inch in diameter and 5/8 of an inch long. The adjusting knob at the left

(Continued on page 308)



# Characteristics Of Mica Transmitting Condensers

By L. R. JEWETT

**P**REVIOUS to 1916, the Leyden Jar was used in practically all wireless telegraph installations for obtaining the proper capacity in the closed circuit of the radio trans-

## Construction.

In its construction, the best India ruby mica is used for the dielectric. Its thickness varies between 0.0015-in. and

assembly, each piece of mica is tested electrically and mechanically. In designing this condenser it was found that allowing 1,000 volts maximum per mil for dielectric strength an ample factor of safety with exceedingly small losses was provided.

The condensers are tested at 21,000 volts maximum and thus 21 sections are necessary. They are all connected in series and in order to obtain a resultant capacity of .004 microfarads, each condenser must have a capacity of .084 microfarads.

In assembling, the sections are placed in a stack, each section being insulated from the next one by a sheet of mica about .015-in. in thickness. The connections are then carefully soldered. The bottom connection of the condenser is attached to the case and a special cover placed on the top for vacuum impregnation. This process was developed after much experimenting in order to eliminate "blowholes" in the wax and result in uniform impregnation. This was found difficult because the wax contracts to a smaller volume than its initial volume upon cooling to its original temperature, and it was found that the correct vacuum pressure lay between very narrow limits. To insure best results, each condenser must be treated separately for impregnation. After cooling, the bakelite cover is placed on the case, the top connection of the condenser being attached to the insulated terminal.

Many other difficulties have been encountered, although the construction seems rather simple. In this condenser approximately 800 sheets of dielectric are used, and thus the slightest defect causes the respective section to be inoperative. However,

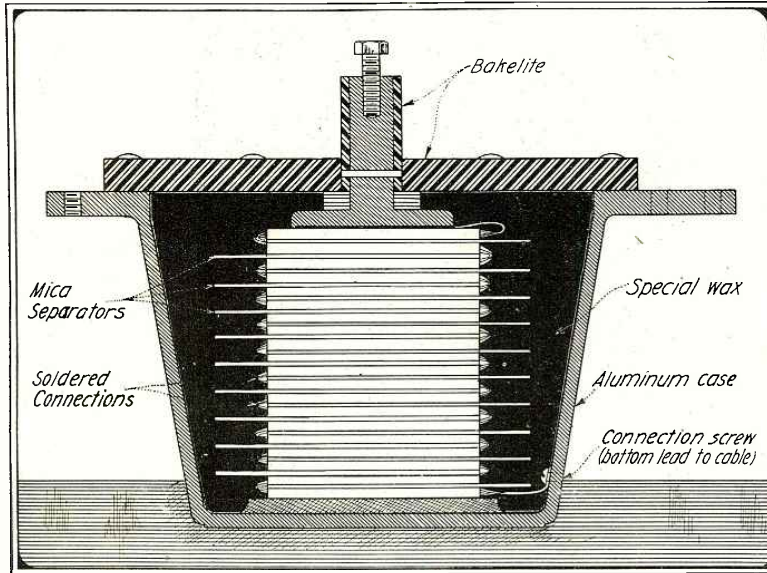

Sectional View of a Transmitting Condenser Using Mica as the Dielectric.

mitter. The present form of the Leyden Jar or glass jar type of condenser has remained practically the same since its invention. A few improvements have been made in construction and several have been adopted, although comparatively small increases in efficiency were obtained. Foreign glass was necessary for the highest efficiency and after the outbreak of the war, this was not obtainable. American glass was substituted, with much poorer results.

Mica, when used as a dielectric in condensers for high voltages, was successfully utilized in 1910, but radical developments were not apparent until 1916. Since that time, thousands of mica dielectric condensers to replace Leyden jars have been purchased by the government and the commercial wireless companies. The development of this type of condenser is the result of the excellent cooperation of the Bureau of Steam Engineering of the Navy Department and the manufacturers. Several types were standardized such that a multiplicity of them may be used for the different sized sets.

## Description.

The standard transmitting condenser has a capacity of 0.004 microfarads, arranged in one complete unit, and this type will be discussed. It is enclosed in an aluminum case and insulated by a special type of insulated wax. One terminal of the condenser is connected to the case and the other terminal to an insulated bushing brought through a bakelite cover.

0.0025-in. This is necessary since other kinds of mica cause greater losses with a smaller factor of safety. Tinfoil or leadfoil is used for the conducting surfaces and the best paraffine wax is utilized for impregnation and insulation. Before

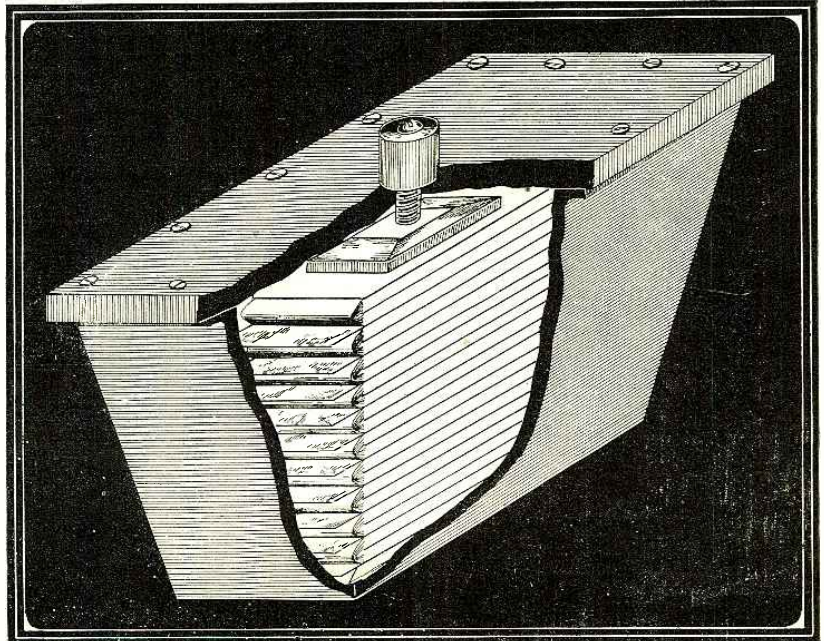

End View of the Stacked Condensers, Showing the Method of Connecting the Sections.

if one section does break down or short circuit, the resultant capacity of the whole condenser increases, since the sections are connected in series. Condensers of this type have operated for an extensive length of time under these conditions. It is very easy to design a condenser of

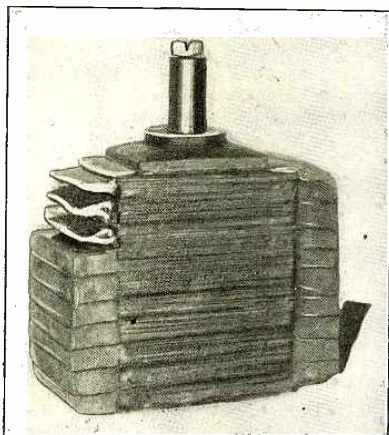

This Shows the Sections Clamped in Place and Method of Insulating Ends.

this type, knowing the capacity required and the working voltage.

In comparison to the glass jar type, it is much smaller, unbreakable, compact, and breakdown does not render it entirely useless. A standard glass jar has only .002 microfarads, therefore two must be connected in parallel to obtain the same capacity. The two jars occupy a space of 530 cu. in., whereas a mica condenser occupies 140 cu. in. However, the cost of two glass jar condensers is about one-fourth that of a mica transmitting condenser, but the advantages easily compensate for the difference in cost.

**Capacity:** Mica has a capacity of 5.0 to 6.5, whereas the glass in commercial use has a dielectric constant of 2.0 to 4.5. Under given conditions, mica will occupy much less space than any other dielectric used for this purpose and its structure is very uniform. American manufacturers have not as yet been able to produce suitable glass free from air pockets or blow-holes, although much experimenting has not affected a quality of glass equal to that produced in Bohemia.

**Phase Difference or Power Factor:** The power factor or the phase difference, which is 90 deg. minus the power factor, has been found to vary between 30 in. and 5 ft. At radio frequency the power factor has been found to be wholly negligible,

when the condenser is constructed properly, since it is a function of the quality of the mica. Since part of the power loss proportional to the power factor, it is seen that this loss is very small. The potential across the dielectric is approximately 1,000 volts maximum under test conditions and this fact is a decided advantage.

**Resistance:** The resistance of a mica condenser of this type varies from .050 to .060 ohms when properly constructed, whereas the resistance of a Leyden jar may be as high as 2 or 3 ohms in some cases. The above values are true for 1,000 meters wave length. The resistance is an increasing linear function of the wave length.

**Change of Capacity with Frequency:** The capacity of mica condensers change when very low or very high frequencies are used, but for all radio frequencies it remains constant.

**Leakage Losses:** Leakage by conduction through mica at radio frequencies has been found to be negligible.

**Series Resistance Loss:** In the series resistance loss is included all the resistances of all contacts, soldered joints and leads. If a mica condenser is constructed properly, this loss may be entirely neglected. In some other types of condensers, this factor has been found to be serious, especially at high radio frequencies.

**Dielectric Loss:** Dielectric absorption is always accompanied by power losses, which are dissipated in the form of heat

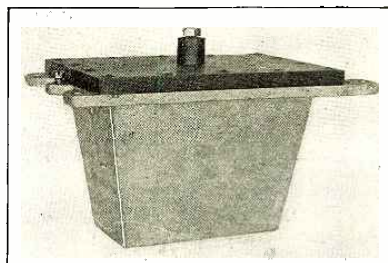

View of the Completed Condenser.

in the condenser. The temperature rise in mica condensers has proven a serious problem at times and government specifications contain a maximum permissible temperature rise. For accurate work, a thermo-couple is attached to the side of the case and its potential measured with a potentiometer. For rough work a thermometer may be used.

**Brush Loss:** Brush losses are negligible since the voltage drop across the dielectric is only 1,000 volts maximum. Since no air is present, ionization is not possible, even if the slightest brushing were

present. Brushing on the glass jar condenser has proven to be a serious cause of losses, especially on potentials higher than 10,000 volts.

**Efficiency:** Several methods have been used for measuring the total losses, which are dissipated wholly in the form of heat,

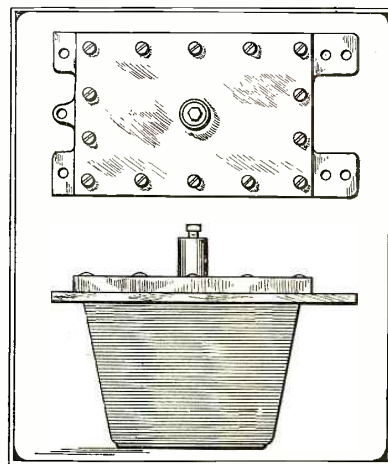

Drawing of the Condenser Showing the Method of Fastening Top.

in a properly constructed condenser. Total losses of only a few watts have been found in many cases and an efficiency of over 99 per cent. is realized. This type of capacity presents the highest efficiency with the possible exception of the compressed air type which is mechanically inefficient.

**Effect of Losses on Life of Condenser:** No endurance tests have been made, to my knowledge, but condensers that have been in service continuously for three years have stood the initial tests without appreciable change.

The writer does not believe it practical for the amateur to construct a condenser of this type. The present stage of development has been accomplished only by intensive and costly experimenting and the proper construction can be attained only by a large outlay of apparatus and a great deal of experience. A large amount of labor is required in constructing this type of capacity and the cost is beyond the limit of the amateur's pocketbook. Very good results may be obtained by inserting a glass jar condenser in the best grade of transil or transformer oil and this is recommended for general use where the cost is prohibitive.

(Photos courtesy American Radio and Research Corporation.)

## French Crystal Detector

As we all know the French are wizards when it comes to the manufacture of precision instruments or apparatus requiring critical adjustment. The detector shown in the photograph is a product of excellent design and workmanship. The base is constructed of hard rubber. The crystal is mounted in soft metal in the cup. The arm which holds the contact adjustment is supported between two washers on the post at the left of the crystal cup. The set-screw controls the pressure of the spring

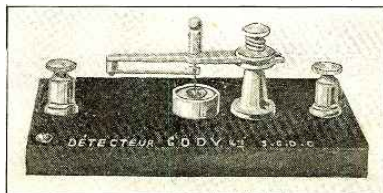

This Detector Is Very Efficient and Is Easily Adjusted.

on the washer and consequently on the arm.

The contact consists of a steel wire which passes thru the small upright piece on the arm and has a ball attached to it. The spring fastened at the left on the arm controls the pressure of the point on the crystal. To locate a sensitive point on the crystal the arm is moved to the right or left. The contact point is raised by pulling up the ball. This detector was tried out and was found to be very sensitive and difficult to "knock out."

# Underground Radio Made Possible for the Amateur

By EDWARD T. JONES†

THE readers of RADIO AMATEUR NEWS will undoubtedly greet this article with open arms since it deals with an underground system accessible to all, no matter how small the back yard.

As is well known, the Rogers system with its lengthy wires stretching in all directions cannot be employed by the Amateurs of today. Take for instance, reception of long wavelengths where a stretch of two thousand feet is required. This would mean that the Amateur would have to dig under fences, etc., for three city blocks in each direction—IMPOSSIBLE—and worse than that. This state of affairs bothered me considerably and I was determined to find some possible solution for this impractical method.

Up with the curtain—for here is how the idea struck me. . . . One sleepless night visions began to parade before my half conscious vision and amongst the crowd was a coil of wire rolling merrily along—AH! the problem was solved. Not trusting my memory I leaped from the bed like it had caught fire, and grasping a pencil I drew roughly as best I could in the glare of the night lamp of .000005 candlepower, what might have passed for two coils of wire and an ordinary audion circuit connected.



Take Down Your Old Sky Antenna, Make Up a Couple of Coils as Shown and Get Ready for Results.

After getting up some five or ten times to make corrections and to jot down new circuits. I finally fell asleep with the sweet strains of "OUT" prancing up and down in my eardrums.

In the morning I went forth with vim and vigor to plant some coils in old Mother Earth. Finding labor scarce I decided to throw them into the lake for a trial. OUCH!—then the fun began. Now to get back to business we will begin with the first experiment carried out at this lake, in order to prove my sanity.

The first experiment made use of two coils, each two hundred feet of Packard auto cable, wound to have an overall diameter of two feet. After being bound so as to hold their form, they were lowered into the water (Lake Pontchartrain, Louisiana), and rested on the bottom at a depth of approximately four feet. The two coils were spaced about ten feet apart, but bringing them as close as within two feet of each other did not seem to have any noticeable effect upon their proper functioning. The following stations were picked up with very good audibilities.\* There was of course no directional effect, in that the coil was in a favorable position to respond from practically all directions. Later on it will be shown how coils were used embodying directional effects.

This article is without doubt the most important one that has appeared in print for some years, as far as amateurs are concerned. When the Rogers Underground Aerial was first announced, many amateurs, particularly those living in cities were bitterly disappointed for the reason that they could not make use of this form of aerial due to the fact that long earth trenches were necessary. Now comes along Mr. Jones with his new invention, showing us how to use a concentrated underground aerial that all of us can use in every city without any trouble whatsoever. The article is epoch-making and should be read by every radio enthusiast worth his name.—Editor.

The exceptional results obtained with this arrangement prompted me to believe that such an antenna for underground work as I had discovered would, if consistent in operation in different localities, eliminate the present practice of digging lengthy and costly ditches in which to lay the wires. Besides, since it is recognized that the picking up of strays is governed by the length of the wire, it is to be expected that a great reduction in respect to such disturbances will be noticeable under actual operation. When employing such small concentrated inductances for underground antennae, what little static is picked up on the wires is entirely eliminated, and the strength of signals is not weakened in the least by employing such small coils. The position of the coils is shown in Fig. 1.

The second experiment followed immediately after obtaining such remarkable results from the first, and the two coils which

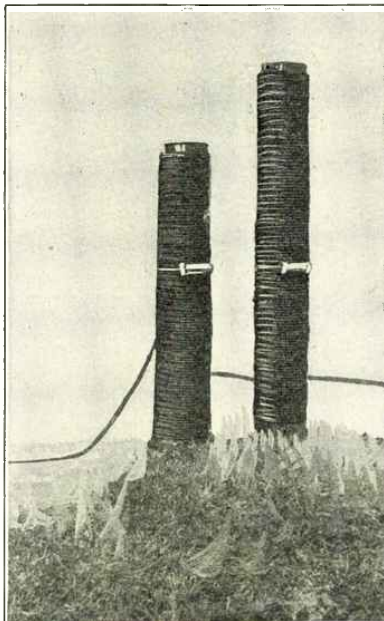

Even Direction Finding is Possible with Coils of This Type.

were used in the first experiment at Lake Pontchartrain were taken up and put into the Mississippi river. The leads from the two coils were brought into a Naval building. In this instance the coils were sunk to a depth of 12 feet in the water; they rested upon the mud bottom of the river, and the distance between the waterline and wharf was approximately 15 feet. Reception commenced at 8:10 P. M. and continued until 10:45 P. M. that night; at the end of which time it was demonstrated that the possibilities of such antennae were indeed practical. The following stations worthy of note were received:

8:10 P. M., Swan Island, signals good; 8:26 P. M., Burrwood, signals strong; 8:27 P. M., Colon, Panama (NAX), signals strong; 8:30 P. M., Key West (NAR), signals strong. (On small set): 8:43 P. M., Miami, Fla. (WST), signals strong; 9 P. M., time from Arlington, Va. (NAA); 9:15 P. M., Guantanamo calls (4—), signals strong; 9:46 P. M. (NAJ), Great Lakes, 600 meters, very strong; 9:56 P. M., Mexican (XAB), very strong; 10:25 P. M. (BZQ), Bermuda, very strong, 1200 meters; 10:40 P. M. (NAN), Beaufort calls CQ, signals very strong. Many ships were received, but there was no method at hand of ascertaining their distance, so they were not included in the above.

Of course in this experiment, as well as

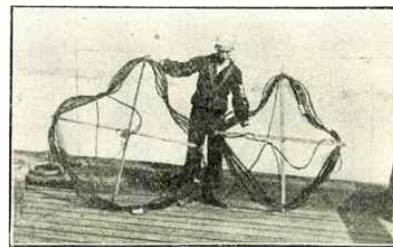

If You Are Looking for Even Stronger Signals Make the Coils This Size.

the first, there were practically no directional effects present, as expected when making use of coils as described; but the exceptional results obtained thru the employment of same was more than gratifying, and I think that the results of the foregoing experiments, if consistent in various localities, will provide a means of saving considerable expense involved in installing the usual Rogers system. Likewise the ratio between signal and static audibilities will be increased, since the inductance is concentrated, and not distributed at considerable lengths.

The coils employed in both experiments were, at each location, drawn from the water and placed on the dock at various angles with absolutely no results in respect to signals, but local strays and heavy jolts were picked up. Of course the local stations NJK and NAT could be heard, but this was of no value. Immediately after placing the coils back into the water the static and strays disappeared and signals were picked up from the various stations outlined previously. Very heavy jolts of static and lightning were recorded by faint clicks. This may have been augmented by making use of non-shielded wires for the leads from the coils to the receiver proper. They acted as an open antenna from the waterline to the receiving apparatus; besides, the apparatus was not screened nor shielded. See Fig. 2 for the details of coils in river.

† Formerly Associate Editor. Inventor new underground system.

\* See end of article.

Two circuits, which gave exceptional results, are shown in Figs. 3 and 4. In Fig. 3 the tickler arrangement was employed to complete the regenerative circuit; however, the connections shown in Fig. 4 greatly increased the selectivity of the system. In

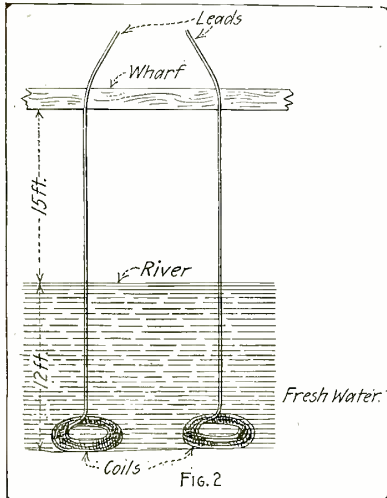

Just Drop the Coils to the Bottom of a River or Pond and Listen to the "Sigs" Come in, in Company Formation.

this case the plate circuit was tuned by making use of the variable condenser C-2 and inductance L; and the tickler coil was set at "minimum" adjustment or relation to the secondary coil. As the inductance in the secondary or tuning circuit was increased, the inductance L also had to be increased, and maximum response was had by varying condenser C-2 until the bulb began to oscillate. This arrangement provides a much wider range of tuning, and instead of acting similar to the thickler coil which has practically a very sharp point of resonance, the plate tuning circuit commences to oscillate slightly at first and gradually increases until maximum response is had.

In the photograph is shown 1st Class Electrician (Radio), Gordon P. Reynolds, holding the coils. Reynolds is a jeweler with a tool kit and it was thru his energetic and valuable assistance that such remarkable success was attained.

In the next experiments the coils were increased in size to ascertain what effect this change would have upon the reception of signals and strays. These coils were wound and supported by the cross sticks shown in the photos having a diameter of four feet. The strength of signals was greatly increased; in fact, to such an

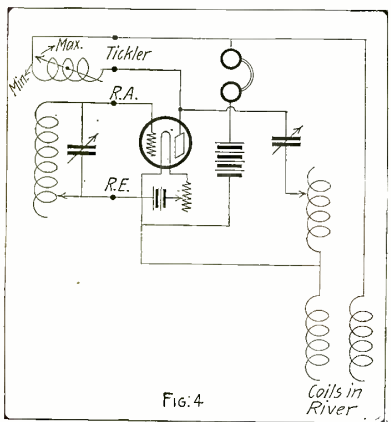

This Arrangement Was Tried Using the Variable Condenser and Inductance to Tune the Plate Circuit.

extent that it was possible to read ships from 100 to 400 miles off the Mississippi river bar.

The occasional jolts of very weak audibilities were picked up by the leads from the coils to the receiver, also by the connections and coils in the receiving circuit proper. This was proven when the same amount of strays was noticeable without the leads connected to the receiving apparatus. The leads of the coils as well as the receiving apparatus and the operator should be screened and grounded to totally eliminate the static.

These coils were spaced fifteen feet apart on the river bed, twelve feet below the waterline, but by increasing this distance to thirty feet the signals' strength was practically doubled.

At 7:30 P. M. tests again were under way and it was fully demonstrated that this type of antenna was highly practical and more efficient than the overhead antenna, for at 7:45 P. M. Swan Island was sending to NJK, the New Orleans station, repeating English three times and coded message four times; while he (the operator at NJK), due to the very heavy static, had difficulty in copying even with so much repetition, I copied this station easily on the typewriter.

While Swan Island was transmitting, the coils were changed from fifteen feet apart to approximately two feet, and Swan Island's signals were reduced to a minimum (just audible); then the coils were moved so as to be separated fifty feet, at which position Swan Island signals

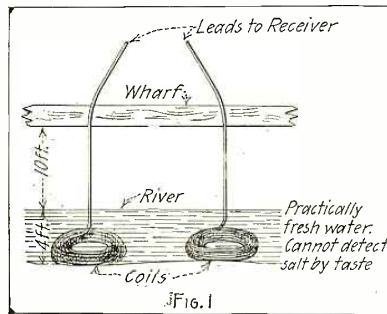

If You Can't Find 15 Ft. of Water, 4 Ft. Will Do the Trick.

were almost doubled in strength as was had when the coils were but fifteen feet apart. This was the greatest distance possible, under the circumstances, that the coils could be spaced, but arrangements were made in order to ascertain whether spacing them further apart would have any noticeable effect on the strength of signals received and the results proved that increasing this distance did not materially increase the strength of received signal strength.

Next the coils and receiving apparatus were removed to the New Orleans station grounds (NJK) where the coils were buried at a depth of four feet, having encountered water three feet below the surface. They were separated thirty feet apart, as was found best by experiments carried out at the Naval building where the coils were placed in the river, and it was an easy matter to change their position.

In order to have this circuit function properly, the apparatus in the receiving room of the station proper was disconnected and notations were supplied from our log, because whenever both of us were on the same setting, say 600 meters, the distance between the two receiving rooms being approximately 125 feet, any change in my apparatus cut him out and vice versa. Also his bulb, when setting on the same wavelength as mine, was easily pickt up and hindered reception on that wavelength.

The same effect was noticeable at his apparatus.

With these coils buried as outlined, signals were received which compared favorably with those pickt up on the overhead

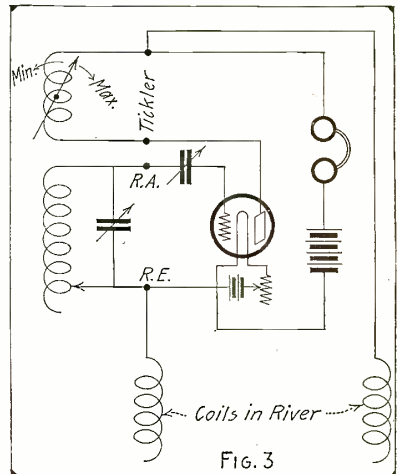

The Ordinary Tickler Circuit With the Coils Shunted Across the Phones and "B" Battery.

antenna. This increase in signal strength as recorded here was brought about by the improvement noticed in diagram Fig. 5, where the 1-Mfd. condenser C was connected between the ground and the RE lead as shown.

In order to get some idea of the fundamental wavelength and capacity of the coils, measurements were taken and the results were quite surprising.

|            | Capacity  | Fundamental Wavelength |
|------------|-----------|------------------------|
| Coil No. 1 | .035 Mfd. | 1150 Meters            |
| Coil No. 2 | .037 Mfd. | 1250 Meters            |

These coils were both free ended and are of the dimensions given previously (200 feet Packard cable, four foot diameter, approximately fourteen turns.)

FREE ENDED coils are used thruout and can be pointed out as the invention itself, since it is absolutely necessary that such coils be used in this work. It has been found thru experiment that a buried CLOSED LOOP will not function, while the open concentrated coil will give the same results as a length of wire stretched underground.

Naturally, it is necessary to employ a two-step amplifier, for signals will not be audible up to any considerable distances without this essential piece of apparatus which reached a very efficient stage during the war. (Continued on page 306)

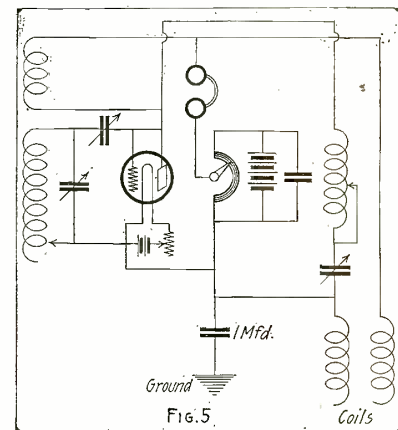

Here the Tickler Circuit Was Grounded Thru a Fixed Capacity of 1 Mfd.

# The New Brunswick Radio Station

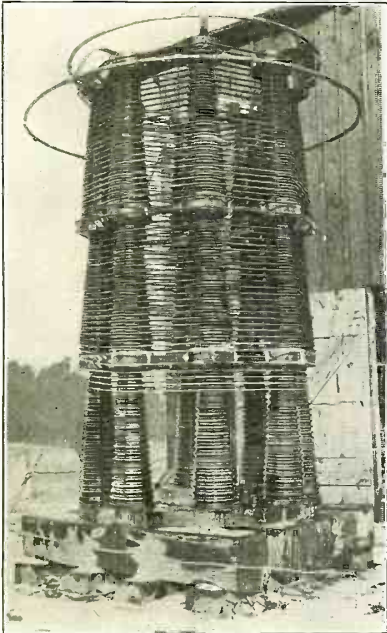

Gigantic Tuning Coil Used for Transoceanic Work at the New Brunswick Station

How often have we listened to the beautiful flute-like note of "NFF" and wondered what sort of apparatus produces such clear tones? Many of us perhaps have been envious when we compared the sound with our own screeching attempt at a 500-cycle note.

The secret of this wonderful tone is contained in the high frequency alternator invented by Dr. E. F. Alexanderson, consulting engineer of the General Electric Company. In the construction of this type of alternator a stationary armature and field is used. The rotating member consists of a steel disc slotted near the circumference so as to form steel spokes. As the steel disc revolves, the magnetic field is automatically strengthened and weakened so that a pulsating current is set up in the armature conductors. When this takes place at a high speed, a high frequency current is produced.

An idea of the size of the 200 K.W. alternator at the New Brunswick station may be gained from the photograph.

The magnetic amplifier also invented by Dr. Alexanderson is used to modulate the high frequency currents when telephone speech is being transmitted. It is an effective device when used as a variable impedance for radio frequency currents. In its simplest form it consists of an iron core having three windings. Two of these windings are connected in parallel and

(Continued on page 310)

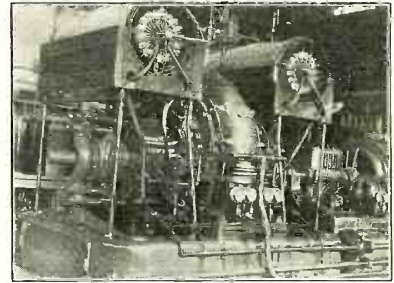

The 200 K.W. Alternator Recently Installed in the Station. Note the Two Large Control Impedance Coils Mounted Overhead

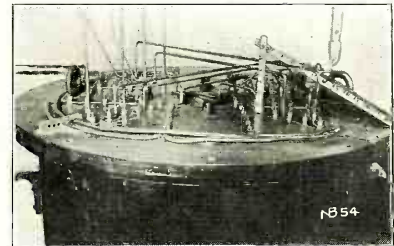

The Top of the Magnetic Amplifier. A Glance at the Rule and You Have an Idea of Its Size

# Radio Emissions From Eiffel Tower

The call letter of the Eiffel Tower Station is FL. Sending is done as follows:

| Greenwich Time         | Transmission                                  | Wave Length | Spark System |
|------------------------|-----------------------------------------------|-------------|--------------|
| 9:45 to 9:55 A.M.      | Meteorological Bulletin                       | 2600        | Musical      |
| 9:56 to 10:00 A.M.     | International Time Signals                    | 2600        | Musical      |
| 10:02 to 10:05 A.M.    | Sideral Time Signals                          | 2600        | Musical      |
| 10:44 to 10:49 A.M.    | French Time Signals                           |             |              |
| 15:00 o'clock to 15:30 | approx. Press Bulletins                       | 3200        | Musical      |
| 16:00 " to 16:10       | approx. Meteorological Bulletin               | 2600        | Musical      |
| 23:29 " to 23:33       | Astronomical Time Signal beats                | 2400        | Quenched     |
| 23:44 " to 23:49       | French Time Signals                           | 2600        | Musical      |
| 23:49 " to 23:51       | Series of figures referring to rhythmic beats | 2600        | Musical      |

Note:—In France and several other Continental countries the time is divided into 24 hours, thus 15 o'clock is 3 P.M.

The Eiffel Tower also sends out signals from its arc set, which are usually press messages, at the following hours: 18 o'clock, 1 A. M. and 4:30 A. M.

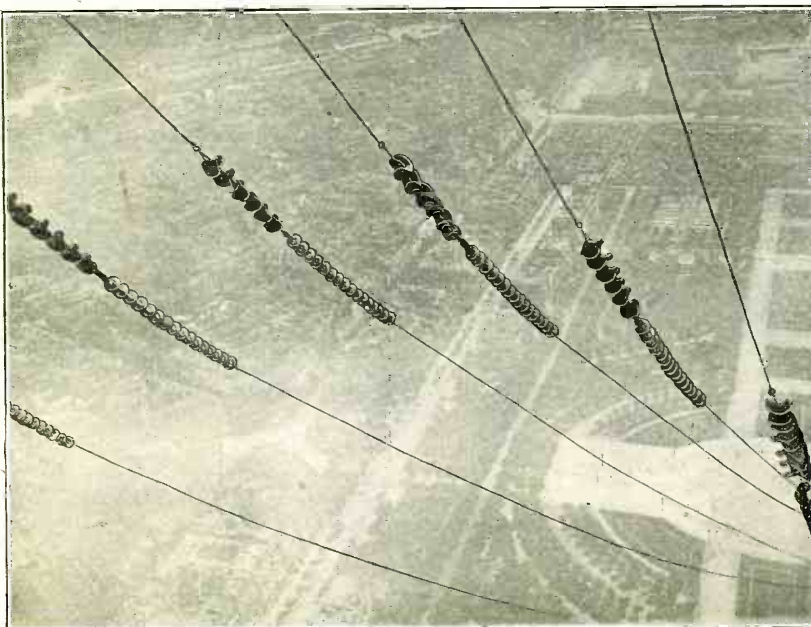

The Eiffel Tower stands on the Champs de Mars, Paris. It acts as a support for the six galvanized steel cable antenna which runs from the top of the Tower to insulators below. The antenna assumes a fan shape and is fairly efficient. An idea of the size and construction of the antenna insulators may be gained from the photograph. They consist of porcelain pulley over which are passed rubber belts.

Originally bronze cables were used for the antenna; but due to their weak mechanical properties, they were replaced by the steel cables. Although the steel has a certain damping effect, it is much better than the bronze cable formerly used. The maximum wavelength used is 3200 meters.

From the second platform of the Tower, a small antenna consisting of two wires, is suspended. The natural period of this aerial is 500 meters. Of course it is only used for experimental purposes.

The ground connection consists of zinc plates 600 square meters in area, buried under the station foundations. As shown in the photograph, in order to prevent the disfiguring of the park grounds, the station itself was built underground.

The main installation of the station contains a 130 k.w. alternator, which gives a musical spark note having a frequency of

Showing the Six Galvanized Steel Antenna Cables of the Eiffel Tower Station and the City of Paris in the Background

600. The resonance principle is used in connection with the transformer; that is, a resistance shunted by a key is placed in series with the alternator and transformer primary. When the key is pressed the resistance is short-circuited, thereby causing resonance in the alternator circuit and a maximum current flows in the transformer secondary circuit.

# \$100 RADIOPHONE PRIZE CONTEST

ONE of the most disappointing features of Radio Amateur Progress at present is the seeming lack of interest in the Radiophone.

The Editor of this publication has always taken the stand that the ultimate goal for all radio enthusiasts lies, without a shade of doubt, in radio telephony.

The reasons are so obvious and so convincing: while not one single argument can be found against it. Radio telephony is the one and only solution out of all the many Radio amateur's troubles, to wit:

With Radio Telephony, interference with Government and Commercial stations is practically done away with at one stroke. Consequently and logically, the radio amateur will at once be placed in a safe and dignified position. He will not be bothered as in the past and present with anti-amateur legislation. *But American radio amateurism will surely perish if its future rests upon radio telegraphy.*

With Radio Telephony no codes need be mastered. You talk, that's all.

With Radio Telephony, the length of time required to send a message is from 1/10 to 1/20 shorter. Consequently more traffic can go on for a given time than now.

With Radio Telephony, the tuning is infinitely sharper and better, consequently less interference. With Radio Telephony, radio amateurism will become truly great—of a national scope. Where there is one radio amateur telegrapher today, one hundred will grow in his stead the moment practical radio telephony is here. Everyone will use the radiophone! The farmer, the business man, country folks, motorboats, autos, etc., etc.

Now the curious and surprising thing is that the radiophone has been with us for some years past. There is nothing new about it, no secrets, no patents that need bother any amateur. Then why don't we use this wonderful invention to the very limit. It will surely boom Radio Amateurism more than any one thing in this world ever can or will. We have all the tools, so where is the hitch?

Now, the Publishers believe in the truly wonderful future of the Radio Telephone. They will stake their reputation—nay, if necessary their all—on their conviction. They will spare no expense, leave no stone unturned, to make American Radio Amateurism one of the world's greatest institutions. And Radio Amateur Telephony will be the keystone to this edifice.

With this in mind the Publishers wish to bring out the best from the ranks of our amateurs, the best being of course radio telephone transmitting instruments. Any modern radio receiver is capable of receiving either radio telegraph or radio 'phone messages. We are concerned here, only with the instruments that *send* the messages.

The Publishers therefore offer prizes of \$100 in gold for the best articles on a practical radio telephone outfit. America's foremost radio experts will act as judges of this contest. As every one of the judges will pass upon the manuscripts submitted there can be little doubt

| PRIZES OF \$100<br>IN GOLD |         |
|----------------------------|---------|
| First Prize . . . . .      | \$50.00 |
| Second Prize . . . . .     | 25.00   |
| Third Prize . . . . .      | 15.00   |
| Fourth Prize . . . . .     | 10.00   |

that all contestants will be treated fair and impartial. Furthermore, we feel certain that this contest will not only bring out the very best there is in the American amateur, but that it will lift the new art to an unknown and undreamt of level.

Here are the men who will act as the judges of the contest. A distinguished array of the best radio talent in America:

- Dr. Lee de Forest, Ph.D., Inventor of the Audion.
- Dr. Greenleaf W. Pickard, Inventor of the Crystal Detector.
- Dr. Louis Cohen, Ph.D., Radio Expert and Inventor.
- Fritz Lowenstein, Radio Expert.
- H. W. Secor, Assoc. I. R. E., Associate Editor, Electrical Experimenter.
- H. Gernsback, Editor, Electrical Experimenter and Radio Amateur News.

## RULES OF THE PRIZE CONTEST.

The set to be described may be of the vacuum tube type, the arc type, the quenched or other spark type. Or it may have embodied in it new features not known at present. The important part is that the set must have been actually built, that it either is in use now or has been in use. "Ideas" or patent descriptions are strictly excluded from this contest. It is also obvious that, insofar as this contest is conducted chiefly to bring out NEW ideas, commercial radio telephone outfits as now sold by several makers, are excluded from the contest.

It is necessary to state what instruments are used, and if certain instruments have been bought, the make must be stated. The transmitting distance of the radio-*phone* should be given, i. e. the record distance covered with the set. A complete diagram of connections, neatly executed in ink, is to be furnished. A good photograph (not smaller than 5 x 7") giving at least two views of the set is necessary. A photograph of the builder is required.

The sizes and the kind of wire used in the construction must be given, as well as the dimensions of the principal parts. More than one outfit may be entered by a contestant. The contest is open to every one (radio clubs included), except manufacturers of wireless apparatus. The manuscript should not be longer than 1,500 words. 1,000 words are preferred. All prizes will be paid upon publication.

**The contest closes in New York April 12th, and the first prize-winning article will appear in May, 1920.**

**Address all manuscripts, photos, etc., to "Editor Radiophone Prize Contest," care of this publication.**

*In connection with the above contest, it grieves us to announce that our second \$100 Radio Prize Contest: "An Ideal Sending Outfit," was abandoned for the reason that of the several manuscripts received, none complied with the most important rule, viz., the actual building of the outfit, and its proof—the required photograph of the set. The manuscripts were therefore returned to the respective authors.*

*The Publishers.*

# The Construction of Vacuum Tubes

By R. S. HAWKINS

**I**N this article an attempt will be made to give a description and the constructional details for the manufacture and development of the vacuum tube. The ideas shown are original with the author and are published for the amateur who may wish to experiment in this line.

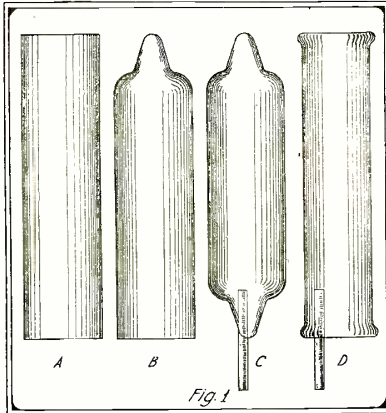

Showing the Steps Used in Working the Tubes Into Shape.

The tubes described are of simple construction and require nothing but patience and persistence to construct them. The methods used are the simplest that could possibly be found and required many months of development.

There are numerous ways of exhausting these tubes and several have been described in previous issues of the *Electrical Experimenter*. These tubes need not be exhausted to the point where no gas can be detected, but may be of the gaseous type. Below are the constructional details of a machine for making the tubes, which is suitable for amateur needs.

In Fig. 1 are shown the various stages for constructing the tubes. The members in the tubes have been left out for sake of clearness. A is a length of glass tubing. This tubing should have thin walls and also a low melting point. The first operation is to seal one end B. The small tube for exhausting the bulb is then put into place as shown at C (side view), D (front view) and this end is then sealed. This simplified construction saves much time and avoids a great deal of trouble.

The machine for constructing the tubes

is shown in Fig. 2. The tube A is in the process of being sealed.

No dimensions of any of the parts are given so that the experimenter can construct a machine to best fit his needs. I, is a plate, preferably of wood. This plate is fastened to the shaft 5, by means of a set screw. The washer 6 holds this plate away from the support R, thru which the shaft 5 passes. Mounted on the face of this plate and spaced equidistant from the center are the two brackets 2 and 2a. These brackets are secured by means of screws A, B, C, D. Secured to the upper bracket is the clamp 4, which holds the tube A in place, E is a small rod to hold the members in place while the tube is being sealed. The bracket 2a is much longer than bracket 2 and has fastened on it the adjustable clamp 4a whose tension may be altered by the wing nut F.

This bracket serves to hold the tube tightly in place. The plate 1a is of the same size as plate 1. Two brackets 3 and 3a are also mounted upon its face equidistant from the center and are secured by screws G H. This plate is fastened to the shaft by means of a set screw. A washer separates it from the support R. The brackets, 3 and 3a, serve to hold the plate P in place. This plate acts as a support for the members H I and for the seal-off 5. R, R, R, R, are bearings for the main shafts. The pulleys 9 and 9a are belted to the shaft 10 underneath the bench, this shaft in turn being connected to a motor. It is necessary to run the machine quite slowly as the work must be very carefully watched. The clamp for sealing the tubes is shown at 12. The stops 14 and 15 prevent this clamp from moving too far in either direction. The wing-nut 16, serves to tighten the clamp when the seal is made. When

the end containing the seal-off is made, a new clamp must be used, details of which are shown in Fig. 3. The size of the base and bearings have been omitted, being left to the amateur's discretion. The gas burner is mounted above the machine and a tip giving a pointed flame is preferable.

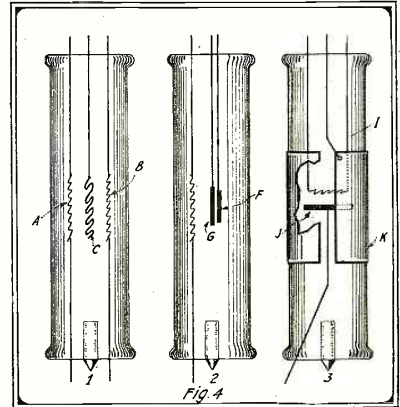

The Tubes After the Elements Have Been Inserted.

Care should be taken not to apply too much heat at the beginning or the tube will crack. The seal-off must also be made very carefully. This completes the description of the machine, its construction and use. Fig. 3 gives the details of the machine. Following is a complete description and explanation for constructing some of the author's tubes. These will be explained together with their method of operation and diagram of connections.

Tube 1, Fig. 4, is a view of one type of tube. This tube, as will be noted, has two filaments A and B with a grid C interposed. One of these filaments A is used to produce electrons, while the other is one form of a plate. The grid is used in the customary manner as the controlling member. It will be noted that the "B" battery has been eliminated and the two "A" batteries are used in its place. A "B" battery may, however, be used and connected in the usual manner.

Tube 2, Fig. 4, has several novel points. Here we have a very small and thin piece of glass, which is used as a plate. The grid is fastened directly to this plate and serves as in shield. The filament is brought very close to the plate and grid element so as to get all the benefit from its heat which is important in the operation of the tube. It is advisable to try several different sizes of plates as some may work better than others.

The tube 3, shown in Fig. 4, is one which has recently been manufactured for amateur purposes and is known as the "Moore-head Tube." This is simply an extension of the Fleming Valve which has a filament and plate in the tube. This tube has an additional electrode K mounted on the outside. This member is placed at right angles to the inside plate. If possible it is advisable to have this outside member copper-plated onto the glass as much better results are obtained then. This tube is perhaps the most simple of those described and it is best to contrast several of each before trying the others.

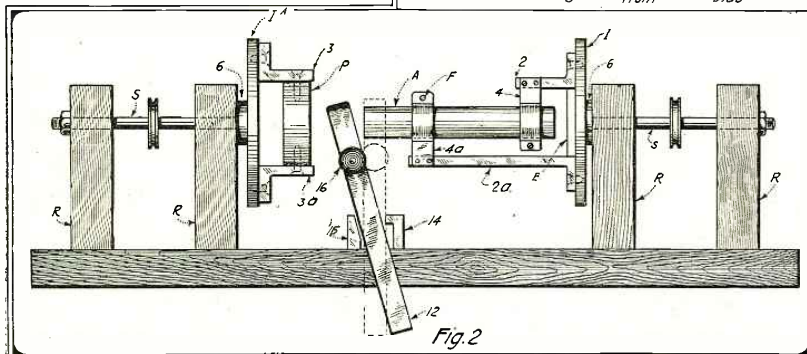
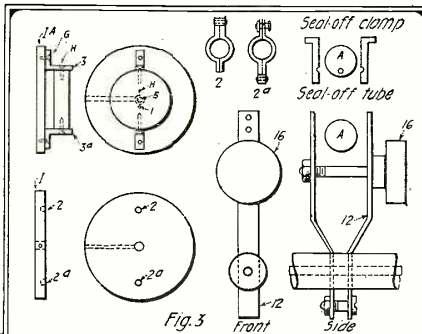

Showing the Constructional Details of the Machine Used in Shaping and Sealing-Off the Tubes.

Having given a general description of the tubes the constructional details will now be taken up. No dimensions of the various parts are given. The tubing, however, must have extremely thin walls.

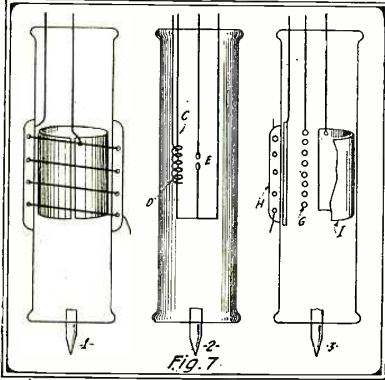

Showing Various Designs Which May Be Used.

The tube 1, Fig. 4, will first be explained. Secure a length of tubing as shown in A, Fig. 5. Insert this in the clamps of the machine as described.

The filaments can now be constructed. The copper leads shown at B, Fig. 5, are first made by flattening the ends C, C, in a vise. They are then bent over as shown at D until they are almost touching. The tungsten wire (from a new 110 V. lamp) is inserted and the ends of the leads pinched together with a pair of pliers. The completed filament is shown at E. The grid F is made of copper wire heavy enough to hold it stiff when placed in the tube. The members are now secured in the tube and drawn tight. Having made sure that everything is all right, start the machine revolving. When it has attained full speed, light the burner. Allow the flame to play on tube until it becomes pliable. Turn the gas off quickly when the glass has reached this point and pinch the tube together with hot pincers. Having pinched it firmly the flame is again lighted and the heat is gradually reduced by cutting off the flame slowly. The machine should revolve during the operation which is known as *annealing*. Allow the tube to cool and then remove it from the machine. The other end is now ready for sealing. This has in addition to the leads the "seal-off tube." It is therefore necessary to change the clamp on the machine. Having done this and secured the member in place repeat the above operation. Extreme care must be taken in pinch-

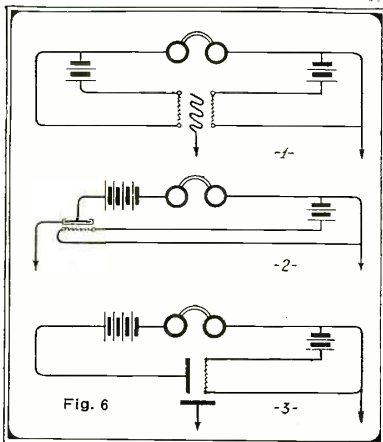

Hook-Ups Suggested for Trying Out the Tubes.

ing the tube as it is liable to break around the seal-off. The tube is now ready to be sucked or exhausted.

As stated before this has been described in previous issues of the *Electrical Experimenter*. We will now go on to the construction of the tube shown in 2, Fig. 4. The plate of this tube consists of an extremely thin piece of glass of small size F, Fig. 5. This plate has a connection fixed to it. The grid G which may be of copper foil is secured directly upon the face of the glass plate. This is done by bending the edges over as shown in Fig. 5 (H). The filament construction is shown in Fig. 4. The tube is placed in the machine exactly the same as was 1, Fig. 4. The members of this tube, that is, the plate and grid element should be as near to the filament as possible, this depending upon the size of the plate used. In exhausting this tube, the vacuum should be a little higher than that of the other tubes described. This tube is quite simple and close examination of the drawings gives sufficient explanation.

The tube shown at 3, Fig. 4, is the "Moorehead Tube." Here we have two inside elements and one outside. The plate of this tube is of nickle and is held in position by the two wires shown at Fig. 5 (J). The filament of this tube is constructed differently from those in tubes 1 and 2, due to the fact that the inside plate must be at right angles to the outside plate, which is a grid. The filament details are shown at 1, Fig. 5. The outside plate may either be copper plated on the tube or consist of a metal cylinder secured

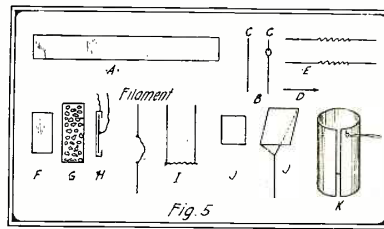

Details of the Element Construction.

around the outside of the tube. Details are shown at K, Fig. 5. Follow the operations for sealing and annealing the bulb as given in the explanation of tube 1. No mention of theory will be made as these tubes all depend upon the electronic emission from a hot filament, to some form of plate; the electrons being under the control of a third member known as the grid. The connections for the tubes 1, 2 and 3 appear at Fig. 6. With the exception of 1 these are regular Audion hook-ups and no further comment is necessary on them. Other connections are possible, however.

The following tubes described offer new lines of experimentation to the amateur and are original with the author. The tube 1, Fig. 7 will be explained first: This tube it will be noticed has no inside hot member. Constructional details of the plate and grid will be given first. Fig. 8 shows the construction of these two members. The grid is of copper wire and may be made by winding the wire around a cardboard tube. The plate is of aluminum and is circular. These two members should be very close to the walls of the tube so as to receive the most benefit from the filament, details of which will now be given. Various materials may be tried for use as a filament as some materials make better filaments than others. Since this filament is on the *outside* of the tube, some provision for the prevention of oxidation must be made. One method is shown here; A, Fig. 8. The filament is first wound around the outside of the tube, a coating of asbestos is put on top of the filament, then a thin layer of cement, made of plaster

of paris is used to completely seal the filament.

The tube is next exhausted in the regular manner. It is advisable to make this tube of as small size as possible as regards its diameter. The construction of tube 2, Fig. 7, will now be given. This

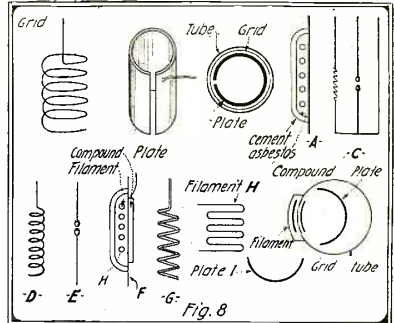

Additional Details of the Element Construction.

tube has been termed a balance member valve. In place of the usual plate are the two balanced members E, Fig. 8: The grid construction is also shown in Fig. 8. The members are made by holding their ends in a flame until a ball forms. In placing these members in the tube see that they are as close as possible without touching. Filament and grid details are given at C, D, Fig. 8.

The tube 3, Fig. 7, is not practical to-day due to the fact that a powerful electron emitting compound which can be made at low cost, has not yet been found. It will be seen that there is chance for much development along this line and an experimental tube is described herein. The complete details of this tube are given in Fig. 8, F to I. The filament construction is the same as tube 1, Fig. 8, except for the fact that it does not completely encircle the tube but is placed so as to give maximum efficiency. The plate is semi-circular. This completes the constructional details of the tubes 1, 2 and 3. The hook-ups for these tubes are shown in Fig. 9.

During the exhaustion of these tubes which have inside filament it is best to burn them at the highest point. A battery should also be connected in the circuit. These tubes exhaust much higher if a little phosphorous is painted on the plate. This is made by making a thin paint out of phosphorous and ethyl-alcohol.

This completes the article in which the author has endeavored to give every stage of Vacuum Tube construction for the amateur.

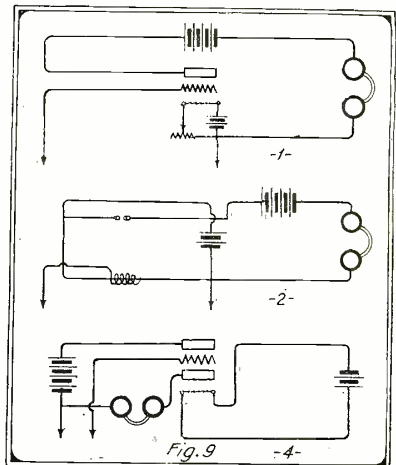

These Circuits Will Also Give Satisfactory Results With the Home-Made Tubes.



# Awards of \$100 Radio Prize Contest

## 3rd Prize Winner \$25.00 in Gold



three sections which are controlled by a dead-end switch. The unit and tens system of tapping is used in this set. This enables the operator to tune in long distance stations accurately and in the shortest length of time. This system also does away with the old rod and slider which was undesirable for the reception of long wavelengths.

The leads from the primary are brought directly to the taps on the front of the panel and soldered. There are twenty-two taps, taken one every tenth turn and ten taps taken, from one from each of ten consecutive turns. This means that there are two hundred and thirty turns on the primary. The wavelength of the primary is three thousand meters.

A large loading coil controlled by a multi-point switch is connected in series with the primary as shown in the photograph. This coil in con-

switch, as seen at the right in the photograph. All of the leads are soldered to the taps on the front of the panel to secure the best electrical connection. The end wire of the secondary and the connection from the secondary switch are brought to the outer poles of a triple pole double throw switch. This is because there are two separate and distinct circuits in this cabinet, one the crystal detector circuit and the other the audion circuit. The object of the switch is to throw from one circuit to the other, without changing any wiring connection whatever.

The advantage of such an arrangement is illustrated when receiving; if the crystal detector loses its adjustment, all one has to do is to throw over the switch and continue to receive. It also enables one to save batteries by being able to change to the crystal detector on short wavelengths, or on loud signals. The other pole of the switch is used to throw the phone connections from one circuit to the other in conjunction with the circuit desired.

As the crystal detectors are independent of the cabinet there are binding posts to connect them to. The detectors are controlled by a small two-point switch. Generally, both detectors are connected in the circuit for different purposes; that is, for using different minerals, with and without a battery current, and for changing from one to the other if one loses its sensitive point. Almost all of the detector crystals have been used with this set, including galena, radiocite, silicon, carborundum, iron-pyrites and pericon. The galena detector was found to be the most sensitive, but for all around work the radiocite was superior to them all by being next in sensitiveness to the galena and by holding its adjustment thru incoming loud signals.

The audion is mounted on the top of the cabinet and is connected permanently with the set. The bulb is an old two-filament type. The connections are made to binding posts on the panel. The filament requires six volts to operate at its best. The filament voltage is varied by a small rheostat mounted on the back of the panel. The plate requires a potential of about fifty volts and this voltage is controlled by a graphite potentiometer.

In the interior of the cabinet there are two fixed condensers; either one or both may be used by throwing a small switch on the side of the cabinet. The condensers are connected across the phones.

(Continued on page 310)

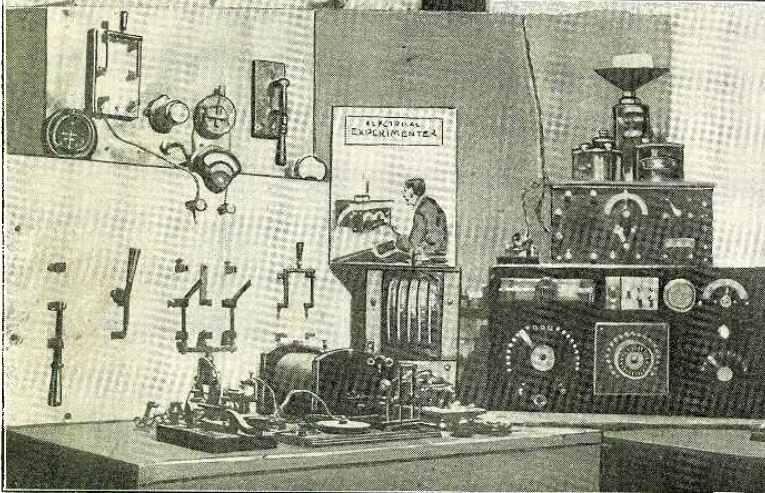

Ralph E. Smith, Who Won the 3rd Prize on the Merits of This Set, Designed and Built by Him. The Arrangement is Very Selective and the Owner Has Reason to Be Proud of It.

## An Ideal Receiving Set

By RALPH E. SMITH

**M**Y largest and best receiving set consists of so many different parts that I find it difficult to begin to describe it. But I will attempt to at least give you an idea of how it was constructed:

The cabinet itself is about two feet long, one and one-half feet high and a trifle over one foot wide. The material used was white pine wood, which when smoothed down and varnished a japanned black gave a good imitation of hard rubber. This gives the cabinet the appearance of a "tailor made" set.

The primary of the receiving transformer consists of a cardboard tube, four and one-half inches in diameter wound with No. 24, double cotton-covered magnet wire. Shellac was used to hold the wire firmly in place. The primary coil is divided into

junction with the aerial adds about 4,000 meters to the actual wavelength of the primary. The cabinet is so connected that if desired the loading inductance may be entirely disconnected from the circuit. This increases the efficiency of the set by reducing the dead-end effect to a minimum.

The secondary of the transformer is wound on a cardboard tube four and one-quarter inches in diameter and seven inches long. It is wound with No. 34 B. & S. silk covered wire. The whole is then given a heavy coat of shellac.

The coupling is varied by a brass rod extending thru the end of the cabinet and fastened to the end of the secondary on the inside. A small dial is attached to the rod to enable the user to determine exactly the degree of coupling he desires. The secondary is controlled by an eight-point

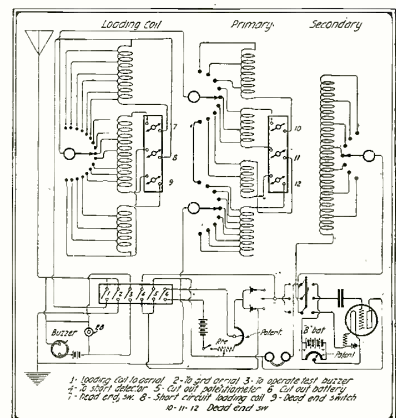

Wiring Diagram of the Prize Set.

# The Amateur Position in England

[The following interesting article will be of great interest to all American radio amateurs. The very next time when you think that the American radio amateur is not treated right and does not get all that is coming to him, then sit down and read the following article.—Editor.]

In view of certain paragraphs which have recently appeared in the daily press indicating that a change has occurred in the amateur position, we give hereunder a complete description of the facilities at present available for amateur wireless work, brought up to date (Oct. 21st).

(1) All amateur licenses have been cancelled and new ones are not yet being issued.

(2) Special informal permission to use receiving apparatus is being granted, and the following is the official statement regarding this:—

## EXPERIMENTS IN WIRELESS TELEGRAPHY.

### AUTHORITY FOR THE USE OF RECEIVING APPARATUS.

#### CONDITIONS OF ISSUE, Etc.

Formal licenses to conduct experiments in wireless telegraphy cannot at present be granted, but, pending the settlement of certain outstanding questions, the Postmaster General is prepared to authorize the use of wireless apparatus for the reception of signals on the following conditions:—

(1) The applicant shall produce evidence of his British nationality and two written references. (A certificate of birth should be furnished if possible; but this will not be insisted upon if the two referees testify

of their own knowledge that the applicant is of British nationality. The references should be given by persons of standing, who are British subjects and not related to the applicant);

(2) There shall be no divulgence to any person (other than properly authorized officials of His Majesty's Government or a competent legal tribunal or any use whatever made of any message received by means of the apparatus);

(3) The installation shall be subject to the approval of the Postmaster-General;

(4) The aerial shall not exceed the under-mentioned maximum height and dimensions:—

|                                                 |                                                                                                                                         |
|-------------------------------------------------|-----------------------------------------------------------------------------------------------------------------------------------------|
| Extreme height of aerial above ground           | } 100 feet                                                                                                                              |
| Total length of wire including leading-in wires | { 100 feet for single wire aerial.<br>140 feet of wire where two or more wires are used (e.g., total length of 70 feet of double wire). |

(5) Thermionic valves shall not be used without the special authority of the Postmaster-General;

(6) The apparatus shall be open to inspection at all reasonable times by properly authorized officers of the Post Office;

(7) A fee of 10/- shall be paid. (It is contemplated that an annual charge of 10/- shall be made in respect of each experimental receiving license to cover the expenses of the issue of the license and the inspection of the station.)

#### PROCEDURE TO BE FOLLOWED.

The applicant should furnish

(a) A formal acceptance of the foregoing conditions;

(b) Evidence and references as described in (1);

(c) His full Christian names and particulars of his occupation;

(d) A remittance of 10/-;

(e) A description of the apparatus which it is proposed to install, and, if authority is desired for the use of thermionic valves, a diagram of the circuits in which they would be used;

(f) A sketch showing the form, height and dimensions of the proposed aerial (including leading-in wires);

(g) The address at which the apparatus would be installed.

If it is desired to purchase wireless apparatus for use under the prescribed conditions full particulars of the apparatus, and the name and address of the firm from which it is proposed to obtain it, should be furnished, in order that a permit for its purchase may, if necessary, be issued. Any receiving apparatus belonging to the applicant, which is in Post Office custody, will be returned to him as soon as authority is granted for its use.

N.B.—If the applicant is a minor, the authority to use wireless apparatus can only be issued in the name of his parent or guardian, who should comply with the requirements set forth above and state his (or her) full address and relationship (if any) to the applicant. Evidence should also be furnished, as indicated in condition (1), of the minor's British Nationality. There is no objection to a minor working the authorized apparatus as the agent of his parent or guardian.

(h) No license or permission to transmit by wireless telegraphy is at present obtainable by amateurs, as the conditions under which this will be allowed are not yet settled.

# Warning to Amateurs

## DEPARTMENT OF COMMERCE

### Navigation Service

Office of Radio Inspector

Customhouse

New York, N. Y.

November 21, 1919.

Editor RADIO AMATEUR NEWS.

Sir: A great number of amateur radio stations are believed to be in operation without proper licenses for the station and for the operator having been obtained from the Radio Service, Bureau of Navigation, Department of Commerce.

When the war restrictions on amateur, training and instruction, and experimental stations were removed by the Navy Department it is probable that many amateurs immediately began transmitting with their radio equipment under the impression that no additional authority was required. Transmitting radio stations of any kind or power come under the Act of August 13, 1912, and require a transmitting license from the above named Bureau.

Many amateurs are also under the misapprehension that if they have a low power transmitting set which they believe cannot transmit beyond the limits of the state in which they are located, that they do not require a license. This is not the fact, inasmuch as the law includes stations which can interfere with messages from outside the state in which the station is located. This proviso, therefore, includes every transmitting station.

Licensed stations require licensed operators, and the amateurs' attention should also be called to this fact. There is a penalty of \$500.00 provided for the person operating an unlicensed radio station, and an additional penalty of \$100.00 and imprisonment of not more than two months or both for an unlicensed operator, and unless some of the offending amateurs are promptly advised of the necessity for station and operators' licenses, there is a possibility of their being prosecuted for violating the law.

The necessary application forms and information regarding licenses can be obtained by communication with the U. S. Radio Inspectors of the different radio districts.

Respectfully,

L. R. KRUMM,

Chief Radio Inspector.

## LOS ANGELES, TOO!

Warning to amateur wireless operators of Los Angeles and vicinity, who have been interfering with Government radio messages, was given recently by J. F. Dillon, Federal radio inspector, who examined 125 candidates for radio licenses at the Y. M. C. A. wireless school. According to Mr. Dillon the practice is widespread in Southern California.

"The Department of Commerce is mak-

ing a special effort to eliminate annoying interferences by amateur radio operators with Government and commercial communications," said Mr. Dillon, "and it is probable that those found guilty of the offense will be prosecuted to the full extent of the law. One of the penalties provided for unlawful operation of radio stations is the confiscation of the apparatus, as well as fines and imprisonment.

"A number of amateurs have spent large sums of money for the equipment of stations, but they will find themselves without apparatus unless they comply with the law. And once the Government gets possession of their instruments it is under no obligation to return them."

The Government examination for radio operators, held at the Y. M. C. A. wireless school, was the largest that has ever been held in Southern California. Two-thirds of the number successfully passed the code test, which is a preliminary requirement. Ten licenses were granted to first-grade commercial operators, many of these successful applicants being graduates of the Y. M. C. A. school.

In the future, applicants for amateur licenses may take the code test at the Los Angeles Y. M. C. A. wireless school under the supervision of J. L. McKinnon, principal, who has been appointed official examiner of amateur operators. By passing the code test under Mr. McKinnon, applicants may operate in amateur stations until regular examinations are held.

# Some Foreign Apparatus

By FRED M. GILL

**T**HIS set can be used for sustained wave signaling, either telegraphic or telephonic, by means of oscillations set up by the standard French amplifier bulbs of the transmitter (see Figs. 1 and 2). With 320 volts on the plates and six volts on the filament, four bulbs con-

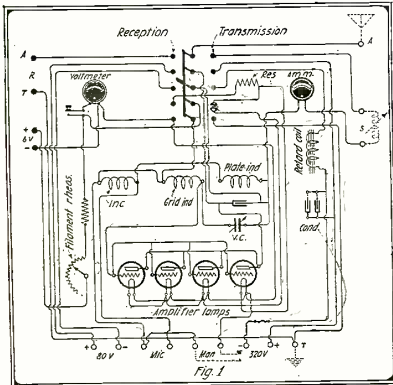

Circuit of the French Type E-3 Telephonic and Telegraphic Transmitter

nected in parallel, 0.6 to 0.8 ampere radiation is had. The antenna used with the E-3 set is horizontally V-shaped, 50 meters on each side, 60-degree angle, supported seven meters above they round on bamboo poles. A wire 15 meters long leads from the apparatus to the point of the V connected to this antenna. This set transmits on wavelengths between 600 and 1,050 meters, to a distance of about 60 miles for telegraphic and 10 miles for telephonic transmission. There is a supplementary antenna loading coil furnished that enables the set to transmit on wavelengths of from 1,000 to 1,800 meters.

Although the distances given are the usual insured communication table, it was possible to copy one of these transmitters at sea over land a distance of 600 miles, using the Navy type SE-143 tuner in connection with one of the old long type Audion (gas) bulbs. This was on the wave length of 2,100 meters. The station mentioned was the Signal Corps station of the Belgian Government at Brussels. All the apparatus used by the Belgians is either German or French, as they have none of their own.

The French 3-Step Amplifier, Type 3Ter, the instrument which I have unfor-

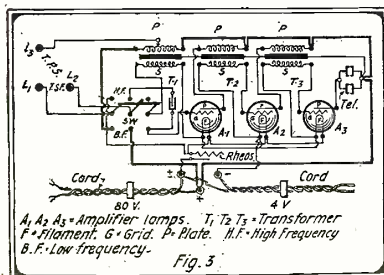

In This Circuit the Cores of the Transformers Are Connected to the Phones to Gather in All the Stray Currents.

tunately been unable to procure photographs of, may be described as follows:

The cabinet is of plain oak finish and all insulating parts are of hard rubber. In the upper right-hand corner are three binding posts, marked "TPS," "S" and "TFS," meaning "TPS" for the reception of the ground system of telegraphy, "S" for the regular secondary connection, and "TFS" for the *sans fil* or *without wire* telegraphy. In the center of the cabinet face are four telephone jacks and, as these run through the face of the cabinet, the Audion bulbs may be seen through them while in operation. On the central left is a switch marked "BF" and "HF" of the DP-DT type. This is the switch controlling the audio frequency and the radio or high frequency. On the central right is an instrument type of switch marked "In and Out," which controls the filament current. On the bottom are the A and B battery connections. The B battery for this amplifier is a storage battery having a paste for an electrolyte, and the way they stand up is quite remarkable. The bulbs are suspended in the cabinet by a band of soft rubber running from the corner of the hard rubber socket base to each corner of the cabinet, thereby depriving the bulb of any serious jarring. All parts are of very heavy material—even the frequency switch would accommodate 30 to 40 amperes easily. The condenser for the grid is of two sheets of 2x5 inches, and having a mica dielectric. The amplifying transformers have an ohmic resistance of 15,000 for the secondary and 4,000 for the primary. *In this circuit the cores of the transformers are connected to the phones to gather in all the stray currents.* (See Fig. 3.)

A word in regard to the French bulbs at this period. They are far from being a standard bulb, and they are of the soft vacuum type. If the operators take a little care and select good ones they are hard to beat.

With one of these sets and a Signal Corps Marconi built receiver it was possible to copy the 12-kw. arc set at Los Angeles, Cal., in Antwerp, Belgium, and all the arc sets in the United States roared in.

A word regarding the generator for the 320-volt plate circuit:

This was marked on the outside of the frame "Westinghouse Auto Starter." The voltage input is twenty and the amperage on the motor side was around thirty, confirming all the operators' beliefs that it was a standard Westinghouse auto starter on the motor side and on the generator side it was no doubt a special winding. Amateurs will do well to inquire from the various manufacturers regarding these starters if they intend using a generator for the B side of an audion transmitter.

As is well known by this time that the Americans used the French aeroplanes and the various reports show that they were inefficient, it is within reason that they

used the French aero sets, and whether the sets were inefficient or not is hard to tell, as we had none of our own.

*French No. A-1 Receiver.*—This is the set supplied to all the French planes at the time of our entry into the war.

The diagram is self-explanatory and only a few words are necessary. (See Fig. 4.)

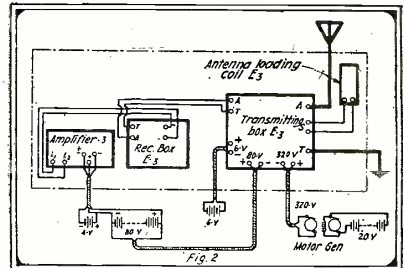

Method of Connecting the Transmitter, Receiver and Amplifier Sets.

The tuning range of this set was from 50 to 1,000 meters, and the coupling was on the variometer principle. This set was very selective and every one that used it was quite satisfied.

The two tapped switches are the primary and the secondary, respectively, and the central switch on the right is the one for the variation of the coupling, while the upper and lower right are the ones for the variable condensers, and the necessary binding posts, including the telephone jacks.

The transmitter supplied with this set was the French type No. 3 (see Fig. 5). It was approximately a four-inch spark coil. It was contained in a box, and when the lid was thrown back it exposed to view the key, gap and the vibrator. It will be noted the different design of the gap points. One is of copper for the antenna and the ground one is of zinc. The aeroplanes, if the conditions were good, were able to work ten to fifteen miles with this set, employing an audion of the same type as the three ter, only there were only two bulbs in the circuit for reception.

It has been noticed in the past that there was considerable talk that the French used a buzzer set for the front line work, but the diagram given here of the French front line set is a 4-in. coil. The ground stakes were one of copper and one of aluminum, spaced about twenty or thirty feet apart. This set worked up to a distance of six miles. The value of it can

(Continued on page 312)

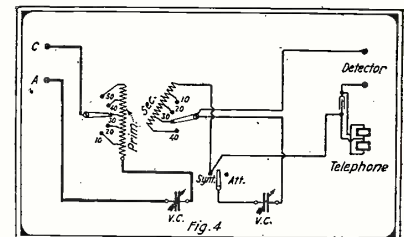

Showing Connections of the French Aero-Plane Set.

# Experiments With Loop Antennae

By C. L. WHITNEY

**T**RANSMITTING station in all experiments was (POZ) Nauen, Germany, at a distance of 600 miles. Receiving was done with one oscillating audion, using a tickler coup-

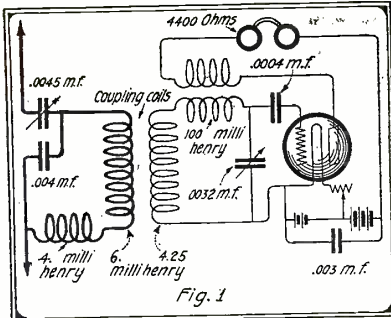

Tickler Circuit Used In Conducting these Experiments.

ling of high inductance. Complete diagram is given in Figure 1.

First, a grounded loop was tried (Fig. 2). The highest part being the point of the loop, which was 80 feet above water, but only 40 feet above the steel deck of the ship. This loop gave the strongest signals of all, the audibility being between 4 and 5.

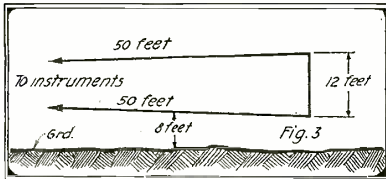

The Horizontal Loop of the Dimensions Shown Gave Fair Results.

Second, a horizontal loop 50 feet long was used (Fig. 3). The lower leg ran parallel to the steel deck at a height of eight feet. (This is the same type of loop used by Mr. Weagant in his experiments at Lakewood, N. J., in 1918.) Signals from Nauen were between two and three times audibility.

Third, a loop of two and three-quarters turns of small size wire was erected inside the wooden Radio House. This loop was six feet high and eight feet long, with the lower part running nine inches above the steel deck. Leads to instruments were 15 feet long (Fig. 4). Nauen signals were practically twice audibility.

Fourth, a loop the same as the third one, except that the top and lower turns were four feet long instead of eight feet. Signals from Nauen were just barely audible.

During each of these experiments the main ship aerial was alternately grounded and open-circuited, to find out if it in any way affected the loops, but there was no difference in signals either way.

In all cases the loops were pointed directly toward Nauen to take advantage of the directional effects of the loop. It might be well to state here that in constructing an aerial to receive across the Atlantic, to take full advantage of the directional effects of a long aerial, the aerial should point toward the transmitting station, not by compass, but toward the shortest route the wave could travel to reach your aerial. In the Marconi station at Lakewood, N. J., where experiments were carried out over long distances, although Nauen and Carnavon lie just north of east from Lakewood, the aerial was built to

point nearly northeast. At first glance this seemed foolish, but it must be remembered that the shortest line between Nauen and Lakewood goes nearly as far north as Greenland toward the center of the dis-

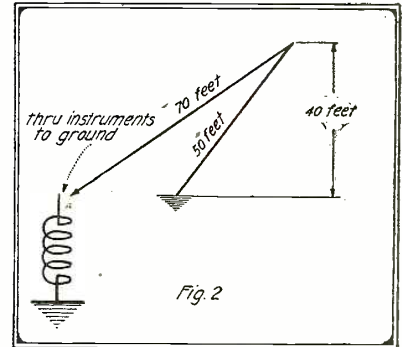

The Grounded Loop Gave the Strongest Signals of All.

tance. This was proven by a large directional finder in actual use.

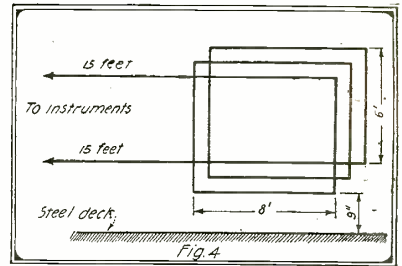

With This Type of Loop Nauen Signals Were Twice Audibility.

## Simplified Arc Reception

By RAYMOND B. WAILES

**M**ANY amateurs do not "listen in" to the undamp wave stations, many of them foreign, thinking that to receive them a very large amount of tuning inductance is necessary. Their wave length is longer than the spark stations, but the large undamped wave inductances, some of them four feet long, are unnecessary, owing to new methods of reception.

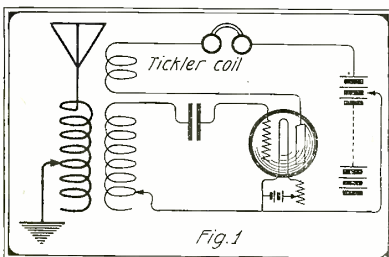

The Ordinary Tickler Circuit for Receiving Undamp Signals.

By employing one of the following hook-ups, the undamped wave stations can be received with ease.

Figure 1 shows connections for a "tickler coil". The "tickler coil," which, literally "tickles" the secondary, consists of about fifty turns of No. 24 wire, wound on a tube 2.5 inches wide, and having the same diameter as the secondary. It is placed in inductive relation with the secondary, either by slipping it over the secondary, or over the two guide rails of the secondary. The coupling only is varied—accomplished by moving the coil over the secondary, or toward it, or away from it.

Thru the additional connection from one of the secondary taps (the correct one determined by experiment), to one of the filament battery terminals, the reception of damped waves is made possible in a simple Audion circuit as in Fig. 2.

Still another method for the reception of arc stations is shown in Fig. 3. The con-

densers, C-2, C-3, connected in series, are of the same size as the grid condenser, C-1. Two sheets of copper, or tin foil, each one and a half inches square and separated by mica, is about the right capacity. The condensers are shunted

(Continued on page 316)

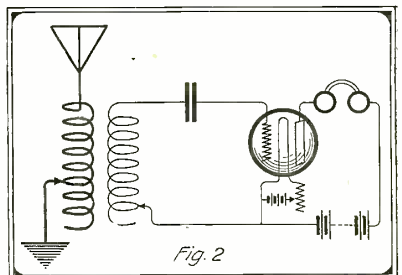

A Third Connection Added From the Secondary to the Filament Battery Would Make This Simple Detector Circuit Oscillator.

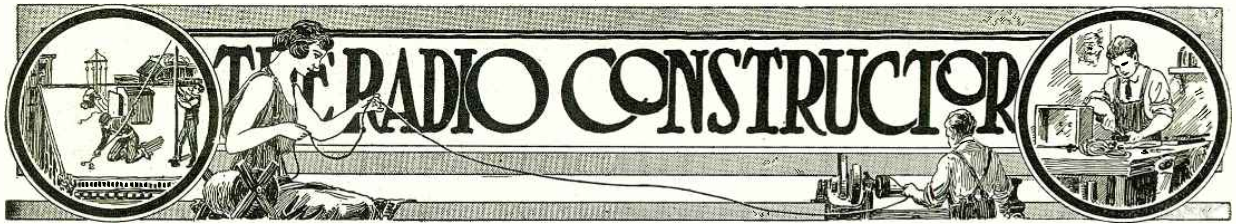

# Construction of an Audion Cabinet

By GIFFORD L. WESTON

**N**O up-to-date amateur station is complete without an audion central panel and yet many amateurs cannot afford a ready made one, as they are often quite expensive. A very efficient audion cabinet can be made easily and with little cost.

The cabinet described below occupies but little space on the operating table and is of simple construction. This cabinet is in use and excellent results are obtained.

The bulb is of the tubular type, which is very nearly as sensitive as the new V. T., and is less expensive. The panel is of  $\frac{1}{4}$  in. bakelite-dilecto,  $3\frac{1}{2}$  in. wide and 11 in. long. The cabinet is made of  $\frac{3}{8}$  in. quartered oak, and is  $10\frac{3}{4}$  in. long,  $3\frac{1}{4}$  in. wide and  $4\frac{1}{2}$  in. deep. The back is the same size as the bakelite panel, and is fastened with wood screws, so that it can be easily

On the panel are mounted the bulb, potentiometer, on and off switch, and bind-

graphite potentiometer is used to vary the plate current, this is placed  $2\frac{1}{8}$  in. from the bottom of the panel. Just below the potentiometer is a small three point switch, which when placed on the two lower contacts, lights the filament and connects the B battery with the plate. A Standard 10 ohm battery rheostat is screwed to the side of the cabinet to regulate the filament. Two small holes are drilled in the side of the cabinet in front of the partition, these are for the wires from the rheostat to the inside of the panel. Ten binding posts are necessary for the panel; a pair for the phones, a pair for the secondary, another pair for the "A" battery, and the remaining four for connection

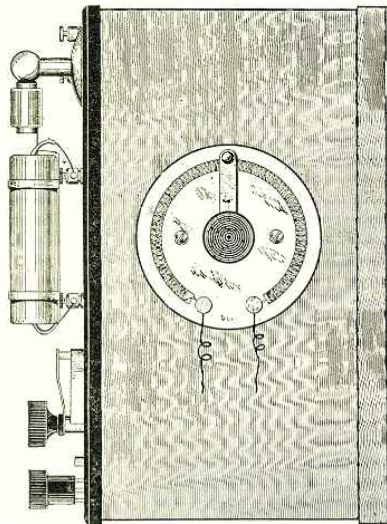

Side elevation of the Audion Cabinet showing the position of the rheostat.

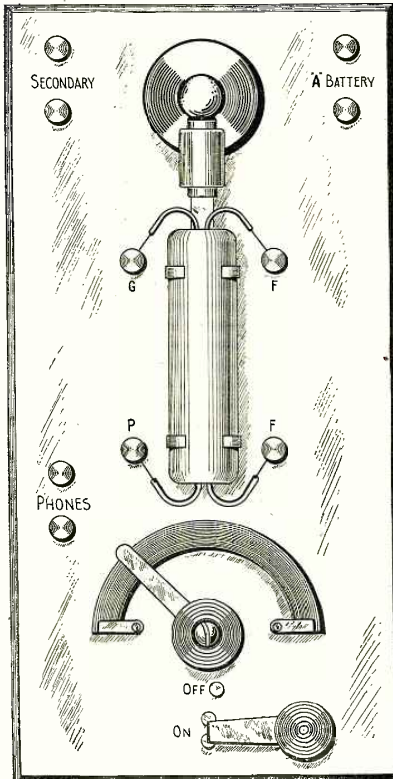

Front View of the Audion Cabinet.

ing posts. A miniature wall bracket, miniature candelabra socket and tubular bulb adapter are used to hold the audion tube. The wall bracket is placed  $1\frac{1}{4}$  in. from the top of the panel, and is fastened with machine screws. A semi-circular

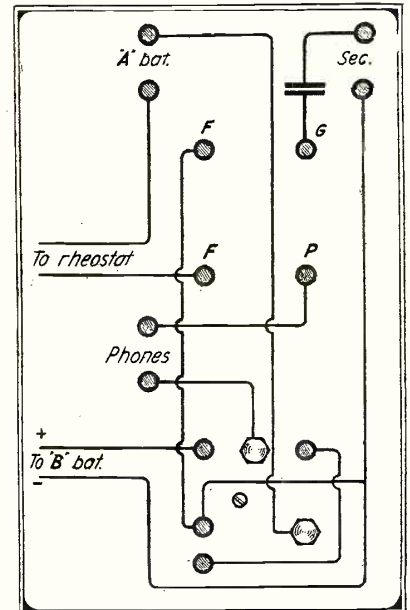

This Schematic Wiring Diagram May Be Followed Clearly.

removed. The B battery is made up of 12 flashlight batteries  $2\frac{1}{2}$  in. wide,  $2\frac{5}{8}$  in. high, and  $\frac{1}{4}$  in. thick. They fit very nicely into the back of the cabinet. The batteries make connection with pieces of strip brass fastened to a  $\frac{1}{4}$  in. wooden partition that will just fit the inside of the cabinet. The contacts are similar to those on the flashlight batteries. They are fastened to the partition with machine screws and nuts. They are connected in series on the reverse side with rubber covered wire, the short contact on the battery being the positive, and the long one the negative. This wooden partition is fastened 3 in. from the rear of the cabinet with the contacts toward the back.

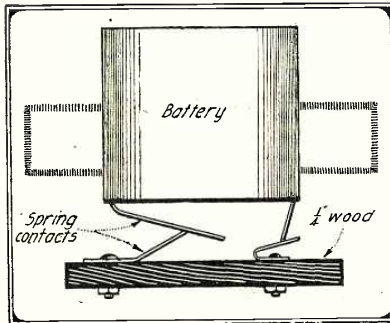

Method of Connecting the "B" Batteries.

with the audion bulb. No binding posts are needed for the "B" battery, as connections are made direct from the wooden partition to the back of the panel. The position of all binding posts as well as the other parts are clearly shown in the accompanying drawings. All connections are made with No. 18 rubber covered wire, and for best results they should be soldered. The panel should be connected as in the accompanying diagram.

If it is desired to build the panel for use with the new V. T. style of bulb, it  
(Continued on page 310)

# Hand Wound Honeycomb Coils

By C. R. DUNN

THOSE who are unable to purchase ten or twenty Universal wound or Honeycomb coils to make a complete set for receiving both long and short wave signals would be entirely satisfied to possess a single coil capable of tuning over a wide range. Altho a coil tapped in this manner is less efficient than a single unit coil, it will be found to possess marked superiority over the average loose coupler used by the majority of radio students, not only in efficiency but in compactness.

The accompanying drawings and directions offer a method of winding Universal coils at home. First make a short length of paper tube that is just two inches outside diameter and four or five inches long. This can be done by winding three or four layers of stiff paper over a round wooden dowel. It is absolutely necessary that shellac be used instead of glue; and be very careful that none of the shellac touches the dowel, or there will be considerable trouble removing the finished tube. After the shellac has hardened mark the tube so that when it is cut, there will be two 1-inch, one 1/4-inch and one 1 1/2-inch sections. Use a very sharp knife and cut the tube *while on dowel* to insure a clean cut edge and to prevent crushing the tube.

Fig. 1 is a plan drawing which when formed into a tube, is designed to just fit over a 2-inch diameter tube section, 1 1/4 inches wide. Our printed drawing should be cut out and pasted around this section.

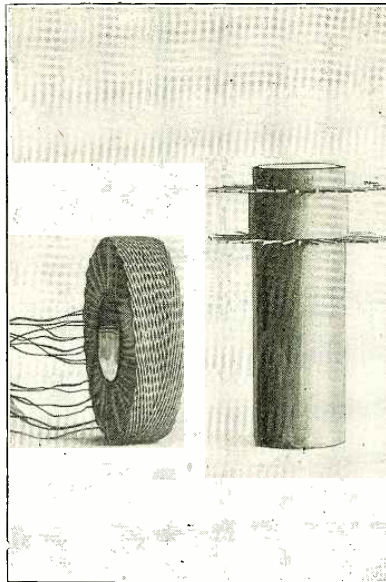

Showing the Form on Which the Coils Are Wound and a Coil as it Appears When Completed.

The lap marks at Number 30 should lay over each other; and if the tube has been made the correct size this method will simplify the winding of the first layer and teach how all the succeeding layers should be wound. The wooden dowel, that was used as a tube pattern, is to be used as a jig to hold the brads used as guides in winding, also as a handle for the work and should be about six inches long.

Slip the 1 1/4-inch section of tube over the end of the jig and down about a half of an inch from the top as shown in the photograph. Next drive a thin brad about 1 1/2 inches long into each of the small circles marked along each edge of the pattern. The brads should be set into the jig about one quarter of an inch, leaving 1/4 of an inch as a guide for wire. Care must be taken that all the brads are driven into the jig, radially; and if a number of lines are drawn radially across end of jig nearest tube this will serve to guide the correct placing of the brads. If the jig has been made correctly there should be two rows of brads, thirty in each row, with one-inch space between the rows.

Two pounds of Number 28 D.C.C. or D.S.C. are required for the set of three coils. Start the winding by leaving enough wire for a tap and take a twist around brad Number 1 in row "A"; hold jig in left hand and guide wire along heavy line to brad Number 16 in row "B"; pass wire back of (Continued on page 310)

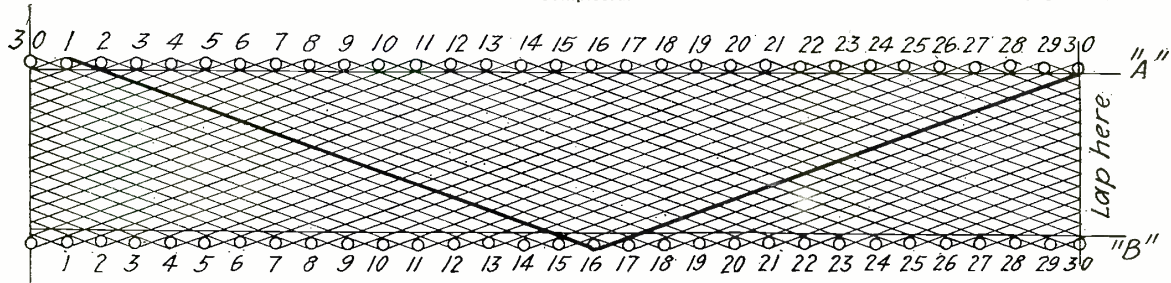

FIG. 1

This Drawing When Cut Out and Pasted Around a Tube 2" in Diameter Will Enable Any Amateur to Follow Out the Method of Winding the Coils Very Easily.

## Construction of Remote Control Antenna Switch

Many find it difficult to construct a reliable Antenna Switch, so herewith are given instructions for the construction of a bridgeform, Antenna Switch.

Besides the advantage of having the easily constructed form, the switch has several other good features over other forms of switches:

First: Requires small amount of material.

Second: Can be placed high on a wall, out of reach of anyone, and operated by hook-pole.

Third: Can be used on very large sets. Of course when it is, the jaws and blade should be proportionately large, and when the voltage is high, the shells of the receivers of very good quality.

The baseboard should be of well seasoned wood, properly varnished or painted, and in size proportional to the size of the switch.

Diagram T shows how the caps of the receivers fasten to the baseboard.

Diagram L shows how Bridge F and

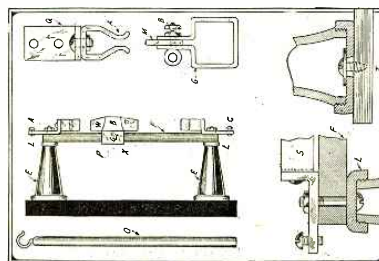

Constructional Details of the Antenna Switch.

angle pieces fasten to the top caps of the receivers.

Diagram A illustrates the construction of the switch jaws and how they are bolted to the angles, Q.

Diagram G gives end view of the sleeve G, which slides up and down bridge F, which is constructed of well seasoned wood, or better still, of Mica or hard rubber.

The eye bolt B is used to move the slider G from the upper to the lower positions, the aerial and instruments.

M is copper blade, and sleeve B can be constructed of any suitable material, sheet iron, copper, brass, etc.

E are shells of telephone receivers.

From top connection A, of switch, the wire goes to Instruments, from the lower connection C, to the ground, and from connections, on the slider, to the aerial.—Contributed by EVERETT LEO DEETER.

# A Quenched Gap for Spark Coils

By HENRY BENTMAN

**N**OTICED how many new "hams" there are nowadays? Say, if you've never heard these young 'uns "squeals," come around to little old New York.

Put on your 'phones any time of day or night, and you'll get your ears so full of

We know everyone can't buy a Clapp-Eastham transformer, a Marconi helix, or a quenched gap. But there is nothing to stop a fellow from making an open core transformer, a real spark coil, or the small quenched gap to be described.

The metal plates and spacing washers of this gap are made of the diaphragms and fibre rings used in telephone receivers. The base is of hard rubber or wood, while "P" in Fig. 2 may be a paraffined wooden dowel. This is about all that must be bought, for almost every experimenter has a knob, binding posts and heavy metal washers in his "junk" pile.

The base is 3 1/2" square and of any thickness. The edges are beveled. In the exact center a hole is drilled to pass an 8-32 machine screw, which is long enough to project for 1/8" on the upper side of the material. A brass stud "w" in Fig. 1 is tapped to take this screw. The metal measures 1/2" diameter by 3/16" thick. A binding post is fastened on one corner of the base, from which a wire runs to the center washer.

The diaphragms used were 2 1/8" in diameter. The four posts "P" are equally placed at a distance of 1 1/16" from the center. If the posts are spaced correctly, the diaphragms should be held snugly when placed inside the cage. A top piece "T" must be made before permanently setting the washers and plates. This is of about the same size as the base. In the center is a hole which is tapped for the adjusting rod, "R."

On the upper end of the rod is a heavy rubber knob. Between the knob and T, a tension spring may be used. At the lower end of the rod there is a heavy metal piece A 1/8" thick and of 1" diameter. This is secured to the rod after a heavy tension spring is put in place. Turning the knob should move the metal piece toward or away from the top T.

At this point the plates may be assembled. The diaphragms are shown at D in Fig. 2, while F represents the fibre spacing washers. The bottom plate M is made of 1/4" brass and rests upon W. Next comes a fiber ring, then two diaphragms, one ring, two diaphragms, etc., as in Fig. 3.

The top metal plate M2 is of 1/8" brass, made stronger because of the pressure placed upon it.

The next thing to be done is to fasten the top on, which finishes the gap. When used with a 1" coil, five metal plates are

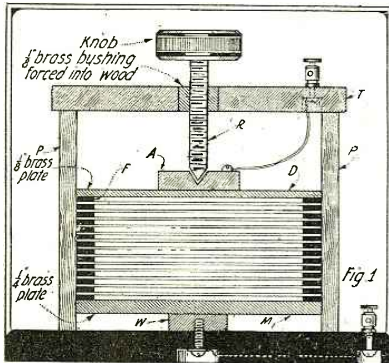

Sectional View of the Assembled Quench Spark Gap.

"amateur jazz" that you'll think it sounds like a doughboy's first night in no-man's-land.

First, you hear a fellow with a 1/2-inch coil, on the next street, trying to send to a friend seven miles away. Next, you hear Navy Yard. 2 H.A.M. butts in on him. But leave it to Navy Yard to come back with his old favorite "Q.R.M." I'll wager the poor "bug" feels the same as I did when little brother Willy pressed the key while I was adjusting my gap. Then you pick up 4 B.U.G. who's going at about ten per minute. Suddenly he stops to adjust his vibrator which felt overheated and wanted to cool off.

But the greatest bother in our little community of 10,143 1/2 "R.A.'s" is the spark coil boy who, sending on a 1" coil, tries "shooting the ether" with a wavelength of anything between 121 and 763.9 meters, and uses two hair pins for a spark gap.

Now, why not have a regular station?

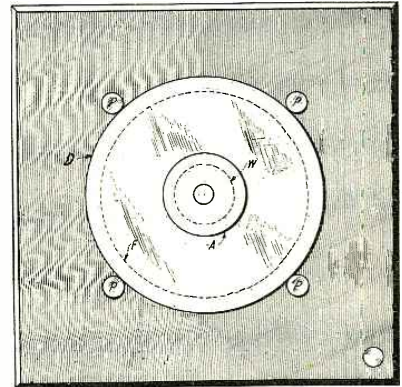

Fig. 2

Method of Assembling the Telephone Diaphragms.

sufficient. For 1 1/2", use seven plates, and a 2" coil takes from 7 to 10. When working with a condenser, less plates may be used on 1 1/2" and 2" coils.

The reason for using fibre rings is this: If the spacers were of solid material, when adjusting, the top plate would move downward at the center only, thereby short circuiting plates Nos. 1 and 2. This would also happen between plates two and three, and at the bottom plate, working upward. The fibre sectional spacers prevent this. As the top plate is pressed inward, the washers constituting each spacer press together, thereby making the space between plates smaller.

The advantages of using a quenched gap may be readily seen. Not only are the spark surfaces cooled more quickly due to the larger area, but the gap is practically noiseless.

# A Variometer of New Design

By W. A. HEPPNER

**N**OW that every up-to-date amateur is using C. W. receiving sets, there is an increase in the demand for a highly efficient variometer of simple construction.

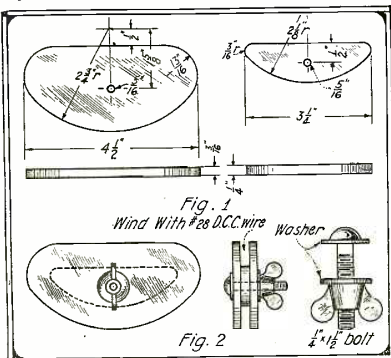

How the Form for the Coils is Constructed.

The "ball and cup" type of variometer is beyond most amateurs, as a lathe and tools are required to turn out the forms.

In the construction of the instrument described below few tools are needed and the materials used may be bought for a very small sum.

The coils for the variometer are the so-called "D" coils and although they have been in use for some time, few amateurs know of their construction.

The coils are wound on a form which consists of four parts,—two sides, a center-piece and a bolt. The dimensions and shapes of these parts are shown in Fig. 1. Ordinary cigar-box wood will answer the purpose in constructing the sides and center-piece. The parts are assembled as shown in Fig. 2.

The winding of the coils is a simple

matter. The slot of the form is filled with No. 28 D. C. C. wire wound tightly, so

(Continued on page 316)

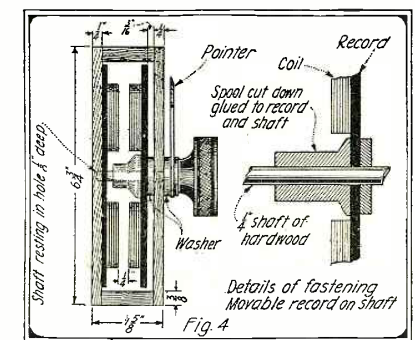

Showing the Manner of Assembling the Variometer.

# Rotary Selector Switch

By HERBERT RICHTER

**H**EREWITH are drawings and description of a switch which permits use of a crystal detector simple audion, one step amplifier or two step amplifier, all by turning one knob. Moreover, turning the knob in position for either of the last three automatically lights filaments and closes "B" battery circuits.

The switch consists essentially of a number of brass or copper strips (in this case eleven) mounted on a revolvable cylinder, and brushes or strips fastened to the inside of the case for the cylinder, and making contact with the strips on the cylinder.

**Description:** In the diagram (Fig. 1) the strips are represented flat, while of course they are to be mounted around the cylinder. Those to be on the cylinder are numbered from A to K. Eight of them (A to H) are shaped like an L, and of dimensions about as shown in Fig. 3. The small x's under the lugs of the L's represent the strips or brushes, arranged around the inside of the containing case, as are also the brushes B' to the left of each strip. It will be noticed that these x's are arranged in parallel horizontal rows or sets; these will be designated by sets M, N, O and P. Each set will be mounted separately, one on each side wall of the case. One wall, however, must have besides its own set also the brushes B'. For this the wall containing set M is preferable, having fewest brushes. Notice that the brushes B' make contact with the strips continually, but those in the various sets (x's) only when the cylinder is so turned that the lugs of the L strips are under any particular set; otherwise they bear on the wooden cylinder. If the cylinder is turned so that set M makes contact, the crystal detector is in circuit; set N, simple audion; set O, single step amplifier; set P, double step.

Besides these L strips there are on the cylinder three others, designated by I, J and K, whose functions are to light the filaments when they are required. I is of such a length that it keeps connected the two brushes a, a mounted in set N, as long as the cylinder is turned so that either set N, O or P makes contact (in this case a little over half the circumference of the cylinder); J is long enough to connect brushes c, c in set O with either set O or P in contact (a little over one-fourth the

circumference); K is a small strip which connects brushes d, d in set P only when set P makes contact. Be sure to have the lower end of these strips even with the lugs on the L strips as in the diagram.

inches long. It would be well to bring the wires from all the brushes up on one side inside, and thence to the binding posts in the top, as then the top cover with the binding posts may be tilted for examination

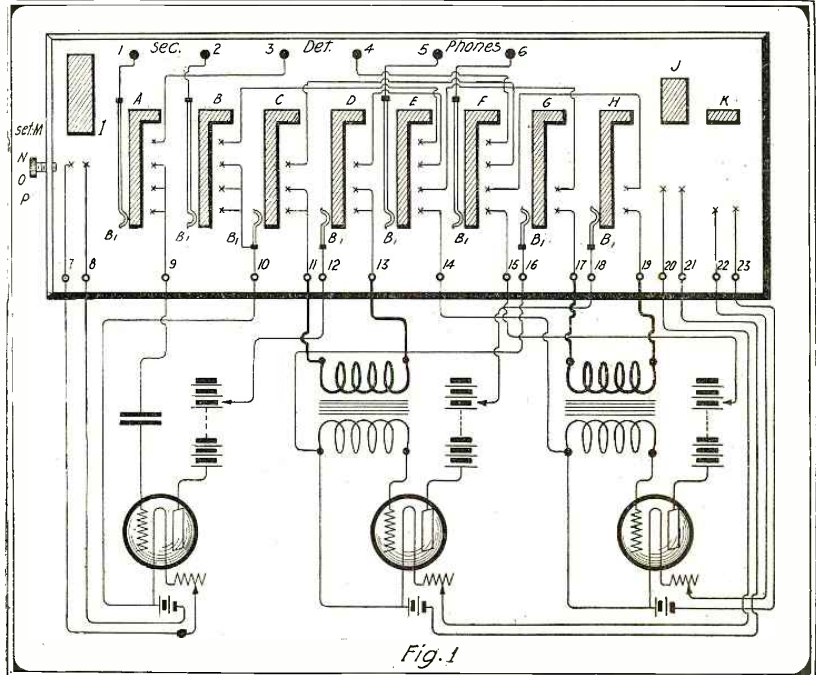

Fig. 1 Schematic of the Rotary Selector Switch. A Crystal Detector, Audion Detector, a One-Step Amplifier or a Two-Step Amplifier May Be Connected by a Turn of the Knob.

By studying the diagrams, the functioning of this switch will be easily understood.

Using a crystal detector and three audions, with this particular circuit, 23 binding posts will be required, but an extra "dead" one will preserve symmetry, as they may then be mounted in three rows of eight. In the diagram a number has been placed wherever a binding post is required.

The various dimensions and smaller details are left to the reader. For this particular switch the cylinder need not be over two inches in diameter and twelve

of connections, etc., without undue stretching of the wires.

Care must be exercised in attaching the brushes so they will not bend or buckle when the cylinder is turned in either direction. The brushes ought to be of phosphor bronze.

In using, be careful to have the cylinder turned just far enough, so that all brushes of the desired set make good contact. Some device which the ingenious reader may design can be used which will make it impossible for the cylinder to stand in any but the four correct positions.

This switch is useful also for many other purposes, as for instance, two or more loose couplers, batteries in series or parallel, etc. Various circuits can easily be designed.

Any additional information will gladly be given, if requested.

**EDITOR'S NOTE:** It is suggested that two washers which will fit the shaft be placed one on top of the other and form four impressions made with a steel punch equally distant around the width. Place the washers on the shaft and fasten one of them to the cylinder and the other one to the case. Upon turning the cylinder, it will snap into the correct position desired.

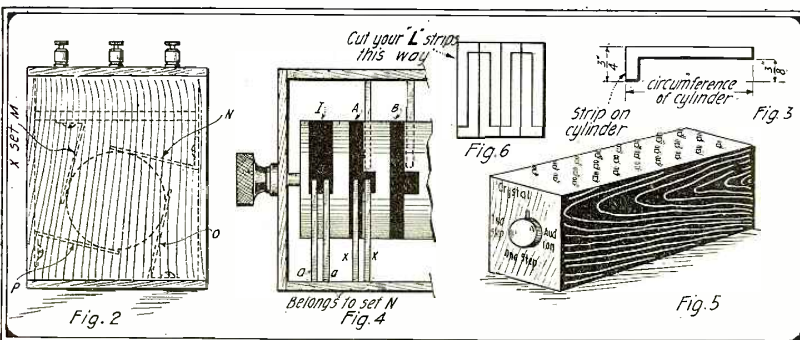

Showing the Construction Details of the Selective Switch.



# Construction of a Modern Amateur Antenna Mast

By OTTO VON BERGEN

TO my mind the construction of a radio must have, for the most part, been sadly neglected by writers on radio topics—both amateur and professional. Because of this fact one may notice from a train window all sorts of masts. Some are bow-legged; other sway-back; while many are nailed together, held by wooden braces, ropes and every other unsightly conceivable contrivance—in fact, most of them look like

they were in the habit of flapping on the ground during every little disturbance in the atmosphere. Some do not judge an amateur station by its aerial and mast, but I do. Therefore, after giving an excuse for writing this article I will proceed with the construction of an ideal amateur mast. The material necessary for the construction of the mast is as follows: Five timbers 18' x 2½" x 1½"; about twenty feet of lumber 1" x 1½"; six bolts, four of

which should be 4" in length by ½" in diameter—the other two should be the same thickness but 5" in length; also one large screw-hook; sixteen large screw eyes; eighty feet of window sash rope; two small iron pulleys—one closed, the other open; twenty-six 2¼" screws; approximately 458 feet of galvanized iron wire; twelve porcelain cleats; two iron bookcase brackets, about 9" x 6"; and four six-pound window weights complete the list.

The mast is constructed in the following manner: Bolt two of the 18' x 2½" x 1½" timbers together, allowing two feet for overlapping and placing the bolts 4½" from each timber end. Refer to Fig. 1. Now do exactly alike with two more of the same sized timbers. Having accomplished this lay the timbers together and bore two holes, one foot apart, correspondingly in one end of two of the bolted timbers. Then take the remaining 18' x 2½" x 1½" timber (which is to be the top section) and, allowing two feet for insertion, bore holes, insert between the timbers of the second section and tightly bolt, using the two 5" bolts, as depicted in Fig. 2. Then measure the entire mast, starting at the joint of the third section, marking off each foot on the double sections. Having finished this operation cut a twelve-inch piece of wood from the 20' x 1½" x 1" and screw into place as the lowermost step. Next carefully measure each foot marking on the mast and cut "steps" from the 20' x 1½" x 1" to fit, as shown in Fig. 3.

The next process is to fasten the aerial pulley and guy wires. This is a very simple process as shown in Fig. 4. Especially (Continued on page 318)

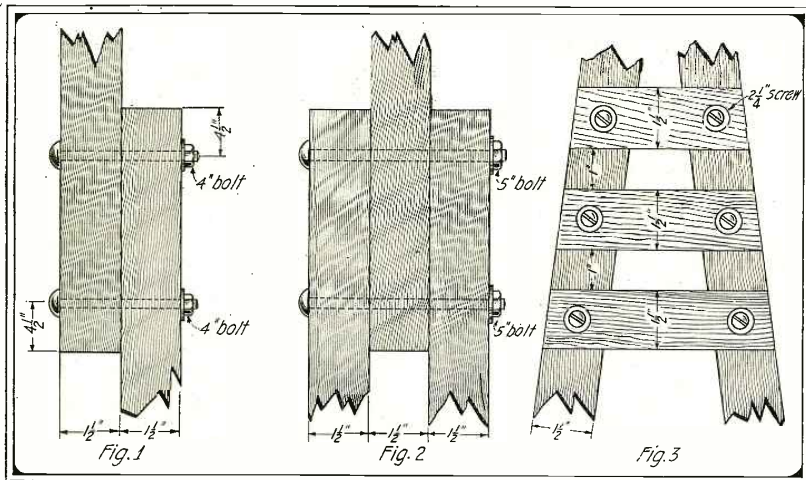

By Bolting the Timbers Together in This Manner a Strong Structure Is Assured.

## A Constant Battery for Audion Filaments

By R. H. LANGLEY

Those of us who find the storage battery a rather expensive part of the audion receiving set may find an easy way out of our difficulties by using a primary battery. There are several very reliable types which we can buy complete and ready to use, but there are also one or two kinds, equally adapted to lighting the filament, and equally reliable, which we can build for ourselves at small expense.

In a primary battery, as in an ordinary dry cell, electricity is generated by chemical action. One of the elements is gradually consumed, but can be easily replaced, which of course is not true with the dry cell. If properly made, the primary battery is also considerable more powerful than the dry cell, and will deliver a continuous current for long periods.

In the days when electricity was young, and before the public service companies had run their wires all over the country, primary batteries were in great demand and were widely used. Many different kinds were invented, and some were patented and manufactured on a commercial scale. Some of these were suited to open circuit work, where a continuous current was not required, and some were suited to closed circuits, such as the filament of an audion detector.

Of the many kinds, one which is suited to our particular purpose, is known as the Caustic Potash Battery. The voltage

of a single cell is about 0.7 volt, so that six or seven cells will be required for the ordinary filament. This battery uses zinc for the electrode that is gradually eaten away, and so long as some of the zinc remains, the voltage is constant. This gives

a decided advantage over the storage battery, in which the voltage falls as the charge is used up. Short circuits do not hurt the Caustic Potash Battery in the least.

The Caustic Potash Battery consists of iron—copper oxid—and zinc in a solution of caustic potash. In the form most easily made at home, we should use six or seven one-quart bottles. These bottles should have a large mouth, so that the iron and zinc elements can be easily inserted. Drug-gists call such bottles "Salts Bottles," but if nothing better is at hand, the ordinary milk bottle can be pressed into service. Each of these bottles should be provided with a rubber stopper with three holes in it.

The iron element is made of ordinary black sheet iron (not galvanized iron) and is cut so that it will line the bottle. It is then fitted with a terminal, which can be a piece of iron rod riveted on with an iron rivet. A ¼" or 3/16" carriage bolt can be filed off at the head end for this purpose, and the threaded end used to fasten the wires after the cell is made up. The element so formed is then carefully rolled on a round stick, so that when it is inserted through the mouth of the bottle, it will spring out against the inside wall. The terminal is bent so that after the element is inside the bottle, the rod will come

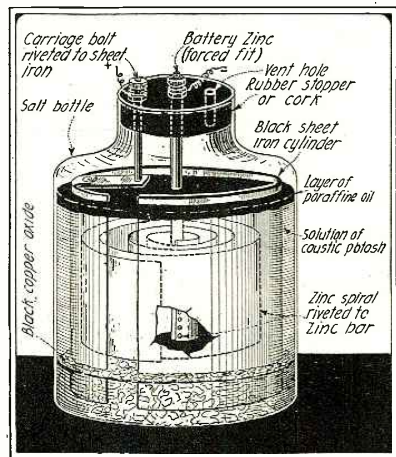

Showing the Construction of a Caustic Potash Battery.

(Continued on page 319)

# Control for Speech Modulation in Radiophone

By FRANCIS R. PRAY

**N**O doubt many readers are constructing some sort of radiophone, perhaps along the lines of Mr. Cohen's article in the first issue of "R.A.N.", but are undecided where to mount the telephone transmitter. If the microphone is mounted on the panel, and that placed out of the way on the operating table, then speaking into the transmitter involves an awkward craning of the neck. The best solution apparently, is to mount the microphone independently as on the commercial desk telephones.

A readily accessible control should be included, whether the microphone is used in a normally closed circuit, say in series with the antenna, or in a normally open circuit.

The sketch shows how this may be accomplished in an attractive and economical way. The stand is nothing but an old telephone receiver shell fastened to a turned wooden base by four wood screws. The transmitter microphone is fastened to the shell by a strip of fairly heavy brass; the details of this part varying with the design of the shell and microphone.

About two inches up inside the shell, a turned wooden plug should be fastened with brass pins and a hole drilled for the center shaft of brass rod threaded at each end. A heavy brass spring is placed between the wooden plug and a brass nut locked to shaft by a drop of solder.

The contacts are made from a silver disc about the size of a dime and cut as in the sketch, on dotted lines. The part "Y" is drilled and tapped to fit the shaft and a locknut screwed on to hold it in place. The outer, stationary contacts are inserted in slots cut in the machine screws passing through the base, and held by locknuts, either above or below the contact "Y" according to the type of circuit, as shown in

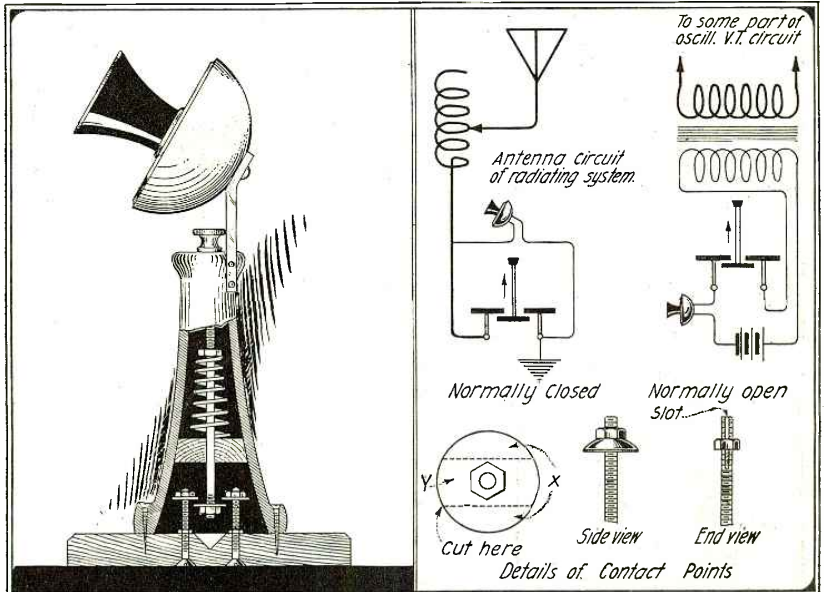

This Is a Clever Stunt for Mounting the Transmitter and Button Control. Note How the Device Is Used in the Circuit.

the sketch of the complete transmitter.

A small moulded knob is screwed on the other end of threaded shaft. A hole is drilled at the top of receiver shell to accommodate the leads from the microphone. The conductor to the panel is taken out from a hole at base of receiver shell. Ob-

viously, three leads must be taken when using the microphone in open circuit. It is important that the button be depressed only when the message is being spoken, for if the microphone is left continuously in circuit, the carbon granules will eventually fuse together.

# Triple Coil Receiving Transformer

By H. E. PARSONS

This transformer uses staggered wound coils which can be mounted like honey-comb coils. In fact, in appearance they greatly resemble these, but they are wound differently. The old style loose coupler is out of date. Its greatest defects are large distributed capacity, dead end effect, etc.

Even banked windows have these defects to some extent. The type to be described effects a great saving in space. As the wires cross each other at short intervals the distributed capacity is reduced to a minimum. No contacts are provided, therefore losses due to poor switch con-

struction are eliminated. By using different size coils all wavelengths can be covered without taps or dead end switches. The mounting provides for three coils; one to be used as a primary, one as a secondary and one as a tickler coil for regenerative circuits.

The coils are wound as follows: Use a piece of hardwood 1 1/2" dia by 3/16" thick, a, Figs. 1 and 2. Put in a number of pins, p, Fig. 3, radially round the disc, hat pins may be used but they must be removed afterward, as they are made of steel.

I have found that stiff brass wires, No. 14 B & S, to be most suitable, as they can be left in to act as supports to the coil. An odd number of pins must be used—say 9, 13, 15, 17, 19 or 21, depending on the size of the coil. The larger the coil, the more pins required. Starting at one of the pins, wind the wire so that it passes each pin on the side opposite to that on which it passed the previous pin. The winding is much like weaving the bottom of a basket. See Fig. 3, A & B.

Wind in this manner till the required depth is obtained—from one to three inches according to the wavelength to be received. It is impossible to give a formula for the wavelength of these coils since it varies with the number of pins and the tension on the wire. The wavelength must be found by experience. After the coil is

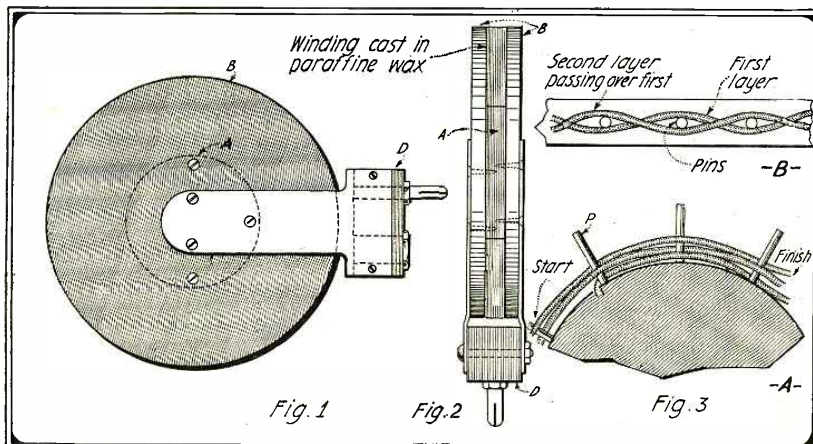

In Constructing This Type of Coil Wind the Turns on Top of Each Other as Shown.

(Continued on page 320)

**AN ELECTROLYTIC INTERRUPTER.**

To make an electrolytic interrupter for use with spark coils, fill a quart mason jar one third full of water and add two ounces of sulphuric acid, stirring the solution well.

Make a wooden top to fit jar and fasten two binding posts to same. Two No. 8 copper wires long enough to reach into the liquid about an inch and a half are connected to the binding posts. Next drill a very fine hole one thirty-second of an inch in a two-ounce glass bottle and place this bottle in the liquid, with one of the copper wires running through the open neck into the liquid.—Contributed by WALLACE K. MOWERS.

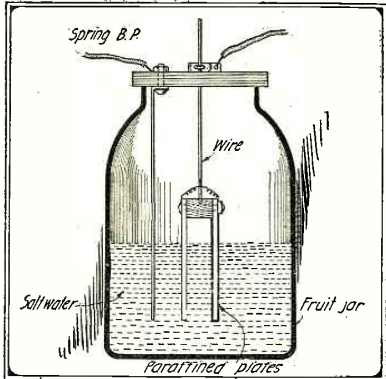

Simple Method of Constructing an Electrolytic Interrupter.

**CLEVER SWITCHING ARRANGEMENT.**

By means of a connection as shown in the accompanying figure a receiving set consisting of an audion and crystal detector can be so used that when operating on the crystal the audion is used as an amplifier or the audion may be used as a detector or an oscillator, all by means of one movement of a four pole double-throw switch.

Referring to the illustration, it can be seen that the audion is in the circuit as a detector, when thrown on the one side and when the switch is reversed the crystal detector is cut into the circuit and at the same time the amplifying transformer, the primary of which is connected to the tuner with detector in series (or parallel) and the secondary of the amplifying transformer connected to the audion so as to complete the amplifying circuit. A grid leak may be inserted and it will be a considerable improvement over a set without such a grid leak.—Contributed by E. B. HECKENKAMP.

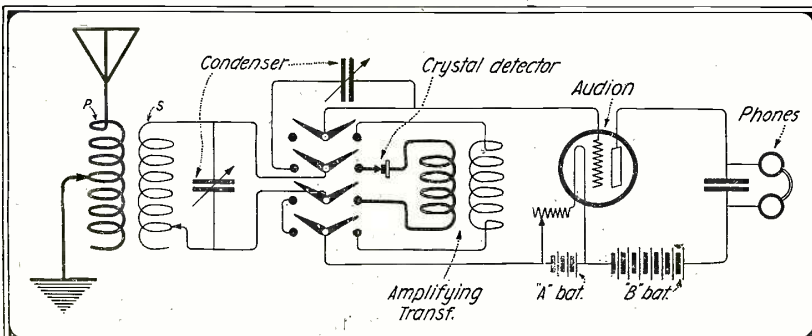

By Throwing the Switch to the Right the Audion is Used as an Amplifier; Throwing It to the Left the Audion is Used as a Detector.

**A SHIELD FOR VARIABLE CONDENSERS.**

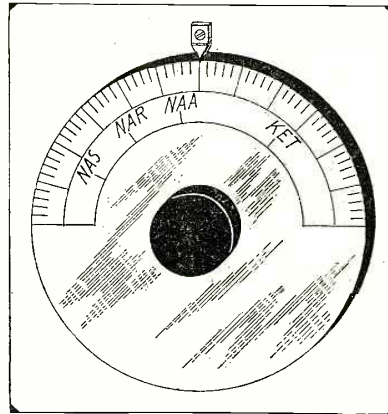

Use a Shield of This Type on Your Undampmt Set.

Every amateur who uses variable condensers in undampmt wave circuits is familiar with the annoying tendency to change the spark note when the hand is removed after adjusting the condenser. This can be eliminated by providing a metallic shield in front of the condenser proper if it is mounted on a panel, or by using a metallic case and grounding same if the condenser is outside.

Such a shield is shown in the accompanying drawing, and should consist of an aluminum disc about 4 inches in diameter, mounted beneath the knob in place of the usual pointer. The scale can be marked on the edge of the disc as shown, and a stationary indicator provided.

Since this disc is thus electrically connected with the rotary plates, this element of the condenser should be connected either to the ground side, if in the primary circuit, or to the filament side, if in the secondary. This device is used in the Navy and Signal Corps sets, and will totally eliminate the effect of the hand.—Contributed by ARNO A. KLUGE.

**HOW TO SQUARE CONTACT POINTS.**

Usually, if the contacts of a telegraph key need squaring, the lever is removed and a fine file is run across each stud a number of times. You may get them set the first time, but usually you don't. Or, again, you may have to clean the points. You would run a piece of sandpaper across each contact and then find you have put the surfaces out of alignment.

A nail-file, if placed between the upper and lower studs, will make an excellent job of it, because the blade is very thin and both faces will be squared with the surface of the file. To clean the contacts run the file back and forth a number of times. An important point is that the lever need not be removed when using this method.—Contributed by HENRY BENTMAN.

**A CONDENSER DIAL.**

The latest dials on cabinet sets have the dial rotate with the knob. The rotating member is usually of hard rubber and rather expensive. I suggest using the blank

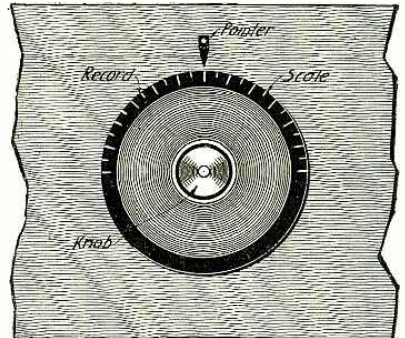

A Ten-Cent Phonograph Record Makes Up a Neat and Inexpensive Dial.

side of phonograph records, the kind you get at 5- and 10-cent stores. The scale can be pasted or scratched on to the disc.—Contributed by THOMAS MILLS-PAUGH.

**AN AUDION "B" BATTERY FUSE.**

One of the most discouraging things that can happen to any amateur is to come home and find that your "B" batteries have been short circuited all day and are hardly able to register a volt to say nothing of supplying the necessary juice to run an audion and perhaps a one- or two-step amplifier besides. With this little scheme all such trouble can be easily avoided.

To make this fuse the following things are necessary:

- 1° 4 small binding posts.
- 2° small block of wood.
- 3° tinfoil.

First cut out a piece of tinfoil in the shape shown in Fig. 1, being sure that it is thin enough in the center to blow at the voltage you intend to give it. About 1/16" is the best as that will blow at 20 volts. It would be better to make a few tests as to the width, as different grades of tinfoil

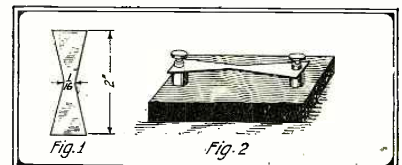

If You Want to Protect Your "B" Batteries Use a Fuse of This Type.

would make a difference in the size required. Put two binding posts on a small block of wood (Fig. 2), about two inches apart and suspend the tinfoil between the two, stretching it rather tight. Two of these should be made and one put in each lead from the battery.—Contributed by ELMORE SPICER.

**AN INGENIOUS NO DEAD-END SWITCH.**

By a HOLLAND AMATEUR

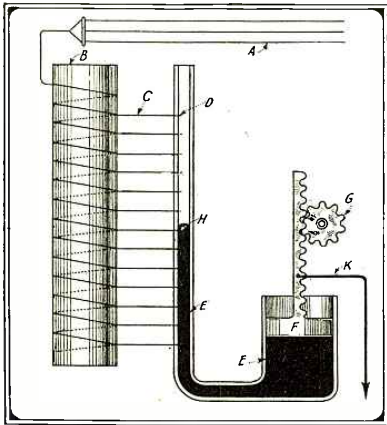

This Clever Arrangement Certainly Has Many Advantages.

Here is a no dead-end arrangement which is quite new. Coil B has leads to tube D (made from glass, ebonite or any insulating material). Tube D is connected to a container of mercury E. The disc F can be regulated by the gear wheel G so that it controls the rise and fall of the mercury.

A slight turn of G causes a great and almost instantaneous rise or fall of the mercury in the tube D. The leads from the coil are short circuited as the mercury comes in contact with them.

A distinct advantage of this arrangement is that the unused portion of a coil is not only cut out of the circuit but also entirely short-circuited. This means that the loss of energy is reduced to a minimum.—Contributed by N. VAN DOLDER, Flushing, Holland.

**INSULATOR FOR ROGERS UNDERGROUND SYSTEM.**

Amateurs experimenting with the Rog-

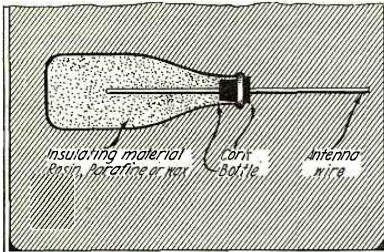

Bear This In Mind When Experimenting With the Jones' Underground System.

ers underground wireless will find difficulty in making an insulator for the end of their antenna. This scheme affords the necessary insulation and gives a neat finish to the antenna.

From the drawing it is clear that I employ a bottle of suitable size to hold the wire and after inserting the wire into the bottle molten rosin or wax is poured in and permitted to cool. For those who are not familiar with the use of such accessories it may be explained that when burying wires to be employed in underground reception the end of the wire must be well insulated. This is accomplished easily and very satisfactorily in the manner shown.—Contributed by W. L. NORVELL.

**NEW TYPE D. P. D. T. SWITCH.**

Here is a new double-pole, double-throw switch which can be used to shift the phone from one set to another or the aerial or ground. The switch blade marked (B) must be insulated from the one marked (A), and when hooked up as in the diagram it will be found that it will save a great deal of time, because the knob has to be turned only about a half inch. When two of these switches are used, one for the aerial and ground and another for the phone, it is an easy matter to shift from the short wave set to the long wave set.—Contributed by JOSEPH DALE.

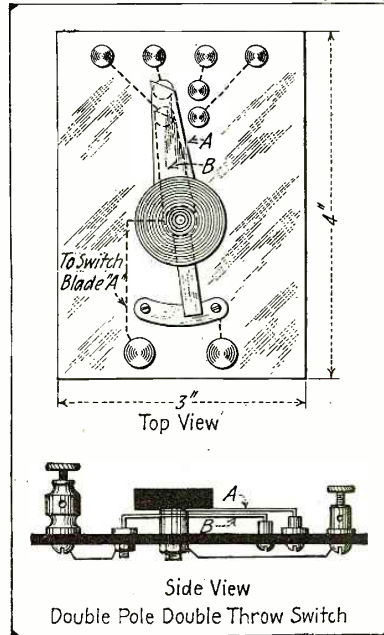

A Switch of This Type May Be Constructed Without Difficulty.

**AERIAL INSULATOR OF PORCELAIN KNOBS.**

This idea shows an aerial insulator made of two porcelain knobs. The drawing shows everything and I guess there won't be any need of writing it out in detail. This insulator is very practical and is simply made.—Contributed by ARTHUR A. LENZ.

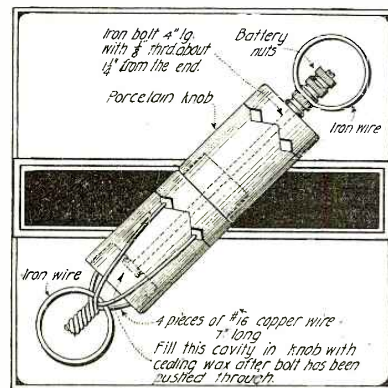

A Simple Insulator for a Receiving Antenna.

**A WAVELENGTH CHANGING SWITCH FOR THE RECEIVER.**

For the base of the switch a piece of hard rubber, or Bakelite 4 inches square,

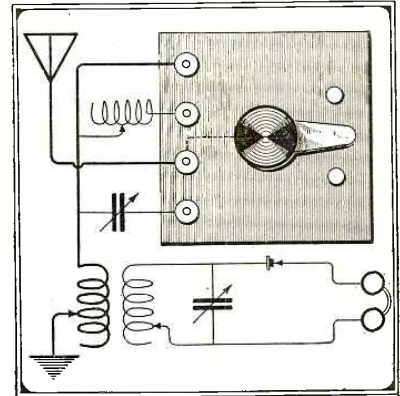

A Simple Method of Constructing a Wavelength Switch.

is required. Lay out the holes for the switch points, blade and binding posts. After drilling the holes finish the base with fine sandpaper. The switch is then ready for putting together. Make connections as shown in the drawing. In use the switch works as follows: Putting the blade on the center switch point will connect the receiver direct to the aerial, putting it on the left hand one will connect the loading coil in series with the aerial and the set, increasing the wavelength, putting the blade on the right hand one will connect the variable condenser in series with the aerial and the set decreasing the wavelength.—Contributed by A. WARR.

**A CRITICAL ADJUSTMENT RHEOSTAT.**

With the new Marconi V.T. detectors bulb the filament does not require a very critical adjustment in temperature. But with the Audio-Tron and similar bulbs the adjustment of the filament current has to be very fine.

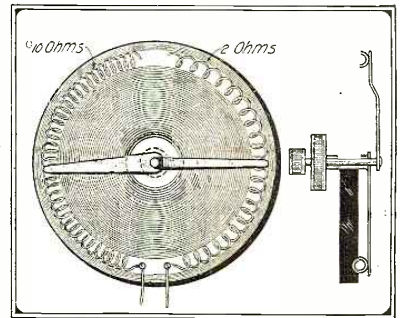

Type of Rheostat Necessary for a Tube Requiring Critical Adjustment.

This I find is very hard to do with the common 11 ohm rheostat now on the market.

I have made a special rheostat and have used it for several months and find it better than any that are on the market.

The critical temperature of the filament can be quickly and easily found with this instrument.

One resistance is wound for about 10 ohms, the other for 1 or 2 ohms. The control is something like that used on variometers, that is, one hollow shaft and a solid one turning inside of that. These shafts do not have to be insulated from one another, in fact they have to make contact with one another, the coarse adjustment is made with the small knob and then the fine adjustment with the large knob.—Contributed by LEO J. ARTHURS.

# RADIO DIGEST

## AIRPLANE ANTENNA CONSTANTS.

By J. M. CORK.

The purpose of this work was to devise a method for measuring airplane antenna constants (*i. e.*, capacity, inductance, natural wavelength) under conditions of actual flight; and to use this method to obtain data on various forms of fixed and trailing wires.

The principle of the method involves a continuous wave oscillator feeding directly into the antenna and substituting for the antenna a variable calibrated condenser and adjusting for the same wavelength as with the antenna in the oscillating circuit. The result obtained is the effective capacity of the antenna. Having found this, a variable calibrated non-inductive resistance is varied until the D.C. component of the plate current reads the same as for the real antenna. This gives the effective antenna resistance. Knowing the effective values of capacity at various wavelengths, the true capacity, inductance and natural wavelength are readily found.

A method for finding the directional transmitting effect of various antennas is also described. In order to compare the amounts of energy received, a detector tube with a three-stage audio amplifier is used. A transformer is placed in the plate circuit of the last amplifier tube, the secondary of which is connected to the heater coil of a thermocouple connected to a D.C. micro ammeter. This, when calibrated, is free from many of the uncertainties of the ordinary audibility meter. A typical directional curve of the trailing wire antenna is included in the paper.—*Abstract from Scientific Paper No. 311, Bureau of Standards.*

## THE INTERNAL ACTION OF A TRIODE VALVE.

By W. H. ECCLES, D.Sc., M.I.E.C.

The most important instrument in modern wireless are the three electrode thermionic vacuum valves. In this article the internal action of the triode valve is thoroughly explained. A chapter is devoted to the theory of the space charge; also the functions of the cylindrical type plate and grid are exprest mathematically. A detailed explanation of the theory of the control electrode is given.—*Abstract from October Radio Review.*

## ON THE ABSOLUTE MEASUREMENT OF H.F. OSCILLATIONS.

By H. ABRAHAM and E. BLOCH.

The exact determination of the wavelength of high frequency electric oscillations is of great importance for the calibration of wavemeters and for all H.F. measurements. The use of standard inductances and condensers to construct a circuit of known wavelength does not permit of an accuracy greater than 1 per cent. The method described by the author involves the direct comparison with a tuning fork standardized by comparison with a standard clock. A source of electric oscillations rich in harmonics is then adjusted (by the method of beats) to have the same fundamental frequency as the fork, while one of its higher harmonics is then compared with the high frequency oscillations. Special arrangements of three electrode valves are used for the comparison source of oscillations, giving harmonics up to 200—300 times the fundamental frequency. The accuracy obtainable is claimed to be closer than 0.1 per cent.—*Abstract from Rev. Gen. de l'Elec.*

## INVESTIGATION OF GASES IN A VACUUM TUBE.

By C. L. FORTESCUE

The examination of the gases given out after the exhaustion of a tube was completed is a matter of intense general interest to physicists, and has brought out certain results which require a good deal of explaining. Two methods have been used, *viz.*:

(1) Spectrum analysis. The valve was overloaded and the "blue glow" examined by means of a spectroscope. Many characteristic lines were observed, and many gases, such as Ar and CO, were clearly identified. Some of the spectra were, however, unusual.

(2) Ionization potential. The grid and the positive electrode were connected together, and the voltage between them and the filament—the latter being negative—was gradually raised, careful observation of the current being made. The curves of current and voltage were then plotted. These curves follow Langmuir's  $3/2$  power law up to certain clearly defined points where ionization sets in. These points are indications of the nature of the gas present. But the voltages at which ionization sets in are quite different from the usually accepted ionization voltages. One gas has not yet been identified and still goes by the name of "electrode gas."—*Abstracted from lecture delivered before the British Association meeting at Bournemouth, England.*

## THERMIONIC AND PHOTO-ELECTRIC PHENOMENA AT THE LOWEST ATTAINABLE PRESSURE.

The pressures attained were as low as  $3.5 \times 10^{-7}$  mm. of mercury. Upon denuding a tungsten plate of its occluded gases by raising it to a bright yellow heat by electronic bombardment, the photocurrent rose to many times the value obtained before such denuding, and further heating produced no further change. The upper wave-length limit of tungsten was observed to be in the region 2100 and 2300 Å. According to Einstein's equation, the corresponding values of the work necessary to free an electron from the metal would then be between 5.7 and 6.3 volts. These are larger than the corresponding values in the case of thermionic emission. A gradually increasing potential difference was applied between the tungsten plate and a glowing filament until the blue haze appeared. No pressure change whatever was observable at the moment of its appearance.—*Physical Review, June, 1919.*

## THE RECEIVING LOOP ANTENNA.

Following the method adopted in a former article dealing with the Marconi antenna, the author studies the dependence of the intensity of reception upon the sharpness of tuning, the dimensions of the loop and the wave length for the case both of undamped and damped oscillations. In both cases the intensity of reception is, within wide limits, independent of the sharpness of tuning and for small loops is about proportional to the third power of the linear dimensions of the frame. The intensity of reception for undamped waves diminishes, however, more rapidly than in a Marconi antenna when the wave length increases, while for damped waves an optimum wave length is demonstrated to exist, the value of which depends upon the damping of the loop.—*Science Abstracts, Section B, June, 1919.*

## ELECTROMAGNETIC WAVES.

This paper contains a general solution of the electromagnetic equations of wave propagation. The formulas are expressed in terms of general orthogonal co-ordinates as well as for spherical polar co-ordinates. Various specific conditions are discussed as well as the equations offered by other authors.—*T. J. Bromwich, Philosophical Magazine, July, 1919.*

## RECORDING RADIO SIGNALS WITH THE AID OF AMPLIFIERS.

By H. ABRAHAM and E. BLOCH.

A frame aerial receiver is used in combination with two multi-valve amplifiers, of eight and three valves, respectively. The first five valves are used for radio frequency amplification, the sixth as a detector, and the last two for low frequency amplification. To the end of this amplifier a special three-stage amplifier is connected, arranged with the grid of the last valve maintained normally at a negative potential, so that the plate circuit current is practically zero. The reception of the signal causes the plate current to jump to the saturation value, and so influences the recorder. This second amplifier thus takes the place of the usual relay.

Any ordinary Morse printer or recording galvanometer may be used. Medium strength atmospheric conditions do not affect the recorder. Using a frame coil of forty turns 1.2 meters diameter, successful records of transatlantic signals have been obtained.—*Revue Générale de l'Electricité, September, 1919.*

## NAVY BOOK REVISED.

The fifth edition of Robison's Manual of Radio Telegraphy and Telephony was recently published. The new edition has been revised and contains information pertaining to the latest type navy ship and aeroplane sets. Additional space has been given to the subject of vacuum tubes and their use as transmitters and receivers. An entire chapter is devoted to the explanation and discussion of antennae from the common four-wire type to the new underground and loop systems. A description of great interest to the amateurs is that of the radio compass used by the U. S. Navy. New photographs and additional data have been added to the Wireless Telephone section. Taken as a whole the book still retains its clarity and is written so that the ordinary amateur can understand it.

## TRANSMISSION OF ELECTRIC WAVES ROUND THE EARTH.

By G. N. WATSON, D.Sc.

A mathematical paper devoted to radio transmission theory. It investigates the consequences of the assumption that the earth is surrounded by a concentric conducting layer (Heaviside layer) at a considerable height, and of the ionization theory of wave refraction and reflection. The conclusion shows that the ionization theory is sufficient to explain the observed facts concerning the rate of decay of electric waves transmitted over large sheets of water, and confirms the theory put forward by Heaviside and Eccles. See also *Radio Review*, p. 78.—*Proceedings of the Royal Society, July, 1919.*

# New Radio Dynamic Controlling System

By Lieut. W. R. COVENTRY, R. A. F.

THE following is a description of an experimental apparatus for controlling several relays together or separately, in any order, from a distance thru radio waves. The idea is my own, and the principle different from any, to my knowledge.

From the diagram of the transmitting apparatus you will see that the electric waves are set up by ordinary means, a high voltage transformer and oscillatory circuit consisting of oscillation transformer, condenser and spark-gap. The primary circuit of the high voltage transformer is closed by a relay R. The radio receiving apparatus in the diagram is equally simple, i. e., a coherer, voltaic cell and sensitive relay.

The working principle of the whole apparatus is this: Transmitting drum D is turning in synchronism with receiving drum W, at a rate of about 30 revolutions per minute. Both drums are rotated by chronometer movements. D is of ebonite or any hard, insulating medium with brass contacts, C<sup>1</sup>-C<sup>5</sup>, arranged spirally, flush with the surface of drum. These contacts pass successively beneath their respective buttons, B<sup>1</sup>-B<sup>5</sup>. None of these buttons make contact with the brass pieces on the cylinder unless depressed. When any button is depressed, however, the circuit is completed thru the battery and relay, which, in turn, closes the circuit to the transformer and a wave of a fraction of a second's duration is impressed upon the ether.

The radio receiving circuit is attuned to these waves, hence, when an impulse is received, relay Y is closed. This actuates one of relays, P<sup>1</sup>-P<sup>5</sup>, corresponding to the buttons, B<sup>1</sup>-B<sup>5</sup>. This is brought about by the means of the drum W, which, as you will remember, is turning in synchronism with the transmitting drum D. X<sup>1</sup>-X<sup>5</sup> are five selenium cells. L is a small battery lamp fixed in the circumference of the drum W. L shines successively on each of the cells X<sup>1</sup>-X<sup>5</sup>. It will be noted that this

produces no effect on the relays P<sup>1</sup>-P<sup>5</sup>, unless the circuit is complete through relay Y.

The operation is as follows: We press, for instance, button B<sup>2</sup>. The transmitting drum or cylinder, in turning brings contact C<sup>2</sup> in electrical connection with B<sup>2</sup>. The circuit is completed through relay R, and a short wave emitted. Release button B<sup>2</sup>. The coherer in the receiving circuit picks up this wave. Relay Y is closed. At

Let the receiving drum be rotated, slightly faster than the transmitting drum. H is an iron bar which is pivoted in the center, vertically. (This is slightly misrepresented in the drawing.) When it swings inward toward drum W, a projection O, on the drum, comes up against it. This is its normal position. Let button B<sup>2</sup> be permanently depressed, so that C<sup>2</sup> makes contact every revolution and a short wave is sent out each time C<sup>2</sup> is beneath B<sup>2</sup>. Just before

this takes place in the transmitting drum, lamp L in the receiving drum will have arrived opposite cell X<sup>2</sup> and drum W will be momentarily stopped by projection O bearing against the bar H. Therefore, when the impulse is sent out from the transmitter by button B<sup>2</sup>, relay P<sup>2</sup> is actuated, electro-magnet G attracts bar H, which is pivoted in the center, thus freeing projection and allowing the drum to proceed in perfect synchronism with the transmitting drum. At the end of every revolution drum W is very slightly in advance of D, is stopped until D catches up, released, and then "carries on."

Naturally, this method of keeping the drums together is unnecessary if it is not required to keep them together for any length of time. I have found by experiment that

with two good chronometer or clock movements two drums can be driven and kept together for quite an appreciable time.

There are several practical applications for the above apparatus which will occur to the reader. My original idea was to try it on a model dirigible for exhibition purposes, but it could be applied with less difficulty to a motor boat. In steering, for instance, one depression of a certain button could be arranged to move the rudder a degree and no more. Hence, by holding the button down, each time contact was made the rudder would be moved another degree and the craft sent on any course.

I have shown the apparatus capable of working five relays. This number, of course, could be greater or smaller.

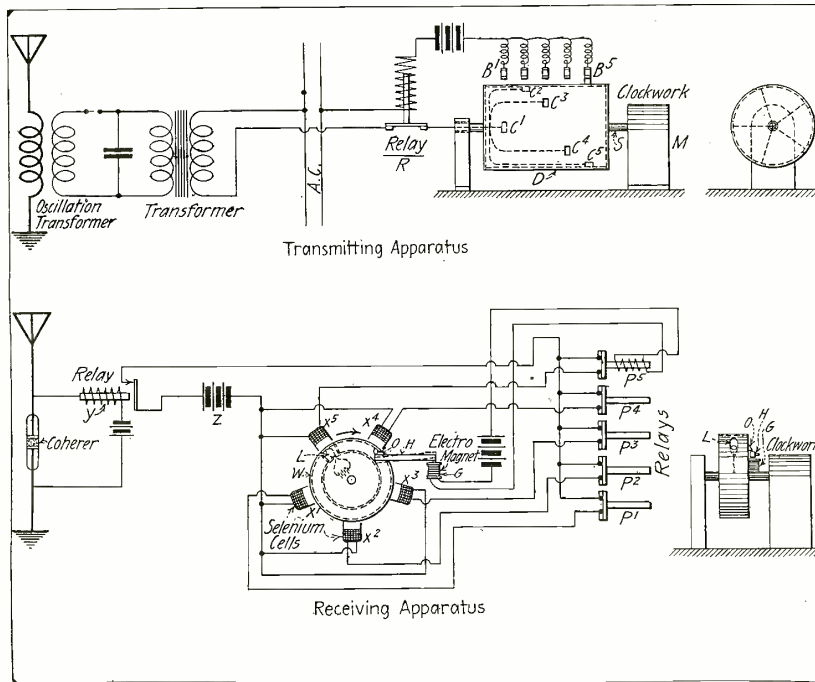

Two Drums Rotated by Clock Work in Synchrony Permits the Transmitter to Control the Receiver as Desired.

this instant the drum W in turning has brought lamp L so that it is directly opposite selenium cell X<sup>2</sup>. The resistance of the cell to electric current is broken down and there is a complete circuit for battery Z to operate relay P<sup>2</sup>. In the same way you may press any of the other buttons, B<sup>3</sup>, B<sup>4</sup>, B<sup>5</sup>, B<sup>1</sup>, in any order, and in approximately a second the corresponding relay in the receiving apparatus, P<sup>1</sup>-P<sup>5</sup>, will be actuated. The celerity with which the latter relays respond depends on the speed of the drums. Of course, this speed must be within limits, because as you increase it, the difficulty of keeping the two drums rotating in synchronism becomes very great.

One way this might be effected is shown in the diagram of the receiving apparatus.

## For Those Who "Listen In"

By Pierre H. Boucheron, Ensign U. S. N. R. F.

"Listening-in" today in the vicinity of important shipping centers, such as New York, Boston, Norfolk and New Orleans, the ether sounds, quite different to the amateur than it did back in 1916-17, and no doubt many wonder what it is all about when they hear several sparks of various frequencies working at approximately the same time and on the same wave length of 600 meters, all using the same call letters, such as NAH, NAB, NAT. The

reasons for this puzzling state of affairs can be ascribed to the various remote control systems which are primarily designed to overcome local interference prevailing in and about congested districts where so many vessels equipped with radio telegraphy are constantly going in and out, every one of them anxiously waiting its turn in order to send a docking or arrival message, or a list of stores wanted, or about a passenger who left his baggage ashore, etc.

Take the case of New York, for instance: the Navy Department has installed eight complete sending and receiving stations located within a radius of 100 miles in such geographical positions as to handle incoming and outgoing vessels without interfering with one another. In order that you may know and recognize them when you listen-in, here they are, call letters and all: Brooklyn Navy Yard.

(Continued on page 321)

# CORRESPONDENCE

## ATTENTION PARENTS!

*My Dear Mr. Gernsback:*

Your splendid conception of a journal devoted to the Radio Amateur fits into a field not sufficiently cared for. We have journals devoted to the interests of "wireless," all of which are excellent. The amateur cannot perhaps be a subscriber to all of them, but he should; and I have on my reading table each journal published in this country. Each is of a different kind from the other, and a new one appearing will only add zest to the present list. I congratulate you on the first issue and may it live long in the interests of the radio amateur.

May I have your columns for this letter which is address to the parents of the boys—especially to the father who in America, I am sorry to say, takes good care of his business and other matters to the neglect often of the needs of the boy? He entrusts the boy's education to the schools, his religion to the church, his morals to his mother, etc., but he does not often enough take the boy as playmate of older growth, as one with whom he enters into the various things which interest the boy and prepare him for the life before him. The Boy Scouts' organization endeavors, in a way, to take this burden from the shoulders of the father and too often he permits his conscience to cease its twittings by paying the dues for his boy in the troop and failing to pay strict attention to the results while the boy is in training. This fact is well known and needs only repeating here to serve as a basis for the suggestion that the father of the boy go back to his own boyhood in thought and action for a short space of time each day, and mingle with his boy in his tastes and aspirations. Let him find out the boy's instincts, his inclinations, his trend of thought, all of which may be boyish and directionless perhaps; but good will flow from the desire of the boy to be a policeman, an engineer, a carpenter, a mechanic, a lawyer, a minister, a doctor or whatnot. It may be that shortly the boy will take another tack in his desires and efforts. Let the father follow each effort of the boy to its conclusion, and if he tires of one thing encourage him in the next. As the boy passes along in life the seed planted by the encouragement of the parent will find fruition.

This is introductory to the following: The wireless art, or science, as it may be called, is one which captures the imagination of the boy and girl as quickly as anything I know. From being a little plaything it can be developed to enormous proportions. Much contributes toward making it so. A piece of wire, a paper tube, a few turns of wire, a telephone receiver, a piece of galena crystal and the boy has the outfit for doing something really wonderful and startling. Powerful stations as well as weak ones in his vicinity, are sending out day and night dots and dashes which the boy can hear and interpret. This may appear simple. So it is, but the boy advances from the simplest on and on, until he brings into play the required knowledge of the most profound problems in electricity and mechanics. The simple apparatus he first uses has in it the elements for keen study and solution. The thickness of the wire, its length, its covering for purposes of insulation, its effect when wound on a cardboard tube and a current of electricity is sent through it, the effect this has on a similar tube passed within the first, the action wireless signals have on the crystal called the detector, and finally the results on the diaphragm of the receiving telephone—these are problems of the highest order. Men of the deepest scientific achievements are studying the problems

these things have occasioned. The boy takes up the simple apparatus and soon he comprehends that there are fields afar for his study and experimentation. He buys or builds other apparatus, he studies it; he improves upon it, he becomes a sender of signals of the wireless code, he begins to delve into the volt, the ohm, the ampere, the farad; he advances along the line of his school studies in electricity, he forms clubs among his fellow enthusiasts, he listens to papers on the subject of radio transmission by telegraph and telephone, he soon entertains ideas of his own, he writes papers or enters into discussions, and it does not take long for the boy who began with his simple apparatus costing a few dollars to have for his personal use an outfit defying criticism and measuring up to the needs of the scientific aspect of the matter. The wireless field is teeming with men who began in this fashion.

So, let this advice to the parent be—encourage your boy in the wireless game! Do not be averse to doing it yourself, if need be, so that the boy will have your help and your cooperation.

I hope that this letter will be read by parents and appreciated as coming from one who late in life took up the study of "wireless" and never gets tired of it; as one who has trained many boys along lines of this character; as one who has seen many a boy graduate from the little crude

### ONE CENT A WORD FOR YOU.

*If you have a good true story to tell us about yourself or your station or any unusual radio occurrence or matter connected with radio, we want that story. We will pay one cent a word upon publication for all accepted stories. We desire you to feel that this new magazine is your magazine, and we will do all in our power to make it so. We want to make it as human as it is possible. Will you help?*

outfit to something great and important.

If this letter has a tone that catches the imagination of the parent, I will be pleased to offer a few suggestions later to those who have a heart to take their boys out of the play of the street and give them something worth while, something that will undoubtedly lay the foundation for a future success in whatever they undertake. I will be pleased to give them a plan to follow, so that the boy will not start falsely, but surely and gradually along a field of endeavor having stupendous results for the outlay in money, time and co-operation.

GORDON M. CHRISTINE, M. D.  
2043 N. 12th Street, Philadelphia, Pa.,  
August 1st, 1919.

### WHICH: RADIO AMATEUR NEWS OR RADIO NEWS?

*Editor Radio Amateur News:*

With pleasure unbounded, I take herewith this opportunity of most heartily congratulating you on the phenomenal success and popularity of the magazine of the hour, RADIO AMATEUR NEWS. It is with much less pleasure, however, and with feelings of the utmost apprehension that I note a growing tendency to change the original title, RADIO AMATEUR NEWS, to the more professional one, RADIO NEWS.

Do you know from whence comes the

real feeling of appreciation and avowed faithfulness for your efforts in erecting this new standard to the everlasting memory of the Radio Art? Do they come from the so-called "Professional Radio Man," who coldly, coolly and quietly scans the pages of Radio Digest that represent the culmination of your splendid gifts and efforts to and toward mankind, with a possible thought of criticism for articles of his own class, or maintain a sneering attitude toward those articles of class "ABC"; or do they come from the "Fresh Hatched Bug", that slim, sly, bright eyed fellow of 14, who with an empty tomato can, a roll of annunciator wire, an old switch and a piece of galena has set up his "lil' lab in a corner of the garret? And then that night of the first tryout; with eyes bright as stars he nervously leafs through a copy of R.A.N. for a hook-up of galena, cans and tuner; he finds it, connections are made and then with pale face he dons the "cans" and starts in: Say, do you remember that first bu-z-z-z? watch 'im hug up tight good old R.A.N. and gasp out "Oh, Boy!" That night in prayer he says a few "extras" for H. Gernsback and R.A.N.

Can you just only form a mental conception of that pathetic little scene up in that garret that night of all nights when this earnest straightforward lad (possibly an embryo Tesla or Edison) reads his first "sigs"; and of a possible tragedy averted all because of R. A. N. Hark you, then, back just a little to the day when he was introduced to R.A.N.

"Say, 'Bud,' kin yuh put me next to a good magazine, that's got just th' right dope fer a fellow who wants to learn about wireless and all about how to make stations fer yerself?" "Sure I kin, 'Bill,' I know of a 'peach' of a magazine fer beginners an' everybody, called RADIO AMATEUR NEWS, an' its got just the right stuff fer us beginners and yuh kin tell it has because it says RADIO AMATEUR NEWS, and amateur means fellows just like you and I." "You see they call it that, but its got some 'tall' stuff, too, for 'professionals,' but they know enuf to have that it's in there without havin' to have it struck off as 'Professional Radio News,' while fellows like you and me who aint 'next to' everything in the art yet and so we have got to be told just when and where to take our 'tips' and so the 'professionals' know better so they sign and we're told better and we sign, fer it and everybody's pleased."

I trust, my dear Mr. Gernsback, that you will bear with me just a little further in this discussion. As a "dyed-in-the-wool" amateur I for one am proud of the name, for it denotes that I still have plenty of room for expansion, as it likewise denotes also that I am still a budding "possibility" and not an inanimate sot with no longer the gift of expansionability, and I feel and know that no true man whose life is spent in scientific research, would be offended with the word amateur, whatever the extent of his knowledge, for if he is really a searcher after new scientific knowledge, he will continually meet with new phases of science in which he is an amateur in the fullest sense of the word. Does it sound sensible to you? Think it over carefully and don't forget those days when you were a boy as you think of the also struggling amateur of today who is successfully coping with problems which look as insurmountable as those of "when I was a boy." We can trust you to do this, can't we? Amateur radio America looks to H. Gernsback. In the meantime as a humble amateur consider me,

Sincerely yours,

W. H. BICKEL.  
Claypool, Ind., August 4, 1919.

# Radio Experiences on the R-34

By R. F. DURRANT, Lieut. R. A. F.

**W**HAT is the secret of success of radio efficiency on a dirigible? To that question I would reply, "The study of detail." All you radio men realize of what para-



The Radio Cabin Assumed an Angle of 45 Degrees.

mount importance are the little details in fitting and testing a station.

In my experience of fitting large dirigibles I found that in nearly 90% of the cases troubles have been traced to some minor fault in wiring. When I have found by our first flight in the heavens that the radio is O. K., I set to work in order to obtain the highest pitch of efficiency by that careful process of overhauling, which is the natural instinct of every true radio enthusiast.

In R-34's first flight we had an exciting adventure. She had been built on the banks of the Clyde and we had completed her radio fitting. The first available morning the air liner was taken out of her shed and was soon aloft. The aneroid needle showed 500, 600 and finally 10,000 feet. I declutched the aerial reel and slowly allowed 500 feet of cable to trail beneath us. I tuned the transmitting and receiving sets and then established communication with the base. How the pulse jumped as the answering "sigs" came from Mother Earth! The wave was checked again, for it had to be "dead on regulation."

Our first flight took us over the Irish Sea. We had been out eight hours, when at 4 A. M. just as the sun was showing his glowing orb over the eastern horizon, a shiver ran thru the ship. All hands were immediately at their posts. The radio cabin assumed an angle of 45 degrees.

"Ting-a-ling, ting-ling," the phone bell rang and the commander's cool voice came crisply thru:

"Signal to the base."

Over went the switch and adjusting myself to the steep angle of the ship, I lighted the filaments of the transmitting tube and "Morsed" out a "rush message." One had to be steady and care had to be taken to emphasize the dots and dashes.

My second radio aide crawled aft and assisted in the work of clearing the jam. After minutes of anxiety the ship gradually assumed her normal position and sped along on an even keel, so we cancelled the message for help.

Another radio incident in mid-air occurred in this way: We were over London and following the Thames which glistened like a silver ribbon beneath us, when I had occasion to make an adjustment near six large battery boxes (this was before the advent of the wind-driven generator). Without warning the thin matchboard deck gave way, and ere I could save it a large battery box, weighing some fifty pounds, was dropping thru space over the crowded city. Visions of being tried for manslaughter appeared before me and I was not very much pleased to hear when we touched the ground that the box had fallen

on a convict prison and laid out three men. This report was incorrect, however, and my mind was vastly relieved by seeing the remains of my one-time high tension battery lying in a sack which had been brought



Ere I Could Save It a Large Battery Box Was Dropping Thru Space Over the Crowded City.



I Joined These Wires Together and Used Pliers for an Antenna Weight.

in by a constable.

One of the things a dirigible radio man is afraid of is the losing of an antenna weight whilst flying. This happened to us one day. The weight certainly obeyed all the laws of gravitation by hitting a milk cart and going clean thru the driver's seat into the ground. Fortunately for the driver he had left his seat some three minutes before.

Another bugbear of radio is interference from the magnetos, far worse than static, which we overcome by using braided cable on the electrical system of the engines.

During our early tests we were caught in a heavy sea fog and had to remain aloft twenty-one hours. The ship's larder being empty, we had to tighten our belts several times! We relied upon our compass stations for our positions until the fog cleared. We lost our antenna and I had to get odd lengths of wire from the engineers. I joined these together and used a pair of pliers for an antenna weight which answered the purpose.

All my assistants agree with me in saying that operating on a dirigible is much harder work than aeroplane radio.

When I come across the pond again I shall expect to hear something of those radiophone sets you are busy on; only don't all call at once.

## Foot Ball Score—Via Wireless Telephone

By MORRIS PRESS

On November eighteenth, Wesleyan played New York University at Ohio Field, New York City. Naturally, the students at Wesleyan were unable to send a large delegation to University Heights from Middletown, Conn. The students unable to go were anxious to know how the game was progressing and in order to satisfy their de-

sires, the authorities at N. Y. U. began negotiations with Dr. de Forest, of audion fame. When Dr. de Forest heard of the plan, he became deeply interested and devoted his personal attention to the experiment.

The night before the game Dr. de Forest established communication with the Physics

Department at Wesleyan. The experiments were continued the next morning and long distance telephone communication established the fact that the Wesleyan station was receiving satisfactorily.

During the game, an N. Y. U. reporter wrote the account of the game which was

(Continued on page 321)



# Amateur Ethics

By PIERRE H. BOUCHERON

*A Timely Discussion on Some Pertinent Points Connected with the Game, as Well as a Few Sidelights and Pointers on How to Behave.*

**A**T last! Once more the ether is restored to us amateurs! We are off into a bright and sunny future. In the height of our glee and enthusiasm, however, let us not run away with our long pent-up exuberance to the point of forgetting the properties in the matter of operating, and let us, therefore, discuss in an impassionate tone some pertinent subjects connected with *amateur transmission*, with the view of adopting, individually, a proper standard of efficiency.

In the old days, before government supervision of amateurs and commercial operators, the ether was used in a happy-go-lucky fashion with no thought of tuning or bothering about decrement, and the larger amount of power available, the better. If one had a thousand dollars or more to spend for a transmitter, very well, it would be a 5 k. w. transformer, and the more interference it caused, the more notorious the owner, as that was the best way of creating a "noise" and becoming prominent in the locality. The writer recalls the days when a certain set of elite amateurs residing near Yonkers and White Plains, all equipped with powerful transmitters from one to five k. w., so controlled the air in and about New York as to have the regular commercial stations such as "DF," "NY" and "MSE" completely at their mercy, so to speak, and often would the latter have to telephone the Yonkers and White Plains "clique" and respectfully ask them to "please" stand by for a few minutes while they tried to "clear" a distant vessel. Of course, all this happened before definite wavelengths had been allotted to all radio stations. Then came the laws and regulations governing radio communication, and with them, inductive coupling of transmitters, a decrement not exceeding 0.2, and a general assignment of specific wavelengths to amateurs and commercial stations with the object of preventing, or at least minimizing, radio interference between each other. The amateurs while operating within a wavelength of 200 meters were not heard by the commercial folks working on 600 meters or more, and here at last began real harmony between the two classes, and incidentally the bugaboo about closing down amateurs completely was thereby most effectively squelched for all time to come, let us hope.

*But now with the world war ended we see a considerable increase in the number of amateurs in the United States; one of the main reasons for this being the great number of young men who, with no previous knowledge of the subject whatever, were taught radio in both the Army and Navy training schools. The Signal Corps alone has trained something like 50,000 men in the theory and operation of the modern radio installation, while the Navy has probably instructed 20,000, and one important fact about this matter is that these men, with few exceptions, are now able to send and receive at professional speed. The greater part of these embryo Marconi's are now back in civilian life again, scattered over all parts of the country and cities, and every one of them having experienced the keen fascination and many thrills known to the radio enthusiast, are now potential amateurs. Many will therefore install complete receiving and transmitting sets in order to keep in touch with the game thus becoming members of that great galaxy known as the Radio Amateur.*

Behold! What will take place? Just this: With the greatly increased number

of amateurs there will perforce be considerable more use of the ether, and since we assume it will all take place on the amateur wavelength of 200 meters, there is bound to be increased interference and particularly will this be true in thickly populated districts such as New York, Boston, Chicago and elsewhere. For this reason we, the amateurs, must in the days to come exercise extreme judgment and discretion when operating. We must be consistent and conscientious in the manner in which we use the air. One must not think that because he is not being hired and paid by the owners of the air, therefore being a free agent, that he can go the limit in sending out whatever comes to his mind in any old style and without any particular method.

Do you know that a certain well-known radio company employs special traveling inspectors whose jobs it is to travel around in all parts of the seven seas—patrolling the ether as it were—intercepting and reporting all instances of faulty or improper

Of this issue, the sixth one since "Radio Amateur News" started, 33,000 copies have been printed and circulated. We have added eight more pages, too, this month, to take care of the many new features, as well as advertising.

With your help and support we promise to double the size of the magazine within the next few months.

Boost R. A. N.

operating on the part of its ship radio operators? Often has an indecent conversation or serious violating of its rules between two ship operators in some remote section of the world where they thought they had little to fear from being overheard by coastal stations resulted in their dismissals upon reaching the home port. A large operating company cannot afford to have and will not tolerate improver operating by its operators, and there is no reason in the world why the highly intelligent and organized amateur body should tolerate it among themselves. Do not misunderstand. The intent of this article is not meant to put a "damper" on enthusiasm; on the contrary, it is meant and should be taken as a constructive discussion on what we may term the ethical side of radio experimenting. The following are a few pointers which might be well to keep in mind when the day of transmission finally returns.

Minimize lengthy or unnecessary conversations and give the fellow with a small outfit a chance to do a little sending also.

Make frequent use of the International Abbreviation List, better known as the "Q" signals, as much as possible in order to shorten the length of messages, and in a short time you will know the most important ones by memory, thus permitting you to establish communication more rapidly and easily.

Employ the standard operating signals and be consistent in their use. Do not start off with a lot of "V's" before finally calling your man; neither should you call "by the

hour" as the saying goes. If your man does not answer after three separate calls with a two-minute interval between each call, it is a pretty good indication that he is not listening-in, so wait the prescribed fifteen minutes before calling him again.

The proper manner of calling is thus: "— — — — 2ZA 2ZA 2ZA de 2AB 2AB 2AB", and the proper manner of answering is, "— — — — 2AB 2AB 2AB de 2ZA — — —". Additional signals to the above are unnecessary and should be avoided.

Do not finish off like this, "OK OK OK GB GB GB CUL CUL CUL OM OM OM GB — — — — — — — — — — — — — — —"; and this is not an extreme case either, as some readers will recall. Such unnecessary signals are inefficient, use a lot of power and accomplish nothing. If you feel so exuberant that you must practice sending, by all means do so, but do it on an improvised buzzer practice set. Do not "jam" everybody within miles by practicing sending with your transmitter when the antenna is in circuit.

Your language should be temperate at all times. Do not "bawl out" the "ham"—you were one yourself once; *perhaps you still are.*

When necessary to test your transmitter, be as brief as possible; do not press your key just for the mere satisfaction of hearing your own spark make a noise.

By all means keep your wavelength within the prescribed limit which, as heretofore, will probably remain at 200 meters for amateur transmission, and adjust your transmitter for the lowest possible decrement. Before the war, the writer often noted amateurs working on 400 and 600 meters, particularly those in remote sections, resorting to this practice, no doubt, in order to cover greater distances. You never fool anyone by doing this, so be honest with yourself.

Be business-like in handling your traffic, and send your despatches in regular message form, including the number of the message, the number of words the message contains or check, etc.

Above all, remember at all times that Department of Commerce officials, stationed in various parts of the United States, have listening-in sets installed at their headquarters whereby they may keep "tabs" on amateurs as well as commercial operators, and if improper communication or willful disregard of existing regulations are intercepted, the revoking of licenses or more drastic action may follow.

## PLAN TO BUILD STATION NEAR VANCOUVER.

Construction of a high powered wireless station, which when completed will be the most powerful radio depot in the British Empire, is proposed for the vicinity of Vancouver, B. C., by the Canadian Marconi Wireless Company.

The station, which will cost, it is estimated, in the neighborhood of \$2,000,000, is designed to handle commercial business between Canada and the Orient, and a station of like power and cost will of course be built in Japan. Negotiations are being carried on simultaneously with the governments of Canada and Japan for licenses to construct and operate the two stations necessary to establish direct communication across the Pacific.

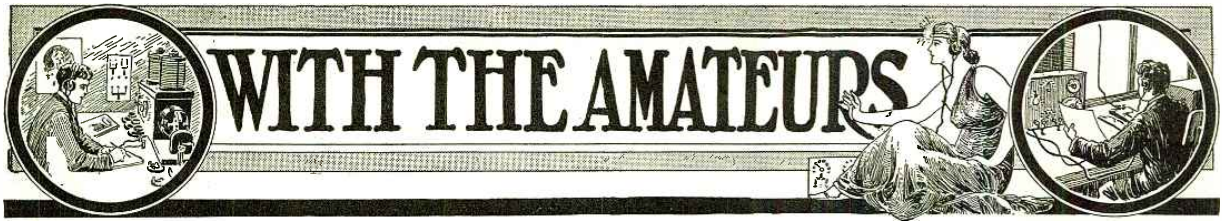

**T**HIS department is open to all readers. It matters not whether subscribers or not. All photos are judged for best arrangement and efficiency of the apparatus, neatness of connections and general appearance. In order to increase the interest in this department, we make it a rule not to publish photographs of stations unaccompanied by a picture of the owner.

We prefer dark photos to light ones. The prize winning pictures must be on prints not smaller than 5 x 7". We cannot reproduce pictures smaller than 3 1/2 x 3 1/2". All pictures must bear name and address written in ink on the back. A letter of not less than 100 words giving full description of the station, aerial equipment, etc., must accompany the pictures.

**PRIZES:** One first monthly prize of \$5.00. All other pictures published will be paid for at the rate of \$2.00.

**CHARLES REYNOLD'S STATION**

I am sending in a photo of my station and myself.

My set consists of the following instruments: 1 k.w. Thordarson Transformer, Murdock moulded condensers, Sayville Rotary Gap (8,000 R.P.M.) and Oscillation Transformer. A commercial type aerial switch for changing from sending to receiving, at the same time cutting off all the current to my transmitting set.

Receiving set consists of a long wave loose coupler, audiotron cabinet, for spark or arc stations, 3 variable condensers, and an extra filament control with very fine adjustment. This is necessary to adjust the filament current of a tube of this type. I also have two meters for measuring the high and low voltage current, 3,000 Ohm phones, and two dead end switches arranged to throw the set from commercial tuning to amateur tuning. Therefore practically any range can be reached with this equipment.

My aerial is 85 feet long, 4 wires, 3 feet apart, and 40 feet high.

I have no trouble in receiving signals from all the high power stations. My operating experience as an amateur covers eight years.

CHAS. L. REYNOLDS,  
Binghamton, N. Y.

**JAMES E. SMITH'S STATION.**

Enclosed is a photo of my station, showing as follows: Sending set—one two-inch spark coil, spark gap, helix, transmitting condenser, toy transformer for spark coil, key. Receiving set—RW3 Mignon type receiving cabinet, loading inductance, loose coupler for receiving amateurs, variable condenser, two pairs of phones. With this set I have had good results. Here are some of the stations which I have heard: NSS, NPL, NAR, NBA, WSO, NPG, XDA,

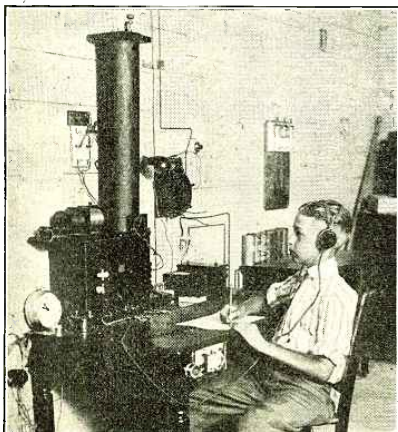

Bugs Get Busy! Look at the Station Built By This Young Amateur.



Prize Winner

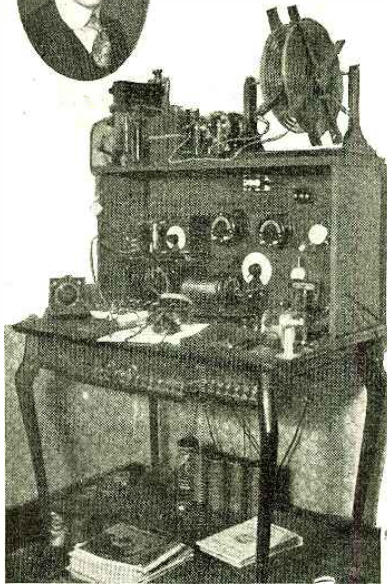

The First Prize of \$5.00 is Awarded to Charles Reynolds. A Neat and Well Designed Station We Say.

NFF, NAT, NDD, WUL, NAW, NIL, NAM, NAU. I receive the time from NSS, NAT, NAR, NBA, NPG. I hear XDA four feet from the phones and can hear other stations, too faint to get their calls. My aerial consists of four aluminum wires seventy feet long and sixty feet high.

JAMES EMORY SMITH.

**PAUL WATSON'S STATION.**

Here is a picture of my amateur radio station at West Chester, Pennsylvania.

The receiving set consists of a "VT" tube detector, loose coupler variable condensers, and loading inductances. The mounting for the "VT" tubes is not visible in the photo, as they are back of the aerial switch. The valve detector is connected to the small panel in the back of the station, and has a "Crystolio" detector for short distance work arranged in connection with this panel.

The transmitter consists of a one-inch induction coil, a section of Murdock moulded condenser, rotary spark gap, and a Murdock oscillation transformer. The entire high tension circuits are connected with rigid copper tubing, as the set will

be raised to a 1 k.w. outfit in a short while, and then there will be need of the rotary gap.

The telegraph sounder seen in the back of the station is connected to a line to several other amateurs, and communication is carried on by two mediums. The telegraph sounder, transmitting set, omigraph, and test buzzer are all connected to the transmitting key, and are cut in, or out, as desired, on the small panel in the middle of the set. Long distances have been covered with this set. FL, Eiffel Tower, has been copied, NGE, Miami, and NAR have been heard. POZ, and OUI have been copied regularly. Many ships have been copied, and their "TRs" signify that they are many miles from New York.

PAUL G. WATSON,  
214 West Barnard Street,  
West Chester, Penna.

**HUBBARD LARKIN'S STATION.**

After seeing numerous pictures of Amateur Stations published, I thought I would send one of my own station. I have a receiving set of the panel type, consisting of: a loose coupler, carburendum detector, two variable condensers, a fixed condenser, potentiometer, a pair of Brandes (Navy type) phones and a test buzzer. I also have a buzzer practice set and a battery box with batteries for the buzzers and detector. My two wire aerial is 100 feet long and 60 feet high.

I am now making plans to build an undamped wave receiver and to install a 1/2 k.w. transmitter.

HUBBARD W. LARKIN,  
2487 Santa Rosa Ave.,  
Altadena, Calif.

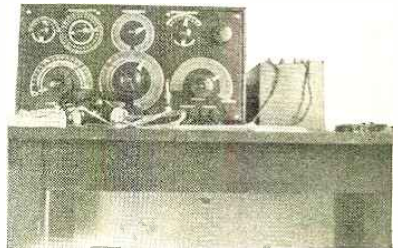

Here is a Receiving Station Worthy of Note.

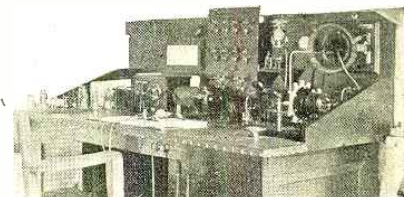

This Small Photograph Which Paul Watson Sent In Does Not Do Justice to His Station.

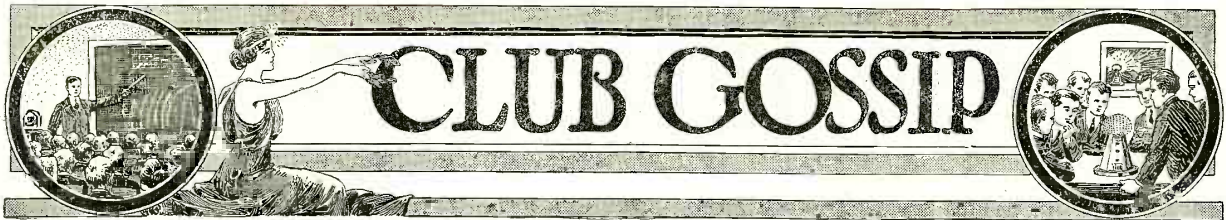

# CLUB GOSSIP



Members of the Three Towns Wireless Club of Plymouth, England.

### INTERNATIONAL ASSOCIATION WANTED.

I am sending you a photo of some of the members of the Three Towns Wireless Club taken at a field day at Plymouth (England). Owing to the restrictions not being taken off in England yet, we are rather slow in getting members, but as long as we can keep going they will come. The instruments in the photo are field telegraph and telephone sets; all we can use at present. The club meetings are spent in lectures, Morse practice and the exchange of ideas. We received a letter from the Milwaukee Amateur Radio Club in regard to making the Radio League an international association for the exchange of ideas, etc. I am writing to tell them that I wrote to the *Wireless World* to advocate this. I am also sending copies of the letter to the rest of the clubs in England. Will some of the American radio clubs approach the *Radio League of America* to see what can be done? If it is possible we will further its interest for England. We are also trying to get an amateur publication started in England.

THREE TOWNS WIRELESS CLUB,  
7 Brandreth Road,  
Plymouth, England.  
W. ROSE, Secretary.

### TOLEDO RADIO CLUB.

DEAR SIR:—As you would like to know I have started a Radio Club and we had our first meeting September 22. There were five present and next meeting we have several more coming in.

We met in my house last night, but one of the members is going to get a small storeroom to meet in.

All the members have wireless outfits or are going to get one, and in a week or so we will have a picture or two, in the *RADIO NEWS*.

Would like to hear suggestions in the

RADIO NEWS or by letter from anyone or from clubs.

Yours truly,  
DUDLEY WEST,  
President, 3944 Hazelhurst Ave.

### EVERGREEN RADIO ASSOCIATION.

Editor RADIO AMATEUR NEWS:

Some time ago we wrote regarding the "Radio Association" and hereby wish to announce that there has been a change in the secretarial chair. All communications should be now addressed to the writer, who has been elected secretary.

Considerable progress has taken place recently in which time we have also constructed a code practise table. A large number of amateurs have applied for membership, and in the near future we expect to have at least 25 members together, among them prominent amateurs of this territory.

The following abstract is the most important contained in the by-laws:

#### ARTICLE II—MEMBERSHIP

Section 2. Members must be 18 years of age or over and must have at least one year or more experience in the Art of Radio.

The photograph shows our code department during a practise period.

ANDREW SCHREINER,  
1722 Putnam Ave.,  
Brooklyn, N. Y.

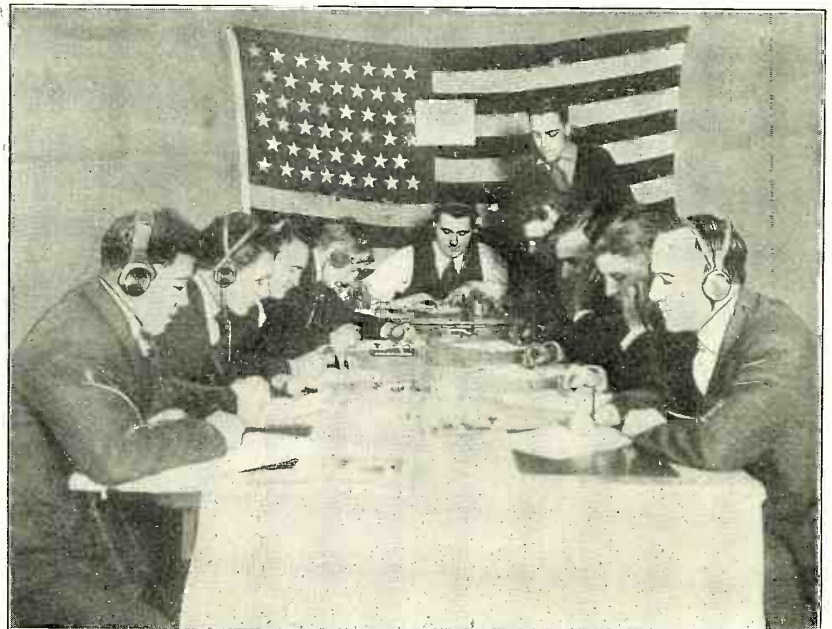

Code Practice and Plenty of It is a By-Law of the Evergreen Radio Association.

### AMATEUR RADIO CLUB MAKING RAPID STRIDES.

The enthusiasm of amateur radio operators is reaching the top note as plans for further developing the Houston, Texas, Radio Club are made. The membership now includes thirty members with fifteen or twenty stations in operation.

At a meeting of the Club held recently it was stated that relay messages would be handled through the American Radio Relay League. With this in view, transcontinental messages may be delivered in record time by the larger stations relaying messages received to the smaller station nearest the point of the final destination.

Many interesting subjects were discussed that promise to give the amateur in Houston due consideration and higher recognition by the national organization of which the clubs affiliated is now assured.

Members were urged to request everyone interested to write to representatives in regard to a legislation which is now before Congress and which if passed will seriously hamper the amateur operator.

A committee was appointed to draw up the constitution and by-laws before the meeting recently, when it will be presented to the members for approbation. The committee is composed of A. N. Dorgan, James Autry, Jr., Mr. Daniels and Mr. Vick.

Officers of the Club are: O. N. Dorgan, president; L. Peine, secretary; J. W. Weatherford, treasurer, and H. E. Worthington, city manager.

### SAN ANTONIO RADIO CLUB.

For the purpose of making a study of receiving and sending radio messages, the San Antonio Wireless Club has been organized with 11 members.

The club will erect its own receiving and sending station and lectures and illustrations on wireless operation will be given from time to time. The club has secured permission from the Government to erect a wireless station of 200 meters capacity.

All amateur and professional operators or those interested in wireless operating are eligible for membership in the new club. The station and clubrooms will be erected on Nixon Street.

The next meeting of the club will be held at the Young Men's Christian Association. The following officers have been elected: President, D. D. Evins; vice-president, J. C. Rodriguez, and secretary-treasurer, R. J. Oliphant, with the following charter members: M. Stockton, A. Scott, L. D. Wall, A. Oeding, B. Arnold, W. Egerton, G. Gregory and G. D. Rayborn.

P. F. OLIPHANT,  
Secretary and Treasurer.

### THE PUTNAM RADIO ASSOCIATION.

This is the name of our Radio Club here in Greenwich, Conn.

Our first meeting was held in the Y. M. C. A. building on Wednesday evening, October 29, 1919. The meeting was preceded by a dinner, after which the meeting was called to order.

The officers for the next year are as follows: President, Mr. Minton Cronkhite; vice-president, Mr. E. F. Coles; secretary-treasurer, Mr. George C. Delage.

Progressiveness is our key-note and a general diffusion of knowledge pertaining to radio-telegraphy our endeavor.

We do not merely propose to gather together only the amateurs of the vicinity but to get those who have not had a chance to learn radio but are interested in it.

We have two standing committees. The Library Committee whose duty it is to keep posted on the latest articles pertaining to

radio and to prepare papers of general interest to be read to the association. The Electrical Committee is in direct charge of all experiments and is to see that all experiments are performed and recorded in a scientific manner.

The association will be glad to hear from anyone interested in this work. Please address all communications to the secretary, P. O. Box 88, Greenwich, Conn.

### YOUNG MEN'S SCIENTIFIC ASSOCIATION.

The Young Men's Scientific Association was organized on October 12, 1919. We have a beautiful meeting room where we have on hand a receiving outfit containing an audiotron bulb, a loose-coupled, variable condensers and a set of 2,000-ohm receivers. Our aerial is 60 feet high 110 feet long. It consists of five strands and is of the T type.

A large laboratory is being set up which will contain all apparatus, both for Radio and Chemistry. We have only six members now, but have applications for six more.

We wish you best of luck with RADIO AMATEUR NEWS.

S. LEBEN, Secretary,  
343 Newport Avenue,  
Brooklyn, N. Y.

### Important Announcement

**A** SPECIAL feature in the January issue of the RADIO AMATEUR NEWS will be a RADIO map in the form of a supplement. This map will show the locations of all the high powered RADIO stations in the world, including the time signal stations. In addition you will be able to tell at a glance how far away any of these stations are. Of greater interest will be the time zones, which will enable the amateur to compute instantly the correct time for the zone in which he is located from any time signal station. A map like this has been a long needed want of the amateur. As this is the first time a map of this kind has ever been published, it will also no doubt be of great value to commercial operators.

Watch for it.

### THE DOINGS OF THE RADIO DEVILS.

The first post-war meeting of "The Radio Devils,"—a peculiar name but a very suitable one—held at the headquarters at Columbus, Ohio, was a very interesting affair and was full of excitement. There were demonstrations on all of the things of wireless telegraphy, such as static, electromagnetism and others of the wireless world. The purpose of this meeting was to instruct, as very few of the members knew little of wireless. In demonstrating the transmitting transformer one of the members accidentally touched the two secondary ends. Consequently he didn't feel like touching them again, as it was a  $\frac{3}{4}$  k.w. transformer. The members then retired to another room and listened to N. A. A. send out time signals. The set was a De Forest unit receiving set, 15 panel type. After an audition bulb was broken and a collection taken to defray expense the meeting adjourned. I would like to add that the fellow who thought a transformer wouldn't shock spent the following week in bed. A very strenuous task when a high-powered receiver of 25,000 meters is in the same room. Let's hear from some more of you "radio bugs" and make this magazine full of pep.

T. S. WINDOM,  
1048 East Main St., Columbus, O.

### THE PHILADELPHIA AMATEUR RADIO ASSOCIATION.

The first meeting of The Philadelphia Amateur Radio Association was held on Thursday evening, October 16, 1919, at Friendship Hall, 1611 Columbia Avenue, Philadelphia. There were twenty-five members present. The following officers were elected: President, Dr. G. M. Christine; vice-president, Wm. Wunder; secretary, H. P. Holz.

An interesting program was arranged for the following meetings which will be held on the second and fourth Mondays of the month.

The next meeting is on the 22nd of December. Everybody is invited to attend and bring friends. A prominent Radio expert will speak at each meeting. All applications for membership should be addressed to H. P. Holz, 1902 N. 11th Street, Philadelphia.

### THE INTERSTATE RADIO CLUB.

The Interstate Radio Club of America was formed on September 1, 1919, with ten charter members from various states.

The purpose of this club is to promote interest and study of Radio Communication among the members. The affairs of this organization are carried on by correspondence. Every action taken is first put to the vote of the members as it is a boys' club run by boys. The club represents no company selling wireless goods and is, therefore, strictly non-partial in every respect. Plans are now under way for the adoption of an official paper or magazine for the club.

A manager is appointed for every state. His duties are to have charge of all matters that arise in his district pertaining to the club.

There are now over 100 members, and it is growing every day. The officers are:

President, Orville F. Claybaugh, 508 West Court Street, Paris, Ill.; vice-president, Horace L. Haynes, 110 West Gill Avenue, Knoxville, Tenn.; secretary, Richard Hershberg, of Barbourville, Ky.; recruiting officer, Byron Lindholm, Chicago, Ill.

There are no dues or expense attached to this club and all boys living in the United States and Canada are eligible and invited to join. Address all applications for membership to the president.

### SHORTRIDGE H. S. WIRELESS CLUB.

Our organization, the Shortridge High School Wireless Club, was established in 1916 and has enjoyed a good healthy existence ever since, with the exception of one year during the war when it was disbanded because of a lack of interest in the subject. On February 14, 1919, the club was reorganized with a membership of eighteen, which number has since increased to thirty-five. At this time the wireless ban had not yet been lifted, and for this reason the principal activities of the club were to educate the members through lectures and to prepare the club station for the time when it might again be put in operation. Government radio operators and professional wireless men talked before the club, and by June, when school closed for the summer, the members as a whole were well advanced in the study of the science.

This year a very interesting series of talks is being made by Mr. Crockett, the instructor of the physics department of the high school. A splendid antenna, 150 feet long, has been suspended between a high tower on one building and the roof of another four-story building. It is expected, if no unforeseen difficulties arise, that the large and powerful station of the club will be in operation within a few weeks.

EDWIN C. HURD,  
President.



## Junior Radio Course

By W. A. HEPPNER, Associate Editor

### Lesson Four

#### TUNING.

UPON reviewing lesson one, the reader will remember that in order to have the receiving station respond to the transmitting station the two must be in resonance; that is, they must both be tuned to the same wave-length.

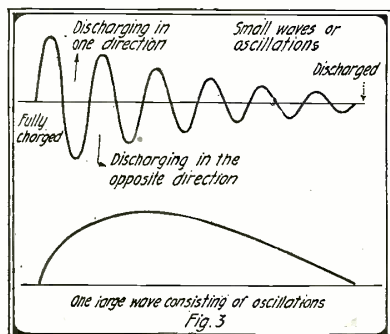

The Small Oscillations Form One Large Wave of Certain Length.

Before taking up the subject of tuning, we must first thoroughly understand the meaning of the term *wave-length*, and its importance in tuning. We saw in lesson one how the paddle at the sending station sent out water waves of a certain height. The other dimension in which we are interested concerning waves is the length. In Fig. 1 we see how the wave-length is measured, from the peak of one wave to the peak of the next wave. Ordinarily we would measure this in feet, but since the metric system is used in radio work it is measured in meters. In Fig. 2 we see how this measurement applies to the wireless waves. In wireless, however, the wave-length cannot be measured with a linear rule, but a certain calibrated instrument designed for that purpose is used.

Another thing which we must take into consideration is the number of waves and their velocity. The condenser in the transmitting circuit, as we have learned, discharges first in one direction and then in the other, until the entire amount of energy has been expended. This action is called the oscillatory discharge of a condenser. When a condenser discharges into the antenna circuit these small oscillations or

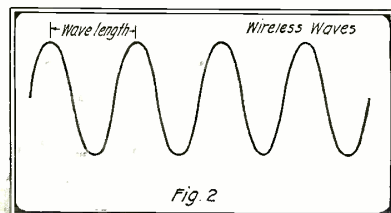

How the Wireless Wave-Length Is Measured.

waves form one large wave of a certain length. Fig. 3 shows clearly what takes place. It is evident from this that the number of waves sent out depends upon the number of oscillations per second; in other words, the frequency of the oscillations.

It has been discovered that wireless waves travel thru the ether at the same speed as light, 3,000,000,000 meters per second. We now begin to understand the relationship between the wave-length and the frequency, and we may make it much clearer by stating it as follows:

$$\text{Velocity of wireless waves} \\ (3,000,000,000 \text{ M})$$

$$\text{The Wavelength} = \frac{\text{The frequency of the oscillations.}}{\text{The frequency of the oscillations.}}$$

Here we see that in order to have the sending station and the receiving station in tune, they must both have the same frequency; just as the tuning forks mentioned in lesson one, must have the same number of vibrations per second or they will not respond to each other.

Suppose that a transmitting station were tuned to 5,000 meters; in order to have the receiving station pick up the signals, the latter would also have to be tuned to 5,000 meters. Now we would be justified

if we increase the length of the antenna, the condenser will discharge at a slower rate thus reducing the frequency and in-

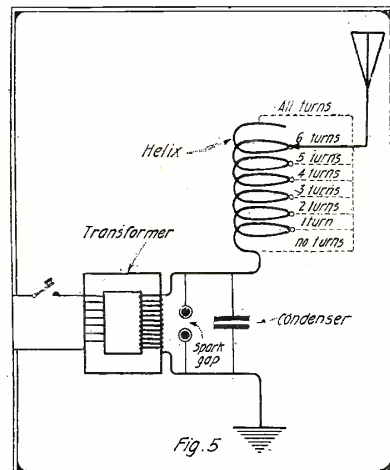

This Shows How the Tuning Coil Is Used to Increase or Decrease the Wave-Length.

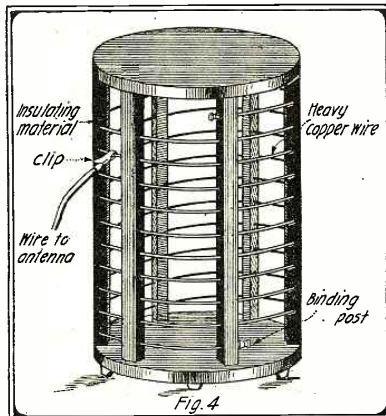

A Tuning Coil or Helix Used to Tune the Transmitting Circuit.

in saying that they were tuned to a frequency of 60,000 oscillations per second; however in spark transmitters and receivers, tuning is spoken of in terms of *wave-lengths*.

The next question which probably enters our mind is: How are these desired wave-lengths obtained? In other words, suppose the transmitting set when connected to the antenna is tuned to 1,000 meters and the desired wave-length is 5,000 meters; what can be done to tune the set to 5,000 meters? To lengthen the antenna would be one way of doing it. As we know the antenna and ground act as a capacity and

creasing the wave-length. This method is not always practical however. Of course we might increase the size of the condenser but that is also impractical. The device which has been designed to make tuning possible is known as a *tuning coil* or *helix*.

As used in common practice, the helix consists of a few turns of heavy copper wire wound on a frame of some insulating material as shown in Fig. 4. As the reader no doubt remembers, in his study of electricity, a helix or inductance has the property of storing up electrical energy in the form of electromagnetic lines of force, when an alternating or pulsating current is passed thru it. This causes the helix to have a reactionary effect when placed in an oscillatory circuit. The result is that the frequency is reduced and the wave-length is increased. We can readily see from this that if the number of turns in a helix are increased the wave-length is correspondingly increased as shown in Fig. 5.

Adding the helix to the transmitting circuit is equivalent to increasing the length of the antenna. This is true for as we have (Continued on page 322)

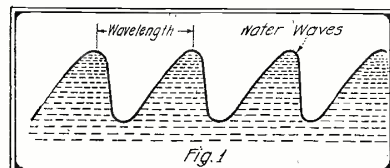

The Measurement of the Length of Water Waves.

**A SIMPLE DETECTOR.**

The material needed may be found in any electrical workshop. It consists of an old spark plug, telephone fuse, bind-

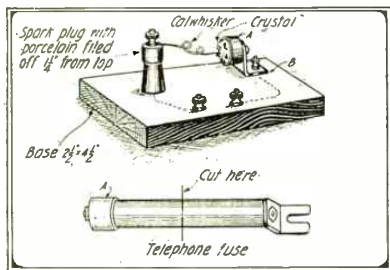

A Spark Plug and a Telephone Fuse Form This Detector.

ing posts from dry cells and a base. The cup holding the mineral may be rotated, raised or lowered. The dimensions and method of assembling are shown in the drawing. An ideal detector for all junior amateurs.—Contributed by CHAS. H. KRESSLER.

**EAVES-TROUGH FOR AN AERIAL.**

I just made my wireless set since the restriction has been taken off, and while putting up my aerial, I wondered how the eaves-trough would work as a substitute as it is about as high as my wire aerial. I discovered the trough went to the mouth of a tile but didn't come in contact with the ground. I connected a wire from the eaves to my instruments and found I could hear Arlington, Va., as plainly as with the wire



Here is a Stunt for Our Suburban Amateurs. aerial when I connected that in.—Contributed by MARSHALL DAVIES.

**LEARNING THE CODE.**

Many amateurs are hindered by not knowing the code. With this chart it may be overcome, for the amateur learns the code while receiving messages.

The chart is used in this method: The receiver hears a dash and immediately places his finger on one dash, which is followed by a dot. The receiver moves his finger one space in the direction indicated by the arrow marked "Dots." This in turn is followed by a dash and the finger is moved down a space; then comes the pause, which tells it is the end of the letter, which has proved to be "K."

This is for the Continental code, but one could be made for the Morse code if desired. — Contributed by JOHN H. PETH.

**A MAKESHIFT CODE TEACHER.**

The only practical way to learn the code is by the use of the omnigraph. This instrument costs so much that the amateur of average means does not have one. A method is described here for constructing a simple omnigraph out of a ten-cent phonograph record.

Drill very small holes as shown at A about 1/4" from edge and 1/8" apart all around the record gradually going in toward the center. After holes are drilled thread the dots and dashes up with number 22 bare copper wire, as shown in diagram at C. For a dot make the wire only cover one space as shown at A. For a dash cover two spaces as shown at B. Between every letter leave one hole. Between every word leave two. Connect wire at B to the center of disc. The diagram also shows a simple way of making an instrument to operate the record on. I is an arm, with a brass contact, that slides over the record and closes the circuit at intervals making dots and dashes. M is a small wooden box used as a case. B is a disc fastened on rod K

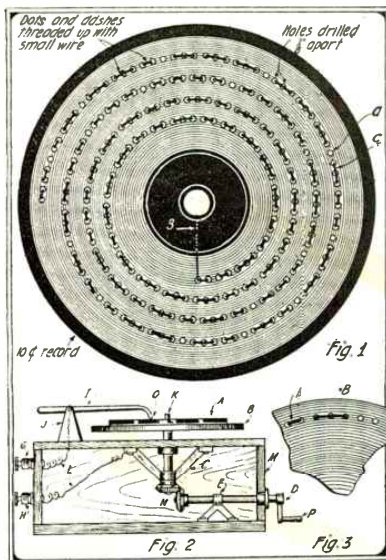

By Weaving the Wire Thru the Holes the Dots and Dashes Are Formed.

to lay the record on. The braces at C, E and F hold rods D and K.

Two small gears at N are used for turning the disc with the crank at P.

Wires are connected as shown from binding post G to rod J and from H to brace C.

This instrument when operated by the handle at P closes the circuit every time the contact O touches the wire on the record. It will be found that as the arm goes toward the center the message will be transmitted at a slower speed; therefore you should turn faster as you approach the center to keep a uniform speed. This instrument can be used to operate a spark coil, buzzer, sounder or anything that the experimenter wishes.—Contributed by ARNOLD BRILHART.

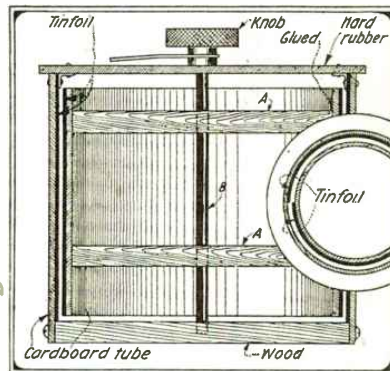

A Variable Condenser Easily Constructed.

**A SIMPLE VARIABLE CONDENSER.**

A variable condenser of the rotary type may be constructed by following the explanation and diagram given herewith. Tin foil is made fast half way around the inside of the larger tube and the outside of the smaller tube, as shown in the drawing. Two blocks of wood, "A" and "A" are glued to the inside of the smaller tube and a rod "B" is fitted tightly thru the center of both pieces. A scale is mounted on the top of the hard rubber top, adding to the appearance of the instrument. No dimensions are given, as the constructor may use those dimensions that best fit his requirements.

The instrument may be completed without any further explanation, as the diagram is self-evident.—Contributed by L. T. BEALL.

|      |   | LETTERS WHICH BEGIN WITH "DOT"  |   |   |   |   |
|------|---|---------------------------------|---|---|---|---|
|      |   | 1                               | 2 | 3 | 4 | 5 |
| DASH | 1 | E                               | I | S | H | 5 |
|      | 2 | A                               | R | L |   |   |
|      | 3 |                                 | U | F | 4 |   |
|      | 4 | W                               | P | 3 |   |   |
| DASH | 1 | J                               | 2 |   |   |   |
|      | 2 |                                 |   |   |   |   |
|      | 3 |                                 |   |   |   |   |
|      | 4 |                                 |   |   |   |   |
|      | 5 |                                 |   |   |   |   |
|      |   | LETTERS WHICH BEGIN WITH "DASH" |   |   |   |   |
|      |   | 1                               | 2 | 3 | 4 | 5 |
| DASH | 1 | T                               | N | D | B | 6 |
|      | 2 | M                               | K | C |   |   |
|      | 3 | O                               | Y | X | 7 |   |
|      | 4 |                                 | Q |   |   |   |
|      | 5 |                                 |   |   |   |   |

Your Troubles Will Cease If You Use This Chart in Learning the Codes.



**High Power Arc Signaling.**  
(No. 1,300,157, issued to Leonard F. Fuller.)

This invention relates to transmission systems of radiotelegraphy and particularly to a means of signaling. An object of the invention is to provide a signaling system for high power

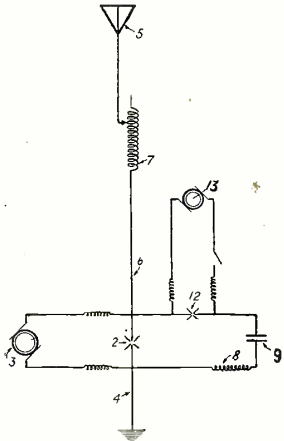

ered arc transmission stations. In the drawing diagrammatically one form of transmission system is shown. The system includes a suitable source of oscillations, preferably continuous oscillations, such as the arc 2 which is inclosed in a hydrogen atmosphere. Current is furnished to the arc by a direct current generator 3. One side of the arc is grounded by the conductor 4 and the other side is connected to the radiating conductor or antenna 5, through the inductance 7. Signaling has heretofore frequently been effected by varying the wave length of the radiated wave, by short-circuiting a portion of the inductance, but in high powered stations the current in the short circuit is large, making signaling difficult.

**Radio Frequency Interference Balance.**

(No. 1,309,400, issued to L. Espenschied.)

The object of this invention is to provide a receiving system which is free from interference, particularly that due to static disturbance, and at the same time efficient in the reception of continuous waves of the frequency to which said system is tuned. No attempt is made to tune out the interference known as "static" but an auxiliary system is provided whose function is, in cooperation with the receiving system, to balance out or neutralize static disturbances with respect to the

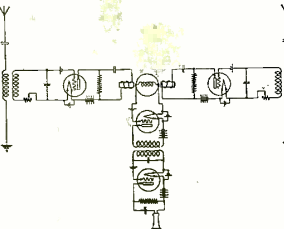

receiving device. The auxiliary system is tuned to a frequency differing from that to which the re-

ceiving system is tuned and is therefore unresponsive to the continuous waves it is desired to receive. The natural oscillations excited by static disturbances in the receiving and auxiliary systems are therefore of different frequencies. For this reason a frequency converting device is provided to convert the frequency of the oscillations in the auxiliary system to equality with that of the oscillations in the receiving system and differentially combine the resultant oscillations with respect to the receiving device. A further feature of the invention consists in providing an auxiliary system whose characteristic damping factor is the same as that of the receiving system.

**Receiver for Wireless Signals.**

(No. 1,301,246, issued to Charles Samuel Franklin.)

In receivers based on the interference principle it is usual to employ a local oscillator which can be so adjusted as to produce oscillations differing in frequency by a desired amount from the oscillations produced in the receiver by the incoming waves.

The result is that during reception there are in the receiving circuits two sets of oscillations which interact with each other, producing a compound oscillation of varying amplitude.

The receiver usually rectifies this compound oscillation into a unidirectional current of varying strength and so produces in the

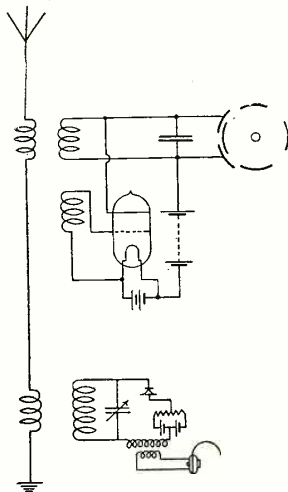

receiving telephone a note, the constancy of which depends upon the constancy of the frequency of the received and local oscillations.

Assuming 30,000,000 to be the frequency received, then the local oscillator must give a frequency of 30,001,000 or 29,999,000, in order to give an interference note of 1,000.

Practically when working with frequencies of this order the interference note varies so rapidly and to such an extent with the small variations of frequency which take place that the signals are unreadable.

According to this invention, the frequency of the local oscillations is varied by a small percentage, regularly and in a continuous manner. This may be done by arranging in the local generator a condenser which consists partly of segments arranged on a rotating disk or cylinder, so that the capacity varies continually between two limits.

**Wave Meter.**  
(No. 1,305,202, issued to H. P. Donle.)

This invention relates to so-called "wave meters" for oscillation circuits and the invention has for its objects to provide simple and effective means for generating or setting up oscillations of definite measured wave lengths.

A special object is to make the meter in as compact form as possible

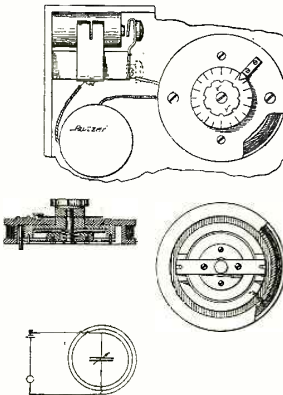

sible so that it may be readily associated with a portable radio set.

Another object is to make the inductance and the capacity of the meter in compact form, occupying but little space and so combined that the two may be handled and treated as a single unit.

Briefly described, the inductance and the capacity are combined by mounting the capacity within a hollow support and mounting the inductance in the form of a coil wound upon said hollow support. This combined inductance-capacity unit is usually connected with a buzzer and suitable current source such as a dry cell or the like, with a switch connected for making and breaking the circuit.

Another feature of the invention is a special form of switch key arranged to directly engage with one element of the cell or battery furnishing the electromotive force.

**Electrical Signaling.**

(No. 1,313,070, issued to L. Cohen.)

The object of this invention is to eliminate electro-static disturbances and interferences in the reception of radio signals, and thus improve the clearness and accuracy in radio communication.

In carrying out the invention, the currents of the disturbances foreign to the signal desired to be received, are transformed into two currents of substantially equal magnitude and delivered to the indicating device as currents of opposite sign, through two circuits, one of which is rendered

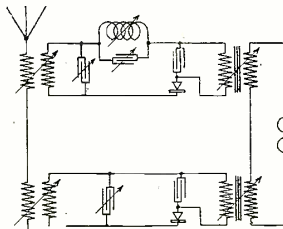

opaque to the current of the signal to be received, preferably by

introducing into it a loop circuit tuned to the frequency of such current, so that the current of said signal will be delivered only through the other of said circuits. In accomplishing this there may be employed two antennae, each with a separate receiving equipment coupled thereto; or a single antenna with two receiving equipments; or one antenna with one receiving equipment and two separate detector circuits associated with the receiving equipment.

**Sender for Hertzian Waves.**

(No. 1,302,129, issued to Victor Bouchardon.)

This invention is characterized by the use of a single high-frequency transformer whose secondary circuit is inserted in the antenna and whose primary circuit is connected with the capacity to be discharged by a special rotary spark gap.

This spark gap is constructed in such a manner that each condenser of the polygon has as many discharges per second as the alternator has alternations. The total number of discharges per second is therefore equal to twice the product of the number of cycles by the number of phases.

The invention permits of obtaining a musical emission with alternators of rather low periodicity which are easily found in the market and which have a greater efficiency than the single-phase generator of singing frequency (up to 2,000 periods) used at present.

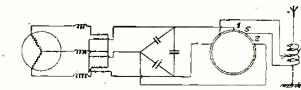

**Transmitting Device.**

(No. 1,299,823, issued to L. M. Cockaday.)

The invention relates to radiotelegraphy and it particularly relates to an apparatus and method whereby

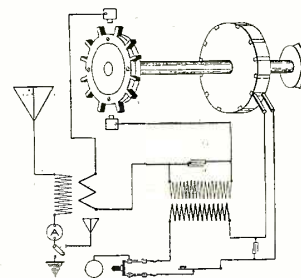

there can be produced high potential electrical oscillations from a direct current or other supply.

According to this invention there are three circuits employed: the power circuit, the closed circuit and the aerial circuit. The current source of energy (preferably direct current) is made and broken by an interrupter hereinafter described which controls the frequency of the applied current in the power circuit, thereby inducing in the closed circuit a series of high potential impacts which are uniformly spaced and separately stored up until discharged through a timing spark-gap device which controls the time of discharge of said impacts and as a result of these discharges energizing by induction the aerial circuit with a series of groups of high potential high frequency oscillations of decaying amplitude and causing wave trains to be emitted from the aerial in the form of Hertzian waves.



**T**HIS Department is conducted for the benefit of our Radio Experimenter. We shall be glad to answer here questions for the benefit of all, but we can only publish such matter of sufficient interest to all.

1. This Department cannot answer more than three questions for each correspondent.
2. Only one side of the sheet should be written upon; all matter should be typewritten or else written in ink. No attention paid to penciled matter.
3. Sketches, diagrams, etc., must be on separate sheets. This Department does not answer questions by mail free of charge.
4. Our Editors will be glad to answer any letter at the rate of 25c for each question. If, however, questions entail considerable research work, intricate calculations, patent research, etc., a special charge will be made. Before we answer such questions, correspondents will be informed as to the price charge.

You will do to the Editors a personal favor if you make your letter as brief as possible.

**WAVE LENGTH OF ANTENNA.**

(94) W. R. Morton, Bangor, Maine, asks:  
 Will you please publish the following questions and answers for me?  
 Q. 1. What is the approximate wave length of my aerial composed of 4 antennae wires. (See inclosed diagram).

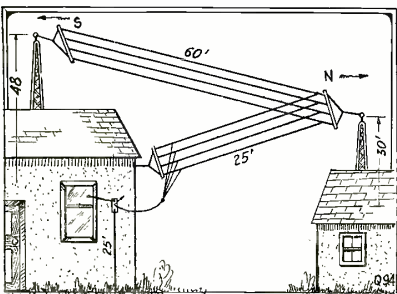

Showing Wave Length of Special Type Antenna.

Q. 2. Would a V.C. of .001 work better than .0005 shunted across secondary of 2,500 meter coupler.  
 Q. 3. What is the smallest amount of B. battery voltage that Marconi Moorhead "A" V.T. will work on as a detector?  
 A. 1. 200 meters.  
 A. 2. Yes, .001 would give you greater maximum wave length.  
 A. 3. About 40 volts is the average, but this differs with various tubes.

**HOOK-UP.**

(95) John Harmon, Cleveland, Ohio, wants to know:  
 Q. 1. The wave length of four single slide tuners 3"x17" wound with No. 24 S.C.C. wire.  
 Q. 2. The wave length of an aerial 75 ft. long and 35 ft. high?  
 Q. 3. Give me a hook-up for the coils used with the following: 1 43-plate V.C., 1

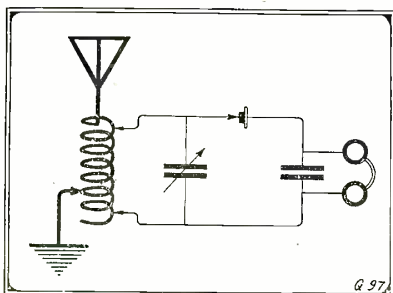

Simple Three-Slide Tuner Hook-Up.

fixed con. galena and silicon detectors, two-point switch for same and 2,000 ohm. head set.  
 A. 1. About 3,500 meters, each.  
 A. 2. 190 meters if there are four wires. You did not state the number of wires.  
 A. 3. Hook-up is given below.

**HOOK-UP.**

(96) Roy E. Robbins, Hamden, Ohio, desires to know:

Q. 1. Please give me best hook-up for loose coupler, variable condenser, fixed condenser, galena detector, phones, and audiotron detector, including A and B batteries, etc.  
 Using the detectors separate, but having it so arranged that the crystal or audiotron detector can be thrown into use by switches.  
 Q. 2. What would be the distance that I could receive with the above named instruments and an aerial 100 feet long and 30 feet high?  
 A. 1. The circuit you desire is shown below.  
 A. 2. About 500 miles.

**VARIABLE CONDENSER.**

(97) C. F. Ginnisman, Hillsdale, Maryland, asks:  
 Q. 1. Please give hook-up for the following:  
 1 three (3) slide tuner.  
 1 fixed condenser.  
 1 Galena Detector.  
 1 pair of phones (3,000 ohms).  
 2. What would be the receiving range of the instruments I described?  
 3. Would a variable condenser be of any help to me? If so, please put it in the sketch.  
 A. 1. Hook-up is herewith given.  
 A. 2. How can we tell your receiving range without knowing what size antenna you are employing?  
 A. 3. Yes.

**CISTERN FOR GROUND.**

(98) Scott Wilson, Primghar, Iowa, wants to know:  
 Q. 1. Can I use a trick cement cistern for a wireless ground?  
 Q. 2. Range of following receiving instruments used with a four-wire aerial, 35 ft. high and 100 ft. long.

Mignon Receiving Cabinet, Type R C 1 3,500 meters.  
 Brandes 2,000-ohm receivers.  
 Crystal detector, Type O, or a good galena detector.  
 "Electro" fixed-variable condenser.  
 A. 1. We cannot understand what you mean by employing a brick-cement cistern for a ground, unless the cistern is actually ground, by contact with the water. Not knowing the exact condition we would advise you to make use of your water works if you have same, or drive a length of pipe

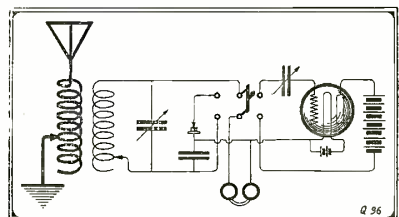

Hook-Up for Changing from Crystal to Audiotron.

into the earth and solder a connection thereto.  
 A. 2. About 1,000 miles.

**LOOSE COUPLER.**

(99) R. Euchenhofer, Dayton, Ohio, asks the following:  
 Q. 1. What number of wire should be used on the primary and secondary of a loose coupler whose primary tube is four inches in diameter and ten inches long. The secondary tube is same length and three inches in diameter?  
 Q. 2. What is the approximate range of this coupler with a galena detector and a three wire aerial a hundred and twenty feet long and thirty-five feet high?  
 A. 1. On primary No. 24 SCC; on secondary No. 32 SCC.  
 A. 2. About 400 miles day work.

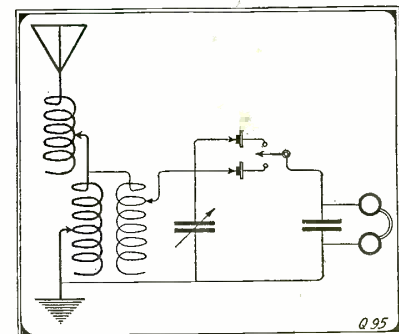

Hook-Up for Using Two Detectors.



**WAVELENGTH OF ANTENNA.**

(100) Russell Kurtz, Lorain, Ohio, asks the following:

I would like to know the following:

Q. 1. The natural wave length of an aerial consisting of one wire 285 feet long,

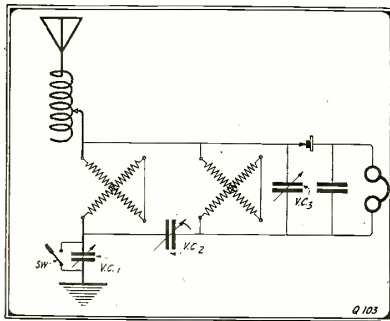

Special Hook-Up Using Two Variometers.

stretching from the top of a 150-foot brick chimney down to the ground.

Q. 2. Whether all aerials having different numbers of strands and located at the same height, but whose total length of wire is the same in all cases; have the same wave length and same receiving powers.

A. 1. About three hundred meters.

A. 2. This varies to some degree. Space would not permit a general discussion. However, you are referred to Dr. Fleming's works, "The Principles of Electric Wave Telegraphy and Telephony."

**AUDION HOOK-UP.**

(101) W. J. C., of Toronto, Canada, asks:

Q. 1. What is the wavelength of my aerial, which is 42 feet long and 26 feet high, consisting of three wires with a lead-in 8 feet long?

Q. 2. What would be the maximum wavelength and receiving range using this aerial with the set described on page 63 of the August issue of the R. A. N.?

Q. 3. Could the hookup of this set be changed to use an audion detector also?

A. 1. Approximately 90 meters.

A. 2. About 500 miles day work.

A. 3. Yes. Any of the usual audion circuits can be applied in connection with this receiver.

**PICKARD PHONES.**

(102) Jos. A. Smith, of Turtle Creek, Pa., wants to know the following:

Q. 1. Would like to know anything that can be told concerning the comparative standing of Pickard and Gebas Phones (French) of 4,000 ohms resistance each?

Q. 2. Hook-up for following: 3-slide tuner, Murdock 43-plate variable, silicon detector, fixed condenser—4 plates 2 in. x 3 in. in paraffine wax and above phones?

Q. 3. Wave length of above instruments when tuner is 2½ in. in diameter, wound 7 in., wound 36 turns to the inch, used with 210 feet flat top single wire aerial 25 feet above ground at both ends?

A. 1. We have no comparative measurements relative to the most sensitive. However, it can be stated that the Pickard phones rank amongst the best manufactured.

A. 2. See Question 97.  
A. 3. You could probably reach up to 4,000 meters with the antenna and apparatus described.

**TREE ANTENNA.**

(103) J. J. Zimmerman, Lakewood, Ohio, asks:

Q. 1. The hook-up for the following instruments: Three variable condensers; two variometers; one varicoupler; crystal detector; 2,000-ohm phones; Murdock loading inductance.

Q. 2. What would the wave length of such a set be?

Q. 3. Can a tree antenna be used with such a set?

A. 1. Hook-up is given herewith.

A. 2. We certainly cannot answer this when you have not furnished the dimensions of the coils.

A. 3. Yes, but it will be necessary to substitute an audion for your crystal detector shown and perhaps a two-step amplifier in order to receive from any distance. This method of reception is very inefficient.

**BENSON'S RECEIVING CABINET.**

(104) Albert Clement, Natrona, Pa., wants to be advised on the following:

Q. 1. Can the receiving cabinet described

**Radio Articles in  
December Issue  
Electrical Experimenter**

*The Carnarvon Station.*

*(Illustrated with special photo.)*

*G. E. Photron Tube Sets.*

*Locating Submarines by Radio  
Symphoning, by E. T. Jones.*

*Calculation of Tree Wave Lengths,  
by A. N. Tennant.*

*Marconi Collapsible Radio Masts.*

*With the usual constructional  
articles and wrinkles.*

by T. Benson in the September RADIO AMATEUR NEWS be used with loop aerial described in August *Electrical Experimenter* as a complete receiving apparatus?

Q. 2. Give diagram for connection of instruments in cabinet to the best advantage.

Q. 3. Give the approximate range of apparatus.

A. 1. Yes; however, you will do better by using the loop as the secondary of your coupler. See article by David S. Brown, in August RADIO NEWS for loop circuits.

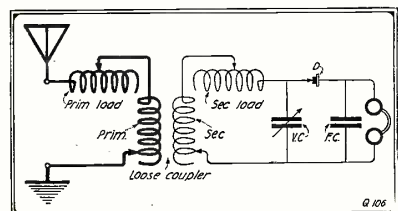

Showing the Use of a Primary and a Secondary Load.

A. 2. Diagrams are given with the article and have been found to furnish the best results.

A. 3. This depends on the type of detector employed, whether an audion or crystal detector and the antenna.

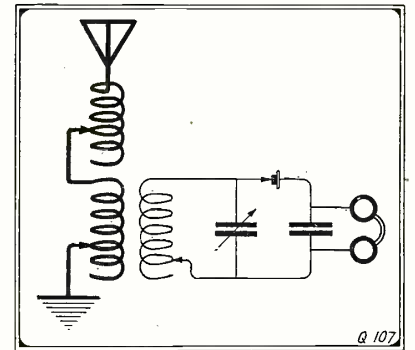

Method of Connecting 8,500 Meter Coupler.

**RECEIVING SET.**

(105) Ross Baxter, Binghamton, N. Y., asks the following:

Q. 1. What would the maximum distance and wavelength of a set consisting of the following apparatus and connected as per diagram: 1 loose coupler with a primary 5 in. in diam. and wound for 11 in. with No. 24 enamel covered wire and whose secondary is 4 in. in diam. and wound with No. 30 D. C. C. wire, an aerial 150 feet long, consisting of 2 wires, a crystal detector, Murdock fixed tel. condenser and 1,000-ohm head set?

A. 1. Wave lengths up to approximately 5,000 meters could be obtained with this set as described. The range would probably exceed five hundred miles during the day, and from three to four times that distance at night.

**INCREASED RANGE.**

(106) Burton W. Depue, Chicago, Ill., wishes to know the following:

Q. 1. What is the receiving range of my set? It contains one loose-coupler of 1,200 meters, one fixed condenser, one 500-meter loading coil, one galena detector and a pair of 2,000-ohm phones, using a single strand indoor aerial 35 feet high and 210 feet long.

Q. 2. How much would the receiving range be increased if I added one 2,400-meter loading coil and one variable condenser?

Q. 3. Please give me a good hook-up for the loose coupler, fixed and variable condensers, two loading coils, galena detector and 2,000-ohm phones.

A. 1. You should be able to receive up to distances of approximately five hundred miles.

A. 2. Your receiving range would be increased considerably for the following reasons: Only stations working on longer wavelengths employ a greater amount of transmitting energy, therefore you would be in a position to pick up stations at a greater distance than at present.

A. 3. Hook-up is given herewith.

(Continued on page 322)

# MURDOCK

## No. 55

### RADIO RECEIVERS

2000 OHM  
COMPLETE  
DOUBLE SET

**\$4.50**



3000 OHM  
COMPLETE  
DOUBLE SET

**\$5.50**



Variable Condenser No. 368, .0005 mfd. \$3.75



Fixed Condenser, No. 358 \$0.70

### MURDOCK APPARATUS

combines the desirable qualities of good design, excellent materials, and efficient operation to an unusually high degree.

Moreover, it is priced so reasonably that it gives the experimenter the "most for his money."

A copy of our latest bulletin will be sent free to those interested in good apparatus.



Variable Condenser No. 366, .001 mfd. \$4.75

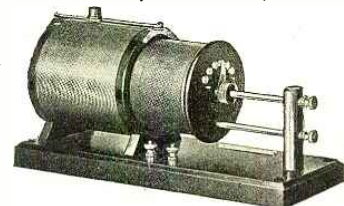

Receiving Transformer No. 344 \$9.00

## WM. J. MURDOCK COMPANY

50 Carter Street  
CHELSEA, MASS.

509 Mission Street  
SAN FRANCISCO

**WIRELESS APPARATUS**



**Make Your Own—SAVE 1/2**

It's easy to make your own at home with the aid of these 4 up-to-date books that you can understand. Each has over 72 pages and over 60 illustrations, 3 color cover, size 5 x 7 inches.

**LESSONS IN WIRELESS TELEGRAPHY** is a course in the elementary principles which you must understand to obtain good results. **WIRELESS CONSTRUCTION AND INSTALLATION FOR BEGINNERS** gives complete details with working drawings for making simple but good sending and receiving apparatus and erecting aerials, etc.

**THE OPERATION OF WIRELESS TELEGRAPH APPARATUS** shows how to obtain best results and greatest ranges with all kinds of apparatus, how to tune the station to 200 meters, use a wave meter, apply for license, etc.

**EXPERIMENTAL WIRELESS CONSTRUCTION** gives details with working drawings for making more elaborate and efficient sending and receiving apparatus, complete sets, etc.

Price 30 cents each, postpaid—\$1.20 the set. Less than the price of one telephone receiver. Order now while the supply lasts.

**COLE & MORGAN, Inc., Publishers**  
Dept. 2, 19 Park Place, New York

**LEARN THE AUTOMOBILE BUSINESS**

Great opportunities for trained men as Motor Experts, Shop Foremen, Licensed Chauffeurs, or in business for yourself.

**YOU CAN EARN \$100 to \$400 Per Month**

You learn here by putting on overalls and doing the actual work, under expert instructors. By this method you cannot fail. If you have yearned for a future where you can make big money—here it is.

Write TODAY for information  
**BUFFALO AUTO SCHOOL**  
Dept. 26 Buffalo, N. Y.

**POPULARITY FOLLOWS THE UKULELE**

If you play quaint, dreamy Hawaiian music or latest songs on the Ukulele you will be wanted everywhere. We teach by means of simple lessons; give you free a genuine Hawaiian Ukulele, music, everything no extra. Ask us to send the story of Hawaiian music. You will love it. No obligation—absolutely free.

The Hawaiian Institute of Music  
1400 Broadway, Dept. 131, New York

**Underground Radio Made Possible for the Amateur**

By EDWARD T. JONES  
(Continued from page 275)

The foregoing experiments proved beyond a doubt the value of such concentrated antennae for underground reception, and the following summary can be drawn:

1. The length of wire having serious and detrimental effects, when longer than 2000 feet, can in this manner be concentrated and will furnish the same results, if not better, in respect to signal-static ratio. Since the coils need not occupy more than a reasonable amount of space, at any rate for long waves 1/100 that necessary when employing the wires stretched to their full length, as in the Rogers system, is sufficient.
2. That practically the same signal strength is received in these tests as was had when employing the outstretched wires and the static was reduced.
3. In this short space of time the foregoing experiments were the only ones that could be tested thoroly; but it is needless to say that this is only a beginning of this new type of antenna in connection with underground reception, which will undoubtedly save thousands of dollars at each initial installation.
4. The coils themselves, being so small, could be easily encased in some form of insulating tube and finally set in a concrete casing which would undoubtedly increase the life of the coils.
5. The coils could be enclosed on the surface of the earth by large tanks which in turn must be grounded to act as the shield. In this manner it would be possible to construct large coils which could be rotated at any angle desired and thereby cause maximum reception from various directions. The coils could be rotated by motors and at the will of the receiving operator, or they may be buried and caused to rotate in the same manner described

above. In this case they would have to be installed in a concrete cellar built under the ground.

Some further experiments which were carried out using the same principle were tried later. The coils employed in this series of tests are shown in the photograph where the author and inventor is seen standing between the two coils.

With these coils laid in the earth or in the water very good results were obtained, and pointing the coils towards or away from any given transmitter did not change the strength of its signal to any noticeable extent. However, it is believed that were the coils constructed at greater lengths, directional effects would be present.

These coils were laid in holes dug in the ground, then water was pumped into the holes by means of a hose. This maintained the coils under the water at all times and permitted such tests as were necessary to ascertain whether or not they possess directional properties. However, no directional effects were present, so the coils were then discontinued and square frame coils were used in their place.

Experiments were carried out with large square framed coils (two hundred feet to the turn, or fifty feet to each side of the square) laid upon the ground. This was tried for long wave undamp reception and exceptional results were had when the ground was wet, immediately after a good rain, for then the wires were practically buried. However, when the ground dried out, the signals vanished and were not received with a readable audibility. It was only necessary to have these coils buried in moist earth and excellent results have been obtained. Receiving on underground from short wavelengths with long outstretched wires demands a critical length of the wire. However on a loop or concentrated open ended coil such as mine, the length does not materially affect such reception until the length exceeds 500 feet to the coil.

Now all ye Amateurs get busy and dig those four-foot holes until permanent moist earth is assured and place your little coils some fifty feet apart, hook her up, and

| Time       | Station                    | Remarks                                                |
|------------|----------------------------|--------------------------------------------------------|
| 12:05 P.M. | SS. Chalmette.....         | Noon, 144 miles southeast of Southpass, Mississippi.   |
| 12:08 P.M. | SS. Geo. W. Barnes.....    | 225 West Sand Key (sending to Tampa).                  |
| 12:09 P.M. | Tampa, Florida.....        | Signals fair. A distance of approximately 500 miles.   |
| 12:10 P.M. | Port Arthur, Texas.....    | Signals good.                                          |
| 12:11 P.M. | (Ship sending to Key West) | Missed his sign—"152 miles north of Tortugas at noon." |
| 12:13 P.M. | KTH calls WPD.....         | They work.                                             |
| 12:14 P.M. | KUM to WUR.....            | Noon, SS. Texas, 148 miles southeast of Sabine Bar.    |
| 12:15 P.M. | SS. Nueces.....            | 494 miles southeast of Galveston, Texas.               |

**MASSACHUSETTS RADIO AND TELEGRAPH SCHOOL**  
RADIO AND TELEGRAPHY Day and Evening Classes  
18 Boylston Street Tel. 7168 Boston, Mass.

**ANOTHER NEW WILCOX SWITCH TYPE 103**

Two double blades on one knob, yet carefully insulated from each other. May be used for changing variable condenser from series to parallel with primary, for changing from crystal to audion detector and many similar purposes. 1 1/2" Radius. Polished brass Finish, 75c; Nickel Finish, 85c. Postpaid.

**BUILD YOUR OWN APPARATUS**

It will not be difficult and your work will have a uniform and beautiful appearance if you use WILCOX STANDARDIZED PARTS. Our switches have highly polished genuine hard rubber knobs, large brass bearings, shafts and adjustable tension springs.

**OUR NEW LOOSE LEAF CATALOG**  
describes our complete line of switches, panels, knobs, binding posts, variometer parts, etc. Sent for 5c in stamps.  
Reliable Dealers Wanted.

Dept. G LANSING, MICHIGAN

THE WILCOX LABORATORIES

there you are. . . . Underground at last in reach of the average Experimenter and Amateurs at large.

The Amateurs not only have my permission to use this system but are encouraged to do so. Any further information will be given upon receipt of query.

**TRANSMISSION OF POWER BY WIRELESS.**

Transmission of electrical power for driving machinery by means similar to that employed in wireless telegraphy has been announced after a series of experiments. The inventor is Dr. H. Barringer Cox of Los Angeles.

According to the scientist, he has succeeded in transmitting power in this manner over a distance of three miles. Revolution in present methods of power transmission is predicted by the inventor when the device is commercialized.

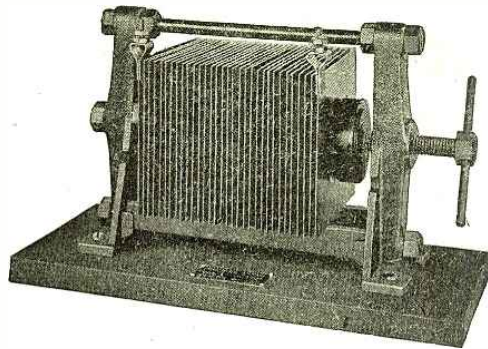

**AMRAD**  
Quenched Gap  
\$17.50

*Four times the energy in your antenna with 60 cycles and a low decrement besides*

Removal of the Government ban has brought with it more severe regulations than before on transmission. For every amateur who has a sending set, the

**“AMRAD”**  
**QUENCHED GAP**  
*is practically a necessity*

This Quenched Gap does not necessitate the use of a 500 cycle generator. Properly operated on a 60 cycle circuit, it will give a 240 spark note, with less than 0.2 decrement.

Full directions for obtaining the 240 spark note, together with pamphlet giving detailed specifications, will be sent gladly on request.

*Ask for bulletin No. 12*



**AMRAD**  
Detector Stand \$4.50

Duplex stand, with selecting switch and two binding posts.  
Single Stand \$2.50



**AMRAD**  
Lightning Switch \$11.50  
100 amperes, 500 volt single pole, double throw, mounted on three 40,000 volt Electro-seal insulators.

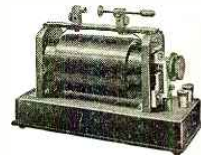

**AMRAD**  
Induction Coil \$28.50

A positively reliable coil for use where A. C. is not available.

**AMERICAN RADIO AND RESEARCH CORPORATION**

21 PARK ROW, NEW YORK, N. Y.

(Laboratory and Works at Medford Hillside, Mass.)

# RADIO AMATEURS!

"ACE" Radio Equipment is a line of professional quality. Comprises complete radio telegraphic and telephonic transmitting and receiving apparatus for any power or wave range. Also all accessories and parts.

- "ACE" Regenerative Receivers.
- "ACE" Audion Control Cabinets.
- UNDAMPED WAVE telegraph and telephone equipment for use with standard V. T. tubes.
- RECEIVING EQUIPMENT for any wave range.
- AUDION AMPLIFIERS using standard V. T. tubes.

We supply anything and everything the radio experimenter requires in wireless telegraphic and telephonic apparatus and build complete outfits to order. We do not furnish any cheap or competitive materials.

This "ACE" Regenerative Receiver enables the amateur to cover long distances with very small antenna. It is built of the very finest materials and like all "ACE" products has real professional quality.

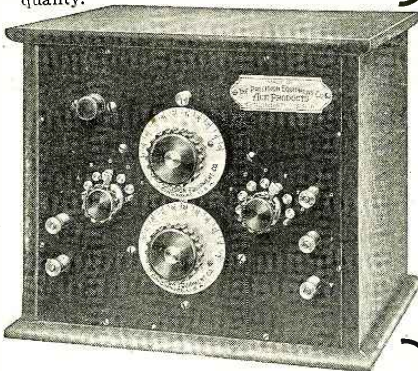

Manufacturers of "ACE" Products

THE PRECISION EQUIPMENT CO., 2437 Gilbert Avenue, Cincinnati, O.

## The Priess Loop Set

By WALTER J. HENRY

(Continued from page 270)

from the open air. Both sets were then placed in dugouts about 10 feet underground and 400 yards apart. Excellent audibility was obtained with only a portion of the available energy, and in addition it was found that the loops radiated sharply.

General E. Russell, Chief Signal Officer of the A. E. F., became interested in this new development and ordered the two sets taken to the front for trial. Reliable communication was shown between sets, in dugouts separated 6 kilometers, when using only 30 watts (with locked key). At 12 kilometers, with one set in a dugout and the other on the ground, good communication was established with the same power. Upon the enthusiastic recommendations of Capt. Robert Loghry, Chief Radio Officer of our army in the field at the time, and both the French and American Signal staffs, General Russell decided to base his entire front-line communication system on the Priess Loop Set. His plans called for the production of 6,000 of these sets by July 1, 1919, deliveries to be at the rate of 1,000 per month, beginning January, 1919.

Lieut. Priess was then sent to the United States to supervise the initial production of these sets and fifty-two days after his arrival three models had been constructed and were tested before General Squier and a number of Staff officers. Contiguously with the manufacture of the three model sets, the design and manufacture of tools for building the sets on the required production basis was carried on. The completed set weighed only 28 pounds including all the transmitting and receiving apparatus, the loop antenna, compass, telephones, tools and spares. The sets showed that with two or three sets above ground reliable communication was possible over a distance of thirteen miles.

The description of the transmitter in detail with wiring diagram will be given in the January issue of RADIO AMATEUR NEWS.

Photographs courtesy of the Wireless Specialty Apparatus Co.

## German Radio War Instruments

(Continued from page 271)

in the diagram has a diameter of 1 1/2 inches. This makes possible a finer adjustment of the tension vibrator wire. The stationary contact at the top is mounted on a stiff spring which is raised or lowered roughly by the set screw at the right. The precise adjustment of this contact is obtained by the movement of the large knob at the bottom. A stiff silver wire may be used for the vibrator contact. This wire is mounted diagonally on the thin sheet iron armature by fastening with solder at each end.

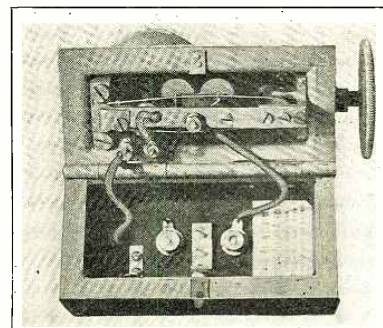

A German Buzzer Which Gives a Beautiful 600 Cycle Note.

## A Receiver that gets Results

Now that Uncle Sam has given us the long delayed "K", what about that long distance work you were going to do? Here's the receiver you've been dreaming about since 1917. Bring in strong signals from them all with a



Short-Wave Regenerative Receiver Type CR-4

Designed since the Armistice especially for long distance work on amateur wavelengths. Range, 170 to 580 meters. Comprises a highly developed circuit of the continuously variable inductance type; capacity effects and other losses reduced to an absolute minimum. A self-balanced variable condenser in the antenna circuit facilitates selective tuning. The mechanical design is characteristic of Grebe apparatus. Ask the fellows who are doing the phenomenal work these days, what they think of Grebe apparatus. Don't be deceived by inferior instruments that resemble Grebe workmanship. Send for free bulletin describing this and other Grebe models operating up to 20,000 meters;—complete catalogue, 10c.

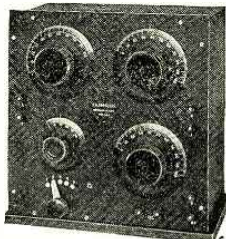

A. H. GREBE & CO., 72 Van Wyck Blvd., Richmond Hill, N. Y.

### 20,000 METER LONG WAVE TUNER

Diagram on bottom, involute coils machine wound that bear honeycombs. XDA comes in on tap No. 1, NSS on tap No. 4. 5 taps P&S. Tested on aerial 25 feet high, 40 feet long. All tuners weigh 2 pounds. No complicated tuning. Coils waxed in. Formica top, full nickel finish. Works through worst static. We satisfy you or return the money.

### 3,000 METER ARLINGTON TUNER

Amplifies NAA sigs 50 times. Tested on 25 foot aerial. Tested in Frisco and Davenport. Also gets all 4000 meter stations. 7 taps primary, 3 on tickler. Receives wireless phone calls.

### 200 METER REGENERATIVE TUNER

Very selective and amplifies sigs from 175 to 300 meters. Fine for RELAY work. Any of above tuner coils set in wax for mounting in cabinet \$10.00. All complete tuners \$15 each delivered to you.

Tuners licensed under Marconi Patent No. 763772.

### KNOCKED DOWN VARIABLE CONDENSERS

- 11 plate grid variable, capac., .00025MF .....\$1.75
- 21 plate Sec. variable, capac., .0005MF ..... 2.25
- 43 plate Pri. variable, capac., .001MF ..... 2.75

Packed in strong box with full directions for assembling. Formica tops, hard rubber knobs, complete with scale and pointer. Aluminum plates .015 thick. Agents and dealers wanted. Catalog free.

TRESCO, Davenport, Iowa

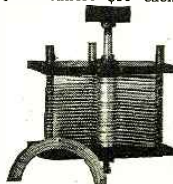

# Learn Wireless At Home

## The Demand for Wireless Operators Far Exceeds the Supply

The U. S. Wireless Institute will make you an operator—AT HOME—in your spare time—quickly, easily and thoroughly. No previous training or experience required. Our Home Study Course has been prepared by Radio Experts. Experts able to impart their practical and technical knowledge to YOU in an easy to understand way. The graded lessons mailed you will prove so fascinating that you will be eager for the next one. The instruments furnished free, will make it as easy to learn the Code as it was to learn to talk. *All you will have to do, is to listen.*

### BIG SALARIES

Wireless operators receive excellent salaries ranging from \$125 to \$200 a month and it is only a stepping stone to better positions. There is practically no limit to your earning power. Men who but yesterday were wireless operators are now holding positions as Radio Engineers, Radio Inspectors, Radio Salesmen at salaries up to \$5000 a year.

### Travel The World Over

A Wireless Operator can visit all parts of the world and receive fine pay and maintenance at the same time. Do you prefer a steady position without travel? There are many opportunities at the numerous land stations or with the Commercial Wireless or with the Steamship Companies.

### FREE Instruments and Text Books

We furnish free to all students, during the course, *the wonderful receiving and sending set exactly as produced in the illustration.* This set is not loaned but given to all students completing the Course.

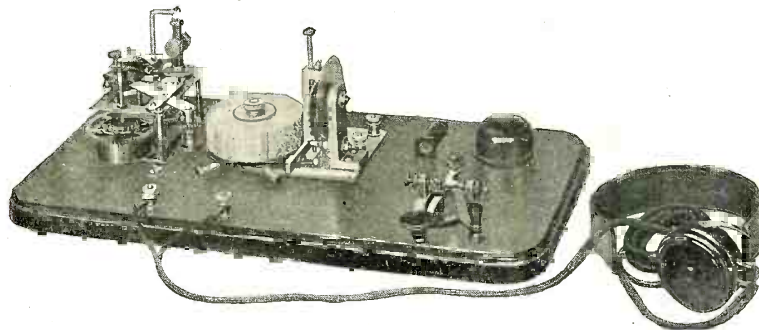

This wonderful Set for learning the Code furnished free with our Course

The Transmitter shown is the celebrated *Omnigraph* used by several Departments of the U. S. Government and by the leading Universities, Colleges, Technical and Telegraph Schools throughout the U. S. and Canada. Start the *Omnigraph*, place the phone to your ear and this remarkable invention will send you Wireless Messages, the same as though you were receiving them, through the air, from a Wireless Station hundreds of miles away.

When you apply for your license, the U. S. Government will test you with the *Omnigraph*—the same model *Omnigraph* as we furnish to our students. Ask any U. S. Radio Inspector to verify this.

#### FREE Post-Graduate Course

A one month's Post-Graduate Course, if you so desire, at one of the largest Wireless Schools in N. Y. City. New York—the Wonder City—the largest port in the World and the Headquarters of every leading Wireless and Steamship Company.

#### Easy Payments

A small payment down will enroll you. We will make the payments so easy that anyone ambitious to enter the fastest growing profession—Wireless—may do so.

#### Send For FREE Booklet

Without obligating you in any way, send for our booklet "How to become an Expert Wireless Operator"—it is free. Mail the coupon below, or postal or letter—but do it to-day.

#### U. S. WIRELESS INSTITUTE

Dept. 41, 258 Broadway, New York City.

Send me free of charge, your booklet "How to become an Expert Wireless Operator," containing full particulars of your Course including your *Free Instrument offer.*

Name .....

Address .....

City or Town.....State.....

# Mesco Radio Buzzer

**With Shunt Resistance—  
U. S. Navy and U. S. Army  
Standard.**

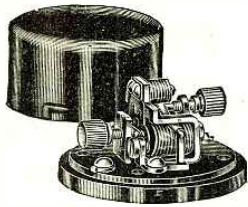

The Radio Officers of the NC planes, after testing all other buzzers, decided to use the "Mesco" on their radio equipment. The R-34 was equipped with two of them.

Why? Because of its reliability and constancy in operation; greater output efficiency; ease of adjustment; unaffected by extreme variations in weather conditions; exposed wire eliminated.

Sparking is almost entirely eliminated, so that the energy lost in light and heat in the operation of other buzzers is here conserved and radiated in the form of oscillating energy.

This buzzer maintains a constant note and is recommended as an exciter for checking wavemeters where pure note and ample energy are required.

List No. 55. Mesco Radio Buzzer. Price...\$2.05

We carry a very large and complete line of standard wireless apparatus and solicit your inquiries. Wireless experts in all of our stores.

**Send for the New Edition of Our  
Catalog M 29**

It is pocket size, contains 264 pages, with over 1,000 illustrations, and describes in plain, clear language all about Bells, Push Buttons, Batteries, Telephone and Telegraph Material, Electric Toys, Burglar and Fire Alarm Contrivances, Electric Call Bells, Medical Batteries, Electrically Heated Apparatus, Battery Connectors, Switches, Battery Gauges, Wireless Telegraph Instruments, Ignition Supplies, etc.

IT MEANS MONEY SAVED TO YOU  
to have our Catalog when you want to buy.

**Manhattan Electrical Supply Co., Inc.**

New York: Chicago: St. Louis:  
17 Park Place 114 S. Wells St. 1106 Pine St.  
San Francisco Office: 604 Mission St.

**The Radio Engineering Company**  
MANUFACTURERS OF



"RADIO APPARATUS"

Beg to announce their reorganization and the opening of a show room and distribution center FOR THE SOUTH, of all standard radio apparatus.

The famous

"RECO" KEY

reduced for a short time to \$6.50. Six cents in stamps will bring our new and revised catalog now on the press.

Note New Address:

**827 Madison Ave., Baltimore, Md.**  
CALL 3 EM

## GLIDE "O" PLANE

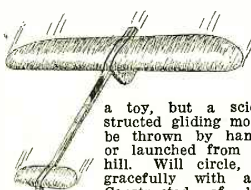

Learn the principles of Aviation by flying our famous glide O plane. Not

a toy, but a scientifically constructed gliding model, which may be thrown by hand on the field or launched from the top of the hill. Will circle, loop and glide gracefully with a light throw.

Constructed of best materials, finished in Bright colors with the insignia of the U. S. Army on the Main Plane. Very durable and easy to fly. All wood, adjustable. Price 55c Postpaid in U. S. Send for catalogue H3.  
HEC Aeroplane Co., 345 E. 49th St., New York City

READ THE CLASSIFIED ADVERTISEMENTS ON PAGES 324-326

Any amateur constructing a wavemeter or a crystal receiver will find a buzzer of this type extremely efficient.

\*(We are indebted to Mr. Geo. L. Emmons, a commercial operator, for the loan of the apparatus used in preparing this article.)

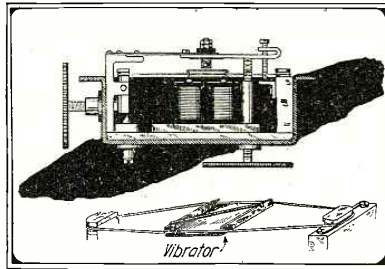

Constructional Details of the Buzzer.

## An Ideal Receiving Set

[By RALPH E. SMITH]

(Continued from page 280)

single battery encased in the cabinet. A push button is provided for a quick test, but if the buzzer is to operate continuously for a moment or two, a small snap switch is also provided.

With this set using the galena detector, I can hear N. N. A. in the day time without an amplifier. My aerial is fifty feet high, one hundred feet long and fifteen feet wide. The wire used is No. 16 B. & S. bare copper and spaced five feet apart. The poles are two by four bolted together and guyed.

With this set using the audion no difficulty is encountered in receiving Arlington, Tuckerton, Sayville, Darien and many others. Ships one thousand miles from here (Galveston, Tex.), have been picked up. Many nights I have heard as many as ten different stations coming in at the same time. Wireless telephone messages have also been picked up. Many times I have heard wireless telephone messages from destroyers in the Gulf waters.

## Hand Wound Honeycomb Coils

By C. R. DUNN

(Continued from page 285)

brad and continue along line to brad Number 2 in row "A"; to Number 17 in row "B" then to brad Number 3 in row "A," and so on to finish of coil. Drop out a 6-inch tap every three layers for first four taps, then four layers for each of five succeeding taps. The complete coil will have thirty-four layers of wire, and each layer should be laid exactly over the turn in the preceding layer. Stagger the taps one brad each, that is, Number 1 tap is the start of the winding at brad Number 1; Number 2 tap is taken off brad Number 2; Number 3 tap off brad Number 3, etc.

After each tap is taken off the coil should be shellacked with a *very thin* coat of white shellac. When winding is complete shellac the entire coil and allow to dry hard, then draw out the brads and slide the coil off the jig. In making all future coils use tube sections one inch wide and use same brad holes for brads. The winding of first coil will give a good idea of spacing to use and any pin can be Number 1. If a larger coil is needed it will be found that by drawing brads out a short way at a time any number of layers can be wound.

The plate coil is wound in the same manner, but there should be only fifteen brads in each row and the tube section should only be 1/2 inch wide. Slip a 1/2-inch section of tube over jig and place a brad in every other mark in row "B." Push section of tube down against this row of brads and drive a row of fifteen more on opposite edge of tube, each one directly opposite the brad in row "B." Start at a brad in row "A," call this brad Number 1, then count to brad 8 in row "B," then to Number 2 brad in row "A" and so on as before. Have the same number of layers as in preceding coils but do not take out any taps. This coil will have approximately one quarter the amount of inductance as the first two coils and is to be used as a plate coil for undamp signals.

Two ten-point dead end switches should be used with these coils and they can be mounted to suit the individual taste. It will be found that the mounting of the coils can be better arranged if one coil has all the taps taken off row "A" and the taps for the other coil from row "B." In this way the switches can be on opposite sides of a panel and the coils can be arranged to tap directly to switch points, making the leads short as possible and keep the direction of winding in both coils the same.

## The New Brunswick Radio Station

(Continued from page 276)

shunted across the alternator while the third winding is connected in series with a source of direct current and a variable resistance. The photograph shows the top of the amplifier which is used with the 200 K.W. alternator.

The tuning inductance which is shown in the photograph is used in the trans-oceanic communication. When we consider that "NFF" transmits on a wavelength of 13,600 meters, the reason for using such a gigantic coil is readily understood.

## The Construction of an Audion Cabinet

By G. L. WESTON

(Continued from page 284)

can be done by cutting a hole slightly larger than the bulb, and mounting the base on the back of the panel, so that when the bulb is inserted in the base the top of it will come through the hole in the panel. With this type of bulb it is not necessary to use a potentiometer, so it may be omitted. If a V. T. is used only 6 to 8 flashlight batteries are required, as the standard plate voltage of one of these bulbs when it is used as a detector is 22.5 volts.

## PLACE A SILVELL DETECTOR SPRING

on your mineral detector and note the decided improvement in signals received. Adjustable to any detector. Set of six mailed on receipt of \$1. Satisfaction or money refunded.

E. S. LINDMARK,

215 Avenue F,

Brooklyn, N. Y.

## AMATEURS

RECEIVING OUTFITS AND INSTRUMENTS

Complete Tuning Coil Receiving Set \$4.00

Send stamp for descriptive literature

MAYMIN RADIO MFG. CO.

1845 E. Twelfth Street

Brooklyn, N. Y.

# The Guaranteed "Better Quality" B-Batteries

The Only Genuine and Original B-Batteries that the Signal Corps, U. S. Army and Navy Use

## COMPARISON

The "BETTER QUALITY" B-Batteries are the very latest development in B-Batteries of extreme qualities. Comparative tests within the last few months—not ancient tests which are valueless in view of the rapid developments in radio telegraphy—prove that the "BETTER QUALITY" B-Batteries are at least 100% more serviceable than any other B-Battery—without exception.

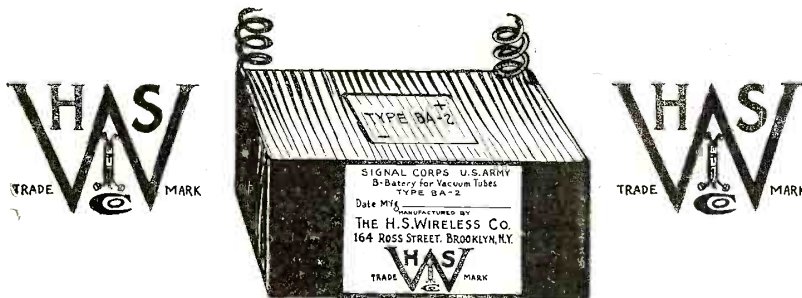

## MAKE ECONOMY AND COMPARISON

The "BETTER QUALITY" B-Batteries are made from pure zinc. It differs from other B-Batteries that are made from tin or other quick chemical eating metals. Other B-Batteries that show high amperage cannot last long on account of the action of the acid contained in other B-Batteries. In other words, to increase the amperage, the battery must have more acid. Therefore, the more acid there is in a Battery the quicker the metal is eaten by the chemical action caused by the acid.

The "BETTER QUALITY" B-Batteries are made according to a formula of a chemist who has tried various means in his laboratory in making B-Batteries of better quality. At last he has succeeded and now we can put it up to the public for inspection. Our "BETTER QUALITY" B-Batteries are not in the least a new thing. They are the same that were used by our own government and in other foreign countries: Our "BETTER QUALITY" B-Batteries are made according to the Government and Bureau of Steam Engineering specifications.

## ADVANTAGE, DISADVANTAGE, ECONOMY AND COMPARISON

Our "BETTER QUALITY" B-Batteries are best for Vacuum Tube transmission and reception. All the cells contained in our "BETTER QUALITY" B-Batteries have their amperage all alike. That is: when you are using our "BETTER QUALITY" B-Batteries through a potentiometer (instead of having a B-Battery that has been tapped and connected to a switch) you are not only getting variable voltage but you are also using all the cells contained in our "BETTER QUALITY" B-Batteries uniformly. Therefore the result is: One cell cannot go "bad" if the others are good. But on the other hand when the B-Battery is tapped in order to get critical plate voltage you are only using a certain amount of cells mostly and then if you would want to have the entire B-Battery in circuit you would notice that the amperage of the entire B-Battery has decreased to the amperage of the cells that you have used the most. Therefore you would not have enough power in the B-Battery for the plate potential if you would need it just at a certain time. Result is that you would have to throw the tapped B-Battery away, because the rule is: When connecting many cells in series and each cell has a different amperage, therefore the amperage of the entire battery will fall to the cell having the lowest amperage.

## WARNING

Do not have your B-Battery tapped. Use a potentiometer in order to get variable voltage because a tapped B-Battery will give only a certain amount of voltage which may be too little or too much. Follow the diagram (which is on the other side) and you will have an up-to-date universal wireless set.

## LOW PRICES AS COMPARED TO OTHERS

We have decided to make our prices as low as possible regardless of the expensive materials which our "BETTER QUALITY" B-Batteries are made. Many wonder why we can make the price so low but it is because we live up to our motto "RETAILING AT WHOLESALE PRICES".

| CAT. No.                                                     | Voltage | Amount of Cells | Type | Kind                     | Dimensions           | Average Life | List Value | Our Price |
|--------------------------------------------------------------|---------|-----------------|------|--------------------------|----------------------|--------------|------------|-----------|
| BB-154                                                       | 22 1/2  | 15              | BA-2 | Signal Corps, U. S. Army | 3 1/4" x 2" x 2 1/2" | 4 months     | \$1.50     | \$1.00    |
| Postpaid add 10c. In Canada and foreign countries add 35c.   |         |                 |      |                          |                      |              |            |           |
| BB-158                                                       | 22 1/2  | 15              | BA-2 | Signal Corps, U. S. Navy | 6 1/2" x 4" x 3"     | 8 months     | 2.50       | 1.95      |
| Postpaid add 35c. In Canada and foreign countries add 50c.   |         |                 |      |                          |                      |              |            |           |
| SBB-3012                                                     | 45      | 30              | BA-2 | Spl. comb. Navy and Army | 14 x 8" x 6"         | 1 year       | 6.00       | 3.90      |
| Postpaid add 70c. In Canada and foreign countries add \$1.00 |         |                 |      |                          |                      |              |            |           |

We Guarantee each and every "Better Quality" B-Batteries on a money-back basis. No higher claims can be made more honestly. We can prove it.

## ORDER THROUGH YOUR DEALER. THIS WILL SAVE TIME AND MONEY

Or if your dealer does not handle our "BETTER QUALITY" B-Batteries send us your order and dealer's name and address. Your order will be filled within four hours

DEALERS: WRITE FOR PROPOSITION. TERRITORY NOW BEING ALLOTTED.

**THE H. S. WIRELESS CO. 164 Ross Street, Brooklyn, N.Y.**



**RADISCO**  
High Frequency  
COILS



**RADISCO**  
BETTER "B"  
BATTERY

Do You Know The Radisco Agent In Your Vicinity? Go To Him For Reliable Apparatus. Here Are Some of Them.

**DISTRICT OF COLUMBIA**

National Radio Supply Co.  
1405 U Street N. W.  
Washington

**ILLINOIS**

Chicago Radio Laboratories  
1316 Carmen Avenue  
Chicago

**LOUISIANA**

L. A. Rose,  
4323 Magnolia Street  
New Orleans

**MASSACHUSETTS**

Atlantic Radio Co.  
34 Batterymarch St.  
Boston

**NEW JERSEY**

Independent Radio Sup. Co.  
118 South N. J. Avenue  
Atlantic City

A. H. Corwin & Co.  
4 West Park Street  
Newark

**NEW YORK**

Amateur Wireless Equip.  
Company  
1390 Prospect Ave.  
Bronx, New York City

**NEW YORK**

Kelley & Phillips Elec. Co.  
312 Flatbush Ave.  
Brooklyn

E. L. Long  
21 Magnolia Terrace  
Albany

Shotton Radio Mfg. Co.  
8 Kingsbury Street  
Jamestown, N. Y.

**PENNSYLVANIA**

K. & L. Electric Co.  
McKeesport

Pa. Wireless Co.  
507 Florence Ave.  
New Castle

Radio Electric Co.  
4614 Henry Street  
Pittsburgh

Shotton Radio Mfg. Co.  
P. O. Box 3  
Scranton

Philadelphia School of  
Wireless Telegraphy  
Broad and Cherry Sts.  
Philadelphia

**RHODE ISLAND**

Rhode Island Wireless  
Equipment Co.  
45 Washington Street  
Providence

**CANADA**

Canadian Radio Mfg. Co.  
Bienville, Quebec

Some good territory open to live agents. For particulars address

**RADIO DISTRIBUTING COMPANY**

NEWARK, N. J.

**Some Foreign Apparatus**

By FRED M. GILL

(Continued from page 282)

be plainly seen when a trench was cut off from all communication this set proved a salvation.

The French wave meters were supplied to all the U. S. Signal Corps stations. They consisted of the variable inductance and the variable condenser and were direct reading. (See Fig. 6.)

And there is one type of wave meter that is shown by sketch that was a direct reading type. The wave was indicated on the variable condenser from 1,000 to 1,800 in groups of twenty-five. This was a pilot lamp system for the radiated wave and for the calibration of receiving sets it had a small buzzer operated by a single flash lamp cell. The cost of construction was not over \$3.00.

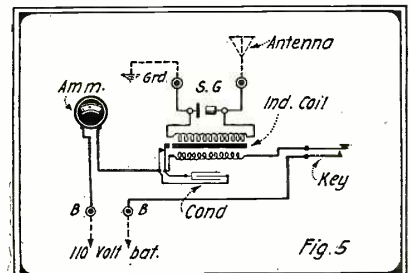

Here is the Circuit of the French Spark Transmitter.

With one of the French transmitting sets it was possible for the station at Antwerp to maintain continuous communication with the station at Chaumont, Coblenz and Paris. Not long ago all the wires to Germany were discontinued, and so all the work of the A. E. F. was placed upon the shoulders of the Signal Corps, relaying from Chaumont and Coblenz to Paris. This station works on the wave length of 2,100 meters, as do all the stations of the French, American and English armies over there.

The station at Antwerp has an antenna

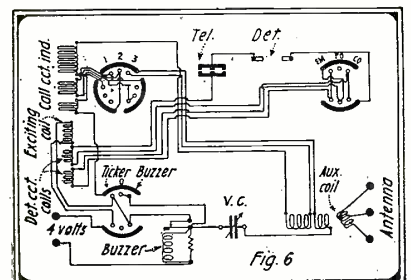

Showing the French Wave Meter Circuit.

of four wires, 275 feet high, with a span of about 1,000 feet between poles.

This is the station that the Germans used for the heavy work and they left four masts of the above size arranged in a square.

The Germans had an arc set of 40 kilowatts there and was used in connection

**GERMAN RADIO SYSTEM TO BE REORGANIZED.**

Berlin, November 22.—The use of the wireless is to be widely extended in Germany, in especial for the press, if the plans of the Ministry of Posts and Telegraph mature. It is proposed to establish a collection central in Berlin, and wireless plants in various wireless districts into which the empire will be apportioned. For this year the construction of thirty-five wireless stations and fifty receiving stations, situated in important trade centers, is planned.

The German papers that comment on the innovation are hopeful, but call attention to the unreliability of the wireless and raise the objection that any one may pick up a message, so that a paper having an apparatus might easily steal the news of another paper.

**SPECIAL SALE!**

We have on hand 2,000 Carbon Grain Transmitters as per photograph. They are first-class instruments and may be used for all kind of experiments, especially for wireless telephone sets, where a heavy current is to be passed through. Slightly used, but in perfect working order. Money refunded if not satisfied. A real bargain. Order one or more today.



Reduced Photograph of Transmitter showing nickel plated case and Hard Rubber Mouthpiece

**\$1.00 ONLY**

Postage extra.

Ship. Weight, 2 lbs.

Diameter, 3 1/4 ins.

**THE ELECTRO IMPORTING CO., 231 Fulton St., NEW YORK**



**Here is an Outfit with Eight Distinct Features You Will Appreciate.**

**Do You Want A Complete, Compact Receiver at a Reasonably Low Price?**

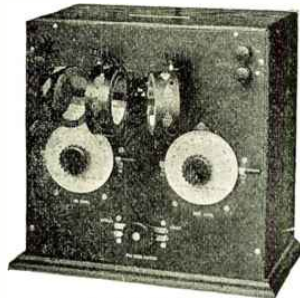

**DE FOREST TUNER**  
Type T-200—\$77.50  
Wave Length  
150 to 25,000 Meters



**DE FOREST**  
Combination Audion-Ultra Audion and  
One-Step Amplifier, \$73.50  
(Type P-300)

- 1—That will respond to any and all wave lengths.
- 2—That is more flexible in coupling than any other system.
- 3—That has a lower distributed capacity, far less high frequency resistance and decrement values than any other type.
- 4—That eliminates cumbersome switches, inefficient taps and losses from dead ends.
- 5—That employs Vernier variable air condensers of unusual design, eliminating capacity effects due to operator's body.
- 6—That makes signals come in always louder and clearer than other types.
- 7—That cannot be surpassed in general efficiency, workmanship and beauty at any price.
- 8—That possesses the decided advantage of minimum table space. The Tuner measures 13 3/8" x 12 1/2" x 8". The P-300 measures 12 1/2" x 9 3/8" x 7 3/4".

No longer is it necessary for you to have two or three expensive, cumbersome tuners cluttering up your operating table, when working all wave lengths.

Ask yourself when you buy your receiver, does it cover any and all wave lengths? Does it possess the other advantages of minimum table space and convenience in coupling embodied in ours? Do the electrical principles employed equal the Genuine DE FOREST "Honey Comb" Coil System of tuning? Then, compare prices!

The DE FOREST Company enjoys the distinction of being the first to inaugurate this unique tuning system which has met with such rapid favor, and you, the progressive Radio Experimenter, should take this opportunity to be among the first to install it in your laboratory. Find out more about it now. Write to

*DE FOREST Agencies are located in all Principal Cities. Ask your regular Electrical Dealer to get you De FOREST Apparatus.*

*A 64-page Radio Manual containing circuits and many useful facts about Radio work and the best Apparatus will be mailed to you for 10 cents in stamps.*

**DE FOREST RADIO TELEPHONE & TELEGRAPH CO.**

1415 Sedgwick Avenue

*Inventors and Manufacturers of High Grade Radio Apparatus*

New York City

# D.H.E. SPECIAL

SOFT TONE                      COMFORTABLE                      SENSITIVE

## 3200 OHM HEADSET \$6.00

TEN DAYS' TRIAL

D.H.E. Navy Coupler, \$18.50

D.H.E. Tuning Coils, 4.50

WE CAN SUPPLY ALL STANDARD  
RADIO APPARATUS AND PARTS FROM STOCK.  
SERVICE AND SATISFACTION GUARANTEED.

CATALOG WILL BE OUT JAN. 1st.

## DOUBLEDAY-HILL ELECTRIC CO.

RADIO DEPT. 719-21 Liberty Avenue, Pittsburgh, Pa.

### An Unusual Opportunity

Imagine the increase in transmitting range one of these highly efficient Roller-Smith Hot-Wire Ammeters will bring you. A sharp wave, with maximum energy on one hump under all weather conditions; rapid adjustment to various wavelengths; increase or reduction of energy to work a certain station,—these are some of the advantages that can be yours.



**U. S. Army Hot-Wire Ammeters**  
Regularly \$13    Our Special Price, \$7

These Ammeters are of the flush type and were made for the U. S. Army Air Service for use on fighting planes. The Armistice brought a cancellation of airplane contracts and these Ammeters could not be used. Each has passed the exacting Government tests and is in perfect condition. They have not been removed from their original cartons and are now ready for immediate shipment.

The scale reading is: 0.25 Amperes. Shunt giving double or triple this range, 75c extra. Only by buying a large quantity of these Ammeters are we able to sell them at almost half the usual price. This is your opportunity to procure at an unusual bargain a standard U. S. Army Air Service Hot-Wire Ammeter. The supply is limited. Better get in on this today as there is a great demand for these instruments. Remit by check or money-order. Dealers write us, we have an attractive proposition for you.

A. H. GREBE & CO., 72 Van Wyck Blvd., Richmond Hill, N. Y.

### WIRELESS AMATEURS, DEALERS AND MANUFACTURERS!

Have You Seen The  
"DEPENDABLE"

Line of Radio Instruments and Complete Sets?

We manufacture a large line of DEPENDABLE apparatus—not the cheap mail order variety, yet our prices are low. Tuners, Couplers, Detectors, Fixed and Variable Condensers, Loading Coils, etc.; also Binding Posts, Switch Points, Switch Levers, etc., etc.

Send for New Catalog No. 9 to our New York office,  
19 Park Place, New York City.

DORON BROS. ELECTRICAL CO.                      HAMILTON, OHIO.

### LEARN WIRELESS TELEGRAPHY

**Fascinating and Educational Work—Big Salaries—Prepare Now**  
The United States Shipping Board is making heavy demands upon us for Dodge-trained wireless operators. Travel all over the world, secure, free, unsurpassed living accommodations and earn a big salary.  
**We Also Teach Morse (Wire) Telegraphy and Railway Accounting**  
School established 45 years. Endorsed by wireless, railway and telegraph officials. Low rates. Students can earn living expenses while attending school. **Catalog Free. Write Today.**  
Dodge's Telegraph and Wireless Institute                      26th St.,                      Valparaiso, Indiana

### Simplified Arc Reception

By RAYMOND B. WAILES  
(Continued from page 283)

across the terminals of the secondary of the loose coupler and the wire joining them is connected to a terminal of the filament battery. The phones may be inserted at "X," if desired. Variable condensers can be substituted for the three fixed ones, with advantage.

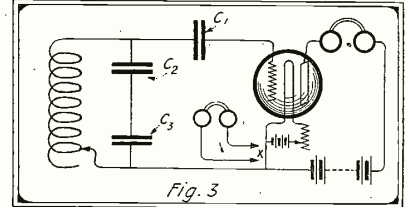

Fig. 3  
Circuit Using Three Fixed Condensers.

### A Variometer of New Design

By W. A. HEPPNER  
(Continued from page 286)

that it will be self-supporting. The winding should also be irregular, or if the amateur has patience, the turns should be spaced slightly. This is important, as it reduces the distributed capacity of the coil. After the winding has been completed the form is removed from the coil by unscrewing the bolt used to hold it

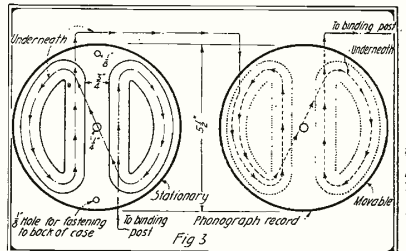
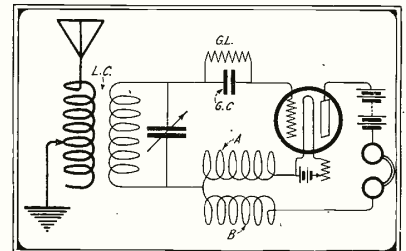

Fig. 3  
Showing How the Coils Are Mounted on the Records.

together. The coil is then given a coat of shellac to strengthen it. Altogether, four coils should be made in this manner. They should all be wound in the same direction.

For the mounting of the coils two tent-cent phonograph records are needed. Two coils are glued to each, as shown in Fig. 3. If the connections are carefully followed in the illustration, it will be seen



Using the Variometer in the Ordinary Regenerative Circuit.

that in both sets of coils, "1, 2" and "3, 4", the inside turn of one coil is connected to the outside turn of the other. In connecting the sets "A" and "B", it is important that the wire coming from "A" should continue into "B" in the same direction; in other words, if coil A-1 and B-1 were fastened together they would form one coil, B-1 being a prolongation of A-1.

The amateur probably has his own idea regarding the mounting of the variometer, especially those who are constructing a short wave regenerative cabinet set. A method of mounting in an individual case

## WIRELESS AMATEURS

Send 2-cent stamp for free description of

### The Barr Mercury-Cup Detector

The most efficient detector on the market. Tested by The Marconi Wireless Telegraph Co. and the United States Government.

Increases the efficiency of every wireless receiving set by making the signals clear, sharp and distinct.

Instantly adjustable at a constant pressure.

Dept. B, THE WYOMING, WASHINGTON, D. C.

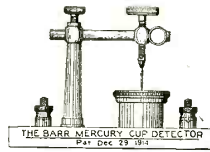

The BARR Mercury-Cup Detector

# THE NEW YORK ELECTRICAL SCHOOL

THE N. Y. ELECTRICAL SCHOOL is the pioneer and premier school of the "Learn by Doing" method. When you have completed this Course you shall be fully qualified to handle ALL branches of Electrical Industry. The equipment of this School is unequalled and up-to-the-minute. No preparation needed to become a "learner" in this school. You can start to learn on any day of any week throughout the whole year. Send for catalogue.

**OPEN ALL SUMMER**

**NEW YORK ELECTRICAL SCHOOL**  
29-31 West 17th St. New York City

The Efficiency and Sensitiveness of Vacuum Tubes is Retained or Increased by Repairing or Replacing Broken or Burned Out Elements. The Establishment of a Complete and Modern High Vacuum Laboratory Enables Us to Repair All Types of Tubes Manufactured in the United States or Abroad.

### THE COST OF REPAIRING

|                                                                                                                                                                                           |                                                                                                                                         |                                                                                                                                                                                                                     |
|-------------------------------------------------------------------------------------------------------------------------------------------------------------------------------------------|-----------------------------------------------------------------------------------------------------------------------------------------|---------------------------------------------------------------------------------------------------------------------------------------------------------------------------------------------------------------------|
| <p><b>RECEIVING TUBES</b></p> <p>MARCONI V. T.<br/>WESTERN ELECTRIC<br/>GENERAL ELECTRIC<br/>DEFOREST<br/>MOORHEAD</p> <p style="text-align: center; font-size: 1.2em;"><b>\$4.50</b></p> | <p><b>AUDIOTRONS</b></p> <p><b>ELECTRON</b></p> <p><b>RELAYS</b></p> <p style="text-align: center; font-size: 1.2em;"><b>\$4.00</b></p> | <p><b>SMALL TRANSMITTING and FOREIGN TUBES</b></p> <p style="text-align: center; font-size: 1.2em;"><b>\$7.50</b></p> <p><b>POWER TUBES</b></p> <p style="text-align: center; font-size: 1.2em;"><b>\$15.00</b></p> |
|-------------------------------------------------------------------------------------------------------------------------------------------------------------------------------------------|-----------------------------------------------------------------------------------------------------------------------------------------|---------------------------------------------------------------------------------------------------------------------------------------------------------------------------------------------------------------------|

Burned Out Tubes Purchased Outright at .50 Each.

A Limited Number of Repaired Tubes on Hand, Guaranteed Same as New at \$5.00 and \$4.50 Respectively.

Money Refunded if Not Satisfactory.

## The VACUUM TUBE REPAIR COMPANY

511 PERRY BUILDING

OAKLAND, CALIFORNIA

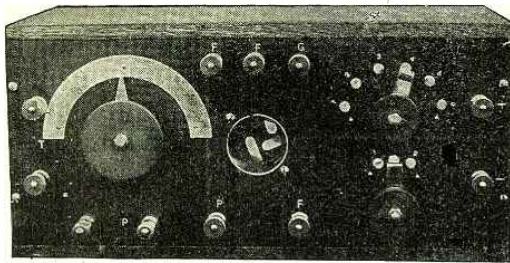

This Audion Control Panel designed and made by Arnold, is the only one of its kind on the market at present and represents the best value of any. Just think of getting an Oak cabinet with polished 1/4" Hard Rubber panel front, equipped so you can use a V. T. Moorhead, or any type of tubular bulb, with switch

so that you can use either at will? A six point switch for battery control giving 16 to 40 volts? Yes, Batteries are included, best make, and a mica grid condenser.

A concealed rheostat with only knob, pointer and scale showing. All connections made with stranded wire, and soldered. Special posts for phone plugs, binding post connections nicely lettered on rubber and filled with white.

Size over all 12" by 6" by 6". Price as shown \$19.50.

Call and try one out.

J. F. ARNOLD

2082 LEXINGTON AVENUE, NEW YORK

Established 1910.

## 4 Famous Books!

THE BOOKS YOU MUST HAVE



EACH ONE A BIG SUCCESS!

### Wireless Course in 20 Lessons

By S. Gernsback, A. Lescarbours and H. W. Secor. E. E.

A course that tells you everything you can possibly want to know about "Wireless" starting off in lesson No. 1 by explaining the Principles of Electricity. The second and third lessons are devoted to magnetism, motors, generators and wiring. And then, by simple, easy stakes, this wonderful Course takes you into "Wireless". The mysteries of "Wireless" are unfolded to you by the use of such simple language so skillfully used that of necessity you must understand every word. The subject is not treated superficially, however, for there is a whole lesson devoted to the Theory and Mathematics of this epoch making subject. To lend charm to the Course, the last lesson (No. 20) is devoted to a history of Wireless and the men who developed it.

Size of book is 7 x 10 1/4 in., 160 pages, 350 illustrations, 30 tables.  
Flexible cloth cover... per copy 75c  
Stiff cloth cover... per copy \$1.25  
Postpaid

### Experimental Electricity Course in 20 Lessons

By S. Gernsback and H. W. Secor. E. E.

A Course of the theory and practice of Electricity for the Experimenters. This is undoubtedly one of the most complete and comprehensive treatises of this special subject ever published. The book is written by the same authors as the famous "Wireless Course in 20 Lessons".

Every phase of experimental electricity is treated comprehensively in plain English. It is a book not only for the beginner but for every experimenter and student of Electricity. New Experiments are described and explained, and nearly every application of Electricity in modern life is given in simple language.

The book contains 128 pages and more than 400 illustrations.  
Flexible cloth cover... per copy 75c  
Stiff cloth cover... per copy \$1.25  
Postpaid

### No. 1. How to Make Wireless Sending Apparatus

No. 2. How to Make Wireless Receiving Apparatus  
By 20 Radio Experts.

#### Two Remarkable Books

Book No. 1 contains 100 pages, size 7 x 5 in., and 88 illustrations, paper bound.  
Book No. 2 contains 100 pages, size 7 x 5 in., and 90 illustrations, paper bound.

These two books have been written and published entirely for the wireless enthusiast who wants to make his own radio apparatus. They contain more information on how to make it than any other books we know of. Only strictly modern radio apparatus are described in these books and the illustrations and descriptions are so clear and simple that no trouble will be experienced in making the instruments.

Book No. 1—How to make Wireless Sending Apparatus ..... 25c  
Book No. 2—How to make Wireless Receiving Apparatus ..... 25c  
Postpaid

THE EXPERIMENTER PUBL. CO. Book Dept. 233 Fulton St., New York

is shown in Fig. IV. The coil disk "A" is fastened to the back of the case, while a small spool is glued to "B" at the center. The spool in turn is fastened to a wooden or composition shaft. The front and back panels form the bearings for the shaft.

A variometer of this type may be made in various sizes, depending, of course, upon the range of wave-lengths desired. A very efficient tickler coupling may be constructed along the lines of this variometer. Several hook-ups are shown here, using

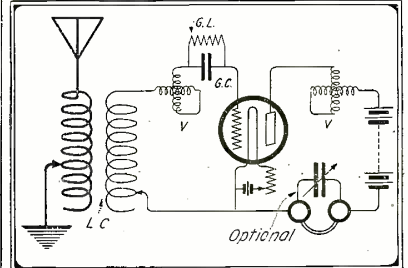

Using the Variometer in the Grid Circuit and the Other in the Plate Circuit.

the variometer as in a regenerative set, also as a tickler coupling.

The advantages of the above type of variometer are easily apparent. It is compact and very efficient as it has a low stray magnetic field. Taking into consideration also, its low cost and simple construction, it should prove popular with the amateur.

## Construction of a Modern Amateur Antenna Mast

By OTTO VON BERGEN

(Continued from page 288)

note the attachment of front and back wires in Fig. 4. Furthermore, all wires should positively be insulated near the ground, if for no other reason than to prevent serious tangles.

If one end of the aerial is fastened in a tree the following device will save the mast and wires from being wrecked in heavy wind storms. Fasten the two bookcase brackets about fifteen feet up the mast side by side, laying a piece of wood across the top with a pulley fastened in the center. The rope may then be pulled out from the

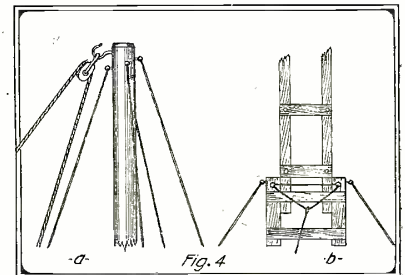

Method of Guying the Mast.

mast and held in that position by this simple device, when the weights have been fastened to the end of the rope. Refer to Fig. 5. The weights used depend entirely upon the weight and pull of the aerial. I have found that four six-pound iron window weights will automatically do the trick, doing heavy winds, when holding up a two-



**DANGER**  
**HIGH-VOLTAGE**

**BOYS**

Here is a sign that will make your friends shudder. Your den is incomplete without it. Fill out your order in pencil and send it NOW! Price only 20c, 3 for 50c postpaid anywhere. Sent unbenet.

**BOYS**

---

LEONARD BECK, 1298 Carroll St., Brooklyn, N. Y.  
I enclose . . . cents for which send me . . . DHV signs, 7 1/4" x 1 1/4". Printed in bright red on stiff cardboard with big bold letters.

Name .....

Address .....

City ..... State ..... R 12

## COPPER AERIAL WIRE



We have just received several thousand pounds of pure copper aerial wire. This is No. 14 gauge, and runs approximately 80 feet to the pound. While it lasts, we are selling it for 50c per pound. When ordering be sure to include postage and insurance charges, adding one pound to the actual weight of the wire for packing weight. Otherwise we will ship the wire by express collect.

We are listing a few other standard bargains below:

|                                                                                     |            |
|-------------------------------------------------------------------------------------|------------|
| Condensers, 1/2, 7/10, 1, 1 1/2 and 2 M.F., each...                                 | \$.50      |
| Faraday Buzzers, 2 adjustment springs, while they last                              | ..... .40  |
| Slightly used Dry Cells, per doz.                                                   | ..... 1.25 |
| Brass binding posts, nickeled, per doz.                                             | ..... .40  |
| Variable resistance lamps, each                                                     | ..... .25  |
| Skinderviken Transmitter buttons, postpaid each                                     | 1.00       |
| 75 ohm Bi-Polar, watchcase receivers with cords, slightly used                      | ..... .65  |
| Watchcase aluminum transmitters, flush type, very sensitive, carbon diaphragm, each | ..... .50  |
| Double-pole, double-throw knife switches, each                                      | ..... .35  |

Prices subject to change without notice.  
Send 5c for our illustrated Catalog, showing many other interesting items at cut prices.

**ELECTRICAL SPECIALTY COMPANY**  
Dept. R, 48 S. Front Street, Columbus, Ohio

## Everything You Want To Know About A. C. Motors

is found instantly in the **ELECTRICAL WORKER'S FRIEND**. The only complete book of its kind for the man on the job or the student. Will make you an expert motor repairman. Contains 66 electric motor drawings with complete instructions for rewinding and reconnecting. Tells how to put each coil in the slots, how to set speed, alternations, cycles, poles, how to find the coil throw, number of coils per group and number of groups, etc.

Covers all practical reconnecting changes from one phase to another, from one voltage to another, or changing both the phase and voltage at the same time.

Written so you will understand it. You need this book—send for a copy today.

**\$4.00** or we will ship  
C. O. D. if you prefer

Free Circular on Request

**Henry F. Bosshart**  
P. O. Box 68, Homewood Sta., Pittsburg, Pa.



Swing 4 in., 11 in. between centers, 17 in. total length. Shipping weight 13 lbs. Bed of lathe is machined. Workmanship first-class. Equipped with wood turning chuck. Can be fitted with 3 in. face plate and drill chuck, special equipment. Order one today. Price \$5.00 cash with order. **SYFHER MFG. CO., DEPT. C TOLEDO, OHIO**

wired, five-strand copper wired aerial 125 feet in length fastened to the topmost branches of a sixty-foot elm tree. The weights on aerials longer or shorter, therefore may be figured out accordingly.

Six persons can raise a mast of this character in perfect safety and in a comparatively short space of time. A block and tackle may be fastened half way up the mast and attached to a nearby house or tree. While two pull the mast into an upright position the other four should hold the guy wires so as to keep it steady. The ends of the mast put into the ground should be heavily tarred.

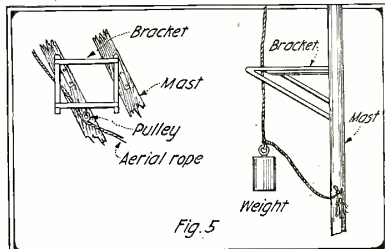

This Prevents the Antenna From Sagging.

If the plans of construction are carefully followed and all guy wires securely fastened there exists no reason why the mast should not stay up in the strongest of wind storms.

### A Constant Battery for Audion Filaments

By R. H. LANGLEY  
(Continued from page 288)

out through one of the holes in the rubber stopper.

The zinc element is made of thin sheet zinc (about 1/32" thick) and is rolled on a small rod in such a way as to form a spiral of three or four turns. It should be about 5" long, so that when it is in the bottle it will be 2 or 3" from the bottom. The best terminal for this element is an ordinary "battery zinc" such as electricians use for small bell-ringing batteries. This zinc rod can be slotted with a hack-saw, and the sheet zinc inserted in the slot and riveted with little strips of the sheet zinc. This element should pass through the mouth of the bottle, and should not spring out after it is inside. The terminals of course, come out through another hole in the rubber stopper. The third hole in the stopper is for the escape of gas.

After both elements are made and ready, the solution is made and poured into the bottles. It is a saturated solution of caustic potash, which simply means that the water has dissolved all the caustic that it can. The solution can be made up in a large stone crock. Put the required amount of water in the crock (a quart for each cell) and then put in the caustic potash crystals. Stir thoroughly with an iron rod and let it stand over night. Cover hermetically. If all the caustic is dissolved in the morning, more should be added until the solution is saturated. Do not use hot water to make the caustic dissolve, and remember that the solution is very powerful, and will eat into almost anything it touches, including the floor and your hands. It should be handled with great care.

Fill the bottles to within about one inch of the top, and insert the iron elements. The remarkable properties of this battery are due to the use of black oxid of copper in the bottom of the cell. This material can be obtained at any chemical supply shop, and the oxid should be dropped into the bottles so as to form a layer about an inch thick in the bottom. The zinc elements are then inserted, and the rubber

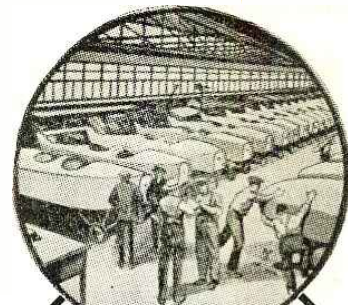

## Thousands of Trained Aviation Mechanics Needed!

for new Airplane manufacturing and assembling plants in all parts of the country. Others are wanted as volunteers for repair stations at aviation training camps and on European battlefronts. Every experienced airplane mechanic in the world is already at work and thousands more are needed. And this is only the beginning of the industry's growth. Already the United States Government is using airplanes to carry mail between Washington and Philadelphia and thousands of flying machines are going to be needed for express and passenger carrying service. Not in a hundred years has any field of endeavor held out such wonderful opportunities as are offered to you today in this great new profession. Prepare to serve your country or to earn big money in private employment as

- |                         |                      |
|-------------------------|----------------------|
| Aeronautical Instructor | Airplane Mechanician |
| Aeronautical Engineer   | Airplane Inspector   |
| Aeronautical Contractor | Airplane Salesman    |
| Airplane Repairman      | Airplane Assembler   |
|                         | Airplane Builder     |

**We Teach You by Mail** Learn at home, in your spare time, in a few short months. Our new, scientific course has the endorsement of airplane manufacturers, aeronautical experts, aviators and leading aero clubs. Every Lesson, Lecture, Blueprint and Bulletin is self-explanatory. You can't fail to learn! No book study, no schooling required. Lessons are written in easy-to-understand, non-technical language.

**OPPORTUNITIES**  
in the  
**AIRPLANE**  
**INDUSTRY**

**This Valuable New Book**  
Send the **FREE** Coupon

Just published Write quick for our special War Emergency Offer and valuable new book, "Opportunities in the Airplane Industry," just published. Sent free. Send the coupon for full particulars. Save nearly one-half the regular price of this complete course. We can enroll only a few more students on this Special Offer. SEND THE COUPON NOW.

**AMERICAN SCHOOL OF AVIATION**  
431 So. DEARBORN ST., DEPT. 2729 CHICAGO, ILL.

American School of Aviation, 431 S. Dearborn St., Dept. 2729 Chicago, Ill.  
Without any obligation on my part, you may send me full information about your complete course in Practical Aeronautics and your Special Emergency Offer.

Name .....

Street .....

Town ..... State .....

## CANADIAN AMATEURS!

At last a Canadian Radio Supply House—Materials and Apparatus Carried in Stock.

Canadian agents for Messrs.  
**Menomine Wireless Apparatus**  
C. Brandes, Inc.

Send 5c Stamp for Price List.

**RADIO & ELECTRICAL SUPPLY CO.,**  
314 St. Catherine St. W. Montreal, Que.  
Year Books and Text Books in Stock

## CAMERAS—LOWEST PRICES

Supplies and printing at reduced prices. Eliminate the middleman. Deal direct and save money. Catalog Free.  
Pearl Photo Place, 640 E. Clementine St., Philadelphia, Pa.

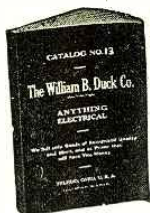

## DUCK'S New Big 264-Page Wireless and Electrical Catalog Just Out

It is mailed for 12c in stamps or coin which may be deducted on first order of \$1.00. Catalog not sent otherwise.

We regard this catalog as our greatest effort. It embraces everything in wireless worth while. 172 pages with no waste space devoted exclusively to wireless instruments. Your amateur friend will tell you that there never has been any wireless catalog to take the place of catalog of this company and above all that you can absolutely depend on our goods. There is no need for any other catalog when you have this big catalog.

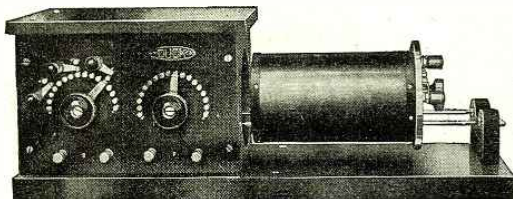

NEW MODEL 5BB. NAVY TYPE RECEIVING TRANSFORMER

A big improvement over our former model. Primary divided into four sections, with three dead end switches, greatly improving selectivity. Secondary divided into three sections, with two dead end switches, eliminating harmonics. The change in the construction of the guide rod support makes it possible to obtain a looser coupling. It is a wonderful improvement over our old model both in performance and appearance. Only \$23.50.

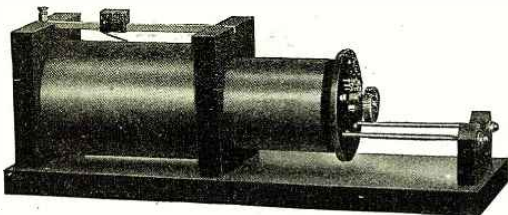

OUR IMPROVED ARLINGTON RECEIVING TRANSFORMER

The secondary on our new type Arlington is divided into two sections with one dead end switch, eliminating dead end effect and harmonic and giving greater selectivity. The end support similar to that on our Navy type permitting of looser coupling. It is a beautifully finished instrument and will be sold by us at the same price as the old model, \$9.00.

THE WILLIAM B. DUCK CO., 240-242 Superior St., Toledo, Ohio

stoppers put in place. The next important thing is to pour a layer of paraffin oil, or petroleum on top of the caustic potash solution. If this is not done the solution will spoil in a few days. The cell is ready for use now.

A cell made up as described will give 0.7 volts and from 1½ to 2 amperes. This is of course more than enough for the ordinary filament. It will operate for several months without replenishing, its life depending upon the size of the zinc element, which can of course be replaced. Batteries of this type have been used successfully in electro-plating, and in electric lighting on a small scale, which is just what an audion filament amounts to.

### Triple Coil Receiving Transformer

By H. E. PARSONS

(Continued from page 289)

wound it is boiled in paraffin wax in a small pie tin and allowed to set in the wax. When set the wax is cut away to within ⅛ inch of the outside of the winding and to the same width as the center disc. If hat pins were used they must now be withdrawn. Two hardwood discs the diameter of the finished coil are now screwed to the

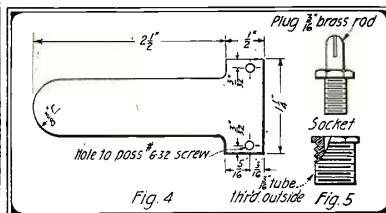

Details of the Coil Fastening Arrangement.

center disc B, Figs. 1 and 2, and polished. Next cut out two pieces of 1/16 brass to the size given in Fig. 4. These sizes are for a coil with 1" of winding, other coils will require different sizes.

These pieces of brass are screwed to the center disc by three wood screws. Place the screws in different positions on each side as shown in Fig. 2, so that they do not touch. If these screws touch they will form a closed loop about the primary and will act as a secondary. D, Fig. 2, is a hard rubber or Bakelite block ½" thick by 1¼" long by ⅜" deep fixed between the two plates by 6-32 brass machine screws. In this block are set one plug (Fig. 5, A), and 1 socket (Fig. 5, B), ⅜" apart. The mounting is shown in Fig. 6.

H & B are pieces of hard rubber 3" by ½" by ⅜" mounted on 3/32" brass brackets C. In this are set 3 hard rubber blocks 1¼" by ½" by ⅜". These blocks are hinged ½" apart by bolts D, fitted with knurled heads to lock the block in any position. Each contains one plug and one socket to fit those on the coil. The idea in putting one plug and one socket in the holder and

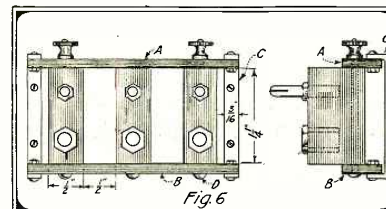

The Coil Mounting Is Constructed as Shown.

## UNIVERSAL RADIO APPARATUS

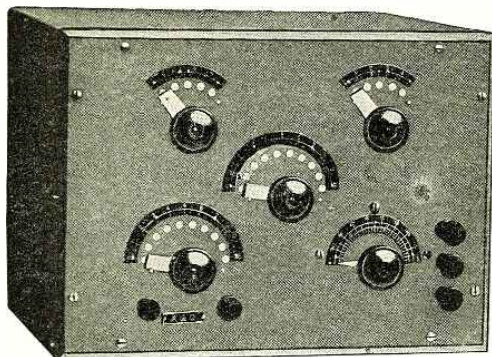

Type UL-5 Receiver

interested in radio apparatus of the highest grade at fair prices, enclose a 2-cent stamp for our catalogue.

Type UL-5 Receiver.

This is a complete receiver for undamped waves up to 17,000 meters. No external coils, couplers or condensers are needed, since it is entirely self-contained. Sizes 8" x 12" x 7" approximately.

We control the patent rights for the Mignon System and can supply these instruments.

UNIVERSAL RADIO MANUFACTURING CORP.

Dept. W

Elmira, N. Y.

It is the policy of this company never to consider a sale completed until the customer is thoroughly satisfied. Incidentally our instruments seldom fail to satisfy, because they are scientifically designed and built on honor. If you are

the same in the coil, is that if the inside wire is always joined to the plug, the coils will be poled the same. For the primary use No. 24DCC wire and for the secondary No. 28 or 30 wire.

With these coils I hear stations regularly which otherwise can only be heard occasionally. The tuning with these coils is accomplished with condensers or variometers. A primary condenser of .001 mfd. and a secondary of about .0008 mfd. are very suitable.

**Foot-Ball Score Via Wireless Telephone**

By MORRIS PRESS

(Continued from page 295)

relayed by messenger from the field to the telephone line which was connected direct to the de Forest laboratories. From here the message was sent by radio-telephone and then, to insure completeness and accuracy, the operators immediately repeated the text by wireless telegraph. Thus the students remaining at Wesleyan were able to follow the game almost as closely as New Yorkers followed the World's Series.

**For Those Who "Listen-in"**

By PIERRE H. BOUCHERON

(Continued from page 293)

| Location                     | Call Letters | Type of Spark                                   |
|------------------------------|--------------|-------------------------------------------------|
| Fire Island, L. I.           | NAH-1        | 500 cycles Quenched                             |
| Montauk, L. I.               | NAH-2        | 500 cycles Quenched                             |
| Rockaway, L. I.              | NAH-3        | 500-cycles Quenched                             |
| Sea Gate, N. Y.              | NAH-4        | { Rotary—about<br>240 cycles<br>Non Synchronous |
| Bush Terminal,<br>N. Y. C.   | NAH-5        | 500 cycles Quenched                             |
| Brooklyn Navy Yard,<br>N. Y. | NAH-6        | 500 cycles Quenched                             |
| Mantoloking, N. J.           | NAH-7        | 500 cycles Quenched                             |

There is hardly a moment, day or night, in which any one of these stations are not working, so if you are located within several hundred miles of them and you have a new receiving set to test out, or a new vacuum tube hook-up, you may tune in for them on 600 meters and you will seldom fail to hear one of them. In fact, there are moments of the day when the ether in this vicinity is filled with a genuine road of ship and shore radio stations—all going at the same time.

Besides the commercial message end of the game, there are exactly five radio compass stations located near New York Harbor as follows:

- Montuk, L. I.
- Fire Island, L. I.
- Rockaway Beach, L. I.
- Sandy Hook, N. J.
- Mantoloking, N. J.

In addition to the above there are the control stations at Boston, Mass.; Cape May, N. J., and Virginia Beach, Va., each of them operating by remote control three individual sets, as well as the radio compasses stationed at the most convenient spots to aid navigation.

The following abbreviations have been adopted, pro-tem, as special radio compass query and answer signals:  
 QTE.....(What is my true bearing?)  
 QTE.....(Your true bearing is.....)  
 QTF.....(What is my position?)  
 QTF.....(Your position is Lat..Long..)  
 The letters "MO" repeated in close order is also a special signal transmitted by vessels which enables each compass station operator to secure the direction of the emitted waves, thereby enabling the compass control station to plot the ship's position. Radio compass operation will shortly be standardized by international agreement.

In the case of NAH (New York), the radio compass, as well as the regular commercial stations are all connected by tele-

**Radio Apparatus Distributors of All Prominent Makes:**  
 De Forest, Wireless Specialty, Murdock, Grebe, General Radio, Clapp Eastham, Arnold, Federal, Acme, Brandes and scores of others  
**LARGEST AND BEST STOCK OF ANY HOUSE IN NEW ENGLAND**

Type P-500 De Forest Control Panel

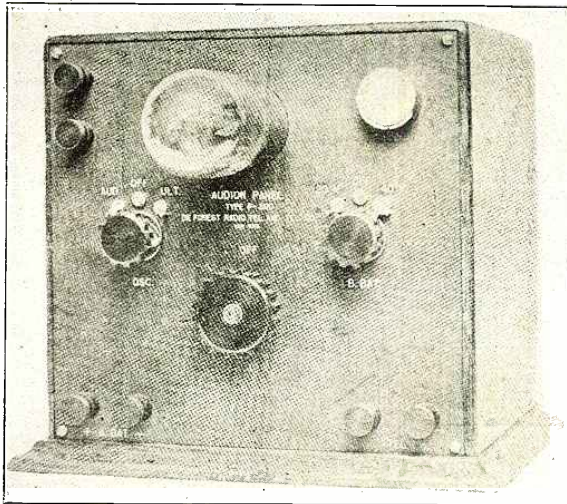

Audion-ultraudion Panel with 20-40 volt "B" battery and oak cabinet, "Early English," shipping wt. 13 lbs. Price \$24.00.  
 Audion Control Panel. Contains larger panel than P-400. With 40-volt "B" battery in oak cabinet. Shipping wt. 13 lbs. Price \$21.00.

EXCLUSIVE DISTRIBUTORS FOR DE FOREST PRODUCTS IN NEW ENGLAND  
 SOME GOOD TERRITORY OPEN TO LIVE DEALERS. WRITE FOR PROPOSITION  
 Send 6 cents in stamps for NEW CATALOG JUST OUT! EVERY AMATEUR should have it!  
 All orders shipped the same day. Give us a trial!

**F. D. PITTS CO. Inc. Dept. C BOSTON, MASS.**

Type P-100 De Forest Audion Control Panel. Contains "B" batteries, amplifying transformer, bridging and stopping condensers, etc. Shipping wt., 35 lbs. Price \$67.50.

Type P-300 De Forest Combination Audion-ultraudion and 1 step amplifier. Contains two audion receptacles, two rheostats, two telephone jacks, "B" batteries, transformer, bridging and stopping condensers, etc. Shipping wt. 35 lbs. Price \$73.50.

Type P-400 De Forest Audion Control Panel. Unmounted. Contains tube receptacle, grid leak and condenser, rheostat and posts. Shipping wt. 6 lbs. Price \$10.90.

Type P-401 De Forest Audion Control Panel. Same as P-400 with cabinet. Shipping wt. 7 lbs. Price \$13.25.

Type P-402 De Forest Audion Control Panel. Same as P-400 with cabinet. Shipping wt. 7 lbs. Price \$13.25.

**ATTENTION AMATEURS**

You may want to purchase a coil, a transformer, a pair of phones, a battery or one of the many pieces of apparatus necessary to properly operate your set. What do you do? You write for catalogues—the result is you have a mass of data and just can't make up your mind what to buy and who to buy it from. Our advice is DON'T BUY IT until you secure some expert's opinion and the piece of apparatus just suited to your needs.

Because we are partial to no particular manufacturer of wireless apparatus and because years of study and sales has enabled us to select wireless products with discrimination, we offer you absolutely without charge, the benefit of our EXPERT INFORMATION BUREAU which is maintained solely for the purpose of guiding the experimenter in the choice of apparatus which will, in our expert opinion, serve him best. Of course we sell apparatus and there again our knowledge manifests itself because we carry the products of over 60 of the leading manufacturers of American made apparatus—therefore you are assured that what you buy is the attainment of modern efficiency in apparatus production. We wish to strongly emphasize the fact that whether you buy of us or not we want to help you in your problems and the cost to you is but a two cent stamp. Write today for our catalogue.

**National Radio Supply Co., "The Nation's Clearing House"**  
 Dept. 105, 14th and U Streets, WASHINGTON, D. C.

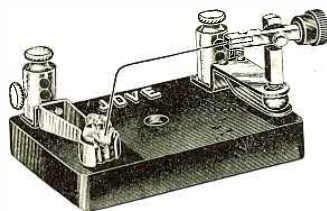

(GHEGAN PATENT)

**Bunnell INSTRUMENTS**  
 Always Reliable

**JOVE DETECTOR**  
 Handiest, Handsomest, Best.

Sample by Mail, \$1.44  
 Tested Galena Crystal, 25c

High Grade, Inexpensive Keys, Transformers, Condensers, Spark Gaps, Receivers, etc.  
 Send stamp for new edition 40RN Catalog.

**J. H. BUNNELL & CO., 32 Park Place, New York**





**Skinderviken Transmitter Button**

The most efficient little Transmitter in the world

Over 15,000 sold in less than a year. Use it for transmitting phonograph music to distant points, for your wireless set, local and long distance telephone, Detectaphones, etc.

**Send \$1.00 for a Button**

Booklet and price list free. Receivers, induction coils and electrical supplies in stock.

**J. SKINDERVIKEN**

335 Broadway N. Y. City or 154 W. Randolph St. Chicago, Ill.

**ATLANTIC RADIO CO.**

Our line of new apparatus comprises the latest post-war equipment.

Prepare your station for the new era in the amateur radio world by equipping with our standard, high grade apparatus, parts and supplies.

34 Batterymarch Street BOSTON MASS.



**VACUUM TUBE CONTROL PANEL**

Most efficient and neatest panel manufactured.

Bakelite panel, graduated dials, mounted in oak cabinet. Variable grid condenser, rheostat, and tube receptacle mounted back of panel.

May be used in any circuit.

**PRICE-less Bulb (with V.T. Base or Audiotron mounting)—\$15.00**

For Full information write

DAYNOR RADIO ELECTRIC COMPANY  
Box 105 Wilkinsburg, Pa.

**Make Your Own Wireless**

receiving set with wave-length range of 170 to 2,500 meters. Think of owning and operating a set that you built yourself! Save money and gain practical experience. Complete, full-size blue-print, instructions, and information of where to buy parts, and cost. Send \$1.00. Write to-day and get started.

K. & G. WIRELESS SUPPLY CO.  
152 Chambers St. New York City

You can be quickly cured, if you

**STAMMER**

Send 10 cents coin or stamps for 70-page book on Stammering and Stuttering. "Its Cause and Cure." It tells how I cured myself after stammering for 20 years.

Benjamin N. Bogue, 653 Bogue Bldg., Indianapolis

graph wire to the main control system located near the Battery, making it possible for the control operator to operate any individual or combination of transmitters by remote control, which same is accomplished by connecting the telegraph line relays to specially constructed circuit breakers, which in turn operate the radio transmitters.

**Junior Radio Course**  
By W. A. HEPPNER  
(Continued from page 300)

learned in our study of electricity, even a straight single wire has a certain value of inductance. If this wire were used as an antenna in connection with a transmitting set, it would radiate waves of a certain length. This wavelength would depend upon the length of the wire, its capacity, and its inductance. It is therefore apparent that if the wire were continued in the form of a coil or helix, the inductance would be increased, thus increasing the wavelength. On the otherhand, if the number of turns are reduced, the wavelength is decreased.

As stated in a previous lesson, it is impractical to tune the transmitting set to the receiving set. Naturally we now wonder why it is necessary to tune the transmitting set at all. Of what other use is the helix? In the next issue these questions will be taken up in detail. We will explain tuning as applied to the transmitter alone.

(Lesson five will be continued in the January issue.)

**I Want to Know**  
(Continued from page 304)

**DIMENSIONS OF LOAD COIL.**  
(107) W. J. D., New York City, asks:

Q. 1. Dimensions a size of tubing for loading coil and size of wire and whether enamelled or B & S wire.

Q. 2. What would be the range in miles and meters of the following station:  
1 loose coupler, 8,500 meters; 1 variable condenser; 1 fixed condenser; 1 silicon detector; 1 set of Brander's phones, 2,000-ohms; an aerial 70 feet high, 20 feet long, composed of 4 wires placed 5 inches apart, the lead-in being about 60 feet long. The aerial is composed of your "Antenium Aerial Wire."

Q. 3. Would you kindly give me a hook-up for this station?

A. 1. Length of tube 36 in. diameter, 4 in., wound to half inch of both ends, with No. 24 enamelled wire.

A. 2. Approximately 10,000 meters.

A. 3. Hook-up is given herewith.

**WAVELENGTH OF ANTENNA.**  
(108) A. K. M., of Pittsburg, Pa., asks the following:

Would you please publish in your RADIO AMATEUR NEWS (I want to know department), the wavelength of each of the following instruments, and kindly tell me my receiving radius with such instruments?

Q. 1. My aerial is 30 feet high on the free end, 60 feet long, with 4 wires spaced 2 feet apart, and 50 feet high on the other end, with a lead-in 10 feet long.

Q. 2. A Navy type loose coupler, with a primary 7¼ feet long, 3 feet wide and wound with No. 24 green silk wire one-half foot from each end. Secondary 6 feet long, 2¾ feet wide, wound with No. 32 enamelled wire one-half foot from each end.

**Radio Intelligence Bureau**

Earn \$125 to \$150 per Month

Complete Course and \$15 Pre-Practice Buzzer Set \$15 paid

Course prepared by a leading authority on the subject. All questions answered free after purchase of course. The entire faculty is at your command to solve your problems.

**We Design** Wireless Receiving sets; Wireless Telephone sets; Underground "Rogers" installations, complete or individual instruments, at nominal cost. Build your own apparatus at one-tenth the cost. We furnish dimensions, drawings, and diagrams complete. Special Questions answered by our Query Department at 25c each. If questions involve considerable research work, etc., a special charge, not to exceed \$5.00, is made.

**RADIO INTELLIGENCE BUREAU**  
864 Roosevelt Pl. New Orleans, La.



Here is the very high-tension circuit standard for whose advent the better class of amateurs have long waited.

It is made of a 7" "Electrose" standard—with polished brass base and copper clip for holding ¼" O. D. tubing (other size clips 10c extra).

No. 6500. Standard—plain base, \$2.25.

Exceptional quality. Order one today, money and transportation charges refunded if not satisfied.

Toledo Radio Specialties Company  
P. O. Box 343 Central Station Toledo, Ohio

**COMPLETE RECEIVING SET \$6.00**

Completely connected and ready for use. Consists of double slide tuning coil, galena detector stand and tested crystal, fixed condenser and binding posts for aerial, ground and receivers. Mounted on hard-wood base, size 8" by 12" by ½". All wood-work finished in dull black, making a beautiful background for brass work, which sets off to great advantage. A very handsome and efficient set.

**UNMOUNTED COILS**

Wound with No. 24 enameled wire on non-shrinkable tubes.

9" by 2½" ..... \$0.75  
10" by 3" ..... 1.00

**MC MAHON & ST JOHN**  
56 West Ave. So. Norwalk, Conn.

INDUC-TANCE WIND-IND WOOD PAT. TERNS

**W. SIEGERT**

1250 West 97th Pl. CHICAGO, ILL.

Special Radio and Electrical apparatus built to order

Electrical Experimental Work

Write for Estimates—I Will Save You Money

**AMATEURS**

Complete line of Radio Materials and all Standard Apparatus.

We have some new and interesting developments.

Write us your needs.

**"RADISCO AGENCY"**

**K & L ELECTRIC CO.**  
427 Olive Street, McKeesport, Pa.

Q. 3. A primary loading coil 20 feet high, 2½ feet wide, wound with No. 22 wire one-quarter foot from each end and using the copper plate arrangement described in the August RADIO AMATEUR NEWS.

- A. 1. One hundred and eighty meters
- A. 2. Five ohms and meters.
- A. 3. About twenty-two hundred meters.

**THE BUZZER-PHONE.**

By V. DENISON.

A very interesting instrument used by the U. S. Army, in France, is the Buzzer-phone, the design of which is similar to the English Fullerphone. The purpose of this instrument is to permit inter-communication which the enemy listening posts equipped with eight and twelve stage amplifiers cannot pick up. The instrument may be used as a phone or as a field service buzzer.

Direct current of extremely low E.M.F. is used in the sending circuit and on the line, but is converted into a fluctuating current in the receiving circuit. If an A. C. or fluctuating current were used on the line the self induction would render the message readable to the enemy.

**Sending Circuit:**

When the key is pressed the current from battery B, goes thru the key and out on the line—returning thru the choke coils. These coils reduce the E.M.F. to an extremely small amount, and prevent the sudden building up of the line pressure. The condensers prevent a sudden decrease in line pressure. In this way sudden line fluctuations are prevented and self induction decreased.

**Receiving Circuit:**

With switch on receiving side, the buzzer operates continuously, thus interrupting the circuit to the receiver (R), at point 2, very rapidly. In this manner the incoming D.C. signals are broken up or are converted into a pulsating current, which causes a buzz in the receiver. The A.C. tending to build up, due to the buzzer action, is eliminated by the choke coils and condensers.

Of course the main object of these circuits is to eliminate A.C. and fluctuating

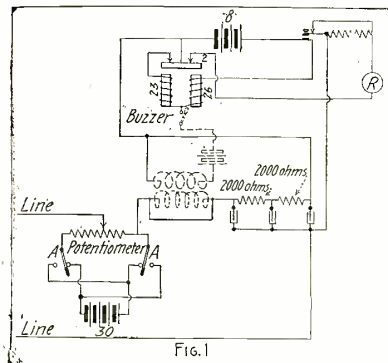

The Circuit Used in the Buzzer-Phone System.

currents which cause self induction, and this is accomplished by means of accurate calculation of condenser and choke coil values.

To use as a field service buzzer the induction coil, shown in dotted line is employed. A telephone transmitter is furnished for phone communication.

Another feature of this instrument is the potentiometer and variometer circuits which neutralize any D.C. in the circuit. That is, if a battery were connected across the line, proper manipulation of the potentiometer and switches A.A. would cause the E.M.F. of battery 30 to neutralize it.



## RADIO INTERNATIONAL TRANSFORMER

### Type TXL-101 A

**Price \$12.00 f. o. b. Factory**

A Standard Transformer modified and re-designed for amateur use. Coils are 1/16" copper, edgewise wound on bakelite supports. Assembly secured to end plates by bakelite nuts. Secondary slides on bakelite rods. This elimination of metal through-out results in maximum efficiency.

**PRIMARY INDUCTANCE** 12 micro henrys (Wavelengths 125 to 500 meters with .008 M. F. Cap.)

**SECONDARY INDUCTANCE** 40 micro henrys (Wavelengths 575 meters max. with average antenna.)

The Transformer illustrated above is only one of many newly designed radio specialties which we have ready for you. Write us for descriptive bulletins which are being issued covering all International Radio Products. Address Department No. 22.

**INTERNATIONAL RADIO TELEGRAPH COMPANY**  
326 Broadway New York, N. Y.



## 3 Inch Dial Indicator

### FOR SALE

BY ALL

## Radisco Agencies

AND BY

# A. H. CORWIN & CO.

4 West Park St. Newark, N. J.

No. 66 Dial only  
Postpaid 75c

No. 67 Dial with  
Bakelite Knob  
Postpaid \$1.30

## Wireless Taught By Mail

**COMMERCIAL RADIO DEMANDS THOUSANDS OF OPERATORS**

Men, women and boys, ages 15 to 45, needed at once for big land wireless offices, merchant marine, railroads, telegraph companies, lake and ocean steamships and aerial mail service. Salaries up to \$250 a month. Opportunities for promotion to radio engineer, government inspectors, mechanics, or radio electrician. Chance to see the world or locate in American land offices.

**COMPLETE COURSE BY MAIL IN TEN WEEKS**

Our students actually pass commercial examinations and secure professional license in ten weeks or less. Start studying now in spare time at home. We send you complete set practice instruments for receiving and sending messages while studying course. Positions guaranteed to all students who secure license. No previous experience or wireless education necessary. Write today for free book and particulars.

**NATIONAL RADIO INSTITUTE**  
Dept. 149, 14th and U Streets, N. W., Washington, D. C.





**THE "ILLINOIS" VARIABLE CONDENSER**  
Hard Rolled Aluminum Plates

Three Styles, No. 1, Panel, No. 2, Open Type as shown, No. 3, Fully Encased. Anti Profiteer. Less than pre-war prices. Fully assembled and tested.

Sent Prepaid on Receipt of Price

|                   |        |        |                                                            |
|-------------------|--------|--------|------------------------------------------------------------|
| Style No. 1       | No. 2  | No. 3  | Money back if not satisfied                                |
| 43 Plates, \$3.00 | \$3.50 | \$3.75 | ded. Just return condenser within 10 days by insured P. P. |
| 23 " 2.50         | 3.00   | 3.25   |                                                            |
| 13 " 2.25         | 2.75   | 3.00   |                                                            |

These condensers are made by a watch mechanic schooled in accurate workmanship. Personally we will need no introduction to Amateurs who have "listened in" for "time" and "weather" from 9. ZS.

G. F. Johnson, 627 Black Ave., Springfield, Ill.

**Buy the Best When You Buy**

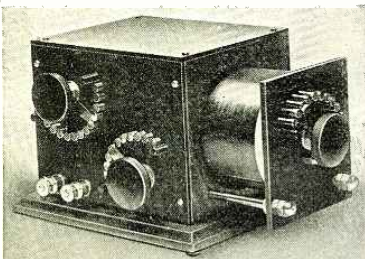

**THE BEST COSTS YOU LESS WHEN YOU BUY FROM US.**

This 200 to 2500 meter loose coupler costs \$18.00. You cannot buy a better instrument if you pay more.

**RADIO EQUIPMENT CO.**  
6302 Washington St. Boston, Mass.

**ACROMATIC TELESCOPE**



Made upon new scientific principles, nicely brass bound with powerful lenses, scientifically ground. Travelers, hunters, farmers, boy scouts and everyone needs a telescope! Have you ever enjoyed the marvels of a telescope? Each telescope guaranteed just as represented, or money promptly refunded. Send 99 cents to-day.

**EASTERN NOVELTY CO., Dept. 90 177 E. 93 St., New York**

**Be FREE from STAMMERING**

**HOME COURSE.** Physical Culture methods strengthen the voice organs. Simple exercises form the habit of easy, correct speech. Results **GUARANTEED or NO PAY.** Write for full particulars. **IT CAN BE DONE AT HOME.**

Sutherland School, Educational Bldg., 70 5th Av., N.Y.

**NEW ORLEANS WIRELESS SUPPLIES AND MINERALS OF ALL DESCRIPTIONS**

**L. A. ROSE**  
4323 MAGNOLIA STREET  
NEW ORLEANS, LA.  
Send 6 Cents for Catalogue

**SEND TO-DAY**  
For Catalog for Complete Line of **Receiving Apparatus**

**REMLER RADIO MFG. CO.**  
163 Sutter St. San Francisco, Calif.

**REPLACING AN INSULATOR AT SAYVILLE.**

At a height of 500 feet four chief petty officers in the radio branch of the naval service recently performed a perilous feat. Practically "lashed to the mast," they worked on the top of the main tower of the radio station at Sayville, L. I., renewing an insulator. The job took three days. Two of the days were very cold. The men were Chiefs Goesman, Welton, Johnson and Nielsen.

In order to install the new insulator the tension had to be relieved upon one of the three guy wires which hold the tower in a vertical position. This in itself was a delicate task and, if not carefully managed, the tower would have fallen. In order to accomplish the feat the men worked for a considerable time on a platform from which extended a long plank, the whole being about eighteen feet in length and built out horizontally eighteen feet from the tower. One of the men, his fingers numb, dropped a turnbuckle weighing about twenty pounds, which crashed through the roof of the main building, splintering a thick beam and by three feet missed hitting a man at work on the roof.

**HARVARD RADIO SCHOOL.**

During the war Harvard turned over a large number of its buildings to the Naval Radio School. Pierce Hall was the headquarters for the bluejackets who also used the Cruft Wireless Laboratory, Perkins, Austin and Hastings Halls, Memorial Hall and the gymnasium. Last winter and spring, after the armistice, the Naval Radio began to demobilize. Meanwhile, the new Harvard Engineering School had been formed. As the Navy vacated, workmen began to rip things to pieces and rapidly rebuilt laboratories for the permanent peace-time use of the new branch of the university.

The process of renovation has now been going on steadily for some five months. Pierce Hall has been considerably rebuilt, partitions put in by the Navy have been torn down and the whole building has been rewired and repainted. A model oil-burning plant has been substituted for the old coal-burning one and furnishes power for the school as well as light and heat for various neighboring buildings. A big set of electrical engineering laboratories second to none in range of quality of equipment has been installed, giving some fifteen to twenty thousand square feet of floor space for this subject alone. They are considered the best laboratories for electrical engineering in the country. At the other end of the building a wing has been set aside and fitted up for the study of the new and rapidly developing science of sanitary engineering. Pierce Hall is the headquarters building and contains most of the offices of the engineering staff, class rooms and the drafting rooms.

The Cruft Wireless Laboratory, which was in charge of the Naval Radio School during the war, is now at the disposal of the Harvard Engineering School students.

**PLAN 6,000 MILE WIRELESS**

It is proposed to erect a wireless station on the coast of British Columbia with a speaking radius of 6,000 miles, which would establish wireless communication with the Orient.

**PIN One Dollar TO COUPON**

Write your name and address plainly, mail us both, and by return mail you will receive your

**Skinderviken Transmitter BUTTON**



**Electro Importing Co.**  
231-A Fulton St., N. Y.

Gentlemen:—  
Enclosed please find One Dollar. Ship at once one Skinderviken Transmitter Button to

Name .....

Address .....

City .....

State .....



