

# RADIO NEWS

REC. U.S. PAT. OFF.

DECEMBER  
25 Cents

Over 200  
Illustrations



BROADCAST  
**WRNY**  
STATION



Edited by HUGO GERNSBACK

*a*  
MULTIPLE TELEVISION

(See Page 528)

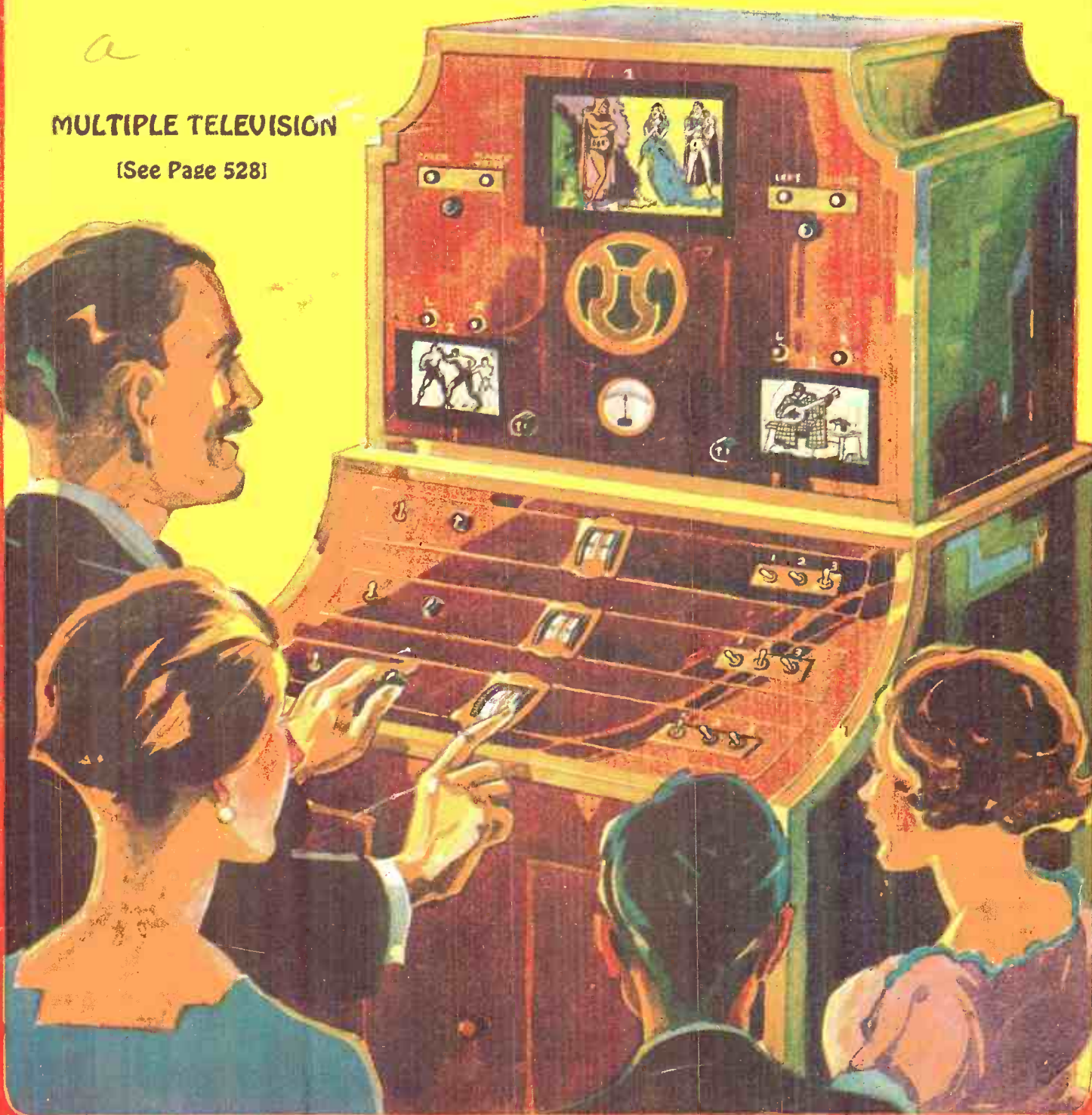

Radio Manufacturers Since 1908



TRADE MARK  
REG.

## PILOT Protects Radio Parts Buyers

The name PILOT stamped on a radio part guarantees scientific engineering and precision manufacture. You can secure Pilot Precision Radio Parts only at the better type dealers.

### RADIO DESIGN

Construction Quarterly. Send 25c coin or stamps for 4 meaty issues.

Radio Design  
103R Broadway  
Brooklyn, N. Y.

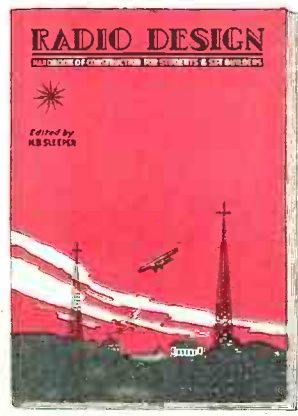

PILOT  
ELECTRIC MFG. CO., INC.

323 Berry Street  
Brooklyn, N. Y.

World's Largest  
Radio Parts Plant

# EARNED \$500 SPARE TIME WITH RADIO

Coplay, Pa., June 4—(RA)—During the few months that Frank J. Deutsch has been a member of the Radio Association of America, he has made over \$500 out of Radio in his spare time.

"Four super-heterodyne sets of my own construction brought me a profit of \$60.00 each, and the other profit was from sales of supplies purchased through the Wholesale Department of the Association," he said. "The Association certainly has a great plan for ambitious men."

In a neighboring state, Werner Eichler, Rochester, N. Y., another member of the Association, has been making \$50 a week during his spare time.

They are only two of the hundreds of Radio Association members who are making money out of Radio in their spare time.

# BECOMES RADIO ENGINEER IN ONE YEAR

Toronto, Canada, May 20—(RA)—One of the newly admitted associate members of the Institute of Radio Engineers is Claude DeGrave, a member of the engineering staff of the DeForest Company of this city. "I knew nothing about Radio and started from the ground up," Mr. DeGrave stated, "when I enrolled a year ago in the Radio Association. Its easy lessons and superb training made it possible for me to become a Radio Expert in less than a year's time. My income is now about 225% more than at the time I joined the Association."

The Institute of Radio Engineers is a well-known organization, so that Mr. DeGrave has reason to be proud of his election.

# Clerk Doubles Income In Six Months Through Radio

Chicago, Ill., May 9—Even though his membership in the Radio Association has resulted in W. E. Thon securing the managership of a Radio Department in a large Chicago store, his ambition was not satisfied. Six months later, he started his own store.

"The Radio Association has an excellent plan for the man who wants to get out of the rut and succeed," says this man who quickly rose from clerkdom to the proprietorship of a profitable radio store. "I attribute my success entirely to the Radio Association of America. Six months after I had enrolled, I had doubled my income through its help."

# 5 Easy Ways to make \$3<sup>00</sup> an hour in Your Spare Time in RADIO

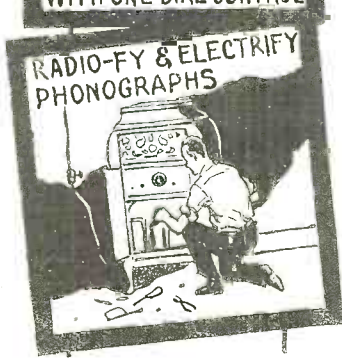

EACH of these plans, developed by the Radio Association of America, is a big money-maker. Set owners everywhere want to get rid of static, to have their sets operate from the electric light socket, the tone improved, and the volume increased, and transformed into single-dial controls. Phonograph owners want their machines electrified and radiofied. If you learn to render these services, you can easily make \$3.00 an hour for your spare time, to say nothing of the money you can make installing, servicing, repairing, building radio sets, and selling supplies.

Over \$600,000,000 is being spent yearly for sets, supplies, service. You can get your share of this business and, at the same time, fit yourself for the big-pay opportunities in Radio by joining the Association.

## Join the Radio Association of America

A membership in the Association offers you the easiest way into Radio. It will enable you to earn \$3.00 an hour upwards in your spare time—train you to install, repair, and build all kinds of sets—start you in business without capital or finance an invention—train you for the \$3,000 to \$10,000 big-pay radio positions—help secure a better position at bigger pay for you. A membership need not cost you a cent!

The Association will give you a comprehensive, practical, and theoretical training and the benefit of our Employment Service. You earn while you learn. Our cooperative plan will make it possible for you to establish a radio store. You have the privilege of buying radio supplies at wholesale from the very first.

## ACT NOW—If you wish No-Cost Membership Plan

To a limited number of ambitious men, we will give Special Memberships that may not—need not—cost you a cent. To secure one, write today. We will send you details and also our book, "Your Opportunity in the Radio Industry." It will open your eyes to the money-making possibilities of Radio.

MAIL THIS COUPON NOW

RADIO ASSOCIATION OF AMERICA  
Dept. RN-12, 4513 Ravenswood Ave.,  
Chicago, Ill.

Gentlemen:  
Please send me by return mail full details of your Special Membership Plan, and also copy of your book, "Your Opportunity in the Radio Industry."

Name.....  
Address.....  
City..... State.....

# RADIO NEWS

Volume 10

DECEMBER, 1928

Number 6

HUGO GERNSBACK, Editor-in-Chief

ROBERT HERTZBERG, Managing Editor

C. P. MASON, Associate Editor

BERYL B. BRYANT, Laboratory Director

C. WALTER PALMER, Director Information Service

## Contents of This Issue

Alternating-Current Set Operation By Hugo Gernsback	523	Some Easy Experiments with Oscillators By Clyde A. Randon	554
Television Makes the Radio Drama Possible By Robert Hertzberg	524	A Unique "No-Dial" Receiver By Hanns Mendelsohn	556
"Multiple Television"—A Forecast	528	Socket-Power Operation for the Old Set	557
Novel Radio Equipment for Airplanes	530	Radio Wrinkles	558
Equipment for Television Experiments By H. M. Bayer	531	On the Short Waves	560
New Disc Keeps Down Image-Frequency By Robert Hertzberg	534	List of Broadcast Station Calls	562
Several Wavelengths Used for High-Frequency Radio Movies and Television	535	RADIO NEWS Laboratories	564
Complex Televisors to Give Large Images By Herndon Green	536	Review of Recent Radio Literature	565
What's New in Radio	538	The Radio Constructor's Own Page By Himself	566
The Fifth Annual Radio World's Fair	542	I Want to Know By C. W. Palmer	567
How Inventors May Guard Their Rights By Leo T. Parker	543	RADIO NEWS Free Blueprint Coupon	570
The Radio Beginner—An Adjustable "B" Power Unit	544	Problems of Handling Big Amplifier Output	572
A Plugless Short-Wave Receiver By P. M. Platten	548	Australia's Edition of the Peridyne	574
How to Succeed in Short-Wave Operation By H. M. Bayer	552	Statement of Ownership, etc.	583
		Why the Vacuum in Vacuum Tubes	585
		250-Type Tubes Designed for Large Amplifiers	590

RADIO NEWS is published on the 10th of each preceding month. There are 12 numbers per year. Subscription price is \$2.50 a year in U. S. and possessions. Canada and foreign countries, \$3.00 per year. U. S. Coin as well as U. S. Stamps accepted (no foreign coins or stamps). Single copies, 25 cents each. Checks and money orders should be drawn to order of EXPERIMENTER PUBLISHING CO., INC.

All communications and contributions to this journal should be addressed to Editor, RADIO NEWS, 230 Fifth Ave., New York, N. Y. Unaccepted contributions cannot be returned unless full postage has been included. All accepted contributions are paid for on publication. A special rate is paid for novel experiments; good photographs accompanying them are highly desirable. Publishers are not responsible for loss of manuscripts, although every precaution is taken with such manuscripts, upon receipt thereof.

RADIO NEWS. Monthly. Entered as second-class matter, July 12, 1924, at the Post Office at New York, N. Y., under the Act of March 3, 1879. Additional entry at Dunellen, N. J. and San Francisco, Calif. Title registered U. S. Patent Office. Copyright, 1928, by The Experimenter Publishing Co., Inc., 230 Fifth Ave., New York. The contents of this magazine are copyrighted and must not be reproduced in the United States without giving full credit to the publication. Translation into foreign languages must not be made unless permission is

The contents of RADIO NEWS are indexed in the Industrial Arts Index, copies of which can be found in every library.

obtained from the publishers. Copyrighted in Germany. Reproduction of articles in Germany is reserved for Radio, Berlin 42.

RADIO NEWS is for sale at all newsstands in the United States and Canada, and at Brentano's, Ave. de L'Opera, Paris, France. European agents: S. J. Wise Et Cie, 40 Place Verte, Antwerp, Belgium.

HOW TO SUBSCRIBE FOR RADIO NEWS. Send your name, address and remittance to Experimenter Publishing Co., 230 Fifth Ave., New York. Mention the name of the magazine you are ordering. We also publish SCIENCE AND INVENTION, RADIO LISTENERS' GUIDE and AMAZING STORIES. Write clearly.

RATES AND TERMS. The subscription rate for RADIO NEWS is \$2.50 per year. (12 numbers). When remitting do so by check, money order, or registered letter if cash is enclosed. Avoid sending cash through the mail if possible. Subscriptions for less than one year are not accepted. Subscription may be made in combination with SCIENCE & INVENTION, RADIO LISTENERS' GUIDE, and AMAZING STORIES.

POSTAGE. We prepay postage in all parts of the United States, Mexico and island possessions. For foreign or Canadian subscriptions we require 50 cents in addition to the subscription price for additional postage charge.

CHANGE OF ADDRESS. Notify us as far in advance as possible. It requires several weeks to make an address change on our records. Always write clearly.

Published by **Experimenter Publishing Company, Inc.**

H. GERNSBACK, President

S. GERNSBACK, Vice-President and Treasurer IRVING S. MANHEIMER, Secretary

Member: Audit Bureau of Circulations

Radio Magazine Publishers Association

Advertising Representatives: RHODES &amp; LEISENRING

New York Offices: 624 Graybar Building

Chicago Offices: 307 North Michigan Ave

Editorial and General Offices

230 Fifth Avenue, New York City

# Learn Electricity By Actual work—not Books in 12 weeks at Coyne



Students Doing Actual Work on Power Transmission Apparatus

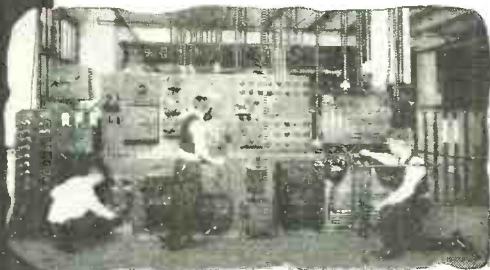

Students Working on Massive A. C. Control Equipment.



Students Practicing House-Wiring In Skeleton Houses

**Learn to Earn \$65 to \$200 a Week!  
Or Go In Business for  
Yourself and Make \$3,500  
to \$15,000 a Year**

Yes, 3 months at the *Great School of Coyne*, located in Chicago, The Electrical Center of the World, will make you an *Electrical Expert* capable of commanding big pay. The whole world of electricity is open to the practical man—the man who has had actual experience with electrical apparatus. Coyne gives you a practical training on the greatest outlay of electrical apparatus of any institution in the World, everything from door bells to power plants.

### Not a Correspondence School

We don't make you a mere "paper" electrician, We train you by practice on our mammoth outlay of actual equipment. We train you in house-wiring by having you do it exactly as it is done outside—not just by reading about it. The same applies to armature winding, power plant operating, motor installations, automotive work and hundreds of other electrical jobs. That's why we can train you to become a *Master Electrical Expert*.

### Learn by Doing—Not by Books

The Coyne practical course is not books, or useless theory. We train you to work with your head and hands on the same kind of electrical apparatus as you will find "out in the field." Age, lack of experience or education is no drawback. Our students range from 16 to 60 years of age. Coyne gives you Free a Life Scholarship which enables you to stay as long as you want without extra charge or return later for more practice, and assists you to a position after graduation. We also include Free a course in radio.

### EARN WHILE YOU LEARN!

*We help students to secure jobs to earn a good part of their living expenses while studying and give you lifetime employment service after graduation.*

**Send For Free Book**

Send for the Big Free Book which shows the Great School of Coyne and a great part of our massive electrical equipment. You will be convinced that the only place to get a practical electrical training is in the Great School of Coyne.

**COYNE ELECTRICAL SCHOOL**  
H. C. LEWIS, President

500 S. Paulina St., Dept. 98-77 Chicago, Ill.

**FILL IN ~MAIL TODAY**

H. C. LEWIS, President  
Coyne Electrical School  
500 S. Paulina Street, Dept. 98-77

Dear Sir: Please send me free your big catalog and full particulars of your special offer.

Name.....

Address.....

# INDEX TO ADVERTISERS

PAGE	PAGE	PAGE	PAGE
<b>A</b>			
Acme Wire Co., The..... 580	Dresner Radio Mfg. Corp. .... 598	Keystone Products Co. .... 602	Radio Doctors, Inc. .... 595
Aerial Insulator Co. .... 584	Dubilier Condenser Corp. .... 580	Kimley Electric Co. .... 584	Radio Equipment Co. .... 597
Aero Products, Inc. .... 602	<b>E</b>		
Aerovox Wireless Corp. .... 572	Electrad, Inc. .... 573-589	Knapp Electric, Inc. .... 579	Radio Institute of America .... 576
All Radio Co. .... 602	Electric Specialty Co. .... 590	Kodel Electric & Mfg. Co. .... 581	Radio Producer Co. .... 585
Allied Radio Corp. .... 583-587-593-594-608	Electro Chemical Co. of America 574	<b>L</b>	
American Radio Hardware Co. 584	Elkon, Inc. .... 520	Lacey & Lacey ..... 598	Rauner Radio Co. .... 584
American Radio & Merc. Co. .... 585	Etched Products Corp. .... 584	Lancaster & Allwine ..... 586	Radio Specialty Co. .... 573
American Sales Co. .... 590-597	Excello Products Corp. .... 607	Lee House, The ..... 599	Raytheon Radio Co. .... 592
American Transformer Co. .... 577	<b>F</b>		
Arcturus Radio Corp. .... 592	Fahnestock Electric Co. .... 584	Leutz, Inc., C. R. .... 521	Raytheon Mfg. Co. .... 592
<b>B</b>			
Barawik Co. 572-574-576-578-580-582-584-585-589-592-594-599-600-602	Fansteel Products, Inc. .... 584	Lincoln Radio Corp. .... 584	Royal Eastern Electric Supply Co. .... 589
Belden Mfg. Co. .... 582	Ferbend Electric Co. .... 584	Littlefuse Laboratories ..... 572	<b>S</b>
Birnback Radio Co. .... 584	Ferranti, Inc. .... 600	Lund Mfg. Co., I. A. .... 584	Samson Electric Co. .... 584
Bodine Electric Co. .... 584	Flechtheim & Co., Inc., A. M. 583	<b>Mc</b>	
Braun, W. C. .... 584	Freshman Co., Inc., Chas. .... 600	McSweeney Electrical Schools .. 576	Scott Transformer Co. .... 602
Browning-Drake Corp. .... 599	Fritts & Co., D. H. .... 584	<b>M</b>	
<b>C</b>			
Carborundum Co., The ..... 600	<b>G</b>		
Carter Radio Co. .... 578	General Radio Co. .... 576	<b>N</b>	
CeCo Mfg. Co., Inc. .... 578	<b>H</b>		
Central Radio Labs. .... 594	Hammarlund Mfg. Co. .... 595	National Company, Inc. .... 594	Teleplex Co. .... 574
Century Radio Panel Corp. .... 584	Hammarlund-Roberts, Inc. .... 522	National Electrical School ..... 572	Televocall Corp. .... 582
Chemical Institute of N. Y., Inc. 596	High Frequency Labs. .... 593	National Radio Institute ..... 571	Thordarson Elec. Mfg. Co. .... 569
Chicago Radio Apparatus Co. .... 592	Hotel Lafayette ..... 578	National School of Visual Education ..... 570	Townsend Labs. .... 583
Chicago Stock Gear Works ..... 586	<b>I</b>		
Clark & Tilson, Inc. .... 576	Illinois Aransformer Co. .... 599	New England Mills Co. .... 598	Transformer Corp. of America.. 586
Clarostat Mfg. Co. .... 580	Independent Electric Works ..... 576	Newark Electric Co. .... 584	Tyrman Electric Corp. .... 603-604-605-606
Conrad Co., Inc., The..... 598-600	Insuline Corp. of America .... 584	Norden-Hauk, Inc. .... 587-591	<b>T</b>
Cornish Wire Co. .... 584	<b>J</b>		
Cortlandt Panel Engraving Co. .... 584	J-M-P Mfg. Co., Inc. .... 599	<b>O</b>	
Coyne Electrical School ..... 515	<b>K</b>		
Craftsman Radio Products ..... 592	Karas Electric Co. .... 587-591-593-602	O'Neil Mfg. Co. .... 584	<b>U</b>
Cunningham, Inc., E. T. .... 572	Kato Engineering Co. .... 572	<b>P</b>	
<b>D</b>			
DeForest Radio Co. .... 596	Kelsey Co. .... 594	Patent Elec. Co. .... 584	Underground Aerial Systems Inside Back Cover
De Jur Products Co. .... 584	<b>M</b>		
<b>E</b>			
<b>M</b>			
<b>N</b>			
<b>O</b>			
<b>P</b>			
<b>Q</b>			
<b>R</b>			
<b>S</b>			
<b>T</b>			
<b>U</b>			
<b>V</b>			
<b>W</b>			
<b>X-Y-Z</b>			
Quality Transformer Co. .... 584	Radiall Co. .... 580-591	Pathfinder ..... 576	X-L Radio Laboratories ..... 602
Radiall Co. .... 580-591	Radio Association of America ... 513	Perryman Electric Co., Inc. .... 584	Yaxley Mfg. Co. .... 582
Radio Association of America ... 513		Pilot Electric Co. .... Inside Front Cover	
		Potter Mfg. Co. .... 585	
		Press Guild, Inc. .... 586	
		Quality Transformer Co. .... 584	

## \$200.00 For Patent Information!

A radio institution desires to obtain documentary information on three well-known radio apparatus.

The concern is desirous to obtain evidence that the apparatus which were patented in another country were already used in the United States, prior to the patents.

The information wanted must be in the form of printed matter, which was published prior to the dates given below. There are four patents in question, and the Company will pay \$50.00 for each set of documents. The Company cannot use typewritten, mimeographed or handwritten evidence. It must be printed evidence, such as catalogs, newspapers, magazines, etc. If the original cannot be obtained, a photographic copy will serve the purpose.

The editors of RADIO NEWS have been chosen as judges, and the full amount will be paid to those who submit the most comprehensive evidence. If no evidence is produced, the cash amounts will not be paid.

Please study the illustrations, and note particularly that the documentary evidence must be prior to the dates given.

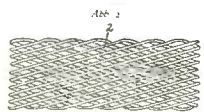
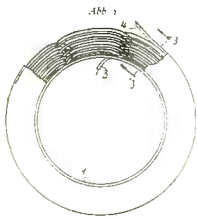

(1) One Patent concerns all so-called honeycomb coils. Evidence is wanted prior to April 4, 1919.

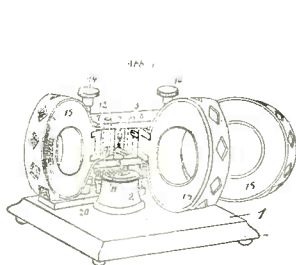

(2) Another Patent concerns couplers and coupling arrangements for all plug-in coils, similar to those shown in illustration, published prior to August 20, 1919 wanted.

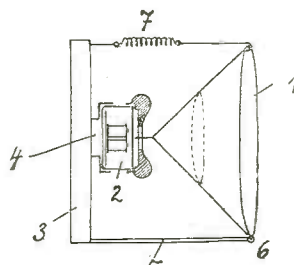

(3) Other Patents relate to Cone Loud Speakers. The data against these pertains to all Cone Speakers, without horns, where a cone is vibrated from an electro magnetic system. The prior date for this must be before November 22, 1919.

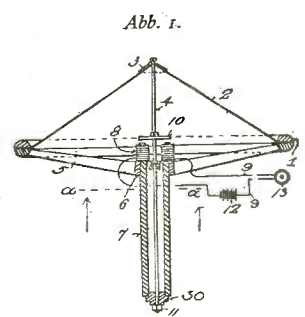

(4) Same as Fig. 3.

Address all correspondence in connection with the above to Box No. 16, c/o  
RADIO NEWS, 230 Fifth Avenue, New York City.

### Read what BIG money these fellows have made in the RADIO BUSINESS

#### \$375 One Month Spare Time



"Recently I made \$375 in one month in my spare time installing, servicing, selling Radio sets. And, not so long ago, I earned enough in one week to pay for my course."  
EARLE CUMMINGS,  
18 Webster St., Haverhill, Mass.

#### \$1597 In Five Months



"The N. R. I. is the best Radio school in the U. S. A. I have made \$1597 in five months. I shall always tell my friends that I owe my success to you."  
HENRY J. NICKS, Jr.,  
302 Safford Ave.,  
Tarpon Springs, Fla.

#### \$1164 Spare Time Profits



"Look at what I have made since I enrolled, \$1,164—money I would not have had otherwise. I am certainly glad I took up Radio with N. R. I. I am more than satisfied."  
HENRY R. HEIKKINEN,  
123 W. Erie St., Chicago, Ill.

#### Over \$1000 In Four Months



"My opinion of the N. R. I. course is that it is the best to be had at any price. When I enrolled I didn't know a condenser from a transformer, but from December to April I made well over \$1000 and I only worked in the mornings."  
AL JOHNSON,  
1109 Shelby St., Sandusky, Ohio.

# I will show you too how to start a spare time or full time Radio Business of Your Own without capital



Radio's amazing growth is making many big jobs. The worldwide use of receiving sets and the lack of trained men to sell, install and service them has opened many splendid chances for spare time and full time businesses.

Ever so often a new business is started in this country. We have seen how the growth of the automobile industry, electricity and others made men rich. Now Radio is doing the same thing. Its growth has already made many men rich and will make more wealthy in the future. Surely you are not going to pass up this wonderful chance for success.

#### More Trained Radio Men Needed

A famous Radio expert says there are four good jobs for every man trained to hold them. Radio has grown so fast that it simply has not got the number of trained men it needs. Every year there are hundreds of fine jobs among its many branches such as broadcasting stations, Radio factories, jobbers, dealers, on board ship, commercial land stations, and many others. Many of the six to ten million receiving sets now in use are only 25% to 40% efficient. This has made your big chance for a spare time or full time business of your own selling, installing, repairing sets.

#### So Many Opportunities You Can Make Extra Money While Learning

Many of our students make \$10, \$20, \$30 a week extra while learning. I'll show you the plans and ideas that have proved successful for them—show you how to begin making extra money shortly after you enroll. G. W. Page, 1807-21st Ave., S., Nashville, Tenn., made \$935 in his spare time while taking my course.

how to begin making extra money shortly after you enroll. G. W. Page, 1807-21st Ave., S., Nashville, Tenn., made \$935 in his spare time while taking my course.

#### I Give You Practical Radio Experience With My Course

My course is not just theory. My method gives you practical Radio experience—you learn the "how" and "why" of practically every type of Radio set made. This gives you confidence to tackle any Radio problems and shows up in your pay envelope too.

You can build 100 circuits with the Six Big Outfits of Radio parts I give you. The pictures here show only three of them. My book explains my method of giving practical training at home. Get your copy!

#### I Will Train You At Home In Your Spare Time

I bring my training to you. Hold your job. Give me only part of your spare time. You don't have to be a college or high school graduate. Many of my graduates now making big money in Radio didn't even finish the grades. Boys 14, 15 years old and men up to 60 have finished my course successfully.

#### You Must Be Satisfied

I will give you a written agreement the day you enroll to refund your money if you are not satisfied with the lessons and instruction service when you complete the course. You are the only judge. The resources of the N. R. I. Pioneer and Largest Home-Study Radio school in the world stand back of this agreement.

#### Get My Book

Find out what Radio offers you. My 64-page book, "Rich Rewards in Radio" points out the money making opportunities the growth of Radio has made for you. Clip the coupon. Send it to me. You won't be obligated in the least.

*This Book points out what Radio offers you Get a copy!*



#### Address

J. E. Smith, Pres.  
Dept. 44S

National Radio Institute  
Washington, D. C.

**This coupon is good for a FREE copy of my Valuable Book. Mail it NOW!**

J. E. Smith,  
President,  
Dept. 44S  
National Radio Institute, Washington, D. C.

Dear Mr. Smith: Send me your book. I want to know more about the opportunities in Radio and your practical method of teaching at home in spare time. This request does not obligate me to enroll and I understand no agent will call on me.

Name.....Age.....  
Address.....  
City.....State.....

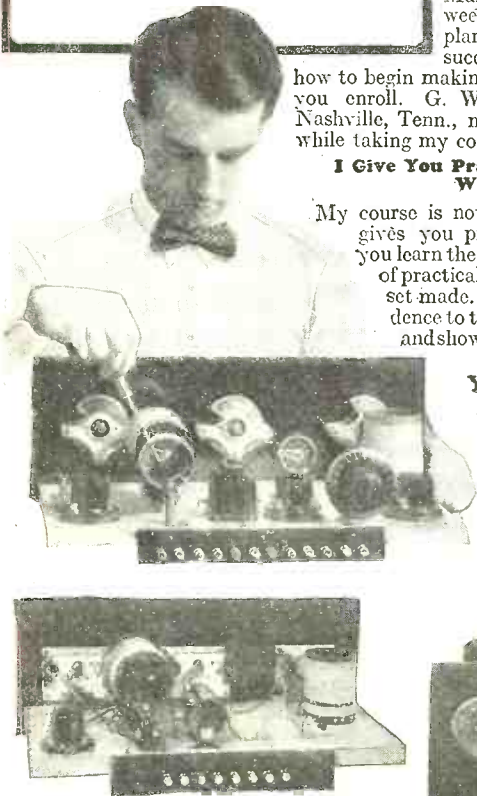

# SM

## We Think You Ought to Know—

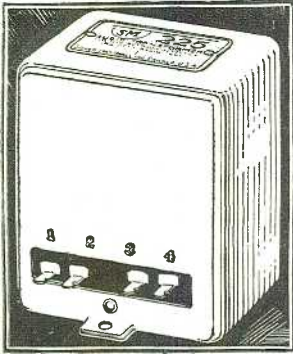

**T**ONE quality is elusive. We can prove, by laboratory measurements and curves, that the new Clough system audio transformers come closer to absolutely faithful reproduction than any others we have ever been able to find, at any price. That may prove nothing to you—but *it's true*, nevertheless. One by one, we are getting reports of tests—made by impartial engineers for manufacturers and others—agreeing with our own findings that *there is nothing on the market to match the tone quality of S-M Clough system audio transformers*. That's what the engineers in the world's largest telephone laboratories said. It's what the professors of an old New England engineering school decided.

To prove this to the public, here are the two fairest ways we know of—and we're taking both of them:

**FIRST:** We are building, and operating in the most public places we can find—the big radio shows, hotels, dealers' show rooms—*comparison amplifiers*, with switches to interchange instantly two sets of audio transformers in the same circuit. We are so well satisfied with the sales of S-M audios resulting from this "hard-boiled" method that we printed and distributed 35,000 copies of an article telling dealers and set-builders how to build such a "comparator". Do you know of any other transformer manufacturer who is doing that? If not, why is S-M the only one who is?

**SECOND:** We are guaranteeing absolutely that the S-M Clough-System transformers *large or small* cannot be surpassed by *any* of the conventional type not utilizing the Clough invention with its practical elimination of hysteretic distortion—at *any price whatsoever*.

If you have the equipment, by all means verify yourself the sweeping claims we make. If you haven't—then listen to one of the public S-M comparator tests. If you can't do that—try a pair. Ask your own ears! We think you ought to know.

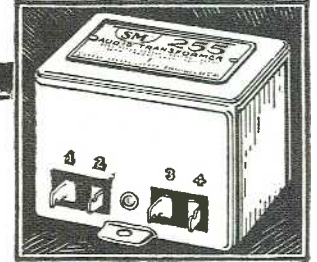

### NOW—Theatre Volume from Any Phonograph at Low Cost

Used with any dynamic speaker having a 90 to 110 volt field—or with two dynamic speakers and supplying the field current for one—the new S-M 678PD Phonograph Amplifier will take the input from any phonograph magnetic pick-up—or from the detector of a radio set, using adapter plug—and boost it to the tremendous volume output of a 250 tube with the tone fidelity and freedom from hysteretic distortion provided only by the new S-M Clough-system audio transformers. It operates entirely from any 105 to 120 volt, 60 cycle light socket and requires: one '81, one '26, and one '50 type tube. Price of complete kit, \$66.00, or wired \$73.00.

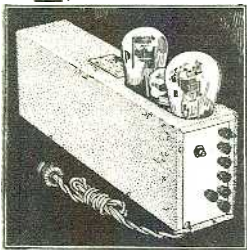

### Record of Audio Transformer Tests

*E* is the two-stage curve for the large-size transformers (S-M 225, 1st stage; and 226, 2nd stage; \$9.00 each; *D* is that of the smaller ones (S-M 255 and 256, \$6.00 each). Note the marked advantage over A, B, and C—a 11 standard eight and ten dollar transformers under equal conditions.

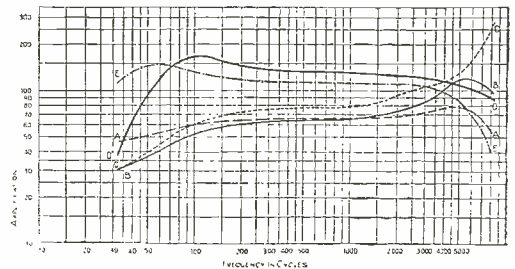

Are you receiving "The Radiobuilder" regularly? No. 5 shows how to build an amplifier for comparing audio transformers. No. 6 tells all about the new S-M Public Address Amplifier. To all Authorized S-M Service Stations, it comes free of charge; to others a nominal charge is made. Use the coupon.

If you build professionally, write us about the Service Station franchises. Or if you don't build, yet want your radio to be custom-made, S-M will gladly refer your inquiry to an Authorized Silver-Marshall Service Station near you.

**ONE** of our cooperating distributors, whose announcement directly follows, joins us in presenting a descriptive summary of some of the outstanding values to be found in the new S-M line.

**SILVER-MARSHALL, Inc.**  
848 West Jackson Blvd., Chicago, U. S. A.

Silver-Marshall, Inc.  
848 W. Jackson Blvd., Chicago, U. S. A.  
Please send me, free, the complete S-M Catalog; also sample copy of The Radiobuilder.  
For enclosed ..... in stamps, send me the following:  
..... (30c) Next 12 issues of The Radiobuilder  
..... (\$1.00) Next 25 issues of The Radiobuilder  
S-M DATA SHEETS as follows, at 2c each:  
..... No. 1. 670B, 670ABC Reservoir Power Units  
..... No. 2. 685 Public Address Unipac  
..... No. 3. 730, 731, 732 "Round-the-World" Short Wave Sets  
..... No. 4. 225, 226, 255, 256, 251 Audio Transformers  
..... No. 5. 720 Screen Grid Six Receiver  
..... No. 6. 740 "Coast-to-Coast" Screen Grid Four  
..... No. 7. 675ABC High-Voltage Power Supply and 676 Dynamic Speaker Amplifier  
..... No. 8 Sargent-Rayment Seven  
..... No. 9 678PD Phonograph Amplifier  
..... Name  
..... Address



# SM

## You'll Find It ALL in S-M— Why Go Further?



720

**720 Screen Grid Six**  
The new S-M 720 embodies in the most perfect form the revolution that screen-grid tubes have brought about in long-distance reception. Three of these tubes in the R.F. stages, with shielded S-M coils, bring in distant stations on the next 10 kc. channel to powerful locals! The new S-M 255 and 256 transformers set a far higher standard of tone quality than ever known before. Custom-built complete in 700 cabinet, \$102.00; complete kit, with pierced metal chassis and antique brass escutcheon but without cabinet, \$72.50.



700

**700 Shielding Cabinet**  
Beautiful two-tone brown moire finish, with walnut finish wood base, \$9.25.

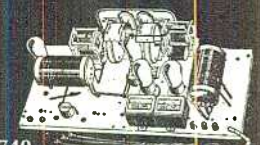

740

**740 Coast-to-Coast Four**  
A time-tested and famous circuit—one R.F. stage, regenerative detector (non-radiating) and two A.F. stages—combined with immeasurably finer coils, the high efficiency of the screen-grid tube, all the gain of smooth-working regeneration, and new S-M Clough-system audios, make the 740 the greatest value in the fifty-dollar class. WIRED in 700 cabinet: 740 (for D.C. tubes) \$75; 740AC (A.C. tubes) \$78. Kit less cabinet: 740, \$51; 740AC, \$53.

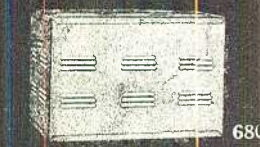

680

**680 Series Unipacs**  
Perfect reproduction and hum-free light-socket operation have made S-M Unipacs famous. There are four types: two single-stage, and two two-stage models, using 210 or 250 tubes singly and in push-pull. Each Unipac supplies 45, 90, and 135 volts B to receivers, and two-stage models supply in addition 1½ and 2¼ volts for A.C. tube filaments. Available as kit or wired. Prices from \$81.50 to \$117.

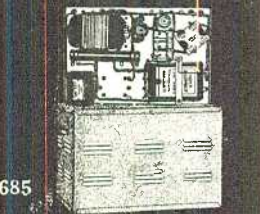

685

**685 Public Address Unipac**  
For coverage of crowds of 1,000 to 10,000 people, indoors or outdoors, with one to twelve loud-speakers, the 685 Public Address Unipac furnishes unequalled tonal clearness. It uses one UX227, one UX226, one UX250, and two UX281 rectifiers in three stages for microphone, radio or record pick-up amplification. 685 WIRED Unipac is priced at \$160.00; or 685 KIT, \$125.00.

**710 Sargent-Rayment Seven**  
Designed by two famous engineers to give the very extreme of results now possible in broadcast reception, irrespective of cost, the S-M 710 Sargent-Rayment Seven sets an entirely new standard. Exhausting the tremendous distance possibilities of 4-screen-grid R.F. stages—bringing in a station on every 10-kilocycle channel right around its single-control dial (with five auxiliary vernier knobs)—equipped with the unequalled S-M Clough system audio amplifier—yet the 710 is only \$175 custom-built complete, or \$130 for kit including aluminum cabinet.

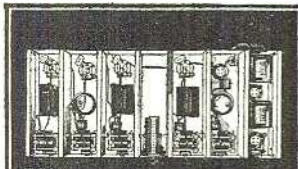

710

**730 Round-the-World Four**  
The famous "Thrill Band" set—for long-distance broadcast reception; has S-M Clough-audio-system tone quality—splendid also for code. One screen-grid R.F. stage, regenerative (non-radiating) detector. Coils in kit tune from 17.4 to 204 meters; S-M 131X Coil (\$1.25) extends range to 350 meters, and 131Y coil (\$1.50) to 650 meters. Aluminum shielding cabinet included with 730 KIT \$51, or fully WIRED \$66. Also with 731 Adapter (plugs into any receiver, converting it to short wave) KIT \$36, WIRED \$46. 732 Essential Kit, \$16.50.



710

**B and ABC Power Supplies**  
The 675ABC with an adapter allows a UX210 or UX250 power tube to be used in the last stage of any radio receiver—to which it supplies B power at 425, 135, 90, and 22 volts; also 22-90 variable. A and C power are supplied to the power tube, and 1½ and 2¼ volts for A.C. tubes if used. Uses one UX281 rectifier. Price \$58 WIRED, or \$54 in KIT form.

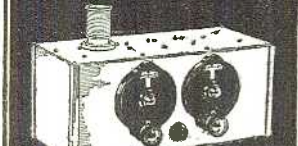

730

670ABC Power Supply has max. B voltage of 180; otherwise similar to the 675ABC. Price, WIRED, \$46; KIT \$43.  
670B Power Supply for B power only, 180 volts max., and lower voltages as in 675ABC: WIRED \$43.50; KIT \$40.50.

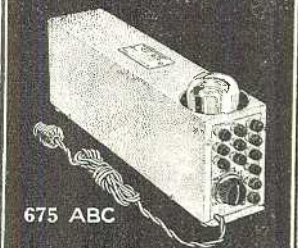

675 ABC

**676 Dynamic Speaker Amplifier**  
A single-stage power amplifier, using one 250 type power tube and one 281 type rectifier. Used with any receiver, as a third stage before a dynamic speaker, it will give wonderfully improved volume and tone quality, WIRED, \$55; KIT \$49.

### We Specialize in All S-M Parts and Kits

Every item in the S-M line, including the new 678PD Phonograph Amplifier and Clough-system audios, as well as other popular and high quality radio parts, can be shipped immediately from our tremendous stock. Get our catalog now. Best discounts to the trade.

## Wholesale Radio Service Co.

A Service of Excellence to the Dealer

6 Church Street

New York City

### Mail the Coupon Now!

WHOLESALE RADIO SERVICE CO.  
6 Church Street, Dept. RN-12  
New York, N. Y.

Please send your new FREE catalog, listing a full line of S-M kits and parts, as well as all other standard brands of radio products for the setbuilder.

Name.....

Address.....

Town..... State.....

# THE AMAZING NEW 5000 HOUR ELKON RECTIFIER FOR "B" ELIMINATORS

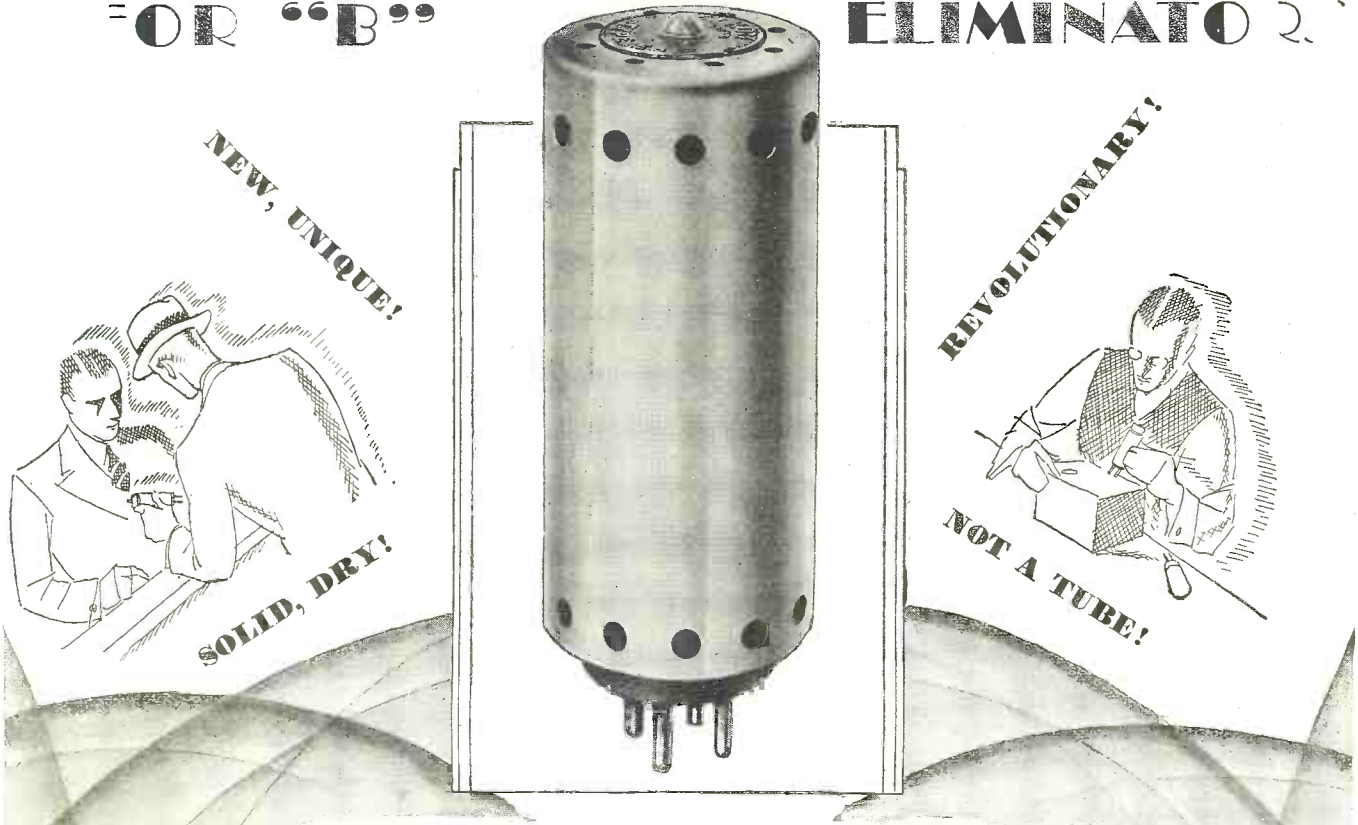

## ONLY 200,000 AVAILABLE THIS SEASON

JUST as the Elkon dry, low-voltage rectifier revolutionized the design of chargers and "A" Eliminators, the new Elkon "B" type Rectifier will revolutionize the design of "B" Eliminators.

The Elkon EBH Rectifier plugs into any Eliminator using the former standard "B" rectifier tube. Simply take out the fragile 1,000 hour tube—plug in the husky Elkon EBH and the change is made. No changes in wiring—no adjustments.

It is sturdy, solid, dry—has none of the frailties of a tube—not affected by accidental overloads or line surges. It is self healing. The power is smoother, quieter.

From the orders already received from dealers and jobbers in all parts of the country, we know that we will be tremendously oversold this season—only 200,000 of these revolutionary rectifiers will be available.

The elaborate manufacturing, testing and aging equipment necessary to produce the Elkon EBH Rectifier precludes any greater production the first year.

Look for the Red and Yellow display carton on your dealer's shelves. The new EBH is packed in a metal can.

Buy one from your dealer today! Plug it into your "B" Eliminator—Trouble free for at least 5,000 hours!

**ELKON, INC.**

Division of  
P. R. Mallory & Co., Inc.

350 MADISON AVE., NEW YORK CITY

ELKON, Inc., Dept. E-25  
350 Madison Ave., New York City  
Gentlemen: Please send me complete information on Elkona Quality Radio Products.  
Name \_\_\_\_\_  
Address \_\_\_\_\_

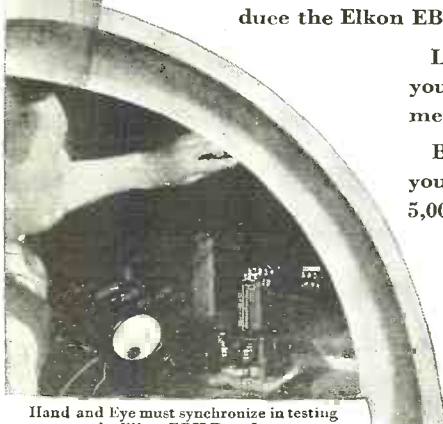

Hand and Eye must synchronize in testing the Elkona EBH Rectifier

Please say you saw it in RADIO NEWS

# THE NEW LEUTZ UNIVERSAL TRANSOCEANIC

9 TUBES

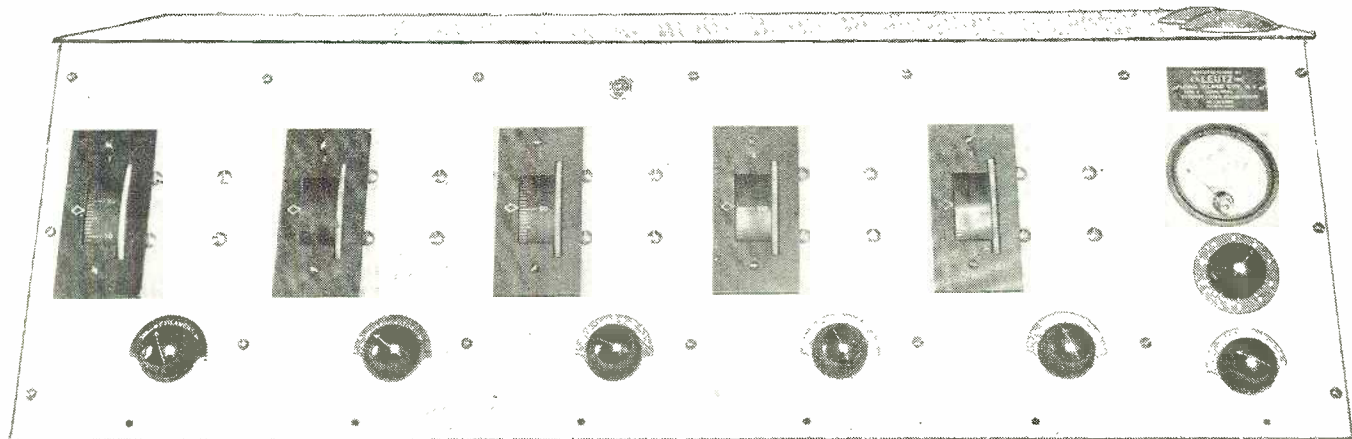

## WITH FOUR UX222's AND 2—UX210's OR 2—UX250's

**D**URING the past two years less than one thousand Universal Transoceanic Phantoms have been manufactured. They have been shipped to points in every state in the Union, every province of Canada, Alaska, Hawaii, Philippine Islands, Porto Rico, and practically every foreign country in the world. In practically every instance the new owner of the Transoceanic Phantom has written to us expressing complete satisfaction and reporting results far superior to any competitive makes used in the same vicinity.

There is no mystery connected with the superior performance of Leutz radio receivers. In 1922, seven years ago, Leutz had 8 and 10 tube Super-Heterodynes on the market, while the nearest competitive set had three tubes. Likewise, Leutz had the first Shielded Set, First Single Control License under the Hogan Patent, first resistance-coupled audio, first interchangeable tuned radio frequency transformers, first metal cabinet, and many other original features used two years ahead of other designers.

Powerful radio receivers, each perfect in every respect, cannot be built hurriedly. Each Leutz radio receiver is made to special order only. The average time required for delivery is three to six weeks after receipt of confirmed order. Leutz receivers are not sold on a trial basis; anyone contemplating the purchase of a Leutz receiver need only inquire from any of our customers and they will be assured that they will obtain the best radio receiver in the world.

The present Universal Transoceanic Phantom Special has the most powerful tube arrangement one could desire, viz., Four 222 Screened Grid Radio Frequency Stages, 200A Super-Detector, four audio stage, two of which are in a push-pull system using either two 210's or two 250's, output adjustable for a small room, or sufficient for six Dynamic Speakers distributed over a battleship.

Only a limited number of Transoceanic Phantoms can be produced this season, and our production is already sold considerably ahead. We suggest placing Phantom orders three to four weeks ahead to prevent disappointments in delivery.

*THE NEW LEUTZ LITERATURE IS THE MOST INTERESTING RADIO LITERATURE YOU EVER READ—DROP A LINE FOR YOUR COPY NOW*

### C. R. LEUTZ, INC.

195 PARK PLACE, LONG ISLAND CITY, NEW YORK, U.S.A.

CABLES "EXPERINFO" NEW YORK

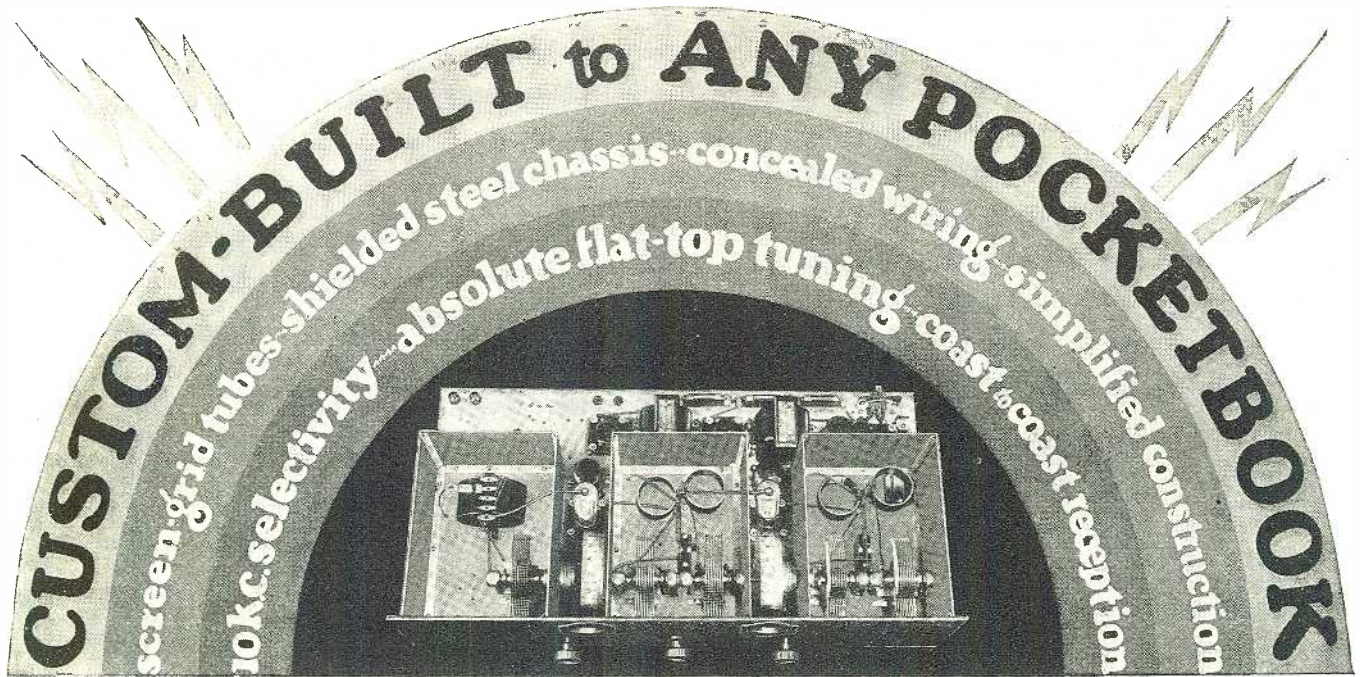

## THE 4 GREATEST RECEIVERS IN HI-Q HISTORY!

TO say that these four new Hi-Q Receivers are the greatest instruments ever produced in Hi-Q History is equivalent to saying that they are the most efficient, most selective, most sensitive and most beautifully toned radios in the world. A powerful, all-inclusive statement. But every professional RADIO-TRICIAN who has built one knows this statement is a fact.

For example, there is no receiver, to our knowledge, which employs the Band Pass Filter—an entirely new system used exclusively in the Master Hi-Q 29 models. This new development effects absolute flat-top *square cut-off* tuning for the first time in radio history. It assures positive 10 K. C. selectivity. Even in crowded areas it is impossible to tune in more than one program at a time. "Cross talk" cannot occur. Oscillation, buzzing, humming and background noises are totally eliminated. Stations don't simply "swish" in—they *snap* in, clear

and positive. Tone is practically identical with the original broadcast at the microphone!

There are FOUR Hi-Q Receivers for 1929—the Junior Hi-Q 29 at \$54.35; the Junior A. C. Hi-Q 29 at \$101.50; the Master Hi-Q 29 at \$99.50 and the Master A. C. Hi-Q 29 at \$151.50—four wonderful receivers which meet practically every range of pocketbook. All these instruments are the joint creation of America's ten leading parts manufacturers. All are stage-shielded,

built on steel chassis from the finest parts available in the industry.

**If You Want Real Radio Value,  
Write for Our New 80-Page Book**

The new 80-page Construction Manual is the biggest and most complete book of its kind ever published. Tells how to build all 4 new Hi-Q Receivers. Photos and diagrams illustrate every detail. Covers power amplifiers, tube and battery combinations, antennae, installation, short-wave adapters, house wiring and a wealth of other data on custom-built radio. Price 25c.

### FOUR MODELS

A. C. or D. C.

*Have One Built by Your  
Local RADIO-TRICIAN*

*Anyone can build the Hi-Q Receiver, quickly, easily, successfully AND AT BIG SAVINGS over factory-made sets of anything like similar efficiency. If you prefer to have it built for you, write for address of your local Radio-Trician. Over 6,000 of these Hi-Q experts in the country. One is near you. He will be glad to demonstrate the Hi-Q Receiver and build one for you at a very moderate fee.*

**HAMMARLUND-ROBERTS, Inc.** 1182-C BROADWAY  
NEW YORK CITY

Associate Manufacturers



Please say you saw it in RADIO NEWS



Editorial and General Offices, 230 Fifth Avenue, New York

Vol. 10

DECEMBER, 1928

No. 6

## Alternating-Current Set Operation

By HUGO GERNSBACK

**T**HIS talk is addressed chiefly to those who either contemplate purchasing or building an "A.C. electric" set, or already have acquired one. There is still in the popular mind a good deal of misinformation and mistrust as to these sets, and it is to be hoped that the remarks made here will clear up a number of important points.

The accusation has been bandied about rather freely, during the past few months, that the new tubes which make A.C. operation possible are extremely fragile and burn out on the least provocation. Many people are still under the impression that such tubes are in the experimental stage and have not as yet been developed as thoroughly as they should be; this conclusion is not quite true. On the other hand, it is admitted that the new A.C. tubes are somewhat more fragile than the others, but only under certain circumstances.

This was brought home to me rather impressively by a recent occurrence. A lady who had purchased one of the new sets about six months ago complained that she had to get new tubes almost every week; the statement she made was that the tubes were no good and kept on burning out. I was sufficiently interested to make a personal investigation, and this is what I found. She has a first-class alternating-current set; but the receiver had been installed by a set builder in an antique cabinet which the family owned. The bottom of the cabinet is used for the table linen and, as the outfit was in the dining room, it is (of course) necessary to open and close the bottom drawer rather frequently; and this is what caused the trouble.

I explained to the lady that under no circumstances should she open and close the drawer, unless it is done very carefully, and while the set is not in operation. If the set were not being used, the doors and the drawer could, without any damage, be opened and closed, but, with the tubes in operation, this should not be done; because the filaments, while incandescent, naturally could not stand up under the continuous slamming and vibration induced by opening and closing the drawer, often rather violently. After this had been explained, no further trouble was experienced.

I have used a single set of tubes in an A.C. set now in my study for some seven months, and the set is in use every day for at least four to five hours. I am still using the original tubes.

Another point which is brought out rather frequently is that many people, who should know better, complain that broadcast stations "change their power every night." One night, so the story goes, the station comes in good and loud; but on other nights, it does not. Even locals seem, according to many people, in the habit of changing their power from practically nothing up to maximum. The persons thus complaining always make it a point to state that they did not seem to have this trouble until very lately. If you pursue this to its logical conclusion, you will find that they never had this trouble while they had their old battery sets but really, it started just recently—in other words, when they acquired A.C.-operated sets. This is very true, and is not at all surprising.

The fault is, of course, not with the broadcast station, which (it need not be said) does not change its power. The average broadcast station probably does not vary its power more than 1% from night to night, if so much. Yet, one night, a certain station comes in weak, while on another night it comes in loud. The intelligent radio man will immediately know the reason for this; the answer lies in the A.C. voltage supply.

The house-lighting current available in the average household

changes from hour to hour; when there is not a great deal of load on the line as, for instance, in the daytime, the actual A.C. voltage across the set goes as high as 120. But, when all the lights are switched on in the evening, the "line voltage" often drops as low as 100, and in some cases, to 95. All of this makes a big difference in the volume of a radio set; and the average listener-in naturally blames it all on the broadcast station, never thinking that it is due to the decrease of the A.C. voltage supply.

There are now made certain appliances which, when attached to an A.C. set, will keep the current supply tolerably constant, whether the line voltage fluctuates or not; at least, within reason. If such an appliance is used, the listener will hardly, if at all, observe any weakening of his favorite station; and if so, probably because of atmospheric conditions.

If you wish to convince yourself of the amount of variation in the A.C. supply, all you need to do is attach a simple voltmeter across the power-supply input leads of your A.C. set. If you will keep this in plain sight, where you can watch it at all times, you will be surprised to note how much the voltage across the average line varies from hour to hour. You will find that it is usually highest in the daytime and lowest between the hours of 7 and 10 in the evening. It tends to go up again after ten, and by midnight, or later, it will be at its high peak.

Another source of trouble, or rather annoyance, with many A.C. receivers, particularly those located in apartment houses, is the fact that such sets are apt to become rather noisy at times. The A.C. set, being connected to the power lines, has an indefinitely long "pick-up," and is very much more apt to be disturbed than the old battery set, which was connected only to the aerial and ground. The A.C. set, in addition to collecting natural disturbances from the ground and aerial, now picks up also artificially-made "static" from the line itself. Vacuum cleaners, X-ray machines, motors, violet-ray apparatus, and the like, also derive their power from the same line and, if the contacts or commutators spark, a good deal of trouble is experienced by set owners. Frequently it is most difficult to do away with this interference.

In a recent case which came under my observation, a family who had installed a set costing them \$600.00 were unable to use it. Every time that the house elevator in the apartment building started to operate, it became necessary to shut off the set; because it was impossible to get anything except a tremendously-loud roar. The receiver in question was a highly sensitive one—a nine-tube affair—and this very sensitivity worked against the success of operation; because the set picked up every electrical disturbance that occurred in the house. Of course, the usual click heard when a light is switched off or on isn't in itself very disturbing, because it does not occur every instant; but in a big apartment house the elevators run almost constantly, and, for that reason, the set became useless.

It was necessary to write to the service department of the power company, which promptly sent its service men. They spent a number of days experimenting and shunted condensers and chokes around the offending motors; but even then the entire trouble could not be overcome and, though the result was at least 75% better, there was still too much interference from the motors. Finally, the problem was solved by placing the set in a different room and connecting it to a different lighting outlet, and by also disconnecting the ground entirely from the set. After this, no more interference was noted and the set now operates as well as should be expected in a New York apartment house.

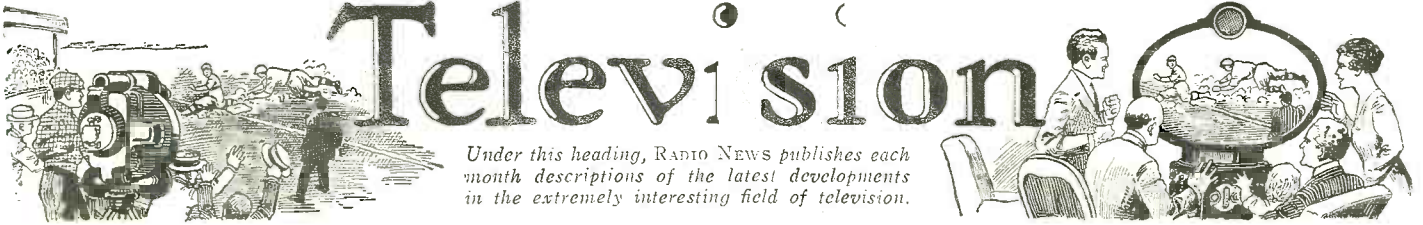

Under this heading, Radio News publishes each month descriptions of the latest developments in the extremely interesting field of television.

## Television Makes the Radio Drama Possible

By Robert Hertzberg

**T**ELEVISION is striding forward, and is today overcoming many obstacles that were once held insurmountable. "Sight" broadcasting is now part of the regular daily programs of a number of stations in the East and the Middle West, and many experimenters are experiencing new thrills in reproducing small, but nevertheless distinguishable, images.

The latest development, and what promises to be the most important as yet, is the successful combining of image and voice for the presentation of drama in the home, via radio. A second noteworthy achievement of the past few months is the transmission of full-length images of two people at a time, and the reproduction of those images at the receiving end to a size of twelve by twelve inches.

On September 11, 1928, WGY, the first station to organize a dramatic group and present plays regularly to the radio audience, established itself also as the first station, anywhere, to broadcast an actual drama with the aid of television; transmitting images and voice simultaneously on separate radio channels. The complete performance was witnessed by a group of newspapermen and scientists gathered in one of the buildings of the General Electric Company, at Schenectady, N. Y., at a short distance from the radio transmitters themselves. It was highly effective, and held the attention and



These two are playing the hands of the televised characters, with the "props" needed to illustrate the action of the playlet.

interest of the rather critical audience as closely as if it had been the highest-priced dramatic hit on Broadway.

Martin P. Rice, manager of broadcasting for WGY and its associated stations, explained that, in presenting the drama through the medium of television, the staff of WGY was co-operating with the radio engineers in the development of a studio technique, far in advance of the time when

it will be practicable to offer the "televised" radio drama to the public as a finished production.

"Such practical application affords the only reliable method of determining the future possibilities, as well as the limitations of television," Mr. Rice stated. "When television has reached that stage of perfection where 'sight' signals may be received as reliably as 'sound' signals are now received, we at WGY hope to be prepared to carry the image as well as the voice of the actor to thousands not heretofore privileged to enjoy the drama."

### WHEN HISTORY WAS MADE

The first play by television was broadcast at 1:30 o'clock, on the afternoon of September 11, 1928, during the regular television period of the Schenectady station; and a second performance was given at 11:30 that same evening. The offering was "The Queen's Messenger," a one-act drama written thirty years ago by J. Hartley Manners. The televised version was the same in every respect as the stage production; but it involved many new problems in dramatic technique because of the limitations of the television "cameras," which could take in only the head and shoulders of one character at a time.

The presentation of the drama by television was made possible through the simplification, by Dr. E. F. W. Alexanderson,

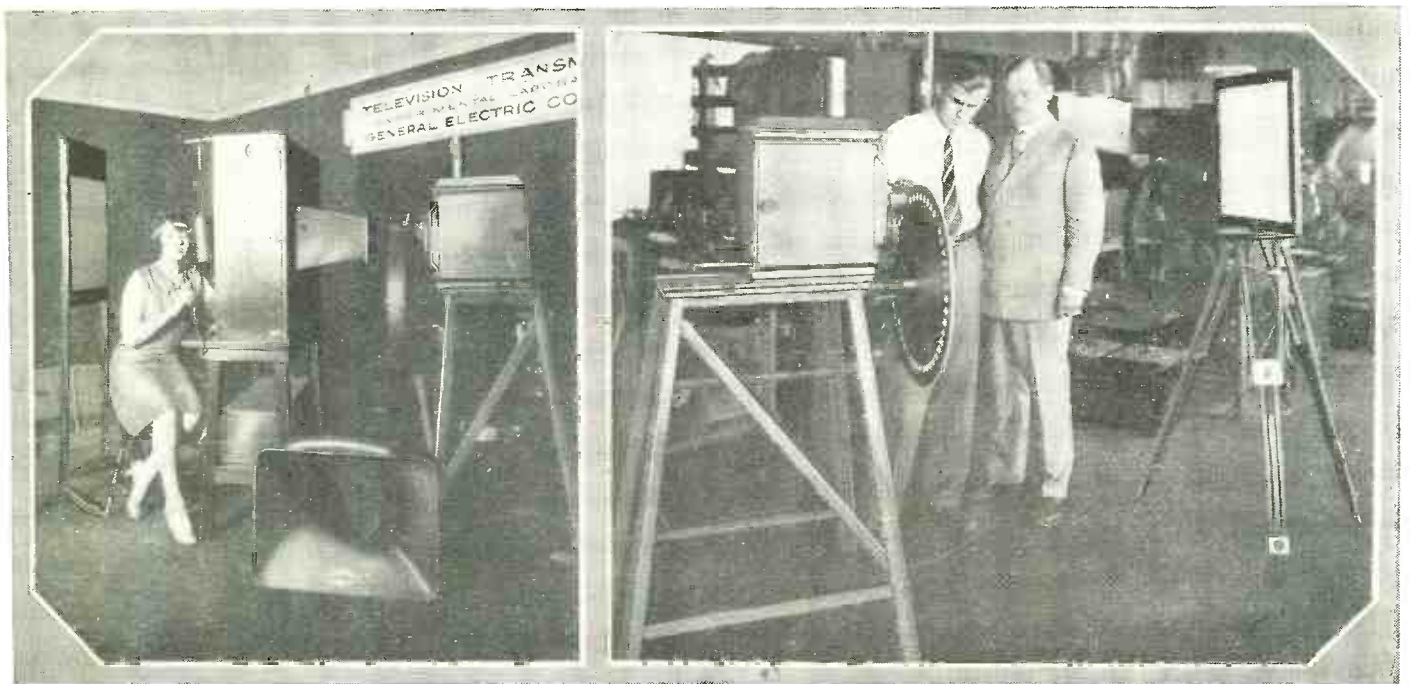

Left, the television transmitter, later demonstrated at the Radio Fair. Right, Dr. Alexanderson with his assistant, R. D. Kell, with

the new projecting apparatus, which throws an image a foot square on the ground-glass screen. The scanning disc contains 48 lenses.

of television transmitting apparatus which hitherto has been large and unwieldy. Readers of Radio News will recall that, early this year, Dr. Alexanderson took television out of the laboratory and put it in the home (see the article entitled "Television Comes to the Home," in the April, 1928 number). The voices and images of several performers were then broadcast by WGY simultaneously on different wavelengths, and observers stationed five miles away saw and heard the artists on television receivers of simplified design.

Dr. Alexanderson has simplified the television transmitting apparatus to such a degree that it can now be carried from place to place, almost as easily as the microphone and its associated amplifiers. The time will undoubtedly come when the televisior will be set up in the radio studio, on the lecture platform, the stage or the banquet table, as readily and as frequently as the ubiquitous microphone now appears at these places. To illustrate the portability of the outfit, WGY engineers recently set up a television "camera" on the platform in the assembly chamber at Albany, N. Y., and televised Gov. Alfred E. Smith of New York, as he delivered his address accepting the Democratic nomination for the presidency.

#### DETAILS OF THE "CAMERA"

The television scanning "camera," as it is used to-day, is a wooden box about a foot square at the ends and about twenty inches long. It contains a twelve-inch 24-



*Izzetta Jewel, first "leading lady" of the television stage, in "The Queen's Messenger" before the scanning camera and microphone at WGY. As only the face and voice were picked up here, another actress was required to impersonate the hands.*

hole scanning disc, driven by a small synchronous motor. Behind the disc is a 1000-watt lamp, the light of which is concentrated by a lens on the area defined by the spiral of holes. A second lens on the outside of the box projects the scanning rays of light on the subject. The box itself is mounted on a regular camera tripod, and greatly resembles a large camera.

Accompanying each "camera" is a pair of photoelectric cells, which are placed in front of and on each side of the "camera," and facing directly toward the person being televised. Each cell is about seven inches in diameter, and enclosed in a wooden box mounted on a tripod. Three outfits, comprising camera and photo-electric cells, were used in the broadcasting of the radio drama.

In the presentation of "The Queen's Messenger," the television instruments were arranged as shown in Fig. 1. One camera was used for each of the two characters in the play, and the third for the introduction of "props" and other visual effects. The play director, standing between the two "cameras" trained on his actors (positions 1 and 2 in the drawing), governed the radio output by means of a small mixing panel; similar in construction and function to the mixing panels used at all broadcast stations for the proper blending of the different instruments of an orchestra. With one knob, he brought any one of the three cameras into the circuit; and, with another, he "faded" the images in and out, very much as the "fade-out" is used in motion pictures. In front of the director was a "monitor" television receiver, in which he could see at all times the images going on the air, and check the performance. In addition to the television cameras, there were microphones at positions 1 and 2, (for the two characters) to pick up the spoken lines of the play.

The performance was broadcast on three wavelengths; the images on 379.5 and 31.4 meters, and the voice on 21.96 meters only.

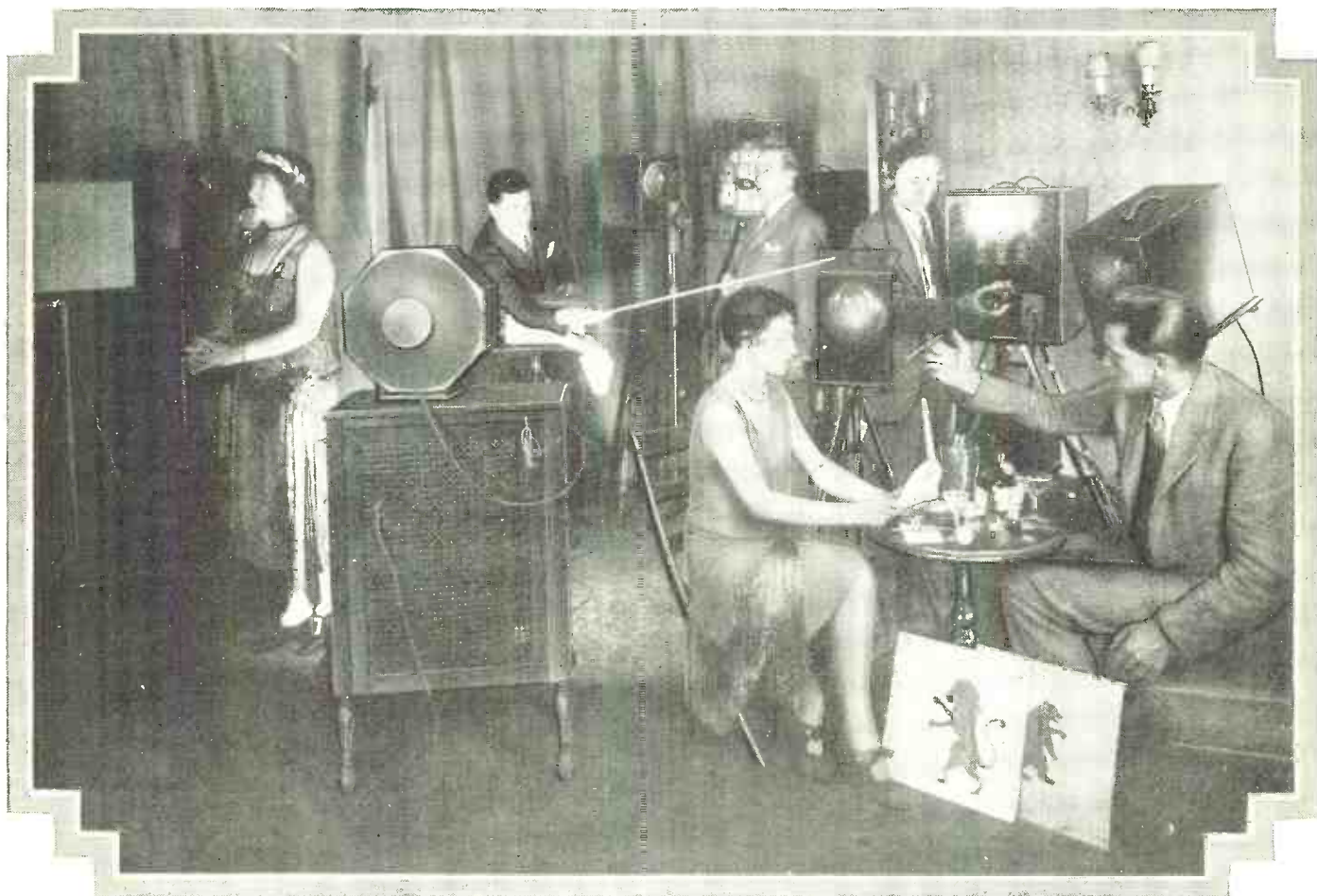

*The "stage" of the first televised drama; its layout can be followed by referring to the diagram at the top of page 526. Left, Izzetta Jewel; Mortimer Stewart, director, with wand; then Maurice Ran-*

*dall. The silent parts are gesticulated by the players at the "prop" table, right, Joyce Evans Rector and William J. Tomiski, whose hands are "picked up" by camera No. 3.*

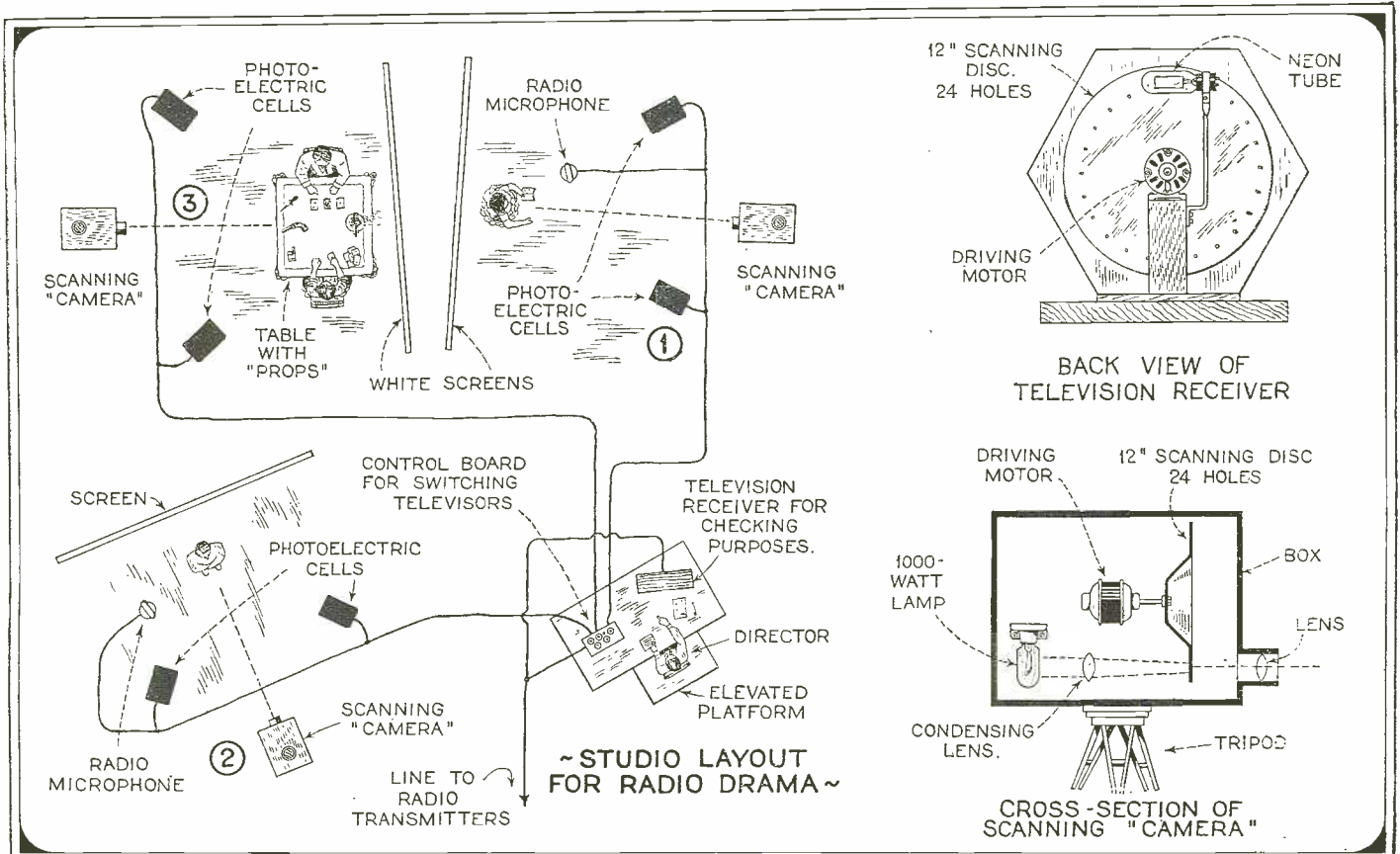

Fig. 1: Three scanning cameras and two "mikes" are controlled by the director of the radio drama, who has a monitor television receiver before him to check the results. The receiver and "camera" shown at the right are similar to those previously described here.

Reports received by WGY several days after the broadcasting of the play indicated that at least two radio experimenters on the West Coast had picked it up and reproduced it successfully.

**TECHNIQUE OF THE DRAMA**

Inasmuch as only the heads of the actors can be transmitted at the present stage of developments, it became necessary for the

director to find some means in addition to head movements or the change of facial expression to convey action. This was accomplished by using the third television transmitter (position 3 in the diagram) for hands and "props." For example, when the lady of the play offers to pour some wine for the messenger, the third camera picked up the image of a lady's hands with bottle and glass, as she poured the wine. Keys,

a ring, a pistol, a dagger, reproductions of the British and Russian royal arms, and many other "props" were thus introduced, to add to the realism of the performance and to break the monotony of the head images only.

The faces of the man and the woman handling the props at position 3 were not shown. Only their hands were televised; the "camera" being switched on at the proper moment by the play director. In this way, the voice of the lady speaking at position 1, while the television camera at position 2 transmitted hands, was heard in the loud speaker at the receiving end while the image of the hands flashed on the television screen.

Because of the limited range of the "camera," great pains were taken to keep the actors "framed," that is, within the small area in which the scanning rays of light might find them. Each character worked in front of a white screen, which gave definition to the features. Borders were established within which the actor had to stand, or be lost to the camera.

The performing artists were confronted with special problems in "make-up;" both because the color-response characteristics of photoelectric cells are altogether different from those of the usual motion-picture camera, for instance, and because the images at the receiving end have the pinkish-red background characteristic of the neon gas used in the glow lamps. The make-up technique of both the stage and the screen was drawn upon, and an effect different from either was finally obtained. The eyes of the actors were accentuated to the point of exaggeration, and the mouth and nostrils were sharply defined with strong color. The skin was softly shaded and blended in an effort to remove the shiny effect. It was



The television stage director is a busy man. Here we have Mortimer Stewart of WGY at his control box, which will "fade" one image into another, movie style.



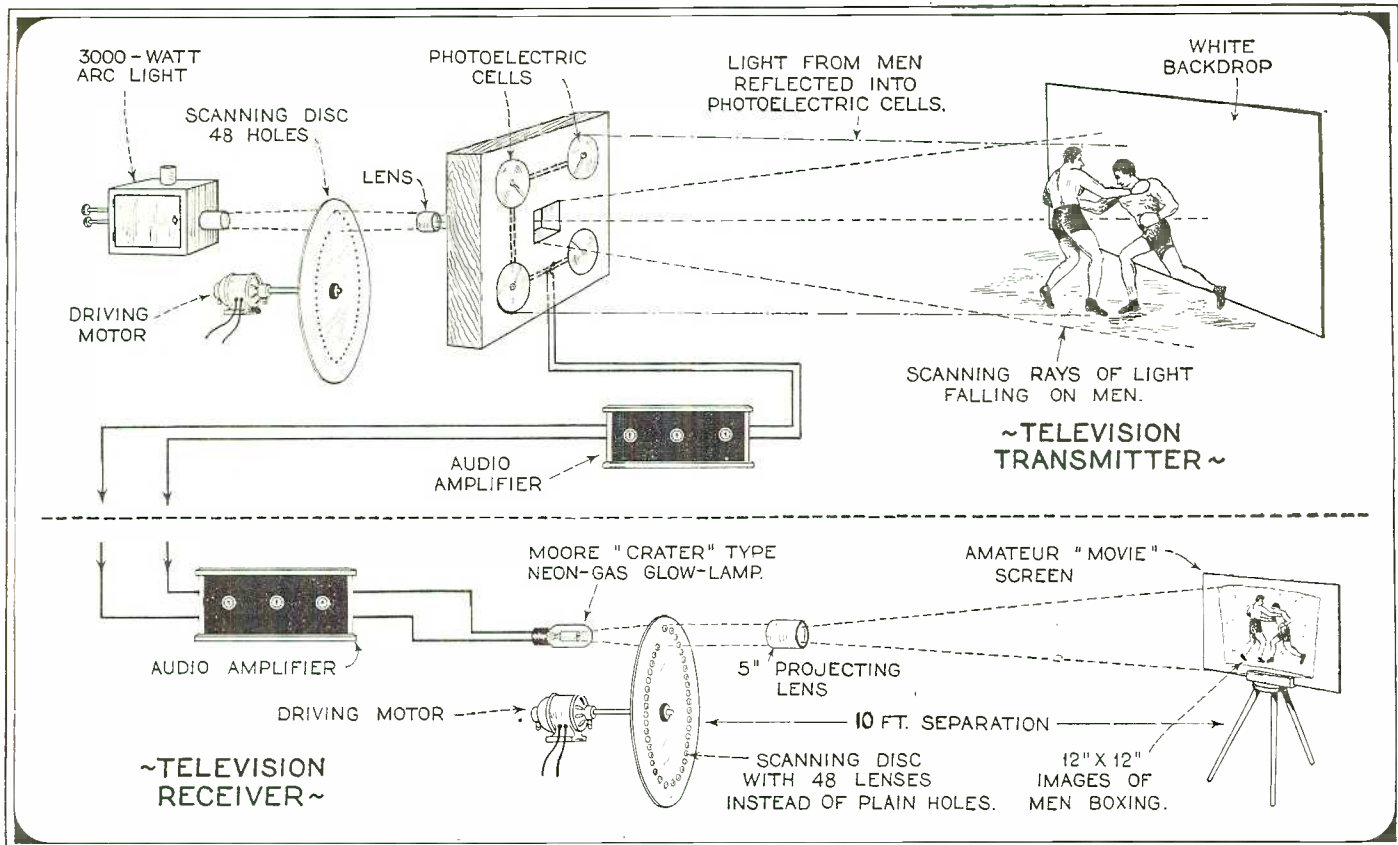

Fig. 2. With the apparatus shown and wire lines, a boxing match outside the 5,000-cycle broadcast limitation. The neon lamp used, was televised to a small screen: though the image frequencies went a special new device, is not available to amateur experimenters.

found that diamonds or other bright stones could not be used on the hands, because they caught the scanning light strongly and produced a disturbing glare on the image.

The actual adaptation of the television apparatus to the play was made by Mortimer Stewart, who is known to many radio listeners as the producer and director of a series of radio plays broadcast by WGY and of numerous dramatic offerings from the New York stations of the National Broadcasting Company. Mr. Stewart's problem was not only the development of a technique for a new dramatic form, but he also had to work with apparatus that was crude and admittedly inadequate.

"The Queen's Messenger" has but two characters. The lady was played by Izzetta Jewel, a former stage star and now the wife of Professor Hugh Miller of Union College. Maurice Randall, veteran member of the WGY Players, was cast for the messenger. Joyce Evans Rector and William J. Toniski "doubled" for Miss Jewell and Mr. Randall; that is, they "doubled" for their hands and, at the third television camera (position 3), handled the various "props" such as cigarettes, glasses, keys, dispatch case, etc.

THE RECEIVING EQUIPMENT

The General Electric engineers constructed a number of special television receivers for use at the demonstration on September 11. In external appearance and over-all size these greatly resembled loud speakers of the cone type, for which they were mistaken at first. Each is about 14 inches high and six deep, and hexagonal in shape. Within the case is a scanning disc 12 inches in diameter, and cut with a spiral of 24 square holes. A neon-gas glow-lamp is supported in back of the disc in a horizontal position. The images as reproduced

on the disc are less than an inch square; but they are enlarged to an apparent size of three inches square by means of a magnifying lens placed on the front of the case. A number of views of this machine are shown in the illustrations accompanying this article.

A back view of the television receiver is shown in Fig. 1, which includes also a cross-sectional view of the television scanning "camera." The discs used at both transmitters and receivers were not actually flat discs, but looked like large soup plates, with scanning holes cut in the flat rim. This method of construction makes the discs very rigid and prevents them from wobbling as much as ordinary discs do.

The people watching and hearing the performance of the play, as it was reproduced on the radio receivers, had to sit about ten feet away from the television instruments, in order to distinguish a clear image. At closer distances the coarse lines of the scanning disc were too plain, and the images appeared to be built of little squares of black and pink. The definition of the images was quite good, in spite of the fact that the television impulses were confined to 5,000 cycles, the modulation limit prescribed by the regulations.

TELEVISION ON A SCREEN

A very interesting laboratory development, demonstrated by Dr. Alexanderson after the broadcasting of the radio play, is the apparatus he now uses experimentally over wire lines, for the transmission of full-length images and their reproduction over a screen area twelve inches square, on a screen ten feet from the projector. The layout of the apparatus is shown in Fig. 2.

In general design, the transmitter is identical with other disc systems, except, of

course, for the quality of the parts and the sensitivity of the photoelectric cells, in particular. A 48-hole disc, about two feet in diameter, is driven by a synchronous motor, and breaks up into thin scanning rays the light from a 3000-watt arc directly behind it; the rays are projected forward by a powerful lens. When only his head is to be transmitted, the person televised sits about fifteen inches from the front of a large wooden frame holding an extremely sensitive photoelectric cell in each corner. The scanning rays fall on him, and are reflected into the cells, which respond in the usual manner by producing varying electric currents.

At the receiving end, a similar scanning disc is used; however, the usual plain holes are replaced by 48 powerful lenses, each only about half an inch in diameter. The glow lamp is a special neon-gas bulb, developed by Dr. D. McFarlan Moore, the renowned scientist whose achievements have done much to make television practical. This lamp, instead of containing the two flat plates found in common neon tubes, uses a small metal cylinder within which is a small, thin electrode. An intense light, hundreds of times more powerful than that produced by any other glow lamp, is thrown out from the cylinder. The light is concentrated by the lenses in the scanning disc, and then thrown on the screen, ten feet away, by a five-inch projecting lens.

To begin the demonstration of this apparatus, a man sat down before the photoelectric cells at the transmitter and his image, fully life-size, appeared on the screen in an adjoining room. Speaking over a wire circuit connected to a loud speaker in the projection room, he maintained a running line of chatter, describing his actions in detail so that no one would miss

(Continued on page 587)

# “Multiple Television”— A Forecast

## Why the Possibility of Receiving More Than One Television Image at Once Is of Practical Importance

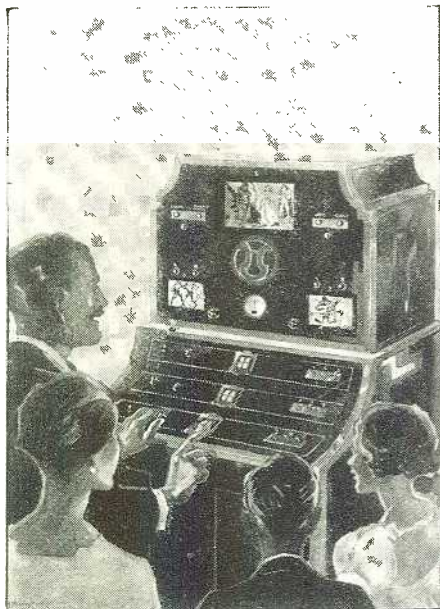

The first-class television receiver of the future will afford more than one program. We may readily predict a family debate as to which scene of action will receive the place of honor in the varied entertainment.

THE scene which adorns the cover of this issue of RADIO NEWS is not, like its predecessor of last month, taken from the life, nor does it incorporate a photograph of television apparatus which is now in existence. But it does represent a scene which will be many times repeated, a few years in the future, when the owner of a television receiver will not only have a choice of several interesting programs, but be able to sample them all at once, as it were, and choose according to the tastes of the family.

There are several reasons why this should be desirable, and possible as well. It is not particularly profitable to tune in more than one broadcast station at a time, so far as the audible or “aural” programs go. In fact, the best efforts of radio engineers and designers—as well as those of the Federal Radio Commission and other branches of government—have been devoted to the endeavor to make this impossible, so far as an involuntary reception of multiple programs is concerned. The reason for this is based on the one-dimensional nature of our organs of hearing; our ears cannot, except by great effort, analyze a medley of unrelated sounds. We cannot listen to two people at once attentively; let alone a jazz band and a quartet of chamber music at the same time. Nobody, therefore, wishes two loud speakers to pour forth different programs. We tune out or switch from one station before we try another.

### WHY SHOULD WE WANT SEVERAL IMAGES?

With our *natural television receivers* (the eyes) the case is otherwise. They receive the ultra-short waves, which we call light, over a large angle simultaneously, and over what seems to us a large area; and, though it is true that our whole field of vision is not equally sensitive, the mobility of these highly-complex organs and their power of accommodation or “focusing” is almost as quick as thought itself. We are therefore able to give at least cursory attention to several moving scenes at once, without their creating interference with each other, as in the case of sounds.

When we have acquired the faculty of

being present at several places of entertainment simultaneously (for purposes of sight and hearing at least) as will be the case when television has developed to the point of reproducing large scenes as faithfully as the microphone now picks up their accompanying sounds, we may well seek to transfer to our receiving instruments the faculty of glancing from side to side which we now possess. In other words, when more than one event is being televised, we shall desire the power to keep in touch with all of them; giving our closest attention to the parts of each visible program which are most of interest. This will be especially true when the action being broadcast is of a nature that cannot be rehearsed, and whose progress is not governed by the broadcaster's allotment of the minutes—which will be true of an increasing number of public activities, as time goes on.

The matter was brought to the mind of the Editor of RADIO NEWS, while he listened in to the opening ceremony of the recent Radio World's Fair. The presence of Mr. Edison, who performed the formal act of inaugurating the show, had been announced in advance; but not that of Mr. Ford and other notables, who were not on the program; and many listeners may therefore have missed an opportunity they would gladly have taken advantage of, the more

so if television reception had also been available to them. The fact suggested the theme of this article: why can we not receive at once several television images on the same receiver, if we have the necessary number of tuning units with which to pick up several broadcast stations simultaneously?

The television image, as all our readers now understand, is in the nature of an optical illusion, created by the motion at a predetermined rate of a scanning disc or similar optical device across a lamp whose illumination is varying at a rate depending on the nature of the image being televised. Each flicker takes place at a time when a different portion of the neon lamp's area is exposed and, therefore, creates the impression of light or darkness over a different portion of the visible area of the disc. The effect is that a complete image is built up before the eye, which cannot see each point of light separately. Take away the disc, and the fluctuations of the light are too rapid to register on the eye; take away the flicker, and a blank, uniformly-lighted area appears before the spectator. The action is of a nature which is called “stroboscopic” (see RADIO NEWS for August, 1927, for a detailed explanation of the term).

Only a very small portion of the disc, however, is used at any one time for the reproduction of an image; the unit space between two successive holes, in the spirally-drilled discs now used, which have been described at considerable length in the last few issues of this magazine. If, therefore, we place additional lamps, flickering at other television-image frequencies, in several positions behind the circumference of the scanning disc, we may produce as many different pictures as we have receivers. (We can, of course, reproduce also the *same* image in multiple at different points of observation, by placing a number of lamps in parallel across the output of a single amplifier; but these images would be “out of frame,” by reason of the different positions they would occupy along the spiral.)

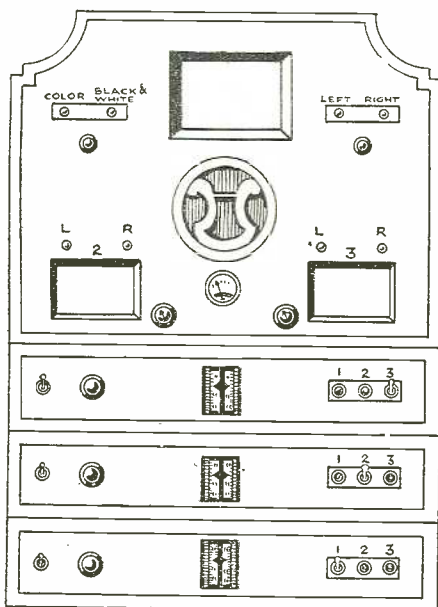

FIG. 2

Here we have the panel layout of a proposed receiver based on the disc system. Each of the three receivers tunes in a program of both sight and sound impulses, though the latter are conveyed to the speaker only in connection with the image in the larger screen. The option of color or of black-and-white with greater speed is obtained in this.

### HOW IT MAY BE DONE

For the purposes of color television, as described in the October issue of this magazine, however, discs have been drilled with more than one spiral of holes. With a disc of this kind (as shown in Fig. 1) we could commence the production of pictures along the outer edge of the area—not merely at point A, as shown, at the top of the disc, but also point B and point C, which are spaced 120 degrees apart, in the case of a disc with three complete spirals. It is true that the lower pictures would be inclined at an angle of 120 degrees to those at the top; but the television receiver of the future will be equipped, undoubtedly, with magnifying devices to bring

up the image to such a size that it can be seen further away from the disc than at present—to accommodate additional spectators. It would, therefore, be possible to introduce either lenses or prisms to bring the last virtual image “right side up.”

Let us then suppose that, instead of reproducing the same image at three positions on our disc, we have three tuning units (See Fig. 2) each with a suitable amplifier for the band of television impulses, and a suitable filter which separates from these the audio frequencies impressed at the same time on the carrier wave. The limitations of our hearing, as already pointed out,

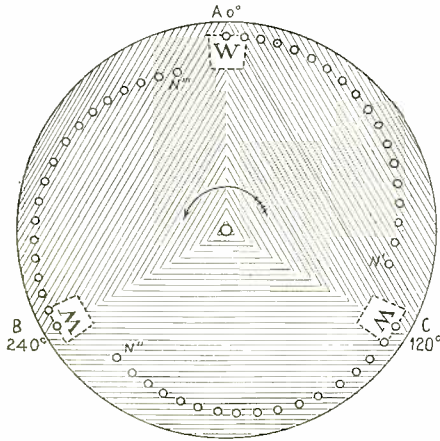

FIG. 1

If we have a three-spiral disc, such as that used for color transmissions, with three neon lamps a separate image may be built up simultaneously in each of the three positions here.

make it undesirable to reproduce more than one audible program; and a single loud speaker with a selective switch enables us to choose any one of the three programs for our ears. Each set of television frequencies, however, is led to a suitably connected glow-lamp—one of these is placed at each of the equally-spaced intervals along the rim of the disc. Here it is scanned by one of the three similar spirals, point for point, just as the other two are dealt with elsewhere. Three images, then, appear at different points on the disc and are brought up to the proper sizes and positions by their respective optical systems. We can then, with an occasional side glance, keep in touch with the three sets of actions being televised at three different radio stations; though devoting the greater portion of our attention to the one of most interest at the moment.

A RECEIVER OF THE FUTURE

It is obvious, of course, that all three of the television programs being thus received must be alike in their characteristics, as regards frequency of scanning and analysis of the images; though there is no necessity that the scenes televised be of equal size or fineness of detail. We can have a television “close-up” or “fade-out,” just as we have in the movies; and will undoubtedly have such effects, as technique in television progresses.

It is certain, however, that the synchronizing systems in use must be exactly alike, if multiple images are to be reproduced; and, even in that case, such factors as varying distances of the receiver from two or more transmitters must slightly affect the phase relationship of the received signals. We shall, therefore, concentrate our main attention on one image, which will be brought up in size and sharpness more than

the others, and keep it “in frame.” While under our hand are compensating devices to do the same for the other images, we can follow their actions in general without this precaution—the more so, as we shall not be endowed with additional hands by the progressive development of television. If, therefore, one of the smaller scenes below interests us more at the moment, the snap of a switch on its tuning unit causes it to exchange places with the image above.

In the sketch (Fig. 2) of the controls of such a receiver, each tuning unit has three switches, designated as 1, 2 and 3. The snap of the No. 1 switch, we may suppose, connects the amplifier to a lamp which produces the large image above and, at the same time, connects the associated audio amplifier to the loud-speaker unit whose sound-opening is in front of the center of the disc. If we suppose the levers interlocking, the same motion throws down the image which previously occupied No. 1 position to the No. 2 or 3 screen below, and cuts off its audio-amplifier output from the speaker. Thus the shifting of scenes is but the work of an instant.

The touch of a button at the right of the large screen adjusts the image and brings it into frame. Similar buttons are provided for the lower images, which will undoubtedly need more effort to keep them in their frames. Nevertheless, as we have said, as they will be used merely to obtain a general idea of the stage of the proceedings which they represent, they will probably be permitted to wander slightly, unless other members of the family desire to watch them more attentively. We may, of course, imagine a slight division in the family council represented on our cover as to which of the available television broadcasts should have the place of honor; presumably the question will be decided by the same gentle influence which has converted the radio receiver from a jumble of crude apparatus on a breadboard to a splendid example of interior decoration in period cabinet work.

COLOR OR SPEED—CHOOSE!

We now come to a second interesting feature of our multiple receiver. As we have already said, our multiple disc is designed for color work; this, however, requires multiple lighting and more complicated connections. We may assume that these are provided at the top of the cabinet alone. The action in the lower screens is seen only in monochrome; pink-and-black if the neon lamp as now used is deemed sufficient for the purpose. At the top, however, three sets of lamps, each giving one of the primary colors, alternately illuminate the successive spirals, producing the effect of natural color. (How this is done was described in a very interesting article in the October issue of RADIO NEWS—consult page 320.) To obtain this effect, however, we must sacrifice some light, as the image is illuminated only one-third of the time in each color. We would find also that, in a scene of very rapid action (such as a boxing match, or a race) our colors will be slightly “out of register;” like the effect you may have seen in color printing when the red, the yellow and the blue were slightly out of the respective places they should have occupied. In addition to this, many broadcasts would undoubtedly be made without color. In this case, we have only to press the button at the left of our large screen, and disconnect the color-separating mechanism. All the primary rays are thrown at once upon the disc, increasing the amount of practically-white light, and each spiral draws a picture in black-and-white. The result is a much more sharply-defined and more highly-lighted image, enabling us to follow the action more closely.

It is not essential to our purpose, of course, that a disc with a triple spiral be used. To obtain the large number of holes required to scan a larger scene in detail, it may be necessary to use a single spiral, and to change the color transmitted only

(Continued on page 589)

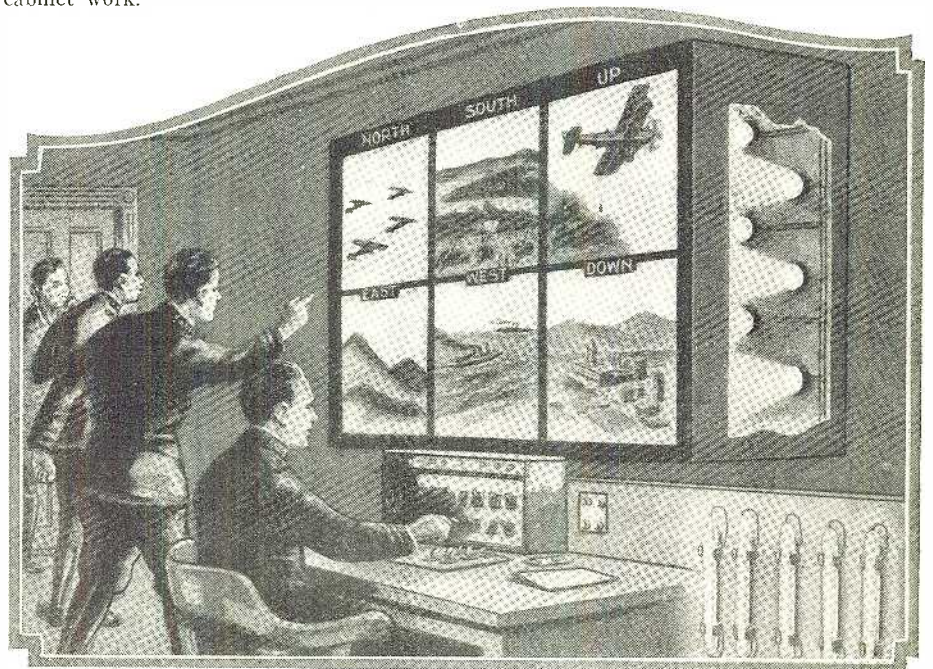

This partial reproduction of a full-page illustration in THE EXPERIMENTER for November, 1924, indicates a military use for multiple television. It is necessary for a modern general to be near his center of communications, well in the rear of the lines. With radio-guided airplanes, equipped with six television cameras—looking up, down, forward, back and sideways—he can see the progress of action as if present, and give his orders accordingly. As one observation plane is shot down, the turn of a switch puts a second into operation instantly. The method of reception here shown may more closely resemble that adopted than does the present disc system with its limitations.

# Novel Radio Equipment for Airplanes

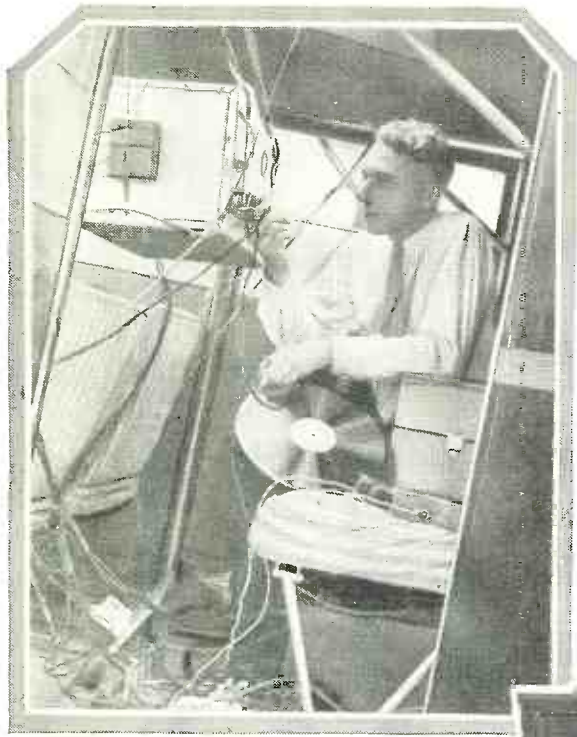

**RADIO PICTURES SENT FROM THE SKY**

At the right, we may see a forerunner of what the well-equipped airplane will radiate in the future. This "radio photograph," as you will quickly determine, represents Col. Lindbergh in a serious moment. It was transmitted from the airplane short-wave set shown in the picture at the left, while the plane was in flight three thousand feet above the ground. This feat demonstrates the possibility of receiving the results of aerial observation for military or civil purposes, without the necessity of a plane's returning to its base.



In the central picture, the apparatus on which the airplane-transmitted photograph, reproduced above, was received at station WFI, Philadelphia. The Rayfoto system, which utilizes a "coronal" discharge to form the image on the paper, was employed in the experiment. The sensitized sheet has just been taken from the cylinder of the machine.

Photos © International Newsreel.



Below, right: This American installation in the plane "Roma" comprises a transmitter, swung on shock-absorbing cords, a wind-driven generator whose mounting permits it to be either swung out for operation or withdrawn to reduce the air resistance; and, on the shelf, the "send-receive" switch and flameproof telegraph key.

© R.C.A.

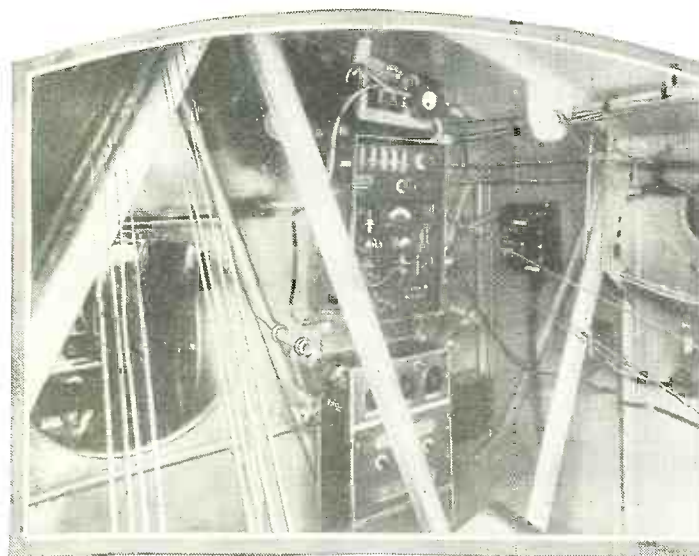

The elaborate equipment of the Dornier-Napier plane, in which the Courtney expedition recently attempted to cross the Atlantic, was instrumental in bringing about their rescue when forced down. Left, opening to fuel tanks; then the handle of the winch controlling the aerial; then at the top, further to the right, the aerial lead in and ammeter; below them, first the transmitter and then the receiver. The apparatus is of British type. © Herbert Photos.

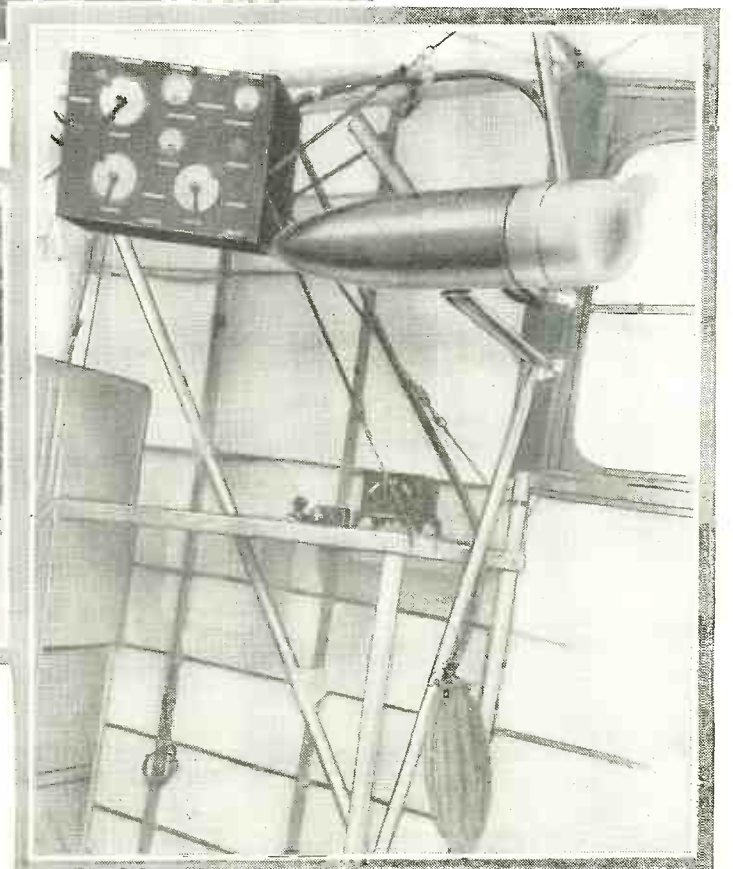

# Equipment for Television Experiments

Apparatus Now Commercially Available Offers an Increasing Choice of Installations for the Enterprising Television Fan to Choose From—Differences Are Mostly in Details



By H. M. Bayer

**E**VER since the inception of a regular schedule of television transmission at WRNY, that station has been swamped by hundreds of letters and phone calls commenting on the queer, staccato signals that are being heard on WRNY's wave, and invariably ending with the same question that is being asked by thousands of radio experimenters and listeners throughout the country: "Is anyone marketing the television receiver; and, if so, where can I buy one and what will it look like?"

Before proceeding with a semi-technical description of the commercial models now available, it may be well to offer a brief explanation of the general situation involved in an answer to the above question; and to attempt to clarify some of the terms connected with television. For example, what generally is termed a television receiver actually is a television *scanning apparatus*; that is, to say the *receiver* itself may be any broadcast receiver being used at present, providing the last amplifier tube, or power tube, is of the 171 type or larger—and providing, also, the audio-frequency amplifying transformers, or whatever coupling devices are used, are of the highest engineering efficiency. It has been stated generally, by those pioneering in television development, that the resistance-coupled type of audio amplification should be employed; because the *undistorted* output of that type of amplifier is high over a wide range of frequencies, when compared to that of the transformer-coupled type of amplification found in the average broadcast receiver. However, some experimenters have obtained good results using the latter

type; and so it is recommended that the amplification system used by the experimenter's receiver be first given a fair test of receiving television images, before any changes are made.

## THE SCANNING MECHANISM

As will be seen from the photographs reproduced in this article, the *scanning apparatus* consists primarily of a scanning disc, a suitable motor to drive the disc—with some means of controlling the speed of the motor so that the disc can be driven at certain definite speeds—a neon-gas glow-lamp and a suitable mounting or framework of the entire arrangement. These items make up the scanning apparatus and are all that is necessary to reproduce television images; providing, as mentioned previously, that the receiver and its amplification system come up to specifications. When adding

the scanning apparatus to a broadcast receiver, all one need do is to remove the loud speaker's cord tips from the output of the set, and in their place insert the wires leading to the neon tube of the scanner.

The various arrangements described herewith have been tested, and found satisfactory for the viewing of radio-transmitted images, when operated in conjunction with the proper type of receiver and according to the directions specified by the manufacturers. The apparatus mentioned in this article does not include all the scanning kits now being marketed; but those shown are all that were available at the time this article was written. Assemblies which are produced after the collection of these data will be described in later articles in *RADIO NEWS*.

## An Elaborate Telesvisor

One manufacturer has announced a tentative arrangement of its scanning apparatus, which is to be of the conventional design outlined in the preceding paragraphs of this article. The development work of this product is under the supervision of John Gelo, chief engineer of the organization, who has made a name for himself as a pioneer researcher in the television field. He is known best, perhaps, as one of the first to confine successful television transmission to the 5000-cycle band, the maximum frequency allowed by the Federal Radio Commission for all radio transmission on the broadcast bands. The illustration in the first column shows Mr. Gelo standing beside the scanning apparatus which he has designed. In this model the speed of the disc (D) is controlled by what is known as

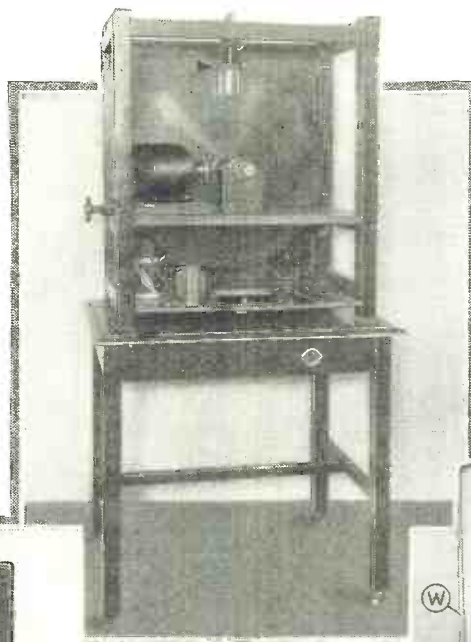
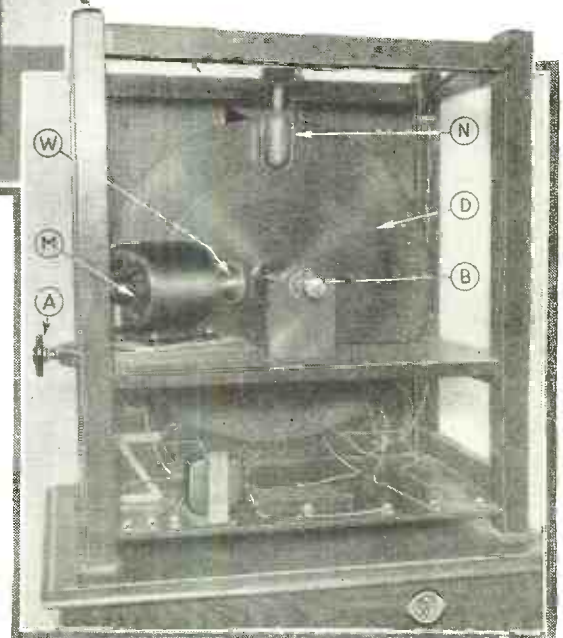

Fig. A (Left.) Mr. Gelo standing beside the receiver of his design. Sponge-rubber blocks separate it from the table on which it rests.

Fig. B (Above). The same apparatus, seen from the rear. The cabinet is home-made, not part of the kit.

Fig. C (Right). The set-up at close range: the motor M drives the disc D by friction, at a speed controlled by the worm-wheel A. As the friction-disc W approaches the shaft, the speed increases. The journal B contains ball-bearings; the height of the television lamp N is also regulable by the use of a collar.



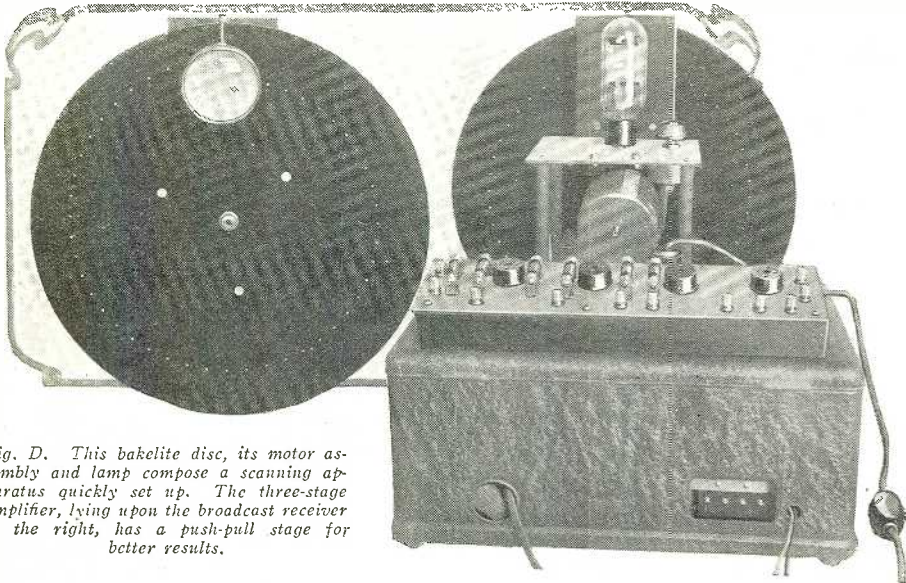

Fig. D. This bakelite disc, its motor assembly and lamp compose a scanning apparatus quickly set up. The three-stage amplifier, lying upon the broadcast receiver at the right, has a push-pull stage for better results.

a "floating" motor M (this excellent arrangement is used also in the Jenkins system described in this article); this varies the speed of the disc by moving the motor on its sliding "ship" by means of the worm-gear A. Refinements, such as the shaft mounted in ball-bearings at B, are not entirely essential to successful operation; although, they, doubtless, insure more even, silent operation of the disc. (See Fig. C.)

Under the shelf supporting the motor mechanism, and the driving-shaft's terminal, may be seen the filter system, comprising suitable condensers and choke coils, used in the neon-tube circuit. On the front panel of the lower shelf are mounted the meter, indicating the current drawn by the neon tube, and the variable resistors employed to control the brilliancy of the tube. The screen-like square seen on the upper section of the large front panel is actually a miniature viewing tunnel, the walls of which

frame an opening about an inch-and-a-half square, the approximate size of the image which can be viewed with this apparatus. The disc is of the 48-hole type, 20 inches in diameter, and is suitable for the reception of televised images from WRNY-W2XAL, the Radio News stations in New York, and W3XK, the Jenkins station in Washington. The latter requires a disc speed of 900 revolutions per minute, while the former operate at a speed of only 450 revolutions per minute.

Manufacturer: Pilot Electric Manufacturing Co., Brooklyn, N. Y.

### A Scanning Apparatus Very Easy to Assemble

A simple, yet efficient, scanning apparatus at present marketed only in kit form is so designed that its assembly is a matter of a few moments, requiring no tools but a screwdriver and a pair of pliers. Alexander

G. Heller, the designer of this apparatus, has concentrated his efforts on the production of a kit of the simplest form for the benefit of the experimenter who is avoiding complications. In this respect Mr. Heller has been successful; the completed assembly is devoid of non-essentials and comprises only those parts absolutely necessary for the operation of the scanning disc. The foundation of the apparatus is a 10 x 7 x ¼-inch bakelite panel or base, upon which are mounted a universal motor and the receptacle for the 110-volt line. Four and a half inches above this base, and supported on four pillars, is a bakelite sub-panel upon which are mounted the socket for the neon tube and the variable resistor; the latter is in series with the 110-volt line leading to the motor and serves to vary its speed. The disc is composed of bakelite, 16 inches in diameter, and has 48 holes.

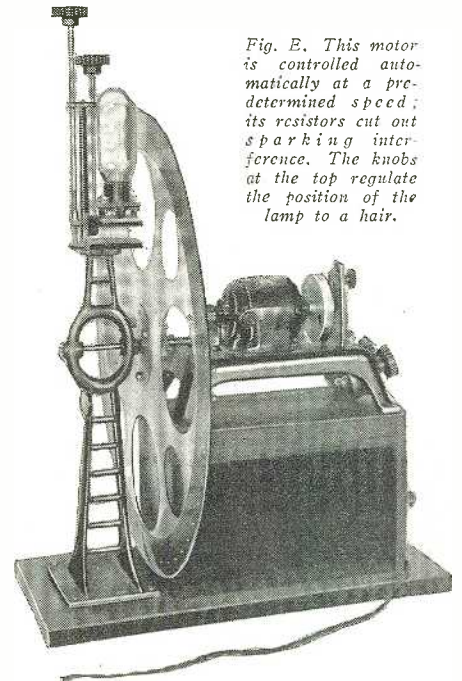

Fig. E. This motor is controlled automatically at a predetermined speed; its resistors cut out sparking interference. The knobs at the top regulate the position of the lamp to a hair.

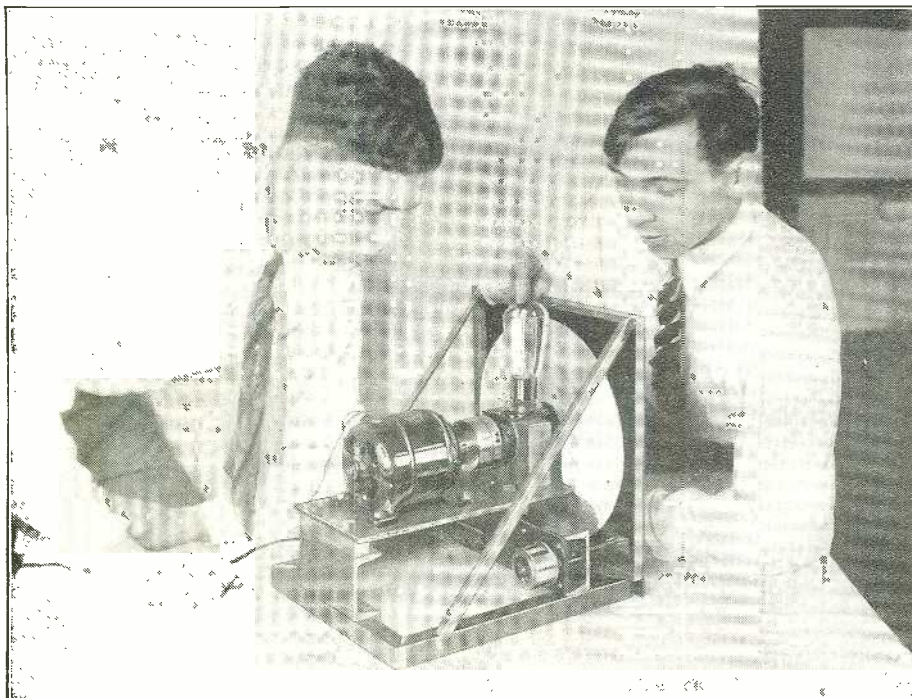

Fig. I. This 12-inch disc brings a television receiver down to more moderate size for the parlor. The same manufacturer has also produced a 6-inch disc, which gives a clear, though small, image which may be magnified again.

The picture (Fig. D, right) shows the apparatus mounted on the cabinet of a broadcast receiver; while in the same illustration is included a front view of the set-up. The magnifying lens is used to enlarge the image and has mounted behind it a disc of ground glass, which may be removed from its circular case if so desired. The neon tube illustrated in the same picture is supplied by this manufacturer; but may be of any type the plate of which measures approximately 1½ x 1½ inches square, providing the plate is parallel to the heavy prongs in the base.

Manufactured by the same company, and indicated in its catalogue as optional equipment for this scanning apparatus, is a three-stage resistance-coupled amplifier designed for power operation. It is shown mounted upon the receiver cabinet. A feature of this amplifier is the accommodation for two 171A-type tubes wired in parallel for last-stage operation. The resistors employed in the grid and plate circuits are of the heavy-duty type and capable of standing a good deal of punishment from heavy currents. Sockets of the sub-panel, spring type are mounted with other parts of the amplifier on a brown bakelite panel 14 x 3¾ inches; which, in turn, is set in a brown crystalline metal

case, 1 3/4 inches deep. Eleven metal binding posts accommodate the necessary input, output and battery connections.

Manufacturer: The Insuline Corporation of America, New York, N. Y.

### Automatic Motor Control

In Fig. E is pictured the commercial result of development work by the engineering staff of another manufacturer. Working on the theory that comparatively large motors of 1/10 or 1/8-horsepower are unnecessary, they selected, instead, a smaller, high-speed motor and made use of a suitable gear-reduction drive for the scanning disc, thus obtaining a highly-responsive and flexible control. The motor used in the apparatus illustrated is rated at 1/25-horsepower, is of the high-speed type with suitable reduction gearing and equipped with flexible coupling for driving the scanning disc.

What is perhaps the most important feature of this assembly is the automatic-motor control feature. On the motor shaft is mounted a special centrifugal governor actuating a pair of contact points in series

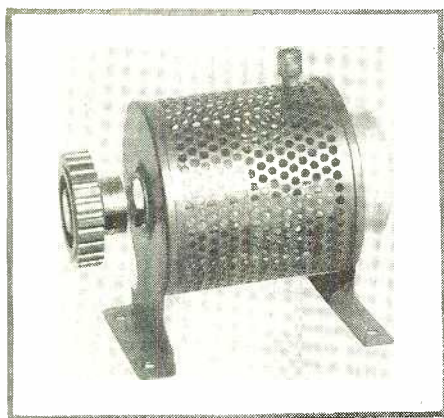

Fig. F. This heavy-duty resistor is designed to regulate motor speeds; the push-button at the rear is a "kicker" adjustment.

with the motor current supply. The contact points are shunted by an adjustable resistance. Thus, when the speed of the motor rises above a given point, the centrifugal governor opens the contact points, thereby reducing the current to the extent of the resistance then thrown into the circuit. As the speed of the motor falls below a given point, the contact points close, short-circuiting the resistance and restoring a full flow of current to the motor.

The completed unit, as shown, comprises a driving motor as described, an adjustable neon-lamp mounting and a 48-hole scanning disc of metal construction. Behind the casting upon which the motor is mounted can be seen the two resistors controlling the speed of the motor and, also, damping the effects of sparking at the contact points by varying the amount of short-circuited resistance. In addition there is a small knob for adjusting the contact points, which serves as a vernier to obtain precise speed. The neon lamp is mounted on an adjustable platform which, by means of rack-and-pinion movements, may be raised or lowered, as well as shifted from side to side.

### Convenient Manual Control for Scanning Speeds

The same manufacturer has produced also for the television fan a variable resistor, enclosed in a new housing which pre-



Fig. J. A front view of the receiver whose mechanism is shown in Fig. I, on the preceding page. The relative size of the image may be judged from the white square. The knob in the center of the panel brings the image into "frame."

sents a unique arrangement. This item is a "stepless" or uniform speed control for the scanning disc's motor, and is placed in series with the 110-volt line leading to the motor input. It comprises a special power-type resistor, housed in a widely-perforated metal casing, and a short-circuiting button. Ample ventilation is provided for dissipating the heat generated by the resistor in

the motor circuit. The wiring connections are made to screw terminals, the ends of which are protected by removable caps. Over several turns of the knob, the device provides a resistance range of from 25 to 500 ohms; which is more than sufficient for scanning-disc control. The push-button (shown in the illustration atop of the housing) is already connected across the resistor; so that pressing it will "accelerate" or speed up the motor when necessary. Universal- or condenser-type motors, up to 1/8-horsepower, may be regulated with this instrument. (Fig. F.)

Manufacturer: Clarostat Mfg. Company, Brooklyn, N. Y. C.

### A Flexible Outfit

Perhaps the most flexible kit available is that shown in the picture at the left (Fig. C.) The scanning disc supplied with the kit is novel in construction; in that it has, not one, but three sets of holes which make it possible to receive either 24, 36, or 48-line images. The assembled kit, with only a simple adjustment of the neon lamp, thus (Continued on page 570)

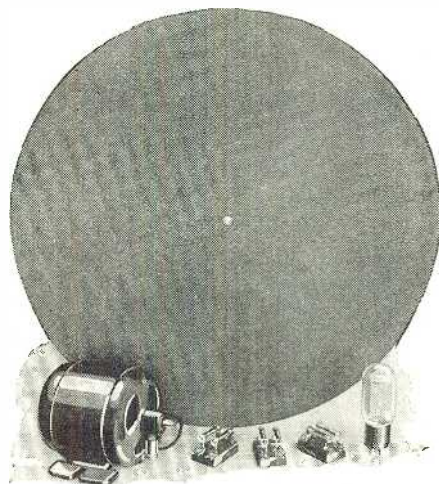
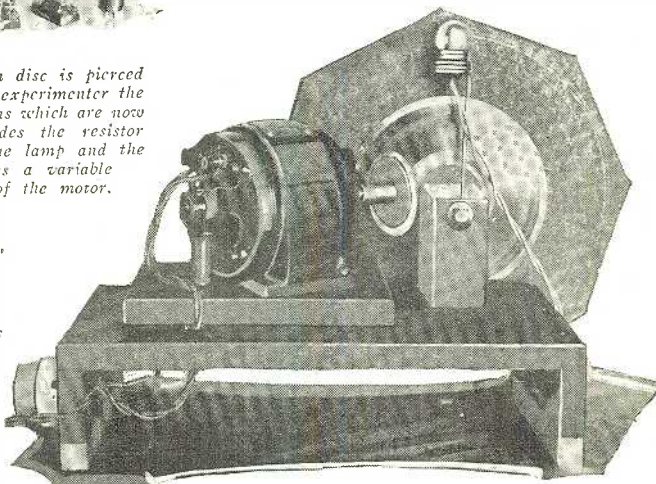

Fig. G. This large television disc is pierced by several spirals, giving the experimenter the option of any of several stations which are now broadcasting television. Besides the resistor couplings for an amplifier, the lamp and the motor shown, the kit includes a variable resistor to govern the speed of the motor.

Fig. H. Probably the least expensive and simplest kit yet offered is the outfit at the right, which comes without a motor, with a paper disc and a 55-cent neon television lamp. Many experimenters have obtained results with equally-simple material.



# New Disc Keeps Down Image-Frequency



Sanabria System Uses a Spiral Divided Into Three Sections to Scan Television Subjects and Obtains Sharp Detail and Clear Distinct Signals Within 5000-Cycle Band



By Robert Hertzberg

ONE of the main attractions at the Radio World's Fair held in New York during September was the exhibition of television transmission and reception staged by Ulises A. Sanabria, the young television expert of Chicago, whose pioneer television work on the broadcast band was described at length in an article appearing on page 219 of the September number of *RADIO NEWS*. Every afternoon and evening during the week, people waited in long lines to get a glimpse of the television images as they appeared in four receivers set up in the exhibition hall of Madison Square Garden. The apparatus was kept running almost continuously from noon till eleven o'clock in the evening, being shut off occasionally only to give the arc light and the driving motors a chance to cool off.

Mr. Sanabria displayed for the first time his new three-spiral-disc system, to which reference was made in the article cited; he thus produces 15 pictures a second, yet keeps the frequency of the image impulses within the 5,000-cycle limit prescribed by law. As a matter of fact, the television signals are actually "sharper" than voice and music signals; that is, they do not spread over the tuning dials of a receiver as much as the latter. This rather surprising effect has been the subject of comment by numerous listeners in and around Chicago, in which city a Sanabria transmitter is in nightly use at WIBO. This station broadcasts television images every morning except Sunday and Monday at 1.00 a.m., Central Standard Time.

## TELEVISION AT STATION WMAQ

By the time this number of *RADIO NEWS* appears, the television transmitter displayed by Sanabria at the New York radio show will have been installed at WMAQ, the powerful broadcast station operated by the *Chicago Daily News*. If you are within

range of this station, you can readily learn the hours of television broadcasting by consulting the daily radio programs printed in your local newspaper.

This machine and that in use at WIBO were built under Sanabria's direction by the Carter Radio Company, of Chicago. Mr. A. J. Carter, its president, stated at the New York show that several other transmitters were then under construction,

hole of the disc comes into position again and the subject is again scanned from top to bottom in one revolution of the disc. The holes are of such diameter that the beam of light thrown out by each just skims by or slightly overlaps the edge of the path covered by the ray of light from the preceding hole. As the holes are in a spiral, the whole surface of the subject's face is smoothly scanned, usually from top to bottom.

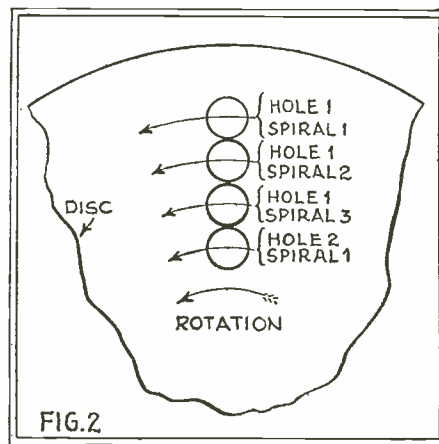

FIG. 2  
Unlike other triple-spiralled discs, however, the Sanabria system covers only one-third of a picture with each spiral. The result is shown in more detail opposite.

and would be installed shortly in different parts of the country. It is likely that one of the new televisions will be taken over by a third Chicago station, although at the time this number of *RADIO NEWS* went to press the final negotiations had not yet been completed. Another transmitter is tentatively scheduled to go to Philadelphia.

Except for the important detail of the disc itself, the Sanabria televisor is much like the numerous other disc machines. A ten-kilowatt arc serves as the initial source of illumination, its light being broken up by a disc into slender rays which flash across the face of the subject being televised. These rays are reflected into a bank of four ten-inch photoelectric cells, which respond to the graduations of tone (reflected from the lighter and darker areas of the face) by producing a flickering current. This current, which is very weak, is amplified by a suitable bank of amplifiers and made to modulate the radio transmitter. This action has been described in detail in numerous articles in *RADIO NEWS*.

In practically all other disc systems designed for ordinary black-and-white transmission, the disc is drilled with a single spiral of tiny holes, which cause a series of beams of light to sweep across, or "scan," the face of the person being televised. With a single spiral (of either 24 or 48 holes, usually), 24 or 48 beams have swept across the subject. Then the outermost

## THE SANABRIA 3-SPIRAL DISC

The Sanabria disc, however, is drilled with *three* spirals, as shown in Fig. 1. Each spiral comprises fifteen uniformly spaced holes, with the spirals themselves set differently in relation to the center of the disc. To understand exactly how the holes are arranged, study Figs. 1 and 2 very closely. Fig. 2 shows how hole 1 of spiral 1, hole 1 of spiral 2, hole 1 of spiral 3 and hole 2 of spiral 1 would look if all four of them could be made to appear together along the vertical diameter of the disc.

Let us start with hole 1 of spiral 1 in the position it occupies in Fig. 2, and start the disc rotating in the counter-clockwise direction. This hole sweeps past the arc light, and is followed by hole 2 of the same spiral, and by the remaining thirteen holes. Notice carefully that holes 1 and 2 of spiral 1 do not overlap or even run closely, edge to edge; in fact they are quite widely separated. Now when the 15th hole of spiral 1 has flashed by the arc, hole 1 of spiral 2 comes into position. This hole just skims beneath the path cut by hole 1 of spiral 1; similarly, hole 2 of spiral 2 runs by just beneath the path traversed a few moments previous by hole 2 of spiral 1. When all 15 holes of spiral 2 have run by the arc, covering half of the dark paths left by the passage of spiral 1, hole 1 of spiral 3 comes into position. This sweeps under the path cut by hole 1 of spiral 2, and above the path cut by hole 2 of spiral 1. The other 14 holes of spiral 3 cover the remaining dark or unscanned strips of the subject's face. The disc revolves at 900 r.p.m., giving 15 pictures per second.

If all this sounds confusing at first, read it over a second time. The system is a rather peculiar one, but it works.

## HOW THE EYE HELPS

At this point you are probably asking: "If the holes of each individual spiral are so far apart, why won't thick, black lines appear in the receiver?" The answer is found in that much-discussed property of the human eye: namely, its ability to retain an image after the original picture has completely disappeared. Actually, what a three-spiral receiving disc builds up is a series of three *separate and distinct* images, each consisting of 15 widely separated lines, as shown in Fig. 3. Practically, however, the eye retains the lines produced by the first scan for some time after spiral 1 has

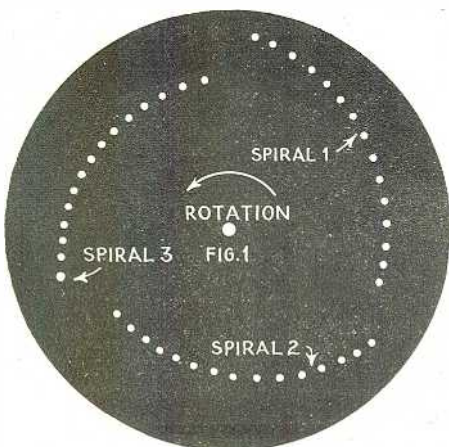

The arrangement of holes, in the disc used by the Sanabria system, is indicated above. It will be seen they form three spiral arcs, as in the color-television system of Baird.



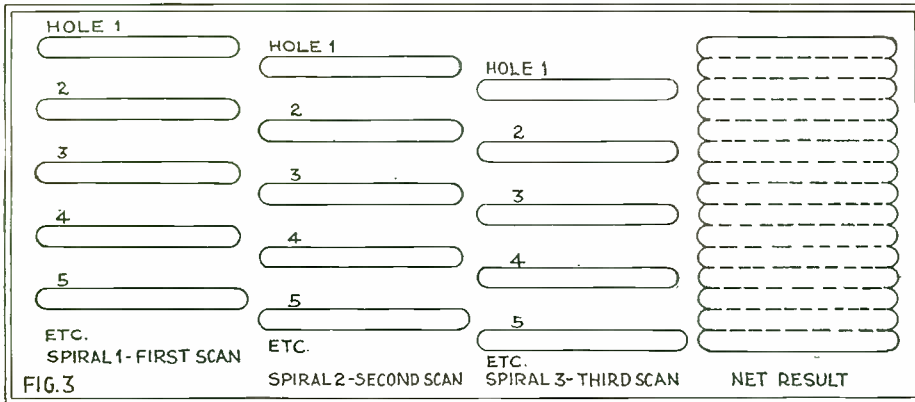

The three spirals of the Sanabria disc scan the image in alternate strips, covering it completely at every revolution, however, just as do the other types of disc in use.

swept by the neon glow-lamp. It also retains both the first and second "scans" while the third spiral is active. The net result, as far as the eye is concerned, is a complete image built up of closely-adjointing beams of light.

The illusion of solidity produced by this arrangement of spirals is very effective in that the received images are not at all badly streaked. Of course, we cannot expect something for nothing: the images are not perfect, and some streaks are evident, but considering the extremely important fact that the image impulses do not exceed 5,000 cycles, the results must be considered quite good. With the 15-image-a-second rate, the subject at the transmitting end

can move from side to side without fear of having his image at the receiving end look like a slow-motion comedy scene.

At the New York radio show Mr. Sanabria showed the usual 1½-inch-square images built up on the plate of a neon-gas glow-lamp, with only the head and part of the shoulders of the subject visible. However, in his own laboratory in Chicago he has been able to show the entire figure of a man, without making any changes in the apparatus. The scanning light is sufficiently powerful, and the photoelectric cells sufficiently sensitive, to make this feat possible. The image of the man at the receiving end is very small, but his whole form may be seen.

SIGHT AND SOUND TOGETHER

One of the interesting experiments Mr. Sanabria performed in Chicago, just before leaving for the New York exhibition, was that of transmitting both voice and images on the same 5,000-cycle broadcast channel, at the same time. At the transmitting end he simply connected the microphone in one of the intermediate stages of the audio amplifier working with the photoelectric cells. At the receiving end he inserted a low-frequency filter in the plate circuit of the last audio amplifier tube, with the loud speaker in the proper position in the circuit.

It is possible for this simple system to work only because the voice frequencies are comparatively low, and the image frequencies relatively high. The voice impulses do tend to break up the images at times; but the experiment was performed with marked success. In fact was actually tried "on the air;" and several experimenters in Chicago reported that they were able to reproduce the voice and images simultaneously.

It is obvious from the foregoing description of the Sanabria television system that a special receiving disc is necessary. The 48-hole disc which has become virtually the standard for television work, for no reason at all, will produce no results. By the time this magazine appears inexpensive three-spiral discs undoubtedly will be available.

Several Wavelengths Used for High-Frequency Radio Movies and Television

STATION WIXAY, located at Lexington, Mass. (near Boston), is now broadcasting both television and "radio movies" on a wavelength of 61.5 meters, a 48-hole disc, revolving at 900 revolutions per minute, being used. This station has been authorized by the Federal Radio Commission to use a wide modulation band for experimental purposes. No definite schedule of transmission has been given; but owners of short-wave receivers can easily pick up the signals and learn the schedules from the broadcast announcements.

The transmitter of WIXAY (which is a companion station of WLEX) is rated at 500 watts, and was designed especially for radiovision work. It should be heard without trouble in most parts of the United States and Canada. Alfred J. Poté, formerly in charge of the experimental laboratory of the Raytheon Manufacturing Company, of Boston, is chief engineer of the station and the designer of the television apparatus.

As the studios of WIXAY-WLEX are located in the same building housing the short-wave transmitter, it will be possible to broadcast the images of performers, either before or after they appear before the microphone. The television transmitter has been built in semi-portable form; so that it may be wheeled from one room to another. It is Mr. Poté's plan to cut a hole in the wall of the main studio and to stand the television inside this; so that the apparatus will not crowd the studio itself.

For the "radio-movie" transmissions, specially prepared motion-picture film will be used. Radio News will publish further details of the apparatus, and will give the full transmitting schedules, as soon as the information is released.

THE Jenkins "radio movies" are now being broadcast on 186 meters, in addition to the 46.72-meter transmissions, announced on page 420 of the November number of Radio News. This wave falls a little short of the tuning range of most broadcast receivers; but it can be tuned in with the biggest coil of the usual plug-in-coil short-wave set. If you cannot pick up the 46.72-meter signals, because of "skip-distance"

effects or merely because of your location, try the higher wave.

The "radio movies" are broadcast on Monday, Wednesday and Friday nights from 8:00 to 9:00 p. m., E. S. T. Announcements are made in both phone and code; the call letters of the station are W3XK. The Jenkins Laboratories, from which the transmitting is done, are located at 1519 Connecticut Ave., N. W., Washington, D. C.

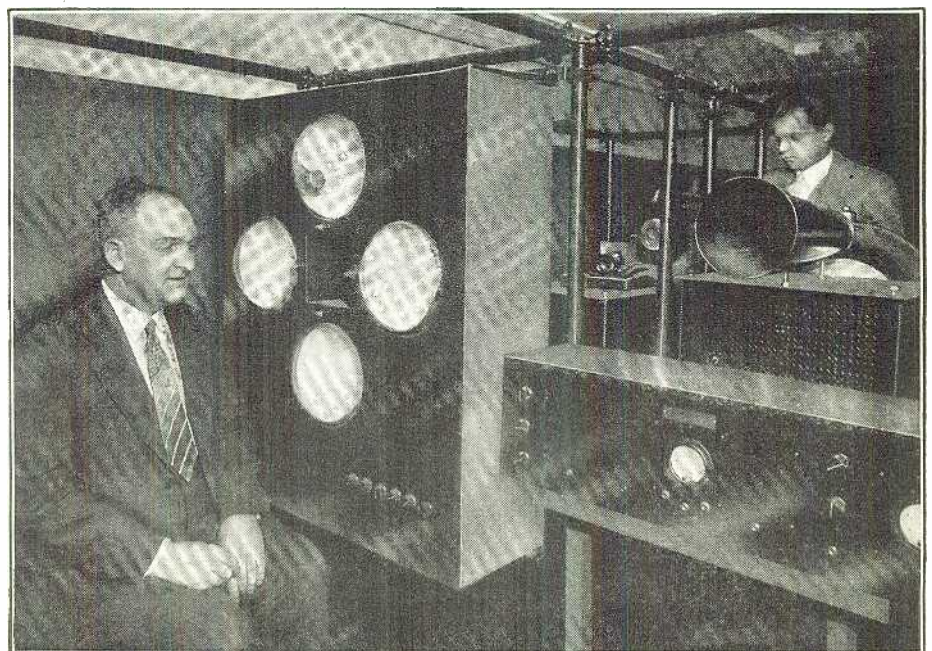

Above, left, A. J. Carter of the Carter Radio Co. being televised by the transmitter which U. A. Sanabria is operating. This apparatus was exhibited at the radio shows held recently in New York and Chicago. The "checking" receiver appears at the right.

# Complex Televisors to Give Large Images



Imitating the Action of Eye with Myriad Cells Eliminates Scanning Disc, and Bank of Lamps Reproduces Televised Scene with Light Enough for Magnification



By Herndon Green

ONE of the most interesting of recent television stories is the development by C. Francis Jenkins of Washington, D. C., the well-known inventor, of a television system from which the usual scanning disc has been eliminated and replaced instead by a picture-analyzing frame containing 2,304 separate photoelectric cells. The disc has been removed from the receiver also; the received images being built up on a frame of similar construction containing 2,304 little flashlight lamps. The latter give white light, and thus produce images considerably brighter than those possible with the usual neon-gas glow lamps.

Because of the high light-sensitivity of the image-analyzing frame, and the brilliance and size of the image-reproducing frame, Mr. Jenkins predicts that within a year he will be able to transmit views of baseball games, inaugural ceremonies and other outdoor events, and to reproduce them before large audiences in theatres. He estimates that his apparatus handles 100,000 times more light than do the present scanning-disc machines; in which the amount of light actuating the photoelectric cells is limited by the tiny apertures in the revolving discs.

FRAME HOLDS 2,304 CELLS  
As shown in the illustration on page 537, the image-analyzing frame at the transmitting end consists essentially of a wooden board slightly more than two feet square. The 2,304 photoelectric cells, each only one-half-inch square, are arranged in 48 parallel rows of 48 each. In the base of each cell is a tiny fixed condenser, connected directly across the electrodes. The condenser is an integral part of the cell, and plays an important part in the operation of the system, as will be explained.

One terminal of each cell is connected to the corresponding terminal of its neighbor; a single wire, common to all these 2,304 terminals, being one of the external connections of the frame.

Separate wires are run from the free terminals of the cells to 2,304 separate little contact points mounted on the inside of a drum of insulating material about fourteen inches in diameter and two inches wide. Revolving against these points, and making contact with only one at a time, is a contact-arm which is driven at the rate of 900 revolutions a minute. A single wire is connected to this arm; in company with the wire from the common side of the cells, the two form the "output" wires. These

are led to a powerful audio-frequency amplifier, which in turn is made to feed the radio transmitter.

The receiving end of the system is practically identical in construction with that of the transmitter. The board on which the receiver images appear is also slightly more than two feet square, and contains 2,304 ordinary flashlight bulbs, in 48 rows of 48 each. These are connected in the same manner as the photoelectric cells, the switching drum being of exactly the same size and design.

## HOW THE SYSTEM WORKS

The operation of the system is simple. The subject to be televised sits in front of a lens which projects his image on the bank of photoelectric cells, just as if the latter were the ground-glass screen or the plate of a camera. Each of the tiny photoelectric cells generates an electric current, the strength of which depends upon the amount of light falling on the cells. For instance, the cells covered by the darker image of the hair will create comparatively weak currents; those on which the lighter portions of the face and skin are projected will generate stronger flows. The whole image is thus broken up or analyzed by the cells, each of which represents a unit area of it. The current produced by each cell charges the condenser contained in the latter; and this operation is continuous, not intermittent as in the scanning-disc systems, in which the cell is exposed to light but 1/2,304th of a second.

Now, when the contact-arm of the commutator is started, it will first touch the contact to which the first cell of the first row is connected. The fixed condenser in that cell then discharges its energy through the circuit. The arm swings to the next contact, discharges the condenser of the second cell, and continues along the line. When the 48th cell of the first row has been discharged, the first cell of the second row is contacted and so forth, down the lines.

As the arm revolves at the rate of 900 revolutions per minute, the whole bank of 2,304 photoelectric cells, or rather their associated condensers, is discharged in one-fifteenth of a second. The stream of 2,304 impulses from the condensers flows into the amplifier practically as a continuous current, varying in amplitude in accordance with the potentials of the condenser charges at the instant the contact-arm passed over the respective contacts. The process keeps repeating itself, fifteen complete streams of current, representing fifteen images, being transmitted during one second.

At the receiving end these impulses are picked up, amplified, detected and amplified again, just as if they were regular radio signals from a disc-television system. The energy from the local audio amplifier is

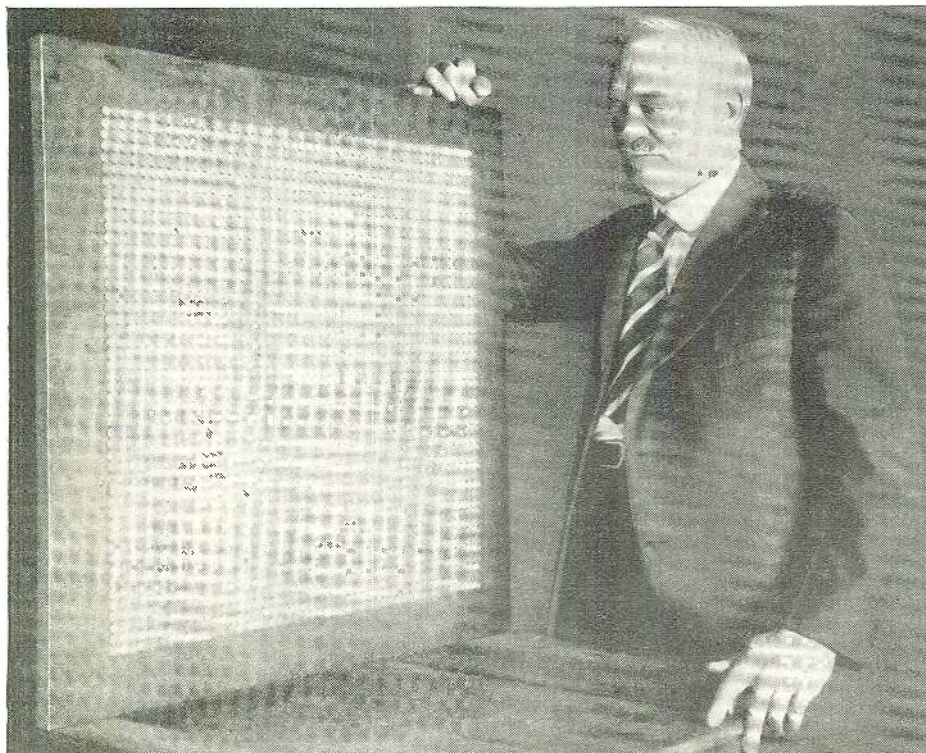

Fig. A

(C) Harris & Ewing.

Mr. Jenkins is shown holding one of the receiving frames, which is studded with small lamps so close together that they produce a complete image at a short distance. Their light will be sufficient to cover a moving-picture screen.

led to the two input wires, running to the commutator and the common side of the flashlight lamps.

HOW THE LAMPS WORK

Suppose that, at the very instant the contact-arm at the transmitter touches the contact of photoelectric cell No. 1 of row No. 1, the arm on the receiver's commutator touches the contact for lamp No. 1 of row No. 1 on the receiving board. This lamp will immediately light up, to a degree depending directly on the amount of light falling on the corresponding cell at the transmitter. The arms move 1/2,304th of a revolution, and actuate the second photoelectric cell and flashlight lamp, respectively. This lamp flashes. The process continues until all 2,304 lamps have been lighted (in the time of 1/15th of a second), and then it repeats itself.

It so happens that a flashlight bulb will stay illuminated for just about 1/15th of a second after the current through it has been turned off. From this fact it can be seen that the first lamp is still burning when the current to the last one has been turned off; in other words, all 2,304 cells glow together, and present, in gradations of light, an image which is a reproduction of the one on the transmitter's analyzing board during that same 1/15th of a second. This persistence of the light is a second important factor in the operation of the Jenkins system.

Of course, at the end of the first 1/15th of a second, the contact arms begin their second revolution. The first lamp of the first row, which has just about died out, is again operated, and the light for the second image is built up. The process being continuous, the images appear on the screen at the rate of 15 per second,—a rate only one picture per second slower than the rate at which "movies" are un-reeled. If the observer stands at a sufficient distance, from the board, the lamps on the latter will lose their identity as separate sources of light, and the image will appear in its natural shading. It may be cast by lenses on a large screen.

THE RADIO "MOVIE"

"Actual tests of the fundamental mechanisms involved have convinced us," says Mr. Jenkins, "that we have more available light than is now employed in theatres for illuminating the picture screens. And the light is white light, not neon-pink; and fortunately the light source is readily available in the open market."

In explaining the operation of his apparatus, Mr. Jenkins stated:

"In the art of transmitting pictures electrically, the accepted plan is to *synthesize* (build up) as well as *analyze*, the picture surface in a *linear* consideration of successive elementary areas of the surface. For example, if the picture surface is divided into forty-eight horizontal lines, each of these lines is assumed to be divided into elementary areas for the whole picture surface.

"If the reception of the picture takes five minutes to be completed, obviously a recording surface must be employed; for example, a photographic film or plate, an electrolytic (chemically treated) paper or a plain piece of paper which ink or other means of coloration is used. However, if the speed of completing each picture is reduced to one-fifteenth of a second, and repeated every fifteenth of a second, no

recording surface is needed; for, because of the persistence of vision, the picture can be assembled directly on the eye, and radio-vision, radio "movies" and television are accomplished facts.

"The picture scanning mechanism employed by Nipkow in a telegraphic device in 1884, and by others since, consists of a rotatable disc with, say, forty-eight miniature apertures therein, the diameter of each aperture being about 1/48th of the length of the scanned line, or 1/2,304th part of the whole scanned area, and conveniently termed the 'elementary area' of the image surface.

HOW THE DISC WORKS

"As each aperture in the disc lies on its particular one of forty-eight such radii, and each aperture is located, by approximately its own diameter, nearer than its neighbor to the axis of the spiral, it will be seen that, when the disc is rotated, the locus of each aperture in succession produces a linear scanning of the whole picture area. Because this scanning disc limits the illumination to the light which can pass through a single one of these tiny holes, a powerful source of light is required for adequate lighting; just as it is required for a pinhole camera, to which the apparatus is comparable."

This light limitation is overcome in the picture-board of Mr. Jenkins, which employs 2,304 cells instead of a single cell as in one disc system, or three or four cells, as in the systems now in general use at stations like WGY, WRNY and W2XAL, WIXAY, WIBO, WMAQ, etc. The switch

gear reduces the 2,304 wires from the cells to virtually a single connection, and makes the application of the board to a standard radio transmitter a comparatively simple matter.

The frequency band covered by this system is not any wider than that covered by a 48-hole disc driven at the same scanning rate, 15 pictures per second. The actual figure is about 10,000 cycles, depending on the particular subject being televised. The width of this band will, of course, prevent the application of the system to the regular broadcast band, but not to the short waves.

Such a system may be used to receive images from a 48-hole disc, as well as those from the cell frame described. So far as the reproducer is concerned, the signals from both types of transmitters are alike if speeds are the same.

The idea of mounting a great number of small photoelectric cells on a board for analyzing a scene for electrical transmission is not new. In fact, Mr. Jenkins himself suggested the scheme more than thirty years ago; but at that time it was impracticable because of the lack of suitable photoelectric cells, for one thing, and the necessity for thousands of connecting wires between transmitter and receiver. At that time the practicability of wireless telegraphy itself had just been demonstrated, broadcasting was undreamed of, and the vacuum tube, then containing but two elements, only an electrical toy. With the development of the art, Mr. Jenkins is now realizing what was once a mere dream.

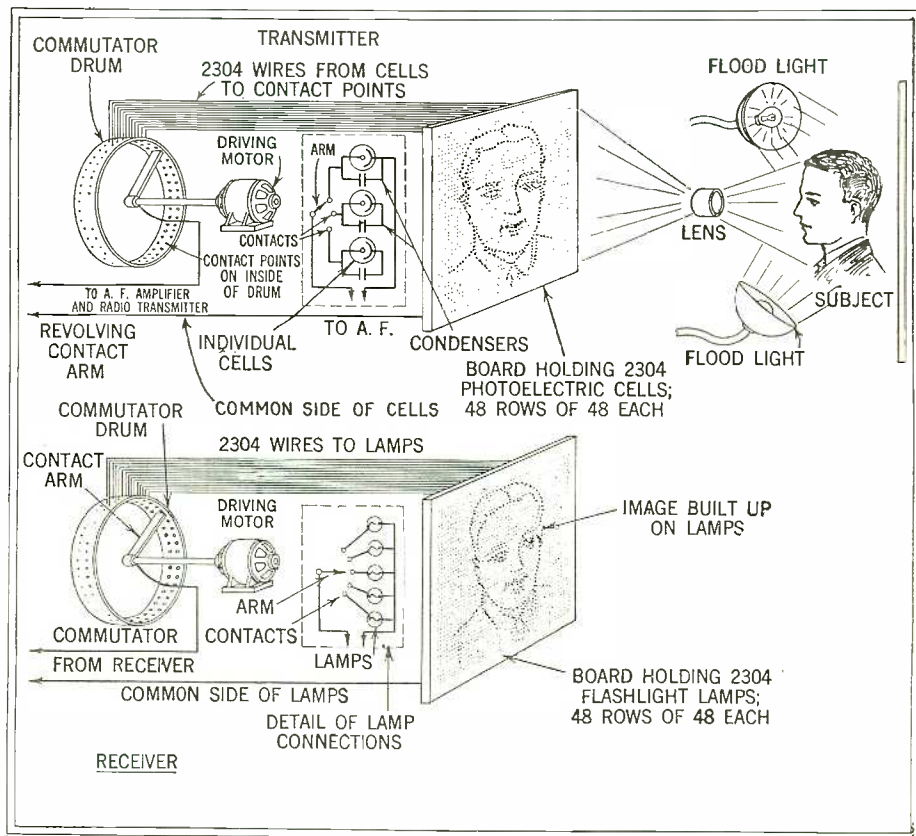
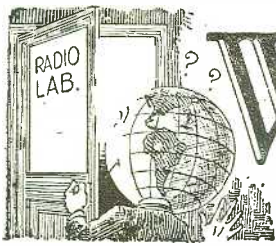

Fig. 1

The Jenkins multiple "camera" is shown above. The image of the subject is not "scanned," but kept continually on all the little cells, each of which charges its condenser in proportion to the light it is receiving. These charges are collected by the commutator and converted into impulses, later impressed in the same order on the receiver, shown below; so that each lights the lamp corresponding to its photoelectric cell. The lamps have also a persistence of illumination after the current has been turned off each, thus holding the image almost continually.



# What's New in Radio



## Screen-Grid Short-Wave Set Enclosed in Metal Case

PLEASEING appearance characterizes the latest products of a manufacturer who has just marketed screen-grid short-wave kits which are available in two models. Both are identical in external appearance, being housed in the same type of aluminum shielding cabinet. The first is essentially a two-tube device used for short-wave reception when connected by an adapter to any broadcast receiver, and is similar in tuning characteristics to the other—a four-tube non-radiating receiver comprising one stage of screen-grid radio-frequency amplification, a regenerative detector and two stages of audio-frequency amplification. Four inductance coils, which may be interchangeably plugged into a five-prong tube socket on the top of the cabinet, provide a tuning range from 17 to 204 meters.

Diagrammatically, the circuit comprises a radio-frequency choke coil, L1, feeding into the screen-grid tube V1. The grid and tickler windings are wound on the form, L2, which has a UY-type base and fits into the standard five-prong socket which is mounted in a conveniently-accessible position on top of the cabinet. In series with the grid coil is the radio-frequency choke coil L3, through which the plate voltage for the screen-grid tube is fed. The .00014-mf. variable condenser C1 is used to tune the grid coil; the tickler is controlled by the .00035-mf. variable condenser, C2.

Between the first audio transformer T1 and the detector output is a radio-frequency choke coil similar in characteristics to the antenna choke coil, L1. The audio transformers used in this receiver are designed under what the manufacturer terms the "Clough System." In this design the transformer actually comprises an auto-transformer, a resistor and a blocking condenser,

all mounted in one case and connected in circuit, as would be any transformer of the conventional primary-secondary type. The direct plate current of the amplifier tube

of the screen-grid tube's filament, a fixed resistor controlling the filaments of the amplifying tubes V3 and V4, a .00015-mf. grid condenser and 5-megohm grid leak, suitable by-pass condensers, and a 20-ohm rheostat R in series with the filament of the detector tube; this rheostat serves as the volume control, and incorporates in its construction a filament switch which is opened when the rheostat is brought to the off position.

An odd feature in the mechanical construction of the receiver is the inverted

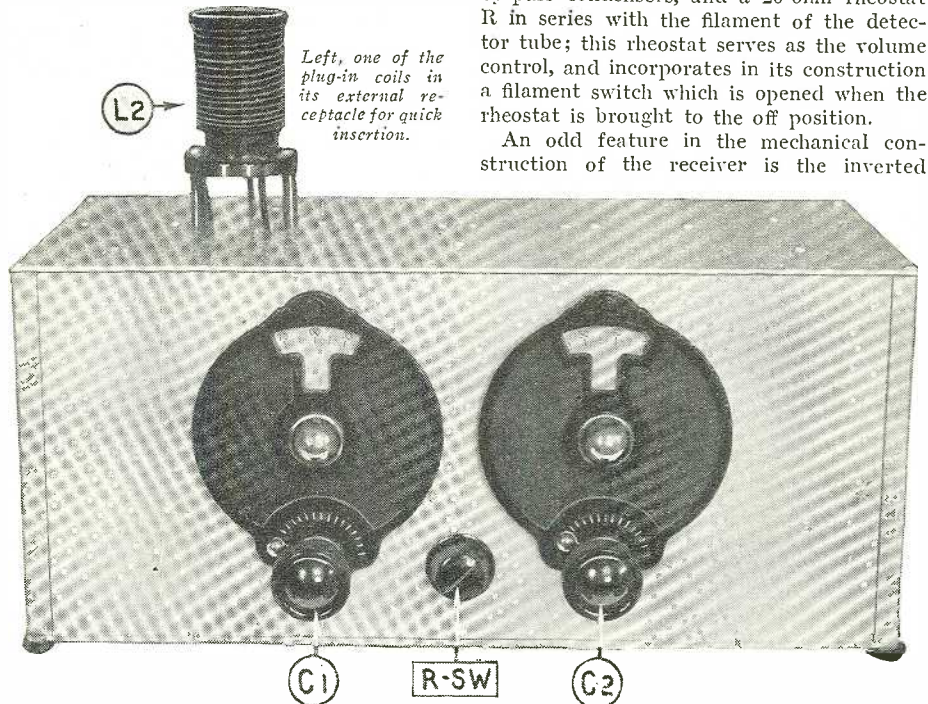

The all-aluminum cabinet effectively shields the receiver. The top of the cabinet, instead of the bottom, serves as a sub-panel to mount the components, which hang downwards.

passes through the resistor, and the A.C. signal impulses flow through resistor, condenser, and the lower or primary portion of the auto-transformer. The ratio of the first-stage transformer is  $4\frac{1}{5} : 1$ , and that of the second  $3\frac{1}{2} : 1$ .

Minor apparatus consists of a 10-ohm fixed resistor placed in series with each leg

mounting of the apparatus which we are usually accustomed to see in an upright position above the conventional baseboard or sub-panel. The tube sockets, radio-frequency choke coils and audio transformers are secured to the under side of the top of the metal cabinet. A good idea of the position of the apparatus when so mounted

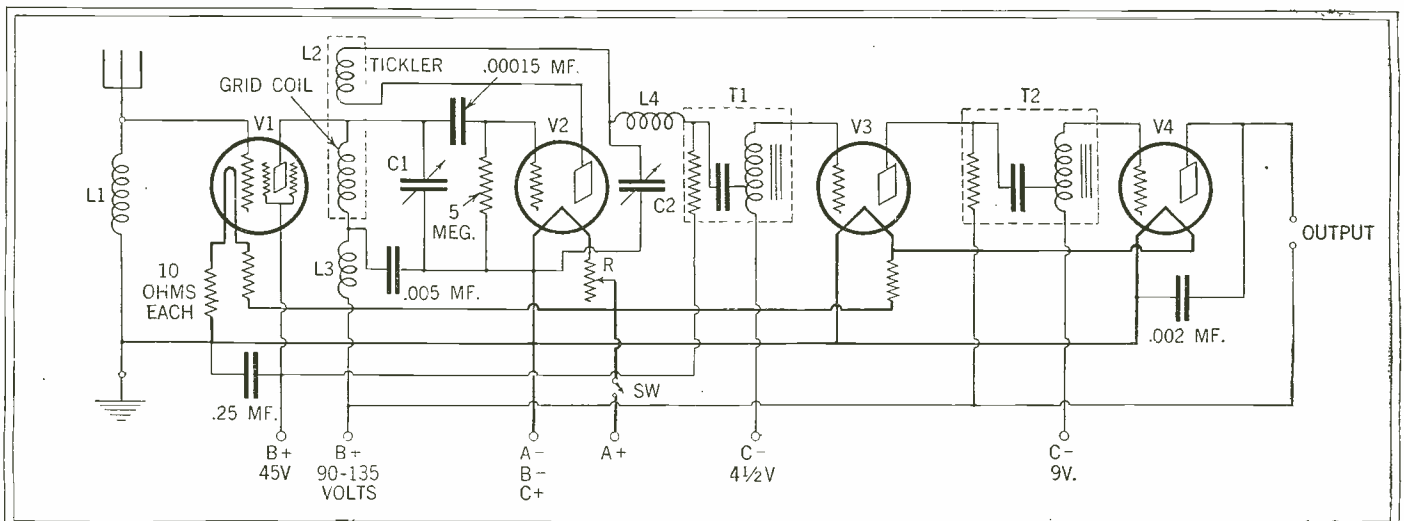

In this diagram of the receiver illustrated above, the dotted lines about L2 indicate the windings incorporated in the plug-in coil, and those about T1 and

T2 show the functioning of the parts assembled by the manufacturer in the housing of these new audio-frequency "Clough System" coupling devices.

can be obtained by turning this page upside down, and then noting the picture showing the internal layout of the receiver.

Atop of the cabinet is the UY socket for the plug-in coils; as it is directly above the detector socket, the leads are short. The additional advantage, of having the coil socket outside of the receiver cabinet, makes possible convenient and rapid changes when switching from one waveband to another. The coils used for this purpose are of the molded bakelite type, measuring 1½ inches in diameter, and have a winding space of 1½ inches. The wavelength ranges of the four coils supplied with this receiver are, respectively, as follows: 17.4-32 meters, 31-58 meters, 57-110 meters, and 104-204 meters. Enamelled wire is used for the grid winding, which is space wound, except in the 200-meter coil, which makes use of green, silk-covered wire.

Neatness is shown in the arrangement of the front panel, upon which are mounted two vernier dials of excellent design, and the rheostat-filament switch. The two phone-tip jacks are mounted on the binding-post strip which occupies the upper section of the rear panel. The cabinet measures 14 x 6¼ x 6 inches and is constructed entirely of 1/10-inch aluminum.

Manufacturer: Silver-Marshall, Inc., Chicago, Ill.

### New High-Voltage "B" Battery Suitable for Television

A NEW plate battery, emulating the "skyscraper" trend of design, is now being marketed by a mid-west manufacturer. A significant note in the production of these batteries can be found in the fact that they are specified for use with the photoelectric cell and the neon tube. Also, they may be found to be a space-and weight-saving factor in radio-equipped airplanes, for which they were originally designed.

They are marketed in two types. One is a battery having a voltage of 108, which measures 15 x 3¾ x 2⅝ inches, and weighs 6 1/3 pounds. It is equipped with four binding posts and provides the following values: 36, 72 and 108 volts.

The other is similar in design, but has a maximum of 144 volts, with a 54-volt tap. It measures 13¾ x 3 x 3 inches and weighs 5 2/3 pounds.



These batteries are designed to take up a minimum of space, as will be seen by comparison of their size with the standard tube between.

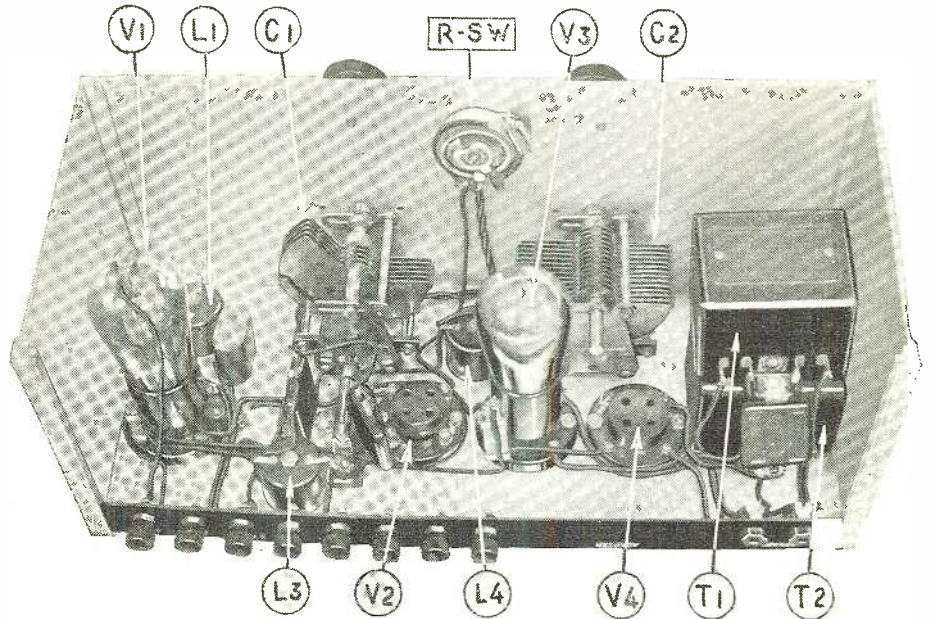

An interior view of the short-wave receiver, inverted; the parts are shown above the aluminum top from which they normally are suspended. Each may be identified by referring to the schematic circuit on the opposite page.

A novel method of construction is used in these batteries, which consists of combining the cylindrical cells in stick form, not unlike a roman candle. Seventy-two cells, ¾ x 2⅝ inches, are used in the 108-volt battery. The 144-volt battery consists of 96 cells, ⅝ x 1⅞ inches, corresponding in size to those used in the most compact "B" batteries.

Manufacturer: Burgess Battery Company, Madison, Wisconsin.

### High-Voltage Condenser Pack for 250-Type Amplifier

THE condenser block shown herewith is being marketed by a New York manufacturer and has been designed to withstand the high voltage which is required by the new 250-type power amplifier tube. It is built into an aluminum casing measuring 7 x 5½ x 3 inches, and has seven lug-terminals, one a common terminal. The other six are wired internally to as many condensers of the following respective capacities: 2 mf., 2 mf., 2 mf., 4 mf., 1 mf., 1 mf., thus offering a total capacity of 12 mf.

The first 2-mf. unit has been designed for an operating potential of 1,000 volts, D.C., and has a flash test voltage of 2,000 volts D.C. This unit is so rated because of its position in the power unit, where it has to withstand the brunt of the maximum voltage pulsations while in operation. The

next section, made up of the other two 2-mf. units and the 4-mf. unit, has an operating rating of 650 volts D.C.; while the two 1-mf. units, which are employed as resistor by-passes, are rated at 450 volts D.C. This rating is quite ample, for the voltage across them rarely exceeds 90 volts D.C.

The smaller instrument, shown at the right of the condenser block, is one of a series of low-capacity components ranging in values from .0001 to .05 mf., in successive ratings, which are now being produced by the same manufacturer. The external design is that of a fixed condenser which has been on the European market for some time; and at first sight appears somewhat larger than the domestic product the American experimenter has been accustomed to. It has an over-all measurement of 2 x 1½ x ¼ inches and is equipped with combination screw and solder lugs; so that connections to the condenser can be readily made without danger of affecting the dielectric by the application of heat in soldering. The internal construction is of the paper-wound type for which the manufacturer specifies an accuracy within 5%, plus or minus, of the rated capacity. This is sufficiently close for all practical purposes.

Manufacturer: A. M. Flechthelm & Co., New York City.

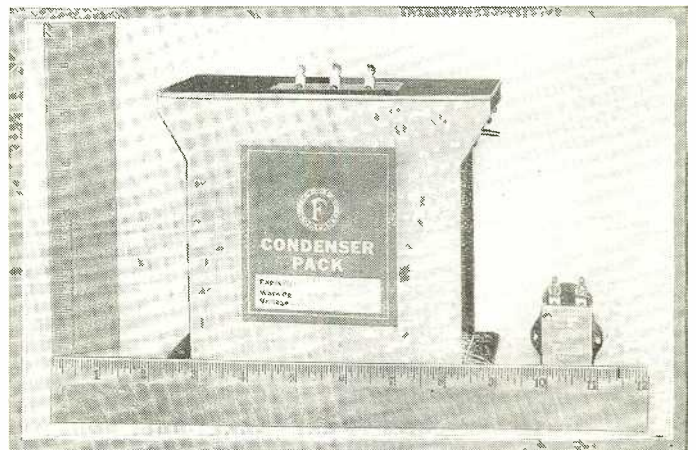

The very large condenser block has dielectric designed to resist the high maximum voltages created in a 250-type power unit. That at the right has binding posts to make cold connections.

### New High-Voltage Rectifier of All-Metal Construction

**A** DRY, high-voltage metallic rectifier of the "electronic" type has been designed to take the place of the gaseous-bulb rectifiers now being used in various "B" power units employing full-wave rectifying circuits. The illustrations herewith depict the new rectifier in both partially-complete and assembled forms. Outwardly it has all the appearance of a screen-grid tube shield. It is  $5\frac{1}{8}$  inches in height,  $1\frac{3}{4}$  inches in diameter and weighs approximately  $12\frac{1}{2}$  ounces. The fact that it is built upon a standard tube base permits its substitution for any gaseous-type rectifier tube designed for the UX socket.

The new item is a result of the development work of Dr. H. Shoemaker. Though the underlying principles of contact-rectification are not new, the perfection of their application to produce a dependable rectifier in low-voltage power systems is comparatively recent; even more so, its use where potentials in the order of 350 volts or more are dealt with.

The picture on this page shows that its internal construction differs radically from all other forms of rectifiers used prior to the development of the metallic-disc type. Since the unit is very nearly all metal, and contains no glass envelope or supporting structure, it is obvious that little or no damage can come to it. The outer extruded aluminum casing serves essentially as a radiator of heat and completes the assembly as to appearance.

The actual rectifier consists of a large number of "couples," each made of a disc of

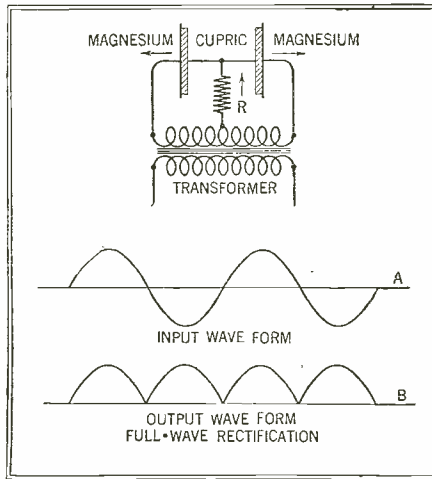

In each half-cycle, the current flows through a different set of discs, but in the same direction through R; thus putting both halves of the "wave-form" A above the line, as at B.

cupric sulphide in contact with an aluminum-magnesium combination. These coupling elements have the appearance of a large number of washers, and are  $9/16$ -inch in diameter. In proper combination they are assembled into "stacks" and then, by means of clamping collars, are forced together hydraulically under a predetermined pressure. The sub-assemblies or stacks, four in number, are then inter-connected electrically to fit the circuit for which the rectifier is intended; thus the base-plug provides for supplying the raw high-voltage alternating current to the coupling units and, finally, for taking off the rectified D.C. output component.

The operation of this type of rectifier is based upon the physical fact that, when bodies highly "electro-positive" and "electro-negative" (relatively) are brought into proper contact and current is passed, so that an electro-chemical reaction takes place at their junction, there is formed at the junction a film which permits the current to pass in one direction only.

Thus, when a disc of cupric sulphide is held, under a sufficient pressure, in contact with a disc of magnesium, and a A.C. voltage of proper magnitude is applied across the junction, the film which has rectifying characteristics is formed generally dur-

ing the first cycle; after which rectified current will pass from the cupric disc to the magnesium disc. When the couples, comprising discs of cupric sulphide and magnesium, are held together by a pressure which insures substantially uniform contact throughout the junction, the current-blocking film formed is observed to unite the electrode discs as though they were fused together. There is thus formed a continuous conductor which has relatively high resistance to the passage of current from the magnesium to the cupric-sulphide disc, but a relatively low resistance to the passage of current from the cupric sulphide to the magnesium disc.

The diagram shows an elementary circuit producing full-wave rectification. It will be seen from the figure that two sets of couples are used, in series with each other and with a center-tapped transformer secondary, which delivers the required voltage. It will also be seen that the resistance R (or combination of plate-circuit currents demanded by the radio receiving set, in practice) is connected from the center tap of the transformer secondary to a point in the circuit between the two sets of rectifiers. This circuit is, in fact, a combination of two half-wave rectifiers and each section of the transformer secondary must give sufficient voltage to force the required current through the load resistance R.

When the current flows in one direction, one set of couples will oppose its flow and the other set of junctions will allow the current to flow through it. When the direction of the current is reversed, the rectifier junctions that previously allowed the passage of current become "blockers" of this current; when the current is a second time reversed, they again pass it. In this manner the two sets of junctions alternate with the flow of the current in functioning as blockers and conductors; this keeps the direction of the current through the resistance R the same during each half-wave. The line "A" in the diagram shows the theoretical alternations of the current as it leaves the transformer secondary, and "B" the wave-form of the current after both halves of the wave are rectified.

Manufacturer: Elkon, Inc., Port Chester, N. Y.

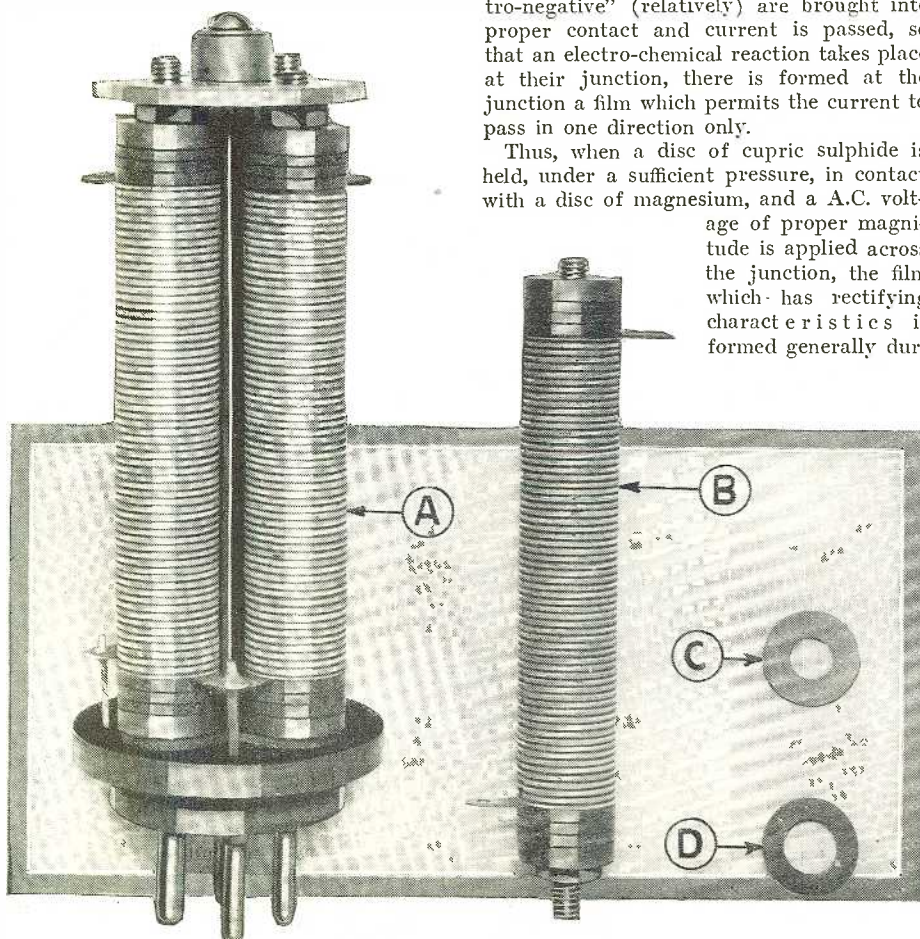

Right, this picture of the metallic rectifier shows its external similarity to a screen-grid tube shield, except for the ventilating holes.

Left, the rectifier as it appears without its housing; its base fits the standard UX socket. Each stack (A, B) is composed of alternate discs C and D, of cupric sulphide and aluminum-magnesium alloy, respectively.

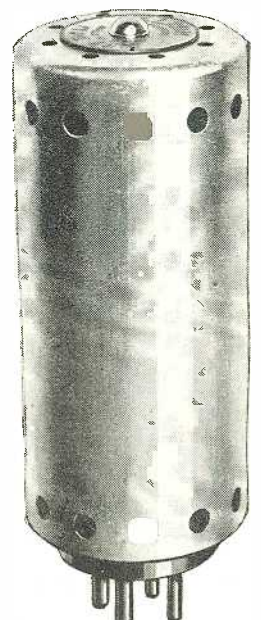

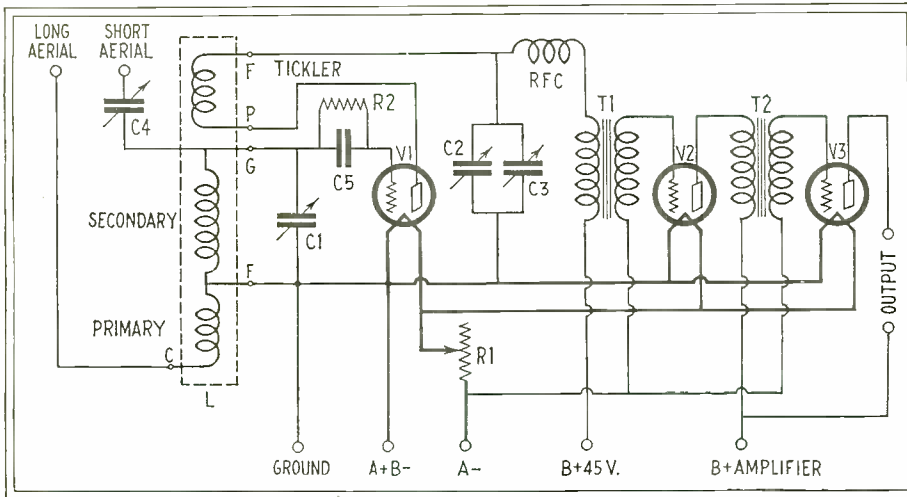

The schematic diagram of the three-tube short-wave receiver illustrated and described below. Optional antenna coupling is a feature. The plug-in coil L fits a standard UY socket.

### Attractive Short-Wave Kit Uses Handy Coils

THE short-wave receiver described in this article was assembled from component parts which are supplied by the manufacturer in kit-form, either for a complete short-wave receiver containing its own audio amplification system, or for the building of a short-wave converter for use in conjunction with the standard broadcast receiver. In both cases the kits are so designed that they can be assembled with a minimum of mechanical effort. The kit to be described embodies its own audio amplifying system and has been designed for operation on wavelengths from 17 to 500 meters.

The circuit, as can be seen from the diagram, is of the straight regenerative type, employing a fixed tickler winding with capacitively controlled feed-back, and was designed for the manufacturer by R. S. Kruse, nationally known for his research work on short waves, and M. B. Sleeper, well-known radio engineer. The plug-in coil L comprises a tapped secondary, and a lower winding which functions as a semi-aperiodic primary. On the same form is the tickler coil, which is tuned by the midget condensers, C2 and C3, connected in parallel for more even control of regeneration on the higher waves.

On the underside of the sub-panel is the antenna tuning condenser, C4; this is a 15-mmf. midget in series with the "short antenna" post which, when used, leads directly to the grid. When the "long antenna" post is used the antenna is out of the grid circuit, thus substituting inductive coupling. Generally, the latter method of grid coupling is to be preferred, as presenting the advantage that any broadcast aerial may be employed to receive short-wave signals.

In line with the antenna condenser under the sub-panel is the grid condenser C5 of the detector tube V1; it has a capacity of .0002-mf., and is used in conjunction with the 2-megohm grid-leak R2, the clips of which are mounted above the condenser on the upper side of the sub-panel. The radio-frequency choke coil RFC completes the equipment on the underside.

From the photographs reproduced here it will be noticed that the mechanical make-

up of the receiver is of average simplicity—the arrangement being of the conventional bracketed-sub-panel type, with as much of the wiring under the sub-panel as the circuit and lay-out allow. The front panel is of mahogany-colored bakelite and measures 7 x 14 inches. Upon this are mounted the

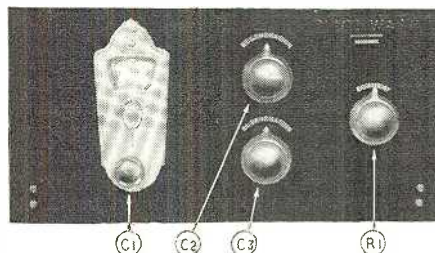

The neat front panel; only one regeneration control (C2, C3) is used at the same time.

tuning condenser C1, with its illuminated vernier dial, the two regeneration condensers C2 and C3, and the 6-ohm rheostat R1 controlling all three tubes.

With the exception of the apparatus mentioned above, everything else that goes to make up the receiver is mounted upon the bakelite sub-panel, measuring 7 x 13 inches, which in turn is mounted upon two bakelite brackets measuring 8½ x 1 x ¾ inches.

Constructional details of the plug-in coils designed for use with this receiver can be obtained by referring to the specifications

on page 332 of the October issue of RADIO NEWS. These coils are well designed; they fit into the standard five-prong socket of the UY type, therefore giving assurance of uniform contact. The diameter is small, 1½ inches, as well as the length, 2½ inches, giving the electrical advantage of a small magnetic field. As an added point of efficiency, the bakelite forms are ribbed in a manner insuring low losses; and the coils fitted with colored rings so that the right coil for any waveband can be spotted instantly. (These rings are removable should their design clash with anyone's ideas of coil construction.) Blank forms are available if the builder prefers to wind his own coils. The tuning condenser specified for use with these coils has a capacity of .00015-mf.

The wavelengths given below are for the coils when used with antenna coupling to the grid, and in the circuit illustrated in connection with this article: red-ring coil, 17-30 meters; orange-ring coil, 30-52 meters; yellow-ring coil, 48-105 meters; green-ring coil, 93-202 meters; blue-ring coil, 200-550 meters. It will be noticed that the wavelength ranges of these coils overlap, so that there are no gaps between wavebands.

The tube sockets used in this receiver are of the standard UX type, with the exception of L, which is a five-prong UY socket; so specified to take the five prongs of the plug-in coils.

One of the features of this receiver is the use of audio transformers (T1 and T2) encased in bakelite housings. This factor is of prime consideration in localities where the percentage of moisture is pronounced. While the most serious result of moisture is the breaking down of insulation under high-voltage strains, thus shorting the turns in the winding, it is responsible also for a good deal of open-circuit trouble due to corrosion of the wire. Both transformers are of a 2:1 ratio and have a primary impedance under operating conditions of 75 henries; giving an impedance of 471,000 ohms at 1,000 cycles. They are well suited for either broadcast or code reception.

It is well to mention that the use of either "A" or "B" socket-power units is not recommended with any degree of enthusiasm for reception on short waves. As a rule, they should be avoided, especially where phones are used. As there is little need for high-voltage, power amplification, dry or storage "B" batteries will serve the purpose and give most satisfactory results.

While the 201A type of tube will give  
(Continued on page 576)

This rear view of the set shows that practically all wiring is run below the sub-panel; the parts may be quickly identified from the diagram above. C3 is hidden by C2 in the illustration; both are .000045-mf. midgets, and only one is used except on the broadcast band (with the 200-500 meter coil supplied in the kit) where greater capacity is required for regeneration. The vernier dial of C1 is illuminated.

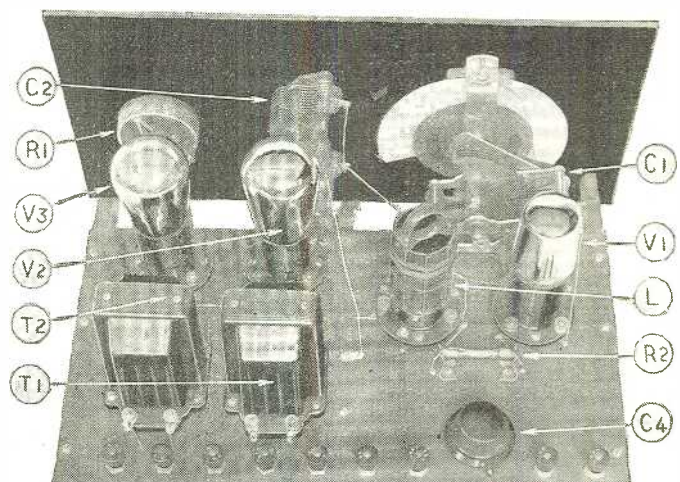

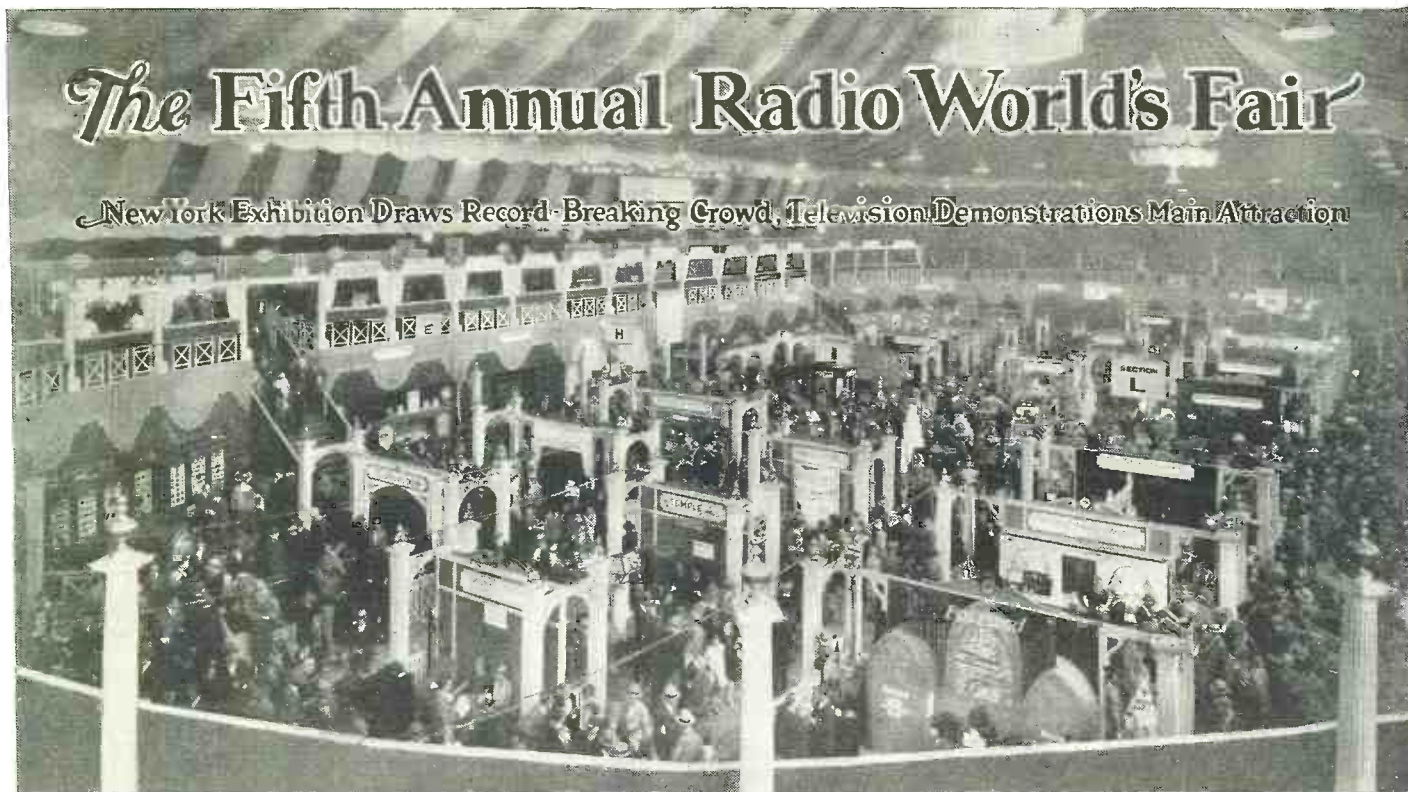

Looking over the arena floor of the new Madison Square Garden during the latest Radio World's Fair.

THE fifth annual Radio World's Fair closed its doors, on the night of September 22, ending what was probably the greatest exhibition of its kind ever held in the history of radio. It was conservatively estimated that over 250,000 people had passed through the gates of Madison Square Garden in New York City, during the six days of the show's run, to gaze upon an assemblage of radio instruments and accessories which vied in magnitude and elaboration with the great furniture and automobile expositions, and demonstrated that the radio industry has, finally, acquired a firm grasp of mechanical and electrical technique, and developed an unrivalled beauty of external design.

To all appearances, the state of operation perfection which has been the goal of the listener, these past seven years, has at last been reached. Operation direct from the light socket—either A.C. or D.C.—is universal; single-dial control—"so that a woman or child could operate it"—has been with us for some time; quality reproduction has been developed to an extraordinary degree; and the designs of the enclosing consoles bear the signatures of some of the world's foremost decorative artists.

At the Fair, one hundred and forty-seven manufacturers submitted their products; the greater portion of the enormous exhibition space was devoted to the display of complete receiving sets; while the next item in the matter of allotted space was the loud speaker. The design of the receiving sets leaned, of course, toward the console type, of which a hundred and forty-one models were exhibited. Table models came next, with a total of seventy, while seventeen phonograph-radio combinations were represented.

#### A SIGN OF PROSPERITY

Whether this is a strong indication of the wealth of the nation, or whether the radio manufacturers desired to put only

their best and most expensive feet forward, is conjectural but the fact was frequently noted, and comment made, that the lower-priced models were kept well in the background; while it was a comparatively-frequent occurrence to walk into a booth and find any number of well-displayed receivers bearing price tags with prodigious figures. If an interested visitor inquired as to the whereabouts of the "medium-pocket-book" set, he was led through a maze of towering works of art until, tucked into a corner somewhere, the modest shrinking table model was found. As manufacturers generally design and market their merchandise with an eye toward the demand and desires of the purchasing public, so prevalent a condition must be looked upon as a favorable indication of the purchasing power of the radio public, as well as its exacting style requirements.

Somewhat more than two hundred different models of radio sets were exhibited by sixty-four set manufacturers; obviously, the majority of circuits employed were of the tuned-radio-frequency type embodying single-dial control. The favorite system of audio amplification this year embodies a final power stage of the push-pull type, with rare instances here and there of a receiver using something smaller than a 171A-type tube in the last stage. The exhibiting cabinet manufacturers, some twenty-three in number, proved that Milady must be served, and served with the finest. So varied and lavish were the cabinets this year that, at first glance, it seemed conclusive, what feature of a radio set attracts today's buyer. Indeed, comment on the internal mechanism of a receiver was rarely heard in the booths; the business of appraisal quite generally resembled that of an art student stepping back from an oil painting and closing one eye with a critical click. After the period of design of the cabinet, the quality and finish of the wood, its potential harmony with the other furni-

ture in the living room, had been discussed to the satisfaction of all, then only, as a rule, was the booth attendant asked to give his certificate of the tone quality. In price the cabinets ranged from "little-or-nothing" to lesser king's ransoms.

#### THE "ACCESSORIES"

Loud speakers exhibited, as they have done at every preceding show, a shade of improvement over the designs of a year before. Perhaps the most notable difference this season was in the impressive displays of electrodynamic speakers; these distinctively-shaped reproducers seemed to hold sway wherever one looked. However, an actual tabulation proved that, out of the total of sixty-four various speakers exhibited by fifty-nine manufacturers, thirty-five were of the electro-magnetic type and only twenty-nine of the dynamic type. The appearance of a preponderance of dynamic speakers over the magnetic type was, no doubt, due to the fact that the observer would find as many as a dozen dynamic speakers with the same type of unit exhibited at one booth.

Nine manufacturers stuck to their guns and showed a number of horns—that species of parlor ornament so rapidly becoming extinct. However, the new improved exponential horns which were exhibited may as yet toss great numbers of straws to their drowning elder brothers—who once did service so nobly to the radio listeners, before the loud speaker pancaked out into paper discs, disguised lamp-shades, goldfish bowls that sing, and Spanish galleons from the sails of which soprano voices emanate.

Four manufacturers showed complete displays of phonograph pick-up devices and phonograph-radio combinations; besides individual turntables, cabinets for the assembly, and electric motors.

The third item, in the importance of exhibition, was the vacuum tube. No fewer

(Continued on page 577)



# How Inventors May Guard Their Rights

Radio Experimenters Should Obtain Protection Against Loss of Inventions

By Leo T. Parker\*

A REVIEW of previously-decided litigation in higher courts discloses that experimenters of radio apparatus may with great certainty protect themselves against loss of their rights to obtain patents. However, the rules laid down by the various higher courts must be carefully followed during the stages of experimentation on new ideas; otherwise the inventor may lose his rights to obtain a patent.

Statistics show that this unfortunate occurrence may result from any of the following reasons:

(1) If another files an application for a patent on the same device, although he may have unfairly acquired knowledge of it from the original inventor;

(2) If another person, who invents the same device *after* the true inventor, files an application for a patent *before* the latter;

(3) If the original inventor delays for an unreasonable period in filing an application for a patent, *after the invention is completed* to a point where it actually will operate; and

(4) If the original inventor fails to establish *properly and legally* his priority rights during the experimental stages of the invention.

## ELEMENTARY PRINCIPLES

Obviously, few persons have sufficient spare time to digest the records of numerous patent lawsuits to obtain accurate information of the tested legal methods of protecting new inventions, at the time the new idea is conceived and when finally the inventor is ready to file an application for a patent.

So, therefore, the purpose of this article is to give this information in condensed form, based upon actual court decisions; so that readers may easily acquire knowledge which will save the expenditures necessary to file applications for patents on unperfected inventions, as well as enable inventors to follow the correct legal procedure to safeguard unpatented inventions.

If the inventor fails to follow tested rules to establish *priority* (that he was first), he may not be successful in introducing convincing and acceptable testimony to prove ownership of the patent should litigation arise.

Many years ago, the Patent Office extended to inventors of unperfected devices the privilege of filing "*caveats*." The purpose of the caveat was to enable the inventor to prove the date on which the invention was partly completed, should later litigation disclose that some other person claimed the right to the patent. However, caveats could be used only to prove the exact character of the invention *on the date the caveat was filed*.

Therefore, subsequent improvements necessitated filing other caveats, at the cost of \$15 each. At present, inventors may

record daily improvements of new ideas resulting from experimentation; and these records, if properly made, are more effective and dependable in proving priority rights than a caveat.

## STATUS OF INVENTIONS

First, it is important for inventors to understand thoroughly the legal status of an application for a patent; which is *not*, as many persons seem to believe, an *absolute protection* against others making and selling the invention.

In other words, the mere fact that a person is first to file an application does not indicate positively that he will obtain a patent. Moreover, contrary to the opinion of the majority of persons, an inventor is entitled to a patent although he files an application *after* another person has secured the patent. This is true because the government *will revoke a patent* issued to a person who is not the real inventor. Therefore, although an inventor may possess a patent, he is not positively certain that he can retain it.

In view of this established law, it is quite apparent that it is doubly important that every person who experiments should maintain a daily record book *in which is kept a record of every experiment*. This is especially desirable for experimenters of radio apparatus; because radio inventions are not discernible by mere inspection. However, it is not necessary that these records be in great detail; a rough sketch, with a few words describing the construction of

the invention and the results produced, is sufficient. Frequently negligence in making these first records of new ideas results in the true inventor losing his rights to a patent.

Of course, where two inventors claim the same invention, both may testify regarding the dates of conception; but such testimony is rarely acceptable unless accompanied by dated sketches having written descriptions.

For instance, in a case decided very recently it was disclosed that two inventors claimed to have invented the same invention on substantially the same days. One of the inventors testified that he had conceived the invention on January 2. The other introduced as evidence a soiled envelope on which he had made a rough sketch showing the circuit; the envelope bore the stamped date of January 10. The Patent Office awarded the patent to the inventor who had made this sketch, irrespective of the fact that the other inventor testified that he had conceived the invention eight days prior to the date on the envelope bearing the sketch.

## HOW PATENTS ARE ISSUED

Many persons are under the impression that a valid patent may be obtained on an invention which is new in the United States. However, the law is well established that a patent is rightfully issued *only to the "original" inventor* of the thing patented. In this respect the word "original" has a very broad and comprehensive meaning; in

(Continued on page 578)

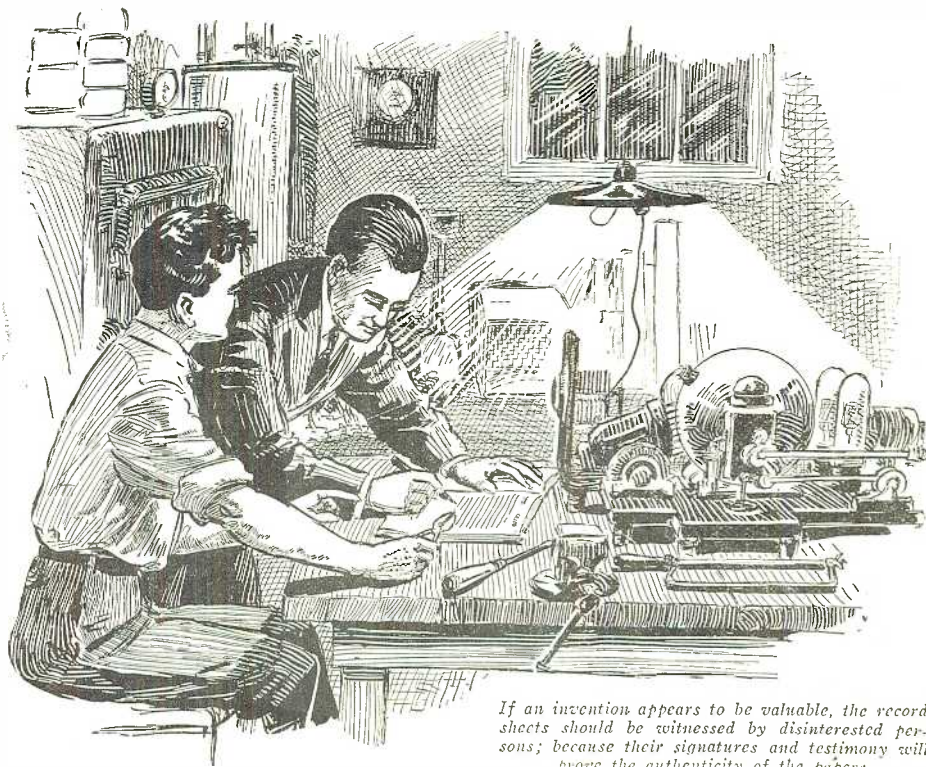

If an invention appears to be valuable, the record sheets should be witnessed by disinterested persons; because their signatures and testimony will prove the authenticity of the papers.

\*Attorney-at-Law, Cincinnati, Ohio.

# The Radio Beginner

## An Adjustable "B" Power Unit for That Battery Set★

Easily Made and Readily Adaptable to any Receiver of Eight Tubes or Less

IN the present radio era the public has been enlightened technically to such an extent that it is hardly necessary, even for beginners, to state the purpose of a "B" socket-power unit in an article describing its construction. For almost two years "B" batteries have been replaced by socket-power units in a large majority of the radio-equipped homes where 60-cycle A.C. house supply is available, and no longer is there much mystery for the lay public in such devices. Although much skepticism was manifested, when house-current-operated radio units were first introduced, these accessories are now considered essential in every modern radio installation.

For the benefit of the fan who is still debating whether or not it is wise to discard his "B" batteries in favor of a "B" socket-power unit, it may be explained that, in the present stage of radio practice, a well-built power unit is, not only entirely satisfactory for the operation of any receiver, but much more economical as well, in a large number of cases. It is true that when "B" substitutes were first introduced many were not entirely satisfactory, this being due largely to the fact that they were incorrectly designed; but today the results obtained with modern power units equal those obtained from batteries.

The question of whether it is preferable to build or buy a "B" socket-power unit is the next problem which confronts the beginner. In this connection, it should be pointed out that these devices are very easy to build; in fact, much simpler than a receiving set. The average "B" power unit has only one-fifth the number of parts required by a 5-tube radio receiver, and usually a dozen connections complete the wiring of the unit. In most cases, the parts

of a power unit may be screwed to a wooden baseboard and wired in less than two hours' time. After the assembly of the unit is complete, it is ready for operation, as there are no delicate adjustments which must be

generally; the first employs a "full-wave" gaseous rectifier tube, and the second uses either a "half-wave" or a "full-wave," filament-type rectifier. Equally satisfactory results are obtained from both types of power units; however, when a gaseous rectifier of the "filamentless" type is used, the filament winding of the power transformer may be employed for heating the filament of the power tube in the radio receiver. Incidentally, the rectifier tube of a "B" power unit is the device which converts the A.C. current obtained from the house-supply wires into direct current, and it may be described as the heart of the system.

Regardless of the rectifier used in a power unit, the general arrangement of the remaining parts is the same in all cases. Every power unit of ordinary present-day construction includes: first, a power transformer which increases the potential of the 110-volt house-supply current to the value required at the rectifier tube; as a modern receiver must have more than 90 volts on the amplifier plates. This transformer is also provided with one or two low-voltage secondary windings which are used for heating the filament of the rectifier tube, or that of the power tube of the set, or both. Both the low- and high-voltage secondary windings of the transformer usually are provided with center-tap connections.

The next important parts of a power unit are the filter choke coils; these are employed to retard the alternating "component" of the pulsating direct current which is supplied by the rectifier tube, and in this way they help reduce the hum in the output circuit. (See "The Uses of Choke Coils" in the I Want to Know department of February Radio News, and "The How and Why of Radio Filters," in the June number.) Most circuits call for the use of two choke coils in the filter circuit, but this design is entirely arbitrary. Choke coils are supplied in single and double units.

Equally as important in the filter circuit as the choke coils are the filter condensers; these by-pass the A.C. component of the pulsating direct current before, after and between the various choke coils and, in this way, make possible the complete elimination of the "hum" created by the 60-cycle alternations of the supply. Most circuits with two choke coils include three filter condensers of various values, depending largely upon the size of the choke coils. The filter condensers must be of high voltage rating, as they are connected in shunt with the maximum output voltage of the rectifier tube, and receive its full force.

After the current has been stepped up to a higher voltage by the power transformer, converted to pulsating D.C. by the rectifier, and filtered by the choke coils and

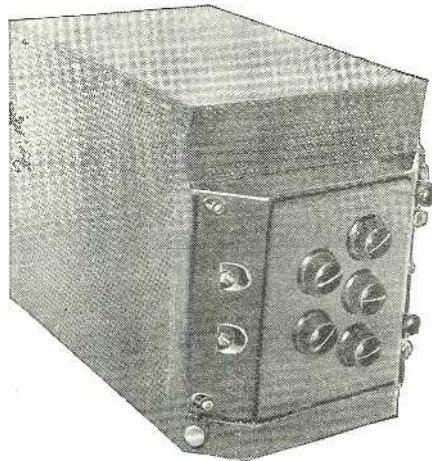

Fig. A

A neat metal case like this will add much to the appearance of the power unit. It may be of brass screen, or of iron painted over.

made. Of course, where a metal case must be made, this requires extra time; but such a housing is not essential to the operation of the unit and the unit may be operated before the case is complete.

### DESIGN OF UNITS

"B" socket-power units may be divided into several classes, and each type is best suited to a particular class of receiver. For the average five- or six-tube set using a 171-type power tube, "B" socket-power units of two different designs are suitable,

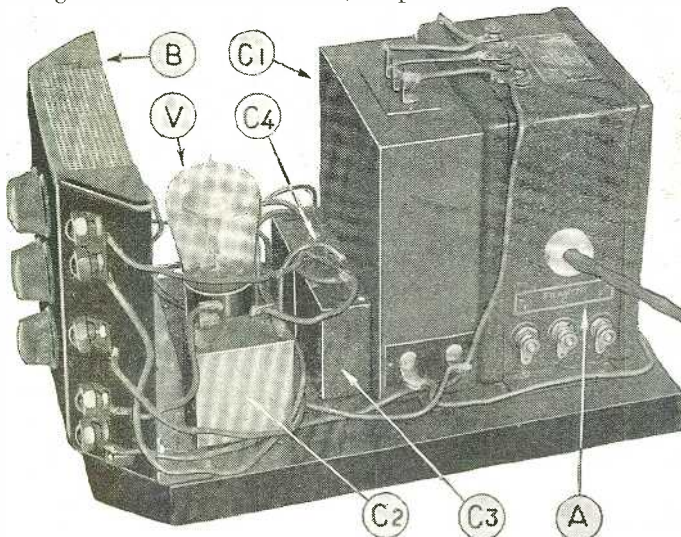

Fig. B

The appearance of the completed power unit; if it is to be placed in a cabinet compartment, the metal case may not be necessary. A well-ventilated location should always be selected, however. The only adjustments are those on the front of the voltage-divider B, which thus forms the panel of the instrument, and settings are permanent. A full-wave gaseous rectifier tube V, the power compact A, the condenser block C1, and three one-microfarad condensers, C2, 3 and 4, are the only parts required.

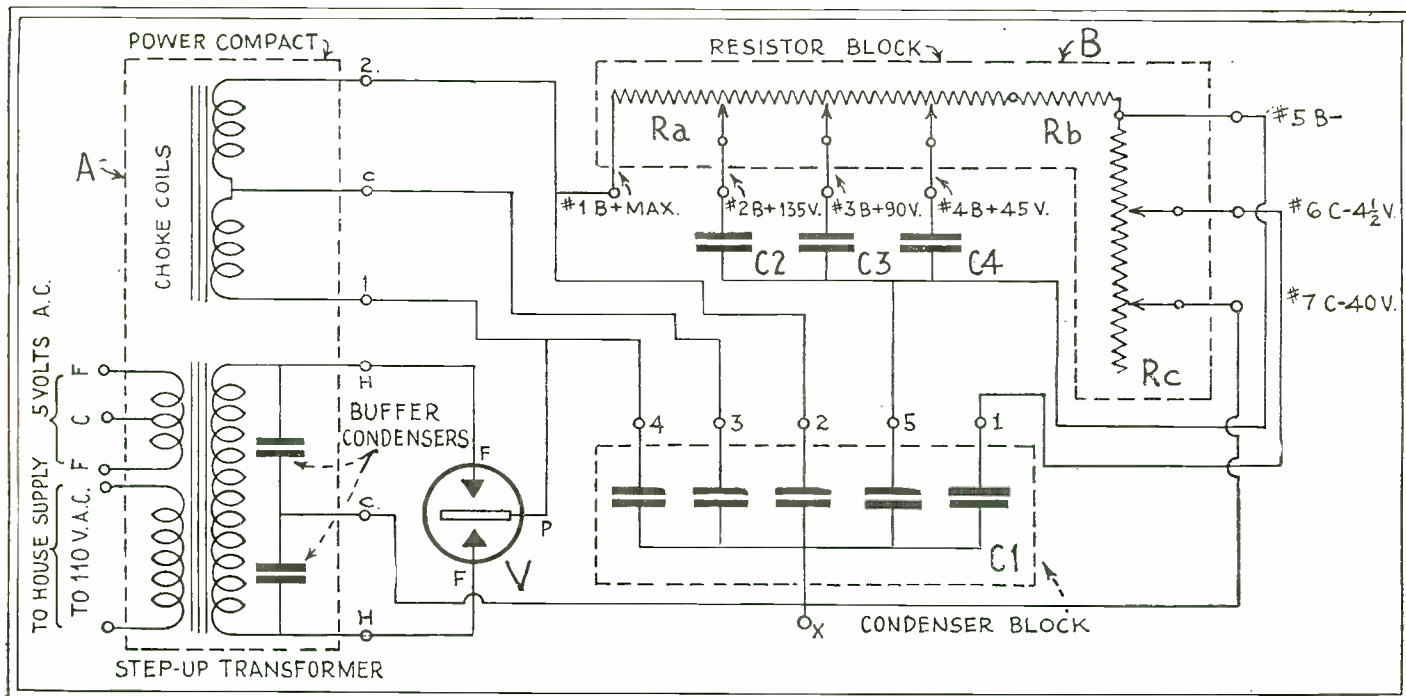

Fig. 1

It will be seen from this schematic diagram how simple the connections of the power unit are. The voltages may be regulated to the requirements of any receiver. The 5-volt A.C. winding is unused, unless it is desired to connect this to the power-tube filaments.

condensers in the circuits of the power unit, it is passed to the voltage-divider connected in shunt with the output terminals of the filter circuit. This instrument is, in reality, a large potentiometer with several arms, which divides the output of the "B" power unit into the exact values of voltage required for the operation of each of the tubes of the receiver. It consists of a fixed resistor of high value, connected across the high-voltage supply, and provided with taps at suitable points for obtaining the desired voltages. In some arrangements, usually for specific receivers, the position of the taps on the voltage divider is fixed; but in units of a more flexible kind there are adjustment knobs which make it possible to obtain any desired intermediate voltage.

In addition to the parts mentioned several other condensers are used in the "B" socket-power unit, as a rule. In circuits which employ gaseous rectifier tubes, a small buffer condenser is always connected between each side of the high-voltage secondary winding and the center-tap connection. These condensers have a capacity of 0.1-mf. each and serve to by-pass slight R.F. currents that gaseous rectifiers sometimes generate. By-pass condensers also are used in the voltage-dividing circuit between each resistance tap and the "B—" terminal, and have usually a capacity of 1 mf. each.

AN EXCELLENT SUPPLY UNIT

The "B" socket-power unit described in this article is of very simple construction, yet highly efficient and suited especially for the beginner. The output voltages are adjustable, thus making it possible to operate any of a large variety of receivers without making changes in the design. When suitably adjusted it will supply ample current for the operation of a receiver employing as many as eight tubes, with a 171-type power tube in the last stage; but it may also be so adjusted that it will operate a receiver using only two or three tubes. From the output binding posts any positive potential from 1

to 180 volts may be obtained from the plate supply, and any negative potential from 1 to 40 volts for the grid bias of the tubes. The power unit makes available four different "positive" voltages, three of which are adjustable, and two "negative" voltages.

From the viewpoint of the beginner, the case with which this power unit may be constructed and the simplicity of the wiring are two very important features. In most assemblies each part must be mounted and wired individually on the baseboard; but in the device under discussion practically all of the parts have been combined into three units. For example, the power transformer,

the buffer condensers and the choke coils are mounted in one unit, the various resistors of the voltage-divider are in one unit, and five of the condensers are in one "condenser block." This system not only improves the appearance of the power unit, but also simplifies the construction and wiring. In addition to the three parts above named, only three by-pass condensers and a socket for the rectifier are needed, in addition to wire and small hardware.

The arrangement of the circuit is illustrated very clearly in the schematic wiring diagram, Fig. 1. In this diagram the three principal components of the set, which have

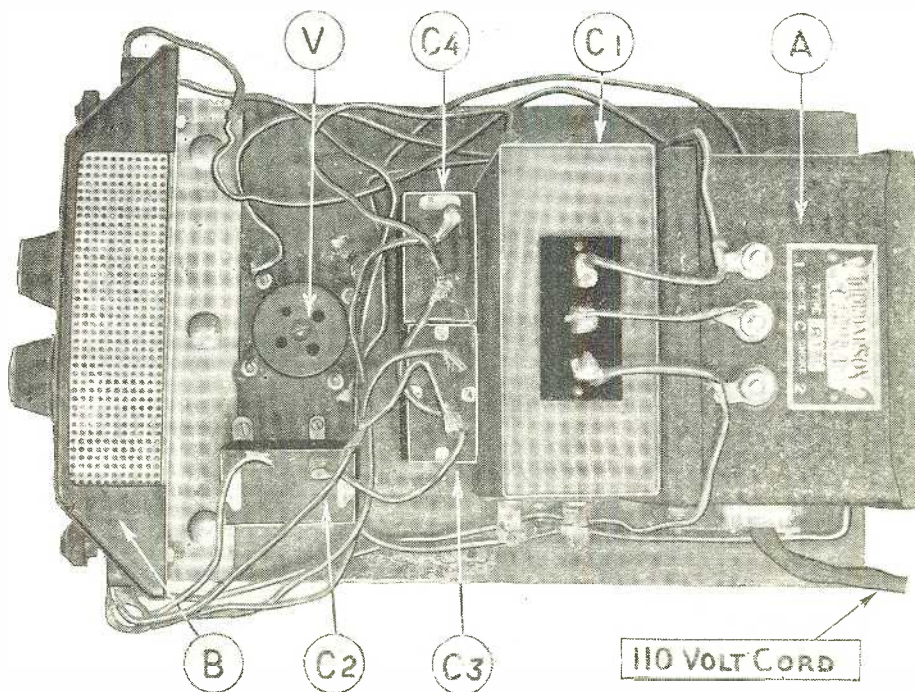

Fig. C

This top view shows the seven parts used in the construction of the power unit, so arranged that connections are the most convenient. Compare this with Fig. 2 on the next page, which illustrates the simplicity of the layout, and should be followed in wiring the apparatus.

been mentioned above, are enclosed within dotted lines. The "power compact," which comprises the transformer, chokes and buffer condensers, is inclosed by the dotted lines lettered "A"; the condenser block is enclosed by those marked "C1"; and the voltage divider by the lines designated as "B". In each case, all the connections shown within the dotted lines have been made by the manufacturer, and it is necessary only for the constructor to complete the external connections to these units as shown.

**PARTS NEEDED**

A complete list of the apparatus employed in the construction of the "B" socket-power unit is as follows:

One 171-type power compact, comprising a power transformer, two choke coils and two buffer condensers. The transformer has a center-tapped high-voltage winding providing up to 85 milliamperes at 320 volts on each side of its center, and a low-voltage filament winding, providing a maximum current of 1 ampere at 5 volts. The choke coils have an inductance of 30 henries each, and the buffer condensers have a capacity of 0.1-mf. each. This complete unit is marked "A" in the illustrations;

One 171-type condenser block of five condensers of the following capacities: 2, 2, 8, 1 and 1 mf. One terminal of each of the condensers is connected to a common terminal. The two 2-mf. sections and the 8-mf. section of the block are high-voltage filter condensers and the two 1-mf. sections are by-pass condensers. This unit is marked "C1" in the illustrations;

One voltage-dividing potentiometer consisting of three wire-wound resistors connected in series. Resistor Ra is a 50-watt, 8,000-ohm unit having three slider contacts; resistor Rb is a 2,000-ohm unit with a low current rating, and resistor Rc is a 50-watt, 1,000-ohm unit with two sliding contacts. This divider is marked "B" in the illustrations;

Three 1-mf. by-pass condensers with 200-volt rating (C2, C3, C4).

One UX-type vacuum-tube socket;

**No. 70**

A set of large blueprints, together with the specifications of apparatus used in constructing the "B" Power Unit illustrated here, will be sent postpaid, without charge, to any reader interested further in this device, on his request; as these blueprints cannot be mailed with magazines. Please turn to page 570 and use the coupon provided for our mutual convenience.

One wooden baseboard, 6 $\frac{3}{4}$  x 11 x  $\frac{3}{4}$ -inch;

Perforated sheet brass or heavy wire mesh for making the metal case. See drawings for quantity required; its use is optional;

One roll of connection wire, flexible-insulation type;

Solder, wood screws, etc.;

One rectifier tube, full-wave gaseous type (V).

**ASSEMBLY AND WIRING**

Mounting the parts on the baseboard of the power unit requires only a few minutes' time. At one end of the baseboard the voltage divider B is mounted in a vertical position with the aid of the metal bracket which is supplied with the divider. When set up in this manner this instrument provides the front panel, control knobs and binding posts for the power unit, which has no other adjustments.

The power-compact unit A is fastened with four wood-screws at the opposite end of the baseboard from the divider. This unit should be so mounted that the name plate faces the divider, as this arrangement greatly simplifies the wiring. The condenser block C1 has been designed especially for the power compact and its terminals

have been arranged to permit the shortest possible wiring. In order to take advantage of this feature, the block must be mounted directly in front of the power compact, with its name plate facing the front. In the space which remains on the baseboard the four condensers and the tube socket are mounted; their positions are indicated clearly in the pictures and diagrams. All of the parts are held in place by wood-screws.

The wiring of the power unit may be accomplished very quickly, as most of the circuit has been completed by the internal connections of the three main units, A, B and C1. However, all the external connections in the power unit should be soldered, if best results are desired. It may be said that, if tinned hook-up wire and rosin-core solder are used for the purpose, the job will not be found at all difficult. It is highly important, also, to use wire having a good insulating covering; this is necessary because the output voltage of some circuits is in the order of 300 volts, or more, and this might be sufficient to break down the insulation on inferior wire.

After the parts have been mounted on the baseboard, the first step is to wire into the circuit the power compact A. This unit is provided with nine binding posts; three for the high-voltage secondary winding, three for the choke coils and three for a filament winding. The two outside terminals of the high-voltage secondary are each marked "H" and these connect to the "F" terminals on the rectifier-tube socket; the center-tap connection of this winding is marked "C" and this connects to the common terminal (marked "X") of the condenser block and the "C-40" post of the divider. The three terminals on the top of the compact (marked "1," "C" and "2") are for the choke coils, and these are connected to corresponding terminals on the top of the condenser block. Also, terminal "1" is connected to the "P" terminal of the socket and to terminal "4" of the condenser block. Connect terminal "2" to the "B+Max" post of the divider, and to terminal "2" of the condenser block.

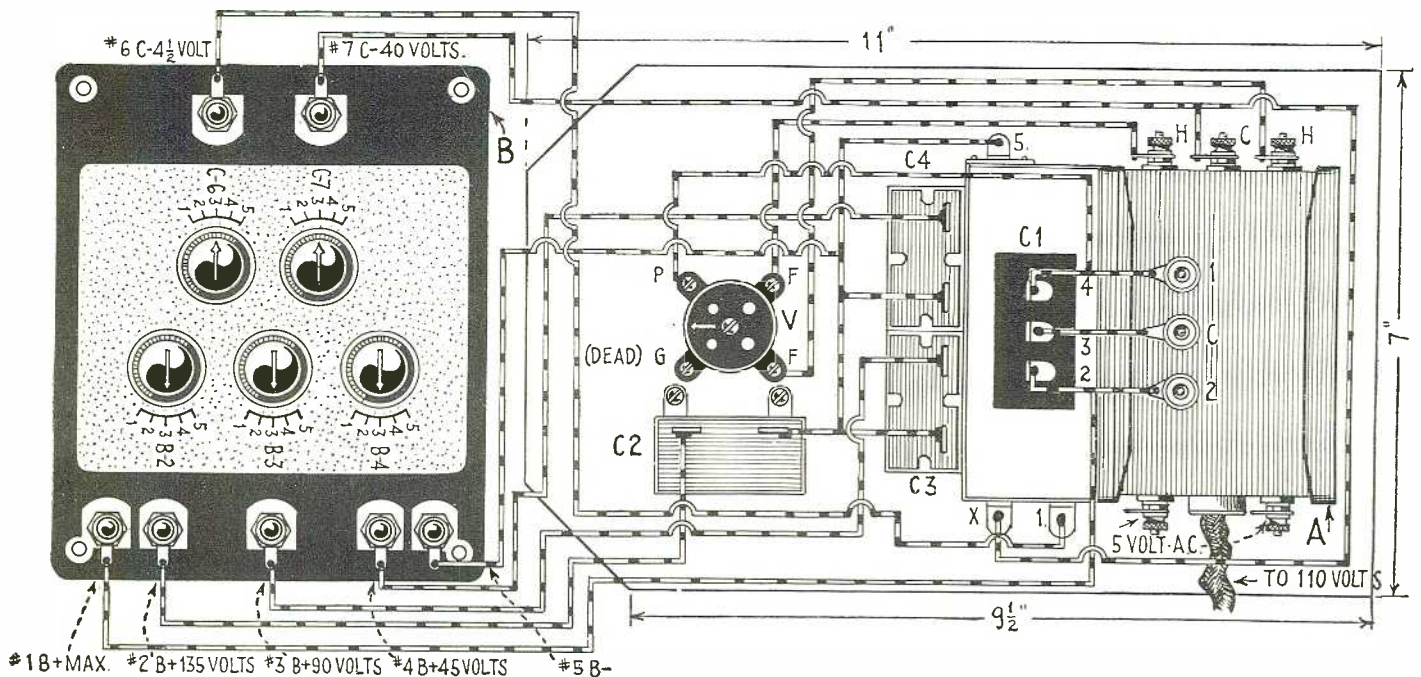

Fig. 2

Follow this diagram with a pencil as each wire is cut and soldered into place.

After the connections described above have been made, the unit is wired except for the by-pass condensers. To make these connections, first run a wire from one terminal of each condenser to the "B—" terminal of the voltage divider. Now connect wires from the three slider contacts on resistor Ra to the free terminals of the three by-pass condensers. This completes the task of wiring the unit; but connections should be carefully checked on Fig. 2.

THE METAL CASE

Fig. 3 gives the details for making a metal case for this power unit. This case may be considered as optional equipment, as it has no effect whatsoever on the operation of the power unit; however, it greatly improves the appearance of the unit and serves as a protector. It may be made from perforated sheet metal, or from wire screening of suitable stiffness.

The operation of the power unit should not require explanation. The binding posts on the voltage-divider are used as the output binding posts and these are connected to the proper wires of the battery cable leading to the receiver. To operate the unit, the lamp cord from the power compact is plugged into a socket and the current is turned on. The knobs on the front of the divider should be adjusted until best results are obtained from the receiver, and then they should be considered permanently set.

In operating a receiver with this power unit, it is important always to turn on the set's filament switch before connecting the power unit with the house-lighting circuit; and the power unit should be disconnected before the filament switch is turned off. Of course, the operation of the receiver may be greatly simplified by using a power-control relay to control the operation of the power unit. When this unit is connected in series with the "A" lead to the set it automatically turns the power unit on and off, as required.

OPERATING HINTS

The builder has the choice of operating his receiver either with both a filament switch on the set and a light switch controlling the power unit, or with an automatic relay which performs the desired switching operations when the filament switch of the receiver is turned on. Such an automatic relay is available in various forms, and comprises, primarily, an electromagnet which causes a switch to be thrown whenever it is "energized" by the storage battery. Two binding posts on the relay are used to "cut" in on the "A—" lead from the battery; thus allowing current from the battery to flow through the relay magnet when the battery switch on the receiver is turned on. When this switch is turned off, current from the battery no longer energizes the relay magnet; this allows the relay switch to fall back to a different position (a spring is usually used to insure this come-back).

In the first position (when the receiver is turned on), the relay switch connects the power-unit transformer to the house line, and disconnects the trickle charger (if one is used) from the "A" battery. When the receiver is turned off, the reverse action takes place: the power unit is disconnected from the 110-volt line and the trickle charger takes its place on the line. Though two plug outlets (one for the power unit and one for the trickle charger) are part of every automatic relay, a charger

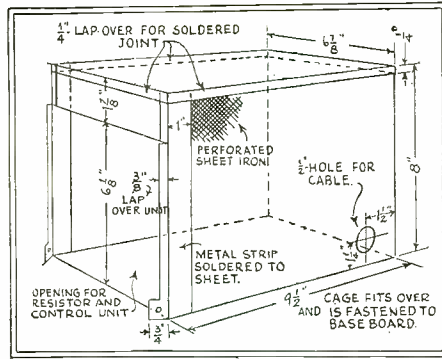

Fig. 3  
Constructional details of a perforated metal cabinet (optional) to fit over the power unit.

need not necessarily be attached to the relay; though it is a great convenience.

After the power unit has been wired to the receiver, halt the proceedings after attaching the final connecting wire. Then if you have no 0-200 volt high-resistance meter, run out and buy, beg, borrow or—well, get one any way. A meter is almost a necessity in adjusting the output voltages of a power unit; you may, of course, adopt the "blind" alternative of adjusting the power unit until speaker results seem satisfactory, but this system is awkward and rarely allows the receiver to function at its best. A test with a voltmeter after an adjustment has been made in this manner, will convince the reader that meters are a necessity wherever unknown voltages are applied to apparatus calling for definite operating values. After the voltages have been adjusted to the requirements of your receiver, however, the controls of the units are to be let alone.

THE FILAMENT WINDING

There will be noticed, under the 110-volt cord opening of the transformer casing, three binding posts which are not made use of in this power unit. They are marked "F," "C," "F;" and are identified by a small metal plate directly above them as supplying 5-volt A.C. This winding is included in the transformer for the benefit of the builder who may desire to light his last audio amplification tube from this winding and so, to some extent, relieve the strain on his storage battery. Considering, how-

ever, the fact that the later type of 171 tube (the 171A), draws but one quarter of an ampere, it is a question whether this negligible reduction of the battery drainage is worth the rewiring of a receiver to use the 5-volt winding.

It, perhaps, will find its use in supplying a push-pull amplifier employing two 171As. Here the current drain may be taken into some consideration, as well as the fact that the amplifier may be a later addition to the receiver or, as in some cases, an external unit for increased amplification. Where the winding is used, a center-tapped filament resistor (such as are being marketed by any number of manufacturers for this purpose) must be used; for the negative or "C" biasing potential for the power stage is run to the center connection of this split, or "two-legged," resistor. This winding cannot be used for lighting the filament of a D.C. (storage-battery-type) tube used in any circuit but the last stage of audio-frequency amplification.

Another factor that should not be overlooked in using this power unit is that suitable voltage for a screen-grid tube can be obtained from the binding post feeding the plate of any other amplifier tube in the same set. The screen-grid of the tube should be connected to the 45-volt "B" tap.

To connect the power unit to a receiver in place of "B" batteries, merely run the present leads from the set to their respective binding posts on the voltage-divider, as indicated in the diagram. As the "C+" is already wired into the circuit it will be unnecessary to use this post on the receiver, as when batteries are employed.

The specification of this power unit as designed for the 171A-type tube does not mean that this tube must necessarily be used in the last stage. If a 201-A or a 112-type is used in its place, the voltage divider is readily adjusted to supply "B" and "C" voltages for it. It should be remembered, however, that these tubes do not require 40 volts of "C," and so the last "C—" post is ignored when using a 201A tube. If a 112A is used, adjust the 40-volt tap so that it supplies no more than the proper "C" bias, which is 9 volts for this tube.

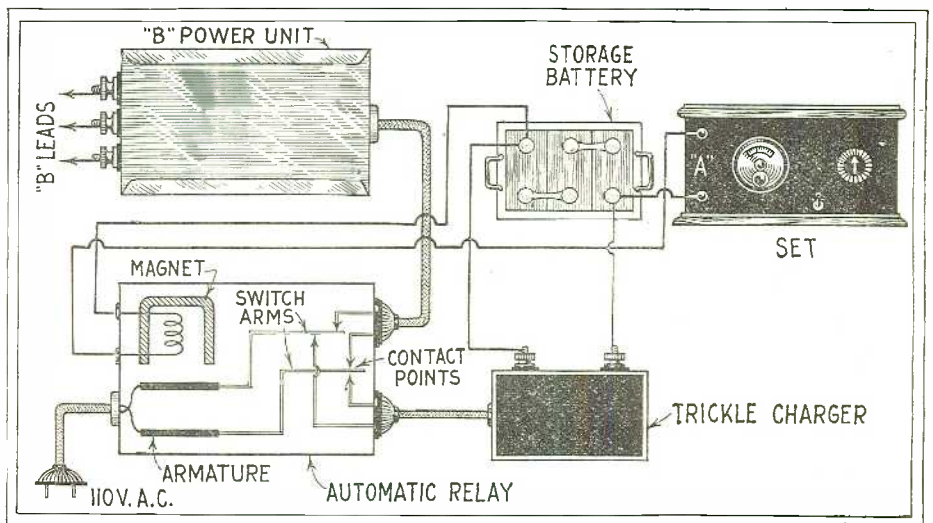

Fig. 4

The method shown above is usually followed in connecting a power unit and a battery together to the house-lighting lines: a relay requires much skill to construct, but may readily be purchased. The "B" leads shown at the left, of course, are brought around to the "B" posts on the set.

# A Plugless Short-Wave Receiver<sup>\*</sup>



A Set Whose Operating Convenience Includes, Among Other Desirable Features, a Selector Switch Giving Instant Choice of Wavebands from 16 to 90 Meters



By P. M. Platten

## No. 69



A set of large blueprints, together with the specifications of apparatus used in constructing the Plugless Short-Wave

Receiver illustrated here, will be sent, postpaid, without charge to any reader who is interested further in this device, on his request; as these blueprints cannot be mailed with magazines. Please turn to page 570 and use the coupon provided for our mutual convenience.

sub-panel makeup which is described in this article.

Years of research and experiment by thousands of amateurs have proved that, the more separate coils used to cover the short-wave bands, the more efficient the receiver; this is very true. Yet, the more coils one winds for that higher state of receiver efficiency, the more labor on the nights when the broadcast set is abandoned for intensive meanderings among the shorter waves. With the average high-frequency set today, it is necessary to plug in and out four different coils when covering the range from 20 to 200 meters. And when one is an ardent enthusiast and is satisfied only when he can range up and down

would to cover the desired bands, are mounted on one piece of bakelite and, by turning the switching knob from one position to another, any band can be tuned without recourse to the familiar plug-in-out system. Although, at first glance, this may look more complicated than the conventional plug-in-coil set, it is, in fact, much more simple to build; for the reason that the coils are mounted on one sub-panel and it is not necessary to build a complete individual coil mounting for each band.

The actual construction is easier than preparing separate bases and mountings.

SHORT-WAVE fans who nightly acquire weary muscles and strained backs plugging in short-wave coils will appreciate the construction of this receiver; in that the manual labor of shifting from one waveband to another has been avoided by means of a novel coil-switching arrangement which allows almost instantaneous choice of any one of three coils, merely by the twist of a knob. Except for this departure from the conventional use of plug-in coils, the receiver itself is the well-known regenerative circuit; using grid-coil tuning, with grid coupling from the antenna, and a fixed tickler winding with series-condenser control. Its wavelength range with the coils specified is from about 16 to 90 meters; but this range can be adjusted to suit the builder by winding additional coils for those bands not covered, and including them in the

The Plugless Set has on its panel vernier dials for tuning and regeneration, the wave-changing switch, rheostat and jack—that's all!

the 20-to-200-meter band—and when the coils go into their socket with a prayer and are enticed out again with the gentle assistance of a derrick—then joy reigns supreme!

### A SWITCHING SYSTEM

By the use of the simple switching device described below the reader may conserve his energy for worthier causes. Coils,

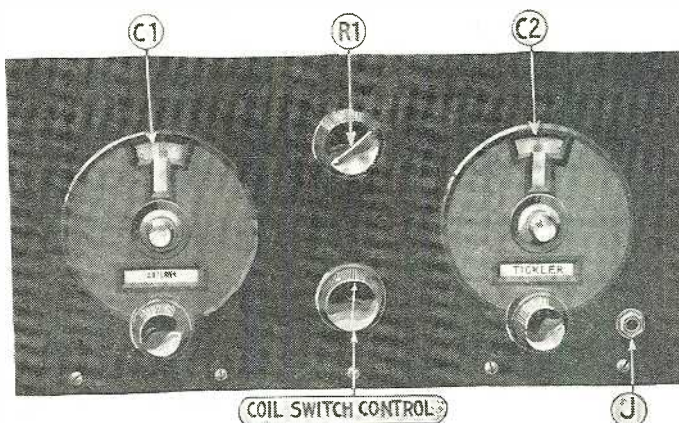

The coils themselves are fastened to the bakelite sub-panel with brass right-angle brackets, and four ordinary switch taps are provided for the grid and tickler-coil connections. The switch itself utilizes a small bakelite block fastened to a shaft by means of a collar arrangement. (This coupling device can be purchased so cheaply that it is hardly advisable for the builder to attempt to make his own; in fact, unless he is a trained mechanic, a good deal of difficulty will be experienced by the average fan in constructing such a device.) In this block are four spring-brass strips, cut and bent so that they slide wipingly over the contacts of each coil; pig-tail leads from these blades carry the connections to the proper places in the circuit, as shown in the diagrams. Although the coils are mounted side by side, it is possible to have only one coil connected in the circuit at a time; and the coils not in use affect the tuning in no way.

The following parts, generally found tossing about in the junk boxes of the set builder, go to make up the receiver; which is described without audio-frequency amplification:

### LIST OF APPARATUS

One 7 x 14-inch hard-rubber or bakelite panel;

One 8 1/4 x 5 3/4-inch hard rubber or bakelite sub-panel;

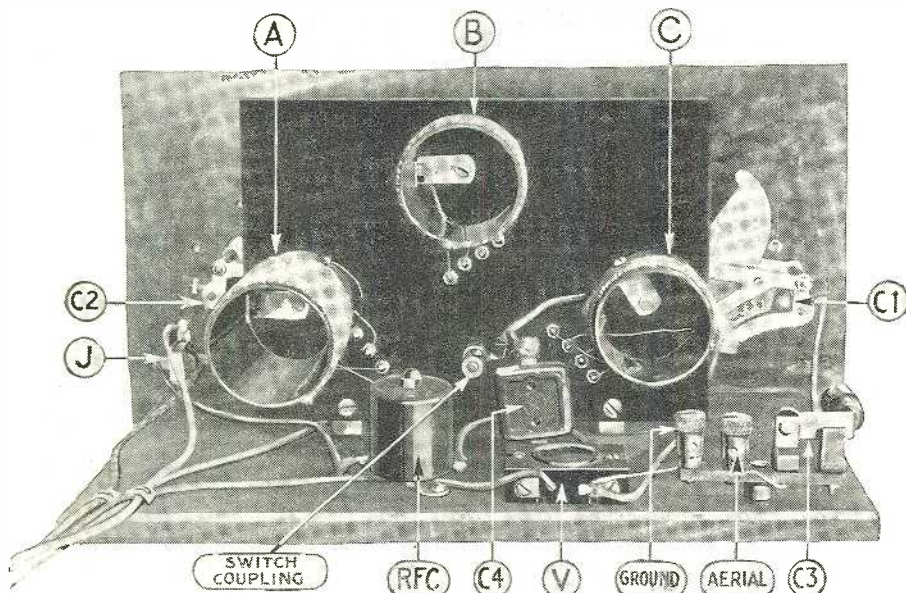

The black vertical panel in the center of this rear view of the Plugless Receiver carries the three coils, A, B, and C, which cover the three wavebands. The switch pivots on its coupling.

\*RADIO NEWS Free Blueprint Article No. 69.

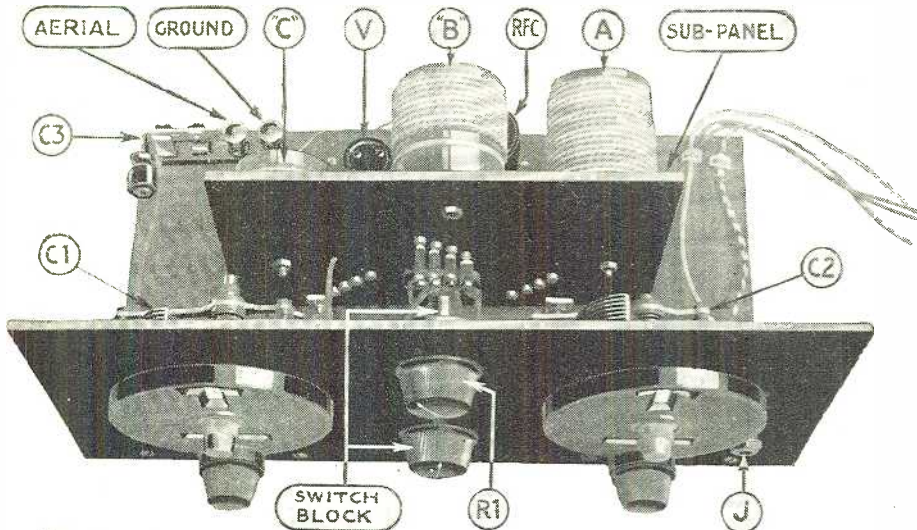

The above view of the Plugless Receiver shows the sub-panel with its coil assembly in place. The receiver comprises a single regenerative circuit, which is the standard for short-wave work, to be used by the operator with phones, but is capable of connection to an amplifier.

- One variable condenser, .00025-mf.;
- One variable condenser, .00015-mf.;
- One rheostat, 20-ohm.;
- One tube socket, UX type.;
- One radio-frequency choke coil. (Those which may be purchased usually work more efficiently over the entire waveband than the home-made type. Better buy one);
- One fixed condenser, .0001-mf., with grid-leak clips.;
- One grid leak. (Anything from 2 to 5-megohm will do.);
- One phone jack, single-circuit, closed.;
- Two dials, vernier type.;
- S.P.D.T. knife switch, to construct the antenna series condenser, C3.;
- Two binding posts.;
- Twelve switch points.;
- One piece of bakelite or hard-rubber, 1½ x 1½-inch, for switch block.;
- One coupling device, preferably with bakelite extension shaft.;
- One section of 2-inch bakelite tubing, 7½ inches long, to be cut into three sections: 1¾ inches, 2¼ inches, 3½ inches.;
- One wooden baseboard, 13 x 7 x ½-inch.;
- Brackets; wood-screws; hook-up wire.;
- roll of No. 18 annunciator wire for coils.;
- No. 24 S.C.C. for tickler windings.;
- twine for spacing coils.

which ordinarily grip the center pole are then widened, so that the center pole may have some lateral motion between these two sides. This motion and the usual up-

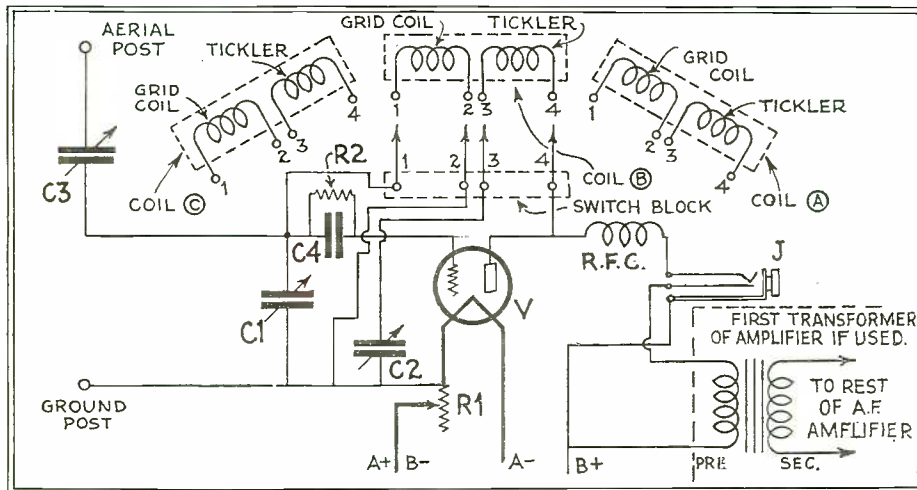

Fig. 1

The schematic circuit may look slightly peculiar, because of the position of the coil terminals; but tracing will show that it is the ordinary one, with the grid coil across the tuning condenser C1 and the tickler in series with the regeneration condenser C2. Note C3.

and-down motion of the central blade will be found sufficient in varying the capacity for antenna-series purposes.

After this has been done, the remaining terminal on the other end of the switch base is removed, thus leaving sufficient space for the mounting of two binding posts for aerial and ground connections. The photograph shows the blade bent at right angles to the base; this has no electrical action on the condenser, but is done so that the projecting arm will not interfere if it is desired to place the set into a cabinet.

A UX socket, shock-proof-type if one is handy, is fastened to the baseboard, and the grid condenser, C4, soldered direct to the grid post of the socket. This condenser should be equipped with clips for insertion of the grid leak, R2. A radio-frequency choke coil such as are being marketed by a number of manufacturers is placed at the right of the socket. Care should be taken to see that the socket and choke coil are mounted as close to the rear edge of the baseboard as it is possible to get them without undue crowding; it should be remembered that the sub-panel with its coils is yet to be mounted. It may even be advisable to construct the sub-panel coil assembly and mount it before mounting any of the other apparatus.

PREPARING THE COILS

After the 2-inch tubing has been cut to 1¾, 2¼, and 3½ inch lengths, they are wound for their respective wavebands according to the coil chart given. In winding coil "A," the largest of the three, it is necessary to drill four terminal holes to secure the winding. The first is drilled ¾ of an inch from the end of the form, and the end of the spool of No. 24 wire

- One section of 2-inch bakelite tubing, 7½ inches long, to be cut into three sections: 1¾ inches, 2¼ inches, 3½ inches.;
- One wooden baseboard, 13 x 7 x ½-inch.;
- Brackets; wood-screws; hook-up wire.;
- roll of No. 18 annunciator wire for coils.;
- No. 24 S.C.C. for tickler windings.;
- twine for spacing coils.

CONSTRUCTIONAL DETAILS

The first item to construct is the antenna series condenser, C3. This can be built in any number of ways. Probably one of the simplest is to mount two right-angle brackets, facing each other and separated about a quarter of an inch. The condenser suggested in connection with this receiver has the advantage of being variable, and is equally simple to make. The knife switch for this purpose should have a bakelite base and not one of porcelain.

Unscrew the center pole and remount it, so that it is approximately one inch from either one of the terminals. The two sides

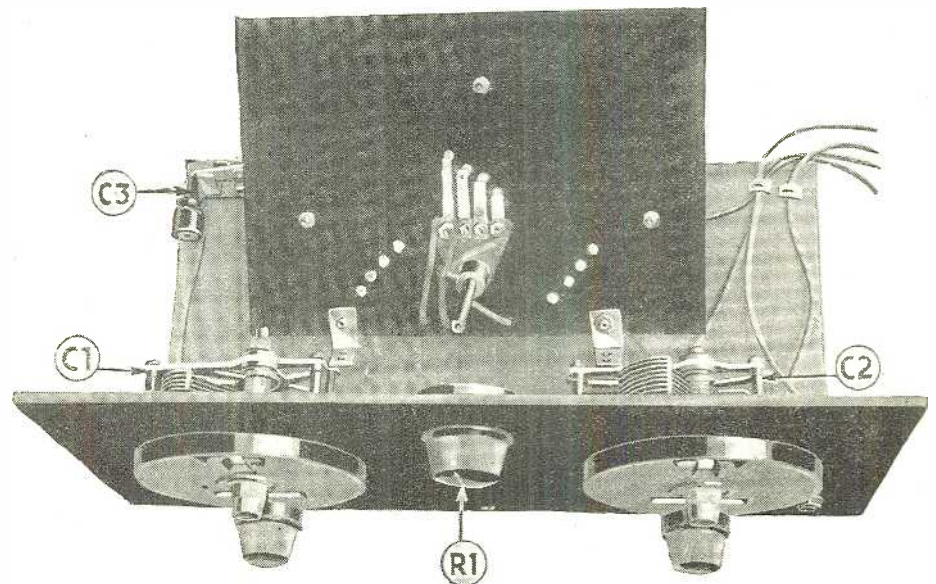

In the view of the Plugless set above, the sub-panel is tilted back to show the three sets of switch points and the positions of the spiral blades which make the four coil connections.

is pushed through this hole, leaving about four or five inches for terminal wiring; the five turns are then wound upon the form as specified in the chart. After the fifth turn, drill another hole in line with the first and push through another five inches for the other terminal of this winding.

A quarter-inch from this hole, drill the third; through which the end of the roll of No. 18 wire is placed, as well as the end of the ball of twine. This is wound with the wire so that there is a layer of twine between each two turns of wire. This is done to reduce the distributed capacity of the coil, and is necessary only in the grid winding. It is a simple matter to wind both twine and wire at the same time, care being taken to see that there are no overlapping turns. After 19 turns of No. 18 have been wound with layers of twine between the turns, the fourth hole is drilled alongside the last turn, in line with the other holes; and sufficient wire is put through the hole to allow for connection to the taps, as was done with the other terminals.

The other coils are wound in the same manner, except that the number of turns differs. Though it may seem needless to add the comment, it is highly important that both windings on each coil should be wound in the same direction; otherwise the circuit will not oscillate and therefore no results will be obtained. After the three coils have been completed they are mounted on the sub-panel, in the positions shown in the layout on the opposite page, by means of right-angle brackets.

**THE SWITCH CONNECTIONS**

The remaining item which requires some constructional explanation is the switch block. The illustration on page 551 shows this triangular in form, but this shape is not essential; the hard-rubber bakelite form may be left square if the builder fears the usual result when sawing so small a piece of bakelite. A double-circuit (four-blade) phone jack when disassembled offers excellent material for the spring contact blades. It is best to mount them on the block, as shown, before cutting, as this work can be done with greater accuracy and convenience when the ends of the blades

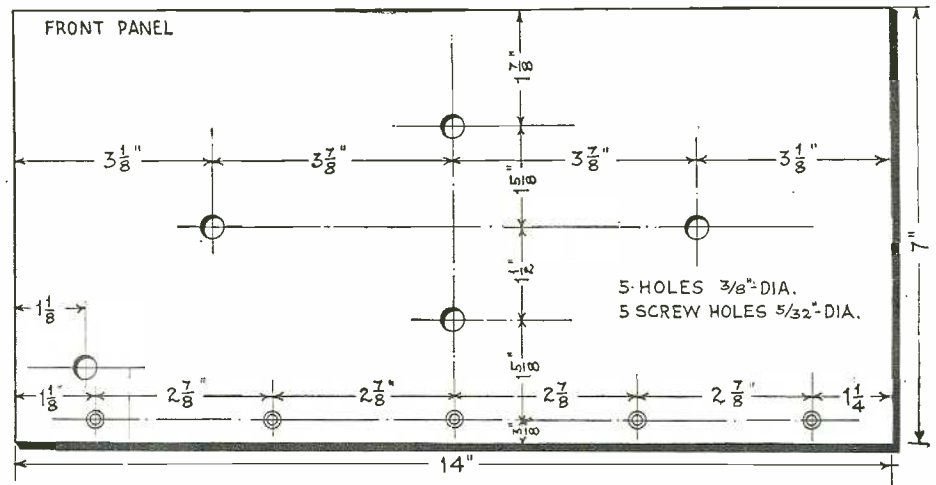

Fig. 5  
Drilling diagram for the front panel of the Plugless receiver; below, that for the sub-panel for coils.

are secured to something substantial. The lengths specified in the chart are the complete measurements; that is, with the wiping

points; this can be arranged after some experimenting. After the sub-panel with its three coils has been completely wired, the switch block with its coupling unit attached, and two angle brackets are secured to the bottom of the sub-panel, the assembly is then fastened to the baseboard, so that the front of the sub-panel is approximately 2 3/4 inches from back of the front panel.

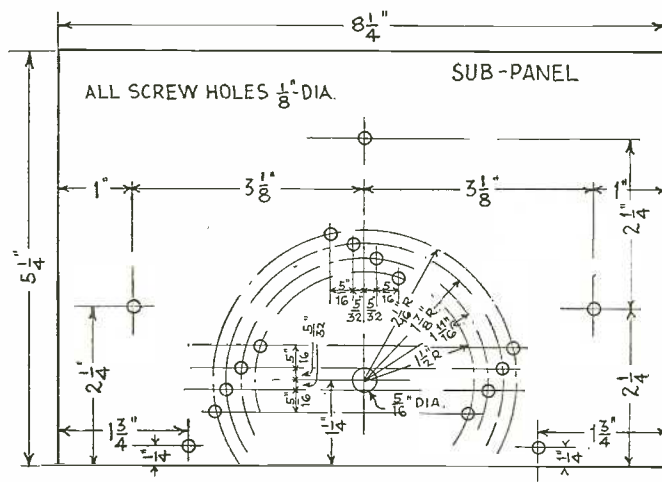

Fig. 6  
A constructor designing his own might extend the number of coils beyond the three used here.

tips bent over. Cutting to the specified lengths, and then bending the tips, will leave the blades just so much short. When mounting the switch block after attaching to the coupling unit, see that the blades make good contact over all the switch

The mounting of the front panel, with its tuning condenser C1, regeneration condenser C2, rheostat R1, control knob for the switching device, and phone jack, requires no explanation. Vernier dials are specified because they are really very essential on the short waves and, though vernier control may be dispensed with on the regeneration condenser, it is absolutely necessary on the tuning condenser.

**OPERATING HINTS**

Few accessories are required for this receiver; a 201A-type tube, a 6-volt storage battery, a 45-volt "B" battery, and a set of headphones make up the complete receiver. The aerial need be only 25 or 30 feet long and need not be, necessarily, of the outdoor type. However, a good ground and ground connection are of the utmost importance in getting desired results.

After the proper connections have been made and the rheostat is turned up, the set should be heard to oscillate. This can be determined from a sharp "cluck" or a squawk in the phones, when the regeneration condenser is turned beyond a certain point. Of course, the best sign of the set's functioning is the reception of signals; but, if these are not heard immediately after turning up the rheostat, some "juggling" may be necessary.

First, turn the switch block so that it

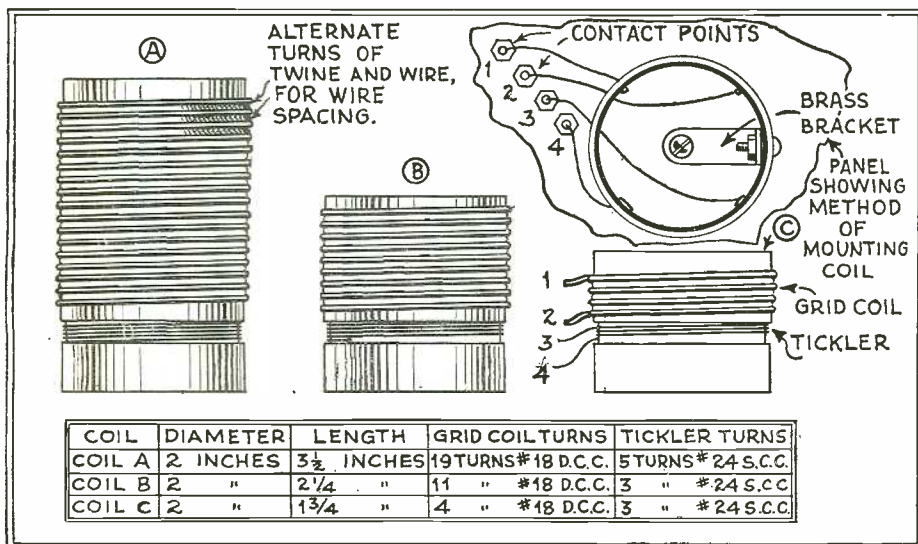
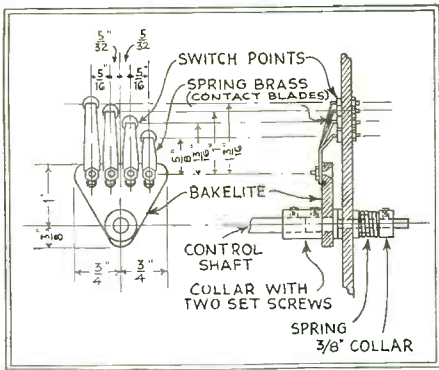

Fig. 3

The coil specifications shown here are those used in the original model, and cover the bands 16-30, 26-49 and 46-90 meters. However, results vary with spacing, and constructors should experiment.





makes contact with the center coil, or coil B, and vary the antenna condenser C3, until the point is found where the receiver will oscillate evenly over the major portion of the tuning dial C1. Adjustments should be made, so that the antenna condenser can be left at the point where maximum oscillation is obtained over the greater part of the tuning dial with each of the three coils. If the break-over point of regeneration

gives a loud squawk, try various values of grid leaks until a resistor is found which allows the set to slide in and out of regeneration with a soft "thud."

The three coils when used with the tuning condenser as specified should cover the following approximate waveband ranges: coil "A", 46 to 90 meters; coil "B", 26 to 49 meters; coil "C", 16 to 30 meters. On these wavelengths, good results with phones can be obtained by the use of the detector tube only; however, if the builder should desire greater volume for loud-speaker operation, it will be necessary to add at least two stages of audio-frequency amplification.

Fig. 4

Detail of the switch and blades, to operate with points spaced as shown in Fig. 6.

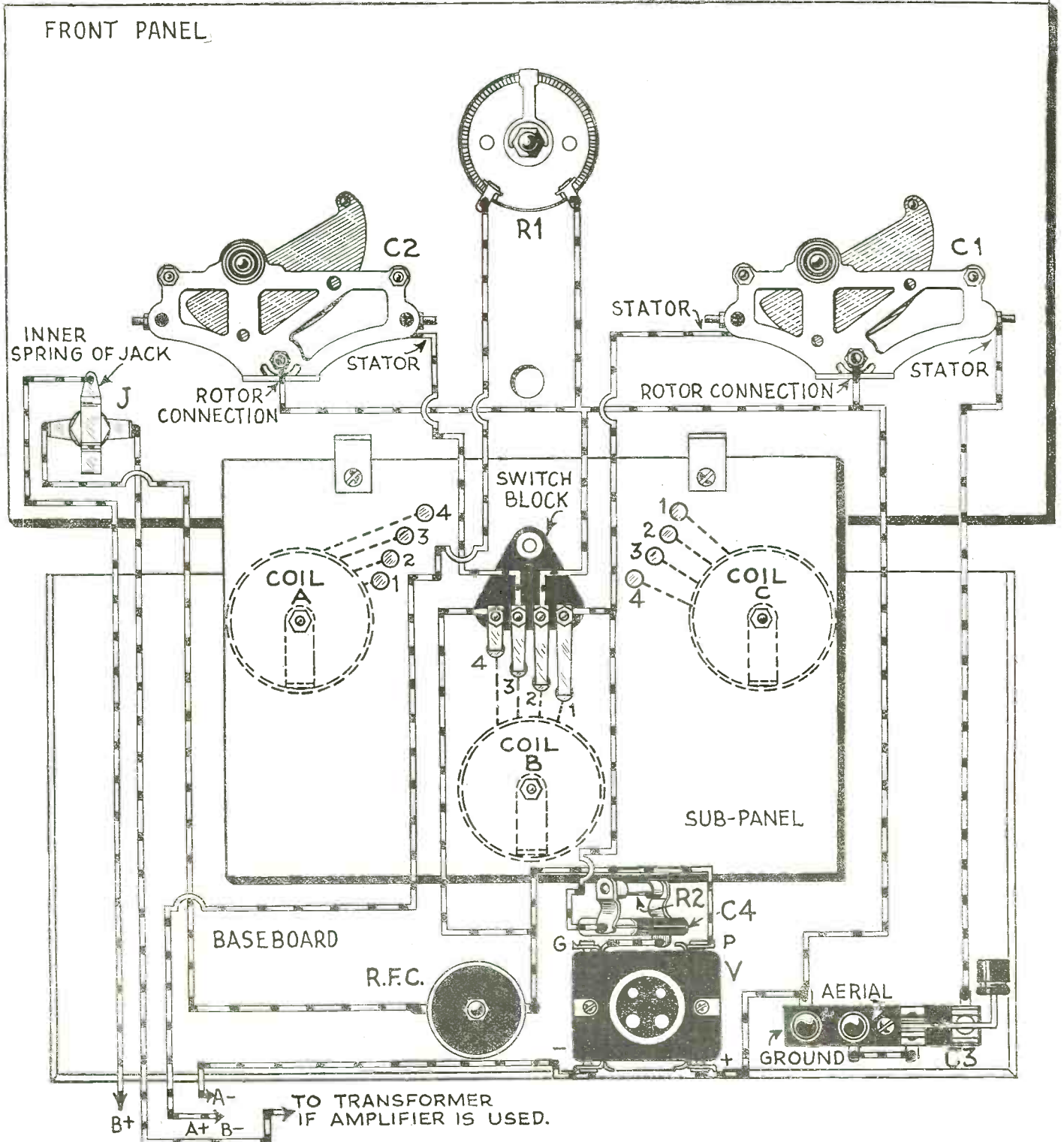

Fig. 2

This wiring diagram shows how much easier than it might seem it is to wire the Plugless receiver. The aerial condenser C3 is made from an S. P. D. switch by bending the blades so that no contact is made, but a small capacity created. The rest is obvious.

# How to Succeed in Short-Wave Operation



Pointers for the Broadcast Fan Who Has Just Constructed a Short-Wave Tuning Unit and Who Is Going Out After the Ten-Thousand Mile Reception He Has Heard About



By H. M. Bayer

**N**OTWITHSTANDING all that has been written on the simplicity and ease of short-wave reception, the beginner in this field should not feel that the reception of transoceanic broadcasting is merely a matter of snapping the switch, twirling the dial and, immediately thereafter, annoying the neighbors with the blasts of PCJJ or 5SW. It simply isn't done. Long-distance reception on short waves is much like DX work on the broadcast bands; for the same amount of patience, a double quantity of perseverance, and an expert knowledge of the working characteristics of the receiver are essential for the former, just as they have been found necessary for successful results on the latter.

In operating his short-wave receiver, the beginner should forget that it has been "slapped together in a jiffy"; instead, he should go after his stations with the same nicety of operation that he would employ if he were before a twelve-tube superheterodyne. It is on short waves, more than anywhere else, that the finger tips must be, almost, sandpapered and the clock turned toward the wall.

## COUNTERACTING HAND CAPACITY

While the short-wave receiver is being built, the usual precautionary methods for the prevention of hand-capacity effects should be employed in the construction. The simplest of these is *grounding the rotor plates* of the variable condensers used in the set; that is, those condenser leads running to the "bottom" of the circuit diagram are connected to the rotors. For example, the tuning condenser should be so wired that

the stationary plates are connected to the *grid* end of the coil, and the moving plates to the *filament return*.

Usually, this method has been found entirely satisfactory for the elimination of hand-capacity troubles of the average variety; but conditions are often encountered where this is not sufficient. To overcome stubborn cases, shielding is placed behind the panel and grounded. It may be very thin sheet copper or brass, and need be placed only behind the tuning controls. The simplest shield is made from heavy tinfoil, which may be pasted on the panel and cut with a penknife wherever there is danger of making contact with any of the instruments.

The finest preventative measure, however, is the use of a complete brass or aluminum cabinet. This not only makes for an electrical efficiency that cannot be equalled by any other shielding system, but also results in a very pleasing finish and the appearance of professional quality. Such cabinets are now available in various forms and sizes, and should be considered standard for every short-wave receiver.

In rare cases where hand-capacity effect will not respond to the aforementioned treatments, it may be found necessary to place on the dial knobs extension rods made of insulating material. These may be of any shape or type, depending upon the ingenuity of the builder; six- to eight-inch rods will be found quite sufficient for the worst cases. Ordinary wooden dowel sticks are fine for the purpose.

## REGENERATION AND THE AERIAL

After hand-capacity effects have been overcome to such an extent that they do

not interfere with efficient operation, the next step will be to obtain a fair degree of oscillation, with every coil, over as much as

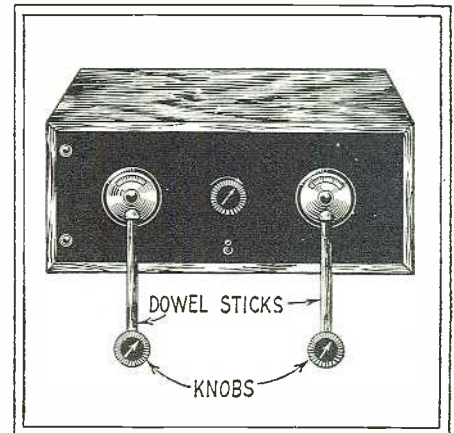

Fig. 2

Cut the dowel sticks six inches long. Drill a small hole in one end of each; remove the knobs from the vernier dials and force instead the drilled ends of the dowels over the shafts. Fasten the knobs to the other ends of the dowels.

possible of the tuning dial. By this is meant that each coil should oscillate smoothly over the whole tuning-condenser dial. Quite often it will be found that regeneration is difficult to obtain on the very short waves; this trouble generally can be overcome by the use of a short aerial; 25 or 30 feet should be sufficient for all short-wave work. In fact, many receivers have been found to work best with no aerial at all. If an antenna series condenser has been provided in the set, try varying it until the desired regeneration is obtained; once adjusted, this value may remain fixed. Short-wave reception and uniform controllable oscillation go hand in hand; for it must be remembered that only the latter makes possible the former. Therefore, it would be well for the builder to spend all the time necessary to solve the problem of controlling regeneration in his set satisfactorily.

## TUBE OPERATION

This period of experimenting offers a good opportunity for selecting the proper grid leak; the determination of which is considered quite an important item in short-wave work. After the receiver has been brought to the point where it will oscillate, with any of the coils, the next step is to bring regeneration to a state of control in which the receiver will go in and out of oscillation with a dull puff or a mild thud, instead of a loud squawk or a sharp plop. The manner of the "breakover" will make all the difference in the world when it comes to bringing in that elusive foreigner; and its importance in short-wave work cannot be underestimated.

To control the regeneration "breakovers," first choose the tube which functions best as a detector; this can be determined sim-

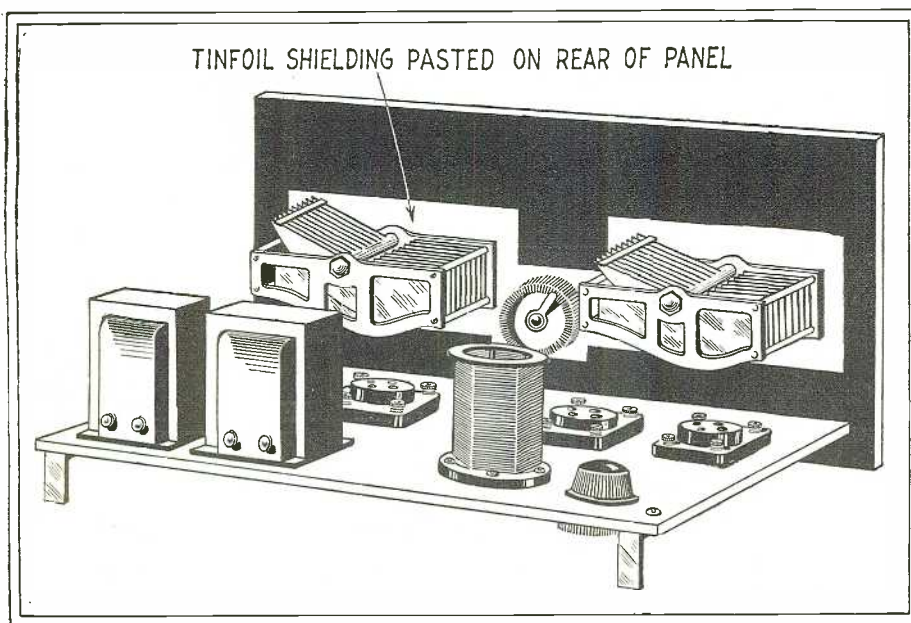

Fig. 1

The delicate tuning of a short-wave receiver is much more sensitive to hand-capacity than that of a broadcast receiver; and the simple shielding method shown is highly advisable.

ply by interchanging tubes until the right one is found. After this has been determined, obtain a fairly complete set of grid leaks and, by the substitution method, find the value that gives the smoothest puff on the oscillation "breakover." If no success is had with any grid leak, try reducing the voltage on the plate of the detector tube, or its filament voltage. An extreme case may require the removal of a turn or two from the tickler winding; though this is a rarity with manufactured coils, and should not be attempted unless one is sure of his mechanical proficiency.

The extremely critical and hairbreadth tuning required with a short-wave receiver must, of necessity, continue for the full period of listening-in. As a general rule, the fingers are not taken from the knobs of the dials unless a station is being received with sufficient volume and stability to warrant such an action. As a rule, when a signal, either code or voice, is heard on short waves (if it is from any distance at all) it develops so many knacks of slipping in and out of the phones that the situation becomes somewhat of a wrestling match between the signal and the operator. It is quite a stunt to bring in a DX signal—it's another feat to hold it. And this can be accomplished only by maintaining one's touch on the dials.

The receiver should be mounted, preferably, on sponge-rubber blocks, regardless

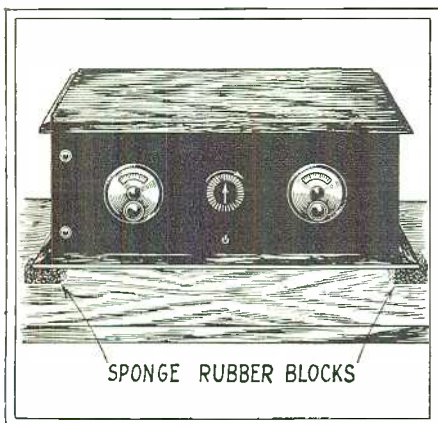

Fig. 3

*So sensitive is such a receiver that unusual precautions against jarring must be taken. The rubber bath sponges indicated here are inexpensive and will serve every purpose.*

of the number of shock-proof sockets in the receiver. Rubber bath sponges serve the purpose admirably and are inexpensive as well; one may be mounted under each corner by screwing down each sponge.

A simple arrangement for more than one pair of phones can be made by placing four or five open-circuit jacks on a small hard-rubber or bakelite panel. These are wired in parallel and connected to two binding posts, the leads from which run to the receiver. This phone block may be placed under the front edge of the table where it will be conveniently located.

#### "BEAT-FREQUENCY" DETECTION

Before operating a short-wave receiver, it is best for the beginner to learn the meaning of "beat frequency"; for it is this method of "demodulation" or detection that is employed by the receiver to produce an audible note in our phones. Though the name of this action conjures up notions of complicated formulas and immense laboratories, it is in reality a very simple process.

When a regenerative receiver is brought to the state of oscillation, it generates *radio-frequency* current. These oscillatory generations are developed in the secondary circuit (that portion of the receiver comprising the secondary winding of the tuning coil and its tuning condenser) and their frequency is regulated by the capacity of the tuning condenser and the inductance of the coil. The frequencies generated in the secondary circuit of the receiver are known as "local" oscillations.

When an external oscillation or "signal" impulse is picked up by the antenna it is imposed upon the primary winding of the tuner, which in turn imposes it on the secondary winding and hence on the grid of the detector tube. The same condition is brought about when the primary winding is omitted and the grid coil is in series with the aerial and ground.

#### "HETERODYNING"

After the tuning condenser has been varied to generate a "local" frequency, very near to that of the transmitted impulses picked up by the antenna, both "local" and "signal" oscillations are impressed upon the grid of the detector tube. The result of the blending of these two frequencies is known as the "beat frequency." This is nothing more than an audible note of a few hundred cycles; dropped off, as it were, in the blending of the incoming and local frequencies, each of which may run into the millions of cycles. Its frequency equals the *difference* between the two radio frequencies; one of which cancels the other except for the "beat-frequency" effect, sometimes called "heterodyne." (See page 554.)

As transmitting stations use different sending frequencies, it is merely a matter of turning the tuning dial in order to vary the frequency of the local oscillation to coincide with that of the incoming wave. It is by this method that a different station is received at each variation of the secondary condenser.

A practical demonstration of the variation in beat frequency can be noted in the change of the received note as the tuning condenser

is turned. This is merely a matter of changing the local frequency, somewhat similar to the action of "damping" or fingering a violin string at various lengths in order to obtain different musical tones.

After a signal has been received, the tickler is retarded to a point known as the "peak" (the position just before the breakover) where the signal will be heard at its maximum strength. This is "reducing the amplitude" or strength of the local oscillation to a point as near to the amplitude of the incoming oscillation as we can bring it. After reducing the amplitude of the local frequency, it may be found necessary to retune, slightly, the secondary circuit. For this reason some emphasis is laid upon *two-handed operation* of a short-wave receiver. In this manner it is a simple matter to tune the signal with the left hand and bring the signal up with the regeneration dial, meanwhile return the left dial to coincide with the reduction of the amplitude.

#### THE "ZERO" BEAT

When receiving code, use is made of a "beat frequency," but this method will not do for the reception of phone signals. In receiving voice the "zero-beat" adjustment is used. The action of this is somewhat similar to the "beat-frequency" principle; for in either method the receiver sets up its local oscillations in the secondary circuit and they are combined or mixed ("beaten" by) with incoming frequencies in the primary.

However, the similarity ends there. It has been explained that, in "beat-frequency" operation, a "beat note" of audible frequency is produced when the incoming frequency and the local frequency are impressed together upon the grid of the detector. In "zero-beat" operation both frequencies are impressed at once upon the grid of the detector; but this produces no beat note, for the simple reason that both frequencies are exactly identical in the number of cycles and the difference between them is zero (or silence). For example, an incoming "signal" frequency of 1,000,000 cycles meets a local oscillation of 1,000,000

*(Continued on page 580)*



Fig. A

*In the position shown here, with his forearms fully supported by the table before him, the operator of a short-wave set can comfortably maintain the position of tuning over a long period.*

# Some Easy Experiments With Oscillators

How Heterodyne and other Interesting Effects Can Be Studied With the Aid of Parts Taken from the Junk Box

By Clyde A. Randon

THE average radio listener can greatly increase his knowledge of radio principles and operation by some interesting experiments with inexpensive equipment. Good radio parts are so inexpensive these days, that the average radio listener can well afford to spend a little for a few extra of these for experimental purposes. For this purpose, too, one need not have the very best; and parts no longer used, or perhaps relegated to the junk box, often serve very well and can be used for numerous interesting tests. Parts too large or not good enough for the radio receiver used in the home are usually just as good as more expensive or modern parts for

principles of the superheterodyne circuit and the production of "beat notes," and perform a host of other interesting experiments too numerous to mention. Some of the more interesting ones will be described.

The superheterodyne receiver is based on the principle that two frequencies, when present in the same circuit, combine to give a resultant "difference-frequency," or a frequency equal to their numerical difference. Thus, a 600-kilocycle frequency and a 599-kilocycle frequency produce a one-kilocycle, or 1000-cycle note. (They also produce an 1199-kilocycle frequency, but there is no converting this into audible sound.)

This phenomenon can be studied by means of two simple oscillators, of the type whose circuit is shown in Fig. 1. The entire set can be mounted on a small baseboard and arranged with Fahnestock clips so that the wavelength range can be varied by plugging in the various coils. A small 199-type tube should be used and then the batteries and all can be mounted on the baseboard, making the set portable and of general use around the radio room.

If two such oscillators, arranged to tune over the same wavelength-range, are placed near each other and a pair of phones is placed in the plate circuit of one of them, it will be noticed that, as the condenser of either is tuned, a "squeal" will be noticed at some particular dial-setting. (In fact, two distinct "squeals" will be discovered, one on each side of the point of resonance.)

Oscillator No. 1 (Fig. 2) is acting as a miniature broadcast station (radiation, however, is entirely negligible, for no antenna is connected.) Its coil produces a magnetic field and induces a current in the tuned circuit of Oscillator No. 2. Oscillator No. 2, however, is also inducing a

current in No. 1 and producing the same effects in its circuit. The frequency induced in No. 2 combines with the frequency produced by this oscillator itself, and gives the "squeals" heard in the phones.

### AUDIBLE DIFFERENCE-FREQUENCIES

Since the resultant frequency is equal to the difference between the two frequencies, "squeals" will be heard on each side of one definite dial-setting (at which the frequency of No. 2 is equal to that of No. 1; the difference-frequency is therefore zero and no note can thus be heard.) On either side of this resonant position, the two original frequencies will react on each other and there will be present the "squeals" or dif-

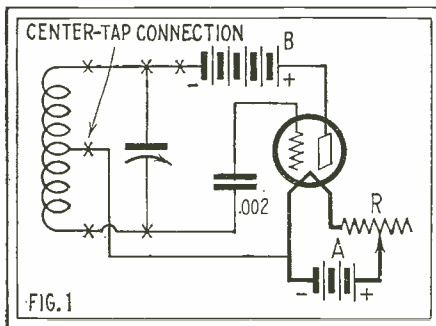

Schematic diagram of an easily-made oscillator. The grid condenser (.002) may be omitted. If it is used with a grid leak the oscillator will generate a modulated signal.

experimental purposes. To illustrate: an old rheostat, a few lengths of wire, a 23-plate condenser, a coil, and an old tube socket are the only extra parts which are really necessary for the oscillator shown in Fig. 1, with which all sorts of interesting experiments can be performed. The tube is perhaps borrowed from the radio set temporarily. One listener has found that his radio friends are only too glad to assist him with the contents of their junk boxes, and many useful parts for experimental work were thus obtained without any expenditure.

### USE OF TWO OSCILLATORS

With two of the simple oscillators shown in Fig. 1, many interesting experiments can be performed. One can compare and measure capacity values of condensers, inductance of coils, compare operation of different loud speakers and their response to the various musical frequencies, study the

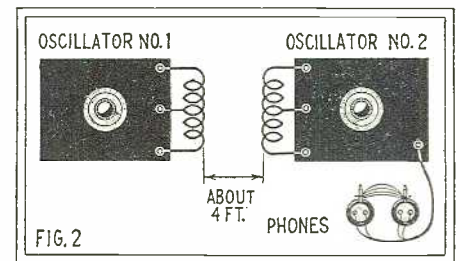

Two oscillators, operated next to a regular broadcast receiver, can be used to illustrate the principle of the superheterodyne circuit.

ference-frequencies which are changed into sound. The pitch of the squeal heard, as the condenser is slowly turned, gradually increases; since the difference between the two frequencies is caused to increase, by changing the capacity value and consequently the frequency of one circuit. The higher the frequency (of the electrical variations producing sound in the phones) the higher the pitch of the note heard.

If the difference in frequency is made too large, the resultant frequency in the phones becomes so high that it cannot be heard; that is, it is beyond "audibility" (the audible range extends from about 20 to 20,000 cycles per second.) An interesting fact in this connection is that the frequency-ranges of the ears of some animals is quite different from that of the human ear. A dog fancier once constructed a whistle which, when operated, could not be heard by the unaided human ear; although the master himself could not hear the whistle (nor the neighbors) the pets could

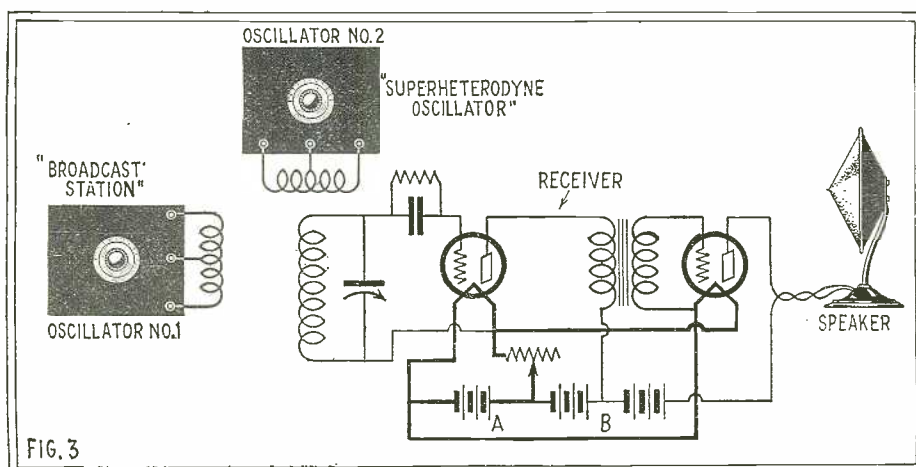

The effect of "heterodyning," or the generation of a third current by the mingling of two currents of different frequency, can be observed with this arrangement. It corresponds to a superheterodyne circuit.

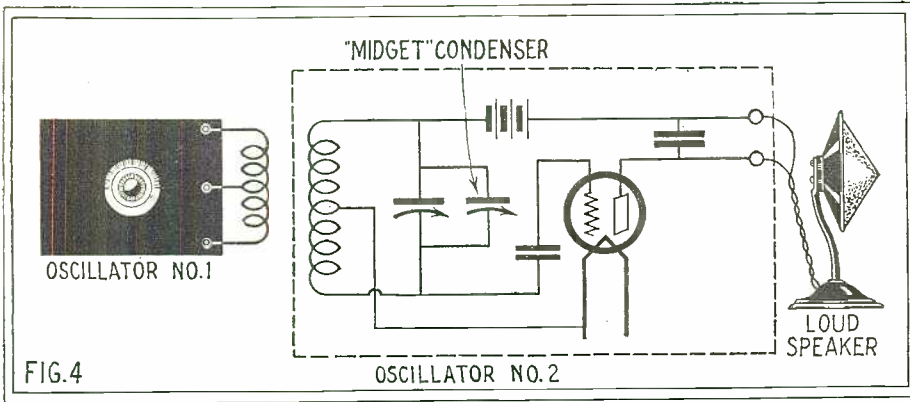

be made to come on the run whenever it was blown.

The oscillator experiment illustrates also, in a striking manner, the difference between audible ("audio") and radio frequencies. Both oscillators are operating at radio frequencies which could not possibly be heard by the unaided human ear, should it be possible to change them to sound (air) waves. The difference-frequencies, however, can be heard in the phones when they are in the audible range. With this description of beat notes, it will be quite simple to understand some more difficult experiments.

A "SUPERHET" EXPERIMENT

One of the most useful purposes for an oscillator in a receiver, is that which it serves in a superheterodyne; the oscillator is used to produce the "local" radio frequency which, when combined with the received signal, produces the "intermediate frequency." This function is easily illustrated by means of the two oscillators; one of these serves as the "broadcast station" (although actual radiation into the "ether" is negligible, it is always good practice to operate any such experimental sets outside of the broadcast band—if you have neighbors); and the other acts as the oscillator does in the superheterodyne receiver; although the intermediate frequency in a "superhet" is above the range of audibility—"supersonic," whence the "super."

The circuit diagram and arrangement is shown in Fig. 3. The receiver shown is an ordinary detector-one-audio set-up, or it may be the ordinary broadcast receiver used for the reception of musical programs if desired; the principle is the same. The receiver is tuned to the frequency produced by the "broadcast station" and the frequency of the broadcast station remains fixed. Nothing will be heard in the speaker unless the receiver is regenerative (if so, turn back the regeneration control until the signal is not heard.) If now, the "superheterodyne oscillator" is operated, the familiar squeals will be heard in the loud speaker. In the case of the regenerative receiver, the detector itself oscillates and the difference-frequency is produced in the same way. Note that a regenerative detector is thus, in itself, an oscillator—as those living near the operators of one-tube sets long ago discovered. The only difference in fundamental operation between the different superheterodynes is the value of the intermediate frequency or difference-frequency used. The difference-frequency produced in this experiment is an audible one and can be treated, in circuit design, as an audio frequency.

In a superheterodyne, the intermediate

Above: With two oscillators adjusted to "squeal" over a range of frequencies, the response characteristics of loud speakers can be measured roughly. Below: Circuit for calibrating with the aid of an oscillator, such as that pictured at the bottom of the page.

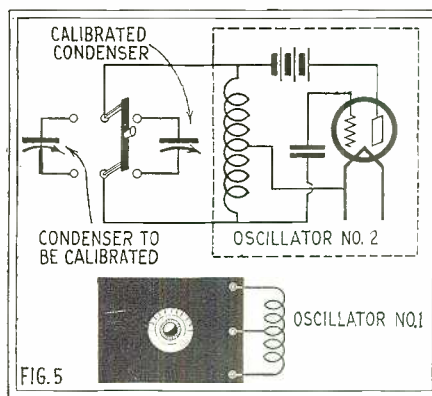

Below: A complete oscillator assembled on a board only; 8 inches long and 4 inches wide. "A" and "B," batteries; L, 75 turns No. 24 wire on 2 1/2-inch tube, tapped in center (See Fig. 1); C, .0005-mf. condenser; T, should be 199-type tube; F, filament ballast, instead of rheostat; G, grid condenser and leak, optional.

frequency may be of the order of 30,000 cycles and up as far as 600,000 cycles. The reason that such a frequency is used is that it is above the audible range and thus extraneous noises, which would also be amplified if an audible intermediate frequency were used, are excluded. In the arrangement shown, the radio-frequency amplifier, or intermediate-frequency amplifier, is an audio amplifier. One often tries mentally to separate too far audio and radio frequencies; although audio- and radio-frequency amplifiers are constructed quite differently, there is only a difference in frequency between radio and audio frequencies. It is only by such experiments as these, that such interesting facts are made clear to the listener.

TESTING LOUD SPEAKERS

As already explained, the two frequencies which are produced by the oscillators are both present in each of the plate circuits of the oscillators; the audible frequency, it has been shown, can be varied by tuning one of the condensers. This phenomenon can be utilized to test loud speakers for their operating efficiency on the various frequencies in the musical scale. The circuit arrangement is shown in Fig. 4. Two binding posts, or a plug and jack, are provided, so that the various loud speakers tested can be plugged in at will.

Perhaps you have wondered just what response your loud speaker gives to a 50-cycle note, compared with its response to a 1000-cycle note, for example. How does the loud-speaker compare at high frequencies with another type? This comparison can be made roughly by means of music, but this is hardly satisfactory; for the notes, and thus the frequencies, are constantly changing. The ear, too is not nearly so accurate when loud speakers are tested in

(Continued on page 581)

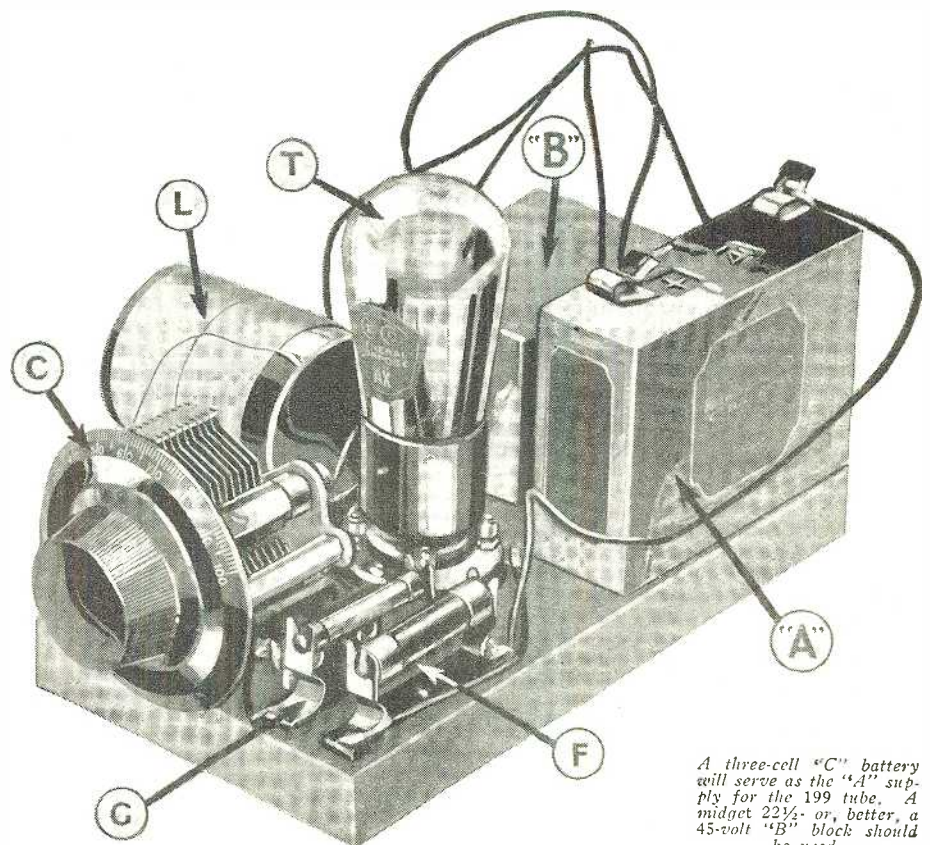

A three-cell "C" battery will serve as the "A" supply for the 199 tube. A midget 22 1/2- or, better, a 45-volt "B" block should be used.

# A Unique "No-Dial" Receiver

A German Engineer Builds a Superheterodyne Which Tunes by Throwing Switches Up or Down

By Hanns Mendelsohn  
(Berlin, Germany)

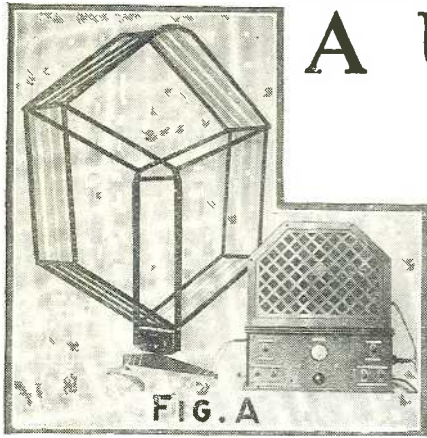

The "no-dial" receiver, with its built-on speaker and loop.

**N**EARLY every radio experimenter has, at one time or another, dreamed of building a no-dial receiver; one that would include all of the good features of a multi-dial set and yet be sensitive, selective, neat in appearance and give good quality of reproduction without the usual twisting of dials and knobs. The construction of such a set calls for considerable skill and ingenuity on the part of the set builder, as well as careful design, in order to give the desired results. It is not the purpose of this article to give directions for the construction of a no-dial receiver, but simply to illustrate how the writer, a German engineer, has worked out the problem to his own satisfaction.

The complete no-dial receiver is shown in Fig. A, together with the loop aerial and loud speaker. Fig. B shows the details of the front panel of the set with the six built-in, three-way switches used to select the desired station. Each switch can be used to select either of two stations, thus making it possible to tune-in any one of twelve stations with this particular set.

A name-plate, with the name or call letters of the station, is mounted above and below each switch on the front panel as shown in Fig. C. The knob in the center of the panel just below the voltmeter, Fig. C, is the only rotating control on the front of the set and is simply a volume control in the loud-speaker circuit. A key, a little below and at the right of the voltmeter, makes it possible to lock the set when not in use. The switch at the left of the meter is used to shift from one set of coils to another and is necessary only because four

of the European broadcast stations which this set was designed to receive operate on very high wavelengths (over 1,000 meters); while the remainder operate on wavelengths corresponding to those used by American broadcast stations.

The twelve stations for which this set is adjusted are Berlin; Langenberg; Vienna (Austria); Königsberg; Frankfurt; Stuttgart; Leipzig; Kattowitz (Poland); Moscow (Russia); Königswusterhausen; Kalundborg (Denmark); and Daventry (England).

## A SUPERHET USED

The hook-up used is practically that of the standard superheterodyne used in America, the only difference being that double-element tubes are used. That is, each tube has two grids, two plates and a common filament. These tubes greatly simplify the wiring and construction of the set.

The tuning of the set is accomplished by means of condensers coupled in parallel across the coils by means of the switches

on the front of the panel, each of which is of the four-pole, double-throw type. Two of these condensers are required for every station that it is desired to receive; to simplify the adjustment of the set, variable condensers have been used. These are mounted on the sub-panel at the rear of the cabinet, as shown in Fig. E. Each set of condensers is adjusted in advance for the station selected. Because the condensers are variable, the combinations of stations received can be changed from time to time, as new wavelengths are adopted and old ones discontinued.

The layout of the parts and the compact arrangement made possible by the use of the double-element tubes is shown in Fig. D. The back cover of the sub-panel is so arranged as to lock in position, making it impossible for anyone but the owner to disturb the adjustment of the condensers, once the proper settings have been determined.

## THE HOOK-UP

The wiring arrangement of two of the station selector switches is indicated at "TS" in the schematic diagram on the next page. Regeneration is accomplished in the first detector by means of the tapped loop aerial. The first double-element tube serves as a detector and oscillator; the second as two stages of radio-frequency amplification; the third as one stage of radio-frequency amplification and the second detector, and the fourth and last tube as two stages of audio-frequency amplification, the output stage being resistance-coupled. No output coupling device is used, but there is a small fixed condenser, connected across the loud-speaker leads, which serves to give a more pleasing tone to the music. An extra tap is provided on the "C" battery for the grid-bias on the radio-frequency amplifiers. No grid leak or condenser is used on the first detector. The change-over switch for shifting from low-wave to high-wave stations is indicated at SW-1.

Close attention to detail and careful wiring were necessary in building this set, in

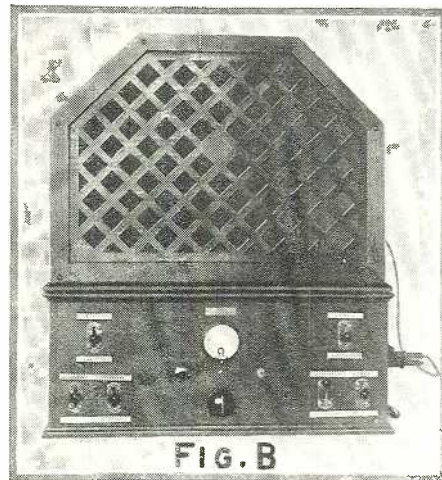

The simple appearance of the panel. Each of the switches will tune in one station when thrown down, and a different one in the "up" position.

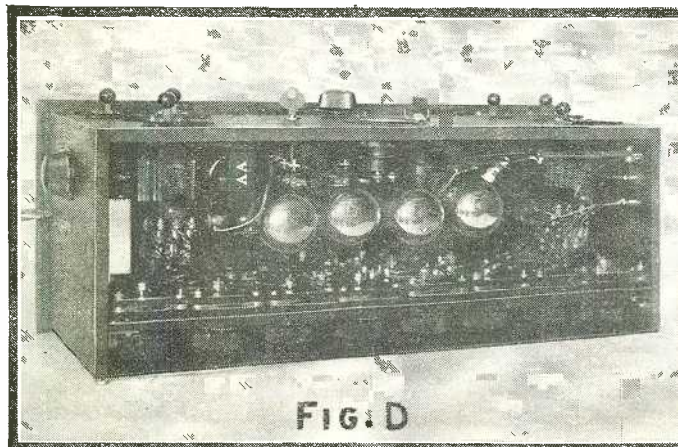

Looking into the top of the set. The four double-element tubes are visible in the center, and under them the twenty-four condensers which tune the oscillator and first-detector circuits for each station.

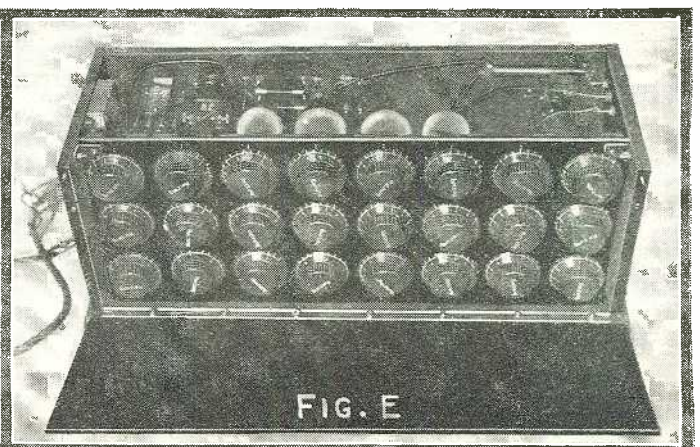

An outer panel protects the tuning condensers. These are variables, because wavelengths change, and it may be desirable to make another choice of stations; but their setting is not otherwise changed in the operation of the set.

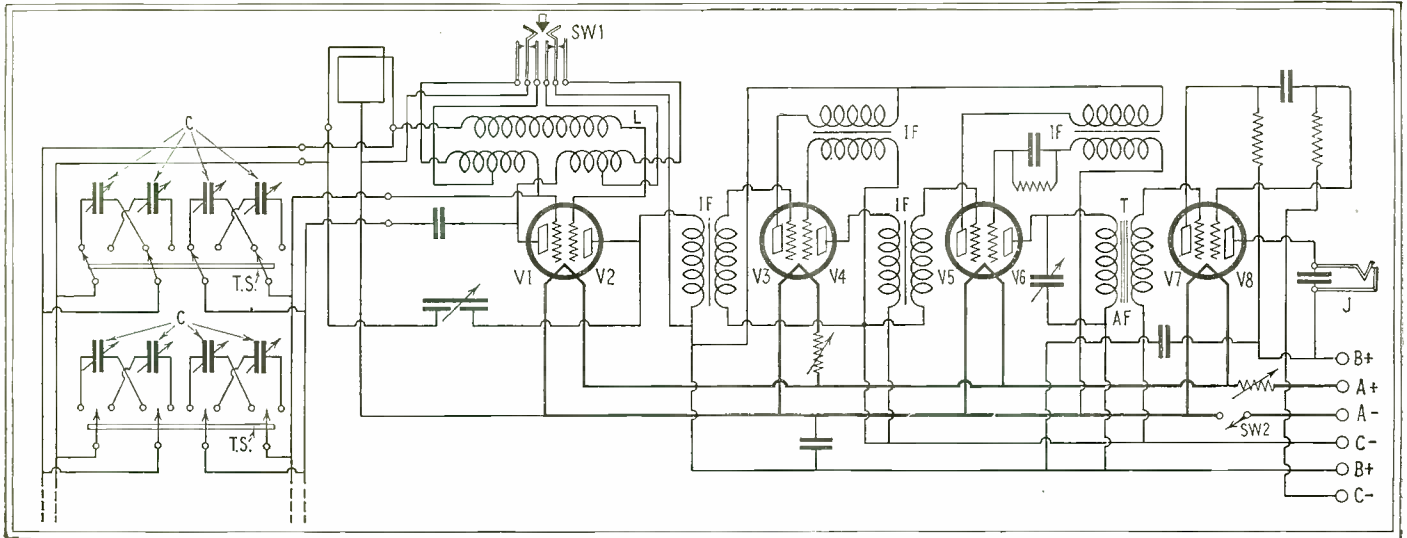

The circuit diagram of the "No-Dial" superheterodyne, with its European two-element tubes; two of the selective-circuit switches with their tuning- and oscillator-condenser connections, are shown

at T.S. This hook-up is not adapted to American conditions or components, so please do not ask for specifications. A dialless receiver of different type is illustrated on the Constructor's Page.

order to prevent feed-back between the different parts of the radio- and the audio-frequency amplifiers. The variable condensers mounted on the sub-panel at the rear of the cabinet are very small and compact, comparing in size with the small vernier condensers used in America; but the German condensers have a somewhat higher capacity, due to a closer spacing of the plates. In adjusting these condensers, the desired switch on the front panel was thrown to the position in which it was desired to receive a certain station, and then the station was tuned-in by adjusting the two corresponding knobs on the sub-panel. Once adjusted, the bearings on the condenser were tightened so that they would not easily lose their adjustment, and the next set of condensers was then adjusted in the same manner.

Obviously, a hook-up of this kind is designed to meet special conditions, and would not be duplicated by an American constructor; nor is the apparatus used available in the United States. The ingenuity, however, of any experimenter who is com-

petent to build so complicated a receiver will undoubtedly be sufficient to determine the necessary details of the tuning circuits for the wavelengths to which he desires to tune. (See page 566, also.)

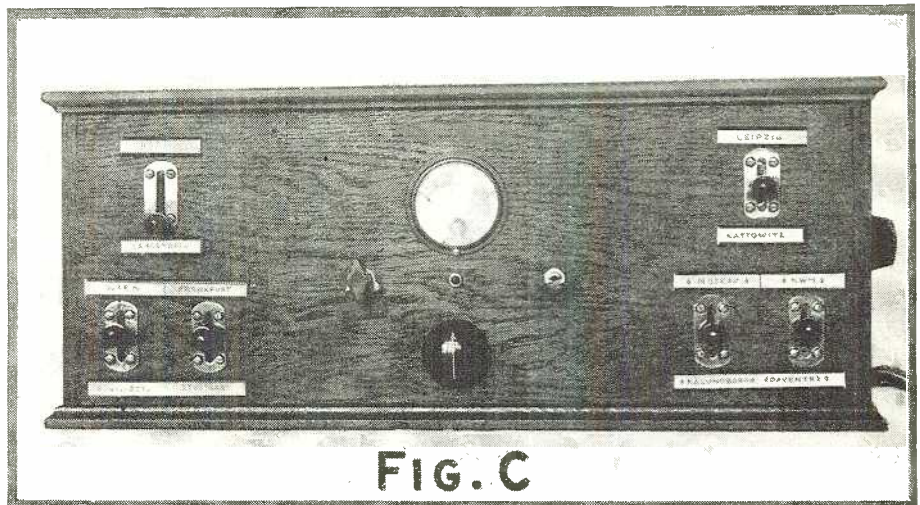

A larger view of the "No-Dial" receiver shows clearly the switches and the names of the two stations each brings in, according as it is thrown up or down. The four at the lower right are long-wave stations—over 1150 meters.

## Socket-Power Operation for the Old Set

If your set is one of the eight million or more originally intended for battery operation, and if that set is functioning properly, it is just plain horse sense to hold on to it. However, in keeping with the times, you may wish for the convenience and economy of socket-power operation, in which case the following suggestions are in order.

The first step in socket-power operation is the "B" supply device, which replaces the "B" batteries with their dwindling power. The advent of power tubes, with their heavy current drain, virtually demands a "B" power unit as the source of power.

There are many types of "B" power units now available. Mass production has served to bring the price of these devices down to new low levels, so that in a year or two of use, depending on the number of hours a radio set is used each day, the instrument can pay for itself in actual savings.

If you already have a "B" power unit,

you have solved at least half the battle of the electrified receiver. Fortunately, aside from the rectifier tube, which should be replaced at the end of a thousand hours of use (a year of typical radio application), there is little to wear out in the properly designed and constructed "B" unit.

With the "B" power requirements taken care of, the next consideration is the "C" potential or grid-biasing source. It is possible to obtain grid-biasing effects by means of the voltage drop through resistors in the different "B" circuits, or again by means of a small "C" battery. Often the latter method is preferable, especially when the battery-type receiver is being converted over to socket-power operation.

### THE FILAMENT PROBLEM

Next and last we come to the operation of the tube filaments. Here we have three courses available, each with its own peculiar advantages:

First, there is the "A" power unit, which converts the usual alternating current of the house-lighting circuit into low-voltage direct current for lighting the usual tube filaments. In conjunction with the "B" device, the use of the "A" unit, in place of the storage battery, provides the simplest electrification job.

Secondly, there is the series-filament method, in which all the tube filaments, with the exception of the power tube, are connected in series. This means rewiring the filament circuits of the receiver, which should be done only by a skilled radio man. The series-filament method calls for an extra-large "B" power unit, employing a 350-milliamperere rectifier tube in the case of the ¼-ampere filament tubes. If the low-current, 99-type tubes are employed, an 85-milliamperere tube may be used to supply the current for the filaments. In rewiring for series filaments, there are just two main

(Continued on page 583)

# Radio Wrinkles

## Automatic Control for the Regenerative Set

ALMOST all regenerative receivers are guilty of producing excessive regeneration on the lower wavelengths, or high-frequency range of the condenser. Considering the fact that the majority of these receivers include a fixed condenser across the primary of the first audio transformer to aid regeneration, on the lower waves, the removal of this condenser will aid considerably in keeping unwanted oscillation at a minimum. Here is a little scheme which will keep the fixed condenser in the circuit at the higher wavelengths, and remove it as the frequency increases.

The fixed condenser is placed on the sub-panel or baseboard near the variable tuning condenser. A piece of thin sheet spring brass is then soldered to the fixed condenser and bent as illustrated. For the cam shown in the illustration, solder a piece of

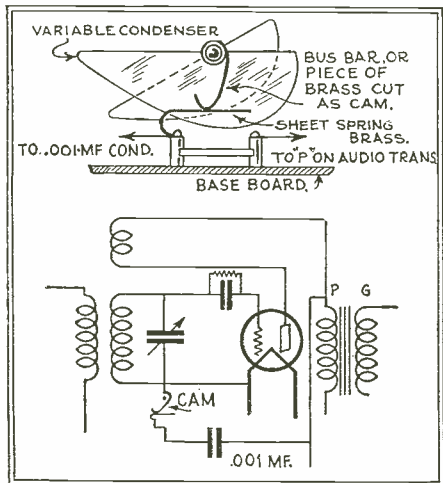

Fig. 1

At the proper setting of the condenser plates the cam breaks the connection to filament of the plate circuit, and reduces the feed-back.

bus-bar or spring brass to the shaft of the tuning condenser and curve it in such a fashion that its end will make contact with the fixed condenser down to the wavelength decided upon.—Louis B. Sklar.

## Salvage from the Junk Box Makes Drum Dials

AN ingenious set builder is able to make many of the parts of a radio receiver which usually are purchased by the average amateur. Those who enjoy making odds and ends will welcome the idea described in Fig. 2; this shows how it is possible to make a very satisfactory double-drum control with parts which may be found in any radio fan's junk box.

This idea is so clearly explained in the illustration that only a very short description is necessary. Two standard (non-vernier) dials, approximately 3½ inches in diameter, are used for the two control drums

of a double-drum dial; and these are mounted on the condenser shaft at right angles to the front panel. The condensers

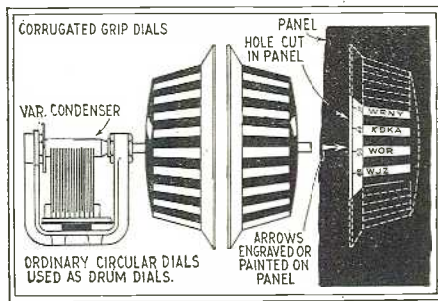

Fig. 2

The old-fashioned big flat dials, especially if they are knurled, can be turned sideways and used as drums in the manner shown above.

are mounted on the sub-panel and a small window, of the proper shape to fit the dials, is cut in the front panel of the set.

Before mounting the dials on the shafts of the condensers it will be necessary to extend the holes for the shaft; as they must go completely through the dials. Also, it may be advisable to make provision for marking the call letters of stations on the grip rims of the dials. It will be an easy matter to do this, as it is necessary only to paste a strip of paper around the rim.

When selecting dials for making a drum control of this type, it is important to make sure that they have large grip surfaces, and the rims on which the calibrations are engraved should be as narrow as possible. When dials of this construction are employed the appearance of the drum control is improved greatly.—Contributed by Herman R. Wallin.

## An Inexpensive Stand-Off Insulator

THE stand-off insulator may be recognized as one of the few items in radio that has withstood the onslaughts of the research and fashion engineers; probably for

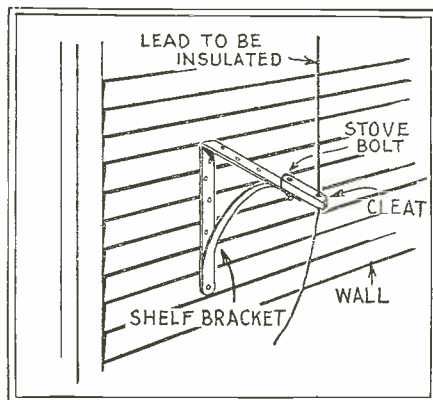

Fig. 3

A pair of cheap shelf brackets furnishes two supports for porcelain lead-in insulators.

no better reason than that it has always given service, and to all appearance will continue to do so in spite of continued inventive progress. Many of us would care to use a larger number of insulators to secure the lead-in more firmly; here is one that not only serves the purpose admirably, but has the added advantage of costing but a few cents. An ordinary shelf bracket is fastened to the side of the house, or wherever the stand-off is desired, and a porcelain cleat (of the type used in house wiring) is bolted to the extreme end. The wire to be insulated is passed through the other end of the cleat. There is an added advantage in being able to obtain these brackets in various sizes to suit the needs of the builder.—Paavo Leed.

## Tinfoil Useful to Shield Control-Grid Lead

SHIELDING is one of the most important considerations in the design of a receiver using screen-grid tubes in the R.F. circuits.

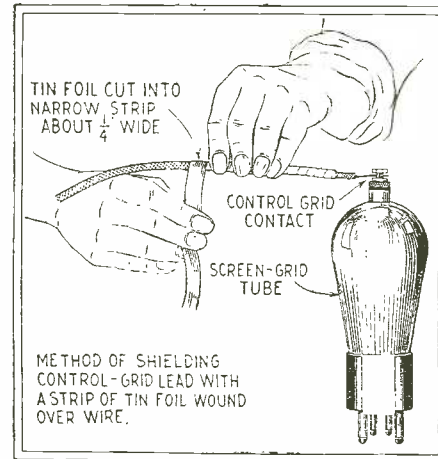

Fig. 4

Tinfoil is conveniently used in this way to protect the grid lead of a 222-type tube.

When properly employed, these tubes are capable of providing several times as much amplification as the usual 201A-type but, if the circuits have not been designed carefully, the expected results will not be obtained. Complete shielding is essential in all circuits using these tubes, if high efficiency is desired. Not only is it necessary to place all apparatus of the circuit within a shielding compartment, but the tube itself and the control-grid lead must be shielded. With the proper circuit operated under these conditions, the amplification per stage is as high as 35.

Radio fans who enjoy building their own apparatus find that it is quite a simple matter to make shield compartments and tube shields, but shielding the grid lead often presents a problem. Also, shielded wire, which may be used for this purpose, is not always available in small radio stores. It is possible, however, to shield a wire,



as illustrated in Fig. 4, very easily and practically without cost.

In doing this, the only parts needed are a length of insulated hook-up wire, a piece of tinfoil and a strip of friction tape. First, the hook-up wire should be connected to the clip which attaches to the control-grid terminal of the tube, and then

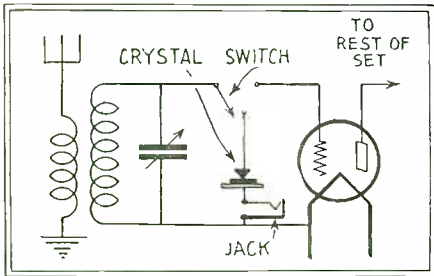

Fig. 5

A flip of the switch, and radio is back where it started—almost. Our readers might figure out a way to switch the crystal to the A.F. amplifier, too.

the tinfoil should be cut in strips about 1/4-inch wide. The tinfoil strips are wound over the insulation on the wire, starting about 1/2-inch from the clip and continuing as far as necessary. In order to insure proper shielding it will be wise to wind two or three layers of tinfoil.

The next problem is to provide a method of making contact to the tinfoil shielding and, for this purpose, the insulation on the wire, starting from a second length of hook-up wire and it is placed in contact with the tinfoil on the first wire. Now the bare wire and the tinfoil-covered wire are bound together with friction tape.

After the shielding of the wire has been completed, it should be carefully examined. It is first necessary to make sure that the tinfoil is completely covered by the friction tape and that the tinfoil does not make electrical contact with the clip or any part of the insulated wire. When this lead is connected in the circuit it is connected like any other wire, except that the bare copper which makes contact with the tinfoil is connected to the shielding.

Contributed by Joseph R. Picnichny.

### Unit-to-Charger Switch

WHERE an inexpensive control for your power and charger units is desired, a simple double-pole double-throw

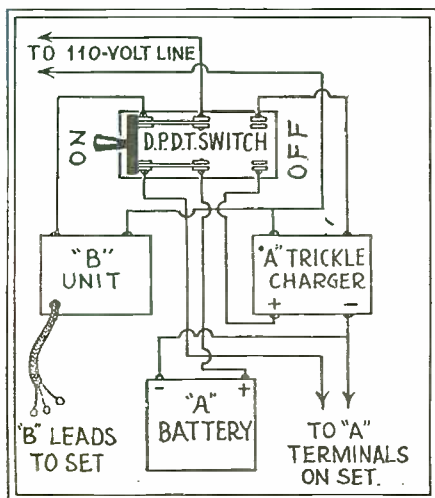

Fig. 6

A relay is best; but while you are saving up for it, this hook-up is cheap.

switch, purchased for from ten to twenty-five cents, will serve the purpose very satisfactorily—providing the user has no objection to manually-operated controls. It is hardly necessary to go into the wiring of this "Wrinkle" as the diagram (Fig. 6) is self-explanatory. The switch, when thrown in the "On" position, connects the "B" unit to the 110-volt line, and the "A" battery to the set. On throwing the switch to the "Off" position, the set is disconnected from the "A" battery, the "B" unit is disconnected from the house line, to which the charger is then connected; while the latter is simultaneously connected to the battery so that charging can take place.—L. R. Ward.

### A Combination for Testing Reproduction

HERE is a wrinkle that will be found useful to the experimenter in his search for a device that will allow him instantaneous choice of either phones, horn speaker, cone speaker, or horn and cone speakers in parallel or in series. All that is required are two switch arms (A and B) cut to the shape

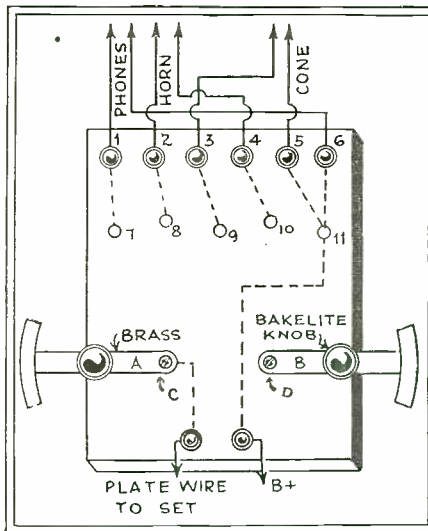

Fig. 7

The ingenious way of cutting the contacts makes five different options available.

shown in the diagram, two hard-rubber or bakelite knobs, six pin jacks (1 to 6), five switch-points (7 to 11), a small hard-rubber or bakelite panel, and four rubber legs if the panel is to be placed upon the table. It may, however, be mounted on the wall or the side of the cabinet where it will be within easy reach. Mount the hard-rubber knobs on the switch blades, care being taken when mounting the latter that proper contact is made when they sweep over the contact points. If desired, two binding-posts may be used for the plate and "B" battery wires. They are shown between the switch arms.

The wiring is self-explanatory and its use is explained as follows:

Lever "1" on contacts	Lever "B" on contacts	Connects
7	.....	Phones only
8	10 and 11	Horn only
9	.....	Cone only
8 and 9	10 and 11	Horn and cone in parallel
8	9 and 10	Horn and cone in series

RADIO NEWS has received from readers so many letters and ballots requesting more "Wrinkles" that it has been decided to re-establish the department. A year's subscription to RADIO NEWS will be given in compensation for each accepted item. If the author of the wrinkle is already a subscriber, his subscription will be extended one year or he may accept a one year's subscription to Science and Invention or Amazing Stories, both published by the Experimenter Publishing Co.

Spring brass may be used for the switch arms, and is easily worked when cutting into shape. The dotted lines indicate wiring under the panel. Switch levers pivot at C and D.—Adel Wharton.

### Back to the Crystal Circuit

IN the hustle and bustle of radio progression, and the roar of super-power amplifiers, the average radio fan has reached the stage where the crystal detector is a thing of the dim and hazy past. However, it is gratifying to learn that there is at least one who has not forgotten his old friend, in spite of the fact that his present receiver absorbs vacuum tubes in dozen lots. He recommends the circuit illustrated in Fig. 5 as a means of keeping in touch with a pleasurable past, and at the same time insuring himself headphone reception at least, should the worst happen to his tube receiver. The parts required are a crystal detector, a miniature single-pole double-throw switch, and a single-circuit jack. Remove the lead from the grid post of the first R.F. socket and wire in the switch as shown in the diagram. The crystal detector may be wired within the cabinet if it is of the fixed type; if it is not, place it in some convenient position where adjustments can be made easily.—Fred B. Huffman.

### Improvising a Tube Socket in a Pinch

A RADIO tube socket is a comparatively inexpensive device, and it is hardly worth while for the average experimenter to (Continued on page 515)

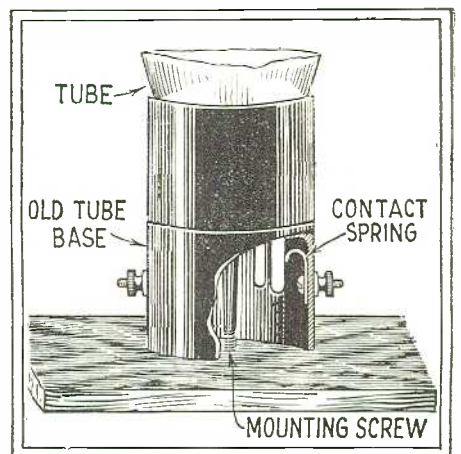

Fig. 8

A study of this wrinkle may, at least, induce you to keep extra sockets handy.



# On the Short Waves



**R**ADIO NEWS will welcome any definite information from our readers about unlisted stations which you may hear putting on programs, only if you hear the call or the announcement of location. Please give the wavelength as closely as you can estimate it. Because of the number of experimental transmissions by amateurs and others, we cannot undertake to list such stations in the short-wave broadcast list on another page, unless confirmation is received of their having a regular schedule; but all definite information received will be published here. Please consult data we have published before writing for information; we have no way to identify a station by its program or language, since many foreign stations transmit in several languages; nor even by its approximate wavelength, unless it is one of the larger and best-known transmitters.

Box especially as I am using for an aerial 100 feet of wire strung in the attic. No doubt because of this, I find two copper pennies a better aerial condenser than the one you suggest. Almost any station in the U. S. can be brought in without aerial and ground. I think, however, that the set can be improved by the simple method of using a panel and shielding. (Quite true; but it was designed only to give the set builder the chance to try the short waves with the least trouble and expense. Other sets are being described which incorporate shielding, screen-grid amplification, and other refinements, at a higher cost, of course.—EDITOR.) I am sure all who build it will be greatly pleased with it.

L. THOMAS CLEAVER,  
212 Mifflin St., Johnstown, Pa.

**B**ECAUSE of the changes in the schedules of long-wave stations whose programs they reproduce, some changes in the hours of the American short-wave broadcast stations may be noticed after the reallocation on Nov. 11; but it is not to be expected that their wavelengths will be altered consequently.

Station WRNY will continue to broadcast television during the first five minutes of each hour while it is transmitting, on its new wave of 296.9 meters; and W2XAL will do the same on 30.91 meters, as hitherto.

### FRENCH 24.50-METER TRANSMISSIONS

Mr. J. K. Uhler, of Easton, Pa., forwards the verification of the Société Française Radio-Electrique, of 79, Boulevard Haussman, Paris VIIIe, France. This electrical manufacturing company has been experimenting on the wavelength men-

tioned with a new directional system of radiotelephony, and states: "We have had excellent results with Argentina, Indo-China and Japan." Quartz-controlled oscillators are used to maintain this frequency.

### FIVE WATTS ONLY!

Editor, RADIO NEWS:

In going over your last issue, I find in the short-wave column a letter from Mr. Schroeder, who has been getting a mysterious station in Costa Rica. The heading of it is "Costa Rica Steps Out."

The station in question is "9RH" and the station consists of one Aero 5-watt radiophone transmitter, built exactly according to our specifications.

This transmitter has been heard all over the Western hemisphere including the Argentine at one time or another, and the owner, Mr. Armando Cespedes Marin, Apartado 40, Heredia, Costa Rica, will undoubtedly be more than glad to tell you something about his operating conditions, etc., if you think it might be of interest.

It certainly is unusual nowadays for a five-watt station to be heard so far away.

BERT E. SMITH,  
Aero Products Inc.,  
4611 E. Ravenswood Ave., Chicago, Ill.

### AUSTRALIAN-NEW ZEALANDER PROGRAMS

Editor, RADIO NEWS:

I constructed the Junk-Box and have very good results. Last Sunday morning (September 2) I heard a program from 2ME, Sydney, Australia, of the dedication of a new cathedral in Sydney during the Catholic congress there. At 3:30 a.m. F.S.T., I heard a concert of victrola records from 1YB at Auckland, New Zealand. I think this reception must be almost a record for the Junk-

The illustration at the right is a close-up of the transmitter of one of the world's best-known stations, on any wave. This is W2XAD, South Schenectady, New York, owned by the General Electric Co., and operated in conjunction with WGY and, at times with the companion short-waver, W2XAF. These two short-wave stations have done more than any others to make American radio well known throughout the antipodes; and whenever a great event takes place on this continent, they have made available its broadcast to the farthest ends of the earth. They have been rebroadcast, from England to Australia; and are among the standbys of the short-wave listener in any part of the earth.

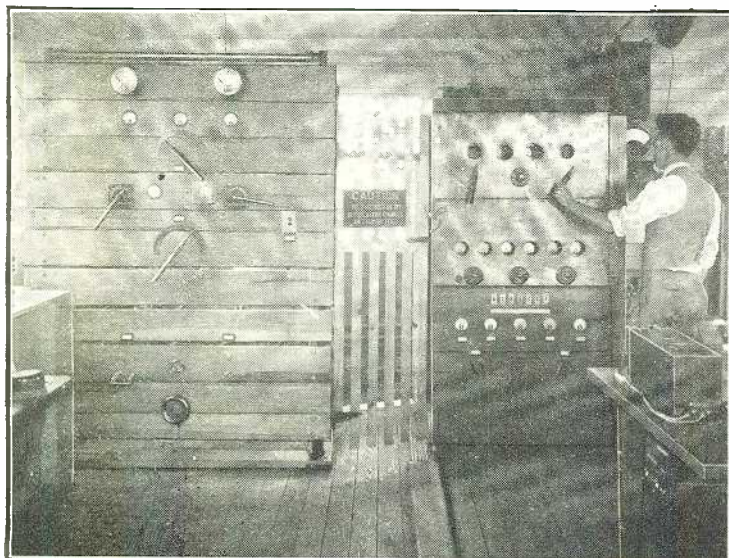
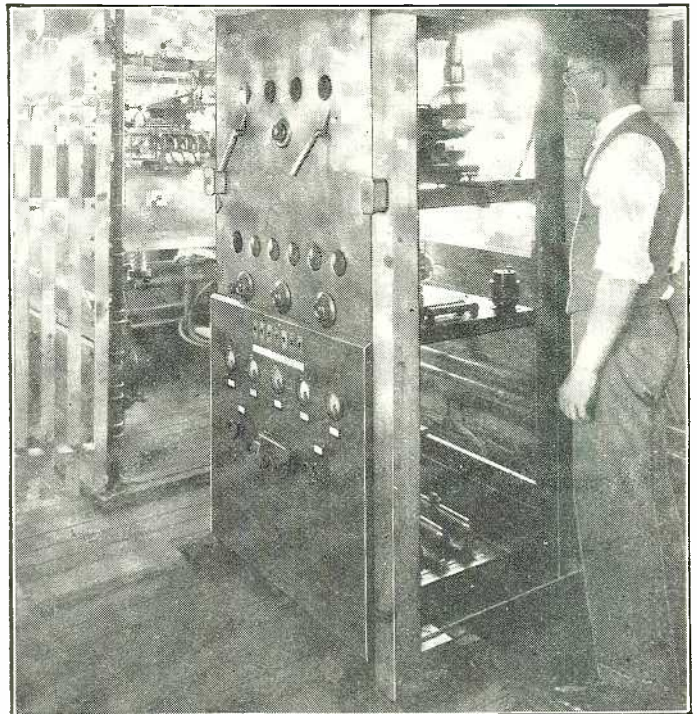

This view of the equipment of W2XAD shows how plain the installation is. It was put up, not for style, but for efficiency. The very short wave used (21.96 meters) lends itself exceedingly well to daylight transmission over very long distances. Each of these transmitters is quartz-crystal controlled, the first stage being a UX-210 tube. From this the power and frequency are stepped up, until four 20-kv. tubes can be used for the last amplifier stage.

Senior E. Marty, of Buenos Aires, reports "Radio-Paris-Femur" on this wave. His log shows it from 1745 to 1930, June 7 and 8, when it came in more clearly than the North American stations.

### A PLEA FOR MORE LOW-WAVERS

Editor, RADIO NEWS:

I have been reading with much interest letters from builders of short-wave sets but have never seen anything from this part of the country. I note that Foreign stations come in regularly on the East Coast, but I can say that on September 17 about 5:30 p.m., Central Standard time, I had 5SW at Chelmsford, England, with sufficient volume on the loud speaker to be heard out in the yard. This station was broadcasting records of the Columbia Phonograph Co.

I have a home-made set, home-wound coils, cheap parts in every way. So far the above-mentioned is the only foreign station I have received. Pittsburgh on 62 and 27, as well as Schenectady on 21.96 and 31.40 come in like locals; both these stations can be gotten in daylight without either aerial or ground. In my opinion, short waves are just coming into their own; why do not all large stations have both regular and short-wave programs? There are several such as WRNY,

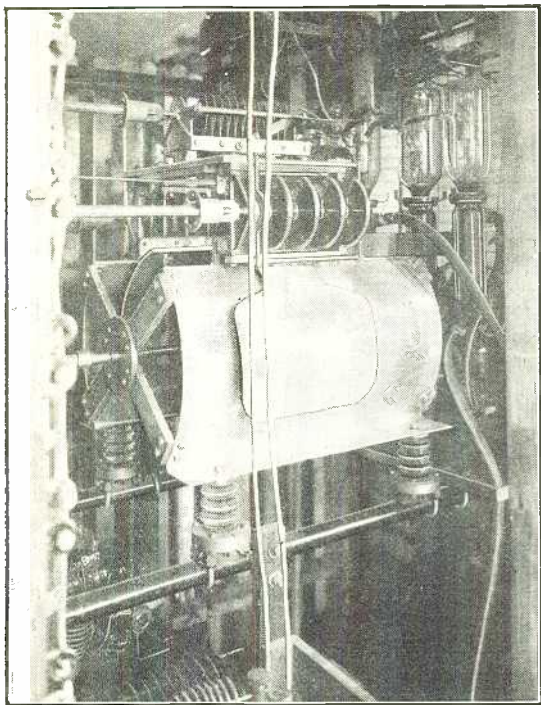

At the left, we have a close-up of the big tuning condenser of W2XAF, the longer-waved of the two best-known high-frequency stations at Schenectady. This condenser, be it noted, must have a capacity small in proportion to its physical dimensions, as it tunes a 3140-meter circuit. The transmissions on this wavelength are better suited to night transmission across the Atlantic than the shorter ones; but the station, for all its power, cannot be heard fifty miles away, because of the "skip distance." Typical hours of these stations were, recently: W2XAD, 4:30 to 9:30 Sundays; 1:30 to 3:30 Mondays and 1 to 3 Thursdays; 5 to 11 Mondays, Wednesdays and Fridays; W2XAF, 5 to 11 Mondays, Tuesdays (to 10:30), Thursdays and Saturdays—all hours p. m. and E. S. T. However, with the new limitation of WGY's time, these will probably be altered.

In addition to these "senders" and the super-power broadcast station recently licensed to put 200 kilowatts into the antenna during daylight hours, there are several other installations in the 54-acre transmitting laboratory grounds near Schenectady. Work has been done from 5 to 1500 meters.

WOWO and several Western stations broadcasting on short waves that I have never received. I say put on more power.

W. D. RICKETTS,  
Sherman, Texas.

(Power on these waves is important, but so is the skip-distance.—EDITOR.)

#### A FLOCK OF FOREIGNERS

Editor, RADIO NEWS:

I have built the short-wave set described in RADIO NEWS for April (To readers: take notice that this issue of blueprints has been used up and is no longer available.—EDITOR.) The results obtained are wonderful. On September 6, between 8:30 a.m. and noon, Eastern Standard Time, I heard a station at 32 on the dial—on which 2XAD is 76—whose announcer spoke in Spanish and called "Allo, Allo," every fifteen minutes. At about the same time I heard another at 26 on the dial, whose announcer spoke in English and said: "This is the short-wave station at Malabar, Java." Every five minutes a man would call "Hello, New York." Then a woman gave a telephone number and a man would start to talk as if on a regular phone. According to what I heard, I am quite sure this is the Malabar station. The same afternoon, between noon and 2:00, I heard a station which came in at 18, broadcasting in French, and made out that they were having a dialogue. I will appreciate any help that other readers may be able to give.

CHARLES DI ILLIO,  
1120 Wolf Street, Philadelphia, Pa.

(This illustrates the difficulty of identifying stations unless announcements are heard, or a receiver has been calibrated for each coil by known transmission. The first station is probably PCLL, Kootwijk, Holland, on 18.10 meters; the Japanese short-wave stations are known to maintain a telephone service with Holland; but we are not informed that they are working with America. Perhaps the correspondent caught regular transatlantic short-wave work between the United States and England on a wave near that of ANH, Java. We understand that Nancy, France, has a 15.50-meter transmitter, but have no details.—EDITOR.)

#### SHORT-WAVE ULTRADYNE TUNING

Editor, RADIO NEWS:

I note that many of the commercial short-wave stations can be picked up on my latest Ultradyne, with great volume, with the I.F. transformers not oscillating. I have certainly heard talk in foreign tongues in the distance. Next, I thought, I would oscillate the receiver, so I turned the potentiometer up and was amazed to find that I got many of the amateur code stations with great volume. I did not write down the particular calls; but I did take particular pains to get one, which was 1MK calling 1CDX.

It is not easy to find just where to tune these in. But after I got the commercial stations, I kept the same relative distance on the antenna

and oscillator dials and that was about, say 35 and 25 or ten points. I travelled down the dial and picked up the same stations again and again and then suddenly the amateur stations changed while the commercial stations held the same relative distance and position. I certainly believe that I am going to get some great DX on the short-wave channel now. I take it that I must have been tuning around forty meters.

I also am sure that I heard a television signal. It may have been WGY on 380 meters as they were sending at that time, but still the character of this signal was not the same as when I tuned deliberately on to WGY's long wave and oscillated.

H. S. WEBB,  
15 N. Park St.  
Bangor, Me.

Editor, RADIO NEWS:

For many years I have been using one of Mr. Lacault's Ultradynes for short-wave reception. In fact, I feel that the only real results are to be obtained through the superheterodyne for short waves. By merely replacing the broadcast-band

Another view, taken from a little greater distance, of the transmitter of W2XAF. It will be seen how small this apparatus is, compared with that of the long-wave broadcast stations; yet such a station is often heard like a local where WGY's 200 kilowatts fail to reach on the longer wave. One of the points about these short waves is that they are affected comparatively little by static, and as a result are heard more readily beyond the Tropic of Cancer.

The power house for this group has one 750-kw. and two 100-kw. rectifiers, as well as modulators for WGY and the short-wavers. The D.C. plate supply of the latter is modulated with the A.F. component at the power house and sent to the separate buildings occupied by the units illustrated here. They may be operated either with WGY or on separate programs. A number of different antenna systems are also available for their use.

loop by a three-inch coil with the proper number of turns for the short-wavelength. The oscillator is sufficiently rich in harmonics to tune in the short waves at two or three places around the dial. However, the condenser used is so much larger than necessary that very careful tuning will be necessary. I find with a 25:1 vernier it is very difficult to get exactly on the shorter waves.

For those who desire, this trouble may be overcome by placing small fixed condensers in series with both the oscillator condenser and the tuning condenser and arranging two small switches so the fixed condensers may be shorted out when tuning on the broadcast bands. In this manner the effective value of the variable condensers is greatly decreased and the set will tune about as easily on short waves as on long waves. By turning the potentiometer on the intermediates until they reach oscillation, very good reception of code can be had on short waves with the Ultradyne.

However, the best arrangement is to mount the oscillator on an old five-prong tube base and the tuning coil on a four-prong tube base. Then wire the oscillator to a five-hole socket and the tuning end to an ordinary socket. Then, by building a few sets of short-wave oscillators and tuning coils you will have an all-wave set of exceptional ability.

JOS. W. REED,  
Box 365, Fairmont, W. Va.

#### SILENCING AUDIO HOWL

Editor, RADIO NEWS:

The Junk-Box is what I call a howling success, PCJJ, 5SW, 8XK, 8XAL, 2XAD, 2XAF, 2XNH, 2XE, all came through with astonishing volume; though KDKA on 27 meters is very weak here. When I first completed the set, I could not receive a thing, and for awhile I was thinking of again junking it. I shunted a .002 fixed condenser across the "B+" and "F—" terminals of my audio transformer, and this made the set oscillate. I have changed the circuit of set by replacing the R.F. choke in the plate lead with the secondary of a variocoupler whose primary is in series with the aerial. Will others who added another stage of audio to the Junk-Box tell me how they did it? All I get with another stage of audio is a continuous whistle.

The Extension receiver was a wow; I received thirty stations the first night I tried it. I am fourteen years old and have been a radio bug for four years.

J. H. SMITH,  
151 Water Street, Newburgh, N. Y.  
(The creation of an audio note when the second transformer is added would indicate that the fields interact. Try, first, reversing the leads on one winding; second, turning one transformer slowly around to see if this produces a reduction of the  
(Continued on page 597)

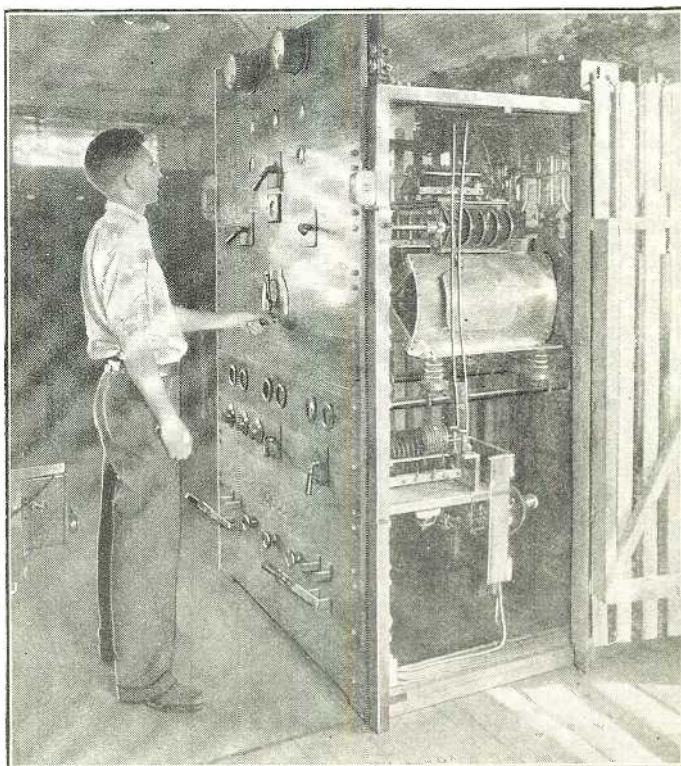

# List of Broadcast Stations in the United States

Radio Call Letters	BROADCAST STA. Location	Wave (Meters)	Power (Watts)	Radio Call Letters	BROADCAST STA. Location	Wave (Meters)	Power (Watts)	Radio Call Letters	BROADCAST STA. Location	Wave (Meters)	Power (Watts)	Radio Call Letters	BROADCAST STA. Location	Wave (Meters)	Power (Watts)
KDKA	East Pittsburgh, Pa.	306	25000	KGIQ	Twin Falls, Idaho	227	250	WAGM	Royal Oak, Mich.	229	50	WGBC	Memphis, Tenn.	210	500
KDLR	Devils Lake, N. D.	243	100	KGIR	Butte, Montana	220	250	WAIU	Columbus, Ohio (Ltd.)	468	5000	WGBF	Evansville, Ind.	476	500
KDYL	Salt Lake City, Utah	232	1000	KGJF	Little Rock, Ark.	337	250	WALK	Willow Grove, Pa.	200	50	WGBI	Seranton, Pa.	341	250
KEJW	Los Angeles, Calif.	240	500	KGKB	Goldthwaite, Texas	200	100	WAPI	Auburn, Ala.	263	5000	WGBS	New York City (Ltd.)	254	500
KELW	Burbank, Calif.	384	500	KGKL	Georgetown, Texas	219	100	WASH	Grand Rapids, Mich.	236	250	WGCIM	Gulfport, Miss.	210	15
KEX	Portland, Oregon	254	500	KGKO	Wienia Falls, Texas	526	250	WBAA	West Lafayette, Ind.	214	500	WGCP	Newark, N. J.	240	500
KFAB	Lincoln, Nebraska	389	5000	KGO	Oakland, Calif.	380	10000	WEAK	Harrisburg, Pa. (day)	268	500	WGHV	Chicago, Ill.	220	500
KFBN	Phoenix, Arizona	484	500	KGRC	San Antonio, Texas	229	100	WEAL	Baltimore, Md.	283	5000	WGHP	Mt. Clemens (Detroit) Mich.	242	750
KFAU	Boise, Idaho	240	1000	KGRS	Amarillo, Texas	213	1000	WEAO	See WJBL			WGMS	See WLB		
KFBP	Havre, Montana	220	50	KGTT	San Francisco, Calif.	200	500	WEAP	Fort Worth, Texas	375	5000	WGN	Chicago, Ill.	416	15000
KFBK	Sacramento, Calif.			KGU	Honolulu, Hawaii	319	500	WEAW	Nashville, Tenn.	201	5000	WGR	Buffalo, N. Y.	545	750
	(Time limited)	229	100	KGW	Portland, Oregon	484	1090	WEBA	Wilkes-Barre, Pa.	248	100	WGZ	Atlanta, Ga.	337	500
KFBL	Everett, Washington	270	50	KGY	Lacey, Washington	211	50	WEBC	Brooklyn, N. Y. City	214	500	WGT	Schenectady, N. Y.		
KFCB	Phoenix, Arizona	229	100	KHJ	Los Angeles, Calif.	333	1000	WEBS	Richmond, Va.	219	100	WGY	(Time limited)	380	50000
KFCR	Santa Barbara, Calif.	200	100	KHQ	Spokane, Wash.	508	1000	WECA	Chicago, Ill.	339	10000	WHA	Madison, Wis.	570	750
KFCM	Beaumont, Texas	535	1000	KIKK	Red Oak, Iowa	535	100	WECC	Rosville, N. Y. City	231	500	WHAD	Milwaukee, Wis. (day)	333	500
KFDC	Shreveport, Louisiana	250	50	KJBS	San Francisco, Calif. (day)	273	100	WECH	Norfolk, Va.	250	100	WHAM	Rochester, N. Y.	258	5000
KFDY	Brookings, S. D.	545	500	KJUR	Seattle, Wash.	309	500	WECL	Charleston, S. C.	250	75	WHAP	New York City	231	500
KFEK	Portland, Oregon	319	250	KKP	Seattle, Wash.	211	15	WECP	Omaha, Neb.	250	100	WHB	Louisville, Ky.	366	5000
KFEI	Denver, Colorado	319	250	KKCN	Pyriteville, Ark. (day)	532	500	WECS	See WEWS, Okla.			WHC	Troy, N. Y.	33	50
KFEQ	St. Joseph, Missouri	535	500	KKDS	Independence, Mo.	316	1000	WECS	Takoma Park, Md.	229	100	WHZ	Kansas City, Mo.	316	1000
KFEY	Kellogg, Idaho	219	10	KKLA	Little Rock, Ark.	216	1000	WEET	Boston, Mass.	220	500	WHCB	Canton, Ohio	250	10
KFQG	Boone, Iowa	229	10	KLS	Oakland, Calif.	211	100	WEFM	Boston, Mass.	244	300	WHBD	Bellefontaine, Ohio	219	100
KFH	Wichita, Kansas	231	1000	KLX	Oakland, Calif.	341	500	WFBS	Union City, N. J.	227	250	WHBF	Rock Island, Ill.	248	100
KFHA	Gunnison, Colorado	319	500	KLY	Denver, Colo.	535	1000	WFBN	New York City	222	250	WHB	Chicago, Ill.	219	100
KFIB	Los Angeles, Calif.	468	5000	KMA	Shenandoah, Iowa	322	500	WFBO	See WLB, N. Y.			WHBP	Johnstown, Pa.	213	500
KFIF	Portland, Oregon	211	50	KMBC	See K LDS			WBOW	Terre Haute, Ind.	229	100	WHBR	Indianapolis, Ind.	248	100
KFIO	Spokane, Wash. (day)	244	100	KMED	Medford, Oregon	211	50	WBRE	Birmingham, Ala.	322	500	WHBU	Memphis, Tenn.	219	100
KFIU	Juneau, Alaska	229	10	KMIC	Ingleswood, Calif.	268	250	WBRL	Wilkes-Barre, Pa.	229	100	WHBV	Anderson, Indiana	248	100
KFIZ	Fond du Lac, Wis.	211	100	KMJJ	Fresno, Calif.	250	50	WBRS	Tilton, N. H.	210	500	WHBY	Philadelphia, Pa.	200	100
KFJB	Marshalltown, Iowa	244	1000	KMMJ	Clay Center, Neb. (day)	405	1000	WBSS	Wellesley Hills, Mass.			WHBY	West De Pere, Wis.	250	50
KFJH	Chicago, Ill.	244	1000	KMO	Tacoma, Wash.	271	500	WBTC	See WLB (day)			WHCA	Minneapolis, Minn.	213	500
KFJI	Astoria, Oregon	219	50	KMEX	St. Joseph, Mo.	271	5000	WBTT	See WLB (day)			WHCF	See WLB		
KFJM	Grand Forks, N. D.	545	500	KMTR	Hollywood, Calif.	526	1000	WBZ	Springfield, Mass.	303	15000	WHCG	Chicago, Ill.	229	100
KFJR	Portland, Oregon	231	500	KNCR	Santa Monica, Calif.	384	500	WBZA	Boston, Mass.	303	500	WHK	Cleveland, Ohio	216	1000
KFJY	Fort Dodge, Iowa	229	100	KNX	Los Angeles, Calif.	286	5000	WBZC	Storrs, Conn.	225	500	WHN	New York City	297	250
KFJZ	Fort Worth, Texas	219	100	KOA	Denver, Colo.	361	12500	WBZD	Canton, N. Y. (day)	246	500	WHO	Des Moines, Iowa	300	5000
KFKA	Grandey, Colorado	341	500	KOAC	Corvallis, Oregon	535	1000	WBZA	Syracuse, N. Y.	246	500	WHPP	New York City	211	10
KFKB	Milford, Kansas (day)	265	1000	KOCW	State College, N. Mex.	500	1000	WBCE	Lincoln, Neb.	210	500	WHQ	Chicago, Ill.	204	5000
KFKC	Lawrence, Kansas	246	5000		Chickasha, Okla.	211	100	WBCL	Lincoln, Neb.	508	500	WIAD	Philadelphia, Pa.	229	100
KFKX	Chicago, Illinois	294	5000					WBCT	See WLB			WIAS	Ottumwa, Iowa (day)	535	100
KFKZ	Kirksville, Missouri	248	50					WBCH	See WLB			WIBA	Madison, Wis.	248	100
KFLV	Rockford, Illinois	213	500					WBCH	See WLB			WIBG	Elkins Park, Pa. (Sun.)	322	50
KFLX	Galveston, Texas	100	1000					WBCH	See WLB			WIBM	Jackson, Mich.	219	100
KFNK	Shenandoah, Iowa	337	500					WBCH	See WLB			WIBR	Steuertville, Ohio	203	5000
KFOA	Seattle, Wash.	236	1000					WBCH	See WLB			WIBS	Elizabeth, N. J.	207	250
KFON	Long Beach, Calif.	240	1000					WIBU	See WLB			WIBU	Poynette, Wis.	229	100
KFOR	Lincoln, Nebraska	248	100					WIBV	See WLB			WIBW	Topeka, Kans.	231	1000
KFPL	Dublin, Texas	219	15					WIBX	See WLB			WIBX	Utica, N. Y.	229	100
KFPM	Sulphur Springs, Ark.	229	15					WICC	See WLB			WICG	Montgomery, Ala.	200	15
KFPW	(day)	224	50					WILD	See WLB			WIL	St. Louis, Mo.	292	1000
KFY	Spokane, Wash.	216	500					WINR	See WLB			WIOD	Bay Shore, N. Y.	248	100
KFQB	Fort Worth, Texas	242	1000	KOIL	Council Bluffs, Iowa	238	1000	WIOW	Miami Beach, Fla.	242	1000	WIP	Philadelphia, Pa.	492	500
KFOD	Anchorage, Alaska	244	100	KOIN	Portland, Oregon	319	1000	WIR	See WLB			WIP	Milwaukee, Wis.	286	250
KFOE	Elly City, Calif.	211	100	KOMO	Seattle, Wash.	211	1000	WIS	See WLB			WIQA	Norfolk, Neb. (day)	283	500
KFOW	Seattle, Wash.	211	100	KOW	Denver, Colo.	216	500	WIUB	See WLB			WIJA	Kokomo, Ind.	229	50
KFQW	Hollywood, Calif.	353	250	KPCB	Seattle, Wash.	248	100	WIUC	See WLB			WIJK	Cedar Rapids, Iowa	250	100
KFR	San Francisco, Calif.	492	1000	KPCM	Prescott, Arizona	200	15	WJAC	See WLB			WIJR	Providence, R. I.	341	250
KFRU	Columbia, Missouri	476	500	KPLA	Los Angeles, Calif.	526	1000	WJAS	See WLB			WIKA	Pittsburgh, Pa.	232	1000
KFSD	San Diego, Calif.	500	500	KPP	San Francisco, Calif.	441	5000	WJAX	See WLB			WIKS	Jacksonville, Fla.	238	1000
KFSG	Los Angeles, Calif.	300	1000	KPQ	Denver, Colo.	297	1000	WJBY	See WLB			WJLD	Cleveland, Ohio	219	100
KFSG	Los Angeles, Calif.	232	500	KPPC	Pasadena, Calif.	250	50	WJBY	See WLB			WJMA	Chicago, Ill.	203	5000
KFTE	Grandey, Colorado	341	500	KPR	Seattle, Wash.	248	100	WJBB	See WLB			WJMC	St. Petersburg, Fla.	297	250
KFU	Colorado Springs, Colo.	236	1000	KPRC	Houston, Texas	326	1000	WJBC	See WLB			WJMI	LaSalle, Ill.	250	100
KFU	St. Louis, Missouri	545	500	KPSN	Pasadena, Calif.	316	1000	WJBI	See WLB			WJMK	Red Bank, N. J.	248	100
KFUP	Denver, Colorado	200	100	KQV	Pittsburgh, Pa.	217	500	WJKB	See WLB			WJML	Ypsilanti, Mich.	219	50
KFUR	Ogden, Utah	229	50	KQW	San Jose, Calif.	220	100	WJBO	See WLB			WJMN	Cecil, Pa.	253	100
KFV	Venice, Calif.	250	100	KQX	Berkley, Cal.	230	100	WJBT	See WLB			WJMU	New Orleans, La.	219	50
KFVI	Geneva, Mo.	248	50	KRGV	Harlingen, Texas	238	500	WJBU	See WLB			WJBW	See WLB		
KFWE	Los Angeles, Calif.	316	1000	KRLD	Dallas, Texas	238	10000	WJBY	See WLB			WJCA	See WLB		
KFWC	San Bernardino, Calif.	250	100	KRMD	Shreveport, La.	250	50	WJCL	See WLB			WJCB	See WLB		
KFWF	St. Louis, Missouri	250	100	KRSC	Seattle, Wash. (day)	268	50	WJCM	See WLB			WJCD	See WLB		
KFWI	San Francisco, Calif.	322	500	KSA	Manhattan, Kans.	513	500	WJCN	See WLB			WJCE	See WLB		
KFWM	Oakland, Calif.	322	500	KSB	Shreveport, La.	297	1000	WJCO	See WLB			WJCF	See WLB		
KFWO	Avalon, Calif.	211	15	KSCJ	Sioux City, Iowa	225	1000	WJCW	See WLB			WJCG	See WLB		
KFX	Denver, Colorado	319	250	KSD	St. Louis, Mo.	545	500	WJCY	See WLB			WJCH	See WLB		
KFX	Edgewater, Colo.	200	50	KSEI	Pocatello, Idaho	333	250	WJDA	See WLB			WJCI	See WLB		
KFXR	Oklahoma City, Okla.	229	50	KSL	Salt Lake City, Utah	265	500	WJDB	See WLB			WJCL	See WLB		
KFY	Flagstaff, Arizona	211	100	KSMR	Santa Maria, Calif.	250	100	WJDC	See WLB			WJCM	See WLB		
KFY	Brookridge, Texas	211	100	KSN	Clairinda, Iowa	237	1000	WJDE	See WLB			WJCN	See WLB		
KFY	Bismock, N. D.	545	500	KSO	Sioux Falls, S. D. (day)	270	1000	WJDF	See WLB			WJCO	See WLB		
KGA	Spokane, Wash.	204	5000	KSTP	St. Paul, Minn.	205	10000	WJDP	See WLB			WJCV	See WLB		
KGAR	Tucson, Arizona	219	100	KTAB	Oakland, Calif.	234	500	WJDQ	See WLB			WJDD	See WLB		
KGB	San Diego, Calif.	220	250	KTAP	San Antonio, Texas	248	100	WJDR	See WLB			WJDE	See WLB		
K															

Main table listing radio call letters, broadcast stations, locations, wave meters, and power (Watts) for various stations across the United States.

LIST OF CANADIAN BROADCAST CALLS

Table listing Canadian broadcast calls, including call letters, locations, wave meters, and power (Watts).

LIST OF SHORT-WAVE STATIONS OF THE WORLD

Stations will prefix their calls with their allotted national letters on or before January 1, 1929.

Large table listing short-wave stations of the world, categorized by country (Africa, Australia, Austria, Belgium, Canada, Dantzic, Denmark, England, Finland, France, Germany, Holland, Italy, Japan, Java, Mexico, Morocco, Norway, U.S.S.R. (Russia), Spain, Sweden, Switzerland, United States) with call letters, locations, wave meters, and power.



# Radio News Laboratories

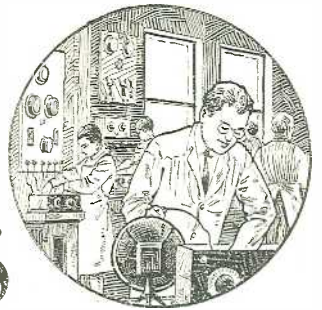

**R**ADIO manufacturers are invited to send to RADIO NEWS LABORATORIES samples of their products for test. It does not matter whether or not they advertise in RADIO NEWS, the RADIO NEWS LABORATORIES being an independent organization, with the improvement of radio apparatus as its aim. If, after being tested, the instruments submitted prove to be built according to modern radio engineering practice, they will each be awarded a certificate of merit; and that apparatus which embodies novel, as well as meritorious features in design and operation, will be described in this department, or in the "What's New in Radio" department, as its news value and general interest for our readers shall deserve. If the apparatus does not pass the Laboratory tests, it will be returned to the manufacturer with suggestions for improve-

ments. No "write-ups" sent by manufacturers are published in these pages, and only apparatus which has been tested in the Laboratories and found of good mechanical and electrical construction is given a certificate. As the service of the RADIO NEWS LABORATORIES is free to all manufacturers, whether they are advertisers or not, it is necessary that all goods to be tested be forwarded prepaid, otherwise they cannot be accepted. Apparatus ready for, or already on, the market will be tested for manufacturers free of charge. Apparatus in process of development will be tested at a charge of \$2.00 per hour required to do the work. Address all communications and all parcels to RADIO NEWS LABORATORIES, 230 Fifth Avenue, New York City. Readers will be informed on request if any article has been issued a Certificate of Merit.

## "A" POWER UNIT

The "Model 29" "A" power unit shown, submitted by the Knapp Electric Co., Port Chester, N. Y., is designed for operation from a 110-volt 60-cycle circuit. It will deliver either 4- or 6-volt supply, being thus adapted to use with any battery-type radio receiver. On the 4-volt tap, the maximum current was found to be 1/2-ampere; on the 6-volt tap, 3-1/2 amperes. The unit employs a step-down transformer with a tapped secondary for voltage regulation; the taps are brought to a multi-point panel switch. A metallic rectifier of the full-wave type converts the current, which is then filtered by a double-choke system and three low-voltage condensers of large capacity. A receptacle is provided for plugging in the "B" power unit; this allows the latter to be turned on and off with the "A" unit. A 3-1/2-foot extension cord with a pendant switch is provided for this purpose, and a 6-foot

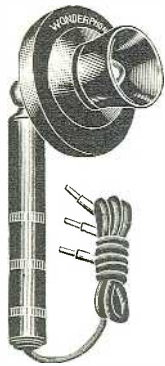

proper by-pass condensers, is included in the housing. A 6-foot extension cord with a UX-base adaptor is provided, for plugging into the detector socket of the receiver. The volume control is actuated by the knob on the top of the housing. The housing is of art-bronze finish; 6-3/4 inches in diameter and approximately 4 inches over all.

With this apparatus connected between the light-circuit receptacle and an A.C. receiver, a constant output of 110 volts is obtained

AWARDED THE RADIO NEWS LABORATORIES CERTIFICATE OF MERIT NO. 2449.

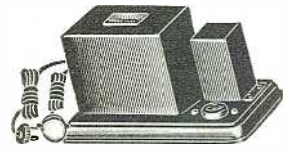

## "A" POWER UNIT

The "Type R-93V" filament-supply power unit shown, manufactured by the Sterling Manufacturing Co., 2831 Prospect Ave., Cleveland, Ohio, is designed for operation on a 110-volt 60-cycle circuit, with a battery-type radio receiver in which 6-volt tubes are used. It delivered 3-3/4 amperes at 6 volts; although, for long periods of operation or continuous duty, it is rated to deliver 3 amperes at 6 volts. Voltage

under a load of 75 watts, with a line-voltage variation 10% above or below the output voltage of the device. It was tested with full load at four input-voltage values (100, 105, 115 and 120) from all of which was obtained a 110-volt output. With 90-volt input, the measured output was 105 volts. The base of the device is 10-1/2 inches by 6 inches, and it has an overall height of 5-1/2 inches. It is provided with a two-foot extension with pendant switch, and has an extension four feet in length for plugging into the lighting receptacle; a convenient receptacle is provided on its base for connection to the A.C. receiver or other power device. It is finished in black lacquer and of neat appearance.

AWARDED THE RADIO NEWS LABORATORIES CERTIFICATE OF MERIT NO. 2450.

## SHORT-WAVE COIL KIT

The "Type LW-3" short-wave coil kit shown, submitted by the Hammarlund Manufacturing Company, 424 West 33rd Street, New York, N. Y., is designed for use in receivers or other short-wave experimental work. The coils are of the plug-in type and of low-loss construction. For secondary

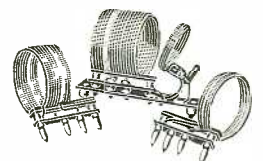

and tickler windings, No. 16 D.S.C. wire is used; for the primary No. 20 D.S.C. wire. The turns are space-wound, separated approximately the diameter of the wire used, and held in position by a celluloid film into which the wires are embedded slightly during the process of manufacture. The three coils will cover a wavelength band of 15 to 107 meters when tuned by a 140-microfarad (7-plate) condenser. The primary, of five turns, is adjustable for coupling by a hinge joint, the bracket of which is supported by the plug-in base mounting; the latter is arranged for either sub-panel or baseboard

mended very good quality of speech was obtained.

AWARDED THE RADIO NEWS LABORATORIES CERTIFICATE OF MERIT NO. 2446.

## MICROPHONE CONTROL UNIT

The control unit shown here has been specially designed by the same manufacturer for use with their hand microphone described above. It is constructed to allow the announcer to change quickly from radio or phonograph reproduction to direct speech through the amplifier and loud speaker. Three pin jacks are provided on the side, to receive the three tips of the microphone extension cord, and two pin jacks to receive the extension cord of the phonographic pick-up unit. Two binding posts ("+" and "-") are provided for connection to a battery (1-1/2 to 6 volts) when the unit is used with an A.C. radio receiver. A three-position, battery switch, located on top of the housing, effects the necessary change for adaption to A.C.-operated radio receivers. A three-



position key switch is provided, for connecting the amplifier to either the microphone or the phonographic pick-up; it cuts out completely the R.F. section of the receiver while either the microphone or the pick-up is in use.

The modulation transformer, with



regulation is obtained with a heavy-duty wire-wound rheostat; a voltmeter having a 0-to-10 scale is provided, in order that the proper adjustment may be made and maintained. The unit employs a step-down transformer which supplies the low voltage to a full-wave rectifier tube of the Tungar type; a low-voltage secondary, for the rectifier tube, is wound on the same core as the supply transformer. The unit incorporates an efficient filter system which enables it to deliver current of excellent quality and without hum. A receptacle is provided for the "B" power unit, and a 5-foot extension cord with pendant switch gives control of both power units; another extension 6 feet in length is provided for plugging into the light socket. The over-all dimensions of the unit are 10-3/4 inches in length, 7 inches in width, and 8 in height.

AWARDED THE RADIO NEWS LABORATORIES CERTIFICATE OF MERIT NO. 2448.

## A.C. LINE-VOLTAGE

The "Auto-Potentialator" shown here, and submitted by the Webster Company, 850 Blackhawk Street, Chicago, Illinois, is an automatic regulator wherein the combination of capacity and inductance is used to govern the input voltage by setting up a phase-difference between two portions of the primary circuit.



extension cord is provided with a plug for the lighting receptacle. The unit is, over all, 12 inches long, 7 inches high, and 7 inches wide. The current supply was found very satisfactory in quality.

AWARDED THE RADIO NEWS LABORATORIES CERTIFICATE OF MERIT NO. 2445.

## HAND MICROPHONE

The "Type R3 Wonderphone" shown, submitted for test by the Universal High Power Telephone Co., Seattle, Wash., is of the differential or twin-button push-pull type. It is designed to carry safely 3 amperes of current and will modulate sufficient power to operate a number of speakers when used in connection with a special modulation transformer and amplifier. On test it was found to be sufficiently sensitive without being affected by external noises. With the control unit and adapter described below, the microphone may be used with any audio amplifier; if it is used with that of a radio receiver the adapter is plugged into the detector socket. The sample submitted for test is of art-bronze finish, although a polished-nickel finish is also made. The housing measures 4 inches in diameter and is 4-1/2 inches in depth to the handle; the latter is 7-3/4 inches long and 1 inch in diameter. When this microphone was used in connection with the accessories recom-

mounting. The support for the primary coil is provided with an insulated handle, as a means of obtaining adjustment without touching the coil; a very desirable feature. All secondary and tickler windings are 3 inches in diameter, and the primary is 2-1/2 inches.

AWARDED THE RADIO NEWS LABORATORIES CERTIFICATE OF MERIT NO. 2452.

#### LONG-WAVE AMPLIFIER AND DETECTOR

The "Type 440" intermediate or long-wave unit shown here, submitted by Silver-Marshall, Inc., 846



West Jackson Blvd., Chicago, Ill., consists of three stages of intermediate frequency and a detector. It was designed especially for the reception of scheduled time signals from the U. S. Naval Observatory through Station NAA, Arlington, Va. The unit may be used also as the intermediate-frequency amplifier and second detector of a superheterodyne radio receiver. The inductors are wound on spools of large diameter, in layers, and impregnated against moisture. The secondaries are tuned by condensers to a frequency whose peak is approximately 10,000 cycles in width which, at their resonant frequency of 112 kilocycles (2677-meter wavelength), insures against sideband

cut-off. The four stages are enclosed and shielded in separate compartments of the "catacomb"; terminals for connection to the amplifier are provided at each end of the unit, and are well insulated from the metal shield. The catacomb is 14-3/4 inches long, 5 inches wide and three inches high.

AWARDED THE RADIO NEWS LABORATORIES CERTIFICATE OF MERIT NO. 2453.

#### A. C. RADIO RECEIVER

The "Type 801A, Series B" A.C. receiver shown here, submitted by the Stewart-Warner Speedometer Corporation, 1843 Diversey Parkway, Chicago, Illinois, is designed to operate directly from the 110-volt 60-cycle circuit. This receiver employs four 226-type, one 227-type and two 112A-type tubes, in three stages of tuned R.F., detector, one stage of transformer-coupled A.F. and a stage of push-pull power amplification. With the exception of the speaker on the cover and the push-pull power stage, this receiver is identical in construction and appearance with the "Model



801A" described in the November issue. It was found satisfactory in quality, sensitivity, selectivity, and volume.

AWARDED THE RADIO NEWS LABORATORIES CERTIFICATE OF MERIT NO. 2459.

#### CONE SPEAKER

The "Model 435" cone speaker shown, submitted by the same manufacturer, is of the balanced-armature type; the cone diaphragm is only 6 inches in diameter. The driving unit is fastened by a special bracket to a special die-punched ring of metal, approximately 7-1/2 inches in diameter, which serves as a means of support for the cone and is, in turn, fastened with screws to the heavy die-cast metal housing. In the front and back of the approximately 5-1/2 by 12 inches,

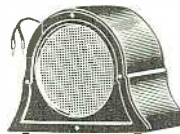

and the height over-all is 8 inches. In the front and back of the housing two screened apertures, 6 inches in diameter, are provided for the passage of the sound waves; while the construction of the housing is such that it acts as a baffle. This reproducer gave ample volume with good quality over the entire audio-frequency band.

AWARDED THE RADIO NEWS LABORATORIES CERTIFICATE OF MERIT NO. 2460.

#### "BOOSTER" KIT

The assembled screen-grid booster unit shown here has been assembled

from a kit submitted for test by the Browning-Drake Corp., Cambridge, Mass. It consists of a single tuned R.F. stage employing a screen-grid tube, and was designed for use with the manufacturer's standard receiver; but it may be used with any other. The plate voltage is supplied through a A.F. choke while the output is connected to the radio receiver through a 250-mmf. condenser. The control grid is directly coupled by a 100-mf. condenser to the antenna;

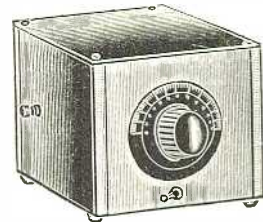

and the antenna-ground circuit is tuned by a single R.F. coil and a 500-mmf. variable condenser. The assembly is enclosed within an aluminum can 8-1/2 inches long, 7 inches wide and 6 inches high. The input and output binding posts are located at opposite sides; while at one end is the vernier bakelite dial with the filament switch directly below. Very high amplification was obtained over the entire broadcast range by the use of this unit in advance of a receiver.

AWARDED THE RADIO NEWS LABORATORIES CERTIFICATE OF MERIT NO. 2468.

(Continued on page 598)

## Reviews of Recent Radio Literature

By H. M. Bayer

**PRACTICAL RADIO**, by James A. Moyer and John F. Wostrel. Third Edition. Published by McGraw-Hill Book Co., Inc., New York City. 7 3/4 x 5 inches; 378 pages; halftones and diagrams. Price \$2.50.

When the first edition of this book was published, it was accepted generally as a standard text for the study of radio, much as one accepts Webster's dictionary. *Practical Radio* has the earmarks of aristocracy, when viewed in the ranks of radio literature; it bears the Back Bay conservatism of the books we always hated to carry to school because they actually taught us something. To the credit of the authors, it must be said that their revised work still teaches radio to the reader as well as acquaints him with the milder forms of commercial apparatus.

Among the subjects which have been added to this edition are the following: radio direction-finding, and the effect of directional distortion caused by buildings and other structures; new types of radio receiving sets, such as the improved superheterodynes; super-power broadcast stations and the effects of distance, fading, interference and static on their transmissions. Practical methods of re-activation of vacuum tubes are explained in detail. Another addition is a radio "trouble chart," similar to those available for automobile operation, to show at a glance the probable causes of the most common troubles, and the remedies when these are not obvious from the nature of the defect in the receiving set or its auxiliary equipment. The revision includes also the recent improvements in A.C. vacuum tubes, socket-power units, copper-oxide rectifiers, loud speakers and short-wave receivers.

**MODERN RADIO RECEPTION**, by Charles R. Leutz. Published by C. R. Leutz, Inc., Astoria, New York City. 9 1/2 x 6 1/4 inches; 383 pages; halftones and diagrams; cloth. Price \$3.00.

Associated with radio for the past fourteen years, five of which have been devoted exclusively to the design of broadcast receivers, Mr. Leutz gives in this book information which is complete, reliable and valuable to anyone connected with, or interested in radio today.

The author deals, for the most part, with up-to-date commercial apparatus, and has omitted nothing in describing the latest receivers, socket-power units and tubes. He has included numerous tables, charts and diagrams that should prove invaluable to the radio service man as well as to the experimenter. Among these are a signal-static ratio chart, a correlated acoustic chart, a table of changes in time, a list of short-wave stations, a wavelength-frequency conversion table, a tube-characteristic chart, a chart of transmission units, and many others of definite value to all interested in the technical phases of radio.

Though no comparisons are made, the book tends to acquaint the student with the vast changes in the radio industry that have come about through the production of modern receivers and socket-power equipment. The subjects are covered thoroughly and technically, yet the text is written in a style not too difficult for the questioning layman or beginner. The author discusses the design, construction and operation of a number of commercial receivers and socket-power units; and, though the aid that these descriptions will render the home-builder may seem somewhat problematical, there is no doubt that the information to be gleaned from the study of these highly developed systems will be of great value to the intelligent experimenter in the choice, design and construction of his own units.

Beginning with a discussion of antenna construction, the author has gone through the gamut of fundamentals (including an interesting note on shielding) up to the higher reaches of the commercial superheterodyne. Liberal use has been made of diagrams and charts and, though they will be of little use to the set builder because of lack of definite specifications, they are interesting as the tried and tested products of the commercial engineer who, of necessity, must take into consideration that thousands of dollars are to be invested in the practical demonstration of the results of his researches.

**PRACTICAL TELEVISION**, by E. T. Lerner. Published by D. Van Nostrand Co., Inc., New York City. 8 3/4 x 5 1/2 inches; 175 pages; halftones; cloth. Price \$3.75.

The unusual clarity and thoroughness with which the author has gone into this subject makes this book one of the best treatises yet published on the

new science. In reading this commendable piece of work the impression is gained that no stone has been left unturned in order to place before the reader the results of every scientific labor devoted to television and its kindred arts.

Beginning with an excellent study of the human eye, its optical impressions and its relation to electrical "vision," the author takes us up the steps of television, stopping at every step to explain in detail the contributory developments of such workers as Bain, Bakewell, Carey, Bernouchi, Korn, and others too numerous to mention.

These systems, ranging from Bain's (1842) to the recent transatlantic television accomplishment, are so treated with explanations and suitable diagrams that the basic fundamentals of television must be understandable by the most inexperienced layman. In the foreword to this book, John L. Baird, one of the developers of modern television, says, "In the present work the author deals very fully with the fundamental principles from which television was developed, and deals with them in such a way as to interest the general reader without departing from strict scientific accuracy."

Some idea of the contents of this book may be obtained from the chapter heads: Historical, Selenium and the Selenium Cell, Photoelectricity and the Photoelectric Cell, Continental and American Researches, Researches with the Cathode Ray, Images and their Formation, The Baird Television, Television Technique and Recent Developments.

Under these heads is found a wealth of information which the student of television cannot afford to overlook, should he desire to delve into recent developments. After he has acquired the thorough rudimentary education which this book offers, he can step up to the practical problems with far greater understanding and assurance of success than if he were merely to "build from the print," as the majority of experimenters do.

The book includes 97 photographs, circuit-diagrams and explanatory sketches, a table of wavelengths of light-rays—something which should be understood by every experimenter; but unfortunately is not—and an interesting table showing the sensitivity of photoelectric cells to the different rays of colored light. It is neatly bound, printed in large type and lacks the disadvantage of bulk. It should be classified as "easily accessible" among those books in the experimenter's library.

(Continued on page 590)

# The Radio Constructor's Own Page

Where Custom and Home Set Builders and  
Experimenters May Swap Experiences

## A DOUBLE-CONTROL SET

Editor, RADIO NEWS:

I feel it is my duty to pass along to my fellow set builders, through RADIO NEWS, (of which I have not missed a copy since 1923), a hook-up using screen-grid tubes in the R.F. stages. I have had this set in constant use since last March, and it has given me wonderful results; way above anything I have tried before, including superhets. I think it has everything a good set should have, including sensitivity for DX, 10-kc. selectivity, ease of tuning and tone quality.

The whole secret is in the tuned stage ahead of the first R.F. tube, which I believe is original. At least, I have never seen it published or used anywhere else. The balance of the circuit is the same as you receive in the CX322-tube carton, except for the regenerative detector.

Condenser C6 is of small capacity—the kind used for neutralizing; C5 is variable from .0002 to .0001-mf. and, when adjusted correctly, permits condenser C1 to be tuned in perfect unison with C2.

I am using copper throughout for shielding. The screen-grid tubes are completely shielded, including the base, and are placed outside of the shielded compartments containing the inductances and tuning condensers. It is important to place the by-pass condensers C10 and C11 also outside of the shielding.

The regenerative detector helps greatly in building up weak signals. For ordinary use, I adjust the tickler coil so that the detector is just above oscillation on the bottom of the dial, and then leave it set that way. Use any good audio amplifier.

GUS SCHREIBER,  
Hawcote, Iowa.

## ANOTHER VOTE FOR THE B.-D.

Editor, RADIO NEWS:

I would like to say a word to back up Frank E. Ekstrom and the many other Browning-Drake boosters. The old-style untampered Browning-Drake is the best. Wind the regenerator at home; use No. 30 D.S.C. for the primary and put at least 35 turns on it. Wind the secondary with No. 22 D.C.C. for a .0005 condenser (Yes, I know they say .00035, but I am talking now). Neutralize by a small plate, the size of a dime, over the winding, center to come at about the 17th turn. Use a 199 tube in a 199 socket (UV?); this is important. Try to neutralize with primary connected both ways; remove one turn at a time till neutralization is effected. I have one with

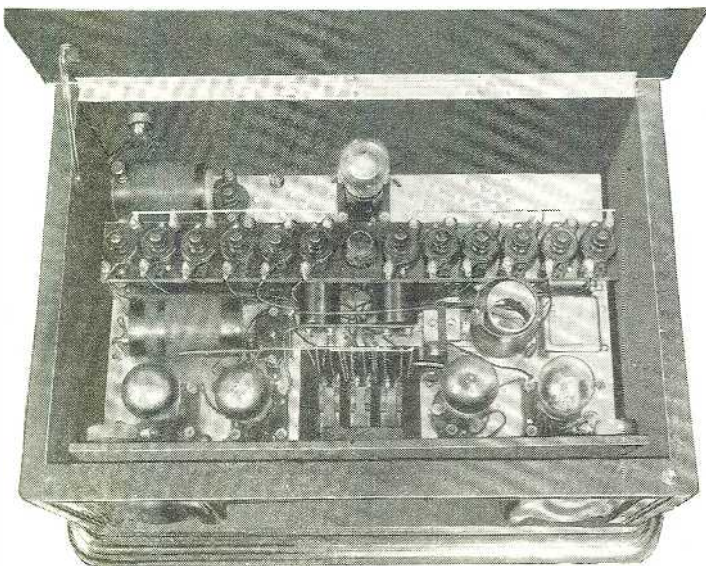

An interior view of Mr. Moore's dialless set. The circuit is a T.R.F. one—the "Everyman Four"—in which the small adjustgrad condensers shown across the width of the sub-panel do the tuning. The three switches on the panel connect the proper pair for each station across the two tuning coils. (The R.F. coil at the upper left is a wavetraps.) The circuit is not complicated, but of course requires extra leads. The selection of stations may be altered at will by resetting the small condensers with the fingers.

B. T. Moore, of 206 Broadway, New York City, with his American "No-Dial" receiver, which he has constructed on plans of his own. It will be seen that there is only a rheostat-and-switch on the front panel, besides the three two-way switches, each of which will tune in a different station in either position—a total of six in all.

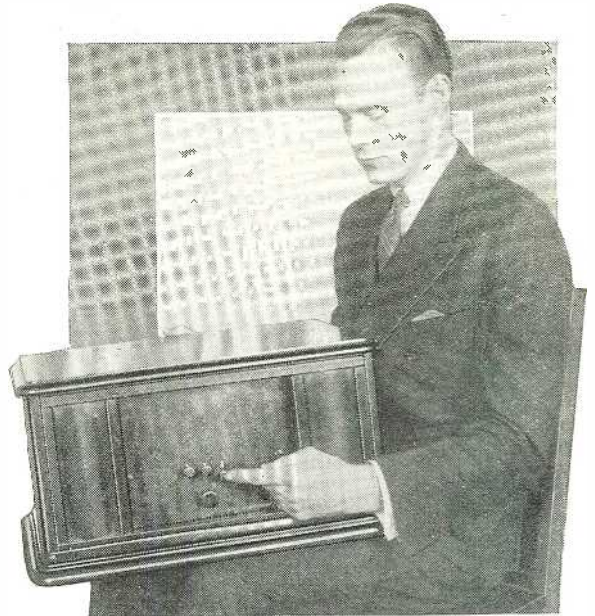

38 turns on the primary, completely neutralized, and (before witnesses) I have turned from New Orleans to Omaha with a three-foot piece of bell wire for an aerial. My regular one consists of a piece of the same material stretched across a small

inch thick. I put this in the lathe and cut the groove; and then start the secondary as close as possible to the groove. I will be glad to answer questions (if accompanied by postage) from anyone who is genuinely interested in the "peer of

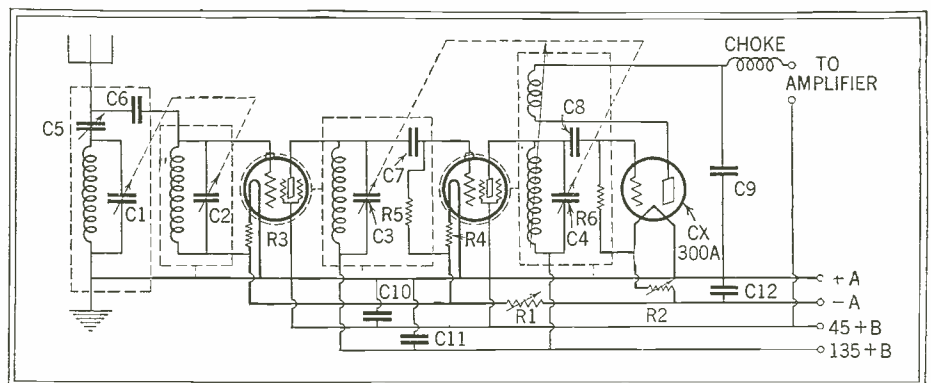

Mr. Schreiber's set has not one, but two tuned circuits in the antenna, making great sensitivity possible. R1, R2, 20-ohm rheostats; R3, R4, 20-ohm fixed; R5, R6, 2-megohm; C1, .0005-mf.; C2, C3, C4, .00035-mf.; C5, 20- to 100-mmf. XL variocoupler; C6, 10-mmf. (?); C7, C8, .00025-mf.; C9, 0005-mf.; C10, C11, 0.5-mf (outside shielding!); C12, 1.0-mf.

room. The selectivity exceeds that of any super I have tried out—several of them, as the bank-roll attests.

I neglected to mention that I make the regenerator by taking a piece of fiber conduit which is three inches in outside diameter and about 3/8-

'em all" for distance and selectivity. With hearty approval of your change in policy.

EARL L. KELLY.

106 Postress Street, Hopewell, Va.

## FADING ON SYNCHRONIZED PROGRAMS

Editor, RADIO NEWS:

I read an article in your magazine about the possibilities of more than one station transmitting the same program on the same wavelength, and asking for any information as to reception peculiarities noticed.

I live about half way between WBZ (Springfield) and WBZA (Boston) which, as you know, transmit the same program on the same wavelength. Now, these stations are continually fading, and distortion is noticed on about five nights out of seven. This would tend to show that the problem of operating two or more stations on one wavelength is far from solution; as the time difference or lag need be only an infinitesimal fraction of a second to cause serious distortion.

(This confirms the supposition, advanced on a purely theoretical basis, that, along the line where the fields of two such stations are nearly equal in strength, such phenomena would take place. This is not due to any fault of the stations, which are transmitting in exact synchronism; but is caused by their waves arriving at the place of reception out of phase. Furthermore, as the path of the waves varies slightly with the electrical condition of the atmosphere, the time required for the waves to arrive varies to an appreciable amount, compared with a radio-frequency cycle; and consequently the signal will fade in and out. Where

(Continued on page 591)





Conducted by C. W. Palmer

RADIO NEWS readers send in every month an average of 5000 letters asking information on every phase of radio theory, construction and operation. We can only print the five or six replies which are of widest general interest.

Other letters will be answered by mail, if inquirers observe these rules: BE BRIEF; TYPEWRITE OR WRITE LEGIBLY IN INK ON ONE SIDE OF THE SHEET ONLY; ENCLOSE A STAMPED ENVELOPE ADDRESSED TO YOURSELF. Many letters are not readable. Simple questions will be answered free;

We cannot supply blueprints of manufactured apparatus; only RADIO NEWS blueprints, which should be asked for on the coupon printed elsewhere. We cannot send magazines, books, dia-

grams, etc., C. O. D. Please read the instructions and do not use pencil or postal cards. RADIO NEWS sells no apparatus, does no custom building, and can not advise "the best set to buy."

**A PRACTICAL BAND SELECTOR**

(2313) Mr. N. L. Allan, Brooklyn, N. Y., writes:

(Q.) "For some time I have thought of building a new radio set; but after reading the article in your March, 1928, issue, in reference to the "Full-Band" tuning system, I decided to wait until further data were available for a set using a tuning system of this type. Since that time I have watched every issue of RADIO NEWS but no further data have been published. The system has remarkable possibilities and I am sure that many of your readers would be interested in obtaining more information about this system. Can you supply us with experimental data or details for making one of these filters for the broadcast band, and also data for coupling it to a tuned-radio-frequency receiver?"

(A.) By referring to the diagram (Fig. Q2313A) or to the diagrams published in the original article, you will see that the filter comprises two coils L1 and L2 tuned by condensers C1 and C2; these two resonant circuits are coupled together through an inductance coil L3. Since L3 acts only as a coupling device for the two resonant circuits, the coil may be replaced by a condenser of rather large capacity. However, for ordinary purposes, a coil is more practical; since the value may be changed more easily.

The theoretical discussion (in March RADIO NEWS) pointed out that, when an aerial is coupled to the filter, the capacity between the aerial coil and the first resonant circuit is sufficient to throw this circuit out of resonance with the other and, in order to gang the two tuning condensers together, it is therefore necessary to place a small compensating condenser (C6, C7) across each of them. A practical circuit with two stages of tuned-radio-frequency amplification is shown in Fig. Q2313B.

**Coil Constants**

In the filter, coils L1 and L2 are wound on 3-inch forms. Coil L1 has a primary of 10 turns and a secondary of 47 turns of No. 24 S.C.C. wire; a space of about 1/4-inch should be left between the two windings. Coil L2 is similar to L1 except that the positions of the two coils are reversed. It is absolutely necessary to shield L2 and L3; since the filter will not operate properly if a current is introduced into these coils from any other source than coil L1. Since coil L1 is coupled to the aerial, it will not be necessary to shield this coil.

The size of coil L3 is very important and these instructions should be followed exactly when building it. It is wound on a tube 1 inch in diameter and contains 5 turns of the same wire as used on the other coils. The inductance of this coil is approximately 1.2 microhenries and, if a condenser is used to replace it, one with a capacity of .025 mf. should be employed. The reason why coil L3 is so critical is that this coil is used to couple the two resonant circuits together. Its value determines the degree of coupling, also the width of the band covered by the filter; and any changes in the constants will also change the characteristics of the filter.

When using the Band Selector with a tuned-radio-frequency set, the other tuning circuits should be made rather broad, so that the good qualities of the filter are not lost. The easiest way to

accomplish this is to make the coils small and use fine wire. With .0003- or .00035-mf. tuning condensers, L4 and L5 can be wound on 2-inch forms with No. 28 D.C.C. wire; the primary with 12 turns and the secondary with 86 turns of the same wire. A space of about 1/8-inch is left between the two coils on the tube. The other parts of the R.F. amplifier are the same as in any other set and any convenient method of oscillation control can be employed. If it is so desired, the condensers C3 and C4 may be ganged

be necessary in order to get the correct band width for your receiver. However, the inductance values were checked in an experimental model and found to give a band slightly wider than 20 kilocycles at 200 meters, and slightly narrower at the higher wavelengths. The use of a condenser for coupling, in place of coil L3, will give slightly better characteristics on the longer waves; since it tends to broaden the tuning or widen the band on the upper waves and narrow it on the shorter waves. However, as explained before, the difficulty in obtaining the correct capacity to give the exact characteristics led to the use of an inductance in the experimental model. The experimental values for the coils and capacities were derived from the formulas and diagrams in the Bureau of Standards' Circular No. 74. For further information on the subject, we would suggest that the experimenter read the previous article on the theoretical operation of the band selector.

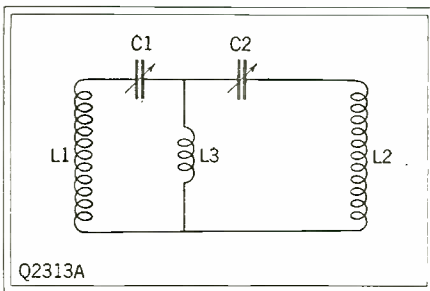

The essential circuit of the Vreeland band-selector. The coupling unit L3 governs the width of the radio-frequency band amplified.

together, since the tuning is purposely made broad in these two circuits. The resistors R2, R3 and R4 are filament ballasts; Their value depends on the type of tubes employed. Any good audio-frequency amplifier may be coupled to the output of the detector tube.

**Coil or Condenser?**

The data given for this band selector are experimental and a certain amount of alteration may

**ELECTRIC ULTRADYNE L2**

(2314.) Mr. Robert Schwartz, Philadelphia, Pa., asks:

(Q.) Will it be practicable to change an old Ultradyne L2, which was built in the early part of 1926, into an electric set by rewiring it for the A.C. tubes? If it will, I would appreciate seeing the diagram with the changes, in the next issue of your magazine."

(A.) You will find the diagram you desire on page 568, (See Fig. Q2314.) A number of changes are necessary, including the use of twisted wires for all the filament leads. The heater-type 227 tubes are used in all stages except the last audio-frequency stage, which employs a 171A or 112A tube; since these power tubes have a much higher level of undistorted output and, naturally, their use will reduce distortion. The center point of the filament circuit in this stage is obtained by connecting the center-tapped resistor R3 be-

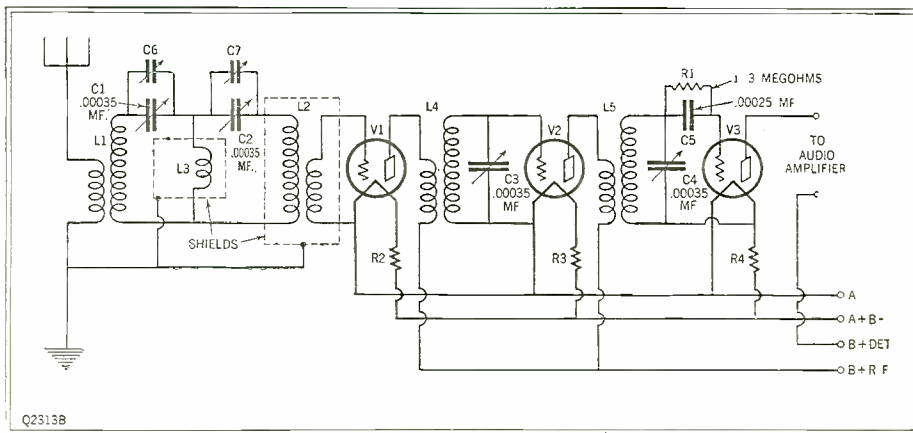

Diagram of a receiver in which a band-selector unit is followed by two R.F. stages. Data for L1, L2 and L3 are given above; L4 and L5 may be any coils suited to the condensers used.

tween the filament leads and the ground terminal. The method of controlling oscillation in the intermediate-frequency amplifier is also changed, since the usual potentiometer method cannot be employed. The control used is the 500,000-ohm variable resistor R2 in the plate lead of the three intermediate tubes; this reduces the plate voltage sufficiently to prevent the tubes from oscillating.

The parts should be laid out so that they are in the approximate positions used in the original battery set. The intermediate-frequency transformers should be placed at right angles, and the usual precautions should be taken to shield the sensitizing coil from the panel. The specifications for the other parts should remain the same; although we believe that better quality may usually be obtained by replacing the transformers with new ones of more recent design, unless they have been changed since the set was originally built.

If you desire to make new coils or replace any of the parts, you will find the diagram and specifications for this set in 1001 *Questions and Answers*, Volume No. 2.

**SCREEN-GRID STROBODYNE DATA**

(2315) Mr. S. Snyder, Hackensack, N. J., writes.

(Q.) "I am building the Screen-Grid Strobodyne from the instructions in the September *RADIO NEWS*, but I have struck a snag in mounting condenser C3. The blueprints do not specify how this condenser is insulated from the shield, but it is evident that it must be insulated; since part of L3 would be short-circuited if the condenser were connected directly to the shield. What I would like to know is, how this condenser should be mounted to the side of the shield?"

(A.) The best way to mount this condenser C3 is as follows:

Only the hole for the shaft of the condenser should be drilled in the front of shield S3. Two bakelite plates will be required as shown in the accompanying diagram, Fig. Q2315. One is drilled with seven holes and the other contains only five. Mount condenser C3 on the mounting plate with seven holes, then place the condenser and the two plates together, with the shaft of the condenser protruding through the hole in the shield. Mark the positions of the four corner holes on the shield with a pencil or center-punch and drill them. Finally, place screws through the holes and fasten the condenser in place. It will be seen from this explanation that the condenser is mounted on one of the insulating plates, while the other serves as a spacer to insulate the mounting screws on the condenser, from the shield. The four screws are so placed that they do not touch the condenser.

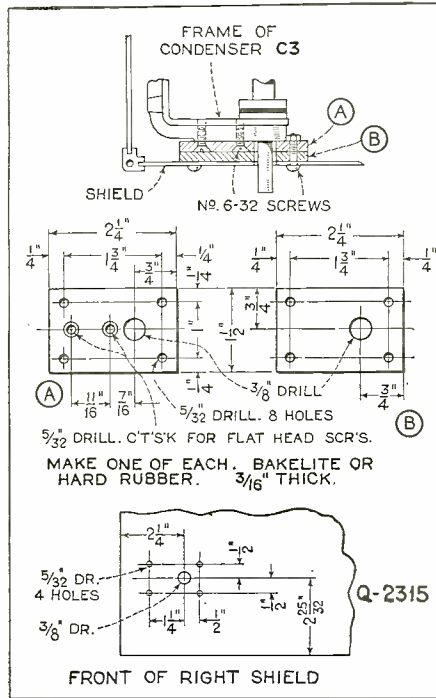

*Builders of the Screen-Grid Strobodyne who have encountered any problem in mounting the oscillator condenser C3 will find a convenient method shown. Consult the diagrams published previously.*

**GROUND CONNECTIONS**

(2316) Mr. J. E. Andrews, Hastings, Neb., writes:

(Q.) "After reading all the available information about ground connections I have come to the conclusion that the ground in my set is not as good as it should be, for the best reception. I have done some experimenting with different grounds on my broadcast and short-wave receivers and I encountered several unusual experiences. For instance, when using my broadcast set, I caused a short-circuit when trying to combine a light-socket aerial with the regular one. In reference to this matter, I believe that I saw a way

for protecting sets, when power units were employed, in a magazine some time ago. I have not been able to locate the article.

"I have also heard that a counterpoise will sometimes work better than a regular ground. I would like to try this type of ground but I do not have any data on hand. On the short waves I have been using an aerial about 100 feet long, but I believe that a shorter one would be better. I certainly would appreciate any information that you can give me, both on my particular problem, and on grounds in general."

(A.) It has often been found on examination that a receiver which has been carefully made, and used with the best available aerial, has a ground connection which is little better than none at all. It must be remembered that the efficiency of the ground is just as important as that of the aerial and the receiver. The signals are received by both the aerial and ground; since they act as the plates of a large condenser, with the air between them as the dielectric. This corresponds to a condenser with one side perfectly connected and insulated and the other poorly made and very carelessly connected. In these days of low-loss apparatus, who would think of using such a condenser? Yet, this is exactly what is done in innumerable cases.

The plates of a good condenser must be made of a good conducting material and, for the same reason, the ground connection must be a conductor. Dry earth is not a good conductor and, for this reason, it is necessary in some manner to penetrate into the wet ground underneath. There are a number of ways of doing this.

**Constructing a Ground System**

The most common method is to connect a wire to the cold-water pipe. This generally forms a fairly good ground because the pipes run down deep into the ground. In most cases, the pipes running to the mains are of metal and the mains are also made of metal. For this reason, the only resistance offered is due to the natural resistance of the pipe material and the joints between the pipes. In order to get the best service from a water-pipe ground, the radio should be connected to the pipe as close to the point where it enters the building as possible. This is especially true if a water meter is located in the building, as shown in Fig. Q2316A, as the meter's construction introduces considerable resistance. The ground wire should be carried down to the basement, even though no water meter is located in the building.

*The gas pipe must never be used for a ground. In the first place, there is danger of fire if a strong static discharge hits the aerial. Then, too,*

*(Continued on page 599)*

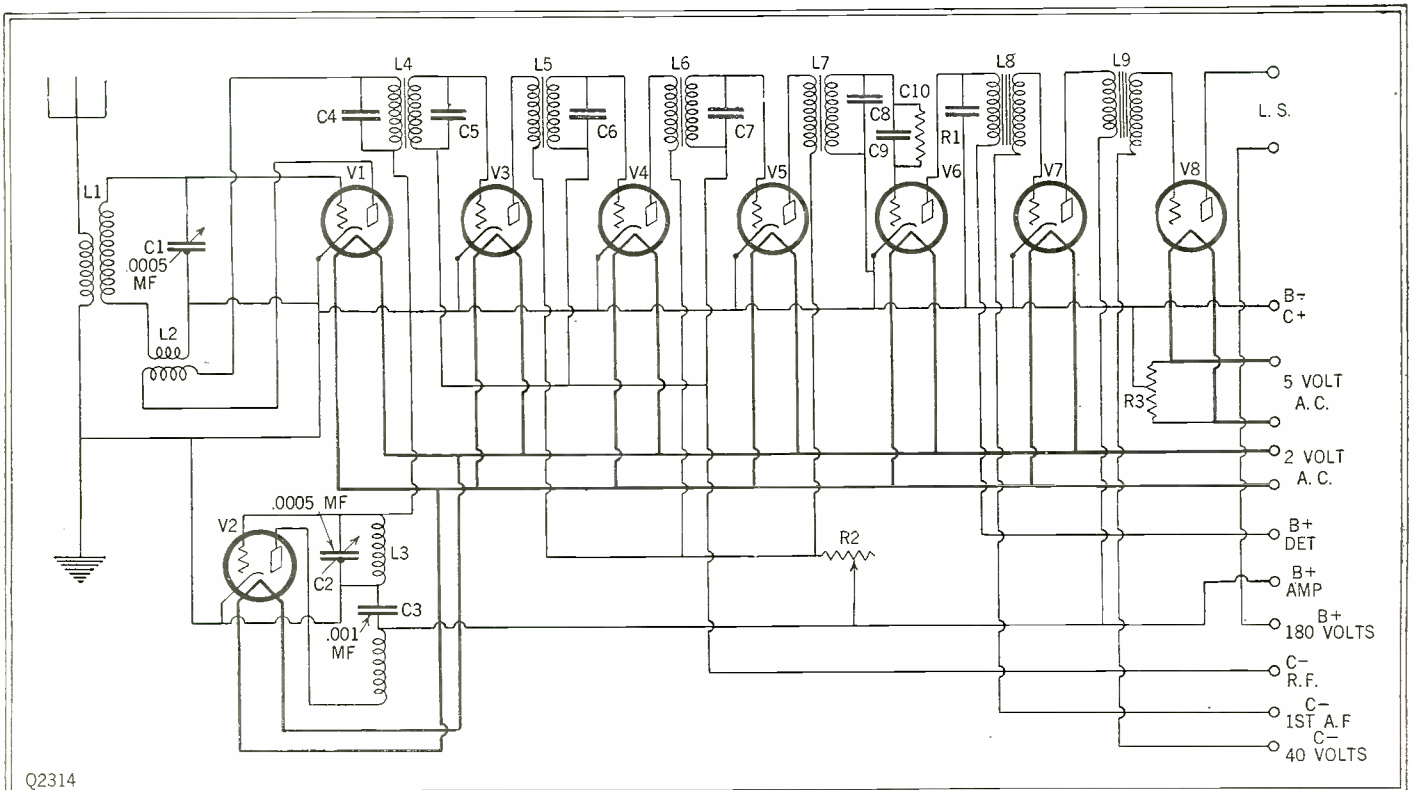

*The Ultradyné L2 schematic circuit is shown above with the necessary changes to adapt it to the use of A.C. (227-type) tubes. Values*

*not given are those of the hook-up as originally published. A different method of oscillation control is used in the amplifier.*



THEY'RE THERE  
IN THE  
WORLD'S  
FINEST RECEIVERS

**S**TANDING guard at the door of tone, Thordarson audio and power transformers do their part in making real musical instruments of hundreds of thousands of radio receivers annually.

Leading receiver manufacturers are well aware of the important relationship between the choice of transformers and the musical characteristics of their instruments. No wonder, then, that the majority of manufacturers of quality radio receivers have turned to Thordarson as the logical transformer source.

When buying your receiver, insist on Thordarson amplification and power supply. The set manufacturer who uses Thordarson transformers can be depended upon to have the balance of his receiver in keeping with this high standard of performance.

*Custom set builders will find Thordarson transformers to meet every radio need at their nearest parts dealer.*

**THORDARSON**  
RADIO  
TRANSFORMERS

**SUPREME IN MUSICAL PERFORMANCE**

3535

# REAL MOVIES

## Teach You ELECTRICITY at HOME

HERE is a new, amazingly simple and practical way of learning to do electrical work. It is so sure of results that we must give you the training and employment service necessary to get you a better job and more money or you need not pay a cent!

Think of it! You take no chance. You are assured of thorough preparation for the many opportunities in this great industry which is constantly calling for more trained men. We not only train you, we help you get the job. How can we do it? *By a wonderful new method of teaching which makes everything about electricity easy to understand.*

### You Learn Easily, Quickly, Thoroughly

We furnish you with the projector, so simple anyone can operate it, and thousands of feet of film. You see all types of electrical machinery in operation, animated diagrams which make the facts about electricity as plain, easy to grasp and as enjoyable as looking at a movie in your favorite theatre!

Here's what a practicing electrical engineer says: "I am amazed at how simply you explain the facts about electricity. The points are so much easier to grasp than by the usual methods of instruction that the student must make quicker, surer progress." Charles E. Fitz, M. E., E. E., formerly associated with Steinmetz.

Course includes drafting instruction and complete professional drafting outfit, preparing you for all kinds of work in electricity. Our employment service helps you locate a big pay job in the branch of electricity which interests you most.

### FREE Three Lessons and New Book "The Film Way to Bigger Pay"

Mail the coupon, for three actual lessons showing how we use real motion pictures to make the facts about electricity easy to grasp. Our new book describes the wonderful opportunities for a better job in electricity and gives complete details of this fascinating way to learn. Start now to move into the bigger pay class,

## The NATIONAL SCHOOL OF VISUAL EDUCATION

*"The Film Way to Bigger Pay"*

**FREE** Three Lessons and our new book, "The Film Way to Bigger Pay in Electricity," if you act at once. Make a start toward a better job and bigger pay. The coupon is the first step; send it NOW.

**Mail this Coupon Now!**

NATIONAL SCHOOL OF VISUAL EDUCATION, Dept. 12-D  
537 South Dearborn St., Chicago, Ill.

Gentlemen: Without obligation to me please send me the lessons and your new book, "The Film Way to Bigger Pay in Electricity." Are

Name \_\_\_\_\_  
St. or R. F. D. \_\_\_\_\_  
City \_\_\_\_\_  
State \_\_\_\_\_

Take the **FILM WAY** to BIGGER PAY

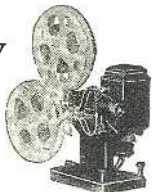

#### You Get This DeVry Projector

Anyone can operate this standard DeVry projector (value \$75) furnished without extra cost to every student for use during the course. Operates from a light connection, or auto battery. Thousands of feet of film included.



#### Drafting Set Given

A complete professional outfit, including fine set of instruments in push-lined case, as shown, given with the course at no added cost.

## RADIO NEWS FREE BLUEPRINTS Nos. 69 and 70



TO encourage the construction of radio apparatus illustrated in this magazine, and make it easier for our readers, RADIO NEWS makes up each month large blue prints of the diagrams which accompany the principal constructional articles; these sets include full-sized drilling templates, coil data, etc., where required, and in each case a list of the apparatus originally used, with full specifications. Several thousand of these have been distributed each month.

If you desire a set of blueprints for any or all of the apparatus described in this month's Free Blueprint articles, fill out the enclosed coupon as directed and send it in. The blueprints requested will be mailed to you without charge, postpaid. We cannot send blueprints with magazines, or accept indefinite requests for blueprints to be issued in the future. Delay will be caused by the use of requests other than on this form, as this publishing office has many departments.

Blueprint Department, RADIO NEWS:  
230 Fifth Avenue, New York, N. Y. (U. S. A.)

(A)

I am interested in the construction of the following apparatus described in RADIO NEWS for December, 1928. Please send me a free set of large blueprints for each of the items checked.

- No. 69 A Plugless Short-Wave Receiver.
- No. 70 An Adjustable "B" Power Unit.

Name .....

Street Number .....

Postoffice .....

State (Province, etc.) .....

(Please typewrite your name and address or print it with a pen—not a pencil—as many signatures cannot be read. This will avoid errors in addressing the mail.)

## Equipment for Television Experiments

(Continued from page 533)

becomes a universal receiver. WGY may be received on the 24-hole section, providing the disc is run at a speed of 1,025 revolutions per minute.

A variable resistor, (not shown in the picture) is included in the kit. Aside from this item, the kit comprises three double-resistor mountings, with a coupling condenser in each base, for the construction of three stages of resistance-coupled amplification; a universal motor of the induction type; a neon tube of the company's own manufacture, the disc as described, and a motor bushing for mounting the last. A comprehensive book of instructions accompanies the kit.

Manufacturer: The Daven Radio Corporation, Newark, N. J.

### Small But Practical Discs

Already making and selling 48-hole discs in two sizes, 24 and 12 inches, one manufacturer announces also the introduction of what is, doubtless, the smallest disc available, together with the frame upon which it and its accessories are mounted. The new disc is but six inches in diameter and of the 24-hole type suitable for viewing the images transmitted from WGY. The discs produced by this manufacturer are of aluminum finished in black and are precision-drilled with round holes. Their 48-hole disc allows reproduction of images 1½-inch

square, from either WRNY or W3XK. The 12-inch disc gives a picture about one inch square, while the 6-inch disc used on WGY gives an image about ¾-inch square. One of the two pictures of this comparatively miniature apparatus (Fig. I), shows a 12-inch-disc receiver made up in the laboratory by Philip A. Eyrick, (at right, pointing to the neon tube), and William G. Smith. The other (Fig. J) shows James Millen, who is another of the radio engineers associated with this design research, operating this receiver in his home.

This machine has a substantial steel frame and is very rigid. The motor is of the synchronous type, turning over at 1,800 revolutions per minute, giving a disc speed of either 450 or 900 revolutions per minute through special reduction gears. The variable resistor mounted behind the panel is for the adjustment of the brilliancy of the neon tube. Proper framing of the image is accomplished by means of a knob on the front panel which shifts the position of the disc without changing its speed. The front panel is of bakelite, 14 inches square.

The apparatus illustrated is an experimental model, which cannot be readily duplicated by the amateur unless he has special machine equipment; its construction is intended to show the practicability of a small disc driven by a small motor. The advantages of the small disc are the avoid-

# I Will Train You at Home to Fill a Big-Pay Radio Job

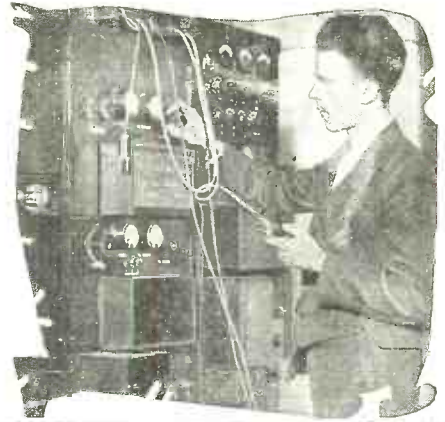

## Here's the PROOF



**Made \$185 in Three Weeks' Spare Time**  
I have met with continued success. For instance, recently I realized a profit of \$185 in three weeks for spare time work. I charge \$1.50 an hour.

Right now I am making more money in my spare time than I am making in my regular job. I have been making good money almost from the time I enrolled. I am going to give up my present position and open a Radio shop. The N. R. I. has put me on the solid road to success. —Peter J. Dunn, 901 N. Monroe St., Baltimore, Md.



**Made \$588 in One Month**

The training I received from you has done me a world of good. Some time ago, during one of our busy months, I made \$588. I am servicing all makes of Radio receiving sets. I haven't found anything so far that I could not handle alone. My boss is highly pleased with my work since I have been able to handle our entire output of sets here alone. —Herbert Reese, 2215 South E. Street, Elwood, Indiana.



**Earns Price of Course in One Week's Spare Time**

I have been so busy with Radio work that I have not had time to study. The other week, in spare time, I earned enough to pay for my course. I have more work than I can do. Recently I made enough money in one month's spare time to pay for a \$175 beautiful console all-electric Radio. When I enrolled I did not know the difference between a rheostat and a coil. Now I am making all kinds of money. —Earle Cummings, 18 Webster Street, Haverhill, Mass.

If you are earning a penny less than \$50 a week, I send for my book of information on the opportunities in Radio. It's FREE. Clip the coupon NOW. A flood of gold is pouring into this new business, creating hundreds of big pay jobs. Why go along at \$25, \$30 or \$45 a week when the good jobs in Radio pay \$50, \$75, and up to \$250 a week. My book, "Rich Rewards in Radio," gives full information on these big jobs and explains how you can quickly become a Radio Expert through my easy, practical, home-study training.

## SALARIES OF \$50 TO \$250 A WEEK NOT UNUSUAL!

Get into this live-wire profession of quick success. Radio needs trained men. The amazing growth of the Radio business has astounded the world. In a few short years three hundred thousand jobs have been created. And the biggest growth of Radio is still to come. That's why salaries of \$50 to \$250 a week are not unusual. Radio simply hasn't got nearly the number of thoroughly trained men it needs. Study Radio and after only a short time land yourself a REAL job with a REAL future.

## YOU CAN LEARN QUICKLY AND EASILY IN SPARE TIME

Hundreds of N. R. I. trained men are today making big money—holding down big jobs—in the Radio field. Men just like you—their only advantage is training. You, too, can become a Radio Expert just as they did by our new practical methods. Our tested, clear training, makes it easy for you to learn. You can stay home, hold your job, and learn quickly in your spare time. Lack of education or experience are no drawbacks. You can read and write. That's enough.

## MANY EARN \$15, \$20, \$30 WEEKLY ON THE SIDE WHILE LEARNING

My Radio course is the famous course "that pays for itself." I teach you to begin making money almost the day you enroll. My new practical method makes this possible. I give you SIX BIG OUTFITS of Radio parts with my course. You are taught to build practically every type of receiving set known. —M. E. Sullivan, 412 73rd Street, Brooklyn, N. Y., writes, "I made \$720 while studying." Earle Cummings, 18 Webster Street, Haverhill, Mass.: "I made \$375 in one month." G. W. Page, 1807 21st Ave., Nashville, Tenn.: "I picked up \$935 in my spare time while studying."

## YOUR MONEY BACK IF NOT SATISFIED

"I'll give you just the training you need to get into the Radio business. My course fits you for all lines—manufacturing, selling, servicing sets, in business for yourself, operating on board ship or in a broadcasting station—and many others. I back up my training with a signed agreement to refund every penny of your money if, after completion, you are not satisfied with the course I give you.

## ACT NOW—

64-Page Book Is FREE

Send for this big book of Radio information. It won't cost you a penny. It has put hundreds of fellows on the road to bigger pay and success. Get it. Investigate. See what Radio has to offer you, and how my Employment Department helps you get into Radio after you graduate. Clip or tear out the coupon and mail it RIGHT NOW.

J. E. SMITH, President  
Dept. 44-S  
National Radio Institute  
Washington, D. C.



**You can build 100 circuits with the six big outfits of Radio parts I give you**

3 of the 100 you can build

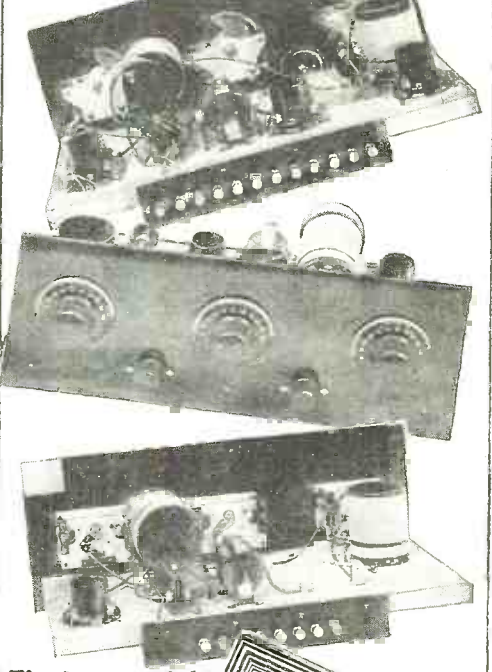

Find out quick about this practical way to big pay

Mail This FREE COUPON Today

J. E. SMITH, President  
Dept. 44-S, National Radio Institute  
Washington, D. C.  
Dear Mr. Smith: Kindly send me your big book, "Rich Rewards in Radio," giving information on the big-money opportunities in Radio and your practical method of teaching with six big Outfits. I understand this book is free, and that this places me under no obligation whatever.

Name..... Age.....  
Address.....  
City..... State.....  
Occupation.....

**Employment Service to all Graduates**  
**Originators of Radio Home Study Training**



## Melodies Caught in Flight with

# Cunningham RADIO TUBES

As the Yule-logs crackle and music fills the air, enjoy the Christmas melodies to their utmost by having new Cunningham Radio Tubes in every socket of your radio.

These "ambassadors of joy" make delightful Christmas gifts.

**E. T. CUNNINGHAM, Inc.**  
New York Chicago San Francisco

Manufactured and sold under rights, patents and inventions owned and/or controlled by Radio Corporation of America

ance of undue wobbling and the excellent images therefore obtainable; they may be magnified conveniently.

Manufacturer: *The National Company, Malden, Mass.*

### An Inexpensive Model

One laboratory, whose transmissions of "radio movies" have proven very popular with short-wave fans, is marketing what is now probably the cheapest and simplest fundamental television kit now available. A 12-inch paper disc, cut with a spiral of 48 holes, is furnished with a wooden block which acts as a support for a large machine-bolt, to which is clamped the paper disc, the bolt acting as a shaft. The disc itself, which is octagonal in shape, is clamped between two 6-inch phonograph records, and is intended to be driven by a small wheel attached to the motor. (This scheme was described in detail on page 420 of the November issue of *RADIO NEWS*). The neon tube, of the cheapest type, is mounted in a simply-wired socket which is supported in the end of the same wooden block which holds the shaft. The driving-motor, which must be supplied by the builder himself, slides on a wooden block. The speed of the disc is adjusted by moving the rubber wheel along the surface of the rear phonograph record; a method similar to the system described at the beginning of this article. In spite of the apparent crudeness of this outfit, it really produces excellent results on the WRNY-W2XAL and the W3XK television transmissions. The image is only about 3/4-inch square but is readily distinguishable. (See Fig. H, page 533.)

Manufacturer: *The Jenkins Laboratories, Washington, D. C.*

### Problems of Handling Big Amplifier Output

ONE of the best lineups for a 250-type power amplifier is that of a three-stage system, using two stages of standard transformer-coupled audio-frequency amplification with 201A tubes and 3:1-ratio transformers and a power stage with the 250 tube. This last stage should be coupled to the second audio-frequency stage by means of a 1:1-ratio audio transformer.

It must be taken into consideration that, unless the proper associated equipment both for the amplifier and for the reproducer is employed, the results may not be as good as they might be.

The large power output of such amplifiers demands that a speaker be used which is capable of handling this tremendous output. If the ordinary type of units such as are used in many horn- and cone-type loud speakers or even the comparatively higher-grade types of balanced-armature units is employed, distortion is bound to result because the armatures of such units, when brought close to the pole pieces, will cause an uneven response to low or high frequencies.

Where great volume without distortion is desired, the best type of loud-speaker unit to employ is the electrodynamic type, in which the diaphragm of the speaker is connected fixedly to a coil winding which carries the speech frequencies. This coil moves in a constant field created by an electromagnet, so that there is no tendency to distort through any uneven attraction of the armature.

# Radio HEADQUARTERS

The newest radio wrinkles—A-C, grid tube, short wave, television, dynamic speakers, newest tubes and circuits—anything and everything in radio—are now ready for you at Barawik's. With elections, football, National broadcasting, Roxy and other big doings filling the air, thousands of newcomers will take to radio this year as never before. Business will be good—Set builders will make money. You can clean up big by buying from Barawik—the oldest, biggest, most reliable radio house in the world. Let us prove it. Send now for the Big Book—all ready for you—free. Get the latest radio information and lowest prices.



**BARAWIK CO.**  
112 E CANAL ST.,  
CHICAGO, U.S.A.

This Big Book Sent to You Free

Name.....  
Address.....  
City.....

# Electricity

Learn in Los Angeles. Thoroughly practical course prepares young men, 18 and over, for technical and executive positions. Unlimited opportunities in California for continuous advancement. 32 instructors. Unexcelled equipment. 23rd successful year. 17,000 active graduates. Highest Type Training. Recognized by Electrical Industry. Nominal Entrance Requirements. Employment Service during and after training. California spending \$100,000,000 in electrical development. Large, illustrated catalog sent Free, Postpaid. Dept. R.N.

NATIONAL ELECTRICAL SCHOOL  
4004 S. Figueroa, Los Angeles

## Electrify Your Radio

With Kato "A" and "B" Units that connect into Light Sockets of any 32-VOLT LIGHTING PLANT  
Costs very little to operate. Write to-day,  
Dept. N  
**KATO ENGINEERING CO.**  
Mankato, Minn.

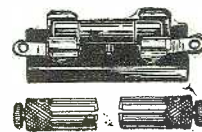

## IT!!!!

LITTELFUSES HAVE IT  
THAT EXTREME QUICKNESS

of action necessary to protect radio and rectifier tubes, filter circuits, galvanometers, milliammeters, etc. (1" x 1/4" dia.). Approved by leading radio laboratories. Mount as shown or hang directly in the line by pushing on a pair of GRYP-CONNECTORS.  
Prices, postpaid (C.O.D. or cash unless rated):  
Littelfuses, 1/32, 1/16, 1/8, 3/16, 1/4, 3/8, 1/2, 5/8, 3/4, 1. Ea. Doz. Per 100  
2, 3 amp. .... .15 \$1.50 \$10.00  
Mounting Blocks ..... .20 2.00 15.00  
GRYP-Connectors—in pairs ..... .15 1.50 10.00  
Littelfuse Laboratories, Dept. 4, 1772 Wilson Av., Chicago

**AEROVOX** Makers of high quality resistors and condensers that are Built Better—to endure.  
Write for The Research Worker.  
A free monthly publication.  
**AEROVOX WIRELESS CORPORATION**  
88 Washington Street Brooklyn, N. Y.



# WHOLESALE PRICES

for Dealers, Community Set Builders, General Repairmen and Agents!

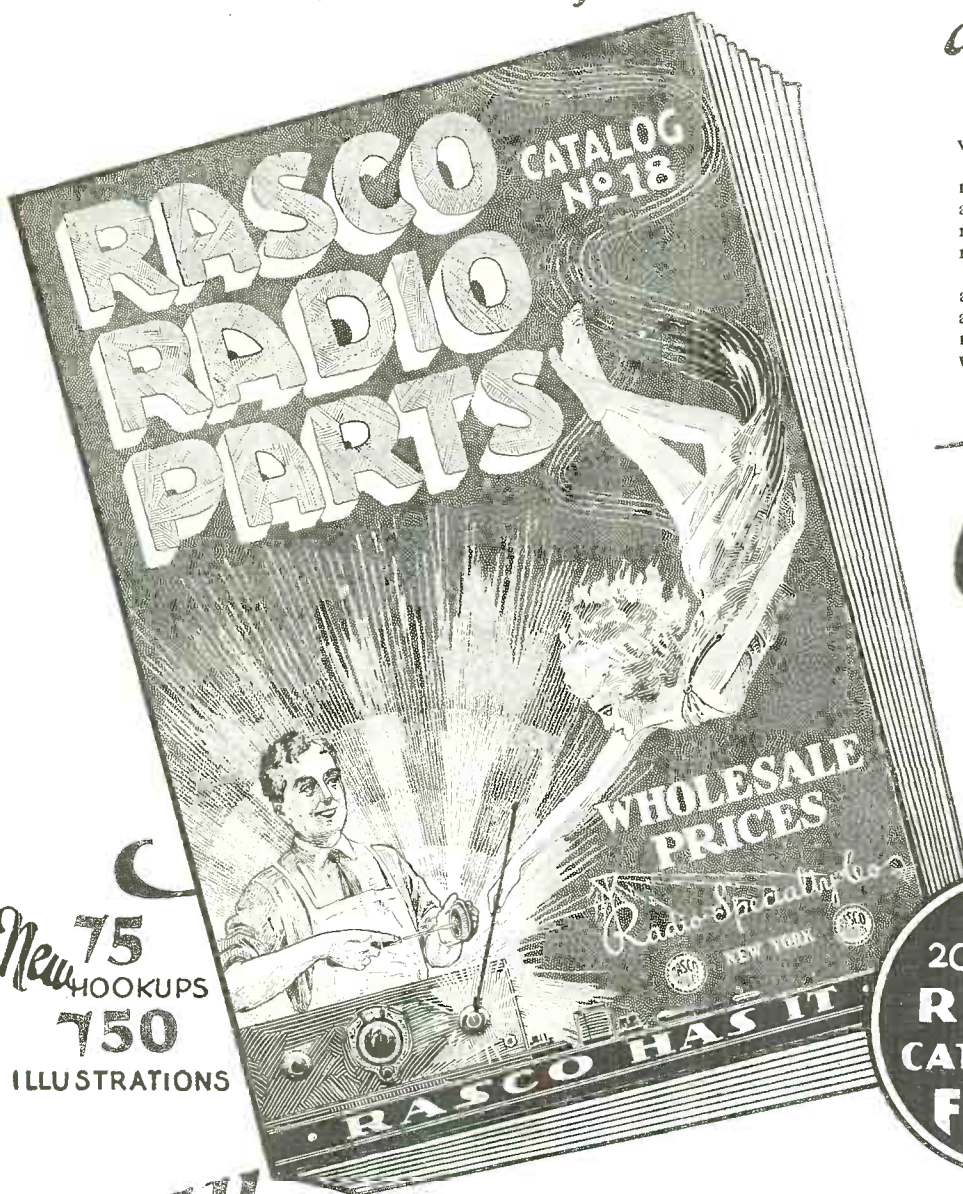

New 75 HOOKUPS  
750 ILLUSTRATIONS

Be sure to get this great 200-page book with net prices to the radio trade.

Radio Specialty Company is radio's oldest radio parts mail order house in the country, and the new confidential prices on standard radio merchandise are the lowest of any radio house.

We are ready now to appoint additional agents in all parts of the country. If you are contemplating mailing big money in radio merchandise, be sure to get in touch with us at once.

## Television is here!

Radio Specialty, as usual, is first with all new things. Send at once for free booklet for lowest prices on all television parts which have been put on the market so far. (If you have Catalog No. 18, just ask for the Television Supplement.)

**THIS 200 PAGE RADIO CATALOGUE FREE**

Those having No. 18 catalog should write to us for new Supplement describing all latest improvements in Radio.

### Buy from Radio's Oldest Mail Order House!

We are the oldest established, exclusive radio mail order house in the country. All orders are positively shipped within twenty-four hours; quick, prompt, courteous service. We carry a larger variety of radio parts, radio instruments, accessories and radio findings than any other radio house in the country. You will find in Catalog No. 19 the largest assortment of radio merchandise in this country. Radio Specialty carries more radio parts and radio material than any other house in the country. You will find in this catalog positively the largest variety of radio merchandise.

If you are in need of certain small radio parts that other radio and mail order houses do not bother to carry, get the Rasco Catalog and you will find the small parts there, anything from a screw to copper ribbon, telephone diaphragms, as well as thousands of other small radio findings. Just to mention a few:

**"RASCO" has it**

ANYTHING IN RADIO

Lugs, nuts, jacks, plugs, all kinds of knobs, cords, panels, screws, sliders, washers, selenium, tinfoil, switches, crystals, cap nut, Litz wire, cord tips, brass rods, resistances, binding posts, switch parts, carbon balls, switch points, lock washers, carbon grains, ground clamps, metal pointers, insulated tubing, low melting metal, antenna connectors, as well as thousands of other articles. We carry the Largest Variety of Small Radio Parts in the World, BUT We also carry All Standard Radio Merchandise.



Radio Specialty Co.



98W PARK PLACE, NEW YORK

# Here's the Answer

to every question about the principles, methods, or apparatus of radio transmitting and receiving.

## THE RADIO MANUAL

**A Complete Course in Radio Operation In a Single Volume**

**A Handbook for Students Amateurs Operators Inspectors**

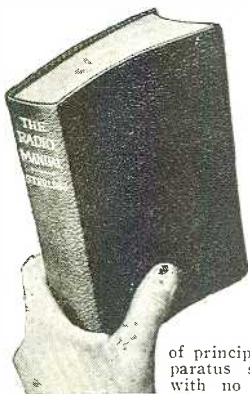

For the first time an entire course of training in one book—the most complete and up-to-date work on radio. Developed simply and clearly from the elementary stage right through all phases of principles, practice, and apparatus so that a beginner with no knowledge of electricity may get all he needs either for amateur operation or to qualify for a government license as operator or inspector.

### Prepared by Official Examining Officer

The author, **G. E. Sterling**, is Radio Inspector and Examining Officer, Radio Division, U. S. Dept. of Commerce. The book has been edited in detail by **Robert S. Kruse** for five years Technical Editor of QST, the Magazine of the Radio Relay League. Many other experts assisted them.

**16 Chapters Cover:** Elementary Electricity and Magnetism; Motors and Generators; Storage Batteries and Charging Circuits; The Vacuum Tube; Circuits Employed in Vacuum Tube Transmitters; Modulating Systems; Wavemeters; Piezo-Electric Oscillators; Wave Traps; Marine Vacuum Tube Transmitters; Radio Broadcasting Equipment; Arc Transmitters; Spark Transmitters; Commercial Radio Receivers; Radio Beacons and Direction Finders; Radio Laws and Regulations; Handling and Abstracting Traffic.

**New Information** never before available such as a complete description of the Western Electric 5-Kilowatt Broadcasting Transmitter; description and circuit diagram of Western Electric Superheterodyne Radio Receiving Outfit type 6004-C; Navy Standard 2-Kilowatt Spark Transmitter; etc.; etc. Every detail up to the minute.

### Free Examination

"The Radio Manual" has just been published. Over 900 pages. Profusely illustrated. Bound in Flexible Fabricoid. The coupon brings the volume for free examination. If you do not agree that it is the best Radio book you have seen, return it and owe nothing. If you keep it, send the price of \$6.00 within ten days.

### Order on This Coupon

**D. Van Nostrand Co., Inc., 8 Warren St., New York**

Send me THE RADIO MANUAL for examination. Within ten days after receipt I will either return the volume or send you \$6.00, the price in full. (Radio News 12-28)

Name .....  
St. & No. ....  
City and State .....

## Australia's Edition of the Peridyne

"Of all the receivers which have been featured in the *Queensland Radio News*," says that magazine (which is published in Brisbane, Australia) in a recent issue—"none has given us more pride and pleasure than the simplified Peridyne Five. Pride, because the set was designed in our own laboratory, and incorporates one or two new features not found in the original model. Pleasure, because the receiver is such a remarkable performer, and will, doubtless, be rebuilt by many of our readers. We recommend this Peridyne wholeheartedly and without reservation."

"Originator of many circuits, and inventor of several important contributions to the art, Hugo Gernsback, who developed the Peridyne principle of variable-shield tuning, describes the Peridyne Five as the ideal uni-control receiver and probably the most powerful five-tube circuit in existence. Not a pessimistic claim, this; but one which is fully justified by a trial of the receiver itself," the technical editor of the *Queensland Radio News* affirms in his constructional article. "Using but five tubes and a crystal detector, the Peridyne is, without a shadow of doubt, more than the equal of many eight-tube superheterodynes, as far as range and volume are concerned. Contrary to what its remarkable performance would lead one to expect, it is neither an expensive nor a difficult set to construct, and it works right from the word 'go.'"

### QUALITY, VOLUME, DISTANCE

"This month, we are going to depart from our usual custom of describing the results achieved by our own receiver, at the end of the article. The results are much too good to keep as long as that, and we feel we must tell you about them right at the beginning. When first our Peridyne was constructed last month, we conformed to the standard design and used two stages of transformer-coupled audio-frequency amplification. However, the volume was so terrific that it was thought it could easily stand the small reduction in strength which would be occasioned by the use of resistance coupling. Accordingly, the first audio transformer was removed and replaced by a resistance-coupled unit. The results were startling, and, whatever the reduction of volume should have been, it was wholly inappreciable in actual practice. The tone quality, as might have been expected, was a revelation, and we straightaway decided that here was the ideal Peridyne."

"The set has been in use for two months, and in that time we have listened to practically all the Australian stations, small and large; the New Zealand stations, IYA and 2YA, and JOAK and JOBK, both in Japan (over 4,500 miles.—EDITOR, RADIO NEWS). All these stations have been heard on the loud speaker and on an indoor aerial 35 feet long. As a matter of fact, we have reached the conclusion that an outdoor aerial is unnecessary with the Peridyne; as the volume appears to be almost as great and the selectivity certainly much better when operating on an indoor wire."

The Australian edition of the Peridyne was built with components of both British

## NEW! 90 Volt Power Unit

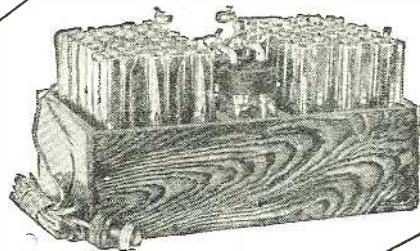

**Positively Eliminates Hums, Line Noises, etc. Greater Volume and Clarity Guaranteed** **\$12.75**

Non-acid and noiseless. All detector and intermediate voltages plainly marked. Simpler to hook up than dry cells. Operates 1 to 12 tubes. If not thoroughly dried return after using 30 days for complete refund. Guaranteed further 2 years. For 110-120 volts A.C. 25 to 60 cycle current, 90 volts, \$12.75; 112½, \$15.25; 135, \$17.50; 157½, \$19.50; 180, \$24.00; 202½, \$26.00. Also built for D.C. current 110 and 32 volts at only \$3.60 additional, any size above. Ample stocks—same day shipments. Simply say—ship C.O.D. or write for my interesting literature, testimonials, etc.

**B. HAWLEY SMITH**  
334 Washington Ave., Danbury, Conn., U.S.A.

## SET BUILDERS Get this Book



**Barwik**, the first and oldest radio specialty house, offers you unusual service this year. Bigger stocks, quicker shipments, lower prices. Deal with an old established, reliable house. Get honest goods, honest service, honest prices. **Barwik** service makes you more money. Send now for big new Catalog showing lowest wholesale prices.

**BARWIK CO.** 212K Canal Sta., CHICAGO, U. S. A.

Mail This Coupon Now for Free Radio Guide

Name .....  
Address .....

## M&H

Radio's largest kit supply house

ESTABLISHED 30 YEARS

We Have Complete Kits For All Circuits Now appearing or which have appeared in "Radio News" and other publications. Send for Circuit Booklet & Catalog

**M. & H. Sporting Goods Co.**  
512 Market St., Phila., Pa.

### Be an Expert RADIO OPERATOR

Fascinating work. Wonderful opportunities. Good pay. **Teleplex Code Sender** teaches you at home in half the usual time. Reproduces actual sending of expert operators. Sends you messages, radiograms, etc.—regular code traffic anywhere, any time, any speed. U. S. Navy and leading schools endorse Teleplex as quick, easy, thorough. Complete set instruction tapes supplied at no extra cost. Write for Booklet NR.



**TELEPLEX COMPANY**  
76 Cortlandt St., New York, N. Y.

**E. C. A. DRI-LINE "A" ELIMINATOR**  
60 cycle, output 3 A., 4-6 V. No Battery—SILENT—\$16.00  
B. Eliminators New Line K, 150 Volt 50 millamps. 4 taps, C bias—280 bulb, complete, \$10.00, Model KW 80 mills, 180 volts, 5.0 V power tube taps, 280 bulb, \$11.75.  
A-B-C Eliminator 3 A., 6 V. "C" side, 180 volts, 5 taps, 80 mills. B 4.5, 27, 40 V. "C" DRI-LINE type \$20.00 complete. Underground Aerials, NEW! No lightning hazard—complete, \$3.75. Shield grid sets, AC sets, parts. Dealers wanted. Above prices are discounts of 30% from list. Catalog 58. **ELECTRO-CHEMICAL COMPANY OF AMERICA**, Indianapolis, Ind.



and American manufacture, and used British four-volt tubes. Its constructor continues in his article:

**ALTERATIONS TO SUIT PARTS**

"In the original Peridyne, three rheostats are specified, one for each R.F. tube, and one for the detector. Intensive experiment failed to show any appreciable advantage which could be gained by their use; so a single rheostat was utilized for controlling both R.F. tubes at the one time, and the detector and audio tubes are placed in charge of amperite automatic filament ballasts.

"To insure efficient transfer of energy between the first and second audio stages, a high-mu high-impedance tube is employed in the third socket, because it is followed by a high resistance in its plate circuit"—with *resistance coupling*. As a .0005-mf. three-gang tuning unit was not obtainable when the set was built, .00015-mf. fixed condensers were placed across the sections of the triple .00035-mf. condenser used; and the constructor reversed connections to the primary of the A.F. transformer to remedy "motorboating" when using a "B" power unit. In other regards, the original Peridyne circuit was followed.

"A final word," adds the Australian at the close of his article: "We have heard quite a lot of adverse comment, mainly from those who have not tried it, concerning the Peridyne circuit. That is always the case with anything new, and is to be regretted. However, with the results which our own model has produced—and from the way in which it is working at the present time—we are convinced that there is no fallacy about the Peridyne principle. It is a noteworthy receiver and one which will be popular for some time to come."

**Radio Wrinkles**

*(Continued from page 559)*

attempt its construction. However, if a tube socket is needed when none is available it is considered an invaluable piece of equipment. In this connection, the wrinkle described in Fig. 8 may prove valuable to many experimenters; this illustration shows how it is possible to make a very satisfactory socket out of an old UX tube base. It is very easy to make a socket in the manner described and the cost is almost negligible.

To make the socket, take any UX-type tube which has been burnt out and remove the glass from the base. (The easiest way to do this is to wrap the tube in paper and apply pressure to it in a vise, or hit it with a hammer.) Now clean out the glass and cement from the inside of the base with a knife. The next step is to break off the four prongs of the base and then drill holes through the base and prongs from the upper side of the tube base; a No. 30 drill should be used for the small prongs and a No. 20 drill is needed for the large prongs.

Five additional holes are needed in the tube base. One hole must be drilled and countersunk in the center of the base, equidistant from the four prongs for the mounting screw; and four holes are needed for the binding posts. The binding-post holes are located about 1/4-inch from the rim of the base and directly under each of the holes for the prongs.

## Solve Your Radio Problems with ELECTRAD RADIO CONTROLS

Whether your problem is one of R.F. oscillations, controlling tone and volume, or control of voltage in B-Eliminators, you will find the true solution in Electro Resistance Control.

These resistances are backed by the highest reputation of quality. We must uphold that reputation. Therefore, only the most scientific designs and finest materials are used in their construction. To assure the highest order of performance and satisfaction, insist on **Electrad Controls**.

### PHASATROL

**A True Balancing Device for Radio Frequency Amplifiers**

You can solve the problem of R.F. oscillation noises by inserting a Phasatrol for each stage of R.F. amplification.

After installation of Phasatrol, it is possible to adjust its variable resistance to a permanent value for an amplifying tube so that no further chance of oscillations breaking out is experienced.

Very easy to install in the circuit. Price \$2.75 each.

### TONATROL

**TRADE MARK**

**A Complete Line of Volume Controls**

Smooth, gradual control of intensity under all conditions will be your reward if you incorporate the Tonatrol Volume Control in your receiver. Tonatrols are variable resistors of the famous Royalty type, especially designed with the requirements of different circuits in mind. Furnished in standard types or with battery switch or power switch attached. From \$1.50 to \$3.00.

### TRUVOLT

**All-Wire Resistances**

Remarkably accurate and efficient for control of voltage in B-Eliminators due to their exclusive, air-cooled design and construction.

Truvolt Variables simplify B-Eliminator construction by eliminating difficult calculation and making all adjustments easy. 22 Stock Sizes, \$3.50 each.

Truvolt Fixed are adjustable to different set values by the use of sliding clip taps—an exclusive Truvolt feature! Made in all desirable resistance values and current ratings.

### ROYALTY

**Variable High Resistances**

A standard resistance widely recommended for its accuracy and dependability wherever variable high resistances are required in high frequency circuits.

Made with the best insulating materials and free from injurious inductance and capacity effects. Same resistance always secured at same point. Entire range of resistance covered in one turn of knob.

There is a type for every radio purpose—11 in all, designated Type A to Type L. Potentiometer types \$2.00. All others \$1.50.

**ELECTRAD, INC.**, Dept. N-12, 175 Varotok Street, New York.

Please send me descriptive circulars on the following products and include in your mailing list for further literature: ( ) Tonatrols; ( ) Truvolt; ( ) Phasatrol; ( ) Royalty; ( ) Variable Resistors; ( ) B-Eliminator; ( ) Electro Resistance Control; ( ) Potentiometer; ( ) Fixed Resistors; ( ) Power Switch; ( ) Battery Switch; ( ) Other (specify): \_\_\_\_\_

Name \_\_\_\_\_ Address \_\_\_\_\_

**ELECTRAD specializes in a full line of Controls for all Radio Purposes, including Television**

# ELECTRAD

Inc

Mail coupon for full information.

# Would you give the price of a shave to earn THOUSANDS IN RADIO?

Mail coupon below for details of amazing home-study radio course.

THE Radio Institute of America, conducted by RCA and sponsored by General Electric and Westinghouse, now offers you at remarkably low cost the training you need for success in radio. The price of an occasional shave saved, more than pays for it! Nothing so clear, comprehensive and up-to-date, nothing so generous in apparatus furnished has ever before been offered in radio training by any organization.

### Helped thousands to succeed

This is basically the same course that has enabled our thousands of graduates to advance to positions of importance and high remuneration in the respected profession of radio. But new and revolutionary changes make the instruction clearer and easier, permitting faster progress—and the course now embraces television, airplane radio equipment and photoradiograms.

You can study at home—when you please and as long as you please. Your rate of progress is limited only by your own ability.

### Mail coupon now

It brings you—free—an interesting illustrated booklet that shows the tremendous opportunities in the radio industry and tells how the Radio Institute of America's course of home study can show you the way to big success in Radio. Mail the coupon at once.

RADIO INSTITUTE OF AMERICA  
Dept. A-12 326 Broadway  
New York, N. Y.



RADIO INSTITUTE OF AMERICA

Dept. A-12 326 Broadway  
New York City

Please send me your new booklet with full information about your Home Study Course of Radio Instruction.

Name .....

Address .....

City .....

The next step in the construction of the socket is to make four contact springs and these should be of phosphor bronze, if possible, or stiff brass. The material used for this purpose should be strips 1/4-inch wide and 1 1/4 inches long, approximately 1/100-inch thick. Each should be bent as illustrated, and a hole drilled in one end for mounting purposes. To complete the tube socket, it is necessary only to mount the contact springs in place with the four binding posts.—Contributed by Clyde Trivetts.

### Robbing the Cradle

WE have often heard that housewives are compelled at times to keep a wary eye upon the doings of hubby; and frequently they note that minor kitchen appointments have mysteriously disappeared, only to turn up some time later reincarnated as some outlandish electrical appurtenance for the benefit of the breadboard radio. We fear that the wrinkle to be described will do little to ease the strain on the family tie. If anything, it will aggravate matters, and even tend to bring a heretofore innocent spectator into the discussion.

The time has come when baby must surrender his rubber nipple so that dad's tubes will end their occasional howling. A contributor has discovered that the large rubber nipples used in conjunction with the wide-mouthed nursing bottle make efficient and economical howl-preventers when slipped over the tubes. If desired, the nipple may be snipped off, though this will have nothing to do with the tube's howl.—Clarence G. Hillner.

### Soldering Iron to Steel

HOME radio constructors occasionally find it desirable to solder iron on steel. This is usually a very difficult procedure, and success rarely results, no matter how enthusiastically the job is undertaken. The following is a way which simplifies the entire process and makes it easy to secure a neat and permanent connection.

The parts are first cleaned thoroughly, using a file or sandpaper. They are then washed in a solution of copper sulphate ("blue vitriol," obtainable at any drug store) which is made by mixing one teaspoonful of the sulphate in an ounce of water (stir with a wooden stick or copper wire). This process puts a coating of copper on the iron surface and provides a suitable base for the solder, which is then applied in the usual manner.—David D. Fairbrother.

### What's New in Radio

(Continued from page 541)

best results, the 199 has been used extensively on short waves for code reception and has been found to give satisfactory results over long distances.

In the selection of a ground for a short-wave receiver even more care should be exercised than in the installation of a broadcast set. The aerial may be of the indoor type, from 20 to 50 feet long, strung around the room; or the broadcast aerial may be used on the "long aerial" post.

Manufacturer: Pilot Electric Manufacturing Co., Brooklyn, New York City.

## Send For This Book—It Offers More Profits to Set Builders!



Radio Fans, from "way back when," will remember the exceptional service that Barawik rendered when getting radio parts was like pulling "hens' teeth." First upon the scene, Barawik was always ready to deliver the newest developments in radio to its customers in the days when changes were fast and furious.

Today Barawik has grown to be a mighty institution in the radio world. Here you can secure the proved, reliable merchandise of the world's leading radio manufacturers—everything from complete sets to the smallest individual parts so necessary to the set builder. You can depend upon the reliability of Barawik goods. You can depend upon Barawik's ability to deliver the kind of service that means time saved in waiting. You can depend upon Barawik's honesty, ability and willingness to serve you—And, last, but far from least, you know that Barawik's big discounts assure you of the lowest prices always—prices that mean huge savings to you in everything you buy.

The newest in radio sets, parts, kits, supplies—all under one roof—ready for you now. Send coupon now for big new Catalog—Free.

**BARAWIK CO.**  
112 C Canal Sta.,  
CHICAGO,  
U. S. A.

Mail this Coupon Now for Barawik's Big Free Bargain Book.

Name ..... Address ..... City .....

## \$75 to \$125 Weekly Charging Batteries Starts You

Let me show you how to make big money right from the start. I've prepared a FREE book explaining all details. First week's profit pays for all equipment. You can get all the battery charging business in your community with my Service Station Charger—it's years ahead of ordinary chargers—handles 50% to 70% more batteries. I explain everything—start you in a business of your own and put you on the way to big money. Write for FREE BOOK.

C. F. HOLMES, Chief Engineer, Dept. R.N  
Independent Electric Works  
5116 Ravenswood Ave. Chicago, Ill.

FREE BOOK—Just Out

## ELECTRICITY Easily Learned IN A FEW WEEKS

Learn with real tools on real equipment. No books, no printed lessons, no dry lectures. McSweeney's SHOP PLAN system of training makes real electricians in shortest possible time. 90 days' training fits you for a big-pay job at \$50 a week, and up. Write for big electrical book FREE—also remarkable tuition offer, which includes FREE R. R. fare. I guarantee satisfaction or money back.

**McSWEENEY ELECTRICAL SCHOOLS,**  
DEPT. 76-T, CLEVELAND, OHIO

## Pathfinder

EVERY WEEK 13 WEEKS TRIAL \$1 A YEAR 15 CENTS

Your neighbors know the Pathfinder and you will like it—the every-week news digest from the Nation's Center. Bright, interesting, dependable, different—nothing else like it. Washington gossip, politics, science, travel, fun, lots of pictures, instruction, entertainment.

Trial 13 weeks—13 big issues—only 15 CENTS or \$1 for full year. Send now. Address: Pathfinder, Dept. 17, Washington, D. C.

## DEALERS & SET BUILDERS!

Complete stock of nationally known parts and accessories. Send for illustrated catalog and discount sheet.

Radio Exclusively Since 1921

**CLARK & TILSON, Inc.**  
122 CHAMBERS ST. New York  
The Nationally Known House

Quality Apparatus

Our latest bulletin No. 929 describing our complete line of quality apparatus is yours for the asking. Write for it today.

**GENERAL RADIO CO.**  
30 State St., Cambridge, Mass.

## Radio World's Fair

(Continued from page 542)

than fifteen tube manufacturers dotted the exhibition floors with booths glittering with banks of tubes. There were displays of all kinds and makes, many unknown to the eastern listeners because of exclusive mid-or far-Western markets. Tubes of every size and purpose were shown; there were the familiar storage-battery types, the newer A.C. products, power tubes ranging from dry-cell to generator-operated, voltage regulators and rectifying tubes of all descriptions. One booth displayed a miniature tube-assembly plant, wherein a number of girls were busily engaged putting together the various elements that go to make up a vacuum tube.

### TELEVISION THE BIG HIT

Television went across with a huge bang! Actual demonstrations offered by the Carter Electric Company, the General Electric Company and the Daven Company kept the Garden's special police force on the brink of mutiny. At one time the lines leading to the various demonstration chambers wrapped themselves about the floor like so many snake-dances and threatened to disrupt the good behavior of the entire floor. At the booth of RADIO NEWS, three attendants did little but answer inquiries as to where the television demonstration might be seen.

A goodly number of manufacturers exhibited television kits and kindred accessories; and reported overwhelming attendance. Six television kits were offered there for the experimenters' market.

Only ten manufacturers placed before the onlookers "A" and "B" power units. The A.C. receiver, with its built-in power unit, has captured the commercial market most thoroughly. At that, some of the power units shown were designed for operation on direct-current lines.

Short-wave adapters came in for their share of publicity and were heralded with mild interest. Those exhibited were of the conventional type, having a wavelength range between 10 to 200 meters (or thereabouts) and so designed that their addition to the average broadcast receiver is a simple matter. They are, for the most part, equipped with an adapter plug resembling a tube base, which is plugged into the detector socket of a standard broadcast receiver; the detector tube is then placed in another socket which has been provided in the adapter. All tuning is accomplished with the dials on the latter.

Parts manufacturers were, of course, brilliantly and plentifully represented. The art of building one's own receiver, it seems, has not as yet lost ground. If anything may be judged from the quality of the apparatus shown, radio set building as a hobby has taken a good many steps forward.

External audio amplifiers occupied the center of interest among the home dabblers; these were exhibited in various sizes ranging from a simple stage of push-pull amplification to a speech-control panel, five feet high, upon which were mounted eight tubes, two of them 250-types. Twenty-seven manufacturers engaged space for the exhibition of parts. Only six manufacturers represented the battery industry.

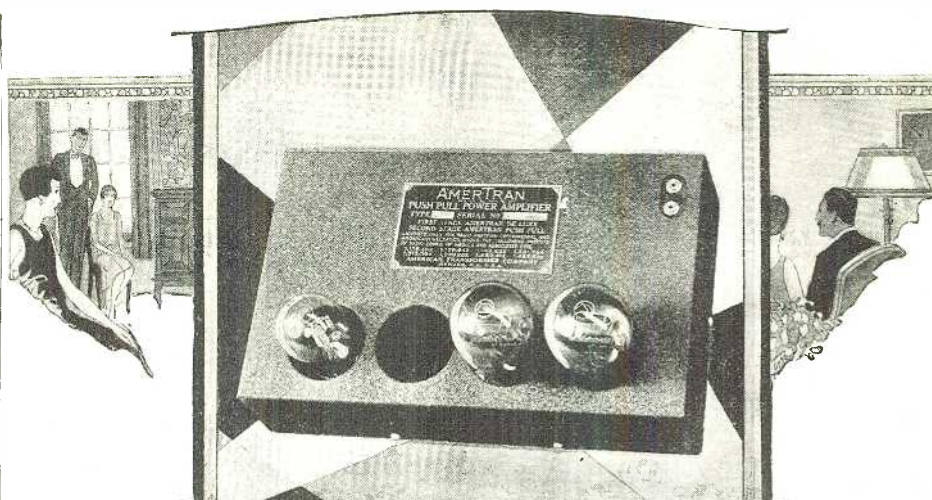

AmerTran Push-Pull complete—2 stage Amplifier. First stage AmerTran DeLuxe and second stage AmerTran Push-Pull for two Power Tubes. Choice of standard amplifier or UX227 AC for 1st stage and two 171 or two 210 power tubes for second stage. Price, cast of Rockies—less tubes—\$60.00

## AMERTRAN Quality Radio Products

— the Basis of Natural Reproduction

EVERY year the importance of radio reproduction has advanced until now, the question among radio enthusiasts has changed from "How much distance can you get?" to "How good is your tone quality?"

The audio amplifier is the basis of tone quality. Since broadcasting came into being, AmerTran products have been the Standards of Excellence for Radio Reproduction. How many times have you heard the question asked, perhaps asked it yourself, "Is it as good as AmerTran?" As long as that question is asked, there can be no doubt as to the standing of AmerTran products in the radio industry.

The products shown on this page are but a few of the thirty odd AmerTran devices in the field of radio reproduction, each of which has attained the degree of perfection necessary to be introduced as an AmerTran product. The facilities of our engineering department are at the service of every one interested in better radio reproduction. We will answer to the best of our ability any question in the audio or power fields.

### AMERICAN TRANSFORMER COMPANY

Transformer Builders for more than 28 years  
264 EMMET ST., NEWARK, N. J.

AmerTran Push-Pull Power Stage (illustrated below)—completely wired with input transformer and a choice of 4 output transformers depending on speaker and power tubes. Adaptable

to 171 or 210 tubes, cones or dynamic type speakers. Price, cast of Rockies—less tubes—\$36.00. AmerTran ABC Hi-Power Box (illustrated below)—500 volts DC plate voltage, current up to

210 ma; AC filament current for rectifier, power tubes and sufficient 226 and 227 AC Tubes for any set. Adjustable bias voltages for all tubes. Price, cast of Rockies—less tubes—\$95.00.

AmerTran DeLuxe Audio Transformer, (illustrated below,) Standard of Excellence, 1st Stage; Turn Radio, 3; 2nd Stage; Turn Radio, 4. Price, each \$10.00.

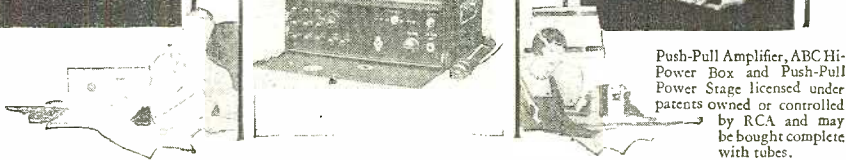
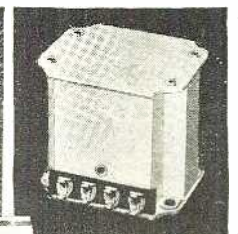
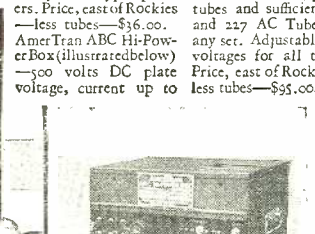
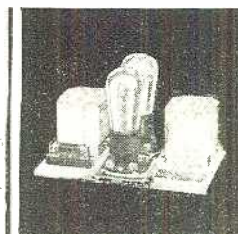

Push-Pull Amplifier, ABC Hi-Power Box and Push-Pull Power Stage licensed under patents owned or controlled by RCA and may be bought complete with tubes.

# POWER



"They cost no more but Last Longer"

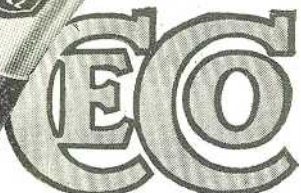

PRONOUNCED  
**SEE - CO**  
RADIO TUBES

**Steadier**  
performance  
—longer life

It's performance that counts! And it doesn't take a critical ear to note the great improvement a set of CeCo Tubes make in reception.

It's a simple matter to avoid disappointing results by making sure that a CeCo Tube occupies each socket of your set.

The exclusive CeCo method of evacuation is largely responsible for their outstanding performance and is directly responsible for their longer operating life for which CeCo tubes have gained a country-wide reputation.

No matter what your tube requirements may be—there are CeCo Tubes made to meet every radio need in both A.C. and D.C. types as well as in "special purpose" types which are obtainable nowhere else.

Try a set of CeCo Tubes and you, too, will find how much better they improve reception. A CeCo dealer will gladly advise you which types to use to obtain the best results.



**CeCo MANUFACTURING Co., Inc.**  
PROVIDENCE, R. I.

## The Inventor's Rights

(Continued from page 543)

other words, a patent is not valid unless the *patentee* (person to whom the patent is issued) was the first to put the invention into practical usage in the *whole world*. There is one exception, however, in that a simple use, *without publication*, in a foreign country will not bar an American inventor from a patent.

When an application for a United States patent is prepared, the drawings, specification, petition, oath and first government fee together are sent to the Patent Office at Washington. The application remains without examination in the Patent Office for a period which is sufficient for the official examiner to act on all cases previously filed in the same department. When its turn comes, the examiner (of the division in which the device is classified) studies the specification, claims and drawings. He then begins a thorough search of previously-issued United States and foreign patents, endeavoring to locate one similar to the invention claimed in the application.

If he fails to find one, then the search is continued in scientific records, magazines, and other United States and foreign publications. If the same invention has been patented by another inventor, or if a description of it has been published by another, the examiner will not grant a patent.

On the other hand, if the Patent Office examiner does not make a thorough search of the various previously-issued patents of the world, and the prior publications in the same area, he may fail to discover a previously-issued patent or publication, and the inventor receives an *invalid* patent; that is, one which is worthless.

### PATENT LITIGATION

Therefore, a patent is merely a certificate issued by the Government which legally entitles the inventor to enter a court and demand damages and profits, if he believes an unauthorized person makes, sells, or uses the invention.

If the person being sued proves that, before the patentee filed his application for a patent, another inventor obtained a patent on the same invention, or another person made and operated the same device, although he filed no application for a patent, or described the same in a printed publication, the patentee not only is deprived of a verdict for damages and profits earned by the infringer, but the patent is automatically declared by the Court to be invalid.

On the other hand, if the patentee has maintained records during the period he experimented with his device, then he may introduce evidence to show that he actually conceived the invention before publication of the invention was made, or before it was made or patented by another.

Under these circumstances, it is quite apparent that records showing when the invention was conceived, and the subsequent steps of its perfection by experiments, may be useful to sustain the validity of an issued patent, as well as to assist the true inventor to obtain the patent which another inventor claims.

### MAINTAIN PROPER RECORDS

Records of experiments of radio apparatus should always be made with pen

# Carter

TUBE SHIELD FOR THE NEW  
FOUR ELEMENT TUBES

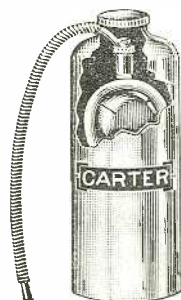

**C**OMpletely shields the tube, including the top connector. It fits snugly around the base of the Carter Adapter ring. Oscillations are entirely suppressed, and greater volume is obtained. Rich dull copper finish.

Any dealer can supply.

Write for catalog of the most complete line of Radio Parts.

"The Majority's Choice"

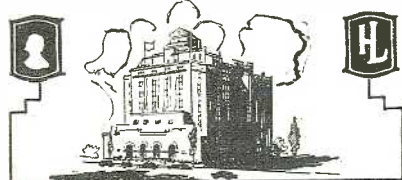

## HOTEL LAFAYETTE

ATLANTIC CITY, N. J.

A new and beautifully furnished fire-proof hotel situated on South North Carolina Ave., in the Boardwalk block near the Steel Pier. Where personal service, homelike surroundings and superior food abound. Carefully selected clientele and friendly prices. Write for Book-let D.

Arthur O. Franklin, Everett L. Cope, Proprietors

**NEWS to Set Builders**

Barawik offers set builders bigger bargains — bigger opportunities to make money this season. New sets, new kit ideas, all the leading parts, dynamic speakers, supplies, etc. Lowest rock-bottom prices. Bigger stocks, quicker service. Send for Big Bargain Book today—free.

**BARAWIK CO.,** 2128 Canal Sta., CHICAGO, U. S. A.

Mail This Coupon Now! For Free Copy

Name .....

Address .....

**FREE Wholesale Radio Catalog**

Set Builders-Dealers! Save Money!

Send for the most complete book of nationally known Parts, Kits, Cabinets, Consoles, Speakers, Power Units, Sets, etc. All at lowest wholesale prices. Quick service on all your needs. Write now, it is FREE—

**SETBUILDERS SUPPLY CO.**  
Dept. 13-6 Romberg Bldg. Madison and Market Sts. CHICAGO, ILL.

and ink. These records should comprise sketches and written descriptive matter sufficiently complete so that persons familiar with radio may comprehend the invention. Each page of the record book should be dated and, if possible, the sketches, description, and results of each experiment should be included on the same sheet.

Also, the inventors should not fail to make at least brief records of all experiments which appear unlikely to result successfully, because very often unimportant ideas result in highly profitable inventions. If the invention appears to be unusually valuable, the record sheets should be witnessed by disinterested persons; because the signatures and testimony of such persons prove beyond a reasonable doubt the authenticity of the papers.

However, signatures of witnesses are not necessary; particularly where the records are made in a book having the consecutive pages dated. On the other hand, if the records are kept on separate sheets, it is important to have disinterested persons sign the same; for otherwise it may appear doubtful that the sketches and descriptions were made on the indicated dates.

**"DILIGENCE" IS REQUIRED**

Of course, the mere fact that an inventor makes records of all experiments leading to the perfected invention does not make it sure that he will obtain a patent. Another person may already have a patent, or may have maintained records bearing earlier dates.

Moreover, the Court will not award a patent to an inventor who perfects an invention and delays an unreasonable period (such as from six months to three years) in filing an application for a patent. The safe plan is to file an application for a patent as soon as the invention is perfected.

For illustration, in one case an inventor maintained complete records of all experiments and filed these away without filing an application for a patent. About two years later, another inventor filed an application for a patent on the same invention and began successfully selling it. The original inventor immediately filed an application for a patent. In later litigation, involving ownership of the patent, the original inventor introduced as evidence the records proving that he had perfected the invention before the other inventor.

However, the Court granted the patent to the person who was last to perfect the invention, but who was first to file the application for a patent. This Court explained that proper records of experiments must be coupled with diligence of the inventor filing an application for a patent.

**MAKING A WORKING MODEL**

The records of another recent case disclose that two inventors were working at the same time and, unknown to each other, perfected the same invention. One of them perfected it and built a model which operated successfully; however, he was financially unable to file an application for a patent. Several months after this inventor had built the model, the other inventor perfected the invention and filed an application for a patent. A few months afterward, the inventor who built the model obtained financial aid and also filed an application for a patent. Considerable and lengthy litigation resulted but, finally, the patent was granted to the individual who had last filed his ap-

# The New Knapp "A" Power Kit

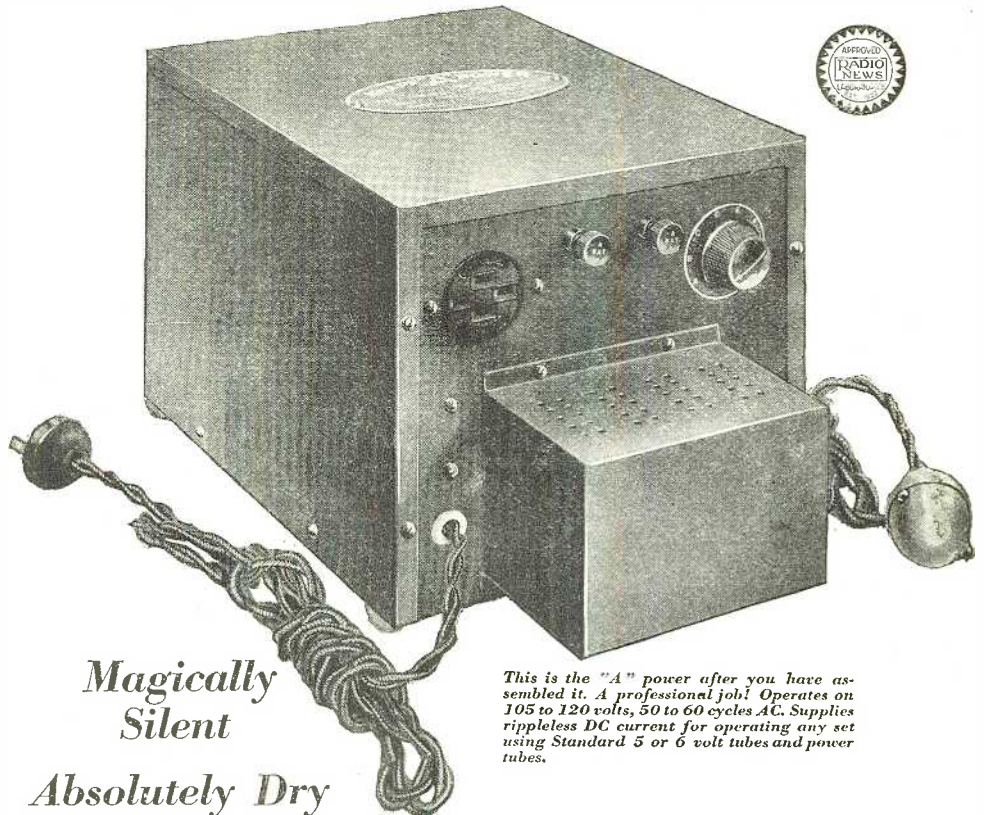

This is the "A" power after you have assembled it. A professional job! Operates on 105 to 120 volts, 50 to 60 cycles AC. Supplies rippleless DC current for operating any set using Standard 5 or 6 volt tubes and power tubes.

*Magically  
Silent*

*Absolutely Dry*

**Greatly Improved—and at a Lower Price  
New Money-Making Plan for Set-Builders**

The new Knapp "A" Power has all of the features of the old model—magic silence—absolutely dry—"B" Eliminator receptacle—voltage regulator—complete, tooled part kit, etc., etc., and also eight new improvements which make it the finest "A" Power ever put out.

Compare the appearance, read the improvements—and remember that the price has been reduced!

*The Only "A" Power Adaptable to Short Wave, Super-Heterodyne and Television Reception*

The Knapp "A" because of its superior filter system and the special Elkon rectifier is so silent and so steady that it functions perfectly.

**The 8 Improvements**

1. Larger Filter System—3 Elkon Condensers instead of 2. Ideal for Super-Hets, Short Wave sets and Television.
2. Improved Choke Coils
3. Pendant Switch Controlling "A", "B" Eliminator and Set
4. Dial for regulating voltage
5. Celeron Front Panel
6. Baked finish
7. Heavier gauge metal cover
8. Die Cast Base Plate instead of wood

**COMPLETE KIT—EASILY ASSEMBLED**

The New Knapp Kit is a tooled job—the parts seem to fall into place.

Every hole is drilled—all you do is put the screws and nuts in place and connect a few wires. Just follow instruction sheet. No extras to buy.

**THE SET-BUILDER TAKEN CARE OF**

Regardless of what the established trade may think about it—I am going to continue to give you the maximum discounts. The coupon will bring you the full details of both the new "A" Power and the special discounts to set-builders.



David W. Knapp, Pres.  
**KNAPP ELECTRIC, INC.**  
—Div. P. R. Mallory & Co., Inc.—  
350 MADISON AVE., N. Y. CITY

Mr. David W. Knapp, President,  
KNAPP ELECTRIC, Inc.,  
Dept. K-25, 350 Madison Ave., N. Y. City  
Kindly send me complete information on the  
Knapp "A" Power and your special discounts for  
Set-Builders.  
Name.....  
Address.....

Type PL-1152 especially designed for the Thordarson 250-2 Stage Power Amplifier and Plate supply, and Thordarson 250 Plug in Power and Plate Supply. Used with Thordarson T-2900 Power Supply Transformer. Price \$17.50



## CONDENSER CANS LOOK ALIKE . . . . BUT WHAT IS INSIDE?

The condensers on a dealer's shelf look very much alike. The sly manufacturer is wise enough to make his product look like the best—but he cannot put the "guts" into it and charge the low prices he does. The name Dubilier on any condenser is your safeguard. You know that Dubilier condensers are honestly made with oversized capacity and a factor of safety that has made them the standard of the leading manufacturers.

## YOU CAN FORGET THE CONDENSERS— IF THEY ARE DUBILIERS

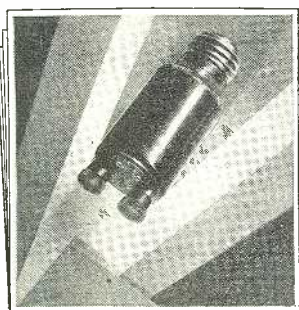

**Dubilier  
Light Socket Aerial**  
"A Moulded Bakelite Product"

A simple device plugged into any light socket—does away with aerials and lightning arrestors. Guaranteed to work on your set. No current consumed. Sold by good dealers on a 5 day, money-back basis. Price \$1.50

Write to Dept. 10  
for free  
catalog.

**Dubilier**

**CONDENSER CORPORATION**



10 E. 43d St.  
New York

Reg. U.S. Pat. Off.

plication, but had perfected and made the model first.

The outcome of this latter case demonstrates the advisability of all experimenters making and keeping models of their inventions. In other words, an inventor who constructs a model automatically acquires the same priority date, as if he files an application for a patent on the day the model is completed.

For example, in one case it was disclosed that an inventor, who kept no records of his experiments, finished a successful model of his invention on July 19, and filed an application for a patent on September 10. Another inventor, who maintained no records and did not construct a model, filed an application for a patent on July 21 on the same invention.

It is interesting to observe that the inventor who built and operated a model on July 19 and filed no application for a patent until two months later was awarded the patent.

Therefore, it is quite apparent that proof of construction and successful operation of a model is equivalent, with respect to priority, to filing an application for a patent.

However, the inventor must not delay in filing an application for a patent longer than two years after he sells the invention or offers it for sale, or places it in public use, otherwise he cannot obtain a patent.

## Short-Wave Operation

(Continued from page 553)

cycles; the only difference frequency which can be produced will be due to the "modulation" of the signal. Should there be any difference in frequencies, the result, of course, will be a "beat note" instead of the "zero beat."

"Zero beating" provides a method whereby the detector may be brought up to its most sensitive working point, and should be used in all cases where very faint phone signals are to be brought in. The listener may have noticed at some time or other that, while tuning his receiver, he spotted a phone signal just between two whistles, or "heterodynes." This is "zero beating" and the whistle on either side of the voice, or music, is a beat-frequency, no longer a zero beat.

### WHAT TO EXPECT

After the signal is located between the beat notes or whistles, the tickler is adjusted to the point where the voice is loudest and still understandable. True, music received under these conditions will sound somewhat "mushy," but the voice may be made out, providing the receiver has been properly tuned.

It is to be doubted whether any experimenter on short waves is most anxious for quality reproduction at this stage of the game. If good music, well transmitted, is sought, the higher waves of nearby broadcasting stations provide the best, except for the listeners who have no good locals; but if distant announcements are desired, try "beating" the higher frequencies. This does not mean that just as good quality cannot be obtained from the low waves as on the higher, but it is a known fact that a long-distance signal which has been carefully tuned in will lose some of its quality and, perhaps, even acquire noticeable distur-

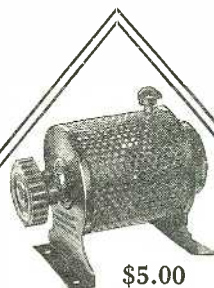

\$5.00

## TELEVISION simplified!

Controlling the receiver scanning disk—that's the big problem in television. Yet there is nothing to it when you have the

## SPEED CONTROL CLAROSTAT

Reg. U. S. Pat. Office

You can bring the scanning disk to speed and hold the image on the screen as easily as you steer your car.

A handsome and useful device, this SPEED CONTROL CLAROSTAT. Controls any variable speed motor of 1/2 h.p. or less, from standstill to practically full speed in several turns of knob. Push-button for quick starts and for momentary acceleration. Heavy metal case. Properly ventilated. Protected screw terminals. 25 to 500 ohm resistance range. 80 watt rating. Readily mounted. Convenient. AND IT SELLS FOR \$5.00.

Ideal for television. BUT THAT'S ONLY HALF THE STORY. The SPEED CONTROL CLAROSTAT has no end of applications in radio and electrical work where a variable or fixed heavy-duty resistance is required.

WRITE for literature regarding the SPEED CONTROL CLAROSTAT as well as other Clarostats for every radio purpose. Better still, send 25c for "The Gateway to Better Radio"—the best investment you ever made in radio.

Clarostat Mfg. Co., 281 N. 6th St., Brooklyn, N. Y.

## CONTROL

Prevent the ups and downs of your tubes. Install AMPERITES—the filament control that keeps voltage constant. AMPERITES insure long tube life and better reception. A type for every tube—battery or A. C.

\$1.10 with mounting (in U.S.A.)

Radiall Company,  
30 FRANKLIN ST., NEW YORK



FREE New "Amperite Blue Book"—brim full of useful radio pointers and circuit diagrams. Write Dept. R.N. 12

## AMPERITE

REG. U.S. PAT. OFF.

The "SELF-ADJUSTING" Rheostat

## SET BUILDERS Get this Book

LATEST RADIO GUIDE

FREE

Barawik, the first and oldest radio specialty house, offers you unusual service this year. Bigger stocks, quicker shipments, lower prices. Deal with an old established, reliable house. Get honest goods, honest service, honest prices. Barawik service makes you more money. Send now for big new Catalog showing lowest wholesale prices.

**BARAWIK CO.** 212J Canal Sta., CHICAGO, U. S. A.

Mail This Coupon Now for Free Radio Guide

Name \_\_\_\_\_  
Address \_\_\_\_\_

## ACME PARVOLT CONDENSERS

By-pass and Filter Condensers in all required MFD capacities and working voltages. Filter Condensers supplied in individual units or in completely wired and housed blocks for the more important power amplifiers. Made by The ACME WIRE CO., New Haven, Conn. Manufacturers of Acme Celatite Wire—high insulation value, non-inflammable.

tion. This may have been noted in the reception of distance on the broadcast bands, and the same assertion will hold true for the short waves; especially as far greater distances are covered by the latter. However, if music is received on the higher frequencies with loud-speaker volume, there is no reason why, other things being equal, it should not have the same quality as reception on the broadcast bands.

### Some Easy Experiments with Oscillators

(Continued from page 535)

this rather crude way. However, the method given here allows one to produce audio currents of any frequency within hearing and these can be maintained quite constant over a period of time; so that any given loud speaker can be compared with any other at any particular audio frequency, and thus more accurate comparisons can quite easily be made.

Since it is the difference-frequency which is the audible one in this case, and the difference-frequency changes very rapidly, relatively speaking, as the radio frequency of one of the oscillators is varied, one must provide a very small condenser and connect this in parallel with the larger one used in the oscillator. Small frequency-changes are also caused by "hand capacity," so that one should use a condenser not influenced by these effects or else (a better way) mount all parts away from the front panel and use a small extension handle on this midget condenser. When the large condenser is properly adjusted, the audible frequencies can be produced by varying the small condenser.

Ordinarily one need not know any more about these audio frequencies than that they are "high" or "low," and this can be judged by the ear. However, if the frequencies must be known, the set can be calibrated by using a tuning fork and adjusting for zero beat at the natural frequency of the fork. A small (.001-mf.) condenser, as shown in Fig. 4, should be used to by-pass the radio-frequencies around the loud speaker. The type of tubes used in the oscillators will depend on the volume desired. Any audio frequency may be amplified with an A.F. transformer but, if the response of a loud speaker is to be compared at the various audio frequencies, even approximately, the transformer may introduce a slight degree of distortion. It is not necessary to have the signals very loud for comparison and it is often better to compare the speakers at a low volume of sound, as the ear is more sensitive to changes when the sounds are not so loud.

#### MEASURING ELECTRICAL VALUES

Inductances and capacities also may be compared by means of the two oscillators. By arranging a double-throw switch for one of the oscillators, either a capacity of known value or one unknown can be connected to the oscillator circuit. (Fig. 5.) With the known value of capacity (calibrated variable condenser, fixed condenser or any kind of a "capacitor" connected to No. 2 oscillator) the other (No. 1) is adjusted to give "zero beat." The condenser to be measured is then connected by throwing the switch to the other side and is

# Your Present Radio

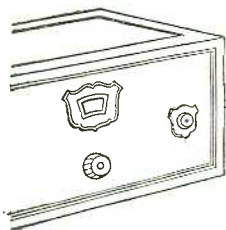

... can be made an Electric A.C. Set *without changes in wiring or even the cost of new tubes*

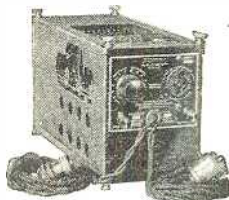

**Kuprox A. C. Power Pack.** Makes any battery set an electric A. C. receiver. \$32.50 up.

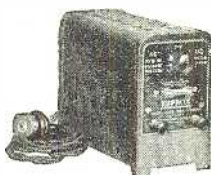

**Kuprox Multi-rate Rectifier.** for trickle charging, dynamic speaker operation, etc. \$11.50



**Kuprox Replacement Unit** eliminates acids, liquids, bulbs from trickle chargers \$5.00

THERE'S no necessity for discarding a good battery operated receiver to get the convenience of A. C. operation. The Kuprox A. C. Power Pack converts any good set into an electric A. C. set, without changes of any kind in wiring, without the use of harnesses or adapters.

Kuprox equipped, your present set, using your present tubes will give you super-fine A. C. operation. Everything your radio did before, it will do even better. And there's nothing to bother about . . . the entire set turns on and off at your light socket. The Kuprox A. C. Power Pack is a permanent addition to your set that will double your radio enjoyment.

Several models are offered. One that supplies all radio power for any size set. Or separate filament and plate models for those who desire this form. And an efficient "A" model that supplies filament current and will operate in conjunction with any good "B" eliminator. Priced from \$32.50 up. See the various models at your radio dealer's. Or, if you first desire more information, we'll be glad to send it if you will write.

TELEVISION! Kuprox A. C. Power Packs are necessary for operating television receptors, which require perfectly smooth D. C. current for motor supply, filament, plate and glow circuits.

THE KODEL ELECTRIC & MFG. CO.  
Formerly The Kodel Radio Corp.

501 E. Pearl St. . . . Cincinnati, Ohio

# KUPROX

## A.C. POWER PACK

# Inspect your Antenna System NOW!

Your radio receiver needs a high grade aerial system if you want consistently good reception. The Belden Aerial Kit contains all the parts of a fine antenna system—each part matched for perfect results. Replace your old aerial with a Belden Aerial Kit. Your antenna system will then be permanent—it cannot corrode! See your dealer, now.

**Bare Copper Aerial Wire Corrodes Rapidly**



**Belden Aerial Wire is protected against corrosion.**



**Other Belden Radio Products**  
 Indoor Aerial Kits, Colorubber Hookup Wire, Aerial Accessories, Battery Cords, Extension Cords and a dozen other items are included in the Belden Line.

Ask your dealer to show you the new Belden Loudspeaker Extension Cord that is flat and lies under the rug. No unsightly wiring around the room. Does not wear the rug.

**Belden Manufacturing Co.**  
 2314-A S. Western Ave.  
 Chicago



# Belden

varied for the same condition. The capacity at this dial-setting must therefore be the same as that of the other condenser at its known rating or dial-setting. From various values a complete calibration for any variable condenser can be obtained and capacity values in general may be measured.

Inductance values also may be compared; the procedure is similar. The value of the unknown inductance can be varied by means of a clip making contact with the various turns of a coil until the approximate value is obtained, or the turns can be reduced until the proper value is secured. The usual problem is to make a coil covering the same range as some other coil. This is easily done by varying the number of turns in the inductance of unknown value. Of course, if a coil having a definite value in microhenries is available, one can calibrate other similar ones. If the capacity of a circuit is known, a simple calculation will give the inductance value in microhenries, or *vice versa*.

Take the wavelength of a circuit, determined by comparison with a known standard of broadcast frequency. Square it and divide by 3.55; the result is the product of the microhenries in the circuit by the micromicrofarads. When either the inductance or the capacity is known, it is easy to find the other.

For instance, if the wavelength is 296.9 meters (that of Station WRNY) its square is 88,150. The product of the capacity and the inductance is then 24,831. If the capacity is 225 micromicrofarads (.000225-mf.) the inductance in the circuit is 110 microhenries; and so on.

This calculation is very slightly inexact, but quite good enough for all practical purposes. The self-capacity of the circuit, the inductance of its leads, etc., will cause a much greater error—one which laboratory methods are necessary to remove entirely.

The wavelengths of the better-known broadcast stations are controlled by crystal devices and kept very accurate, so that an oscillator of this kind can be calibrated by observing when it is in exact "zero-beat" relation to the carrier-wave of such a station or its "harmonics," which are even fractions (one-half, one-third, one-quarter, etc., of its wavelength).

The experimenter who is interested in the formulas for calculating such circuits will find them in textbooks and in the literature issued by the Bureau of Standards. The fundamental formula is that "the frequency (per second) is equal to 1 divided by 6.28318 times the square root of the product of the capacity in farads by the inductance in henries." (6.28318 equals 2 "Pi," or the ratio between the radius of a circle and its circumference.) From this, for instance, is derived the formula above, which is better adapted to use with radio frequencies.

Many other interesting tests can be performed with apparatus of the type described in this article, and articles are continually appearing in the radio press which will suggest new uses for such oscillators to the ingenious reader.

**ANOTHER VERSION**

HARRY: "MacTavish never tries to get anything but locals on his set. I wonder why?"

PATRICK: "Whisht! Don't you know he thinks there's an extra charge for long distance?"—*Wm. G. Mortimer.*

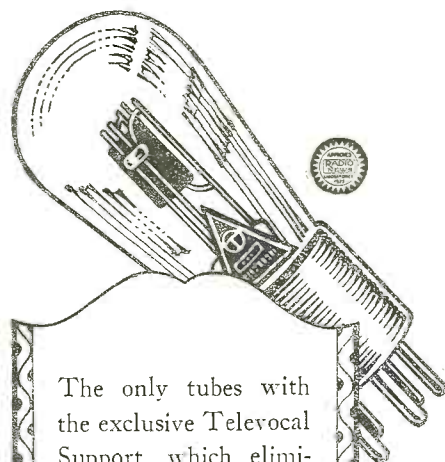

The only tubes with the exclusive Televocal Support, which eliminates microphonic noises. Made in all standard types. Ask for them at your dealer's.

**Televocal Corporation**  
 Televocal Building  
 Dept. A-5  
 588—12th Street  
 West New York, N. J.

# Televocal Quality Tubes



## Junior Rheostat



Small in size, but a master instrument. Ask your dealer to show you the exceedingly fine adjustment and velvet smooth action. Diameter, 1 1/8 in.

- Up to 400 ohms. .... \$0.75
- 1,000 and 2,000 ohms. .... 1.00
- Potentiometers. .... extra .25
- Self-attaching, positive-acting switches for Junior Rheostats. .... .40

### FILAMENT AND GRID TYPE RESISTANCE UNITS

Here is where you need absolute dependability and you get it with Yaxley Resistance Units. Run true to rating. Convenient screw eye and soldering lug terminals for easy mounting. One to 3,000 ohms, 15c. to 40c.

**YAXLEY MFG. CO.**

Dept. N 9 So. Clinton St., Chicago, Ill.

### More Profits To Set Builders

One good radio idea may be worth millions. Barawik has thousands of ideas for radio set builders to make more money. Barawik's Big Radio Book will help you while elections are on and big national events stir the world.



Send for your copy today — NOW. **BARAWIK CO.** 212C Canal Station, CHICAGO, U. S. A.

Mail This Coupon Now! For Free Copy  
 Name .....

Address .....



## Socket-Power Operation for the Old Set

(Continued from page 557)

points to observe, namely: the application of the proper voltages on filaments, plates and grids; and confining the radio-frequency currents to their proper circuits.

Thirdly, there is the A.C. tube, which may be applied either by rewiring the receiver; or, what is far simpler and usually preferable, by substituting A.C. tubes for the usual battery tubes, without rewiring, by means of a "harness" or ready-made wiring cable, together with a suitable step-down transformer. The harness method provides excellent results, and there is a harness available for practically every type of battery-operated receiver.

### "B" POWER UNIT ESSENTIAL

It should be noted that, irrespective of the method of conversion, a "B" power unit is essential. Therefore, the investment made in this instrument is a lasting one. The only change with the "B" unit is to plug it into the same source of lighting current as the filament supply, and to provide a common switch which will turn the entire set on or off.

There is an erroneous idea that A.C. tubes operate entirely on alternating current, and so do away with the "B" power unit. This is far from true. While the A.C. tubes can and do operate on raw alternating current, stepped down to the required low voltage, a source of direct current for the plate is still necessary, whether it is supplied by batteries or "B" power unit. The self-contained electric receiver must include a "B" power unit.

### STATEMENT OF THE OWNERSHIP, MANAGEMENT, CIRCULATION, ETC., REQUIRED BY THE ACT OF CONGRESS OF AUGUST 24, 1912.

of RADIO NEWS, published monthly at New York, N. Y., for October 1, 1928.

State of New York,  
County of New York, ss.

Before me, a Notary Public, in and for the State and county aforesaid, personally appeared Hugo Gernsback, who, having been duly sworn according to law, deposes and says that he is the Editor of Radio News, and that the following is, to the best of his knowledge and belief, a true statement of the ownership, management, etc., of the aforesaid publication for the date shown in the above caption, required by the Act of August 24, 1912, embodied in section 411, Postal Laws and Regulations, to wit:

1. That the names and addresses of the publisher, editor, managing editor, and business manager are:  
Publisher, The Experimenter Publishing Co., Inc., 230 Fifth Avenue, New York, N. Y.; Editor, Hugo Gernsback, 230 Fifth Avenue, New York, N. Y.; Managing Editor, Robert Hertzberg, 230 Fifth Avenue, New York, N. Y.; Business Manager, Alfred A. Cohen, 230 Fifth Avenue, New York, N. Y.

2. That the owners are:  
The Experimenter Publishing Co., Inc., Hugo Gernsback, Sidney Gernsback, H. W. Secor, Dr. T. O'Connor Sloane, I. S. Manheimer—all of 230 Fifth Avenue, New York, N. Y.; Robert W. DeMott, 245 Fifth Avenue, New York, N. Y.; Mrs. Catherine Major, 545 West 158th Street, New York, N. Y.; M. M. Pluncan and L. P. McClure, 720 Cass Street, Chicago, Ill.

3. That the known bondholders, mortgagees, and other security holders owning or holding 1 per cent or more of total amount of bonds, mortgages, or other securities are: None.

4. That the two paragraphs next above, giving the names of the owners, stockholders, and security holders, if any, contain not only the list of stockholders and security holders as they appear upon the books of the company but also, in cases where the stockholder or security holder appears upon the books of the company as trustee or in any other fiduciary relation, the name of the person or corporation for whom such trustee is acting, is given; also that the said two paragraphs contain statements embracing affiant's full knowledge and belief as to the circumstances and conditions under which stockholders and security holders who do not appear upon the books of the company as trustees, hold stock and securities in a capacity other than that of a bona fide owner; and this affiant has no reason to believe that any other person, association, or corporation has any interest direct or indirect in the said stock, bonds, or other securities than as so stated by him.

H. GERNSBACK.

Sworn to and subscribed before me this first day of October, 1928.

JOSEPH H. KRAUS.

(My commission expires March 30, 1929.)

[Seal.]

# Over 60,000 Townsend "B" Power Units Now in Use -- they must be good!

They ARE good! Besides full tone, clarity and volume, you get the thrill of startlingly clear long-distance reception. Never in radio history has anything given such sensational results for such a low price. UNSURPASSED QUALITY built in with money saved by unified production methods and low merchandizing costs. New thousands of set owners learning amazing value of this Unit.

Utmost economy and convenience. Plug into light socket and forget it. Delivers up to 100 volts on any set on D.C. or A.C.—any cycle. YOU TAKE NO RISK. Sold on real GUARANTEE—it must satisfy or money paid us will be returned.

Complete  
**\$6.85**  
\$1.00 Down  
Balance C.O.D.

SEND ONLY \$1.00 Fill in coupon and send with only \$1.00. Prove this marvelous value to yourself. Use it ten days. Then if it fails to do everything we say, return it and money paid us will be refunded. Make a REAL receiver of your set.

### APPROVED

and passed by the rigid laboratory tests of "Popular Radio" and "Radio News."

### From This Month's Mail

Your Eliminator has given two years of very satisfactory service.  
S. G. Pursell, Urbana, Ill.

Have been using Eliminator every day for over a year and it has given perfect service.  
Caleb B. Miller, Elizabeth, N. J.

Have used your Eliminator for about two years and find it a money-saver.  
C. F. Bornemann,  
Chippewa Falls, Wis.

Eliminator bought fifteen months ago still going strong as ever and getting wonderful results.  
E. H. Smith, Dundas, Ont.

Eliminator sure is great. Have had it almost a year and no trouble with it.  
John M. Todd, Turtle Creek, Pa.

My Eliminator has been in use for over a year and is working fine.  
H. H. Herman, Dayton, Ohio.

Almost a year since you sent my Eliminator. It is great, and I recommend it without reserve, both for efficiency and economy.  
Wm. C. Degehman,  
Pittsburgh, Pa.

Have had your Eliminator in use for more than a year and like it fine.  
T. C. Houghland, Gardner, Kas.  
Eliminator bought from you about a year ago has given me good service.  
Fred Wicks, Albany, N. Y.

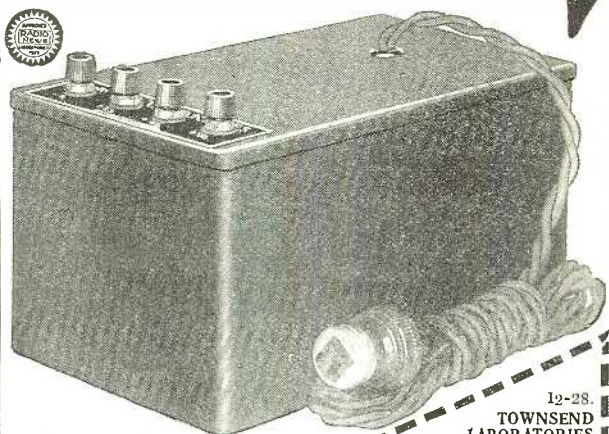

Attach only  
\$1.00  
to this  
coupon

Gentlemen: Attached find \$1.00 Power Unit, C.O.D. \$5.85, plus postage, on guaranteed 10-day Free Trial.

Name.....  
Address.....  
City..... State.....

12-28.  
TOWNSEND  
LABORATORIES  
Dept. 25,  
713 Townsend St.,  
Chicago, Ill.

### Everything in Radio at Wholesale

We supply every radio need from our mammoth stock of kits, parts and sets of latest design. Lowest wholesale prices. Expert attention; immediate service. Write for big, illustrated Catalog "B-2."

**Allied Radio  
CORPORATION**  
711 W. LAKE STREET, CHICAGO

## FLECHTHEIM SUPERIOR CONDENSERS

Best for power packs, power amplifiers, and for the countless uses to which high-grade condensers are put. Conservatively rated, dependable in operation, and very reasonably priced, Flechtheim condensers have won for themselves an enviable reputation—a fact readily attested to by custom set builders, radio amateurs and experimenters everywhere. Complete Line from 250 to 3,000 Volts D. C. Also High Grade Voltmeters for A. C. and D. C.

Write for New Catalog  
A. M. FLECHTHEIM & CO., INC.  
136 LIBERTY ST., NEW YORK, N. Y. Dept. NR.

Insure your copy reaching you each month. Subscribe to Radio News—\$2.50 a year. Experimenter Publishing Co., 230 Fifth Avenue, N. Y. C.

Please say you saw it in RADIO NEWS

# RADIO DIRECTORY



**RADIO-LITE-TENNA**

Write for details

**AERIAL INS. CO.**  
GREEN BAY, WIS.

**AMERICAN**



Sub-Panel Brackets  
Sub-panel brackets in various sizes ranging from 1" to 2 1/2" in height and from 7" to 11" in length. Cut illustrates No. 11. Write for literature.

**American Radio Hardware Co.**  
Dept. 108, 135 Grand St.  
New York, N. Y.

**MAJESTIC CONE**  
Natural Tone



List Price \$12.50  
**YOUR PRICE \$2.25**  
Postpaid

Designed for use with or without power tubes

**AMPLIFLEX LOOPS**  
Collapsible, Folding — Built-in Compass. List price, \$32.50; our price, \$2.79, postpaid. Write for Special Bargains now.

**SPIEGEL RADIO COMPANY**  
135 Liberty St., New York City



**BIRNBACH**

Moisture-Proof Extension Cords

Birnback Extension Cords permit the Loud Speaker to be moved to any room in the house. Attaches instantly. Install a Birnback Cord and put an end to distortion so often due to badly insulated cords. Your neighborhood dealer has these sizes in stock: 10-20-30-40-50-100 foot lengths. Send for Catalog.

**BIRNBACH RADIO CO.**  
254 W. 31st St., New York



If you want more hours of service per tube, insist upon

**PERRYMAN RADIO TUBES**

"The tubes with the patented shock-proof bridge."

A tube for every radio purpose. All the A.C. types. Write for literature.

**Perryman Electric Co., Inc.**  
33 West 60th Street  
New York City

**USE YOUR RADIO MORE!**  
Thousands of homes get more use of their radio because of the exceptional economy and dependability of our "R" and "AII" equipment. WRITE!

**KIMLEY ELECTRIC CO.**  
441 East Ferry St.  
Buffalo, N. Y.

**BAKELITE PANELS**  
MAHOGANY or BLACK

7 x 18.....	1/8	3/16
7 x 21.....	1.20	1.75
7 x 24.....	1.40	2.00
7 x 26.....	1.50	2.15

All Odd Sizes Cut to Order, 1/2c per Sq. In.  
Mail Orders Filled Same Day  
Send Money Order, Plus 15c for Postage

**CENTURY RADIO PANEL CORP.**  
Now located at  
67P Cortlandt St., New York  
Telephone Rector 7468

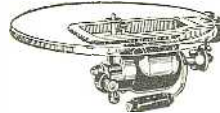

**BODINE ELECTRIC TURNTABLE**  
For radio-phonograph combinations — no brushes, no commutators, no sparking. Positively no interference in the loudspeaker. Write today for full information on this big new development.

**BODINE ELECTRIC CO.**  
2264 West Ohio St., Chicago, Ill.

**Lincoln 8-80**  
One-Spot Super

Custom set builders all report Coast to Coast reception with heavy volume in summer time. New engineering principles throughout.

No harmonics, no oscillation, 10 K.C. separation with tremendous volume.

Complete Kit \$92.65.  
Enclose 25c for "Secret of the Sleeper."

**Lincoln Radio Corp.**  
329 S. Wood St., Chicago

**SEND NOW for New 1929 WESTERN RADIO'S CATALOG**

LATEST and FINEST nationally known A.C. sets, consoles, cabinets, speakers and accessories at **LOWEST PRICES**. Catalog sent FREE on request.

**WESTERN RADIO MFG. CO.**  
128 W. Lake St.  
Dept. RNC11 Chicago

**O'NEIL Dynamics**

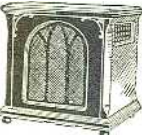

*The Speaker Hit of the Season*

Two types—one for A.C. operation, the other for D.C. Equipped with our dynamic units. Beautiful two-tone walnut finish to match the popular sets. Write for literature.

**O'NEIL MFG. CORP.**  
West New York, New Jersey

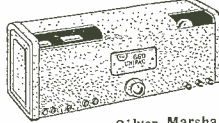

Silver-Marshall  
660-171A UNIPAC

Supplies complete "A-B-C" Power. Contains built-in push-pull amplification stage requiring two 171A type power tubes.  
List Price, Wired \$76.00 **\$29.50** YOUR COST

In Kit Form—Your Cost \$26.50  
ALL NEW SEALED CARTONS.  
**RAUNER RADIO CO.**  
142 Liberty St., New York City

**Balkite Radio**  
In cabinets by Berkey & Gay



**Fansteel Products Co., Inc.**  
NORTH CHICAGO, ILL.

**REMLER "29"**

Marvelously realistic reproduction—Perfect control of volume—Clean cut separation of stations—Superheterodyne sensitivity—Shield grid amplification—Easy to build—Can be assembled, wired and put into operation in one evening—Eliminator or battery operated—Unit construction—All difficult wiring done at factory—Power amplification—Reasonable cost—Complete parts in stock—Immediate shipment—Write or wire for full information.

**NEWARK ELECTRIC CO.**  
226 W. Madison  
CHICAGO



For great power with quality use

**SAMSON Symphonic Push Pull Units**

Send for full data on P. P. Transformers and Chokes.

**SAMSON ELECTRIC CO.**  
CANTON, MASS.



**BAKELITE and HARD RUBBER DRILLING — ENGRAVING PUNCHING — STAMPING Latest Circuit Panels in Stock**

We cater to retail as well as manufacturing trade.

**Cortlandt Panel Engraving Co.**  
165 Greenwich St., N. Y. C.

**SPEAKER TABLE**



Beautiful Colonial design. Solid walnut, hand rubbed. Size, 30" x 12 1/2" and 31" high. Made with Temple Air - Chrome speaker or for dynamic speaker. This is only one of many beautiful Fritts creations for this year. Write for full particulars and free catalog.

**D. H. FRITTS & CO.**  
604 Hearst Bldg., Chicago

**200,000 RADIO NEWS** readers carefully scan the **RADIO DIRECTORY** every month.

**YOUR** product here, at the lowest cost in the world's largest and most widely read radio magazine.

**RATE PER ISSUE \$25.00**

No order for less than three insertions accepted. Write for information.

**Radio News, 230 5th Ave.**

**TELEVISION Kits and Parts**



Complete receivers assembled in 15 minutes. 5 models from \$37.50 up.

**DISCS MOTORS NEON TUBES AMPLIFIERS** and other parts

Write for Catalog

**Insuline Corp. of America**  
78-80 Cortlandt St., N. Y. C.



**BRAUN'S RADIO**

Dealers, write for catalog.

**W. C. BRAUN CO.**  
552 Monroe St., Chicago



**NOPHONONIC TUBE CAPS**

Stop That Howl!

To get the best from your set, be sure that all tubes will employ Nophononic Tube Caps. Stops all vibration of the filament. List Price..... 25c

Ask your dealer or write direct

**MERTZ SPECIALTY CO.**  
1308 Stockton Street  
Wilmington, Del.

**Pacent PHONOVOX THE ELECTRIC PICK-UP**



**Pacent Electric Co.**  
Inc.  
91 7th Ave. New York

**FAMOUS FAHNESTOCK CONNECTION CLIPS**

PRESS DOWN HERE

Fahnestock clips meet every demand of the radio public.

Use them for appearance, positive contact, and durability. Write for catalog or pick them out at your nearest dealers.

**FAHNESTOCK ELECTRIC CO.**  
Long Island City, New York

**SEND FOR NEW RADIO BOOK**

All the new hook-ups. Parts, supplies, A.C. sets, television, short wave, etc.

Write for free copy now.

*The Barawick Co.*  
211 B Canal Sta., Chicago



**HEAVY DUTY "B" POWER — \$18.50**

Complete with Tube. Delivers up to 180 volts on any set. Dry—no liquids. Write for literature.

**FERBEND ELECTRIC CO.**  
425 W. Superior St., Chicago, Ill.

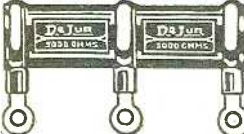

**DE JUR VITREOUS ENAMELED POWER RESISTANCES**

For "B" eliminators, power amplifiers and electric sets. These resistances are backed by 16 years of continuous, satisfactory service to the radio public. Write for catalog.

**DE JUR PRODUCTS CO.**  
199 Lafayette St., New York, N. Y.

**SAVE YOURSELF MONEY**

**SEND FOR OUR MONEY SAVING CATALOG Now**

**SET BUILDERS DEALERS!**

Save money, time and bother by purchasing kits and parts from us. Maximum discounts to dealers. Latest kits and parts always in stock. Send NOW for catalog.

**Wholesale Radio Service Co.**  
6R Church St.  
New York

**NAME PLATES**

WE SPECIALIZE IN NAME PLATES OF ALL VARIETIES: ETCHED PLATES, EMBOSSED PLATES AND RADIO ESCUTCHEON PLATES

Write for Samples and Prices.

**ETCHED PRODUCTS CORP.**  
Queens Boulevard,  
LONG ISLAND CITY - N.Y.

**CORWICO BRAIDITE Hook-Up Wire**

"The Braid Slides Back" Make your connection, solder it and the insulation slides right back into place. If your dealer can't supply you, order direct

25 Ft. Solid, 30c  
25 Ft. Stranded, 35c

**CORNISH WIRE CO.**  
32 Church St., New York

**Send for This**

We have a new illustrated catalog showing our up-to-the-minute stock of kits, parts and sets — everything you want in radio — all at dealers' wholesale prices. Write today for Catalog "B-2."

**ALLIED RADIO CORPORATION**  
711 W. Lake St.  
Dept. "B-2," Chicago, Ill.

The RADIO DIRECTORY is your buying guide. Space permits display of only one product at a time. Write advertisers for complete catalogue.

# RADIO DIRECTORY

**LUND RADIO CABINETS**  
Our line includes twenty different models. There is a suitable cabinet or table for every set and every requirement. Write for complete illustrated catalog.

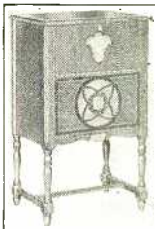

Model 5, Walnut  
Price \$25.00

**HELLO JAPAN!**

Hello China; Hello Australia; Hello New Zealand; Hello Ireland; Hello Danzig, 9,000 miles away; Hello Iceland, 10,000 miles away. All confirmed reception. Most amazing performance of any Radio Receiver ever designed. U. S. Stations all locals on the Magnaformer 9-8. Write today for FREE X-RAY Wiring Diagram and Instruction Sheet.

Radiart Laboratories Co.  
1012 Assn. Bldg., Chicago, Ill.

**THE B. B. L. MOTOR**

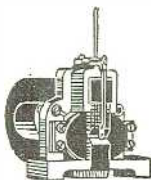

An improved motor for loud speaker operation. Power without saturation. Eddy currents reduced to minimum. Permanent adjustment assures the highest quality tone reproduction.

Write for details

**BEST MANUFACTURING CO.**  
200 Grove St. Irvington, N. J.

**Shield Grid PLUG-IN KIT**



No. 222

An efficient shield grid plug-in kit consisting of two units Nos. 222A and 222C for use in the form of a shield grid circuit. Write for literature.

**Twin Coupler Company**  
Poughkeepsie New York

Set Builders! Mfrs! Experimenters! Save Jobber and Dealer Profits by Buying Direct

**QUALITY A. C. Filament Transformers**—Input; all types 115 volts, 60 cycles. **RCA**—Supplies six 226s, two 227s, and two 171s. **ARCTURUS**—supplies nine or less Arcturus 15-volt tubes. **KELLOGG**—supplies ten 3-volt filaments.

State type wanted.  
List price \$8.00.  
**Factory to You Price—\$3.90 prepaid.**

**Quality Transformer Co.**  
Box 135 Oak Park, Ill.

**BUILD YOUR OWN Exponential Horn**

This marvelous 17x21-in. exponential horn with a 36-in. air column can be easily built of 1/4-in. soft wood by any amateur. It produces the most wonderful tone quality. We furnish you with a set of FULL-SIZED PATTERNS, which have been accurately and scientifically worked out according to the exponential principle. Simply saw out the wood to the size and shape of the patterns and nail and glue together and you have the latest and

**MOST EFFICIENT TONE PRODUCER AN IDEAL XMAS GIFT**

Send \$2.00 for a set of these full-sized patterns and complete instructions, or we can furnish you the COMPLETE KIT, which includes the wood cut to fit, the nails, the glue, our large-sized CONCERT UNIT, and full instructions. All complete with postage prepaid for \$11.75 in the United States and \$12.75 in Canada.

**RADIO PRODUCER COMPANY**  
1245 Jefferson Bldg. Peoria, Ill.

## Why the Vacuum in Vacuum Tubes?

ABOUT the most difficult production job ever undertaken by modern industry is putting nothing into glass bottles and selling them as vacuum tubes. In other words, the attaining of the highest vacuum, or degree of next-to-nothing, is a feat which challenges the best efforts of research and production engineers. Yet a vacuum tube can be no better than its vacuum; for upon a good vacuum, in the first place, and the maintenance of that vacuum, in the second, depend the performance and the life.

Now the degree of vacuum in a vacuum tube (or rather, the amount of air remaining as an impurity of the vacuum) is measured in microns. One micron represents one one-millionth part of the usual atmospheric pressure, which is 14½ pounds per square inch. Perfect vacuum would be zero microns; but such a condition is a theoretical ideal that can never be realized even with the most intricate laboratory technique. Even a partial vacuum represents a bitter struggle between Nature and the engineer.

The interior of the usual incandescent lamp represents a vacuum down to about 150 microns. Pumping is carried to a given degree of vacuum in the short space of time dictated by economic considerations; following which the "getter" (which amounts to a chemical broom) is employed to sweep out or clean up the remaining water vapor and all possible gas in order to obtain a satisfactory vacuum. Phosphorus is the usual getter, and it leaves no perceptible lining on the glass bulb.

In radio vacuum-tube production, however, pumping is carried to a far greater degree. The usual pumping produces in 72 seconds a vacuum down to about 90 microns, which is the usual economical compromise between sufficient vacuum and production speed. The "getter" then brings the vacuum down to two or three microns, which is the usual standard for vacuum tubes available to the general public. Special vacuum tubes, particularly the Western Electric tubes, attain less than one micron of vacuum, due to long and individual pumping of each tube. However, such production is costly; so that such tubes are not suitable for ordinary broadcast receivers.

Long tube-life, as well as uniform and satisfactory performance, are direct results of the degree and the permanence of the

## Potter Condenser

Selected by leading manufacturers to be used in the finest radio set makes it safe to follow their good judgment.

Insure the operation of that radio set and power amplifier with the use of Potter Condensers.

Potter T-2900 Condenser Block for the single 250 type tube amplifier—\$20.00.

Potter T-2950 Condenser Block for the push-pull 250 type tube amplifier—\$22.50.

Potter R-171 Condenser Block for power packs arranged for output for the 171 type power tube—\$12.75.

Potter SR-210 Condenser Block for power packs designed for operation with the 210 type power tube—\$15.50.

### Potter Extra Duty Condenser

For Grid and By-Pass work. Constructed with high and permanent resistance giving no current leak.

The radio frequency is low so as to pass all effective currents.

Each condenser tested with 2,000 volts direct current.

### Potter Interference Eliminator

Enjoy radio broadcast programs normally spoiled by interference from oil burner, ice machine motors, fans, violet rays, vacuum cleaners, etc.

Simply connect a Potter Interference Eliminator to the line circuit at the point where interfering device is connected and your troubles will be over.



## Potter Manufacturing Co.

North Chicago, Ill.

A National Organization at Your Service

**Wholesale Prices on RADIO**

Get our big new 1929 Radio Catalog—hot off the press. Contains thousands of amazing bargains. Latest, nationally advertised Radio equipment. Latest in Ham Transmission equipment. Everything at lowest wholesale prices.

**NEW RADIO CLUB—Big Prizes**

Get all the facts about "Ether Trappers" Club, now. No dues. Many advantages. Write for FREE Membership at once.

This Big Book of money-saving bargains is yours FREE. A regular Radio encyclopedia. Write today for your copy of this book.

**AMERICAN RADIO & MERC. CO.**  
Dept. 10  
American Radio Building  
KANSAS CITY, MO.

**NEWS to Set Builders**

Barawik offers set builders bigger bargains—bigger opportunities to make money this season. New sets, new kit ideas, all the leading parts, dynamic speakers, supplies, etc. Lowest rock-bottom prices. Bigger stocks, quicker service. Send for Big Bargain Book today—free.

**BARAWIK CO.** 211AA Canal Sta. CHICAGO, U. S. A.

Mail This Coupon Now! For Free Copy

Name .....

Address .....

# Enjoy LOUD SPEAKER OPERATION from a CRYSTAL

NO "TUBES" - NO "B" BATTERIES - NO COSTLY "ELIMINATORS"

## WITH THE SKINDERVIKEN TRANSMITTER UNIT

Simple microphone unit provides a most effective and inexpensive way to satisfactory speaker operation. Easy to build and operate circuit.



Everybody can do this now with a Skinderviken Transmitter Unit.

The unit is fastened to the diaphragm of the speaker unit. It will act as a "microphonic relay." Every time an incoming signal actuates the diaphragm, the electrical resistance of the microphone unit will be varied correspondingly and the current from the battery, in series with it and the loud speaker, will fluctuate accordingly.

Thus the problem of securing sufficient power to actuate the loud speaker is simply and adequately solved.

The results from this very novel and simple unit will astound you.

The expense of this hook-up is trifling compared to the elaborate tube circuits that give no greater actuation of the speaker.

Besides this there are many other valuable uses in Radio Circuits for this marvelous little unit. Every builder of Radio sets should have a few on hand.

### LISTENING THROUGH WALLS

This Unit makes a highly sensitive detectaphone, the real thing—you listen through walls with ease. Plenty of fun and real detective work too.

### CONDUCTING SOUND THROUGH WATER

Make yourself a miniature submarine signaling apparatus like those used during the war. Simple circuit with this microphone unit gives splendid results.

### 12-PAGE INSTRUCTION BOOKLET

containing suggestions and diagrams for innumerable uses, furnished with each unit.

### P. G. MICROPHONE TRANSFORMER



A Modulation Transformer specially designed for use with the Skinderviken Transmitter Unit. Has many other uses. Primary resistance, 1/2 ohm; secondary, 55 ohms. **\$2**

### FOR SALE AT LEADING DEALERS

Or Order Direct, Using Coupon Below

## SEND NO MONEY

When the postman delivers your order you pay him for whatever you have ordered, plus a few cents postage.

PRESS GUILD, INC. R.N.-12-28  
16-18-R—East 30th St., New York, N. Y.

Please mail me at once as many of the following items as I have indicated.

... Skinderviken Transmitter Units at 95c. for 1; \$1.75 for 2; \$2.50 for 3; \$3.20 for 4.

... P. G. Microphone Transformers at \$2.

When delivered I will pay the postman the cost of the items specified plus postage.

Name.....

Address.....

City..... State.....

vacuum. An insufficiently evacuated tube will be "soft"; which means that it cannot withstand the "B" voltage necessary for amplification purposes. Such a tube can be used only for detection. An improperly-made tube may start out with a sufficient vacuum, only to soften gradually during use.

The de-gasification of metal parts is an art in itself. Solid as nickel and molybdenum wires and plates may seem, these metal masses are, in reality, metallic sponges soaked with air which must be driven out by heating, and replaced by some inert gas before these parts can be sealed in a vacuum. Otherwise, these gas-soaked parts, when heated during the operation of the tube, will give off water vapor and gas, causing poor operation and early termination of the tube's useful life.

The exhausting and sealing of vacuum tubes is carried on today in continuous-production machines, which may be likened to a merry-go-round. One girl attendant loads the assembly of glass and metal, called the "stem," together with the glass bulb slipped over it, while the other girl unloads the exhausted and sealed bulbs. The glass bulb travels through an asbestos tunnel, and is heated during a large part of the journey by gas flames kept just below the melting point of the glass. Further on, the tube filaments light as the wire leads touch contact rails. The tube is seen to glow blue, indicating a residual gas content, as pumping gets well under way.

Then a heavy coil, through which high-frequency current is passing, slips over the glass bulb and, by so-called "bombardment," heats the internal metal elements to incandescence and drives out whatever gas may still be retained in the metallic sponges, while pumping continues. Another step further on, a second bombardment coil slips over the bulb, and the blue glow disappears entirely. The getter is fired at the right moment, flashing the chemical broom to clean up whatever active gas may still be within the bulb. Immediately the bulb is "sealed off," as the getter condenses on the inside of the cool bulb and forms the characteristic uniform, silvery lining of a well-flashed tube. The timing of the bombardment, flashing of the "getter" and prompt sealing, while keeping sufficient active "getter" for gas cleanup during the entire life of the tube, are matters of engineering skill in designing the automatic machinery.—By A. B. Dumont, chief engineer, De Forest Radio Company.

Station  
**WRNY**  
NEW YORK  
297 METERS—1010 KILOCYCLES  
and W2XAL, 30.91 METERS

is owned and operated by the  
publishers of this magazine  
Our Editors will talk to you  
several times every week—  
See your Newspaper  
for details  
**TUNE IN ON  
WRNY**

## Make Your Set a Modern A. C. Power Receiver

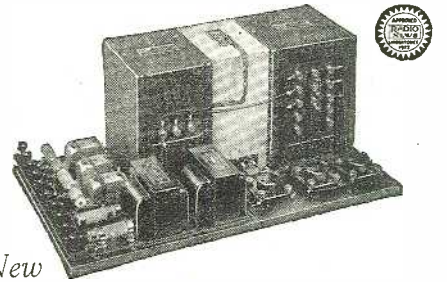

## New AMPLIPACK

A Complete A. C. Power Supply—"A" and "B" and "C"—Makes any D. C. Set into an Ultra-Modern A. C. Receiver. Uses two 210 type tubes in Push-pull; or one of the new 250 type tubes. Power Amplification gives perfect reproduction over the entire musical scale range.

### QUICKLY ASSEMBLED

You can assemble an Amplipack easily in one evening. We supply complete layout diagrams. Simple to install. Attached to set in three minutes. Consumes no more current than an ordinary 50-watt light. Cool, quiet, dependable.

### ASK YOUR DEALER

Leading dealers can give you full details and our simple assembly diagrams. Don't be satisfied with out-of-date reception—build an Amplipack tonight!

### FREE Booklet

Write for our new Free Booklet—the latest word on Power Amplification and A. C. Conversion.

### TRANSFORMER CORP. OF AMERICA

1428-1432 Orleans Street, Chicago, Ill.  
Manufacturers of the T. C. A. Line of Power Transformers, Auto Transformers, Chokes, Power Packs and Power Amplifiers.

## PATENTS TRADE-MARKS

**Service**

Without charge or obligation, we will inform you on any questions you may put to us touching on patent, trade-mark and copyright law. You may ask: "Should I protect myself by patent, or register under the trade-mark or copy-right laws? What kind of a patent should I obtain?" and many other questions that may occur to you. These are vital points to consider and questions will be cheerfully answered.

**Evidence of Conception**

Before disclosing your invention to anyone send for blank form, "EVIDENCE OF CONCEPTION," to be signed and witnessed. As registered patent attorneys we represent hundreds of inventors all over the United States and Canada in the advancement of inventions. The form, "Evidence of Conception," sample, instructions relating to obtaining of patents and schedule of fees sent upon request.

**LANCASTER & ALLWINE**  
270 Ouray Bldg., Washington, D. C.  
*"Originators of forms "Evidence of Conception"*

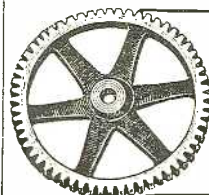

**GEARS**  
All kinds—Small

The most accurate made and prices reasonable. We carry a complete line of gears in stock for immediate shipment. Can also quote on special gears of all kinds. Send us your inquiries. Write for Catalog 40  
**Chicago Stock Gear Works**  
105 So. Jefferson St., Chicago

## Television Makes the Radio Drama Possible

(Continued from page 527)

them. He opened his mouth, and the teeth, tongue and throat were plainly visible. The definition was remarkable; certainly the best that has ever been shown in television. The image was as good as the average motion picture produced by an amateur cinematographer with a hand camera. At a distance of ten feet from the screen, the observers could distinguish the scanning lines only by looking hard for them.

### THE TELEPUGILISTS

The real thrill came when the subject announced, jocularly, that he had been insulted by a co-worker, and was going to settle with him before the televisor. He then turned his head, walked back about ten feet and pulled another man into view. This whole operation appeared on the receiving screen as plainly as if it had been taken with a movie camera! The images of the two men, engaged in a mock boxing match, were reproduced at full length in a twelve-inch square, with every detail of their fistie maneuvers plainly discernible.

Dr. Alexanderson exhibited this same apparatus at the Radio World's Fair, which was held in New York the following week. However, he did not then show full-length images, but merely gave short passages from "The Queen's Messenger." The screen on which the images were projected was a regular silvered motion-picture screen about two feet square, of the kind supplied to amateur photographers for home "movies."

It is not likely that radio experimenters will be able to reproduce full-length images for some time to come; as the frequency band covered by the 48-line transmitter ran well up into 20,000 cycles. The general broadcasting of television on such an ambitious scale awaits the development of more advanced broadcast transmitting equipment and the clarification of a horribly muddled broadcasting situation.

At the time of the Schenectady demonstration, Dr. Alexanderson issued the following statement, which contains some interesting facts:

### ODDITIES OF TELEVISION

"In order to avoid any widespread misunderstanding, it should be made clear that this demonstration is conducted over a short wire line, and that we are not prepared to transmit television of the same quality over any considerable distance. The television system of the future will consist of the television camera, the radio transmission, and the television projector. In addition to these three essential elements there will in most cases be a fourth element—a wire connection between the studio and the radio station.

"Each of these elements will be improved as time goes on. We are looking forward to more sensitive photoelectric cells for the camera and a more brilliant source of light for the projector. The principal difficulty, however, which limits the use of television at the present day is in the unknown factors of radio transmission; and constant efforts are being made to solve the new radio problem introduced by television.

"For this reason we are broadcasting television regularly from Schenectady five times

# NORDEN-HAUCK NEW 8 TUBE AC ELECTRIC MODEL



FOR  
1929

Size 8x11x22

Weight 35  
lbs.

Wave length  
range 200 to  
550 meters.

The Norden-Hauck Electrophonic is an entirely new and superior broadcast Receiver operating directly from house current. It is well built, handsomely finished and compact. Truly it represents the highest type of efficiency obtainable in point of range, selectivity and simplicity combined with utmost quality of reproduction.

## 10 OUTSTANDING FEATURES

**ELECTRIC.** The Electrophonic is all electric operated and self-contained. No Eliminators or batteries whatever. Employs standard Radiotron or Cunningham alternating current tubes.

**CIRCUIT.** The Electrophonic employs an 8-tube circuit; three stages direct tuned radio frequency amplification fully neutralized, detector, and three-tube power audio amplifier push-pull type.

**SHIELDING.** The Electrophonic is totally shielded. Complete inter-stage shielding permits high amplification not obtainable otherwise.

**SIMPLICITY.** The Electrophonic has but one control for wavelengths, one control for volume. Illuminated drum dial calibrated in degrees and in kilocycles.

**SENSITIVITY.** The Electrophonic has carefully balanced radio frequency tuning circuits which with superior quality of materials and workmanship combine to make the Norden-Hauck Electrophonic a long distance Receiver.

**SELECTIVITY.** In the Electrophonic total shielding and carefully balanced circuits and quality permit unusual selectivity so necessary in congested districts.

**QUALITY.** The Electrophonic is of the highest quality of construction and design throughout. Comparable only with costly custom built Receivers.

**FINISH.** The Electrophonic has an exquisite solid mahogany cabinet, brown finish. Heavy cast bronze escutcheon plate and tuning knobs lend to the rich appearance of the Receiver which will fit in any surroundings. Cabinet high French polish and full piano hinge. Back removable and ventilated.

**GUARANTEE.** The Electrophonic material and workmanship are fully warranted against any defects whatsoever.

**PRICE.** The Norden-Hauck Electrophonic Receiver is moderately priced at \$125.00. Packed for shipment.

List Price **\$125<sup>00</sup>** f.o.b. Phila.

COMPLETE illustrated literature gratis. Write, telegraph or cable today.

## NORDEN-HAUCK, INC., ENGINEERS

MARINE BUILDING, PHILADELPHIA, PA.

Builders of the Highest Class Radio Apparatus in the World.

E  
L  
E  
C  
T  
R  
O  
P  
H  
O  
N  
I  
C

**WRITE  
TODAY**

Send for large, new illustrated Catalog "B-2," showing the latest of everything in radio at wholesale prices.

**Allied Radio  
CORPORATION**  
711 W. LAKE STREET, CHICAGO

**FREE BOOK**

New Hook-ups. This book shows how to make Short-Wave Receivers, and Short-Wave Aerials.  
How to use the new screen-grid tube in D.C. and A.C. circuits.

How to build Power Amplifiers, and ABC Eliminators. Up-to-the-minute information on all new radio developments.  
Set Builders, Fans, Dealers, send for it today!



*Write for it!*

**KARAS ELECTRIC COMPANY 4038M2**  
4038M2 N. Rockwell St., Chicago, Illinois  
Please send me your Free Book!

Name.....  
Address.....  
City.....State.....

Insure your copy reaching you each month. Subscribe to Radio News—\$2.50 a year.  
Experimenter Publishing Co., 230 Fifth Avenue, N. Y. C.

Please say you saw it in RADIO NEWS

# New!

EDITION

## TELEVISION

*A Magazine for the Experimenting Fan*

"TELEVISION" is a magazine pledged to further the art of the infant industry for which it is named, and to supply the "fans" with the latest information and developments in this fast-growing field. Television, as a science, occupies the same position today as radio did ten years ago. Like the radio fans of years back, enthusiasts of this new field have had to

fight for whatever meager knowledge they have been able to obtain. This magazine, then, comes as manna to the information-hungry fan. It is our purpose to keep these enthusiasts constantly informed, through "TELEVISION," of each new development. The second issue of "TELEVISION" is now on the newsstands.

You will find below a partial list of its interesting contents

In the Television field there are all of the thrills that the radio fan knows so well. Get on the band wagon with your fellow enthusiasts. Be the first in your neighborhood to own a television set. Obtain a copy of "TELEVISION"; it will show you how to build a real Television receiver.

The first Television magazine was published by the EXPERIMENTER PUBLISHING COMPANY about a year ago. Over 50,000 copies of this magazine, "TELEVISION," have since been sold. This, alone, is sure proof of the popularity of this interesting new art.

### Partial List of Contents

New Jenkins Radio Movies  
New Belin Photo Transmitter  
Vacuum Cameras to Speed Up Television  
Infra-Red "Eye" Sees at Night  
Valensi Television  
Connection of Photo-Electric Cell

Practical Demonstrations Scheduled for Station WRNY  
Campbell Swinton Television System  
Quartz Crystals Synchronize Television Sets  
Baird Optical Lever Increases Speed  
Recording Pictures with Air Jet  
How to Build a Radio Photo Recorder

and many other articles of equal interest

AT ALL NEWSSTANDS

THE **25c** COPY

OR WRITE DIRECT

EXPERIMENTER PUBLISHING CO., INC., 230 Fifth Ave., New York, N. Y.

EXPERIMENTER PUBLISHING COMPANY, INC.  
230 Fifth Avenue, New York City, N. Y.

Gentlemen: Please forward to me a copy of TELEVISION. Enclosed find 25 cents.

Name.....

Address.....City.....State.....

a week. These television broadcast programs are being sent out both on the regular wave of 390 meters and one of the short waves (22 meters or 32 meters) which is used for international broadcasting. In this way our own investigators are able to make their observations while at the same time we are enlisting the co-operation of many amateurs. I have been making systematic observations for some time at my summer home at Lake George, which is at a distance of 50 miles from the transmitting station. These observations have been intensely interesting from a scientific point of view; but not encouraging if we were looking for immediate practical results from television. On the other hand, we have had consistent and encouraging reports from amateurs in Los Angeles.

"A difficulty particularly brought out by the Lake George observations is a phenomenon which may be described as 'mirage.' It is analogous to the mirage that can be seen over a lake in the morning and evening, and results in the distortion of images and sometimes in the appearance of several interwoven images. It appears as if the reflecting Kennelly-Heaviside layer (which we assume to be located about one hundred miles over the earth) were broken up sometime into several layers at different heights; each reflecting a separate image and sometimes giving an irregular and blurred image.

"The radio waves travel at the velocity of light and, though we are in the habit of thinking of this velocity as being almost infinite for anything that occurs on the earth, we find that these rays are too slow for television.

"Light travels at the rate of 186,000 miles per second and, yet, we find that light will travel only about 200 miles in the time required for tracing one line in a television picture and only 50 miles in the time required to trace one quarter of a line in a picture. Thus, if two rays have travelled from the transmitting to the receiving station through different paths, and the length of these paths differs by only 50 miles, they will register separate images differing as much as one quarter of the width of the picture. Each of these rays will then trace its own picture and we will have two pictures displaced by that amount. On the other hand, a multiplicity of rays may arrive after having traversed different paths, each tracing its own picture; with the result that all the details of the picture appear blurred.

"This is a pessimistic view of the situation, but these mirage effects are not always present. It is also probable that some wavelength may be selected which will not produce these mirage effects. Our efforts at present are to gather all the facts and in this the co-operation of the skilled experimenters all over the world is valuable. The history of radio in the past has shown that obstacles that appeared insurmountable have been overcome in this way. Static, which for years made radio communication extremely unreliable, has been conquered to such an extent that transoceanic radio communication is never interrupted. Similarly, the difficulties of fading on short waves has been practically overcome. Our conclusions regarding television are that it is a subject which should be of intense interest to the skilled experimenter at the present time; although there will be some time before it will be available as an entertainment for the general public."

## Multiple Television

(Continued from page 529)

once during each revolution, instead of three times, as previously described. This does not, however, alter the principle of the system's operation, and involves only a gearing down to a one-third ratio of the mechanism which alternates the operation of our colored lamps or ray-filters; to compensate for the fact that each turn of the disc produces only one change of color.

### TELEVISUAL AVIATION CONTROL

The application, however, of the multiple television is not limited to household entertainment, appealing though its cultural value may be for those who desire the most elaborate conveniences. The system will lend itself admirably to the purpose of replacing a visual observer at a place where it is inconvenient to maintain the latter; just as the various "mechanical men," "tele-voxes," etc., permit remote control of power stations and other important machinery.

First and foremost among these applications we may list the operation of an airship by remote control—and it is interesting to note that this very possibility was predicted on the first laboratory demonstration of television—actual, though crude—by the Editor of this magazine. "The Radio-Controlled Television Plane" by Hugo Gernsback, appeared in *THE EXPERIMENTER* for November, 1924, with the illustration reproduced partially, and in reduced form, at the bottom of page 529. It depicts "The Plane Which Sees."

Since that time, an airplane has been flown successfully by the Signal Corps of the United States Army, for a considerable period, without a human being aboard; its controls being directed solely through relays operated by radio signals sent out from the ground. However, this demonstration, though an interesting one, tied the plane very closely to the operators on the ground; as they would have had no way of estimating its motions had it flown out of the range of their direct observation.

Let us suppose, however, the plane of the future without any crew aboard except its radio-operated relays and its sextuple transmitting television, which is continually taking synchronized observations ahead, beneath, behind, to right, to left, and above. Around the multiple receiving television at headquarters will gather three or more men.

The "pilot" sits at one side, his eyes hidden by the hood that covers the reproduction of the image which shows the view ahead, and slightly downwards, in the direction of the plane's flight. He holds the controls which steer the plane up, down, right or left, as well as those which govern the speed of the motors. In the edge of the television image are framed visible characters impressed on the image by the automatic recording instruments of the plane; so that the pilot may note their condition, just as if they were on the instrument panel before him.

Beside the pilot sits the "observer," equally intent upon the moving scene below the plane, and informed also as to the longitudinal and transverse inclinations of the plane, and its speed. He controls the radio-operated camera, which takes pictures of the ground or sea beneath, and the relays which drop the cargo, perhaps. If the



# TRUVOLT

## DIVIDER

The Missing Link in  
Power Plant Construction

# TRUVOLT DIVIDER

U. S. Patent 1,676,869, and Patents Pending

## A Universal Voltage Separator

**T**HE Truvolt Divider offers the eliminator builder for the first time a complete resistance unit around which a power plant can be built.

It is so arranged with adjustable contacts that proper voltages can be obtained with any set and eliminator combination. By dividing the filtered voltage into usable values, it eliminates all necessity of mathematical calculations in constructing a power pack. It does away with a great deal of wiring and the need of voltage regulator tubes. It makes it possible to build a power supply device which is universal in its application.

The Truvolt Divider provides the missing link in power plant construction and any power pack can be built around it. It is designed to take care of any desirable load with a generous factor of safety.

Made with genuine bakelite, it will add a smart appearance to any unit. Five potentiometer type control knobs show values on a scale of high visibility. Can be mounted on baseboard or sub-panel, or used as the front panel on a metal cabinet, at the same time providing binding posts for all B and C voltages. PRICE \$12.50

*Electrad specializes in a full line of Controls for all Radio purposes including Television.*

**ELECTRAD, INC.**  
Dept. NA-12  
175 Varick St., New York, N. Y.

Please send me FREE my copy of the Electrad Truvolt Divider Manual and put me on your mailing list for Circuit Data and information.

Name.....

Address.....

City..... State.....

**Mail coupon for full information**

# ELECTRAD

Inc.

## SET BUILDERS

### Get this Book



**LATEST RADIO GUIDE**  
FREE

**Barawik**, the first and oldest radio specialty house, offers you unusual service this year. Bigger stocks, quicker shipments, lower prices. Deal with an old established, reliable house. Get honest goods, honest service, honest prices. Barawik service makes you more money. Send now for big new Catalog showing lowest wholesale prices.

**BARAWIK CO.** 212H Canal Sta., CHICAGO, U. S. A.

Mail This Coupon Now for Free Radio Guide

Name.....

Address.....

## FREE TO SET BUILDERS AND DEALERS NEW 100 PAGE CATALOG

HAMMARLUND OFFICIAL DISTRIBUTORS  
SILVER - MARSHALL KIT HEADQUARTERS  
NATIONAL COMPANY AUTHORIZED JOBBERS  
AERO SHORT-WAVE AND DAVEN TELEVISION

We are ready to ship all kits or parts produced by the above manufacturers as well as any others specified in any radio publication.

**31 Years of Service to the Trade**  
**ROYAL-EASTERN PAYS THE FREIGHT**  
**Lowest Wholesale Prices**

Send for your copy of our catalog  
**ROYAL-EASTERN ELECTRICAL SUPPLY CO.**  
20 West 22nd Street, New York City, N. Y.

## Synchronous Motors for Television

In addition to building reliable and satisfactory motor generators, "Esco" has had many years of experience in building electric motors for a great variety of applications.

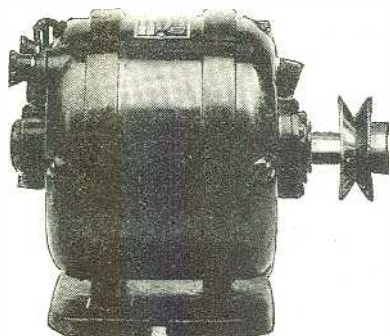

*Synchronous motors*, small, compact, reliable, self-starting are now offered for *Television* equipment. They require no direct current for excitation, are quiet running and fully guaranteed.

Other types of motors suitable for Television may also be supplied.

*Write us about your requirements.*

ELECTRIC SPECIALTY CO.

211 South St.

Trade "ESCO" Mark

Stamford, Conn.

Send for WESTERN RADIO

# new

## 1929 Catalog

### DEALERS AND SETBUILDERS

THE NEW 1929 Catalog is crammed full of the FINEST, NEWEST, nationally-known A.C. sets, consoles, cabinets, dynamic speakers, kits, eliminators, and accessories at LOWEST PRICES. Largest stock of Radio Parts. Prompt delivery. *Write for our FREE catalog.*

WESTERN RADIO MFG. CO.

128 WEST LAKE ST. Dept. RN-12 CHICAGO, ILL.

FREE



The Big Friendly Radio House

A REAL SPECIAL OFFER!!

LIST PRICE  
\$39.50 ea.

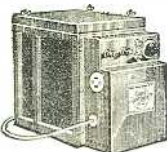

EXTRA SPECIAL

\$13.75  
ea.

Brand new, in original factory cases, complete with extra fuse.

The New Gould  
Kathanode

## Unipower

GOULD PRODUCT

WITH BUILT-IN RELAY

Automatic Radio "A" Power From Light Socket

Model AC-6-K (6-volt) Kathanode Unipower is the highest quality "A" Power Unit built. Furnishes rich, smooth, unflashing "A" current without any trace of hum for the largest power tube sets. Installed in less than three minutes, makes any set as simple and convenient to operate, as an expensive AC outfit at only a fraction of the cost. No rewiring necessary in your set.

Its Kathanode construction insures longer life and freedom from service expense and when sold it will take care of itself. It is very economical and will outlast several storage batteries. Its Kathanode construction is an exclusive patented feature now being used by the U. S. Government in their Submarine Batteries which are furnished by Gould.

Equipped with a new noiseless Balkite Charging Unit which has four graduated charging rates and in addition one booster rate (1½ amperes) for an emergency charge. Operates on 110-120 V., 50-60 A.C. cycle current.

AMERICAN SALES CO., 19-21 Warren St., New York City

plane is a military one on a war errand, he is the "bomber."

The views to the rear, either side and above are of less pressing importance, perhaps. Their observers are placed on the other side of the machine, looking through the disc in the opposite direction—this makes no difference in the operation, as the transmitters are designed accordingly. There is no problem of the different pictures being variously out of frame; as they are scanned by machinery operating from the same motor and driving gear. One of the operators at the rear keeps them "isochronized" with the receiver and in frame, so that the pilot and the observer are relieved of the task. These operators glance occasionally over the telepanorama, but are not likely to be called into action unless the swooping attack of a hostile plane is noted. In this case, they wait for it to "cross the wires" (which indicate on the screen the line of fire of the fixed machine guns that the plane carries) and let off a reel of cartridges at the foe.

Somchow, we begin to have recollections of that *quattrocento* battle in Italy, in the days when mail was of proof, and two armies fought all day with but one fatality, due to one soldier's breaking his neck by a fall from his horse. When the machinery is to do all the fighting and dying, it will be more comfortable—if equally laborious—for the military forces converted into a mechanical service of supply.

## 250-Type Tubes Designed for Large Amplifiers

IT often seems that in their eagerness to be among the first to make use of a new tube, some radio engineers, fans and writers do not give due consideration to the proper use of such tubes. In some instances, this has been the case with the 250-type tube.

This tube was primarily brought forth to satisfy the demand for power amplifiers for use in auditoriums and other large gathering places. When used in such connections, the use of an amplifier before the last stage capable of providing a voltage amplification sufficient to bring out the best in the power stage is required.

The use of a push-pull power stage using two 250 tubes is not generally recommended, except for instances where extraordinarily large power output is required. Certainly such an amplifier has no place in the average home.

For ordinary home use, the greatest advantage of the 250 tube lies in the fact that it will give, with lower plate voltages, an output equivalent to that obtained with a 210-type tube at much higher voltages. For home use, therefore, the plate voltage used should not be higher than 300 volts.

## Radio Reviews of Literature

(Continued from page 565)

TELEVISION FOR THE HOME, by Ronald F. Tiltman. Published by Hutchinson & Co., Ltd., London, England. 7½ x 5 inches; 106 pages, illustrated with photos; cloth. Price 2s 6d (61 cents in England).

The above title, as shown by the author, offers in itself some room for discussion after one has completed the perusal of this book. It is then that a



solid doubt arises as to the literary intentions of Mr. Tiltman, who writes interestingly and profusely of John L. Baird, the Scottish television researcher. One would gather from the title that the author originally intended to describe a number of television systems for the benefit of the home builder and experimenter.

However, such is not the case. True, the author deals with the fundamentals of the new art in non-technical language and in a manner that can be grasped readily by the layman; but, in the main, the book is an interesting and well-written history of the development of television, centering conspicuously about Baird and his system.

The author, evidently, is endowed with the admirable quality of patriotism, which he has allowed to enter his scientific dissertation with painful repetition and emphasis. For example, we find in his book: "It was, however, left to a British inventor to achieve true television first, and this, naturally, caused all international rivals to redouble their efforts." Later we find that, "We, and Mr. Baird, should be immensely proud of this wonderful all-British achievement, which adds further to the glory of our scientific history."

An interesting chapter on "noctovision," or television through darkness, is included, and sets forth in a vivid manner the possible uses of this remarkable development; and also mentions of a "whispered" development—also by Mr. Baird—of which there were no details available at the time of writing.

Yet the book offers no data for the construction of television apparatus; though the construction of a suitable radio receiver is discussed and the use of a set comprising R.F. amplification, detector and two stages of A.F. (ostensibly transformer-coupled) is recommended. This is in interesting contrast to the specifications of our engineers, most of whom lay particular stress on the exclusive use of resistance-coupled amplifiers in television reception.

The book may be recommended, however, to those who desire interesting reading of a non-technical nature on the subject of television and, though it is not sufficiently complete and comprehensive to enlighten the reader thoroughly, it has nevertheless its place in the library of the new science. (The commercial enterprise resulting from the Baird inventions, Television, Ltd., is also mentioned.)

## The Radio Constructor's Own Page

(Continued from page 566)

one of the stations is much more powerful than the other, this will not occur. The question then comes up whether, if a considerable number of stations are operating on the same frequency, on the law of averages the phase variations will not cancel each other, as regards the more distant stations? This problem will probably be answered by the English; as the British Broadcasting Company is undertaking to operate eight or more small local stations on a 288.5-meter wave, as planned a couple of years ago.—EDITOR.)

In my estimation, the practice of parts supply houses offering dealers' discounts indiscriminately should be stopped; as dealers and custom set builders for the most part depend on the profit on the parts to pay them for the work; and the quoting of discounts to individuals who are not custom builders and not entitled to it will soon ruin the parts business.

ALBERT E. GLEASON,  
45 Benefit Street, Worcester, Mass.

### A NEW TRANSATLANTIC HOOK-UP MAY BE EXPECTED

Editor, RADIO NEWS:

Having been a reader of the best radio magazine—in the world—and I don't mean maybe—for nearly four years, I venture to add my thanks and congratulations to those you have already received for your first-class production.

With reference to the letter of Mr. T. H. Heneker in the September issue, headed "Radio is for Men Only": Well, is it, now? Surveyed broadly, the assertion may be admitted as a generality; but one meets occasional exceptions. I met one at a dance in the shape of a lady who was my partner in the "Yale Blues"—which, contrary to title, happened to be an English invention. I happened to mention a dance number I had heard on the air, and immediately she started to discourse on tubes, R.F. and A.F. transformers, hook-ups—described in English equivalent terms, of course—and her opinions of their merits or otherwise.

I'll allow that this is practically an isolated

# New Admiralty Model NORDEN - HAUCK SHIELDED SUPER-10

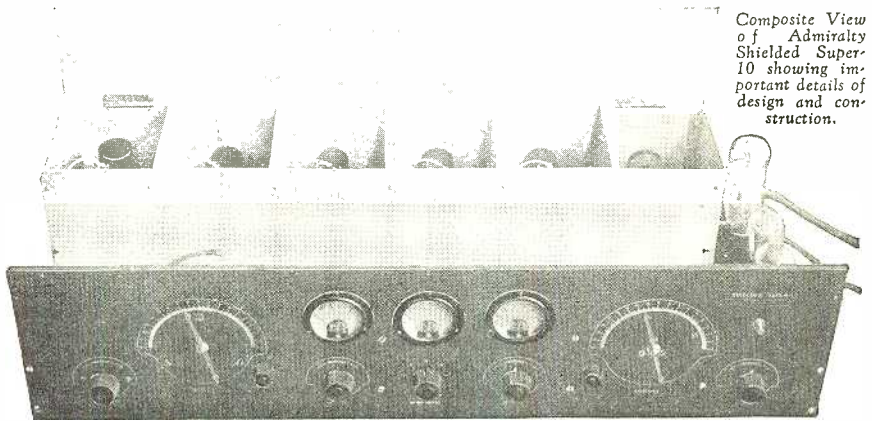

Composite View of Admiralty Shilded Super-10 showing important details of design and construction.

This great new Receiver is far in advance of competition. It is a powerful 10-tube model incorporating the most complete and up-to-date principles. Using the new screen grid tubes in the R. F. amplifier and push-pull audio system, make this new model the outstanding development in Receiver design for years.

### Features

10 tubes used. Five 222 screen grid R. F. amplifiers, 200A detector, two 240 Hi-Mu's and two 210 tubes in the power audio amplifier.  
Extremely sensitive—long range.  
Totally shielded.  
Super-selective—10 Kc. separation.  
Perfect quality of reproduction.

Indicating Meters on Panel.  
Removable R. F. Transformers for all wave lengths up to 25,000 meters.  
Electric or Battery operated.  
Simple to operate—only two major tuning controls.  
A laboratory precision Instrument built according to U. S. Navy Standards.

Complete attractive illustrated literature sent upon request. Full size genuine Blue Prints and constructional data \$2.00 Postpaid.

Write, telegraph or cable today.

## NORDEN-HAUCK, Inc., Engineers

Marine Bldg., Philadelphia, Pa.

Builders of the highest class radio apparatus in the world.

Cable—Norhauck

**For ANY Tube  
D.C. or A.C.**

AMPERITE automatic filament control increases tube efficiency and lengthens tube life. \$1.10 with mounting (in U. S. A.)

**Radiall Company**  
50 FRANKLIN ST., NEW YORK

FREE New "Amperite Blue Book" of latest radio information and circuit diagrams. Write Dept. R.N. 12

**AMPERITE**  
REG. U.S. PAT. OFF.  
The "SELF-ADJUSTING" Rheostat

### New Karas Short-Wave Kit Reaches Around the World!

New radio thrills await you. Listen to Australia, Europe, Asia. Tune in on the world's airplane flyers, ships at sea; in fact, the whole world. You can do it easily with the remarkable Karas Short-Wave Receiver. You can't know the fascinations of radio until you experience this new sensation. Karas engineers have developed short wave to new peaks of perfection. Easy to build. Easy to tune with Karas Micrometric dials, 63 to 1 ratio. Uses famous Karas condensers, built like a fine watch. Karas coils and audios—the world's standard. Send now for full information and construction blueprint—Free.

**KARAS ELECTRIC COMPANY**  
403SM4 N. Rockwell St., Chicago, U. S. A.

Name.....  
St. and No.....  
City and State.....

Insure your copy reaching you each month. Subscribe to Radio News—\$2.50 a year. Experimenter Publishing Co., 230 Fifth Avenue, N. Y. C.

Please say you saw it in RADIO NEWS

# TELEVISION IS HERE

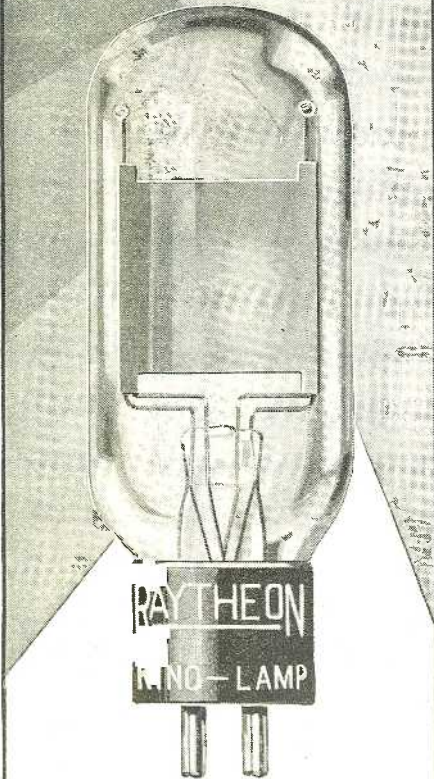

**T**ELEVISION is now an accomplished fact.

Experimenters will welcome the Raytheon Kino-Lamp, the first television tube developed commercially to work with any system.

Uniform glow over the entire plate, without the use of mirrors or ground glass, gives it perfect reproduction qualities.

Kino-Lamp is the latest achievement of the Raytheon Laboratories which have made so many original contributions to radio science. List Price \$7.50.

Write for information

RAYTHEON MFG. COMPANY  
Cambridge, Mass.

**Raytheon**  
Foto-Cell

Available in both hard vacuum and gas-filled extra sensitive types—each in two sizes. Write us for special specifications.

**Raytheon**  
KINO-LAMP

instance in my own experience and, while I hold no brief for the opposite sex—indeed, I endorse Mr. Heneker's letter—in the subject under review, it surely does seem difficult to enumerate a hobby, pastime, trade, or profession in which women are not represented.

LESLIE F. GODDARD,  
"Argyll Lodge," 8 Hollemoor Road, Shirley,  
Southampton, England.

(There is no doubt that the percentage of feminine radio fans, as distinguished from furniture fanciers and program supervisors, is small; yet their letters received by the Wrinkles editor show often much ingenuity, and the Radiotics and Broadcastists editors will testify that the ladies read radio publications carefully and follow the humor of radio most successfully. There are also a number of "amateurs"—or whatever we may call lady "hams"—who are quite as enthusiastic and quite as adept in the pursuit of their hobby as any of the OM's their colleagues.—EDITOR.

**I**NQUIRIES for information not given here should be sent, not to RADIO NEWS, but to the constructor direct—but he should NOT be asked to furnish data already published, here or elsewhere, or for instructions that an experienced builder should not need; for this is not a beginners' department. Courtesy demands that such requests should be accompanied by postage; as they are often very numerous. Reply coupons can be obtained from the postoffice for international inquiries. On the other hand, readers who solicit general correspondence must expect to bear their own share.

This department is for free discussion to the extent that space permits; but RADIO NEWS accepts no responsibility for the opinions of readers as to the relative merits of apparatus and circuits.

Letters describing good results, but which do not explain the system used, are unsuited for publication; as they entail too much needless correspondence for the editors and the contributors. Give the details the first time.

### SOUNDS LIKE DX

Editor, RADIO NEWS:

I recently built the two-tube Extension receiver described in RADIO NEWS (Blueprint No. 53) and am using in conjunction with it a three-stage audio amplifier which consists of two stages of impedance coupling followed by a transformer stage and power tube. Northern Electric 1.1-volt tubes, in series, are used in all stages except the last, which is a 5-volt power tube. (Readers in the United States are cautioned not to ask where they can get these tubes.—EDITOR.) This combination, in my estimation, makes a set that is hard to beat; the tone is all that could be desired and the volume and distance must be witnessed to be appreciated.

During last fall and part of the winter, I used a 3-tuber of my own design; of the usual type, consisting of a regenerative detector and two stages of audio. I used the Northern Electric R215A 1.1-volt tubes with a three-foot cone. I brought in 315 stations, including CZE, CKY, PWX, KFI, KFSD, etc., KYW, WLW, WJZ, etc., were commonly heard during the noon hour. I consider that real DX.

Leave your magazine the way it is now. It couldn't be better.

ROBERT C. POTTER,

R. R. 3, Beamsville, Ontario, Canada.

(Mr. Potter, who is one of our frankest critics, is now satisfied; but we shall be glad to have others point out opportunities for improvement. As to the hook-ups, while outside of the United States a much wider range of tubes is generally available—including many designed for very low battery consumption—it is probable that any results can be duplicated with good standard tubes available here; though voltages must be adjusted to their requirements and, perhaps, their capacities taken into account in designing R.F. coils.—EDITOR.

### ATTENTION, SCOTCH FANS!

Editor, RADIO NEWS:

If this information is of any use to the short-wave fans, I am glad to pass it on. I am using two discarded 45-volt "B" batteries from the broadcast set on my two-tube short-wave receiver. They test 30 volts each, and I find the results are the same as on new batteries.

R. V. PERRY,

600 West 141st St., New York City.

(Since Mr. Armstrong Perry's article on the

# Test these tubes to-day

**SET** dials—replace old tubes with Arcturus A-C Long Life Tubes. Notice immediately increased volume.

In addition, these tubes are immune to line surge—have a longer life—in many cases over 5,000 hours.

Complete line of Arcturus Low Voltage Tubes—126H, 126, 071H, 127 and 180. "Get Action with Arcturus Tubes—Quicker, Better."

## ARCTURUS

A-C LONG LIFE TUBES

Arcturus Radio Company  
220 Elizabeth Ave.  
Newark, N. J.

## —CHI—RAD—

New 1929 Catalog  
FREE to Set Builders

Includes Complete Parts for

H. F. L. ISOTONE

New TYRMAN "80"

MADISON-MOORE "AC"

New THORDARSON Power Amp.

Discounts for Set Builders

Write us for Circular on the World's Finest  
Dynamic Speaker

Chicago Radio Apparatus Co.

415 S. Dearborn St., Dept. RN, Chicago

## SET BUILDERS

Get this Book



Barawik, the first and oldest radio specialty house, offers you unusual service this year. Bigger stocks, quicker shipments, lower prices. Deal with an old established, reliable house. Get honest goods, honest service, honest prices. Barawik service makes you more money. Send now for big new Catalog showing lowest wholesale prices.

**BARAWIK CO.** 212-1 Canal Sta., CHICAGO, U. S. A.

Mail This Coupon Now for Free Radio Guide

Name \_\_\_\_\_  
Address \_\_\_\_\_

## \$1 SAVES YOUR SPEAKER

The CRAFTSMAN Dollar Speaker is guaranteed to relieve speaker of plate D. C. (180 to 250 volts). Complete Protection. One Dollar Postpaid.

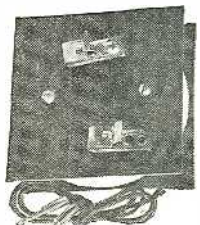

CRAFTSMAN RADIO PRODUCTS

351 Halsey St., Newark, N. J.

Loveless aerial has caused so many readers to think that RADIO NEWS was putting up a job on them, we hasten to say that we cannot guarantee them Mr. R. V. Perry's results from used batteries. The reason for discarding such is that, as the voltage falls and the internal resistance rises, some cells become dead before the rest, and the result is apt to be noise. The ideal battery, of course, like the One Hoss Shay, would keep its full voltage to the end and give out all at once.—EDITOR.)

**THE STROBODYNES GO TO THE DOGS**

Editor, RADIO NEWS:

How many times have we all longed to see what a DN bound really looks like? Well, here we are with a real photograph of said bound. This English bull terrier is a real devotee of radio, and we see him out on the lawn listening



to a good program. You will see that it is a Strobodyne receiver; and my pal "Pete" would like to appear on your cover.

MICHAEL J. MURPHY,  
267 West 35th St., New York City.

(Sorry, but our readers seem to draw the line on "human interest" covers, and canine interest, we fear, will have to take this inside page.—EDITOR.)

**THESE FANS GOT GOOD RESULTS**

We have made several of the Loveless antennas, with wonderful results. At first results were very mediocre, but we soon found, that one optimum point of coupling exist, at which stations roar in. This point is exceedingly critical, a movement of 1/8-inch in any direction immediately stopping all response. We tried this on CHIC in Toronto, which came in with very good volume on this aerial, when it was exactly in the correct position; but would absolutely disappear on the slightest movement, even as much as 1/16-inch either horizontally or vertically. Next we tried the antenna on WCCO, only about 1600 miles from here. The results were exactly the same. On KFI, about 400 miles from here, any limited movement of about one inch in any direction did not seem to affect the volume.

Our next trial was at 1:00 p.m. KFI came clear and loud. Comparative tests with five other aerials, from 30 to 150 feet long, brought absolutely no response. This was our first summer afternoon reception of KFI. It's some antenna, when she is in correct adjustment.

The above results were on your Peridyne, which is a wow; although it received more cussing at first in our shop than any other set. But after we got the hang of it properly, we humbly apologized to "Dear Old Perry." Thanks for the good stuff you give us now in R.N.

H. E. KRUGER  
463 Ethel Ave.,  
Mill Valley, Cal.

Editor, RADIO NEWS:

As a constant and appreciative reader of your magazine for a number of years, I wish to express my pleasure with reference to your new policy on construction articles. At the same time I wish to add my O.K. to the thought expressed by Mr. Harris regarding a more adequate description of circuit parts.

For example, in your August number Mr.

# HFL

## Model 10

# ISOTONE RECEIVER

The MOST SENSITIVE Long Distance RECEIVER Ever - Designed

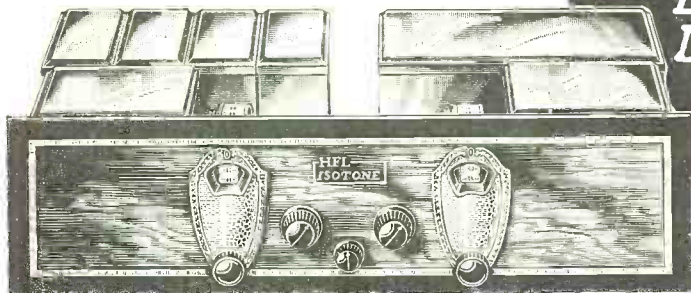

**Screen Grid ~ Custom Built ~ Radio Phonograph**  
**Over a Hundred Stations in One Evening**

PERFECT separation on every wave channel. Absolute 10 kilo cycle splits between locals and distant stations. The H F L Isotone will actually separate super-power stations like WEAJ and WMAQ, WBBM and WJZ, WHO and KRLD.

The Isotone is unquestionably the most sensitive receiver that the world has ever seen. It will absolutely out distance all other receivers, regardless of price or type of construction. The amazing sensitivity of the H F L screened grid amplifier remains unequalled. So sensitive is the Isotone that stations over 2,000 miles away have to be tuned down. Tremendous volume is obtained from stations all over the North American continent.

Through the use of an ingenious system of filament control, the H F L Isotone operates perfectly with batteries or the special H F L-A. C. power supply. The same tremendous re-

serve power is available with batteries. The same crystal clear tones are developed with A. C. Only 30 mils. of plate current are required by the entire receiver, including the two power tubes.

Some of the marvelous new features built into the Isotone are:

- One Spot Dialing
- Phonograph Operation
- Variable Transformers
- Dual Detection
- Master Switching
- Laboratory Wired Units
- Push-Pull Audio
- Loop or Antenna

These and over 25 other radically new ideas combine to make the Isotone the greatest of all receivers.

Write for all information on the most sensational receiver of the season. See the circuits and photographs and read our absolute guarantee of performance. Send for this literature TODAY!

HIGH FREQUENCY LABORATORIES  
28 North Sheldon St.  
Chicago, Ill.

Free  
Circuit Diagrams  
and All Information  
Mail Coupon Today

**SEND THIS NOW**

High Frequency Laboratories, Office 5  
28 N. Sheldon Street, Chicago, Ill.

Gentlemen:

Without obligation send booklet describing the ISOTONE Receiver and the HFL Power Supply.

Name.....

Address.....

City..... State.....

(Please print plainly)

**SEND FOR NEW RADIO BOOK — IT'S FREE!**

New hook-ups. This book shows how to make short-wave receivers and short-wave adapters. How to use the new screen grid tube in D. C. and A. C. circuits. How to build power amplifiers, ABC eliminators. Up-to-the-minute information on all new radio developments. It's free. Send for copy today.

KARAS ELECTRIC COMPANY  
4038M1-North Rockwell St., Chicago, Ill.

Name.....

St. and No.....

City and State..... 4038 M1

**This Wholesale Catalog Will Save You Money**  
Write today for our large illustrated new Catalog "B-2," showing how this organization of men with years of experience in Radio can give you personal service.

**Allied Radio CORPORATION**  
711 W. LAKE STREET, CHICAGO



NATIONAL Screen Grid Short-Wave Set

## No Other Short-Wave Set Just Like This

THE right short-wave receiver will bring broadcast programs into your home with loudspeaker volume and clearness from all over the world; from England—Europe and even Australia.

This NATIONAL Screen Grid Short-Wave set in the home of Mr. B. H. Taylor at Haverhill, Mass., on Sept. 15th brought in the entire afternoon and evening services of the EUCHARISTIC CONGRESS broadcast direct from Sta. 2ME, of Sydney, Australia. This was loudspeaker reception.

There is no other short-wave set just like it.

# NATIONAL

SCREEN GRID SHORT-WAVE RECEIVER

Send for Short-Wave Bulletin 128-R N

NATIONAL CO. INC., MALDEN, MASS.

## More Profits To Set Builders

One good radio idea may be worth millions. Barawik has thousands of ideas for radio set builders to make more money. Barawik's Big Radio Book will help you while elections are on and big national events stir the world.

Send for your copy today — NOW. **BARAWIK CO.** 212 Canal Station, CHICAGO, U. S. A.

Mail This Coupon Now! For Free Copy

Name .....

Address .....

**Print Your Own**  
Cards, Stationery, Circulars, Paper, etc. Save money. Print for others, big profit. Complete outfits \$8.85. Job press \$11, \$29, Rotary \$149. All easy, rules sent. Write for catalog process type etc. **THE KELSEY CO., P-72, Meriden, Conn.**

Canfield described a very interesting short-wave set. The coil data is given, but nothing on the chokes. He takes pains to state the aerial choke is special, and if not available a resistance may be used from one megohm, down, and suggests experimenting with several; at the same time stating that this is not as satisfactory as the choke. We do not wish to experiment with less satisfactory equipment and why not give winding directions for the choke required? National parts for this set are not yet available in the local radio stores.

(Where it is practicable to give such details, they are given; but when the constructor cannot hope to duplicate the factory-made part, for lack of machinery, he must either send for it or use something slightly less satisfactory. For instance, in the case mentioned, he can use the resistor mentioned, or any R.F. choke; but at high frequencies, the special choke with low inductance may give better results. It is wound with very fine wire and placed in a tube for grid-leak mounting. Readers whose stores do not stock parts for several months may be excused for writing direct to the manufacturer.—EDITOR.)

In this article a 222 rheostat is mentioned for the screen-grid tube. This means but little as these tubes have been described as using 10, 15, 20, and 25 ohms, depending on hook-up and bias required. Why not give the resistance for this particular set?

(As the instrument used is an automatic rheostat, it can not be rated by resistance; for its resistance varies with the current flowing through it. Such devices are purchased for use with the tubes for which they are designated. The constructor who prefers to use a fixed resistor can quickly calculate the needed resistance by dividing the voltage drop desired by the current flowing through the tube. For instance, a 6-volt supply must be reduced at least 2.7 volts for the 222-type tube, which draws 0.132-ampere. Dividing 2.700 by 0.132 gives 20.45, the number of ohms required. The constructor who substitutes parts should be familiar with Ohm's Law, as explained in detail in an article on page 1348 of RADIO NEWS for June, 1928; and will then be able to answer any such question without difficulty.—EDITOR.)

I have been interested in experimenting with the two-coil Loveless antenna. In my location it gives about the same results as an aerial; if one wishes to determine the result of reception in a steel-frame building, this coil will do the trick. I recently tried this in a steel-frame apartment building with the following results: With the coils suspended in the room no reception whatever could be had. On placing the coils on a six-foot stick and holding them about three feet outside the window, reception was very strong. You will note the only difference was the location of the coils, that is either inside or outside the building. When they were placed about six inches outside the window, reception just begun to be audible.

M. H. MERRILL,  
465 California St., San Francisco, Calif.

Editor, RADIO NEWS:

I have built the Loveless aerial described by Mr. Perry in the September issue and have gotten some results, but not exactly the same as Mr. Loveless. I am using an Atwater Kent 6-tube receiver (Model 30) and have a 50-foot outside aerial. For local stations I use only a 5-foot insulated cord attached to the aerial post as it gives me all the volume the set will stand. Now, here is something I have never understood about this receiver. About 50 on the dial I get about twice as much volume with the ground disconnected provided there is very little static, while I get better results with a ground below 50. I have disconnected both ground and aerial using only the five-foot cord attached to aerial post and brought in WHQ, Des Moines, Ia., with volume like local; while Cincinnati is about the most distant station I have been able to get with an outside aerial.

Now for the Loveless aerial: with wires connected to aerial post and ground as described, it is just a little stronger than five-foot cord when ground is connected, therefore you see I get very little outside of local below 50 on the dial. If I disconnect the ground wire to set but leave the ground wire from coil-aerial connected. I get signal as strong and sometimes stronger than when using outside aerial even with ground disconnected. I find that varying the two coils makes a difference on local. That is, the signal is at its loudest on some stations when the coils are directly even, one within the other. On other stations if I raise the inside coil about an inch the signal is louder, and on still others 2 or 3 inches or by lowering it better results are obtained. There are two things which might make a



## The Art of Tuning

Is more than just turning a Dial

Cord Type Standard Modu Plug, \$2.50

Mere reception of a radio signal is not enough. It has ceased to be. "How many stations did you see importance today is, "How well did you get them?"

There are two major operations in tuning a set: locating the station—and modulating it so as to obtain the best quality of tone.

The Centralab Modu Plug is the perfect volume and modulation control. With it, all the true beauty of tone and naturalness of speech reproduction can be obtained.

It is attached to any set in a moment without additional wiring or complicated connections. Equally as adaptable for volume control on phonograph pick-ups and speakers remote from the set.

An interesting book full of picture and wiring diagrams showing the use of Centralab Volume Controls and Resistors is yours for the asking.

CENTRAL RADIO LABORATORIES



20 Keefe Avenue Milwaukee, Wis.



## BIG CATALOGUE FREE—Send Postcard for Catalogue and Discount Sheet

Hundreds of bargains in latest kits and parts at liberal discounts. See our new catalog for **Electric Phonographs**, pick-ups, turn- tables, dynamic speakers. **Shield-Grid Kits**, **Television kits** and parts. **Short-wave sets**, kits, parts, and other parts. **Power Packs**, all kinds, including 250-tube and push-pull circuits. Van-Ashe has everything, at big discounts ready for 12-hour shipment.

**Dan-Ashe Radio Co.**  
210 North 10th St. ST. LOUIS, MO.

**Wholesale Prices**  
Tremendous stock and sales volume, with rapid turn-over to the thousands of radio dealers we serve enables us to make you worthwhile savings at lowest wholesale prices. Write for latest, new illustrated Catalogue "B-2"

**Allied Radio CORPORATION**  
711 W. LAKE STREET, CHICAGO

difference. One is that I am using it on the first floor or ground floor, and the other is that I used some No. 18 magnet wire which I had (Cotton covered, not enameled) instead of bell wire; but was told by an electrician that there was no difference in the conductivity of the two, only in the insulation. I would be glad to hear from you regarding other receivers when used with and without ground.

F. H. BLAIR,

1568 So. Clarkson St., Denver, Colo.

(Mr. Blair's odd results are apparently what we call "location," in other words the electrical character of his "ground" is evidently peculiar. The letters above show the very critical nature of this antenna with certain receivers; the capacity appears to be the variable factor. Many readers were unsuccessful, like the following.—EDITOR.)

**THESE FANS GOT NONE**

Editor, RADIO NEWS:

I and some of my friends built five different Loveless aerials as per instructions given in this article, and all five have been failures.

I don't believe a magazine with the standing of RADIO NEWS would publish an article about a machine without it having some merit. We have carefully checked the aerials we manufactured with the instructions given in this article and find they have been made according to specifications.

The article reads well and I have been subscribing to RADIO NEWS for a good many years, and know they would not intentionally publish a fake. Let me hear from you.

Jos. H. STEWART,

Stewart-Gwynne Co., Memphis, Tenn.

Editor, RADIO NEWS:

I tried the Loveless aerial four different times, rewiring it each time, but it failed to work. Could you give me any information on this, as I believe it is all right if it will work. I couldn't ground either end of these coils and get results; but if I hooked one end to the aerial post I could get stations and with about three-fourths less static. Wish you could tell me why I couldn't get results.

A. AHRLIN,

Box 16, Rutland, North Dakota.

(It is evident that the aerial in question acts as a critically-tuned antenna circuit. Because of the quantity of wire used, it forms a very considerable collector of energy; its inductance is high, and therefore a low self-capacity brings its peak into the broadcast band. A very slight change of the position of the coils, say users, makes a considerable difference in reception. As the capacity is the critical factor, we suggest again that our readers who have been hitherto unsuccessful—and have not already lost confidence—try the effect of a midget variable condenser between the open ends of the windings.—EDITOR.)

**40 Non-Technical  
Radio Articles**

every month for the beginner, the layman and those who like radio from the non-technical side.

SCIENCE AND INVENTION, which can be bought at any newsstand, contains the largest and most interesting section of radio articles of any non-radio magazine in existence.

Plenty of "How to Make It" radio articles and plenty of simplified hook-ups for the layman and experimenter. The radio section of SCIENCE AND INVENTION is so good that many RADIO NEWS readers buy it solely for this feature.

**Radio Articles Appearing in  
December Science and  
Invention Magazine**

- TELEVISION RECEIVER HINTS  
—By Henry Townsend
- FUTURE RADIO RECEIVERS—a proposition by Dr. Lee de Forest
- WRNY's TELEVISION TRANSMITTER
- A RADIO-CONTROLLED BATTLESHIP
- A NEW A.C. SET
- NEON LAMP HAS RADIO USES
- NEW RADIO DEVICES
- RADIO ORACLE—Questions and Answers
- RADIO WRINKLES

**Short-Waves Are IT!**

**A Fascinating Field  
For Experimentation  
By the Radio Fan**

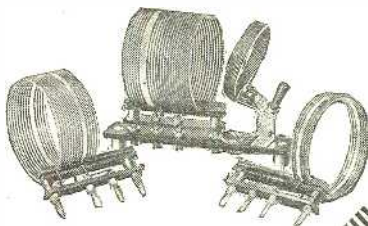

**W**HETHER you wish to listen to the short-wave broadcasts—to catch the code sent out by amateurs all over the world, or whether you are interested in television, that lusty new infant of radio, you will need the best short-wave equipment obtainable.

**Short-Wave Coils**

**S**PACE-WOUND on the thinnest of dielectric material, Hammarlund Plug-In Short-Wave Coils have extremely low distributed capacity and D.C. resistance. The plug-in terminals are widely spaced. The standard coil set covers the 15-107 meter range. Other coils are available for down to 8 meters and up to 215 meters.

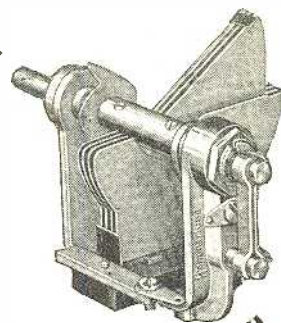

**Short-Wave Condensers**

**H**AMMARLUND Short-Wave Condensers have been for years the choice of radio experts and experienced amateurs. Available in the 5, 7 and 11-plate sizes, with either the famous "Midline" or "SFL" tuning curve.

**HAMMARLUND MANUFACTURING CO.**  
424-438 W. 33rd St., New York, N. Y.

Write for **Hammarlund** Write for  
Folders **PRECISION PRODUCTS** Folders



**BE A RADIO DOCTOR**

If you are interested in radio, the quicker you decide to make radio your life work the sooner you will be assured of success and Big Money.

**\$5,000** a year is possible for men connecting at once with our big National Radio Service organization.

**I Need 1200 Men at Once for Chain Service Stations**  
Don't be a "tinkerer," get in on the ground floor with a big proposition. Investigate at once.  
"Have a licensed Radio Doctor fix it" is the slogan where our men operate.

Write today for our free booklet, "Why the Radio Doctor"

**E. W. PARKER, Pres. RADIO DOCTORS, INC.**  
Dept N3, Essex St., Salem, Mass.



Insure your copy reaching you each month. Subscribe to Radio News—\$2.50 a year. Experimenter Publishing Co., 230 Fifth Avenue, N. Y. C.

# SUCCESS

## from

"Since my graduation from your school in 1924 I have been going ahead steadily. I was first assistant to Dr. Barnett of Stanford University, doing private research work. This year I was promoted to official technician for the Stanford Service in San Francisco Hospital." (Signed) *M. S. Llano.*

"I got the job! Three and one-half hours after your recommendation must have reached Mr. A—I was called in to his office and promoted over heads of at least twelve men." (Signed) *J. J. Kelly.*

"I am now cleaner and dyer for the above-named company, and I believe that the course which I am taking with you is the cause of my getting this place. My salary is almost double what it was when I started with the course." (Signed) *E. H. Lasater.*

"I thought I would write and let you know of my success. I now have a fine position as chemist at Du Pont's Dye Works. It was through your course alone that I have been so successful." (Signed) *B. G. Bennett.*

# CHEMISTRY

**NOW**  
Is the Time to Study  
Chemistry

Not only are there boundless opportunities for amassing wealth in Chemistry, but the profession affords congenial employment at good salaries to hundreds of thousands who merely follow out its present applications. These applications are innumerable, touching intimately every business and every product in the world. The work of the chemist can hardly be called work at all. It is the keenest and most enjoyable kind of pleasure. The days in a chemical laboratory are filled with thrilling and delightful experimentation, with the alluring prospect of a discovery that may spell Fortune always at hand to spur your enthusiasm.

**Easy Monthly Payments**

You don't have to have even the small price of the course to start. You can pay for it in small monthly amounts—so small that you won't feel them. The cost of our course is very low, and includes everything, even the chemistry outfit—there are no extras to buy with our course. Our plan of monthly payments places a chemical education within the reach of everyone. Write us and let us explain our plan in full—give us the opportunity of showing you how you can qualify for a highly trained technical position without even giving up your present employment.

**C**HEMISTRY has no equal as a profession in the modern world. There is mystery, romance, and fortune awaiting the man in the laboratory.

Millions have been made by the discoverers of the chemical formula of dynamite, bakelite, and many other world-known chemical products.

Opportunities in the chemical profession abound on every hand—and as modern business and competition progresses the chemist will play an important part.

Profit by the experience of Mr. Kelly and many others; resolve to study chemistry NOW.

**YOU CAN LEARN AT HOME**

To qualify for this remarkable calling requires careful specialized training. Formerly it was necessary to attend a university for several years to acquire that training, but thanks to our highly perfected and thorough system of instruction, you can now stay at home, keep your position, and let us educate you in Chemistry during your spare time. Even with only common schooling you can take our course and equip yourself for immediate practical work in a chemical laboratory. Dr. Sloane gives every one of his students the same careful, personal supervision that made him celebrated throughout his long career as a college professor. Your instruction from the very beginning is made interesting and practical, and we supply you with apparatus and chemicals for performing the fascinating analyses and experimental work that play such a large part in our method of teaching, and you are awarded the Institute's official diploma after you have satisfactorily completed the course.

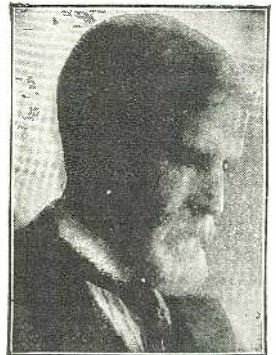

T. O'CONOR SLOANE,  
A.B., A.M., LL.D., Ph.D.

Noted Instructor, Lecturer and Author. Formerly Treasurer American Chemical Society and a practical chemist with many well known achievements to his credit. Not only has Dr. Sloane taught chemistry for years, but he was for many years engaged in commercial chemical work.

**GOOD CHEMISTS COMMAND HIGH SALARIES**

**MAIL COUPON FOR FREE BOOK**

Your name and address on the coupon will bring you by return mail our interesting free book, "OPPORTUNITIES FOR CHEMISTS," and full particulars about the course and what it will do for you. You owe it to yourself to get this book. Send the coupon right now while it is fresh in your mind. Or just write your name and address on a postal and mail to us. But whatever you do, act today.

**DON'T WAIT—MAIL COUPON NOW!**

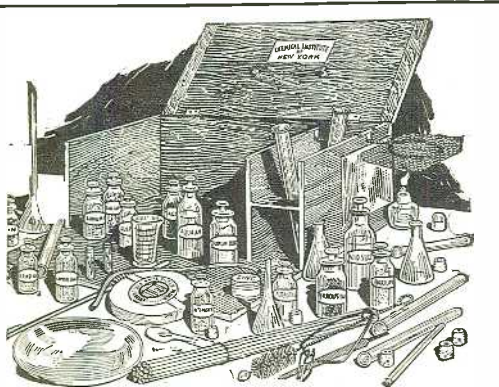

**EXPERIMENTAL EQUIPMENT FURNISHED TO EVERY STUDENT**

We give to every student, without additional charge, this chemical equipment, including fifty-two pieces of laboratory apparatus and supplies, and fifty-two different chemicals and reagents. These comprise the apparatus and chemicals used for the experimental work of the course. The fitted heavy wooden box serves not only as a case for the outfit but also as a useful laboratory accessory for performing countless experiments.

**Chemical Institute of New York, Inc.**

Home Extension Division 12  
16-18-R East 30th St.  
New York, N. Y.

**CHEMICAL INSTITUTE OF NEW YORK, INC.**  
Home Extension Division 12  
16-18-R—East 30th Street, New York, N. Y.

Please send me at once, without any obligation on my part, your free Book, "Opportunities for Chemists," and full particulars about the Experimental Equipment given to every student. Also please tell me about your plan of payment.

NAME.....  
ADDRESS.....  
CITY..... STATE.....

## On the Short Waves

(Continued from page 361)

howl. Test the windings with a battery and phones for continuity. Try a fixed high resistor across the secondary winding of the second transformer—value somewhere between 100,000 ohms and a megohm. One of these expedients should determine where the trouble lay.—EDITOR.)

### CORRESPONDENTS WANTED

I am a licensed amateur and would certainly appreciate correspondence from brother hams and experimenters; I am 15 years old. My transmitter uses an ordinary 201A on 40 meters, "B" battery plate supply; and I would like to make arrangements with any hams in my vicinity for a QSO. 73.

TED REID, 7HR,  
Orofino, Idaho.

Would any short-wave phone transmitter, male or female (and there are not many ladies who transmit in this part of the world) please write me? I am interested in underground acrials. Photos enclosed (*too small for reproduction*) showing my 43-foot aerial mast.

L. N. H. RICHARDSON,  
Houston Street, Stawell, Victoria, Australia.

Would any boy around my own age (14) please write me a letter. I am interested in three- and four-tube sets; and will answer all letters.

J. SOUTHEY,  
Punwicky, Saskatchewan, Canada.

### ROUND-THE-WORLD TESTS

It has been mentioned in these columns that mechanical recording devices show that high-frequency, short-wave signals come in two series—one corresponding to the time required for short-wave travel, and the other to that needed to go the long way round the earth. In some instances, with high-power signals, it is possible to trace the effects of another signal impulse which has gone nearly twice around the world.

The recognition of this phenomenon has been succeeded by its use as a regular method of test. It is no longer necessary to send out experimental signals and wait for messages from far seas as to whether or not they have been picked up. "These days we do it quite differently," Dr.

## AMAZING STORIES

In Our  
December Issue:

**The World at Bay**, by B. and Geo. C. Wallis. The chapters of the final instalment of this story are vibrant with excitement and strategy to combat the horrors of the Troglodytes and their unknown deadly poisonous gas. It is no mean job to fight the fiends in their strangely-devised helicopters, run by radium energy. But not once is the human interest part of the story allowed to lag.

**The Space Bender**, by Edward L. Rementer. May it not have been, after all, purely accidental that the anthropoid adapted itself to varying conditions on this planet more quickly than the others, and so finally evolved into the higher animal—a human being? It is an interesting conjecture, what the results of a snake or fish ancestry, for instance, would be like.

**Before the Ice Age**, by Alfred Fritchey. We know practically nothing about the "pre-record" civilizations, but this story told with the easy facility of sailor-inn charm and freshness, makes delightful reading, though there is plenty of food for thought.

**The Appendix and the Spectacles**, by Miles J. Breuer, M.D. We are sure that all those readers who have read Dr. Breuer's short stories of medical science and psychology, will be glad to welcome him back. In this new story, our author enters into a slightly new combination with his medical science.

And Others.

Radio's  
greatest  
value!

7  
SUPERPHONIC

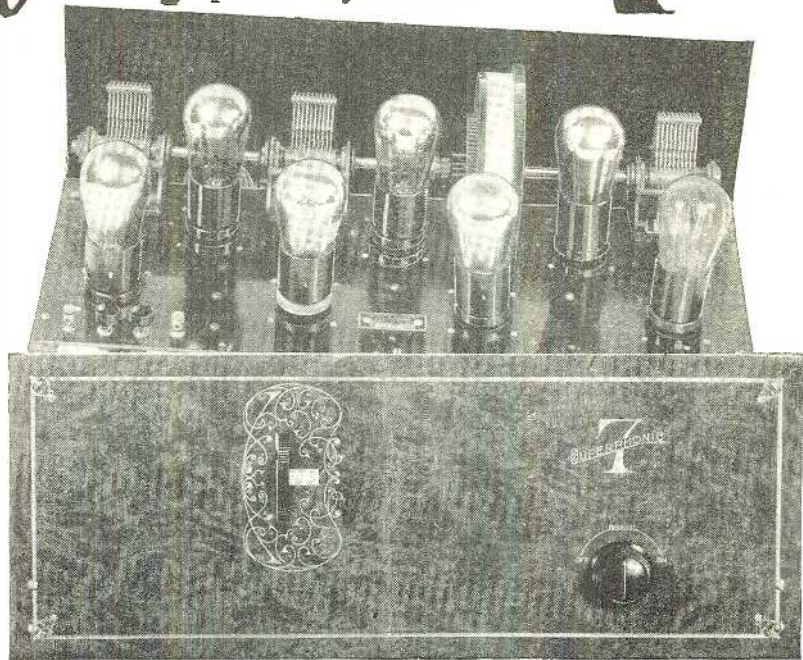

### 7 Tubes--Single Dial

Superphonic 7 is a world beater! An exceptionally high grade receiver that is amazing the Radio World. Latest 7-tube tuned radio frequency circuit, using 4 radio frequency amplifiers, detector and 2 stages of audio. Power tube can be used in last audio stage. Extremely selective, marvelous sensitivity. Single drum dial control. Straight line wavelength condensers permit accurate, equally spaced tuning over entire wave band. All sockets spring cushioned to eliminate microphonic noises. Bakelite subpanel (8 1/2" deep) insures minimum dielectric losses. Clear and realistic reception guaranteed. An exceptionally beautiful, walnut finish, metal front panel 7" x 18". Complete chassis. No extra parts to buy. All parts mounted ready to wire. No special tools needed. All hook-up wire and colored battery cable included. Value \$60.00; our price \$16.95.

#### TESTED AND APPROVED

Severe laboratory tests have proved the remarkable efficiency of this set. Owners everywhere are sending us letters praising its wonderful receptive qualities.

#### SIMPLE WIRING DIRECTIONS

Very easy to wire this set with the instructions we furnish. Just connect a few wires. All you have to do is follow numbers. Simple as adding 2 and 2. Can be wired in a few minutes by anyone. No radio knowledge needed. Make money by wiring these sets in your spare time and selling them to your friends.

#### SEND NO MONEY

Just write your name and address on a postcard and ask us to send you this wonderful outfit. We ship right away. Upon arrival pay only \$16.95 plus a small delivery charge. (Foreign countries send \$19.50 with order. We pay shipping charges.)

RADIO EQUIPMENT CO. 549 S. Wells St., Dept. 12M, CHICAGO, ILL.

Only  
\$16.95

COAST  
to COAST  
RECEPTION

## A REAL SPECIAL OFFER!!



### UNI-RECTRON POWER AMPLIFIER

(Ideal for use with Dynamic Speakers)

Model AP-935

As the Uni-Rectron stands it is a super power amplifier, which can be used in connection with any radio set and loud speaker. Binding posts are provided for input to the Uni-Rectron and output to the speaker.

Requires no batteries for its operation. It obtains its power from the 110 volt, 60 cycle alternating current lighting circuit of your house.

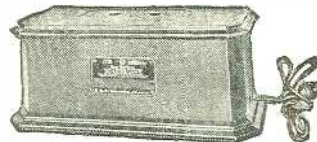

List Price \$88.50  
(without tubes)

Special - \$19.75 ea.

Every one new and packed in original factory carton

The UX-210 super power amplifying tube and the UX-216B or 281 rectifying tube are used with this amplifier, which cannot overload. From the faintest whisper to the loudest crash of sound—R. C. A. Uni-Rectron amplifies each note at its true value. High and low notes are all treated alike. The volume and quantity delivered will be a revelation.

AMERICAN SALES CO., 19-21 WARREN ST., NEW YORK CITY

Insure your copy reaching you each month. Subscribe to Radio News—\$2.50 a year  
Experimenter Publishing Co., 230 Fifth Avenue, N. Y. C.

Please say you saw it in RADIO NEWS



For those who appreciate better radio reception, the *new, perfected* De Forest Audions—the latest achievement of Dr. Lee De Forest—assure the true tonal values of reproduction which add so much to radio enjoyment.

Sold by leading dealers everywhere

DE FOREST RADIO CO.  
Jersey City, New Jersey



## DRESNER SHORT-WAVE CONVERTER

WAVE-LENGTH RANGE  
15 to 550  
Meters



COMPLETE  
**\$22.50**  
(SPECIAL)

May be used with any type of broadcast receiver. Easily connected in just a few moments' time. No complicated wiring. Simply plugged into the detector socket in the set. Covers the entire range of wave lengths from 15 to 550 meters. Maximum satisfaction from top to bottom. Don't miss the excellent programs now being broadcast on the short waves. Get a Dresner Converter. Five interchangeable coils furnished with each unit. If your dealer can't supply you, Send **MONEY ORDER** Direct and we will ship P. P. Prepaid. **GUARANTEEED.** (When ordering unit, be sure to specify whether it is to be used on A.C. or D.C. set.)

DRESNER RADIO MANUFACTURING CORP.  
640 Southern Boulevard, Dept. E, New York, N. Y.



Matchless bargains in radios and accessories. Full line of Sleeper, Browning, Drake, Carter, Utah, Tower Speakers, Temple, Majestic, Kodol, G. E., Tungar, Burgess, Jewell, Belden, Cunningham tubes, nationally advertised parts, storage batteries, chargers, etc. Big opportunity for live ones who can sell radio. Double sales quick. Use your letterhead. Exclusive territories open. Act—NOW!  
**NEW ENGLAND MILLS COMPANY**  
Distributors of Nationally Advertised Radio Lines  
Dept. R200 851-55 Washington Blvd. Chicago, Ill.

**PATENTS** As one of the oldest patent firms in America we give inventors at lowest consistent charge, a service noted for results, evidenced by many well known Patents of extraordinary value. Book, Patent-Sense, free.  
Lacey & Lacey, 631 F St., Washington, D. C. Estab. 1869

A. H. Taylor, chief of the naval research laboratory explains: "we simply go out eight or ten miles from the station to be tested, with a modern high-frequency set, where we are away from local interference, send a signal and if, after one-seventh of a second, we have not heard it *around the world*, we know the set is not up to standards."

### DISTRIBUTION OF SHORT-WAVE STATIONS

Of 862 short-wave stations throughout the world (aside from amateurs) as listed recently, nearly a third, or 246 in number, are in the United States and the Philippines, and 125 in various parts of the British Empire. Germany has 81; Holland 75, France 56, Japan 36, Italy 28, Russia and Brazil each 24, Mexico 19, Sweden 17, Argentina 10 and China 10. In the case of the nations which have stations in their colonial possessions, even at a considerable distance, these are included in the above numbers. The majority of these, of course, are code stations.

There are, it is calculated, between 50 and 13 meters, 884 channels suitable for point-to-point communication, under the international allotment of frequencies. Of these the United States government has already allocated 228, or over 25%, and it is evident that the long-despised short waves are of high commercial value.

### STANDARD-FREQUENCY TRANSMISSIONS

The Bureau of Standards has announced its winter schedule of frequencies to be transmitted monthly, as given below. These will be of considerable value to the owners of short-wave receiving sets who are desirous of calibrating them, or their wavemeters, to facilitate identifying and locating stations. The signals, however, are given in code; full directions for their reception will be found in the Bureau's letter circular No. 171, which it will send on request to its office in Washington. The transmissions of each frequency, as given beneath, begin at the exact time stated (Eastern Standard), and last for eight minutes, with four minutes for readjustment before the next transmission. (Meters in parentheses) below kilocycles, which are opposite the times.

(p.m. EST)	Nov. 20	Dec. 20	Jan. 21	Feb. 20
10:00	1500 (199.9)	4000 (74.9)	125 (2399)	550 (545.1)
10:12	1700 (176.3)	4200 (71.4)	150 (1999)	600 (499.7)
10:24	2250 (128.8)	4400 (67.5)	200 (1499.4)	650 (461.3)
10:36	2750 (109.9)	4700 (63.8)	250 (1199.5)	800 (374.8)
10:48	2850 (105.2)	5000 (60.0)	300 (999.3)	1000 (299.8)
11:00	3200 (93.7)	5500 (54.5)	375 (799.6)	1200 (249.9)
11:12	3500 (85.6)	5700 (52.6)	450 (666.2)	1400 (214.2)
11:24	4000 (74.9)	6000 (50.0)	550 (545.1)	1500 (199.9)

### Radio News Laboratories

(Continued from page 565)

#### FILTER-CONDENSER BLOCKS

The "Type RM 14" filter-condenser block shown below, submitted by A. M. Flechtheim & Co., 136 Liberty Street, New York City, was designed for use in "B" power units of the "Thordarson R-171 Compact" type, which use a gas-filled rectifier. Condenser sections of 8-, 2-, and 2-mf. capacity, rated at a D.C. working voltage of 650, are provided; and two 1-mf. sections of 450-volt D.C. rating, to by-pass the voltage-divider taps. The terminals of the former sections are placed upon the top, and those for the 1-mf. sections at the right and left; the common terminal for all sections is at the right. The five sections are hermetically sealed in a silver-finished housing 5-1/2 inches high, 4 inches long and 2-1/4 inches wide; insulating compound is used to hold them in position. The capacities of the components were found within 5% of their rating; and, when used with the "R-171" compact, a humless "B" power supply was obtained from the filter.

AWARDED THE RADIO NEWS LABORATORIES CERTIFICATE OF MERIT NO. 2471.

The "Type FA 10" filter-condenser block submitted by the same manufacturer was designed for use in "B" and "C" power units operating a UX-210 power amplifier. Condenser sections of 2-, 2-, 2-, 4-, 1-, and 1-mf. capacities, respectively, are provided; these all have a rating of 650 volts D.C., working voltage. The three 2-mf. sections lead to terminals at the top, the terminals for the two 1-mf. sections are found at the right; and the 4-mf. connections and the common terminal

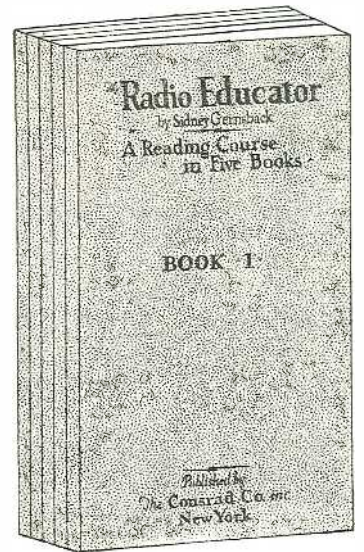

Price \$1.97

## A RADIO EDUCATION

IN 5 VOLUMES

### "THE RADIO EDUCATOR"

Theory, Design, Construction, Operation and Maintenance

LEARN AT HOME

THESE five component parts of a complete Radio Instruction Course are outlined in five volumes that contain not merely the essentials as so many books do, but more, they contain all that any modern up-to-the-minute textbook on any subject would cover. They are in themselves a COMPLETE radio education teaching every possible portion of Radio science.

Size of each book 6 by 9 inches, handsomely bound and illustrated with charts, diagrams, descriptions of equipment, etc. Each volume 52 pages.

SEND NO MONEY for these books. Just forward your name and address. We send you the books at once. On receipt of same you pay the postman \$1.97 plus a few cents postage and then they are yours.

Distributed by

**The Consrad Co.**

Incorporated

230 Fifth Ave., New York, N. Y.



**Your Set Can Now Get Short Waves**



Sent anywhere in the U. S. post paid upon receipt of price. Canada and Foreign, 60c additional. Money order only. Also sent C. O. D. plus postage in U. S. if \$1.00 accompanies order to insure carrying charges. In ordering be sure to name set and tubes used, such as UV199, UX199, WD11, 201A, UX226 or UY227. Price \$15.00 or \$17.50 for A. C. Sets.

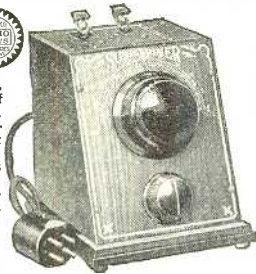

**The SUBMARINER**

will convert your regular set into a short-wave receiver by simply inserting a plug in place of one of the tubes. This takes but a few seconds. With "Submariner" it will enable you to tune between 20 and 65 meters.

This device operates with all sets, such as T.R.F., Neutrodyne, Super-Heterodyne and others. A C or D C operated. No additional tubes, batteries, or coils required. If set operates a speaker it will do so with "Submariner" attached. Operates as a wave changer with Super-Heterodyne and as detector unit with others.

**SHORT-WAVE RECEPTION**

is practical, as short waves penetrate better and there is less static. The "Submariner" waveband includes practically all powerful stations which broadcast programs. You may also listen to amateurs from all parts of the world who transmit code messages. You will have one of the most efficient short-wave receivers when the "Submariner" is attached to your set. Get a "Submariner" so you may have command of the short-wave activities as well as the broadcast band. Never before has so much in radio been offered for so little money! A new thrill awaits you! If your Dealer does not carry

**ORDER TODAY DIRECT**

This device has been nationally advertised, and sold in all parts of the world for the past two years

**J-M-P MANUFACTURING CO., INC.**  
3401 Fond du Lac Ave. Milwaukee, Wis., U. S. A.

**Come to Washington**

The educational advantages of a visit to the Capital of our Nation are of inestimable value

Stop at

**The LEE HOUSE**

15th and L Streets, N.W.

Three squares to the White House. A new and modern Hotel. Refined environment.

250 ROOMS - 250 BATHS

Rates:

- Single room ..... \$ 3.50 daily
- Double room ..... 5.00 "
- Single room (with meals) .. 6.00 "
- 2 persons (with meals)..... 10.00 "

**ROBERT BLOCK, President**

**NEWS to Set Builders**



Barawik offers set builders bigger bargains—bigger opportunities to make money this season. New sets, new kit ideas, all the leading parts, dynamic speakers, supplies, etc. Lowest rock-bottom prices. Bigger stocks, quicker service. Send for Big Bargain Book today—free.

**BARAWIK CO., CHICAGO, U. S. A.**

Mail This Coupon Now! For Free Copy

Name .....

Address .....

**Custom Set Builders**

Browning-Drake has an interesting and unusual proposition. Take advantage of the fact that more Browning-Drakes are built than any other.

Write today

**BROWNING-DRAKE CORP.**  
CAMBRIDGE, MASS.



**AUDIO TRANSFORMERS 97c**  
Think of it! A \$4.00 audio transformer—a genuine Illinois "all frequency" unit of the finest musical capability, offered direct from the factory for only 97c each. A real bargain opportunity. Thousands have bought them. Sold with positive guarantee of satisfaction or money back. Supplied in ratios of 1 1/2 to 1, 3 to 1, and 5 to 1. Order now. **ILLINOIS TRANSFORMER CO.**  
Dept. 110 223 W. Elm St. Chicago, Ill.

for all the sections at the left. All sections are insulated and held in position by a special compound in a hermetically-sealed container; which is of a silver finish, 3-1/2 inches high, 4-1/2 inches long



No. 2471



No. 2472

and 3-1/2 inches wide. The sections were found within 5% of their respective capacity ratings. When the block was used in a "B" power unit's filter system a humless high-voltage supply was obtained.

AWARDED THE RADIO NEWS LABORATORIES CERTIFICATE OF MERIT NO. 2472.

**I Want to Know**

(Continued from page 568)

in almost every installation a piece of insulating tube is inserted in the pipe, either in the gas meter or between this meter and the inlet. This insulated section makes the gas pipe a very poor ground in comparison with the water pipes. The hot-water pipes are also inferior to the cold water pipes because of the greater number of joints and because the heater system is also included in the line.

In the absence of water pipes, the best method of reaching the ground moisture is to drive a long pipe or pipes into the ground at least five or six feet; and it is better to drive one long pipe deep into the ground than a number of short ones. A metal plate of any kind is very good, but requires much more labor to install than the pipe.

A rather clever scheme which gave remarkable results was described in the March issue of RADIO NEWS, under the head "Encircling the World with a Two-Tube Set." The system consisted of an old worn-out auto radiator and a number of pipes. The building, in which the set was operated, was located on slanting ground, and the radiator and pipes were buried in a line, with the former at the upper end. Water was then poured into the radiator and as it gradually leaked out, the ground around the pipes was moistened. This is a rather elaborate arrangement, but the success

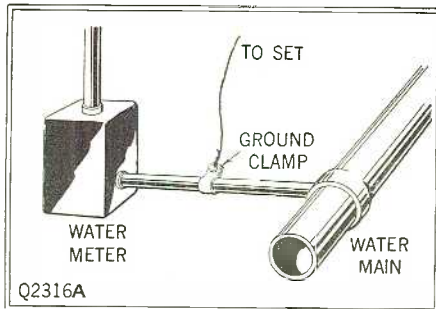

The ground connection should be made outside the meter and as close to the main as possible.

obtained shows the importance of having a good ground system.

In country districts a stream or well can be utilized by dropping a length of bare wire into the water. Cisterns built inside of buildings are not always good grounds, however, since they are often insulated by their own construction.

Whether a water pipe or pipes driven in the ground or a wire dropped into a stream is used for the ground, the wire leading from the set should be soldered, if possible, at every joint and, in cases where soldering is impossible, the metal should be scraped very carefully and a good friction contact be made. It must be remembered also that a ground which is very good in winter and spring may be a very poor one in summer, when the ground has become dry. For this reason every available ground connection should be tried and the best one used.

**The Counterpoise**

In some cases, because of the nature of the ground or other local conditions, it may not be possible to make a good ground connection by

Until you have heard the

**New Victoreen**

A. C. or D. C.

you cannot realize the marvelous development in Radio Reception

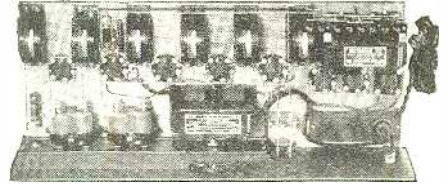

The new Victoreen is simply wonderful—that is the only way to describe it. It has wonderful tone—wonderful selectivity, wonderful sensitivity. It is wonderfully simple to assemble, wonderfully easy to operate. Anyone who has the slightest "knack" can assemble in a few pleasant hours a set which, from every standpoint, simply cannot be surpassed.

This is a season of wonderful radio programs. With a Victoreen you can enjoy them from coast to coast. If a Victoreen can't get a station it can't be had.

Victoreen R.F. Transformers have been greatly improved—the circuit has been still further developed—many other radical improvements have been made which make Victoreen more than ever the world's standard "Super."

Write for the complete Victoreen story and the FREE Blue Print giving constructional data and full directions. You'll have a set that you can boast about when you have a Victoreen.

The Blue Print is FREE

**Victoreen Power Amplifier and "B" Supply**

makes any good set better

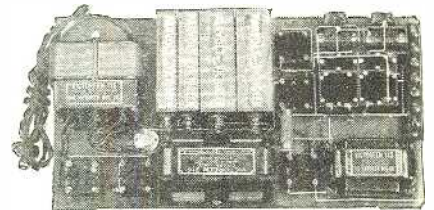

Supplies 45, 90, 180 and 450 volts, using a UX 210 or 250 in the last stage. Contains two voltage regulator tubes so that the 90 and 180 volt taps are supplied with a constant volt potential. It is the last word in "B" supply. For the most satisfactory results you must have it.

FREE BLUE PRINT, with list of parts and complete assembly instructions, will be sent upon request.

The George W. Walker Company  
Merchandisers of Victoreen Radio Parts  
2825 Chester Ave., Cleveland, Ohio

**Victoreen**

Quality Radio Parts

# FERRANTI

## Audio Frequency TRANSFORMERS and RADIO PRODUCTS

*receive preference by engineers who KNOW*

Real audio transformers with flat curves. Special output transformers for all speakers and tubes. High grade iron core chokes for "B" Eliminators. Three range portable meters. 1,000 ohms per volt. Cobalt magnets 10/50/250 scale. Three range portable meters. 200 ohms per volt. 150/7½ volt and 15 Mill. scale with switch. By-Pass condensers—2MF—400 volt and 200 volt.

Circulars sent on request.

Send 15c in coin for copy of 1929 Ferranti Year Book.

**FERRANTI, INC.**  
130 W. 42d St., New York, N. Y.

**FERRANTI, LTD.**    **FERRANTI ELECTRIC**  
Hollingwood,                      LIMITED  
England                              Toronto, Canada

any of the methods mentioned above and, in this case, a counterpoise should be employed. The counterpoise consists of one or more wires strung several feet above the ground and very carefully insulated from it; this is usually placed directly below the aerial. It is connected in place of the ground and constitutes the lower plate of a condenser of which the aerial is the upper. The dimensions of the counterpoise are not very critical, although it is better to have it larger than the aerial and to use several wires connected in parallel. The same care should be used when insulating the counterpoise as in insulating the

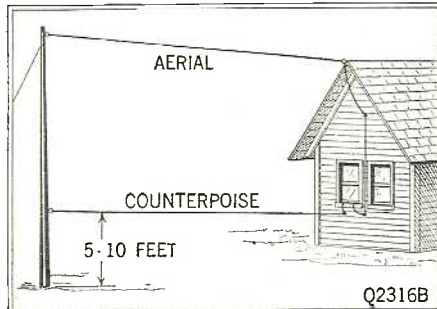

The counterpoise may be called an artificial "ground"; with the aerial it forms a condenser of small capacity. It is used extensively in transmitting work.

aerial. for the former is nearer the ground. The distance at which the counterpoise is placed above the ground is not critical and may be one foot or ten with practically equal results. The counterpoise may be placed either indoors or out, so long as it is placed beneath the aerial. If it is erected outdoors, it will be necessary to protect it with a lightning arrestor in order to follow the Fire Underwriters' rules. A typical arrangement of aerial and counterpoise is shown in Fig. Q.2316B.

#### Ground Condenser

When power units are used with sets, a good precaution is to connect a condenser of large capacity between the set and the ground lead. In this way, the set is completely disconnected from the ground, as regards any direct-current circuit; while the condenser passes radio-frequency currents with no difficulty. The condenser used for this purpose should have rather large capacity, so that it will not affect the operation of the set. When the tuning of a set is too broad, the use of a small fixed condenser will increase the selectivity without reducing the volume noticeably. A value between .00025- and .001-mf. will be found suitable as a rule for increasing the selectivity, depending on the size

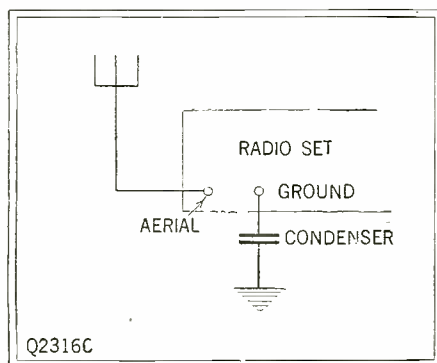

A condenser of 1.0-mf. capacity in this position is too large to affect the tuning of the set; but affords desired protection if a power unit is used.

of the aerial and the particular set in question. For simply isolating the set, a condenser of about 1 mf. is used; the method of connecting it is shown in Fig. Q.2316C.

#### CHOICE OF A.C. TUBES

(2317) Mr. W. E. Wilson, Pelham Bay, New York, writes:  
(Q.) "I have noticed that many manufacturers of alternating-current sets are using the cathode-heater A.C. tubes (227-type) in preference to the usual method of using this tube only in the detector socket of the set. Can you explain the reason for this and also the advantages gained by the use of these tubes? I have noticed that the 227-type tubes do not all operate with the

## SAVE YOUR MONEY! BE YOUR OWN SERVICE MAN

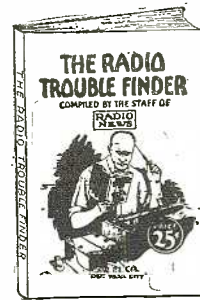

### THE RADIO TROUBLE FINDER

Even the highest-priced radio set occasionally develops a fault and that at a time when you least expect it—maybe right in the middle of an interesting program. But, a handy copy of

*The Radio Trouble Finder* is the simple means for tracing every defect and remedying it in the easiest manner possible. There is no mishap that could befall a radio, but what is fully covered in this valuable book.

*The Radio Trouble Finder* is edited by men fully versed in the subject covered—men with years of actual experience behind them—and who have grown to prominence since the infancy of radio.

Don't wait till your set goes bad—get your copy of this remarkable guide to radio trouble now. Fill in the coupon and we will send you by return mail a copy of *The Radio Trouble Finder*, a money-saving investment. You can be your own service man.

The **25c** Copy

## Shanco Battery Clip

GRIP-TITE      POWERFUL TENSION

THE Shanco Battery Clip design assures free and uninterrupted flow of electrical current. No springs to heat up, burn or drop out. Made of powerful tension, tempered spring steel solidly riveted together. All parts electroplated before assembly (not galvanized or tinned), acid-resisting. Jaws open wide and are easily applied. The Griptite bulldog teeth "stay put" and bite right through corroded bars and terminals. Clip cannot fall over and "short" your battery.

Write Dept. 73 for free literature and prices.

**SHANKLIN MANUFACTURING CO.**  
Dept. 73, Springfield, Illinois

## NEWS to Set Builders

LATEST RADIO GUIDE

Barawik offers set builders bigger bargains—bigger opportunities to make money this season. New sets, new kit ideas, all the leading parts, dynamic speakers, supplies, etc. Lowest rock-bottom prices. Bigger stocks, quicker service. Send for Big Bargain Book today—free.

**BARAWIK CO.,**    212d Canal Sta.,  
CHICAGO, U.S.A.

Mail This Coupon Now! For Free Copy  
Name .....  
Address .....

# FRESHMAN

## YOUR ULTIMATE RADIO

AT ALL  
AUTHORIZED  
DEALERS

## HOOK-UP BOOK FREE

Improve your reception with  
**CARBORUNDUM**  
Stabilizing Detector Units,  
Grid Leaks and Resistors

THE CARBORUNDUM COMPANY  
DEPT. D-1, NIAGARA FALLS, N. Y.

## BUILD YOUR OWN RADIO SET

### 150 RADIO HOOK-UPS

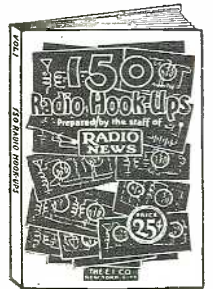

This is the latest issue of this remarkable book. Absolutely new and up-to-date. All the best circuits of the day. Full instructions on how to build. Make your own set from the diagrams shown in *150 Radio Hook-Ups*. Write today—pick the set you want to build and make it. Then you are sure to be satisfied with the results you get.

*150 Radio Hook-Ups* was prepared by the staff of *Radio News*. An accurate guide to better set construction for the radio "fans."

The **25c** Copy

MAIL THIS COUPON NOW

### CONSRAD CO., INC.

230 FIFTH AVENUE NEW YORK, N. Y.

CONSRAD COMPANY, INC.  
230 Fifth Avenue, New York, N. Y.  
Gentlemen:  
Kindly send me a copy of 150 RADIO HOOK-UPS... THE RADIO TROUBLE FINDER... (check which or both).  
Enclosed find.....cents in full payment.

Name.....  
Address.....  
City.....State.....

# OPPORTUNITY AD-LETS

Follow these advertisements every month. Reliable advertisers from all over the country offer their most attractive specials in these columns.

Classified advertising rate twenty-six cents a word for each insertion. Ten per cent discount for 6 issues, 20 per cent discount for 12 issues. Names and addresses must be included at the above rate. Cash should accompany all classified advertisements unless placed by an accredited advertising agency. No advertisements for less than 10 words accepted.

Objectionable or misleading advertisements not accepted. Advertisements for the February issue must reach us not later than December 1st.

**CIRCULATION LARGER THAN THAT OF ANY OTHER RADIO PUBLICATION**

EXPERIMENTER PUBLISHING CO., INC., 230 Fifth Avenue, New York, N. Y.

## Agents Wanted

**Guaranteed Genuine Gold Leaf Letters** anyone can put on store windows. Large profits, enormous demand. Free samples. Metallic Letter Co., 422 N. Clark, Chicago.

**Agents**—We start you in business and help you succeed. No capital or experience needed. Spare or full time. You can earn \$50-\$100 weekly. Write Madison Products, 569 Broadway, New York.

## Books

**Books, Magazines, Art Publications** in French, Spanish, English. Photo novelties, samples, lists, etc., 20 cents stamps. Villaverde Co., Dept. 211, Box 1329, Havana, Cuba.

## Business Opportunities

**Amateur Cartoonists:** Sell Your Cartoons New Plan. Smith's Service BX1194, Wenatchee, Wash.

**Inventions Commercialized.** Patented or Unpatented. Write Adam Fisher Mfg. Co., 278 Enright, St. Louis, Mo.

**Free Book.** Start little Mail Order business. Hadwil, 5A-74 Corlandt Street, N. Y.

## Chemistry

**Learn Chemistry at Home.** Dr. T. O'Connor Sloane, noted educator and scientific authority, will teach you. Our home study correspondence course fits you to take a position as chemist. See our full-page ad on page 473 of this issue. Chemical Institute of New York, 16 E. 30th Street, New York City.

## Correspondence Courses

**Used correspondence school courses** sold on repurchase basis. Also rented and exchanged. Money-back guarantee. Catalog free. (Courses bought). Lee Mountain, Pisgah, Alabama.

## Detectives

**Detectives Needed Everywhere.** Travel. Experience unnecessary. Particulars Free. Write, American Detective System, 2190 Broadway, N. Y.

## Electricity

**Electric Fun!** Seventy stunts, 110 volts, \$1. Cooperco, Campbell, Calif.

## Esperanto

Send for free illustrated sample lesson of the international language, Esperanto. It immediately enables you to correspond with all nations of the world. Benson School of Esperanto, 518 Broad Street, Newark, N. J.

## For Inventors

**Inventions Commercialized.** Patented or Unpatented. Write Adam Fisher Mfg. Co., 278 Enright, St. Louis, Mo.

If you have a good invention, write Hartley, Box 928, Bangor, Maine.

## Help Wanted

**Address Envelopes** at home—spare time. Experience unnecessary. Dignified work. \$15.825 weekly easy. Particulars 2c stamp. Imperial Stationery Company, Department 3, Greenfield, Ohio.

## Help Wanted—Instructions

**Wanted Immediately,** men to qualify for Railway Mail Clerk, P. O. Clerk-Carrier Tests, \$140-\$225 month. Write, Ozmest Inst., 251, St. Louis, Mo.

## Instruction

**Learn Chemistry at Home.** Dr. T. O'Connor Sloane, noted educator and scientific authority, will teach you. Our home study correspondence course fits you to take a position as chemist. See our full-page ad on page 310 of this issue. Chemical Institute of New York, 16 E. 30th Street, New York City.

## Male Help Wanted

**Firemen, Brakemen, Baggage-men** (white or colored), Sleeping Car, Train Porters (colored), \$150-\$250 monthly. Experience unnecessary. 237 Railway Bureau, East St. Louis, Ill.

## Miscellaneous

**Inventions Commercialized.** Patented or Unpatented. Write Adam Fisher Mfg. Co., 278 Enright, St. Louis, Mo.

**Forms to Cast Lead Soldiers, Indians, Marines, Trappers, Animals,** 151 kinds. Send 10c for illustrated Catalogue. H. C. Schlercke, 1034 72nd St., Brooklyn, N. Y.

**Guaranteed Solder for Aluminum,** Mail, \$1. Pierman, Belmar, N. J.

## Motorcycles

**Used Motorcycles.** Low Terms. Also Parts, Accessories. Catalog Free. Western Motorcycle Co., 946 East 15th St., Kansas City, Mo.

## Old Money Wanted

**\$2 to \$500 each** paid for hundreds of Old or Odd Coins. Keep all old money, it may be very valuable. Send 10c for New Illustrated Coin Value Book 4x6. Guaranteed prices. Get posted. We pay Cash. Clarke Coin Company, 14 Street, LeRoy, N. Y.

## Patent Attorneys

**Patents**—Send for form "Evidence of Conception" to be signed and witnessed. Form, fee schedule, information free Lancaster and Allwine, Registered Patent Attorneys in United States and Canada, 269 Ouray Bldg., Washington, D. C.

**Patent Sense**—Valuable book free. See Lacey's ad, page 507. Lacey & Lacey, 631 F. St., Washington, D. C. Established 1869.

**Patents**—Time counts in applying for patents. Don't risk delay in protecting your ideas. Send sketch of model for instructions or write for free book. "How to Obtain a Patent" and "Record of Invention" form. No charge for information on how to proceed. Communications strictly confidential. Prompt, careful, efficient service. Clarence A. O'Brien, Registered Patent Attorney, 309 Security Bank Building (directly across street from Patent Office), Washington, D. C.

**Patents procured** at reasonable rates with time to pay. Sales negotiated. Staff of registered attorneys and engineers. A complete service for inventors. Write for particulars. Inventors Service Bureau, Union Trust Bldg., Washington, D. C.

**Patents**—Send drawing or model of your invention for examination and instructions. Advice and booklet free. Highest references. Best results. Promptness assured. Watson E. Coleman, Patent Lawyer, 724 9th Street, N.W., Washington, D. C.

## Patents

**Inventions Commercialized.** Patented or unpatented. Write Adam Fisher Mfg. Co., 278 Enright, St. Louis, Mo.

## Printing, Engraving and Multigraphing

**200 Letterheads and 100 Envelopes,** \$1.10, postpaid. Oberman Company, Box 1042, Chicago.

**Multigraphing,** two dollars thousand. Miscellaneous Printing, Mayer Key Corporation, Monmouth, Illinois.

## Radio

**Wanted:** Men to work with National Radio Service organization. No selling scheme. Radio Doctors, Inc., Dept. N, Essex St., Salem, Mass.

**Five-Tube Used Sets,** \$15. Guaranteed in perfect condition. Crosley Super Musicone speakers, \$2.75. Require cone paper only. Transformers, \$ .75. 17280 tubes, \$1.75. Ameco condensers, \$1.50. 30 heavy chokes, \$1.00. 2 microfarad blocks, \$ .65. Rheostats, \$ .25. Potentiometers, \$ .35. Battery cables, \$ .35. Double slide tuners, \$ .75. Sinal speaker units, \$2.00. Crystal detectors, \$ .45. Jacks, \$ .20. Speaker plugs, \$ .25. All items guaranteed. Send money order with order. Charles Hoodwin Co., 4240 Lincoln Ave., Chicago, Ill. Dealers in Bankrupt stocks.

**Free Radio Catalogue and text book.** Guaranty Radio Goods Company, 145 West 45th Street, N. Y. C.

**Chemistry in Radio.** Complete outfit full of miscellaneous chemicals, metals, apparatus, etc. Complete set of chemical and radio experiments, even television included. Never before offered for sale at \$4.98 prepaid U. S. A. Send money order, or C.O.D. Chemical Radio Co., 4730 Drexel Blvd., Dept. A, Chicago, Ill.

## Song Writers

**Songwriters:** Get in touch with me at once. Bell, D-11, 4718 So. Broadway, St. Louis, Mo.

## Telegraphy

**Telegraphy**—Both Morse and Wireless taught thoroughly. Big salaries. Wonderful opportunities. Expenses low, chance to earn part. School established fifty years. Catalog free. Dodge's Institute, Cour St., Valparaiso, Ind.

# DON'T MISS the NEW EDITION of AMAZING STORIES QUARTERLY

Readers of the AMAZING STORIES MONTHLY can find many hours of pleasant reading in the NEW, BIG ISSUE OF THE AMAZING STORIES QUARTERLY. Off the press in a few days, this issue vies with the last in an effort to surpass. Tales by world-famous authors. The same kind of exciting narratives that have so pleased you in the past. Stories of the future, of weird happenings—startling adventure, of other worlds and of other people.

BE SURE AND GET YOUR COPY OF THE NEW SPRING ISSUE

50c. the copy

At all newsstands or write direct

EXPERIMENTER PUB. CO., 230 Fifth Ave., New York, N. Y.

# AERO KITS



## INTERNATIONAL Short-Wave Converter

Will Add Thousands of Miles To Your Receiving Range

Broadcast reception on short waves is remarkably clear and free from static. Programs are brought in from greater distances with the utmost simplicity of control. You can easily build the Aero International Short-Wave Converter and receive short-wave programs on your present set. No changes in wiring necessary. Just plug into detector socket.

AERO KIT No. 9..... \$38.90

### THE "STANDARD"

No extra tube is needed for this Aero Short-Wave Converter. Plug into detector socket of your receiver and insert the tube which you removed from set into the Converter. Kit is complete with all parts. Can be assembled in a few minutes. For A.C. or D.C. receivers.

Price—\$32.00

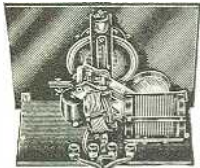

Write for information about the New 1929 Aero Green Book

**AERO PRODUCTS**  
INCORPORATED  
Dept. 198, 4611 E. Ravenswood Ave., Chicago, Ill.

## Neutralization Means More Power From Any Set

Science has proven that neutralization is the only satisfactory method of controlling oscillation in a Tuned Radio Frequency Circuit and that it increases the actual power per stage of amplification 25 to 300 per cent.



**MODEL "N" VARIO-DENSIFIER**  
Has variable capacity, adjustable from 1.8 to 20 micro-microfarads, which is .0000018 to .00002 microfarads.  
Price Each \$1.00

The Neutrodyne principle can be applied to practically every set by the simple installation of X-L Vario-densifiers. The result is an amazing increase in the efficiency and power of the receiver. Send for interesting book of circuits and picture diagrams showing the use of the Vario-densifier.

## XL Radio Laboratories

Dept. A, 1224 Belmont Ave., Chicago, Ill.

## Newest Radio Hook-Ups — Free —

Send now for the newest radio hook-up book. Shows how easy it is to build remarkable new A.C. and D.C. receivers of longest range, greatest volume, purest, clearest tone, and super-selective. Also shows how to make short-wave receivers and adapters, how to use new screen grid tube in A.C. and D.C. circuits, how to build power amplifiers and A-B-C eliminators. Latest information on all new radio wrinkles. Send for free copy now.

**KARAS ELECTRIC COMPANY**  
4038M3 N. Rockwell St., Chicago, U. S. A.

Name.....  
St. and No.....  
City and State.....

same brilliancy. Does this affect the operation of the tubes in any way, or is it a normal condition? Another point which has bothered me for some time is the use of such low voltages on the filaments of the A.C. tubes. Can you explain why these low voltages are employed and, also, why different values are used for the different types of tubes?"

(A.) The reason why manufacturers of alternating-current sets are now employing the heater-type tubes more extensively is, primarily, the greater ease of building sets with these tubes. Now that proper means for regulating supply-voltage variations are being provided, and experimenters are becoming more familiar with the methods of handling unusual line voltages, this tube is considered as a very good all-purpose tube. The construction of sets with these tubes involves less work and fewer parts than the use of the direct-filament A.C. tubes, because of the simpler methods of balancing to reduce the "hum." In sets employing the direct-filament tubes, a number of tapped resistors with adjustable taps are required to obtain the center points of the filament circuits, and extreme care must be exercised in wiring the sets. When the heater-type tubes are employed, no balancing resistors are required and the sets are much easier to construct for this reason.

The inter-electrode capacity of the 227-type tube, too, is much lower than the capacity of the 226-type tubes, and this makes it a better radio-frequency amplifier. The lower capacity also tends to make the tube more stable and, because of the construction, slight changes in the filament voltage do not cause a noticeable change in the output.

### Brilliancy of the Tubes

Radio fans who have experimented with the heater-type tubes are frequently puzzled by the fact that these tubes do not always glow with the same brilliancy, even when the operating voltage remains unchanged. The contrast with the battery-type tubes is quite marked; the latter showing quite uniform brilliancy. The reason for the difference is quite simple and it will be seen from this explanation that such differences in the brilliancy of the A.C. tubes do not affect the performance of the tubes in any way.

The filament which carries the heating current is made of pure tungsten, which is threaded through a cylinder of insulating material. The filament is exposed at the top of the insulation and any slight change in the contact and space left at the top will result in a change in the apparent glow of the tube. It is interesting to note that the filament is not operated close to the melting point; so that the voltage on the filament can be increased a great deal over the rated value without burning it out. The use of too high a voltage for great lengths of time, however, will reduce the life of the filament and for this reason, it is advisable to measure the filament voltage from time to time with an A.C. voltmeter. If the filament is operated at a voltage higher than that specified by the manufacturer, the glow will naturally be increased.

### Low Filament Voltages

The reasons for the use of very low voltages for the filaments of alternating-current tubes may be unknown to many fans, but they will quickly be appreciated. The first is that a low potential difference between the ends of the filament results in a weaker electrostatic field and a corresponding reduction in the tendency to produce an A.C. hum.

The second important reason is that the use of a low voltage permits the use of a heavier filament and heavier current which reduces the effect on the plate current of temperature changes (due to the current variations created by the alternations) and, consequently, the tendency to hum. This is especially true with 25-cycle current.

The different types of tubes have different filament characteristics because of the difference in their construction and operation. The heater-type tube requires a longer filament than the direct-filament type, because of its insulating sleeve. On the other hand, the method of reducing the hum in the direct-filament tube requires a very low-voltage high-current characteristic; so in order to keep both tubes operating at their highest efficiency, different filament voltages are employed.

### GASEOUS-CONDUCTION RECTIFIERS

(2318) Mr. H. N. Nielson, Plainfield, N. J., writes:

(Q.) "Can you explain how the gaseous-rectifier tubes operate? I have tried for some time to figure how current is rectified by two electrodes in a gas-filled tube."

(A.) The operation of the gaseous-rectifier tubes  
(Continued on page 607)

## NION FIXED-RIGID DETECTORS



Have built over 50 sets including 3-4 tube Grimes and used NION without a single failure. On straight Regenerative and R. F., I omit Grid Leak and connect 22 1-2 volts tap to crystal improving tone 100 per cent without affecting volume or distance. I have found no other so dependable. Sincerely, H. Peigh, 647 N. Lawndale, Chicago.



## TOP NOTCH

RECEPTION AT EVERY POINT GUARANTEED

50c At Your Dealers or by Post

## KEYSTONE PRODUCTS CO.

304 Gardenia Avenue  
ROYAL OAK, MICHIGAN

### DEPENDABLE "B" BATTERY POWER

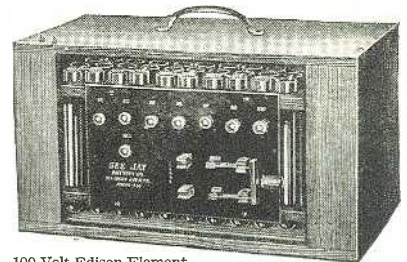

100 Volt Edison Element.  
Non-Destructive, Rechargeable "B" Battery with charger. Shipped dry, with solution, \$12. 140 Volt with charger, \$17. 180 Volt Power Unit, with Trickle Charger, \$24.00.  
SEND NO MONEY—PAY EXPRESSMAN  
Write for our Free Literature  
SEE JAY BATTERY CO., 915 Brook Ave., New York

## More Profits To Set Builders

One good radio idea may be worth millions. Barawik has thousands of ideas for radio set builders to make more money. Barawik's Big Radio Book will help you while elections are on and big national events stir the world.



Send for your copy today — NOW. 212G Canal Station, **BARAWIK CO. CHICAGO, U. S. A.**

Mail This Coupon Now! For Free Copy

Name .....

Address .....

## SCOTT WORLD'S RECORD SHIELD GRID 9

Build the 9,400-mile receiver. Listen in on all the world. Easy and economical to construct. Results guaranteed. Write today for free circuit diagram, parts list and testimonials from satisfied users.

**SCOTT TRANSFORMER COMPANY**  
4460 Ravenswood Ave. Chicago

\$5.50 buys this famous cabinet

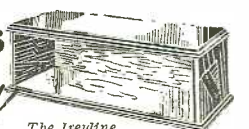

The Iteyline  
Sizes range from 7x18x10 to 7x30x12. Mahogany finish, \$5.50 to \$8.75. Solid Walnut, \$6.50 to \$10.25. F.O.B. Hickory. Twelve-hour service. Write for Catalog.  
**SOUTHERN TOY COMPANY, MANF'R. HICKORY, N. C.**

## EVERYTHING IN RADIO

AT ATTRACTIVE PRICES. SETS OR PARTS.  
Orders shipped exactly as ordered. Prompt Service.  
Write for Prices. Inquiries Invited. Send Your Address.  
**ALL RADIO COMPANY, 417 North Clark St., Chicago**

TYRMAN LABORATORY TESTED PRODUCTS

# GET FULL INFORMATION *From* THESE JOBBERS

## MICHIGAN Headquarters for *Tyrman*

Dealers and Set Builders  
Send for Our Catalog

*Prompt Shipment—Lowest Prices*

We specialize in Tyrman products and you may be assured we will give your inquiries prompt and careful attention.

Full line of cabinets, consoles, speakers and other accessories.

Our stocks are complete—our service quick.  
Write today for Free copy of our catalog.

**Henry L. Walker Company**  
Dept. T-C, 27 E. Jefferson St., Detroit, Mich.

## Western Radio's NEW 1929 Catalog

is crammed full of the Finest, Newest, Nationally known A-C sets, consoles, cabinets, dynamic speakers, kits, eliminators and accessories at **LOWEST PRICES**. Prompt delivery. Write for our Free catalog today.

*Tyrman*  
80-72-60  
in stock

Quick Delivery—Lowest Wholesale Prices

**Western Radio Mfg. Co.**  
Dept. T-C, 128 W. Lake St. Chicago, Ill.

## Your Inquiry for *Tyrman* Products

*Given Prompt Attention*

Write us for full information regarding Tyrman Products, with the assurance that your inquiry will receive prompt attention.

Complete stock of cabinets, consoles, speakers and accessories. Lowest Prices. Prompt deliveries. Write us today.

**Telephone  
Maintenance Company**  
Dept. T-C, 123-25 S. Wells St., Chicago, Ill.

## NEW YORK Headquarters for *Tyrman*

Maximum discounts to dealers and set builders. Quick service.

**All Radio Kits in Stock**

We have ready for shipment the newest kits as specified by Citizen's Radio Call Book, Radio Broadcast, Radio News and other leading Radio publications.

Complete stock of cabinets, consoles, speakers and accessories.

Write today for Free catalog and discounts.

**SUPER-SERVICE  
RADIO CO.**  
Dept. T-C, 107 Liberty St. New York, N. Y.

SEE "*Tyrman*" AT YOUR JOBBERS

# Tyrman AGAIN LEADS THE PARADE



ONCE again Tyrman leads. A year ago Tyrman engineers introduced the Shielded Grid principle in radio circuits. Now they introduce Complete A-C Operation using Shielded Grid Tubes.

Today finds progressive manufacturers adopting the Shielded Grid principle as originated by Tyrman. We recount this, not in a boastful spirit, but because it definitely indicates Tyrman's engineering leadership, and because it impresses the fact that the Shielded Grid principle as pioneered by Tyrman is recognized as the outstanding advance toward better radio reception.

In this new series of Custom Built Receivers, Tyrman engineers contribute new engineering leadership in design, performance and refinement that again sets the pace for manufacturers to follow as best they can. You will find in Tyrman Custom Built Receivers, Performance, Beauty and Value not approached in other receivers today. Send for free booklet and prove it to your own satisfaction.

## NOW! Shielded Grid A-C-Complete Socket Operation

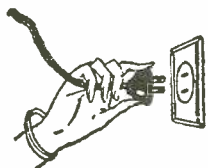

A-C operation in the full sense of its meaning. The Power Supply is designed solely for the Tyrman Imperial "80." Tyrman ingenuity places it on sub-panel with other parts as an integral part of the chassis. Factory assembled, no adjustments. Dynamic speaker filament can be energized directly from the "80" Power Supply. An outstanding feature. Any type of speaker can be used.

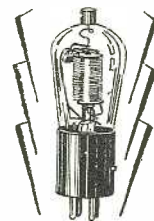

Before offering Tyrman A-C Shielded Grid Receivers, the A-C Shielded Tubes were subjected to months of rigid tests. It has practically the same inter-element capacity as the direct current type. Tests for life, heater emission, change, plate impedance characteristics and amplification prove the absolute efficiency of A-C Shielded Grid Tubes.

## Tyrman Imperial "80" Custom-Bilt Shielded Grid



CHECK THE FEATURES

Designed for those who want the finest in A-C Socket Operated Receivers. The actual performance of the "80" is defined by a practically positive 10 K.C. selectivity over entire broadcast wave band without sacrifice of volume. Plug-in coils for short waves. Superior tone quality through use of CX350 or 310 amplifier tube. Unequaled stability—Sensitivity. Permanent phonograph connection. One-spot—Non-oscillation. Adjustable to antenna. No critical adjust-

ments. Individual in appearance and beauty. Panel only 8 x 21" of genuine wood-walnut impressed on steel. New Tyrman Worm Drive Illuminated Drum. Heavy steel sub-panel Cadmium plated. Special precision-made parts. The Imperial "80" uses (3) A-C Shielded Grid tubes, (4) 327 tubes, (1) 350 or 310 tube and (2) 381 tubes. Complete parts and Power Supply factory packed ready to assemble. **\$199.50**

LIST PRICE



CHECK THE FEATURES

## Is It Any Wonder Tyrman Leads?

### Send for this BOOK

Showing schematic and wiring diagrams with full description. Mailed free.

### See it at Your Jobbers



Tyrman Electric Corporation, Dept. 418-314 W. Superior St. Chicago, Illinois

Without obligation send me FREE book describing "80" Tyrman Custom Built Receiver.

Name .....

Address .....

My jobber is .....

TYRMAN LABORATORY TESTED PRODUCTS

# GET FULL INFORMATION *From* THESE JOBBERS

## Pittsburgh, Pa.

### Headquarters

### Specializing in

## Tyrman

Send us your orders. Prompt delivery.  
Lowest wholesale prices.

Complete stock of high grade cabinets,  
speakers and accessories.

Your inquiries for information given prompt,  
thorough attention. Write today.

**L. R. MIDDLEMAN CO.**  
Dept. T-C, 228 Diamond St. Pittsburgh, Pa.

*Oldest Exclusive Radio Jobber in the West*

## CHI-RAD

### Headquarters for SET BUILDERS

The latest kits

Power Amplifiers

Transmitting apparatus

A new complete stock of parts and accessories made  
by leading manufacturers.

## Tyrman

80-72-60

and other latest kits. Prompt service. Dealers and  
Set Builders write for our special bulletins, Free  
catalog and discounts.

**CHICAGO RADIO  
APPARATUS CO.**  
Dept. T-C, 415 S. Dearborn St. Chicago, Ill.

## Tyrman

### 80-72-60

### in stock

### Quick Delivery

Get our NEW 1929 Catalog Free, describ-  
ing all latest developments including TEL-  
EVISION. Lowest Wholesale prices on all  
new kits, accessories and cabinets. Get the  
BEST in Radio—at Biggest Saving. Com-  
plete Stock carried. No delays.

Write for Catalog today!

**WALTER ROWAN CO.**  
Dept. T-C, 833 Washington Blvd., Chicago, Ill.

## OHIO

### Headquarters for

## Tyrman

Prompt service. Your inquiry for informa-  
tion regarding Tyrman products will be  
given prompt and careful attention.

Speakers, cabinets and accessories at Low-  
est Wholesale Prices.

Prompt deliveries.

Write us today!

**M & M COMPANY**  
Dept. T-C, 500 Prospect St., Cleveland, Ohio  
*The Third Successful Season as  
Tyrman Distributors*

# SEE "Tyrman" AT YOUR JOBBERS

**TYRMAN**  
Laboratory Tested  
PRODUCTS

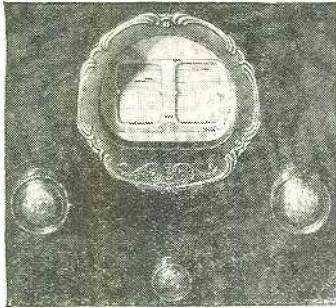

**Tyrman Illuminated Worm Drive Double Drum**

Isn't this a good looking dial? Just as efficient as it is good looking, too. Universal in its application. Condensers fit without filing or sawing. Worm Gear Drive—positive and sure in action. Insulated mounting is provided for condensers, also insulated coupling disk which prevents body capacity. Translucent window reflector provides indirect illumination on the dials.

The Tyrman Worm Drive Double Drum comes completely assembled. You need only to connect your tuning condenser by fastening set screws. Includes two matched knobs for tuning, one for volume control. Complete only \$12.00.

Cut away front view of Tyrman double drum dial showing how it looks when mounted on panel. Volume control knob not shown.

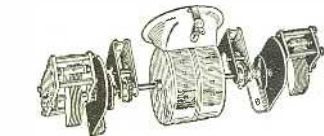
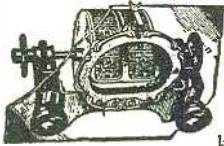

Rear view of the Tyrman Double Drum Dial ready to mount.

**Tyrman Illuminated Single Drum Dial**



The same general design of the Double Drum except knob for volume is on the left so only two knobs are needed. Packed complete with two matched knobs, price only \$8.00.

**Tyrman Shielded Socket Automatically Grounded**



An advanced and perfected design of shielded Socket with an automatic contact for grounding shield when used with Shield Grid Tubes. Ventilated and built of heavy aluminum. Readily dissipates heat generated by the filament of new heater

type A. C. tubes. Of utmost importance considering reaction of heat on the neighboring R. F. apparatus. Type 2-26 for four prong tubes or Type 2-27 for five prong heater type tubes, complete with Socket and Shield—Price \$1.25.

# This New 2-Way Design AGAIN Proves Tyrman Leadership

The Tyrman "72" is a "two-way" Receiver. Completely assembled for either A-C or Battery operation. In line with the Tyrman principles of design, the "72" is not merely adaptable to A-C operation but when assembled for A-C, it is completely socket operated using A-C Shielded Grid and A-C tubes with Power Supply mounted on sub-panel platform as an integral part of the chassis. Power Supply especially designed for the "72" circuit. In circuit design, the "72" closely follows the "80," embodying many of its features. Distance, Selectivity, Stability and Sensitivity comparable only to the "80."

## Tyrman "72" Custom-Built Shielded Grid

The "72" provides an advance Shielded Grid Receiver for those who wish to keep their present batteries or eliminators, or for localities where A-C power is not available. Even if assembled as a battery operated set, it is a simple matter to convert it to complete A-C operation by merely changing a few parts and the sockets for A-C tubes and making a few changes in the wiring scheme.

In appearance the "72" closely resembles the "80" except that the front panel is of metal with burl-walnut finish. It is equipped with the new Tyrman Illuminated Double Worm Drive Drum. 110 A-C switch and phonograph jack on panel. Easily and quickly assembled. Like the "80," all parts for the "72" are special and built to rigid specifications to assure uniformity. All parts packed complete at factory ready for assembly.

The Tyrman "72" when assembled for A-C operation uses (3) A-C Shielded Grid tubes, (1) 371 tube, (3) 327 tubes and (1) 380 tube in Power Pack. Complete parts for A-C or battery operation fac-

torily packed, ready to assemble. . . . . **\$98.50**  
List Price

"72" Power Pack for A-C Socket Operation, factory assembled **\$55.00** List Price  
Complete Set of 4 short wave coils, \$10.00 List Price

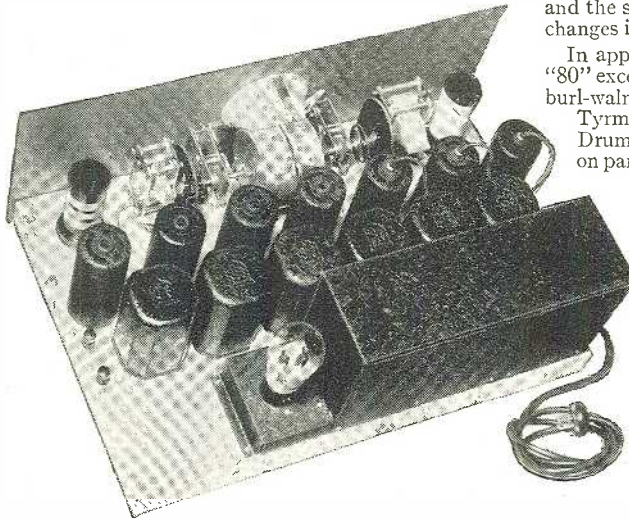

# AMERICA'S BIGGEST VALUE!

## Tyrman "60" Custom-Built Shielded Grid

The Tyrman "60" is designed for Battery or Eliminator Operation. Uses Shielded Grid tubes, Type 222. Combines many of the features of the famous Tyrman "70". Like all Tyrman Shielded Grid Receivers, the "60" circuit is designed especially for Shielded Grid tubes, assuring efficient use of the enormous amplifications of the tubes. Panel only 7" x 18" equipped with Tyrman Single Vernier Drum Dial. For Appearance, Tone Quality, Distance, Selectivity, Sensitivity and Stability, the Tyrman "60" is comparable only to other Tyrman Shielded Grid Receivers. Set Builders tell us it is the biggest value for a high grade receiver in the country **\$69.50** List Price today. Parts complete packed, ready to assemble. . . . .

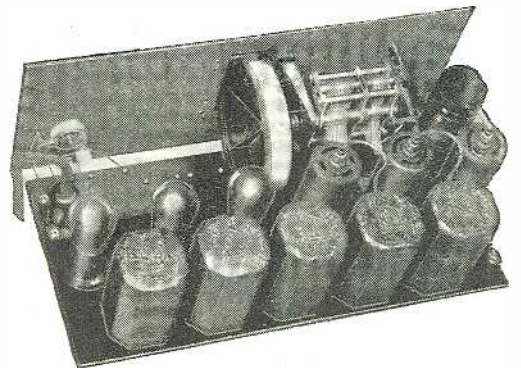

## SEND FOR THIS FREE BOOK



Showing schematic and wiring diagrams with full description. Mailed free.

**SEE Tyrman PRODUCTS AT YOUR JOBBERS**

Tyrman Electric Corporation, Dept. 418—314 W. Superior St. Chicago, Illinois

Without obligation send me FREE book describing ("72") ("60") Tyrman Custom Built Receiver.

Name.....  
Address.....  
My jobber is.....





# I Want to Know

(Continued from page 602)

which are used so frequently in "B" power units, is a very interesting subject. The operation depends on the ionization of helium gas and for this reason it is advisable to discuss this subject first. A gas is made up of extremely small particles called "atoms"; these, in turn, are made of particles carrying negative and positive charges of electricity, and called "electrons" and "protons," respectively. Ionization consists of releasing one of the negatively-charged electrons from the atom (of helium, in this case) and this electron acts as the carrier of electricity.

The potential applied to the electrodes in the tube produces in the helium atoms an unusual activity, which causes them to collide with each other. In these collisions, electrons are knocked off, thus ionizing the gas. This loss of negative electricity causes the atoms to be controlled by their positive charges, and they seek the cathode, or negative element of the tube. There they pick up other electrons, which restores them to their original state, and the process is repeated. The electrons which were originally lost have sought the positive terminal (or anode) of the tube; and hence a continual flow of electrons or electricity from the cathode to the anode takes place, through the external or supply circuit. If the anode and cathode were equal in size, current would flow equally well in either direction.

However, when one electrode is small in comparison with the other, the positively charged atoms may readily strike one electrode and pick up electrons; while their chance of striking the other electrode, during the time that the applied current is flowing in the opposite direction, is much less. Those atoms which do strike the small electrode cause a small counter-current or reverse current to flow; but by careful design of the electrodes this affect can be made almost negligible.

The life of the gaseous tubes depends upon several things. First, the purity of the helium employed; then, the amount of the gas introduced into the tube; the removal of the impurities from the materials used in the rectifier, and the amount of current passed through it.

## RESISTANCE-COUPLED AMPLIFIERS

(2319) Mr. I. N. Jefferson, Peoria, Illinois, writes:

(A.) "I am building a resistance-coupled amplifier with two high-mu tubes and a power tube. The high-mu tubes are of the 240 type, while the power tube is a 210. I do not know the correct values for the plate and grid resistors in the amplifier. Can you supply the data? I am also undecided whether it would be better to use an impedance in place of the grid leak in the last tube circuit. The coupling condensers in my amplifier have a capacity of .01-mf. Is this correct?"

(A.) In building a three-stage resistance-coupled amplifier with high-mu tubes of the type you mention, the plate resistors in each case should be given a value of approximately 0.25 megohm. The grid resistors for the first two stages should have values of 1 megohm; that for the power tube, if a resistor is used, should have a value also of approximately 1 megohm. Better results are, however, usually obtained with a suitable choke coil in this circuit; especially if power units are used to supply the plate current to the tubes, because of the tendency of the amplifier to "motorboat." The values of the grid resistors given here are slightly lower than those usually specified; their use will tend to reduce the volume to some extent; but it will overcome the possibility of blocking and, when a grid choke of very high inductance (say 100 henries) is used in the power-tube circuit, there will be very little chance of "motorboating."

The coupling condensers you are using will be quite suitable.

When using a resistance-coupled amplifier with a radio receiver, it is very important that a by-pass condenser be connected between the plate of the detector tube and the "B—" terminal, to keep R.F. currents out of the audio circuits. The omission of this condenser will often prevent the correct operation of the amplifier and, in some cases, the latter will refuse to work at all until the condenser is inserted. Most sets have a .001-mf. fixed condenser at this point and this value is quite suitable; but it is advisable to be sure that the condenser is incorporated in the set before trying to operate it.

# EXCELLO Radio Consoles

Designed for Atwater Kent, Crosley and all standard A.C. Receivers.



STYLE R-18  
Size 51 in. x 26 in. x 16 1/2 in.

Highest quality cabinet work, all panels five-ply walnut, doors matched butt walnut. Receiver compartment is sliding drawer; accommodates set and speaker. Walnut finish, hand rubbed.

At your dealers or write for complete catalog of many styles.

Excello Products Corp., 4832 W. 16th St. Cicero, Ill. (Suburb of Chicago)

# To Get the Utmost in Performance out of the

## Tyrman Imperial "80" Custom-Bilt Shielded Grid

# USE ONLY SHIELDPLATE A-C TUBES

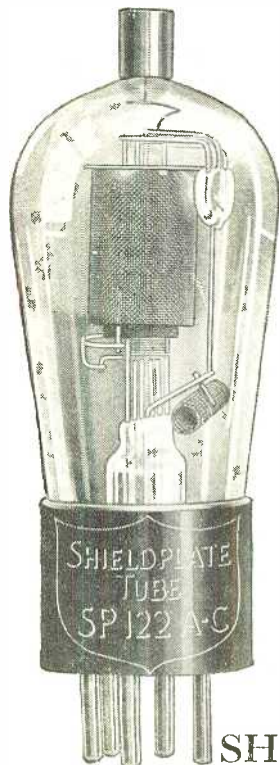

TYPE SP 122 A-C

SHIELDPLATE SP 122 A-C Shielded Grid Amplifier Tubes are the latest development in radio. They are especially designed for use in the Tyrman Imperial "80," and make possible its wonderful performance. Here is a real long-life shielded grid A-C tube that is naturally rugged and dependable, due to precision construction.

### Greater Results Guaranteed

Now you can be assured of better radio reception with the use of this new SP 122 A-C tube. SHIELDPLATE tubes are manufactured by the makers of the original and famous SP 122 SHIELDPLATE tube, which created a big sensation among radio engineers last season. PRICE \$7.00 EACH



### Six Superior Features

1. Amplification constant is 300 compared with constant of 8 in general purpose tubes
2. Oscillation is entirely eliminated
3. It is self-neutralized
4. Operates on 2.25 volts—A-C
5. Brings in DX stations like locals
6. Long Life—Rugged Construction

Use "DIATRONS"—A Tube for Every Radio Purpose

Write TODAY for FULL PARTICULARS

SHIELDPLATE TUBE CORPORATION

4051 Diversey Avenue, Chicago, Illinois

SHIELDPLATE TUBE CORPORATION  
4051 Diversey Ave., Chicago, Ill.

Gentlemen: Kindly send me FREE special information describing the new SHIELDPLATE SP 122 A-C tube.

Also place my name on your mailing list to receive advance information of the new developments in your laboratory.

Name .....  
Address .....  
State .....  
Jobber's Name .....  
Address .....

Please say you saw it in RADIO NEWS

**164  
PAGES  
of RADIO  
VALUES**

# A NEW CATALOG JUST OFF THE PRESS

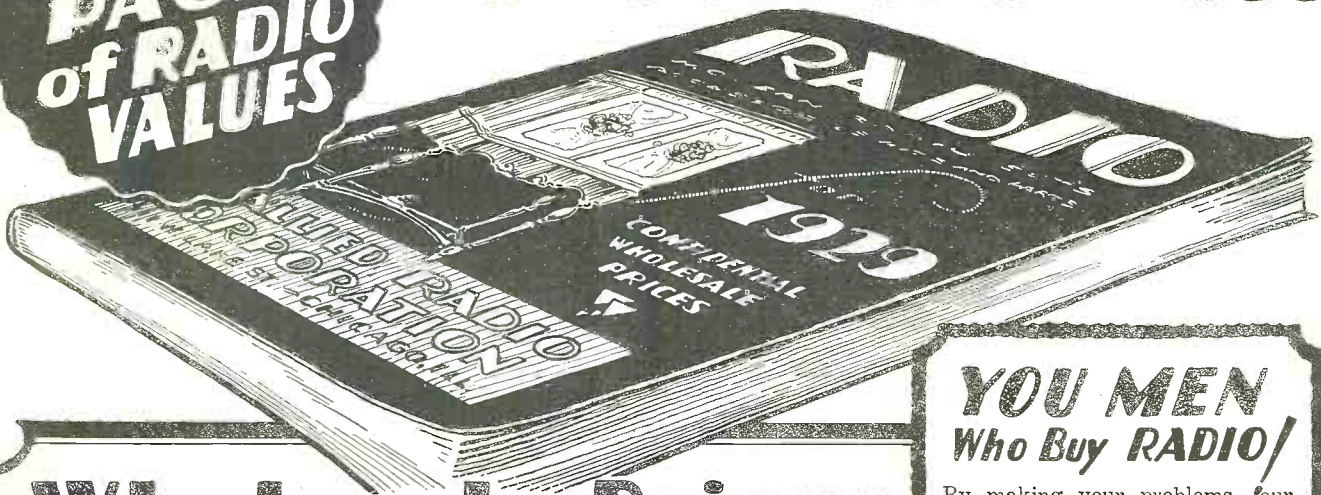

## Wholesale Prices

**T**his big new catalog heralds a new era in radio. Never before have you been offered such variety—**such quality**—such sterling value in radio as you are now offered in this large new catalog. In it, **wholesale prices** are not a myth—but *actual* reality. You will marvel that such merchandise, comprising everything that is **new and worthwhile** in radio can be offered at such prices. Here you will find high quality that is not high priced. If you are interested in radio you cannot afford to be without the **Allied Catalog**.

### SET BUILDERS!

Set Builders, Amateurs and so called "Hams" will delight in the *unusual variety*—and **remarkable values** that are offered in standard kits and parts. Tremendous stocks—**real organization**—prompt shipping service all combine to make Allied your ideal source of supply.

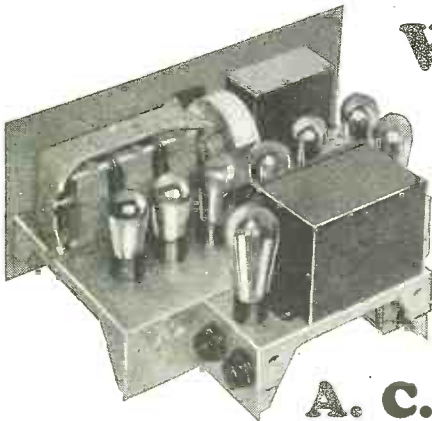

**A. C.**

### ELECTRIC SETS

Allied offers you a new—complete line of A-C Receivers, available in either chassis form or in a wide variety of beautiful console models. Prices range from \$32.95 to \$199.00. Dollar for dollar they stand out as one of the season's leading receivers. Engineered to unusual perfection they offer you features found only in the highest priced sets.

### YOU MEN Who Buy RADIO!

By making your problems our problems, we know the service you require—and to render you such service the entire Allied organization is dedicated—to give you the service you have a right to expect. Tremendous stocks, remarkable values and a real desire to serve, all combine to make Allied your ideal source of supply.

### RADIO DEALERS!

The live radio dealer—the man who keeps pace with the rapid advance of radio will find much of **real interest** in the Allied Catalog. New A-C Sets, D-C Sets, Dynamic and Magnetic Speakers, television equipment, in fact **everything** that an impatient radio public is demanding.

## What Allied offers you!

Allied Service will prove a revelation to you in what radio service can really be. Allied Executives backed by years of training in radio are practical men. They know radio. Their vast experience has built up around them an organization trained to serve. Months of effort have built up here a tremendous reserve of stock that makes for prompt shipments; and this stock is new stock comprising the seasons pick of such prominent manufacturers as Silver-Marshall, Tyrman, Aero, Hammerlund-Roberts, etc.

### You Profit When You Buy Right

Buying right is half the battle. From the small set builder to the large dealer, your success depends upon gauging the public pulse of radio and in **buying right**. Everything that is new in radio—the items the radio public is now demanding are here, ready for your call. Write now—the catalog is **free** for the asking.

**Write for Catalog Now**

**Allied Radio  
CORPORATION**

**711 W. LAKE ST. Dept. B-2 CHICAGO, ILL.**

# Now-AVOID STATIC Enjoy Real Radio Pleasure

## Amazing New Aerial Invention Brings Reception Clear As a Bell!

### SUB-AERIAL Endorsed by Experts

SUB-AERIAL has been subjected to the severest tests and has convinced many radio experts and fans of its remarkable performance. Radio engineers and magazines will tell you that SUB-AERIAL is the reliable system of avoiding static and interference and improving the tone, volume, selectivity, sensitivity and distance getting ability of a radio. Read the endorsements reproduced below, then send for Free Trial of SUB-AERIAL and *prove* its merits at our risk.

May 8th, 1928.

"I am very glad to state that after testing many Aerials in my Laboratory I find your Sub-Aerial is the best for clarity of tone and elimination of static, also for greater volume and selectivity."

"Your Sub-Aerial will fill a long-felt want among the Radio Fans."

A. B. Johnson, Radio Engineer.

Aug. 31, 1928.

"I received my Underground Aerial all O. K. It has any aerial beat I have ever seen. I have used every aerial on the market since I have been a radio fan. The first day I installed it I got distant stations that my set had never touched before. It wasn't good radio weather either. I got stations in the East that I had never dreamed of getting and with absolute clearness and without static or interference. I heartily recommend your instrument to any lover of good radio reception."

A. N. Whitae, Box 565, El Reno, Okla.

At last science has found a way to avoid static and other maddening outside noises with the newest improvement in radio—SUB-AERIAL. Experts say your unsightly, haphazard roof aerial is the weak link in your radio reception. The air is full of static and your overhead aerial picks it up and delivers it to your speaker. SUB-AERIAL comes down out of the air and takes the radio wave from the ground, where it is pure, clear and practically static-free. You can't imagine the *difference* in reception with this amazing invention!

### Volume — Distance — Selectivity

Now a new joy in radio reception awaits you! Don't put up with shrieks, howls, fading and other annoyances. You don't have to! Get reception—music, singing, speaking—as clear and pure as if the artists were "in the next room." Get increased volume and better long distance reception. Get sweeter tone and finer selectivity without distortion. Use the whole earth as a static and noise filter with SUB-AERIAL!

### How This New Ground Aerial Works

SUB-AERIAL takes the radio waves from the ground, where they are filtered practically static-free, delivering to your radio all the notes in their true, natural form. Interference from other radios or stations is either eliminated or greatly reduced. Cut through and enjoy remarkable selectivity. Your radio is more sensitive in picking up distant signals. You are free from lightning risk and have a *permanent* ground aerial guaranteed for 25 years. And the cost is so small no one can afford to be without this great new invention.

### Low Original Cost—No Upkeep Cost

SUB-AERIAL costs no more than an overhead or loop aerial—and less than many. Its first cost is the only one. SUB-AERIAL is permanent. No trouble—no hard work, or risking your neck on roofs.

## TRY IT FREE!

We know so well the surprising results you'll get that we'll let you put in a SUB-AERIAL entirely at our risk. You be the judge. Don't take down your overhead aerial. Pick a night when there is a lot of static. If Sub-Aerial doesn't sell itself to you right then on performance—you needn't pay a cent. Send for "all the dope on SUB-AERIAL." You'll be surprised. Do it NOW.

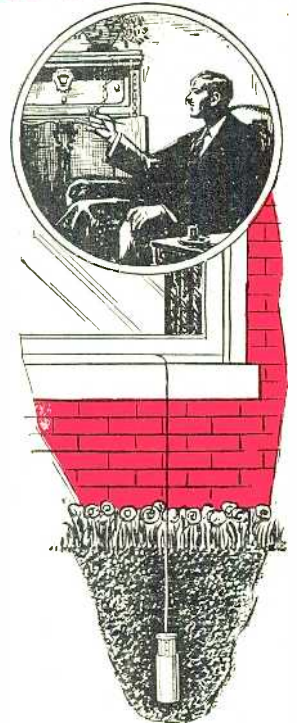

Can be installed  
in a few minutes

Mail  
This  
Coupon



### UNDERGROUND AERIAL SYSTEMS

St. Clair Bldg., Dept. 827-T.S.

Corner St. Clair and Erie Sts., Chicago, Ill.

Replace Your Old Noisy Aerial with

# SUB-AERIAL

25-  
Year  
Guarantee

Send me complete information on Sub-Aerial, Proof and Free Trial Offer. No obligation.

Name.....  
Address.....  
City.....  
State.....

UNDERGROUND AERIAL SYSTEMS, Dept. 827-T.S.,  
St. Clair Bldg., cor. St. Clair and Erie Sts., Chicago, Ill.

FACTORY TO YOU—SAVE 50%—COMPARE WITH COSTLIEST OUTFITS BEFORE YOU BUY

# Enjoy a powerful new **Miraco** 30 DAYS FREE

Set or complete outfit  
AC Electric or Battery

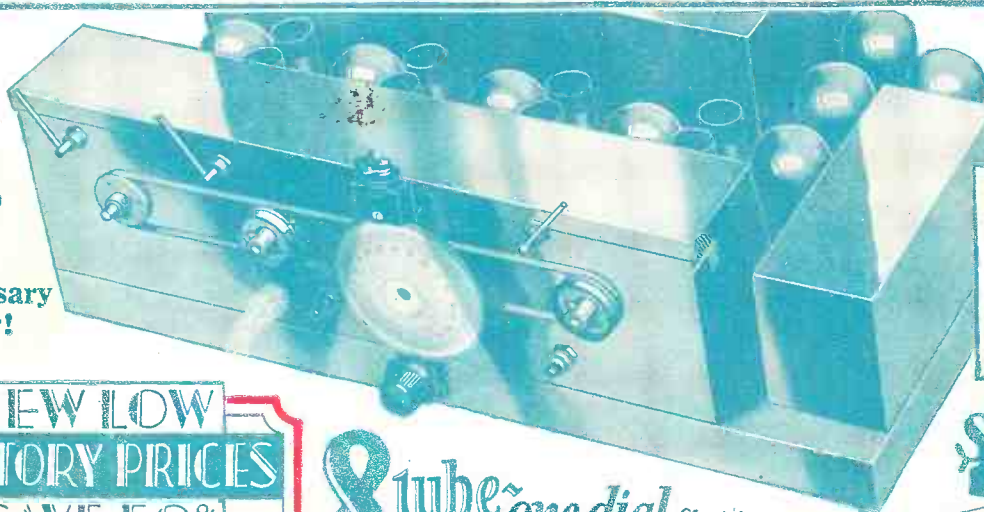

**3 Year Guarantee**

**Get Our Send No Money 9th Anniversary Offer!**

**Built like, Looks like, Performs like a \$200 set**  
Marvelous new 3-year guaranteed, lighted 1-dial control. All metal Super Shielded Miraco set, removed from cabinet. Front switch, phonograph pick-up connection and all latest features. Built in power section on AC models.  
**The Latest, Finest and Costliest Construction**

**\$49<sup>88</sup>**  
COMPLETELY ASSEMBLED

**NEW LOW FACTORY PRICES SAVE 50%**

**Wide Selection of Beautiful Cabinets AC or Battery Sets**

**30 DAYS HOME TRIAL**



A popular walnut Hi-Boy Console, with drop-leaf desk. Beautiful two-tone finish. Rare bargain!

Richly designed, genuine walnut console of finest type. Electro-dynamic or magnetic power cone, or long air column speaker. Marvellous value.



Beautifully graceful Spinet console, genuine two-tone walnut. Choice of speakers. Also comes in Electric Phonograph-Radio Combination.



A new-type arm-chair console. Genuine walnut. Very pretty. Low priced. Electro-Dynamic or Magnetic-Power Speakers.



At right, a Lo-Boy console, walnut finish, that costs little. A gem!



Above, popular inexpensive combination. Set on Table Speaker (sold separately).



Metal or wood compact style cabinets. Wood cabinets in walnut or new shaded silver-chrome finishes. Cathedral Electro-Dynamic or Magnetic-Power Speaker to match!

**8 tube ~ one dial** Electric Lighted

# MIRACO

TRADE MARK REGISTERED

**CATHEDRAL TONED, SUPER SELECTIVE, POWERFUL DISTANCE GETTERS**

Celebrating its 9th successful year, America's big, old, reliable Radio Corporation springs a genuine sensation in high-grade sets. With its latest, Super-powered, 1-dial Miracos—the All Electric wholly self-contained, hum-free, AC-8 and AC-9, using AC tubes or the new 8-tube models

hum-free operation, tremendous "kick" on distant stations and razor-edge selectivity—with its costly sturdy construction, latest features, including phonograph pick-up connection, ease of tuning, beauty, and economy—a Miraco will make you the envy of many whose radios

**BIG DISCOUNTS**  
Exclusive Territory to User-Agents on **BATTERY OR AC ELECTRIC OUTFITS**

for batteries or Eliminators—you are guaranteed values and savings unsurpassed in the fine set field.

Compare a Miraco with highest-priced radios, for 30 days in your home. Surprise and entertain your friends—get their opinions. Unless 100% delighted, don't buy it! Return everything—the complete outfit—at our expense. Your decision is final—absolutely!

Only exceptionally fine radios, of the very latest approved type, at rock-bottom prices, could possibly back up so liberally unconditional a guarantee. Send coupon now for **Amazing Special Factory Offer!**

**Don't Confuse with Cheap Radios** With its rich, clear Cathedral tone,

**Miraco Outperforms 'em All In Chicago** On the Miraco Unit, to start with, will say: I got to date 61 stations outside of Chicago, from the Pacific Ocean to the Atlantic Ocean, and from Anchorage, Alaska, to the Gulf of Mexico, and I tried the set with 3 different antennas. That is an outside aerial 152 feet, an inside aerial 20 feet, and

cost 2 to 3 times as much!

Many thousands of Miracos—bought after 30 day home comparisons—are cutting through locals and getting coast to coast with the tone and power of costly sets, their delighted users report. Miracos are laboratory-built with finest parts, and embody 9 years' actual experience in constructing fine sets. Approved by Radio's highest authorities.

**Deal Direct with Big Factory**

Everything reaches you splendidly packed and rigidly tested to insure your instant enthusiasm. Enjoy the outfit 30 days—then decide. Liberal 3-year guarantee on each set. Play safe, save lots of money, and insure satisfaction by dealing direct with Radio's old, reliable builders of fine sets—9th successful year.

I want to say that your set does outperform the other sets I have. I put it up against a World Record Super 9 and beat that one. Then I put it up against a (names expensive make), and beat that one. Next I put it up against a Neutrodyne and beat that one. HARRY KOPP, 6555 South Peoria Street, Chicago, Illinois.

**MIDWEST RADIO CORPORATION, 404-RD Miraco Building, Cincinnati, Ohio**

**BEAUTIFULLY ILLUSTRATED CATALOG, AMAZING SPECIAL FACTORY OFFER, TESTIMONY OF NEARBY USERS—All the proof you want—of our honesty, fairness, size, financial integrity, radio experience and the performance of our sets—including Amazing Factory Offer—sent with catalog.**



**Free!**

**MIDWEST RADIO CORPORATION**  
Pioneer Builders of Sets—9th Successful Year  
404-RD Miraco Bldg., Cincinnati, Ohio

**THIS COUPON IS NOT AN ORDER**

WITHOUT OBLIGATION, send free catalog, Amazing Special Factory Offer, testimony of nearby users, etc.  User  Agent  Dealer  
 Check here if interested in an **EXCLUSIVE TERRITORY PROPOSITION**

NAME ADDRESS