

CIRCULATION LARGER THAN THAT OF ANY OTHER RADIO PUBLICATION



RADIO NEWS

REG. U. S. PAT. OFF.

25 Cents

FEBRUARY

Over 200
Illustrations

Edited by HUGO GERNSBACK

**"WIRELESS"
RADIO DANCING**
SEE PAGE 1120



RADIO'S GREATEST MAGAZINE

EXPERIMENTER PUBLISHING COMPANY, NEW YORK, PUBLISHERS OF

SCIENCE and INVENTION

THE EXPERIMENTER

MOTOR CAMPER & TOURIST



SINCE 1915 - STANDARD FOR ALL SETS **PRICE \$2.50 EACH** IN THE ORANGE AND BLUE CARTON

GOOD MEN TO KNOW—

The tens of thousand of **RADIO DEALERS** who sell and recommend

CUNNINGHAM RADIO TUBES

They consider the ultimate satisfaction of their customers of the utmost importance.
They want your business not only today and to-morrow but next month and next year.
Your confidence is the foundation of their success.



A type for every radio use: C-11, C & CX-12, C & CX-301A, C-299, CX-299, C & CX-300, CX-112, CX-220, CX-310. Rectifier Tubes CX-313, CX-316B.

Cunningham dealers are good men to know, good men to trust, good men to patronize

Home Office 182 Second Street
 SAN FRANCISCO

E. J. Cunningham Inc.

CHICAGO
 NEW YORK

Tower



REG. U.S. PAT. OFF.

New Diaphragm— —A Distinctively Exclusive Feature

WE will pay \$500 cash for a name best describing the new Tower Diaphragm—the most important discovery in over 50 years of experimental work in the acoustical field. Over 1000 other valuable prizes will be awarded to persons submitting names of merit.

Over fifty years ago Alexander Graham Bell invented the telephone receiver with its all-metal Diaphragm. Until now the world's greatest acoustical experts have been unable to effect any radical improvements on this type.

Now—after exhaustive experiments, Dr. Herman Fisher, the eminent Russian scientist and acoustical expert of the Tower Co., has perfected a marvelous new Diaphragm—revolutionary in principle and unparalleled in performance.

The Diaphragm consists of two different materials, one of which reproduces the upper register of the scale, and the other, the lower, making it a veritable double diaphragm which brings out ALL the notes with an amazing mellowness of tone, increased volume and COMPLETE absence of distortion, hitherto never attained in a radio loud speaker.

The name "High-Low Tone" has been suggested but we believe some one can suggest a better one. Let us have yours—it may win the \$500 prize or one of the 1000 additional awards.

Names must be submitted on U S postcards with name and address of sender clearly printed—no others considered. Send as many names as you wish. Contest closes February 15th, so act promptly. Decision of Tower Company officials will be final. In event winning name is suggested by more than one person, prizes will be divided equally.

Tower Mfg. Corp., Boston, Mass.

*Only Tower Speakers equipped
with this New Diaphragm*



\$8.50
Scientific

\$3.25
Midget

Meistersinger *\$15.00*
CABINET MODEL

PATENT PENDING

\$15.00
Meistersinger
\$4.95
Little Spitfire
\$2.25
Tower Scientific

Phonograph Attachment
\$3.25

WORLD'S GREATEST SPEAKER VALUES

RADIO NEWS

Published by EXPERIMENTER PUBLISHING COMPANY, INC.
 Publishers of "Radio News," "Science and Invention,"
 "The Experimenter" and "Motor Camper & Tourist."
 Editorial and General Offices: 53 Park Pl., New York City
H. GERNSBACK, President. S. GERNSBACK, Treasurer
 R. W. DEMOTT, Secretary
 MEMBER: AUDIT BUREAU OF CIRCULATIONS
 RADIO MAGAZINE PUBLISHERS ASSOCIATION

VOLUME 7

CONTENTS

FEBRUARY, 1926

NUMBER 8

In Our Next Issue

\$1,000.00 Prize Contest

Our recent "What's Wrong" prize contest, chronicled in this issue, was such a brilliant success that we are going to run a most interesting and original prize contest in our March issue—something never before attempted in this country. As there will be a tremendous demand for this issue—containing the biggest contest ever staged by RADIO NEWS—it is suggested that you order your copy from your newsstand at once.

A Wonderfully Selective Receiver, By the Laboratory Staff of RADIO NEWS.

This receiver will afford a sure and quick relief for all those who find it difficult to tune in DX through the locals.

Long Distance Power Control by Radio, By A. K. Laing.

In this intensely interesting article by Mr. Laing, a resumé of the efforts of inventors along the lines of radiodynamics is given. Tells how ships and torpedoes are controlled at distances by radio. It is a long wanted article which will be especially valuable and interesting to all.

In This Issue

- | | |
|---------------------------------------------------------------------------|--------------------------------------------------------------------------------|
| Unexplored Radio.
By Hugo Gernsback 1107 | Special Cathode-Ray Oscillographs.
By Charles B. Bazzoni 1132 |
| Results of \$300 "What's Wrong" Contest 1108 | International Radio 1134 |
| Radio Receivers by Production Methods.
By John A. Pern 1110 | Ion Pri Esperanto Kaj Radio.
By James Denson Sayers 1135 |
| Furniture For Sale.
By Andreas MacGillicuddy 1111 | The Autoregenerator.
By Sylvan Harris 1136 |
| Thirty Years in the Dark-room 1112 | Facts and Fallacies of Radio Wave Transmission.
By Dr. J. H. Dellinger 1139 |
| The Radio Industry of Today.
By George Wynne 1114 | The "Peanut" Super.
By Morris Levy 1140 |
| New Developments in Radio Apparatus.
By A. K. Laing 1115 | The Browning-Drake Regenerator.
By Volney D. Hurd 1142 |
| A 3000-Mile Super-Heterodyne.
By R. A. Stuart-Frey 1118 | Duo-Ways-Range Receiver.
By Joseph Bernsley 1144 |
| Wireless Radio Dancing.
By Hugo Gernsback 1120 | A Balanced Reflex Circuit.
By L. W. Hasty 1146 |
| Five Broadcast Stations in One Room.
By S. R. Winters 1121 | The Radio Beginner.
By A. P. Peck 1148 |
| The Ultimate in Single-Control Receivers.
By Ashur van A. Sommers 1121 | Solving the Problem of "A" Current Supply.
By R. A. Klack 1149 |
| Speaking Into Microphones.
By C. D. Isaacson 1122 | With the Amateurs.
By Jack Milligram 1151 |
| News Pictures of Radio Progress 1124 | The Improved Isorad Receiver.
By Byron B. Minnow 1152 |
| More About Radio Waves.
By Joseph Riley 1126 | Radio Wrinkles 1153 |
| The Mysteries of the Wire Tables.
By Herndon Green 1127 | Radioties 1155 |
| Calibrating Receivers with Crystals.
By J. Louis Reynolds 1128 | Correspondence From Readers 1156 |
| New Short Wave Tube.
By Joseph Riley 1130 | Standard Hook-Ups 1157 |
| Secret Broadcasting—Its Possibilities.
By L. Kelley 1130 | New Radio Patents.
By John B. Brady 1159 |
| Where Radio and Heat Waves Meet.
By Donald H. Menzel 1131 | RADIO NEWS LABORATORIES. 1160 |
| | I Want to Know.
By Joseph Bernsley 1162 |
| | List of Broadcast Station Calls 1164 |

RADIO NEWS is published on the 10th of each preceding month. There are 12 numbers per year. Subscription price is \$2.50 a year in U. S. and possessions; Canada and foreign countries, \$3.00 a year. U. S. Copy as well as U. S. stamps accepted (no foreign coins or stamps). Single copies, 25 cents each. A sample copy will be sent gratis on request. Checks and money orders should be drawn to order of EXPERIMENTER PUBLISHING CO., INC.

All communications and contributions to this journal should be addressed to Editor, RADIO NEWS, 53 Park Place, New York, N. Y. Unaccepted contributions cannot be returned unless full postage has been included. All accepted contributions are paid for on publication. A special rate is paid for novel experiments; good photographs accompanying them are highly desirable.

RADIO NEWS, Monthly. Entered as second class matter, July 12, 1924, at the Post Office at New York, N. Y., under the Act of March 3, 1879. Additional entry at Long Island City, N. Y., and San Francisco, Calif. Title registered U. S. Patent Office, Copyright, 1924, by E. P. Co., Inc., New York. The Experimenter Publishing Co., 53 Park Place, New York. The contents of this magazine are copyrighted and must not be reproduced without giving full credit to the publication. Copyright in Germany. Reproduction of articles in Germany is reserved for Radio, Berlin 42.

New York City
 General Advertising Dept.
 53 Park Place

Western Advertising Representatives
 Fineman & McClure
 720 Cass St., Chicago, Ill.

New England Advertising Representative
 T. F. Magrane, Park Square Building, Boston, Mass.

RADIO NEWS is for sale at all newsstands in the United States and Canada, and at Brunner's, Ave de l'Opera, Paris, France. European agents: S. J. Wise & Co., 40 Place Verte, Antwerp, Belgium.

TO SUBSCRIBE FOR RADIO NEWS, Send your name, address and remittance to Experimenter Publishing Co., 53 Park Place, New York. Mention the name of the magazine you are ordering. We also publish SCIENCE AND INVENTION, the EXPERIMENTER and MOTOR CAMPER & TOURIST. Write clearly. RATES AND TERMS. The subscription rate for RADIO NEWS is \$2.50 per year. (12 numbers). When remittance is by check, money order, or registered letter it can be enclosed. Avoid sending cash through the mail if possible. Subscriptions for less than one year are not accepted. Subscription may be made in combination with SCIENCE AND INVENTION or the EXPERIMENTER.

POSTAGE. We prepay postage in all parts of the United States, Mexico and island possessions. For foreign or Canadian subscribers we require 50 cents in addition to the subscription price for additional postage charges.

CHANGE OF ADDRESS. Notify us as far in advance as possible. It requires several weeks to make an address change on our records. Always write clearly. ON EXPIRATION of your subscription we enclose a renewal blank in our last number to you; we stop our delivery to you on expiration.

Pacific Coast Advertising Representatives
 A. J. Norris Hill Co.
 Hearst Bldg., San Francisco, Calif.
 Detwiler Bldg., Los Angeles, Calif.

Kansas City Advertising Representatives
 Davies and Dillon
 15 W. Tenth St., Kansas City, Mo.

Detroit Advertising Representative
 Roy Buell, Donovan Bldg., Detroit, Mich.

*Powel Crosley Jr.,
has always done the
unexpected.*

*His announcement
of December Twen-
ty-sixth was no ex-
ception to that rule.*

*No Dials
No Panels
Built in
Loudspeaker*

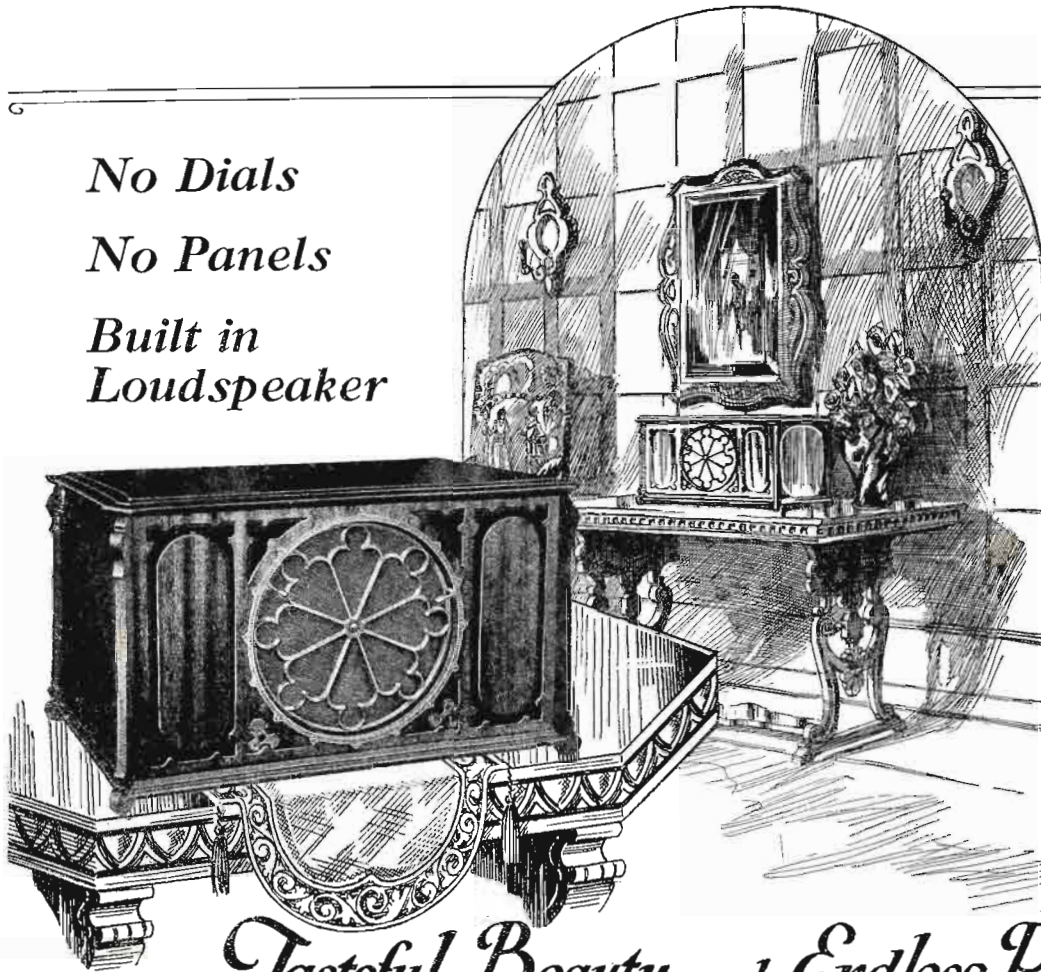

Tasteful Beauty and Endless Pleasure

THIS utterly new kind of receiver, the ULTRADYNE, Model L-3, achieves the truly artistic form and simplicity of line. It blends harmoniously into almost any scheme of furnishings. Unobtrusively in good taste.

New, too, in its extremely simple operation. Stations are selected by two inconspicuous levers. No intricate tuning.

This new beauty, this new simplicity, is amplified by an accentuated tonal richness, range of selection and freedom from extraneous sounds. It is radio's utmost achievement further refined and extended.

A demonstration of the ULTRADYNE, Model L-3 Receiver at the nearest dealer-representative will satisfy your most critical exactions. May we mail you a handsome descriptive folder?

Ultradyne Model L-3 is a 6 tube receiver employing the principles of the best circuits, greatly refined and marvellously simplified. In a Duco-finished, two-toned mahogany cabinet.

\$135.00

West of the Rocky Mountains \$140.00

In beautiful Console Model
\$175.00

The Ultradyne was designed by Mr. R. E. Lacauff, E. E., Chief Engineer of this Company and formerly Radio Research Engineer with the French Signal Corps Research Laboratories. To protect the public Mr. Lacauff's



personal monogram seal (R. E. L., shown here) is placed on the assembly lock bolts of all genuine Ultradyne Model L-3 Receivers. All receivers are guaranteed so long as these seals remain unbroken.

ULTRADYNE
MODEL L-3

PHENIX RADIO CORPORATION, 114 East 25th St., NEW YORK

RADIO NEWS READERS' BUREAU

Time and Postage Saver

IN every issue of RADIO NEWS you undoubtedly see numerous articles advertised about which you would like to have further information. To sit down and write an individual letter to each of these respective concerns, regarding the article on which you desire information, would be quite a task.

As a special service to our readers, we will write the letters for you, thus saving your time and money.

Just write the names of the products about which you want information, and to avoid error the addresses of the manufacturers, on the coupon below and mail it to us.

If the advertiser requires any money or stamps to be sent to pay the mailing charges on his catalogue or descriptive literature, please be sure to enclose the correct amount with the coupon.

We will transmit to the various advertisers your request for information on their products.

This service will appear regularly every month on this same page in RADIO NEWS.

If there is any Manufacturer not advertising in this month's issue of RADIO NEWS, from whom you would like to receive literature, write his name, address and the product in the special section of the coupon below.

TEAR ALONG THIS LINE

READERS' SERVICE BUREAU,
 Experimenter Publishing Co., Inc., 53 Park Place, New York, N. Y.

RN-2-26

Please advise the firms listed below that I would like to receive detailed information on their product as advertised in the issue of RADIO NEWS.

 DO NOT USE THIS COUPON FOR TECHNICAL QUESTIONS

NAME	ADDRESS (Street — City — State)	List here specific article on which you wish literature.	If Catalogue of complete line is wanted, check in this column
.....
.....
.....
.....
.....
.....

Use this space if you desire information from a manufacturer whose advertisement does not appear in this month's issue.

NAME	ADDRESS (Street — City — State)	
.....
.....
.....

Your name Dealer's name

Your address His address

If you are dealer check here. City State City State

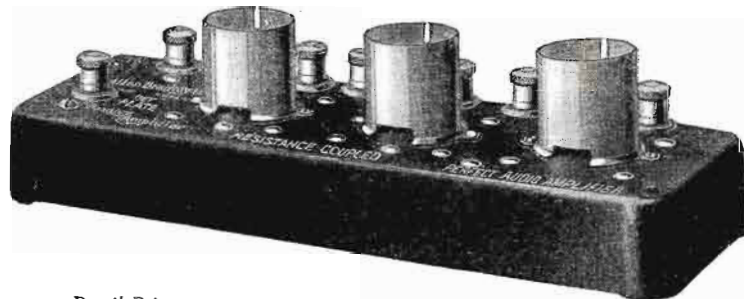

Retail Price
 In U. S. A. \$15.00
 In Canada \$21.00

Why You Should Use A Resistance-Coupled Audio Amplifier

THE tone quality of a radio receiver is vitally affected by the construction of its audio amplifier. Poor, overloaded audio transformers are the most frequent cause of distortion, because they are unable to amplify equally all the tone frequencies of a musical program. Some tones are over-amplified, while others are subdued, or entirely eliminated. Harsh, unnatural tones are therefore produced by the loud speaker, and the quality of rendition is extremely unsatisfactory.

The better type of audio amplifier uses no transformer whatever. It is called the Resistance-Coupled Amplifier, because small fixed resistance units take the place of the bulky transformer of earlier models and they produce amplification without distortion. For clarity and purity of tone, nothing has excelled the resistance-coupled amplifier.

Why You Should Choose **Bradley-Amplifier** Resistance-Coupled **PERFECT AUDIO AMPLIFIER**

THIS compact resistance amplifier is easily installed by any one in any type of radio receiver. Convenient terminals make the Bradley-Amplifier as easy to connect as a B-Battery. The sockets will hold old or new tubes without adapters, and a C-Battery connection is provided for the new tubes.



The distinguishing feature of the Bradley-Amplifier is the use of Bradleyunit Resistors. These small, solid, molded units cannot break, deteriorate or change with age. They are soldered into place and require no attention. For amplification without distortion be sure to ask your dealer for a Bradley-Amplifier. Try one tonight!



Allen-Bradley Co.

287 Greenfield Ave.,
 Milwaukee, Wisconsin

Please send me your latest booklet on the Bradley-Amplifier.

Name.....
 Address.....



Earn \$75 to \$200 a Month Learn at Home

The astounding growth of Radio has created thousands of wonderful opportunities for earning big money. Millions upon millions of dollars are being spent every year since broadcasting has become so popular. Radio is indeed sweeping the world like a forest fire!

A few years ago only a very small number of men were actively engaged in Radio. Today, with but few exceptions, these men are holding key positions in this marvelous new industry. In the same way, the young men and ambitious boys who get into Radio now will be the leaders a few years hence. The opportunities right now are a hundred times greater than they were ten years ago.

Recognized Radio Experts In Urgent Demand

Trained experts—not just half trained amateurs—are needed for the many big paying positions which have developed as a result of the tremendous expansion of Radio. Broadcasting stations are constantly needing operators, stores are sadly in need of trained experts as salesmen, installers, repair men, demonstrators. Factories need inspectors, assemblers, testers and executives.

These are just a few of the opportunities. Radio operators on board ship travel all over the world without one cent of expense, see historically important places, meet prominent people on board ship, mingling with the passengers and earning salaries equal to \$200 a month in any land job. How often you've dreamed of travel, of being able to talk from experience of gay Paris, the beauties of the Mediterranean sunset, the awe of Egypt's pyramids. As a radio operator you can see them first hand.

Hundreds of Big Paying Positions Open Right Now—in Radio!

Hardly a week goes by without our receiving calls for our graduates. This is how some of them read: "We need the services of a competent Radio engineer"; "We want men with executive ability in addition to Radio knowledge to become store managers"; "We require the services of several resident demonstrators."

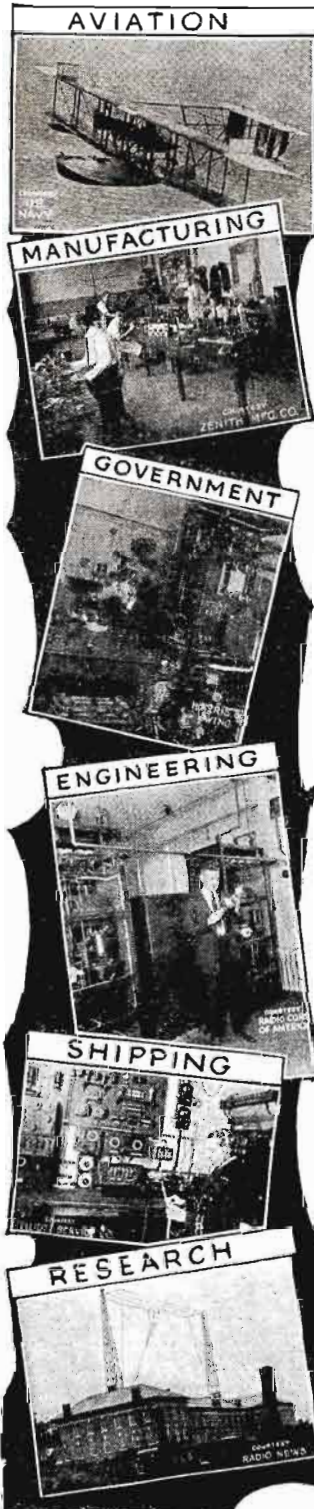

PROOF!

Pay Increases Over \$100
a Month



I am averaging anywhere from \$75 to \$150 a month more than I was making before enrolling with you. I would not consider \$10,000 too much for the course.
(Signed) A. N. Long,
Greensburg, Pa.

Doubles Salary

I can very easily make double the amount of money now than before I enrolled with you. Your course has benefited me approximately \$3,000 over and above what I would have earned had I not taken it.
T. Winder,
Grand Junction, Colo.



Strong Praise for N. R. I.



The N. R. I. course is by far the best. I have made very good money and enjoy myself in the Radio game. A thorough training from the N. R. I. will set any man well on the road to happiness and prosperity in the Radio world.
Lawrence Vanek,
Iowa City, Iowa.

Earns \$50 to \$83 a Week

I enjoyed every one of your lessons and had no trouble whatever. I earn \$50 to \$83 a week besides a commission on sales. Your course not only enabled me to get bigger pay but broadened my education as well.



Michael De Marco,
Boston, Mass.

FREE Instruments

Given Without
Extra Cost



Week as a Radio Expert in Spare Time

MORE PROOF!

\$405 In One Month

I cleared up \$405 in one month recently. Not so bad—is it—for a fellow who just completed your course a short time ago. I sure have been coin'g the dough. I never will regret the money I paid for your course.
Eunnet Welch,
Peculiar, Mo.



From \$15 to \$80 a Week



Before I enrolled with you I was making \$15 a week on a farm. Now I earn from \$2,080 to \$4,420 a year and the work is a hundred times easier than before. Since graduating a little over a year ago, I have earned almost \$4,000 and I believe the course will be worth at least \$100,000 to me.
(Signed) George A. Adams,
Tamaqua, Pa.

Triples Salary

I am earning three times as much as before enrolling and I have clean interesting work that takes me to all parts of the globe. I tell you, boys, it's Radio for me.
Arthur Herke,
Vancouver, B. C.



Earns College Education



I entered the maritime service of the Radio Corporation of America and served several months on board ship. I not only had the advantages of visiting foreign countries at no cost to me but I was able to save enough money to pay for my tuition to college.
G. E. Rogers,
Troy, N. Y.

The big radio firms are coming to us for their men—they call on us first because they know that our graduates are one hundred per cent. trained experts—they are Recognized Radio Experts.



Earn Big Money While Learning

No matter if you know nothing at all about Radio or electricity, you can easily and quickly become an expert. Age is no drawback. Our method of teaching makes it fascinating and interesting to learn the mysteries of this new science. Instruments for practical training given FREE with this course are shown at the bottom of this page.

Scores of our students earn big money during their spare time after finishing the first few lessons. Mathew Waldron made \$150 in one month—Fred W. Sullivan, of Fall River, Mass., made \$34.60 in three weeks. Graduate D. H. Suitt, Newport, Ark., says: "While taking the course I did assembling, repairing, installing and made approximately \$900. This made my course pay for itself many times even before graduating." Student F. A. Kazmarek, Santa Cruz, California, says: "I have done over \$1200 worth of business in the past two months just in spare time. I am going to go a little easy on the selling business now so I can finish my course right away." Many students more than pay for their course in this way—while they are studying.

Satisfaction Is Guaranteed

Our faith in our method of training and in our ability to fit you for a bigger pay is evidenced by our guarantee to refund every cent of your money if you are not satisfied when you finish the course. The National Radio Institute, established in 1914, the first school to successfully teach Radio by mail, and now the largest Radio training organization in the world, stands behind that guarantee.

Send for FREE BOOK

We will gladly send you Free, without any obligation on your part, our book, "Rich Rewards in Radio," which gives you more facts about the big pay opportunities in Radio, tells you how we prepare you at home in spare time, and about how we are asked to fill hundreds of fine positions every year. No matter what you are doing now—no matter what your plans for the future are—send for this Free Book of wonderful opportunities. Mail the coupon NOW.



NATIONAL RADIO INSTITUTE

Dept. BW1

Washington, D. C.

for practical training at home

These parts and receiving sets included in our course without charge. Our Book "Rich Rewards in Radio" tells you all about the practical training given with these instruments. You get a thousand mile receiving set, parts for building a regenerative receiving apparatus, also all parts for building a receiving set of the more simple kind.



World-Patented Neutromator, Patent of National Radio Institute.



Small set shown for use with Neutromator and receiving set.



Each of these instruments given for learning the code quickly.

NATIONAL RADIO INSTITUTE,
Dept. BW1,
Washington, D. C.

Without any obligation on my part, send me your book, "Rich Rewards in Radio," which tells all about the big money opportunities in Radio, how spare time study will enable me as a recognized Radio Expert and also how your Employment Service will help me get a good position.

Name..... Age.....

Street

City..... State.....



This 84-Page Book Has Shown 3187 Men How to Make More Money

HAVE you reached the point where you must have more money? Are you finding some difficulty in making ends meet on the money you are earning?

THEN—YOU ought to have this book.

Are you sick and tired of the buzz of the alarm clock? Do you sometimes feel as if you'd never like to see another time clock.

THEN—You'll Find a Way Out in This Book.

Have you reached the point where you realize that you are not getting ahead by working for the other fellow. Are you beginning to realize that you are just a cog in the boss' machine, grinding away, wearing out, making money for someone else.

THEN—it's time you read this book.

Do you sometimes wonder how things are going to come out when your age begins to tell on you? Does it ever dawn on you that you haven't the pep you used to have? Maybe the boss hasn't noticed it, but have you?

THEN you are going to find a lot of relief in this book.

Have you ever wondered why some men seem to get more fun out of life than you do? Why they live in better houses, drive better cars, dress their families better than you do.

THEN—this book is going to be a real awakening to you.

Do you work day in and day out, steadily keeping at it but sometimes feel that no matter how hard you plug it don't seem to do any good? Have you ever had that feeling, the one that just makes you say to yourself—what's the use.

THEN—if ever a man should read this book that man should be you.

Have you ever thought that the day might come when you will own a business of your own, be independent, be your own boss and forever quit working for anyone else.

THEN—this book is going to show you how to do it.

In the past four years 3187 men who felt just exactly as you do have found the Ozarka Plan, *their* way out — maybe it is yours—who knows.

At any rate isn't it worth a postage stamp to find out? This book cost me a lot of money, but I'll gladly send it, without charge, without obligation to any man who wants to really and truly improve his condition.

It's not fire extinguishers, clothing, house to house selling, correspondence school, oil burners, shoes, pants presser, in fact nothing of that nature — it's a basic business proposition requiring a little capital, not much, but some, a plan for men who have never sold as well as those who know they can sell.

Surely such a book is worth writing for — then why not sign the coupon today? — you may forget it tomorrow. Tear it off and mail right now!

Use This Coupon!

J. Matheson Bell,
Pres., OZARKA, Inc.,
122 Austin Avenue E,
Chicago, Illinois

I am greatly interested in the FREE Book, Ozarka Plan No. 100, telling how I can establish myself in the radio business and increase my present income.

OZARKA



INCORPORATED

122 Austin Avenue E
Chicago, Illinois

122 Austin Avenue E
Chicago, Illinois

Name.....
Address.....City.....
County.....State.....



RADIO NEWS

H. GERNSBACK, Editor and Publisher
SYLVAN HARRIS, Managing Editor

EDITORIAL AND GENERAL OFFICES, 53 PARK PLACE, NEW YORK

Vol. 7

FEBRUARY, 1926

No. 8

UNEXPLORED RADIO

By HUGO GERNSBACK

ALTHOUGH Radio, as we understand that term, has been in continuous use some twenty years or more, starting with the old days of wireless, there are still many things—and as a matter of fact the majority of them—that are unexplored and that present a book with seven scalps to even our best radio research scientists. The average radio man probably does not like to admit this, but if you press him hard enough and begin to ask questions, he will soon capitulate and admit that what he does not know about radio would fill a great many volumes.

While many branches of the radio art have been reduced to mathematics and to an exact science, still the greater part of the art is uncharted, even in mathematics, and most of it is based upon experimental and hit-or-miss methods. It may come as a surprise to many to learn that even such a simple thing as a double-layer coil, used in many radio sets, can not be calculated mathematically. It is a case of trying out by experiment just which coil works best.

But leaving alone mathematics, the attempt to get a correct picture of many phases in radio is a great task in itself, and we immediately come into uncharted seas. Take the radio waves of which your radio scientists speak so glibly. What we do not know about radio waves would fill whole libraries. We know that there is probably such a thing as a wave or waves that link a transmitting station to your receiver. But just what this wave consists of, no one has the slightest idea.

It was at first thought that a radio wave leaves the aerial of the transmitting station in a spherical shape, as if you had one soap bubble within another and multiplied them indefinitely. In other words, the waves were supposed to go in all directions, up, down, sideways, reaching into the sky and far deep into the bowels of the earth. Whether this picture is correct or not we do not know even today. However, we begin to doubt it.

Dr. Alexanderson, in his researches, tends to show that radio waves can not possibly have this shape. As a matter of fact, he insists that they tend to twist in a corkscrew fashion.

Furthermore, if we consider the Marconi beam projector, by which the waves are sent out in only one direction, over a narrow beam, it would seem that the spherical radio wave theory no longer could hold true. What shape a beam-wave assumes perhaps no radio scientist would venture to accurately predict. Which brings us to the question, "Is there such a thing as a radio wave at all?" and "Is it necessary to imagine that there is a wave?"

Nikola Tesla is able to explain all radio transmission without any wave formation, and the researches of Dr. Rogers, of underground radio fame, seem to get along very well without the wave idea. According to Tesla, the transmitter is one plate of a condenser while the receiving aerial forms the other plate. Electric surges take place between these two, mostly through the ground, the same as electric surges take place in an ordinary condenser. And when you

ask Tesla "How about an airship or airplane getting radio signals?" he will answer your question satisfactorily by telling you that the airplane merely constitutes another plate of the condenser, and that the entire radio transmission is based only upon a difference in potential, and not on an orthodox wave formation, as we have contended right along. All of which goes to show how little we really know about it.

We know that something happens between the transmitting station and the receiving station, but what this something is we know mighty little about.

Coming closer home and taking a peek into our receiving sets, we find a lot of interesting points to speculate upon in our ignorance as to radio matters. In the regulation radio set we have the radio frequency currents as they come in over the aerial, also called high frequency currents, and then we have another set of currents, audio frequency currents or low frequency audible currents. The average radio engineer will tell you that there is no connection between the two; but the careful radio set builder knows better, and knows that there is some interaction between the radio and the audio currents, and that unless the set is built right the audio currents will kill the radio currents, and vice versa.

Exactly what the interaction is, no one seems to know. But the experimenter does know that, unless the set is built right, it emits nothing but shrieks and howls. We do not even know the effects of radio currents upon those bodies which we call insulators. Once upon a time it was thought that certain electrical insulators were also insulators for radio frequency currents. We know something more about it today and know that electrical insulators sometimes are good conductors for radio frequency currents. But the surface has as yet not been scratched, and what we believe is true today may be entirely wrong tomorrow.

Some day some one is going to invent a new sort of lens by which it will be possible to look into a radio set and actually see the radio frequency currents, just as you can see the aurora on a high frequency Tesla coil, with its weird glow in total darkness. When that happens, whoever the investigator is, he will see weird things. He probably will see the precious currents oozing out in fine streams from the edges and points of the condensers and other sharp points or edges throughout the receiver; that is, providing that the radio frequency currents act as other high frequency currents do. If they do not, the picture may be reversed. My guess, however, is that any sharp point along the radio frequency current's path just decreases the efficiency of the set by so much.

I might go on indefinitely, pointing out and asking questions about such subjects as fading, dead spots, effect of atmosphere on radio transmission, and dozens of others. The list may be extended considerably without finding a satisfactory answer to any of dozens of different questions.

Mr. Hugo Gernsback speaks every Monday night at 9 P. M. from Station WRNY on various radio and scientific subjects.

Result of \$300.00 "WHAT'S WRONG" Contest

The judges going over the final entries. Left to right: A. K. Laing, Technical Editor; Hugo Gernsback, Editor; Sylvan Harris, Managing Editor; C. P. Mason, Assistant Editor.



Stack of close to ten thousand replies heaped behind the editors. The largest number of replies ever received by RADIO NEWS in any contest.

The Prize Winners

Although over 9,700 replies were received in the "What's Wrong?" Contest, none of the contestants found all the mistakes on the November cover. Therefore, no first prize can be given.

The following prizes have been awarded to those who came nearest the correct solutions in their correct rotation:

Second Prize, \$75.00—A. R. Collard, 1016 East Second Street, Brooklyn, N. Y.

Third Prize, \$50.00—Walter J. Howell, 1746 Fifty-fifth Street, Brooklyn, N. Y.

Fourth Prize, \$25.00—Henry Hansmeyer, 9137 Eighty-second Street, Woodhaven, L. I.

Fifth Prize, \$10.00—Robert G. Geiger, 1112 North Cedar Street, Lansing, Mich.

Sixth Prize, \$5.00—Miss Cloie Van Hoosen, 5507 Askew Avenue, Kansas City, Mo.

Seventh Prize, \$5.00—Roy Baltus, 146 Rue Richard Vandevelde, Brussels, Belgium.

Eighth Prize, \$5.00—Frank L. Sulloway, 120 Ledge Road, Burlington, Vt.

Ninth Prize, \$5.00—Everett S. Pennell, 216 Main Street, Brunswick, Me.

Tenth Prize, \$5.00—F. P. Jameson, Rainier-Grand Hotel, Seattle, Wash.

Eleventh Prize, \$5.00—D. Theodore McAllister, Caledonia, N. Y.

Twelfth Prize, \$5.00—Howard Benjamin, 411 Irving Street, Saginaw, Mich.

Thirteenth Prize, \$5.00—F. A. Anderson, 618 Mulvey Avenue, Winnipeg, Canada.

IN OUR November, 1925, issue appeared our now famous "What's Wrong?" Contest. On the cover of that issue appeared an illustration of a radio set, in which there were no less than 34 mistakes. We invited our readers to use their ingenuity in trying to find the hidden mistakes that we had planted there, and offered to award \$300.00 in prizes to the lucky winners.

We were particularly careful to make ourselves understood as to just what was meant by a mistake; but it seems many of our readers did not read the conditions carefully and jumped to their own conclusions. We, furthermore, cautioned our readers not to work from the picture which appeared on page 593 of the November issue, but to work from the cover. We laid particular stress on the latter, but either this was disregarded, or else most of our readers are not good observers.

One of the most prominent mistakes was the difference in color between the cabinet and the top. No manufacturer would make a set with an oak top and a mahogany body. Nevertheless, this simple mistake escaped the majority of the readers.

Another mistake; namely, the man blowing smoke rings from a cigar that is not lighted, was not universally observed.

Nevertheless, the contest was a great and howling success. It was, without exception, as far as interest is concerned, the biggest contest which the publishers ever had in their twenty years' experience.

We are sorry that no first prize could be awarded, for the reason that out of the thousands of letters there was not one that had the answers correctly, with all of the mistakes as given in the list presented herewith. It is true that all of the mistakes were found by different people; but, strange to say, they were not found by any single individual who listed them ALL.

The prizes were, therefore, awarded to those who came nearest to the correct solution in the regular order in which the questions were answered.

(Continued on page 1210)

CORRECT ANSWERS IN THE "WHAT'S WRONG?" PRIZE CONTEST

- (1) Cigar not lit, while man is smoking.
- (2) Wrong phone cord for double headset.
- (3) One phone terminal not connected.
- (4) Phone cord connected to horn terminal instead of phone terminal.
- (5) Loud speaker connected to phone terminal.
- (6) Set supposed to be operating, but switch on "OFF" position instead of "ON."
- (7) Cabinet made of oak and mahogany, instead of one wood.
- (8) Cover of set screwed on. There should be no screws.
- (9) "PLUS" and "MINUS" binding posts should be "AERIAL" and "GROUND."
- (10) Only two turns on loop. Should be at least ten.
- (11) Loop too small in size.
- (12) Wrong foot on right side of cabinet.
- (13) "DINE" in "MUSI-DINE" misspelt. Should be "DYNE."
- (14) Dial marker missing on central dial.
- (15) Three different dials used, making it impossible to log set.
- (16) Center dial numbered incorrectly. There should be no "30" mark.
- (17) Figures on third dial, "30" and "40," reversed.
- (18) Arrowhead above left rheostat missing.
- (19) Shadows of set wrong. There could not be two shadows as pictured.
- (20) "C" batteries not connected.
- (21) One "C" battery wrong position. Two "—" come together.
- (22) "C" batteries connected to "A" posts.
- (23) "B" batteries incorrectly connected.
- (24) "B" batteries connected to "C" binding posts instead of "B."
- (25) "B+" detector post connected to "B—"
- (26) "A" battery connected to "B" terminals.
- (27) Two "—" signs on "A" battery.
- (28) Only one "A" terminal should be in red.
- (29) One battery handle missing.
- (30) One storage battery filler cap vent missing.
- (31) Center vent of "A" battery has vent hole missing.
- (32) Three dials are out of step. Impossible to receive broadcast in this position.
- (33) No "C" batteries are used on standard tuned radio frequency sets.
- (34) Both phones and horn are used simultaneously, which is not possible. The listener must use either one or the other.

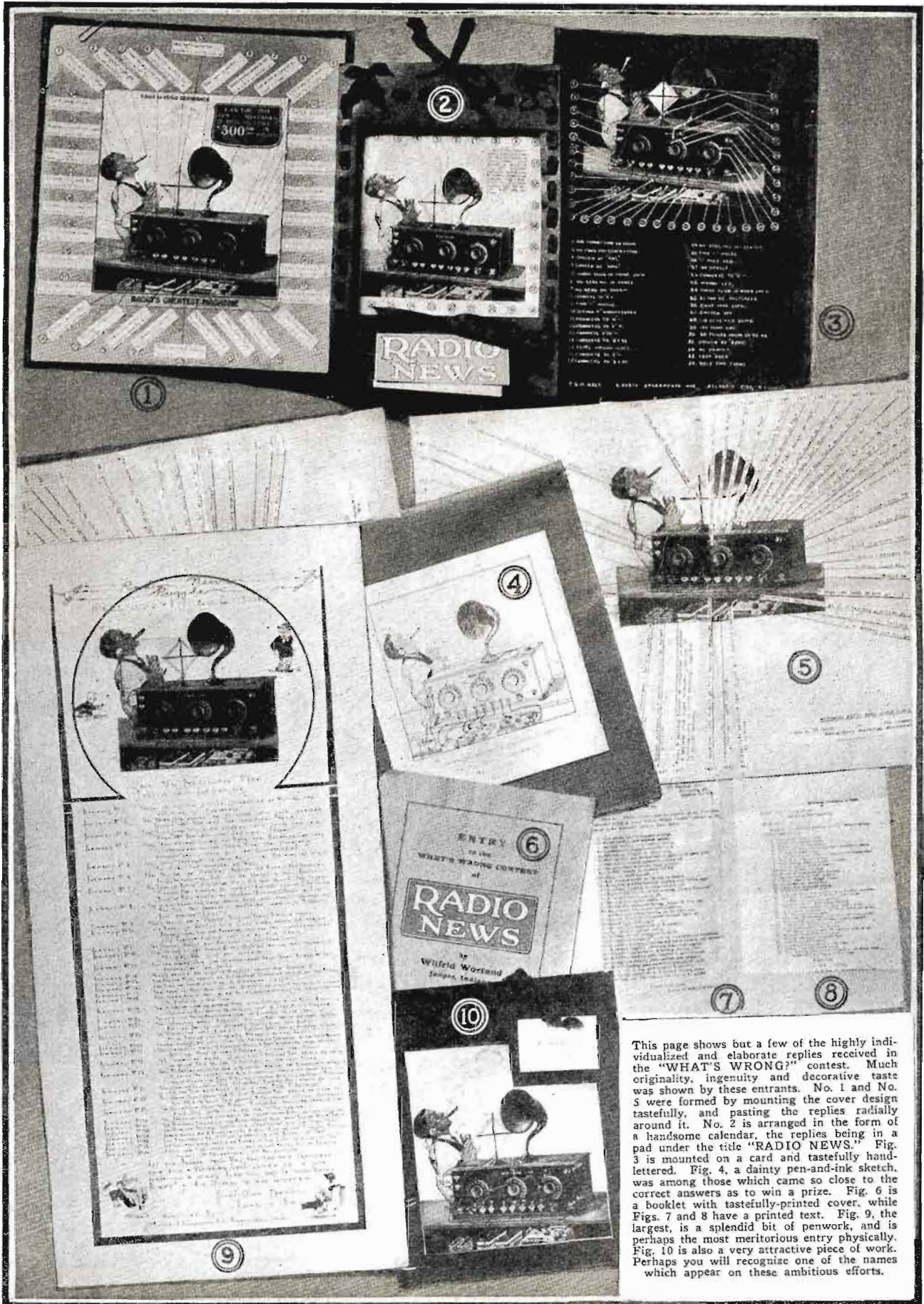

This page shows but a few of the highly individualized and elaborate replies received in the "WHAT'S WRONG?" contest. Much originality, ingenuity and decorative taste was shown by these entrants. No. 1 and No. 5 were formed by mounting the cover design tastefully, and pasting the replies radially around it. No. 2 is arranged in the form of a handsome calendar, the replies being in a pad under the title "RADIO NEWS." Fig. 3 is mounted on a card and tastefully hand-lettered. Fig. 4, a dainty pen-and-ink sketch, was among those which came so close to the correct answers as to win a prize. Fig. 6 is a booklet with tastefully-printed cover, while Figs. 7 and 8 have a printed text. Fig. 9, the largest, is a splendid bit of penwork, and is perhaps the most meritorious entry physically. Fig. 10 is also a very attractive piece of work. Perhaps you will recognize one of the names which appear on these ambitious efforts.

Radio Receivers by Production Methods

By JOHN A. PERN

A tour by proxy through one of the largest plants engaged in the manufacture of radio receiving equipment. The reader of this article will be able to form some idea of the magnitude of the fastest-growing industry in the world.



IT IS a very difficult matter for anyone, not actively interested in the radio industry, to form any clear idea of its magnitude or extent, unless he is fortunate enough to be permitted to make a tour of inspection through the factories of some of the greater concerns in the radio industry.

The average person is well aware of the great interest the public in general takes in radio, because he reads of it in the newspapers; he reads the radio supplements and magazines; he sees antenna after antenna on the roofs of private homes and apartment houses. But even all this does not permit him to form any adequate conception of how, great and general is the use of radio apparatus, and how intense the interest the people take in receiving the splendid concerts that are being broadcast.

The growth of the radio industry has been phenomenal; things had been brewing for many years—at least fifty—since the first classical researches in radio were conducted by the pioneer investigators. But little had been done in placing its developments before the public until after the great war, during which many of those who went "over there" became first acquainted with the utility and advantages of radio.

CREATING A GREAT NEW INDUSTRY

Almost over night, an enormous demand for radio equipment was felt; adventurers in the industrial field tried to supply the great demand, and in a short time the market was flooded with an overabundance of equipment of all sorts, and of all qualities. Many of these makers were entirely new in the manufacturing business; but there were others who had for a long time been engaged in the production of similar equipment, and were, as a result, able to undertake the manufacture of radio apparatus at once.

Among the latter was the Atwater Kent Manufacturing Company of Philadelphia. For many years they had been manufacturing, and supplying a national demand for their automotive starting, lighting and igni-

tion systems. With the introduction of radio, they were comfortably in a position not only to assemble radio parts, but to make every piece that was used in their receiving sets. This was easily done, as the peculiar machinery used in making ignition equipment is quite similar to that necessary to make radio parts.

Radio design is a special branch of electrical engineering, where the "transients,"

of manufacturing these high-powered, far-reaching sets, may be summarized in the following sketchy description:

To begin with, there are several departments, each of which can be considered as acting independent of the others. These are the departments in which the separate pieces of apparatus are made and assembled, as, for instance, condensers, rheostats, transformers, etc. Each of these departments



An assembling room, showing the trays in which the unit parts are supplied, and the finished instruments to the right of each worker's place.

or small details, encountered in regular power engineering become the important things. Automotive systems deal mainly with electrical "transients," so that previous experience in that line became more valuable when radio manufacturing was begun.

The Atwater Kent daylight factory extends over twelve acres and employs hundreds and hundreds of people. It is intensely interesting to the ordinary person, as well as to the technically-inclined man, to watch the astonishing transformation of the rough material into mechanically perfect radio parts, in this huge, efficient factory. The process

receives its screws, bolts, etc., from the machine shop or the stock room, winds its own coils, conducts its own tests, assembles the equipment, and then passes it on to the set assembly department. There the parts are put together, on the panel, and in the cabinet, tested, and finally packed for shipping. Everything that goes into the receiver is made in the Atwater Kent factories.

MACHINERY OF ALMOST HUMAN INTELLIGENCE

It is difficult to say what is the most interesting process of manufacturing in this factory; but the specially-designed machines that operate at a tremendous speed are usually first to attract a visitor's eye.

All coils used in the receiver and loud speaker are wound on special automatic winding machines in a twinkling. Most of these machines are attended by skillful girls with deft fingers.

Every advantage is taken of the possibilities of automatic machinery. Special gang-drills bore many holes simultaneously, as, for instance, in the bakelite end-plates of the condensers. A huge punch-press stamps out all the holes in the plate which is to become the panel, in one operation. Spot-welding machines weld the sub-panel to the panel, and the supporting ring to the A.F. transformer casings.

Even the mahogany cabinets, in which the receivers are housed, are made and given that "much coveted" satin piano finish in this plant. Unique devices in wood-working machinery help to speed manufacturing, and lacquer spray-guns facilitate production.

PRESSES COMMAND ATTENTION

The gigantic presses, weighing thousands of pounds, used for shaping the bell of the loud speaker, are especially interesting. The first big press, with a tremendous crash, punches the steel required for the bell out of huge steel sheets, and converts the bell into a shape that resembles a dishpan.

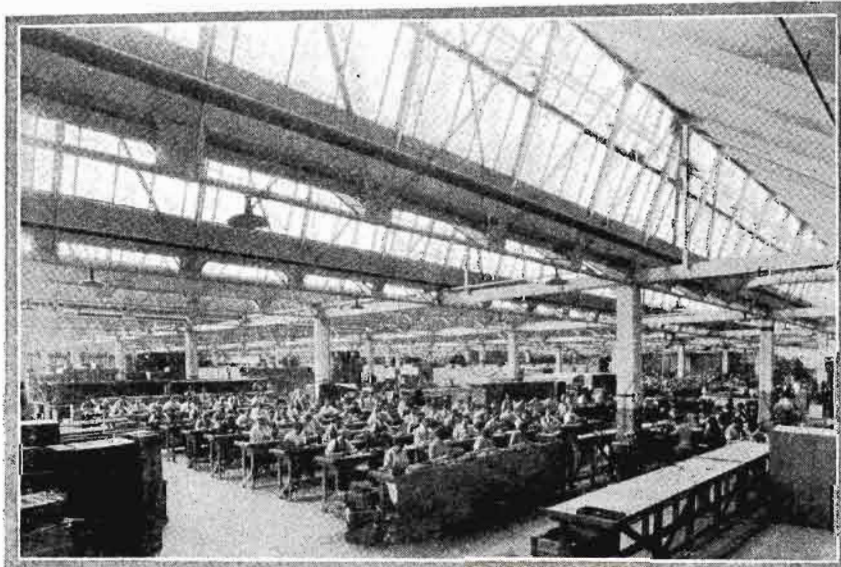

One of the assembling rooms in which condensers and similar instruments are made up from the unit parts supplied from the stamping and milling departments.

After the bell is punched into shape, smoothed and ready for the paint shop, holes are automatically drilled in it to receive bolts or screws for fastening to the neck of the horn.

Departments such as the tool-making section may be omitted from this summary, as they do not enter into the special order of radio work; although these departments are as essential as any other. These may be classed as routine steps in the journey, somewhat in the same way as we regard the machine-maintenance or repair departments.

MULTITUDE OF TESTS NEEDED

Every piece of equipment made in the factory receives an individual test before it passes to the next department in line. Finally, when the receiver has been completely assembled, it is given two more tests.

Every transformer is compared with a standard transformer before it is passed. If it does not measure up to the mark it is rejected. Both voltage and amplification tests are given it, the voltage test to determine how the insulation stands up, or to detect a broken winding, and the amplification test to determine whether any of the turns are short-circuited or not. This is accomplished by very ingenious set-ups, so

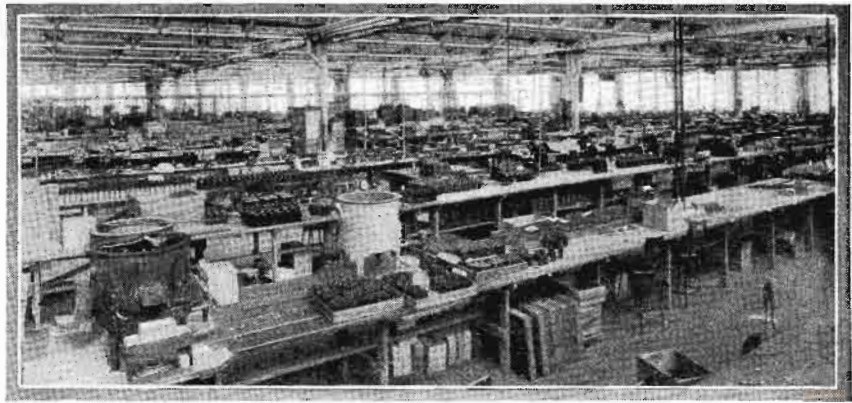

One of the coil departments. Note the vat of impregnating compound, and the various jigs for use in completing the coils, before they are sent to the assembling departments.

that when the transformer is connected, the reading of a meter will tell the tale.

All the molded parts used in the receiver are made at the factories, which include what is said to be the largest privately-owned molding plant in the world.

It is interesting to note that almost every tenth man in the Atwater Kent plant is an inspector. Each receiver is subjected to 140 gauge and physical inspections and 19 electrical tests before it is allowed to leave the factory.

Furniture For Sale

By ANDREAS MacGILLICUDDY

Mr. MacGillicuddy utters words of grave portent and omen, for the edification of innocents who fare abroad into the alien field of radio, in search of objects pleasing to the aesthetic eye.

IT HAS not been so long since I stopped in to see a dear friend of mine, who happened to be employed with a large concern selling radio outfits to the "ignobile vulgus"—the unsophisticated masses. We had a long talk at that time, regarding the general aspects of the radio business of the current and the coming seasons; and among other things that we discussed was the growing tendency of the people to buy radio receivers which are disguised as pieces of furniture.

In line with this phase of our conversation, we also discussed the matter of publicity—that is, the various ways and means of enlightening the general public as to the meritorious design and construction of the receivers put out by his company.

But, without going into any details about that matter, there was one remark which my friend made, that caused me to sit up and take notice. Trusting to my memory for the exact verbiage:

INTELLIGENT CUSTOMERS NOT SOUGHT

"We don't want to sell radio receivers to people who know radio—that is, to those who intelligently read the radio magazines, such as RADIO NEWS. We want to sell furniture."

Well, my dear reader, you can see in this remark something to be dreaded; you can see in it the attempts of a stock corporation to foist anything upon the radio purchaser that he will buy, regardless of whether or not the purchaser does his buying wisely.

It is a far cry, from such "salesmanship," to the procedure that would be followed if concerns such as I have described above tried to be truthful and sincere in their business methods. They should have the caption "FURNITURE FOR SALE" on their bulk windows which display the radio receivers, and not the caption "RADIO RECEIVERS."

For it is notorious that there are many so-called receivers which make beautiful pieces of furniture, and which bring in the broadcast station six blocks away. And there are other receivers which bring in "the coast" very easily, whether they be housed in beautifully periodic cabinets or not.

BUYING FOR LOOKS OR USE?

The point is, that if the afore-mentioned "ignobile vulgus" require simply "radio re-

ceivers" they will be sold "furniture"; but if they are to do their purchasing with a certain amount of intelligence, and with a certain knowledge of what constitutes a "good" receiver, they will have to do it elsewhere, or else "build their own."

And, finally, there is a moral to this story; it is very important to draw a fine distinction in this matter—that is, between furniture and radio receivers. Let us hope that such concerns as I have described above will not last long in the radio business.

If any of my readers encounter a little difficulty in following the idea that I have attempted to put into a few words of warning, let them simply remember that the *movement* in the watch is the important thing, the *works* in the piano, and the *equipment* and *design* in a radio receiver. The clothes may make the man, as the clothiers say, but an Antique-Semi-Period-Elizabethian-Gothic-Radio-Receiver will not receive a thing, if the works are not inside.

BE WARNED, MRS. BUYER

Men will come, and men will go, but the precepts of Barnum go on forever.

Remember that a suave clerk, who assures you that his sole reason for living is the hope of gaining your favor, will

fail to recognize you the next time you come in. And remember that imitation Grinling Gibbon carving is all very lovely to the eye, but has something less than nothing to offer the ear, especially when the internal workings are skimped to pay the woodcarver's bill.

Radio, after all, is a matter of copper and thoriated tungsten, of bakelite and hard rubber, of mica and vacuum. It is these that must be paid for first of all in a radio set; for radio is not, after all, a matter of matched heart-of-walnut-bole, nor of imitation Chinese lacquer in the Queen Anne manner, nor of rococo brass handles and hinges from the boudoir set of La Pompadour.

The Manchurian mandarin brooding over a bowl of goldfish in the southeast corner of the cabinet door is interested in a type of wave far removed from the Hertzian; and the best lacquer that ever was made from small Oriental insects doesn't compare with "airplane dope," when it comes to making a coil self-supporting.

If you want radio, be sure you are paying for radio.

If you want furniture, add to the radio allotment the amount you would pay for the cabinet alone at the New York Galleries.



The salesman is not lying. Oh, by no means! Purchasers of this set will be able to hear 2LO loud and clear. It is merely necessary that they move to London.

Thirty Years In the Dark Room

The Experiments of D. McFarlan Moore

The third installment of a biography written by W. B. Arvin of RADIO NEWS, telling of Mr. Moore's entry into the lighting business, and giving details of early work that paved the way for his revolutionary discoveries in the field of gaseous conduction.

IT WAS a rather timid youth who walked up the steps that led to the front entrance of the old brownstone residence which stood, thirty years ago, at No. 65 Fifth Avenue, New York City. One would have judged from his appearance that he was not a native New Yorker.

Inside the dwelling he looked around, surveying his surroundings. It was not at all the sort of establishment that he had expected to find. A small sign outside the door had borne the legend *United Edison Manufacturing Company*; but the interior resembled a deserted, yet still half furnished, mansion. This, in effect, was what it was. The first Edison enterprise in New York had for its headquarters one of the old mansions, socially well known in days before business began to creep up Fifth Avenue.

An assistant who happened to pass by just then reassured Moore that he was in the right building, and directed him to the head of the construction department. So the young man presented himself before a rather pre-occupied gentleman who appeared to be handling a great deal too much work for one individual. Moore had corresponded with a friend and former fellow student who was working for Edison. In consequence, his status was quite a bit better than that of the casual job-hunter.

After a few minutes spent in discussion, while the superintendent sized up his man, it was decided that a place could be made for Moore in the draughting room. They went up a couple of flights of stairs to the "art department" of the plant. This was a large room in which two or three draughtsmen were busily at work behind huge drawing boards. Moore, in a few operations, showed that he was qualified to do the necessary work.

"How soon will you be ready to start?" asked the foreman.

By way of answer, Moore took off his coat, sat down, and adjusted one of the boards to the proper height. The foreman was a bit surprised. Draughtsmen, as a rule, didn't act like that. But Moore had already hired his room and was anxious to make his start in the new industry that was to be his life work.

One of his first jobs consisted in making

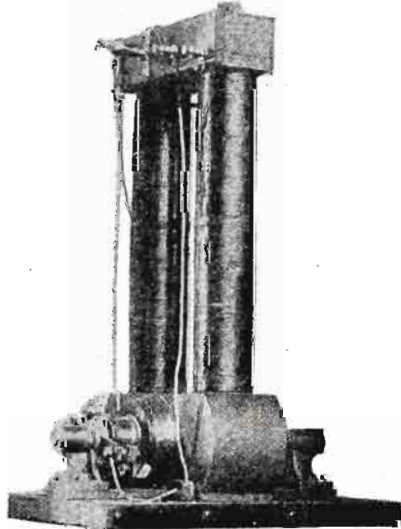

An early bi-polar dynamo of the type standard in the industry when Moore first went to work for Edison.

the drawings for blueprints, and then making the prints themselves by the old, cumbersome "sun" process. The tracings were placed over the sensitized paper and placed in a big frame which slid out on two iron tracks in the back wall of the house. Here the sunlight furnished the necessary illumination for their printing.

A great many of the drawings were of fixtures. The electric lighting business of the time was principally a method of selling these gaudy hangings of brass and bronze. Moore fell to the work with a will and in a short time was head of the draughting department, or "art work" as the men about the plant insisted on calling it.

He learned about the electric business by leaps and bounds. All the details had to be set out in the drawings which he was supervising, so he had practically the whole of the industry at his finger tips. He got to know the sub-station in the basement of the house by heart. There was a small boiler, a steam engine belted to an old bi-polar dynamo. The field magnets of the machine were tall and the armature ran at an astounding speed.

THE FIRST ENGINEERING WORK

Soon Moore was designing plants like the one he had studied in the basement of the company's offices. During one of these jobs, the boss sent him up to look over the installation which had been made four years before in the Metropolitan Opera House. This was the largest job of the kind which had been done. It was excellently carried out, according to all the reports of it. The foreman who had had it in charge had made a name for himself in the results the installation had obtained. His name was Nikola Tesla.

Moore looked the job over thoroughly and went back to the problem at hand. One of the greatest difficulties was in obtaining steam engines which would turn over at a great enough speed to furnish the necessary revolutions per minute for the dynamo. The little machines had to run at an astounding rate in order to deliver the necessary power to the lines.

Edison himself sent through the order telling the purchasing agents how best to obtain them. He said to ask for bids and place the necessary speed at double that needed. The bidders would all boost their own product a bit, he thought, and the stretching of the necessary speed would give the company protection from too much hopefulness on the part of the builders of the engines.

IMPROVEMENT IN SWITCHBOARDS

With the particular bit of construction upon which he was engaged at the time he did what was considered a very good piece of work. Before this time all switchboards had been built after the fashion of wooden fences. Standards had been erected and boards nailed on them horizontally. This was found a very handy arrangement. The instruments could be suspended upon them with wire or screws and the spaces between the cross supports left ample space for the lead wires run to the terminals on the back of the switches and meters.

It was extremely difficult to figure the voltage and the power needed for the work at hand. There were no voltmeters and there was no watt, no designation at all for the actual power of electricity. The voltage was usually regulated by a trial lamp which was hooked across the terminals of the dynamo. The operator would then

adjust the field rheostat until it showed the proper brilliance. That was the proper operating voltage for the machine. There were ammeters, and very simple and efficient instruments they were, consisting of a solenoid with a plunger and a pointer affixed to the end of the plunger. The instruments were usually supported upside down and were read backwards!

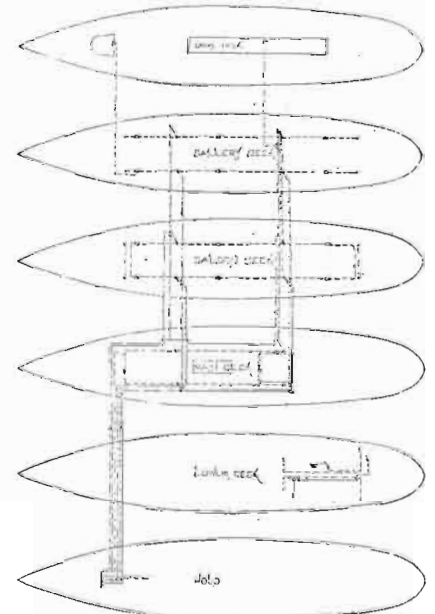

One of Mr. Moore's early drawings. It shows the wiring arrangement for the successive decks of a Fall River steamer, one of the first to be equipped with electric lights.

When Moore first entered the industry, there was but one central station system as we know them today. The units were manufactured complete and were sold to those who could afford to install a complete outfit. That is, when lights were sold, a whole electric plant was sold to make them work. The salesman went about the large hotels and clubs trying to sell them an electric lighting plant for their buildings. The Hotel Netherland, in New York, was one of the first of such structures to order a plant.

Really the greatest thing that Edison ever did was to correlate two of the ideas which he originated. It is the simplest thing imaginable but at the same time one of the greatest. As with all the great advances of civilization, it seems obvious to those who see it and know of it after the correlation has been made. Edison first conceived the idea of making a central station which would furnish the power for a number of individual lighting installations and then running the necessary wires and allowing the lights simply to be installed and the individual to pay for the electric service and the lights. At that period the sale of the lights was the big thing. Edison had a plant manufacturing them and had to have some output for the product so he hit upon the central station plan. The first New York station was installed in Pearl Street.

Moore was in the industry all during the period of development. His first year found the electricians running the wires on the walls of houses and then placing the plaster over them. This seemed an ungainly and costly method of making the installations

and wood moulding was decided upon. Therewith, for the sake of efficiency, Moore set about designing standard pieces of moulding to take the wires and by which manufacturers could work. Those same standards of a moulding are used today and are accepted by the electrical industry generally.

Wood was the only insulating material used. When wires were strung in buildings of any kind the pairs of conductors were fastened to the walls and ceilings with wooden cleats. Moore also designed the standard size and shape of these.

THE "ELECTRICAL CLUB"

Jobs had become frequent, one following directly on the heels of the next. Moore was kept inordinately busy. He had little time for anything outside his work and did little else. He had been in New York only a short time and, being very busy, had had little time to call his own in which to cultivate the lighter side of life. One diversion, however, was never-failing. Those most interested in the business of the new industry had formed what they called the Electrical Club, with headquarters in an old building in Twenty-third Street. Here they held regular meetings and general gab fests. Upon occasion they would invite

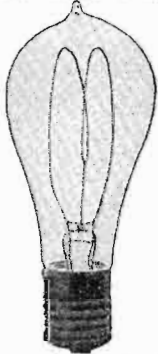

This illustration shows one of the lamps manufactured for the first installations on a commercial scale in New York City. The filament is of treated cellulose, and has an efficiency in candle-power per watt higher than any other type of carbon filament since developed.

some celebrity to speak to them. One of the most notable of these was the appearance one evening of Sir Hiram Maxim, inventor of the famous Maxim machine gun. He brought his deadly invention to the club, and after he had finished a particularly interesting and witty speech told the assembled members that he would give them a demonstration of his new gun. There were looks of wonderment around the room, but they were cut short by his setting the instrument up in the center of the room with its muzzle pointed at the fireplace. There was the press of a button and bang, went the first shot. The others followed in such rapid succession that further wonder was cut short in the rhythm of the bullets. A definite tempo made itself heard and suddenly someone in the crowd said "Yankee Doodle." The inventor had played it with his gun.

But the excitement was not yet complete. Dr. Gatling was present at the meeting and arose to a few points of order. A discussion started. Dr. Gatling's gun had made a striking success in the Franco-Prussian War and therefore was a tried and tested instrument. The argument waxed warm and the guests thoroughly enjoyed themselves.

It was in the early part of 1893 that a Mr. Steringer called at the office and invited Mr. Moore to lunch one day. Moore went and to his surprise found that his host was none other than the man who was building the wonderful fountains at the Chicago World's Fair. The fountains had been the talk of the town for some months—ever since the knowledge of their erection had been made public. Steringer had a notion that they should be electrically lighted and wanted Moore's opinion as to what could be done on the matter. There followed long discussion.

The result was that the fountains were electrically lighted and were the talk of the

exposition. Moore made many of the drawings and sketches for the installation and worked out the engineering principles involved.

Shortly following this meeting came the first great Electrical Congress, at which most of the authorities in the field were either present or sent a representative and a paper to be read before the gathering. Moore missed none of it. And it was indeed a notable gathering. It was during the meetings that Sylvanus Thompson read his paper concerning the operation of an oceanic telegraphic cable. He said that it could be entirely revolutionized if "proper distribution of the electrical capacity of the cable could be made." This was the very beginning of tuning in electrical circuits. It was the first real attention that had been paid to the correlative effects of inductance.

This was the forerunner of Oliver (now Sir) Lodge's work in connection with "synthetic telegraphy"—or tuning in radio! The two were closely related.

Later, this same principle set out by Thompson was to be made practical through his coils designed to keep the phase angle at the proper value on telephone lines. The Thompson statement was simply the setting out of the theoretical law upon which Pupin's coils were to work and make long-distance telephony possible.

Edison was not at the convention. His work, indeed was such that he would not be likely to attend such a gathering. Men who knew him in his early work report that he relied far more upon what seems to have been an occult sixth sense than upon science or mathematics in the design of his systems and instruments. One remembers his classic remark that his dynamo was the correct shape "because it worked right." He was typical of the inspirational, not the research, inventor.

INSTALLATION OF NIAGARA FALLS PLANT

About a year later, there was excitement throughout the industry. There had been much talk floating about for some time regarding the installation of an electric plant at Niagara Falls so that the huge water power resources there could be made available. Finally, something definite had been done and the plant was actually to be constructed.



The United Edison Manufacturing Company, as it appeared on the day that D. McFarlan Moore applied for, and landed, his first position in the electrical business.

The work of planning the plant was to be done. Moore acted as consultant in dynamo design, although he disclaims any credit for the finished job.

Meantime he had gained a little more time to himself and established, through his family and friends, some very enjoyable social contacts. One of the best of these was with Charles Scribner, the publisher. It was at the home of this illustrious gentleman that he met the famous Cleveland H. Dodge and many others. There was also J. C. Cady, the architect who had designed the Metropolitan Opera House. It was from Cady that Moore heard all about the problems encountered in the installation of the electric fixtures and plant under the supervision of the young Tesla.

In those days the electrical business was (Continued on page 1208)

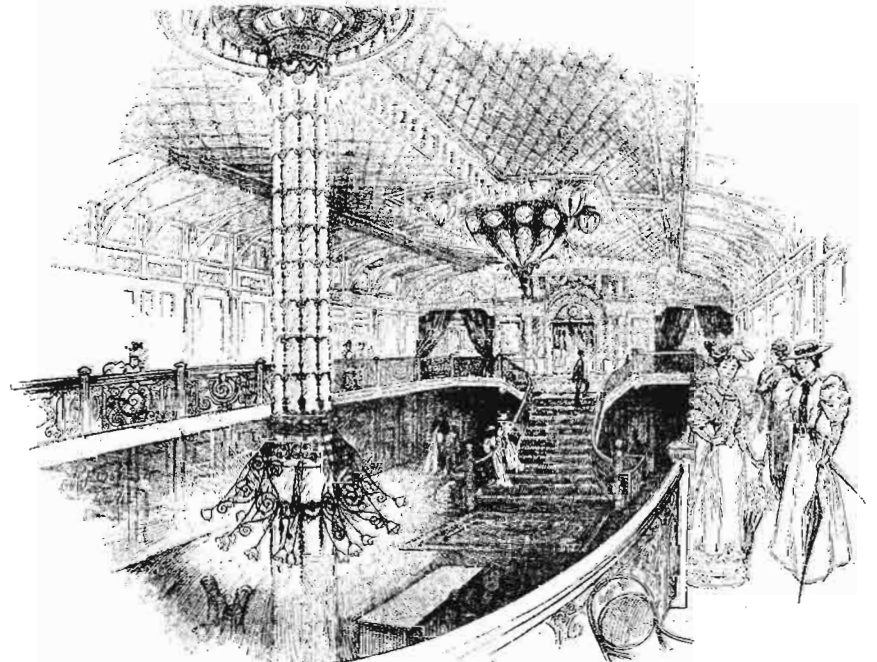

This old drawing gives some idea of the ornate fixtures in vogue in the middle Nineties. It shows the "grand staircase and main saloon" of the S. S. Priscilla, one of the first ships to be equipped with electricity. On the opposite page may be seen a diagram of the arrangement of feeders and mains connecting the various decks with the power plant in the hold.

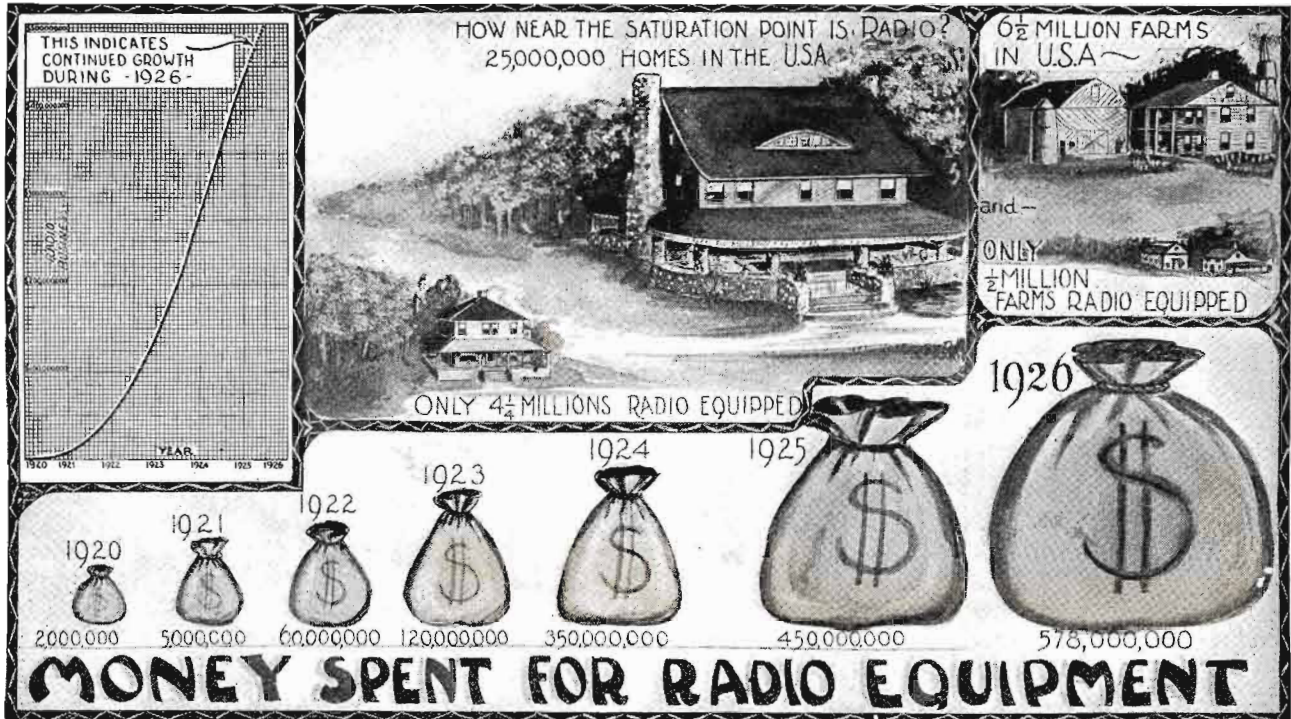

The Radio Industry of Today

By GEORGE WYNCOTE



Alarmists, during the past few months, have been amusing themselves with dire predictions that the radio industry has reached a point of inflation, and will shortly commence to deflate again. Such opinions are based more upon superficial aspects than upon a knowledge of the facts involved. In this article an actual analysis of conditions is made, showing beyond any possibility of doubt that the radio industry will continue its pace of development throughout 1926.



IN OUR July, 1924, number the readers of RADIO NEWS were made acquainted, through an article by Mr. Roger Babson, with the fact that the radio industry of that year far surpassed in extent and magnitude the importance that is generally assigned to it.

Mr. Babson, in that article, showed that within the short period of about five years, the radio industry had assumed a place among the thirty-five leading industries of the United States.

Contrary to the general opinion, radio is not a fad; it is estimated by the Department of Commerce that at the present time there are approximately four and a quarter million radio sets in operation in the United States! And of these sets, scattered all over the country, there are only a little over half a million sets on farms.

Now let us see what this means in regard to the radio industry and business of the coming year. There are, approximately, twenty-five million homes in the United States. Assuming only one set to each home, this means a potential market for over twenty million sets! In other words, only 17 per cent. of all the homes in the United States are radio equipped. And, furthermore, just think of how many are only superficially equipped.

The radio equipment in many of these homes can hardly be called such; and with the awakening of the general public to the advantages and possibilities of radio, the market in this field alone is prodigiously big.

A RADIO FOR EVERY FLIVVER

Up to the present time the radio industry has received its poorest support from the farms. In the year 1925 there were only 553,000 radio receivers on farms, representing only 13 per cent. of the total number of radio sets in use. But the most important

phase of the farm radio question is that only 8 1/2 per cent. of all the farms in the United States are radio equipped.

The table shows an appalling discrepancy in the distribution of radio sets between the farms and the other homes.

Now let us see what all this means in money. On the basis of approximately three million radio sets in the homes during 1924, the year 1925 shows an increase of about a million and a quarter, or 42 per cent. Also, on the basis of about three hundred and fifty million dollars worth of business in 1924, there must have been something like four hundred and fifty million dollars spent by the people of the United States for radio equipment during 1925.

We have attempted to depict these ideas in the illustrations on these pages. We see

house representing in size the number of homes not equipped.

There has been much apprehension among many of those interested in the radio industry that the condition of saturation would soon be reached. From the figures which we present in this article, and their visualizations in the illustrations and graph, it appears that there is not much ground for these fears.

PROSPECTS FOR 1926

The curve shown in the illustration, although it cannot be interpreted too literally, indicates in a general way what we may expect. Certainly it is plain that the curve does not droop appreciably, but continues to go upward. If it did not, there would be good cause to worry about the coming year; but

	HOMES	RADIO EQUIPPED	PER CENT.	NOT RADIO EQUIPPED	PER CENT.
Total	25,000,000	4,250,000	17.0	20,750,000	83.0
Farms.....	6,500,000	553,000	8.5	5,947,000	91.5
Others	18,500,000	3,697,000	20.0	14,803,000	80.0

here a large money bag, increasing in size from one year to the next. The size of the bag represents the amount of money spent during each year for radio equipment.

The same information has been plotted into the form of a graph, by means of which it is possible to prognosticate the business of the coming year; that is, very approximately, and, of course, not taking into account unforeseen conditions which may arise in the industry.

MILLIONS OF PROSPECTS LEFT

We also show a picture of two houses; the small house representing in size the number of homes equipped with radio, and the large

from all appearances 1926 promises to be a good year in the radio industry, continuing the growth shown in every year hitherto.

The main point to be emphasized, however, is that the great majority of possible purchasers is as yet untouched. Many people are waiting for the receiver that conquers static. Others are waiting for complete fidelity of tone reproduction. Both of these problems seem to be well on the way toward solution. The latter, indeed, is practically solved. It now remains to tell the untouched 87% of the buying public that radio at last has reached the state of development that has been predicted.

New Developments in Radio Apparatus

By A. K. LAING

The radio industry is reaching rapidly a point of stabilization. Reliable apparatus is becoming simplified and standardized, while spurious sets and their fly-by-night makers are being forced from the field. Tone fidelity is emphasized as never before, and "single control" is the by-word of the hour. Low-loss parts are now standard equipment in all good sets; and manufacturers like those whose products are described on these pages are seeking still newer refinements.

THE "frenzied finance" period of radio has definitely passed. No longer does the demand so far exceed the supply that any box with dials on it can be sold as a radio set. Manufacturers as a whole are concerning themselves with seri-

wave-length calibrations, five separate binding posts are provided for antennas of varying length; and under ordinary conditions each binding post should be used only with the proper length of antenna specified for it. But within the "shock area" of a broadcast-

stages, acting as well as a filament switch. The other controls a variable resistor in the grid circuit of the first radio frequency tube, and is used to reduce the initial energy of powerful signals so that they will not be subject to distortion in later stages, due to over-amplification.

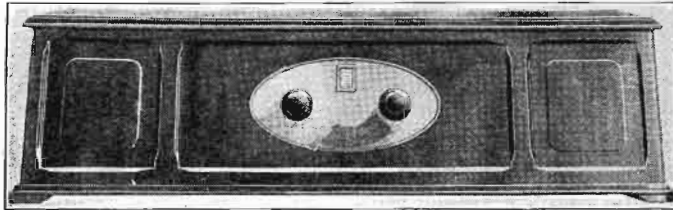

A pleasing departure in panel arrangement is shown in this illustration. The "speedometer" type indicator is calibrated accurately in meters. Photos by courtesy of J. B. Ferguson, Inc.

ous, sane efforts to improve their products; and those who still cling to the old "fool-the-public" methods are being forced out of the running by the new, keenly competitive aspect of the radio business.

Two general trends are noticeable in the program for this year. The first is toward improvements in the fidelity of tone reproduction. The second aims at maximum simplicity of control. This alone is enough to show that radio has reached a stage of comparative stability.

The present-day purchaser expects that any five- or six-tube radio set will have a reliable range of one thousand miles, and of double that distance under favorable conditions. Low-loss parts have solved this problem, and the manufacturers are enabled to give more attention to the features of simplicity and reproduction.

A PRECISION-BUILT RECEIVER

The photographs on this page illustrate a receiver typical of the more recent ideas in design. It comprises two stages of balanced tuned radio frequency, oscillating detector (non-radiating), and three stages of matched audio frequency amplification. All of the tuning controls are on a single shaft operated by the left-hand knob. This shaft rotates three condensers, two coupling coils and the wave-length drum. The knob revolves at a 60-to-1 ratio with the main shaft. A split gear having a special spring action eliminates back-lash and free-play. The knob shaft pivots upon a ball-bearing, insuring smoothness and permanence of alignment.

The complete radio unit is mounted upon a rigid aluminum frame, similar to an automobile chassis. This feature minimizes trouble from shocks which are apt to occur in shipping, etc.

The three variable condensers tune the grid circuits of the two radio frequency tubes and the detector tube. Special insulated universal joints are used in mounting these condensers. The coupling coils control the oscillations and regulate the volume of the receiver.

Three matched transformers are used in the audio frequency amplifier. These are of ample size, and are designed especially to pass the low notes that are filtered out in most receivers. The three rheostats need be adjusted only when new tubes are substituted. One controls the radio frequency tubes, another the detector and the third the audio stages.

In order to maintain the balance of the receiver and to insure the accuracy of the

ing station (about one mile radius) the post marked VERY LONG should be used with a short antenna. This will make the tuning

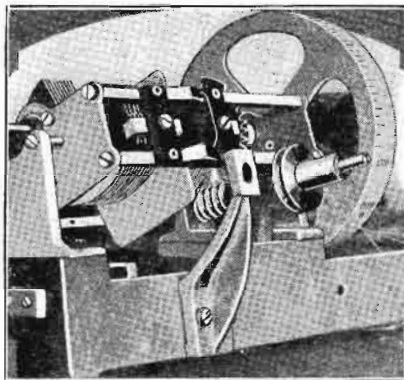

A portion of the cast-metal chassis, showing the master-control worm gear and pinion, the tandem condensers, and the indicator drum which is accurately calibrated in wave-lengths at the factory, making it very easy to find any desired station.

very sharp, and allow the local station to be tuned out more readily.

The right-hand control is for volume. It consists of two independent knobs with concentric shafts. One varies the number of

TUNED WITH ONE OPERATION

It will be seen from the foregoing description that the receiver is truly "single control," for the left-hand knob controls all tuning operations simultaneously. Many so-called single-control receivers have additional compensating and balancing devices which must be adjusted carefully, after a station has been tuned in to maximum volume, in order to suppress oscillation, or to bring the various stages into exact synchronism. In this receiver the only balancing control is mounted behind the panel, and is set but once when the receiver is put into operation. After that it remains fixed until it is necessary to change tubes, at which time the balancer must be readjusted to make up for the change in internal characteristics.

The right-hand dual knob has nothing to do with tuning, and nothing to do with balancing. It performs merely the functions of turning the tubes on and off, and of adjusting loud-speaker volume.

The panel design is itself worthy of note. A few years ago a panel of insulating material and a wooden base upon which to mount the apparatus was the rule. The manufacturers are now reversing this procedure to a considerable extent. Panels of wood or of metal and base "boards" of bakelite or hard rubber have become almost the rule, instead of the exception. This is a very logical and sane development. Discounting appearance, there is almost no necessity for insulating material on the front panel, while there is a need for a metal shield. Similarly, the base board upon which most of the instruments are placed, and to which most of the wiring is closely adjacent, should have a high factor of resistivity. The real need for an insulated front panel passed with the practice of placing binding posts upon the panel instead of upon a sub-panel in the rear of the set.

The result is a decided gain in efficiency and simplicity, both inside and out.

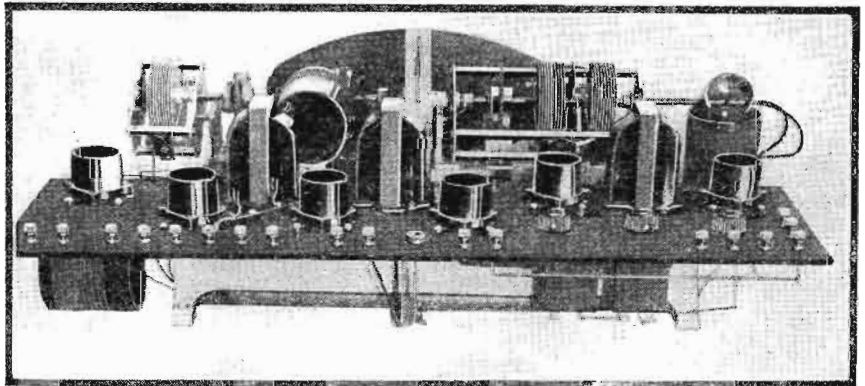

Sturdy construction prevails throughout this six-tube tuned radio frequency receiver. The sub-panel is mounted upon a strong metal casting which includes in its construction bearings and supports for the master-control shaft with its condensers and coupling coils. Note the ample size of the three matched audio frequency transformers, which eliminate the possibility of core saturation.

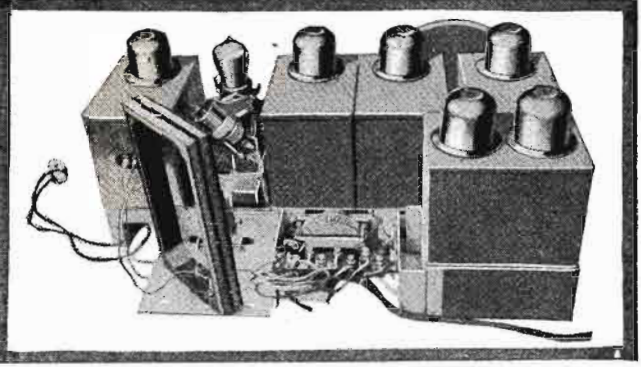
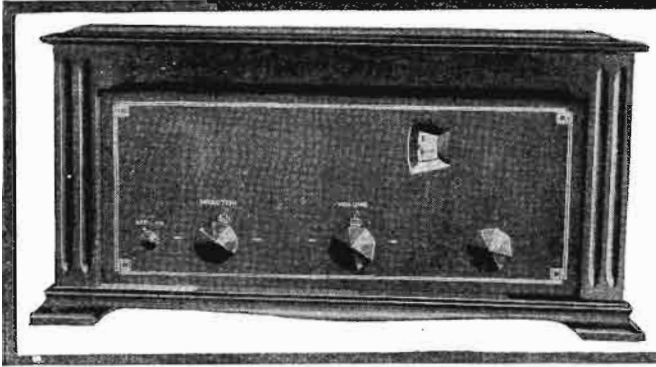

The illustration at the left shows the completely assembled receiver. The small knob at the extreme left is a snap switch; the next controls the loop, and is called the "station selector." The central large knob controls volume by detuning the loop, and the right-hand knob is the master control of the five tuning condensers. At the right may be seen the rear view of the set removed from its cabinet. Note that one of the shielding boxes has been removed to show the condenser and radio frequency transformer. *Photos by courtesy of the Music Master Corporation.*

A COMPLETELY SHIELDED NEUTRODYNE

The circuit diagrams and other illustrations on this page are of another up-to-date receiver. This, too, is of single-control design. It employs four stages of tuned radio frequency amplification (neutrodyne principle), a detector and two stages of audio

coupled to the first and fourth radio frequency transformers.

Perhaps the most novel feature of this set is the independent shielding of each stage that carries radio frequency, and the isolation of the audio frequency tubes in another shielding container. Each tube with its attendant apparatus forms a complete electrical unit. In the top view of the set one may see the method of inserting the tubes. Each has a removable metal cap, one of which is shown entirely removed and the other lying on its side on the shielding at the left. In the same view may be seen the inclosed loop, which is operated by the left-hand knob. Due to the complete shielding of the set, a small loop may be used without danger of having the wiring of the set and the transformers pick up an appreciable amount of energy. The loop is, therefore, very critical in operation, and the set is especially suited for use near large broadcasting stations.

current. For this reason the larger fluctuations are partially suppressed, while the smaller ones pass unchanged. The result is a peculiar form of distortion in which almost all sounds have the same intensity; and in which the more powerful impulses are given a sound best described as "mushy."

It is obvious that a reduction of voltage on the last tube filament will not help, but instead will make matters even worse by further decreasing the straight portion of the graph. The only solution, therefore, is to reduce the initial strength of the signal; hence the de-tuning of the first stage. When the original impulse is weakened sufficiently to allow the strongest wave peak to pass the last tube without slopping off the straight portion of the graph, distortionless amplification of all impulses will result.

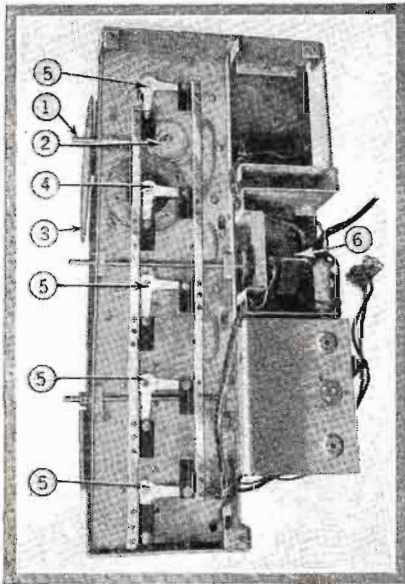

Bottom view of the shielded neutrodyne. 1 is the single control shaft; 2, intermediate gear; 3, wave-length indicator; 4, main gear on one condenser shaft; 5, the remaining condenser shafts; 6, condenser controlling volume by detuning the loop circuit.

The middle knob (marked "Volume") controls the condenser (6), inserted in the loop circuit. Its function is equivalent to the loosening of coupling, although its actual operation is the detuning of the grid circuit of the first tube. In the set previously described, resistance is introduced into the grid circuit of the first tube to perform the same function. This forms an interesting contrast in methods for regulating the input energy. Both use the same general principle, the introduction of losses into the tuned circuit.

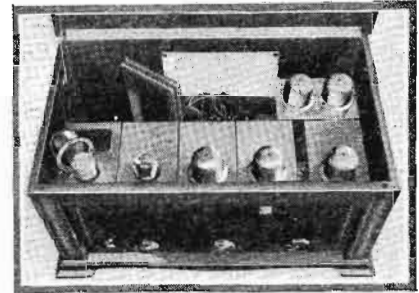

A top view of the shielded neutrodyne, showing one of the tube covers removed, and another lying on the shielding at the rear of the cabinet.

TECHNICAL REASON FOR DE-TUNING

This feature is one that has not been emphasized sufficiently until recently. Anyone who is familiar with the common "characteristic curve" of a vacuum tube should know that, when the fluctuation of grid voltage becomes greater than the amount of voltage represented by the straight portion of the graph, distortion will result. This fluctuation, in the average set, should not exceed six or eight volts. When the voltage has risen or fallen from normal more than one-half this amount, the additional change in voltage has little or no effect upon the plate

RECENT REPRODUCER DESIGN

The trend in loud speaker design is away from horns and other forms of restricted air columns or chambers, toward large, freely moving membranes having a minimum of inertia. The object in reproducers is to set up sound waves as similar as possible to those originally impressed upon the transmitting microphone. The reproducing apparatus need not resemble in form the original emitter of the sound waves, as long as the waves themselves are similar.

frequency. Five tuning condensers, four for the radio frequency stages and one for the detector, are mounted with shafts arranged vertically. The accompanying photograph of the bottom of the set shows clearly the method used to control these condensers with one knob. A pinion on the shaft (1) meshes with the gear (2), which, in turn, meshes with the large gear on shaft (4). The motion of this gear is applied to the two transverse rods that, in turn, control all the other shafts marked (5). Thus a movement of the knob on shaft (1) controls simultaneously five different circuits. Note the insulating blocks on the transverse rods and the insulating disc in the center of the large gear, designed to keep the rotor plates isolated from the metal frame. The large disc (3) is calibrated directly in wave-lengths, and may be read through the window cut in the right of the panel. A glance at the circuit diagram shows that the method of neutralizing by means of small capacitances to balance the grid-plate capacitance is standard. The suppression of oscillations is completed by two small-load circuits

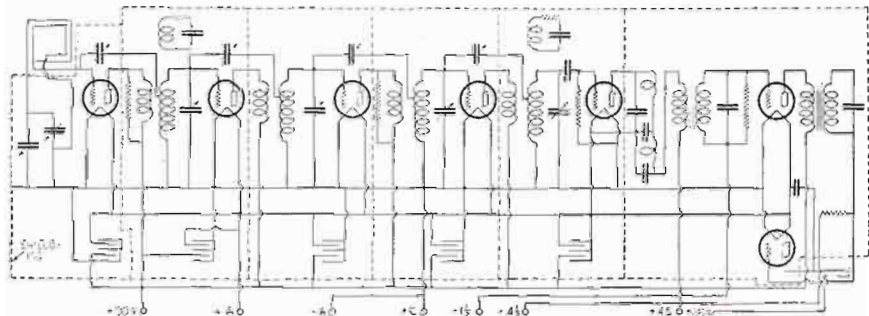

A complete circuit diagram of the shielded neutrodyne. Two condensers are shown in parallel across the loop. One of these is controlled in synchronism with the other four tuning condensers; the other is used in controlling volume by de-tuning the loop. It may be seen at the rear of the set in the upper right-hand illustration.

TWO NEW LOUD SPEAKERS

The double free-edge cone speaker shown in the illustrations in this column marks another step toward perfect reproduction of sound energy. The ideal speaker must have no "natural period of vibration." This

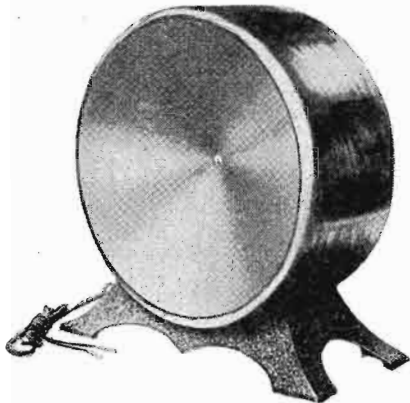

The double free edge cone speaker, designed to have diaphragms with a minimum of inertia. The edges of the cones do not touch the drum frame, which is lipped merely to protect the paper from damage. The sole suspension is at one point in the center.

Photo by courtesy of Acme Apparatus Co.

means, practically speaking, that the diaphragm must float as freely as possible, with a minimum of support, and must vibrate naturally at a period well above or below the limits of the musical range to be reproduced. At the present time it is hard to conceive of a more freely floating device than a fairly large sheet of paper. The natural period of vibration of such a diaphragm is well below audibility. This fact is made use of in the loud speaker illustrated in the accompanying diagram and photograph.

In the early cone loud speakers the edge of the cone was held rigidly by some form of supporting ring, giving the diaphragm a fundamental note in the vicinity of 30 or 40 cycles. This balanced with imperfect transformers to give approximate fidelity on the

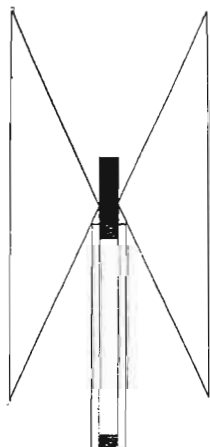

A skeleton cross-sectional drawing of the double free edge cone loud speaker. The two uprights are permanent magnets, linked by a soft iron block at the bottom. The black oblong represents the two soft metal diaphragms and the coil between them.

low notes, but had the bad feature of greatly over-emphasizing static and other stray impulses. The free-edge cone construction overcomes this difficulty entirely.

An inspection of the line drawing shows how the two cones are supported at the center only. In order to reduce damping of the high notes, the cones themselves are supported by two smaller diaphragms of thick, soft metal, capable of conducting magnetism. They, in turn, are supported by the two extremities of a "horseshoe" magnet, indicated by the two vertical bars in the drawing. Between the diaphragms is placed a solenoid of wire, centering in the strongest portion of the magnetic field. A current flowing in this coil changes the flux, and

thereby the mutual attraction of the two magnetized diaphragms. A rapidly fluctuating current will cause corresponding fluctuations in the positions of the diaphragms, and these are impressed upon the paper cones and converted into sound energy.

While this method of reproduction is somewhat less efficient than the older types in the actual ratio of electricity converted into sound, it is practically non-selective, reproducing all frequencies with the same fidelity.

THE CYLINDRICAL TYPE

Another recent development quite as novel in design is shown in the illustrations in the right-hand column. The "diaphragm" is almost cylindrical in shape, and is arranged in such a manner that its diameter increases and decreases in size, in unison with the electrical impulses applied to it. The line drawing shows the manner in which the magnetically-actuated link is connected to one edge of the cylindrical membrane which takes the place of the usual flat or conical diaphragm. There is nothing radically new in the electro-magnetic portion of the device. The novel feature is the cylindrical vibration surface, which allows the sound waves to be distributed in a more natural manner than any device that projects them in a single direction.

In this speaker, as in the one already described, the main consideration in design has been equal reproduction of all frequencies. As the cylindrical membrane that forms the sounding surface has almost no tendency toward free vibration, and a very low factor of inertia, this ideal condition is very closely approached.

No attempt has been made by the designers of this instrument to produce the maximum sound energy possible from a given number of watts of electricity. Fidelity of reproduction is the primary consideration, and is obtained at some sacrifice of volume.

The instrument, while larger than the ordinary loud speaker, is very attractively finished in mottled green and gold, applied to the membrane as well as to the frame.

ACCURACY MAY SEEM STRANGE

Purchasers who use for the first time loud speakers like the two described and illustrated on this page must remember that the output may not sound at all like the output of radio sets that they have remembered as being unusually good. There is a difference between accurate reproduction and reproduction that is merely pleasing. For example, the sound box and horn of an ordinary phonograph will reproduce the music of a clarinet with remarkable fidelity, but fall down rather miserably in reproducing the human voice. Radio horns have similar defects. One of the most outstanding is their tendency to add mellow overtones that are not in the original music or speech at all. This gives to speech or music from most of the old-style loud speakers the effect of a higher scale of notes. One of the newer loud speakers will sound in comparison a bit "heavy"; but actually its output is much nearer the original sound than that of any horn.

LOUD SPEAKER EVOLUTION

It takes no more than a glance at the design of the two reproducers illustrated on this page to see that the fallacy of inclosed, fixed or rigid tone chambers of any kind is passing. A few years ago it was a popular pastime to design tone chambers that were supposed to be similar to the human throat, to the sounding box of a violin, or to some particular wind instrument. All such designs leave out of account the very obvious facts that the human throat and mouth change shape for every note emitted, that the sounding box of a violin is actuated by strings which may be changed in length or in tension, and that almost all wind instruments are supplied with stops, keys, and changeable orifices to alter the characteristics of the vibrant air column. No such provision has been made in loud speakers.

The inclosed air columns, therefore, have but one, or at most a few, natural vibration periods. When a note that is in tune with any such period comes through the loud speaker, it is subject to resonant amplification. In addition, the air column tends to vibrate at one of its natural periods even after the tuned note has ceased at the diaphragm. Thus both over-amplification of

2 MAGNET COILS, CONNECTED IN SERIES

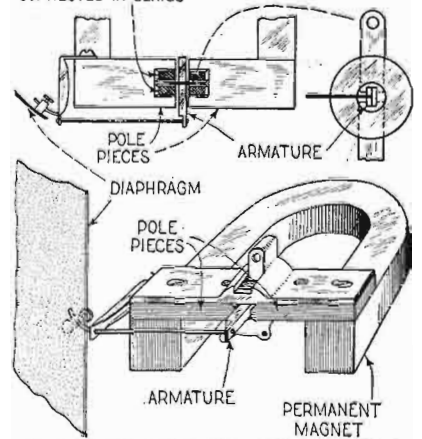

These drawings show the manner in which a link mechanism controls the vibrations of the partially cylindrical diaphragm. The instrument is adjusted by means of the small thumb nut, shown at the lower left corner of the bottom illustration.

some notes and distortion of others is the result.

The freely floating diaphragm, large enough to impress vibrations directly upon the surrounding air, does away with both of these difficulties, and seems to place the burden of further evolution in loud speaker design upon the electro-dynamic system alone. There is still room for a slight improvement here, as well as in the audio frequency stages of the set itself, before absolute fidelity can be achieved.

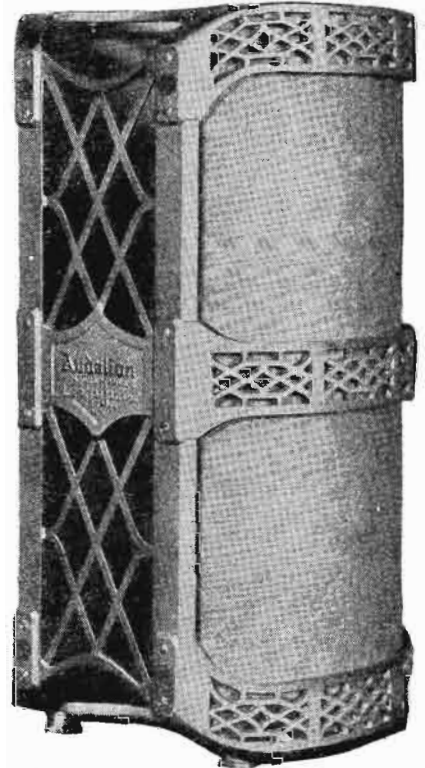

The unusual design of the new cylindrical-diaphragm speaker is shown clearly in this illustration. The instrument is attractively finished in a mottled green and gold effect. Photo by courtesy of The Aundalon Co.

A 3,000-Mile Super-Heterodyne

By R. A. STUART-FREY,
Paris, France

In the illustration below the author is shown operating his receiver, a super-heterodyne, which is described in this article.

That consistent long-distance reception of broadcast stations can be accomplished by ordinary radio fans is attested by the experiences of this writer. Mr. Stuart-Frey regularly receives in France concerts from WRNY, the RADIO NEWS broadcast station, on the receiver described here.

ceived WRNY at loud speaker strength for half an hour until fading set in. This fading was 40 seconds in duration. Atmospherics were absent.

RECEPTION CONDITIONS IN PARIS

Here in Paris, long-distance reception is difficult, owing to the fact that the town lies in a valley and also suffers from the shielding effects of tall buildings. Atmospheric conditions here are not good at any time, and it is only by using a loop aerial that long-distance reception can be carried out without serious interference from the high-powered stations and atmospherics.

The chief cause of interference is Eiffel Tower, FL, transmitting on 2,600 meters with 25 k.w. in the aerial. This station jams almost everything.

As a whole, I can receive WRNY fairly regularly, together with other American stations, if conditions are fair.

The receiver I mentioned above is of my own design and very efficient. Once the transformers have been tuned, the controls are reduced to the main dials.

The panel is 40 inches long by 8 inches wide. This panel carries the two variable condensers, rheostats, potentiometer, variocoupler for the oscillator circuit and a small two-way switch for placing the variable condenser in parallel or series with the loop, for long or short wave-lengths.

The intermediate transformers have adjustable iron cores. This enables the amplifier to be stabilized and prevents distortion which might take place from the cutting off of the side bands by the very sharp tuning obtained with these transformers.

The construction of the transformers is as follows:

A piece of hard rubber rod $1\frac{1}{4}$ inches in diameter is obtained and cut into lengths of 2 inches. Four of these are required. The rod is then placed in a lathe and seven slots, each $\frac{1}{8}$ inch wide and about $\frac{1}{8}$ inch apart, are cut. The first slot is $\frac{3}{8}$ inch deep and the second $\frac{1}{4}$ inch deep. Continue this, cutting each alternate slot $\frac{1}{4}$ inch deep, until the seven slots are cut. (See Fig. 1.) The deep slots are for the secondary windings. A $\frac{1}{4}$ -inch hole is now drilled in the center of the transformer to receive the iron core. In one end four holes are drilled and

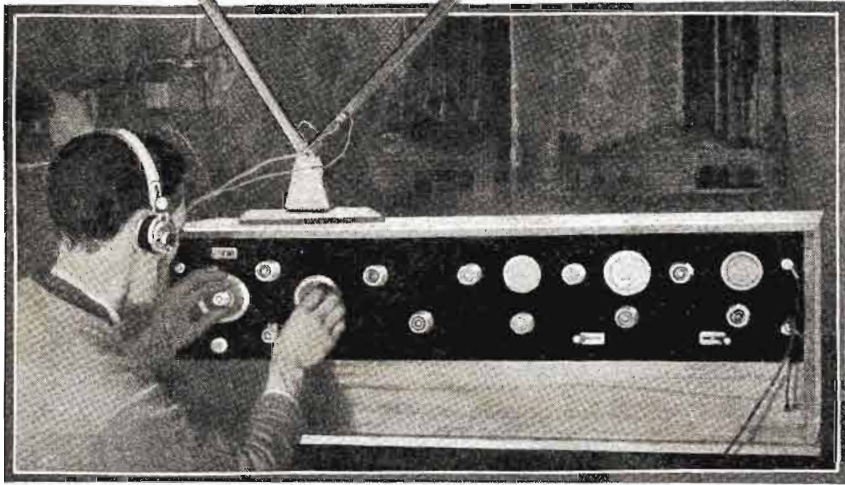

UPON the opening night of WRNY I listened for it, but, on account of very unfavorable conditions prevailing at that time, I found it impossible to pick up the station. Later, after many unsuccessful attempts, I succeeded in locating WRNY at about 1:30 A. M., Greenwich Mean Time. Conditions were bad, atmospherics and fading being very prevalent. The signals were just audible with telephones. At the time I was using an 8-tube super-heterodyne, comprising first detector, oscillator, three intermediate frequency, second detector and two audio frequency, in conjunction with a two-foot loop aerial. Afterwards, I experimented with a small indoor aerial and also an outdoor aerial. These aerials brought in WRNY with greater strength, but the signals were drowned by atmospherics, mush, etc., from high-powered arc stations.

After considering the matter carefully, I decided to change the circuit and to utilize the Tropadyne system for the detector and oscillator, placing a radio frequency tube in front of the combined detector and oscillator. In so placing this radio frequency tube, I was confronted with an extra control, which meant complicated tuning. I then decided to use an aperiodic air-core transformer, but so designed as to cover a small wave-band. It was necessary to construct a number of these transformers, the complete series covering from 100 to 600 meters. To make these transformers easily interchangeable, I mounted them on tube bases,

so that they could be plugged into a standard French tube socket.

After constructing this apparatus and using the same two-foot loop aerial, I succeeded in pulling in WRNY with local strength, at times sufficient to work a loud speaker. At

RADIO NEWS takes pleasure in presenting herewith a constructionally descriptive article concerning a super-heterodyne which has been used for the past half year to bring in station WRNY in Paris. Several novelties are incorporated in the design of the set, one of the most important of which is the use of adjustable iron cores in the intermediate frequency transformers.

Complete details are given in the article for the construction of the set. It employs the Tropadyne system of heterodyning and one radio frequency tube before the detector-oscillator for increasing sensitivity and selectivity. Many fans in congested centers would do well to copy the design.—EDITOR.

the time fading was bad. The result of adding the radio frequency tube before the detector was very marked, as regards the signals received, and also the absence of much interference from high-powered arc stations. Sharper tuning also resulted.

As the winter months approached, I re-

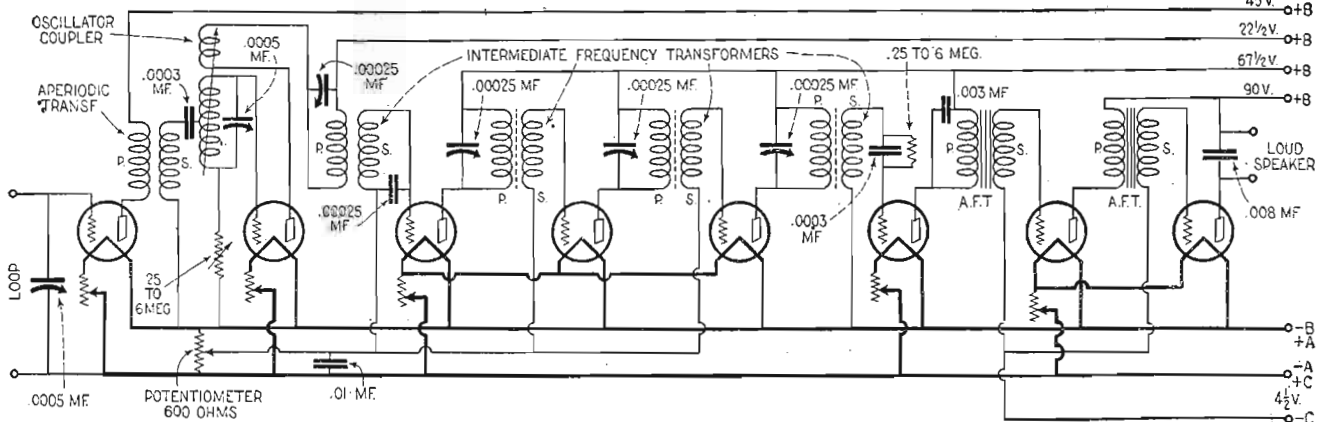

The circuit diagram of the super-heterodyne receiver which receives WRNY regularly on a loop in France. The circuit has several new points about it in connection with the design of the intermediate transformers, which are described and illustrated on the following page.

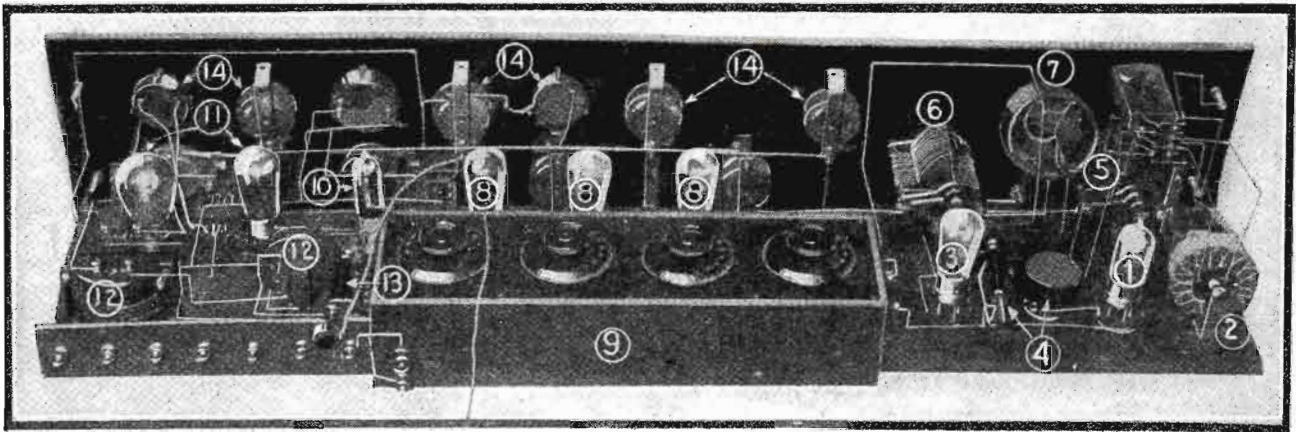

The receiver is divided into units: 1, first detector; 2, oscillator coils; 3, oscillator; 4, grid leak and condenser; 5, tuning condenser; 6, oscillator condenser; 7, coupling and pick-up coil; 8, intermediate frequency amplifiers; 9, intermediate transformers; 10, second detector; 11, A.F. amplifiers; 12, A.F. transformers; 13, grid leak; 14, rheostats.

tapped and into them are screwed four tube bases, so arranged that they plug into a standard French tube socket.

Now the transformer is ready for winding. This may be done on a lathe or by hand. Into the first slot wind 150 turns of No. 38 S.S.C. wire. When this is finished continue the winding into the third slot, and so on, until you have 150 turns in each deep slot, making 600 turns in all. Into the remaining three slots wind 100 turns per slot of No. 38 S.S.C. wire, making a total of 300 turns in all. The ends are now soldered to the tube bases, as shown in the diagram, the beginning of the primary winding going to the B+ and the beginning of the secondary winding to A-, or the potentiometer center arm.

On the top of one of the transformers a fixed condenser of .00025 mf. is screwed. This condenser is shunted across the secondary winding. The transformer is now the input or filter transformer.

Four variable condensers of a capacity of .00025 mfd. are now obtained. These condensers are mounted on a piece of hard rubber which is, in turn, mounted on a box. On one side of the box are mounted four tube sockets, into which the transformers will be plugged. (See diagram.) All the plate and grid leads are brought to terminals which pass through hard rubber bushings, also the leads which go to the potentiometer center arm. The "B" and "A" positive leads are brought out to terminals on opposite sides of the box. The condensers are connected across the primary windings of the transformers. The box is now mounted behind the tube sockets and connected up in the usual way. By placing the transformers in a box all leads are hidden from view. A small hole is drilled opposite each transformer, so that the iron core may be inserted after the transformers have been tuned.

The aperiodic transformers used before the detector are constructed as follows:

Fig. 1 gives a sectional view of a spool made from hard rubber discs. The transformers are wound with No. 34 S.S.C. wire, the primary and secondary windings being wound in the same direction. The primary is wound on first and covered with a thin layer of silk thread or insulating tape. The secondary winding is then wound on top of it. Then the ends are soldered on

30 turns of No. 26 D.S.C. If it is desired to use a small indoor aerial, a coil should be made up as follows:

Obtain a tube 3½ inches long and 3 inches

INTERMEDIATE TRANSFORMERS

PRIMARY - 300 TURNS OF No 42 S.S.C. WIRE, 100 TURNS PER SLOT.
SECONDARY - 600 TURNS OF No 42 S.S.C. WIRE, 150 TURNS PER SLOT.
PRIMARY TUNED WITH VARIABLE CONDENSER .00025 MF. (MICA TYPE)

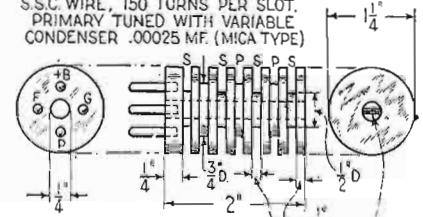

ADJUSTABLE IRON CORE
3 PIECES SILICON STEEL
2" LONG X ¼" WIDE X .003" TH.

**\$1,000.00
Prize Contest**

Watch for it in our March issue. The biggest contest from every point of view that RADIO NEWS has ever staged. See page 1098 for further particulars.

the tube bases, as shown in the diagram. The beginning of the primary winding goes to the "B" positive and the beginning of the secondary winding to "A" positive. The number of turns given below is for primary and secondary, as each winding has the same number of turns:

The oscillator coupler is made from a 180-degree variocoupler. The stator consists of 47 turns of No. 24 D.S.C. wire tapped at the center and the rotor (for regeneration) of

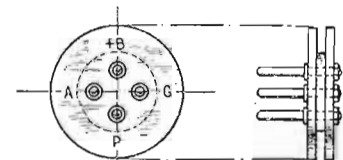

APERIODIC TRANSFORMER

Fig. 1. The design of the intermediate transformers is shown in this illustration. It is possible for any radio fan to copy this design.

No. of Turns	B & S Wire	Inner Diam.	Outer Diam.	Width of Slot	Wave-Length
30	34 S.S.C.	1 3/4"	2"	3/8"	190-240
45	"	"	2 1/4"	"	240-300
80	"	"	2 3/4"	"	300-400
150	"	"	2 7/8"	"	400-600
150	"	"	3"	"	550-750

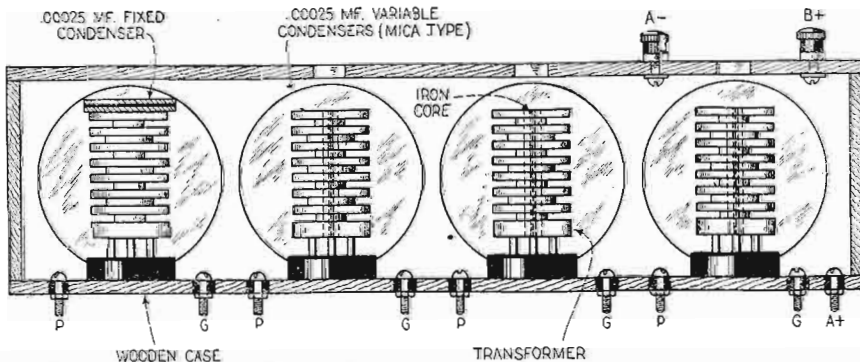

The layout of the intermediate transformers and the condensers which tune them. The transformers are mounted below the condensers, which are of the variable mica dielectric type. The whole is then enclosed in a wooden casing to keep out all dust and dirt.

in diameter and wind on it 36 turns of No. 20 D.S.C. wire. Over the center of this winding wind 8 turns of No. 16 D.S.C. wire. This is used for the aperiodic aerial coil.

The loop aerial consists of 12 turns of flexible wire, tapped every three turns.

The operation of this set is simple. After having plugged in a suitable radio frequency transformer before the detector, the tickler coil is set at zero and a local station tuned in. This should be received without the aerial. (In fact, I have received a station a distance of 550 miles away without aerial, the signals being audible on the loud speaker.) The transformers are so tuned that the loudest signals are received. Now tune in a distant station and retune the transformers, which are very sharp in tuning. It

(Continued on page 1196)

"Wireless" Radio Dancing

By HUGO GERNSBACK,
MEMBER AMERICAN PHYSICAL SOCIETY



The secret of the wireless radio dancing exposed. Tinfoil strips are placed under the rug, while the cord that usually goes to the loud speaker is connected to the tinfoil. The dancers wear metallic bracelets on which one tip of the headphones is grounded. The concert comes through loudly and clearly as soon as the stations are tuned in.

SINCE writing my last article, "Parlor Magic with Your Radio Set," in the October issue, I have had hundreds of letters from those who have tried the experiments and who wanted additional tricks. The "Wireless" Dance described herewith comes under that classification, and is a rather mystifying sort of scientific entertainment, from which a great deal of pleasure may be derived. Here are some of the variations:

You ask your friend to sit down in a comfortable chair, then hand him a pair of receivers, asking him to put them on his head. You then ask him to grasp one of the 'phone tips of the head set, and to his unbounded astonishment he will hear music, clearly and loudly. You ask him to get up from his chair and walk around, the head set remaining on his head, and he will still hear the music as before. Next you ask your lady friend to have a "wireless" dance with you, as depicted on the front cover of this magazine, and in the illustration on this page. All that is necessary is that both of you don headsets and that each of you touch one of the 'phone tips of the telephone receivers, which may either be held in the hand or attached to a metallic bracelet (the latter can be made from a piece of copper or other metallic ribbon and a small binding post to secure the 'phone tip). As you dance merrily along, the music will be heard loudly and clearly in the two headsets.

Not only that, but if you touch your partner's hand, the music in the 'phones will be even louder.

MYSTERIOUS MELODY

It is a rather unusual sight to see a few couples dancing around the floor with radio sets on their heads. There is, of course, no music to be heard anywhere by the spectators; while the radio set may be in the same

room or it may be in an adjoining room. It makes no difference.

The explanation is very simple. The writer, who devoted a good deal of experimentation to this latest scientific trick, wishes to say here that an apparently similar idea originated in England some time ago. The English method, however, is entirely different from the one described here; because with the English one it is necessary to have extra apparatus for the radio set, particularly transformers to step up the energy, and the head sets are not standard sets, but must be made specially to order, as they contain condensers.

In the apparatus described here, any standard radio set, providing it has more than three tubes, can be used, as well as any

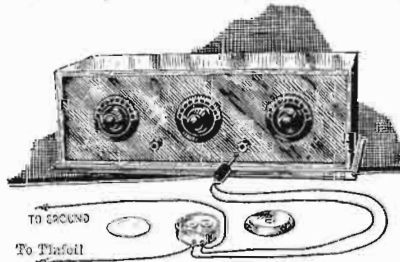

Fig. 4. Here is shown how the connections are made to ground and tinfoil. In order to silence the phone, the cap and diaphragm are removed as shown. When tuning in a station, merely replace the diaphragm to aid you in locating the station.

standard head receiver. I first started out with the method shown in Fig. 1 (page 1212), with a wire running around the room, to which one side of the audio output is connected, as shown, while the other side is grounded. At first I tried, instead of the telephone receiver or loud speaker, a step-up



Fig. 3. Electrical connections showing how tinfoil under the rug is connected with the output of a multi-tube radio set. With some sets it is necessary also to ground one connection; the phone may be muffled, or the cap and diaphragm taken off, as shown in Fig. 4.

transformer; but my experiments soon showed that the transformer is not necessary, and that all you need is a telephone receiver in order to give the circuit the necessary impedance. In tuning in, I found that if one remains close to the conductor stretched around the room, the sounds will come in with a fair intensity with a 5-tube set, but never loud. If one moves to the center of the room, the signals are barely audible, and the results all around are poor.

YOURSELF A PART OF YOUR SET

In all of these experiments it is of the utmost importance that you grasp one of the 'phone tips with your fingers or hold it in your hand, thus making good contact with your body. The explanation is that your body becomes one conductor of a condenser, while the wire running around the room is the other conductor of the condenser. The nearer you come to the wire the better the results. If you let go of the 'phone tip the signals stop almost entirely, unless you are very close to the air wire. Disconnecting the ground also decreases the signal intensity a great deal.

The results having been rather poor, I next tried hanging tinfoil along the walls at regular intervals (Fig. 2). This gave about 50 per cent. increase in audibility, but still the results were not very good. A peculiar thing was observed; that is, on grasping one of the 'phone tips in the hand and touching the other loose 'phone tip to something metallic in the room, such as a metallic cigar stand, a door knob, an ash tray, or anything at all metallic, of any size, the signal intensity would be increased a great deal.

GETTING EFFECTIVE RESULTS

The final and best arrangement, which at all times is reliable, is shown in Fig. 3. We

(Continued on page 1212)

Five Broadcast Stations In One Room

By S. R. WINTERS



If any of our radio friends should happen to have in his workroom five radio sets at once, he should be tempted to call him a radio "nut." Nevertheless, Uncle Sam has five transmitters operating in one room down at Arlington; but these are all for special and definite purposes, as we shall see when we read this article.



A TWENTY-KILOWATT vacuum-tube transmitter, built by the Washington Navy Yard, has been installed at NAA, the Naval radio station at Arlington, Virginia. This sending set, capable of "pumping" 20,000 watts into the antenna, is the most powerful in operation at present by any government department, and is the forerunner of an 80-kilowatt vacuum-tube transmitter to be installed at the San Diego Naval radio station.

This powerful electric-radiating unit, de-

signed by T. D. Carroll and built by the Radio Test Shop of the Washington Navy Yard, uses two 20-kilowatt vacuum tubes, operating in parallel. Unlike most vacuum tubes designed for propagating electromagnetic waves, this new tube transmitter does not fall short of its rated capacity; in fact, under ideal operating conditions, it can put 25,000 watts into the antenna.

Traffic heretofore routed from the Navy Department in Washington by remote control, through the radio station at Sayville, Long Island, New York, will be cleared through this 20-kilowatt transmitting equipment. Operating on the wave-length formerly assigned the Sayville station, 9,145 meters, the 200-kilowatt arc sending set on Long Island will be thrown into the discard and the Sayville station abandoned. The international Morse telegraph code, and not voice communication, will be the method of signaling.

This means that the Naval Communicating Service, instead of using the Sayville station as an intermediate medium of communicating with the battleship fleet on the Atlantic Ocean, will direct its traffic through NAA, at Arlington, or Radio, Virginia. Formerly, messages flashed to the fleets have been intercepted by the Naval station at San Juan, the radio operator at the latter station repeating the message to Sayville as an indication that the signals were of sufficient strength to be copied by radio operators on battleships. Now, the Naval radio station at San Juan will "work" with Arlington.

It is a far cry from the original 100-kilowatt spark transmitter installed at Arlington, in 1913, to an elaborate transmitting equipment whereby the United States and outlying possessions are blanketed by the invisible radio waves. The Naval radio station
(Continued on page 1218)

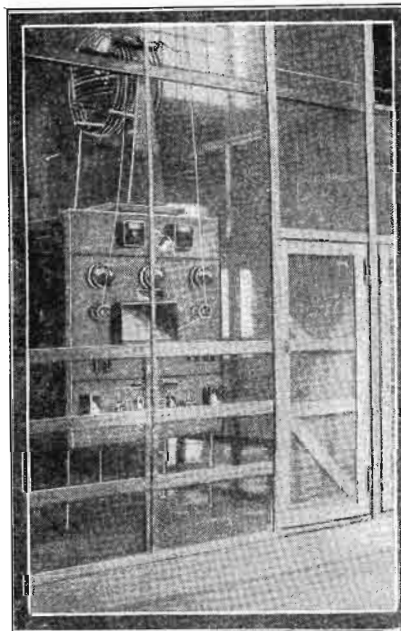

Above: One of the five transmitters; it is perfectly shielded so that there is no interference from the other transmitters in the room. Right: Some of the apparatus located inside one of the cages, showing the transmitting tubes and tuning apparatus.

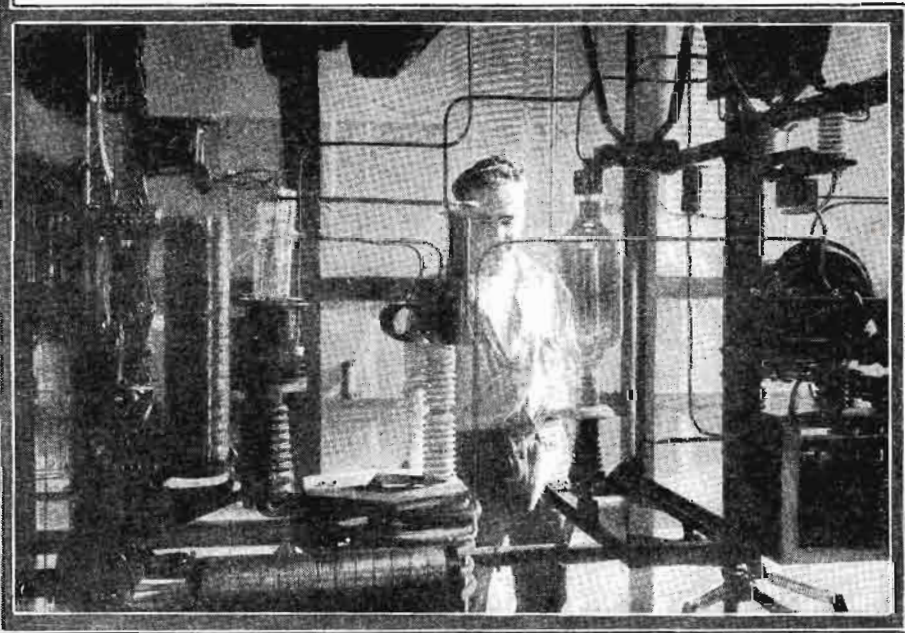

The Ultimate In Single-Control Receivers

By ASHUR VAN A. SOMMERS



It has long been known that it is at times possible to use a bed-spring in lieu of an antenna, but we have never before heard of such goings-on with a bed-spring antenna as are described by this radio fan in this article. Truly, this is an age of wonders, and there is no telling what is likely to happen next!



NO ONE as yet has made out a very convincing case to prove that the trouble-shooter's life is an easy one. I know. I'm a trouble-shooter; which, translated from the dog Latin, means that I'm traveling the zig-zag path to the sanatorium, perhaps to the penitentiary. Can I prove it? Aye, verily. It's merely a case of selecting one of the least aggravating of a long series of daily idiocies. It takes will power to keep from choosing a real, ravening, long-fanged chimera of a case; but nobody would believe me, so I'll hark back to a mild little incident of last week. The truth of this, by the way, is sworn to and subscribed on imposing, embossed le-

gal documents bearing the respective seals of seven be-spectacled notaries. The young lady in question is too modest to have her name broadcast to listening millions. That realization was a great shock to the writer. In one brief half-hour he lost all convictions that such a thing as modesty exists. nay, had ever existed since the first fall of man. When the telephone gurgled urgently last Thursday evening, I extracted my hands from the entrails of an organically-deranged neutrodyne in time to hear the sweetest of sweet voices wait over the wire. The amazing thing was the way the voice was splitting words in the middle in order to insert

more swear-words. The ordinary spaces were not enough. It seems that her Sc\$oe ?&S"¼ ra-%&*dio &&?æ was &#oæ on (to make a long story short) the blink, and that the first thing she knew she'd have to buy one of these super-%?&-hereto-?&æcæ-dynes. Luckily, my phone is fitted with an automatic break-in system, so after the first ten minutes I was able to inquire what the trouble might be. It seemed that the &%?æ thing wouldn't tune any more, that it would do nothing but WEAF all afternoon, and that she was *&%\$ tired of this perpetual weafing. So I strapped on my climbing irons, tucked
(Continued on page 1225)

Artists of the Microphone

A Further Discussion of WRNY and Its Development

By CHARLES D. ISAACSON, Program Director WRNY

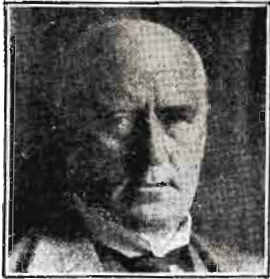

CHARLES DANA GIBSON

Charles Dana Gibson, the prominent illustrator, is the creator of the "Gibson Girl" and publisher of "Life." Mr. Gibson and his associates handle the Humor Department for WRNY.

LEATRICE JOY—you have seen her in the movies, no doubt—fascinating actress of the screen, came to WRNY. It was in the *Motion Picture Review*. We had announced her along with a number of other stars, directors and personages of the screen. When she came in, she said: "I—I—I—really wish you would excuse me, I cannot go on, I am nervous, I have never spoken to an air audience before." There was no doubt about it, no acting, she was frightened beyond words.

Finally, she consented to go into the studio and just look at the microphone, and then she heard her name mentioned and some things about herself, and she spoke. It was a lovely impromptu speech she made, one of the most felicitous I have heard in many a day. When she was through she jumped with joy, she had done it, she had made her first spoken appearance!

Now she cannot wait until she goes on again. One of her friends said: "But how do we know that anyone is hearing it?"

Then I remembered Election Night here at WRNY. We had been on the air from noontime until 7 o'clock, when we started to broadcast the election returns in the midst of a program of light opera music and many other features. We had loud speakers in every big reception room. Members of our staff were handling other returns from the telegraph lines. At 11 o'clock, the "Up and Down Broadway" feature began, and members of the cast of "Dearest Enemy" were heard, and authors, composers, members of the orchestra, chorus; and big hits from the show were put on the air.

At midnight we had permission to broadcast the first Indoor Golf Tournament direct from the Roosevelt. The biggest golf champs were to be there. Then we discovered that every available line that could be used for broadcasting from the Hendrik Hudson room where the tournament was to take place, was in use. What could be done? Last minute arrangements brought about this condition:

William S. Lynch, who is the popular music and sports editor of the station, placed himself in the Hendrik Hudson room at the telephone. At his side was Miss Hazel Crakow, with Sarazen, McFarlane, and others,

Head of the New York State Knights of Columbus, including one-fifth of the total membership of the Knights of Columbus of America, Mr. Daniel Tobin, directs the Catholic Circle at WRNY.



DANIEL TOBIN

A most interesting singer, Rose Laurent, is known as the "American Songstress." She sings at WRNY the works of the American composers. Her voice has been called perfect for radio.



ROSE LAURENT

Now she cannot wait until she goes on again. One of her friends said: "But how do we know that anyone is hearing it?"

Then I remembered Election Night here at WRNY. We had been on the air from noontime until 7 o'clock, when we started to broadcast the election returns in the midst of a program of light opera music and many other features. We had loud speakers in every big reception room. Members of our staff were handling other returns from the telegraph lines. At 11 o'clock, the "Up and Down Broadway" feature began, and members of the cast of "Dearest Enemy" were heard, and authors, composers, members of the orchestra, chorus; and big hits from the show were put on the air.

At midnight we had permission to broadcast the first Indoor Golf Tournament direct from the Roosevelt. The biggest golf champs were to be there. Then we discovered that every available line that could be used for broadcasting from the Hendrik Hudson room where the tournament was to take place, was in use. What could be done? Last minute arrangements brought about this condition:

William S. Lynch, who is the popular music and sports editor of the station, placed himself in the Hendrik Hudson room at the telephone. At his side was Miss Hazel Crakow, with Sarazen, McFarlane, and others,



MRS. EDGAR CECIL MELLEDGE

The director of the Women's Club Hour, Mrs. Edgar Cecil Melledge, prominent leader of women, heads the weekly symposium each Tuesday morning at 11.00 from WRNY.



IRWIN KURTZ

Heading the Talking Machine and Radio Men, Inc., Irwin Kurtz directs one of the most popular features at WRNY, and will bring stars of the leading phonograph companies to WRNY.

"Hello Jane," he says, and "Hello Phil," she answers, and then the two proceed with popular and concert numbers. Lillian Gordon and Phil Elliott are "Jane and Phil."

Eugene Frey is the "Lieder Singer." He will present the works of the immortal Germans in lieder songs: music of Schumann, Brahms, Schubert, etc. His period at WRNY will be a fortnightly adventure.

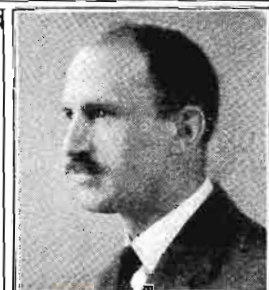

EUGENE FREY

Star of the Radio Art Players, who produce the dramatic classics of the past for WRNY audiences. Shakespeare and Moliere will appear in their program, as well as Rostand, Wilde, Barrie and Shaw.



MADELAINE HUNT



DR. SIGMUND SPAETH

Dr. Spaeth is author of the "Common Sense of Music," and the popular "Barber Shop Ballads." His hour at WRNY is a fortnightly feature.



THE SADRIAN TRIO

The Misses Phillips and Miss Berley comprise the Sadrian Trio, which has been reviving the delights of the old-time musical comedies for those who remember them with a feeling akin to affection. In this repertoire has been comprised music of Gilbert and Sullivan, De Koven, Straus, Offenbach, Sousa, Victor Herbert and many others. The Sadrian Trio comes from Boston, and have had many club engagements.

Ilonka and her kiddie dancers. Ilonka joins WRNY and will be heard every other week in actual dance demonstrations. Sensitive boards and other apparatus will enable the

audience to hear and visualize the movements. Ilonka's full name is Ilonka Sheer. She is the youngest dance mistress, and the creator of all the dances which her pupils use. Ilonka will be starred in a Broadway production this season.

ordering them around as though they were amateurs. I put the microphone at my desk and as Lynchie telephoned up the reports, I repeated them into the microphone, and added such comments about the election, the station, and related and unrelated matters as I could summon to my tongue. There were moments when Lynchie was gathering information, and while waiting during one of these intervals for reports, I decided to find out if anyone was actually listening. On my desk are several telephones—Vanderbilt 7360, Vanderbilt 8662, Vanderbilt 9200 and Vanderbilt 10218. I spoke into the microphone and asked the listeners to let me know by any of these numbers if they liked what we were doing, or not.

The words were scarcely out of my mouth when the phone began to ring, so that the persons calling in could get a response from their telephone as well as their loud speaker. I would sandwich Lynchie's comments into the broadcasting along with all the calls from New York, Brooklyn, Long Island, New Jersey and Connecticut. I think this had gone on for about 15 minutes when the telephone supervisor, in great excitement, said: "Please, please, please beg the people to stop calling these lines. Every single office in New York and Brooklyn is clogged with hundreds of calls waiting for you. We

(Continued on page 1182)

Tom Hill is the president of the American Society for the Promotion of Aviation, Inc., and brings all of the eminent aviators to WRNY to inform the public on this vital subject of interest to every American.



TOM HILL



Dr. Christian F. Reisner: Pastor of the Chelsea Methodist-Episcopal Church, and pastor-to-be of the new skyscraper temple, appears regularly at WRNY on Sundays.

DR. CHRISTIAN F. REISNER

Patrick Pierce directs Roger Wolfe Kahn's orchestra at WRNY. It is a fine ensemble of eight gifted young musicians. Occasionally Mr. Kahn takes part himself and he can play any instrument.



PATRICK PIERCE

Eminent Consulting Neurologist on the staff of leading hospitals of Manhattan and Brooklyn, Dr. Siegfried Block speaks on mental and health matters from WRNY.



DR. SIEGFRIED BLOCK



Samuel Polonsky: A pupil of Alexander Block, and later of Leopold Auer. He is now dividing his time between his concert work and teaching. He plays popular concert classics at WRNY.

SAMUEL POLONSKY

Hetty Fithian Cattell: You know her as "The Birthday Lady." Every night she appears at WRNY in the feature "Whose Birthday Today?" Her talks bring out the mystic astrological and numerological meaning of the day. Has she read your name as yet?



HETTY FITHIAN CATTELL

Ralph Christman: Asst. Musical Director at WRNY, and a capable official accompanist. He reads any music at sight.



RALPH CHRISTMAN



↑ Gilbert Moss, the wireless operator, is sailing around the world in the "Elizabeth & Blanche," a lifeboat of twelve tons, to demonstrate the necessity for ships' boats in case of wreck. He will keep in touch with the world and notify the marine stations in case of any mishap. Four hardy seamen will man the craft. © Henry Miller Service

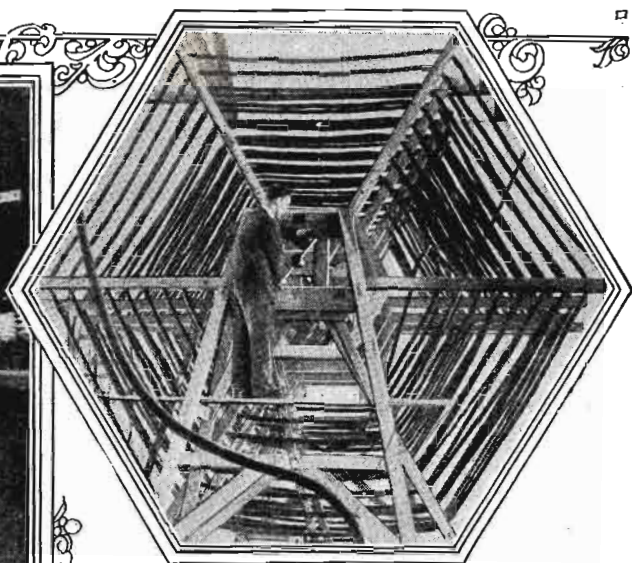

↑ Here is shown one of the enormous inductance coils used in some of the latest high-powered radio transmitting stations. The huge inductances used at Konigswusterhausen, Germany, are similar to the one shown.



It is possible to radiophone from the S. S. Berlin just as we telephone in the ordinary way on land. Below is a view of some of the apparatus used in this installation, and the photo on the right shows a passenger radiophoning. The telephone transmitter is located in a regular 'phone booth.

← A passenger in the radio phone booth on board the S. S. Berlin communicating with a ship several hundred miles away and talking just as though he was in an ordinary telephone booth on land.

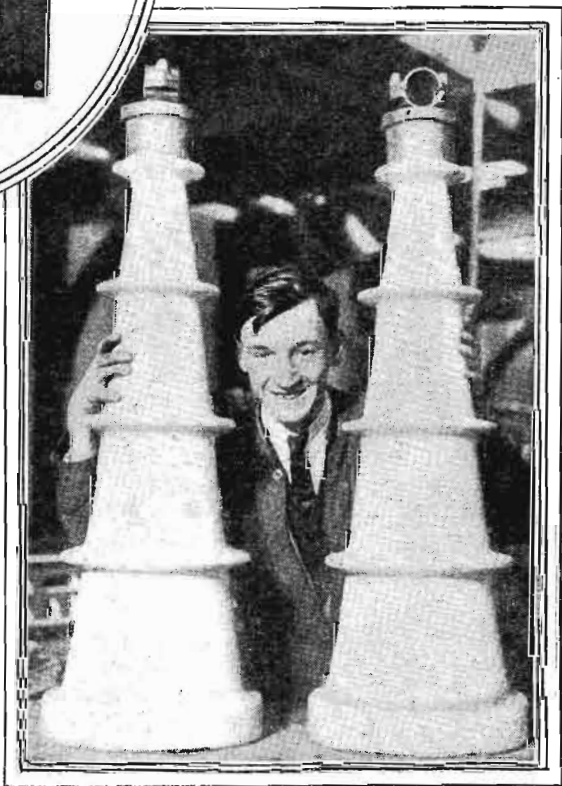
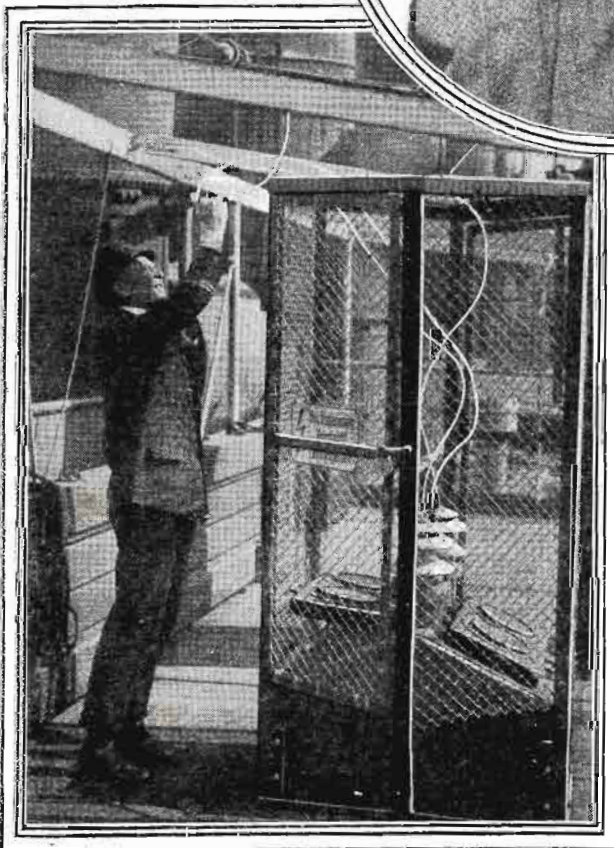

↑ Here are two of the enormous stand-off insulators used in the very high-powered and high-voltage radio transmitting installations. Note the comparative size with the man standing between them.



↑ LISTENING TO THE SOS FROM THE STEAMER LENAPE. The operators of WRNY were on the job when the distress signal came in from the steamer Lenape. The photograph shows Chief Operator Gilson V. Willetts (rear) and Assistant Operator Bayley. Mr. Willetts was radio operator on the Lenape for a year before the war. The photo was taken at 2:02 A. M., when Willetts and Bayley were copying a message stating that the Lenape had anchored inside the Delaware Breakwater.

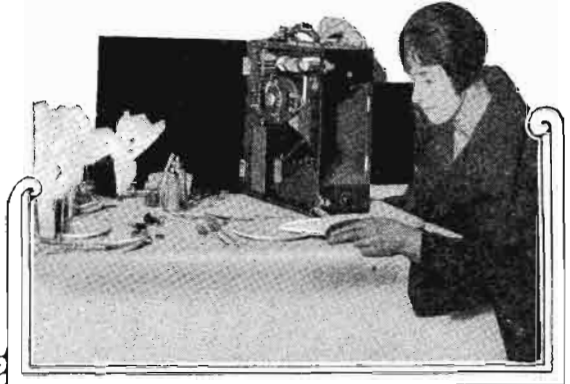

↑ Radio with meals is furnished by English restaurateurs. The picture shows an English maiden listening in to a loud speaker portable set while having her lunch in a London cafe. There is no aerial, earth or accumulators. © Henry Miller Service.

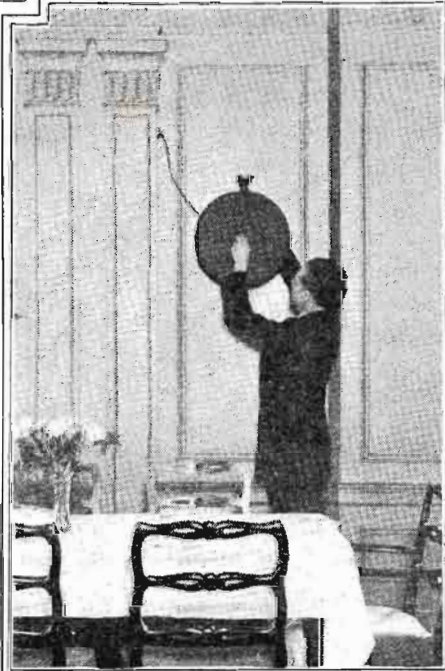

↑ One of the most interesting amateur radio stations extant is 2AGW, maintained by students of Brooklyn (N. Y.) Technical High School. Using but five watts of power and operating on 40 meters, it has been heard in every state of the Union. Note its construction—"spread all over the lot" on boards—which was compelled by the very limited space that it had to be built into. It is a real "hole-in-the-wall" station, but lack of space has not lessened its efficiency to any degree. Howard Wolf, a student of Brooklyn Technical High School, is shown at the board of 2AGW. © Kadel & Herbert.

With the installation of elaborate receiving and amplifying equipment, the Cornell Club in New York takes the lead in introducing the "new science" into club life. The Cornell Club's receiver is a super-heterodyne, and a powerful four-tube amplifier intensifies the energy which is received and sends it through to the loud speakers on the panelled walls of the various rooms of the clubhouse. A public address system is also installed—microphones pick up the speeches, which are carried to all parts of the club through the loud speakers, one of which is shown being set up in the dining room of the club. ©Kadel & Herbert.

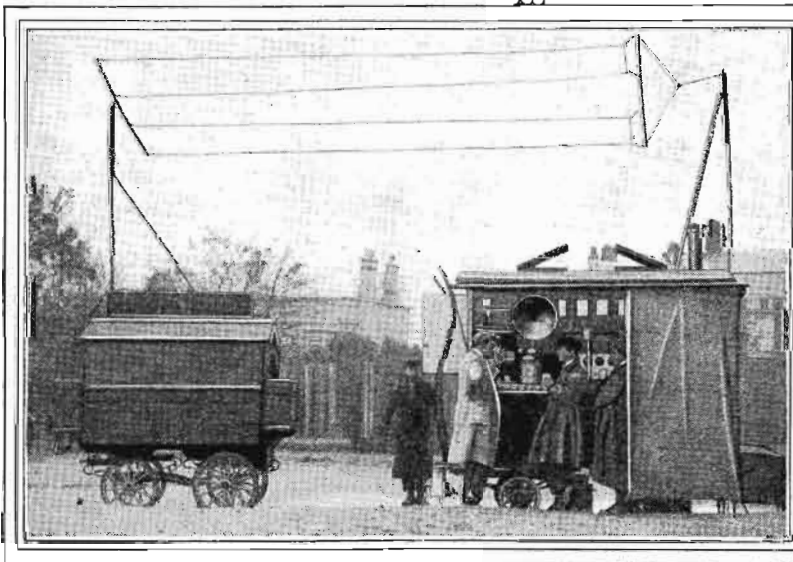

↑ A TRAVELLING RADIO TRANSMITTER. The portable radio transmitting station shown in the photograph is in use by the American Telephone and Telegraph Co. for making tests of various kinds. The trailer on the left houses the generator and associated apparatus, and the one on the right contains the control apparatus of the transmitter and a radio receiver. This equipment is used for short-wave transmission, as can be judged from the shortness of the antenna strung between the two wagons.



More About Radio Waves

By JOSEPH RILEY

In this article we have a continuation of the series of studies being conducted by Mr. Riley on the Propagation of Radio Waves. The first article of the series appeared in the January issue of RADIO NEWS. These articles will be found very instructing and interesting, and will enable the reader to co-ordinate all the ideas he has had heretofore on the subject.

IN THE last issue of RADIO NEWS I attempted to explain, by means of various analogies and diagrams, how the radio wave, on being emitted from a vertical grounded antenna, goes through various contortions and is propagated from the antenna through space. No attempt was made to enlighten the reader as to how or why the magnetic field is brought into existence, so, before going further into the discussion of how the waves act, it will be well to explain this.

DISTRIBUTION OF THE CHARGE

In Fig. 1 there is shown a portion of a vertical antenna wire. The portion shown is supposed to be so short that the density of the electric charge on it is uniform from one end of the portion to the other. The charge is not actually distributed uniformly, but varies continuously from one point to the other. However, if we take a short enough portion, we can say, without sensible error, that the charge is distributed uniformly over it.

At a certain instant, therefore, when the charge on this portion of the antenna wire has a certain value, the field strength around the wire has a certain value. The field may be represented by a number of lines stretching radially from the wire. It must be remembered that the lines of force always emanate from a charged surface in a direction at right angles to the surface. At a distance from the conductor, however, the lines may change their direction, due to many things, as is seen in the distribution of the electrostatic field about a grounded vertical antenna at some distance from the latter.

Now to return to Fig. 1. At the point A in this short portion of the antenna is a small electric charge, an electron, say. A line of electric force represented by AC emanates from this electron. The electron is one of many, the flow of which in the wire constitutes the electric current in the antenna. This current is oscillating at a very high rate, so that the electrons also oscillate up and down in the wire, over distances equal to their mean free path during the period of a half-cycle. Now suppose that during an extremely short interval of time the electron moves from the point A to the point B, in Fig. 1. It carries along with it the end of the line of force, and because these lines of force possess something akin to inertia, they tend to lag behind the electron. The line of force then assumes the shape indicated by BC, Fig. 1. This represents an interval of time equal to one-quarter of a cycle.

Now, during the second quarter-cycle the electron in the antenna returns to the point A, all the time carrying the end of the line of force with it. At the same time, the kink

produced in the line travels outward from the antenna, much as a kink in a whip is carried away from the handle as the whip is cracked. The line of force then takes the form shown in Fig. 2. As the electron travels further, at the end of the third quarter of the cycle the line has the form shown in Fig. 3, and at the end of the cycle, the form of Fig. 4.

The amplitude of the kink in the line, or, the distance it is from the original line AC, at any instant, decreases as the distance from the antenna is increased. This decrease in the amplitude of the kinks accounts for the major part of the decrease of signal strength

from the antenna. The original line is AB EF. The kinked line is ABCDEF. The directions of the lines are indicated by the arrows. Now the movement of the line from the position Bh to the position Cg can be considered to be produced by the creation of a closed line of electric strain of equal strength represented by the dotted rectangle drawn in Fig. 5. If such a closed line were created the lower part would oppose, or destroy, the line Bh, and the upper part would create the line Cg. We may regard the effect created by this closed line of electric strain to be similar to the effect of an electric current traveling in a circular turn of wire. It

would set up magnetic lines of force, and the direction of these lines could be determined by the usual right hand rule. In the present case, therefore, represented by Fig. 5, the magnetic lines of force would come up to the reader, out of the paper, on the left side of the antenna wire, and down into the paper on the right-hand side.

A magnetic field will thus be created about the wire; the lines of force will be circular about the antenna in planes perpendicular to its axis, in other words, parallel to the earth, since we are considering a perpendicular antenna. The electric and magnetic fields were shown clearly in the diagrams in

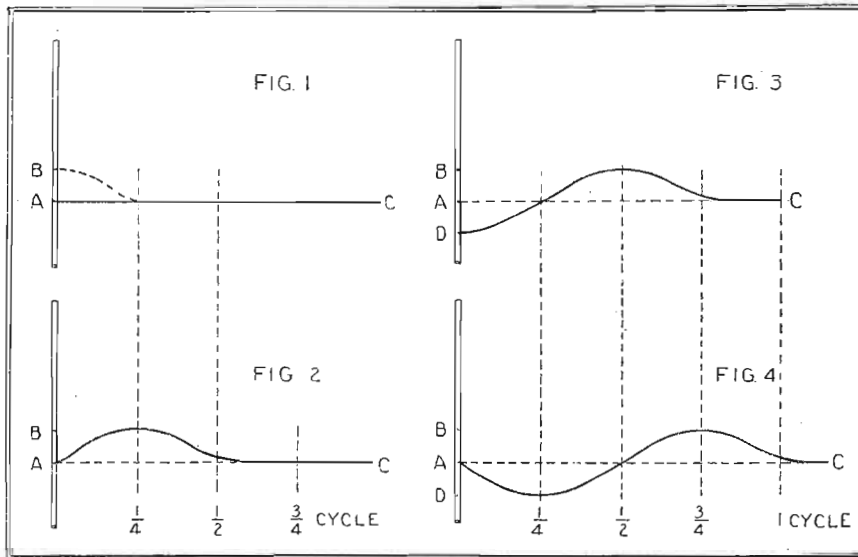

As the electron oscillates up and down in the antenna wire, a kink is formed in the line of electric force, which travels outward from the wire. The complete phenomenon is shown in four stages, of a quarter-cycle each.

as the distance from the antenna is increased. The reason for this will be better understood as we proceed.

HOW THE ELECTRIC CURRENT IS DISTRIBUTED

The next thing to explain is why this change in the shape of the electric line of force acts like an electric current in space and produces the magnetic field which always accompanies it. For the sake of simplicity let us suppose that the kink, instead of having the sinusoidal wave form shown in Fig. 4, has a rectangular form, as shown in Fig. 5. The line is continued on both sides of the antenna wire, for it must be understood that the lines emanate radially in all directions

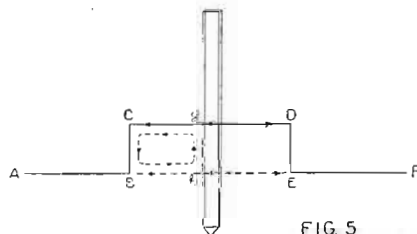

FIG. 5

The displacement of a line of force has the same effect as if a closed line of electric displacement were brought into existence. The portion Bh is nullified and the portion Cg is formed by this hypothetical closed loop.

my article in the preceding issue of RADIO NEWS.

The energy radiated in this manner from an antenna is thus transferred periodically back and forth between the electric and magnetic fields. The total energy is at one instant in the form of magnetic energy and the next instant in the form of electric energy.

The explanation given above, by means of the closed line of electric strain, has been given by Dr. J. A. Fleming, and follows from a principle of Maxwell's. The strength of the magnetic field created by the movement of the lines of electric force depends upon the displacement of these lines, and it therefore follows that the displacement must decrease as the distance from the antenna wire increases. To tell the truth, this should be stated the other way round, but for our purpose we may think of it this way.

In our previous explanations we have considered the antenna system to be a straight rod, having the source of high frequency current at its middle. The opposite halves of this rod are at any instant charged to an opposite polarity, so that the lines of electric strain start on one part, say the upper, and terminate on the other, say the lower. As the electrons oscillate back and forth, kinks are produced in the lines which travel outward from the antenna, which, due to the

ertia of the lines, unite into loops of electric force, which are detached from the antenna. When a ground is used, with the source of high frequency current near the ground, the ground being considered a fairly good conductor, these loops must be semi-loops starting at the electrons in the wire, and ending with their feet resting on the earth. As each loop is formed it pushes the preceding ones outward, so that the whole field may be represented, as in Fig. 6.

DR. FLEMING'S EXPLANATION

A very interesting picture of the whole thing is given by Dr. Fleming in the following:

"If we can imagine a being endowed with a kind of vision enabling him to see the lines of electric strain and magnetic flux in space, he, standing at any spot on the earth's surface, would see, when the radiator was in action, bunches or groups of lines of electric strain fly past. Near the earth's surface these strain lines would be vertical. Alternate groups of lines of strain would be oppositely directed, and the spectator would also see groups of lines of magnetic flux fly past, directed in a horizontal direction, or parallel to the earth's surface. The strain and flux lines would move with the velocity of light, and the distance between two suc-

After detaching themselves from the antenna, the lines of electric displacement become semi-loops with their feet on the ground.

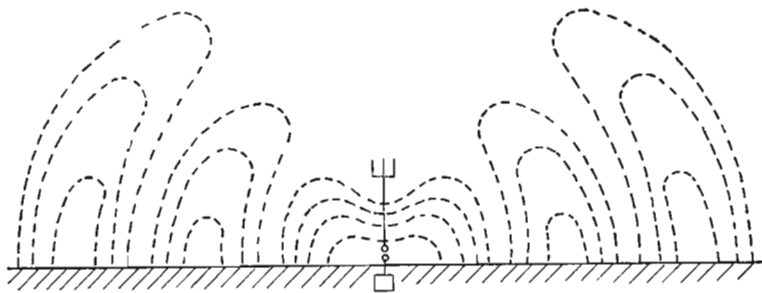

FIG. 6

cessive maxima of electric strain directed in the same direction would be the wavelength of the wave."

This is a very graphic illustration, which our artist has endeavored to portray in the drawings on this page. All of the discussions in this article and the one preceding supposed a perfectly conducting earth. The effects that occur when the earth has considerable resistivity will be discussed in the next article.

What happens when an antenna is made to radiate at a frequency or wave-length other than its fundamental, is very interesting. The radiation field assumes a complicated form. In particular, there are two sets of loops of electric strain brought into existence. One of these sets is similar to the preceding case where the antenna was oscillating at its fundamental. If it is made to radiate oscillations which have a frequency equal to twice the fundamental frequency (i. e., the first harmonic), we have the condition shown in Fig. 7. The radiated electric field consists of semi-loops terminating on the earth, which follow the curvature of the earth, and groups of closed loops which are shot off in an oblique direction away from the earth. This high angle radiation may account for some of the effects that have been lately noticed, especially in

connection with short-wave transmission.

A FIELD FOR EXPERIMENTS

It might be possible, when transmitting from an antenna at a frequency higher than its natural frequency, to reflect the high angle radiation so that it either reinforces or opposes the normal radiation. The reflection may be due to the Heaviside layer. Here is a fertile field for experimentation in the short-wave region. If waves sufficiently short were used, as for instance, waves of about 1 or 2 meters in length, it would be an easy matter to construct an antenna longer than the wave-length of the oscillator. In other words, make the antenna or radiator equal in length to twice the wave-length. It will then be radiating a wave, the frequency of which will be twice its natural frequency. There will then be a normal and a high-angle radiation. It should be possible to reflect the latter so as to reinforce or oppose the former by means of suitable reflecting screens. The main thing in the problem would be to get the wave-length short enough to enable us to build an antenna and reflecting system which would not be too large.

In the next article of this series we shall consider the effects of the earth on the propagation of the radio waves. It must not be forgotten that, so far, we have assumed a perfectly conducting earth.

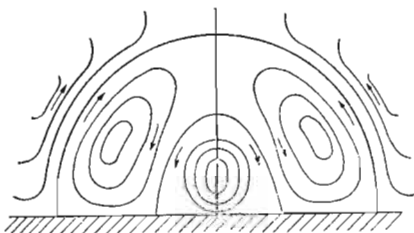

FIG. 7

From an antenna radiating at twice its natural frequency, loops of electric force are shot off at an angle from the earth, and semi-loops are propagated parallel to the earth.

The Mysteries of the Wire Tables

By HERNDON GREEN

Despite the fact that the wire tables are being used thousands of times a year by thousands of persons, there are few of them who regard the tables as anything other than a mere unsystematic collection of numbers. To tell the truth, even the wire tables are prepared in a systematic and scientific manner, as those who read this article will readily understand.

THERE is, perhaps, no table that is used so often, in electricity in general, or in radio design, as the table of wire constants, and it is interesting to note how little is generally known about the wire tables. We shall, therefore, endeavor to point out some interesting things about the tables on this and succeeding pages.

In the first place, the numbers assigned to wires of various diameters have not been assigned haphazardly. The relation between the gauge number and the diameter of the wire in inches is given by the formula

$$d = \frac{.3243}{(1.123)^n}$$

The graph of this equation is shown in Fig. 1. Why or how the formula given above is developed, this writer does not know, but these are the facts.

In this formula, d is the wire diameter, and n is the gauge number. (For the large sizes of wire, let 0000 = -3, 000 = -2, 00 = -1, 0 = 0.)

The other things which I am going to point out happen to be coincidences. Look at the table which gives the diameters corresponding to the various gauge numbers. Take No. 10, for instance. The diameter of No. 10 is 101.9 mils (a mil is equal to 1/1000 of an inch). This is roughly 100 mils (or .1 inch). Now count up three

places in the column. We find that the diameter of No. 7 is 144.3 mils. This is roughly 1.4 times the diameter of No. 10 wire. Now count down three places from No. 10. The diameter of No. 13 is 71.96 mils, which is the diameter of No. 10 divided by 1.4. The value 1.4 happens to be

the square root of 2. Therefore, in the table of wire diameters, as we go down the list, the diameter corresponding to every third gauge number is obtained by dividing by 1.4 or the square root of 2. So far so good!

Now look at the diameter of No. 10 wire (Continued on page 1215)

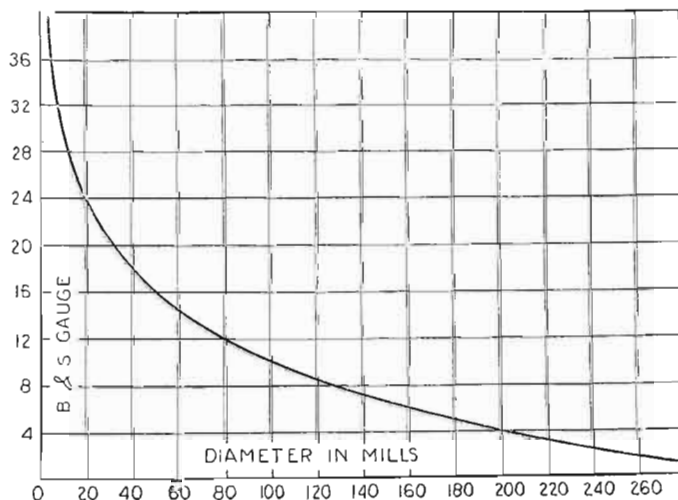

This smooth curve proves that there was a method in the madness of the man who got up the wire tables. The gauge numbers and wire diameters follow a very definite rule, represented by this curve, and the formula in the first column on the left.

Calibrating Receivers with Crystals

By J. LOUIS REYNOLDS*

The versatility of the quartz crystal is manifesting itself in nearly all phases of radio. Here we have the crystal being used in connection with the calibration of radio receivers in a large factory. The arrangement used is very ingenious and simple. In the future there will be little, if any, guess work in building radio receivers for the use of the general public.



A FEW years ago the "oscillating crystal" was a mythical piece of radio apparatus, mentioned by radio men only in a jocular fashion. The mere term was considered a synonym for "impossible," and was used in discussions to express scepticism of a projected radio set or instrument. Time has changed this attitude considerably, for now the oscillating crystal is a very tangible and efficient piece of apparatus which is doing respectable service in many important radio broadcast installations and which is also finding employment in other fields of activity.

ADVANTAGE OF CRYSTAL OSCILLATOR

The particular advantage of the crystal oscillator lies in its absolute constancy of frequency. This characteristic is applied to advantage in the close control of short-wave broadcast transmitters, in which the slightest shift in wave-length means a swinging signal at the receiving end, and has also been applied now for the accurate testing and calibration of receiving sets. The system, decidedly unique in many respects, is not at all complicated, and can be duplicated on a smaller scale than outlined here for purposes of amateur experimenting.

Briefly, the system is an arrangement employing two units, consisting of four tubes and one oscillating crystal piece, the entire assembly furnishing four separate and distinct frequencies, which are fed to one common aerial feed wire and which can be tapped off that wire all at once, without interference, for the purpose of testing as many as a dozen receivers at one time. The scheme suggests other possibilities, such as duplex transmission for actual radio service, and at any event will provide the radio enthusiast with many opportunities for interesting experimentation.

The system has been in constant operation, at the time of this writing, for almost two months, at the rate of 24 hours a day. In all that time neither the frequency of the oscillations nor their amplitude has varied to any perceptible degree.

The accompanying photographs and diagrams give a comprehensive idea of the affair. A detailed description follows:

The entire oscillator apparatus is housed in a large steel filing cabinet, which serves

very conveniently as a complete shield. When the doors are closed the only thing visible is a single shielded wire, which is the laboratory "aerial." There is no direct ground connection, the capacity of the installation to earth being sufficient to "float" the system.

As can be seen from the illustration, there are five shelves. The first and third support the two oscillator units, which are identical except for electrical constants. The second shelf holds the interference-preventing traps, the fourth an audio oscillator, and the fifth the "A" and "B" batteries. The crystals, spring-suspended to prevent mechanical jarring, are plainly visible in the upper left-hand sections of the instrument panel.

THE DIAGRAM EXPLAINED

A complete hook-up of one of the units is given. At first sight this appears to be extremely complex, but upon close examination it will prove to be readily understandable. There are four tubes, all UV-201As, which are respectively designated as T1, T2, T3 and T4. T1 is the actual oscillator and T2 is the modulator, which modulates

the radio frequency output so as to produce a signal of the broadcast type; T3 amplifies the fundamental frequency as determined by the inductance and capacity elements of T1, while T4 amplifies the first harmonic of that frequency. The one crystal thus supplies two frequencies at the same time. This particular unit is designed for a fundamental of 550 meters, so the harmonic is 275. The other unit is set for 400 meters and, consequently, 200 also.

Following through the diagram from left to right, we have at the extreme end the crystal itself. This is bridged across the grid circuit of T1, which is made to oscillate by the tuned plate scheme; the frequency is determined by the setting of the condenser C2, and is kept absolutely constant by the crystal. L2 is a simple straight solenoid of ordinary broadcast dimensions, and C2 is a .00035 mfd. variable condenser. Coil L5 in the grid circuit (and the L5 coils on the extreme right) is a radio frequency choke consisting of 2,000 turns of No. 38 enameled wire, wound in 20 sections of 100 turns each on a hard rubber tube 3 inches long and 5/8 inch in diameter. Each section is placed in a groove in the tube 1/8 of an inch deep, the idea of the separate sections being to reduce the inherent self-capacity of the coil.

T2 is the modulator tube, whose grid circuit is actuated by a 1-K.C. note generated by a simple audio oscillator, shown under the crystal in the diagram. The .5 mfd. fixed condenser passes the R.F. output of the oscillator tube to the modulator T2, the output of the latter being in turn coupled to the amplifiers T3 and T4 by means of the couplers LC1 and LC2. LC1 consists of a hard rubber tube 2 inches in diameter and 3 inches long, wound with a 100-turn secondary in two sections of 50 turns each, a 10-turn primary being wound directly between them. LC2 is identical, but for a 60-turn

Here is the complete assembly of crystal oscillator, modulating system, and master oscillators. The author is shown in front of the panels making the necessary adjustments. Note the compact arrangement of the panels, behind which is housed the multiplicity of apparatus indicated in the diagram on the following page.

Every receiver is given a thorough calibration test before it leaves the factory. Here is shown one of the stock receivers going through its paces. The system is so arranged that there is little for the operator to manipulate, and consequently the human equation has little effect upon the accuracy of the calibration.

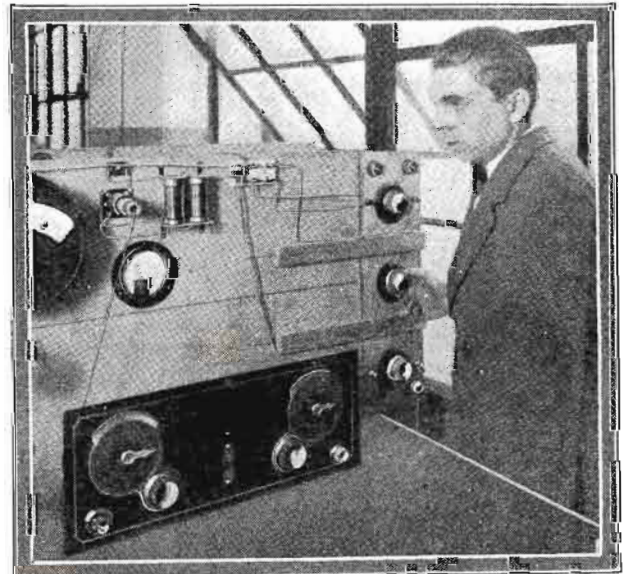

* Chief Engineer, Sleeper Radio Corporation.

secondary. The joints between the secondary sections serve as center taps for the windings. Condensers C3 and C4 are straight .00035 mfd. variables, while condensers C5 are small balancing condensers of 40 mfd. maximum. The latter, in conjunction with the split secondaries, serve to neutralize the amplifiers completely, an action which is necessary to prevent interference between T3 and T4. The coils L5 are regular R.F. chokes, and serve to prevent short-circuit of the various radio frequency currents through the agency of the common "B" battery.

T3 amplifies the fundamental frequency and T4 the harmonic. As T3 will also amplify the harmonic when tuned to the fundamental, a tuned trap, L6-C6, is provided in the plate circuit of the tube, and this effectively suppresses any harmonic amplification in T3 as far as the output is concerned. L6 is a straight 60-turn, 2-inch coil, and C6 is a .00035 mfd. variable condenser.

This unit is the 550-275-meter one. The 400-200-meter one is just like it, except for the differences in condenser adjustments.

The two amplified outputs of T3 and T4 are connected directly to one wire, as are the 400-200-meter outputs from their respective amplifiers. These wires then run into a trap system which keeps all frequencies in a single antenna wire which feeds the receiving set under test, and which also keeps them out of each other. The traps are simple, comprising inductance and capacity units adjusted to the wave-length figures indicated. Only three waves, 400, 275 and 550 meters, are employed in the system pictured, so the 200-meter trap shown in the hook-up is not actually used. The three condenser dials of this trap unit are shown on the second shelf in the photograph. The 200-meter channel can be used any time it is desired.

The series traps need little explanation, being much like receiving wave traps. The

400-meter circuit chokes out the 400-meter wave from the 400-meter oscillator (not pictured), thereby keeping it out of the 550-275 unit, while the 550- and 275-meter circuits perform a corresponding function for the benefit of the 400-meter oscillator.

As mentioned, a single "aerial" wire is the only external connection of the whole apparatus. This is tapped at the various test tables where receiving sets are being examined, each table being equipped with a separate trap system of its own. These are shown diagrammatically, and need little explanation. Each circuit contains a straight coil and condenser tuned to one of the three frequencies tapped from the common antenna feed wire. The variable resistances provide over-all control of the input. The fixed condenser "C" and the resistance "R" simulate actual antenna conditions, "C" being about .0025 mfd. and "R" about 15 ohms.

OPPORTUNITY FOR EXPERIMENTATION

The system as a whole is an interesting one to work with, as it provides a definite amount of energy at the aerial and ground posts of a receiving set, which energy in turn actuates the set to some established standard. Direct comparative readings are obtained from a vacuum tube voltmeter, so there is a real basis for set comparisons. If it is known that a set in perfect condition gives a certain meter reading, then any set not approaching this figure can be rejected as inferior in one respect or another. The tester's ear is not involved in the process at all, and as audibility tests judged by ear are of doubtful value, the accuracy of this system can be appreciated.

One very important point about the whole arrangement is that it causes no interference in neighboring receivers, as both the oscillator and the "aerial" wire are completely shielded.

The writer has not attempted to discuss any of the theories of operation concerned in this oscillator system. He has described

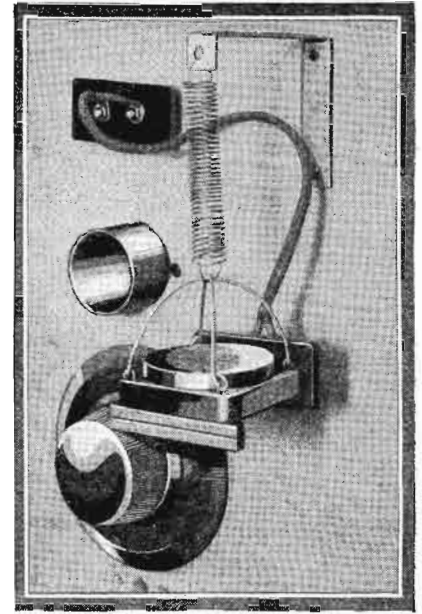

A close-up view of the crystal. It is hung on springs in order to obviate errors which might arise from vibration of the building, panels, etc.

only his own adventures with the crystal in one interesting and hitherto untouched branch of their application, and he hopes the readers of RADIO NEWS will find some material for experiment in the article.

[For the interest of our readers, it may be well to note that on page 952 of the preceding issue (January) of Radio News there was a very interesting article on the crystal oscillator. The present article, together with the previous one, will give the reader a very good idea of the importance of the crystal oscillator, and some of its many uses in radio work.—EDITOR.]

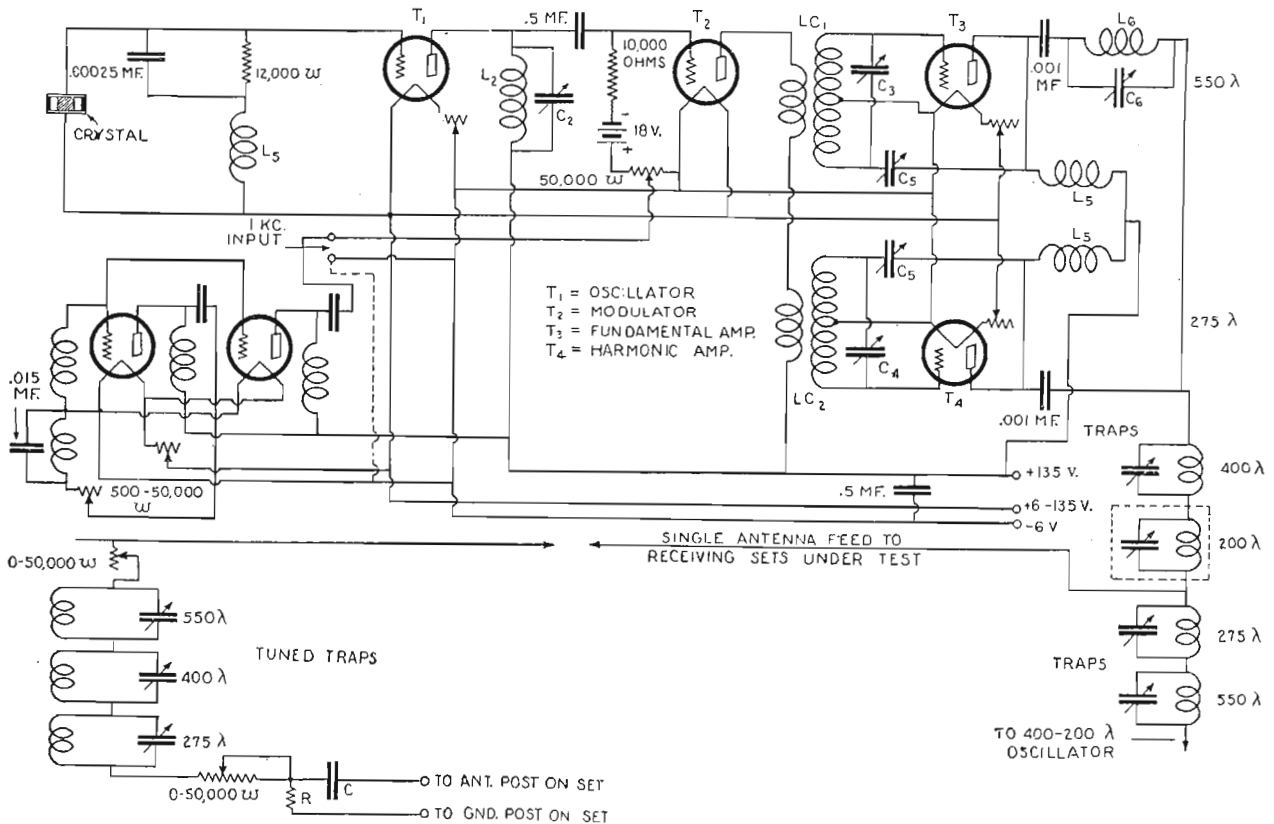

The crystal-controlled oscillator in the upper left corner combines its output with the oscillator directly below it, in the modulator next on its right. At the upper right, one circuit takes care of the fundamental, and the other of the harmonic. The wave-traps below the latter filter out whichever is required for the particular test. To the traps are connected the sets under test. Only one oscillator is shown, for simplicity, although there are two systems in use in the apparatus shown on the opposite page.

New Short-Wave Tube

By JOSEPH RILEY

The enthusiasm of the amateurs for short-wave transmission is waxing great, and to assist them in their researches, one company has developed a transmitting tube especially for short-wave transmission. This tube is built in such a way as to minimize the capacities between the electrodes, and at the same time enable considerable amounts of power to be handled.

THOSE who have followed the advance of short-wave work, as it has been described in RADIO NEWS from time to time, will remember some seven or eight months ago a description of a short-wave high-powered set incorporating a new short-wave tube. In the illustration herewith is shown that tube, now in commercial form, part of the development of which was done in RADIO NEWS laboratories. It has now been brought to final perfection by the DeForest Radio Company and is available to amateurs especially for short-wave work. It will be remembered during the early months of experimentation in short waves no end of trouble was encountered with the adaption of tubes to this particular type of work. Bases were removed, special makes designed, and still parasitic frequencies made themselves evident and much trouble was encountered in making the tubes oscillate. Since that time, however, the advance of this particular branch of the art has given us a more thorough knowledge as to the behavior of the circuit of these high frequencies and has, of course, given us special designs in tubes for these frequencies. When the experiments on five and one meters were decided upon by the editors, it was desired that a tube having a good capacity for power should be employed. At that time there was none on the market. However, a short conference with Mr. Hunter, engineer with the DeForest Radio Company in charge of

the tube designing department, gave rise to the present form. The requirements were first figured out mathematically and submitted to him. He worked out the mechanical design, electrical details and sent two of the tubes to RADIO NEWS, which were later used in the experiment. It is a notable fact that since the first experiments with these tubes, others have been carried on at constantly rising frequencies. The last experiment, some three months ago, found the tube generating a wave-length of less than one meter and putting about 17 watts into the oscillating circuit.

Special care is taken in the manufacture and pumping of tubes used for short-wave work. With this particular tube the final pumping process is carried on with a potential of 1200 volts on the plate so that every possible care is taken to see that the residual gases in the tubes are at an absolute minimum. The filament is of the old type, being of straight tungsten and therefore demanding a rather high consumption current, about 3½ amperes. 750 to 1000 volts may be used on the plate without danger.

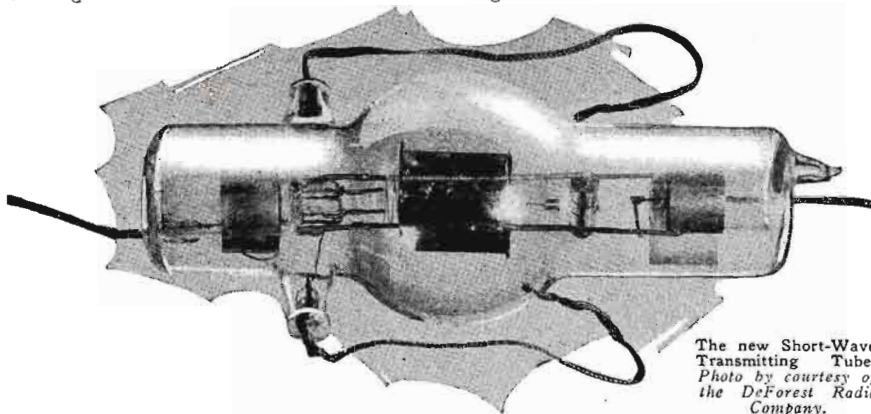

The new Short-Wave Transmitting Tube. Photo by courtesy of the DeForest Radio Company.

Secret Broadcasting—Its Possibilities

By L. KELLEY

There is no necessity of pointing out to our readers the value and advantages of secret broadcasting, were such a thing practically possible, and it may interest them to know what developments have been going on along these lines. Mr. Kelley tells us in this article about some work that has been done on secret broadcasting in Europe.

NOW and then, in his perusal of the various radio publications, the broadcast listener chances upon an article dealing with the problem of financing of his favorite indoor sport. In most cases, Mr. B. C. L. passes by this rapidly, in search of something more to his taste.

That is true in America, where broad-

casting is for every man—if he has the price of a receiver.

Across the Atlantic, our European cousins are confronted with an entirely different proposition. Throughout Great Britain, France, Germany, Russia, Spain and many other countries, millions of eager and interested listeners are paying annually to their respective governments amounts of money

mounting into the millions for the privilege of listening to broadcast programs. This money is collected from the people for licenses to own and operate radio receivers, and part of it goes toward the upkeep of the broadcasting stations; recompense for the artists, etc. Therefore, Mr. B. C. L. is seriously concerned with any changes that will affect his purse-strings.

Lately, in England, there has been some talk about secret broadcasting, and it has caused John Bull to snap to attention—*qui vive!* Now just what is this means of broadcasting messages or programs, that are unintelligible except to a chosen few? In a few words, the transmitting system is so arranged that the message put on the air is mixed, in such a fashion that it can only be deciphered by a special receiving apparatus. Anyone picking up the transmitted message with an ordinary receiver would hear merely a meaningless jargon or noise. And how is this type of broadcasting accomplished?

TWO MODES OF UNSCRAMBLING

There are two classes of systems by which it is possible to transmit messages, so that they may be comprehended by only "the chosen." They are:

(1) Methods which cause a change in the wave-length at certain intervals, and by some form of synchronization from the

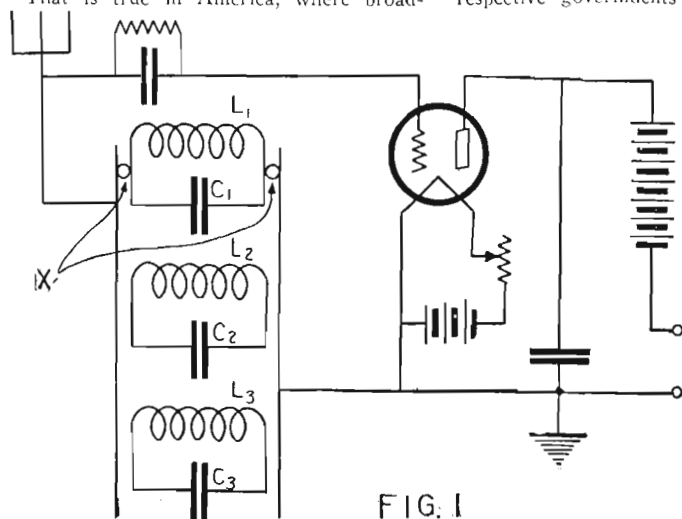

The first method described utilizes a succession of tuned circuits, which are alternately connected into the transmitter circuit at regular intervals of time, changing the wave-length. The diagram shows schematically how it is done: a pair of metal balls roll down an incline together, connecting the three tuned circuits in succession, and this is repeated continually. A similar apparatus, properly synchronized, is needed at each receiver.

FIG. 1

(Continued on page 1198)

Where Radio and Heat Waves Meet

By DONALD H. MENZEL

The electromagnetic theory of light and electric waves was demonstrated mathematically by Maxwell a long time ago, but it has never before been demonstrated experimentally. At least experimenters have never before produced waves short enough to be classed in the same range as the heat or light waves. In this article the production of waves short enough to be included in the heat wave-range is described.



SIXTY years have elapsed since Clerk Maxwell, as the result of an elaborate mathematical analysis, formulated his theory of light which pronounced the idea that the radiations known as light are due to electric oscillations in the ether. At that time the phenomena known as wireless waves were not yet discovered and the demonstration of their existence in 1888 by Hertz was considered a

mentally—producing electrical waves which could be detected by heat-measuring devices—induced further research.

Fig. 2 shows the simple manner in which Hertz produced his waves. The oscillator consists of two similar brass rods terminating at one end in polished brass knobs. At the other ends were fixed metallic plates (P) which acted as condensers. These were fastened as shown to the secondary terminals of the induction coil. The passage of an oscillatory discharge through the gap caused the emission of the electric waves. The more rapid the oscillations, the more frequently the waves are produced and consequently, since the speed of all is the same, the shorter the wave-length. This condition may be brought about by decreasing the size of the oscillator and the condenser plates, for less electricity may then be stored within it. It was by increasing the size of the inductances and capacities that Marconi was enabled to obtain the longer waves he used for wireless telegraphy.

About a year ago, Arkadiew found evidence for the existence of short-wave electric radiation by passing an electric discharge through a paste of metal filings, as shown in Fig. 3. Each small filing acted as an individual oscillator of the Hertzian

framework consists of very fine quartz rod, A, and mica strips, B. E corresponds to the darkened side of the vanes of the radiometer and is usually made of a fine film of platinum. The whole device is suspended from a quartz fibre and placed in an air-tight vessel from which the air is exhausted. Any energy entering through the window of the enclosure and falling upon the blackened surface E will tend to cause a rotation in the direction of the arrow. The amount of rotation was measured by the deflection of

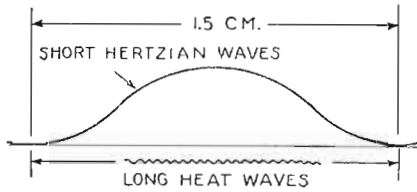

FIG. 1

More than a hundred cycles of the long heat waves may be included in space of time included by one cycle of a short Hertzian wave.

remarkable confirmation of Maxwell's theory, since he proved that they travel with the same speed, and exhibit the same properties of reflection, refraction, and polarization as those of light. They appeared to differ only in wave-length, Hertzian waves varying from 1.0 to 1500 cms., and visual light from 1/25,000 to 1/12,000 of a cm.

In spite of their apparent similarity, an enormous gap existed between the shortest of the wireless waves and the longest of the light waves. An extended investigation by many physicists showed that radiation existed of slightly longer wave-length than visual light—the heat waves of the so-called infra-red region of the spectrum out as far as wave-lengths only a few tenths of a millimeter long.

While there was no real doubt in the minds of all the scientists that the electrical and heat waves were identical, yet the hope of actually joining the two experi-

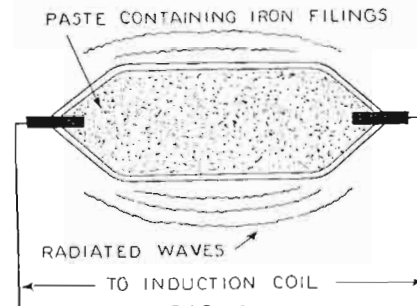

FIG. 3

By passing an electric discharge through a paste of metal filings, Arkadiew, about a year ago, produced electric waves of extremely short wave-length. Each small filing acted as an individual oscillator of extremely small inductance and capacity.

type, generating the energy which was observed.

The problem of the detection of electric waves by the same methods as were used in detecting heat was not easily solved. By an ingenious modification of the device known as Crooke's radiometer, the late Ernest Fox Nichols and J. D. Tear accomplished it in the following manner: The radiometer, often seen in jewelry stores, is pictured as Fig. 4. The four vanes are made from mica, polished on one side and blackened on the other. This is mounted upon an axis so that it will rotate, and then placed in an exhausted glass vessel. When light falls upon it the blackened surfaces become warmer than the polished ones, due to their greater absorptive power. Thus a molecule of the rarefied gas within the enclosure will leave the dark surface with greater energy than the other and, as with a bullet shot from a gun, there is a corresponding "kick" or reaction which causes the vanes to rotate.

THE ADAPTED RADIOMETER

Professor Nichols' adaptation of the above principle is diagrammed in Fig. 5. The

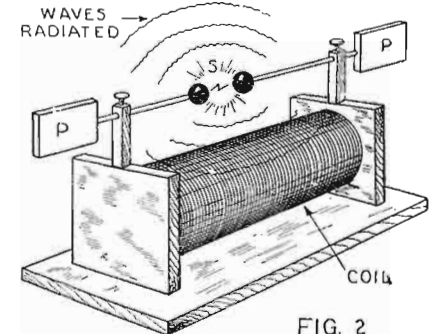

FIG. 2

The original Hertzian waves were produced by an induction coil and spark balls, as pictured here. Waves as short as one centimeter were produced by Hertz.

the beam of light from the scale mirror M. The difficulty of making so small, sensitive and accurate an instrument may be judged from the insert (Fig. 5a) drawn to scale.

NICHOLS' OSCILLATOR

Professor Nichols' oscillator is similar to that shown in Fig. 2 except that it was reduced to the smallest possible size. Fig. 6 shows its construction, except that the parts are quite out of proportion. Two minute pieces of fine tungsten wire, A, only two-tenths of a millimeter long, were sealed into the ends of the glass tubes B, immersed in kerosene oil and so adjusted that the gap between them was not more than a few thousandths of a millimeter. The high potential leads from the induction coil were put into the open ends of tube to within 2 mm. of the tungsten wires.

(Continued on page 1217)

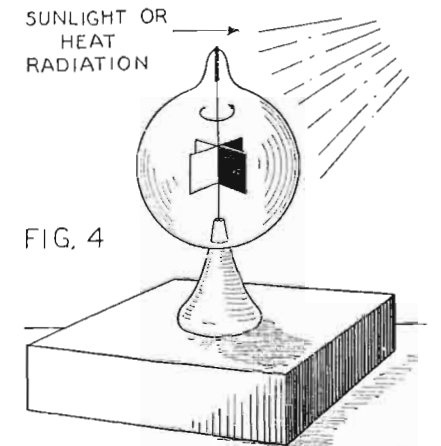
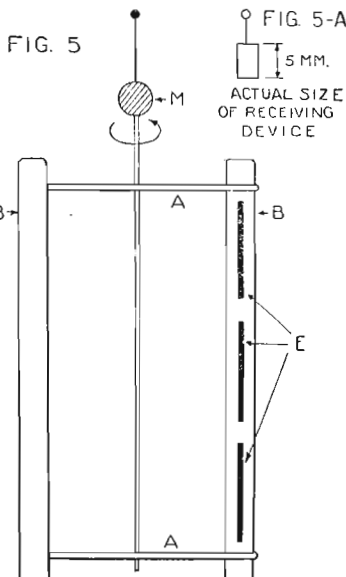

FIG. 4
The light rays from the sun, falling upon the polished sides of the vanes are reflected, and those falling on the dull sides are absorbed, thus causing the radiometer to rotate as indicated by the arrow.



Professor Nichols' adaptation of the radiometer principle. When light waves, or extremely short radio waves fall on the blackened surfaces E, E, E, the whole mechanism rotates about the axis of the quartz-fibre suspension.

Special Cathode-Ray Oscillographs

By CHARLES B. BAZZONI

The general principle of the cathode-ray oscillograph was discussed in our last issue. In this article Dr. Bazzoni discusses some of the practical forms of this instrument, and describes various uses to which it is put in the field of electrical and automotive engineering.

IN OUR last issue we described the *Cathode-Ray Oscillograph*, explaining how a narrow beam of electrons, shooting through a hole in the anode of a discharge tube, may be deflected by an electric or by a magnetic field. The deflections thus produced, being proportional to the electrical or magnetic forces applied, may be used to measure those forces. Since the

used with a tap at the middle of the secondary winding. The condensers C are of .05 μ f. capacity, and the choke coil L has an inductance of about 5 henrys. The current delivered through the tube is direct, very nearly of constant value, and under about 10,000 volts pressure. The power which can be drawn is, of course, limited by the size of the kenotron tubes, K_1 and K_2 .

These tubes are two electrode devices having a hot filament and, therefore, of unilateral conductance, exactly similar to the well-known "Tungar" rectifier bulbs, but larger. This circuit looks simple and is simple, but, on account of the high voltages involved, the condensers must be of somewhat special design, and are, therefore, expensive. The condensers and inductance serve to smooth out the D.C. pulses coming from the kenotrons, and thus produce a voltage which is nearly uniform.

MEASURING THE TEN-MILLIONTH OF A SECOND

We shall now consider in some detail experiments made recently with a cold-cathode oscillograph, in the course of which definite photographs were obtained of electrical surges that occupied less than one-millionth of a second. This work was done in the laboratories of the General Electric Company by K. B. McEachron and E. J. Wade. These workers used an oscillograph devised

ing the fluorescent screen sideways, or by moving the beam sideways over the screen.

The first scheme—that of moving the screen sideways fast enough to spread out the wave form—is practically impossible when dealing with radio frequencies. If the frequency were one million the screen would have to be moved at least 2 millimeters in one-millionth of a second, or at the rate of 2 kilometers per second. The second method can, however, be used, since a second pair of deflecting plates or a pair of coils for magnetic deflection can readily be employed to pull the beam sideways at any speed desired. A difficulty then arises, due to the fact that the end of the beam moves so fast over the fluorescent material, passing one spot on it only once, that no visible fluorescence is produced. Nothing at all is seen on the screen unless the end of the beam retraces its exact path a very large number of times in a short interval. This makes it immediately apparent that the fluorescent screen cannot be used in the study of brief electrical impulses. To get a record of such impulses we are forced to use a *photographic plate* in place of the fluorescent screen. A single passage of the end of the cathode beam over the face of a photographic plate, even at the rate of fifty miles per second, will be readily visible after the plate is developed.

THE DUFOUR OSCILLOGRAPH

Although it seems that it ought to be simple to substitute a photographic plate in place of the screen, nevertheless actually troublesome complications are necessary. The plate must be *inside* the vacuum tube so that the cathode beam strikes directly on its sensitive surface. This means that the tube must be, in part at least, of metal and that it must be re-evacuated each time the plate is charged.

The oscillograph which Dufour designed to meet these conditions is sketched in Fig. 2. The glass tube BD contains the cold cathode at C, the anode, with its perforation through which the electrons shoot, at A, and a pair of deflecting plates at K to act on the beam leaving A. The lower part of the instrument, below D, is a casting of dense bronze with windows of glass at the sides, WW, and a removable front wall, S, ground in like a stopper so as to be air-tight. At L and M outside the tube are two pairs of current coils through which current can be passed to produce magnetic fields that deflect the electron pointer. These pairs of coils are fixed in a frame at right angles,

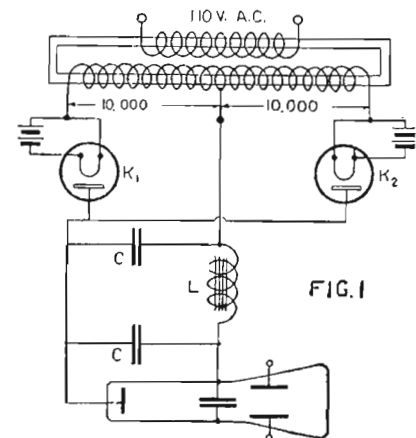

Cold-cathode oscillograph tubes require a potential of about 10,000 volts on the cathode. This is supplied by a rectifier circuit like that shown above.

electron beam, which is the "pointer" and only moving part of this device, has practically no inertia, its indications will follow the variations in the forces without lag; and, consequently, changing or alternating forces can be plotted accurately, no matter how high the frequency of their alternation. We saw how this instrument could be used to study the "wave form" of wireless waves and also how it could be applied to other purposes as, for instance, to the accurate synchronizing of oscillating circuits.

Commercial tubes can be purchased to carry out such experiments as we mentioned last month; but many of the most interesting applications of the cathode-ray oscillograph have been made in special experimental tubes. It is our purpose in this article to describe some of the special tubes and certain of the uses to which they have been put.

KENOTRON CIRCUIT FOR COLD CATHODE TUBES

In the first place, with reference to the equipment necessary to the operation of cathode-ray tubes, it will be recalled that these oscillographs are of two types: (a) hot-cathode tubes, and (b) cold-cathode tubes. Hot-cathode tubes can be operated with 300 to 400 volts of ordinary dry "B" batteries between anode and cathode; but cold-cathode tubes require in the neighborhood of 10,000 volts on the anode. Although the hot-cathode tube is the more widely useful of the two, nevertheless, in special work the cold-cathode type is often employed. It will be of interest to call the attention of radio users how the necessary high D.C. voltage for the cold-cathode tube can be obtained from the ordinary 110-volt A.C. lines.

Fig. 1 is a diagram of a *kenotron* rectifier circuit useful for this purpose. A transformer delivering 25,000 to 30,000 volts is

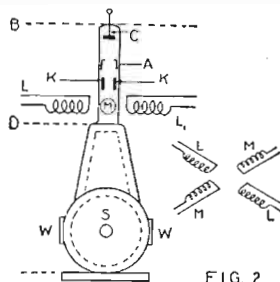

The Dufour oscillograph, which has a vacuum pump continuously operating when in use, is shown above. The metal reservoir is a film container.

and built by the French scientist, Dufour, which was specially designed to deal with very high frequencies. Dufour's oscillograph is particularly interesting to radio users, since it was developed in the first place to study the "wave form" in the antenna of the transmitting station in the Eiffel Tower in Paris.

It will be recalled from last month's article that, when no oscillating potential is acting on the deflecting plates to either side of the electron beam in the oscillograph, the point of impact of the beam on the fluorescent end of the tube is indicated by a single bright *spot*; whereas, when an oscillating potential is applied to the plates this spot is drawn out into a *line*. The end of the beam travels up and down this line once for each cycle of the potential—the persistence of the fluorescence and of the image on the retina of the eye causing a line to appear on the screen. We can learn very little from a mere inspection of this line. If we wish to examine the wave form of this applied potential we must spread the line out sideways, so that successive journeys of the end of the beam do not take place over the same line. This can be done, either by mov-

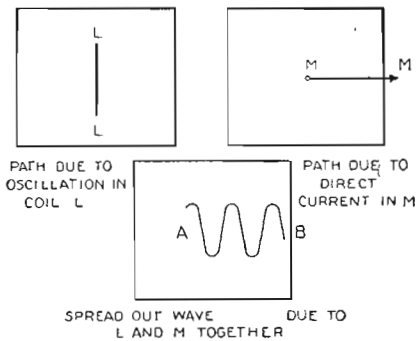

Showing how the oscillating and direct currents in the coils of Fig. 2 combine to show the exact wave-form of the former.

but the entire frame is free to rotate about the axis of the tube.

The cylindrical cavity behind S contains a "film reservoir," in which are six squares of film and one fluorescent screen, any of which can be turned into position under the end of the electron beam. Thus the beam path can be examined visually on the fluorescent screen by looking through the windows and, after adjustments are perfected, six successive pictures of the beam path can be taken before the films must be changed and the vacuum lost. The entire tube is evacuated to a high degree by fast-running vacuum pumps which are kept in action continuously during operations.

THE OSCILLOGRAPH IN OPERATION

Suppose now we pass the current from an oscillating vacuum-tube circuit through the pair of coils L. The resulting alternating magnetic field will deflect the electron beam and produce a straight line on the film (LL—Fig. 3). Let us now stop the current in L and pass a single pulse of direct current through the coils, M; this will deflect the beam sideways, once, sweeping it across the film along the line MM, and off the edge. If now both currents are passed through their respective coils simultaneously evidently the beam as it is swept across the film by the field of coil M will at the same time be thrown up and down by the oscillations in Coil L and a curve like A-B (Fig. 3) will result. This curve will represent the wave form of the oscillation in L even though the rate of displacement due to M may not be entirely uniform.

The sketch of Fig. 4 is drawn from a photograph taken by McEachron and Wade with an oscillator frequency of 50 kilocycles. The scale drawn along the top line shows how much of the record corresponds to one-millionth of a second.

In the lower part of the curve of Fig. 4 an extra disturbance *abcd* is to be noted. This represents the potential variation associated with the discharge of a condenser through a gap between two needles in parallel with it. At the point *a* an automatic switch applied a voltage to the condenser. The potential across the needle gap is seen to read a constant value at the point *b* after one-millionth of a second. About eight-tenths of a millionth of a second later, at *c*, a spark jumped in the gap. The oscillations subsequent to the spark are shown on the curve.

VISIBLE TRAIL OF ELECTRONS

This record measures to the tenth of a millionth of a second the lag, between the application of a breakdown potential to a needle gap and the actual breakdown. The record was made by connecting the two sides of the needle gap in a suitable manner to the oscillograph deflecting plates, K; the coils, L and M, being set so that the deflection along the plate, due to the current in M, is

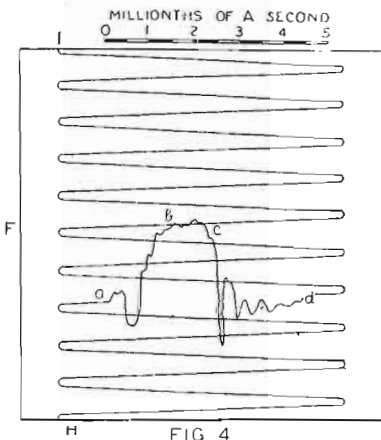

FIG 4
The ragged portion of the graph, a, b, c, d, is caused by a condenser discharge, and the attendant voltage fluctuation.

in the same direction as that due to the deflecting plates K. Three influences are thus seen to be acting simultaneously on the electron beam. It is being swept crosswise, F to G, by the 50-kilocycle oscillation at the same time that it is thrown upward from H to I; and during its travel from *a* to *d* it is also deflected up and down by the surge across the needle gap.

This is the first instance where time lags of a tenth of a millionth of a second have been directly measured. Such time intervals are inconceivably short—yet here we see them accurately compared and measured.

PATH TRACED AT 50 MILES PER SECOND

To get such records a carefully devised automatic rotating switch is necessary, to ensure that the needle gap discharges during the time the beam is moving from H to I. This journey is made only once on each record. The actual speed of the end of the electron beam in going along the curve is about fifty miles per second; and the whole record represents only about one ten-thousandth part of a second, so that careful adjustments must be made.

HOT-CATHODE SENSITIVE OSCILLOGRAPHS

Since in the Dufour oscillograph, as in all such tubes with cold cathodes, the electrons in the beam are projected through the anode perforation after a voltage drop of 10,000 or more volts, they move along to the film with tremendous velocities and suffer relatively small lateral displacement from the action of the deflecting plates or coils. If the electrons were moving more slowly they

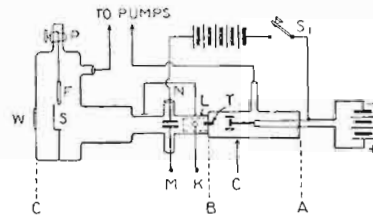

FIG 5
A hot cathode oscillograph ascribed to Sir Joseph Thomson. This type requires a voltage of only three or four hundred volts for normal operation.

would be displaced further to the side by the same deflecting forces by the time they reached the film, and the instrument would be more "sensitive" and could be used in investigating less energetic happenings than the condenser discharge described above.

For the multitude of uses where a more sensitive instrument is a necessity we must turn to the hot-cathode oscillograph. In this type, since the electrons are produced from a hot wire by the thermionic effect, well defined beams of electrons can be obtained under driving voltages of 300 to 400 volts. Such beams are readily deflected by small lateral forces.

THE THOMSON OSCILLOGRAPH

One of the best of the hot-cathode oscillographs is that described by Dr. D. A. Keys of McGill University, the design of which is ascribed by him to Sir Joseph Thomson, the great English physicist. This oscillograph is sketched in Fig. 5. The part A to B is made of glass—the part B to C of brass. The glass part contains at C a spiral tungsten wire cathode, which can be heated to incandescence with a storage battery. The filament is surrounded by a short metal tube connected to the negative end of the filament battery. This negatively-charged tube serves to concentrate the electron discharge from the wire into a beam. At T is the anode which is the end surface of the brass part of the tube. Perforating its center and perpendicular to it is a tube with a fine bore of about one-quarter of a millimeter.

When the cathode is 400 volts or so nega-

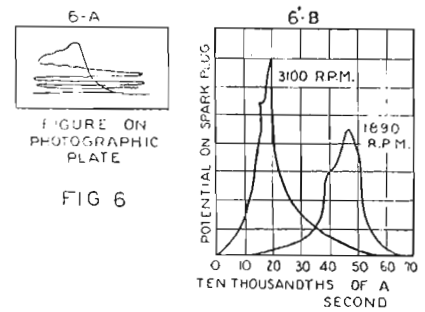

FIG 6
The oscillograph record of spark plug potential, and the resultant graph used in studying magneto design, and similar problems of ignition.

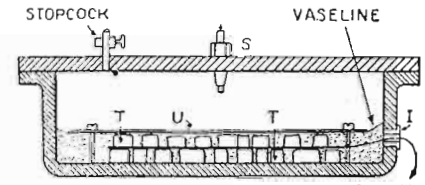

FIG. 7
An apparatus for the study of explosions in gas engines and other similar devices. The effect of the pressure on layers of tourmaline crystals is registered by the oscillograph.

tive to the anode some electrons from the filament shoot through this tube, and coming out into the deflection chamber on the far side constitute the oscillograph beam. At K L and M N we have pairs of deflecting plates between which the beam shoots. At S is a fluorescent screen which can be viewed through the window W for purposes of adjustment; while at F we have a photographic plate supported by a silk thread from a little glass stop-cock windlass P, so that it can be lifted up or down without opening the instrument. This device is evacuated by a high-speed pump which is allowed to run continuously, just as in the Dufour pattern. The electrical connections are also shown in the diagram. The anode and one plate of each pair are all connected to the brass case, and earthed to the positive end of the high potential battery, the negative end of which goes to the cathode.

SPARK PLUG POTENTIALS

Let us consider the application of this oscillograph to the investigation of the potential rise across the terminals of a spark plug connected to an automobile magneto. The insulated central terminal of the plug must be connected to the plate K and the body of the plug must be earthed. As the potential of the central terminal changes, the electron beam will be deflected crosswise on the plate. The plate M is now connected to one side of an oscillating vacuum tube circuit, oscillating at a known frequency and giving a pure sine wave voltage. The changing potential on M, due to this oscillator, will cause the end of the electron beam to move up and down on the plate once for each complete cycle of the current. If the oscillator is set at 1,000 cycles then the up path of the beam will take one two-thousandths of a second, and the down path an equal time.

Of course, the spot does not move at an even pace. It moves most rapidly at the center of its motion and then slows up toward the ends going through, in fact, what is called in physics "simple harmonic motion." If the frequency is known it is, however, very easy to calculate the actual time in seconds between any two points on the sine wave path. After these connections to K and M have been made the key, S, connecting the cathode of the tube to the high potential battery, is closed for an instant. The electron beam is at once established and, being drawn sideways by the spark plug potential at the same time that

(Continued on page 1178)

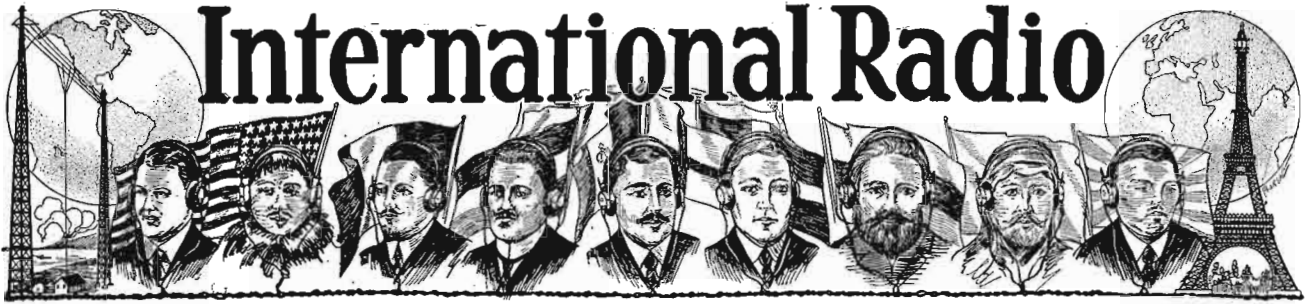

GREAT BRITAIN

Over 1,400,000 British Are Listening In

British applications for radio licenses continue at a rate which belies any current opinion that less interest is shown in radio abroad than here. The

following is a list of monthly statistics on receiving-licenses in effect during the summer and early fall:

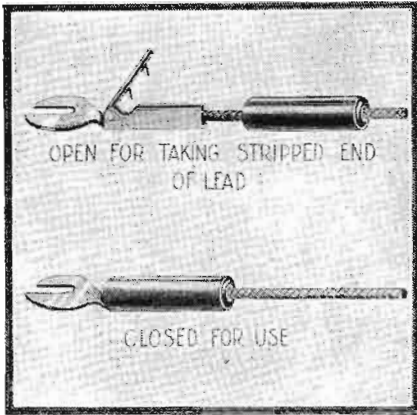

Here is an interesting spade connector for insulated wires. After the wire is skinned and slipped into place in the connector the arm with the prongs is pressed down. The prongs catch into the insulation; and, after the insulating sleeve is slipped over it, there is no further likelihood of the wire pulling out of place, nor necessity of bothering about soldering the joint, for the prongs bite into the copper wire.

May	1,371,581
June	1,387,933
July	1,379,275
August	1,422,603
September	1,464,674

It will be noticed that for the month of July there was a slight falling-off in the number of monthly licenses taken. This is due to the vacation season, as radio in Great Britain experienced the same summer slump that has become common in America.

DENMARK

Two Stations for Danish Radio Fans

Despite wide public interest, broadcasting in Denmark has lagged behind in the world-wide race for better stations. The main trouble has

been the lack of co-operation between the various governmental departments that now operate stations. At present there are five stations on the air, each having a comparatively high wave-length, but their special functions prevent any adequate broadcasting service to the public at large.

A committee, appointed about a year ago by the government, has recently made a report recommending the installation of two stations. One will have a minimum output energy of two kilowatts in the antenna, per-

mitting one-lamp reception within a radius of at least 300 kilometers. The other will permit the use of crystal sets within a radius of 15 kilometers of its location in Copenhagen. Both stations will be owned and operated by the government, and will be supported by a tax on licenses for reception. The proposal provides as well for a program committee of 39 members, composed of representatives from the government, the press, the radio clubs, and other organizations interested. It is expected that the yearly upkeep of these stations will total 500,000 crowns (\$124,250). This amount will be derived, it is estimated, from approximately forty thousand radio owners.

SOUTH AFRICA

Re-broadcasting at 9,000 Miles

A new world's record for re-broadcasting at a great distance was established recently, when the Westinghouse radio station KFKX, at Hastings, Neb., broadcast a program which was picked up in Johannesburg, South Africa, a distance of more than nine thousand miles airline, and transmitted by land wire telephone from the amateur receiving station to the local broadcaster, where it was amplified and re-broadcast.

The achievement is even more remarkable when we consider that the event was not pre-arranged. The amateur who received KFKX merely plugged his amplifier into the commercial telephone, after calling up the broadcasting station.

The impulses received at the broadcasting station were almost perfect in tone; and those who heard the re-broadcast program declared that it was nearly as clear and un-

derstandable as if the artists had been in the local studio, instead of in America, nine thousand miles away.

HOLLAND

25-KW. Station for Dutch

The high-power broadcasting idea is being taken up across the water almost as rapidly as it is here. Holland is the latest recruit. The old station at Hilversum is being renovated, and shortly will be in operation with a power of 25 kilowatts.

THE HIGH SEAS

Prescriptions by Radio

In nineteen twenty-two the United Fruit Company instituted a free medical service via radio. The advice of doctors on its ships, and in its various hospitals in Central America, was offered to ships and communities having no doctors, or those needing the advice of specialists. This service has been recently expanded and made available for all ships within communication distance of the eastern seaboard of North America. An agreement with the Tropical Radio Telegraph Company now provides for this service a chain of radio stations extending from Boston to Santa Marta, Colombia. The complete list of land stations, through which this service is offered, follows:

- Boston, Mass., WBF; Miami, Fla., WAX; New Orleans, La., WNU; Burrwood, La., WBW; Fort Morgan, Ala., WIO; Mobile, Ala., WNN; Swan Island, Caribbean, US; Tegucigalpa, Honduras, UG; Tela, Honduras, UC; Puerto Castilla, Honduras, UA;

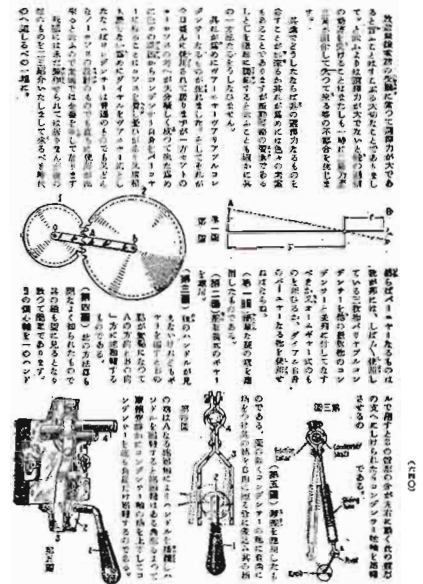
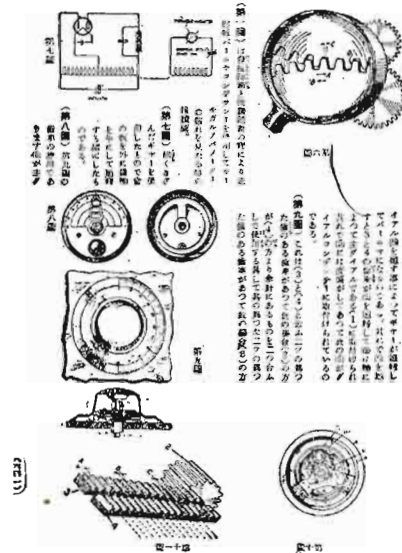

To show how widely RADIO NEWS is read, we present here a reproduction of a page out of a Japanese radio magazine, "The Radio Experimenter." It shows part of an article entitled "All About Verniers," written by Sylvan Harris, in the July, 1925, RADIO NEWS, as reprinted by the Japanese Radio Experimenter.

Puerto Barrios, Guatemala, UF; Managua, Nicaragua, UL; Bluefields, Nicaragua, UQ; Cape Gracias, Nicaragua, UW; Puerto Limon, Costa Rica, UX; Almirante, Panama, UB; Santa Marta, Colombia, UJ.

United Fruit Company hospitals are located in Santa Marta, Colombia; Puerto Limon, Costa Rica; Almirante, Panama, and Puerto Barrios, Guatemala. Requests for medical aid may be sent to any of these hospitals by a radiogram, addressed to "United Fruit," to any radio station in the above list. Medical advice, however, may be had direct from any of these stations, or from any United Fruit ship, the call letters of all which are listed in the International Call book.

Due to the fact that this service is free, the United Fruit Company assumes no responsibility for errors or delay.

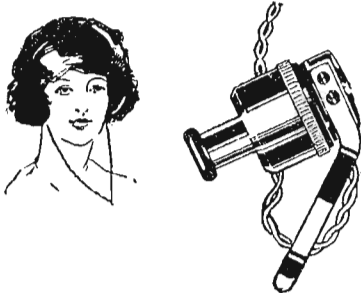

A British manufacturer has produced a very light and compact pair of ear-phones, shown in the accompanying illustration. It is claimed that their weight is negligible, and that the size of both, with supporting clips included, is less than that of one of the old type. The extremely light weight of these phones makes a conventional headband unnecessary.



SPAIN

The Treaders Take the Air

An endeavor has been made in Spain to broadcast the "atmosphere" of the national sport, the bull fight. A microphone

From left to right: Miss Sumiko Kurishima, Mr. Kahichi Shimada, Mr. Yukichi Iwata, Mr. Namino-suke Horikawa and Miss Choko Iida, broadcasting a radio drama from the station in Nagoya, Japan.

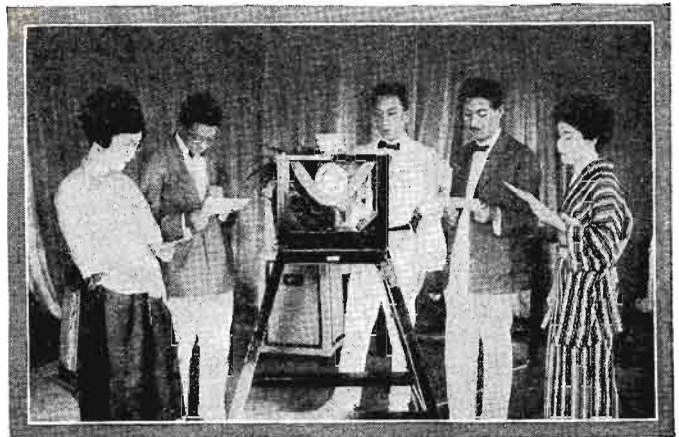

has been erected in one of the boxes of a bull fight ring in Madrid. This is connected by land line to the local station, which broadcasts the events of the ring and speeches by the leading toreadors as well. This feature, it is understood, is meeting with much favor among the Spanish audiences, who love a bull fight as much as Americans do their baseball.

An Interesting View-point On DX

This condition is emphasized in a story that comes to us from Mr. F. Garibay, Jr., of Tampico, Mexico.

A certain rich Spaniard, whose estates are located in the foothills of the Pyrenees, purchased, while in Madrid, an excellent Super-heterodyne set of the latest model. He returned to his country home, installed the outfit, and invited the local elite to attend a demonstration.

After a few preliminary adjustments, a voice was heard. Unfortunately, however, it was the British station DX12, located in

In another column the fact is mentioned that the average European audience is concentrated rather closely about the broadcasting station.

London. As none of the assembled audience understood English, the set owner became excited and started to find another station.

The next voice heard was speaking a language that someone was able to identify as German, but that no one was able to understand. The gentleman who had arranged the demonstration tried again, and another British station was the result. One after another they came in, DX stations from all over Europe, and all equally unintelligible. Finally the owner, in sorrow and anger, declared the demonstration at an end.

In despair he took the set back to the capital, and hunted up the clerk that had sold him the outfit.

"Sir," he said, "this is undoubtedly a wonderful outfit, but won't you be good enough to allow me to exchange it for one that speaks Spanish?"

LITHUANIA

Among the first seven radio receiving sets licensed by the Lithuanian Post, Telephone and Telegraph Administration was one in the American Consulate at Kovno. Others include the Seamen's Union, the Kovno Lotto Club, a seminary and a motion picture house.

Hom Pri Esperanto Kaj Radio de* JAMES DENSON SAYERS

Mr. Sayers has been writing articles on Esperanto for quite a few months past for RADIO NEWS. He has also spoken on Esperanto from the radio broadcast station of RADIO NEWS, WRNY. These articles and lessons have been received very well by our readers, many of whom have become able to speak or write in Esperanto without any other instruction than was obtained from these articles.

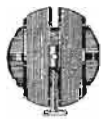
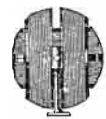

La legantoj de RADIO NEWS kiuj lernis Esperanton per la kursoj publikigitaj en ĉi tiu revuo rajtas ĝojigi pri la lastatempa progreso de Esperanto kiel la monda helplingvo kaj speciale en la fako de radio. Kaj ĉi tie, antaŭ ol iri antaŭen mi volas doni laŭdon kie ĝi taŭgas. RADIO NEWS estis la unua granda radio-revuo en la mondo entrepreni subtenadon al Esperanto kiel la bezonata mondhelplingvo, sekvita baldaŭ de la granada Brita revuo, *Experimental Wireless & The Wireless Engineer*. Nun, preskaŭ sin escepto, radio-revuo de Eŭropo kaj multaj en aliaj landoj sekvas la gvidemon de la supre cititaj revuo kaj vigle proklamas Esperanton.

Parolante kun du aliaj redaktoroj de usonaj radio-revuo pri Esperanto, ili respondis al mi jene: "Ni atendas ĝis niaj legantoj postulas Esperantan fakon. Ni kredas ke Ameriko ne bezonas la internacian lingvon sufiĉe nun por doni spacon al ĝi." Sparemu! de spaco je la kosto de vera progreso! Tiu kiu ne povas vizi la morgaŭan tagon kiam la finoj de la mondo estos en ĉiu laŭparolilo estas ja blindulo. Vere progresema, valora revuo enketas pri tiaj demandoj kiuj koncernas siajn legantojn kaj gvidas en la afero. Tia estas la devo de

ĝi. Estonte, kiam estos ordinara, ĉiutaga afero uzi Esperanton inter nacioj per radio, la mondo memoros la brilan, insistentan pioniron, RADIO NEWS, kaj ĝian ĉiame antaŭenrigardantan redaktoron, Hugo Gernsback. Eble ŝajnos ke ne tute decas ke tiaj vortoj aperigu en RADIO NEWS, sed mi petas la Helpan Redaktoron, S-ro Harris, permesi ilin esprimi. Mi nur respregulas la sentojn de Esperantujo.

Al la listo publikigita en RADIO NEWS de disaŭdigaj stacioj tra la mondo uzantaj Esperanton ni povas nun aldoni aliajn ĝis la nombro—laŭ plej novaj raportoj—de 27. La granda, nova stacio ĵus finita en Nagoja, Japanujo, uzos Esperanton en sia programo. Estas en tiu Japano urbo eidonata granda tagiurnalo, *Ain-Nichi*, kiu regule havas Esperantan fakon.

La plej brila lastatempa sukceso de Esperanto estis ago de la Universala Telegrafa Unuigo kiu akceptis Esperanton kiel klaran telegrafalingvon. La Unuigo sidis en konferenco en Parizo dum septembro kaj oktobro. La decido sekvis la deziresprimon de la Ligo de Nacioj, kiu, antaŭ iom da tempo, petis la Unuigon fari tion. La decido signifas ke oni nun povas telegrafi alilanden

per Esperanto sin pagi pli ol por klara, nacia lingvo. Alie, oni devus pagi same kiel por koda kablegramo. La Unuigo rifuzis similan akcepton al aliaj internaciaj lingvoj, tiamaniere montrante ke Esperanto estas la sola kiu meritas tian konsideron.

S-ro Kenji Ossaka, de la Ministerio de Imperiaj Fervojoj de Japanujo, eble la plej fervora Esperantisto de la Malprokisma Oriento, kiu nun studas fervojan teknikon en Usono, diras ke la Japanoj, speciale la pli juna generacio, treege interesigas pri radio kaj ke pro la fakto ke en Japanujo Esperanto estas tre vaste konata, la interligo de la monda radio-lingvo kun radio estas natura rezultato.

Mi ĵus ricevis la novan liston de libroj de la Brita Esperanto-Asocio. Ĝi listas 130 lernolibrojn (gramatikojn, vortarojn, legolibrojn, k.t.p.), 350 literaturajn librojn kaj 27 librojn aŭ pecojn de muziko kun kantoj en Esperanto.

Laŭ plej novaj sciigoj, estas nun eldonataj en la mondo 67 ĵurnaloj, revuoj, k.t.p., en kaj por Esperanto.

Inter multaj leteroj kiujn mi estas ricevinta de legantoj de RADIO NEWS, una (Continued on page 1222)

*President, New York Esperanto Club.

The Autoregenerator

By SYLVAN HARRIS

The autoregenerator described in this article is a further development of the one described by Mr. Harris in the last issue of RADIO NEWS. Our readers will find this an exceedingly interesting circuit with which to experiment; there are presented new thoughts along new lines, which undoubtedly will furnish the inveterate radio reader some relief.

IN THE January issue of RADIO NEWS a type of radio receiver was described in which regeneration is obtained in the usual manner, by using the tickler coil arrangement, but in which it is controlled in a new manner, by shunting the loading inductance in the secondary with a high resistance, and coupling the circuit to the antenna by means of a pick-up coil.

The schematic arrangement is shown in Fig. 1. A is the pick-up coil, which may be connected to the antenna and ground, or connected to the plate circuit of another tube which acts as radio frequency amplifier. A set employing a radio frequency amplifier is described in this article. In the previous article we dealt only with the regenerative detector.

The radio frequency amplifier circuit is exactly the same as that of the detector, with the exception that the grid leak and condenser are omitted. Exactly the same number of turns are used on the coils, and the same coil diameters are used.

FUNDAMENTAL PRINCIPLE

Before we go any further with the description of this receiver it will be well to review

an example, suppose the current in the circuit oscillates at the rate of 500,000 cycles per second and the resistance between A and B happens to be 2 ohms. Then, when the frequency increases to 1,000,000 cycles per second the resistance will increase to 8 ohms.

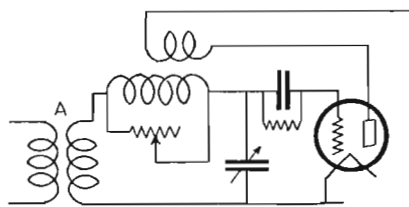

FIG. 1

The basic circuit arrangement upon which the operation of the set depends is shown in this diagram. There is but little departure from the usual three-circuit tuner, but the results obtained from the departure are noteworthy.

The frequency has been doubled, or multiplied by 2. The square of 2 is 4. The apparent resistance between A and B is, therefore, 4 times the original resistance, or 8 ohms. This method of determining the change of re-

REGULATION OF THE RESISTANCE

We have now the essential elements of the circuit described in this and the preceding article by the writer. We have, on the one hand, an increase in the apparent resistance of a circuit, according to the square of the frequency, and on the other hand, a decrease of the apparent resistance, also according to the square of the frequency. Both of these effects are accomplished by different means; but by combining the two effects in the one circuit, it is possible so to regulate things, that the circuit can be continually held on the verge of self-oscillation, which is the condition, as everyone knows, under which a vacuum tube is most sensitive as a receiver of radiated energy, either as detector or radio frequency amplifier.

Thus the two circuits shown in Figs. 2 and 3 are combined to form the one shown in Fig. 1. The generator of high-frequency oscillations has been replaced by a small pick-up coil, shown at A in Fig. 1, and the main inductance in the circuit, which is tuned by the variable condenser, acts as a secondary loading coil. The load in the generator, in Fig. 2, is replaced by the vari-

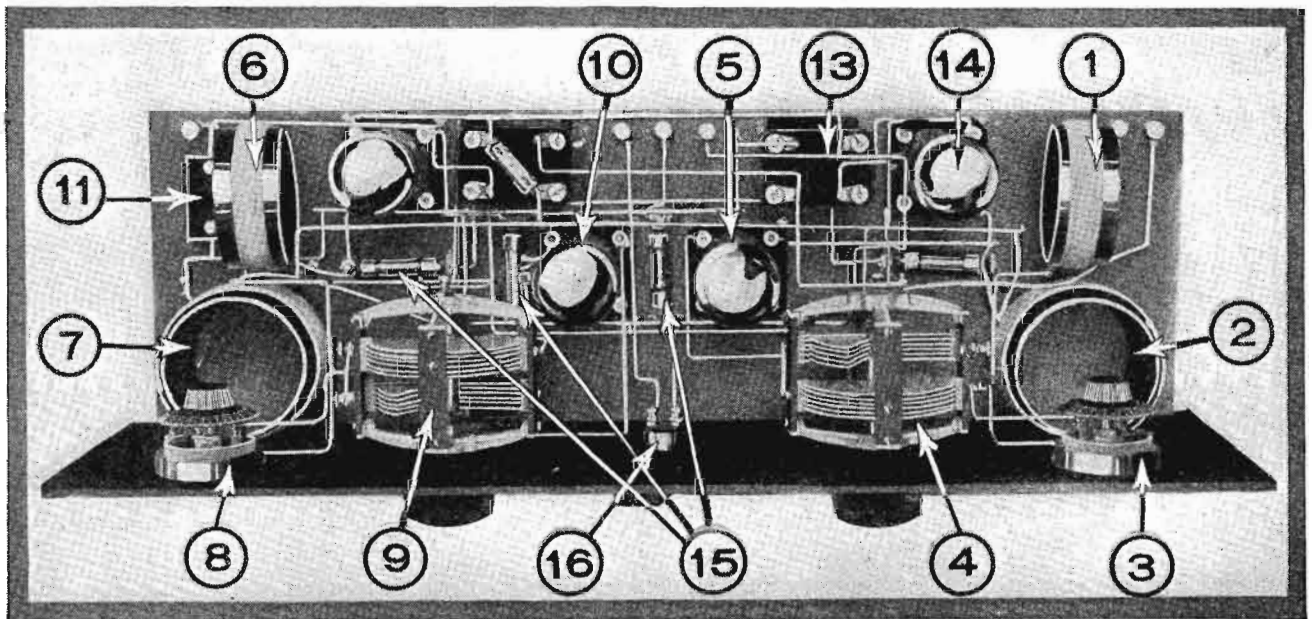

Plan view of autoregenerator. 1, antenna coupling coil; 2, secondary loading inductance and tickler of R.F. tube; 3, R.F. stage high resistance; 4, R.F. tuning condenser; 5, R.F. tube; 6, interstage coupling coils; 7, secondary loading inductance of detector; 8, detector circuit high resistance; 9, detector tuning condenser; 10, detector tube; 11, 13, A.F. transformers; 12, 14, A.F. amplifier tubes; 15, amperites; 16, filament switch.

briefly the principle on which this system operates, and what it is supposed to accomplish. In Fig. 2 we have a source of alternating current supplying energy to a series circuit, composed of any kind of a load, and an inductance shunted by a high resistance. The total resistance of the circuit is composed of two parts, one of which is in the load, and the other between the points A and B.

It is the part between A and B which interests us most at the present time. It can be easily shown that when a high resistance is connected in shunt with an inductance coil, whose resistance is very small compared with its reactance, the resistance between A and B will increase as the square of the frequency of the current in the circuit. As

disturbance with frequency may be applied, whatever frequency or resistance happens to be.

Now, let us consider what happens in a three-circuit tuner, or a vacuum tube circuit in which regeneration is accomplished by means of inductive feed-back. The simple circuit of the three-circuit tuner is shown in Fig. 3. Without going into very much detail concerning the theory of the three-circuit tuner, it is generally understood that the regeneration is accomplished by reducing the apparent resistance of the input circuit connected to the grid and filament of the tube. It is also known that this apparent resistance decreases as the square of the frequency. A study of this has been made by Jolliffe and Rodman of the United States Bureau of Standards.

able condenser in Fig. 1. The resistance of this latter is supposed to remain constant as the frequency varies. We know it does not; in fact, it not only varies with the frequency, but it also varies with the setting of the condenser plates. However, in many cases the resistance of the conductor, in the usual band of frequencies, is much lower than the resistance of the rest of the circuit, so that a close approximation can be obtained in working at the point of incipient oscillations. Besides this there is also the resistance in the pick-up coil, which has to be considered, but this, likewise, can be made small enough to be neglected.

MAKING THE SET SENSITIVE

It may be objected that the introduction of the resistance in the tuned circuit may

SCHEMATIC LAYOUT OF AUTOREGENERATOR

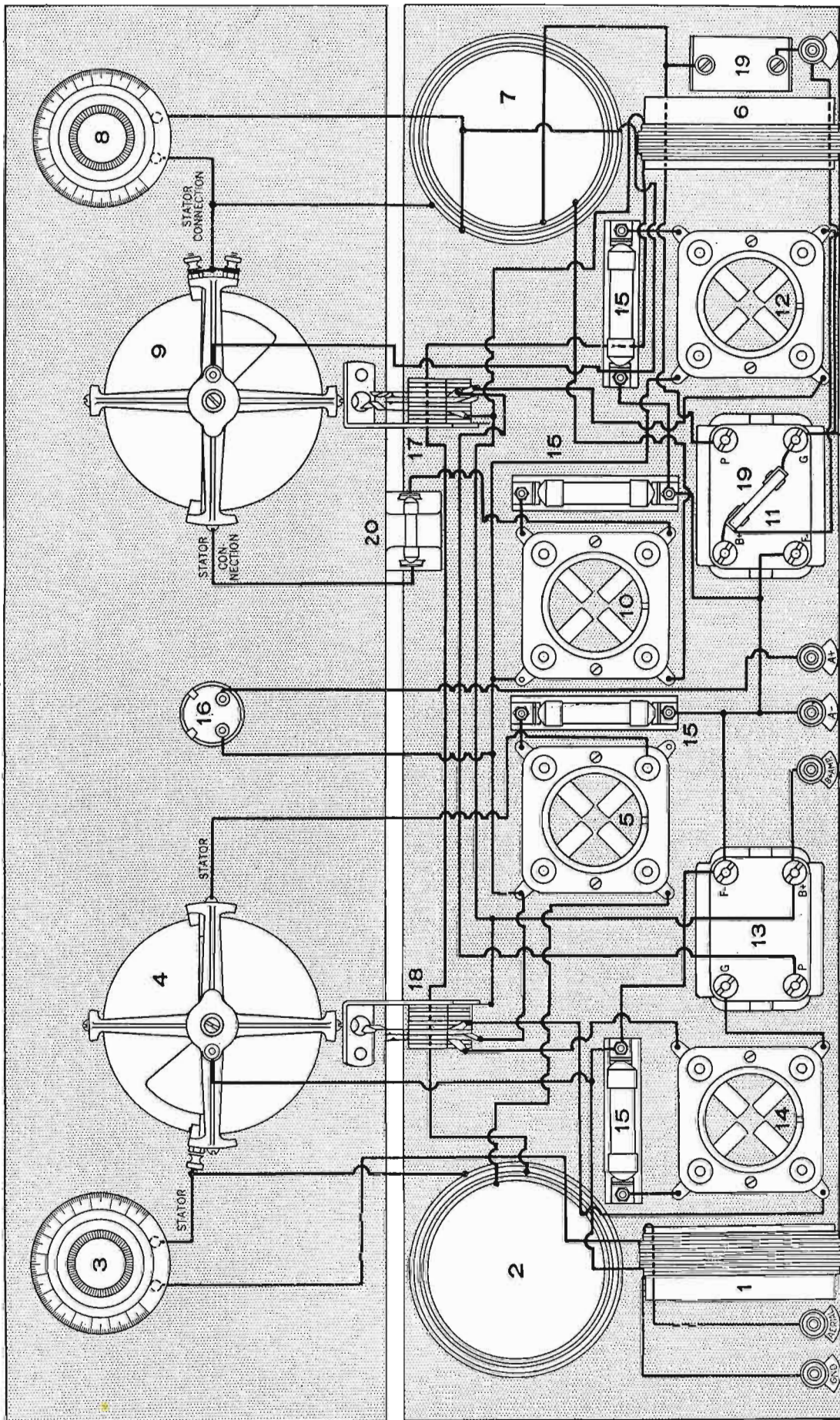

Detailed layout of the Autogenerator. 1, antenna coupler; 2, R.F. secondary loading coil and tickler; 3, high resistance, shunting coil; 4, R.F. tuning condenser; 5, R.F. amplifier tube; 6, interstage coupling coil; 7, detector circuit secondary loading coil and tickler; 8, high resistance, shunting coil; 9, detector circuit tuning condenser; 10, detector tube; 11, 1st A.F. transformer; 12, 2nd A.F. transformer; 13, 2nd A.F. transformer; 14, 2nd A.F. transformer; 15, ampere; 16, filament switch; 17, first filament control jack; 18, second filament control jack; 19, by-pass condensers; 20, detector grid-leak and condenser.

render the circuit insensitive and will also cause it to tune broadly. This is true, if the proper values of resistance are not used. Under the best conditions for operation, however, high values of resistance are used to shunt the coil, so that the resistance will have much less effect on the tuning than one would imagine. To tell the truth, this resistance may range from 25,000 ohms all the way to 100,000 ohms, depending upon the voltages used on the plates of the tubes, and on the condition of the tubes themselves.

The complete wiring diagram is shown in Fig. 4. It will be seen, as explained before, that the radio frequency amplifier is identical in the circuit arrangement with the detector circuit, with the exception that the grid condenser and grid leak have been omitted. The only difference in the operation or adjustment of the two stages is that different voltages have to be used on the plates of the tubes. These voltages are the same that everybody has been accustomed to use, so that no worry can be caused on that score.

ADJUSTING THE CIRCUIT

In adjusting the receiver, all that is necessary is to set the high resistances at any convenient dial setting, when tuning in on a station. These two resistances should have very nearly the same setting, since the coils are alike and the tubes are supposed to be alike. If there is a slight difference in the characteristics of the tubes, it will be found that there will be a difference in the settings of the high resistances, but this will not be very great.

After tuning in on a station, and setting the resistances about the same, next turn the tickler coils until the circuits are on the verge of oscillations. Self-oscillation in the circuits is indicated by the squeal that occurs, due to the beat frequency existing between the incoming carrier wave and the nearly equal frequency of oscillation set up in the receiver.

The procedure of adjusting the circuits properly is a rather ticklish one, since it is difficult to determine which stage is oscillating. Perhaps the best way to perform the adjustments is to set one of the resistances, say that in the detector circuit, at its minimum value, or else turn the tickler coil all the way out, so that the feedback will be very little, if any. Then adjust the radio frequency stage. After this is adjusted properly, make a note of the settings of the tickler coil and the high resistance. Then adjust this circuit, just as the detector circuit was adjusted, so that no oscillations can occur, and adjust the detector just as it is on the verge of self-oscillation.

It should be found, if this procedure has been followed carefully, that there will be

This is a back view of the autogenerator. The numbers shown in the photograph are identical with those of the illustration on the opposite page and in the wiring diagram below. Note that the set has a very orderly and pleasing appearance, and furthermore is very simply constructed. All unnecessary controls have been eliminated. It was not thought necessary to reduce the number of dials, from the two which we have to simply one, but this feature is one on which the reader can experiment himself.

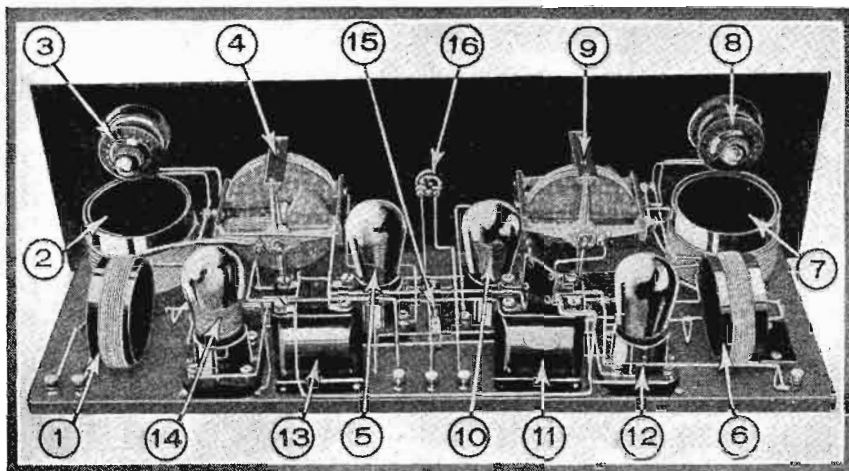

The coils 1 and 6 are primary and secondary, the primary wound on top. The tube diameter is 3 inches, having on it 17 turns for the secondary and 11 turns for the primary, of No. 20 D.C.C. wire. The loading inductances 2 and 7 are wound on tubes 3/4 inches in diameter, and have 34 turns of No. 20 D.C.C. The tickler coils slide inside these, having a diameter of 3 inches and 5 turns of No. 20 D.C.C. wire each. The variable condensers have a capacity of 0.0005 mf., and the high resistances have a maximum resistance of 50,000 ohms.

very little departure from the condition of incipient oscillation, over the whole broadcast range of frequencies. In simpler terms, there should not be much change in

the adjustments again. A condition of affairs will be found for which there will be no appreciable change in amplification over the whole range.

SATISFACTORY DX RECEPTION

It will then be possible for the operator of the receiver to sit down in front of it and tune in one station after another, without annoying either himself or his neighbors with any squealing, which generally seems to occur just at the time we are listening to our favorite musical number. Besides this, we will be getting out of the circuits all that it is possible to get out of them, for the tubes will be working always very close to the critical point, where the amplification is greatest.

This receiver was designed and constructed in the Radio News laboratory, and has been found to operate very satisfactorily. Many distant stations were tuned in; in fact, there was hardly one important broadcast station east of the Mississippi that could not be brought in at one time or another on this set. The volume is very good; all the tests were conducted on a loud speaker, as we feel that no set is worth considering if it does not bring in the stations with sufficient

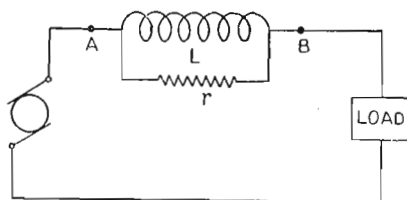

FIG. 2

The principle upon which the circuit of Fig. 1 is based is derived from the phenomena occurring in this diagram of connections. The resistance between A and B varies in just the right manner to control automatically self-oscillation.

amplification, whether we tune the receiver in to a 500-meter wave or to a 200-meter wave. It may be found that there will be an appreciable decrease of amplification on the longer waves, and a tendency to squeal on the shorter waves. If this is so, go over

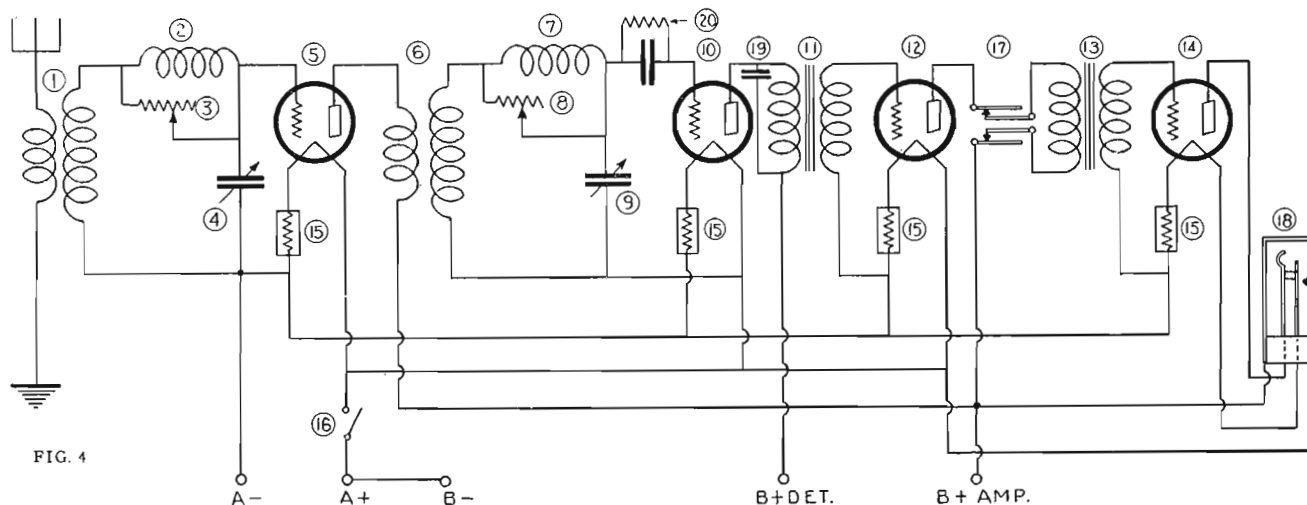

FIG. 4

This shows the complete wiring diagram of the receiver. The numbers on the diagram are identical with those that appear on the pictures in this article. Wherever it has been possible to do so, automatic control has been employed. There are automatic filament control jacks and ballast resistances, as well as automatic control of regeneration.

volume to be heard without straining our ear-drums.

The selectivity of the receiver was likewise very good, and little, if any, serious interference was encountered. Even in New York City, where the congestion of stations is great, very little difficulty was encountered in the way of interference.

BUILDING THE SET

We shall next consider the construction of the set itself. The pick-up coils, both that connected to the antenna and the ground, and that connected to the output of the first tube, are identical in construction. They are wound on tubing 3 inches in diameter. The secondary winding is put on the tube first, consisting of about 17 turns of No. 20 D.C.C. wire, and the primary winding is

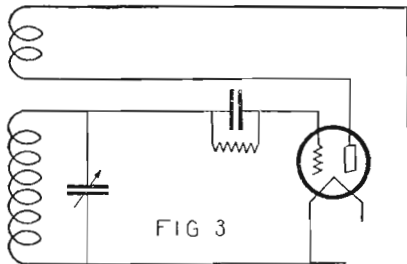

wound directly over this. The primary winding has 11 turns of No. 20 D.C.C. wire. The secondary loading inductances are

This is a view of the front of the set. Nothing superfluous shows on the panel; all that we see are two tuning dials and a phone jack. 4 and 6, tuning condensers; 16, filament switch. In the first column, the simple three-circuit tuner (Fig. 3).

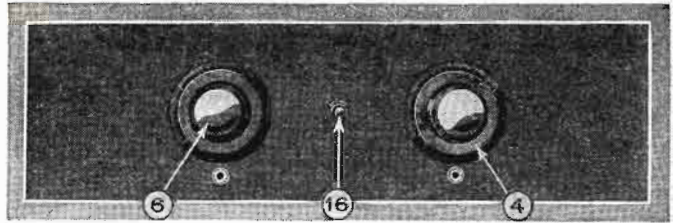

wound on 3/4-inch tubing, and consist of 34 turns of No. 20 D.C.C. wire, wound in a single layer.

The condensers used for tuning have a maximum capacity of 0.0005 μ f (microfarad).

TICKLERS

The tickler coils are not made to rotate inside the secondary loading inductances. They are simply single-layer coils made to slip inside the loading inductances, being 3 inches in diameter and having 5 turns of No. 20 D.C.C. wire on them. Instead of turning the tickler coil to vary with the feed-back, it is simply pulled out, or pushed into the secondary loading inductance. The maximum feed-back is obtained when the tickler coil is directly at the center of the loading inductance, and decreases as the tickler is moved toward either end. How the mutual inductance varies in such a coil was discussed rather completely in an article on Coupling in the December issue of RADIO NEWS.

There is not much more to be said at the present about this set, with perhaps that it is about the most satisfactory combination of regenerative detector and high frequency amplifier circuits that the writer has come across. There is no difficulty found in adjusting the set, in most cases, and when once adjusted, the results will be very gratifying. There is no squealing; the set is very quiet in operation, that is, there are no tube noises or other circuit disturbances heard, excepting, of course, the noise which we want to hear, viz., the concert being received. The quality also is very good, providing, of course, the audio frequency stages are properly designed. There is room for considerable latitude in the construction and design of this receiver, for it is susceptible of all the changes, additions and "improvements" that have been made on other types of receivers. Various combinations of push-pull, impedance or resistance coupling can be used for the audio stages according to the whims of the constructor.

Facts and Fallacies of Radio Wave Transmission

By DR. J. H. DELLINGER

With so many and public differences by experts in interpreting radio waves, "ceilings" and "layers" to the general reader, the latter is much in need of assistance to clarify his conceptions. In this article Dr. Dellinger, who is chief of the Radio Laboratory of the Bureau of Standards, United States Department of Commerce, offers information which even the beginner will readily grasp and co-ordinate with his previous ideas.

I HAVE been asked to comment on recent announcements of spectacular advances in the utilization and understanding of short radio waves. The experimentation of the last few years on the ultra-high frequencies (short waves) has been an outstanding aspect of radio progress. It has led to valuable applications, but there is no ground for belief that radio has been or is to be suddenly revolutionized by startling new developments. A wonderful appeal was made to the imagination by Marconi's announcement of some two years ago that he had succeeded in transmitting halfway around the world with but a fraction of the power that would have to be used on long waves for such an extreme distance. Both before and after his announcement extensive experimentation and routine handling of message traffic on high frequencies have been conducted by numerous commercial organizations, by the Navy and other Government departments, and by amateurs and others. This work continues very actively at the present time, and is leading to a determination of the ultimate usefulness of the short waves. About a year ago Marconi stated his belief that high frequency transmitting stations could be built for reliable commercial communication over any desired distance at a very small fraction of the cost of long-wave stations. Despite occasional repetitions of this opinion by others, most of the research in this country is throwing grave doubt on this conclusion. In spite of their success in bridging great distances, these waves are subject to far more vagaries and peculiarities of behavior than the more familiar longer waves.

THE "RADIO ROOF"

The many puzzling characteristics of short waves have stimulated widespread examination of our knowledge of the mechanism of

radio wave transmission. Recent comments on the idea of a radio roof or ceiling over the world indicates the need for a clarification of what is new and what is old, of what is understood and what is not under-

MUCH has appeared lately in popular radio journals about transmission and reception of radio waves, especially in connection with the Heaviside-Kennelly "layer" theory. Great distances have been spanned on the short wave-lengths with little power, although they are, unfortunately, erratic in their behavior; so that investigation of their nature is both necessary and promising. We commend to our readers a following of the series of articles by Joseph Riley on "Radio Waves," now appearing in RADIO NEWS. This starts at the beginning, and describes graphically the known phenomena and the theories of wave-action.

stood, of what is true and what is false, in such explanations.

There is nothing startling about the idea of such a radio ceiling nor of the propagation of waves along this upper atmospheric surface in such wise as to explain many of the peculiarities of radio transmission. The existence of this conducting surface due to low density and ionization high in the atmosphere was postulated by Prof. Schuster in England in 1887, before radio existed. In 1900, not long after Marconi succeeded in sending radio waves across the Atlantic, it was suggested by Heaviside, the great electrical genius, and by Prof. Kennelly, of Harvard, that this surface or ionized region

might have some effect in radio wave propagation. Then, in 1912, Dr. W. H. Eccles published some calculations on the interactions of radio waves and the ionized air and showed how the waves are thereby bent down to follow the curvature of the earth.

In 1920 the Bureau of Standards introduced the idea that waves may be transmitted either along the earth's surface or along the upper atmospheric conducting surface, and used this idea to explain the superiority of long waves in the day and shorter waves at night and also worked out from this an explanation of the prevalence of fading and great transmission distances at night. This explanation, published in 1921, cleared up many of the peculiarities of radio transmission that had previously been a mystery. It was the basis of the numerous discussions of the double transmission path (ground waves and upper air waves) which have appeared since.

The simile of a "radio roof or ceiling of the sky, with waves reflected as from the dome in a whispering gallery, was not used in the bureau's explanation, and does not give a true picture of what happens. Probably a better picture is that set forth in the original publication, radio wave transmission being compared with the German long-range gun which bombarded Paris at a distance of 70 miles. The rarified higher portions of the atmosphere which permitted the projectile to fly toward Paris with little resistance played the same rôle that the upper electric strata of the air play in radio transmission as, by their particular conditions of ionization, they permit radio waves of particular frequencies to travel enormous distances around the earth. And, just as the Germans aimed the gun at a very high elevation so as to put the projectile quickly up into the little-resisting portions of the at-

(Continued on page 1190)

The "Peanut" Super

By MORRIS LEVY

This peanut super-heterodyne is surely a "peanut." Although employing seven tubes, the whole outfit is very small in size, as may be seen by making a comparison of the size of the four-inch dial and the total height and length of the cabinet, as illustrated below. And it positively DOES work! The secret of its compactness lies in the use of the so-called "peanut" tubes.

BEFORE describing the set, it would not be amiss to explain the title of this paper. A standard super-heterodyne circuit using seven tubes is employed. The writer believes this set is one of the smallest and most compact super-heterodynes ever constructed. The complete set is mounted on a panel measuring only 7 x 10 inches and extending 4 1/2 inches back of the panel. It is complete in every way, containing two variable condensers, rheostats, potentiometer, seven sockets, two audio frequency transformers, "C" battery, three 1/2 mfd. by-pass condensers,

PEANUT TUBE USED
It gets its name chiefly from the fact that Western Electric peanut "N" tubes are used. They are the smallest tubes available, having characteristics more or less like the WD12 tubes, in that both types use oxide-coated filaments, operating on 1.1 volts and .25 amp. Of course, not as much volume can be expected from these tubes, as from the larger ones, and to their rather low mutual conductance, about 240 as compared with about 350 for UV199. The volume is (when using a loop) better than one step of audio amplification with larger tubes.

"N" tubes are very uniform and fairly non-microphonic, which gives them some advantage over the UV199, as the latter are notorious for both these qualities.

Split loop regeneration by the Rice method is employed. This is controlled by a small variable condenser. The loop terminals are connected to the three binding posts, on the lower left side of the panel. They can be clearly seen in the photo. The top terminal is for the center tap. The use of regeneration results in quite an improvement in signal strength. No remarkable DX results are claimed, but fairly consist-

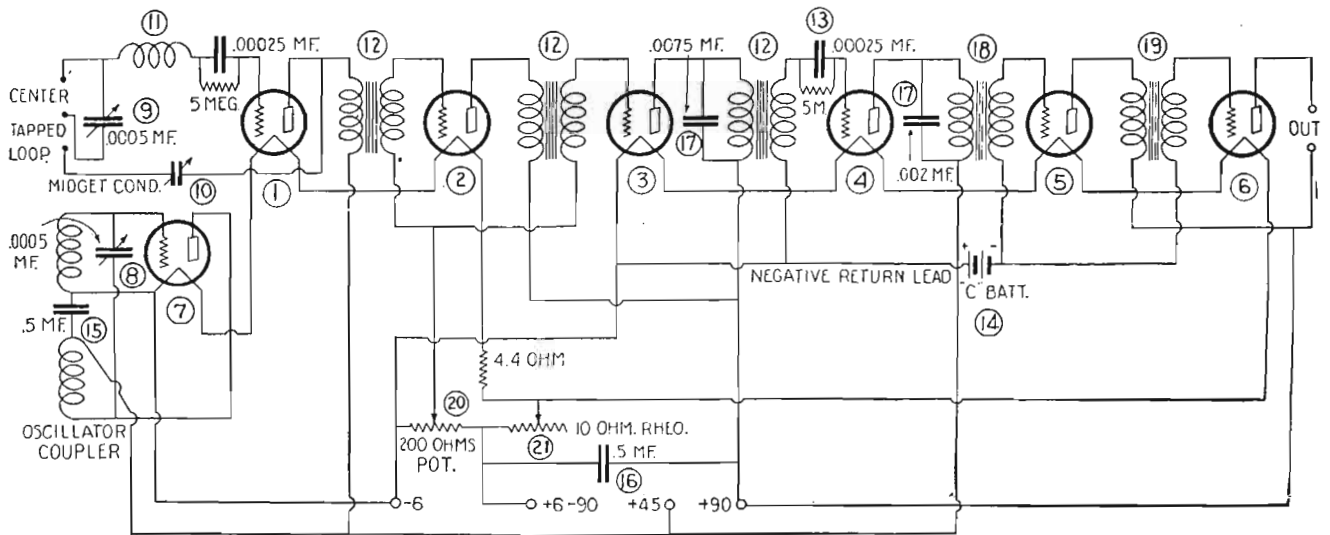

1, first detector; 2, 3, Intermediate Amplifiers; 4, second Detector; 5, 6, A.F. Amplifiers; 7, Oscillator tube; 8, Oscillator Tuning Condenser; 9, Loop Tuning Condenser; 10, Midget Condenser; 11, Grid Coil; 12, Intermediate Transformers; 13, Grid Condenser and Leak; 16, 17, By-pass Condensers; 18, 19, A.F. Transformers; 15, 0.5 mf. condenser; 14, C Battery; 20, Potentiometer; 21, Rheostat; 22, Filament Switch.

oscillator coupler, 60 K.C. intermediate R.F. amplifying unit, two grid condensers and leaks and smaller by-pass condensers, also a three-plate variable condenser. It is really a peanut in size, compared to the 20- and 30-inch mastodons of the usual super construction.

The writer recommends that UV199 be used if difficulty is found in obtaining "N" tubes. By using UV199 sockets, it would be necessary only to move the sub-base a half-inch lower and extend it about 5 inches back instead of 4 1/2, as the writer has it. Otherwise, everything might remain the same.

tent results from stations as far west as Denver have been recorded, with quite a number of them on the loud speaker. The tuning is sharp and the tone quality very good. This is for loop reception, using an ordinary 13-turn pancake-type loop, tapped at the seventh turn. By the use of an antenna coupler and loose coupling, far better results are obtained, due to the better regenerative qualities of the coupler and use of antenna. But at this time of the year antenna reception is not recommended because of the great amount of static and noise which is picked up.

No detailed instructions will be given, since the reader may want to use a larger panel or other parts, or may wish to modify his present apparatus along these lines, but a general idea of the layout follows:

The photographs show front, back and top views of the set. The location of the parts can be easily seen from these illustrations. The front view photo shows two 3-inch dials controlling two .0005 mfd. variable condensers. At this point it may be noted that no condensers having a greater overall diameter than 3 1/4 inches should be used in order to save space. These condensers are mounted 2 inches from the bottom and 2 inches from each end of the panel. A small variable condenser is mounted between the two condensers. The upper part of the panel holds the 10-ohm rheostat, 200-ohm potentiometer and filament switch. They are so placed that the shaft and bind-

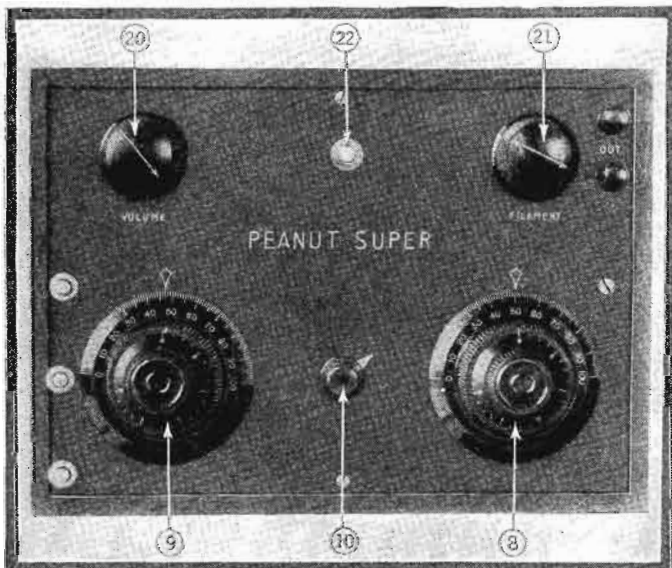

The completed receiver is very convenient as to size, and pleasing as to appearance. It will be noted that there are only two tuning controls; the remainder of the controls can be set, and allowed to "stay set." 8 is the oscillator condenser and 9 is the loop condenser. 22 is the filament switch, 20 is the potentiometer and 21 the rheostat.

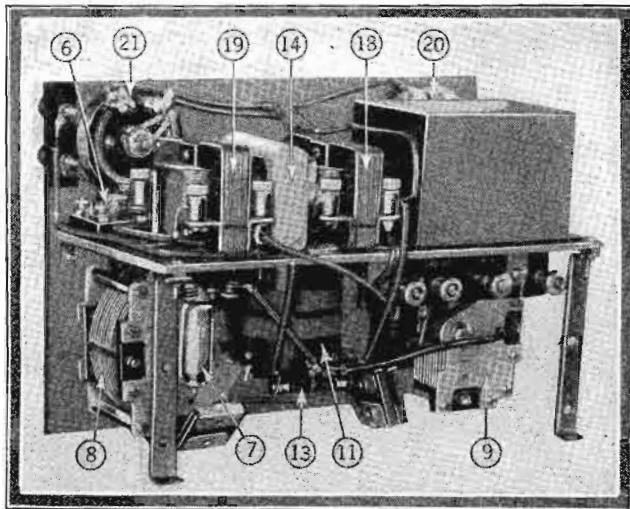

The interior of the receiver is as neat and compact as the outside appearance suggests. It may look a little crowded, but that must be expected after putting seven tubes and the associated apparatus in such a small space.

ing posts will come between two tubes without touching the tubes. The back view photo shows this clearly. The filament switch is in the center, at the top.

The top back view shows six small, 1-inch sockets for the "N" tubes mounted on the sub-base next to the panel. The right end of the base holds the 60 K.C. intermediate R.F. transformer unit, which is very efficient and compact. Next to the unit can be seen two audio frequency transformers; use the low ratio 3-1. A 4½-volt "C" battery can be seen between the two transformers.

The back and bottom view shows the tube and socket mounted underneath the sub-base; next to this is the oscillator coupler. This tube is the oscillator tube, and both it and the coupler are placed directly behind the oscillator variable condenser, making the oscillator wiring very short. The grid condenser and leak for the first detector can be seen connected to the spring, supporting the rotor of the oscillator coupler. The two fixed condensers of .006 and .002 connected together, which can be seen near the grid condenser, are connected across the filter of the intermediate transformer unit. These two condensers are connected to one terminal of ½ mfd. by-pass condenser which, in turn, is fastened under the sub-base. Another by-pass condenser can be seen lying against the main panel. The other variable condenser serves to tune the loop or antenna coupler. The second detector grid-condenser and leak are mounted underneath the sub-base between the oscillator coupler and the main panel. The photo does not show this.

ASSEMBLING THE SET

To assemble the set, mount the two variable condensers and the small condenser first, mounting the variable condensers as low down as possible, especially if 199 tubes are used. Tackle the sub-base next. On one side mount the six tube sockets, as near the edge and as far apart as possible. The 60 K.C. transformer measures 4¼ x 2½ x 2¼ inches, and is mounted with the A.F. transformers behind the sockets. Before proceeding to mount anything on the under side of the sub-base, mount the base on two long brackets directly on top of the two variable condensers. Having mounted this base, proceed to locate the position underneath the sub-base for the various parts to

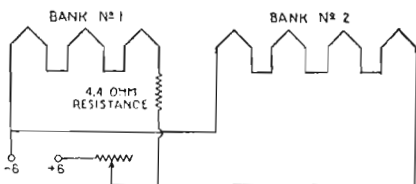

This shows how the tubes and rheostats are connected in order to control R.F. and A.F. separately.

be mounted, so that they will clear the rotary plates of the variable condensers. The photographs show how this is done. With base still mounted, place tubes in sockets, and locate positions for rheostat, potentiometer and filament switch so that they will clear the tubes.

In wiring the set, use No. 22 wire, covered

wire four of them in series for use on a 6-volt supply. Since there are seven tubes, they will have to be connected in two banks of four and three, in series parallel. Since one bank has one more tube, it will be necessary to place a 4.4-ohm resistance in series with the 3-tube bank so that one rheostat may control both banks and permit an equal division of current in each bank. (See diagram for filament number.) The total current consumption is ½ amp. at 5-6 volts. It is, therefore, practical to use four dry cells connected in series. If 199 tubes are used connect them all in parallel for three dry cell supply. This is an advantage when using the 199 tubes. If the "N" or WD12 tubes are connected in parallel, 1¼ amps. will be required. This prohibits the use of dry cells.

The writer's set was completely shielded, cabinet was copper lined, panel and sub-base were copper-shielded. This was found to be superfluous and the cause of considerable trouble. It is, therefore, suggested that shielding be eliminated since the R.F. transformers are shielded, and their container may be grounded, with by-pass condenser cans, etc. Shielding may be helpful, but the trouble required to keep the various parts from grounding to the shielding makes it hardly worth the trouble.

THE LOOP

Most loops on the market have entirely

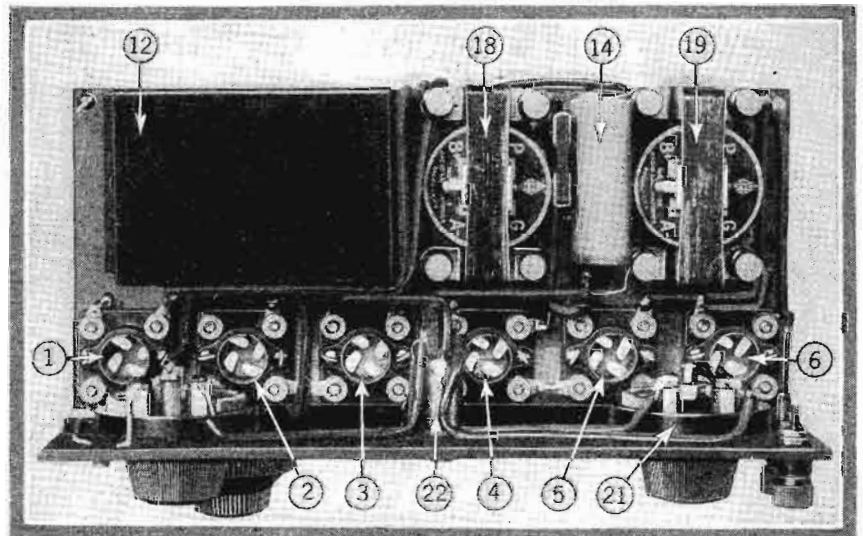

The down-view shows the general arrangement of the apparatus in the receiver above the sub-panel. The numbers are the same as in the wiring diagram.

with spaghetti. Make the leads as direct as possible. There isn't room enough for square bends. Use resin-core solder only. In wiring the filament circuit, the following should be taken into consideration: If "N" or WD12 tubes are used, it's possible to

too many turns for use with a .0005 mfd. condenser. If, when using the loop, it is found impossible to tune the shorter waves and the long waves can be tuned in without using nearly all of the condenser, the loop

(Continued on page 1222)

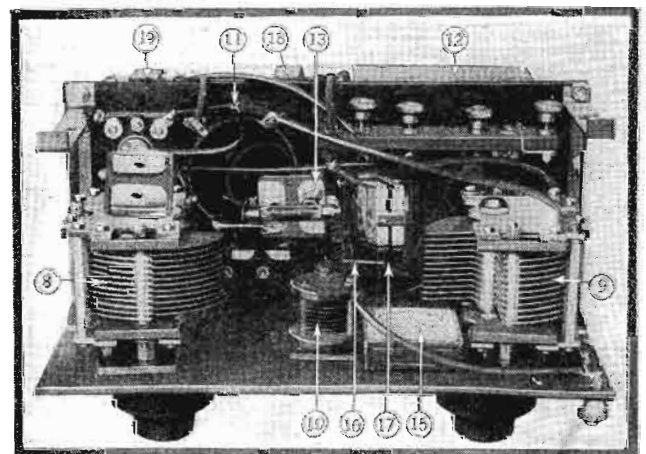

The set looking from the bottom upwards toward the sub-panel. Note the compact arrangement of all the parts. The numbers on the photograph correspond with those on the wiring diagram on the preceding page.

The Browning-Drake Regenaformer

By VOLNEY D. HURD

The Browning-Drake receiver has acquired considerable popularity throughout the country, so that an article dealing with recent improvements in this circuit will be welcomed by our readers. Full descriptions of the circuit are given, which will enable the reader to duplicate Mr. Hurd's receiver, while the non-technical explanation of its theory tells clearly how the receiver works.

AFTER all is said and done, the prime requisite in radio is a set that will prove to have good quality on the audio end and have sufficient radio frequency amplification to get down to the "static level." We will not discuss audio amplification, since that has been handled at length in this magazine. Any type of good audio amplification may be applied to the set under consideration.

This brings us to the sensitivity of a receiver. The static level has been described many times as a wall beyond which no reception is possible. In other words, a set may be so sensitive that the station between the receiver and the desired broadcast station is louder than the program being sent out. It is quite desirable that a set should be sensitive enough to get down to this level. Beyond this point the only result will be noise. This has been borne out by thousands of experiments with super-sensitive receivers.

The set we are about to describe is sensitive enough to get down to this level and does so with a minimum amount of tubes and apparatus in keeping with good tone quality. It has been found that the greatest losses in radio frequency amplification have

that is necessary in order to get down to the static level. It is just this very transformer that has finally been developed by two Harvard University Engineering School Research Fellows, Frederick H. Drake and G. H. Browning.

The method they used in attacking the problem of obtaining the correct design of the tuned radio frequency transformer was unusual, as well as interesting. The circuit shown in Fig. 1, which comprises a tube as a radio frequency amplifier and a tuned transformer, was attacked from a theoretical standpoint, and the circuit completely solved mathematically. The theory predicted the correct constants for maximum amplification, but it was only after a slot-wound primary had been adopted that 90 per cent. of the predicted amplification was obtained.

The capacity coupling between the primary and secondary was the cause of most transformer losses. In order to get a large amount of energy into the secondary, a great number of turns should be wound on the primary. If these should be wound according to the regular practice, such as directly underneath or on top of the secondary, the capacity coupling would undo all the good

The controls are cut down to a comfortable minimum, since only two tuning controls are used. The transformer tunes very sharply, and gives an amplification with a tube, such as was mentioned before, of about ten or twelve compared with the three or four of an ordinary transformer. The sharpness of the tuning is further augmented by the introduction of regeneration, which not only increases the sensitivity of this particular circuit, but also aids in sharpening up the tuning. The first tube not only acts as an amplifier, but also as a blocking tube, preventing the neighbors from being disturbed by radiation.

The antenna system utilizes a tapped coil and a small condenser in series with the antenna itself. This also makes the first circuit tune quite sharply. With the addition of a good audio amplifier, we have, therefore, a set that is as sensitive as possible within the limits of practicality, which is selective and which is simple to tune. In addition, the combination of constants used seems to produce an unusually good quality of tone which, when put through a good audio amplifier, gives an accurate reproduction of the original program.

We can hardly take space at this point

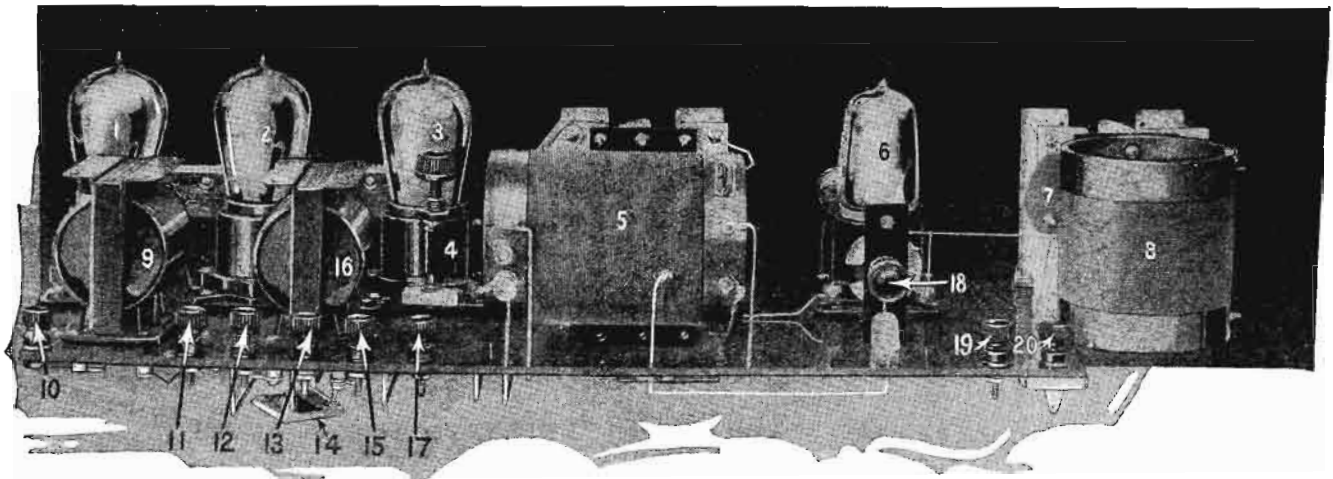

The general layout of apparatus is seen above: 1, 2, A.F. Amplifier Tubes; 3, Detector Tube; 4, Grid Leak and Grid Condenser; 6, R.F. Amplifier Tube; 7, Tuning Condenser; 8, Antenna Coil; 9, 16, A.F. Transformers; 5, Regenaformer; 18, Balancing Condenser; 14, By-Pass Condenser; 19, Ground; 20, Antenna. The other binding posts are shown in the illustration on the following page.

ordinarily been transformer losses. We don't mean by this the so-called "low-loss" coil, as it has been explained in the radio press of recent months. We are dealing with the transfer of energy from the primary to the secondary of a radio frequency transformer. Although we get an amplification of, say, seven or eight in an ordinary tube, the actual amplification which gets over into the grid circuit of the next tube with a tuned transformer drops to about three or less.

DEVELOPING THE CIRCUIT

We know a regenerative detector gives extremely high radio frequency amplification and is an extremely economical method of utilizing the ever necessary detector tube. The writers have felt that a radio frequency tube placed ahead of a regenerative detector using a truly efficient transformer that actually gives a step-up will prove to be all

that had been achieved by using these extra turns. Capacity coupling may be described as the condenser effect between the primary and the secondary of the radio frequency transformer; that is, the primary acts as one plate of a condenser, and the secondary as the other. The problem to be solved was, therefore, a question of using the necessary number of turns on the primary, still keeping the capacity coupling very small and, at the same time, having the co-efficient of coupling relatively high. This was finally achieved after much experimental work by winding the primary in a narrow groove with fine wire. Thus the primary became a closely bunched inductance, giving but little capacity coupling, and at the same time effecting a relatively high degree of coupling. With this transformer, a sensitive set was developed, a set sensitive enough to get down to our old friend, "static level."

to discuss results with this set, except in a very brief way. Thousands of these have been made by experimenters throughout the country, and the only set with which it is compared is the super-heterodyne. It may be used very successfully on an extremely short antenna, say thirty or forty feet. As to distance reception, it is sufficient to say that verified reception has been obtained by Mr. L. D. Yont, located in Boston, from KGO, Oakland, Calif.; KHJ, Los Angeles, Calif.; Mexico City; Calgary, Canada and Madrid, Spain.

CONSTRUCTIONAL DATA

The layout of the parts entering into the complete receiver has been so planned as to make the connecting leads as short as possible. Thus, the R.F. amplifier tube is placed between the antenna tuning system and the regenaformer, while the three other tubes are placed at the right of the second

Duo-Wave-Range Receiver

By JOSEPH BERNSELY



Broadcasting abroad is not confined to as narrow a band of wave-lengths as it is in America. In order to receive some of the foreign stations it is necessary to tune as high as 2000 meters. In this article, Mr. Bernsley describes a four-tube set equipped with a switching arrangement that allows it to be used over the entire wave-length range of from 200 to 2000 meters.



IT SEEMS that in the present stage of receiver construction, a certain set method of design is being universally employed by radio constructors. This is especially true where the wave-length range is concerned, the most commonly used being approximately from 200 or 225 to 550 meters.

(Transmission experimental; wave-length only approximate.)

DS	Iroquois, Canada	1590
DT	Twin Falls, Ontario	1590
5XX	Daventry, England	1600
CD	(Replaces Chelmsford, 2LO; relay)	
	Ocean Falls, B. C.	1600
	Issy sur Molineaux, Fr.	1600
HFF	Belgrade, Yugoslavia	1625
EGC	Madrid, Spain	1650
	Rakovitza, Yugoslavia	1650
GED	Croyden, England	1680

Besides the above, there are numerous commercial-code stations, which transmit press and weather reports, sometimes using a speed of from eight to fifteen words a minute, which gives the would-be amateur an excellent opportunity to learn how to copy code.

Such practice as this is greatly to be desired, as the precision transmission, often by special sending machines of the Morkrum or Creed type, cannot be excelled in accuracy and, when manual comparison is made, cannot even be equalled.

The aspiring amateur operator will not be satisfied until he (or she) has tried the wrinkle described below.

A SUBCONSCIOUS EDUCATION

Head-phones are donned a short time before retiring. A station sending machine code, at a rate not too much in excess of the abilities of the tyro, is tuned in. After retiring, still with the headphones on, code instruction continues, automatically, while the pupil sleeps. The main requisite is to find a soft spot on the pillow that will permit one to sleep while wearing the "cans" (as old operators call the head receivers).

This is a new method for improving speed in the reception of code signals. The navy and other interested government departments have given the idea a thorough try-out, and as a result it now bears the coveted stamp of approval of the government. It is probably due directly to this official approbation that civilian radio schools have adopted the scheme, with instant and satisfactory results. Of course, it is necessary to tune in a code station which, from experience, is known to be rather sure to transmit for a long period. Many of these long-wave code stations transmit "press" and other matter of a continuous and understandable nature (as distinguished from cipher messages and special transmissions, unintelligible as straight "copy" to the listener) for almost twenty-four hours without stopping.

LONG WAVES AND THE SUPER-HETERODYNE

It is also well known to the experienced radio man that much greater distances are attained by those stations which transmit at the higher wave-lengths, than those using the shorter. This is undoubtedly due to the increased efficiency of a transmitter at the lower frequencies; and also due to the greater amplification of a signal at the ra-

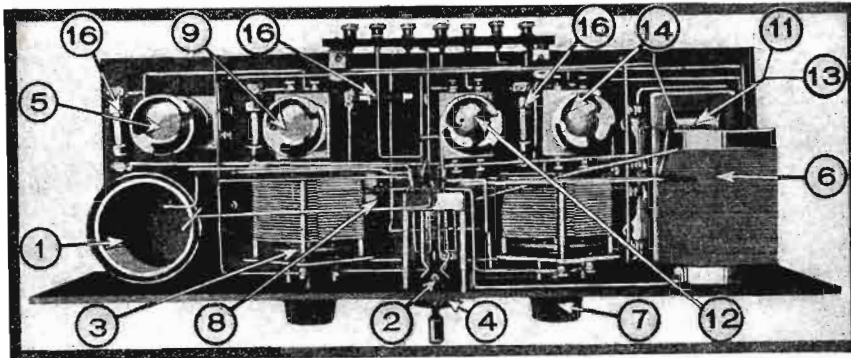

Top view of the receiver. An accurate idea of the layout of the parts can be obtained by comparing the numbers of the parts with those of the schematic diagram.

most of the broadcast stations in this country, the real DX listener-in, who attempts to receive foreign stations, will be interested to know that a good deal of their broadcasting is done on the higher wave-lengths, by which we mean within approximately 1,000 to 2,000 meters. The writer, before beginning on the design of this receiver gathered together all the available data on foreign broadcast stations and the following list was compiled:

SFR	Clichy (Radio Paris), Fr.	1780
8AJ	Paris, France	1780
KAV	Norddeich, Germany	1800
OKB	Brunn, Czechoslovakia	1800
DV	Victoriaville, Que., Can.	1900
DW	Gouin Dam, Que., Can.	1900
DX	Quebec, Canada	1900
DY	Thetford Mines, Quebec, Can.	1900

INTERNATIONAL LIST OF STATIONS

Call	Station	Wave-length
OKP	Prague, Czechoslovakia	550
YN	Lyons, France	550
PRG	Prague, Czechoslovakia	570
CD	Ocean Falls, B. C.	600
OHW	Vienna, Austria	600
SPE	Rio de Janeiro, Brazil, S. A.	600
	Honegg, Switzerland	650
	Zurich, Switzerland	650
SASD	Sundsvall, Sweden	680
	Berlin, Germany	750
	Copenhagen, Denmark	775
	(Closed for repairs—see Ryvang)	
2BZ	Calcutta, India	800
	Kiev, Russia	850
	(All announcements in "Ido")	
HB2	Lausanne, Switzerland	850
	(Aerodrome Station)	
FND	Dijon, France	900
	Abbeville, France	900
	Leningrad, Russia	940
MTI	Budapest, Hungary	950
HB	Budapest, Hungary	950
	(Ryvang Relay)	
	Odense, Denmark	950
	Moscow (Sokolniki Station), Russia	1010
PX9	Amsterdam, Holland	1050
NSF	Hilversum, Holland	1050
PCMM	Ynuiden, Holland	1050
HDO	Hilversum, Holland	1060
PCGG	The Hague, Holland	1070
HBI	Geneva, Switzerland	1100
HB1	Lausanne, Switzerland	1100
HBK	Kloten, Switzerland	1100
RAV	Haeren, Belgium	1100
2FC	Sydney, Australia	1100
	Ryvang, Denmark	1150
	(Substitute for Copenhagen)	
EBX	Cartagena, Spain	1200
	Hjorring, Denmark	1250
	(Ryvang Relay)	
6WF	Perth, Australia	1250
LP	Berlin, Germany	1300
	(Konigswusterhausen Station)	
SASE	Boden, Sweden	1370
RDW	Moscow (Central Station), Russia	1450
NRD	Toulouse, France	1525
	(Aerodrome Station)	
2XAH	Schenectady, N. Y.	1532

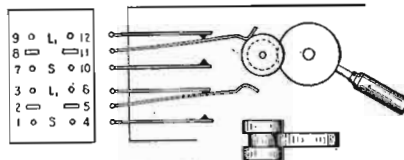

This switch is the entire secret of the two range idea. The numbers indicate the connections.

Eighteen nations and even a larger number of different peoples are represented by this list. It is surprising, to one accustomed to working at lower wave-lengths, how clear reception is from these stations. Of course, it is to be understood that listeners in different localities, different countries, will hear different aggregations of stations.

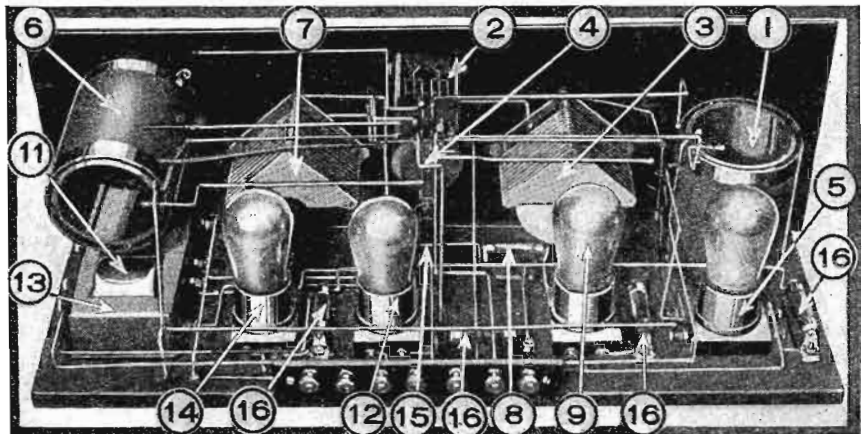

Another view of the receiver. Where the nature of instrument is not clear, it may be determined by comparing the number with that of the schematic diagram.

dio frequency attained at the higher wave-lengths, which mainly accounts for the widely popular acceptance of the super-heterodyne circuit, as an extremely efficient receiver.

It is advisable to point out here that the super-heterodyne has an amplifier unit, called the "intermediate frequency amplifier," designed to respond to only one frequency, 30 kilocycles (or 10,000 meters). The tuning unit, however, is ordinarily designed to cover no wider band than 50 to 1,000 meters, it being considered of no value to construct a super-heterodyne to work on wave-lengths above 1,000 meters.

Tuned radio frequency amplification is admittedly the best alternative under these conditions and, since it was a case of "Hobson's choice," tuned radio frequency amplification was decided upon to fill the requirements.

THE DUO-WAVE RECEIVER

While an efficient super-heterodyne would have two oscillator dial settings for most stations, the set described has only one setting of either variable condenser for a given station.

Concerning the design of the receiver: a stage of tuned radio frequency amplification is used to obtain selectivity and increased signal strength. A detector and conventional two-stage audio amplifier follows. The difference of this receiver from all other "all wave" receivers is in the simple, but extremely efficient, method of changing from one wave-length range to the other. Simplicity of tuning was a prime consideration, resulting in the layout and parts shown in the illustrations. Variable-grid biasing control of oscillation by potentiometer was used in the receiver shown, affording complete control of circuit regeneration and, in consequence, selectivity and sensitivity.

TUNING TO THE HIGH WAVE-LENGTHS

A Federal anti-capacity switch consisting of two double-pole double-throw arrangements, is used for adjusting to either of the two wave-length ranges of the set. When the switch is on one side the range is from 200 to 600 meters; when it is thrown to the other side the wave-length range of 550 to 2,000 meters is obtainable. This is accomplished by changing the inductance values; the capacities of the condensers remaining constant, an increase in primary and secondary windings of each circuit enables the receiver to tune to the higher wave-lengths.

It is evident to set designers that neither the aerial coil primary or detector coil primary values could remain fixed if the secondary range was varied to either of the extreme

The front appearance of the receiver. The two little knobs below the dials are for obtaining vernier adjustments.

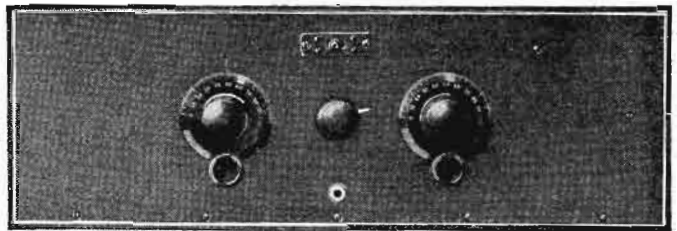

values obtainable in the receiver under discussion. The determination of the exact values for the primary coils for both wave-lengths and their inductive relation to their respective secondaries was the most difficult part of the problem; since too loose primary-secondary coupling, or a wrong primary-secondary turns-ratio for either band resulted in erratic operation, the most com-

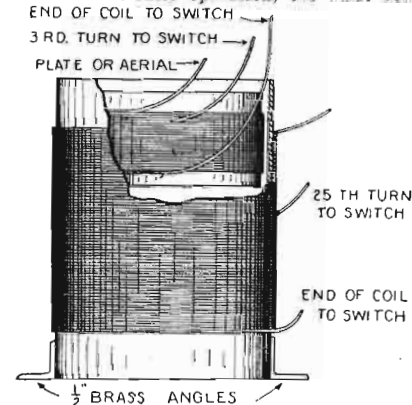

Constructional details of both coils in the Duo-Range Receiver. The primary winding is placed within the secondary.

mon effect being clear, weak signals at one end of a given range and distorted reception at the other end of that range due to strong and uncontrollable circuit oscillation.

PARTS NEEDED FOR THIS SET

- The list of parts necessary to build this receiver is as follows:
 2 .001 low-loss variable condensers
 1 Federal anti-capacity switch, two-double pole double-throw type
 1 400-ohm potentiometer
 1 single circuit filament control jack
 4 amperites
 4 sockets
 1 .00025 grid condenser
 1 2-megohm grid leak

2 audio frequency transformers; 6 to 1 ratio for first stage, 3 or 3 1/2 to 1 ratio for second stage

- 1 1/2 16. spool of No. 22 D.S.C. wire
- 2 4-inch lengths of bakelite wire tubing, three inches in diameter.
- 2 2-inch lengths of bakelite tubing, 2 3/4 in. in diameter
- 1 7 by 21 bakelite panel
- 2 vernier dials
- 1 binding-post terminal block.

Miscellaneous, such as bus-bar, spaghetti, wood screws, etc.

It may be advisable to state that the constant filament-current devices (amperites) used are obtainable for use with any of the standard tubes on the market; the ones in this set being of the 1/4-ampere size, for use with 6-volt, 1/4-ampere filament tubes.

WINDING DIRECTIONS

The primary and secondary coils are both wound in the same direction, the secondary winding consisting of 130 turns and tapped at the 25th turn. Both secondary coils are wound similarly. The primary has 35 turns, with a tap at the third turn; both primary coils are wound similarly. The end of the coil nearest the tap will be considered the grid end, and the primary coil is mounted within the secondary coil so that the end of the primary coil nearest the tap (third turn) is opposite the grid end of the secondary coil. This is specifically shown in Fig. 1.

ADJUSTMENT OF THE RECEIVER

It must be remembered that the switch must be either on the left or the right side for reception. The contact points of the switch are open when the knob is perpendicular to the panel, thus creating open circuits in the tuning portion of the set. All four tubes should light when the head phones or loud speaker (preferably head phones for initial test) are plugged into the jack; due, of course, to the filament circuit being controlled by the switch portion of the jack. The initial test should be made on local broadcast stations. Note how the reception increases

(Continued on page 1208)

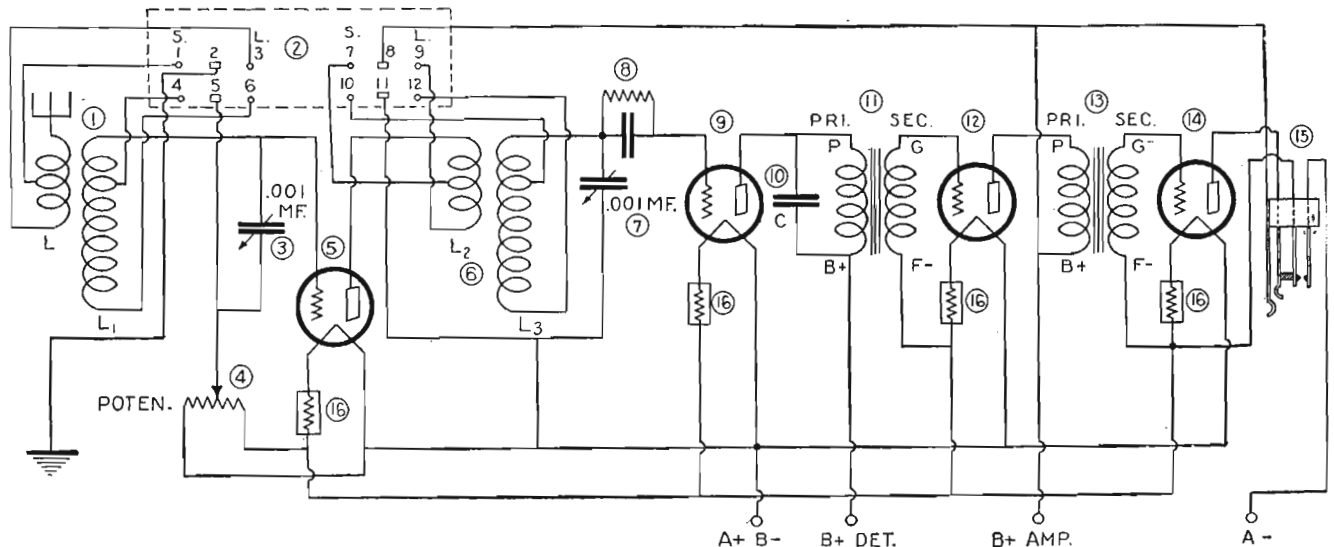

Schematic diagram of the Duo-Range Receiver. (1) antenna coil; (2) anti-capacity switch; (3) .001 variable condenser; (4) 400-ohm potentiometer; (5) first tube socket; (6) inductance coils; (7) .001 variable condenser; (8) .00025 grid condenser, 2 megohm grid leak; (9) second tube socket; (10) .001 mfd. fixed condenser; (11) first audio frequency transformer; (12) third tube socket; (13) second audio frequency transformer; (14) fourth tube socket; (15) single circuit filament control jack; (16) automatic resistances.

A Balanced Reflex Circuit

By L. W. HATRY



In the past, users of reflex circuits have come to realize that "You can't get something for nothing," as any saving in the number of tubes and in current consumption was balanced by the uncontrollable squeals and the distortion to which such sets were subject. In this article, Mr. Hatry casts some doubt upon the truth of the old adage; for his novel method of reflexing does away with the most outstanding faults of the old circuits.



THE troubles that have accompanied reflexing do not have to be enumerated. The howling, queer actions, instability and distortion, as well as occasional surprising performances, have been sufficient commentary. The reflex has been the bad boy of radio.

The circuit of the set of the illustrations and Fig. 3 is one devised by the writer. To one familiar with circuits it acts in a normal and rational manner. It will howl when not neutralized, but even that is normal and understandable. It will not howl when adjusted rightly. At least it is new and it works. Try it.

THE CIRCUIT

The essentials of the circuit, wherein it differs from others for the technical man, are covered in Fig. 1 (page 1206). It will be seen immediately that the usual fixed condenser of reflex circuits is not connected in the filament return. It becomes a grid condenser, in the sense in which that term is usually understood. It is a blocking condenser to isolate the audio currents from the low resistance path of the R.F. transformer secondary; and, at the same time, it is the pass condenser for the R.F. energy to the grid of the same tube. This grid condenser is in shunt to the audio transformer secondary and, therefore, must be of very small capacity. If the capacity is very large bad distortion results. Blocking of the tube is prevented, because the audio transformer secondary provides the grid-leak resistance.

Before going further with the description, a word about the evolution of the above circuit would probably be interesting. Fig. 2a shows the usual reflex grid circuit. It has two disadvantages: the condenser across the secondary of the audio transformer has to be relatively large to provide sufficient conductance for R.F. currents; at the same time it has to be too small.

It has to be too small, because it introduces distortion in being across the A.F. transformer, so that as small a size as possible must be used. The small size results in the audio transformer taking more R.F. energy than necessary. This leaks back into the other circuits, resulting in instability, distortion, grumblings, unexpected oscillation and other foolishness.

The writer's first step to eliminate feed-

backs was to isolate the audio transformer from R.F. energy completely, by the use of an R.F. choke, as in Fig. 2b. This stabilized the action of the reflex remarkably. After that the successive steps were quite obvious. Since distortion was caused mainly, providing pretty good transformers, by the size of the condenser, C being too large, a reduction of their capacity was in order. These were tried with luck down to .00005 mfd. Finally the condenser was removed entirely, as in 2c. The step to 2d is obvious. Without a condenser, the circuit capacity serves to return the R.F. energy to the filament. To overcome the hand-capacity effect the final circuit of Fig. 1 was devised. The grid condenser has a capacity of .00005 mfd. It can be seen how logically the final circuit came up. This final circuit did not come to the writer's mind until assembly of the set of this article had begun.

THE THREE-TUBE CIRCUIT

The three-tube circuit, as described, is shown in Fig. 3. Its result is that of a five-tube set.

Two stages of tuned R. F. amplification with a tube detector, and reflexed two stages of audio amplification result.

Complete freedom from distortion is practically impossible. Audio transformers are not made with perfectly straight-line voltage-frequency curves over the useful audio ranges. If there were such a transformer we might hope to build an absolutely distortionless reflex, with any number of stages in reason. As it is, to build a reflex with more than two audio and radio stages reflexed, and yet not incur mixed quality, is "some" job. The building of the three-tube set, however, is not difficult and the quality of reproduction will very likely surprise reflex users. Two ways were found to serve with satisfactory dependability: a detector of the normal sort with a .0001 mfd grid condenser and a 100,000-ohm grid leak (.1 megohm); or the detector without a grid leak and condenser, with 45 or 67½ volts "B" and with the filament return to the negative leg. With the grid condenser the detector used 22½ volts "B" as usual. These dimensions are for the 201A tube. The 199 tube is not big enough for a good reflex amplifier in any of several reflexed stages, so that it was not tried for anything. It

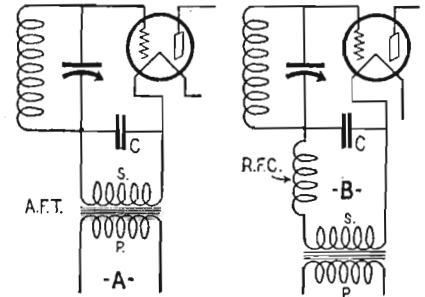
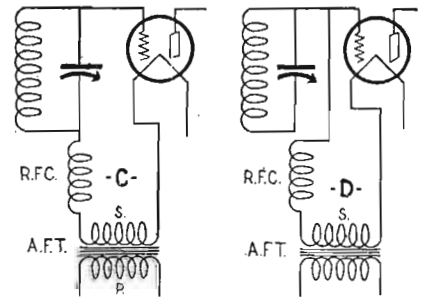

FIG. 2



These four diagrams trace the evolution of the grid circuit of a reflex receiver. The final circuit eliminates the by-pass condenser, as may be seen in the diagram on page 1206.

is probable that the same things would be true of the 199, for it acts much as the 201A as a detector.

The proper operation of the tubes is partly provided for through the use of the correct "C" battery values. With conditions of that sort the excessive load on the "B" battery is removed and the distortion resulting from overloaded tubes does not result. These last two can best be remembered from neodyne days, when five tubes would soak up a set of ordinary "B" batteries within one month, sometimes. The three tubes of this reflex absorb less energy than the five-tube neodyne, with proper "C" battery potentials, insofar as the "B" battery is concerned, and yet seem to give practically equal results.

However, there is no desire to claim anything for this circuit, save that it is certain to act more sensibly and reproduce with less distortion than any other reflex circuit extant using the same materials.

THE R.F. CHOKES

It may seem odd to start the more con-

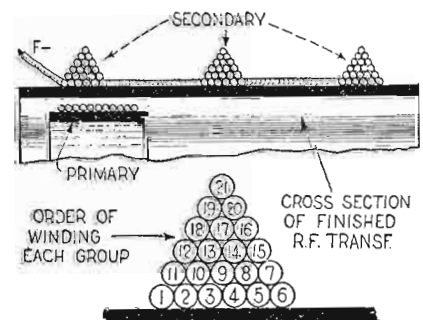

The numbers on the illustration at the left correspond with those on the circuit diagram on the opposite page. Note the simplicity of the wiring, usually so complex in a reflex receiver.

Fig. 5. The coupling transformers have primaries of nine turns on a separate tube, and secondaries layer-wound in three groups.

FIG. 5

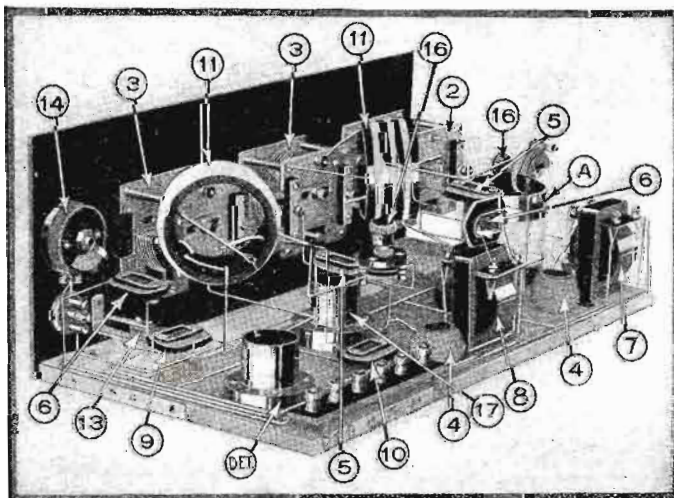

structional part of the article with reference to what seems a detail of the circuit. Yet these little chokes can make or break the set. They can waste or conserve all of the energy. It is important that the specification given herein be adhered to, unless you possess the knowledge of principles and electric action that will permit you to change these as you wish. At the same time, *don't* misunderstand me to forbid experimentation.

These chokes consist of 1,000 turns of very fine wire wound in a jumbled fashion. No attempt should be made to wind the choke in layers, or even. To make it compact it is necessary that it be wound in a bunch, and to make it effective the bunch should be disheveled. The inside diameter of the choke is one inch or more. I used a piece of broomstick handle for each winding form but tubing, cardboard or moulded material will be just as good. Fig. 4 (page 1206) shows the choke and the way it was mounted. The chokes should be kept well away from the tuned R.F. transformers—an easy thing to accomplish—or else, if they must be close, mounted at right angles to the R.F. transformer. If the chokes are separated by several times their diameter, both can be mounted vertically; but otherwise they should be mounted at right angles to each other.

THE R.F. TRANSFORMERS

There are three R.F. transformers. The antenna-coupler forms one, being an auto-transformer. The inter-stage coupler forms the second, and the detector-coupler the third. The latter two are inductive transformers of a quite normal sort; i. e., in function. The appearance of the secondaries of the inductive transformers may be puzzling, because of the special form of winding. This mode of winding is not necessary and is troublesome to make besides. As a coil experiment on my part it was justified, but as a specification of this reflex it is not. Any ordinary tuned R.F. transformer is satisfactory for the circuit, although dimensions of those used are given. Of course, R.F. transformers not well designed will not give maximum satisfaction. That is taken care of by the furnishing of specifications for R.F. transformers later in this article.

CONSTRUCTIONAL DATA

The antenna-coupler is 50 turns of No. 24 D.C.C. on a three-inch tubing. The inter-

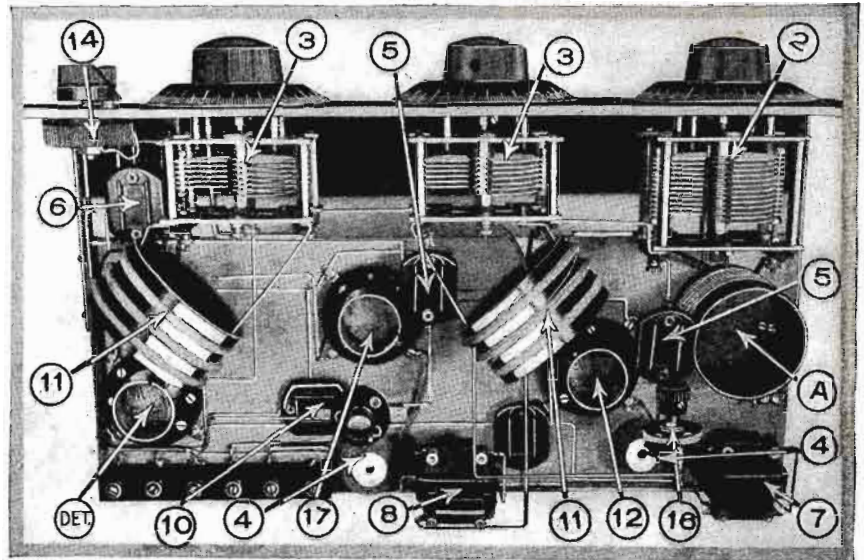

Plan view of the balanced reflex. All numbers correspond to those on the circuit diagram at the bottom of this page. The two radio frequency choke coils, (4-4) are the main features of departure from the usual reflex practise. The first condenser is larger than the other two due to the difference in size of the autoformer, (A) and the transformers (11-11).

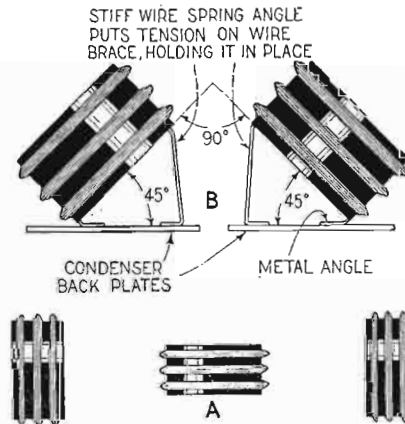

FIG. 6

The method of mounting the radio frequency coupling transformers is shown in this illustration. The secondary is wound in three groups, one of which is closely coupled to the primary, as shown in Fig. 5 on the opposite page.

stage coupler has a primary of 20 turns of No. 34 D.S.C. wound in a lump on tubing small enough to fit inside the 3½-inch diameter secondary form. The secondary was wound of No. 24 D.C.C. wire in three sections. Each section contained 21 turns, being wound according to Fig. 5, and was separated from the next section by ¼ inch. This made a total of 63 turns to the secondary, which was too much. After the set was operating a turn at a time was removed from the secondary until the maximum wave-length tuned by the shunt condenser was 550 meters. The inter-stage coupler secondary only had 48 turns on the secondary as a result; i. e., two full 21-turn sections and one single-layer 6-turn section. This secondary was tapped at 15 turns from the end connected to the filament. The detector-coupler had a primary wound in the same way, but of 15 turns on No. 34 D.S.C. The D.C. secondary consisted of but 53 turns of No. 24 D.C.C.; i. e., two 21-turn sections and a two-layer of 11 turns of the third section.

(Continued on page 1204)

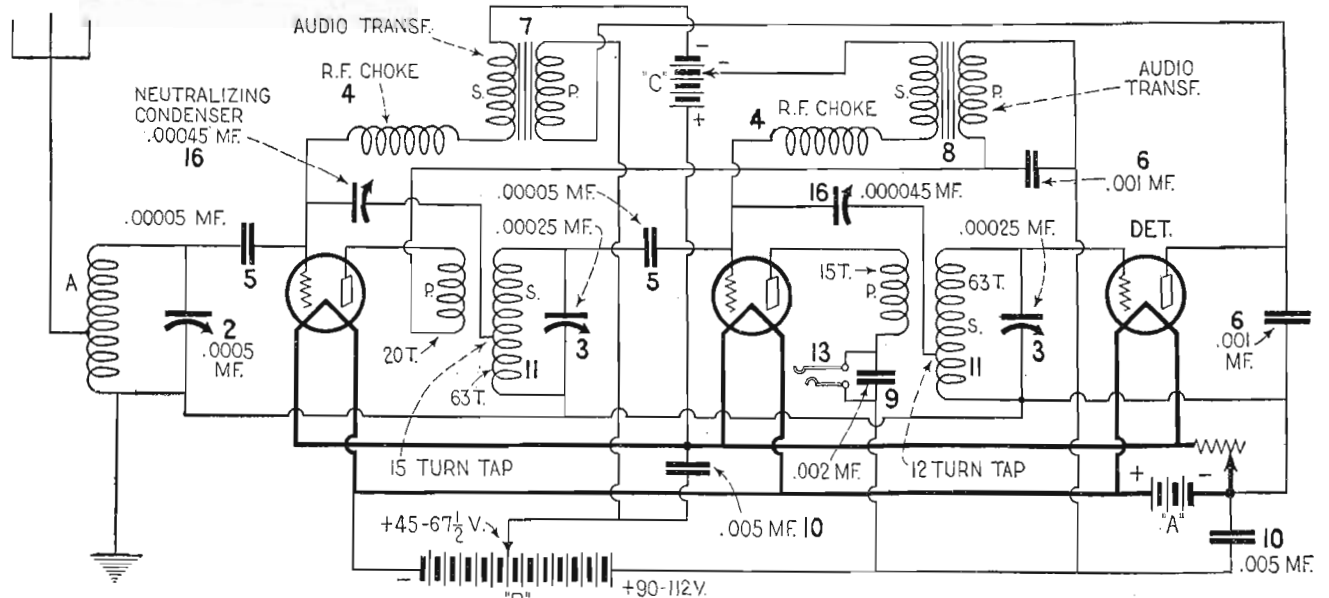

Fig. 3. Complete circuit of the balanced reflex set. (A) antenna autoformer; (2) first tuning condenser, .0005 mf; (3-3) transformer tuning condensers; (4-4) radio frequency choke coils; (5-5) blocking condensers; (6-6) plate circuit bypass condensers; (7-8) audio frequency transformers; (9) phone condenser; (10) battery bypass condenser; (11-11) r.f. coupling transformers; (12-17) amplifying tubes; (13) phone jack; (14) rheostat; (16-16) neutralizing condensers. Notice the manner in which the r. and a.f. circuits are connected in shunt across the grid-filament.



The Radio Beginner

“What Loud Speaker Shall I Buy?”

By A. P. PECK

Here you will find much information that will be of great assistance to you when buying a new loud speaking reproducer for your radio set.

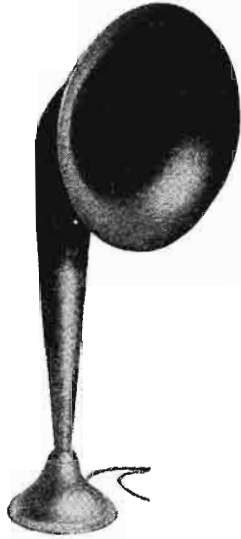

Fig. 3 of conventional type of loud speaker built with a straight enclosed column of air.



Fig. 4. Also a common type of horn loud speaker in which the horn itself is curved.

AT VARIOUS times in these columns the writer has presented various pertinent facts regarding different types of radio receiving sets and parts, but has never before dealt at length with loud speakers in general. There has been a constant demand for information relative to loud speakers; and, from the letters received, the writer has collected a quantity of material and presents here the main details. You will note that all technicalities and difficult terms are omitted, but we believe that the resulting article will aid the prospective purchaser of a loud speaker in making the selection that will be most advantageous to himself.

All loud speakers have their faults and their good points, and we will attempt to point both out in connection with various types of speakers. Before entering into this, however, it will not be amiss to say a few words regarding the propagation of sound waves. We can liken the manner in which sound is transmitted to that in which radio waves go out through the ether; with the exception, however, that sound waves are transmitted through the air and not through the ether, as is the case with radio waves.

Our constant readers will undoubtedly remember the explanation and analogies given in connection with radio wave formation, particularly the one where a tuned string was described. When a string vibrates, it sets up waves in the air, and if it is vibrating throughout its full length, it sets up a wave equal to its own length. This can be seen by referring to the solid line A in Fig. 1. (See page 1176). The dotted line C shows the opposite extreme of the string's movement under vibration. This string is now giving out a sound which is known as its fundamental vibration. However, the string can be made to vibrate in two sections; and in this case, it is said to be operating at its second harmonic. The curve of such a wave form is indicated by the line B in Fig. 1.

IMPORTANCE OF HORN DESIGN

Now let us see how these few facts relate to loud speaker construction. For a few moments we will consider only the horn type, as it is to this that the facts apply. The whole philosophy of loud speaker horns

in general is that, when the diaphragm of the reproducer vibrates in accordance with the sound current set up by the radio set, the column of air contained within the horn is vibrated by the diaphragm and the result is an amplification of sound. If the horn is properly designed, this is true, but if, on the other hand, a poorly-made or incorrectly-designed horn is employed, the results will be most disappointing.

It is obvious that the column of air within the horn vibrates at the same frequency as the diaphragm and, if the diaphragm sets up a wave as long as that indicated by the line A in Fig. 1, a horn that will satisfactorily reproduce this wave must have an air column within it, equal in length to that wave. If loud speaker horns were to be made straight, a horn capable of fine quality reproduction on the longer wave-lengths of sound would be extremely cumbersome in size. Therefore, a good many manufacturers resort to curving the horn so as to get a greater length of air column in a given space and keep the loud speaker from being bulky.

EARLY HORN DESIGN

One of the earliest attempts at this work presented to the radio public is the old-style horn illustrated in Fig. 2. Note the resemblance of this instrument to the old automobile horns that were sounded by pressing a



Fig. 6. A new type of cone loud speaker of free-edge construction, giving excellent reproduction.

Photo courtesy of the Fitch Radio Company.

rubber bulb. This instrument gave rather good reproduction, except that sometimes the metal comprising the horn started to vibrate when some certain frequency of sound wave was reproduced, with the result that distortion was heard. This, of course, was not desirable and soon this type of horn was abandoned for something still better.

Horns went through various stages of evolution and many freak forms were devised. However, they merely bloomed and died a very sudden death, and radio went happily on. Then came the long straight horns, such as the one shown in Fig. 3. This horn was usually constructed of some non-metallic substance, such as fibre or some other compressed material. This was done in order to eliminate any vibration of the horn itself because, as mentioned above, such vibration tends toward distortion.

Many and varied were the tricks that different manufacturers tried to get away from horn vibration. Experiments were made with all kinds of materials, and it was finally decided that a non-metallic horn would give the very best results. However, some manufacturers used aluminum, and when the walls of the horn were made heavy enough, there was little, if any, noticeable distortion from the horn itself. Remember, throughout this entire discussion of horns, that we are dealing with the horn itself, and not with the reproducing element.

The horn illustrated in Fig. 3 was made rather long in order to get a satisfactory length of air column and, in order to reduce the length somewhat, another type of horn was evolved, such as that shown in Fig. 4. In this instrument, the upstanding column of air was formed into a curve by the shape of the horn. Thus the column could be made longer in a given height, and the loud speaker was not quite so bulky.

TESTING THE HORN

To sum up the qualifications of loud speakers of the horn type, disregarding the reproducing unit for a moment, we may say that, in general, a fibre or non-metallic horn which has no natural period of vibration of its own is about the best. To test for a natural period, tap the horn with the fingers. A dull thud should be heard with little or no vibration. In other words, the material should be “dead” as far as vibrations are concerned.

Other manufacturers tried other stunts to produce satisfactory loud speakers, and one of the best of them is illustrated in Fig. 5. This reproducing horn can be made quite small and compact and is graceful in appearance.

(Continued on page 1172)

Solving the Problem of "A" Current Supply

By RAYMOND A. KLOCK*

The author describes a method of combining the best features of both storage batteries and eliminators, through the use of a storage battery and a charger that operates at a low rate all the while the set is not in use. This keeps battery constantly fresh, and at a steady voltage.

THE service records of radio dealers show that approximately 60 per cent. of users' complaints are due, directly or indirectly, to failure of the "A" current supply. It is manifest that a practical device which would materially strengthen this important accessory to the radio set is of great interest alike to the industry and to the user, and it is the purpose of this article to explain how this may be accomplished.

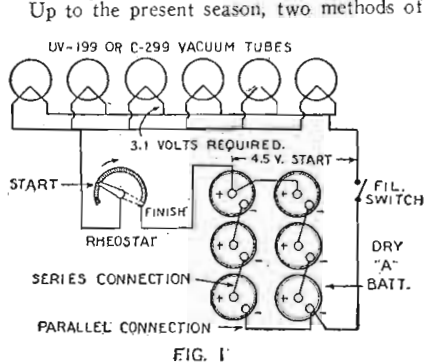

FIG. 1
The usual series-parallel connection for dry "A" cells. This arrangement has the disadvantage of a constantly falling potential. See graph in Fig. 2.

supplying the "A" or filament current have been generally recognized by radio set builders and by vacuum tube manufacturers as standard; one, requiring dry cells for its operation and the other requiring six volts of storage battery which, in turn, necessitates some means of recharging the storage battery.

In general, dry cell equipment of the "A" circuit of the radio set is a necessity where house-lighting current, either from the city mains or from a house-lighting power plant, is not available. Irrespective of developments in "A" current supply from the house-lighting lines, dry battery equipped radio "A" circuits will always be in demand. However, where the home of the user is wired for A.C. electric service, very material advantages in operation are now possible to users of radio sets at present equipped with dry batteries for the "A" current supply.

Since the method we shall describe is of equal advantage to users of storage batteries and, since these advantages apply to practically any make or type of radio set now in use as well as to the new sets offered on the market this year, the reader, whether he uses dry batteries or storage "A" batteries, should profit by careful consideration of the difficulties it overcomes in both types of radio sets.

DRY "A" BATTERY DIFFICULTIES

Fig. 1 shows a typical dry battery "A" circuit in which the tubes are lighted by six dry cells wired three in series and two in parallel. Each new dry cell should register 1½ volts. By connecting the positive of one cell to the negative of the next the voltage of each succeeding cell in a series of three is added to the voltage of the preceding cell so that we have a total of 4½ volts between the first cell terminal, which is A minus, and the third cell terminal, which is A plus. A set of three cells so connected will light six vacuum tubes if they are UV-199 or C-299 or their equivalent, for the time; but the total current drawn by these six tubes is too heavy for three cells and it is necessary to add a

second series of three cells working in parallel with the first three, the negative of one series being connected to the negative of the other and similarly with the positive. With this arrangement, each series of cells takes half of the load and the working life of the battery is thus prolonged. This method of assembly is practically standard at this time for six-tube dry battery equipped radio sets.

Referring to Fig. 2 you will observe that while the tubes require a reasonably constant voltage for normal operation the dry battery unit starts at a voltage much higher than required—which is compensated for by the radio set rheostat—and finally ends up at a voltage too low to operate the tubes. At the finish the rheostats are all the way over. It is important to note that the battery has no fixed voltage value, although the tubes operate at best efficiency at approximately a fixed voltage. Again, while the addition of the second series of batteries theoretically doubles the "A" battery life, it doesn't always do so in fact, because if one cell in either series is low in voltage the current will flow from one series of batteries to the other series, thus reducing the voltage supplied to the radio set. Finally, if all the instruments operating a particular dry battery equipped set are not readjusted when a new set of dry batteries has been installed, tubes are often paralyzed by attempting to operate with the rheostats all the way over.

INSURING AGAINST THESE TROUBLES

Since dry batteries have only a definite number of working hours, failure to turn off the radio set before retiring is, perhaps the most frequent cause of disappointment when the set is wanted the following evening.

A simple, sure method of supplying the

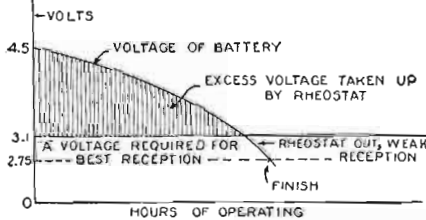

FIG. 2
Dry "A" batteries have an initial voltage considerably higher than is needed, which falls off rapidly in use, as is illustrated in this curve.

exact voltage wanted, when wanted, that will in no way alter the operation of the radio set as originally designed, insuring against the annoyances we have just enumerated, will obviously greatly improve the average reception of radio sets equipped with dry battery tubes.

The storage "A" battery, as commonly

used in radio receiving service, supplies a voltage that is sufficiently constant to operate the hard type of vacuum tube without change in rheostat adjustment for approximately 70 per cent. of its discharge but, referring to Fig. No. 3, it will be noted that there is considerable variation in voltage at both ends of the curve. It will also be noted from this figure that under certain conditions of operation a storage battery may be made to maintain a practically constant voltage at all times—a characteristic that will be discussed more fully later.

Since a storage battery deteriorates when kept for any length of time in a semi-discharged condition, the storage battery user often fails to get either the reception or the battery life possible to his equipment. Radio storage batteries suffer chiefly from undercharge. Scarcely one in a thousand is overcharged.

Since the trend in radio set design is toward more ornamental cabinets, it has become necessary to install the current supply equipment within the cabinet. As the storage battery gives off a small but definite amount of gas it is necessary that provision be made for positive ventilation in such installations.

Many storage battery charging devices, otherwise efficient, are noisy in operation, necessitating installation at a point remote from the radio set, and all require a degree of manipulation and attention apart from the attention required by the "A" storage battery itself.

If we would overcome the difficulties already outlined and secure the advantages of constant voltage in our "A" supply we require a device that will deliver a constant voltage, that is automatic in operation, noiseless, free from power line noises or interference, clean, sightly, safe, free from need of adjustment or replacement of parts and capable of installation in fine furniture.

HOW A CONSTANT VOLTAGE IS OBTAINED

In a wide variety of commercial uses storage batteries have been kept at one voltage constantly, year in and year out, by means of a low continuous charge, which is generally referred to as a "trickle charge." This low rate of charge holds the battery at one voltage at all times (Fig. 3) which is practically the voltage of a freshly charged storage battery during its first five or six hours of operation. This "top of the charge" gives the radio set a pep that is lost as the voltage drops. The value of an apparatus so designed as to take advantage of this time-proven principle of storage battery operation, giving to the radio set a maximum punch at all times, is obvious to every user of an "A" storage battery. To the dry cell user it means the punch of the fresh dry battery.

Fig. 6. A method of adding a "B" eliminating device to the "A" current supply system is shown in this illustration. Notice that the master control switch breaks only one side of the circuit between the power battery circuit and the radio set.

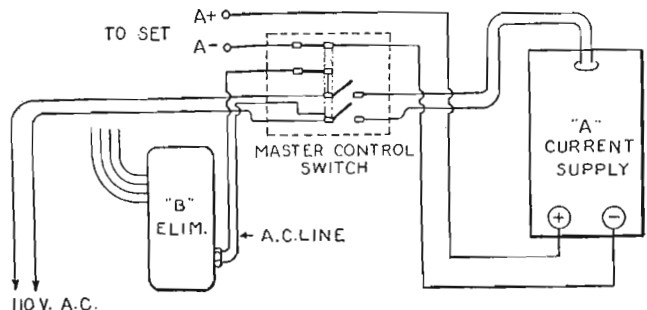

*Radio Dept., Gould Storage Battery Co.

THE CIRCUIT

The circuit by which this is obtained is shown in Fig. 4. No change is necessary in the radio set, the circuit remaining as in Fig. 1. We introduce a master control switch with the device, which is used to turn the radio set off and on in place of the filament switch which is always kept in the "ON" position. This master control switch helps make the system automatic and serves as a terminal for the alternating current line which, in this system is never applied, directly or indirectly, to the radio set. Tracing the "A" radio circuit back to the master control switch, you will note that when the switch is in the "on" position the radio A-plus and A-minus are connected to the terminals of the storage battery, which is a part of the device, and when the switch is in the "off" position the radio A-plus and A-minus terminals are disconnected from the storage battery terminals and the house lighting current from the socket and the house lighting transformer, which is a part of the device, which in turn puts the battery cells on charge.

Let us now trace the charging circuit. The alternating house current from the lamp socket passes through the master control switch, and through the primary of the transformer and thus sets up an alternating current of lower voltage in the transformer secondary, passing thence through a ballast resistance to the negative terminal of an electrolytic rectifier cell. The rectifier cell permits only the positive half of the alternating current to pass through to the positive side of the battery, the current continuing thence to the negative terminals of the battery and back to the transformer. Only a comparatively small amount of current of low voltage is consumed in this operation so that the cost of house-lightning current thus used is nominal.

HOW IT OPERATES

By a proper design of the ballast resistance with reference to the requirements of the radio set and the type of storage battery employed, this system of current supply delivers exactly the same voltage to the radio set every time the switch is turned on, as it takes advantage of the trickle charge principle previously described. When the user is through with the radio set and turns the master control switch to the opposite position the house current replenishes the battery cells and keeps them at full strength at all times. This system thus retains the advantages of the storage battery at its maximum efficiency while normally eliminating the personal factor in its upkeep.

We use the word normally because, as we have already pointed out, the radio set is often left connected to its battery from one evening to the next and provision must be

Fig. 5. A commercial form of "trickle charger", master switch, and battery, combined in one unit. (1) is the master switch, (2) the light plug, (3) the emergency switch, (4) a standard automobile fuse, (5) the cable connecting to the filament binding posts of the set. Photo courtesy of Gould Storage Battery Co.

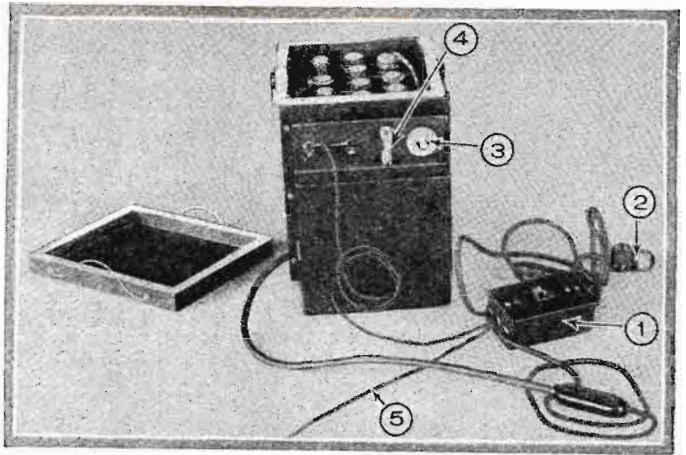

made to supply a heavier charge in case of this or like accidental drain on the current supply. This is done by means of the familiar push-pull switch which, as will be noted in Fig. 4, may be used to cut out the ballast resistance, thus permitting a high charge rate to pass through the battery cells bringing them back to normal in a relatively short time. The push-pull switch is usually restored to its normal position after an overnight charge at the high rate.

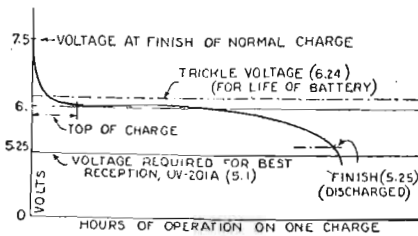

FIG. 3
Unlike the dry cell type, a storage "A" battery has a fairly steady voltage for most of its useful life, but varies sharply at both ends of the graph.

Since this method of installation should maintain a constant voltage, it will be found that the rheostats do not normally require the adjustment that is incident to the usual types of "A" current supply. Hence, if it is found necessary, at any time, to advance the rheostats beyond the normal position the necessity for using the high charge rate is clearly indicated and when the rheostats may be returned to their normal position the user closes the push-pull switch and continues with the normal operation of the current supply, thus eliminating the hydrometer and

similar testing equipment. If the radio set is equipped with a voltmeter, all the better.

ROUTINE ATTENTION

Water must be added at regular intervals to any type of storage battery cell. In order to compel the user to add water before the battery plates are damaged through lack of water the device we describe is so built that the charger will cease to function if the water level drops to the danger point. This addition of water is necessary four or five times a year and since it is the only attention the device requires it is unlikely that the average user would allow the water level to drop until the charge is discontinued but this provision eliminates the possibility of harm to the battery plates through overcharging.

The rectifier cell, which uses acid of the same specific gravity as the battery cells and requires water at the same intervals, is so designed that when the water has evaporated to a point below the negative electrode charging ceases. When water is added to all the cells, charging begins instantly.

HOW IT IS BUILT AND INSTALLED

Fig. 5 shows the complete unit, the control switch being shown at the right. The device proper includes the rectifier and battery cells in one compartment, separately covered by a gas-tight top with a tube which provides an exit for gases incident to operation through the enclosing cabinet wall to the outer air. The shelf front mounts the push-pull switch and the battery terminals together with a fuse which protects the radio set wiring as well as the wiring of the device itself. Underneath this shelf is the transformer and ballast resistance in a compartment completely separate from the battery and rectifier compartment. It will be noted that this device is readily installed within a closed cabinet, it being necessary only to provide for ventilation, for access for the purpose of adding water and for operation of the push-pull switch when necessary.

The master control switch is preferably installed external to the cabinet but is so designed that it may be installed as a flush switch either in the wood wall of the cabinet or on the radio panel itself, provided that care is taken to avoid too close proximity of the lines leading to the lamp socket and the radio frequency circuits.

With the development of various types of "B" current supply sets, it is obvious that a universal type of "A" current supply should be so designed as to permit the addition of a "B" current device, if desired, without complicating the operation of the radio set. This is provided for, as shown in Fig. 6. In this circuit it will be noted that the master control switch breaks one side only of the circuit between the "A" power battery terminals and the radio set. The remaining side of the switch is employed to turn the house

(Continued on page 1180)

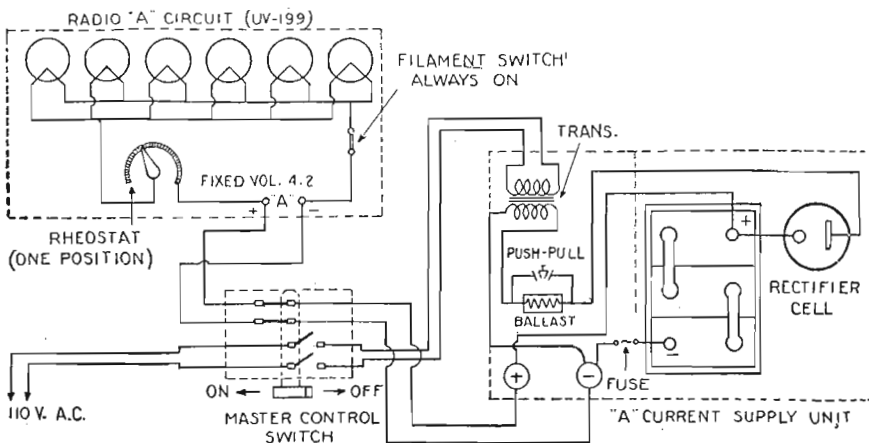

FIG. 4

The arrangement shown in this illustration keeps the storage battery at the "top of the charge" point continually, making it unnecessary to adjust the filament rheostat constantly. Turning the set "off", automatically starts the charger.



About Station Arrangement

By JACK MILLIGRAM

Mr. Milligram divides amateur transmitting stations into three classes, experimental, traffic, and DX, giving hints on the proper arrangement of apparatus in a station of each class.

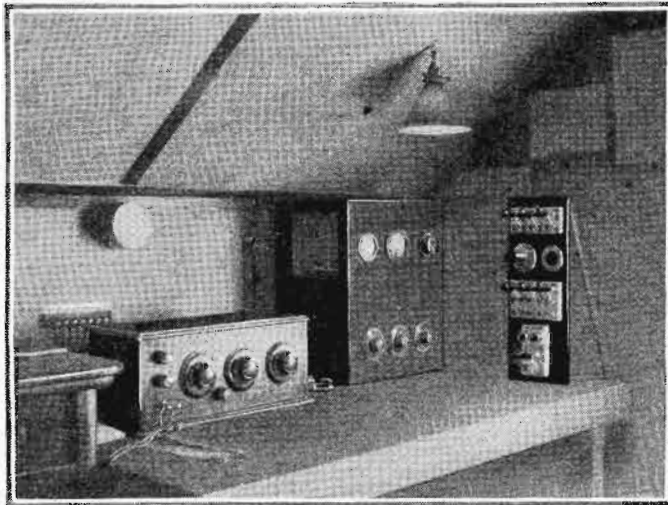

Fig. 1. This is an ideal arrangement for the fellow who is less interested in experimentation than in handling traffic. It is not at all suited, however, to the ham who is continually changing the circuit of his transmitter, nor to the one whose apparatus must be "nursed" carefully in trying for extreme DX.

THERE are a good many things to be said relative to the arrangement of apparatus in ham stations; but, before we go into that particular item in detail, let us see just what ham stations are used for. Generally speaking, there are three different classes of hams. In the first place, there is the operator who delights in sitting in at his apparatus evening after evening, and even into the wee small hours of the morning, trying to work the antipodes. He is the DX hound and that is practically all he cares about in connection with amateur radio. Then for the second class, we have the traffic man. His goal in life seems to be to pile up a big record for traffic handling and he would rather relay a half dozen messages along their way than to eat supper. The third and last general classification includes the experimenter—the man who likes nothing better than to arrange and rearrange his apparatus, and to try out different circuits and fool stunts of his own concoction.

Now it is perfectly obvious, to anyone at all familiar with radio, that these three different classifications of hams are going to need, to a greater or lesser extent, different arrangements of apparatus in their stations, which, of course, can be standardized. However, there are various things to be considered. Some day, the handling of traffic is going to start to bore the traffic man, or the fellow who goes out for DX is going to work the limit and then become dissatisfied.

What are they going to do then?

Probably turn toward experimental work. Now here is where the fun begins. If, for instance, the traffic man has maintained a typical traffic station, he finds that he has hours of work on his hands tearing the transmitter apart so as to bring it into some sort of shape for experimental work. The same applies, to a very great extent, to the DX hound. Undoubtedly both of these classes, when they build their sets, put them together compactly and arranged the various necessary controls on the panel, with the other apparatus in back of that panel. The result is that all of the apparatus is extremely inaccessible and changes are hard to make. For instance, reference to Fig. 1 will show just what is meant. This, we think, is a very neat layout for certain purposes,

but, on the other hand, it is not so good for experimental work.

The receiver is perfectly OK. Every station should have a permanent receiver which can be relied upon to operate satisfactorily under all conditions, whereas other apparatus can be at hand for experimental work. In the case of a transmitter, however, we have a good bit of comparatively expensive apparatus; and to keep duplicates of all of them on hand, so that one set can be permanently arranged and the other fixed for experimental work, is something that the average ham cannot do. In the set shown in Fig. 1, the completed transmitter is located at the right of the receiver, and a battery charging panel appears to the right of the transmitter. For the traffic man who does not want to worry about details, or for the

DX fan who wants to sit in and work continually without worrying about his transmitting apparatus, a layout such as this would be ideal. But so small a thing as substituting a new grid-leak for an old one, or placing a variable leak in the circuit instead of a fixed one, would require quite a little work. The set would have to be disconnected from the power supply and moved from its position. Then it would be necessary to work rather carefully upon it in order to prevent disarranging other apparatus.

This particular layout shown was in use in a ham station in the East for quite some time, but soon the operator started to get restless and the layout did not permit him to make any radical changes without much difficulty. Therefore, the whole matter was thought over carefully, and plans were made for completely rebuilding the transmitter so that it would fulfill the ideals of any one of the three classifications of hams mentioned in the first part of this article. After much designing and redesigning of parts and the collecting together of various ideas covering the construction of transmitters, it was finally decided to place the whole business, oscillator and power supply, together upon one large table so as to be instantly and easily accessible at all times. The final set resulting was that illustrated in Fig. 2. Now we have located the transmitter over

(Continued on page 1214)

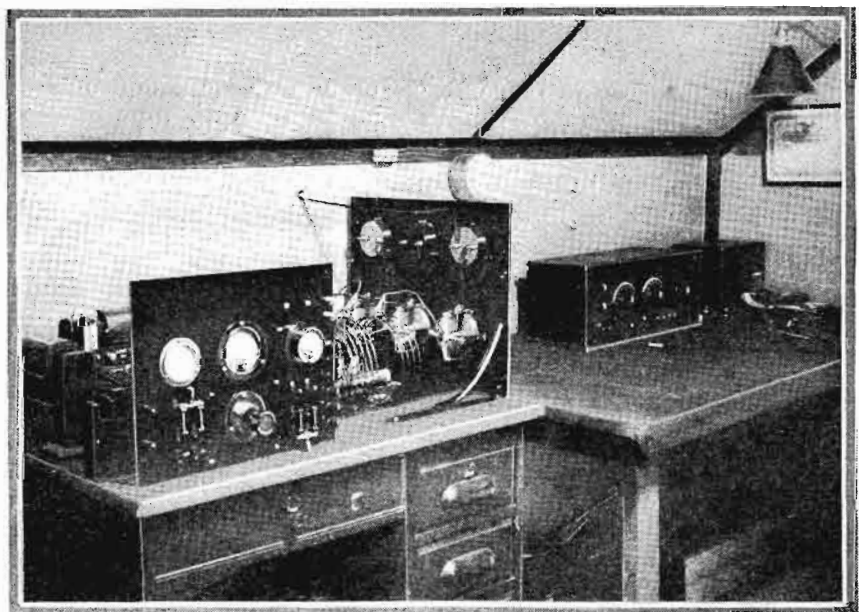

Fig. 2. This layout, with the transmitter made easily accessible on a table of its own, well within reach of the operator's left arm, is good for the experimenter, but is not to be recommended for relay work.

The Improved Isofarad Receiver

By BYRON B. MINNIUM*

In the December issue of RADIO NEWS was presented an article in which constructional details of the Isofarad circuit were given. In this article, an Improved Isofarad circuit is described, with a clear explanation of the theory on which the circuit operates. It is a neutralized circuit, neutralizing being obtained by an all-capacitance bridge, and the main advantage of the system is that all elements which are likely to vary, such as inductance coils, are eliminated from the bridge.



IN ANY form of transformer-coupled radio frequency amplification we are confronted with two immediate problems. Both arise from the use of fairly large inductances in both grid and plate circuits of all the amplifier tubes; and both may be solved by overcoming the same phenomenon, self-oscillation. The first of these problems, from the set owner's point of view, is distortion of signals and various howls that arise in the radio frequency stages.

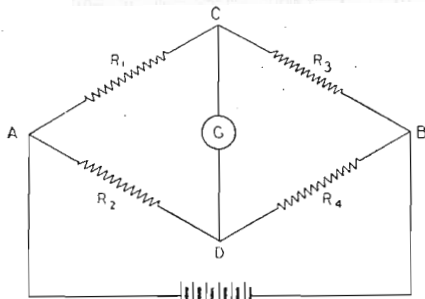

FIG. 1

All bridge circuits can be referred to the classical Wheatstone bridge shown here, which has four resistance arms, a source of voltage and a current-indicating instrument.

The second must cause some concern to the set owner, and a great deal to his neighbors. It is the tendency to radiate.

OVERCOMING SELF-OSCILLATION

In overcoming the tendency toward self-oscillation, two methods are in common use. The first consists in reducing the number of primary turns in the interstage transformers (or what is, in effect, the same, the coupling between the primary and secondary coils), to a point where the tendency to oscillate either does not exist, or is slight enough to be controlled easily by such means as filament temperature. The second consists in the introduction of resistance into the circuits. It is obvious that both of these conditions may, and frequently do, co-exist in the same receiver. This means that when low-resistance parts are used, coupling in the repeating transformers must be reduced below the value that is correct for ordinary parts, tending toward lower signal strength and somewhat great selectivity. Conversely, it is possible to use slightly greater coupling if enough resistance is introduced to overcome instability, which may be introduced into the circuit in the form of a potentiometer to control grid bias, or by an actual resistor in the grid or plate circuits of the tubes, or by placing the coils close to condensers or other masses of metal. This would mean slightly increased signal strength and a corresponding decrease in selectivity, as compared to the same circuit employing low resistance apparatus and fewer primary turns. Thus it is apparent that the use of efficient apparatus in combination with any of these methods of introducing losses is merely a subterfuge. What is gained in one way is counteracted in another, making useless the extra expenditure for the efficient apparatus.

It is at once apparent that none of the older methods of suppressing self-oscillation is satisfactory from the viewpoints of both quality and efficiency. What is gained in one field in each case is lost in the other. The

Isofarad circuit is the successful outcome of an apparent attempt to combine stability with a high degree of amplification. It was the last of a number of devices tried. All those previously experimented with were found either to result in poor amplification, or to require adjustment of compensating devices at different frequencies, or to be unstable at all settings.

The Isofarad circuit eliminates the cause of instability in radio frequency amplifiers at its source, in the grid-to-plate capacitance of the tube. It employs the old principle of the Wheatstone bridge (shown in its simplest form in Fig. 1), to balance potentials in such a manner that any tendency to feed back from the plate to the grid is completely blocked. Any bridge arrangement such as that shown may be so arranged that two of the points are electrically isolated from the other two, no matter what value the potential impressed upon the bridge may have. If, for example, a potential of ten volts were impressed across the points A-B, with A positive, there will be a progressive "voltage drop" from A to B along both paths that the current may take. It is obvious then that no matter what may be the respective resistances of the two paths, some-

be a flow of current between them, as they are both at the same potential, and a potential difference is necessary to cause a flow of current.

THE WHEATSTONE BRIDGE

It can be demonstrated mathematically or by electrical measurement that when a Wheatstone bridge is in a condition of balance (i.e. when a potential applied to two opposite points has no effect upon the circuit connected between the other two points), the resistances of the four "arms" have the following relation:

$$\frac{R_1}{R_2} = \frac{R_3}{R_4}$$

In the usual laboratory form of the bridge, a galvanometer G is used to indicate a state of balance. One or more of the resistances may be adjusted until the galvanometer ceases to show a deflection, indicating that the points C and D are at the same potential, and that the circuit CGD is completely independent of the rest of the instrument.

A bridge arrangement similar in principle to this simple Wheatstone bridge is used in the Isofarad receiver, the principal difference being that the four arms of the bridge are capacitances instead of inductances. The arms may be inductances, capacitances, or resistances, and in some cases combinations of two or of all three are used. In this case the inductances are connected across opposite points of the bridge and therefore do not figure in the equation or in the balancing.

As has been mentioned, the function of the Isofarad bridge arrangement is to keep the grid and plate circuits electrically independent of one another. The output or plate circuit of the tube has an alternating voltage developed across it by the plate current and, at high frequencies, an appreciable part of this plate energy flows back into the tuned grid circuit through the capacitance existing between the grid and plate of the tube. The solution, then, is so to arrange the parts of the circuit that: First, the grid-to-plate capacitance forms one arm of a bridge (see Figs. 2 and 3); second, the plate (or output) circuit is connected between two opposite points of the bridge; and third, the tuned input circuit of the tube is connected between the remaining two opposite points of the bridge. In accomplishing these three things it is likewise desirable, from the standpoint of economy of apparatus, to use in the composition of the bridge as many as possible of the circuit elements necessary to the operation of a tuned stage without the bridge arrangement. Furthermore, if it is desired to operate the amplifier at different wave-lengths (that is, to tune over a band, say, from 200 to 500 meters) and to have it remain balanced against self-

(Continued on page 1166)

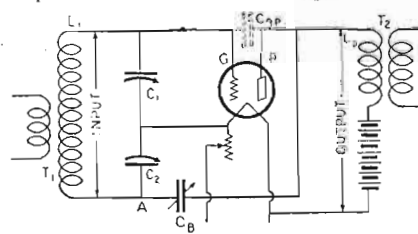

FIG. 2

This arrangement of capacitances in the Isofarad circuit results in the bridge connection, as seen by comparison with Fig. 3 below.

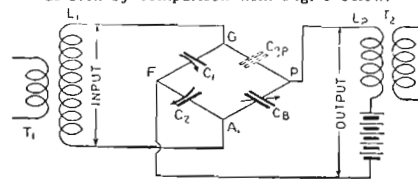

FIG. 3

The Isofarad circuit drawn in the conventional bridge style. The lettering here is in accord with the lettering of Fig. 2 above.

where on each a point can be found corresponding to any desired voltage between zero and 10. If we take, for example, a point C that has a potential of 6 volts as compared to B, there will also be a point D somewhere on the other arm that will have a potential difference from B of 6 volts. If we bridge these two points there can never

To show that amplification in the separate stages is not what is desired, simply loosen the interstage coupling sufficiently, and no energy is passed on to the succeeding stage. In other words, by loosening the coupling to kill self-oscillation the efficiency of the system is impaired, so other means for obtaining stability must be used.

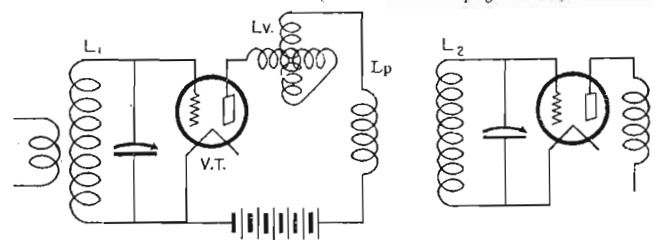

FIG. 4

*Radio Engineer, Walbert Mfg. Co.



VACUUM TUBE ADAPTER

With the advent of the new UX-120 tube, many fans wish to use this tube in the last stage audio, where formerly a UV-199 was used. Adapters for changing this base to standard 199 sockets are slow in making their appearance and also fairly expensive. Unless sockets are changed an adapter is necessary.

A simple adapter which any radio fan is capable of making is described herein.

Remove the bakelite base from a broken or burnt-out UV-199 tube, clean out wax, unsolder lead wires and see that holes in base through which they pass are free of solder.

Remove cotton or silk covering from eight or ten inches of No. 18 or 20 magnet wire and wind a coil or spiral, as compact as possible, using a $\frac{3}{8}$ drill shank or something of like diameter as winding form. Wind a spiral half an inch or so long.

When removed you will find this will slip over one of the large posts of the UX tube. Wind two of these and then two using a $\frac{1}{8}$ -inch drill or form, for the smaller posts. Leave a stem of wire an inch or so long on one end of each coil. Place the 199 base in a 199 socket, and then place the stems of the coils in the base holes of the base. The two larger coils should be placed in the holes making connection to the F mark on the

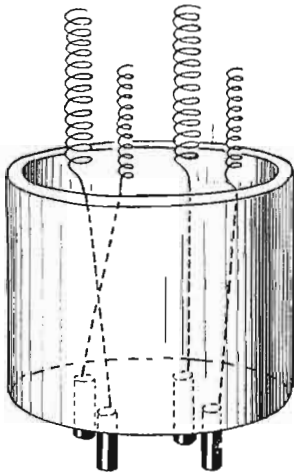

An adapter for the new UX tubes, which allows them to be used in standard sockets. Note the juxtaposition of the two terminals at the left.

socket and then slightly bent into line. The stems of the two smaller coils go to the G and P markings and are lined up opposite the larger. The result may be seen in the accompanying sketch.

Pull the wire stems down until a turn or two of the coil is lower than the top of the base, then cut off and solder. Melt some wax, from a discarded B battery, and fill the tube base to the top.

The tube base fits the 199 socket and the prongs on the UX tube slide into the spirals with just enough resistance to make good contact.

Contributed by L. B. Ockert.

FILAMENT SWITCH LIGHT

A combined filament switch, panel light, and tell-tale light may be made from a large phone plug, as shown in the drawing. A window is cut in the side of the plug as shown, allowing the light to illuminate the panel, and a piece of red celluloid is glued over the hole in the end of the plug. One of the connecting terminals inside is removed and a

Radio Wrinkles



contact spring put in its place. The bulb is fastened to the other terminal by means of a few turns of wire. The voltage and candlepower of the bulb will depend upon the

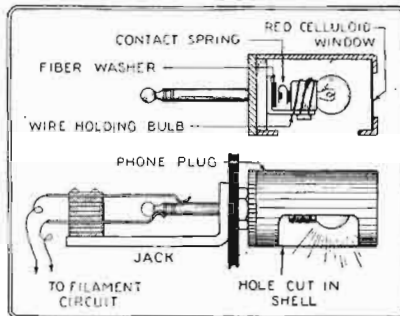

Above is illustrated a panel light, tell-tale light, and filament switch combined into one instrument. A sudden change in the intensity of illumination indicates that a tube has burned out.

number and kind of tubes in use, but in general a bulb of the lowest voltage and highest candlepower available is recommended. Pushing the plug in closes the filament circuit and lights the bulb.

Contributed by David Jenkins.

AN AUTOMATIC ANTENNA CLEANER

It is generally admitted that a brightly polished aerial, free from oxide, is a better gatherer of radio waves than a wire covered with dirt and corrosion. But some of us have antennas that have been erected in awkward places, difficult to erect and take down; and the expense of installing new wire sometimes counts. Here's a way to clean your antenna by letting the wind do the work. And the cost is almost nil.

Cut a large spool in half. Line the hole with emery, or some other abrasive, by spreading a thin coat of liquid glue first and dusting the abrasive over it. If the wire is in a state of bad corrosion it may be necessary to apply several alternate layers of glue and abrasive. This should not be done unless the wire is in bad condition, as the abrasive will tend to reduce the diameter of the wire even after it is clean. The abrasive may be fine emery powder, carborundum, or even sand.

Cut the wheel from a piece of tin or thin aluminum. It may be three or four inches in diameter. Two washers with holes small enough to keep them from sticking on the splices at the ends of the wire will keep the traveling wheel from becoming jammed. If it is necessary to install the cleaner without taking the wire down, the splits in the spool, wheel and washers will be necessary; otherwise, not. The method of installation is clearly shown in the photographs.

It is well to have the parts as closely bal-

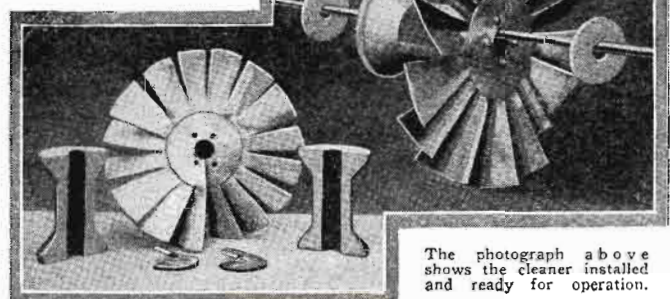

The photograph above shows the cleaner installed and ready for operation.

anced as is convenient, to avoid noisy action, for the wind keeps the wheel whirling back and forth over the wire night and day. The abrasive material should last just long enough to get the wire bright, and then the motion of the wooden spool will keep the wire polished. Heavy sleet will stop operations temporarily, but as soon as the storm lets up the little wheel will get back on the job.

Contributed by H. H. Buckwaller.

STORAGE BATTERY SOLDERING IRON

Directions follow for building a simple soldering "iron" for low voltages. The materials needed to construct it are:

- 1 piece of carbon rod $\frac{3}{4}$ -inch long by $\frac{1}{8}$ -inch dia. (obtainable from a "dead" B battery or flashlight cell).
- 1 piece of brass rod 6 inches by $\frac{1}{8}$ -inch thick.
- 1 porcelain tube insulator.
- 6 feet twisted double lamp cord.
- 3 storage battery clips.

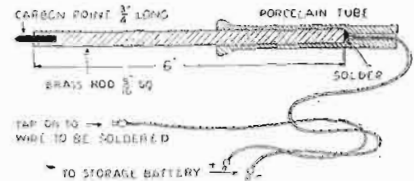

This low voltage soldering "iron" will be of especial interest to experimenters whose homes are not electrically wired. It operates from a 6-volt storage battery, and may even be used with dry cells.

Drill a $\frac{1}{8}$ -inch hole axially in one end of the brass rod and a similar $\frac{1}{8}$ -inch hole in the other end. Each should be $\frac{1}{4}$ -inch deep. Force the carbon tip in the $\frac{1}{8}$ -inch hole and solder one lead of the lamp-cord in the hole in the other end of the rod. If the carbon does not fit firmly it may be gripped by cupping the side of the brass rod with a ball-peen hammer, or by squeezing it in a large vise. This must be done carefully to avoid breaking the carbon.

Pull the porcelain insulator over the wire and force the rod into it. If it does not fit firmly, wedge it with a few bits of wood. If the hole in the insulator is too small, the corners of the brass rod will have to be filed down at one end. Solder the battery clips to the free ends of the wire as shown. Numbers 2 and 3 should be connected to the storage battery terminals; and Number 1 should be clamped to the metal portion of whatever is being soldered. When the car-

The illustration shows how the automatic antenna cleaner may be assembled without taking down the antenna wire. The wheel does its work day and night, keeping the antenna at peak efficiency.

bon point touches the metal to which clip Number 1 is connected, a complete circuit is formed and an arc appears. This causes the carbon tip to become red hot in a moment, melting the solder quite as efficiently as a commercial type of iron.

Contributed by W. Cotter.

MAGNETIC RECTIFIER

A magnetic rectifier for charging storage batteries, and one that is all simplicity to make, can be constructed by carrying out the following details. The instrument is self-polarizing and once set it needs no further attention.

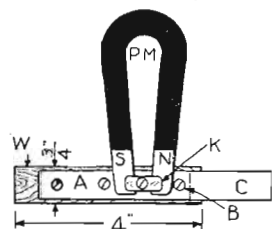
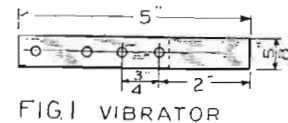
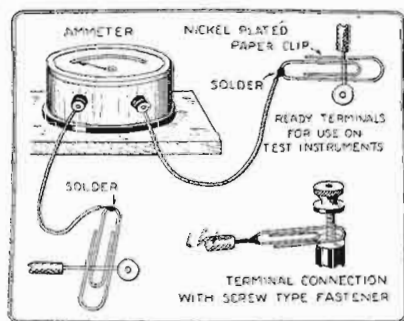

FIG. 2 VIBRATOR ATTACHED TO SUPPORT

Fig. 1 shows a diagram of the vibrator piece. This is a strip of spring steel $\frac{3}{8}$ -inch wide by 5 inches long. A band of steel, such as that which comes wrapped tightly around a bundle of shingles, or a piece of clock spring may be used for this. The former is easier to handle and works just as well. Having cut the strip to the size shown in the figure, drill or punch a $\frac{3}{8}$ -inch hole at exactly two inches from one end. If the steel is very hard, it must first be softened in a flame at this point. Next punch a $\frac{3}{8}$ -inch hole just three-quarters of an inch from the first one. Finally, drill two more holes at random on the other end of the strip. Having done all the drilling, the vibrator is now



One electrician has discovered that common paper clips make neat and efficient terminals for testing instruments and the like.

complete except for the bending, which will be done later.

Fig. 2 shows how the vibrator is attached to its support. This is a wooden block (W), $\frac{3}{4}$ -inch high and one inch wide by four inches long. On the $\frac{3}{4}$ -inch side the vibrator is fastened so that it rests exactly as in Fig. 2, the hole at B being placed in a little from one end of the wooden block. Screw in two brass screws at the left, as shown, and over the third hole place the poles of a permanent horse-shoe magnet (PM). The purpose of this is to give a constant polarity to the vibrator, and the larger and stronger the magnet is, the better. In the writer's case a magnet 5 inches long with poles one-half inch apart was found to work satisfactorily. The North pole must be nearest the "C" end of the vibrator. Across the poles of the magnet attach a strip

of bakelite or brass (K) by means of a brass screw. Then bend the "C" end at B in your direction until it makes an acute angle with A. (See also Fig. 3). The vibrator assembly is now complete, and the method of fixing it to the base follows.

In Fig. 3 a plain open view of the complete parts and their arrangement is shown. The base is made of chestnut and is $\frac{3}{4}$ -inch thick. The wooden support (W) is screwed firmly to the base, while two binding posts are fastened into the base on opposite sides of the vibrator, one near its support (B) and the other near its end (A). The post A forms the contact point, whereas B is used to

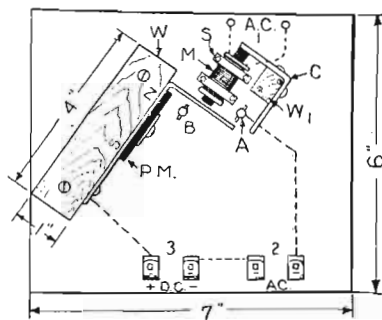

FIG. 3 - COMPLETE SET

These illustrations show how a low-power rectifier may be made up from spare parts that should be found in the odds-and-ends box of any experimenter's workshop.

dampen the free oscillations of the vibrator when not in contact with A, thus making it fly back quickly. The adjustment of B is not critical.

As soon as the set is all made, slip through the binding post a piece of No. 14 copper wire so that it just presses lightly against the vibrator. "A" is fixed in like manner except that the copper wire point is rounded off a bit with a file and placed so that it rests just off the side of the vibrator.

The fourth and final step is to make an electromagnet (M) which will actuate the vibrator. The writer used the core from a small spark coil, one-half inch thick. Tape this neatly and wind on the six layers of wire (No. 28). Two brass strips serve to secure the magnet into place. One of its poles is just $\frac{1}{8}$ -inch away from the center of the vibrator. Against the farther pole is placed a right angle (C) bend made of soft steel strips and fastened to a block of wood (W) as shown. The presence of this part is not absolutely necessary but it helps form an easier magnetic circuit, or "flux," and thus better synchronize the oscillations of the vibrator. Connection to the electromagnet is made by two binding posts (1) near an edge of the base. On the opposite edge four Fahnestock clips are fastened. Two of these (2) connect with the A.C. supply and the other two (3) furnish the rectified D.C. Notice that the whole arrangement is such that the left clip at (3) will always give a positive (+) charge, provided the N pole of the permanent magnet is placed nearest the free end of the vibrator. Again, it is understood that the electromagnet current is of the same source as that of (2), as in the case of an "exciter" coil wound on the same core of the transformer as the secondary.

The above assembly is good for very small currents only. If it is necessary to pass more than half an ampere it will be found necessary to employ silver contacts soldered to the vibrator and to the rod held in A.

Contributed by Arthur Siniscal.

QUICKLY DETACHABLE ELECTRICAL TERMINALS

For quickly attaching voltmeters, ammeters, bell and test buzzers, one electrician has found that heavy nickel-plated paper fasteners, of the familiar type, are excellent means for making a quick connection, and also are

the least expensive form of terminal that possibly could be devised.

The illustration (col. 1) shows how the wire is secured to the fastener and soldered to form a good contact.

The paper clip will slip over the round of a bared wire and secure a good hold, while at the same time, if necessary to secure to a screw type of terminal, the shape of the fastener lends itself to this method of fastening.

The idea will have an especial appeal to the electrician for emergency purposes.

Contributed by G. A. Luers.

UNI-CONTROL FOR FILAMENTS

Although much has been done of late to standardize vacuum tubes, we are still faced with the practical necessity of using a rheostat for each tube in a multi-tube set. This is so because a tube, especially in a radio frequency stage, must be adjusted to a very critical point for best efficiency, and a slight increase of current above this point will make the tube break into oscillation. Therefore, if the critical points of adjustment of all the tubes do not coincide, and one master control rheostat for all tubes is used, some must be run at less than normal efficiency, or else oscillations will develop, with attendant distortion.

The accompanying sketch shows a method of overcoming this difficulty. Small adjustable resistances are included in the filament circuits of all the tubes. These are adjusted separately to compensate for the differences in the various filament characteristics, thus allowing a master rheostat to be used to control all the tubes at once.

The obvious advantages of such an arrangement can be seen when we consider that in the ordinary arrangement each rheostat must be adjusted separately when the

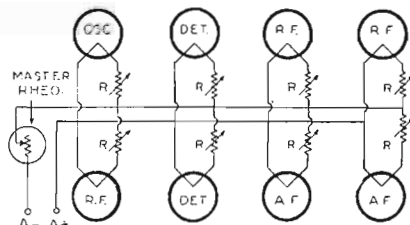

When a master rheostat is used, it is only necessary to make one adjustment when the battery weakens, or is changed.

battery weakens or is changed; but with the use of the master control it is necessary merely to adjust the master rheostat to bring the voltage across each filament to the exact value needed for best reception.

In the drawing, the resistances marked "r" serve to compensate for the differences in tube characteristics. These may be of any type suitable for the tubes, but as they are adjusted once for all, it is hardly necessary that they be expensive. The semi-fixed type of resistance, usually used in series with a rheostat to increase its resistance, will be satisfactory. These need not have a resistance of more than one or two ohms, for the storage battery tubes, or five ohms for the dry cell types. The master rheostat must be selected to suit the number of tubes in use, as well as the characteristics of the individual style of tube. First of all, it must be capable of carrying the combined amperage of all of the filaments. If the receiver uses eight storage battery tubes, the master rheostat must be able to carry two amperes without heating. Any technical man or student of physics should be able to help the beginner in figuring the proper resistance of this control for any special number of tubes.

As a final precaution, it is necessary to leave the master rheostat with as much resistance "in" as possible, when adjusting the various unit resistances. This allows one to make full use of the life of the storage battery between charges.

Contributed by Virgil Collier.

- Radiotics -

HOOPS COMING BACK?



According to a headline on the radio page of the *Trenton* (N. J.) *Evening Times* for November 11, "Directional Use of Radio HOOPS" we may expect to see hoops return before long. This would be an excellent opportunity for the fair sex to conceal—among other important things—radio receiver, especially if copper hoops were used.
Contributed by A. H. Albert.

HERE'S HOT DOPE!

In the classified advertising section of a New York tabloid daily appears the following most intriguing item: "One-tube radio electric GRILL for three tube set." Aha—just the thing for that wise guy who always gets Chile. And with this attachment we bet anything he could tune in on the Hot Place.
Contributed by Sigmund Vacht.



KISS ME AGAIN



The *Campus* of City College of New York for November 16, in reporting a radio lecture, announces that "the antenna, OSCULATOR and modulator were explained by the speaker." Whaddayuh mean, explained? All we got to say is that if the "explainer" is a lady, young and good-looking, we want the "osculator" explained, too!
Contributed by M. Wm. Lynn.

WHAT CAPACITY HAVE GREAT GUNS?

The *Trenton* (N. J.) *State Gazette* recently carried the statement that, "A .005 FLORED condenser across the output terminals of a cone speaker will improve reproduction sometimes." We wonder how far these condensers have to be fired before they are fit for use. Perhaps the makers of "the food that's shot from guns" could tell us.
Contributed by Leon Rohrbacher.



TUNING IN THE DAILY DOZEN

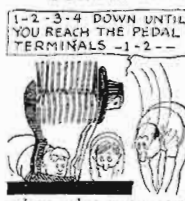

The *Radio Age* for December bears an advertisement recommending HEALTH variable condensers. Why waste your money buying an apple a day? One health variable condenser should keep the whole family in trim indefinitely, especially in view of the fact that its capacity is listed as .0025 mfd. Ten times the usual value; what more could you ask for your money?
Contributed by J. P. Ueschger.

SILENT, SILENTER, SILENTEST

Radio Broadcast for November carries an advertisement claiming that the new Tangar charger is "MORE SILENT THAN EVER." Whereas, heretofore, the silence could be stirred with a spoon, it is necessary now to cut it with a knife. Fine distinction, that, between silent and more silent!
Anonymous.



SO'S YOUR OLD BACK YARD

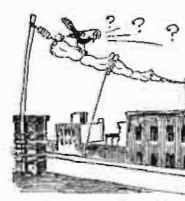

A heading in the *Radio World* for November 22, reads "USE 125 FEET FOR AERIAL." As a member of the S.P.C.A., S.P.C.C., and many other S.P.C.s, I violently object to any such plan. Vivisection and amputation is bad enough in any form, but to string a whole line of feet from the house top in plain view of all seems an utterly unpardonable procedure.
Contributed by F. Daniels.

VERY HIGH HAT



An advertisement in the December RADIO NEWS announces with what appears to us astonishing but very commendable frankness that the Wizard Wire Winder is "now only \$7.50, FORMALLY \$9.50." Of course, we all know that many a gyp artist will charge whatever he thinks from your appearance he can get; but this is the first bright guy to make the price dependent upon the presence or absence of the dinner jacket.
Contributed by James Miller.

SHERMAN SAID IT

In the November 15 issue of the *Portland* (Maine) *Telegram* and *Press-Herald*, we are advised, to our considerable astonishment, that "a portable set should have the BATTLES in the cabinet." Wassa matter, Oswald? We'll say that all the sets we've ever heard DO have their battles in the cabinet!
Contributed by Philip Smith.



SILENCE AND LITTLE OF THAT!

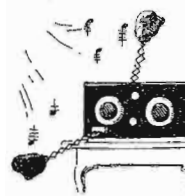

An ad in the September, 1925, RADIO NEWS tells us, with greatest pride that "No note is too high—no note is too low to be LOST by the Autoforcer." This is indeed a record to be proud of. And come to think of it, we have suffered from many a receiver which would have been greatly improved by such an adjunct.
Contributed by J. H. Kusera.

WHISKEY AND—!



In the "want-ads" of a Portland, Ore., newspaper, someone is offering for sale a "five-tube SODA-Neutrodyne." Previous to the passing of the eighteenth amendment this would have been a popular set—and might answer a useful purpose even yet, if properly equipped with "bootleg" tubes.
Contributed by William Christie.

DEAD FROM THE NECK UP

The *Honolulu* (Hawaii) *Star-Bulletin* for October 24 advises the radio fan that if he "wears the HEADSTONES for any length of time, it may be wise to wipe the moisture from the diaphragms in order to prevent possible rust." We dunno, but we guess these things must lie to wear during the "graveyard watch."
Contributed by Sgt. H. W. Wilson.



KEEP YOUR HEAD DOWN!



The radio program page of the *Toronto* (Ont.) *Daily Star* for November 14 announces a soprano to sing "MISS ME AGAIN!" by Victor Herbert. Were these the fateful words uttered by William Tell's little son when Pa was taking pot shots at the apple on his head? Or by the knife-thrower's partner in the vaudeville act?
Contributed by D. R. Patterson.

PAGE THE KNOT-TYING EXPERTS

The *Oak*, in the *Rockester* (N. Y.) *Times-Union* for November 16, says, "Tubes are OVER-LEADED, greatly shortening their life." This is probably due to the fact that they vibrate so much that extra weights must be added to hold them down, causing destruction. I would advise tying them down.
Contributed by W. H. Freese.



SET OWNER COMPLETELY RULED OUT

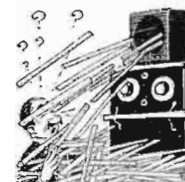

The *Randolph Radio Corporation's* catalogue states: "Purchasers have reported 2,000 RULES and more on the Commodore." In the old days we used to have visions of horrible death when NAH was reported as coming in like a ten of bricks, but to receive 2,000 rules is an even more novel experience.
Contributed by Ray Blanchfield.

WHAT'S IN A NAME? PLENTY!

The *Muncie* (Ind.) *Review Press* for November 16 advises in a headline "Give the Old FADIO Set to the Poor." If this advice were followed, lots of Radios (or Fade-ies) would change hands. The radio that doesn't "radio" as well is scarcer than pin feathers on an alligator.
Contributed by R. Johnson.



COIL-WINDER FOR SPAGHETTI EATERS



The *Toronto* (Ontario) *Globe* of November 14 ran its radio programs on a page emblazoned with the headline "MACARONI WEEK." We weep for Signor Marconi. It looks as if the printer were in league with the manufacturers of Spaghetti tubing, and subsidized to put this over as an advertising stunt.
Contributed by D. R. Patterson.

MORE DAMPED WAVES



The *Montgomery* (Ala.) *Advertiser* in its issue of October 25, thinks that "Loop aerials can be used to best advantage in buildings where there is no metallic screening to obstruct the flow of the WAVES. I wonder if the eaves flow into the radio set or into the rain barrel?"
Contributed by Carl M. Hayes.

IF you happen to see any humorous misprints in the press we shall be glad to have you clip them out and send to us. No RADIOTIC will be accepted unless the printed original giving the name of the newspaper or magazine is submitted with date and page on which it appeared. We will pay \$1.00 for each RADIOTIC accepted and printed here. A few humorous lines from each correspondent should accompany each RADIOTIC. The most humorous ones will be printed. Address all RADIOTICS to Editor RADIOTIC DEPARTMENT, c/o Radio News.

DX OR D.T.'s? The *Raleigh* (N. C.) *Times* of November 10 advises us as follows: "A community sing has been added to WLW broadcast program. It will be conducted the FIRST and THIRD SATURDAY of each WEEK." We have no statistics on the number of pints of corn whiskey necessary to make two Saturdays per week appear on the calendar, but we hereby register our desire to emit damped waves from the whiskey tender's sector of that community sing.
Contributed by H. C. Davis.

HAD YOUR IRONS TODAY? In the *Degas Times* for November 22, we read, "The cathode throws off more than 200,000,000,000 IRONS per second." Upon reading this Maggie went out of the business of bringing up father, feeling completely outclassed in her own particular field by this upstart, Cathode.
Contributed by Oscar Docentry Dandensing.



Correspondence from Readers



In this department the readers air their views on many important questions of the day. Comment is invited and an attempt is made to give equal weight to both sides of a controversy regardless of the magazine's policy.

REGENERATIVE INTERFLEX RECORD

Editor, RADIO NEWS:

Being interested in the construction of receivers, and having been a constant reader of RADIO NEWS, I became interested in your article on the One-Control Regenerative Interflex.

I assembled one, following your instructions, and had an agreeable surprise.

While I am not an E.E., I have been experimenting with radio circuits for nearly five years as a pastime and relaxation.

I like the exactness and care required in this work. Not having the exact parts which you may have used, I nevertheless constructed the Flexo-Coupler and used what parts I happened to have on hand.

The following statement may seem, even to you, an exaggeration, but—believe me or not—here goes. After connecting the Interflex to antenna, ground and batteries, with less than ten minutes' adjustment of tickler, rheostat and balancing condenser, I received fifty-seven stations in one evening from 6:15 to 11:00 p.m., covering an area from Canada to Texas and as far northwest as Minnesota.

It covered the wave-band from KSD, St. Louis, 546, to as low as 217 meters, all audible on the loud speaker.

M. W. BACHMAN, D.D.S.,
Philadelphia, Pa.

FOR A SEA GOING OPS' ASSOCIATION

Editor, RADIO NEWS:

No doubt you are swamped with mail from "sea-going ops" regarding the controversy over the commercial field. I haven't much to say because several articles already published in RADIO NEWS express my feelings exactly, namely by Messrs. Howard S. Pyle and J. E. Hara, and also a letter by Paul E. Miller. They fill the bill, and my opinion is that something ought to be done. If suggestions are in order, I would suggest several things: First, all operators in this game for a living and who are in it to stay if conditions are improved, get together by forming an association or fraternity; second, said body put it up to radio schools to give their students a little side training on traffic handling, and duties and conduct aboard ship; third, for the members of the association to gather information that would be of interest to other members and make up a set of rules that would cover the situation.

H. M. WOLLAM,
16 California St.,
S.S. Juvigny, c/o Lind Nav. Co.,
San Francisco, Calif.

FOR TRANSPOSING UNITS

The editor has received a letter from Karl Edler of Tübingen, Germany, calling our attention to international differences in radio terminology. Herr Edler suggests that we print tables and formulas for converting the constants of one nomenclature to that of another. His letter follows in part:

"You go so far as to give schematic diagrams of the sets and specifications how to build copies. Do you realize, however, that the terms of the specifications are unintelligible in other countries?"

"Here in Europe, for instance, the metric system is in vogue. Everything is measured in meters, centimeters and millimeters. A condenser, instead of being .0005 microfarads is 500 cubic centimeters, etc. Wire, instead of being No. 24 is around 0.3 millimeters.

"I have tried everywhere I have been here in Germany to get information about the relationship of your wire numbers and the European wire millimeters.

"In view of the fact that your magazine has such a wide circulation in countries using the metric system, would it not be advisable to publish in one of the issues of RADIO NEWS a list of your wire numbers with the corresponding millimeter size? You could even extend this chart to the other size systems used in countries your magazine circulates in."

We in America, who have become accustomed to using the English and the metric systems of measurement more or less interchangeably, are apt to lose sight of the fact that specifications in the English system may be completely unintelligible in countries where for many years nothing but the metric system has been in use. Similarly, as the C.G.S. system links up so well in its entirety with the purely linear measurements of the metric system, it has become customary abroad to speak of inductance and capacitance in terms of centimeters; microfarad and microhenry are unknown in common European scientific parlance.

It is a simple matter, however, to transpose the terms of one system to those of another. Only in rare instances is it necessary to use anything more than a simple formula solvable in a single arithmetical operation. All of the more common operations are covered in the following formulas and tables. Units of Length:

To convert inches to centimeters, multiply by 2.54.

To convert feet into meters, multiply by .3048.

Units of Inductance:
To convert microhenrys into centimeters, multiply by 1,000.

Units of Capacitance:
To convert microfarads to centimeters, multiply by 898,957.

Wire Tables:
The following tables give diameters in millimeters corresponding to the Brown & Sharpe gauge, standard in America, and the S.W.G., standard in Great Britain.

	Brown & Sharpe	S.W.G.
000.000	11.785
00.000	10.972
0.000	11.683	10.16
000	10.404	9.448
00	9.266	8.839
0	8.251	8.229
1	7.348	7.62
2	6.544	7.01
3	5.827	6.401
4	5.19	5.893
5	4.621	5.385
6	4.115	4.877
7	3.665	4.47
8	3.263	4.064
9	2.906	3.657
10	2.588	3.251
11	2.305	2.947
12	2.052	2.641
13	1.828	2.337
14	1.628	2.032
15	1.449	1.829
16	1.291	1.626
17	1.15	1.422
18	1.024	1.219
19	.911 6	1.016
20	.811 3	.914 4
21	.722 9	.812 8
22	.643 8	.711 2
23	.573 3	.609 6
24	.510 5	.558 8
25	.454 6	.508
26	.404 9	.457 2
27	.360 5	.416 6
28	.321 1	.375 9
29	.285 9	.345 4
30	.254 5	.315
31	.226 7	.294 6
32	.201 9	.274 3
33	.179 8	.254
34	.160 1	.233 7
35	.142 6	.213 4
36	.127	.193

A DISCOVERY IN CRYSTALS

We learn from an Italian correspondent that Sig. Giovanni Battista Schintu, Lieutenant of Engineers of the Radio Telegraphic Section of Cagliari, has experimented with the application of two new minerals of the ferro-manganese class, corresponding to the type of mineral called psilomelane and wad. This is a mineral generally very impure, so that its composition is doubtful, in general a hydrated manganese manganate. It may contain iron, silicon, aluminum and barium. These minerals, when used as detectors, have marvelous qualities from the standpoints of sensitivity and purity of sound.

The first has a compact or fibrous structure, externally of stalactitic, mammillary, reniform structure, black or brown in color; internally the mineral is grey and earthy. Its hardness is between 5½ and 6; its chemical composition varies a great deal.

Wad is found almost always associated with psilomelane and may be termed a ferro-manganese mineral, the composition of which is also variable. It is distinguished by its porous surface and by extreme lightness; it is so porous and spongy that it floats in water.

The numerous experiments carried out by Sig. Schintu have proved that the above minerals treated by a bath of acidulated water preceding their installation acquire sensitiveness and purity of reproduction to a surprising degree. As these minerals are uniformly sensitive in all their parts, and as they acquire great sonority in virtue of the above-described treatment with acid, they are superior to all other detectors of the class hitherto known. While crystal detectors are almost universally influenced by humidity, and, in the presence of parasite currents, sometimes cease to act, and besides this are not sensitive in all their parts; the new minerals, on the other hand, have the exceptional qualities of purity of action and of maintaining a constant and undisturbed sensitivity.

From investigations made in almost the whole of Europe, it was found that the minerals of which we treat are only to be found in Sardinia, in the great mineral basin of Iglesias.

The application of the new detector described above will undoubtedly acquire great scientific and commercial importance.

The new science of wireless telephony will certainly be greatly benefited by this discovery, considering the infinitesimal cost in proportion to the strength and purity of the detecting, the durability of the detector, and finally the simplicity and ease of installation.

SUPERVISOR OF RADIO IN NEW QUARTERS

For the information of radio amateurs and all those having business with the Supervisor of Radio, announcement is made that the offices of the United States Supervisor of Radio and staff have been removed from Room 603, Custom House, New York City, to the third floor of the United States Sub-Treasury Building, Wall, Nassau and Pine Streets (entrance on Pine Street), New York City. The new telephone numbers are John 4083 and 4084.

Driver of huge motor van, held up by owner of little two-seater: "Hi! there. Can't you get your blinking crystal set out of the way?"—*News of the World*, London (England).

STANDARD HOOK-UPS

EVERY month we present here standard hook-ups which the Editors have tried out and which are known to give excellent results. This leaf has perforation marks on the left-hand margin and can be cut from the magazine and kept for further reference. These sheets can also be procured from us at the cost of 5c per sheet to pay for mailing charges. RADIO NEWS has also prepared a handsome heavy cardboard binder into which these sheets may be fastened. This binder will be sent to any address, prepaid on receipt of 20c. In time there will be enough sheets to make a good-sized volume containing all important hook-ups. Every year an alphabetical index will be published enumerating and classifying the various hook-ups.

Handy Reference Data for the Experimenter

A PRECISION WAVEMETER

Circuit No. 142. An essential instrument that every experimenter should have is a carefully calibrated precision wavemeter. It can be used for calibrating receivers, checking upon transmitting amateur stations, measuring the wave-length range of a given coil and condenser, and as a means of finding the position on the dials of a receiver that a distant station will be tuned in on, if the wave-length of the station is known. A well designed low loss condenser is the first necessity. Be sure the bearing construction is of the finest, rigid alignment of the rotor and stator plates, and a celluloid case enclosing the condenser to keep out dust. The condenser must be of .001 mfd. capacity. The coils are the next essential. The coils should be wound with the least loss and highest efficiency obtainable kept in mind, and some sort of plug in attachment mounted on the form so that the coils can be changed with ease. An arrangement similar to that on plug-in type honeycomb coils may be used. A coil of 30 turns of No. 22 D.S.C. on a 3-inch bakelite form will cover the range of 150 to 650 meters, 15 turns will have a range of 75 to 275 meters, 5 turns will have a range of 40 to 110 meters. These are, of course, approximate, exact curves must be plotted from a standard wavemeter. The rest of the material required are as follows: one thermo-galvanometer 0 to 100 scale, one good high frequency buzzer, one "on and off" switch, bakelite panel, sheet aluminum or zinc for shielding panel.

The method for using the wavemeter after it is calibrated is as follows: to find wave-length range of receiver, place all condensers and other factors that vary the wave-length range of the receiver, at minimum, plug in the coil that covers the broadcast range, turn switch on, which will allow the current from the battery to excite the buzzer, then turn dial of wavemeter slowly until buzzer note is heard loudest in headphones which are connected to the receiving set. The reading then obtained when looked up on curve chart will give minimum wave-length obtainable with the receiver. For maximum wave-length repeat process but reset tuning controls to maximum wave-length obtainable with receiver.

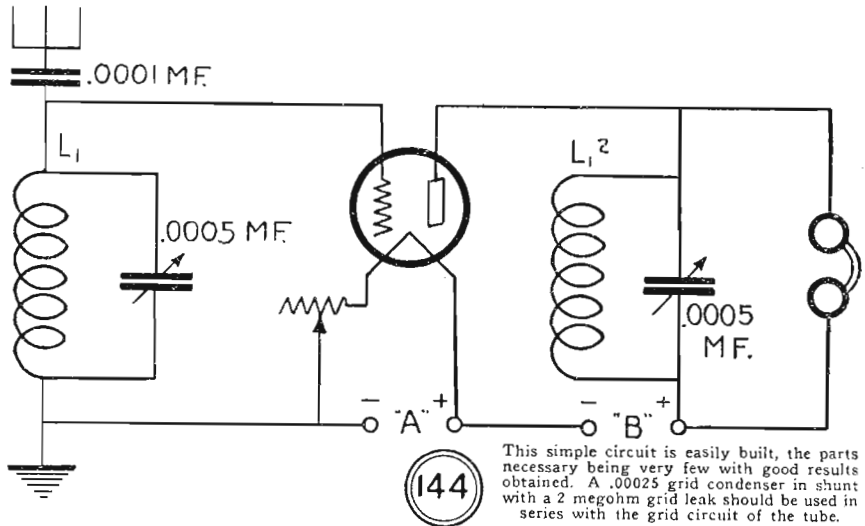

This simple circuit is easily built, the parts necessary being very few with good results obtained. A .00025 grid condenser in shunt with a 2 megohm grid leak should be used in series with the grid circuit of the tube.

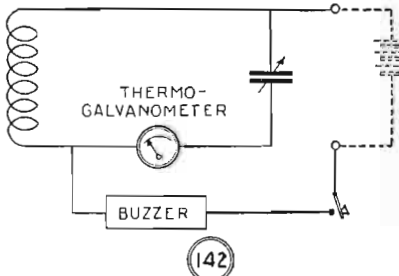

A precision wavemeter circuit is herewith shown. A buzzer is used to produce high frequency oscillations.

To check wave-length of transmitting station. Tune station in until loudest point is reached, set wavemeter a few feet away, turn switch on to start buzzer, turn wavemeter dial slowly until buzzer note is heard loudest in headphones which will, of course, conflict with the note of the transmitting station, trace dial reading on curve which will result in the wave-length of the station transmitting.

Other valuable uses that a wavemeter may be put to can be found in any radio book dealing in radio measurements.

Other valuable uses that a wavemeter may be put to can be found in any radio book dealing in radio measurements.

AN EFFICIENT REGENERATOR

Circuit No. 143. Every experimenter with radio circuits has undoubtedly been impressed by the range and possibilities of a receiver incorporating regeneration. Herewith is shown a circuit combining a stage of radio frequency amplification and detector with tickler regeneration coupled back to the antenna coil. The set will be somewhat tricky in tuning, due to the extremes that regeneration is carried to, but after the slight difficulties are mastered unusual reception should be obtained. The antenna coil consists of approximately 45 turns wound on a 3-inch tube, the plate coil has 25 turns wound with No. 24 D.C.C. on a 2-inch tube which is placed within the antenna coil. A .0005 mfd. condenser is placed across the antenna coil, and a .0003 mfd. condenser, 17 plates, across the plate coil. A grid condenser of .00025 or .0003 mfd. is used, and a .001 fixed condenser across the headphones to by-pass the stray r.f. currents that may be in the audio side of the circuit.

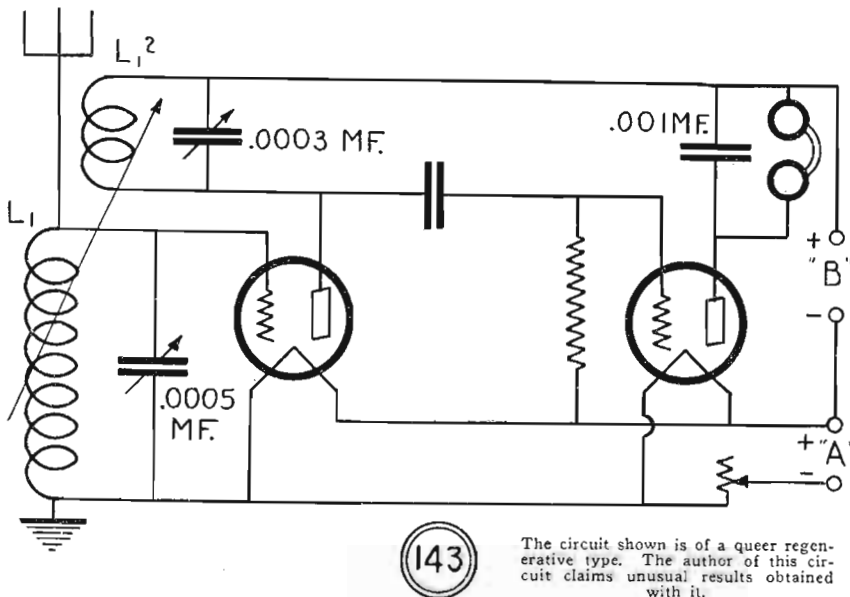

The circuit shown is of a queer regenerative type. The author of this circuit claims unusual results obtained with it.

When tuning in for stations, the set should be made to oscillate by rotating the plate coil which is then fixed in that position. Regeneration will then be controlled by the variable condenser which is wired across that coil. The tuning for stations is done with the larger condenser, the other being used to increase the volume. Extreme care must be taken in tuning with the regeneration control, as the oscillation point is approached the dial should be turned slower to prevent spilling over and to attain the highest amount of amplification possible.

A ONE-TUBE TUNED IMPEDANCE SET

Circuit No. 144. Any builder of this circuit will be more than satisfied if it is able to duplicate the results that the originator of this circuit claims to have achieved. Undoubtedly, its efficiency is facilitated by the simplicity of controls and the circuit itself.

The antenna coil is wound with No. 22 D.C.C. on a 3-inch tube, and has approximately 45 turns. The same size wire and coil is used for the plate winding, but a slider or tapped arrangement must be provided for to aid in the control of regeneration. The variable condensers are of .0005 mfd. each. A .0001 mfd. fixed condenser is placed in series with the antenna.

A ONE-TUBE LOOP RECEIVER

Circuit No. 145. A one-tube set that operates on a loop efficiently where local broadcast stations are concerned, and fairly satisfactory on distant stations, can be constructed if the following instructions are carefully followed. Of course, for best results, a storage battery type tube must be used.

The circuit is the conventional primary, secondary, and tickler affair, which has proven reliable so many times, the primary is wound on a 3-inch tube and consists of ten turns of No. 22 D.C.C. Alongside is wound the secondary coil, using the same size wire and having 45 turns. The condenser that is connected across it is of the low loss type and has a capacity of .0005 mfd. The plate or tickler coil is wound on a 2-inch tube, the number of turns being 25.

Tuning is accomplished with the variable condensers and the loop. The loop has a decided directional effect, and is a great aid in securing the desired selectivity. To receive a station at maximum signal strength the loop must be pointing towards it; if the station interferes the loop is placed in a parallel position to it. Volume and oscillations is controlled by the rotating of the tickler coil.

A fairly large pickup loop should be used, the crossticks being at least four feet in length, and having about 12 turns. Should

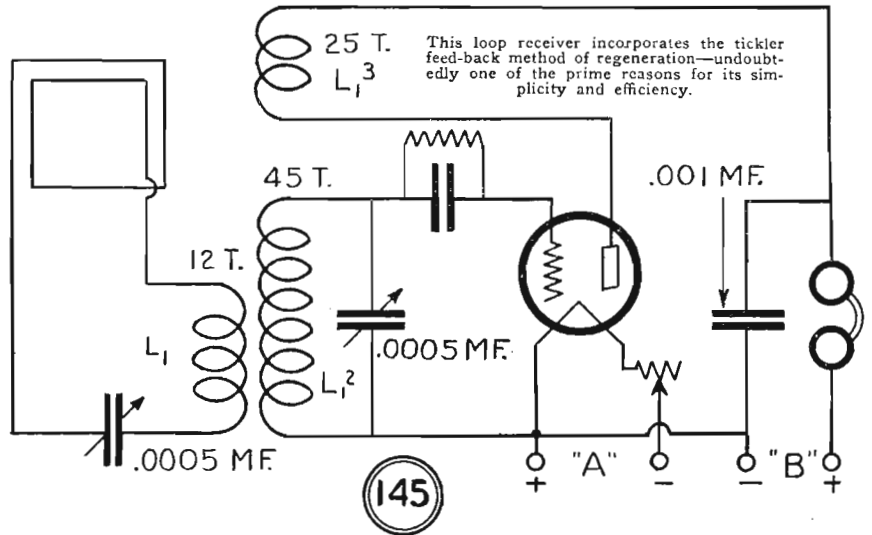

the range be unsatisfactory the loop constant only should be changed. Never change the value of the primary winding, as the coupling effect between that coil and the secondary winding will be affected.

connected to minus A. A .001 fixed condenser is placed across the plate and B+ terminals of the detector jack.

Selectivity of the set may be controlled by changing the position of the switch lever. By using a lower number of turns in the primary circuit greater selectivity is obtained. The rotating of the tickler coil will control volume. The various stations are tuned in with the variable condenser.

A SIMPLE SELECTIVE RECEIVER

Circuit No. 146. The following is a receiver that has remained popular for the past two years and is still adding to its number of enthusiastic adherers. The circuit is of a modified three-circuit design, is extremely simple to build and operate, and has an unusual degree of sensitivity.

An ordinary variocoupler may be re-wound and made to accomplish the desired results. An addition of 8 turns tapped at every 2 turns is required; this is wired in series with the secondary as shown in diagram, thus making the primary conductively coupled to the secondary circuit. The outside diameter of the tube should be 3 inches, and the secondary consists of 65 turns of 22 D.C.C. The tickler winding has 25 turns on a tube 2 inches in diameter which is placed on a shaft within the larger tube, so that it can be rotated at will. A double circuit jack is used at the end of the detector stage, which automatically closes and connects in the audio amplifier when the plug is removed from that stage. Separate rheostats are used for each tube; this will be a great aid in controlling the operating characteristics of the various type tubes. A "C" battery may also be used, and should be connected so that C is connected to the F side of the transformers. Plus C will then be

RECEIVING WITHOUT AN ANTENNA OR LOOP

Circuit No. 147. The following is a description of a set in use at station MSU, France, which operates without antenna or loop. The author reports hearing programs from English stations with his receiver located at Toulon, France, an approximate distance of seven hundred miles. The receiver is of the super regenerative type, and the experimenter should not undertake it in a casual way.

It will be understood that constants of the circuit are open to much experimental work. For various wave bands, such as the amateur, broadcast, government, and so on, changes will necessarily be made in the inductances and capacities. A good plan will be to construct this receiver on a large, dry board, with ample spacing of all parts. Low loss instruments and coils may be used to good advantage here, where the slightest loss not only may impair the strength of the signal, but can easily throw the receiver out of the perfect balance that is so essential.

(Continued on page 1221)

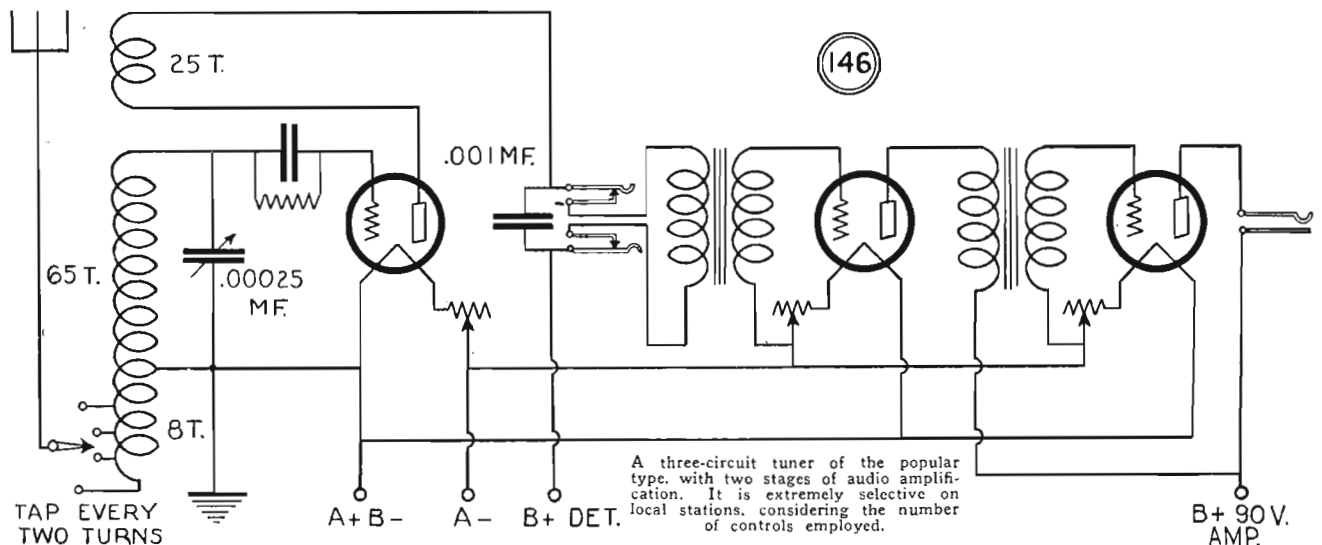

A three-circuit tuner of the popular type, with two stages of audio amplification. It is extremely selective on local stations, considering the number of controls employed.



By JOHN B. BRADY*

(1,553,625, J. Mills. Filed December 24, 1920; issued September 15, 1925. Assigned to Western Electric Co., Inc.)
 Duplex radio system where side tone interference at the receiving station due to simultaneous recep-

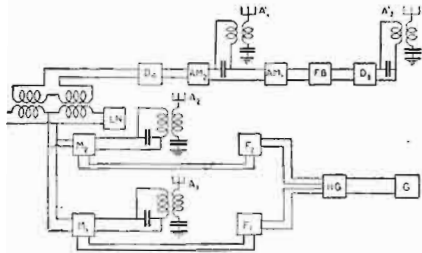

tion of the locally transmitted energy with the desired signaling energy is eliminated by the generator of an auxiliary wave by the local transmitter, which opposes current in the receiving circuit induced therein by the local transmitter.

(1,555,253, W. H. Priess, Belmont, Mass. Filed January 6, 1922; issued September 30, 1925. Assigned to Wireless Specialty Apparatus Co.)
 Variable electrical condenser where a body of mercury is enclosed within a rotatable reservoir which contains conductive side plates on opposite

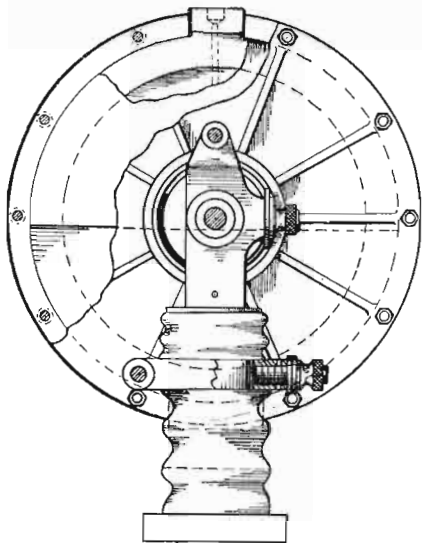

sides thereof. The reservoir may be moved to different positions to displace the mercury from the reservoir for providing different overlapping relationships between the mercury and the side plates for varying the capacity of the condenser.

(1,557,049, J. H. Hammond, Jr., Gloucester, Mass. Filed May 10, 1918; issued October 13, 1925.)
 Electrical antenna for ship use, and particularly submarines, where the antenna is carried in an

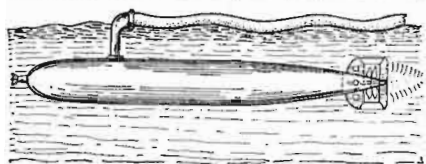

elongated buoy tube arranged to float on the surface of the water and trail the ship. The antenna wire is carried within the tube and connections established with the apparatus aboard the moving vessel.

(1,558,437, I. Langmuir, Schenectady, N. Y. Filed October 29, 1913; renewed February 29, 1924;

issued October 20, 1924. Assigned to General Electric Company.)
 Electrical discharge apparatus in which an auxiliary conductor is provided within a three-electrode electron tube adjacent the cathode and maintained at a substantially uniform positive potential with

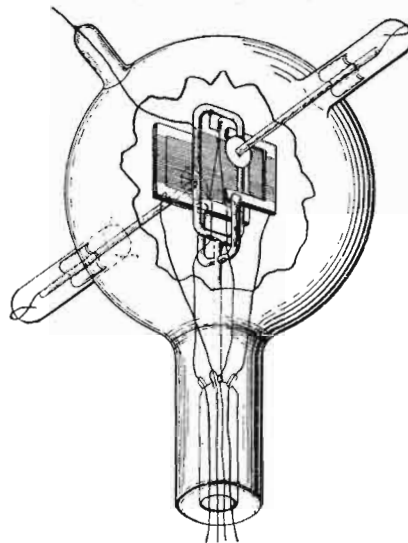

respect to the cathode. By this arrangement the effect of space charger in an electron discharge device is reduced, the effect of negatively charged bodies in the proximity of the cathode is eliminated, the discharge current with a given applied voltage is increased and electrons having a relatively uniform velocity are developed.

(1,552,670, G. Belfils. Filed August 29, 1921; issued September 8, 1925.)
 A radio transmitting system in which a plurality of alternators are used in connection with the same

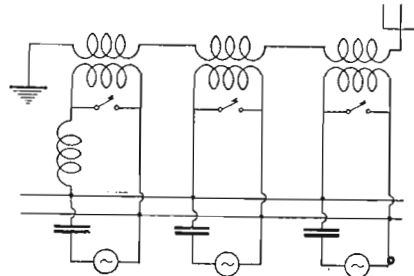

antenna system. The alternators may be parallel connected to a radiating system and synchronized for operation with respect to each other.

(1,557,529, E. T. Jones. Filed December 3, 1921; issued September 15, 1925.)
 Electrical reproducer for phonographs where a diaphragm is actuated to vary the magnetic reluct-

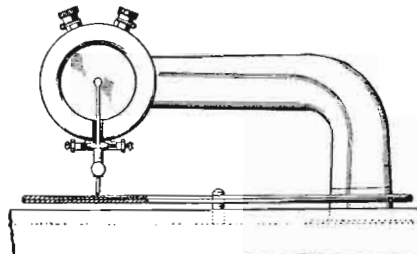

ance of a telephone circuit for reducing electrical energy in a pair of associated windings. The energy is amplified and reproduced in accordance with the vibrations of the diaphragm.

(1,556,137, R. A. Weagant, Douglas Manor, N. Y. Filed February 7, 1919; issued October 6, 1925. Assigned to Radio Corp. of America.)
 Method and apparatus for radio signaling where-by static interference may be reduced to a minimum. Two pick-up circuits are provided, one of which

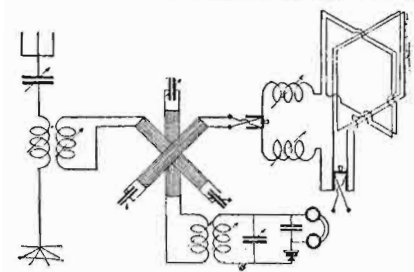

efficiently receives horizontally propagated signal waves, while the other efficiently receives static impulses as currents substantially in opposite phase to the signaling currents. By this arrangement the static is balanced out while retaining the signal currents.

(1,558,120, F. G. Simpson, Seattle, Wash. Filed April 3, 1921; issued October 20, 1925.)
 Radio receiving system in which an alternating current regenerator consisting of an electron tube system is provided at the receiver and a magnetic

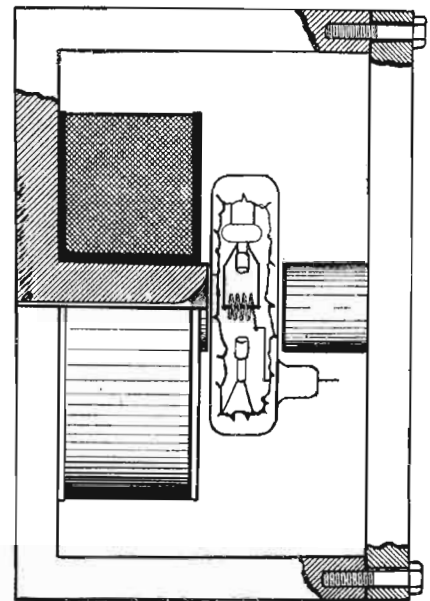

field established transverse to the electron stream for varying the velocity of the electron stream in accordance with incoming signaling energy for correspondingly varying the frequency of the alternating current generator and operating a suitable observing circuit.

(1,553,244, C. F. Jacobs. Filed July 10, 1923; issued September 8, 1925.)
 An antenna spreader for an antenna where the wires are arranged in the form of a cage. The



spreader consists of a flat metallic ring having notches at its periphery in which the antenna wires fit and in which they are secured in spaced relationship forming the antenna cage.

*Patent Lawyer, Onray Building, Washington, D. C.



RADIO NEWS LABORATORIES



RADIO manufacturers are invited to send to RADIO NEWS LABORATORIES, samples of their products for test. It does not matter whether or not they advertise in RADIO NEWS, the RADIO NEWS LABORATORIES being an independent organization, with the improvement of radio apparatus as its aim. If, after being tested, the instruments submitted prove to be built according to modern radio engineering practice, they will each be awarded a certificate of merit, and a "write-up" such as those given below will appear in this department of RADIO NEWS. If the apparatus does not pass the Laboratory tests, it will be returned to the manufacturers with suggestions for improvements. No "write-ups" sent by manufacturers are published on these pages, and only apparatus which has been tested by the Laboratories and found to be of good mechanical and electrical construction is described. Inasmuch as the service of the RADIO NEWS LABORATORIES is free to all manufacturers whether they are advertisers or not, it is necessary that all goods to be tested be forwarded prepaid, otherwise they cannot be accepted by the Laboratories. Apparatus ready for the market or already on the market will be tested for manufacturers, as heretofore, free of charge. Apparatus in process of development will be tested at a charge of \$2.00 per hour required to do the work. The Laboratories will be glad to furnish readers with technical information available on all material listed here on receipt of a stamped envelope. The Laboratories can furnish resistances of the various instruments, amplification curves of transformers, losses in condensers, etc., and other technical information. Address all communications and all parcels to RADIO NEWS LABORATORIES, 53 Park Place, New York City.

C-H. POTENTIOMETER

This potentiometer was submitted to the RADIO NEWS LABORATORIES for test, by the Cutler-Hammer Mfg. Co., Milwaukee, Wis. The arm of the potentiometer is fixed and the

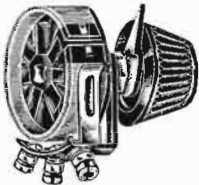

resistance is the rotating member. It has a resistance of 400 ohms and in appearance is the same as the rheostat in another column.

AWARDED THE RADIO NEWS LABORATORIES CERTIFICATE OF MERIT NO. 1073.

ROYAL BLUE TUBE

The tube illustrated was submitted to the RADIO NEWS LABORATORIES for test, by the Royal Blue Tube Labs., Newark, N. J. This tube was found to operate satisfactorily as a



detector or amplifier in a broadcast receiver. It is of rugged construction and has a fairly long filament life.

AWARDED THE RADIO NEWS LABORATORIES CERTIFICATE OF MERIT NO. 1064.

UNIVERSAL TERMINALS

The terminals shown herewith were submitted to the RADIO NEWS LABORATORIES for test, by the L. S. Williams, 1210 Parkside Boulevard, Toledo, Ohio. These terminals are



used in connection with bus-bar wire and makes firm contact. They may also be used for sliding contact where necessary.

AWARDED THE RADIO NEWS LABORATORIES CERTIFICATE OF MERIT NO. 1070.

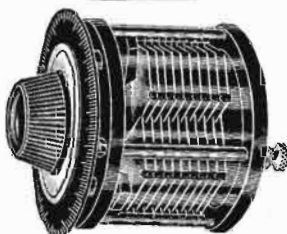

S-L. VARIABLE CONDENSER

The variable condenser shown in the first column was submitted for test, to the Radio News Laboratories, by the Canfield Radio Mfg. Co., 807 Harrison Street, Oakland, Calif. This condenser is of unique construction and of the straight-line wave-length type. It has an extremely low minimum capacity.

AWARDED THE RADIO NEWS LABORATORIES CERTIFICATE OF MERIT NO. 1071.

SCIENTIFIC SPEAKER

This loud speaker was submitted to the Radio News Laboratories for test, by the Tower Mfg. Corp., 98 Brookline Avenue, Boston, Mass. It affords very good production of

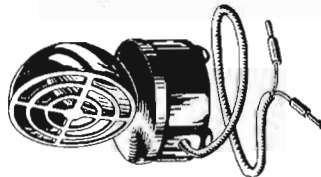

radio concerts without disturbing distortion and with sufficient volume for all ordinary purposes. It is constructed of celluloid and is extremely small in size. It also may be used satisfactorily in portable receivers.

AWARDED THE RADIO NEWS LABORATORIES CERTIFICATE OF MERIT NO. 1065.

WING CELL-O-METER

The cell-o-meter shown in the illustration was submitted to the



RADIO NEWS LABORATORIES for test, by the Cellokay Mfg. Corp., 175 Fifth Avenue, New York City. It is used as an indication of current consumption of a tube in a receiver, and also of the condition of the storage battery.

AWARDED THE RADIO NEWS LABORATORIES CERTIFICATE OF MERIT NO. 1063.

MARCO VERNIER DIAL

The dial illustrated was submitted to the Radio News Laboratories for test, by the Martin-Copeland Company, Providence, R. I. The vernier action of this dial is fairly smooth, having a ratio of approximately 11 to 1. Provision is made for the taking in of the back-lash by removing the knob. Provision is also made



on the side of the dial for station marking. The dial is extremely neat and made in a dull black finish.

AWARDED THE RADIO NEWS LABORATORIES CERTIFICATE OF MERIT NO. 1066.

RADIO WORLD TIME CLOCK

This time clock was submitted to the RADIO NEWS LABORATORIES for test, by George B. Gardner, 923 Hutchinson Court, Brooklyn, N. Y. The time-clock arrangement, which shows the time in various time-belts



of the world, makes it easy for the listener-in to calculate the difference in time and know exactly at what hour the distant station will be broadcast.

AWARDED THE RADIO NEWS LABORATORIES CERTIFICATE OF MERIT NO. 1069.

TOROIDAL COIL

The toroidal coil shown in the illustration was submitted to the RADIO NEWS LABORATORIES for test, by the Orbit Coil Company, 6 Howard Street, New York City. This



coil has a unique method of winding and is found to be efficient in ordinary broadcast receivers. It consists of a primary and secondary.

AWARDED THE RADIO NEWS LABORATORIES CERTIFICATE OF MERIT NO. 1086.

CUTLER-HAMMER RHEOSTAT

The rheostat shown in the illustration was submitted to the Radio News Laboratories for test, by the Cutler-Hammer Mfg. Co., Milwaukee, Wis. This rheostat is of unique construction. It has a fixed-arm contact, the resistance being the rotating member. It is of a single-

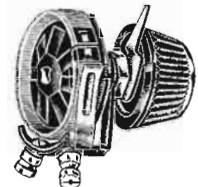

hole-mounting type. The knob and point are of neat appearance.

AWARDED THE RADIO NEWS LABORATORIES CERTIFICATE OF MERIT NO. 1058.

TUNING COIL

This tuning coil was submitted to the RADIO NEWS LABORATORIES for test, by the Bruno Radio Corp., 221 Fulton Street, New York City. It is of low-loss construction for short-wave work. It is bound with flat copper ribbon upon a glass rod to decrease the enormous losses that occur at the higher frequency.

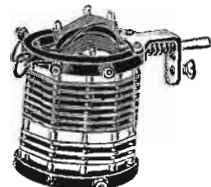

AWARDED THE RADIO NEWS LABORATORIES CERTIFICATE OF MERIT NO. 1062.

STARR TRANSFORMER

The transformer shown in the illustration was submitted to the RADIO NEWS LABORATORIES for test, by the Starr Equipment Company, 366 Hamilton Avenue, Brooklyn, N. Y. This transformer is of rigid and efficient design. When placed in the ordinary receiver it is loud and clear for production. The coil is enclosed within a metal casing to prevent magnetic-field interference.

AWARDED THE RADIO NEWS LABORATORIES CERTIFICATE OF MERIT NO. 1074.



"SADDLE" GROUND CLAMP

The "Saddle" ground clamp shown in the illustration was submitted to the RADIO NEWS LABORATORIES for



test, by the Meritz Specialty Co., 206 West 10th Street, Wilmington, Del. AWARDED THE RADIO NEWS LABORATORIES CERTIFICATE OF MERIT NO. 1057.

LEAD-IN

The lead-in shown in the illustration was submitted to the RADIO NEWS LABORATORIES for test, by the Aurora Electric Co., 100 South Sixth Street, Brooklyn, N. Y. This lead-



in, of unique construction, includes a small switch by which an aerial can be disconnected during thunder storms.

AWARDED THE RADIO NEWS LABORATORIES CERTIFICATE OF MERIT NO. 1067.

FELT CUSHION FEET

The felt cushion feet submitted to the RADIO NEWS LABORATORIES for test, by F. Muller, 31 West 17th Street, New York City, can be used



underneath any cabinet to prevent marking or scratching of the table it rests on. They also prevent vibration from reaching the receiver.

AWARDED THE RADIO NEWS LABORATORIES CERTIFICATE OF MERIT NO. 1072.

VARIABLE GRID LEAK

The variable grid leak shown in the illustration was submitted to the RADIO NEWS LABORATORIES for test,



by the Bourton & Rogers Mfg. Co., 75 Boylston Street, Boston, Mass.

AWARDED THE RADIO NEWS LABORATORIES CERTIFICATE OF MERIT NO. 1062.

ARBEE RESISTANCE

This resistance was submitted to the RADIO NEWS LABORATORIES for test, by the Arbee Mfg. Co., 68-70 Springfield Avenue, Newark, N. J.



It has been found to be fairly accurate and may be used in connection with resistance-coupled amplifiers.

AWARDED THE RADIO NEWS LABORATORIES CERTIFICATE OF MERIT NO. 1076.

SINGLE JACK

The jack illustrated was submitted to the RADIO NEWS LABORATORIES for test, by the Aurora Electric Co.,



100 South Sixth Street, Brooklyn, N. Y. This jack does away with the ordinary jack and plug arrangement, ordinary phone tips being used.

AWARDED THE RADIO NEWS LABORATORIES CERTIFICATE OF MERIT NO. 1068.

MAGNAVOX TUBE

This tube was submitted to the



RADIO NEWS LABORATORIES for test, by the Magnavox Company, 2725

East 14th Street, Oakland, Calif. This tube can be used satisfactorily as an amplifier in the ordinary broadcast receiver. It has a rugged internal construction and has a long filament life.

AWARDED THE RADIO NEWS LABORATORIES CERTIFICATE OF MERIT NO. 1059.

E-Z BATTERY FILLER

The battery filler shown in the illustration was submitted to the



RADIO NEWS LABORATORIES for test, by the Bemco Mfg. Co., 243 West 55th Street, New York City.

AWARDED THE RADIO NEWS LABORATORIES CERTIFICATE OF MERIT NO. 1084.

BERNARD PLIERS

The pliers shown in the illustration were submitted to the RADIO NEWS LABORATORIES for test, by the William Schellhorn Company, New



Haven, Conn. This combination of cutting and bending pliers is used where bending of a circular nature in radio receiver construction is necessary.

AWARDED THE RADIO NEWS LABORATORIES CERTIFICATE OF MERIT NO. 1077.

ANTENNA GROUND SWITCH

This antenna ground switch of unique construction was submitted to the RADIO NEWS LABORATORIES



for test, by Simons Bros., 21 Pantton Street, Haymarket, S. W. 1, London, England.

AWARDED THE RADIO NEWS LABORATORIES CERTIFICATE OF MERIT NO. 1082.

AERO COILS

The aerial coils shown in the illustration were submitted to the RADIO NEWS LABORATORIES for test, by the Henninger Radio Mfg. Co., 1772 Wilson Avenue, Chicago, Ill. One

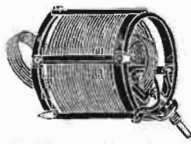

is the ordinary three-circuit tuner wound in low-loss fashion with an aperiodic primary. Both coils have

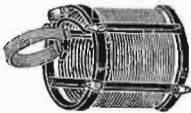

an arrangement whereby the coupling effect may be either loosened or tightened.

AWARDED THE RADIO NEWS LABORATORIES CERTIFICATE OF MERIT NO. 1083.

ARBEE GRID LEAK

The grid leak shown in the illustration was submitted to the RADIO NEWS LABORATORIES for test, by the Arbee Mfg. Co., 68-70 Springfield Avenue, Newark, N. J. This grid



leak has been found to be fairly accurate, and can be used in connection with resistance-coupled amplifiers, or where a fairly accurate resistance is necessary.

AWARDED THE RADIO NEWS LABORATORIES CERTIFICATE OF MERIT NO. 1075.

SOCKET

This socket was submitted for test to the RADIO NEWS LABORATORIES,



by the American Hard Rubber Co., 11 Mercer Street, New York City. It is of unique construction, having a light metal frame to decrease losses.

AWARDED THE RADIO NEWS LABORATORIES CERTIFICATE OF MERIT NO. 1085.

FIXED RESISTOR

The resistor shown in the illustration was submitted for test, to the RADIO NEWS LABORATORIES, by the Micamold Radio Corp., 1037 Flushing Avenue, Brooklyn, N. Y.



It has been found to be fairly accurate and can be used in connection with resistance-coupled amplifiers, or where a fairly accurate resistance is necessary.

AWARDED THE RADIO NEWS LABORATORIES CERTIFICATE OF MERIT NO. 1087.

GLASS INSULATOR

The glass insulator shown in the illustration was submitted for test, to the RADIO NEWS LABORATORIES, by the J. E. Marsden Glass Co., 200



Fifth Avenue, New York City. It is of rugged construction and capable of withstanding large pressure strain.

AWARDED THE RADIO NEWS LABORATORIES CERTIFICATE OF MERIT NO. 1081.

TUF GLASS PLATE

This glass plate was submitted to the RADIO NEWS LABORATORIES for



test, by the J. E. Marsden Glass Co., 200 Fifth Avenue, New York City. It is used as a protective device to prevent acid spilling on floors or carpets.

AWARDED THE RADIO NEWS LABORATORIES CERTIFICATE OF MERIT NO. 1080.

TUBE REACTIVATOR

The tube reactivator shown in the illustration was submitted to the RADIO NEWS LABORATORIES for test, by the Radio Television Co., 9410 Catharine Avenue, Cleveland, Ohio.

AWARDED THE RADIO NEWS LABORATORIES CERTIFICATE OF MERIT NO. 1023.

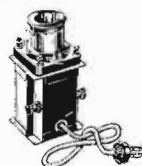

CRESCENT RESISTANCES

This resistance, manufactured by the Crescent Supply Company, 1-3-5 Liberty Street, Jamaica, New York, was submitted to the RADIO



NEWS LABORATORIES for test. It is non-inductive and can be used in all places where a non-inductive resist-

ance is required. It comes in various values and is made for both transmitting and receiving purposes. AWARDED THE RADIO NEWS LABORATORIES CERTIFICATE OF MERIT NO. 874.

NU-WAY SNAP TERMINAL

This snap terminal, submitted by The Hatheway Mfg. Co., Bridgeport, Conn., is made for soldering on the ends of wires. The instrument for the terminal strip of a set is equipped with the other half of

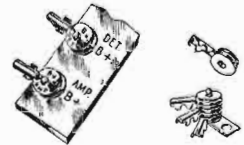

the snap, so that the connection may be made instantly. The end parts of the snap are merely pressed together. Good electrical contact is assured.

AWARDED THE RADIO NEWS LABORATORIES CERTIFICATE OF MERIT NO. 918.

VOCALOUND SPEAKER

This receiver shown in the illustration was submitted to the RADIO NEWS LABORATORIES for test by the



Vocalound Radio Mfg. Co., 674 Broadway, Brooklyn, N. Y.

AWARDED THE RADIO NEWS LABORATORIES CERTIFICATE OF MERIT NO. 1040.

CRYSTAL DETECTOR

This crystal detector was submitted to RADIO NEWS LABORATORIES



for test, by the S. A. M. Radio Co., Securities Bldg., Omaha, Nebraska. It has been tested in conjunction with various receivers and found to be very efficient. It is of solid construction and retains its sensitivity a long period of time.

AWARDED THE RADIO NEWS LABORATORIES CERTIFICATE OF MERIT NO. 1037.

BROWNLIE DETECTOR

The detector shown in the illustration was submitted to the RADIO

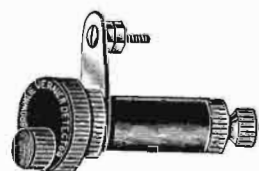

NEWS LABORATORIES for test, by Roland Brownlie & Co., 22-24 Saunders St., Medford, Mass.

This crystal detector was found to be very efficient when tested in an ordinary crystal receiver and in a reflex receiver. It has a unique vernier attachment which regulates the motion and tension of the cat-whisker.

AWARDED THE RADIO NEWS LABORATORIES CERTIFICATE OF MERIT NO. 1017.

H. & H. PLUG

This plug was submitted to the RADIO NEWS LABORATORIES for test, by Hart & Hegeman, Hartford, Conn.



AWARDED THE RADIO NEWS LABORATORIES CERTIFICATE OF MERIT NO. 1122.



Conducted by Joseph Bernsley

THIS Department is conducted for the benefit of our Radio Experimenters. We shall be glad to answer here questions for the benefit of all, but we can publish only such matter as is of sufficient interest to all.

1. This Department cannot answer more than three questions for each correspondent. Please make these questions brief.
2. Only one side of the sheet should be written upon; all matter should be typewritten or else written in ink. No attention paid to penciled matter.
3. Sketches, diagrams, etc., must be on separate sheets. This Department does not answer questions by mail free of charge.
4. Our Editors will be glad to answer any letter, at the rate of 25c for each question. If, however, questions entail considerable research work, intricate calculations, patent research, etc., a special charge will be made. Before we answer such questions, correspondents will be informed as to the price charge.

Mr. Bernsley answers radio questions from WRNY every Thursday at 8:30 P. M.

R.C.A. TUBE DATA

(2158) Mr. Joel Martin, Newark, N. J., asks:

Q. 1. Please give construction details of the Greene Concert Selector and the Splindorf receiver.

A. 1. The schematic circuit of the Splindorf receiver, and all available information in regard thereto, appears in an article starting on page 53 of the July, 1925, issue of *Radio Review*. All available information on the Greene Concert Selector also appears in *Radio Review*, in an article starting on page 59 of the October, 1925, issue.

Q. 2. Is it possible to obtain a list of foreign broadcasting stations operating on wave-lengths below 550 meters? A list showing wave-lengths above

the primary of the audio frequency transformer connected in the plate circuit or, from the plate binding post of this winding to the "A" battery. This is made clear in the circuit diagram, No. Q-2160.

Regeneration is controlled by means of variable condenser "C" which we may call the "throttle condenser." It may have a value of .0005 to .001 μ f., the exact value being governed by the natural capacities of the instruments used. The distributed capacity, as it is called, of the audio frequency transformer, is represented as "C.L." If its value is large, only a small capacity variation will be necessary in "C," to start and stop circuit oscillation.

space the primary and the secondary more than 1/8-inch. Rotor, 20 turns of the same size wire on a 2 1/2-inch tube or ball, placed at the grid end of the secondary and rotably arranged. If dry cell tubes having lower internal capacities are used, it will probably be necessary to increase the number of tickler, or rotor turns to about 35 to 40, in which case it may be more convenient to use a smaller size of wire. The exact number of turns for the tickler must be such that the rotor can be left in one position, almost full coupling, and not changed thereafter. The number of tickler turns must be so proportioned that throttle condenser "C" will fully control circuit oscillation at all wave-lengths, without recourse to an adjustment of "rotor."

It is advisable to operate this circuit with at least one stage of audio frequency amplification, as otherwise the capacity of the phone cords would become part of the "throttle" capacity and capacity effects would be very noticeable and annoying; every movement of one's head would vary the phone cord capacity and, thereby, the regenerative balance of the circuit.

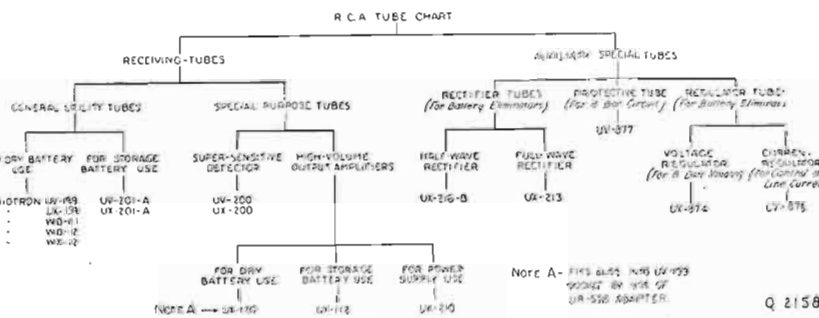

This chart may be used to determine the best tube for receivers, both plain and those employing various methods of amplification, or using dry cells in place of storage batteries.

this maximum appeared in the "I Want to Know" department of the December, 1925, issue of RADIO NEWS.

A. 2. The list of foreign broadcasting stations appears in the Late Fall Edition (1925) of the Radio Listeners' Guide and Call Book, obtainable from the Book Department of RADIO NEWS.

Q. 3. Please state the particular usages of the new "UN" type tubes.

A. 3. The "tree" marked Q-2158 shows the particular uses to which the complete line of R.C.A. receiving tubes and auxiliary receiving tubes are best adapted.

DATA ON FRESHMAN SET

(2159) Mr. M. G. Schmidt, Willowdale, Ont., asks:

Q. 1. Kindly tell me at what angle and how should the radio frequency transformers be placed in the Freshman tuned radio frequency set, which was shown in the "I Want to Know" columns of the April Radio News.

A. 1. The placement of these coils is described in detail in the "I Want to Know" columns of the July, 1925, issue of Radio News, answering question No. 2126.

Q. 2. Where could a loop be used in this set?

A. 2. A loop may be added to the Freshman set, or any equivalent receiver of the tuned radio frequency type, in the manner made clear in the "I Want to Know" department of the August, 1925, issue of Radio News, answering question No. 2136.

Q. 3. What are the advantages of using three rheostats instead of two?

A. 3. The use of three rheostats instead of two will result in greater selectivity, sensitivity, quality and volume, since these four points are all closely related and considerably dependent upon the heat of the tube filaments. The third rheostat makes it possible to have independent control of the radio frequency tube filaments, the detector tube filament and the audio frequency tube filaments, giving more flexibility in the control of circuit regeneration, present in such receivers to varying degrees.

THROTTLE CONTROL OF REGENERATION

(2160) Mr. V. Sia, Shanghai, China, asks:

Q. 1. What is "Throttle" control of regeneration?

A. 1. This is control of regeneration by means of a variable by-pass condenser connected across

Because of the enormous amount of mail handled by this department, questions addressed to the "I Want to Know Department" and unaccompanied by the usual remittance of 25 cents per question cannot be answered by letter.

tion; and if small, the value of the other may be made larger.

The three-coil coupler is of standard type and may, for example, have the values stated below:

Primary, 6 to 15 turns at the filament end of the secondary, about 50 turns of No. 24 D.C.C. wire wound on a 3-inch tube, at the end of the primary winding. It is not necessary to

Q. 2. What can I use to fill the unwanted holes in a panel used for experimental work?

A. 2. Black sealing wax may be used for black panels and the proper shade of brown sealing wax for brown panels. The proper degree of "mottling" may be obtained by the addition of a very slight amount of black sealing wax.

Q. 3. How are panels given a dull finish?

A. 3. The original polish of bakelite, formica or hard rubber panels is easily removed with No. 00 emery cloth. The grinding is usually done with a left-and-right motion. If a somewhat finer finish is desired, the panel may be rubbed with very fine emery powder. For bakelite, a light machine oil lubricant may be used with the powder; on hard rubber, oil should not be used, plain water being much better.

O'CONNOR FREQUENCY CHANGER

(2161) Mr. W. T. Lambert, W. Palm Beach, Fla., asks:

Q. 1. Please give full construction details for making the O'Connor Frequency Changer. I wish to use it in conjunction with a Neurodyne receiver.

A. 1. Full details for the arrangement you mention appeared in the June and August, 1925, issues of Radio Broadcast Magazine. The important details are contained in the text below:

"Pri. 1" is the primary winding of the first transformer, and it is absolutely necessary that this primary connect ONLY to the two posts indicated as "output." (Fig. Q.3161).

The Neurodyne is adjusted for the maximum wave-length, which will be in the neighborhood of 600 meters. After once being adjusted, there is no further adjustment of this receiver required. The

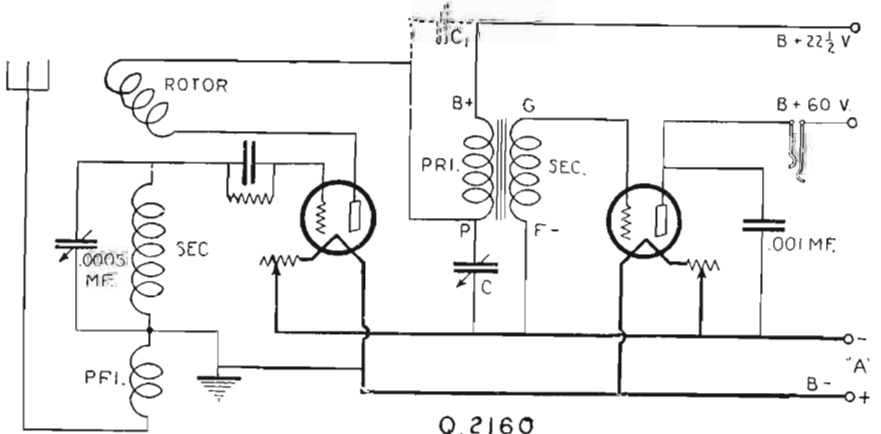

A regenerative circuit employing the use of inductive and capacitive feed-back, termed "throttle control."

tuning controls are now reduced to two, the two tuning condensers in the frequency changer.

The object of the O'Connor Frequency Changer is to transfer incoming received signals to the wave-length for which the regular receiving set has been tuned to respond.

This effect is obtained by means of the usual "Heterodyne" method.

In "heterodyning" a signal from one wave-length (frequency) to another, a second, or "beat" frequency is used. The difference between the beat frequency and the incoming signal is called the "intermediate" frequency. In regular Super-heterodyne the "intermediate" frequency is of a wave-length between 1,000 and 10,000 meters. In the arrangement shown in this month's "I Want to Know" department the intermediate frequency is about 600 meters, the exact wave-length being determined only by the adjustment of the standard receiver being used, in this case one of the Neutrodyne type.

There is one big advantage in the use of the combination shown which will appeal to any one having had previous experience in operating a standard Super-heterodyne. It will be recalled that stations in the middle of the tuning band were heard at two different points on the oscillator dial. Those unfortunates having sets that tune in stations from three to eight times are probably wishing their sets would work in such a way as to bring in stations at *not over* two points on the oscillator dial; but such receiving sets have other afflictions than an intermediate frequency amplifier—signal response to wave-lengths between 1,000 and 10,000 meters, the cause for reception of stations at two points on the oscillator dial.

By using the extremely low intermediate frequency of 600 meters, it is not possible to hear twice any broadcast stations that operate on the present American wave-length band of 200 to 545 meters, so far as intermediate frequency amplifier design, the main governing factor, is concerned.

The oscillator design has a wave-length range of approximately 161 to 287 meters, in order to heterodyne stations in the regular broadcast range, so as to produce the 600-meter intermediate frequency.

The oscillator design is as follows:

"L" and "L-1," 49 turns of No. 24 D.C.C. wire, wound double-spider-web" or "Lorenz" fashion. The coils are 1/8-inch thick, with a 5/8-inch core, and are slidably arranged on a 3- or 4-inch insulating rod, the best coupling of the two coils being determined by test.

The exact number of turns required for "L," is readily determined experimentally, by varying the number of turns in this grid coil until a 545-meter signal station is heard with the oscillator dial at about 95.

The use of the .00013 mf. condenser results in obtaining tuning over exactly the wave band desired, with a half-circle variation of the capacity of the .00025 mf. condenser.

The "B" and "A" battery shown may be the regular current supply to the radio set. Be sure "B" minus connects to the same "A" battery terminal of both the oscillator and the regular set. Probably not more than 10 turns will be required in "Pri.1," depending upon the particular tube used as the detector-oscillator.

Q. 2. Please show a circuit using the regular three-circuit coupler, but with provision for:

- (a) Grid leak rectification

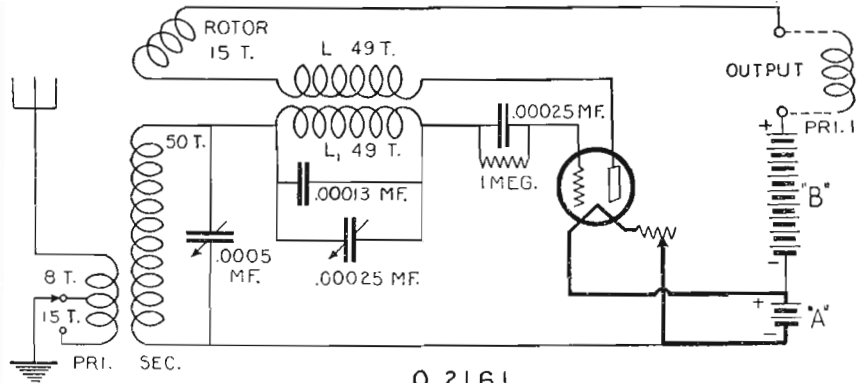

Q. 2161

The O'Connor frequency changer, which may be used in connection with any receiver.

- (b) Grid bias rectification
- (c) Crystal detector rectification.

I would like to have any one of the three arranged to be had optionally.

A. 2. The circuit requested is shown as Q.2161-A (page 1186).

Switches Sw. 1 and Sw. 2 may be of the push-pull type, in which event the crystal shunted by Sw. 1 should preferably be of the fixed type.

The grid leak shunted by Sw. 2 is variable, and must be of the very finest quality, otherwise noisy operation is sure to result.

Condenser rotor plates are indicated by the arrowhead.

Q. 3. I would wish to be advised as to how my 2-variometer circuit can be arranged so that there is regeneration control by means of a potentiometer. I have a 400-ohm potentiometer I can use. The two variometers are in inductive relation, resulting in strong circuit oscillation at the shorter wave-lengths.

A. 3. We have modified your circuit in the manner requested. It is shown in diagram Q.2161-B. We are inclined to believe it would be better to transpose the aerial and ground connections, although it is stated that results are exceptional with the arrangement shown.

NOVEL PLATE SUPPLY

(Q. 2162) Mr. Jno. J. Ruby, Brooklyn, asks:

Q. 1. Please show how to combine an amplifier using UX-112 tubes and the radio frequency circuit accompanying this inquiry.

A. 1. We believe you will find the circuit shown in the diagram Q. 2162 will meet your requirements. (See page 1188.)

The constants are as follows:

- L 48 turns of No. 24 D.C.C. wire (tapped at 2 turns from the filament end of the coil for "L-1," 8 turns for "M," and 15 turns for "S.")
- L-1 50 turns of No. 24

D.C.C. wire wound on a 3-inch tube. One-eighth of an inch from the filament end of this coil is wound L-2, 25 to 40 turns (depending upon tubes used) of the same size wire, wound on the same tube with a separation between L-1 and L-2 of about 1/4-inch. For UV-201A type tubes 25 turns will probably be found about right. For dry cell tubes, more nearly 40 turns will be required. L-3, 15 to 35 turns (depending upon tubes used) of No. 27 D.C.C. wire, on a 3-inch tube. L-3 is separated from L-1 by a distance to be determined by test. It will probably be about 3 inches, and in inductive relation as shown. All coils are wound in the same direction. Condenser C-1 may have a maximum capacity of .0005. C-2 has a value of about .00025 μ f.

It may be advisable to connect a choke coil at "X," this coil to consist of about 200 turns of No. 30 D.S.C. wire on a 2-inch tube.

To insure greater quality, grid-bias rectification is used, instead of the more ordinary grid-leak rectification.

Good audio frequency transformers must be used. Chokes one and two may be Autotransformers with a voltage step-up ratio of 1:1 1/2.

To eliminate strong hand-capacity effect, the writer has shown the rotor of C-2 connecting to the "C" battery side of the instrument.

An illustration of the radio frequency instrument and a lay-out that may be followed appear on page 796 of the December, 1925, issue of Radio News.

The electrolytic rectifiers are very easily made. The tubes are 1 x 6-inch test-tubes filled with a solution of sodium phosphate, made by dissolving about a teaspoon full of the chemical in a cup of water (use the neutral salt, not acid sodium phosphate). The electrodes are thin aluminum and iron strips, 1/4-inch wide and 6 inches long. The positive element, the aluminum, must be of the purest grade obtainable.

The iron or negative electrode serves only as a connection to the electrolyte. It is the aluminum oxide film, the formation of which is described, with which we are most concerned.

The transformer is a 50-watt, 110-volt, 60-cycle transformer with a 220-volt secondary winding tapped about evenly. This secondary voltage, which

(Continued on page 1186)

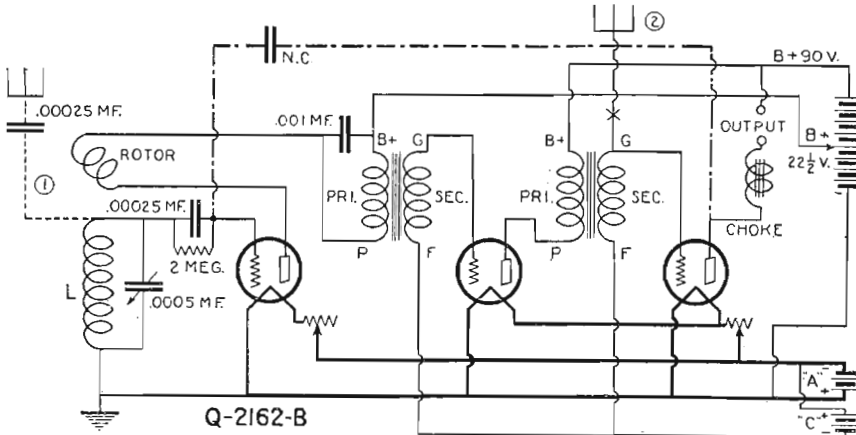

Q-2162-B

A single circuit receiver designed so as to reduce radiation to a minimum.

Variable condenser "C" is a Chelton Midget, or the equivalent thereof.

A 400-ohm potentiometer is to be preferred. The writer is of the opinion that this is the first time this composite diagram has ever been shown. It affords complete mastery of the major rectification means.

The "B" potential should be varied to determine the best value. It will probably be found that 22 1/2 volts is the required potential.

Try reversing tickler leads.

Crystal rectification and grid-bias rectification are best for quality; grid leak rectification is best for sensitivity.

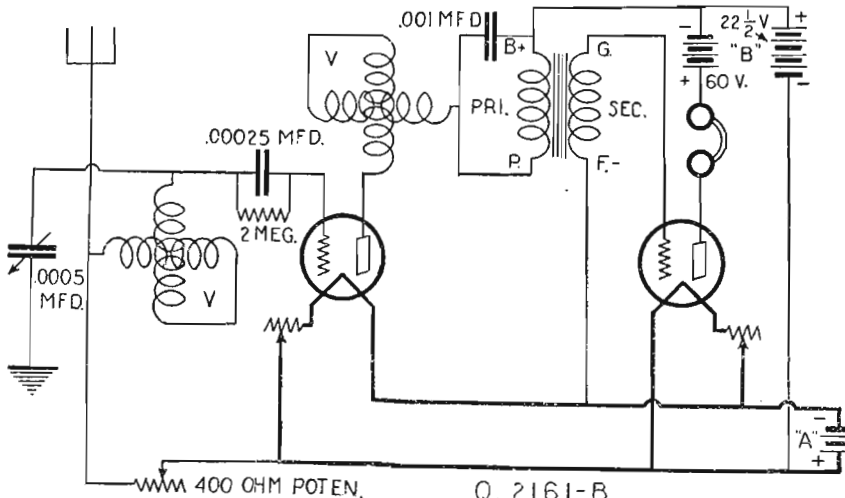

Q. 2161-B

A circuit employing the use of two variometers and a potentiometer to control regeneration.



American Broadcast Stations



REVISED TO DATE

Call Letters	Name	Location	Power & Wave Length	Call Letters	Name	Location	Power & Wave Length	Call Letters	Location and Name	Power & Wave Length
KDKA	East Pittsburgh, Pa.	Westinghouse Electric & Mfg. Co.	Variable—309.1	KFJY	Fort Dodge, Iowa	Tunwall Radio Co.	50—246	KFRX	Pullman, Wash., J. Gordon Klemgard	10—217.3
KDLR	Devils Lake, N. D.	Radio Electric Co. & Wilson Insurance Agency	5—231	KFJZ	Fort Worth, Tex.	South-Western Baptist Theological Seminary	50—254	KFRY	State College, N. Mex., New Mexico College of Agriculture and Mechanic Arts	50—266
KDFM	Cleveland, Ohio	Westinghouse Electric & Mfg. Co.	500—250	KFKA	Greeley, Colo.	Colorado State Teachers' College	50—273	KFRZ	Hartington, Neb., Electric Shop (P. M. Thies)	15—222
KDYL	Salt Lake City, Utah	Newhouse Hotel	50—246	KFKQ	Conway, Ark.	Conway Radio Laboratories	100—250	KFSG	Los Angeles, Calif., Echo Park Evangelistic Assn.	500—275
KDZB	Bakersfield, Calif.	Frank E. Siefert	100—209.7	KFKU	Lawrence, Kans.	University of Kansas	500—275	KFUJ	Breckenridge, Minn., Hopper Plumbing & Heating Co. and F. H. Rettig	50—242
KFAB	Lincoln, Neb.	Nebraska Buick Auto Co.	1000—340.7	KFKX	Hastings, Nebr.	Westinghouse Electric & Mfg. Co.	2000—233.3	KFUL	Galveston, Tex., Thomas Goggan & Bros. Music Co.	50—258
KFAD	Phoenix, Ariz.	McArthur Bros. Mercantile Co.	100—273	KFKZ	Kirksville, Mo.	F. M. Henry	5—266	KFUM	Colorado Springs, Colo., W. D. Corley	100—242
KFAF	San Jose, Calif.	Montgomery Hotel	50—217.3	KFLR	Albuquerque, N. Mex.	University of New Mexico	100—254	KFUO	St. Louis, Mo., Concordia Seminary	500—545.1
KFAJ	Boulder, Colo.	University of Colorado	100—261	KFLU	San Benito, Tex.	San Benito Radio Club	10—236	KFUP	Denver, Colo., Fitzsimons General Hospital	50—234
KFAU	Boise, Idaho	Boise High School	500—278	KFLV	Rockford, Ill.	Swedish Evangelical Mission Church	100—229	KFUR	Ogden, Utah, Peery Building Co.	50—224
KFAW	Santa Ana, Calif.	The Radio Den	10—214.2	KFLX	Galveston, Tex.	George R. Clough	10—240	KFUS	Oakland, Calif., Louis L. Sherman	50—256
KFBB	Havre, Mont.	F. A. Butrey & Co.	50—275	KFLZ	Atlantic, Iowa	Atlantic Automobile Co.	100—273	KFUT	Salt Lake City, Utah, University of Utah	100—261
KFBC	San Diego, Calif.	W. K. Azbill	10—224	KFMQ	Fayetteville, Ark.	University of Arkansas	750—299.8	KFUU	San Leandr, Calif., Colburn Radio Labs.	50—224
KFBG	Tacoma, Wash.	First Presbyterian Church	50—250	KFMR	Sioux City, Iowa	Morningside College	100—261	KFUV	Springfield, Mo., G. Pearson Ward	10—252
KFBK	Sacramento, Calif.	Kimball-Upton Co.	100—248	KFMW	Houghton, Mich.	M. G. Sateren	50—263	KFVD	San Pedro, Calif., McWhinnie Electric Co.	50—205.4
KFBL	Everett, Wash.	Leese Bros.	100—224					KFVE	St. Louis, Mo., Film Corporation of America	500—240
KFBS	Trinidad, Colo.	School District No. 1	15—238					KFVG	Independence, Kansas, First Methodist Epis. Church	10—236
KFBU	Laramie, Wyo.	The Cathedral (Bishop N. S. Thomas)	50—270					KFVH	Manhattan, Kansas, Whan Radio Shop	15—218.8
KFCB	Phoenix, Ariz.	Nielson Radio Supply Co.	100—238					KFVI	Houston, Texas, Fifty-sixth Brigade, Headquarters Troop	10—240
KFCF	Walla Walla, Wash.	Frank A. Moore	100—256					KFVN	Welcome, Minn., Carl E. Bagley	10—227
KFDD	Boise, Idaho	St. Michael's Cathedral	50—278					KFVR	Denver, Colo., (near) Moonlight Ranch, Route 6, Eugene Rossi	50—244
KFDH	Tucson, Ariz.	University of Arizona	50—258					KFVS	Cape Girardeau, Mo., Cape Girardeau Battery Station, Oscar C. Hirsch	50—224
KFDJ	Corvallis, Ore.	Oregon Agricultural College	500—354	KFMX	Northfield, Minn.	Carleton College	500—336.9	KFVU	Eureka, Calif., Radio Shop, Standard Publishing Co.	5—209.7
KFDM	Beaumont, Tex.	Magnolia Petroleum Co.	500—315.6	KFNF	Shenandoah, Iowa	Henry Field Seed Co.	500—266	KFVW	San Diego, Calif., Airlan Radio Corp.	500—246
KFDX	Shreveport, La.	First Baptist Church	100—250	KFOA	Seattle, Wash.	Rhodes Dept. Store	500—454.3	KFVX	Bentonville, Ark., Radio Shop, R. H. Porter	10—236
KFDY	Brookings, S. Dak.	South Dakota State College of Agriculture and Mechanic Arts	100—273	KFOB	Burlingame, Calif.	Burlingame Chamber of Commerce (Albert Sherman)	50—226	KFVY	Albuquerque, N. Mex., Radio Supply Co.	10—250
KFDZ	Minneapolis, Minn.	Harry O. Iverson	10—231	KFOJ	Moberly, Mo.	Moberly High School	10—242	KFWA	Ogden, Utah, Browing Bros. Co.	100—261
KFEC	Portland, Ore.	Meier & Frank Co.	50—248	KFON	Long Beach, Calif.	Echophone Radio Shop	100—233	KFWB	Hollywood, Calif., Warner Bros. Pictures (Inc.)	500—252
KFEL	Denver, Colo.	Winner Radio Corp.	50—254	KFOO	Salt Lake City, Utah	Latter Day Saints University	250—236	KFWC	Upland, Calif., L. E. Wall	50—211.1
KFEQ	Oak, Nebr.	Scroggin & Co. Bank	500—268	KFOR	Salt Lake City, Utah	Latter Day Saints University	250—236	KFWD	Arkadelphia, Arkansas, Arkansas Light & Power Co.	500—266
KFEY	Kellogg, Idaho	Bunker Hill & Sullivan Mining & Concentrating Co.	10—233	KFOT	Wichita, Kans.	College Hill Radio Club (College Hill Methodist Church)	50—231	KFWF	St. Louis, Mo., St. Louis Truth Center	250—214.2
KFFP	Moberly, Mo.	First Baptist Church	50—242	KFOX	Omaha, Nebr.	Technical High School	100—248	KFWH	Chico, Calif., F. Wellington Morse, Jr.	100—254
KFFV	Lamoni, Iowa	Graceland College	100—250	KFOY	St. Paul, Minn.	Beacon Radio Service	50—252	KFWI	South San Francisco, Calif., Radio Entertainments (Inc.)	500—226
KFFY	Alexandria, La.	Louisiana College	50—275	KFPG	Los Angeles, Calif.	K. M. Turner Radio Corp. (Oliver S. Garretson)	500—238	KFWM	Oakland, Calif., Oakland Education Society	500—206.8
KFGC	Baton Rouge, La.	Louisiana State University	100—268	KFPL	Dublin, Texas	C. C. Baxter	15—252	KFWO	Avalon, Calif., Lawrence Mott	250—211.1
KFGH	Stanford University, Calif.	Leland Stanford Junior University	500—270	KFPM	Greenville, Texas	New Furniture Co.	10—242	KFWP	Brownsville, Tex., Rio Grande Radio Supply House	10—214.2
KFGQ	Boone, Iowa	Crary Hardware Co.	10—226	KFPR	Los Angeles, Calif.	Los Angeles County Forestry Department	500—231	KFWU	Pineville, La., Louisiana College	100—238
KFGX	Orange, Tex.	First Presbyterian Church	500—250	KFPW	Cartersville, Mo.	St. Johns Church	20—258	KFWV	Portland, Ore., Wilbur Jermain	50—212.6
KFHA	Gunnison, Colo.	Western State College of Colorado	50—252	KFPY	Spokane, Wash.	Symons Investment Co.	100—246	KFXB	Big Bear Lake, Calif., Bert-ram O. Heller	500—202.6
KFHL	Oskaloosa, Iowa	Penn College	10—240	KFOA	St. Louis, Mo.	The Principia	50—261	KFXC	Santa Maria, Calif., Santa Maria Valley R. R. Co.	100—209.7
KFI	Los Angeles, Calif.	Earle C. Anthony (Inc.)	3000—468.5	KFOB	Fort Worth, Texas	Searchlight Publishing Co.	150—263	KFXD	Logan, Utah, L. H. Strong (Packard Motor Co.)	10—205.4
KFIF	Portland, Ore.	Benson Polytechnic Institute	100—248	KFOC	Taft, Calif.	Kidd Brothers Radio Shop	100—231	KFXE	Waterloo, Iowa, Electrical Research & Mfg.	10—236
KFIO	Spokane, Wash.	North Central High School	100—266	KFQP	Iowa City, Iowa	George S. Carson, Jr.	10—224	KFXF	Colorado Springs, Colo., Pikes Peak Broadcasting Co.	500—250
KFIQ	Yakima, Wash.	First Methodist Church	100—256	KFOT	Denison, Texas	Texas National Guard, 36th Signal Company	10—252	KFXH	El Paso, Texas, Bledsoe Radio Co.	50—242
KFIU	Juneau, Alaska	Alaska Electric Light & Power Co.	10—226	KFOU	Holy City, Calif.	W. E. Riker	100—217.3	KFXJ	Denver, Colo., Mountain States Radio Distributors, Inc. (Portable)	10—215.7
KFIZ	Fond du Lac, Wis.	Daily Commonwealth and Wisconsin Radio Sales, Inc.	100—273	KFOV	North Bend, Wash.	C. F. Knierim	50—215.7	KFXM	Beaumont, Texas, Neches Electric Co.	10—227
KFJB	Marshalltown, Iowa	Marshall Electric Co.	10—248	KFOW	Hollywood, Calif.	Taft Radio Co.	50—226	KFXV	Flagstaff, Ariz. (Orpheum Theatre), Mary M. Costigan	50—205.4
KFJC	Junction City, Kansas	Episcopal Church (R. B. Fegan)	10—218.8	KFQZ	Hollywood, Calif.	Taft Radio Co.	50—226	KFYF	Oxnard, Calif., Carl's Radio Den (Newcomb Radio Co.)	10—205.4
KJFF	Oklahoma, Okla.	National Radio Mfg. Co.	225—261	KFRB	Beeville, Tex.	Hall Brothers	250—248	KFYJ	Houston, Tex., Houston Chronicle Publishing Co. (Portable)	10—238
KFJI	Astoria, Ore.	Liberty Theatre	10—246	KFRC	San Francisco, Calif.	City of Paris Dry Goods Co.	50—268			
KFJM	Grand Forks, N. Dak.	University of North Dakota	100—278	KFRM	Fort Sill, Okla.	Lieut. James P. Boland, U. S. A.	50—242			
KFJR	Portland, Oregon	Ashley C. Dixon & Son	50—263	KFRU	Columbia, Mo.	Stephens College	500—499.7			
KFJX	Cedar Falls, Iowa	Iowa State Teachers' College	50—258	KFRW	Olympia, Wash.	United Churches of Olympia	50—218.8			

THE complete international list of Broadcast Stations, arranged for convenient reference, will appear every other month in RADIO NEWS, with revisions and changes up to the closing date of this magazine. The first number after the name of each station is its power, expressed in watts; and the second number—following the dash—the wave-length of the station, expressed in meters.

(Continued on page 1227)



“These Eveready Batteries are the correct size for your set. With average use they will last you a year or longer”

“YOU have been one of the many who use ‘B’ batteries that are too small in capacity for their receivers. That is not economical. It makes you buy ‘B’ batteries twice as often as necessary. Fit the right size Evereadys to your set and add a ‘C’ battery,* if you haven’t one, and you’ll get the maximum of service at the minimum of cost.”

The life of your Eveready “B” Battery depends on its capacity in relation to your set and how much you listen in. We know, through a careful investigation, that the average year-round use of a set is

*NOTE: In addition to the increased life which an Eveready “C” Battery gives to your “B” batteries, it will add a quality of reception unobtainable without it.

two hours a day. Taking that average we have proved over and over that on sets of one to three tubes the No. 772 Eveready “B” Battery used with a “C” battery will last a year or longer. On sets of four and five tubes, the larger Heavy Duty Eveready Batteries used with a “C” battery will last eight months or more.

Here is the secret of the utmost “B” battery satisfaction and economy:



LEFT—Eveready Layerbilt “B” Battery No. 486, 45 volts, for maximum economy on four, five or more tubes.
RIGHT—Eveready Dry Cell Radio “A” Battery, 1½ volts. The battery built especially for dry cell tubes.

EVEREADY
Radio Batteries
—they last longer

With sets of from 1 to 3 tubes, use Eveready No. 772.

With sets of 4 or more tubes, use either the Heavy Duty No. 770, or the even longer-lived Eveready Layerbilt No. 486.

We have prepared for your individual use a new booklet, “Choosing and Using the Right Radio Batteries,” which we will be glad to send you upon request. This booklet also tells about the proper battery equipment for use with the new power tubes.

Manufactured and guaranteed by
NATIONAL CARBON CO., INC.
New York San Francisco
Canadian National Carbon Co., Limited
Toronto, Ontario

EVEREADY HOUR
EVERY TUESDAY AT 9 P. M.
Eastern Standard Time

For real radio enjoyment tune in the “Eveready Group.” Broadcast through stations—

- | | | |
|-----------------|----------------------------|-----------------|
| WEAF—New York | WVI—Philadelphia | WSAI—Cincinnati |
| WJAR—Providence | WGR—Buffalo | WWJ—Detroit |
| WEEI—Boston | WCAE—Pittsburgh | WOC—Davenport |
| WTAG—Worcester | WCCO—Minneapolis, St. Paul | KSD—St. Louis |
| | | WEAR—Cleveland |

GEN-WIN

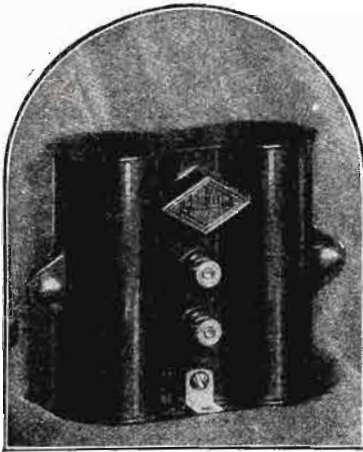

Patents Pending

LEMNIS COIL

Reg. App. U. S. Pat. Off.

To get all that any set can give, you must use this greatest scientific advancement of all—GEN-WIN Lemnis-Coils. They give astonishingly better results because they are the only inductances offering you all these advantages:

- 1—Lemnis-Coils are wound with an elongated reverse curve. This form confines the electro-magnetic field and neutralizes the tendency toward oscillation. The extraordinary length of the curve reduces the resistance otherwise encountered in small diameter coils.
- 2—Lemnis-Coils have no "peak." They afford high, uniform amplification on all wavelengths in the broadcast band. They do not cause distortion.
- 3—Lemnis-Coils amplify only what is received from the preceding stage. Their non-pick-up qualities reduce the annoyance of static and other interference.
- 4—Lemnis-Coils are kept free from dust by means of sealed Bakelite cases, thus retaining their full efficiency.
- 5—Lemnis-Coils used to replace any type of tuned radio frequency transformers or antenna couplers, will increase the sensitivity and selectivity of your receiver.

GENERAL WINDING CO., INC.,
214 Fulton Street New York, N. Y.
SEND THIS COUPON IF DEALER HAS NO GEN-WIN LEMNIS-COILS

GENERAL WINDING CO., INC.,
214 Fulton Street, New York, N. Y.

You may send me one guaranteed Kit of three GEN-WIN Lemnis-Coils, complete with blue-print, showing detail of hook-up.

Enclosed is money-order for \$12. (Ship postpaid)

Send C. O. D. (I will pay postman \$12 plus postage.)

It is understood that these coils are guaranteed to afford the utmost in tuned radio frequency reception.

Name

Street and No.

City

State

The Isofarad Circuit

(Continued from page 1152)

oscillation at all points, it is necessary that the bridge balance be exact over the entire tuning range.

THE SOLUTION

Since it is impossible to construct inductances that have no distributed capacitance (that is, pure inductances), but is a simple matter to build condensers having practically no inductance, it follows that only a bridge having capacitances for all four arms will satisfactorily fulfill the requirements. Capacitances do not change in value with frequency, whereas the inductances of coils do change.

Fig. 2 shows a single stage of the Isofarad circuit, an arrangement that fulfils all of the above requirements. Fig. 3 is the all-capacitance bridge as used in Fig. 2 analyzed in the rhombus layout of the conventionalized bridge. Note that the same lettering is used in both figures. C_1 and C_2 are tuning condensers of the same size across the input coil L_1 . They are controlled simultaneously by the same tuning dial and preferably should be built in tandem with rotors on a common shaft. Their capacitances are thus equal on all settings of the dial. C_{RP} is the capacitance existing between the grid and the plate of the tube. C_b is a small variable condenser, with micrometer adjustment, used to balance the bridge. G is the grid of the tube; P is the plate; F is the filament; and A is the remaining point of the bridge. As in Fig. 1, this circuit is balanced when

$$\frac{C_1}{C_2} = \frac{C_{RP}}{C_b}$$

and since $C_1 = C_2$, then C_b must equal C_{RP} . It should be noticed that this balanced condition is independent of such things as mu-

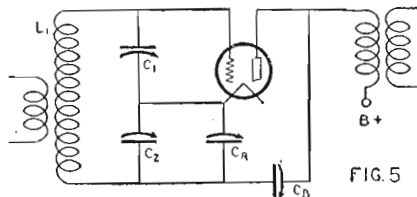

tual conductance of the tube, so the circuit cannot be made inefficient or obsolete by changes in tube design, as is the case with certain receivers employing other means for preventing self-oscillation. When the bridge is balanced by the adjustment of C_b , the voltage set up across the points P and F by plate currents flowing through L_2 has no effect upon the input circuit between points G and A . And this condition of balance will remain practically fixed for all positions of the tuning dial which controls C_1 and C_2 .

IMPORTANCE OF COUPLING TRANSFORMER

The effectiveness of the coupling transformer between tubes in a radio frequency amplifier is limited by the tendency toward oscillation. This tendency is controlled to a different extent by the older devices, some of which will counteract completely a strong tendency to oscillate, while others will have difficulty in suppressing feeble oscillations. Such a situation has resulted in many instances in too great emphasis upon the control device and too little upon the design of the transformers. The general tendency has been to emphasize the value of regeneration and to discount the electrical efficiency and voltage step-up factor of the transformer. The most successful of the older sets have been those supplied with some manually-operated device to keep regeneration at the peak, just below the point of oscillation.

The Quiet NILES

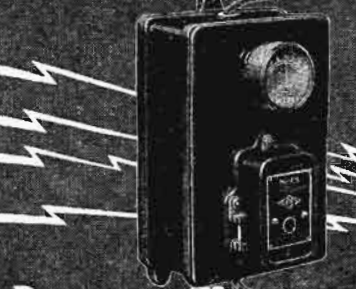

Battery Charger

Saves Time—
Saves Current

The only 10-ampere charger. Uses no more current than low ratio chargers. No bulbs—no acids—no fumes. Model A for 6-volt batteries, \$19.00; Model AB for 6-volt and 24-volt to 120-volt batteries, in series, \$21.00. West of Rockies, \$1 extra. Ask Any Radio Dealer.

NILES MANUFACTURING COMPANY
Dept. 20, Ypsilanti, Mich.

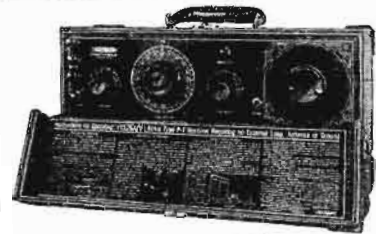

The Famous Truly Portable TELMACO P-1 Receiver

Four Tubes Do the Work of Seven

The peer of portables in size, weight, ease of tuning, selectivity, distance, volume, workmanship and price. Aerial, loud speaker and batteries self contained. Complete with tubes and batteries. \$125.00. Receiver only \$141.50.

P-1 Kit Saves You Money!
Our offer of the Telmaco P-1 Receiver in kit form has met with enthusiastic reception. This contains all parts, as built by us, including case, drilled and engraved panel, and illustrated instructions. \$80.00. Complete kit.

Ask your dealer or write us. Descriptive folder free.
Radio Division:
Telephone Maintenance Co.
20 So. Wells St. Dept. B Chicago, Ill.

Quality Radio Exclusively Established 1918

WELL PAID RADIO OPERATORS



You can be one—ever increasing demand—pleasant and interesting—leads to big positions—hundreds of successful graduates praise our practical courses for operators, mechanics and dealers. Write NOW for free booklet on "Opportunities in Radio."

Y. M. C. A. RADIO INSTITUTE
158 East 86th Street, New York City
Lenox 6051

ATWATER KENT RADIO

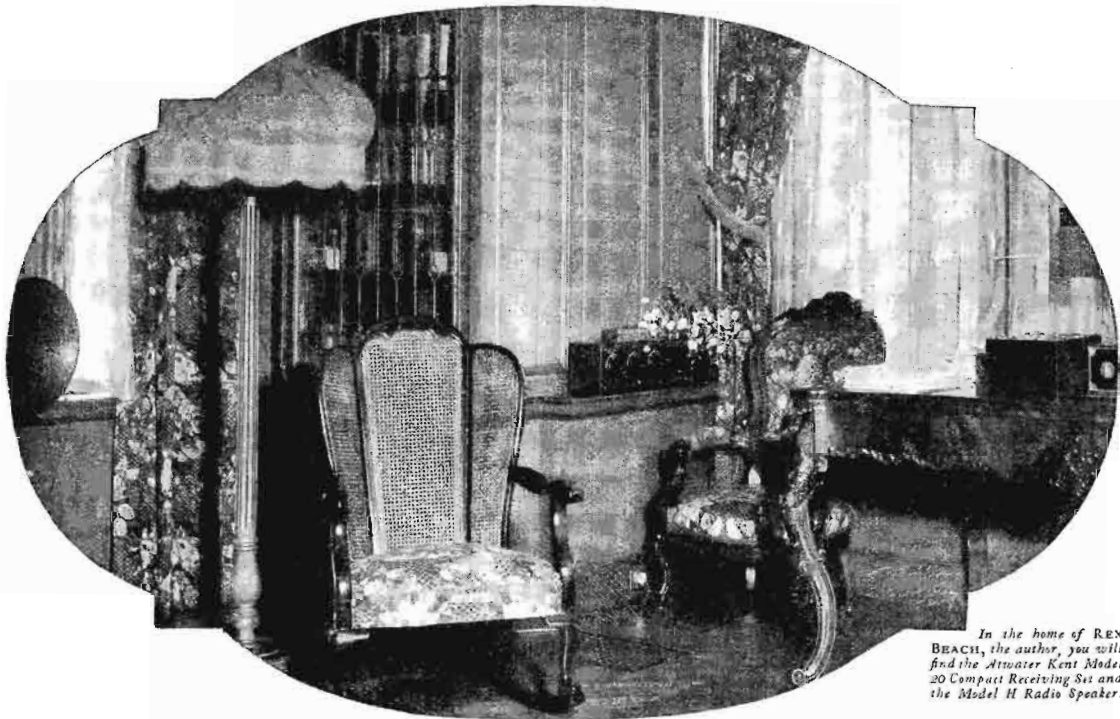

In the home of REX BEACH, the author, you will find the Atwater Kent Model 20 Compact Receiving Set and the Model H Radio Speaker.

Radio is meant to be heard
—not necessarily seen



Model H, with 9' flexible cord, \$22



Model 20 Compact, including battery cable, but without tubes, \$80

Prices slightly higher from the Rocket test, and in Canada

Hear the Atwater Kent Radio Artists every Sunday evening at 9:15 o'clock (Eastern Standard Time) through stations—

- WEAF New York
- WJAR Providence
- WEFI Boston
- WCAP Washington
- WSAI Cincinnati
- WCCO Min.-St. Paul
- WEAR Cleveland
- WFI } Philadelphia
- WOO } alternating
- WGAE Pittsburgh
- WGR Buffalo
- WOC Davenport
- WTAG Worcester
- RSD St. Louis
- WWSI Detroit
- WLIB Chicago

No longer than a row of a dozen books, no higher than your fountain pen, light enough to be carried on one hand—that's the Atwater Kent Model 20 Compact.

It is the Receiving Set of tomorrow, here today. It has all the power in half the space.

It is only 6½ inches high and 19¾ inches long. It is right in step with the modern trend of saving space. You can put it anywhere—on a small table,

beside your favorite arm-chair, among your books and flowers and magazines; no new furniture is needed.

For any room, in any home—for beauty, convenience and efficiency—you can do no better than to select the receiving set so satisfying in so many homes—the Model 20 Compact.

See it—hear it at any store where Atwater Kent Radio is sold—today.

Write for illustrated booklet telling the complete story of Atwater Kent Radio

ATWATER KENT MFG. CO.
A. Atwater Kent, President
4713 WISSAHICKON AVE., PHILADELPHIA

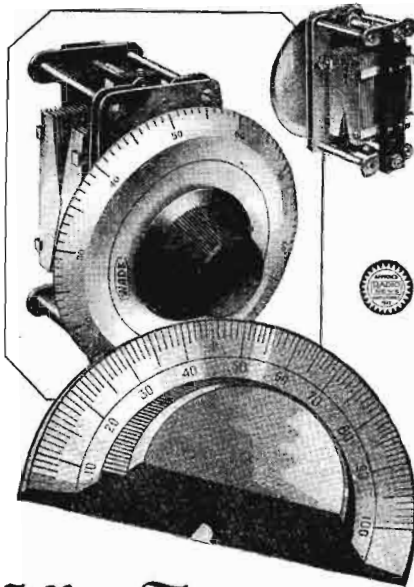

Why Tune With Only Half a Dial?

UNIQUE design of Wade Condensers spreads stations over the entire 360 degree dial. The Wade is a complete tuning unit built with specially designed vernier dial. This means twice as much space between stations for close tuning adjustment; even wider separation of stations than the rotor plate types of straight line frequency condensers using standard 180 degree dials. None of the annoyance of overlapping stations and jumbled reception. The Wade Condenser gives the lowest minimum capacity and wider tuning range. Covers the whole broadcast range and down below 200 meters.

No Body Capacity Effects

A separately grounded frame insulated from both sets of plates shields the condenser from all body capacity effects—an important feature, exclusively in Wade Condensers.

Wade Tuning Unit

Including Condenser and Dial

The Wade Tuning Unit consists of a Wade Condenser geared to a four-inch 360 degree vernier dial of 16 to 1 ratio. Finest possible control with no backlash. Prices below are for the complete unit.

Capacity .000125 mfd....	\$6.00
Capacity .00025 mfd....	6.25
Capacity .00035 mfd....	6.35
Capacity .0005 mfd....	6.50

THE VIKING TOOL AND MACHINE CO., INC., Licensee

745-C 65th Street Brooklyn, N. Y.



That the gain due to the coupling transformer alone has some importance may be seen by referring to Fig. 4. Here, in addition to the primary winding, we have connected in the plate circuit a variometer L_v . Also, the input coil, L_2 , has been placed at a great distance from L_p . Now, by varying L_v , we can bring the tube YT as closely as is desired to the point of self-oscillation. But since L_p and L_2 are widely separated, the amount of energy fed to the following tube will be infinitely small. Here, then, is a case where the circuit is brought to incipient self-oscillation, but where the arrangement is a decidedly poor radio frequency amplifier. Thus we have, as an extreme case, the highly undesirable condition of a radio frequency stage which oscillates violently but which is a poor amplifier. The ideal to be achieved is the opposite extreme, in which the radio frequency circuit is an extremely good amplifier but is perfectly balanced against self-oscillation. This requirement is met in the Isofarad circuit since it permits high efficiency in inter-stage transformers without instability in operation.

USE OF UNEQUAL CONDENSERS

The original Isofarad circuit employed double condensers of equal size in tandem, for C_1 and C_2 . The improved circuit makes use of unequal condensers, C_2 being greater than C_1 . This results in an increase in signal voltage applied between grid and filament, as the voltage drops across two condensers in series are inversely proportional to their capacitances. That is, the voltage developed across the input coil L_1 is the same, at any instant, as the total voltage across the two condensers C_1 and C_2 in series. Of this total voltage, however, only that portion across C_2 is effective in producing a signal; and since the smaller the capacitance, the greater the voltage developed across it, it follows that C_1 should be small and C_2 relatively large. In the improved Isofarad circuit C_1 has a capacitance of 0.00025 μf , and C_2 a capacitance of 0.0005 μf .

"If the relation, 'the lower the capacitance, the greater the voltage' is true," one might ask, "why not make C_1 still smaller and C_2 larger, so that the unused voltage across C_2 would be negligible in value?"

Such a question leaves out of account the fact that the combined capacitance of two condensers in series can never be greater than that of the smaller condenser alone. In order to have a reasonable tuning range we must set a minimum limit, therefore, for C_1 .

As a matter of fact, the voltage amplification per stage is increased 34 per cent. over that of the original Isofarad, which used two condensers of equal size for the capacitances C_1 and C_2 , and 67 per cent. of the total voltage across the coil L_1 is impressed upon the grid.

When we remember that such an increase in the first two stages is further augmented in all succeeding stages, it is apparent that the actual signal intensity is greatly increased over that obtainable with two condensers in tandem.

So far we have neglected two small capacitances: first, the capacitance within the tube between the plate and filament; and second, the similar capacitance between grid and filament. The first of these is across two opposite points of the bridge and, therefore, cannot affect balance. The second is due to the small capacitance between the grid and filament, and is connected in direct shunt with the variable condenser C_1 . It is necessary only to place a like capacitance across C_2 to balance off the grid-filament capacitance. This is a simple matter when C_1 and C_2 are equal in value, as in such a case the bridge is balanced throughout by equal capacitances compensating for one another and as the only two variable con-

Build the Set That Holds 4 World's Records



The receiver that brought in stations 6,000 to 8,000 miles distant with loud speaker volume night after night. All records fully verified.

Holds World's Records For

- (1) Longest distance ever received on a loop aerial—8,375 miles.
- (2) Most consistent reception of stations 6,000 to 8,000 miles distant—117 programs in three months.
- (3) Brought in 6 different stations in 2 1/4 hours—all over 6,000 miles.

PRICE

Complete Set of Parts.....\$89.00
(Includes all parts necessary to make an exact duplicate of this wonderful receiver, together with blue prints and complete building instructions.)

Story of development and proofs of records sent on receipt of stamped and addressed envelope.

Scott Radio Laboratories

35 S. Dearborn St., Dept. 618, Chicago

Dealers and set builders write for discounts

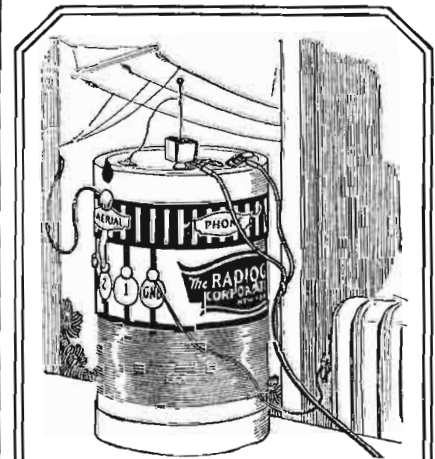

THE SIMPLEST PRACTICAL RADIO SET MADE

\$1⁰⁰

The RADIOGEM

The simplest radio outfit made—yet as practical as the most expensive. A crystal receiving set that you can operate and enjoy even though you know absolutely nothing about radio. You receive the RADIOGEM unassembled, together with a clearly written instruction book, which shows you how to quickly and easily construct the set, using only your hands and a pair of scissors. The outfit comprises all the necessary wire, contact points, detector mineral tube on which to wind the coil, etc., etc. The instruction book explains simply and completely the principles of radio and its graphic illustrations make the assembling of the RADIOGEM real fun.

THE RADIOGEM CORP.

66-R W. Broadway New York City

Insure your copy reaching you each month. Subscribe to RADIO NEWS—\$2.50 a year. Experimenter Publishing Co., 53 Park Pl., N.Y.C.



A Type for every Tube
Application

I got 'em!

REGARDLESS of the set—in the final analysis it's the tubes that tell the story of whether "you get 'em" or not—that makes possible clear, joyous, reception. That's why Sylvania Tubes are preferred and insisted upon by every radio user that has ever tried them.

Sylvania Tubes have clearly demonstrated time and time again their absolute superiority over the average product—yet they cost no more and you can buy them from any wide awake dealer. If the dealer in your town does not have them—write us direct.



To Wide Awake Dealers and Jobbers

We are interested in making a connection with wide awake dealers and jobbers covering the exclusive selling rights of Sylvania Tubes in the territory covered—For details write or wire today.



Sylvania

Radio Tubes

SYLVANIA PRODUCTS COMPANY

Emporium, Pennsylvania



**He was amazed—
he had been sure
it was static—**

MANY fans are blaming static for noises which are not static at all. They are noises which can be eliminated. For example unless you keep your contacts between tube and sockets clean at all times, corrosion is going to cause disturbing noises which you may lay to static.

It is easy to keep these contacts clean with the Na-Ald No. 400 De Luxe Socket. Just a turn or two of the tube in the socket cuts away all corrosion from tube terminals and clears up the voice of your radio instantly. No need to take the tube out and sandpaper each terminal with this socket. When the tube is turned in the socket, the exclusive side-scraping duo-contacts scrape away all corrosion and the terminals come to rest on the scraped portions. The Na-Ald No. 400 De Luxe Socket is the only socket that eliminates noises due to corrosion. Meter tests have proved this action sure and positive.

And our No. 400-S Socket (the regular No. 400 on spring mount) also eliminates microphonic noises due to vibrations.

Both the No. 400 and the 400-S sockets are made of Alden-processed Bakelite which conserves all the current energy. Laboratory tests proved Na-Ald Sockets most efficient in low loss and low capacity. Na-Ald Socket No. 400 was selected by ten famous radio engineers as best for the famous Hammarlund-Roberts set. It is part No. 6. List prices: No. 400 and No. 400-S, 75c.

The New Socket That Takes All the New Tubes

The new Na-Ald Socket No. 481-X takes all the new tubes without adapters. Sure, Positive Contact. Alden Processed Bakelite for lowest losses. List price, 481-X, \$35.

Write for full information on the complete line of Na-Ald Sockets, Dials and Adapters.

ALDEN MANUFACTURING COMPANY

Dept. K16, Springfield, Mass.

Alden Processed



densers remain equal at all times, the "fixed" values need no adjustment whatsoever. The necessity for a vernier adjustment is provided for in condenser C₇, shown in Fig. 5.

It is more or less common knowledge that most radio frequency amplifiers are relatively insensitive on the longer waves. This is due partly to variation in the efficiency of the coupling transformer. Therefore transformers whose efficiency decreases greatly with increase in wave-length should be avoided. As this effect is least pronounced in transformers of the solenoid type, they are used in the Iso-rad receiver.

The result is a receiver having remarkable amplification on all wave-lengths, pure tone due to the absence of regeneration, inherent stability and smoothness of operation, and truly remarkable selectivity—which is necessary in an ultra-sensitive receiver.

**SOLUTION TO LAST MONTH'S
CROSSWORD CALL-LETTER
PUZZLE**

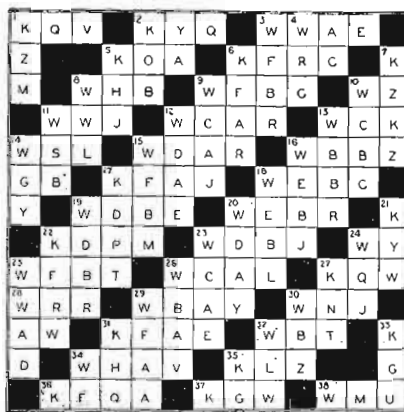

**YOUR NEXT-DOOR NEIGHBOR
MAY BE THE STATIC**

Some fans have been blaming their receiving sets as poorly constructed because crackling noises resembling static are heard, even when the antenna and ground are disconnected. It is true that such noises may develop from faulty connections, cheap condensers, or defective batteries; but frequently they arise from causes outside the set.

It is reported that one fan became so exasperated with his set that he finally threw it out of the window, only to discover later that the crackling noises were caused by the operation of a violet-ray machine in the adjoining apartment.

Another was troubled nightly by a sharp staccato that started up promptly at eight, continued for a while, and then died suddenly. No explanation could be found, although the annoyance continued for months. The odd feature was the fact that it never occurred Saturday nights. It finally turned out that it was caused by the car of a neighbor who left for work at eight, every night but Saturday, from the garage to which the far end of the antenna was attached.

Sewing machine motors, vacuum cleaners, washing machines, and similar devices are subject to much sparking at the commutator when a lack of proper oiling causes them to overheat. These form another common source of "local" static. Investigations should be made to see if trouble arises from such causes, before condemning the set.

AN OLD SONG RESUNG

FIRST NEIGHBOR: Say, Bill, what was that music I heard coming from your house last night?

SECOND NEIGHBOR: Music? Shucks, that wasn't no music. That was the radio!
Contributed by William Griffin.



Sensation of Season

**B-Eliminators
using New RAYTHEON
Tubes with**



Operating a radio set is now a source of keen delight to every member of the family. Consistent performance every night is assured with the new B-Eliminators using the remarkable new Tubes and Dongan Transformers and Chokes. And anyone can build this B-Eliminator at small cost.

Indorsed by leading radio engineers and well-known magazine editors, every radio lover can now possess the simplicity and 100 per cent. reception possible with the new Tube B-Eliminators.



**Transformers
List \$7.00**

- No. 509 Full Wave for RAYTHEON Tubes.
- No. 537 Full Wave for R.C.A. UX-213 Tubes.
- No. 537 Full Wave for Cunningham CX-313 Tubes.
- No. 538 Half Wave for R.C.A. UX-210-B Tubes.
- No. 538 Half Wave for Cunningham CX-310-B Tubes.



**Chokes
No. 514 20 henry
No. 506 30 henry
No. 539 50 henry
List \$5.00**

Full instructions and description mailed on request. Ask your dealer or send check or money order to factory. Sold under guarantee.

For Set Manufacturers

Dongan is the standard maker of transformers and chokes for the leading manufacturers of B-Eliminators. Engineering data and quotations on request.

More than 12 of the country's leading sets use Dongan Audio Transformers. Any type you require. Your requirements can be handled promptly in our big plant. Prices on request.

DONGAN ELECTRIC MANUFACTURING CO.
2977 Franklin St., Detroit, Mich.

TRANSFORMERS of MERIT for FIFTEEN YEARS

RADIO long distance COMPLETE sets

THESE are the finest long distance sets at the lowest prices in history. Wonderful new circuit that brings amazing results. SATISFACTION GUARANTEED. Everything furnished with complete sets. There's a set for every pocket.

- 5 TUBE SET—100 Amp. Storage "A" Battery, rubber covered "A" Battery cabinet, "B" Battery, 90 V., 5 Tubes, Loud Speaker, Loud Speaker Plug, Antenna \$95.95
 - 3 TUBE SET—3 Dry Cells; "B" Battery, 90 V.; 3 Tubes, Loud Speaker, Head Phones, Antenna \$49.95
 - 2 TUBE SET—2 Dry Cells; "B" Battery, 45 V.; 2 Tubes, Head Phones, Antenna \$29.95
 - 1 TUBE SET—1 Dry Cell; "B" Battery, 22.5 V.; 1 Tube, Head Phones, Antenna \$18.95
- Sets also sold without accessories. Full line radio accessories and partly assembled kits.

THE MELLODYNE RADIO COMPANY
Dept. R-2 Cincinnati, Ohio

Write for free catalog today

RADIO—BARGAINS

FREE RADIO CATALOG & GUIDE of newest ideas, approved special hook-ups with illustrations. Tremendous savings on standard radio parts, sets, kits, Be sure to get this thrifty book before you buy. Wonderful! Unusual? You'll say so. Write letter or postal NOW. BARAWIK CO., 102-142 S. Canal St., CHICAGO, U.S.A.

Insure your copy reaching you each month. Subscribe to RADIO NEWS—\$2.50 a year. Experimenter Publishing Co., 53 Park Pl., N.Y.C.

FANSTEEL
Balkite
Radio Power Units

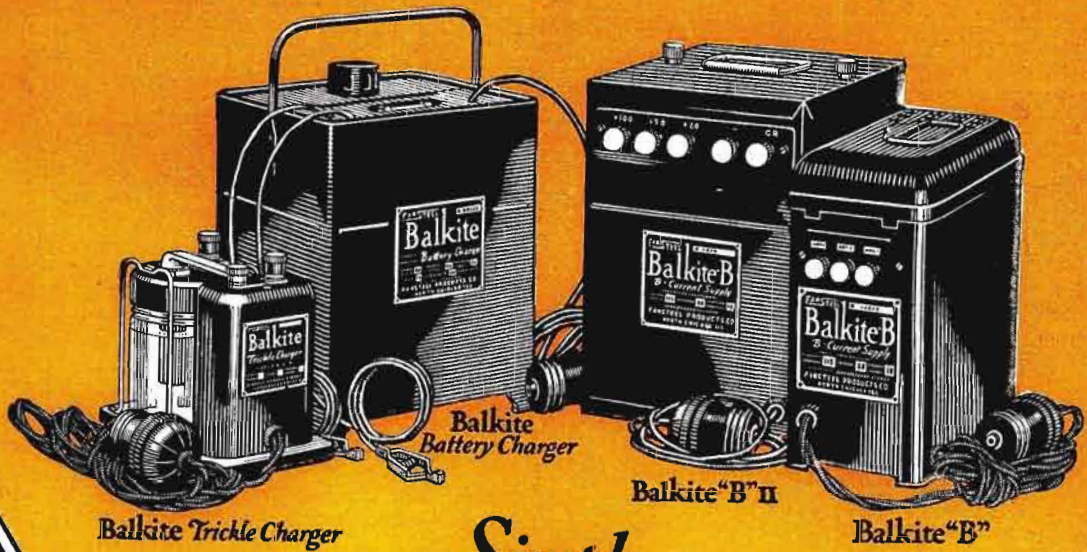

Balkite Trickle Charger

Balkite Battery Charger

Balkite "B" II

Balkite "B"

*Simple
 Entirely Noiseless
 Permanent*

Manufactured by FANSTEEL PRODUCTS COMPANY, Inc., North Chicago, Illinois



Convert your radio receiver
 into a light socket set with

Balkite Radio Power Units

Ask your radio dealer

FANSTEEL PRODUCTS CO., Inc., North Chicago, Ill.

Sole Licensees in the United Kingdom: Messrs. Radio Accessories, Ltd., 9-13 Hythe Rd., Wellesden, London, N.W. 10





For EVERY Radio Set

A stunning piece of furniture that restores order in the room where you have your Radio! No more cluttered table-tops, nor litter of equipment under-foot.

No unsightly horn in evidence, either! This console has its own loudspeaker, in-built. It's out of sight, but with very apparent tonal superiorities. For it has the highest-developed type of unit, With horn built of special non-vibrating, extra-hard material. Produces clear, non-vibrant tone.

There's ample room for everything; space for A and B wet batteries—or battery eliminator—and for a charging outfit, too.

Finished in mahogany, or walnut color. Dainty design of parqueterie on two front panels. Top, 38 in. x 18 in.

Additional pattern No. 128 (Special for Radiola No. 125) in two-tone finish. Top, 21 in. x 31 in. Fitted with doors for access to control switches of combination eliminator-charger.

The price, forty dollars, is for the complete console and includes the loudspeaker horn and unit. Thousands of dealers are showing this artistic addition to home radio equipment.



The Radio Beginner

(Continued from page 1148)

ance. Equipped with a reproducing unit in the base, it throws the sound upward and outward toward the listeners. The result is an amplification of sound, due to the directional effect so obtained, and also due to the concentration of the waves by the shape of the bowl-like horn. Speakers of this type are to be considered as quite good, inasmuch as they are small, compact and give very good reproduction. The particular type



Fig. 2. An older type of loud speaker horn which employed curved tubing to obtain an effective long column of air.

shown was made in either wood or pressed fibre and, since the concentrating part of the loud speaker had no natural period of its own, it did not enter into the reproduction in any other way than to concentrate and direct the sound waves.

THE NEWEST REPRODUCERS

After having been burdened with horn types of loud speakers for several years, the radio public was suddenly presented with something entirely new and novel in the line of radio reproducers. These are what are now generally known as cone types of speakers. Inasmuch as they employ no horn, we can disregard the length of any column of air that may be used, because the cones themselves are really enormous diaphragms that serve to shake or vibrate a large quantity of air every time they are set into vibration. There is no horn or other shaped object to concentrate or direct the sound and no column of air need be set in vibration in order to obtain amplification. This is because of the fact that the cone itself sets up vibrations in a large quantity of air at any one time and thus the necessity of concentration is done away with.

When cone loud speakers were first introduced, they had a good many defects. One was that the reproduction was not even in volume over all frequencies, and distortion was quite noticeable in many cases. This distortion characteristic seemed to be quite erratic and could not always be controlled. However, these types have been improved upon constantly and today there are a good many types of cone speakers on the market that are to be regarded quite highly.

"Binghamton, N. Y. to the Pacific on this indoor aerial!"



Effarsee
ANTENNAE
REG. U. S. TRADE MARK
PATENT PENDING

Sweetens Reception—
Greater Selectivity—
Volume to Spare—

New development of a radio engineer has proved more efficient than outside aerials. Increased range, knife-like selectivity, greater volume.

Large Size Has
1000 Feet of Wire!

Type IXL EFFARSEE contains 1000 feet of copper aerial wire, covered with parchment. Equipped with special fixed condensers. Used inside or out—can be hung on walls, used under eaves, anywhere. Write for distance reports of enthusiastic users.

Type IXL (large) . . \$4.00
Type BXL (small) . . 2.50

At any radio dealer
—or write direct.

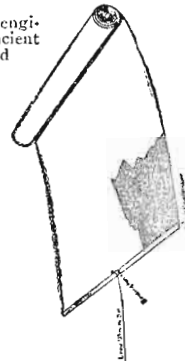

FISHWICK RADIO CO.
131 CENTRAL PARKWAY, CINCINNATI, O.

FAHNESTOCK CLIPS

"Popular Wherever Radio Is Used."



PRESS
DOWN
HERE

FAHNESTOCK Connectors are used by nearly every manufacturer of standard radio sets and manufacturers of high grade "A" and "B" Batteries. FAHNESTOCK makes connectors for every radio purpose.

"THE IDEAL CONNECTOR"
Catalog sent upon request
FAHNESTOCK ELECTRIC COMPANY
Long Island City, New York

Free to Men Past 40

What is prostate gland disorder? Why does it come to two-thirds of all men past middle age? Why does it cause loss of vitality, sciatica, aching feet, back and legs? Amazing book, written by well known American scientist, answers these questions and tells how 20,000 men have found relief without drugs, surgery, leeches. Simply send name and address for copy, no obligation. Address the **ELECTRO-THERMAL CO.**, 604 1/2 Main St., Steubenville, Ohio. West Office: Dpt. 60-W, 711 Van Nuys Bldg., Los Angeles Cal.

Sylfan "RADIOMATES"

Receivers - Reproducers - Tubes
BAKER-SMITH CO., INC., San Francisco
Branches in Principal Cities

You must see our new 64-page Catalog before you buy anything in Radio. It's FREE. WRITE RANDOLPH RADIO CORP. 159 N. UNION AV. Dept. 2 CHICAGO, ILL.

WILLARD RADIO



BATTERIES

are heartily endorsed by the radio industry. More than 200 leading broadcasting stations have standardized on Willards because of their steady power and freedom from electrical leakage. Broadcast listeners all over the country look to them for unfailing, satisfactory reception.

To every buyer you are also able to offer the convenient service and complete recharging facilities that are featured in the advertising of the Willard Battery Men.

WILLARD STORAGE BATTERY CO.
CLEVELAND, OHIO

The Right Selling Plan for Radio Dealers

Your local Willard Service Station will act as your jobber on Willard Radio Batteries.

This means a quick source of supply of strictly fresh, well charged batteries which you can turn over to your customers in the pink of condition.

No servicing problems for you. Your local Willard Service Station assumes the responsibility for service.

Willard Radio Batteries are being advertised more extensively than ever. Have your local Willard Service Station show you this advertising and explain the details of our new and practical plan for selling radio storage batteries. The advertisements will be signed:

Sales and Service through
The Willard Battery men
and their
Authorized Radio Dealers

Appropriate signs and window cards will identify you as an Authorized Dealer. Booklets and other valuable selling helps will also be furnished.

*Your Nearest Willard
Service Station is Your
Nearest Willard Jobber*

STUDY RADIO!

Radio, the field of unlimited opportunity, calls for more trained men.

Prepare yourself for a high salaried position by using your spare time to study radio at home.

Radio Institute of America, the world's oldest radio school, has graduated more than 7,000 students. The value of RIA training is universally recognized—and graduates readily secure positions.

This coupon will bring you a wealth of important and interesting information.

RADIO INSTITUTE OF AMERICA

Formerly Marconi Institute
Established in 1909

324 Broadway
New York City

TEAR OUT

Radio Institute of America
324 Broadway, New York City
Please send me full information about your Home Study Course of radio instruction.

I am interested in the complete course, including code instruction, which qualifies for the U. S. Gov't Commercial or Amateur Radio License.

I am interested in the technical course for radio dealers, jobbers and salesmen.

Name

Address

One of the best and most reasonably-priced cones on the market today is that illustrated in Fig. 6. One reason for its quality of reproduction and its freedom from distortion is the fact that it really employs two cones, placed one within the other, but the angle at the peak of the inner cone is greater than the peak of the outer one. Thus we



Fig. 5. A novel reflecting type of loud speaker, built of wood, which operated well.

have two dissimilar diaphragms being vibrated simultaneously by the same reproducer unit, and the result is that when one diaphragm falls down on the job of reproducing a certain frequency, the other can almost invariably be depended upon to carry on this work and thus achieve very nearly perfect reproduction (see page 1148).

The reproduction unit used in this particular type of loud speaker is one that is most



Fig. 7. A combined power amplifier and loud speaker that will provide ample volume for a dance hall.

Photo by courtesy of the Radio Corporation of America.

rugged in construction, and the other day the writer witnessed several very striking demonstrations of the power that can be produced with this unit when connected to an ordinary radio receiving set. In one instance, the cones were removed from the vibrating shaft and the unit was propped up against a large plate glass show window. The vibrating shaft was placed in contact with the glass at about the center of the window, and immediately the sheet of plate glass became a diaphragm and gave forth quite a faithful reproduction of the radio concert being received. This demonstrated that the unit was strong enough and ruggedly enough built to actually shake or vibrate the entire

for REAL ENJOYMENT



Burns LOUD SPEAKER

Assures utmost in volume and clarity of tone—reaches full range of musical scale, giving a faithfulness of reproduction that equals hearing the original.

Flare in several handsome finishes.
PRICES \$22.50—\$25.00—\$30.00

Manufacturers

American Electric Company

State and 64th Sts., CHICAGO

22½ VOLT

unacid overlasting rechargeable

"B"

STORAGE BATTERY

\$2.95

Includes chemical



45 volts, \$5.25; 90 volts, \$10.00; 112½ volts, \$12.50; 135 volts, \$13.75; 157½ volts, \$16.80. Truly the biggest buy today. Easily charged on any current including 32 volt systems. Any special detector plate voltage had. Tested and approved by leading authorities such as Popular Radio Laboratories. Over 3 years sold on a non-red tape 30-day trial offer with complete refund if not thoroughly satisfied. Further guaranteed 2 years. Knock-down kits at greater savings. Complete "Hawley" "B" Battery Charger \$2.75. Sample cell 35c. Order direct—send no money—simply pay the expressman cost on delivery. Or write for my free literature, testimonials and guarantee. Same day shipments.

B. HAWLEY SMITH

314 Washington Ave.

Danbury, Conn.

CRAIN CRAFT JR.

Crystal Set \$12 COMPLETE WITH

100 ft. aerial wire, 35 ft. ground and lead-in wire, aerial insulators, porcelain tube, lead-in strip, ground clamp, nail-it knobs, set head phones. (Without accessories, \$6.00.)

Send for FREE Descriptive Booklet, giving name of your dealer.

CRAIN BROS. RADIO SHOPPE

2304 Telegraph Avenue

Oakland, Calif.

RADIO BARGAINS

FREE RADIO CATALOG & GUIDE of newest ideas, approved special hook-ups with illustrations. Tremendous savings on standard radio parts, sets, kits. Be sure to get this terrific book before you buy. Wonderful! Unusual! You'll say so. Write letter or postal NOW. BARAWIK CO., 102-142 S. Canal St., CHICAGO, U.S.A.

now we'll have clear music



MAGNATRONS in your set will give sweet purity of tone—clear and complete rendition of all the wealth of overtones. Music and speech come from the loudspeaker of the Magnatron equipped set with rich fidelity and generous volume, recreating in your home the actual performance itself, whether it be ten or a thousand miles away.

Magnatrons are the product of the oldest exclusive makers of vacuum tubes. That, in a large measure, explains their excellence.

There's a Magnatron for every purpose. The DC-201A, the DC-199, (large or small base), the DC-120 (for super volume), and the Rex (for B eliminators) all list for only \$2.50 each.

Write for your FREE copy of "Pot Pourri"—a snappy review of mirth and music to Dept. N.

CONNWEY ELECTRIC LABS.,
Magnatron Bldg., Hoboken, N. J.

Complete factory stock for Pacific Coast carried at Pacific Radio Labs.
256 So. Los Angeles St.,
Los Angeles, Cal.



MAGNATRONS

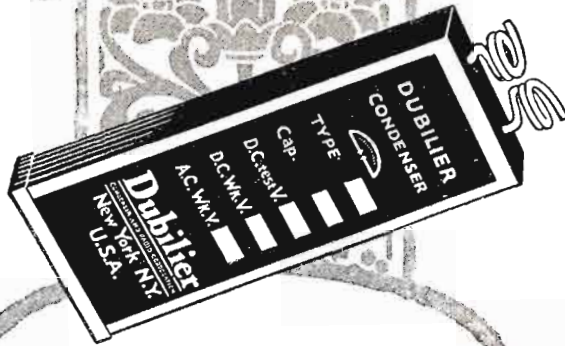

Be Sure to Use the Right Condenser for the Job



If you are building a "B" battery eliminator, be sure to use the right type of condenser in the filter circuits. The usual type of "By-Pass" condenser is not designed for the high voltages required.

Dubilier Filter Condensers are especially designed for use in the filter circuits of "B" battery eliminators. Their working voltage is very conservatively specified. That is why they give a permanent life of efficient service at voltages up to their maximum working ratings.

Remember that, *with no load*, the D.C. voltage impressed on the condenser in your filter circuit is 1.4 times the secondary terminal voltage of the A.C. transformer.

Use the right condenser for the job—made by the pioneer manufacturer of radio condensers.

Dubilier

CONDENSER AND RADIO CORPORATION

window. Then another demonstration was carried on. The unit was placed so that its vibrating rod was in contact with an ordinary desk and the entire desk became a reproducing medium. It vibrated quite strongly and gave forth very good reproduction. It is obvious that a unit of this type, constructed as strongly as this, can be depended upon to give good service even though it is handled quite roughly and subjected to abuse that would ordinarily cause loud speaker mechanism to become damaged.

Another new type of loud speaker that has recently appeared on the market and which is equipped with a power amplifier is that illustrated in Fig. 7. This is another one of the cone types of instruments and, although it is rather expensive at first cost, still the results obtained with it are certainly wonderful. Using this unit with its power amplifier connected to an ordinary two- or three-tube receiving set, more volume can be obtained than anyone could possibly need in their own home. In fact, sufficient volume of sound can be obtained to fill large halls and places of entertainment.

HOW TO BUY INTELLIGENTLY

Now you will probably want to know what you should do when you go to your

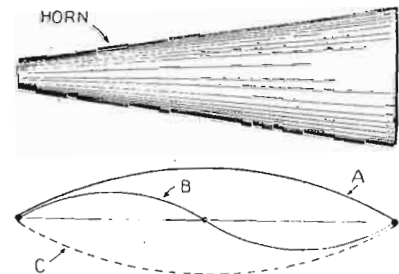

FIG. 1. This drawing shows why a long horn must be used on a horn type of loud speaker, in order to reproduce satisfactorily sounds of the longer wave-lengths.

radio dealer's store to purchase a loud speaker. Have him demonstrate each and every one of them to you on a working radio set, and listen to one after the other in succession. During the test of each speaker, have the demonstrator tune in various stations so that you get different kinds of reproduction to listen to. For instance, if a soprano singer happens to be on some station within range, listen to her and note whether or not the loud speaker reproduces high notes faithfully. Then turn to something else, such as a speaker or bass singer. Note how these tones reproduce.

When you find a loud speaker that is reasonable enough in cost for your pocketbook and seems to reproduce quite well on both the high and low notes, as well as on the medium ones, then that one is the one for you to buy.

Do not, however, be disappointed if, when you take it home, it does not seem to work quite as well on your set as it did on the dealer's. In such an event, the trouble is undoubtedly due to your amplifier. Remember that no loud speaker can be any better than the amplifier that supplies it with its motive power. If your transformers are of poor construction, or not designed properly, they will distort the incoming signals and the result will be that no loud speaker, regardless of how good it is, can ever hope to give good reproduction with that particular amplifier.

More so than with the horn type of loud

Mr. Peck, the author of this article, is Associate Editor of SCIENCE AND INVENTION. His popularly-written articles on Radio appear regularly in RADIO NEWS.

FARAWAY RADIO

\$22.50
Gets stations Far and near Loud and Clear

FARAWAY RADIO AGAIN TO THE FRONT
Amazing new set, Model 15-5 tube set—at an exceptional price. Most advanced set on the market today—designed exclusively for the new tubes. Gets stations from New York to Princeton—loud and clear. Operates with either dry cell or storage battery. SATISFACTION GUARANTEED.

2 Tube Set—\$22.50 5 Tube Set—\$63.50
Dealers!—Agents!—Biggest possibilities you ever heard of. Write for ideas and literature quickly.

THE FARAWAY RADIO CO.
Dept. S3, 125-27 E. 3rd St., Cincinnati, Ohio

Rubber Covered Insulators

Actual Size

Neat and efficient. For antenna, ground and for lead in wires. Small screw starts readily and makes finished job. Great improvement over ordinary large, unsightly insulators. They keep the wires in place and out of the way. Packed 10 in a box, 25c at your dealers or direct from us.

CULVER-STEARN'S MFG. CO.
Worcester, Mass., U. S. A.

Insure your copy reaching you each month. Subscribe to Radio News—\$2.50 a year
Experimenter Publishing Co., 53 Park Place, N. Y. C.

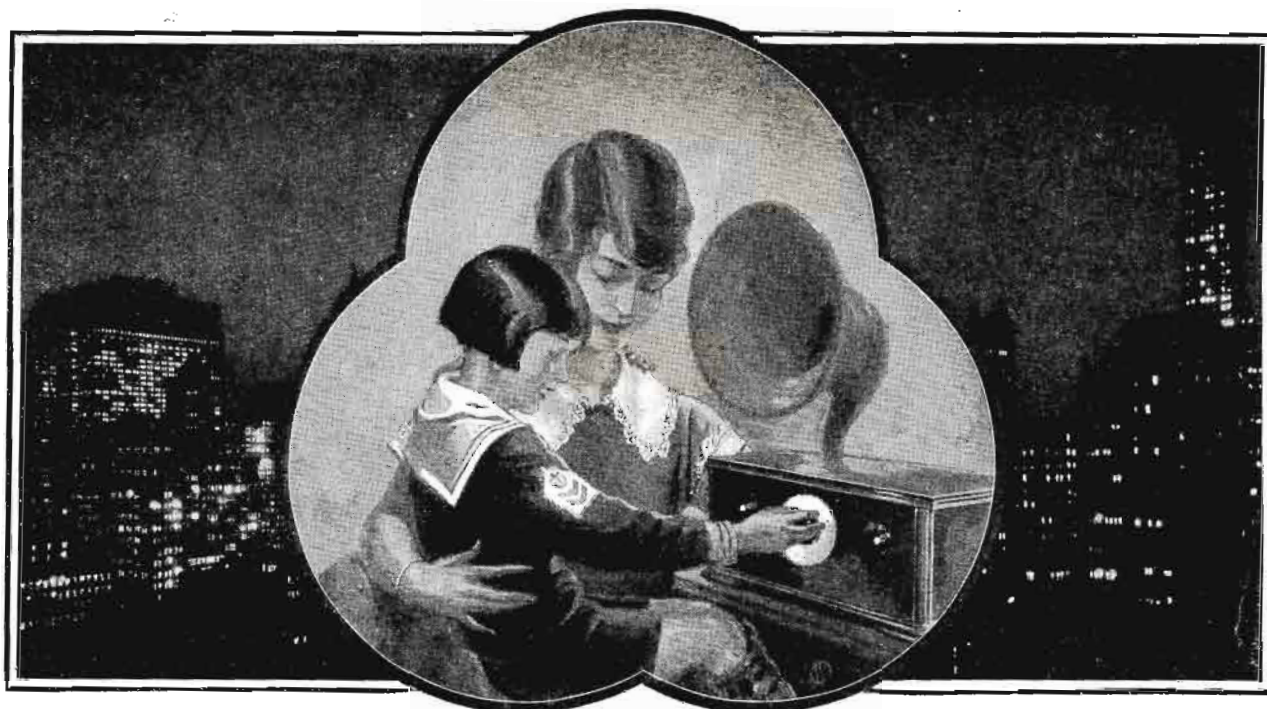

Enchanting Radio Nights for Everyone

Each night, when a myriad flashing lights make fairylands of the cities, a million folks tune in. Play-weary youngsters hear wonderful bed-time tales; light-footed boys and girls dance to the rhythmic music of fine orchestras, and their elders listen to great musicians and world-famous men. Winter nights no longer drag in Radio Homes.

Bakelite played no small role in bringing radio within reach of all. Makers of radio sets and parts quickly found that the use of Bakelite improved both performance and appearance. That its splendid insulat-

ing properties made it ideal for tube bases and sockets, transformers, rheostats and many other parts and accessories. That its strength and permanently beautiful color and finish made it superior for panels, dials and knobs.

Make sure that the radio equipment you buy is Bakelite Insulated. 95% of the radio set and parts manufacturers use Bakelite.

Write for Booklet 24

BAKELITE CORPORATION
247 Park Avenue, New York, N. Y.
Chicago Office: 636 West 22nd Street

"The registered Trade Mark and Symbol shown below may be used only on products made from materials manufactured by Bakelite Corporation. Under the capital 'B' is the numerical sign for infinity, or unlimited quantity. It symbolizes the infinite number of present and future uses of Bakelite Corporation's products."

BAKELITE

THE MATERIAL OF  A THOUSAND USES

REGD. U. S. PAT. OFF.



Bell Mfg. Co.
Vernier Dial



Shaw Insul. Co.
Dial



Polymet Mfg. Co.
E-Z-Stat

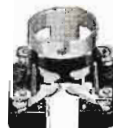

Airgap Products Co.
Socket



O. R. Gischow Co.
Gee Haw Dial

Send for this RADIO BOOK FREE

The World's Largest Exclusive Radio Mail Order House Will Send You This Wonderful Book FREE



1926 Catalog of Everything New in RADIO at a Big Saving

64 illustrated pages containing thousands of radio sets, semi-finished sets and radio kits of all styles, sizes and approved circuits at attractive prices. Beautiful models of the very latest designs and types. Elaborate console models with loud speakers built right into cabinets of genuine mahogany and walnut. **All Sets Guaranteed.** Coast to coast receiving range. Catalog also contains everything in radio supplies, including batteries, chargers, loud speakers, transformers, condensers, rheostats and any other parts you may want for improving your set or building a new one.

You must have our catalog no matter what set or kit you want. Our line is complete and includes all popular sets.

Our semi-finished sets come with all parts mounted on the panel and baseboard, ready for wiring.

No matter what you want in radio—anything from a one tube to an eight tube set, kit, or semi-finished sets—anything in parts or supplies—any radio data—it's in our wonderful catalog.

OUR GUARANTEE
Every article exactly as represented. Every article is tested before shipping. Complete satisfaction or money cheerfully refunded.

A Complete Manual of Radio. You Cannot Afford To Be Without This Book. It's FREE.

Our Catalog
Includes complete list of broadcasting stations and general information and facts about our free service division. Our radio engineers will help you solve all your radio problems. Send your name and address on a card or in a letter. We will send catalog FREE.

REMEMBER—WE ARE THE LARGEST EXCLUSIVE RADIO MAIL ORDER DEALERS IN THE WORLD AND CARRY THE BEST OF EVERYTHING IN RADIO. SEND FOR OUR CATALOG TODAY!

RANDOLPH RADIO CORPORATION

The Largest Exclusive Radio Mail Order House in the World
159 N. Union Ave. Dept. 244 Chicago, Illinois



Special Library of Information on

RADIO PATENTS and TRADE MARKS

JOHN B. BRADY

Patent Lawyer

Ouray Building Washington, D. C.

Cable address: RADIOPAT

Telephone: Main 4806

Insure your copy reaching you each month. Subscribe to Radio News—\$2.50 a year. Experimenter Publishing Co., 53 Park Place, New York City.

speaker is it true that cone loud speakers show up poor amplifiers. Therefore, after you get your speaker, regardless of what type it is, if you find that it does not reproduce as well as it did on demonstration, get the amplifier of your radio set fixed. It may only need some little kink attached to it, such as a variable high resistance across the primary or secondary of one of the transformers, or a couple of by-pass condensers may clear up the trouble. In any event, you must have your amplifier up to snuff and operating correctly before you can hope to get good reproduction from your loud speaker.

Practically any of the speakers on the market today will give you fairly good results if attached to a good amplifier and so, when we come right down to it, the main part of your selection will be deciding just how much you are going to invest in a loud speaker. Then you can proceed as described above and be sure that you will be quite satisfied with the results obtained.

Special Cathode-Ray Oscillographs

(Continued from page 1133)

it is deflected vertically by the oscillator, will produce a figure on the photographic plate more or less in appearance like Fig. 6A. From this a curve showing how the potential of the central electrode of the plug varies with time can be drawn. A pair of such curves as determined by Keys for different speeds of the magneto are shown in Fig. 6B. It is evident that results of this sort can be used to improve the design of magnetos, by showing exactly how the output is affected by changing the windings or the shapes of certain parts.

EXPLOSION AND GAS ENGINE PRESSURES

Since the electron beam of this instrument is readily deflected by small potentials applied to K, it may be used in connection with piezo-crystals to register pressure changes such as occur in explosions. Certain crystals as, in particular, those of Rochelle salts, quartz and tourmaline, develop small differences of potential between opposite faces when they are subjected to bending or to pressure. This is referred to as the piezo-electric property. If pressures developed in gases or liquids are to be studied, tourmaline is a very suitable crystal to use, since the potential developed between opposite faces of a crystal of this material is directly proportional to the hydrostatic pressure applied to it.

Keys devised a vessel for investigating explosion pressure by the use of tourmaline. This vessel is shown in Fig. 7. T and T are layers of tourmaline crystals separated by a sheet of metal foil, a wire from which is led out through the insulator I to plate K of the oscillograph. The layers of crystals are clamped down by the plate U in the manner shown, so as to be held at all times under pressure, and are buried in vaseline to ensure good insulation for the metal foil and its connections. An explosive mixture can be introduced into the vessel through suitable stop-cocks and can be fired by means of the plug S. If the oscillograph key be closed immediately before the explosion takes place a figure like Fig. 8A will be produced on the plate from which the curve of 8B can be plotted.

MANY OTHER APPLICATIONS

A great number of applications can be made of the tourmaline pressure indicator in connection with the cathode-ray oscillograph. For instance, it could be used, as suggested by Keys, to measure explosion pressures in guns, and, with an oscillograph

Next Year's Radio Set Will Be Designed to Operate On House Electric Current!

Have Next Year's Set Now
by Using the New McCullough AC Tube



The New McCullough AC Radio Tube

is now being manufactured, for the McCullough Sales Co., by KELLOGG SWITCHBOARD & SUPPLY COMPANY, CHICAGO.

An assurance of standard of quality and uniformity, and of sufficient production to meet the tremendous nation-wide demand for this greatest-of-all advance in Radio development.

An ALTERNATING CURRENT Tube, operated by simply plugging into the AC lighting socket (through small step-down transformer). Developed to perfection—the fulfillment of radio's greatest requirement.

A Tube with greater electron emission and increased signal response. A Tube of more rugged construction and LONGER LIFE.

LIST PRICE \$6.00

Radio Set Manufacturers and Jobbers of Radio Tubes are urged to get in line with this important development.

Tubes Ready For Prompt Delivery

McCULLOUGH SALES CO.

DISTRIBUTORS McCULLOUGH AC TUBES

963 Liberty Avenue, Pittsburgh, Pa.

New York:

25 W. Broadway

Chicago:

533 Wabash Ave.

Outstanding Features of the McCullough AC Tube:

OPERATES FROM ALTERNATING CURRENT WITHOUT A HUM, because the AC circuit is insulated from the wiring which carries signal impulses.

GREATER EFFICIENCY THAN BEST STORAGE BATTERY TUBES, due principally to the greater electron emitting surface of the cathode, which replaces the customary filament.

BETTER QUALITY OF SOUND REPRODUCTION, because of a longer straight portion of the tube's characteristic curves.

LONGER LIFE, because it is operated at a temperature

of about half that of storage battery tubes, thus decreasing wear on electron emitting surface.

FREEDOM FROM MICROPHONIC NOISES, because grid construction of cathode prevents vibration.

GREATER ECONOMY—the elimination of expense of "A" battery, charger, etc., more than justifies the greater initial cost of the AC tube.

BUT SIMPLE CHANGES REQUIRED IN THE CIRCUIT OF ANY SET TO USE McCULLOUGH AC TUBES. An instruction chart enclosed with every tube explains slight changes necessary.

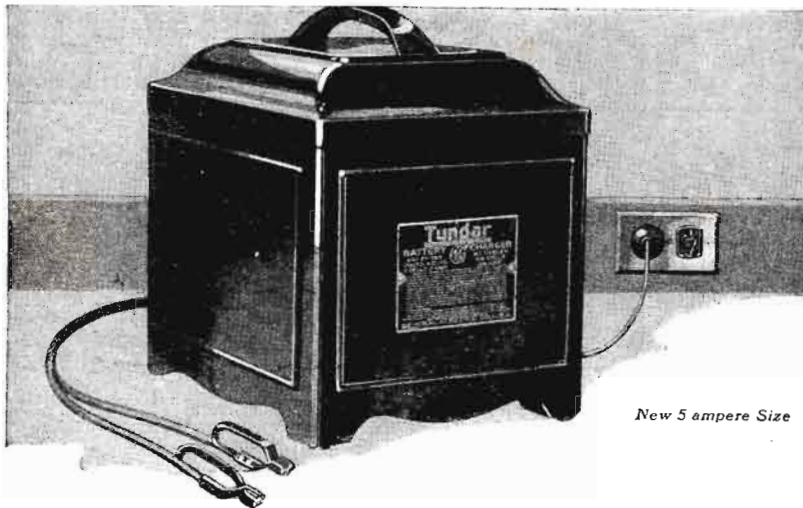

New 5 ampere Size

Say Tungar

when you want the best battery charger



"Tungar" is fast becoming the word for battery charger. And no wonder!

Tungar is the trouble-proof, easy-to-use charger for *all* batteries. It's the original bulb charger. It's made by General Electric. It's noiseless. It can't blow out Radiotrons. *And it needs no attention!*

The Tungar is a G-E product developed in the great research laboratories of General Electric.

The New Tungar charges 2, 4 and 6 volt "A" batteries; 24 to 96 volt "B" batteries, in series and auto batteries, too. No extra attachments needed.

East of Rockies
Two ampere size \$18.00
Five ampere size \$28.00
60 cycles . . . 110 volts
Merchandise Department
General Electric Company
Bridgeport, Connecticut

Tungar

REG. U.S. PAT. OFF.
BATTERY CHARGER

Tungar—a registered trademark—is found only on the genuine. Look for it on the name plate.

GENERAL ELECTRIC

LET BOICE HELP YOU BUILD IT!

Send for his 64-page booklet containing helpful information and describing Boice-Crane Bench Circular Saws, 14" Band Saw, Jig Saws, Lathes, Jointers, Drills, Mortiser, the Boice Guarantee and E-Z Pay Plan.

8 inch Bench Lathe
It Turns, Drills, Saws, Sands, Grinds and does Jig Sawing in wood or soft metal. Supplied with con- pound rest. Swings 8". Cap. 19" C. to C.



Junior Saw Table 10"x12". Saws 2 1/4" stock. Dadoes 3/8"x3/8". Cuts 5/8" mould- ings. Attachments for grooving, sanding, drill- ing, etc. Sold with or without motor and base.



All Boice machines driven by 1/2 to 1/2 H.P. motor attached to light socket.
W. B. & J. E. BOICE, Dent. 802-B, Toledo, O.

REAL TONE FROM YOUR SET
SIMPLY CHANGE OVER THE AUDIO
END TO RESISTANCE COUPLED
AMPLIFICATION USING
MEGGIT RESISTORS
AT VERY SMALL COST IN 2 HOURS
SEND FOR FREE CIRCULAR
WITH DETAILS AND LAYOUT
COLE RADIO MFG. CORP., BLOOMFIELD, N.J.

Build the New DUODYNE Circuit
with the Camfield Type 22 Duoformer, and the Camfield Type 885 .00025 mfd. Straight Line Condenser. Designed for new power tubes. 5 Tube Set.
Send 25c for Booklet
"The Duodyne Circuit," with complete instructions and drawings for building, to
CAMFIELD RADIO MFG. CO.
807 Harrison St. Oakland, Cal.

Insure your copy reaching you each month. Subscribe to Radio News—\$2.50 a year. Experimenter Publishing Co., 53 Park Place, N. Y. C.

modified in the direction of compactness and portability, it might serve to measure stress changes in the members of an airplane or airship during flight.

A very promising application would be to study the pressure cycles in gas engines during operation. A suitably mounted crystal could be inserted in the piston, in the cylinder head or in the cylinder walls of the engine. Being absolutely without lag or inertia, and capable of showing negative pressures as well as positive ones, it could doubtless be relied upon to give more accurate information than we now possess, as to what actually happens in the cylinder of a gas engine at different speeds, with different mixtures, different firing points, and so on.

In this article we have gone over a few of the uses to which special cathode-ray oscillographs, one each of the two principal types, have been put. It will be at once apparent to the most casual reader that the possibilities of these instruments are very large, particularly to those who have the time and facilities to work with the specially-designed outfits suited to investigational work. We can look forward confidently to the discovery of many new and interesting electrical and mechanical facts, through the continued development and application of instruments of this nature.

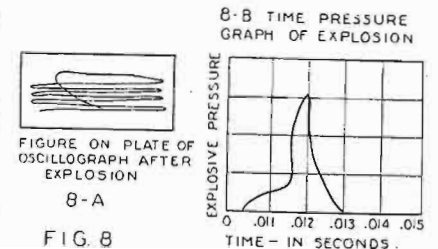

FIG. 8
On the left may be seen the oscillograph record of an explosion, and on the right the working graph plotted from this information.

Solving the Problem of a Current Supply

(Continued from page 1150)

current on and off from the "B" current supply device which is employed. With the control switch thus wired, the radio user may combine the advantages of the "A" current supply set described with the "B" device which he favors and thus operate his radio set at the click of the master control switch.

The device we have described, which is built for both four- and six-volt operation, employs, as we have shown, no radical or untried principles but rather adapts in one unit to the needs of the radio user, principles and apparatus which have had the test of years of use in many commercial fields. It thus insures to the user a practical and reliable method of operation with finest radio reception and eliminates most of the causes of "A" current failure in radio service.

VALUE OF SMALL RHEOSTATS
One of the advantages of small rheostats is that the turns of wire are close together, and smooth operation results. They can be used in small spaces between other pieces of apparatus on the panel. The main disadvantage has been that a short contact arm is apt to be stiff and make a stiff-working piece of apparatus. A contact arm should be springy so that it will hit every turn of wire to make good contact, but must not offer too much friction as the arm moves over the wires.



Not reproduction but re★creation

CONNECT a Rola Re★creator to your receiving set and give its marvelous perfection the heightened expression of true re★creation. Rola is no mere reproducer of dominant notes. It truly re★creates. Every shade of tone is brought to life by Rola. The timbre of every instrument and voice, reproduced truthfully, should be yours. Rola re★creation is so perfectly realistic that the performers themselves seem actually present with you.

The Rola Re★creator is a precision instrument, so finely attuned acoustically that it

seems to be any musical instrument—or all—at the will of radio. Rola re★creates the swelling bass of an organ, the poignant throb of a violin, the clear lilt of a tenor, with all the individual color and charm of each of these. It is the great master of radio re★creation. Sold by better dealers.

THE ROLA COMPANY
45th and Hollis Streets
Oakland California



*Rola Cabinet Re★creator,
solid mahogany. \$46*

Marketed nationally to jobbers through BAKER-SMITH Co., Inc. *Head offices:* Call Building, San Francisco. *Branch offices in the following cities:* 1270 Broadway, New York City; 80 North Dearborn, Chicago; McClintock Building, Denver; 136 East Broadway, Salt Lake City; 443 S. San Pedro, Los Angeles; Henry Building, Portland, Ore.; L. C. Smith Building, Seattle; 179 Pender Street West, Vancouver, B. C.

Rola

RE ★ CREATOR

\$36

—AROUND THE WORLD—

2 L O London
365 m., 2FC Syd-
ney 1100 m., RH
Vienna 600 m.,
BAV Haeren 1100
m., DKP Kbely
1150 m., KOM-
AROV 1800 m.,
OXE Lyngby,
2400 m., BEP-
LIN 430 m., PA5
Amsterdam 1050
m., EBX Carla-
gona 1200 m.,
ROME 470 m.,
LP, Königswus-
terhausen 680 m.,
WGY Schenecta-
dy 109 m., 3LO
Melbourne 1720
m., KOA Denver
322.4 m., BUDA-
PEST 2000 m.,
SBR Brussels 270
m., WEA F New
York 491.5 m.,
HAMBURG 392
m., WMBF Mi-
ami Beach 384.4
m., CFAC Cal-
gary 430 m.,
WGY Schenectady

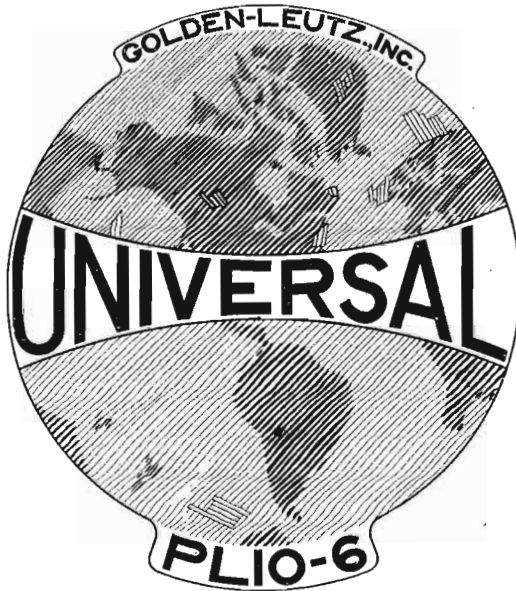

40 m., 5MA Ade-
laide 850 m.,
CYX Mexico City
350 b., FL Eiffel
Tower 2600 m.,
2BD Aberdeen 495
m., PRG Prague
1000 m., PGGG
The Hague 1070
m., 2FL Sydney
770 m., STOCK-
HOLM 440 m.,
HBI Geneva 1100
m., WGY Sche-
nectady 1660 m.,
BRESLAU 415
m., KGO Oak-
land 361.2 m.,
CKAC Montreal
425 m., CHAC
Halifax 400 m.,
PWX Havana 400
m., KDKA Pitts-
burgh 64 m.,
F R A N K F O R T
467 m., W O A Z
San Antonio 394.5
m., N A A A r l i n g-
ton 2500 m.,
CHXC Ottawa 435
m., W O C D a v e n-
port 483.6.

Traveling around the World

A yacht equipped with a Universal Plio-6, traveling around the world, would hear broadcasting programs every night regardless of its location, because the Universal Plio-6 tunes all wave-lengths from 35 meters to 3600 meters. An American owner of this Golden-Leutz Receiver can listen for all European stations as it tunes to the different wave-lengths used by foreign broadcasters. In addition, for reception of American broadcasting stations from foreign countries this wonderful receiver, designed by Chas. R. Leutz, is already breaking distance records.

Cable, wire, write or phone for literature today

Manufactured by

GOLDEN-LEUTZ, INC.

(With which has been incorporated Experimenters Information Service and E. I. S., Inc.)

476 Broadway - - New York City

CABLES "EXPERINFO," NEW YORK

Speaking Into Microphones

(Continued from page 1123)

cannot handle them. We figure there are at least fifteen thousand telephone calls waiting in New York and Brooklyn alone, and there are hundreds of out-of-town calls." I do not think I will again give my numbers to find out if people are listening in.

Now, let us see what are some of the big and new things that we have coming. I do not think I have told you as yet about the Talking Machine and Radio Men, Inc. Here is an organization of more than a thousand leading dealers in instruments. Their association, headed by Irwin Kurtz, holds a big revel of the phonograph stars. Columbia, Pathé, Vocalion are already co-operating, and in all probability, other phonograph companies will also follow.

Have you heard that WRNY has been honored by the Metropolitan Opera Company in having been chosen as its official broadcast station? Every night at 7:15 bulletins of the Metropolitan Opera Company are issued to the general public which give last-minute notifications of the cast, changes from the printed announcements, stories of the operas, comments on the singers, and such official statements as the Metropolitan wishes to broadcast. This is the first time that the Metropolitan Opera Company has paid attention in any way to the radio. We believe it is a precursor and forerunner of any further developments from a radio point of view. My compliments again, if you please, to Mr. Otto H. Kahn, Giulio Gatti-Casazza, Edward Ziegler and Billy Guard.

Now WRNY is the official station of the Federated Women's Clubs of America. Under the direction of Mrs. Edgar Cecil Melledge the strength of the Women's Clubs expresses itself through this station.

A little understanding of what this means might be conveyed by this fact: there are more than four hundred thousand club-women in New York City alone, more than eight hundred thousand in New York State and more than four million in America. The opening gun in this direction was very impressive. The Grand Ballroom was filled on the morning of November 17 with the leaders in women's club life, including such women as Mary Garrett Hay, Mrs. William Dick Spornborg, Mrs. Charles M. Dickinson and Mrs. John Clapperton Kerr. You see WRNY is gradually becoming the station of big groups.

The Jewish Circle brings together all the prominent Jews and Jewish groups, under the direction of Dr. Isaac Landman. The Catholic Circle is the expression of the Knights of Columbus, introducing prominent members of the church, and assures a tremendous listening public of Knights and their families. The Protestant Circle is under the direction of Dr. William B. Millar and is a combination of one thousand churches in New York City alone, with a membership of over two million in the metropolis.

Kiwanians everywhere are following our WRNY Kiwanis Alliance.

Of course, the music goes brightly on. WRNY, because of the Metropolitan, Musical Courier, New York Symphony, and Philharmonic Society, has gained a prestige which no other station in America can equal. Added to the opera companies and other new song features might be mentioned the Oldiero Quartette; the "American Songstress," Rose Laurent; Eugene Frey, the "Lieder Singer"; Fanny Davidson, singer of "Moods in Music"; the Becker Stringed Quartette, a splendid ensemble which heads



100 AMP. RADIO BATTERY

6 Volt Rubber Case

TWO-YEAR Written Guarantee by THOMAS WITHERBEE

Storage Battery Pioneer for 28 Years. Shipped direct from factory to you. No middlemen's profit—no delays—no grief.

Send No Money

This is an actual 100 amp. Radio Storage Battery honestly built of purest materials by real battery builders. Solid Rubber Compartment cases—not wood (non-leakable)—will outlast the battery itself. Lead coated carrying handle. Wing binding posts. Will operate the average 5 tube radio set from three to four hours daily for a month to six weeks.

NO DEPOSIT or Advance Payment Required

Simply order—and we will ship by express and you can examine battery at your express office to your heart's content. If you agree with us that it's the biggest offer ever made—pay the expressman \$9.98 plus express charges.

If you prefer to remit with order—deduct 50c. You run no risk as we replace any defective battery during two years.

THOMAS BATTERY CORP., 511 West 50th St., New York, N.Y.

Build!

The RADIO BROADCAST
UNIVERSAL

FOUR TUBE RECEIVER

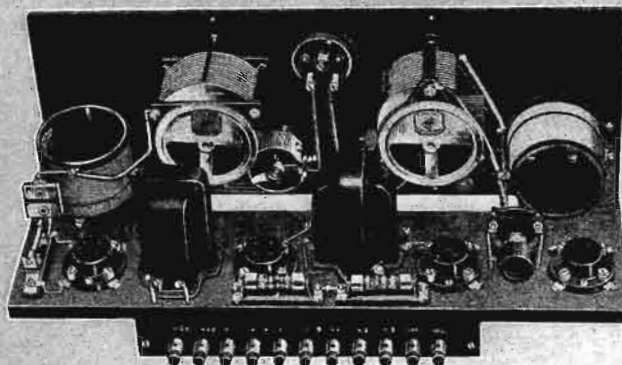

The Radio Broadcast UNIVERSAL has been selected from more than 200 circuits as representing the best practice in receiver design. It embodies all the desirable features of radio construction.

We recommend this circuit to the amateur set-builder with assurance that his fullest expectation will be met from every conceivable angle of good radio reception.

The "UNIVERSAL" still but a few weeks old, has already gained the nationwide approval of Radio Engineers and Radio Editors.

Build one now and be ready for International Radio Week, January 24--30, 1926.

Ask your dealer or write for booklet containing complete construction data.

GENERAL RADIO

COMPANY

Cambridge

Massachusetts

IT IS TRUE!



(Not a Wave Trap!)

188 times the energy!

WOAI signal intensity of 11, on the audibility meter, jumped above 2000 with Penetrola—188 times as strong! WCAL signal intensity of 35 was scrambled with WCBD at 29. But with Penetrola WCAL went to 2000 plus, and WCBD to zero—*selectivity with a vengeance!*

Any Penetrola demonstration will show you things like that on any set with any number or arrangement of stages. The wanted station is immensely intensified; interference is overwhelmed. So much volume is available for distance that a shorter aerial may be used. Your set is stopped from radiating, and is stabilized. It is needless to approach oscillation. And dial readings stay substantially the same.

Principles known to be of immense promise, but hitherto elusive, are now successfully applied

by Walbert Penetrola. The widely heralded Isofarad Circuit, latest Walbert development, is the foundation of Penetrola—unduplicated in any way by anybody, because there is no other Isofarad circuit. Nor is there any substitute for Penetrola action, which amplifies ahead of the detector, strengthening signals which would otherwise never be detected! Remember, signals too weak to detect cannot be amplified beyond the detector.

In a few moments any receiver, however costly, can be transformed with Penetrola. Or anyone can quickly assemble the Penetrola kit and obtain amazing Penetrola results most economically. The Penetrola price buys performance which cannot be obtained with any amount of investment in a receiver alone.

WALBERT MANUFACTURING COMPANY, 925-41 WRIGHTWOOD AVE., CHICAGO

For the sensation of the European tests note Penetrola Reception!

If your dealer is not stocked, remit purchase price direct to factory and you will be promptly supplied. State whether you wish Penetrola for outdoor aerial or for loop receiver.

Penetrola in Black Crystallite, for Instant Attachment **\$35**

Penetrola Kit with Complete, Simple Instructions **\$15**

PENETROLA

100 Volt Storage "B" Battery for \$10⁰⁰!



Service "A" Batteries
Indestructible rubber case. Two year guarantee.
5 volt. **\$14.00**
6 volt. **\$16.00**
120 amp. hr.

Everybody can now enjoy the benefits of Storage "B" Batteries—more power, quieter reception, greater economy. Rubber case prevents leakage or shorting. Easy to recharge. Will last for years with ordinary care.

SERVICE Rechargeable "B" Batteries in all-rubber cases
50 VOLT **\$5.50**
100 VOLT **\$10⁰⁰**
125 VOLT **\$12.50**

Prices in Canada
50 VOLT **\$7.75**
100 VOLT **\$14.50**
125 VOLT **\$17.00**

SERVICE BATTERY CO. of Canada, 137 Roncesvalles Ave., Toronto, Ontario

SERVICE BATTERY CO.
704 East 102nd Street Cleveland, Ohio

SERVICE Double-Duty CHARGER

Charges 6-volt "A" or Auto Batteries or up to 125 volts of "B" Battery IN SERIES. Noiseless in operation. Extremely economical. The height of convenience.



Complete with Bulb
\$14⁵⁰

the Chamber Music Groups, and composed of Rose Becker, Paul Ross, Isaac Kass and Samuel Kass, all symphony people. Amongst the popular features might be mentioned June Lee, who sings popular songs; Katza, Russian female Balieff; Lucille De Wolfe, the greatest little singer with the ukulele I have heard in many a day, and many more.

Have you seen WRNY'S Honorary Advisory Board, which includes such names as Charles M. Schwab, General Kincaid, Frederick Brown, Richard Hageman, Josiah Zuro, Bertha Kalish, Walter Damrosch; Sophie Irene Loeb, Jack Dempsey, Babe Ruth, Red Grange, and many others?

I was glancing over a list of prominent people who have been at the station. It is perfectly amazing how, in three months, WRNY has had the greatest men and women in all walks of life.

In passing, I want to call your attention to the "Side Walks of New York," in which every neighborhood of the city responds to the roll call and tells about itself in five-minute appearances. This goes on from the Battery to the Bronx, and from one river-side to the other.

And now I want to tell you what is the most important thing that has happened since I wrote you last. I have just sent to press the *Radio Forecaster*. It is a 64-page book which gives a six months' program of WRNY from December 15 to June 15, with pictures of all the artists who are featured, and stories about them which enable the WRNY listeners to know the interesting facts about their favorites. The book is going on the newsstands at 25 cents a copy, but I have persuaded the publishers of *RADIO NEWS* to let me give a copy of this to anyone who writes to me before February 15, at the Roosevelt. So, if you have not had a copy, ask for it at once.

DIGEST OF THE MONTH

In addition to the appearance of the grand and light opera companies in their regular performances of the classics, every one of the feature artists at WRNY has had one to four appearances during the month.

Ben Bernie's and Orlando's orchestras at the Roosevelt have had their orchestras on the WRNY platform frequently, and the Literary Department has functioned and has brought many celebrities.

The Radio Theatre Players, under the direction of Alfred Rigali, have presented "Nothing But the Truth," "Bought and Paid For," "Her Husband's Wife" and "Civilian Clothes."

The Radio Art Players, under the direction of Mr. V. P. Newmark, have been heard in Moliere's "Affected Young Ladies," Chekhov's "The Boar" and Shakespeare's "Taming of the Shrew" and "The Merchant of Venice."

Harvey Wiley Corbett has brought such men as Grosvenor Atterbury, Professor William Dinsmore and Alfred C. Bossom.

The Women's Hour has taken big form. The Novelty Night Features on Friday nights are among the most popular in the radio field. There was one night that Mental Telepathy was the feature and you should have heard the calls and seen the letters from the listeners that the telepathic idea had actually gone across. People caught our thoughts. Then there was the Old German Band Night, and how everyone roared over it! "Superstitions" was an unusual feature on Friday the thirteenth. There was a repetition of the Spiritualistic Seance. There was the Simultaneous Musicale that A. Russ Patterson broadcast with a company of artists, and the program was simultaneously sung in hundreds of homes, churches and schools.

Then there was the Aviation Banquet, which was given at the Roosevelt, and which was broadcast by this station through Tom

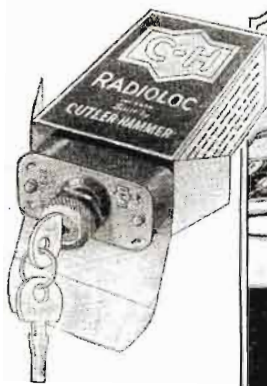

C-H Radioloc

The radio switch that locks with a key. Protects tubes and batteries against children and meddling adults. One hole mounting—quiet operation. Dustproof case. Two keys with every switch.

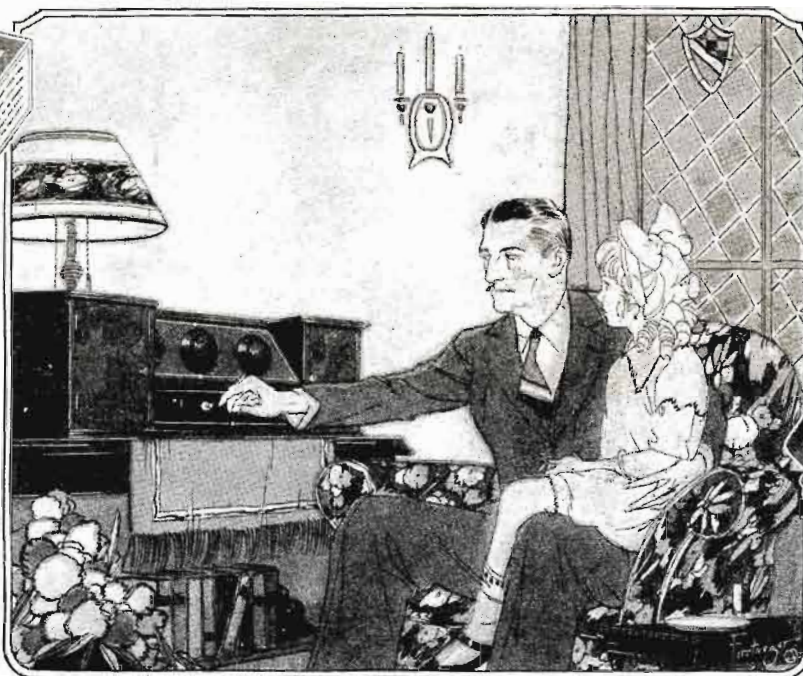

C-H Heavy Duty Radio Switch

More than a million in use. Preferred by both home set-builders and manufacturers. Many have imitated the knob, but no one can duplicate the patented "floating contactor" construction—the secret of its long life.



Thus More Than a Million Concerts Start Every Night

THE first panel mounting switch built exclusively for radio service? It carried the Cutler-Hammer trade mark.

The first radio switch that locked with a key to protect tubes and batteries from meddling fingers? It was designed by C-H engineers.

The first handy toggle type radio switch? Yes—it, too, was built by Cutler-Hammer.

Little wonder that they are found in more than a million sets today. For they were designed to render the trouble proof service for which they are now famous and their patented mechanism cannot be duplicated. Because they sell in such tremendous quantities their cost of production is remarkably low.

That explains why most radio fans build them into their sets, and why you find them on so many manufactured sets today.

Your new set will, most likely, have a C-H Switch, whether it is the product of your own hands or a huge factory.

A list of some of the prominent radio manufacturers using C-H Radio Switches

- Acme Apparatus Co.
- American Bosch Magneto Co.
- Argus Radio Corporation
- Astral Radio Corporation
- Chas. A. Branston Co.
- Chelsea Radio Co.
- Dayton Fan and Motor Co.
- Freed-Eisemann Radio Corp.
- Gillfillan Bros., Inc.
- Howard Radio Co.
- Malone-Lemmon Laboratories
- Wm. J. Murdock
- Robbins Radio Co.
- Silver-Marshall Co.
- R. E. Thompson Co., Inc.
- Victoreen Radio Co.
- Workrite Mfg. Co.



C-H Radio Toggle Switch

The very popular toggle switch idea applied for the first time to radio. Beautiful appearance. "On" or "off" with a flip of the finger. Neatly etched plate to indicate position. Requires very little space back of panel. Contacts are broad and self-cleaning. Quiet operation. One hole mounting. Nickel finish.

THE CUTLER-HAMMER MFG. CO.

Member Radio Section, Associated Manufacturers of Electrical Supplies
MILWAUKEE, WISCONSIN

CUTLER-HAMMER
Radio Parts for Performance

Now you can hear ALL notes!

A Thordarson Autoformer Amplifier built in accordance with instructions and diagrams furnished with each Autoformer.

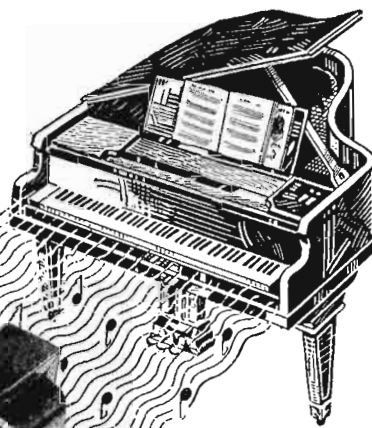
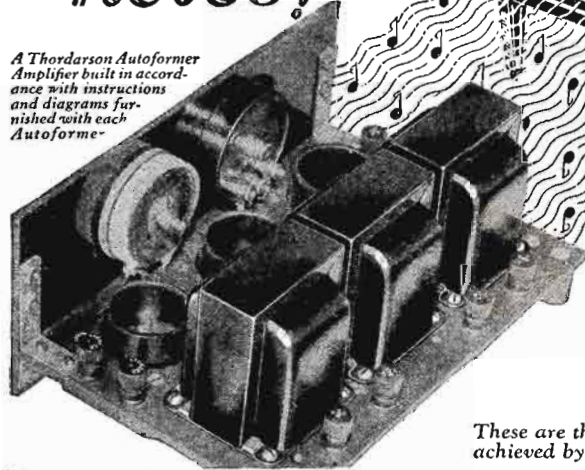

- 1 Full amplification of those bass notes hitherto largely "lost."
- 2 Greater clarity on all notes.
- 3 Improved reception of distant programs.
- 4 Better volume control.

These are the four great improvements achieved by Autoformer Amplification

Deepest Bass to Highest Treble Brought Out Clearly

The Thordarson Autoformer is not "another transformer." It is an all-frequency amplifier, an entirely new instrument developed and built only by Thordarson. Autoformer Amplification is step-up impedance coupled with capacities and resistances. Write for fully descriptive literature. Autoformers, \$5 each. Dealers everywhere.

THORDARSON
Autoformer

Trade-Mark Registered
All Frequency Amplifier



Other Thordarsons

Thordarson Super Audio Frequency Transformers in either sub-panel or top mounting type. Three ratios: 2-1, \$5; 3 1/2-1, \$4; 6-1, \$4.50. Thordarson Power Amplifying Transformers, \$13 the pair. Thordarson Interstage Power Amplifying Transformers, \$8 each. All Thordarson products are unconditionally guaranteed.

THORDARSON ELECTRIC MANUFACTURING CO.
Transformer specialists since 1895
WORLD'S OLDEST AND LARGEST EXCLUSIVE TRANSFORMER MAKERS
Chicago, U.S.A.

ZENITH
KENNEDY
Radiodyne
Pfanstiehl
Howard
Thermodyne
OZARKA
Deresnadyné
ADLER-ROYAL
MURDOCK
MU-RAD
Vallejtone
LEICH
Silver-Marshall
GLOBE
Wheelerwork
Newport
BUCKINGHAM
NUNN-LONDON
KUSTOMBILT
and many others
use Thordarson Super-Amplifying Transformers

Also choice of the MacMillan Arctic Expedition



GEM TUBE

A Guaranteed Radio Tube Within Reach of All

Every tube guaranteed. A tube for a dollar of \$3 value. A trial order will convince you as it has thousands of others. Send your orders at once.

Orders sent C.O.D. parcel post.
Type.....401A **\$1.00**
Type.....400
Type.....499
Type.....499A **EACH**

(with standard base)
Dealers, Write for Discounts

GEM TUBE CO.

Dept. N. 200 B'way, N. Y. City
220 So. State St., Chicago, Ill.
Lafayette Bldg., Detroit, Mich.

BIG CATALOG FREE
DISCOUNTS
TO RADIO DEALERS

All-time opportunity is open for you as a radio dealer. Radio promises its biggest record-breaking season. Make the most of it by getting our new big catalog before you buy. Huge stocks of standard radio parts, sets, kits ready for quick shipment at lowest rock-bottom wholesale prices. Wonderful special offers on finest sets, tubes, batteries. Write for free copy NOW.

W. C. BRAUN COMPANY 34-565, Clinton St. Chicago, U. S. A.

Insure your copy reaching you each month. Subscribe to Radio News—\$2.50 a year
Experimenter Publishing Co., 53 Park Place, N. Y. C.

Hill, President of the American Society for the Promotion of Aviation, Inc.

There were many distinguished guests, among whom might be mentioned the Hon. Fiorello La Guardia, General William Fechet, Colonel Bishop, Colonel W. Hartney, and many more.

One day in the grill room of the Roosevelt, a unique picture was the sight of two hundred choir singers under the direction of Dr. Morgan, on the very spot where people dance to the music of Ben Bernie, and Dr. Millar delivering his sermon in the spot when Ben Bernie hands out his wise cracks.

The Up and Down Broadway feature has been a knockout all the way through. Among the companies that have appeared this month have been "Laff That Off," "Dearest Enemy," "Twelve Miles Out," "Earl Carroll's Vanities" and "The Florida Girl."

Every day at WRNY is packed full of excitement and interest.

P. S.: Charles D. Isaacson's Concerts at De Witt Clinton Hall, Tenth Avenue and 59th Street, and broadcast through WRNY, are quite the event of the air. Every Sunday night WRNY's program director and his associate assistants appear at De Witt Clinton Hall. The concerts are free of charge and from a thousand to fifteen hundred people are always in the audience. These concerts have been running for more than ten years, and over three million people have been in attendance at them.

I Want To Know

(Continued from page 1163)

is very critical, is the plate potential to be determined by test.

Although 8- μ f condensers are shown, condensers of larger capacity will reduce any ripple that may remain in the out-put.

Before using this rectifier on the set, switch Sw.C should be set for the lowest possible voltage and the transformer connected to the 110-volt line for about 10 minutes. The oxide film will then be formed on the aluminum electrodes.

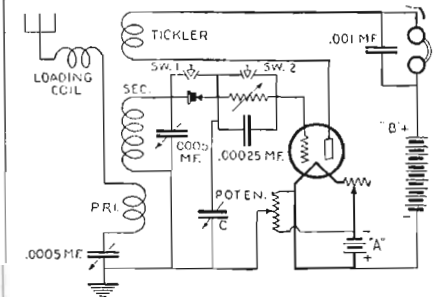

Fig. 2161-A. A three-circuit tuner, arranged so that a crystal detector, grid leak and condenser, or grid bias method, of rectification may be obtained. See page 1163.

Switch Sw.B may be a push-pull arrangement, for selecting either the first or second stage of power amplification. The tubes recommended for the two-power stages marked 4 and 5, are UX-112 type tubes. Type UX-210 tubes can also be used in these two positions with extraordinarily good results. In the event that these tubes are used, no filament resistance is required at "R," with a 6-volt supply. When UX-112 tubes are used a resistance capable of carrying 1/2 ampere per tube must be provided for the set. The UX-210 type tube will require a negative "C" bias in the neighborhood of 15 volts.

The 8- μ f. condensers must have a high insulation value.

By use of the unusually efficient and high plate voltage supply described above, one need not give the attention needed by "B" batteries of the usual type which age rapidly under such heavy duty service and eventually become noisy, or the storage "B" battery that requires frequent recharging, or the next best proposition, the motor generator with its attendant and undesirable commutator noises.

This circuit is an unusually efficient one for driving cone-type reproducers.

How to improve your radio set

A THOUSAND fellows may tell you a thousand different ways—but based on the experience born of making the first audio amplifying transformer for receiving sets ever sold to the public and the first C. W. Transmitting apparatus, Acme believes you may be interested in knowing what we recommend. The 10th edition of "Amplification without Distortion" explains it fully. Over 300,000 Acme friends have found this book helpful—perhaps you will too—at any rate send for it and see.

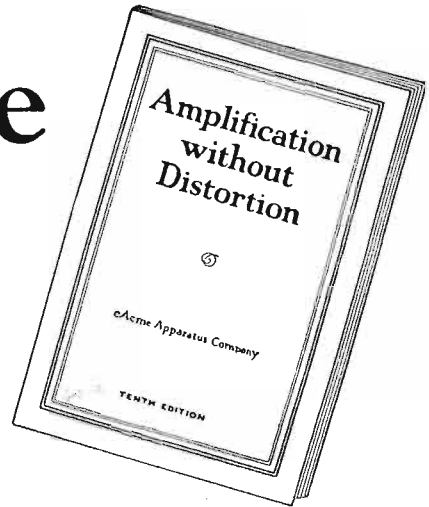

THIS book, "Amplification without Distortion," has brought thousands on thousands of enthusiastic letters telling of the help it has been in improving radio reception. Save this paragraph, print your name and address in ink across it and mail with 10¢ to Acme Apparatus Company, Dept. K12, Cambridge, Mass., U. S. A.

Claude Hains
President, Acme Apparatus Co.

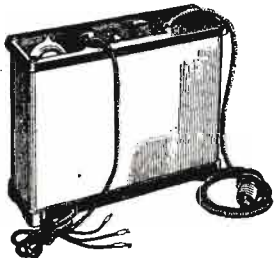

The new Acme B-eliminator. Two models, E-1 (110 volts 60 cycle) \$50. E-2 (110 volts D. C.) \$20. Raytheon Tube included. Everlasting.

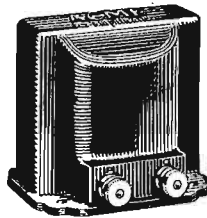

New Acme MA-2 Amplifying Transformer, closed metal box type. Price, \$5.

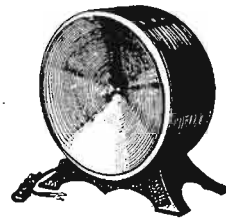

The new Acme "double free-edge cone" loud speaker. Round model (shown) \$25. Cabinet model, \$35.

BEFORE
your "B" batteries
go dead...
....do this!

WHEN you notice the first signs of fading, do this... get the last "B" supply you'll ever need—an Acme B-eliminator. Unlike others, it has no filament to burn out; is everlasting, has no noise, no hum, no distortion; gives greater volume; adds more distance to any set, 1 tube or 10.

More volume
" distance
" quality
...this new way

THE new Acme MA-2 Audio Transformer removes the "clutching hand" from radio's sensitive "throat." The delicate under and overtones are now amplified (not choked off) as clearly as the middle voice and musical ranges have always been. The result is more volume, distance and quality.

If your loud speaker sounds like "Cohen on the telephone"do this!

YOU know the old record, "No, this is not Lieutenant Cohen, it's your tenant Cohen." Distortion made this joke. But it's no joke to have to eternally strain to make out what an announcer is saying. Get an Acme "double free-edge cone" loud speaker and your megaphone days are over.

Sold only by Authorized Acme Dealers

ACME ~for amplification



BENJAMIN
Straight Line Frequency Condensers

String out the stations symmetrically from one end to the other. That is selectivity supreme! Every station has a clear space for tuning. The old-time crowding is eliminated. Tuning is simplified and best of all, with its low loss characteristics, radio reception is definite and distinct.

The precision in workmanship is superlative. The finish is dull silver. In three sizes: .00025 Mfd.; .00035 Mfd.; .0005 Mfd.

Benjamin Cle-Ra-Tone Sockets

Stop tube noises by preventing the transmission of outside vibrations into microphone disturbances. Four springs support the socket — "float" it above the base and absorb all shocks and jars. The new "Push" type Cle-Ra-Tone sockets are for standard UX and WX tubes.

Patented July 26, 1923; May 2, 1911



Benjamin Electric Mfg. Co.
 120-128 S. Sangamon St. Chicago
 247 W. 17th St., New York
 448 Bryant St. San Francisco

Manufactured in Canada by the Benjamin Electric Mfg. Co. of Canada, Ltd., Toronto, Ontario

Benjamin Tuned Radio Frequency Transformers

Even in what has been considered an excellent set, it is astounding what an improvement in tone, volume and selectivity the introduction of these coils produces. Put up singly and in sets of 3. Use .00035 Mfd. condensers with these coils.



Patents Pending

BENJAMIN
 TRADE MARK

Old Tubes Made Good As New



\$3.65

THIS latest Laboratory product will recondition any old, run-down, even worthless tubes, as long as the filament still lights. Makes them as good as new in a few minutes' time. Costs but few cents more than new tubes! Simple, efficient, practical. Big money-saver. Thousands in use. Operates on either A. C. or D. C.—110-120 Volts. Model No. 20 for UV-201A (CIVOLA, etc.) and all similar types. Model No. 20 for UV-200 (C-200, etc.) and all similar types. Bound to do the work on our

Money-Back Guarantee

Money cheerfully refunded if desired results fail. But we are sure you will find the Mack Reconditioner pays for itself in one evening. Many making good money restoring friends' and neighbors' old tubes. You cannot lose! Act quick on this special short-time introductory price. Sent Postpaid with full directions on receipt of \$3.65 (\$3.85 in Canada and foreign countries). Be sure to state Model No. wanted. Our guarantee refund price protects you. Send now.

724 Cass St. MACK LABORATORIES Chicago, Ill.

For fine tone quality, volume, and distance, your tubes MUST be in perfect condition.

MACK RECONDITIONER
 "THE CURE FOR RUN-DOWN TUBES"

Readers will be interested to know that a set built with this form of plate supply reproduced the signals of a broadcast station fifty miles away so loudly and clearly as to be perfectly understandable at excellent audibility, two miles from the loud speaker.

Experimenters desiring more detailed information regarding the tuning system and circuit, selected for the plate supply selected for the reasons enumerated above, are advised to study these references: "The One-Stage Radio Frequency Amplifier," page 21, in the November, 1925, issue of QST magazine (Hartford, Conn.); "The Rectodyne Circuit," page 796, December, 1925, issue of Radio News; "Electrostatic A.C. to D.C. Converters," page 1077, March, 1923, issue of Science and Invention.

Q. 2. In the November, 1925, issue of The Experimenter magazine, in the article "How to Make and Use a Wave-Meter" (A. P. Peck, Radio 3MO), page 18, is a circuit, Fig. 1, showing a

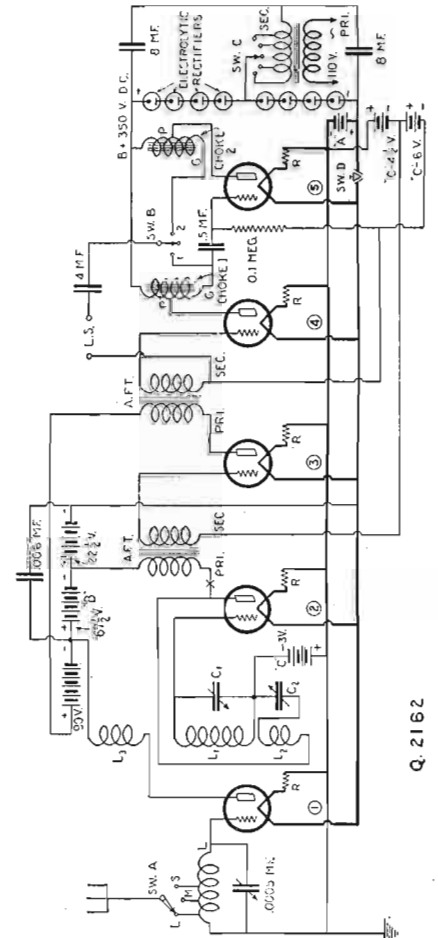

An unusual circuit employing the use of electrolytic rectifiers to supply B voltage for the plates of the last two amplifier tubes. (See page 1163).

Neon tube for indicating resonance in transmitter wave-length determinations. I understand the Neon tube may be made to cause circuit oscillation. If this is the case at audio frequency, I would like to know how to make an audio frequency oscillator using the Neon tube.

A. 2. The circuit suggested is No. 2162-A (shown on page 1190). Resistance "R" may be a fixed unit. The value required is most easily determined by making "R" variable with a range of 27,000 to 250,000 ohms, for testing the initial set-up.

The out-put may be used for testing the response for loud speakers, audio transformers and headphones to various audio frequencies.

The Neon tube may be an "Osgeon lamp" obtainable in England, or the more easily acquired Neon lamps used in the Westinghouse "Spark-C" adjustable spark plug tester, or the Airco "Ignition Gauge."

Since this type of lamp only requires about 15 milliamperes at 200 to 300 volts, to "strike" the tube (The word "strike" is taken from electrical nomenclature, ordinarily used in connection with electric arcs, with reference to the starting of the arc action; and relates in this instance to the lighting of the tube), and since the current required to maintain oscillation of the Neon tube circuit is only about two milliamperes, an ordinary "B" battery will furnish amply sufficient current. In fact, "B" battery current consumption is about one-third that of the ordinary vacuum

Q. 2162

RADIO 'RITHMETIC



© 1926, W. E. & M. Co.

How to Prove this Result

Complete your set with a Rectigon! Keep your batteries so full of life that every turn is a tune, every adjustment of the delicate knobs a means of furthering your radio joys.

It's a simple thing with a Rectigon. Just snap the leads into place and your "A" and "B" batteries—also your automobile bat-

tery—will surprise you with their old-time pep.

There's no muss or fuss with a Rectigon. No acids or chemicals. No moving parts and no noise. It's a handsome, bright, maroon-enameled helper that will get the best out of your radio—and continue to do so.

No storage-battery radio is complete without a Rectigon.

WESTINGHOUSE ELECTRIC & MANUFACTURING COMPANY / SOUTH BEND, INDIANA

Westinghouse manufactures, also, a complete line of Micarta radio panels, Micarta tubes and instruments.



The Westinghouse Rectigon Battery Charger

Swooping Down on Static

As an eagle swoops down on its prey, devouring it hungrily, so does

AERO-LOOP

devour static, consume interference, and swallow up regenerative squeals.

Unleash the hidden power in your radio set! Give it a chance to perform at maximum efficiency.

Attach this "loop-within-a-loop." The inside loop is stationary, acting as a booster, while the outer loop is adjusted by rotation.

Used with—or to replace—outside antenna.

Ask your dealer. If he does not carry it yet, we will ship direct, express prepaid, on receipt of price. Be sure to specify the set with which it is to be used and please give your dealer's name.

Sells for
\$12.50

Write now for Descriptive and Diagrammatic Booklet. Your Copy Mailed Free.

MANUFACTURED BY
UTT-WILLIAMS ELECTRICAL PRODUCTS CO.
SANTA ANA, CALIFORNIA



SCOTT SALES COMPANY
National Distributors

443 SOUTH SAN PEDRO ST. - LOS ANGELES, CALIFORNIA



Beautifully finished in mahogany
Dimensions
30 in. x 8 x 7 in.



A Radio Cabinet of Beauty and Elegance Direct to You at Lowest Cost



Lid splined both ends to prevent warping.
Nickeled piano hinge—Full length.
Nickeled lid support of artistic design.
Anti-vibration cushion feet (not visible in cut).
Edges of lid moulded to match bottom.
Shipped securely packed in strong carton.
Prompt shipment. Big stock for holidays.

	Hand-wood	Solid
	rubbed Black	Black
	Mahog- Amer-	any
	any	lean
	Finish	Walnut
7x18x7 1/2 or 10		
in. deep ...	\$3.50	\$5.00
7x21x7 1/2 or 10		
in. deep ...	3.75	5.25
7x24x7 1/2 or 10		
in. deep ...	4.00	5.50
7x26x7 1/2 or 10		
in. deep ...	4.75	6.25
7x28x7 1/2 or 10		
in. deep ...	5.50	7.00
7x30x7 1/2 or 10		
in. deep ...	6.00	8.00
Add 25c for "E-Z" Fono Plug.		

Cash with Order or C.O.D. If 1/2 of price sent with order. Prices F.O.B. Hickory, N. C. Order express shipment, often cheaper than mail and much safer from damage. Free with Each Cabinet a glued-up stock non-warping 1/2-inch Baseboard. Free Catalogue.

THE SOUTHERN TOY COMPANY, INC., Dept. N., HICKORY, NORTH CAROLINA

tube. Another feature is the elimination of the "A" battery.

Q. 3. If it is possible to incorporate the new DeForest Anti-Radiation device of Roy A. Weagant with a regenerative receiver of the so-called single-circuit type, so as to prevent radiation of squeals and whistles, please show how it can be done and give all details necessary. Would the large Acme audio transformer work satisfactorily in the set? Or would the Erla code transformer work best?

A. 3. Yes, it is possible to apply the principle you mention with no difficulty at all. The changes are probably made sufficiently clear in circuit diagram Q. 2162-B on page 1163.

The aerial is removed from its usual position (1) and placed as shown at (2). The .0025 μ f. condenser shown in the first position of the aerial may be tried at point "X" of the aerial in the second position, but it will probably not be found at all necessary for its usual purpose—increasing selectivity.

The coil marked "Choke" may be the secondary of a good radio frequency transformer of the aperiodic type, such as the Acme R-2, the Duratran, the All-American R-201A, etc.

A Chelton Midget condenser may be used as N.C. Other condensers of the type used in neutro-

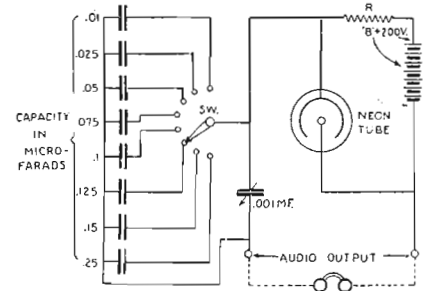

Fig. 2162-A. An audio frequency oscillator, involving the use of a Neon tube.

dynes for neutralizing purposes will probably prove satisfactory, if 50 μ l. capacity can be obtained.

Any good make of audio frequency transformers may be used, with the lower ratio transformer in the second stage.

The ratios of the new and old model Acme transformers, and other comparative data are:

NO.	RATIO	HEIGHT	DEPTH	WIDTH	WEIGHT
A-2	4 1/2:1	3"	2"	2 1/2"	8 oz.
MA-2	5:1	3"	4"	4"	16 oz.

It is inadvisable to use the code transformers mentioned, unless it is desired to receive mostly code signals, in which case inductances "L" and "rotor" would be entirely different from their broadcast values; which may be, for example, "L," 50 turns of No. 20 D.C.C. wire on a 3-inch tube; "rotor," 20 to 40 turns of No. 24 D.C.C. wire wound on a 2 1/4-inch form, the exact number of plate coil turns determined by the particular tubes used.

The Erla code transformer is called the "1,000-cycle" transformer and at this frequency at which it peaks, a voltage amplification ratio is approximately 30:1 and is the most suitable transformer on the market for the amplification of code signals of 1,000 cycles frequency (approximately).

Facts and Fallacies About Radio Wave Transmission

(Continued from page 1139)

mosphere, so we are nowadays using new forms of antennas to shoot high-frequency radio waves upward instead of starting them out horizontally.

Recent theoretical work by Larmor, another English physicist, has extended this theory by showing that the height of the conducting level in the atmosphere is different for different wave-lengths, and this presents an explanation of the differing character and distance of transmission of short waves of different frequencies and at different times. The effect of the earth's magnetic field upon the wave transmission is a most important further addition to the explanation of wave propagation and is due to Messrs. H. W. Nichols and J. C. Schelleng of the Bell Telephone Laboratories, New

Insure your copy reaching you each month. Subscribe to Radio News—
\$2.50 a year. Experimenter Publishing Co., 53 Park Place, N. Y. C.

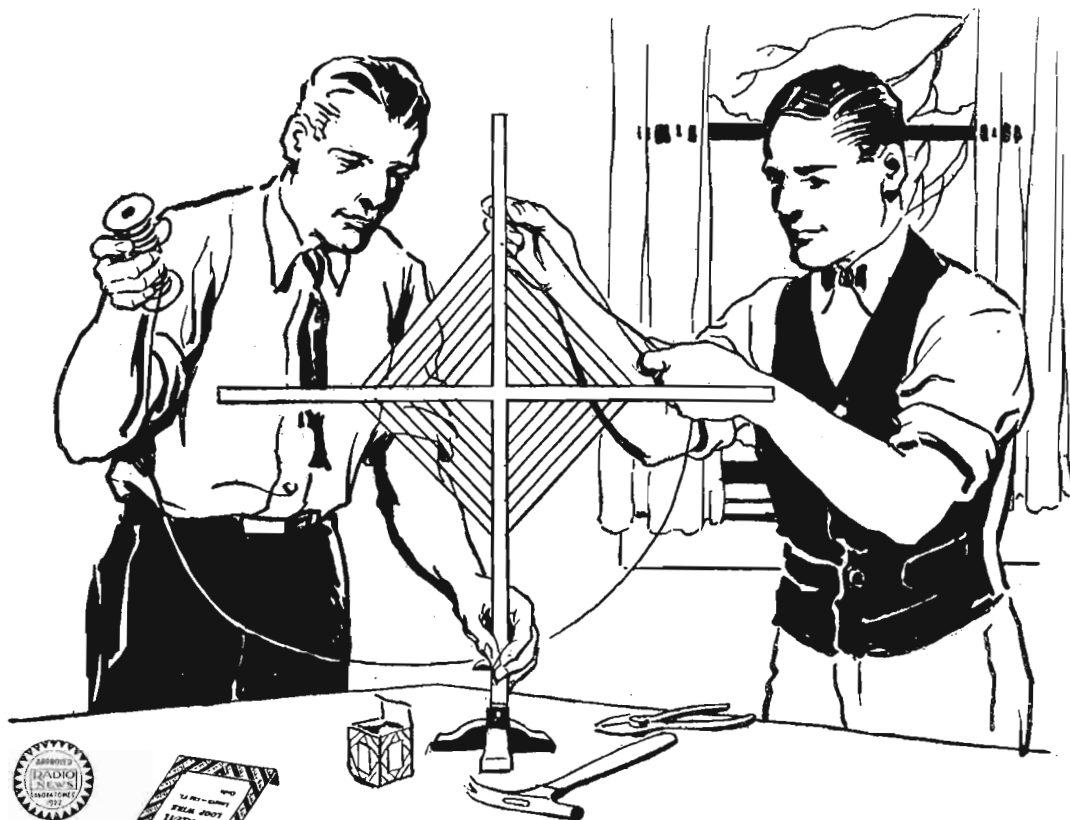

Look for the distinctive Belden Striped Carton. Furnished in maroon cotton or braided with brown or green Rayon (artificial silk).

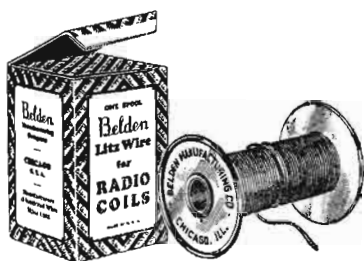

Belden Litz Wire is a special high-frequency conductor, ranging from 20 to 43 strands of Beldenamel. Furnished in 100-ft. spools for winding high-frequency coils and aparatus.

A Good Loop is Easy to Build if You Use Belden Loop Wire

WHEN you build your new loop antenna, obtain maximum efficiency by using the special loop wire prepared by Belden engineers for standard loops. The Belden loop wire is made of sixty strands of No. 38 copper wire combined with five strands of No. 36 copper wire which has been treated to prevent stretching. All strands are insulated with a double wrap of cotton or with a Rayon braid. This unique construction provides a non-kinking, non-stretching, non-sagging conductor that will make a splendid loop, and one that will keep taut.

Ask your dealer for Belden loop wire!



*Mail the Coupon
for Free Illustrated
Booklet*

BELDEN MANUFACTURING CO.
2314 1/2 South Western Ave., Chicago

Please send me your booklet entitled "Helpful Hints for Radio Fans."

Name

Address

Belden

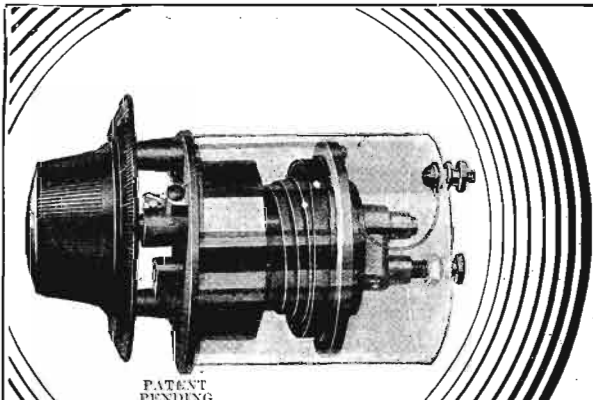

PATENT PENDING

FURNELL 360° TAPER COIL CONDENSERS

The First radical improvement in radio SLF condensers

AT LAST! A new era in variable condensers. With practically all other radio parts undergoing constant improvement the limitations and deficiencies of the old-style multiple plate condenser have handicapped progress.

But now—professionals recognize in the new FURNELL Condenser—based on an entirely new and simplified principle—the most practical and efficient condenser ever designed for straight-line Frequency tuning. It is the only condenser of its type on the market and experts agree that:

"It's the most important step forward that has yet been made in its field."

Simplicity is the keynote of progress. The FURNELL replaces open multiple plates with only two shielded plates, each coiled in the form of an evolute. Simple—sound—durable. Assures clean-cut separation of stations, tone clarity and scientific precision heretofore impossible. Dust-proof, moisture-proof, damage-proof. Each condenser complete with special 4" Bakelite 360 Dial and enclosed in Pyralin Dust-proof case.

Exclusive Sales Franchises Available to Reputable Jobbers in Locations Still Open.

Write for Literature

FURNELL MANUFACTURING CORP.

24 SCOTT ST. Newark, N. J.

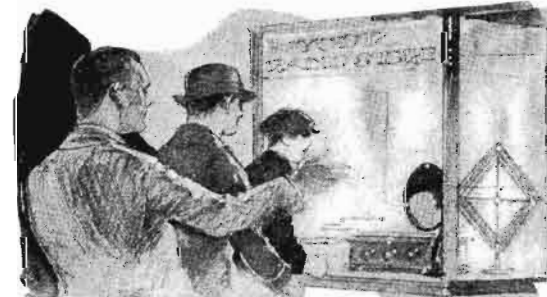

Hommel is a Helpful Jobber

- ¶ He maintains close contact with his dealers at all times.
- ¶ He carries ample stocks of reliable radio apparatus only so that his dealers are assured prompt deliveries.
- ¶ All user inquiries, resulting from his national advertising, are turned over to his dealers.
- ¶ A dealer repair and inspection department is maintained so that all sets needing minor repairs can be fixed up immediately—thus saving the time and trouble of sending them to the factory.
- ¶ And last, but not least, he issues a complete catalogue of the Radio Sets and Apparatus he carries—known as the "Hommel Encyclopedia of Radio Apparatus" that Hommel dealers find invaluable in ordering and dealing with their customers.

Write Today for Hommel's Encyclopedia No. 466-S

WHOLESALE EXCLUSIVELY

LUDWIG HOMMEL & CO

929 PENN AVENUE PITTSBURGH, PA.

York. They advanced this theory in March of last year and have already used it to effect remarkable advances in our knowledge of the reasons why fading is more pronounced on some frequencies than on others, and why the plane of polarization of radio waves is rotated as the wave advances. This change of polarization has been experimentally demonstrated by E. F. W. Alexander-son of the General Electric Company, and is seen to have an important bearing on reception through interference and static and in explaining the dead areas or skip distances familiar to amateurs working with short waves. In fact, this advance is introducing an entirely new view in radio science and its implications are by no means all known as yet.

SOME MISCONCEPTIONS

The remarkable nature of some of the new discoveries in connection with short waves is such that the imaginations of all who dabble in radio have been given free rein, and many wild theories are being announced. It may not be out of place to advert to some widely quoted theories which are more or less in error. The first of these is the explanation of all these phenomena in terms of an alleged "Heaviside layer." Related to this is the ascribing to Heaviside of the current explanations of radio wave propagation phenomena. Heaviside did not know much about the phenomena of radio wave propagation and did not postulate a layer. What he did do was very valuable and still stands, namely, the suggestion that at a certain height in the atmosphere a conducting surface can exist which can effect and assist the propagation of radio waves. Beyond this he did not go, and it seems to me that the expression "Heaviside surface" is in accordance with Heaviside's ideas, but that the expression "Heaviside layer" is not. Since, furthermore, the recent theories of Larmor and of Nichols lead to the existence of numerous levels rather than a single level in the atmosphere which facilitate the propagation of waves at particular frequencies, even the expression "Heaviside surface" is no longer very useful.

Another misconception or instance of loose thinking is the explanation of the wave propagation as reflection. I do not say that reflection may not eventually be established as the proper explanation, but the evidence is that the waves are guided by a conducting surface and that their propagation is in large part explained by a quasi-refraction caused by the interaction of the radio field intensity and the velocities of the ionized particles of air. Reflection in the true sense is not an accurate description of any phase of this process. The essential fact of upper-air transmission of radio waves is no more reflection than is propagation of waves along the ground.

Another theory which I cannot accept and which is closely tied to the reflection theory is that the differing characters of propagation at different frequencies are due to differing heights of the effective strata; that is, the popular idea conceives the waves of varying frequency or wave-lengths to be shot out from the transmitting antenna and certain of them to be reflected from a sort of sky mirror located at one height and those of another frequency or wave-length from a different sky mirror at a different height. These strata of differing conductivity doubtless exist and exist at different heights, but the phenomena which result are almost certainly not due to the difference in height of the strata, but to the difference in electrical character, such as differing ionization.

If I may be pardoned for still another attack on what I believe to be popular misconceptions, I will refer to the rather free use of the idea of interference (as between light waves) to explain fading. This, again, is tied in with the conception of propagation

Helpful Information

*of Utmost Importance to
Owners of Models L-1 and L-2*

ULTRADYNE

Receivers

NOW, after two years, I have found a new development that is of vital interest to all owners of both Models L-1 and L-2 Ultradyne Receivers.

Thousands of Ultradyne owners have asked us to solve this very problem. It deals with an easier, more economical method of operation and maintenance of your present Ultradyne Receiver.

If you have ever written us about any phase of your Ultradyne, write us again. We are now able to give everyone helpful information that has never been available before.

While this information applies directly to the Ultradyne (Models L-1 and L-2), it will prove of equal value to owners of all types of Super-Heterodyne receivers.

Complete details, as a part of our service, will be given, without cost, if you write at once.

Address all correspondence to Mr. R. E. Lacault, Phenix Radio Corporation, 114 East 25th Street, New York City.

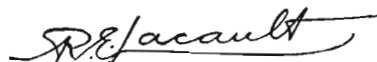

Chief Engineer.
PHENIX RADIO CORPORATION.



NAVY MODEL C-10 Super-Heterodyne

The Highest Class Receiver in the World

Wave length range 50-600 meters with removable Coils.
 Panel Dimensions 28 3/16 in. x 8 in. x 1/4 in.
 Only two major tuning adjustments.
 Total amplification almost 2,000,000 times.

No Batteries

are required even to operate the most powerful 10-tube receiver pictured above, if you use the new laboratory type

Model A Power Unit

A high powered 10-tube Broadcast Receiver capable of receiving over 3,000 miles under favorable conditions, and having a degree of selectivity far in advance of others.

We believe the Navy Model C-10 represents final superiority over any receiver now being manufactured or even contemplated for broadcast reception.

Attractive illustrated literature gladly mailed upon request. Write direct to

NORDEN-HAUCK, INC.
Engineers

1617 Chestnut Street, Philadelphia, Penna.

It Stabilizes Any Reflex—

THE CARBORUNDUM STABILIZING DETECTOR UNIT

To make the Carborundum Fixed Detector even more efficient for Reflex Sets this Stabilizing Detector Unit has been evolved.

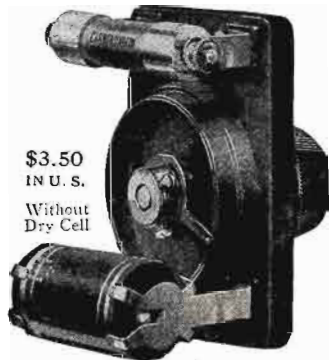

\$3.50
 IN U. S.
 Without
 Dry Cell

With this Stabilizer you can absolutely perfect your Reflex Set because it adjusts the detector resistance to match the circuit.

It stabilizes the circuit, controls self oscillation, eliminates howls, increases sensitivity. Gives you greater range and increased volume.

By a turn of the knob you supply a potentiometer controlled booster voltage to the Carborundum Fixed Detector, adapting the detector instantly to the receiving conditions. A tiny flash-light battery is all you need to complete the device. The unit comes to you equipped with a genuine Carborundum Fixed Detector.

From Your Dealer or Direct

Send for Illustrated Booklet showing Hook-Ups

THE CARBORUNDUM COMPANY, NIAGARA FALLS, N. Y.
 New York, Chicago, Boston, Philadelphia, Cleveland, Detroit
 Cincinnati, Pittsburgh, Milwaukee, Grand Rapids

C-7-SUPER

The new model C-7 SUPER is the greatest set known for Distance, Volume and Quality of Reception. Its 7 tubes outperform other 10-tube receivers. Write today for complete description and price list.

RADIO PARTS CO., LABS., 8 S. AUSTIN BLVD., OAK PARK, ILL.

DEALERS!

Complete stock of nationally known parts and accessories. Send for illustrated catalog and discount sheet.

Radio Exclusively Since 1921

CLARK & TILSON, Inc.
 552 Seventh Ave. :: New York
 The Nationally Known House

by reflection. Now it is almost inconceivable that the effective atmospheric strata are so uniform as to permit reflection of the uniform character that would be required to explain interference, or that individual conditions of interference would not be statistically averaged out. The nature of fading and other phenomena is such that it seems clear that the received intensity fluctuations are due to variable absorption in the medium caused by turbulence or non-uniformity in the ionized strata. The result of this is that the wave arriving at a given receiving point is really a complex of waves from different directions, with differing intensities, and different degrees of polarization. A variation in the upper air path of any part of this complex appears to the observer as a change in the resultant direction, intensity and polarization of the received wave.

The explanation of the greater prevalence of fading at distances around 100 miles from the transmitting station than at either shorter or longer distances will probably be developed in the further working out of the theory of Nichols and Schelleng, as it has already explained the existence of the worst fading between 1,000 and 2,000 kilocycles (300 and 150 meters). The explanation is almost certainly not the one frequently given that there is varying interference at this distance between the ground wave and the upper air wave. This theory is untenable because the ground wave is nowhere near intense enough to play a noticeable rôle in the fading night intensities. The ground wave is what carries the ordinary broadcasting waves during the daytime and at 100 miles its intensity is much weaker than the night intensity.

All of the phenomena are, of course, so complex that no possible explanation should be overlooked or ruled out, and it is quite possible that interference does occasionally affect the transmissions, and that, indeed, varying paths in various portions of a wave front do experience interference. There are but few types of fading, however, which look like genuine interference.

Rather extreme and wholly unwarranted conclusions have appeared in some recent reports to the effect that these discoveries would go a long way to eliminate fading, that they furnish a cure for static, that present radio distances would be increased and transmission cost reduced. In other words, every user of radio enters this day into paradise. These statements bear a remarkable similarity to the claims put forth for patent attachments to automobiles; they all positively increase the number of miles per gallon, give more power—everyone knows the list. Now, surely, the increase of knowledge leads to improved methods. We can expect a full understanding of fading to lead eventually to its cure. But we are a long way yet from that full understanding. A knowledge of the facts of wave polarization places an additional weapon in the hands of the radio engineer in his struggle against static and station interference. None of the work done to date, however, points to any profound revolution in the trend of radio development.

THE MONTH'S NEW QRAs

- 2AHA—Benjamin L. Berger, 166 Montgomery Avenue, Irvington, N. J. Five watts C.W. on 40 meters. All crds QSLd.
- 3AHH—Chas. F. Spitz, Box 64, Blairstown, N. J. Twenty watts on 175 meters. phone. C.W. on 20, 40 and 80 meters. Crds QSLd. Repts appctd.
- 3AHD—Chas. Younger, North Branch, N. J. 250 watts.
- 8CN—Howard H. Brokate, 217 Washington Street, Port Clinton, Ohio. Also QRA 8AJJ.

(Continued on page 1196)



No ↑
Room for Them!

The Ordinary
Small Diaphragm

THE small diaphragm heretofore used in radio speakers accommodated the middle and upper notes of the scale, but it could not handle clearly the vibrations of the bass.

The lower registers of voice and instrument were literally crowded off the program.

The Bristol SUPER-UNIT Has "Tone Room" for Every Note

Bristol Models "S" and "C" are equipped with this Super Unit. It contains an unusually large diaphragm that brings in the full range of tones from bass to treble. The rumble of the tympani, the roll of the snare drum, the low tones of the viols, tuba, organ, saxophone and voice—notes you never heard before in radio—are there in a Bristol program. Your dealer will gladly let you try the Bristol in your own home.

Send for Free Booklet

"How To Select Your Loud Speaker." It tells how to look for and find tone quality in a loud speaker.

BRISTOL SPEAKER

(THE AUDIOPHONE)



THE BRISTOL COMPANY, RADIO DIV. S, WATERBURY, CONN.

For 36 years makers of the highly sensitive and accurate Bristol's Recording Instruments.

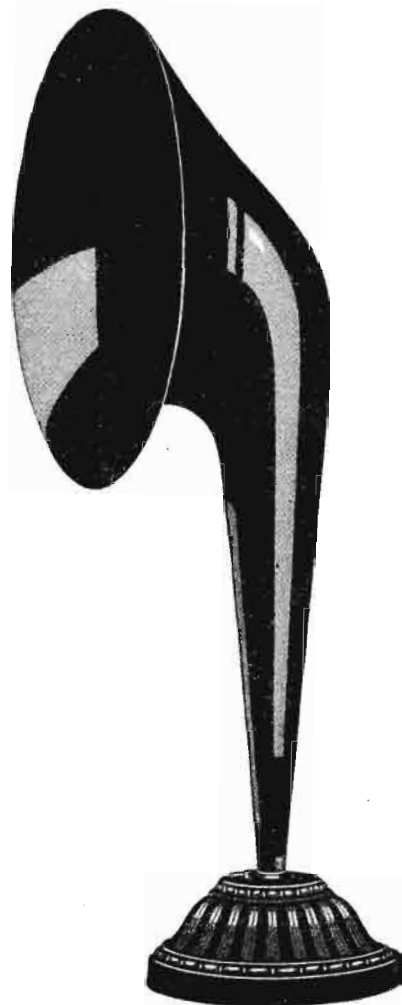

Super S—\$25.00

Rubber horn 14½" diameter. Cast metal throat. Black velvet mat finish with gold base decorations. There is also a handsome Cabinet (Model C) at \$30 and other speakers as low as \$15. Models C and S have the Super Unit.



The Most for Your Money

Trimm Home Speakers outperform other speakers costing twice as much. Model 25 has large Volconite horn, 18 inches high, with a 12 inch bell which prevents tinny, scratchy noises, and gives a full well-rounded tone.

Factory regulation assures maximum volume without blasting or distortion. Carries the Trimm Lifetime Guarantee of perfect satisfaction. Have your dealer demonstrate it to you.

TRIMM	
Superior Reproducers	
HEADSETS	
Professional - -	\$5.50
Dependable - - -	4.40
PHONODAPTERS	
Giant Unit - - -	\$10.00
Little Wonder - -	4.50
SPEAKERS	
Home Speaker - -	\$10.00
Entertainer - - -	17.50
Cabinette - - - -	17.50
Concert - - - - -	25.00
Chello - - - - -	30.00



A 3000-Mile Super-heterodyne

(Continued from page 1119)

will be noticed that there is a distortion due to the fact that the side bands are cut off. The iron cores are now inserted through the holes in the box. These cores consist of three pieces of silicon steel 2 inches long, 1/4 inch wide and .003 of an inch thick. These cores are inserted until all the distortion has disappeared. The iron core is not inserted into the input or filter transformer. Once the transformers have been tuned to the maximum signal strength, they need not be touched again. Now the regeneration coil is rotated until the maximum strength is obtained.

To change from one wave-length to another it is only necessary to insert a radio frequency transformer of a suitable wave-length into the tube socket before the detector.

It is also well to mention that tubes taking .06 of an ampere at three volts are used throughout this receiver.

You will find this set very stable, easy to handle, very sensitive and selective on weak and distant stations, and any reader who constructs this set will feel himself well repaid for the time and labor spent. He ought, under reasonable conditions, to be able to receive European stations.

The Experimenter

has come back! If you are one of the one hundred thousand readers of the old ELECTRICAL EXPERIMENTER, you will no doubt be glad to hear that the EXPERIMENTER has come back BIGGER AND BETTER THAN EVER.

Experimental Radio

Nothing but experiments, written by the foremost radio authorities, also a monthly editorial by H. Gernsback. But best of all for you radio readers, is the big radio section of over twelve pages of some fifty radio experimental articles—and mind you, NOTHING BUT EXPERIMENTS.

INTERESTING ARTICLES TO APPEAR IN THE FEBRUARY ISSUE OF THE EXPERIMENTER

- Fire Under Water. By T. O'Connor Sloane, Ph.D.
- The Cathode-Ray Oscillograph. By Dr. Bacher.
- Microscope Illumination by Means of Quartz Rod. By S. B. Leiter.
- Mirrors Made from Chemical Convex Covers. By Earle R. Caley.
- Spiral-Cut Bottle
- Short Sketch of a Young Experimenter's Personal Experience.

The EXPERIMENTER will be on sale at all newsstands January 20, 1926.

THE MONTH'S NEW QRAS

(Continued from page 1194)

- 9BQD—C. J. Webster, Science School, Wahpeton, N. D. Ten watts phone and C.W. on 175 meters; 75 meters C.W. Replaces 9DFS and 9IK. QSL's appctd.
- 9EFS—C. R. Miller, 526 C Avenue, East Cedar Rapids, Iowa. QRK mi 50 watts on 40 es 20 meters. Hw abt a schedule?
- 9CHM—Theodore Lucke, 700 First Avenue, S.W., Le Mars, Iowa. Five watts C.W. on 80 meters. Repts appctd, OSR. QRV.
- 2AFS—Leon L. Adelman, 860 East 164th Street, Bronx, New York City. Pse QSL—"or what have you?"
- 2APV—Jack Berliant, 1057 Grant Avenue, Bronx, New York City (Ex2BEE). "Round the world on one watt!"

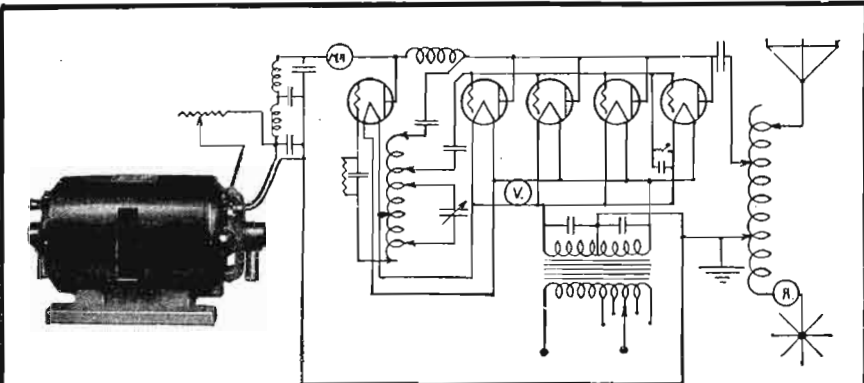

Item No. 8 Type M. G. 113 500 volts 150 watts when used with one five wattor as a master oscillator and four as amplifiers, will make a set of which the owner may be justly proud. A real DX getter.

Or if this set does not suit there is Bulletin 237B listing over 200 other combinations. Write for your copy today.

ELECTRIC SPECIALTY COMPANY

TRADE "ESCO" MARK

211 South Street

Stamford, Conn.

Manufacturers of Motors, Generators, Motor-Generators and Dynamotors.

HEATH CONDENSERS

For Real Radio Reception

Write for Literature

HEATH RADIO & ELECTRIC MFG. CO.,
206 First St., Newark, N. J.

RADIO BARGAINS

FREE RADIO CATALOG & GUIDE of newest ideas, approved special hook-ups with illustrations. Tremendous savings on standard radio parts, sets, kits. Be sure to get this thirty book before you buy. Wonderful! Unusual! You'll say so. Write letter or postal NOW. BARAWIK CO., 102-142 S. Canal St., CHICAGO, U.S.A.

Use ELECTRAD the Electrically Perfect Lead-In—

Join the Legions of Electrad Lead-In users and put an end to your aerial lead-in troubles. It meets that high standard set by all "Electrad" products. There is a difference.

The convenient lead-in. Now you need not scar or mar your walls or sash with unsightly holes or ugly porcelain tubes. This flat, highly insulated and waterproofed lead-in fits under locked windows and doors. The windows may be closed tightly—there need be no loss of heat in the room. Pliable, it bends into any shape—meeting your every need. Price 40c.

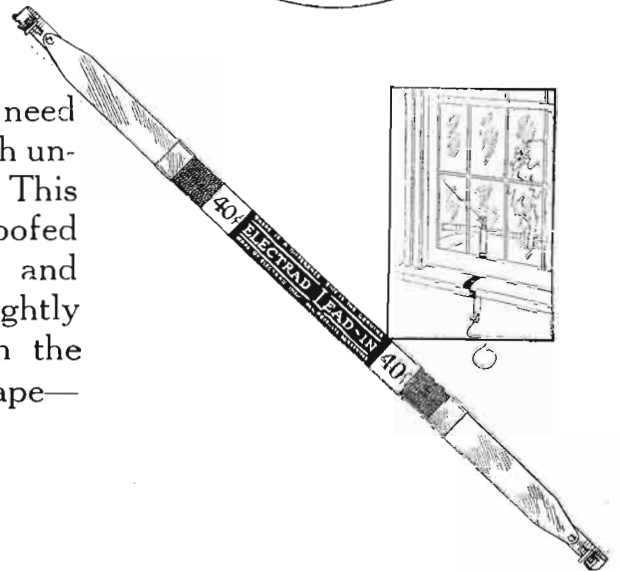

ELECTRAD, Inc.
428 Broadway
New York

ELECTRAD

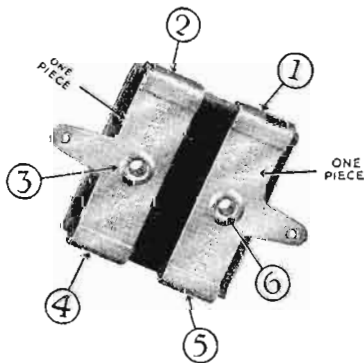

*"The Six Point
Pressure Condenser"*

THE "Electrad" Certified Fixed Mica Condenser is a revelation in accuracy and design. Ingenious, rigid binding and firm riveting fastens parts securely at Six different points insuring positive electrical contact. Impervious to temperature and climatic variations. Exerts even pressure upon the largest possible surface—can't work loose. Binding strap and soldering lug in one piece. Accuracy and quietness assured always. Value guaranteed to remain within 10% of calibration. Standard capacities, 3 types. Licensed under Pat. No. 1,181,623, May 2, 1916, and applications pending. Price 30c to 75c in sealed dust and moisture proof packages.

OTHER STERLING DEVICES

- "Home" Tube Testers
- "Universal" (Set Servicing) Tube Testers
- Battery Chargers
- Pocket and Panel Meters

Are Those Overworked Tubes of Yours in Need of Reactivation?



TUBES that have been on the job night after night need stimulation. Like a run-down storage battery in need of recharging, your tubes can be revitalized with the Sterling Tube Reactivator. They can be made to give hours and hours of up-and-doing service, to carry on through the entire season.

Tube reactivation is a scientific process made simple and sure by the Sterling method. No need for guessing at results for the Sterling Reactivator is meter equipped. This feature permits the owner to see instantly whether the tube needs reactivation, and, after treatment, how much better the tube really is.

The tubes you save, the better reception you get, the very simplicity and certainty of the Sterling metered instrument, make this device a necessary part of your equipment.

Read the Meter

Price \$12.50 (50-60 cycle)
\$14.00 (25-40 cycle)

THE STERLING MFG. COMPANY
CLEVELAND Dept. H OHIO

Sterling

TUBE REACTIVATOR
RENEW'S YOUR TUBES, and TESTS THEM, TOO

-it's in the TUBE

YOUR receiving set can be no better than its tubes. CeCo Tubes give maximum results in clarity of tone, rich volume and long life.

Our charted tests (results confirmed by laboratories of national reputation) PROVE CECo TUBES' SUPERIORITY—as detectors, as amplifiers.

Buy CeCo Tubes whether your set takes one tube or eight.

Now ready! CeCo Tubes with new type Long PRONG BASES. Also, power amplifier tubes, E (Dry Cell Type), F (Storage Battery), for last stage of Audio Frequency. Ask your radio dealer.

C. E. MFG. CO., INC.
702 Eddy Street Providence, R. I.



	"A"	"B"	"C"
Filament Volts.....	5.0	3.0	3.0
Filament Current.....	0.25	.06	.06
Plate Voltage.....	20 to 120	20 to 80	20 to 80



CECO TUBES

BUILDING A SET?

You must have rheostats of correct ohmage. Insist on the genuine.

KLOSNER RHEOSTATS
Made by pioneer makers of the center. FREE—Send for valuable Rheostat Chart and information on the care and operation of vacuum tubes. Mention dealer's name.
KLOSNER RADIO CORPORATION
1024 East 178th St. Rheostat Specialists, N. Y. C.



PATENTS

C. L. PARKER
Formerly Member
Examining Corps,
U. S. Patent Office,
PATENT - LAWYER
McGill Bldg., Wash., D. C.

Patents, Trade Marks, Copyrights, Patent Litigation
Handbook for Inventors, "Protecting, Exploiting and Selling Inventions," sent upon request.

Secret Broadcasting—Its Possibilities

(Continued from page 1130)

transmitting station cause the receiver to respond to the exact frequency on which the signals are being transmitted.

(2) Methods whereby the frequency of the signals at the transmitting end is so changed that a special receiver is needed to interpret them.

Let us consider for a moment a transmitter and receiver that fall under the first classification, where the mixing of the signals is done by changing the wave-length. The principle underlying such systems is that two, three or even more wave-lengths are used on which to transmit the signals in a certain definite order and for a certain duration of time; in order that if a person should tune in the station on one of the wave-lengths he would hear the signals for only a certain time—a few seconds or minutes, as the case may be—and then there would be a gap in the signals until the first wave-length was again employed.

We shall assume that the signals are to be transmitted on three wave-lengths, 100, 200 and 300 meters. In the transmitter are three separate sets of inductances and capacities, each being accurately adjusted in its values so that it will tune the transmitter to one of these wave-lengths, when it is thrown into the circuit. There are also similar sets of inductances and capacities for the receiver, with proper allowances made for local conditions, in order that they may tune the receiver to 100, 200 and 300 meters.

To these three sets of inductances and capacities is connected some suitable means for throwing them one at a time into the transmitting circuit. This switch may be in the form of two grooves in which metal balls are caused to roll down, making contact with the tuner as they go.

SYNCHRONIZING THE SETS

In Fig. 1 is shown a diagram of a simple receiving circuit, which will perhaps make clear the operation of the system. There are three tuned circuits mentioned above, L_1C_1 , L_2C_2 and L_3C_3 , inclosed within the special switch connecting them to the grid circuit of the tube. In this switch there are metal balls, marked X, which as they roll down past each tuner connect it to the circuit. If all these switches are identical and inclined at the same angle to the horizontal, the balls, if also identical, will roll down in the same time.

ARE you interested in motoring, touring or camping? If you are, do not fail to read the February issue of

MOTOR CAMPER AND TOURIST

Here is a magazine that tells you things in connection with your car—things that you never even suspected.

Are you just running around the country or are you getting the full benefit of your car? MOTOR CAMPER & TOURIST shows you the way. On all newsstands.

ARTICLES IN FEBRUARY ISSUE

- Along the Old Santa Fe Trail, By Omar Barker
- Camping Along Historic Trails in Southern New Mexico, By L. A. Cardwell
- The Romance of New Mexico, By Gilean Douglas
- A Trip To Hopi-Land, By Bonney R. Gastra
- El Morro, By Isabel Florence Tracy
- Trailer Construction, By H. H. Buckwalter



At the CLICK of a switch

Unipower gives you continuous, unfailing "A" power of the highest quality ✓ ✓ ✓

YOU click a switch. Your set begins to operate—feeding on a new kind of "A" power, rich and quiet and always at full voltage.

Again you click the switch. Your set is off. Your "A" power supply *automatically* begins to replenish itself direct from your house current. That is Unipower!

A new thrill in radio

Unipower has ushered in a new convenience, a new perfection, a new economy in radio operation. It is now in use in thousands of sets and has the enthusiastic endorsement of set manufacturers. It does away with "A" current failure—the most frequent cause of poor radio reception.

Unipower is a single compact unit, quickly and easily installed. Just connect two wires to your set, plug in on your light current, and the job's done! Unipower is equipped with an exclusive Balkite charger of special design. It will last you for years, and contains no tubes, bulbs, lamps, or other parts that require frequent replacement. Unipower is *not* a battery eliminator, and should not be confused with any other radio power device.

*Off when it's on—
On when it's off*

A unique feature of Unipower is the master-control switch that governs the operation of your entire set. When this switch is ON, your set operates quietly and perfectly, drawing its "A" power from Unipower's rich, full reserve. When the switch is OFF, your set is off—and Unipower automatically recharges from the house current.

The nearest radio dealer can supply you with Unipower. Ask him for a demonstration today.

THE GOULD STORAGE BATTERY CO., Inc.
250 Park Avenue - - - New York



THIS SHOWS HOW SNUGLY THE 6-VOLT UNIPOWER FITS INTO LIMITED SPACE.



FREE! Write for interesting booklet, "Unipower — a Triumph in Radio Power" describing Unipower's many advantages and economies.

The standard Unipower operates from alternating current, 110-125 V-60 cycle. It is supplied in two types. The 4-volt type is for sets using UV 199 tubes or equivalent and retails for \$35.00. The 6-volt type is for sets using UV 201-A tubes or equivalent and retails for \$40.00. West of the Rockies, prices are slightly higher. (Special models, 25-50 cycle, are available.)

Unipower

TRADE MARK



*Off when it's on
On when it's off*

Hear Europe with the Universal Plio-6



35 Meters to 3600 Meters

No Batteries

are required even to operate the powerful receiver pictured above, if you use the new laboratory type

Model A Power Unit

A new broadcast receiver representing the highest type of efficiency obtainable in point of extreme range, tremendous audibility and remarkable selectivity.

Maximum Efficiency—Inexpensive

Parts or Completely Constructed

Write for information today

NORDEN-HAUCK, Inc.
Engineers

1617 Chestnut Street, Philadelphia, Pa.

40 Non-Technical Radio Articles

every month for the beginner, the layman and those who like radio from the non-technical side.

SCIENCE & INVENTION, which can be bought at any newsstand, contains the largest and most interesting section of radio articles of any non-radio magazine in existence.

Plenty of "How To Make It" radio articles and plenty of simplified hook-ups for the layman and experimenter. The radio section of SCIENCE & INVENTION is so good that many RADIO NEWS readers buy it solely for this feature.

List of Radio Articles Appearing in the February Issue of "Science and Invention"

- New Radiophone Ship Installation.
By Jack Milligram.
- A Short Wave Receiver.
By A. P. Peck, Assoc. I. R. E.
- Power Amplification From Your Ford,
By Ralph H. Slater.
- A Portable Radio Laboratory,
By Raymond Herchert.
- More About "B" Eliminators.

Then comes the problem of synchronization, or making all these switches operate simultaneously. At the transmitting station there is a separate circuit that sends out short, powerful signals at regular intervals, which are picked up by a special tuner in every receiving set. These signals are employed to energize a relay, which in turn operates a ratchet wheel, one tooth at a time. This ratchet wheel is arranged to carry a number of these metal balls; and when it moves the width of one tooth, one ball on each side is released and allowed to roll down the metal groove. Suitable arrangements are made to return the balls to the ratchet wheel after their journey down the groove. In this way the balls are started rolling at the transmitting station, and all receiving stations at exactly the same instant.

It can be easily seen from the foregoing that, while it is quite possible to broadcast secretly, there are many difficulties to be surmounted. One of the greatest of these is that in this system there are really four different wave-lengths employed and under conditions, such as they are today, this plan is hardly feasible for broadcasting programs. Of course, the three wave-lengths could be much closer—within 20 meters perhaps—but still this is a handicap.

INTRODUCING OTHER NOISES

Another example of a secret transmitting system operates by the introduction of an objectionable noise at the transmitter, which can only be eliminated by a special receiver. In this case a normal form of radio telephony is employed, and the objectionable noise is introduced into the microphone along with the regular program. Therefore, there is transmitted with the usual music a noise such as to make it impossible, or at least extremely unpleasant, to receive a program with the ordinary type of receiving apparatus.

However, all that is required at the receiving station, to eliminate this objectionable noise, is a proper filter. Let us assume that in speech or music the frequencies vary from 25 to 5,000 cycles per second. Therefore, if a constant note of 3,000 cycles is introduced into the microphone along with the regular music, it is a simple matter to have a filter in the receiving circuit that will pass everything but this 3,000-cycle note.

It is also possible to introduce in the same manner a note below the frequency range mentioned in the preceding paragraph. This

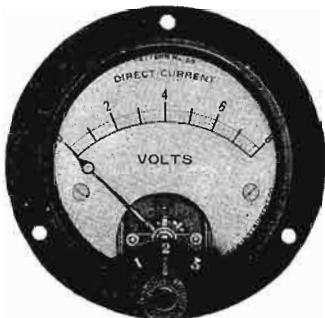

(Patented Feb. 24, 1925)
Pattern No. 55

Ask Men Who Know

—Amateurs, Radio Engineers, or Manufacturers—and they will tell you that JEWELL Instruments lead in radio.

Why?

—Because JEWELL Engineers are also radio men and know what is required in radio work. Also because JEWELL has been the first to develop new radio instruments and accuracy is always our aim.

Don't fail to get a Jewell 15-B Radio Catalog.

Order from Dealer

Jewell Electrical Instrument Co.

1650 Walnut St. : Chicago
26 Years Making Good Instruments

New Business! FOR LIVE RADIO DEALERS

Did you know that the readers of RADIO NEWS buy twice as much Radio Equipment as the average? That's because RADIO NEWS stimulates and encourages Radio activity. Why not sell RADIO NEWS to your customers? It will stimulate their buying of Radio Parts and bring additional profits to you.

Address: M. B. FLAUM, Dept. 2RB 53 Park Pl., N. Y. C.

No matter what circuit— Far, Far Better Results

with

KARAS

Orthometric Condensers and Harmonik Transformers

KARAS instruments have been tested and recommended by leading technical editors for use in all types of sets from the most elaborate supers to the simplest low loss 3-tube receivers. The most exacting homeset builders, the country over, demand Karas Transformers and Condensers—and will use nothing else. Nothing can take the place of these scientifically designed, precision instruments. Use them in your next set—or improve your present set by installing them. It's easy to do—the results will be worth many times the cost.



*"The Best
Transformer
Money Can Buy"*

**Spreads Stations Evenly
Over the Dial**
—No Crowding
Whatever!

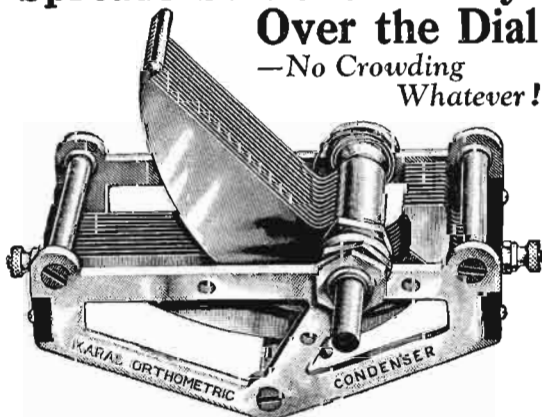

For Long Distance with Big Volume and Keen Musical Quality

Karas Harmoniks deliver perfect music with loads of volume from stations one to two thousand miles distant. DX broadcasting becomes really enjoyable. "Fishing" for distant stations is only a matter of finding programs you want to hear—not straining to catch only the bare announcement and making up a list of call letters.

Even from far away points, Karas Harmoniks bring out full, round musical tones. All the vital harmonics and rich overtones are fully retained. Low bass notes pour forth, rich, sweet, sonorous. If you want music like this, you must have Karas Harmoniks in your set. Get a pair TODAY!

The Karas Orthometric Condenser positively separates all adjoining wavelengths by EQUAL distances on the dial—giving you full benefit of the 10 Kilocycle frequency separation fixed by the government. Ordinary condensers jam 70 of the 100 Government allotted wavelengths into the first 30 points on the dial—even straight-line-wavelength condensers crowd 57 of them below 30. But with Karas Orthometrics, each point on the dial corresponds to one of the 100 allotted wavelengths. The result is marvelous simplicity in tuning—and better, clearer reception—all side bands without interference.

Brings in KDKA at 53

Not at 17—or 28, but at 53 where it belongs, leaving lots of room for the 52 wavelengths that must come in below it. The Karas Orthometric is a "precision job"—entirely of brass. Every joint soldered. Plates patent-levelled and securely bridged.

If your dealer is out of Karas Instruments

Order Direct on This Coupon

Most good dealers everywhere sell Karas parts. If your dealer happens to be one who doesn't, we will supply you direct at no trouble on your part—on our 30-day money back guarantee. Just fill in and mail this coupon at once. Send no money. You can pay the postman on delivery.

**KARAS ELECTRIC CO., 4038 North Rockwell Street
CHICAGO, ILLINOIS**

For more than 30 years makers of PRECISION Electrical Apparatus

**Karas Electric Co.,
4038 N. Rockwell St., Chicago**

Please ship me the instruments checked below. I will pay the postman prices listed; plus postage upon delivery. It is understood that I have the privilege of returning these goods, for full refund, within 30 days, if they do not prove entirely satisfactory.

..... Karas Harmonik Audio Transformers. (\$7.00 each)

..... Karas Orthometric Condensers: Size.....
(23 plate \$7 ea.; 17 plate \$6.75 ea.; 11 plate \$6.50)

Name.....

Address.....
If you send cash with order, we'll send package postpaid

McMURDO SILVER'S NEWEST RECEIVER THE SILVER "SIX"

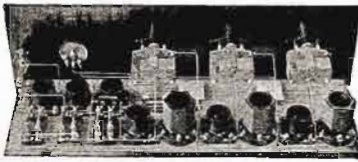

TYPE 600 KIT, includes all parts necessary to build the complete "SIX" \$53.00
 TYPE 610 KIT, essentials only, including 3 condensers, 3 inductances and 3 inductance sockets\$27.75

Anyone can build the Six

SM Low Loss Inductances
 All-bakelite Low Loss Inter-changeable Coils for 50-550 meters. These new coils may be used as oscillators, antenna adaptors and R F transformers in standard circuits. Prices of all types. Each...\$2.50
 Sockets for any size Coils. Each\$1.00

SM 210 and 211 Transformers
 Designed so that maximum amplification will be obtained at 60 Kilocycles. Both types in bakelite housings, hermetically sealed. No. 210 is iron-core type while No. 211 is of the air-core type supplied with measured tuning condenser. Each transformer is furnished with individual laboratory curve chart. Price: Both Types.....\$8.00 ea.

SM SLF Condensers
 These new condensers are particularly adapted for short wave reception because of their extremely low dielectric and eddy-current losses. They are the smallest SLF Condensers made. Supplied with special attachment for single control. Prices: No. 310.....\$6.00
 No. 311 .00035 5.75

The Improved RAYTHEON-THORDARSON B-ELIMINATOR

The SM Type 650 Kit includes Thordarson transformer, choke, Tube condensers, genuine Raytheon tube, Bradleyohms and all necessary parts. Price \$34.

This eliminator will deliver from 20 to 200 volts at three different, adjustable voltages with maximum current of 50 milliamperes—more than enough for the largest receiver.

Send for Assembly Instruction by McMURDO SILVER 10c

Circulars on SM Products mailed on request.

SEE SM PRODUCTS AT YOUR DEALER'S
SILVER-MARSHALL, Inc. 116 S. WABASH AVE. CHICAGO

SUPERADIO RECEIVER

Matchless tone quality is obtained in this Receiver by the Reactodyne System of R. F. Amplification by which automatic control of oscillation is effected

over the entire broadcast range. Each of the 5 tubes performs the maximum amount of work, thus assuring greater volume and greater distance.

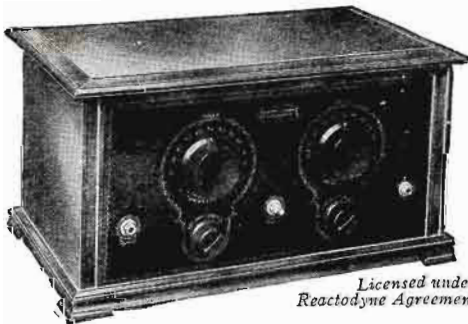

Licensed under Reactodyne Agreement

Only 2 tuning dials, economical upkeep. A truly wonderful value. Price \$56.

Ask to see this scientific product at your dealer's or write us for full details.

JUST OUT—
THE PERFECTED
SUPERADIO "B"
BATTERY
ELIMINATOR

Insist on having your tubes tested before you buy. The Superadio Dynamometer tests tubes so you can understand it. Measures Amplification Factor, Plate Impedance and Mutual Conductance without Curves or Calculations.

DE WITT LA FRANCE CO., INC.

54 Washburn Avenue, Cambridge, Mass.

Boston Representative
 Martin, Hartley & DeWitt Sales Co., 99 Bedford St.

Chicago Representative
 William A. Welty & Co., 36 So. State St.

"Lighting Fixtures"
 READY TO HANG
 (Direct from Manufacturer)
 Completely wired including glassware
 Send for new Catalogue No. 27
 (Just reduced prices)
 Special Proposition to Dealers
ERIE FIXTURE SUPPLY CO.
 STATION R ERIE, PA.

**NO MORE LOOSE CONNECTIONS
 X-L PUSH POST**
 A binding post that really does excel. Looks, action, service, and convenience. Push it down—insert wire—cannot jar loose from vibration. No screwing or danger of shearing off wires. Furnished attractively plated with soldering lug and necessary markings.
 Price Each15 Cents
X-L RADIO LABORATORIES
 2426 Lincoln Avenue Chicago

might be in the neighborhood of 25 cycles per second and of course would be as objectionable as the higher tone, if it were not eliminated in a like manner by a filter.

Naturally, in a system of this character, it would be more or less of an easy matter for anyone to have a system of filters incorporated in a receiver and get rid of the noise; but these objectionable notes can be so often changed that it will be a difficult matter to eliminate the noise continually.

Systems of secret broadcasting that fall under the second classification (*i. e.*, a change of frequency at the transmitting station) are a great deal more complicated in their apparatus, but are much more ingenious than any of the others. The change of frequency mentioned is not a change in the wave-length on which the signals are sent out, but a change in the frequency of the signals.

It is commonly known that every sound has a definite frequency, or combination of frequencies. For instance, middle C on the piano has a value expressed in terms of vibrations of 256 cycles per second. However, there are also overtones in music that are 2, 3, 4, etc., times the fundamental frequency, or, in the case of middle C with its fundamental of 256, they are 512, 768, 1,024, and so on.

FILTERING OUT THE NOISES

In this system of broadcasting these fundamental frequencies and their companion overtones are caused to modulate a continuous note of perhaps 3,000 cycles. Therefore, we will have two side bands of resultant frequencies; one ranging upward, 3,256, 3,512, 3,768, 4,024, etc., and the other downward, 2,744, 2,488, 2,232, 1,976, etc. These are, as may be seen, the sum and difference of the two frequencies and overtones. Now one of these side bands can easily be eliminated by an appropriate filter system, and the remaining one used to modulate a carrier wave in a broadcasting station. Naturally, what an ordinary receiver would reproduce would sound like anything else on earth except middle C.

However, at the receiving end of such a system it is possible to reproduce the original note with its usual characteristics; and it is done in exactly the reverse manner that the process is performed at the transmitting station. The received frequencies are caused to modulate a continuous note of the same frequency as that employed when the middle C was changed at the transmitter, *viz.*, 3,000 cycles. Once again there are two side bands set up, being the sum and difference of the two frequencies, in this case (if the upper side band has been eliminated at the start) 256, 512, 768, 1,024, etc., and 5,744, 5,488, 5,232, 4,976, etc. Here again a filter is used to eliminate the upper band, and we are left to put through the receiver the original middle C.

This example serves to illustrate how such a system is used; and there are many complications that can be introduced in order to make the untangling more difficult. For instance, the essential band of frequencies from 25 to 5,000 might be divided into three, each of these used to modulate a different note, and then the three transmitted as a whole. The same type of filters could be used at both ends of the system; and it is easy to imagine that such transmission would be most difficult to untangle without a proper receiving set.

All that has gone before shows that it is entirely possible for two stations to have intercommunication without the world listening in. Such secrecy is undoubtedly essential in warfare, business transactions, etc., but it is hardly possible for broadcasting as we know it today. There are too many disadvantages; the cost of the requisite apparatus, the use of several wave-lengths in one instance; and many other too numerous to mention. Our present system, while it has its multitudes of faults, is really one that is fundamentally most economical for general use.

In Every Popular Construction Set

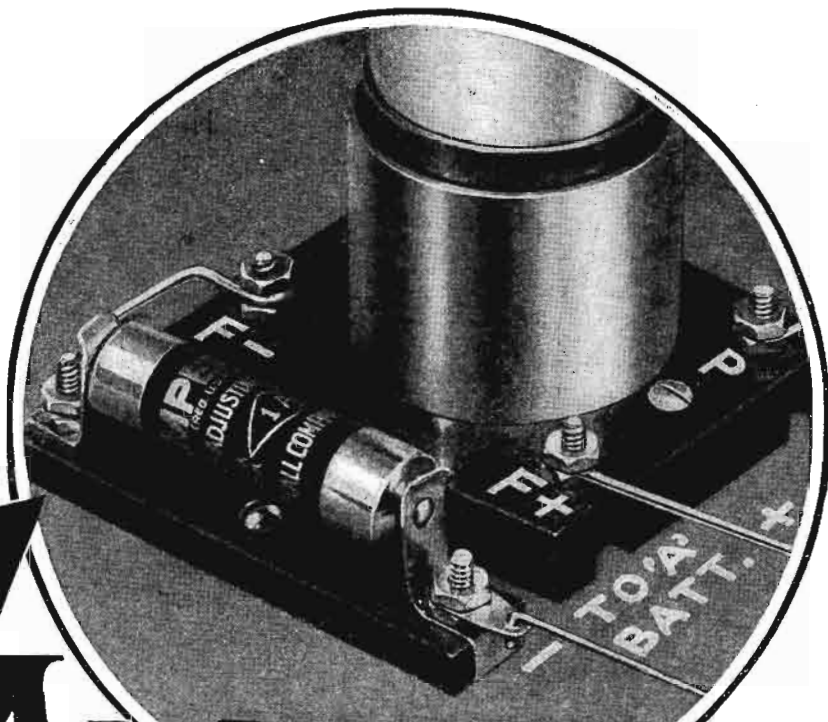

Write today for FREE Hook-Ups

AMPERITE

REG. U.S. PAT. OFF.

The "SELF-ADJUSTING" Rheostat

Insures Perfect Automatic Tube-Control Because AMPERITE—

Sold Everywhere
\$1.10 complete
with mounting
(in U. S. A.)



- 1—Eliminates Hand Rheostats, thereby simplifying control.
- 2—Permits use of the latest types of tubes or any combination of tubes.
- 3—Simplifies and reduces set-wiring, thereby making for greater compactness and avoids losses.
- 4—No moving parts, hence no grinding noises; clear and full tones.
- 5—Prolongs tube-life by keeping filaments at a constant temperature.
- 6—No filament meters needed.
- 7—Brings the most out of each individual tube—automatically—no guessing.
- 8—Makes every set-owner a master operator, no knobs to turn.

Obsolete

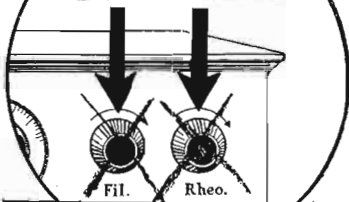

For the new tubes:

Amperite No. 112—for the UX-112 and CX-112
Amperite No. 120—for the UX-120 and CX-120

Radiall Company

Dept. R.N.-2 50 Franklin Street New York City

Be sure that the set you buy or build is equipped with AMPERITE

Manufacturers of
TUNE-RITE
5% STRAIGHT-LINE FREQUENCY DIAL

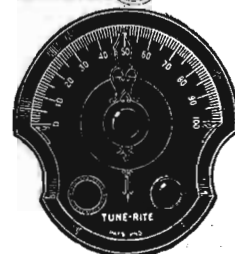

BARKELEW Porcelain Pedestals

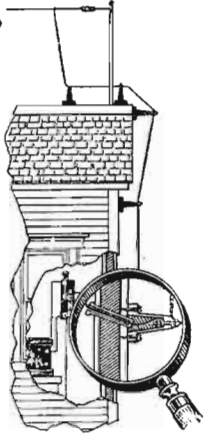

An insulator with a rigid clamp for the lead-in wire.

A pedestal mounting for Ground Switches, Lightning Arrester Switches or Lightning Arresters.

An insulating spacer for mounting free of table or wall, any other piece of apparatus.

In all cases it spaces the apparatus 5" clear of the mounting surface.

This brown glazed Porcelain Pedestal has so many different applications that it at once becomes a fast moving stock article.

Two wood screws 2" long are furnished with each pedestal.

See our Radio Catalog at your Dealer. If he hasn't his copy, we have one for him.

The Barkelew Electric Mfg Co.
Middletown, Ohio, U.S.A.

NEW YORK, 157 Chambers St.
BOSTON, 31 Bedford St.
WASHINGTON, D. C., Mills Bldg.
ATLANTA, GA., 180 Spring St.

CHICAGO, 15 S. Clinton St.
DENVER, Denham Bldg.
MINNEAPOLIS, 1017 Lumber Ex.
SEATTLE, 1041 Sixth Ave. S.

SAN FRANCISCO, 75 Fremont St.
LOS ANGELES, 443 S. San Pedro St.
TORONTO, 20 Bloor St. W.
MONTREAL, 286 St. Paul St. W.

BROWN GLAZE



No. 611 Price \$.50 ea.

Carton Quantity
10 Pedestals... 12 lbs.

Standard Package
100 Pedestals... 150 lbs

A Balanced Reflex Circuit

(Continued from page 1147)

These R.F. transformer specifications can be departed from widely.

The two inductive couplers are mounted at an angle to each other that will, to the imagination, immediately assume mysterious proportions. It should not. The two are mounted at right angles, 90 degrees, to each other, as the diagram in Fig. 6 shows clearly. Fig. 6A is just as good a method. If the set were crowded less than has occurred in the particular case in the pictures, it would be very neat, without a freak manner of mounting the coils. To make room, and yet keep clear of the condensers and each other, for the apparatus behind the panel, the method of mounting was resorted to. It will be seen that the antenna-coupler is at right-angles to the other two, by being mounted vertically. (See page 1147).

THE FIXED CONDENSERS

The fixed condensers used in this set are of a capacity decided upon from simple radio-electrical mathematics. Larger capacities can be used, but it is decidedly not advisable. I should be tempted to forbid the use of other sizes, save for the fact that I know they can be used with satisfaction. The size of the amplifier grid condenser, .00005 mfd. (please notice the four ciphers, as a .0005 mfd. size is 10 times too large) is chosen to avoid two things: it must not materially resonate the transformer to cause distortion, and the ratio of secondary inductance to this small capacity makes it all right; and it must not be large enough to materially affect the terminal secondary voltage, and again this capacity is all right. The .001 capacities used across the primary circuit of each audio transformer are OK for the transformers I used. If the big audio transformers of present-day design are used, as should be done, these can just as well be .0005 mfd. They should NOT be larger than .001. The size was chosen on the same requirements as the .00005 mfd. size.

THE AUDIO TRANSFORMERS

The quality of reproduced music and voice obtainable from the set using this circuit is entirely dependent upon the audio transformer used. Much has been said lately about the design of audio transformers, and much stress has been placed upon the use of sufficient primary turns, a large core, and so on. The time will come, and is coming soon, when all of our parts will be rated in sensible figures. For instance, a transformer designed

AMPLION

Product of Over 30 Years' Experience

Bring in those distant programs clear and loud!

THE actual originators and world's oldest makers of loud speaking devices have created in The Amplion a long distance radio reproducer so clear and powerful that many users say it can be used instead of another tube in a set. Hear The Amplion—in comparison!—and you will understand the reason it leads in sales throughout the world—is the choice of the Royalty and Nobility abroad, and of the musically critical everywhere. Write for the "Amplion Pedigree."

THE AMPLION CORPORATION OF AMERICA
Executive Offices: Suite 5, 280 Madison Ave., New York City
Canadian Distributors: Burndep of Canada, Ltd., Toronto



ALFRED GRAHAM & CO.
LONDON, ENGLAND
Patentees

Supreme clarity of tone caused Amplions to be chosen for use in St. Peter's, Rome, to reproduce important papal ceremonies.

All Amplions are completely equipped with cords and panel plugs.

Speakers and console units

\$12 to \$4250

Radio Dealers WANTED!

If you are the type of dealer who hustles after business, who isn't content to wait for trade to come in but who takes sets out to demonstrate, can talk and sell quality merchandise, and knows Radio values, we have a big proposition for you. Are you that dealer?

50% DISCOUNT TO DEALERS

We manufacture a complete line of high grade receivers and sell to dealers at 50% discount. We are distributors for more than 225 Nationally advertised lines.

FREE Write today for amazing offers, new 112-page catalog and regular monthly catalogs quoting below-the-market prices on latest merchandise—all free. Everything in Radio for less.

AMERICAN RADIO MFG. CO.,
1416-18 McGee St., Dept. A, Kansas City, Mo.



ALMOST TOO GOOD TO BE TRUE X-L VARIO CONDENSERS

INSTALL THEM IN YOUR SET AND LEAVE THEM SPEAK FOR THEMSELVES

Endorsed and Used by the Foremost Radio Engineers

MODEL N—Capacity range 1.5 to 20 micro-microfarads. For balance in Roberts two tube, Brownling-Drake, McMurdo Silver's Knockout, Neutrodyne and tuned radio frequency circuits. Price \$1.00

MODEL G—For the Cockaday circuit, filter and intermediate frequency tuning in super-heterodyne and positive grid bias in all sets.

G-1—.0002 to .0001 MF. G-10—.0003 to .001 MF.

G-5—.0001 to .0005 MF. Price each with Grid Leak Clips \$1.50

X-L RADIO LABS., 2426 Lincoln Avenue, Chicago

Station WRNY
NEW YORK
258.5 Meters - 1160 kilocycles
is owned and operated by the publishers of this magazine
Our Editors will talk to you several times every week
See your Newspaper for details
TUNE IN ON WRNY

BUILD YOUR OWN RADIO SET!

FREE

TWO VALUABLE BOOKS

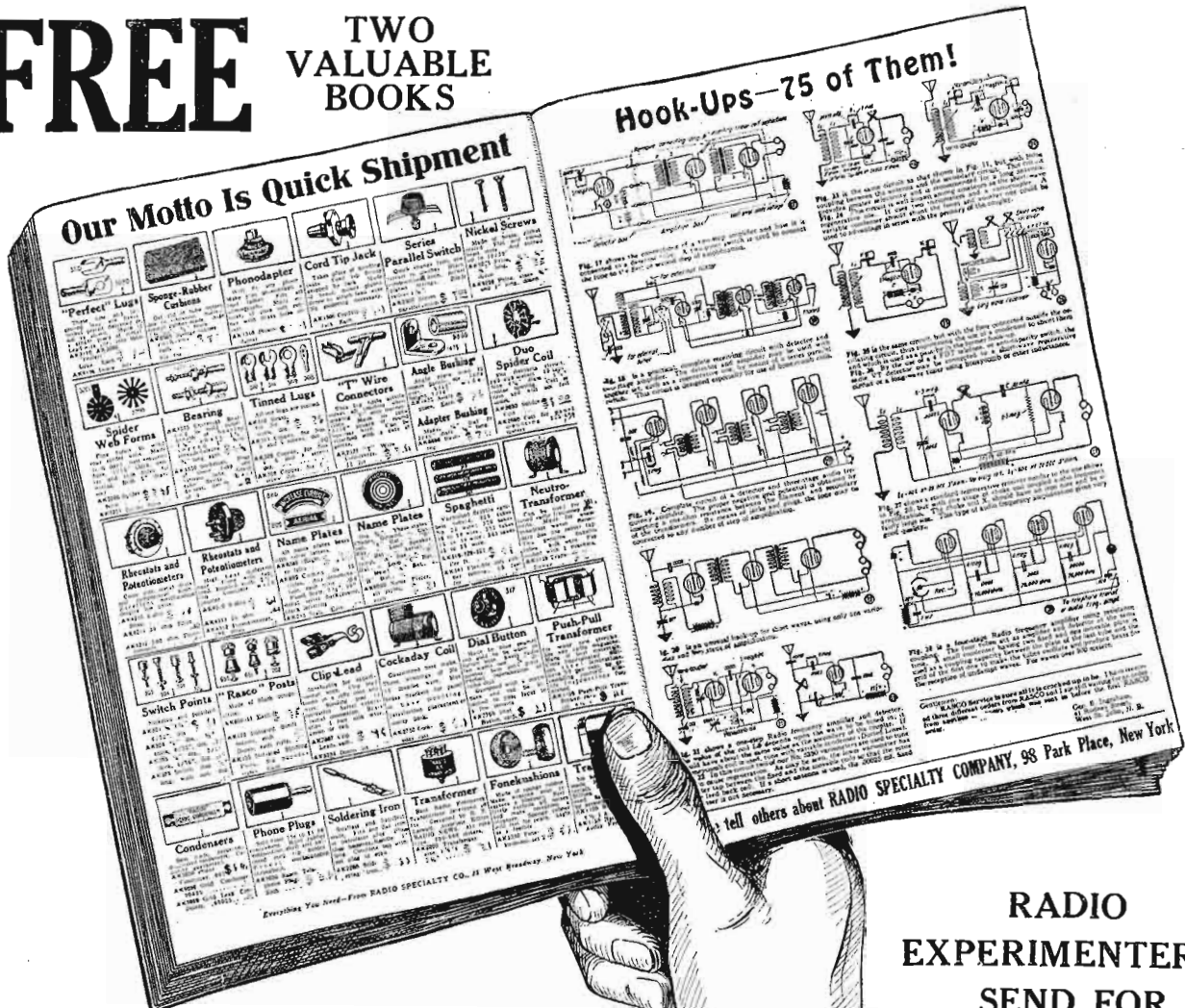

Photographic
Reproduction of
Two Catalog Pages

**RADIO
EXPERIMENTERS,
SEND FOR
THESE BOOKS
TODAY**

Buy from Radio's oldest Mail Order House

THE NEW RASCO CATALOG No. 15

Contains the Following Hookups.
 All Armstrong Circuits: These important circuits are explained clearly, all values having been given, leaving out nothing that could puzzle you. Just to name a few of the Vacuum Tube circuits: The V.T. as a detector and one-step amplifier; Super Regenerator; one-step radio frequency amplifier and detector; three-stage audio frequency amplifier; short wave regenerative circuits; 4-stage radio frequency amplifier; radio and audio frequency amplifier; inductively coupled amplifier; all Reflex Circuits.
 This catalog is crammed full of small parts and radio findings, literally thousands of them. In addition there is much useful information contained herein.

WE are the oldest established, exclusive radio mail order house in the country. Our motto is "Quick Shipment." All orders are shipped within 24 hours. Quick, prompt, courteous service. We carry a larger variety of radio parts and findings than any other radio house in the country.

RASCO HAS IT. If you are in need of certain small radio parts that other houses do not bother to carry, look in your RASCO parts catalog and you will find it there—anything from a screw to copper ribbon and telephone diaphragms as well as thousands of other small findings.

TWO VALUABLE BOOKS. "Don't fail to get our free "NO SOLDER RADIO RECEIVER KIT CATALOGUE NO. 14." Contains 36 pages, 7 by 10 inches, packed full of the most interesting matter ever put into a radio catalog. All kits are shipped on approval, on send-no-money plan. Lowest prices in the country. Revolutionary method to build your own receiver. ALSO the New 1926 RASCO PARTS CATALOG NO. 15, contains 75 hookups, 300 illustrations and over 500 articles, all interesting and valuable.

If you will paste this coupon on a post card and mail today, we will be pleased to send you our two Catalogues at once.

RADIO SPECIALTY CO.
 98 Park Place New York City

RADIO SPECIALTY CO. R.N.-2-26
 98 Park Place, New York.
 You may send me, without charge or obligation, your KIT CATALOGUE NO. 14 () RASCO PARTS CATALOG NO. 15 (). (Write on margin if you please)
 Name
 Street
 P. O. State



ELECTRICITY

—as taught in the Great COYNE Shops—

Prepares You for a Big-Pay, Fascinating Steady Job in Radio or Electrical Field!

Electricity and Radio are the fields of Wonderful Opportunities today. They offer BIG PAY, clean, fascinating work and steady employment—anywhere, any time! COYNE-TRAINED MEN are in demand because COYNE training is complete and thorough. If you want to know more about Radio, learn all about Electricity—at COYNE. All practical, personal training, on real equipment, in great shops.

EARN WHILE YOU LEARN AT COYNE!

Mr. big EMPLOYMENT DEPARTMENT helps you to get a job to earn part or all of your expenses while training and assists you to a good job on graduation. It stands by you THROUGH LIFE without a penny extra cost to you.



Complete Electrical Training In 12 Happy Weeks at COYNE

My newly-enlarged Electrical Course is the result of 27 years of experience, solving the needs of young men and of the Electrical Field. My course is absolutely thorough, easy to master, covers every single phase and factor of the subject and fits men for BIG Electrical jobs, HIGH-SALARIED, thrilling jobs.

YOU DON'T NEED ADVANCED EDUCATION OR EXPERIENCE



Students producing "artificial lightning" on Tesla coil in great shops of Coyne. Students operating large switchboard at Coyne.

EARN \$60 TO \$200 A WEEK

Big Special Offer If You Act Now! I'll include with my course, without extra charge my big Extra Courses in Radio Electricity and Auto, Truck and Tractor Electricity.



Send Right Away for My Big FREE Book and Special Offer of 2 Big Extra Courses

Be sure to send at once for my big FREE BOOK containing 151 actual photos of electrical operations and methods; also my special offer of 2 Big Courses without extra cost. Write today before offer is withdrawn.

COYNE ELECTRICAL SCHOOL

H. C. LEWIS, President Established 1899
1300-10 W. Harrison St., Dept. 5942, Chicago

H. C. LEWIS, President
COYNE ELECTRICAL SCHOOL
1300-10 W. Harrison St.
Dept. 5942, Chicago, Illinois

Dear H. C.—You can just bet I want one of those big handsome FREE 12x15 books with 151 actual photographs of electrical operations and shop scenes, printed in two colors. Send it quick, before the supply is exhausted. Be sure to tell me all about Special Offer of 2 Big Extra Courses.

Name _____
Address _____

to give a primary impedance of at least 20,000 ohms at 60 cycles frequency can be considered a good transformer.

R.F. TRANSFORMER DIMENSIONS

As has been mentioned, the R.F. transformer dimensions given for the set in the pictures need not and should not be adhered to. Dimensions for any condenser, variable, can be given, and for that reason are. If one has three variable condensers of three different sizes, they can be used in the set. There is little need of getting any particular size of variable condenser. The primary dimensions should be adhered to for 201A tubes. The secondary dimensions alone change with the size of the variable condenser.

The antenna-coupler dimensions for a .0005 mfd. condenser have been given. For a .00035 mfd. these dimensions are changed



- FINISHED -

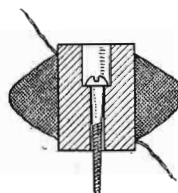

- CROSS-SECTION -

R.F. CHOKE
FIG. 4

Constructional details for a special coil to block radio frequency current from the audio frequency transformer.

but slightly; the number of turns are increased to 62. For a .00025 mfd. a second change in turns is necessary and a different method of coupling the antenna had best be used. The number of turns will be about 74, with a tap in the middle for the antenna. The antenna is connected to this tap through a .0001 mfd. fixed condenser. Experiments with the size of the antenna series capacity should be made, since this will vary with the antenna size.

The R.F. transformers, between stages and coupling to the detector, have primary turns as specified previously; don't change that unless you want to experiment. The secondaries become 45 turns, 3-inch diameter, No. 22 D.S.C. for .0005 mfd. variable condensers. For .00035 mfd. condensers the secondaries are 3-inch diameter, 60 turns of No. 22 D.S.C.; and for .00025 mfd. there are 75 turns of the same wire on the same diameter. The taps for neutralization are always made from the filament end of the secondary in turns specification. *If three-quarters of the number of turns in the primary are tapped off on the secondary you will always be right:* that is a simple rule to remember and can be depended upon. For instance, the tap is at the secondary 15th turn for the 20-turn primary.

While the set pictured has been designed for 201A tubes, it was tested with good speaker volume and good distance using 199 tubes.

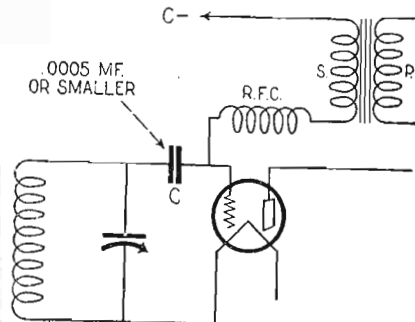
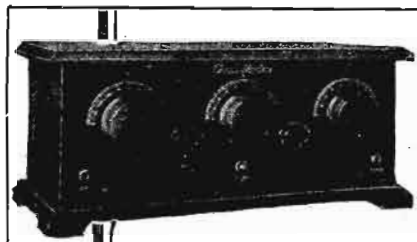

FIG. 1

The coil marked R.F.C. is the radio frequency choke shown in detail in the other illustration on this page.



In 7 x 18" Solid Mahogany Cabinet

It's a 5-Tube

GOLD MEDAL TUNED RADIO FREQUENCY RECEIVER

Was \$60 without accessories

NOW \$25

without accessories

Satisfaction Guaranteed

Delivered free anywhere in the United States

GOLD MEDAL RADIO

1034 Longwood Avenue
New York City

NION FIXED-RIGID DETECTORS



Have built over 50 sets including 3-4 tube Grimes and used NION without a single failure. On straight Regenerative and R. F. I omit Grid Leak and connect 22-2 volts tap to crystal improving tone 100 per cent without affecting volume or distance. I have found no other so dependable. Sincerely, H. Peigh, 647 N. Lawndale, Chicago.



TOP NOTCH RECEPTION AT EVERY POINT GUARANTEED

50c At Your Dealers or by Post

KEYSTONE PRODUCTS CO.
304 Gardenia Ave., ROYAL OAK, MICH.

Insure your copy reaching you each month. Subscribe to Radio News—\$2.50 a year. Experimenter Publishing Co., 53 Park Place, N. Y. C.

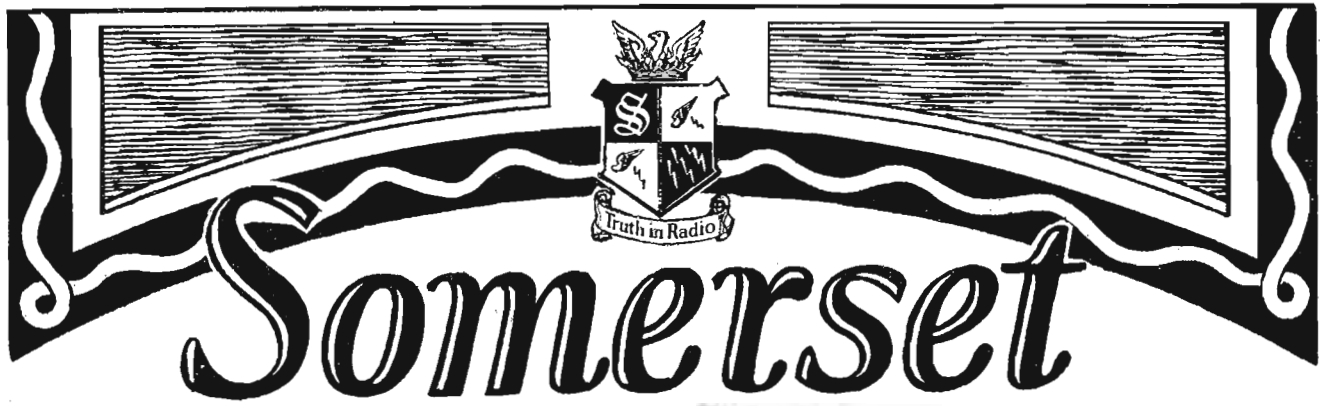

STANDISH MODEL 4-C



"TRUTH IN RADIO"

Synchronized, Single Master Control Gives Greatest Simplicity of Operation

Ever since SOMERSET Radio made its appearance two years ago, these beautiful sets have endeared themselves to the public on account of absence of extravagant claims.

SOMERSET Standish Model 4C achieves absolute simplicity in operation. One synchronized control takes care of all major tuning for local stations. A vernier control underneath the large dial is used only when listening to distant stations.

This is a 4-tube set entirely enclosed in an antique mahogany, two-tone, beautifully inlaid cabinet, with built-in Utah Loud Speaker, the best that money can buy. There is space for both "A" and "B" batteries in this large cabinet. Not just a cabinet, but a perfect piece of furni-

ture. The total size of the cabinet is 28½" x 13" x 13½".

Storage batteries or dry cells can be used. Standish Model 4C operates from 200 to 600 meters. There is an automatic filament control, eliminating chances of burning tubes too brightly and does away with extra controls.

Straightline Frequency condensers of the latest type do away with crowding of the short-wave stations.

This receiver is the best and most pleasing model of the SOMERSET line of modern radio receivers. It is handsome, powerful, and practical throughout—built by men who have been in the radio business since 1908.

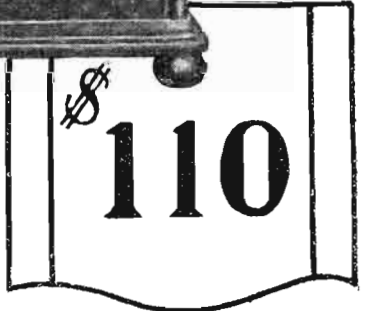

Special Dealer FRANCHISE

Extra valuable dealer franchises for the SOMERSET line are still open to some dealers who are interested in the better model receivers that are ready for quick installing, backed by a liberal advertising campaign in your own territory. Write for complete plan. Wire for your territory or use this coupon, as we are closing all territory rapidly.

SOMERSET RADIO CORPORATION
113-119 Broadway Brooklyn, N. Y.

SOMERSET RADIO CORP.,
113-119 Broadway, Brooklyn, N. Y.

2-26

Gentlemen: Kindly send me at once details as to Special Dealer franchise.

Name

Address

City, State

How to Get the Most Out of Your Set

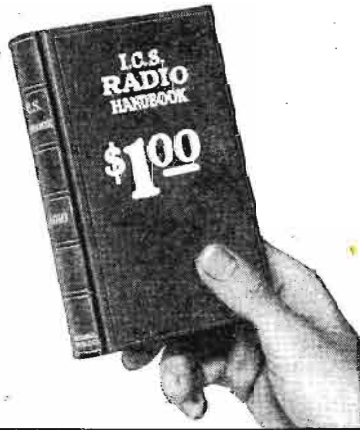

Learn the principles of radio from this remarkable book
514 PAGES

Compiled by HARRY F. DART, E.E. Formerly with the Western Electric Co., and U. S. Army Instructor of Radio Technically edited by F. H. DOANE

STOP turning the dials blindly. Learn what happens when you turn them and why. Then you will get greater distance, greater volume, most enjoyable quality.

The I. C. S. Radio Handbook will help you to get more enjoyment out of radio. It clears up the mysterious — tells you just what you want to know. Written by nationally known radio authorities in language that you can understand. An absolute necessity for every radio fan. A wonderful bargain at \$1. Note this partial list of contents —

Electrical terms and circuits, antennas, batteries, generators and motors, electron (vacuum tubes), many receiving hook-ups, radio and audio frequency amplification, broadcast and commercial transmitters and receivers, super-regeneration, licenses, etc.

Send only \$1 with the coupon today and get this 514-page I. C. S. Radio Handbook.

Money Back if Not Satisfied

International Correspondence Schools
Box 8281-G, Scranton, Penna.

I enclose \$1. Please send me—post-paid—the 514-page I. C. S. Radio Handbook. It is understood that if I am not entirely satisfied I may return this book within five days and you will refund my money.

Name.....

Address.....
Check here and enclose \$1.50 instead of \$1 if you wish the De Luce Leatheroid Edition

Pictures by Radio With the PHOTOTRON

The New, Sensitive, and Practical Alkali-Metal Photo-Electric Tube

Also for Radio—Movies—Pictures by Wire—Burglar Alarms and Electric Control Systems—Cardiograph Apparatus—Color and other Sorting Devices.

An interesting booklet on the remarkable PHOTOTRON yours for the asking.

PHOTON ELECTRIC CORPORATION
247 Park Ave., 1269 Cochran Ave.,
New York, N. Y. Los Angeles, Cal.

Insure your copy reaching you each month. Subscribe to RADIO NEWS—\$2.50 a year. Experimenter Publishing Co., 53 Park Place, N. Y. C.

Duo-Wave-Range Receiver

(Continued from page 1145)

in volume as the potentiometer arm is tuned towards the negative side of the resistance (the negative end of the resistance is the end that connects to "A —,") until finally reception stops and a slight whistle is heard. Of course, the proper setting for the potentiometer arm would be just before the point of oscillation, or whistling; inversely when in tuning in—if slight whistles or oscillation occur—the potentiometer arm is turned towards the positive side of the resistance, until the squeal or whistle clears up into reception.

If the set is unselective, the primary tap on the antenna coil should be moved from the third turn to the second, or vice versa, if at first selectivity is too great. If the set fails to oscillate on the higher wave-lengths increase the overall number of turns on the primary of each coil.

Thirty Years In The Dark Room

(Continued from page 1113)

on a far less firm basis than is commonly imagined, and it took both courage and foresight to remain in it and to realize its possibilities. This may be realized from a story that Mr. Moore tells of the installation of the lighting system in the Metropolitan Museum of Art.

It was discovered that the feeder wires from the generators were somewhat smaller than specified, and Moore was sent to investigate the report. He verified the statement, and thereupon was told by the engineer in charge to change the specifications on the drawings, so the wire would agree with the specifications. This was done because the original plans called for lighting a wing of the building that was later omitted from the scheme, and the feeder wires could be reduced in accordance.

But the matter looked peculiar to the inspectors, and was referred to the fire underwriters. So Moore was sent to adjust the matter with Mr. Alexander, of the Board.

"There's no use worrying about this case," that gentleman said casually. "There have been too many fires from electric wiring already. We have decided to forbid all electric wiring, beginning next week."

Thus casually did a group of men think it possible to nip progress in the bud, and to kill the beginnings of one of the world's most indispensable industries. It was nothing but the spirit, determination and vision of such men as Moore that kept the industry alive during its most crucial period.

RADIATING RECEIVERS

Regeneration is a decided asset in most receivers, so long as it is kept permanently below the point of oscillation. The damage it does, however, when the point of oscillation is overstepped, is entirely out of proportion to its benefits. A single oscillating receiver can spoil the program of a broadcast station for hundreds of other listeners. An indication of the possible extent of this interference is found in the communication between Chicago and New York recently achieved by an amateur, using but one dry cell tube as a transmitter.

A MATTER OF FREQUENCY

He: "Now, my dear, since I've fully explained the radio set to you, are there any questions?"

She: "Yes, I am curious to know how often they read the wavemeter."

Contributed by Jack Bront.

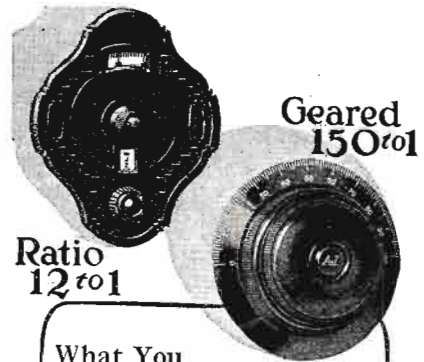

What You COULD Get from Your Set

It isn't what you're getting now. It's how much more you could get from your present set.

MYDAR Recording Dial shown at the left above, offers a degree of tuning efficiency not usually associated with this price. Ample space for call letters insures permanent logging of all stations. Genuine Bakelite, handsomely embellished—12 to 1 Ratio. Price \$1.75.

The A. J. (Vernier) shown at the right above, geared at 150 to 1, brings tones into sharp focus like a fine camera lens. Beautiful, dignified. Genuine Bakelite. A master product of master craftsmen. Price \$2.25.

Accuracy (not shown) geared 80 to 1 is admirably suited to every type of tuning requirements.

No panel drilling necessary to substitute any one of these dials.

MYDAR Radio Company,
7 Campbell Street Newark, N. J.

BRANT

**Unfailing "B" Power
GUARANTEED
TWO YEARS**

Stops all worry about "B" Battery supply. Makes your set work better and more powerful—100 Volts and more. Clean, compact unit.

WRITE TODAY FOR OUR
BIG CIRCULAR "R"

BRANT BATTERY CO.
1622 W. 16th St., Los Angeles, Cal.

**1926 CATALOG
JUST OUT!
SEND FOR YOUR COPY**

RANDOLPH RADIO CORP.
159 N. UNION AV. Dept. 2 CHICAGO, ILL.

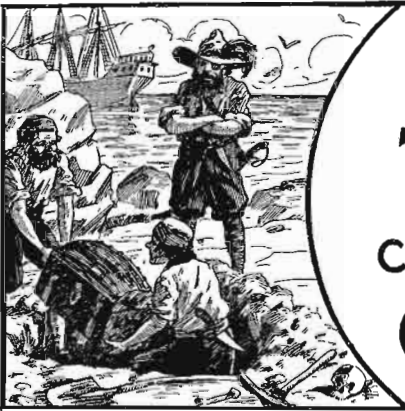

BURIED TREASURE

can still be found in

CHEMISTRY

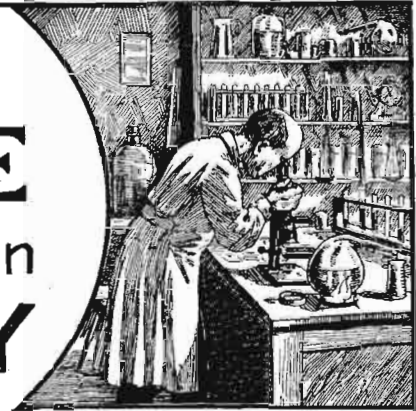

Good Chemists Command High Salaries

and you can make yourself independent for life by unearthing one of chemistry's yet undiscovered secrets.



T. O'CONOR SLOANE,
A.B., A.M., LL.D., Ph.D.

Noted Instructor, Lecturer and Author. Formerly Treasurer American Chemical Society and a practical chemist with many well known achievements to his credit. Not only has Dr. Sloane taught chemistry for years but he was for many years, engaged in commercial chemistry work.

Do you remember how the tales of pirate gold used to fire your imagination and make you want to sail the uncharted seas in search of treasure and adventure? And then you would regret that such things were no longer done. But that is a mistake. They are done—today and everyday—not on desert islands, but in the chemical laboratories throughout your own country. Quietly, systematically, the chemist works. His work is difficult, but more adventurous than the blood-curdling deeds of the Spanish Main. Instead of meeting an early and violent death on some forgotten shore, he gathers wealth and honor through his invaluable contributions to humanity. Alfred Nobel, the Swedish chemist who invented dynamite, made so many millions that the income alone from his bequests provides five \$40,000 prizes every year for the advancement of science and peace. C. M. Hall, the chemist who discovered how to manufacture aluminum made millions through this discovery. F. G. Cottrell, who devised a valuable process for recovering the waste from flue gases, James Gayley, who showed how to save enormous losses in steel manufacture, L. H. Baekeland, who invented Bakelite—these are only a few of the men to whom fortunes have come through their chemical achievements.

What Some of Our Students Say of This Course:

I have not written since I received the big set. I can still say that it far exceeded my anticipations. Since I have been studying with your school I have been appointed chemist for the Seranton Coal Co. testing all the coal and ash by proximate analysis. The lessons are helping me wonderfully, and the interesting way in which they are written makes me wait patiently for each lesson.—MOBLAIS COUZENS.

I wish to express my appreciation of your prompt reply to my letter and to the recommendation to the General Electric Co. I intend to start the student engineering course at the works. This is somewhat along electrical lines, but the fact that I had a recommendation from a reliable school no doubt had considerable influence in helping me to secure the job.—H. VAN BENTHUYSEN.

So far I've been more than pleased with your course and am still doing nicely. I hope to be your honor graduate this year.—J. M. NORKUS, JR.

I find your course excellent and your instruction, practically, the clearest and best assembled I have ever taken, and yours is the fifth one I've studied.—JAMES J. KELLY.

From the time I was having Chemistry I have never been thus explained to me as it is now. I am recommending you highly to my friends, and urging them to become members of such an organization.—CHARLES BENJAMIN.

I shall always recommend your school to my friends and let them know how simple your lessons are.—G. J. AMBARI.

I am more than pleased. You did right in from the start. I am going to get somewhere with this course. I am so glad that I found you.—A. A. CAMERON.

I use your lessons constantly as I find it more thorough than most text books I can secure.—WAL. B. TILUS.

Thanking you for your lessons, which I find not only clear and concise, but wonderfully interesting. I am—ROBT. H. TRAYLOR.

I received employment in the Consolidated Gas Co. I appreciate very much the good service of the school when a recommendation was asked for.—JOS. DECKER.

Now Is the Time to Study Chemistry

Not only are there boundless opportunities for amassing wealth in Chemistry, but the profession affords congenial circumstances at good salaries to hundreds of thousands who merely follow out its present applications. These applications are innumerable, touching intimately every business and every product in the world. The work of the chemist can hardly be called work at all. It is the keenest and most enjoyable kind of pleasure. The days in a chemical laboratory are filled with thinking and delightful experimentation, with the alluring prospect of a discovery that may spell fortune always at hand to spur your enthusiasm.

You Can Learn at Home

To qualify for this remarkable calling requires elaborate specialized training. Formerly it was necessary to attend a university for several years to acquire that training, but thanks to our highly perfected and thorough system of instruction, you can now stay at home, keep your position, and let us educate you in Chemistry during your spare time. Even with only common schooling you can take our course and equip yourself for immediate practical work in a chemical laboratory. Dr. Sloane gives every one of his students the same careful, personal supervision that made him celebrated throughout his long career as college professor. Your instruction from the very beginning is made fascinating and practical, and we supply you with apparatus and chemicals for performing the fascinating analyses and experimental work that plays such a large part in our method of teaching, and you are awarded the Institute's official diploma after you have satisfactorily completed the course.

Easy Monthly Payments

You don't have to have even the small price of the course to start. You can pay for it in small monthly payments—so small that you won't feel them. The cost of our course is very low, and includes everything, even the necessary outfit—there are no extras to buy with our course. Our plan of monthly payments places a chemical education within the reach of everyone. Write us and let us explain our plan in full—give us the opportunity of showing you how you can qualify for a highly technical technical position without even giving up your present employment.

Special 30 Day Offer

Besides furnishing the student with his Experimental Equipment, we are making an additional special offer for a short while only. You owe it to yourself to find out about it. Write today for full information and free book "Opportunities for Chemists." Send the coupon below now while it is fresh in your mind. Or just write your name and address on a postal and mail it to us. But whatever you do, act today before this offer is withdrawn.

DON'T WAIT—MAIL COUPON NOW!

CHEMICAL INSTITUTE OF NEW YORK Home Extension Division 2 66-R—West Broadway New York City

Please send me at once, without any obligation on my part, your free Book "Opportunities for Chemists," and full particulars about the Experimental Branch—sent given to every student. Also please tell me about your plan of payment and your special 30 day offer.

NAME
ADDRESS
CITY STATE

R.N.—Feb. '26

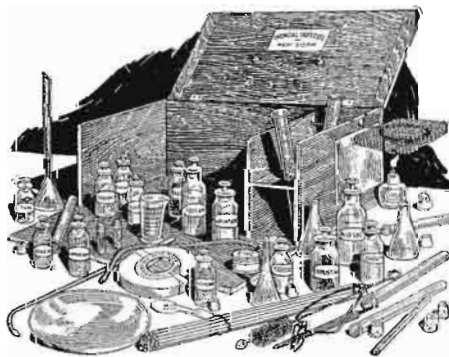

Experimental Equipment Furnished to Every Student

We give to every student without additional charge, this chemical equipment, including forty-nine pieces of laboratory apparatus and supplies, and forty different chemicals and reagents. These comprise the apparatus and chemicals used for the experimental work of the course. The fitted heavy wooden box serves not only as a case for the outfit, but also as a useful laboratory necessary for performing countless experiments.

CHEMICAL INSTITUTE OF NEW YORK, Inc.

HOME EXTENSION DIVISION 2

66-R—WEST BROADWAY NEW YORK CITY

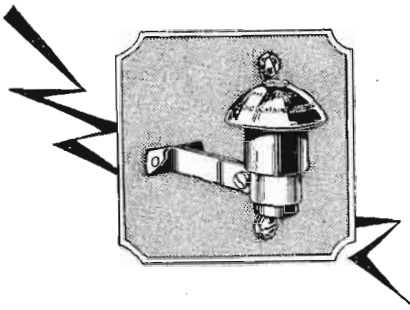

It Says "STOP" and Lightning Won't Harm Your Set

The National Board of Fire Underwriters specify that an improved Radio Lightning Arrester *must* be used with all out-door aerial installations.

Protection is easy. Insure your insurance and save your set with a WIRT LIGHTNING ARRESTER (listed as standard by the Underwriters Laboratories). The cost is a trifle.

The WIRT LIGHTNING ARRESTER is an approved air gap type, made of bakelite giving ample insulation, with brass terminals moulded in bakelite, far enough apart so that there is no leakage. A "petticoat" of bakelite shields the arrester from water and dust. Handsome and rigid. Lasts a lifetime. Easy to install. Full directions on box.

THE WIRT LIGHTNING ARRESTER IS LISTED AS STANDARD BY THE UNDERWRITERS LABORATORIES

Wirt Lightning Arrester...\$1.00
Wirt Insulator35

When you install your WIRT LIGHTNING ARRESTER get a WIRT INSULATOR and prevent leakage along your lead-in wires. It keeps the wire at the proper distance, provides perfect insulation, and prevents wear and tear on the wire by preventing sagging and swaying.

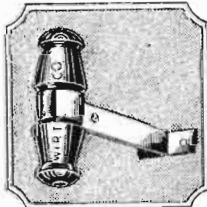

Sold by Leading Radio Dealers

WIRT COMPANY
PHILADELPHIA, PENNSYLVANIA
Makers of Dim-A-Lite

BE A JAZZ MUSIC MASTER
Play Piano By Ear
Play popular song hits perfectly. Hum the tune, play it by ear. No teacher—self instruction. No tedious drill—daily practice—just 20 brief, entertaining lessons, easily mastered.
At Home in Your Spare Time
Send for FREE BOOK. Learn many styles of bass and syncopation—riffs and licks. If 10¢ (coin or stamps) is enclosed, you also receive wonderful booklet, "How to Entertain at Piano"—and many new tricks, stunts, etc.
Niagara School of Music
Dept. 857 Niagara Falls, N. Y.

Send for this Free Book

RADIO BARGAINS
FREE RADIO CATALOG & GUIDE of newest ideas, approved special knock-outs with illustrations. Tremendous savings on standard radio parts, sets, kits. Be sure to get this directory book before you buy. Wonderful! Unusual? You'll say so. Write letter or postal NOW.
BARAWIK CO., 102-142 S. Canal St., CHICAGO, U.S.A.

\$300 Prize Contest

(Continued from page 1108)

AN INUNDATION OF REPLIES

We may say that it was a tremendous job to go through the thousands upon thousands of letters, and it took a large staff of clerks a number of days and nights to assort and go over the replies. It was, of course, impossible to answer the thousands who asked for a personal acknowledgement of their letters.

Many unique replies were received, and we are sorry that we can reproduce only a few of the wonderful samples (Illustration on page 1109). Replies came in from all over the world, including Alaska, Hawaii, Canal Zone, Porto Rico, Canada, Newfoundland, British West Indies, Mexico, Cuba, Central America, Brazil, England, Scotland, Ireland, France, Belgium, Holland, Germany, Austria, Hungary, Czecho-Slovakia, Poland, Russia, and many others. There were replies in Russian, French, Spanish and German.

A great surprise to the judges was the fact that several entries came in printed, evidently having been set up on linotype machines by their operators.

The longest list of answers came from Harry D. Krug, of Rochester, N. Y., who found 87 mistakes, and claims that if he had a little more time he could find three times as many. However, even his 87 did not include all the correct answers.

There were replies mounted handsomely on large cardboards, answers made up in the form of beautiful calendars, pen-and-ink sketches and blueprints. There were even replies in poetry.

Mr. E. B. Sanchez, of Washington, D. C., informs us that a friend of his bet him that the judges would not even read his letter; and we are deciding the bet right now in Mr. Sanchez's favor. The letter was read, but, sorry to say, no prize was won because the answers were not correct.

ANSWERS THAT DIDN'T COUNT

Here are some of the most popular, irregular answers which had no bearing on the contest at all; and most of which should, of course, never have been used, together with a few oddities:

- Man in the wrong position—behind set.
- Man should register disgust, not contentment.
- Impossible to blow smoke rings with a cigar in mouth.
- Loud speaker should not be placed on cabinet or near loop.
- Loop cannot be used with this type of set.
- Too much "C" voltage for "B" battery.
- No label of manufacturer on set.
- "Music" should be "Musie."
- Horn is not proper size for set.
- Man's ear is missing, or misplaced.
- Man's hair reaches down into his collar.
- No screws in panel.
- Left rheostat turned off.
- Set home-made—no trademark should be used.
- Artist omitted signature.
- Horn cable lying on loop wires is liable to cause audio feed-back coupling to grid of first tube.

SINCERE, BUT HYPERCRITICAL

- Hair parted on wrong side.
- "Horn" should be marked "Loud Speaker" (L. S.).
- Loud speaker plug not in jack.
- Rheostat arrow has feathers all on one side.
- Name of set wrong, as it would not apply to a tuned R.F. circuit.
- Only two pounds of wire (sic) on loop.
- All battery wires same color.
- "Horn" spelled "Horn." (Incorrect.—EDITOR.)
- "Conkoo-Dyne."
- Not necessary to mark one jack "Phone" and one "Horn," as they are interchangeable.
- Switch is a toggle switch, and does not move according to the "on" and "off" position indicated.
- Set has one too many "C" batteries.
- Amateur Handbook needed, but absent.
- Rheostats mounted impossibly low on panel, as they would touch baseboard. (From an inspector.)
- Table top and battery case not of uniform thickness.
- Arrowheads on rheostat should extend around three-quarters of circumference.
- A good evening to receive radio is cool enough to wear a coat.

Adapto RADIO CABINETS



Adapto Cabinets are constructed to accommodate every type of present day radio receivers. Loud Speaker horn built in—space for the accommodation of all batteries and equipment. Your choice, Mahogany or Walnut.
Write for illustrated circular showing various models and prices.

L. R. DONEHUE CO.
PERTH AMBOY, N. J.

nothing
like this radio set has ever been known before
You can build it yourself!

"a new 5-Tube Set with all the power and none of the grief of the Supers" — so wrote Henry M. Neely, Editor of Radio in the Home, Philadelphia.

Get This Book

Write today for this big fascinating 32-page booklet which tells how you can build the truly amazing new QUADRAFORMER receiver. Based on a new radio principle, five tubes give remarkable results.

Enclose 10c and you'll have it by return mail
Gearhart-Schlueter Radio Corp'n
713 Voorman Avenue, Fresno, California

RADIO RENCH
15¢
Niagara Metal Stamping Corporation
Dept. 600 Niagara Falls, N. Y.
Radio Free
PREMAX

Insure your copy reaching you each month. Subscribe to RADIO NEWS—\$2.50 a year. Experimenter Publishing Co., 53 Park Place, N. Y. C.

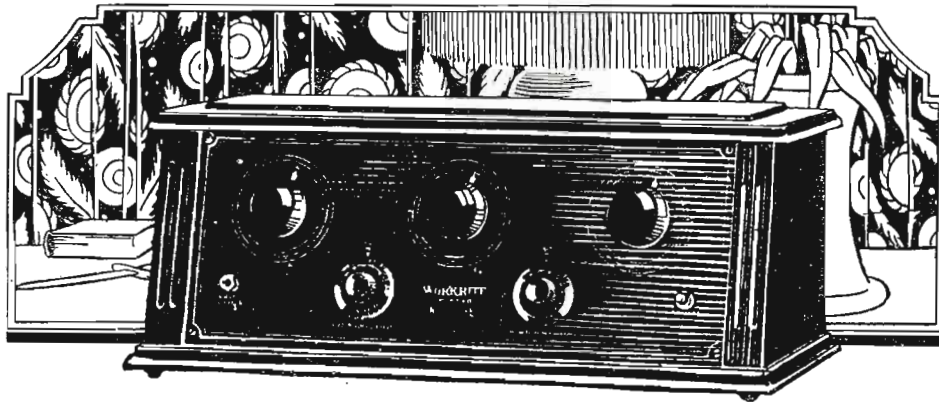

WORKRITE WINNER FIVE

Here is a Receiver that is taking the country by storm. Think of the great value in a genuine licensed Neutrodyne Receiver, five tubes, a beautiful dark brown walnut cabinet, sloping panel and knobs to match, gold trimmings, battery cable, everything of the latest and best, at \$80. The WORKRITE WINNER FIVE will easily bring in stations at unbelievable distances with great volume and wonderful tone quality. The WORKRITE WINNER is the outstanding value in radio this year. Test it against other sets selling for much more. PRICE \$80.

DEALERS—GET OUR ATTRACTIVE PROPOSITION

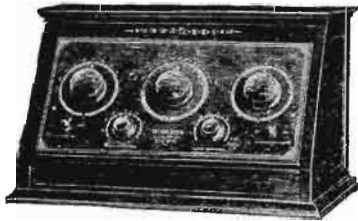

Workrite Radio King Six

A six tube resistance-coupled Neutrodyne. To appreciate the beauty and performance of this remarkable set, you must see and hear it. A very artistic cabinet made from genuine mahogany with special loud speaker built in, will give the utmost radio enjoyment. PRICE \$170

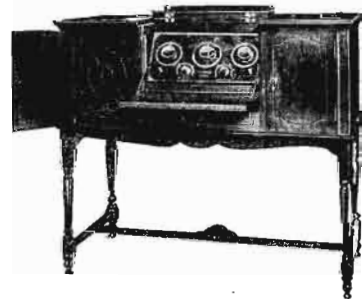

Workrite Aristocrat Six

The best in a set in the finest mahogany console. A radio you will be proud to own. Its beauty is only equaled by its performance. Six tube, resistance coupled. PRICE \$275

Workrite Air Master Six

A six tube resistance-coupled Neutrodyne with absolutely true tone quality without distortion. Mahogany panel and knobs to match cabinet. Gold trimmings. WAVE LENGTHS SHOWN ON PANEL—you can turn to any station almost instantly. As one customer said: "I never heard real radio until I listened to this marvelous WORKRITE." PRICE \$125

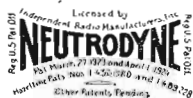
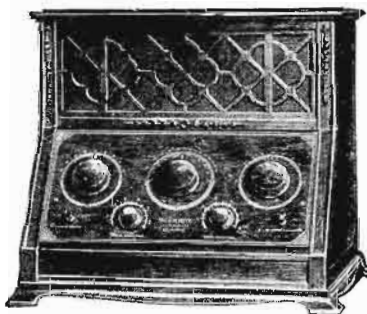

THE WORKRITE MFG. CO.
1814 E. 30th Street, Cleveland, Ohio

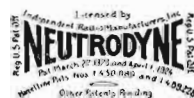

WORKRITE

SUPER NEUTRODYNE RADIO SETS



Amsco's Newest!

Grid Gates, Resistors and Resistance Couplers

Grid Gates are the Amsco improvement on "leaks." They provide measured and exact control of the current flow. Extra large for noiseless service. Fit all mountings. Insist upon Amsco Grid Gates, Amsco Resistors, Amsco Resistance Couplers. The latter are made with .006 condenser in genuine Bakelite base with mountings for two Resistors.



The New Amsco Universal Sockets

Especially designed to fit all the new types and sizes of U. X. and C. X. radio tubes. Clicks into contact—making positive wipe connection. Most compact and fool-proof socket made. One hole mounting. The Ultimate Socket—will be 1926 standard. Ask your Dealer.

AMSCO PRODUCTS, Inc.
Broome and Lafayette Sts., N. Y. C.



ARE YOU THE MAN

to be first in your town to sell and demonstrate POWEROLA, the famous 5 tube NO-BATTERY ELECTRIC LIGHT SOCKET RADIO RECEIVER (not an attachment), universal for D.C. or A.C. (100-115 v., 40-50 cycle), now sold and demonstrated by THE NEW YORK EDISON CO., public utility companies and radio, electric and music dealers everywhere. Absolutely dependable, fully guaranteed, powerful, practical, perfect in performance.

Are You the Man Who Sees Opportunities Ahead for Real Money Making? Write for literature, terms and prices at once.

"You, too, can make Powerola"

Send \$1.00 for Wiring Diagrams showing parts used and how to make one set at almost (use to eight tubes) operate satisfactorily from A.C. or D.C. current.

POWEROLA RADIO CORP.

DEPT. R.N.

1845 Broadway New York City

Listener, instead of blowing smoke rings, should be fixing set.
Man is sitting in impossible position.
Several criticisms upon the anatomy of figure.
No man with a tie as loud as that could hear the set, anyway.

RIGHT NUMBER, BUT WRONG ANSWERS

Only a few contestants gave up before reaching 34 errors. Most of them marked the exact number, but a few went beyond this. A large proportion of the contestants are electrical or radio dealers, or otherwise connected with the business; but there are many housewives, invalids and shut-ins, schoolboys, as well as professional men, lawyers, doctors and clergymen, in the number.

Clifton M. Searle says, "Please have no more picture contests, as I worked three days before I had time to read the magazine."

The number of replies received in this contest was many times greater than for any other contest ever staged by the publishers; and its success has been so great that we shall probably run a different one soon again.

The editors wish to thank the readers for the great interest shown in this contest, and express their sorrow that a first prize could not be awarded.

"Wireless" Radio Dancing

(Continued from page 1120)

simply cover the floor with a network of tinfoil strips; one or two pounds of tinfoil about 3 or 4 inches wide will serve for even a large room. The idea is to cover as much of the floor as possible, and the spaces not covered by tinfoil should not be bigger than 4 inches square. After the tinfoil has been laid, replaced the rug on top of the foil. One connection of the tinfoil goes to the output side of your radio set, as shown in the illustration. The other goes to the ground.

It is necessary here to make a few experiments, in order to get the best results. In the first place, it is most important to connect an ordinary telephone receiver across the output side of your set. Take off the cap and diaphragm, which makes the telephone absolutely silent. Or you may also place the radio set in an adjoining room, when it is,

FIG. 1

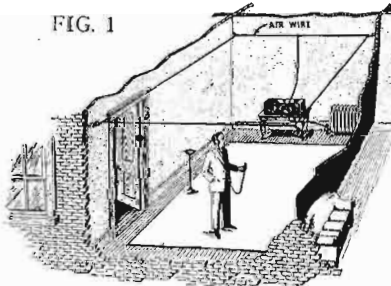

The author's first experiment, where the audio output is connected to an air wire and to ground.

of course, not necessary to silence the phone, and you may then use your usual loud speaker if you wish to do so. For all-around purposes, however, I believe that the silent telephone receiver without the diaphragm and cap is best, because it gives absolute silence, and the effect derived is much better on your audience. Any standard telephone receiver, of 1,000 or 1,500 ohms resistance can be used. (See Fig. 4, page 1120)

The wire that goes to the tinfoil should be insulated. No. 18 bell wire will do nicely. It should be concealed, so that the dancers will not know of the tinfoil underneath the rug. Attach the wire that goes to the tinfoil to the high potential side of the telephone receiver. A little experimenting will have to be done to find out which is the high potential side. It is usually the side that is connected to the + pole of the B battery. If

All the stations—evenly spaced around a 360° dial—with

ALL-AMERICAN

TRADE MARK

STRAIGHT-LINE-FREQUENCY TUNING

A free-running Condenser with perfect mechanical balance—modern, highly efficient Toroid Coils.

The Traffic Cop of the Air

Add a Ferbernd Wave Trap to your Radio Set and "Police" your reception. Regulate traffic! Guaranteed to tune out interfering stations. Widely imitated, but never equalled. Not a "toy"—quality, material, workmanship equal to that of the finest receiving sets.

The original and only successful WAVE TRAP. Now in its fourth year. Sent postpaid upon receipt of \$8.50 or C.O.D. plus postage. Send for Free Booklet.

Ferbernd Electric Co.
425 W. Superior St., Chicago
See the new Ferbernd "B" Eliminator announcement on page 1227

U. S. Post Office, Billings, Mont.

"Ferbernd Electric Co. Gentlemen: With my Fada Neutrodyne and Ferbernd Wave Trap I received the address of Fred Goodlee from WOA-W Omaha, on a special wave length. Many fans tried to get it but failed. Also the baseball World Series from WOA-W and K.M.A. Spandan and K.M.A. Had W.E.A.F. New York, loud enough to carry across the street. Will put my Get and Wave Trap up against any in the city regardless of price. (Signed) J. A. Thompson, Supt. of Mails."



Get the BIG PAY RADIO Job

ILL SHOW YOU HOW!
There are thousands more big pay fascinating radio positions open than there are men to fill them. I know what and where these real positions are—and I can qualify you, in a few weeks spare time, to fill one of these positions so you can earn \$3,000 to \$10,000 a Year—Learn how to make you a full-fledged radio expert quickly; a fitted, big pay man. You will learn how to install and maintain transmitting and receiving apparatus, professional and amateur, land and sea. You will know Radio thoroughly—and will get the bigger money because of your better, broader training. **BIG SET GIVEN!** Send name and address for a full outline of my course and how to get the big A. R. E. Twin Superion Receiver. Set absolutely GIVEN. Write me personally! Irwin J. Mendels AMERICAN RADIO ENGINEERS 1010 Hearst Square, Dept. 107, Chicago

MAIL THIS COUPON
Irwin J. Mendels, American Radio Engineers, Dept. 107 Hearst Square, Chicago, U. S. A.
Send me your big outline and full particulars of your complete course of training. Also tell me more about the A. R. E. Twin Superion Long Distance Receiver and how I can get it free.

Name _____
Address _____
City _____ State _____

you do not wish to take the trouble to trace the circuit, try first one side of the 'phone and then the other. The connection that gives the loudest results is, of course, the right one.

GROUNDING THE PHONE

It is necessary that the other side of the 'phone be grounded, either directly or inductively. No exact rule can be given, as every set is different, and you must experiment for yourself to find the proper connection. If, after the first tryout, you find that you get the signals quite loudly and clearly, the audio side of the set probably is grounded somewhere and no additional ground is needed. If results are poor, then you will find it necessary to connect the other side of the 'phone to either the radiator or water-pipe for maximum results. As some sets are already grounded, you will have to be careful when making the ground connection. *Touch the two wires quickly.* If a spark results, no ground is necessary. If there is no spark at all, the ground will probably make the intensity of the signals louder.

After everything is in readiness, plug in your usual loud speaker and tune in the station that you know will be on the air for some time to come. Tune it in where it comes in best. Then unplug the loud speaker

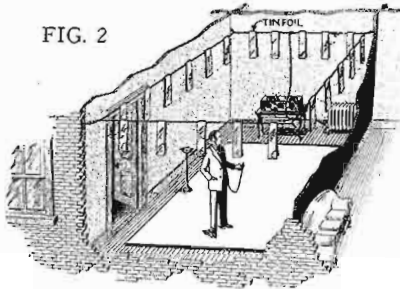

FIG. 2

Fig. 2. The second experiment, which gave somewhat better results. Here the arrangement of Fig. 1 is repeated; but additional capacity is obtained by tinfoil strips hung to the air wire.

and plug in, instead, the silent 'phone with one connection to the tinfoil and the other to the ground (if such is required). Put on the pair of head receivers and walk on the prepared floor. The music should come in loud and clearly, particularly when you touch one of the 'phone tips. Sometimes a little retuning is necessary to get the best effect.

TWO HEARERS ARE BETTER THAN ONE

You will find that as you walk along the rug, no matter where in the room, the reception will be startlingly loud and clear. You will also find that when you touch your dancing partner's hand with yours the intensity of the signals will increase somewhat, for the reason that you are now adding an extra "body" capacity to your own. In other words, you have increased the size of the human body-condenser.

It is a good idea to leave the telephone cord as long as possible, because results will then be found best. If you do not care about the expense, you can cut off one of the cord tips and the three or four inches of cord that goes with it, having simply a single cord tip to which connection is made by hand or by the metallic bracelet, as explained above.

As long as you are directly over the tinfoil the reception will be loud and clear, no matter how far away you are from the receiving set. The effect even extends somewhat beyond the tinfoil layer, and you will be able to receive weak music two or three feet away from the rug.

This pretty, as well as interesting, experiment works well with sets from 3 tubes up, although a 5-tube set or a more powerful one is even better.

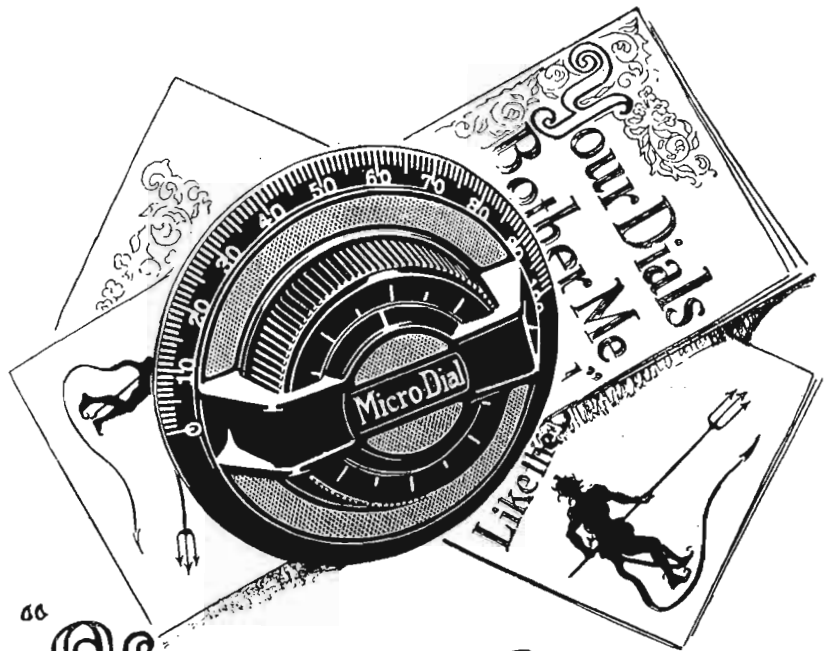

"Your Dials Bother Me Like the Devil"



THAT'S what an enthusiastic Micro-Dial user wrote us after his first night's experience. And his bother was STATIONS.

STATIONS he had never heard before—or ever heard of! Stations that came in so fast that he hadn't room for them all in the gaps he had left in his log book! Stations that kept coming long after his bedtime hour had passed!

READ the simple story of what Micro-Dials did for this broadcast listener, as he told it to us, over his own signature.

Write for our folder, "Your Dials Bother Me Like The Devil." We will send it postpaid to any address.

BETTER still, get the folder from your Jewett Dealer. Read it on the spot and take your Micro-Dials home. You can install them yourself without drilling or sawing, and using no tool but a screwdriver.

JEWETT RADIO & PHONOGRAPH COMPANY
5702 TELEGRAPH ROAD PONTIAC, MICHIGAN

Factories: Allegan, Michigan — Pontiac, Michigan

In Canada
Jewett Radio-Phonographs, Ltd.
Walkerville, Ontario

Export Sales Office:
116 Broad Street, New York City

The Jewett
Micro-Dial

© 1925 Jewett Radio and Phonograph Co.

"Quality Broadcasting to Match
Quality Products—Station WJR"

Do You Know About the "SUPERUNIT" FAMILY?

They are all tested assemblies which make possible the construction of various sets with no worry about the location of the parts.

They are all equipped with cushion sockets and nickeled brackets.

They solve the problem for the folks who like to build their own set.

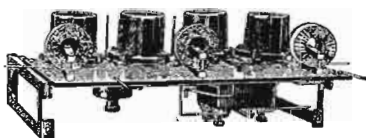

4 TUBE "SUPERUNIT" Type A for standard base, Type B for UV199, Type C for UX tubes. Add two stages \$37.50 of audio for 6 tube set.

"SUPERUNIT-6", the same as the standard tube but with two stages of Thordarson audio mounted and \$50.00 connected. Size 5 x 15".....

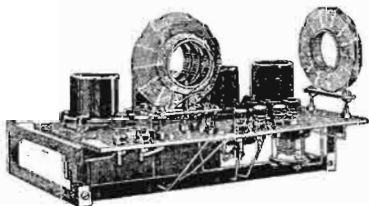

"SUPERUNIT, JR." 4 tubes with low loss plug in coils, R.F., detector and two stages of Thordarson audio. \$37.50

Any "SUPERUNIT" can be used with the S-C Capacity Element which we manufacture. NOTE: The S-C Capacity Element is specified by Mr. Arthur H. Lynch for the Radio Broadcast Aristocrat Receiver.

BULLETINS ON REQUEST

Hanscom Radio Devices
Woonsocket, R. I., U. S. A.

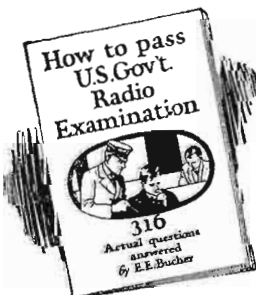

316 Actual questions answered by E.E. Bucher
60c For a short time only

RADIO INSTITUTE OF AMERICA
324 Broadway New York City

PASS the U. S. Government Commercial or Amateur Radio License examination! This book will help you do it! Send sixty cents in stamps or coin for your copy—postage prepaid to any point in the U. S., Canada or Mexico.

The Browning-Drake Regenaformer

(Continued from page 1143)

- No. 1 and Rheo. No. 2).
- 1 voltmeter with a range from 0 to 6 volts (VM).
- 1 .0001 mf. fixed condenser (c).
- 1 .001 mf. or .002 mf. fixed condenser (cb).
- 1 .00025 mf. fixed grid condenser (cg).
- 1 grid leak (Rg).
- 1 double open-circuit filament control jack (J2).
- 1 filament switch (SW).
- 1 one mf. by-pass condenser (This is optional. 1MF.).
- 9 binding posts.
- 20 feet of wire for connecting parts.
- 4 tubes.
- 1 "A" battery.
- 1 "B" battery for at least 67½ volts.
- 1 "C" battery of 4½ volts.
- 1 .0005 condenser.
- 1 .00035 condenser.
- 1 antenna coil as described above.
- 1 regenaformer as described above.

About Station Arrangement

(Continued from page 1151)

at the left of the operator and every part of it is perfectly accessible. Its main panel, with the three variable condenser controls and the three meters, faces the operator so that he can keep a constant check on the action of the transmitter and all parts of the oscillator, and power supply are easily reached. The compactness of this outfit was made possible by the use of S tube rectifiers in place of the old electrolytic type, which took up so much room and was more or less a constant source of trouble. The S tubes take up only as much room as a couple of vacuum tubes, and are far more reliable than the electrolytic.

And so, we find that if a transmitter is carefully planned before it is put together, it can be made to fulfill the wants of those three classes—the traffic man, the DX hound and the experimenter. If the experimenter is a little careful in his work and goes about making changes judiciously and with care, a set of this nature need not be out of operation for more than an hour or so at a time. With this type of set, the typical radio ham can amuse himself in any way he may see fit. If, for instance, the mood seizes him to try out a new circuit, or he gets hold of some instrument that he thinks may work better than one in his set, he can go to it and make that change with the very least possible amount of trouble. Then, on the other hand, for days at a time he may desire to work DX and, for instance, try to raise a few "Aussies" or "Zedders." Then, again, when he is listening in some night and someone asks him to take a few messages for relaying, he doesn't have to refuse because the transmitter isn't "perking" just right, but he can sit right in, take the messages and handle them in short order.

And now, as with everything, we should have a moral, but in this case, is a moral necessary? We think not—draw your own conclusions.

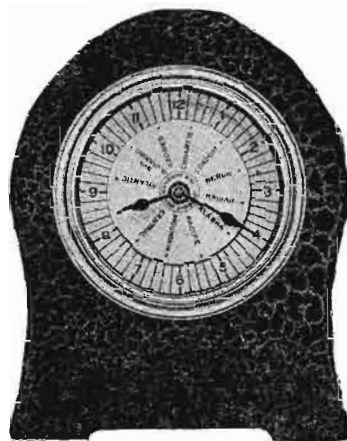

NEW RADIO INVENTION

Radio World Time Clock

Tells correct time in all parts of world

This remarkable invention has become a necessity not only to owners of radio sets, but also in that part of our commercial life handling ocean shipping cables, radiograms and worldwide trade.

The Radio World Time Clock shows DX fans of time changes the world over at a glance. It may be used as an ordinary clock or removed from the frame and easily inserted in the panel of your set. Guaranteed mechanically perfect.

There is nothing like this new time device—it is being hailed with delight by radio fans everywhere. Amateur broadcasters will find this clock absolutely essential.

Now selling rapidly by John Wanamaker and other leading department stores. Dealers write now for price list.

If your dealer cannot supply you send us check or money order for \$3.75, and we will ship promptly postpaid.

O. L. ANDERSON COMPANY
Manufacturers and Sales Promoters
12 Middlesex Road Stoneham, Mass.



N
O
W

Complete Separation of Low Wave Stations

Perfectly accomplished with Tune-Rite, the straight line frequency dial. A marvel in scientific construction, it instantly converts any set to straight line frequency. Bring your present set up-to-date by replacing your old dials with Tune-Rite. Beautiful in appearance. Easily mounted without drilling. Price \$3.50

Write for Instructions

Radiall Company
Dept. T.R.N.-4, 50 Franklin St., N.Y.
Makers of AMPERITE

TUNE-RITE
THE STRAIGHT LINE FREQUENCY DIAL

FREE—Our 64-Page Catalogue. Filled With Radio Bargains. Write Today!
RANDOLPH RADIO CORP.
159 N. UNION AV. Dept. 2 CHICAGO, ILL.



A BROAD TUNER

Mysteries of the Wire Tables

(Continued from page 1127)

again. It is about 100 mils, or $\frac{1}{8}$ of an inch. Now look at the diameter of No. 16 wire. It is about 50 mils, or one-half that of No. 10. In other words, as the gauge number increases by 6, simply cut the diameter in half. Thus:

Gauge No.	Approximate Diameter (mils)
4	200
10	100
16	50
22	25
28	12
34	6

Now for the next mystery. Let us look at the table of cross-sections. The cross-sections corresponding to the various gauge numbers are given in square inches, simply for the sake of convenience. Rules apply to this column very similar to those that applied to the table of diameters, excepting that in this case use the multiplier 2 instead of the square root of 2. For instance, note the following values, taken from the table:

Gauge No.	Cross-section (sq. in.)
4	.03200
7	.01600
10	.00800
13	.00400
16	.00200
19	.00100
22	.00050
25	.00025
28	.000125

Note that every time we add 3 to the gauge number we cut the cross-section in half. Or, going the other way, every time we reduce the gauge number by 3, we double the cross-section.

Now look at the gauge No. 0, 10, 20, 30, etc. See what happens. Here it is:

Gauge No.	Approximate Cross-section (sq. in.)
0	.80
10	.008
20	.0008
30	.00008
40	.000008

In other words, every time the gauge number advances 10 places, the cross-section is divided by 10. This happens no matter where we may start, as for instance, if we should take the numbers 5, 15, 25, etc.

The inverse rule holds true of the D.C. resistance of copper wires. For instance:

TELETONE CABINET SPEAKER



\$ 32⁵⁰

Ready to listen

Beautifully finished in Walnut, it stands 15 inches high and is only 3 1/4 inches deep.

Makes Any Radio Receiver Sound Better

TELETONE represents an entirely new principle in sound wave conduction and amplification. Its clear, full-toned resonance, the result of exclusive design and all wood construction, transforms *any* receiving set into an instrument of quality.

Interior of seasoned spruce—the same wood used in the finest violins. Exterior of walnut—beautifully finished and artistic in the extreme.

Compact in form. Handsome in appearance. Amazing in performance. Reproduces clearly every note, either vocal or instrumental, with purity of tone, satisfying volume and freedom from distortion.

Fill in and mail coupon below, for illustrated booklet and the name of your nearest Teletone dealer, who will gladly demonstrate the vast superiority of Teletone over all other types of loud speakers.

TELETONE CORPORATION
449 West 42nd Street
New York City

TELETONE Principle

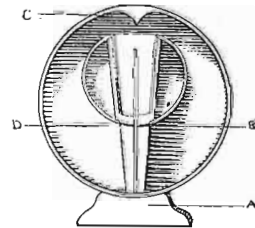

Based on Structure of Throat and Mouth

Note that a sound-wave coming from the sound producing unit "A" (the human vocal chords) is amplified through the orifice "B" (the human larynx) until it reaches the conducting area "C" (the back of the throat), whence it is again conducted to the point of greatest amplification "D" (the correctly formed and opened mouth of the singer).



TELETONE CORPORATION,
449 West 42nd St., New York.

Please send me, without obligation on my part, Teletone booklet and the name of your nearest dealer.

Name

Address

CHELSEA

Super Five \$50.00

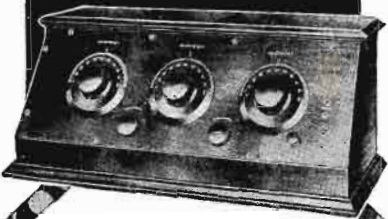

The Ideal Receiver!

ADVANCED engineering and years of production experience by one of the oldest radio manufacturers in the country produced the new Chelsea Super-Five—a Receiver with performing features and refinements found in much higher priced sets.

Fine mahogany finish cabinet with graceful sloping panel and large dials for easy tuning. Convenient cord leads (no unsightly binding posts). Fool-proof, dust-proof inside panel to protect delicate parts. Rugged bus-wiring, hand-soldered connections and other refinements. This Set delivers wonderful tone quality and volume and is one of the most selective sets on the market. Choose Chelsea and save the difference.

See your dealer or write us for New Descriptive folder.

CHELSEA RADIO CO.
Chelsea, Mass.

M & M Low Loss INSULATORS

Perfect your entire installation by insulating your antenna-ground system. Your set is not responsible for energy lost thru a poorly insulated aerial. Use M & M Low-Loss Lead-in and Wall Insulators.

4" Lead-in Insulators	50
10" Lead-in Insulators	80
20" Lead-in Insulators	81.50
5" Wall Insulators	60

Dealers: If your jobber can not supply you write us direct, giving us your jobber's name. Send for our catalog.

The M & M Co.
CLEVELAND, OHIO.

Mysteries of the Wire Tables

(Continued from page 1215)

Gauge No.	(Approximate) Ohms per Thousand Feet
0	.1
10	1
20	10
30	100
40	1000
and again,	
0	.1
3	.2
6	.4
9	.8
12	1.6
15	3.2
18	6.4
21	12.8
etc.	etc.

To sum up our little exposition, let us condense the rules as follows:

1. Adding 6 to the gauge number cuts the diameter in half.
2. Adding 3 to the gauge number divides the diameter by 1.4.
3. Adding 10 to the gauge number divides the diameter by a number slightly greater than 3. (To be exact, 3.16)
4. Adding 6 to the gauge number divides the cross-section by 4.
5. Adding 3 to the gauge number cuts the cross-section in half.
6. Adding 10 to the gauge number divides the cross-section by 10.
7. Adding 6 to the gauge number quadruples the resistance.
8. Adding 3 to the gauge number doubles the resistance.
9. Adding 10 to the gauge number multiplies the resistance by 10.

It is no longer necessary to hunt around for an hour to find a table of wire constants. Just remember the above rules. When two or three of them are known, the rest are self-evident. Also remember the resistances of 0, 10, 20, 30, etc. These will be found very helpful in estimating the D.C. resistances of wires, coils, etc., very quickly, and accurately enough for many purposes.

B & S Gauge	Diam. in Mils.	Square In.	Ohms per 1000 Ft.
0000	460.0	.1662	.04901
000	409.6	.1318	.06180
00	364.8	.1045	.07793
0	324.9	.08289	.09827
1	289.3	.06573	.1239
2	257.6	.05213	.1563
3	229.4	.04134	.1979
4	204.3	.03278	.2485
5	181.9	.02600	.3133
6	162.0	.02062	.3951
7	144.3	.01635	.4982
8	128.5	.01297	.6282
9	114.4	.01028	.7921
10	101.9	.008155	.9989
11	90.74	.006467	1.260
12	80.81	.005129	1.588
13	71.96	.004067	2.003
14	64.08	.003225	2.525
15	57.07	.002558	3.184
16	50.82	.002028	4.016
17	45.26	.001609	5.064
18	40.30	.001276	6.385
19	35.89	.001012	8.051
20	31.96	.0008023	10.15
21	28.46	.0006363	12.80
22	25.35	.0005046	16.14
23	22.57	.0004002	20.36
24	20.10	.0003173	25.67
25	17.90	.0002517	32.37
26	15.94	.0001996	40.81
27	14.20	.0001583	51.47
28	12.64	.0001255	64.90
29	11.26	.00009953	81.81
30	10.03	.00007894	103.2
31	8.928	.00006260	130.1
32	7.950	.00004964	164.1
33	7.080	.00003937	206.9
34	6.305	.00003122	260.9
35	5.615	.00002476	329.0
36	5.000	.00001964	414.8
37	4.453	.00001557	523.1
38	3.965	.00001235	659.6
39	3.531	.000009793	831.8
40	3.145	.00000766	1049.

SUPERTRAN AUDIO TRANSFORMER

Equip your set with Supertran Audio Transformers and note the difference in tone. Supertran is the transformer that amplifies without distortion. Ratios, 3 1/2 to 1 and 5 to 1.

\$6.00

★

FORD "B" ELIMINATOR

for Alternating Current

\$32

Here is a well balanced, carefully made and thoroughly tested "B" Eliminator, designed by our own engineers and made by us in our own factory. Will supply your set with a steady and uniform flow of current, without any noise or hum.

At All Dealers

FORD RADIO & MICA CORP.
111 Bleeker St., New York

FREE BLUEPRINTS

To Set Builders

TO PROVE THE SELECTIVE AND SENSITIVE COMBINATIONS OBTAINABLE WITH

WERNER R. F. TRANSFORMERS

which cover the entire broadcasting wave range and have been used by the best radio engineers for the past two years, we will furnish a full size Blueprint of a selective Radio Loop receiver FREE if you order from us direct.

Werner R. F. and Audio Transformers are fully guaranteed and are tested on actual broadcast reproduction. Guaranteed damp and moisture proof and will give perfect reception in all climates.

RADIO FREQUENCY \$4.00
AUDIO FREQUENCY \$6.00

Both types for any standard vacuum tube

Werner Loop Antenna

Used with any type of loop receiver. Adjustable to a fine degree of clearness, can be folded or extended without tools. Approved by Popular Radio.

Price Postpaid \$14.00

Send for free circuit diagram and descriptive literature. Book contains nine up-to-date practical R. F. circuit diagrams and treatise on R. F. Amplification. Postpaid 25c. Ask your Dealer for Werner Products.

WERNER RADIO MFG. CO.
204-206 Ninth St., Brooklyn, N. Y.

MARKO RADIO BATTERIES

are ALWAYS DEPENDABLE

MARKO STORAGE BATTERY CO.
Brooklyn, New York

Where Radio and Heat Waves Meet

(Continued from page 1131)

The short electric waves generated by the passage of the spark between the tips of the electrodes were brought to a focus by the gold concave mirror and the paraffin lens. They were then passed through a device which separated out specific wave-lengths and finally focussed on the delicate radio-meter. The fundamental wave-length emitted from the oscillators was found to be from 3 to 1 mm. with harmonic overtones as small as 0.22 mm. The presence of these radiations was detected just as if they had originated in heat waves and afforded a final

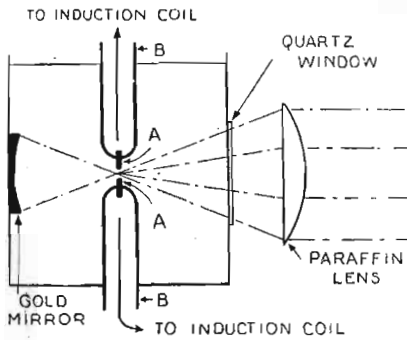
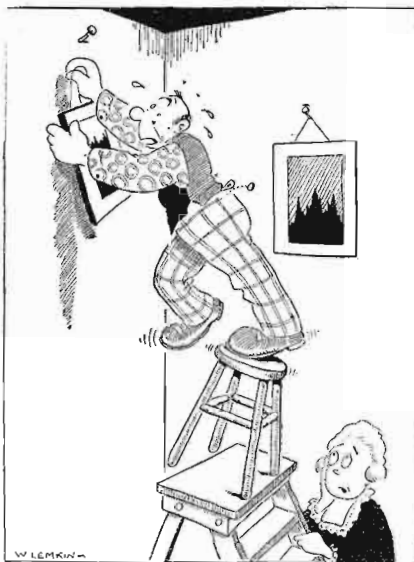

FIG 6

The extremely short radio waves are reflected, like heat waves, from a gold mirror, and turned into a parallel beam by the paraffin lens.

proof of the truth of the analogy between light and electrically generated waves.

Now an unbroken chain is established, from the longest of the radio waves, through the visual spectrum and ultra-violet, down to the infinitesimally short X-rays. They differ only in wave-length.



A difficult hook-up.

HIGH- AND LOW-RATIO TRANSFORMERS

Most set builders specify the use of two audio frequency transformers of differing ratio, such as $1 \div 6$ and $1 \div 3$; and state that the high ratio should be used in the first stage. This is a curious misapprehension, for which there is no scientific reason. Actually, the low-ratio transformer should be used in the first stage, and the high-ratio in the second.

SAVE TIME AND MONEY

We have radio Tools of every description for every conceivable set building purpose

You will be astonished at the remarkable tools we have for your work and delighted at our low prices

NO. 202



COMBINATION PLIER

Combination Plier, Wire Cutter, Wire Former and Wrench. Drop forged, slender but exceptionally strong. 6 inches long. No. 202—Combination Plier, Wire Cutter, Wire Former and Wrench.....75c

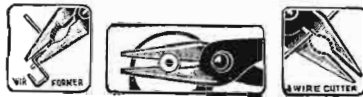

RADIO TOOL SET

This is the handiest set of tools ever made for Radio Work by the makers of the famous "YANKEE" Tools. It contains the following: 1 Ratchet Screw-driver, 6 1/2 in. long holding all attachments; 1 Blade, 5 1/2 x 3-16; 1 Blade, 3 1/2 x 1/8; 1 Blade 2 1/4 x 1/4; 1 Countersink; 2 Socket Wrenches for all small nuts; 1 Reamer to enlarge holes in panel from 1/8 to 1/4; 1 Wrench, one end 5-16" square or hex. for jack, other 1/2" hex., etc.

PRICE per set—No. 701.....\$3.00

NO. 701

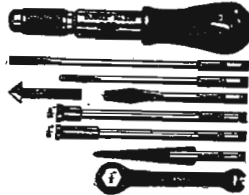

SIDE CUTTING NIPPER, LAP JOINT

For cutting all kinds of wire. Jaws hardened and oil tempered. Natural steel finish with polished jaws. Length 6 inches.

PRICE—No. 20175c

NO. 201



CIRCLE CUTTER

Especially designed for the Radio Constructor. Made of the finest material and equipped with the highest grade high steel cutting bits. It does three things at once. It drills its own pilot, cuts out plug and puts bead or scroll around the hole in one operation. Cuts holes 3/4 to 4 in. in diam.

PRICE—No. 402\$3.00

Nos. 401 & 402

NO. 304

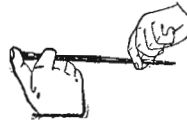

401. Same tool but smaller and not fitted with bead or scroll in one operation.

PRICE—No. 401\$2.00

SCREW STARTER and DRIVER

Holds any screw by its slot with a firm grip, makes it easy to place and start screws in difficult places. Just the tool for the Radio Constructor. All parts heavily nicked and polished.

PRICE—No. 304\$1.00

NO. 800



ELECTRIC SOLDERING IRON

A perfect tool for Radio Work. Operates either on 110-volt A.C. or D.C. The heat element is of Nichrome, which prevents overheating and assures the desired even temperature. Size of Iron, 10 1/2 in. long. A 4-ft. cord and plug is furnished.

PRICE No. 800\$2.00

NO. 302

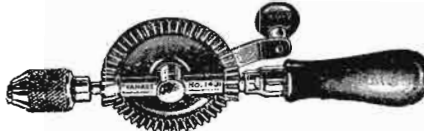

HAND DRILL

Especially designed for Radio Work by the makers of the famous "Yankee" Tools. A beautiful balanced, small, powerful drill with 4 to 1 ratio of gears for speed. Special chuck 9-32" capacity, to take largest drill, mostly furnished with drill or tool sets. Length over all, 9 1/2 in. Weight 1 1/2 lbs.

PRICE—No. 302\$2.75

Order all tools by order number. All goods are shipped free of transportation charges to all parts of the United States and possessions the same day as the order is received.

MONEY REFUND GUARANTEE

If you are not satisfied money will be refunded on return of goods.

THE RADIOGEM CORPORATION

66-R West Broadway

New York, N. Y.



TRIMM
Home Speaker \$10

Amplifying Horns

used in the great majority of the best radios made in this country are supplied by

Miller

These horns are inert, non-absorbing, unaffected by atmospheric conditions. They will not crack, split, swell up, dry out or rattle. Being moulded, they are exactly accurate in size.

Forty-One Models

— straight, curved, folding, are all worked out on scientific principles so as to give the best acoustic results.

One of these models, Mr. Manufacturer, is designed to meet your requirements and at a competitive price.

Shall we mail you full details?

The MILLER RUBBER CO.
of N. Y.
AKRON OHIO

OHIO Motor Generator CHARGER

*Charges in one-third the usual time or several batteries in parallel. Capacity 3 to 18 amps. at 6 to 10 volts. Merely hook to light socket. Fully automatic. Lasts a lifetime.

Satisfaction guaranteed or money back. In writing state if you wish to charge both "A" and "B" Batteries.

THE OHIO ELECTRIC & CONTROLLER CO.
5907 MAURICE AVENUE - CLEVELAND, OHIO.

Illinois VG Connectors
New Vise-Grip connectors for phone, line, speaker or wire connections in sets. Easy to attach without soldering. Beautifully N. P. Impresses appearance any set. Cheapest and best. Only 10c each. If your dealer doesn't have them, order direct. Thousands in use.

No. 1 Series
No. 3 Cord Tip

ILLINOIS RADIO CO., 800 S. 4th St., Springfield, Ill.

Five Broadcast Stations in One Room

(Continued from page 1121)

tion at Arlington is unique in at least one particular—that is, five broadcast stations are housed under one roof. To be more explicit, there are five transmitters and an equal number of antennas and all of them may be operated simultaneously 24 hours a day, if traffic conditions warrant. Furthermore, all of the sending sets make use of vacuum-tube transmitters, and the arc and spark equipments have been discarded.

The five-tube transmitters vary in rated capacity from one kilowatt to the recently installed 20-kilowatt sending unit. Four of these electro-radiating devices propagate dots and dashes, whereas the fifth transmitter is known as the "broadcasting set" since voice communication is dispersed. The 10-kilowatt transmitter, installed some months ago, sends out the time signals from the Naval Observatory, heard by millions of broadcast listeners.

THE INTRICATE ANTENNA

The antenna system of NAA probably has no counterpart in the world. The heavy traffic, as well as the variety, handled at this point necessitated the erection of two auxiliary masts. Thus, all told, five antennas, operating in conjunction with an equal number of transmitters, may be used simultaneously at one sending station. The multiplicity of this antenna system may be appreciated when it is considered that the use of two antennas at one transmitting station is the ordinary limit. Traffic from the various government departments has made necessary this multiple system of transmission.

The traffic burdens at NAA, as heavy as they are, hardly equal the diversity of its service. From the sending of a "hog flash"—market quotations on swine—to a diagnosis of neuralgia and the broadcasting of a Presidential message, the offerings emanating from Radio, Virginia, eclipse the proverbial "57" varieties. The transmission of time signals, reports on weather conditions, broadcasts on the subjects of geology, labor, child welfare, education and life-saving on our coasts, are among the diversity of themes treated. Of its programs much has been written, earning for NAA the title of "Most Serviceable Government Radio Station in the World."

THE FIRST ANTENNAS

This article, therefore, is primarily concerned with its unique radiating system, anticipating that broadcast listeners and radio amateurs will be interested in this multiple antenna system. The three original masts or towers were built in 1913, this being the first unit in the chain of high-powered stations subsequently erected by the United States Navy Department. One of these original masts is 600 feet high, and the other two are 450 feet tall. They are spaced 350 feet apart, and the towers are designed to withstand a load of 10,000 pounds. Contrary to recent designs of towers, the first ones built at Arlington are of the three-legged type and they include about three times as much steel as masts built within recent years.

The two auxiliary antennas erected about three years ago, are comprised of masts 200 feet high, and if a sixth tower is erected in the future it will probably duplicate the features of these recent installations. This contemplates the possibility of installing a short-wave transmitter at Arlington for handling traffic on wave-lengths from 20 to 80 meters. The 200-foot towers recently added to this antenna system were in use formerly at the Washington Barracks and were purchased by the War Department for the needs of the Signal Corps when its traffic

WRITTEN 2-YEAR GUARANTEE

ARROW BATTERY

Battery Prices SMASHED!

To Consumers Only
Here is a real battery quality, guaranteed to you at prices that will astound the entire battery-buying public. Order Direct From Factory. Put the Dealer's Profit in your own pocket. You actually save much more than half, and so that you can be convinced of true quality and performance, we give a **Written 2-Year Guarantee**. Here is your protection! No need to take a chance. Our battery is right—and the price is lowest ever made. Convince yourself. Read the prices!

Auto Batteries	Radio Batteries
6 Volt, 11 Plate, \$9.50	6 Volt, 100 Amp. \$9.50
6 Volt, 13 Plate, 11.50	6 Volt, 120 Amp. 11.50
12 Volt, 7 Plate, 13.00	6 Volt, 140 Amp. 13.00

Buy Direct—Send No Money
We ask no deposit. Simply send name and address and style wanted. Battery will be shipped same day we receive your order Express C.O.D. subject to your examination on arrival. Our guarantee accompanies each battery. We allow 5% discount for cash in full with order. You cannot lose! Send your order today.

ARROW BATTERY CO.
Dept. 6 1215 So. Wabash Ave., Chicago

\$3 brings you this genuine AMPL-TONE Loud Speaker Unit

Ten days' free trial. Your Three Dollars unconditionally returned if at the end of ten days you are not perfectly satisfied with this Phonograph Attachment and do not find it to be of exceptional value for volume and clear reproduction.

Reverse the tips and note the difference in pitch. Will not de-magnetize. Phonograph people spent years perfecting the acoustic. Take advantage and use our unit on your phonograph.

UNION FABRIC CO.
(Makers of the French Headset)
DERBY, CONN.

SEND FOR YOUR FREE COPY TESTED HOOK-UPS

Submitted By Users of Our

Wonderful transmitter Button for loud speakers. Amplification and experiments.

Price \$1.00 Postpaid with Instructions

K. Electric Co., 15 Park Row, New York

BLACKBURN GROUND CLAMPS

Telephone companies using MILLIONS. Adjustable—fits any size pipe. Requires no pipe cleaning—screw boxes through rust and scale. Send 12 cents for sample and postage.

BLACKBURN SPECIALTY COMPANY
1961 E. 66th St., Cleveland, O.

CRESCENT LAVITE RESISTANCES

A Laboratory Product

for Distortionless Amplification
Used by chief radio experimenters and amateurs in America. All resistances 12,000 ohms and up. Special sizes made to order. Write today for full information. Liberal discounts to dealers.

CRESCENT RADIO SUPPLY COMPANY
1-5 Liberty Street, Jamaica, N. Y.

was assigned for transmission through NAA. The joint operation of this station by the Navy and War Departments has obviated the expense that would have been incurred by the erection and maintenance of separate stations, a procedure once contemplated.

DIVISION OF SERVICE

The complete antenna system at Radio Virginia (the only place in the United States so designated), is allotted to specific services. The five antennas are described as "main," "aircraft," "army," "navy" and "radiophone." An equal number of transmitters are operated at the same time if traffic conditions justify. One of these transmitting units, a 1-kilowatt vacuum tube, is reserved for the broadcasting of radio-telephone communications, and the other four sending sets transmit radio-telegraph signals.

Strangely enough, NAA, with its fivefold capacity for the radiation of messages on electromagnetic waves, is not provided with facilities for the reception of wireless signals. Moreover, both the Naval Communication Service and the War Department handle their traffic from different buildings by remote control systems. That is to say, the Naval Communication Service directs its traffic by means of operating a telegraph key on the second floor of the Navy Department building, which is connected by land line to an automatic relay at Arlington. In this manner, dots and dashes are sent to such points as Key West, New Orleans, Boston, San Juan, and other far-distant points.

The effectiveness of this multiple radiating system is such as to embrace the entire United States and outlying possessions. For instance, under favorable weather conditions, this newly installed 20,000-watt tube transmitter could be heard occasionally by a battleship cruising on waters 5,000 miles distant from Washington. Daily reliable communication with San Juan during daylight hours is reasonably anticipated. The distance between the two points is about 1,500 miles. By means of the "broadcasting set," so called, an address by President Coolidge or Secretary of the Navy Wilbur could be dispersed effectively throughout the Middle Western States and southward as far as New Orleans. The voice of this 1-kilowatt broadcast set was heard on the *Mayflower*, the presidential yacht, off Swampscoot this summer.

Fans living within about a thousand miles of Washington may now pick up a "new" and powerful broadcast station. But the call is an old one in the East; it is "NAA," Arlington, Va., the pioneer Naval radio station and Government broadcaster.

A new 1-k.w. tube set has been installed and the station will start using its new "voice" just as soon as a suitable wavelength can be secured from the Department of Commerce. The old wave of 435 meters, it is said, would interfere seriously with the two local stations, WRC and WCAP. On account of the increased power, a lower or higher channel is being sought. Formerly only 50 watts were used in this radiophone transmission. The broadcasts from NAA consist chiefly of official matter such as weather forecasts, market, agricultural and public health reports, etc.

SAVING MONEY ON TUBE UPKEEP

Users of small transmitting tubes will find their expenses decreased, in the long run, by using more tubes and operating them at a lower input than that for which they are rated. Careful tests have shown that a tube operated at a filament potential five per cent. above the rated value will have an operating life eighty per cent. lower than that of a normally operated one; while a tube operated at five per cent. below the normal voltage will have its life doubled.

The Best Panel is also The Most Handsome

Because of its structural strength, fine insulating qualities and splendid finish, Formica has been preferred as a panel material by the great majority of makers of quality radio sets.

Complete Formica panels supplied with decorations by the Veri-Chrome process have an attractiveness that makes them great favorites with set buyers. In numerous instances where manufacturers making different models have used Veri-Chrome decoration on one panel and not on others, the Veri-Chromed panel has proved to be a large sales maker.

When you select your radio set ask to see one with a Formica panel decorated by Veri-Chrome—and form your own conclusions.

Complete panels decorated with Veri-Chrome are available for some of the better known kits. In some instances the Veri-Chromed panel is included in the kit package by the manufacturer.

Formica panels in standard sizes are sold in neat individual envelopes by leading parts dealers everywhere.

The Formica Insulation Co

4618 Spring Grove Avenue,
Cincinnati, Ohio

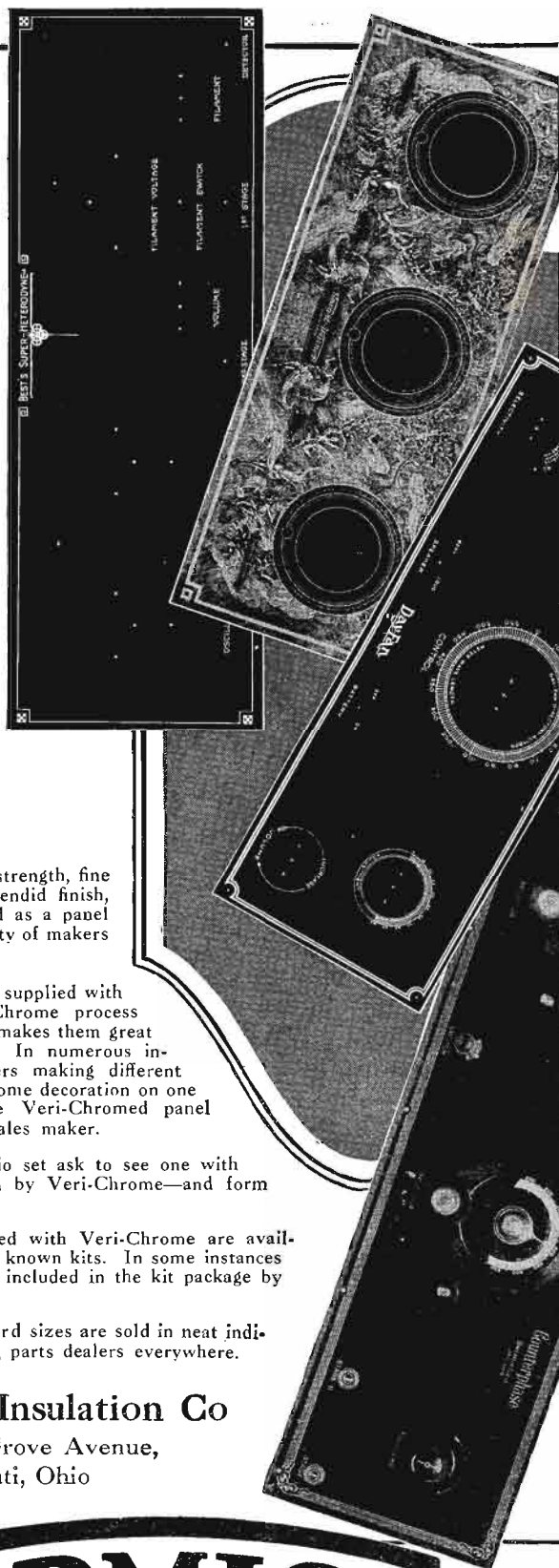

FORMICA
Made from Anhydrous Bakelite Resins
SHEETS TUBES RODS

Now Combined!



Large
Magazine
Size
200 Pages
300
Illustrations

These Two Great Books Are Now Combined!

- 1** **HOOKUP REVIEW**
Plenty of new and practical hook ups, illustrated and explained in a constructional and non-technical manner. For the radio set builder and amateur.
- 2** **RADIO ENCYCLOPEDIA**
Every issue contains an installment of S. Gernsback's Radio Encyclopedia. The first complete, authentic work of its kind. Valuable to everyone interested in radio.
- 3** **RADIO PRESS DIGEST**
New ideas in radio, radical improvements, etc. Altogether, this section is novel, interesting and keeps you in touch with radio from other countries.
- 4** **CALL BOOK**
This is a very valuable reference, a complete list of Broadcast and amateur stations, Canadian stations and foreign amateur and broadcast stations. The most complete list of its kind.
- 5** **RADIO LISTENERS' INFORMATION**
This section gives many hints and ideas on the care and operation of a receiving set, together with practical information on radio from the listener's point of view.

Containing *five* big, complete sections for beginners, broadcast Listeners, and amateurs

Watch for the new book entitled

RADIO REVIEW

combined with

RADIO LISTENERS' GUIDE and CALL BOOK

Beginning with the February issue, RADIO LISTENERS' GUIDE AND CALL BOOK will be combined with RADIO REVIEW and will be issued *four times a year* in one great complete volume.

Each issue of this great new book contains a complete digest of practical radio hookups culled from the radio press throughout the world, S. Gernsback's well known radio encyclopedia, in installments, an international radio press digest of news and information, a complete accurate list of Broadcast station call letters, and a valuable section replete with information for the Broadcast listener.

ALL FOR 50c the COPY. Watch for the first issue on all newsstands and all radio stores beginning February 1st.

You will buy the biggest value in wealth of radio reference material ever printed for the radio broadcast listener, amateur or professional.

Published and Distributed by

The Consrad Co., Inc., 64 Church Street, New York, N. Y.

FOR SALE EVERYWHERE
50c THE COPY

Standard Hook-Ups

(Continued from page 1158)

The following is a description of the set, and the parts used:

First: There is no coupling between Lg and Lp.

Second: The condenser C2 is the grid condenser and has a value of .004 microfarad.

Third: As in an ordinary detector the grid must be positive in relation to the filament, but here is connected to the positive "B" battery (45 plus or 90). Experience has shown that this arrangement is much more flexible than if connected to the positive "A" battery.

The resistance connected from grid to plate of the tube should have a variable range from 0 to 25 megohms.

The coil Lg is wound on a 3-inch tube with 22 or 24 D.C.C. numbering 50 turns. Plate coil Lp has the same dimensions but is wound in the opposite direction. (Evi-

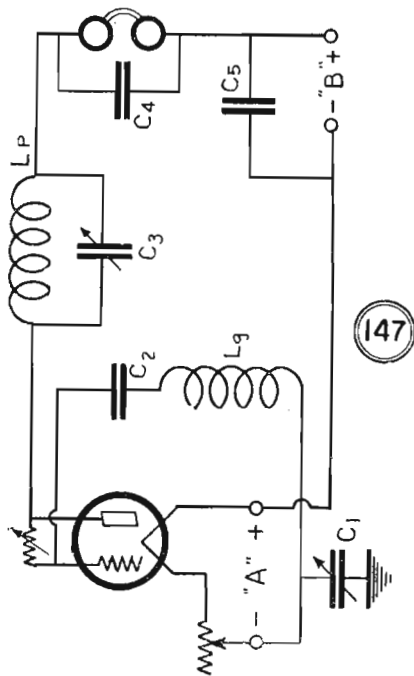

147. This receiver uses no antenna nor loop. It depends upon the amount of energy picked up by the coils and wiring of the set.

dently to prevent conflicting fields should the coils be placed near each other.)

Condenser C1 has a capacity of .00025 mfd.

Plate circuit condenser, or C3 has a value of .001 mfd.

Phone by-pass condenser, .001 to .002 mfd. Battery by-pass condenser, 1 to 2 mfd.

A good ground connection should be used, either a water pipe or other good metal connection to the ground will be satisfactory.

In placing the receiver avoid the presence of any metallic substance or any coil not in use, as absorbing or deflecting material will disastrously impair the efficiency of the receiver.

A few additional words of advice: Extreme patience must be used, as the adjustment of this receiver is very delicate and the amateur who experiments with it must have some knowledge of radio receivers, the nature and origin of their peculiarities.

The moustache, the beard and the bustle are hopelessly out of date. But no more so than the obsolete slow 2-ampere battery charger!

Buy nothing but an up-to-date 5-ampere charger!

The New Improved 5 AMP. A & B GOLD SEAL HOMCHARGER

\$19.50



Over 500,000 already in use

Modern-Fast-Efficient!

NOW you don't have to wait for days while your battery charges. The new 5-ampere GOLD SEAL HOMCHARGER charges A or B batteries three times as fast as last year's slow chargers - - it fully charges the average radio battery OVERNIGHT!

This year when you buy a battery charger, be sure it is a modern fast charger - - one that charges at 5-amperes. To be absolutely sure, insist on the 5-ampere GOLD SEAL HOMCHARGER.

Free Write for new edition of our interesting 16-page booklet "The Secret of Distance and Volume in Radio."

THE KODEL RADIO CORPORATION
501 EAST PEARL ST. CINCINNATI, OHIO



"DIALITE"

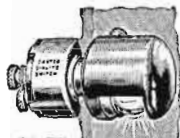

\$1.75
Complete with Lamp
Half Size

Any dealer can supply

CARTER

Can be combined to light dials, also to switch "A" Battery "off" and "on." Current consumption negligible. Single hole mounting. Makes accurate logging and re-tuning possible.

Fits flush against the panel. Cords hang down. Cord instantly attached or detached. Cord tips completely concealed. No trick triggers—position sure—adds to appearance of any set.

In Canada, Carter Radio Co., Limited—Toronto



300 S. BROADWAY AVENUE
CHICAGO, ILL., U.S.A.

"FLAT" PLUG
(Pat. Pend.)

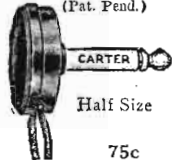

Half Size
75c

Write for catalog

Insure your copy reaching you each month. Subscribe to Radio News—
\$2.50 a year. Experimenter Publishing Co., 53 Park Place, N. Y. C.

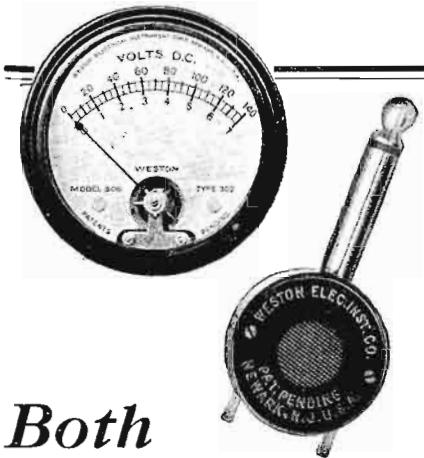

Both Small in Size Both Big in Radio Results

FOR fast, sure, positive connection to headset or loudspeaker use a Weston pioneer automatic Radio Plug. Known everywhere as the best. Made like a precision instrument, but only 60c.

Model 506 Radio Panel Voltmeters, Ammeters and Milliammeters, are only 2" in diameter yet they embody the famous Weston construction and dependability. They have an exceptionally high internal resistance of 125 ohms per volt. A Model 506 will point the way to economical operation of your set, will make possible longer tube life, will prevent discarding dry cells prematurely, will show when storage batteries need recharging and will make set operation a pleasure.

For further information write for the free booklet "Weston Radio Instruments."

WESTON
ELECTRICAL INSTRUMENT CORPORATION
173 Weston Avenue, Newark, N. J.



RADIO TUBES

Repaired—Exchanged—Sold
\$1.25
Send broken or burned out tubes to us. We repair and return them good as new. \$1.25 each for common types. Or we exchange one of your present tubes for another type, for your tube and \$1.25. Renewed tubes, guaranteed perfect \$1.75 any popular type. Send no money. We ship C. O. D.

We Operate Our Own Laboratory
You are assured perfect tube performance with our repairs because we operate our own tube laboratory. Don't take chances. Send your tubes to us—one of the oldest high frequency laboratories in the country.

CHICAGO ELECTRIC DEVICES CO.,
70 E. 22nd Street, Dept. 32, Chicago, Ill.
Established—1920

Print Your Own
Cards, Stationery, Circulars, Paper, etc. Save money. Print for others, big profit. Complete outfits \$8.95. Job press \$12, \$35, Rotary \$150. All easy, rules sent. Write for catalog presses type etc. THE PRESS CO., Y-72, Moridon, Conn.

A "Peanut" Super-heterodyne

(Continued from page 1141)

is entirely too large. Either decrease the number of loop turns or use smaller variable condenser. Use a center-tapped loop.

The writer had the pleasure of hearing the set work as soon as the wiring was completed. No trouble has been experienced for six months. It tunes sharply and gives fine DX. It is excellent for portable use, because of its compactness and efficiency, as well as the fact that dry cells can be used for filament heating, and small size 22.5-volt batteries for plate. The plates draw 12-16 milliamps, for seven tubes. Everything can be placed in a case with small loud-speaker and collapsible loop. It is suggested that a small voltmeter be mounted on the front panel. Connect it across one bank of tubes. Do not allow the filament voltage to go over 4.8 volts for four tubes.

The detectors and oscillator can use 30-45 volts on the plate. The R.F. tubes will work about the same on 45 or 90 volts. Use 90 volts or higher for the audio frequency amplifier. It will be found that if the tubes ("N" or WD11 or 12) are operated at normal filament voltage, the potentiometer lever can be placed on full negative without the R.F. amplifier breaking into oscillation. Stations with waves up to 450 meters can be tuned in on two points on the oscillator dial. Waves above 450 can only be tuned in on one point.

Lessons In Esperanto

(Continued from page 1135)

el la plej surprizigaj kaj ĝojigaj estas de S-ro P. H. O'Brien de Atlanta, Georgia. Li diras, parte: "Mi eksciis esperanto antaŭ ses semajnoj de via lecionoj en la Radio News kaj kredas esti plej mirinda lingvo de la mondo." Kvankam tio ne estas tute korekta gramatike (nur estas tri malgravaj eraroj), oni povas perfekte kompreni ĝin, kaj tio estas skribita post nur ses semajna studado izolite kaj per la tri leciona kurso en RADIO NEWS.

S-ro V. P. Miller kaj edzino, de Hannibal, Missouri, fervoraj legantoj de RADIO NEWS, jam fargis bonegaj Esperantisoj per la kursoj en RADIO NEWS, intencas organizi Radio-Esperanto-Klubon en sia urbo.

Vigla, fervora junulo en De Leon, Texas, S-ro Bunny Chambers, lernis Esperanton perfekte de RADIO NEWS kaj ĝis nun estas varbiginta kvin aliajn personojn al la studado kaj uzo de Esperanto. Li kaj kunulo jam havas korespondantojn inter radio-amatoroj en kelkdeko da aliaj landoj.

Bonaj ekzemploj! Aliaj faru la saman.

Logantoj en kaj ĉirkaŭ Nov-Jorko interesigos pri la Esperanto Instituto de tri monataj studado kaj praktikado de Esperanto kiam mi, kun la helpo de kelkaj samideanoj, malfermos por doni senpagan instruon en Esperanto, komencante frue en Januaro. Komence, la lecionoj kaj praktikado en la lingvo nur okazos dimanĉe, posttagmeze. Mi speciale invitas legantojn de RADIO NEWS partopreni tiun Instituton.

English Translation:

SOMETHING OF ESPERANTO AND RADIO

The readers of RADIO NEWS who learned Esperanto by means of the courses published in this review, have a right to be happy over the recent progress of Esperanto as the world auxiliary language and especially in the sphere of radio. And here, before going further, I want to give praise where it is

FREE

Our Latest 100-Page RADIO CATALOG

Just off the press—waiting for you. All the latest sets with special kits to build them. Parts and accessories by well-known manufacturers. Every fan needs this latest guide-book to the best in radio. Write for your FREE copy.

CHICAGO SALVAGE STOCK STORE
509 S. State Street, Chicago, U. S. A.
Dept. RN

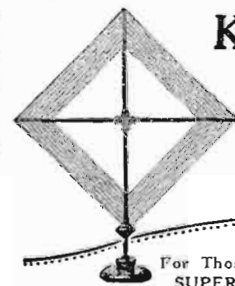
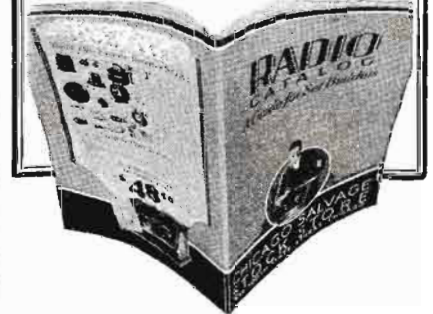

KORACH

Tuned Loop
Multiple Switch
Board Tuner
Directional
Base Compass for
Logging
Collapsible

For Those Who Demand SUPERIOR RESULTS

Leads the march towards perfect radio reception under all conditions. Not merely a "loop" but an ingenious arrangement of mechanical skill designed for superior results. L. M. Czekaday, using this loop, reached out across the Atlantic to audibly hear many trans-continental stations. Selectivity Plus Distance unheard of with common loop aeriads. The Korach excels on all sets designed for loop reception. Priced at \$12.50, and for sale by all good dealers. Full particulars sent for 2c stamp and name of local dealer.

KORACH RADIO CO.,
20 E. Jackson Blvd., Dept. 7, Chicago, Ill.
Dealers and Jobbers: Write today for attractive proposition.

The Korach Junior
A modification of
the "Senior" but possess-
ing all its important features—\$10.00.

GO INTO THE RADIO BUSINESS

We specialize in Equipping New Dealers with entire stock—advice free.

Send for Our Radio CATALOG AND BARGAIN LISTS Wholesale Only

MANHATTAN RADIO COMPANY
112 Trinity Place New York City

Day-Fan RADIO

A Year Ahead

The set with the air telephone directory
The Dayton Fan & Motor Company
DAYTON, OHIO

Authorized Cockaday Coil \$5.50
Precision Autodyne Coupler \$3.50

PRECISION COIL CO., Inc.
209 CENTRE ST., NEW YORK CITY
Specialists in the manufacture of all types of radio coils

due. RADIO NEWS was the first great radio review in the world to undertake support of Esperanto as the needed world auxiliary language, followed soon afterward by the great British Review, *Experimental Wireless & The Wireless Engineer*. Now, almost without exception, radio magazines of Europe and many in other countries follow the leadership of the above-mentioned reviews, forcefully proclaiming Esperanto.

In speaking with two other editors of American radio magazines about Esperanto, they answered me as follows: "We will wait till our readers demand an Esperanto section. We believe that America does not need the international language enough now to give space to it." Misers of space at the cost of real progress! He who cannot vision the morrow when the ends of the earth will be in every loud speaker is indeed a blind one. A truly progressive, worthwhile magazine inquires into those questions which concern its readers and guides in the matter. Such is its duty. In the future, when it comes to be an ordinary, everyday affair to use Esperanto between nations with the radio, the world will remember the outstanding, persistent pioneer, RADIO NEWS, and its ever forward-looking editor, Hugo Gernsback. Perhaps it will seem not entirely proper that these words appear in RADIO NEWS, but I beg the Associate Editor, Mr. Harris, to permit them to go to press. I only reflect here the sentiments of the Esperanto world.

To the list published in RADIO NEWS of broadcast stations throughout the world using Esperanto, we can now add others' up to the number—according to most recent reports—of twenty-seven. The large, new station just finished in Nagoya, Japan, will use Esperanto in its program. It is in that Japanese city that the great daily newspaper, *Ain-Nichi*, is published, which has regularly an Esperanto section.

The greatest recent success of Esperanto was the action by The Universal Telegraph Union which accepted Esperanto as a clear telegraph language. The Union sat in conference in Paris during September and October. The decision followed the petition of the League of Nations, which, a short time ago, asked the Union to take this action. The decision means that one now can telegraph to foreign countries in Esperanto without paying more than for a clear, national language. Otherwise, one would have to pay the same as for a code cablegram. The Union refused similar acceptance of other international languages, thereby indicating that Esperanto is the only such meriting that sort of consideration.

Mr. Kenji Oosaka, of the Ministry of Imperial Railways of Japan, perhaps the most fervent Esperantist of the Far East, who is now studying railroad technique in the United States, says that the Japanese, especially the younger generation, are becoming extremely interested about radio and that, because of the fact that in Japan Esperanto is very widely known, the linking-up of the world radio language with radio is a natural result.

I just received the new list of books of the British Esperanto Association. It lists 130 study books (grammars, dictionaries, readers, etc.), 350 books of literature and 27 books or pieces of music with songs in Esperanto.

According to the most recent information, there are now being published in the world 67 newspapers, magazines, etc., in and for Esperanto.

Among many letters which I have received from readers of RADIO NEWS, one of the most surprising and enjoyable is from Mr. P. H. O'Brien of Atlanta, Georgia. He says in part: "I knew about Esperanto six weeks ago from your lessons in RADIO NEWS, and believe it to be most wonderful language in the world." Although that is not entirely correct grammatically (there are only three unimportant errors), one can perfectly understand it, and that was written after just

"There's Only One B-T"

At the various radio shows, in person, by mail and phone we heard over and over thru the fall months:

"You'll never beat the B-T Nameless."

We felt sure we had beaten it, but it has never been B-T policy to encourage a belief that would not be justified.

But now, the same radio fans are saying:

"I didn't believe it possible."

Day after day the letters pile in expressing praise beyond all previous experience.

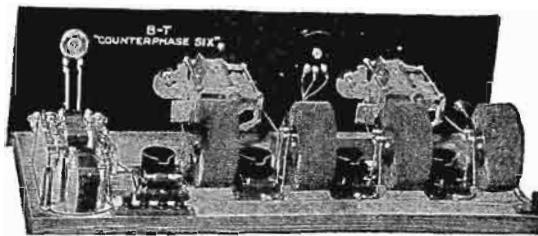

B-T Counterphase-Six

We firmly believe the COUNTERPHASE will not be equalled for years to come. B-T products have a habit of not going out of date—and the more sets and parts there are "dumped" on the market the greater the B-T demand.

The Counterphase, as well as B-T toroid coils, are covered by exclusive B-T patents. Don't let your experience with any other type of enclosed coil shake your confidence.

There's Only One B-T

At Chicago scores are bringing in West Coast stations on the Counterphase on the *first audio stage*. Think what that means in tone quality with a B-T Euphonic Audio Transformer.

Read about the Counterphase in *Radio Broadcast, Radio Age, Popular Mechanics, Radio Digest*, etc.

Send 10c for 9th edition "Better Tuning." The best radio information available. Circulars free.

BREMER-TULLY MANUFACTURING CO.

Canal & Harrison

Chicago

Potter

BY-PASS

CONDENSERS

- Prevent "B" voltage fluctuation
- Allow undistorted amplification
- Make possible full bass tones
- Improve reception with "B" Supply Units.

Made in $\frac{1}{10}, \frac{1}{4}, \frac{1}{2}, 1, 2, 3$ and 4 Microfarad sizes





At Your Dealer's

POTTER MANUFACTURING COMPANY
North Chicago, Illinois

Insure your copy reaching you each month. Subscribe to Radio News—\$2.50 a year. Experimenter Publishing Co., 53 Park Place, New York City.

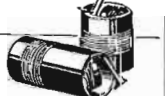
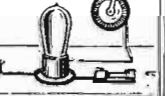

**25
CENTS**

<p>CHAPTERS Each of the six illustrations shown here represent the various general subjects covered by this handbook and illustrate it's thoroughness.</p>	<p>GENERAL TROUBLES</p> 	<p>AERIAL TROUBLES</p> 	<p>TUNER FAULTS</p> 	<p>DETECTOR TROUBLES</p> 	<p>AMPLIFIER TROUBLES</p> 	<p>REPRODUCER TROUBLES</p> 
-----------------------------------------------------------------------------------------------------------------------------------------------------------------------	--------------------------------------------------------------------------------------------------------------------	-------------------------------------------------------------------------------------------------------------------	----------------------------------------------------------------------------------------------------------------	----------------------------------------------------------------------------------------------------------------------	------------------------------------------------------------------------------------------------------------------------	-------------------------------------------------------------------------------------------------------------------------

Trouble Finding and Correcting Simplified for Everyone

No matter how much or how little you know of your radio receiver, this new "Radio Trouble Finder" book is going to be a big help.

It explains the common and special faults of all the standard receivers of today; tells how to recognize instantly, by various sounds, where the trouble lies and also gives special simple tests by which you can determine what is wrong with your receiver. Then for each particular fault there is explained the proper procedure for correcting it.

All troubles and their remedies are arranged in simple charts so that even the most inexperienced radio user will have no trouble in keeping his set at all times in first class condition.

All parts of the radio set are illustrated to show the layman how to proceed in correcting faults.

THE PRICE OF THIS BIG BOOK IS ONLY 25c. Everyone can afford a copy. Keep one around the house for any emergency. Order today by using the coupon below, enclosing 25c.

Published by The E. I. Company

Distributed by

The Consrad Co., Inc., 64 Church St., New York, N. Y.

68
Pages

200
Illustrations

Size
6 x 9 Inches

Sold everywhere
on Newsstands
and Radio Dealers

CONSRAD CO., INC.,
64 Church St., New York, N. Y.

Gentlemen:—I am enclosing 25c. Kindly forward at once one copy of "The Radio Trouble Finder."

Name

Address

City, State

six weeks' isolated study, and that of the three-lesson course in RADIO NEWS.

Mr. V. P. Miller and wife, of Hannibal, Missouri, enthusiastic readers of RADIO NEWS, already have become most excellent Esperantists by means of the courses in RADIO NEWS, and intend to organize a Radio Esperanto Club in their city.

A wide-awake, enthusiastic young man in De Leon, Texas, Mr. Bunny Chambers, learned Esperanto perfectly from RADIO NEWS and up to the present has converted five other persons to the study and use of Esperanto. He and a chum already have correspondents among radio amateurs in some ten other countries.

Good examples! May others do the same. Those living in or about New York will be interested about the Esperanto Institute of three months' study and practice of Esperanto which I, with the help of some fellow-Esperantists, will open to give free instruction in Esperanto, commencing early in January. At the start, the lessons and practice in the language will only take place Sundays, in the afternoon. I especially invite readers of RADIO NEWS to participate in the institute.

The Ultimate in Single-Control Receivers

(Continued from page 1121)

a soldering iron behind my ear and started for an apartment in Sullivan street. When I knocked the voice said "Come in." The voice said other things, best deleted. For the sake of clarity I will omit the symbolic representation of such things throughout the remainder of this tale of woe.

Now it may be my up-bringing in the vast open spaces makes me feel a bit out of place in the city of dreadful night. Whatever it may be I was slightly taken aback to find the purveyor of the sweet voice curled up in the middle of the bed, squirming.

"Lady," I said, "you have mistaken my motives—"

She cut in that she didn't give a picturesque word about my motives. She wanted the radio fixed.

"Is that," I enquired, "any reason for receiving me in this charming but rather distressing negligée?"

Yes, it was. It increased the body capacity. It made the set easier to tune.

I turned for more congenial companionship to the loud speaker, that was rendering at the time its own odd version of another barytone solo.

"Look," she said, crawling on hands and knees to an extreme corner of the bed, "there's no effect whatever."

"But why should there be any effect?" I ventured to ask, timidly. I make a point of treating such cases by persuasion. Violent or abrupt methods will never do. I have had enough horns twisted around my neck to know that well by now.

It seems that that was the way she always tuned. A shift of six inches toward the south-west corner of the bed used to be sufficient to tune WEAF out and WNYC in. Curling up in the extreme north-east corner would bring in WOR loud and strong, and the hanging of one arm over the edge of the bed would bring in WMCA, no matter where the body was disposed.

Gently, very gently, I suggested a change of climate, a whiff of bracing mountain air, a beaker full of the warm south, or something of the kind. For my pains I had the pleasure of stopping a vase with my head. There followed a disquisition on former methods of tuning-in various faraway stations by simulating certain curious angles. Swaying, I was told, could be counteracted by a slow systematic movement of the toes of the left foot, or, if you happen to be a contortionist, by wiggling the ears. There were other interesting side lights.

You must protect the circuit against leaks and losses

RADION

The Supreme Insulation

does it!



HOME set builders and radio manufacturers have the same problem—selecting insulation that protects the circuit against leaks and losses. Radion offers the *utmost possible protection*. Designed by engineers exclusively for radio purposes, it is the most efficient insulation as indicated by authoritative, impartial tests.

Radion panels reduce surface leakage and dielectric absorption to a minimum. Their beautiful surface finish adds to the attractiveness of any set. Radion Dials match their beauty of finish and help to get close tuning. Radion Sockets eliminate capacity effects; they are made both for new UX tubes exclusively and with collar adapters for old-type tubes.

Radio dealers have the complete line of Radion low-loss parts. Manufacturers will find it to their interest to write us for prices on moulded parts. Send for catalog.

FREE Booklet, "Building Your Own Set", mailed on request.

AMERICAN HARD RUBBER COMPANY,
Dept. A14, 11 Mercer St., New York City.

Chicago Office: Conway Building

Pacific Coast Agent: Goodyear Rubber Co., San Francisco—Portland.

MUTER
Standard Complete Aerial Kit
\$3.50 at all dealers

RADIO PANELS
OF GENUINE BAKELITE
Cut, drilled and engraved to order. Send rough sketch for estimate. Our New Catalog on Panels, Tubes and Rods—all of genuine Bakelite—mailed on request.
STARRETT MFG. CO.
520 S. GREEN ST. CHICAGO

64 Illustrated Pages of Radio Bargains!
Write for Catalog Today
RANDOLPH RADIO CORP.
159 N. UNION AV. Dept. 2 CHICAGO, ILL.

GEARS
All Kinds—Small
The most accurate made and prices reasonable. We carry a complete line of gears in stock for immediate shipment. Can also quote on special gears of all kinds. Send us your inquiries.
Write for Catalogue #4
Chicago Steak Gear Works
105 South Jefferson St., Chicago

The New

RADIO NEWS

Amateurs' Handibook

118 Hookups ~ Over 300 Illustrations

Contents
of
this Issue

In the latest revised issue of RADIO NEWS AMATEUR'S HANDBOOK, there is a collection of the very best articles that have been published in RADIO NEWS, Radio's Greatest Magazine, these articles having been selected so that every group of radio fans will find something to interest them. There are sets and how to build them for the broadcast listener and there are circuits and transmitting information for the Amateur. There are kinks and wrinkles for the experimenter and builder and there are 118 standard circuit diagrams of general interest to all. In the division for the broadcast listener, only those sets are described and illustrated that are new, practical and efficient. The same applies to the Amateur section where much worth while information on the new short waves will be found. Transmitting and receiving sets capable of working over thousands of miles are described in detail and data is given for the construction of each one. No effort has been spared to make the book the most complete and concise source of information that could be had. Each article was carefully selected from long lists of data, special care was taken to approve of only those articles of practical use. All descriptions and illustrations of circuits are written in a simple, constructional nature so that all readers will quickly grasp the details.

The RADIO AMATEUR'S HANDBOOK is for everybody. It is a complete authentic record of the best radio developments of the day. It is a sure, ready reference, good to have on hand at all times.

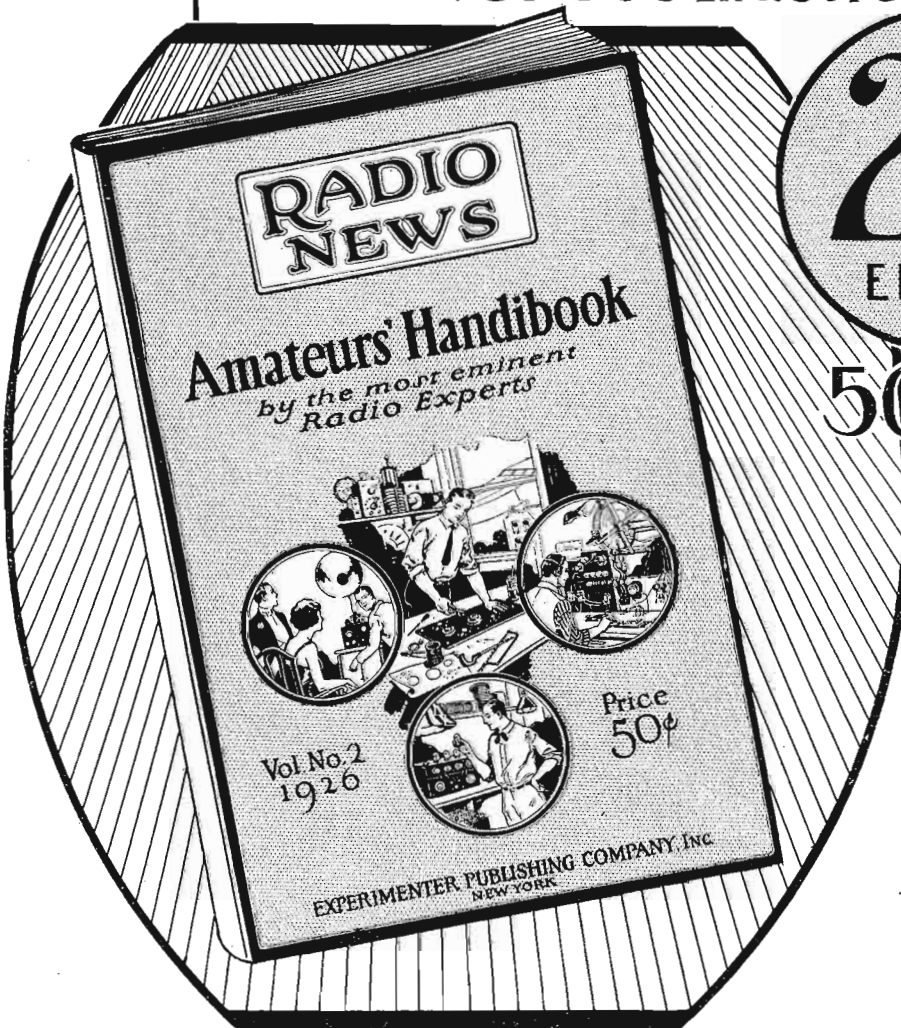

2nd
EDITION

50 CENTS
THE COPY

All New
Articles
New
Hookups
New
Information
New Data

The Reference Book of Radio Facts!

Any electrician will tell you that his Electrical Handbook is his most valuable reference—so also, the builder, the mason, the carpenter, all use a handy reference book no matter what the job may be. It is as important as the tools they use to work with.

EVERY MAN SHOULD HAVE A RADIO HANDBOOK, the real, concise, yet comprehensive book on everything of reference value to anyone interested in radio whether he builds his own set or is engaged in professional radio activity.

All information for this book has been carefully

culled from the pages of no less authority than Radio's Greatest Magazine, RADIO NEWS. Radio men in constant touch with all radio material have selected the most valuable articles.

The RADIO NEWS AMATEUR'S HANDBOOK contains a complete resume of every phase of radio. It is the first book of its kind, a veritable gold mine of radio information.

Published in the large size 9 by 12 inches, contains 128 pages, illustrated.

PRICE 50 CENTS THE COPY

"But," I pleaded piteously, sidling over to the set, "why not tune with the dials?"

"Don't touch the dials!" she bellowed. "My brother told me never to monkey with the set. That's what makes them all go wrong."

"But my dear lady," I expostulated. "That's what the dials are for."

Not, it seems, on that set. Brother made that set in a special way. He wanted it to be fool-proof. He set the dials once and for all—

By that time I was sneaking toward the door, stealthily. But before I made it, I felt something twining around my left foot. As I stooped to disentangle it, I noticed that it was the aerial lead from the set. It was caught in a shoe hook; and as I was freeing myself the young lady with the sweet voice espied it and leaped from the bed shouting "That's it. That's it. It's become undone."

"Pardie, it is I that am undone," said I to myself, waxing Shakespearian.

She held up the end of the aerial lead, then flourished it, and commenced a snake dance.

"That's all that's the trouble," she shouted gaily. "It became unsoldered. No wonder the old set wouldn't tune."

Firmly, to preserve my professional dignity, I expostulated.

"The aerial lead," I pointed out, "has nothing to do with tuning."

"Did you ever," she said severely, "did you ever hear signals fade when an outside antenna swings in the wind. Yes, you have. What causes it? Change of capacitance with the ground. Right?"

"Yes," I said meekly, wondering what was coming next.

"Well, it happens that that wire has become unsoldered from the bed-spring."

The light began to dawn. The light burst upon me in a dazzling flood. Feverishly I reattached the antenna lead to the bed-spring and soldered it in place. The barytone faded out and died with a deep gurgling sound, as if stuck in the jugular (which I would God may happen to all barytones). The young lady bounced into the middle of the bed. There was a deep silence. Then one arm was allowed to dangle, and in boomed WMCA. A shift to the north-east corner and WOR appeared.

"How much do I owe you?" she said suddenly.

"Not a thing," I replied, grabbing my hat, "I've learned many things today. I, if anyone, am the debtor."

But to be serious for a moment, the idea is great for somnambulists. One has only to tune the set, with the bed vacant, to a strong station, and detune again by body capacity upon going to bed. Then, you see any attempt at an involuntary parade will be interrupted by strains of sweet music, notoriously good for breaking into the trance of a sleep-walker.

A revolutionary step forward~



\$9.75

Complete, nothing else to buy.
Operates at maximum efficiency at all times on either direct or alternating current, any frequency. Noiseless—no hum.
Delivers unlimited current to any re-

FERBEND "B" ELIMINATOR

Now you can supply plate voltage to your Radio Set at a price scarcely higher than new "B" Batteries! Your electric light socket and the new *Ferbend "B" Eliminator* furnish the permanent means of efficient "B" current supply for any set. No need for you to pay more than \$9.75 for a "B" battery eliminator for Ferbend guarantees theirs to be equal or superior to any on the market *regardless of price*. Our price was fixed with the interests of the radio buying public in mind. The result is efficient and permanent "B" current now placed

ceiving set, regardless of number of tubes.

Delivers 100 volts to any set.

Cost of operation less than 50c a year. It lasts indefinitely.

All parts are specially designed and manufactured by us for this purpose only.

Unconditionally Guaranteed

to be equal or superior to any eliminator on the market, regardless of price.



FERBEND Wave Trap

This company also manufactures the famous Ferbend WAVE TRAP—the instrument which has been widely instituted but never equalled. It is the only original and genuine. See advertisement on page 1312

Within Reach of All

The price of this remarkable new unit is spectacular in more ways than one. Besides saving you from \$15 to \$50 it is amazingly low considering the quality and superiority. Surely it marks a revolutionary step forward in radio. Equip your set NOW with this marvelous instrument, and be convinced.

Ask your dealer, or send direct

Until nation-wide distribution is completed it is possible that your dealer hasn't stocked the *Ferbend "B" Battery Eliminator* as yet. So you will not have to wait, we will make shipment direct to you upon receipt of \$9.75, or C. O. D., if desired. Remember, *superior results are guaranteed* or your money back. Be one of the first to own and use the *Ferbend Maxmin "B" Battery Eliminator*. Use the coupon NOW!

FERBEND ELECTRIC CO.

425 W. Superior St. - Chicago, Illinois

FERBEND ELECTRIC CO.

425 West Superior St., Chicago

Send at once. I am enclosing \$9.75.

Send C. O. D.

Send Literature.

Name.....

Address.....

City.....

State.....

List of Broadcast Stations

(Continued from page 1164)

Call Letters	Name	Location	Power & Wave Length
KGB	Tacoma, Wash., Tacoma Daily Ledger	Tacoma	100—250
KGO	Oakland, Calif., General Electric Co.	Oakland	3000—361.3
KGTT	San Francisco, Calif., Glad Tidings Tabernacle	San Francisco	50—200
KGU	Honolulu, Hawaii, Marion A. Mulrony	Honolulu	500—270
KGW	Portland, Ore., Portland Morning Oregonian	Portland	500—491.5
KGY	Lacey, Wash., St. Martins College	Lacey	5—246
KHJ	Los Angeles, Calif., Times Mirror Co.	Los Angeles	500—415.2
KHO	Spokane, Wash., Louis Wassmer	Spokane	500—273
KJBS	San Francisco, Calif., Julius Brunton & Sons Co.	San Francisco	5—220
KJR	Seattle, Wash., Northwest Radio Service Co.	Seattle	1000—384.4
KLDS	Independence, Mo., Reorganized Church of Jesus Christ of Latter Day Saints	Independence	3000—440.9

LEARN RADIO!

Become a big-pay man in the greatest industry of all time. Quickly, easily and right at home, you can fit yourself for highest salary positions, or you can cash in on your spare time. The call is urgent for mechanics, operators, designers, inspectors. Unlimited, fascinating opportunities on land or sea.

I WILL TRAIN YOU AT HOME TO BE A RADIO EXPERT

Under my practical, easy to understand, instruction—you qualify in an amazingly short time. No previous experience is necessary. Every branch of radio becomes an open book to you. You learn how to design, construct, operate, repair, maintain and sell all forms of Radio apparatus. My methods are the latest and most modern in existence.

FREE Wonderful home construction tube revolving set of the latest design. **Write Today** "Radio Facts" **FREE**

A. G. Mohaupt, Radio Engineer, RADIO ASSOCIATION OF AMERICA, Dept. 152, 4513 Ravenswood Ave., Chicago



Insure your copy reaching you each month. Subscribe to Radio News—\$2.50 a year. Experimenter Publishing Co., 53 Park Place, New York City.

The Loud Speaker Sensation!



The KODEL MICROPHONE LOUD SPEAKER

An exact replica of the transmitting microphone used in broadcasting stations.

The efficient KODEL SOUND UNIT, with an ingenious new snail-shell horn, mounted inside the microphone case, produces a remarkably clear, full-toned volume, with every note as rich and true as when it enters the transmitting microphone in the studio. Non-vibrating tone chamber absolutely eliminates distortion.

\$15 Model incorporates new Kodel, Jr. unit; with large Kodel unit, \$20.

Radio dealers everywhere have them.

THE KODEL RADIO CORP.
501 E. Pearl St. Cincinnati, O.

Manufacturers of Kodel Radio Receivers and Accessories, and Homcharger Battery Chargers.



Gets Them All With Double Force What a Difference! UNIVERSAL AERIAL WIRE

It's coated with several layers of weatherproof, corrosion proof enamel. Signal strength remains the same from year to year. Does not weaken through aerial resistance. Smoke, grime or moisture does not change it. It has proven best wherever tried. Our Special 100 foot roll will be sent, postpaid, on receipt of \$1.00.

RIX RADIO SUPPLY HOUSE, INC.
5505 4th Ave., Dept. 45, Brooklyn, N. Y.

RADIO AGENTS WANTED 5 Tube Demonstrator FREE!

Earn \$25 to \$100 a week, part or full time. Everyone a prospect. Complete line standard sets and accessories, \$5.00 to \$30.00. Write today for illustrated catalog and exclusive selling plan for live dealers and community agents. 20TH CENTURY RADIO CO., 1001 Coca Cola Bldg., Kansas City, Mo.

List of Broadcast Stations (Continued from page 1227)

Call Letters	Name	Location	Power & Wave Length
KLS	Oakland, Calif., Warner Bros. Radio Supplies Co.	250—252	
KLX	Oakland, Calif., Tribune Publishing Co.	500—508.2	
KLZ	Denver, Colo., Reynolds Radio Co.	250—266	
KMA	Shenandoah, Iowa, May Seed & Nursery Co.	500—252	
KMJ	Fresno, Calif., Fresno Bee.	50—234	
KMO	Tacoma, Wash., Love Electric Co.	100—250	
KNRC	Los Angeles, Calif., Clarence B. Juneau	250—208.2	
KNX	Los Angeles, Calif., Los Angeles Evening Express	500—336.9	
KOA	Denver, Colo., General Electric Co.	5000—322.4	
KOB	State College, N. M., New Mexico College of Agriculture and Mechanic Arts	1000—348.6	
KOCH	Omaha, Neb., Omaha Central High School	250—258	
KOCW	Chickasha, Okla., Oklahoma College for Women	200—252	
KOIL	Council Bluffs, Iowa, Monarch Mfg. Co.	500—278	
KOP	Detroit, Mich., Detroit Police Department	500—278	
KPO	San Francisco, Calif., Hale Bros.	1000—428.3	
KPPC	Pasadena, Calif., Pasadena Presbyterian Church	50—229	
KPRC	Houston, Texas, Post Dispatch	500—296.9	
KPSN	Pasadena, Calif., Pasadena Star News	1000—315.6	
KPP	Portland, Ore., H. B. Read	500—212.6	
KQV	Pittsburgh, Pa., Doubleday-Hill Electric Co.	500—275	
KQW	San Jose, Calif., Charles D. Herrold	500—231	
KRE	Berkeley, Calif., Berkeley Daily Gazette	100—256	
KSAC	Manhattan, Kans., Kansas State Agricultural College	500—340.7	
KSD	St. Louis, Mo., Post Dispatch	750—545.1	
KSL	Salt Lake City, Utah, Radio Service Corp. of Utah	1000—299.8	
KSO	Clarinda, Iowa, A. A. Berry Seed Co.	500—242	
KTAB	Oakland, Calif., Tenth Avenue Baptist Church	1000—240	
KTBI	Los Angeles, Calif., Bible Inst. of Los Angeles	750—293.9	
KTBR	Portland, Ore., Brown's Radio Shop	50—263	
KTCL	Seattle, Wash., American Radio Telephone Co.	1000—305.9	
KTHS	Hot Springs, Ark., New Arlington Hotel Co.	500—374.8	
KTNT	Muscatine, Iowa, Norman Baker	500—256	
KTW	Seattle, Wash., First Presbyterian Church	1000—454.3	
KUO	San Francisco, Calif., Examiner Printing Co.	150—250	
KUOM	Missoula, Mont., University of Montana	250—244	
KUSD	Vermillion, S. D., University of South Dakota	100—278	
KUT	Austin, Texas, University of Texas	500—231	
KVOO	Bristow, Okla., Voice of Oklahoma	500—374.8	
KWUC	Le Mars, Iowa, Western Union College	50—252	
KWG	Stockton, Calif., Portable Wireless Telephone Co.	50—248	
KWKC	Kansas City, Mo., Wilson Dumeau Studios	100—236	
KWKH	Kennonwood, La., W. G. Patterson	500—261	
KWSC	Pullman, Wash., State College of Washington	500—348.6	
KWWG	Brownsville, Texas, City of Brownsville, Board of City Development	500—278	
KYW	Chicago, Ill., Westinghouse Electric & Mfg. Co.	2000—535.4	
KZKZ	Manila, P. I., Electrical Supply Co.	100—270	
KZM	Oakland, Calif., Preston D. Allen	100—240	
KZRQ	Manila, P. I., Manila Hotel, Far Eastern Radio (Inc.)	500—222	
KZUY	Baguio, P. I., F. Johnson Elser	500—360	
WAAB	New Orleans, La., Valdemar Jensen	100—268	
WAAC	New Orleans, La., Tulane University	100—275	
WAAD	Cincinnati, Ohio, Ohio Mechanics Institute	25—258	
WAAP	Chicago, Ill., Chicago Daily Drovers Journal	200—278	
WAAM	Newark, N. J., I. R. Nelson Co.	500—263	
WAAP	Omaha, Neb., Omaha Grain Exchange	500—278	

Developed for Those Who Demand the Best

Apex Vernier Dials

are constructed on exhaustively tested and truly scientific principles and are engineered to meet the precise requirements of experts—consequently they more than meet the expectations of the average radio user. They bring in distant stations with alacrity and positiveness seldom encountered and provide control and accuracy essential to full radio enjoyment. They impart a degree of elegance that creates a marked improvement in the appearance of any set. Clockwise or counter clockwise. Royal Brass Finish, 4 in. \$1.50; 3 1/4 in. \$1.25. Satin Silver Finish, 4 in. 1.75; 3 1/4 in. 1.50. DeLuxe Gold (24K) 4 in. 2.50; 3 1/4 in. 1.85.

Apex Rheostat Dials

are little brothers to Apex Vernier Dials. Accurate, handsome—a necessity to satisfactory operation, beauty of appearance. Royal Brass Finish, \$.60. Satin Silver Finish, .70. DeLuxe Gold (24K), .80. If your dealer is unable to supply you, order direct from us.

APEX ELECTRIC MFG. CO.
1410 W. 59th St., Dept. 206 Chicago



G-S DETECTOR SILK-CORE

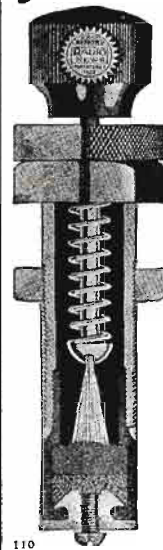

WHY IT IS BETTER!

Look at the Construction

Judge for yourself!

The one adjustable detector or insuring strong signals. Will operate on any set designed for a crystal detector, regardless of tube capacity.

Guaranteed 100% Ask your dealer, or write directly. \$1.50

Manufactured by G-S RADIO RESEARCH LAB. 1269 Cochran Ave. Los Angeles National Distributors: BAKER-SMITH CO. New Call Building San Francisco Offices in all principal cities.

RADIO BARGAINS

FREE RADIO CATALOG & GUIDE of newest ideas, approved special hook-ups with illustrations. Tremendous savings on standard radio parts, sets, kits. Be sure to get this thrifty book before you buy. Wonderful? Unusual? You'll say so. Write letter or postal NOW. BARAWIK CO., 102-142 S. Canal St., CHICAGO, U.S.A.

List of Broadcast Stations

(Continued from page 1228)

Call Letters	Location and Name	Power & Wave Length
WABB	Harrisburg, Pa., Harrisburg Sporting Goods Co.	10-266
WABC	Asheville, N. C., Asheville Battery Co.	20-254
WABI	Bangor, Me., First Universalist Church	100-240
WABO	Rochester, N. Y., Lake Avenue Baptist Church	100-278
WABQ	Haverford, Pa., Haverford College Radio Club	100-261
WABR	Toledo, Ohio, Scott High School	50-263
WABW	Wooster, Ohio, College of Wooster	50-206.8
WABX	Mount Clemens, Mich. (near), Henry B. Joy	500-246
WABY	Philadelphia, Pa., John Magaldi, Jr.	50-242
WABZ	New Orleans, La., Coliseum Place Baptist Church	50-275
WADC	Akron, Ohio, Allen Theatre	500-258
WAFD	Port Huron, Mich., Albert B. Parfet Co.	500-273
WAGM	Royal Oak, Mich., Robert L. Miller	50-258.6
WAHG	Richmond Hill, N. Y., A. H. Grebe & Co.	500-315.6
WAIT	Taunton, Mass., A. H. Wait & Co.	10-229
WAUW	Columbus, Ohio, American Insurance Union	500-293.9
WAMD	Minneapolis, Minn., Hubbard & Co.	500-244
WAPI	Auburn, Ala., Alabama Polytechnic Inst.	500-248
WARC	Medford Hillside, Mass., American Radio Research Corp.	100-261
WBAA	West Lafayette, Ind., Purdue University	250-273
WBAK	Harrisburg, Pa., Pa. State Police	500-275
WBAO	Decatur, Ill., James Milklin University	100-270
WBAP	Fort Worth, Texas, Wortham-Carter Publishing Co. (Star-Telegram)	1500-475.9
WBAV	Columbus, Ohio, Erner & Hopkins Co.	500-293.9
WBAX	Wilkes-Barre, Pa., John H. Stenger, Jr.	100-256
WBBA	Newark, Ohio, Plymouth Congregational Church	20-226
WBBL	Richmond, Va., Grace Covenant Church	150-229
WBBM	Chicago, Ill., Atlas Investment Co.	1500-226
WBBP	Petoskey, Mich., Petoskey High School	200-238
WBBR	Rossville, N. Y., Peoples Pulpit Assn.	500-273
WBBS	New Orleans, La., First Baptist Church	50-252
WBRU	Monmouth, Ill., Jenks Motor Sales Co.	10-224
WBBV	Norfolk, Va., Ruffner Junior High School	50-222
WBBY	Charleston, S. C., Washington Light Infantry	10-268
WBBZ	Chicago, Ill. (Portable), C. L. Carrell	50-215.7
WBCN	Chicago, Ill., Foster & McDonnell	500-266
WBDC	Grand Rapids, Mich., Baxter Laundry Co.	50-256
WBES	Tacoma Park, Md., Bliss Electrical School	100-222
WBNY	New York, N. Y., Shirley Katz	500-209.7
WBOQ	Richmond Hill, N. Y., A. H. Grebe & Co.	100-236
WBRC	Birmingham, Ala., Bell Radio Corporation	10-240
WBRE	Wilkes Barre, Pa., Baltimore Radio Exchange	100-231
WBT	Charlotte, N. C., Charlotte Chamber of Commerce	250-275
WBZ	Springfield, Mass., Westinghouse Electric & Mfg. Co.	2000-331.1
WBZA	Boston, Mass., Westinghouse Elec. & Mfg. Co.	250-242
WCAC	Mansfield, Conn., Connecticut Agricultural College	500-275
WCAD	Canton, N. Y., St. Lawrence University	250-263
WCAE	Pittsburgh, Pa., Kaufmann & Baer Co.	500-461.3
WCAH	Columbus, Ohio, Entekin Electric Co.	500-266
WCAJ	University Place, Neb., Nebraska Wesleyan University	500-253
WCAL	Northfield, Minn., St. Olaf College	500-336.9
WCAO	Baltimore, Md., Albert A. and A. Stanley Brazer	100-275
WCAP	Washington, D. C., Chesapeake & Potomac Telephone Co.	500-468.5

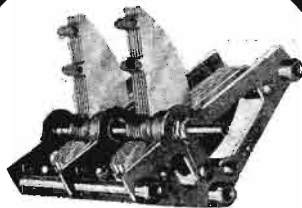

Made under Hogan Patent No. 1,014,002
Jan. 9, 1912

Reduces Interference

The most vexing problem you have to face with your radio set is INTERFERENCE.

U. S. Tool Engineers have perfected a Straight Line Frequency Condenser that distributes the stations uniformly over your dial and makes possible a degree of selectivity you never thought possible.

No more crowding—minimum interference when you use U. S. Tool Straight Line Frequency Condensers.

Write for Booklet

U. S. TOOL COMPANY
INC.
AMPERE, N. J.

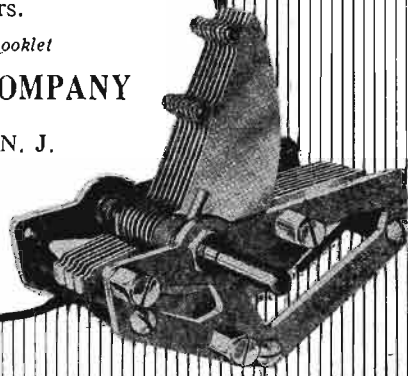

LEARN THE CODE AT HOME

WITH THE OMNIGRAPH

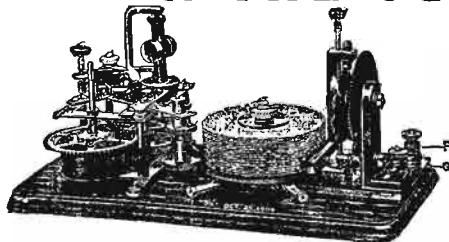

THE OMNIGRAPH Automatic Transmitter will teach you both the Wireless and Morse Codes—right in your own home—quickly, easily and inexpensively. Connected with Buzzer, Buzzer and Phone or to Sounder, it will send you unlimited messages, at any speed, from 5 to 50 words a minute. THE OMNIGRAPH is not an experiment. For more than 13 years, it has been sold all over the world with a money back guarantee. The OMNIGRAPH is used by several Depts. of the U.S. Govt.—in fact, the Dept. of Commerce uses the OMNIGRAPH to test all applicants applying for a Radio License. The OMNIGRAPH has been successfully adopted by the leading Universities, Colleges and Radio Schools.

Send for FREE Catalog describing three models. DO IT TODAY.
THE OMNIGRAPH MFG. CO., 15 HUDSON STREET, NEW YORK CITY
If you own a Radio Phone set and don't know the code—you are missing most of the fun

TO THE RADIO DEALER

Thousands of dealers sell RADIO NEWS over the counter because buyers come back each month for the new issue. It makes them steady callers. Are you selling your customers? For information address

M. B. FLAUM, Dept. 2RA,
Experimenter Publishing Company, 53 Park Place, New York City

Three "E" Straight Line Rheostat



Perfect Control of Filament Temperature

6-15-30 Ohms
Illustration 1/2 Size

Master Engineering Precision and Skill now offer you the utmost in Rheostats.

Patent Pending

Designed and produced by one of the largest manufacturers of electrical power equipment. Used by those who demand the best results. Perfect Reception depends on a fine, smooth, dependable variation of filament temperature in the detector tube. For there is only one temperature at which efficient reception is obtained and this point is very critical.

The THREE "E" STRAIGHT LINE RHEOSTAT finds this critical point as no other can. It gives straight line variation, runs smoothly, is absolutely NOISELESS and once set "stays put!" By all means secure this precision instrument at once. Ask your Dealer or order direct, giving us his name.

Price \$2.50—Postpaid

ELECTRICAL ENGINEERS EQUIPMENT CO.

Radio Division

708 W Madison St., Dept. 6,
Chicago, Ill.

Circulars on Request



The Aristocrat of Rheostats

Trade Mark CHICAGO U.S.A.

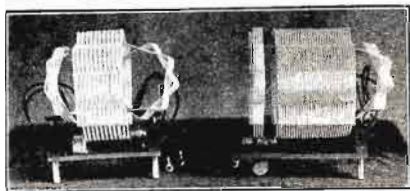

LOW LOSS

Tuners and Coils for all circuits

3 Circuit Amateur and Broadcast tuners... \$7.00
Radio Frequency Transformers (each)... \$2.00
Coils to order. Write for literature.

Davenport Radio Laboratories
647 Cedar St. Davenport, Iowa

9 Circuits-1 Tuning Dial!

A Separate Circuit for each 40 Meter Wavelength Band. A single tuning dial, yet greater sensitivity. Let our nearest dealer show you the great Kellogg.

KELLOGG WAVE MASTER

Or write for complete descriptive folder No. 1-B today.
KELLOGG SWITCHBOARD & SUPPLY COMPANY
1041 W. Adams Street Chicago, Ill.

PATENTS

DON'T LOSE YOUR RIGHTS

Before disclosing your invention to anyone send for free blank form "EVIDENCE OF CONCEPTION" to be signed and witnessed.

LANCASTER & ALLWINE
Reg. Pat. Atty. in U. S. and Canada
276 Garay Bldg., Washington, D. C.
Originators of the term "Evidence of Conception"

RADIO BARGAINS

FREE RADIO CATALOG & GUIDE of newest ideas, approved special hook-ups with illustrations. Tremendous savings on standard radio parts, sets, kits. Be sure to get this thrifty book before you buy. Wonderful! Unusual? You'll say so. Write letter or postal NOW.
BARAWIK CO., 102-142 S. Canal St., CHICAGO, U.S.A.

EVERYTHING IN RADIO
AT ATTRACTIVE PRICES
SETS OR PARTS
Mail order only
ALL RADIO COMPANY, 417 North Clark St., Chicago

Insure your copy reaching you each month. Subscribe to RADIO NEWS—\$2.50 a year. Experimenter Publishing Co., 53 Park Pl., N.Y.C.

List of Broadcast Stations

(Continued from page 1229)

Call Letters	Name	Location	Power & Wave Length
WCAR	San Antonio, Texas, Southern Radio Corporation of Texas		500—263
WCAT	Rapid City, S. D., South Dakota State School of Mines		50—240
WCAU	Philadelphia, Pa., Universal Broadcasting Co. (Durham & Co.)		500—278.
WCAX	Burlington, Vt., University of Vermont		100—250
WCAY	Carthage, Ill., Carthage College		50—246
WCBA	Allentown, Pa., Queen City Radio Station		15—254
WCBC	Ann Arbor, Mich., University of Michigan		200—229
WCBD	Zion, Ill., Wilbur G. Voliva		5000—344.6
WCBE	New Orleans, La., Uhalt Brothers Radio Co.		5—263
WCBG	Pascagoula, Miss. (portable), Howard S. Williams		10—268
WCBH	Oxford, Miss., University of Mississippi		50—242
WCBM	Baltimore, Md., Hotel Chateau		50—229
WCBQ	Nashville, Tenn., First Baptist Church		100—236
WCBR	Providence, R. I. (portable), Charles H. Messer		30—205.4
WCCO	Minneapolis, Minn., Washburn-Crosby Co.		5000—416.4
WCCE	Elgin, Ill., Liberty Weekly		1000—273
WCLO	Camp Lake, Wis., C. E. Whitmore		50—231
WCLS	Joliet, Ill., H. M. Couch		150—214.2
WCWH	Portland, Me., Congress Square Hotel Co.		500—256
WCWS	Springfield, Ohio, Wittenberg College		100—248
WCUW	Worcester, Mass., Clark University		250—238
WCWS	Providence, R. I., United States (Portable) Chas. W. Selen		100—209.7
WCX	Detroit, Mich., Detroit Free Press		2500—516.9
WDAD	Nashville, Tenn., Dad's Auto Accessories (Inc.)		150—226
WDAE	Tampa, Fla., Tampa Daily Times		250—273
WDAF	Kansas City, Mo., Kansas City Star		500—365.6
WDAG	Amarilla, Texas, J. Laurance Martin		100—263
WDAY	Fargo, N. D., Radio Equipment Corporation		50—261
WDBC	Lancaster, Pa., Kirk Johnson & Co.		50—258
WDBE	Atlanta, Ga., Gilham-Schoen Electric Co.		100—270
WDBJ	Roanoke, Va., Richardson-Wayland Electrical Corporation		50—229
WDBK	Cleveland, Ohio, M. & F. Broz Furniture, Hardware & Radio Store		100—227
WDBO	Winter Park, Fla., Rollins College		100—240
WDBQ	Salem, N. J., Morton Radio Supply Co.		10—234
WDBR	Boston, Mass., Tremont Temple Baptist Church		100—261
WDBZ	Kingston, N. Y., Boy Scouts of America		10—233
WDCH	Hanover, N. H., Dartmouth College		100—256
WDOD	Chattanooga, Tenn., Chattanooga Radio Co.		50—256
WDRC	New Haven, Conn., Doolittle Radio Corp.		100—268
WDWF	Cranston, R. I., Dutee W. Flint		500—440.9
WDZ	Tuscola, Ill., James L. Bush		10 and 100—278
WEAF	New York, N. Y., American Tel. & Tel. Co.		5000—491.5
WEAH	Wichita, Kan., Hotel Lassen Rigby-Gray Hotel Co.)		50—268
WEAI	Ithaca, N. Y., Cornell University		500—254
WEAM	North Plainfield, N. J., Borough of North Plainfield		250—261
WEAN	Providence, R. I., Shepard Co.		500—270
WEAO	Columbus, Ohio, Ohio State University		500—295.9
WEAR	Cleveland, Ohio, Goodyear Tire & Rubber Co.		750—389.4
WEAU	Sioux City, Iowa, Davidson Bros. Co.		100—275
WEAY	Houston, Tex., Iris Theatre		500—270
WEBA	Highland Park, N. J., The Electric Shop		15—233
WEBC	Superior, Wis., Walter C. Bridges		100—242
WEBD	Anderson, Ind., Electrical Equipment & Service Co.		15—246
WEBE	Cambridge, Ohio, Roy W. Waller		10—234
WEBH	Chicago, Ill., Edgewater Beach Hotel Co.		1000—370.2
WEBJ	New York, N. Y., Third Avenue Ry. Co.		500—273
WERK	Grand Rapids, Mich., Grand Rapids Radio Co.		100—242

FOR CLEAR, QUIET "B" POWER



RADIO Storage "B" Battery

12 Cells 24 Volts Lasts Indefinitely—Pays for Itself
Economy and performance unheard of before. Recharged at a negligible cost. Delivers unflinching power that is clear, pure and quiet. Approved and listed as Standard by leading Radio Authorities, including Pop. Radio Laboratories, Pop. Sci. Inst. Standards, Radio News Lab., LeRay, Inc., and other important institutions. Equipped with Solid Rubber Cases, an insurance against acid and leakage. Extra heavy glass jars. Heavy rugged plates. Order yours today!

SEND NO MONEY Just state number of batteries wanted and we will ship day order is received. Extra offer! 4 batteries in series (96 volts), \$10.00. Pay expression after examining batteries. 5 per cent discount for cash with order. Mail your order now!

WORLD BATTERY COMPANY
1219 So. Wabash Ave., Dept. 75 Chicago, Ill.
Makers of the Famous World Radio "A" Storage Battery!
Prices: 6-volt, 100 Amp. \$11.00; 150 Amp. \$13.50; 140 Amp. \$14.00.
All equipped with Solid Rubber Cases.

World STORAGE BATTERIES

Set your Radio Dials at 210 meters for the new 1000 watt World Storage Battery Station, WSRB, Chicago. Watch for announcements.

KDKA • WEA • WGN • WJS • KHJ • KGO • KFAP • WJY • KCB

RADIO CATALOG also LOG

FREE Our 1926 Beautiful Illustrated Catalog of all the latest Radio Merchandise

JUST OFF THE PRESS

The largest line of Standard Radio Merchandise in stock. Write for this Wonderful Book today, before you buy anything. Delay means losing exceptional chance to participate in this sale. All those who rush their name and address at once will receive also a **LOG BOOK FREE**

Economy Radio Sales Co.
288 Sixth Ave. Dept. F New York
DEAL DIRECT AND SAVE REAL MONEY (No Dealers)

IVORY RADIO PANEL

Grained white IVORYLITE makes most beautiful set of all. Any size 3 1/2 sq. inch, 3/16 in. thick. Beautiful IVORYLITE dials inlaid gold numerals \$1.35 ea. Knobs, 55c ea. Shipped anywhere pre-paid or C.O.D. Write for FREE sample.

IVORYLITE RADIO PANEL CO.
3222 Avenue F, Dept. N Fort Worth, Texas

Here's a way to Develop Steady Customers

Practically every customer who buys from you is a potential reader of RADIO NEWS. Why not sell RADIO NEWS to him over the counter, and you will have the reader returning each month for the new issue.

It makes steady customers of them.

For information address
M. B. FLAUM, Dept. 2-RC
EXPERIMENTER PUBLISHING CO.
53 Park Place, New York City

List of Broadcast Stations

(Continued from page 1230)

Call Letters	Name	Location	Power & Wave Length
WEBL	New York, N. Y., Woolworth Bldg., United States (portable), R. C. A.		100—226
WEBM	New York, N. Y., United States (Portable) Woolworth Building		100—226
WEBQ	Harrisburg, Ill., Joseph R. Tate		10—236
WEBR	Buffalo, N. Y., H. H. Howell		50—214
WEBT	Dayton, Ohio, Dayton Cooperative Industrial High School		5—256
WEBW	Beloit, Wis., Beloit College		500—268
WEBZ	Savannah, Ga., Savannah Radio Corp.		5—263
WEEL	Boston, Mass., Edison Electric Illuminating Co. of Boston		500—475.9
WEHS	Evanston, Ill., Evanston Township High School		20—202.6
WEMC	Berrien Springs, Mich., Emmanuel Missionary College		500—285.5
WENR	Chicago, Ill., All American Radio Corp.		1000—266
WEW	St. Louis, Mo., St. Louis University		100—248
WFAA	Dallas, Tex., Dallas News & Dallas Journal		500—475.9
WFAM	St. Cloud, Minn., Times Publishing Co.		10—273
WFAV	Lincoln, Nebr., University of Nebraska		500—275
WFBC	Knoxville, Tenn., First Baptist Church		50—250
WFBD	Philadelphia, Pa., Gethsemane Baptist Church		5—234
WFBE	Seymour, Ind., Van de Walle Music and Radio Co.		10—226
WFBG	Altoona, Pa., William F. Gable Co.		100—278
WFBH	New York, N. Y., Hotel Majestic (Concourse Radio Corp.)		500—273
WFBI	Camden, N. J., Galvin Radio Supply Co.		250—236
WFBJ	Collegeville, Minn., St. John's University		50—236
WFBK	Syracuse, N. Y., Onondaga Hotel		100—252
WFBN	Bridgewater, Mass., Radio Sales & Service Co.		10—226
WFBP	Baltimore, Md., Fifth Infantry, Maryland N. G.		100—254
WFBZ	Galesburg, Ill., Knox College		20—254
WFDZ	Flint, Mich., Frank D. Fallian (Police Building)		100—234
WFI	Philadelphia, Pa., Strawbridge & Clothier		500—394.5
WFKB	Chicago, Ill., Francis K. Bridgman		500—217.3
WFRL	Brooklyn, N. Y., Robert M. Lacey and James A. Bergner (Flatbush Radio Laboratories)		100—205.4
WGAL	Lancaster, Pa., Lancaster Electric Supply & Construction Co.		10—248
WGBB	Freeport, N. Y., Harry H. Carman		100—244
WGBC	Memphis, Tenn., First Baptist Church		10—278
WGBF	Evansville, Ind., Finke Furniture Co.		100—236
WGBI	Seranton, Pa., Frank S. Megargee		10—240
WGBK	Johnstown, Pa., Lawrence W. Campbell (Pointine Chaten)		5—248
WGBM	Providence, R. I., Theodore N. Sarty		30—234
WGBQ	Menomonie, Wis., Stout Institute		100—234
WGBR	Marshfield, Wis., George S. Ives		10—229
WGBS	New York, N. Y., Gimbel Brothers		500—315.6
WGBT	Greenville, S. C., Furman University		15—236
WGBU	Miami, Fla., Fulford-by-the-Sea		500—278
WGBW	Spring Valley, Ill., Valley Theater		10—256
WGBX	Orono, Me., University of Maine		100 252
WGCP	Newark, N. J., Grand Central Palace		500 252
WGES	Oak Park, Ill., Coyne Elec. School		500—250
WGHB	Clearwater, Fla., The George H. Bowles Developments		500—266
WGHP	Detroit, Mich., George H. Phelps		1500—270
WGMU	Richmond Hill, N. Y. (portable) A. H. Grebe & Co.		100—236
WGN	Chicago, Ill., The Tribune (Drake Hotel)		1000—370.2
WGR	Buffalo, N. Y., Federal Radio Corp.		750—319
WGST	Atlanta, Ga., Georgia School of Technology		500—270
WGY	Schenectady, N. Y., General Electric Co.		5000—379.5

Let the Pure Tones Through

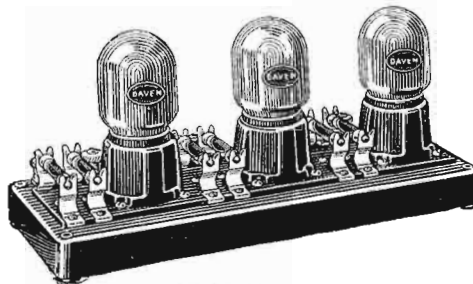

Make Your Old Set A 1926 Model!

The Daven Super-Amplifier used with any set or circuit carries through the full, clear tones of the broadcasting station programs. If you prefer to assemble the Amplifier, obtain the Daven 3-stage Kit, which includes all parts except sockets.

PURE tones, beautifully clear and full, go out from the broadcasting station. They reach your detector still pure and clear. But what then?

From the detector your amplifying apparatus operates. Distortion arises unless you take advantage of a method of amplifying that far-sighted manufacturers and thousands of set builders are now adopting—Resistance Coupled Amplification. Resistance Coupling is not new, but Resistance Coupling with real volume amplification is new. It is the most approved method of letting pure tones through.

The Daven Super-Amplifier costs little. It is easily and conveniently installed in any set made. Buy it complete to save hook-up labor. For those preferring to assemble, the Daven 3-stage Kit gives all the necessary parts except sockets. You will join hundreds of others who have written to thank us for the improvement Daven has given.

Write us today for The Resistor Manual, an authoritative book on Resistance Coupled Amplification, 25c at good dealers, 30c by mail.



The new Daven Special Coupling Condenser Type "A", for Resistance Coupled Amplification, sold separately and also included in all Daven Amplifiers, Kits and Resistor-Couplers. For greater volume and better quality.



The new Daven High MU Tube Type MU-20, used with the Daven Super-Amplifier, gives 50% more volume—6 volt, 1/2 ampere. A Daven Power Tube Type MU-6 in the last or output stage helps any set regardless of the method of amplification—6 volt, 1/2 ampere.



THE RESISTOR MANUAL is the handbook of Resistance Coupled Amplification. At your dealer's or by mail postpaid 30c.

DAVEN PRODUCTS ARE SOLD ONLY BY GOOD DEALERS

The Sine of Music
DAVEN RADIO CORPORATION
Resistor Specialists
Newark, N. J., U. S. Pat. Off. New Jersey

CLIP THIS COUPON
DAVEN RADIO CORPORATION
159 Summit Street, Newark, New Jersey
Please send me the following on Resistance Coupled Amplification:
Check One
 Resistor Manual, 30c is enclosed.
 Complete Catalog (free).

Name.....
Address.....
For Dealers: Send your letterhead and we will have our nearest distributor communicate with you.

THE BIG LITTLE THINGS OF RADIO

Superior Performance Has Won the Country

POWER-PLUS Fieldless Coils Take the Lead

Now, at the height of their first season, the POWER-PLUS Fieldless Coils are being accepted nationally as the outstanding successes of the year. If you are building a set—or improving the old one—you will only be fair to yourself if you send for the POWER-PLUS folder and the seven copyrighted hook-up blueprints offered FREE with the coupon below. Ask your dealer about POWER-PLUS—or clip and mail the coupon.

POWER-PLUS, the new superior fieldless coil. Mail coupon below for FREE blueprints and descriptive folder.

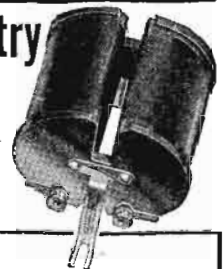

POWER-PLUS

A. F. HENNINGER CORP.
4505 Ravenswood Ave. Chicago, Ill.

A. F. Henninger Corp., 4505 Ravenswood Ave., Chicago, Ill. Gentlemen: Kindly send me your folder and 7 copyrighted hook-up blueprints. I understand that they are absolutely FREE—and that I am obligated in no way.
Name.....
Address.....
Town..... State.....

It's easy to build the set you want,



The kind of a set you need depends on your location, Home-built sets help you solve individual problems.

The principal reasons so many thousands of radio listeners today have built their own sets are:

FIRST—The receiver, built at home, can be made large or small, powerful or weak to most nearly fit your desires.

SECOND—Home Built sets are more simple to construct than the average person imagines. With seven simple tools, found in the average household, the largest and most complicated receivers have been successfully built by thousands of listeners.

THIRD—A wide selection of patterns, far more simple than those for a lady's dress pattern, have been developed by CONSRAD for the man who has never handled a radio part before. Every smallest detail is explained simply, made easy to understand. Step by step the building of the set is explained so that you can't go wrong.

Each CONSRAD pattern contains two or more large, full sized blueprints. One of the detailed panel layout and the others of the wiring diagrams. A large booklet goes with each pattern explaining everything and giving illustrations at various stages of the work.

Why not start the set you want today by obtaining a CONSRAD Pattern from your local radio dealer? They are sold EVERYWHERE—and the price is only 50c EACH.

COMPLETE LIST OF CONSRAD PATTERNS

- No. 2—A Two-Stage Amplifier.
- No. 4—A Rehnartz Receiver.
- No. 5—A Reflex Receiver.
- No. 6—A Cockaday Receiver.
- No. 7—A Neutrodyne Receiver.
- No. 9—The S. T. 100 Receiver.
- No. 11—A Five-Tube Cockaday Receiver.
- No. 12—A Portable Receiver.
- No. 13—A Harkness Receiver.
- No. 14—The Original Genuine Super-Heterodyne. List \$1.00.
- No. 15—A Low Loss Receiver.
- No. 16—The Tropadyne Superadio.

50c Each

Consrad Patterns are Sold at All Radio Stores

The Consrad Co., Inc., 64 Church St., New York, N. Y.

Consrad

RADIO'S FOREMOST PUBLISHERS OF BOOKS, PATTERNS AND DIAGRAMS

To Dissatisfied Set Owners

If your set is not performing satisfactorily, if it is not giving the proper results, you can easily replace it by building a new set from a CONSRAD Pattern at less cost than what you can obtain by selling the old receiver. Think it over.

List of Broadcast Stations
(Continued from page 1231)

Call Letters	Name	Location	Power & Wave Length
WHA	Madison, Wisconsin, University of Wisconsin	750—535.4	
WHAD	Milwaukee, Wis., Marquette University and Milwaukee Journal	500—275	
WHAG	Cincinnati, Ohio, University of Cincinnati	100—233	
WHAM	Rochester, N. Y., University of Rochester (Eastman School of Music)	100—278	
WHAP	Brooklyn, N. Y., Wm. H. Taylor Finance Corp.	100—240	
WHAR	Atlantic City, N. J., Seaside House Hotel	500—275	
WHAS	Louisville, Ky., Courier-Journal & Louisville Times	500—399.8	
WHAT	Minneapolis, Minn., George W. Young	500—263	
WHAV	Wilmington, Del., Wilmington Electrical Specialty Co.	100—266	
WHAZ	Troy, N. Y., Rensselaer Polytechnic Institute	100—379.5	
WHB	Kansas City, Mo., Sweeney School Co.	500—365.6	
WHBA	Oil City, Pa., Shaffer Music House	10—250	
WHBC	Canton, Ohio, Rev. E. P. Graham	10—254	
WHBD	Bellefontaine, Ohio, Chas. W. Howard	20—222	
WHBF	Rock Island, Ill., Beardsley Specialty Co.	100—222	
WHBG	Harrisburg, Pa., John S. Skane	20—231	
WHBH	Culver, Ind., Culver Military Academy	100—222	
WHBJ	Fort Wayne, Ind., Lane Auto Co.	50—234	
WHBK	Ellsworth, Me., Franklin Street Garage	10—231	
WHBL	Logansport, Ind., James H. Slusser	50—213.7	
WHBM	Chicago, Ill., C. L. Carrell	20—233	
WHBN	St. Petersburg, Fla., First Ave. Methodist Church	10—238	
WHBP	Johnstown, Pa., Johnstown Automobile Co.	100—256	
WHBQ	Memphis, Tenn., Men's Fellowship Class of St. John's M. E. Church South	50—233	
WHBR	Cincinnati, Ohio, Scientific Electric & Mfg. Co.	20—215.7	
WHBU	Anderson, Ind., Riviera Theatre and Bings Clothing	10—218.8	
WHBW	Philadelphia, Pa., D. R. Kienzle	100—215.7	
WHBY	West De Pere, Wis., St. Norbert's College	50—250	
WHDI	Minneapolis, Minn., William Hood Dunwoody Industrial Institute	500—278	
WHEC	Rochester, N. Y., Hickson Electric Co.	100—258	
WHK	Cleveland, Ohio, Radio Air Service Corp. (Warren R. Cox)	250—273	
WHN	New York, N. Y., George Schubel	500—361.2	
WHO	Des Moines, Iowa, Bankers Life Co.	5000—526	
WHT	Deerfield, Ill., Radiophone Broadcasting Corp.	1500—238	
WIAD	Ocean City, N. J., Howard R. Miller	100—250	
WIAS	Burlington, Iowa, Home Electric Co.	100—254	
WIBA	Madison, Wis., Capital Times Studio	100—236	
WIBC	St. Petersburg, Fla., L. M. Tate Post No. 39, Veterans of Foreign Wars	100—222	
WIBG	Elkins Park, Pa., St. Paul's Protestant Episcopal Church	50—222	
WIBH	New Bedford, Mass., Elite Radio Stores, James T. Moriarty	5—209.7	
WIBI	Flushing, N. Y., Frederick B. Zittel, Jr.	50—218.8	
WIBJ	Chicago, Ill. (Portable), C. L. Carrell	50—215.7	
WIBK	Toledo, Ohio, University of the City of Toledo	100—205.4	
WIBM	Chicago, Ill. (portable) Billy Maine	10—215.7	
WIBO	Chicago, Ill., Nelson Bros. (Russo & Tiorito Orchestra Exchange)	1000—226	
WIBQ	Farina, Ill., F. M. Schmidt	5—205.4	
WIBR	Weynton, W. Va., Thurman A. Owings	50—246	
WIBS	Elizabeth, N. J., (portable) N. J. Nat'l. Guard, 57th Infantry Brigade	20—202.6	
WIBU	Poyette, Wis., The Electric Farm	20—222	
WIBW	Logansport, Ind., L. L. Dill	100—220	
WIBX	Utica, N. Y., Grid Leak (Inc.)	5—205.4	
WIBY	Henderson, N. C., Jewel Radio Co.	25—263	



Enjoy Radio at its BEST!!

RADIO reception depends on the harmonious working of many "little things." One poorly-designed part in a receiver may put the stamp of mediocrity on the entire outfit—it may be the one weak link which spoils the chain. Use Hammarlund Products and enjoy the perfections of fifteen years' experience.

Straight-Line-Frequency Condenser

This newest member of the Hammarlund Condenser family is rugged, compact and exceptionally effective in distributing stations equally over the dials. It has all the famous Hammarlund low-loss features and several new ones including Isolantite, insulation and one-hole mounting.

"Hammarlund, Jr." (Midget)

The most perfectly designed midget ever offered, having every feature of the larger models. It has many valuable uses in a receiver. Diagrams on request.

Space-Wound Coils

Hammarlund Space-Wound Coils have created a sensation. Here for the first time the famous solenoid coil is successfully anchored to a film of dielectric material and definitely spaced between turns, thus reducing distributed capacity and resistance to a minimum. They are approved for the new Hammarlund-Roberts Receiver and are made in various sizes and arrangements for other standard circuits. The Hammarlund-Roberts Units are illustrated here.

Hammarlund-Roberts Receiver

The composite ideal of ten leading radio engineers. A receiver that has won the plaudits of phans and experts throughout the country, because it makes only five tubes as sensitive and selective as a multi-tube super-heterodyne and delivers remarkable volume with beautiful tone quality. You can build it yourself from parts costing only \$62.30. Send 25 cents for complete, illustrated construction book.

HAMMARLUND MANUFACTURING CO.
424-438 W. 33rd Street, New York





For Better Radio

Hammarlund

PRECISION PRODUCTS





BLUEBIRD RADIO TUBES
— are powerful — sensitive for distance, give clear volume and long service.

GUARANTEED

to work in Radio Frequency, Neutralized, Super Heterodyne and Reflex.

WITH BAKELITE BASE

Type 401A \$2.00 All Standard Types
Type 400
Type 499
Type 412

Also 499A with Standard Base 202.5 Watt Transmitter \$3.00

When ordering mention types Shipped Parcel Post C.O.D.

BLUEBIRD TUBE CO.
200 Broadway Dept. N New York

Eureka Dial Pointers



add to the beauty of your set. Eureka, Eureka Jr. or DX Owl in nickel 10c, DX Owl gold plated 15c.

EUREKA SOLDERLESS AERIAL LEAD-IN CLAMP gives you the equal of a soldered joint for one-tenth the trouble. Useful anywhere outdoors for connecting wires.

Give your set a chance by making a no-loss connection between aerial and lead in. Best way of connecting a lightning arrester. Obtain any of these items at your dealers or send amount in stamps or money order for samples.

C. W. BUTTS, Inc.
42 HEDDEN PLACE,
EAST ORANGE, N. J. 25c EACH



Insure your copy reaching you each month. Subscribe to Radio News—\$2.50 a year. Experimenters Publishing Co., 53 Park Place, N. Y. C.

FREE!

12-Cell — 24-Volt Storage 'B' Battery

Positively given free with each purchase of a WORLD "A" Storage Battery. You must send this ad with your order. WORLD Batteries are famous for their guaranteed quality and service. Backed by years of successful manufacture and thousands of satisfied users. Equipped with Solid Rubber Case, an insurance against acid and leakage. You save 50 per cent and get a

2-Year Guarantee

Bond in Writing

Approved and Listed as Standard by Leading Authorities including Radio News Laboratories, Popular Science, Institute of Standards, Popular Radio Laboratories, Radio Broadcast Laboratories, Radio in the Home.

World BATTERY COMPANY
1219 So. Wabash Ave., Dept. 10 CHICAGO, ILL.

Set your Radio Dial at 210 meters for the new 1000 w. World Storage Battery Station, WSBG, Chicago. Watch for announcements.

World STORAGE BATTERIES

KOKA = WFAF = WGN = WJS = KHL = KGO = KFAB = WJY = KOL

List of Broadcast Stations
(Continued from page 1233)

Call Letters	Location and Name	Power & Wave Length
WIBZ	Montgomery, Ala., Powell Electric Co.	10-231
WIL	St. Louis, Mo., St. Louis Star & Benson Radio Co.	250-273
WIP	Philadelphia, Pa., Gimbel Brothers	500-508.2
WJAD	Waco, Texas, Frank P. Jackson	500-352.7
WJAG	Norfolk, Nebr., Norfolk Daily News	200-270
WJAK	Greentown, Ind., Clifford L. White	100-254
WJAM	Cedar Rapids, Iowa, D. M. Perham	100-268
WJAR	Providence, R. I., The Outlet Co. (J. Samuels & Bro.)	500-305.9
WJAS	Pittsburgh, Pa., Pittsburgh Radio Supply Co.	500-275
WJAZ	Mojin Prospect, Ill., Zenith Radio Corp.	1500-322.4
WJBA	Joliet, Ill., D. H. Lentz, Jr.	50-206.8
WJBB	St. Petersburg, Fla., L. W. McClung	10-254
WJBC	La Salle, Ill., Hummer Furniture Co.	100-234
WJBG	Charlotte, N. C., Interstate Radio (Inc.)	10-224
WJBI	Red Bank, N. J., Robert S. Johnson	250-218.8
WJBK	Ypsilanti, Mich., Ernest F. Goodwin	10-233
WJBL	Decatur, Ill., Wm. Gushard, Dry Goods Co.	500-270
WJBN	Sycamore, Ill., St. John's Evangelical Lutheran Church	10-256
WJD	Granville, Ohio, Denison University	10-217.3
WJJD	Mooseheart, Ill., Supreme Lodge, Loyal Order of Moose	500-302.8
WJR	Pontiac, Mich., Jewett Radio & Phonograph Co.	1500-516.9
WJY	New York, N. Y., R. C. A.	1000-405.2
WJZ	New York, N. Y., R. C. A.	1000-454.3
WKAA	Cedar Rapids, Iowa, H. F. Paar	500-278
WKAD	East Providence, R. I., Charles Loeff (Crescent Park)	20-240
WKAF	Milwaukee, Wis., WKAF Broadcasting Co.	250-261
WKAP	Cranston, R. I., Dutee W. Flint	50-234
WKAQ	San Juan, P. R., Radio Corp. of America	500-340.7
WKAR	East Lansing, Mich., Michigan State College	1000-285.5
WKAV	Laconia, N. H., Laconia Radio Club (Portable)	50-224
WKBB	Joliet, Ill., Sanders Brothers	100-214.2
WKBE	Webster, Mass., K & B Electric Co.	1000-231
WKBG	Chicago, Ill. (Portable), C. L. Carrell	100-215.7
WKRC	Cincinnati, Ohio, Kodel Radio Corp.	1000-325.9
WKY	Oklahoma, Okla., E. C. Hull and H. S. Richards	100-275
WLAL	Tulsa, Okla., First Christian Church	150-250
WLAP	Louisville, Ky., W. V. Jordan	20-275
WLAX	Greencastle, Ind., Greencastle Community Broadcasting Station	10-231
WLB	Minneapolis, Minn., University of Minnesota	500-278
WLBL	Stevens Point, Wis., Wisconsin Department of Markets	500-278
WLIB	Elgin, Ill. (near), Liberty Weekly	2500-302.8
WLIT	Philadelphia, Pa., Lit Bros.	500-394.5
WLS	Crete, Ill., Sears, Roebuck & Co.	1500-344.6
WLTS	Chicago, Ill., Lane Technical High School	100-258
WLW	Harrison, Ohio, Crosley Radio Corp.	500 & 800-422.3
WLWL	New York, N. Y., Missionary Society of St. Paul the Apostle	1000-288.3
WMAC	Cazenovia, N. Y., Clive B. Meredith	100-275
WMAF	Dartmouth, Mass., Round Hills Radio Corp.	1000-440.9
WMAK	Lockport, N. Y., Norton Laboratories	500-266
WMAL	Washington, D. C., M. A. Leese Optical Co.	15-212.6
WMAN	Columbus, Ohio, First Baptist Church	50-278
WMAQ	Chicago, Ill., Chicago Daily News	500-447.5
WMAY	St. Louis, Mo., Kingshighway Presbyterian Church	100-248
WMAZ	Macon, Ga., Mercer University	500-261
WMBB	Chicago, Ill., American Bond & Mortgage Co.	500-250
WMBG	Detroit, Mich., Michigan Broadcasting Co. (F. G. Siegel)	100-256.4

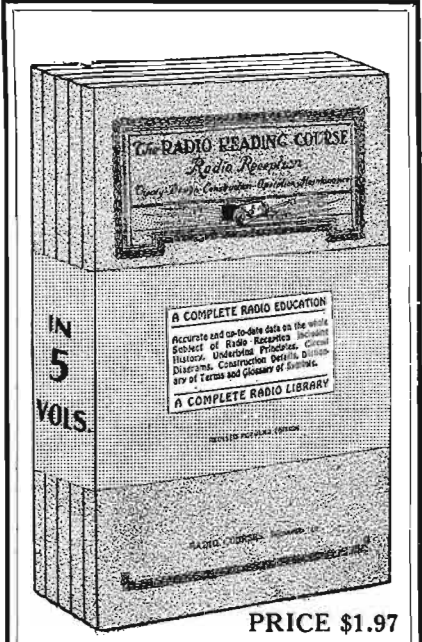

A Radio Education
IN 5 VOLUMES

Theory, Design, Construction, Operation and Maintenance
Learn at Home

These five component parts of a complete Radio Instruction Course are outlined in five volumes that contain not merely the essentials as so many books do, but more, they contain all that any modern up-to-the-minute textbook on any subject would cover. They are in themselves a COMPLETE radio education, teaching every possible portion of Radio science.

Size of each book 6 by 9 inches, handsomely bound and illustrated with charts, diagrams, descriptions of equipment, etc.

SEND NO MONEY for these books. Just forward your name and address. We send you the books at once. On receipt of same you pay the postman \$1.97 plus a few cents postage and then they are yours.

Distributed by
The Conrad Co.
233 Fulton St. New York, N. Y.

DELIGHTED

With this Beautiful Radio Cabinet— See how well it will accommodate your set, batteries, and you can have a BUILT-IN LOUD SPEAKER if you wish it.

\$25 Club Price

Regular \$50.22 Retail Price.

BROWN MARIOGANY FINISH.

At our Special Club Price you save one-half. Big Radio Values in the WIRTHMORE BULLETIN. Write for your copy. MAKE EXTRA MONEY. Guaranteed Quality.

WIRTHMORE CABINET CO.
910 Wirthmore Street
Rockford :: Illinois
"REALLY WORTH MORE"

RADIO CATALOG

Dealers! Send for new 1925-1926 Catalog. Contains nationally advertised high quality sets, kits and parts. Use your letterhead.

Western Radio Co.
134-136 W. Lake St. Chicago, Ill.

List of Broadcast Stations

(Continued from page 1234)

Call Letters	Name	Location	Power & Wave Length
WMBF	Miami Beach, Fla., Fleetwood Hotel Corp.	500—384.4	
WMC	Memphis, Tenn., "Commercial Appeal"	500—499.7	
WMCA	Hoboken, N. J., Hotel McAlpin (Greeley Square Hotel Co.)	500—340.7	
WNAA	Arlington, Va., United States Navy	1000—434.5	
WNAB	Boston, Mass., Shepard Stores	100—250	
WNAC	Boston, Mass., Shepard Stores	500—280.2	
WNAD	Norman, Okla., University of Oklahoma	250—254	
WNAL	Omaha, Nebr., Omaha Central High School	50—258	
WNAR	Butler, Mo., First Christian Church (C. C. Rhodes)	20—231	
WNAT	Philadelphia, Pa., Lenning Brothers Co.	100—250	
WNAX	Yankton, S. Dak., Dakota Radio Apparatus Co.	100—244	
WNBH	New Bedford, Mass., Irving J. Vermilya and A. J. Lopez	250—248	
WNJ	Newark, N. J., Radio Shop	100—252	
WNYC	New York, N. Y., City of New York	1000—526	
WOAC	Lima, Ohio, Page Organ Co. (H. P. Maus)	50—261	
WOAI	San Antonio, Tex., Southern Equipment Co.	2000—394.5	
WOAN	Lawrenceburg, Tenn., James D. Vaughn	500—282.8	
WOAW	Omaha, Nebr., Woodmen of the World	1000—526	
WOAX	Trenton, N. J., Franklyn J. Wolf	500—240	
WOC	Davenport, Iowa, Palmer School of Chiropractic	5000—483.6	
WOCG	Sycamore, Ill., Triple Alliance Radio Station	10—205.4	
WOCL	Jamestown, N. Y., Hotel Jamestown	15—275	
WODA	Paterson, N. J., O'Dea Temple of Music	250—224	
WOI	Ames, Iowa, Iowa State College	750—270	
WOK	Homewood, Ill., Neutrowound Radio Mfg. Co.	500—217.3	
WOKO	New York, N. Y., Otto Baur	50—233	
WOO	Philadelphia, Pa., John Wanamaker	500—508.2	
WOQ	Kansas City, Mo., Unity School of Christianity	1000—278	
WOR	Newark, N. J., L. Bamberger & Co.	500—405.2	
WORD	Batavia, Ill., Peoples Pulpit Association	5000—275	
WOS	Jefferson City, Mo., Missouri State Marketing Bureau	500—440.9	
WOWL	New Orleans, La., Owl Battery Co.	10—270	
WOWO	Fort Wayne, Ind., Main Auto Supply Co.	500—227	
WPAK	Agricultural College, N. Dak., North Dakota Agricultural College	50—275	
WPCC	Chicago, Ill., North Shore Congregational Church	500—258	
WPDQ	Buffalo, N. Y., Hiram L. Turner	50—205.4	
WPG	Atlantic City, N. J., Municipality of Atlantic City	500—299.8	
WPRC	Harrisburg, Pa., Wilson Printing and Radio Co.	100—215.7	
WPSC	State College, Penna., Pennsylvania State College	500—261	
WQAA	Parkesburg, Pa., Horace A. Beale, Jr.	500—220	
WQAC	Amarillo, Tex., Gish Radio Service	100—234	
WQAE	Springfield, Vt., Moore Radio News Station	50—246	
WQAM	Miami, Fla., Electrical Equipment Co.	100—263	
WQAN	Seranton, Pa., Seranton Times	100—250	
WQAO	New York, N. Y., Calvary Baptist Church	100—360	
WQJ	Chicago, Ill., Calumet Rainbow Broadcasting Co.	500—447.5	
WRAF	Laporte, Ind., The Radio Club, Inc.	100—224	
WRAC	Escanaba, Mich., Economy Light Co.	100—256	
WRAM	Galesburg, Ill., Lombard College	100—244	
WRAV	Yellow Springs, Ohio, Antioch College	100—263	
WRAW	Reading, Pa., Avenue Radio & Electric Shop	10—238	
WRAX	Gloucester City, N. J., Flexon's Garage	500—268	
WRBC	Valparaiso, Ind., Immanuel Lutheran Church	50—278	
WRC	Washington, D. C., Radio Corp. of America	1000—468.5	
WRCO	Raleigh, N. C., Wynne Radio Co.	100—252	
WREC	Coldwater, Miss., Wooten's Radio & Elec. Co.	10—254	

RADIO — BARGAINS

A Message to Radio News Readers

This message is directed to thousands of our friends who are looking forward to the page bargain announcements we carried in these columns last year. Because the growth of radio has been so rapid, we find that it would take an entire issue of *Radio News* to list the many bargains in radio that Barawik has to offer this season. For this reason we have compiled the Barawik Catalog and Guide, in which is shown thousands of bargains such as the radio world has never known before. We have gathered together the greatest collection of radio sets, kits and parts ever assembled by any institution and these are fully illustrated, described and priced at tremendous savings in the new BARAWIK BARGAIN BOOK.

Free Copy to Radio News Readers

Every reader of *Radio News* is entitled to this book free and we have reserved a supply for just this purpose. Free copy will gladly be sent to you upon request. Simply send us your name and address and your copy will be mailed at once. (Please include names of other radio fans to whom we can send free copy also.)

Don't Spend a Penny for Anything in Radio Until You have Seen this Catalog

Don't spend a penny for anything in radio until you have seen this catalog. It will be a happy surprise for you. Send letter or postal today—NOW—and you will be money ahead.

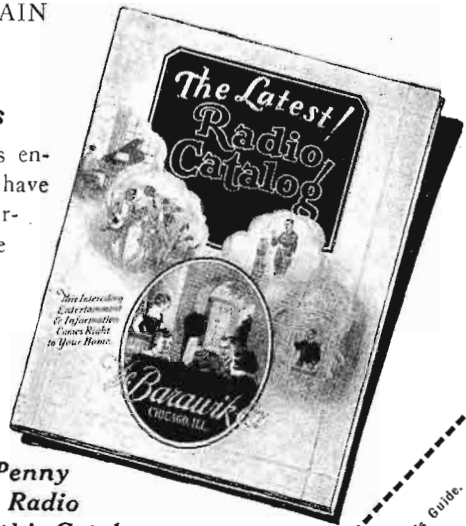

The Barawik Co.

102-142 So. Canal St., Chicago, U. S. A.

BARAWIK CO., 102-142 So. Canal St., Chicago, Ill.
 Send me my copy of your new Radio Catalog and Builder's Guide.
 Name _____
 Address _____
 Friend _____
 Address _____
 Friend _____
 Address _____

Free 6 Days Trial in your home

Test your talent Free on a BUESCHER SAXOPHONE

See what you can do. We know you can play it. That's why we want you to try. 3 free lessons with each new instrument give you a quick, easy start. Practicing is fun because you learn so fast. Play Jazz in a week, tantalizing music that sets them going. Be the life of the party, always welcome. Get into the big fun. 6 days' free trial, any instrument. No obligation. If you like it pay a little each month. Send now for beautiful free literature. Get our liberal proposition. Send postal today. Address:

Buescher Band Instrument Co. 1226 Buescher Block Elkhart, Indiana





ACME

"B" Power Unit

No Noise or Hum. Operates on all types of sets. Sold on money-back guarantee. Write for circular.

The Sensation of the Year

THE ACME ELECTRIC & MFG. CO.
 1344 Hamilton Ave. Cleveland, Ohio
 Manufacturers of the Acme Charger

\$28.50 Complete East of Rockies

The Best by Test—

Insure your copy reaching you each month. Subscribe to *Radio News*—\$2.50 a year
 Experimenter Publishing Co., 53 Park Place, N. Y. C.

Keeping Pace with the World's Greatest Achievements in

RADIO - SCIENCE CHEMISTRY-ELECTRICITY

Do you want to
know what is going on
in these great fields from
month to month?

RADIO NEWS

Tells you about the whirlwind progress of the mighty new force in the life of the people throughout the world. RADIO NEWS is radio's greatest and largest magazine, containing new hook-ups, up-to-the-minute news and information, illustrations and all the details of the great Radio Industry.

SCIENCE AND INVENTION

Contains page after page of startling, new scientific achievements with plenty of news and pictures from every corner of the world. A never-ending panorama of events in the great world of Science and its co-partner, Invention. Everything in SCIENCE AND INVENTION is illustrated in pictures or drawings and many novel ideas are explained for home builders.

THE EXPERIMENTER

Any man who loves to build things at home and develop and design his original ideas should read THE EXPERIMENTER. It is full of news, hints and suggestions for the experimenter and contains page after page of information on new experiments, large and small. Every word is of benefit. Interesting from cover to cover. THE EXPERIMENTER will afford many hours of pleasure and entertainment.

Published and Distributed by

THE EXPERIMENTER PUBLISHING CO., Inc.
53 Park Place New York, N. Y.

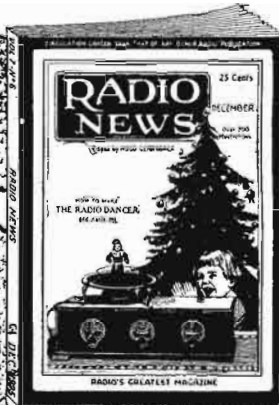

Get These Valuable Premiums

With every subscription to any one of our magazines we are giving free, your choice of a beautiful "Tokko Stamp Album," the new radio craze for keeping stamps of various stations logged, or a copy of the "Radio News Amateurs' Handbook," a compact, illustrated Radio Instruction Book containing over 200 pages of radio data and information.

SUBSCRIPTION OFFERS

One Year's Subscription to:—
 RADIO NEWS\$2.50
 SCIENCE & INVENTION 2.50
 THE EXPERIMENTER 2.50
 Combination Subscription
 Any two magazines, One year each\$4.25
 Or any one magazine for Two years.

EXPERIMENTER PUBLISHING CO., Inc.,
53 Park Place, New York, N. Y.

Gentlemen: I am enclosing \$..... for a years
 subscription to RADIO NEWS, SCIENCE AND INVENTION,
 THE EXPERIMENTER.

NAME

ADDRESS

CITY STATE

PREMIUM DESIRED

List of Broadcast Stations
(Continued from page 1235)

Call Letters	Name	Location	Power & Wave Length
WRRO	Lansing, Mich., Reo Motor Car Co.		500—285.5
WRHF	Washington, D. C., Washington Radio Hospital Fund		50—256
WRHM	Minneapolis, Minn., Rosedale Hospital		50—252
WRK	Hamilton, Ohio, Doron Bros. Electrical Co.		100—270
WRM	Urbana, Ill., University of Illinois		500—274
WRMU	Richmond Hill, N. Y., M. U. I. (Yacht) A. H. Grebe		100—236
WRNY	New York, N. Y., Experimenter Publishing Co.		500—238
WVRR	Dallas, Tex., City of Dallas, Police and Fire Signal Department		350—261
WRST	Bay Shore, N. Y., Radiotel Mfg. Co.		250—215.7
WRVA	Richmond, Va., Larus & Bro. Co.		1000—236
WRVW	Tarrytown, N. Y., Tarrytown Radio Research Laboratory (Koenig Bros.)		500—273
WSAI	Mason, Ohio, United States Playing Card Co.		500—325.9
WSAJ	Grove City, Pa., Grove City College		250—229
WSAN	Allentown, Pa., Allentown Call Publishing Co.		100—229
WSAR	Fall River, Mass., Doughty & Welch Electrical Co.		100—254
WSAU	Chesham, N. H., Camp Marienfeld		10—229
WSAX	Chicago, Ill., Zenith Radio Corp.		100—268
WSAZ	Pomeroy, Ohio, Chase Electric Shop		50—244
WSB	Atlanta, Ga., Atlanta Journal		1000—428.3
WSBC	Chicago, Ill., World Battery Co.		500—209.7
WSBF	St. Louis, Mo., Six Baer & Fuller		250—273
WSBT	South Bend, Ind., South Bend Tribune		250—275
WSDA	New York, N. Y., City Temple		250—263
WSKC	Bay City, Mich., Worlds Star Knitting Co.		100—261
WSM	Nashville, Tenn., National Life & Accident Ins. Co.		1000—282.8
WSMB	New Orleans, La., Saenger Amusement & Maison Blanche Co.		500—319
WSMH	Owosso, Mich., Shattuck Music House		20—240
WSMK	Davon, Ohio, S.M.K. Radio Corp.		500—275
WSOE	Milwaukee, Wis., School of Engineering of Milwaukee		500—246
WSRO	Hamilton, Ohio, Radio Co. (Harry W. Fahrlander)		100—252
WSUI	Iowa City, Iowa, State University of Iowa		500—483.6
WTAB	Fall River, Mass., Fall River Daily Herald Publishing Co.		100—266
WTAC	Johnstown, Pa., Penn. Traffic Co.		100—268
WTAD	Carthage, Ill., Robert E. Compton		50—236
WTAG	Worcester, Mass., Worcester Telegram Publishing Co.		500—268
WTAL	Toledo, Ohio, Toledo Radio & Electric Co.		10—252
WTAM	Cleveland, Ohio, Willard Storage Battery Co.		350—389.4
WTAP	Cambridge, Ill., Cambridge Radio & Electric Co.		50—242
WTAQ	Osseo, Wis., S. H. Van Gorden & Son		100—234
WTAR	Norfolk, Va., Reliance Electric Co.		100—261
WTAS	Elgin, Ill. (near), Charles E. Erbstein		250—302.8
WTAT	Boston, Mass. (portable), Edison Elec. Illuminating Co.		100—244
WTAW	College Station, Tex., Agricultural & Mechanical College of Texas		500—270
WTAX	Streator, Ill., Williams Hardware Co.		50—231
WTAZ	Lambertville, N. J., Thomas A. McGuire		15—261
WTG	Manhattan, Kans., Kansas State Agricultural College		50—273
WTIC	Hartford, Conn., Travelers Insurance Co.		500—348.6
WWAD	Philadelphia, Pa., Wright & Wright, Inc.		250—230
WWAE	Plainfield, Ill., Lawrence J. Crowley (Alamo Ball Room)		500—242
WWAO	Houghton, Mich., Michigan College of Mines		250—263
WWGL	Richmond Hill, N. Y., Radio Engineering Corp.		500—212.6
WWI	Dearborn, Mich., Ford Motor Co.		500—266
WWJ	Detroit, Mich., Detroit News		1000—352.7
WWL	New Orleans, La., Loyola University		100—275

50% Discount to Dealers

Two Complete New Lines



More Profit for You

Direct Factory to Dealer Plan Allows You Bigger Profits

We manufacture and sell to dealers at lowest wholesale prices. American Beauty set above just one of dozens of attractive new radio numbers proved satisfactory by tests in thousands of homes. American products build confidence, regular customers, big repeat. Outsell and outdemonstrate all competition.

GET THIS!  **CATALOG FREE EVERY MONTH**

AMERICAN RADIO MFG. COMPANY
1416-18 McGee St., Dept. Q, Kansas City, Mo.

WHOLESALE PRICES OF OVER 225 NATIONALLY ADVERTISED LINES

Authorized distributors for over 225 nationally advertised lines. Big stock always on hand. You are assured shipment when you want it. Three hour service. Everything in Radio for less. Dealers, write today for 112-page catalog just off the press. Get your name on our list for valuable monthly mailing. Keep in touch with the latest and best. Get prices that make you profit. Amazing offers will delight you.

PIN TO YOUR Letterhead and Mail

AMERICAN RADIO MFG. CO.
1416-18 McGee St., Dept. Q, Kansas City, Mo.

Gentlemen: Mail me your new 112-page catalog. Also put me on list for regular monthly mailings.

Name.....
Address.....
City..... State.....

those* who know recommend

AEROVOX

Fixed Condensers

*Tested and approved by M. I. T., Yale, Radio News, Popular Radio and Popular Science. Used by over 200 of America's leading set manufacturers.
Made in all capacities. Also manufacturers of Grid Leaks, Resistors, Resistofomers and Rheostats.

another reason why you should insist on them-

AEROVOX WIRELESS CORPORATION

Chicago Office: 53 W. Jackson Boulevard
Cincinnati: 304 Palace Theatre Building

493 Broome Street, New York City

OPPORTUNITY AD-LETS

Follow these advertisements every month. Reliable advertisers from all over the country offer their most attractive specials in these columns.

Classified advertising rate twenty-two cents a word for each insertion. Ten per cent discount for 6 issues, 20 per cent discount for 12 issues. Name and address must be included at the above rate. Cash should accompany all classified advertisements unless placed by an accredited advertising agency. No advertisement for less than 10 words accepted.

Objectionable or misleading advertisements not accepted. Advertisements for the April issue must reach us not later than February 1st.

CIRCULATION LARGER THAN THAT OF ANY OTHER RADIO PUBLICATION

EXPERIMENTER PUBLISHING CO., INC., 53 Park Place, New York, N. Y.

Agents Wanted

Big Money and fast sales. Every owner buys gold initials for his auto. You charge \$1.50; make \$1.35. Ten orders daily easy. Write for particulars and free samples. American Monogram Co., Dept. 133, East Orange, N. J.

Guaranteed Genuine Gold Leaf Letters anyone can put on store windows. Large profits. Enormous demand. Free samples. Metallic Letter Co., 422 N. Clark, Chicago.

Bankrupt and Bummage Sales. Make \$50.00 daily. We start you, furnishing everything. Distributors, Dept. 213, 699 Division, Chicago.

Best seller—Jem Rubber Repair for tires and tubes; superspeeds vulcanization at a saving of over 800 per cent.; put it on road, it vulcanizes itself in two minutes and is guaranteed to last the life of the tire or tube; sells to every auto owner and necessary dealer. For particulars how to make big money and free sample, address Amazon Rubber Co., 204 Amazon Building, Philadelphia, Pa.

Agents—Steady Income. Large manufacturer of soaps, perfumes, toilet articles and pure food products, etc., wishes representatives in each locality. Manufacturer direct to consumer. Big profits. Honest goods. Whole or spare time. Cash or credit. Send at once for particulars. American Products Co., 5798 American Bldg., Cincinnati, Ohio.

Earn \$10 daily silvering mirrors, plating, refinishing metalware, headlights, chandeliers, bedsteads. Outfits furnished. Bolanger Decie Laboratories, 1133 Broadway, New York.

Sell Nationally Advertised Radio Sets in spare time. Three sales weekly pay \$90.00 profit. Write for wholesale prices. Direct Radio Co., 197C Fourteenth St., Milwaukee, Wis.

Aviation

Boys—Get a three-foot model aeroplane free. Write to Aero Shop, 3650 Hurbit Ave., Detroit, Mich.

Learn to Fly by cheapest method. Send fifty cents (coin) for complete instructions. Aviator James, P. O. Box 16, R. N., Morris Heights Sta., N. Y.

Business Opportunities

Free Book. Start little Mail Order Business. Pier, 999 Central Street, N. Y.

Responsible manufacturer wants competent men to manage office and salesmen. \$300 to \$1,500 necessary; will allow expenses to Trenton if you qualify. Address Manager, 536 First Bichey Bldg., Trenton, N. J.

\$50 a week. Mail Order business. Booklet tells how. Sample and plan 2c. Outfit furnished you free. Bradford Co., Dept. E, Shawnee, Okla.

Electricity—Short day or evening courses in Electricity, Drafting, Engineering, and Architecture. In Chicago earn while you learn. Part Time positions pay expenses. Faculty of experts. Special short courses. Diploma in 2 years. B.S. Degree in 3 years. Small classes. Individual instruction. 25 year old institution with thousands of successful graduates. Enter any time. Employment bureau. Moderate tuition—monthly payments. New College building—all athletics. All details in 72 page "Blue Book." A copy will be sent to you free. Write today. Chicago Technical College, Dept. 27, 118 E. 26th St., Chicago, Ill.

Wanted—Building-Draftsmen. Train at home, in spare time, to be a Building-Draftsman. Big demand means big salaries and steady work. Get into Building America's \$7,000,000,000 industry. Keep right on with your present work. We train you by mail. Free Trial Lesson and Blue Print plans to show you how easily and quickly you can learn. Get into the \$3,000 to \$10,000 salary class. Write for Free Lesson, Blue Prints and catalog. All free, no obligation. Chicago Technical College, Dept. 1685, 118 E. 26th St., Chicago, Ill.

Make Money at Home—making toys. We show you how. Send \$1 for complete working drawings and instructions. DeKalb Designing Co., Dept. 57, Decatur, Ga.

Become a Builder. The World's Big Pay Field—Building. Be an estimator, superintendent, or have a contracting business of your own. Train at home, in spare time, to earn \$5,000 to \$20,000 a year, or more. No matter what your job is now—there's a big opportunity for you. A virch field with no overworking. Free book, "How to Read Blue Prints," actual Blue Print Plans and Catalog sent free. See how quickly and easily you will learn this fascinating big-pay profession. If you are earning less than \$75 a week, write us now. Send for free books and Blue Print Plans today! Chicago Technical School for Builders, Dept. 2773, 118 E. 26th St., Chicago, Ill.

Chemistry

Learn Chemistry at Home. Dr. T. O'Connor Sloane, noted educator and scientific authority, will teach you. Our home study correspondence course fits you to take a position as chemist. See our full page ad on page 1207 of this issue. Chemical Institute of New York, 66 W. Broadway, New York City.

Educational

Used Correspondence School courses save over half. Bargain Catalogue 1000 courses free. Used courses bought. Students' Exchange, Dept. A, 47 West 42d St., New York.

Exchange

200-20,000 meter Receiver Radiotron \$25.00. Smith, 4416 Market, Philadelphia.

Farms and Orchards

Pecan-Orange-Fig Groves "On the Gulf." Guaranteed care. Monthly payments. Big quick returns. Suburban Orchards, Dept. R, Biloxi, Miss.

For Sale

RCA and Signal Corps transmitting parts for Amateurs; large stock. R. Wood, 58 Waye Ave., Corona, New York.

Help Wanted

All men-women, 18-65, wanting to qualify for Government Positions, \$140-\$200 monthly, write Mr. Ozment, 251, St. Louis, Mo., immediately.

Detectives Needed Everywhere. Travel. Experience unnecessary. Write, George Wagner, former Government Detective, 1058 Broadway, N. Y.

Detectives needed everywhere; large salaries; free particulars; write National Headquarters, 188 East 79th, New York.

Qualify for \$150-\$300 railroad jobs. Fireman, Brakeman, Baggage-man, Sleeping Car or Train Porter. 237 Railway Bureau, East St. Louis, Ill.

Incorporations

Delaware Incorporator, Charters; Fees Small; forms, Chas. G. Gayer, 901 Orange St., Wilmington, Del.

Insects Wanted

Why not spend Spring, Summer and Fall gathering butterflies, insects? I buy hundreds of kinds for collections. Some worth \$1 to \$5 each. Simple outdoor work with my instructions, pictures, price-list. Send 10 cents (not stamps) for my illustrated Prospectus before sending butterflies. Mr. Sinclair, Dealer in Insects, Dept. 40, Box 1210, Victoria, B. C., Canada.

Instruction

Learn Chemistry at Home. Dr. T. O'Connor Sloane noted educator and scientific authority, will teach you. Our home study correspondence course fits you to take a position as chemist. See our full page ad on page 1207 of this issue. Chemical Institute of New York, 66 W. Broadway, New York City.

Miscellaneous

Skinderviken Transmitter Button. Free tested hook-ups. Loud Speakers, Experiments. K Electric Co., 2 Rector Street, New York City.

English Bull Dogs. Catalogue ten cents. Box 95, Triangle Kennels, Jackson Center, Ohio.

Motion Pictures

Films for Toy Machines. Hart—Nix—Chaplin. Complete stories 1000 feet \$3.50. Special 200 foot lengths \$1.50 post paid. Big Boys list free. Monarch Films, Department 2, Memphis, Tenn.

Motorcycles, Bicycles

Don't Buy a Bicycle Motor Attachment until you get our catalog and prices. Shaw Mfg. Co., Dept. 6, Galesburg, Kansas.

Old Coins

German Gov't Bond 5,000,000 Mk. 1924. \$1.50. 2,000,000 Mk Bond 1923. \$5.00. 500,000 Mk. Bill and Catalogue, 10c. Norman Shultz, Colorado Springs, Colo.

Old Coins. Large Spring Selling catalogue of coins for sale, free. Catalogue quoting prices paid for coins, ten cents. William Hesselin, 101K Tremont Street, Boston, Mass.

Old Money Wanted

\$2 to \$500 each paid for hundreds of Old or Odd Coins. Keep all old money, it may be very valuable. Send 10c for New Illustrated Coin Value Book, 45c. Guaranteed prices. Get posted. We pay Cash. Clarke Coin Company, 14 Street, LeRoy, N. Y.

Patent Attorneys

Inventors—Should write for our Free Guide Books and "Record of Invention Blank" before disclosing inventions. Send model or sketch of your invention for our Free Inspection and Instructions. Radio, Electrical, Chemical, Mechanical and Trademark experts. Terms reasonable. Victor J. Evans & Co., 929 Ninth, Washington, D. C.

Patents. Send drawing or model for examination and report as to patentability. Advice and booklet free. Highest references. Best results. Promptness assured. Watson E. Coleman, Patent Lawyer, 644 G Street, N. W., Washington, D. C.

Patents—My fee in installments. Free personal advice. Frank T. Fuller, Washington, D. C.

Patents—Send for form "Evidence of Conception" to be signed and witnessed. Form, fee schedule, information free. Lumsater and Allwine Registered Patent Attorneys in United States and Canada. 269 Ouray Bldg., Washington, D. C.

Mr. Inventor—If you have a patent or invention for sale, write Harley, 44 Central St., Bangor, Me.

Patent-Sense—As one of the oldest patent firms in America we give inventors, at lowest consistent charge, a service noted for results, evidenced by many well-known patents of extraordinary value. Patent Sense, free. Lacey & Lacey, 621 F St., Washington, D. C. Estab. 1869.

Patents

Inventions Commercialized. Patented or unpatented. Write Adam Fisher Mfg. Co., 278 Eight, St. Louis, Mo.

Personal

Lonesome—Join car club—make acquaintances everywhere. Big illustrated book with descriptions and photos, sent in plain wrapper for ten cents. Bonafide Co., Dept. 58, Kansas City, Mo.

Free to Radio Fans. For Rupture. The system embodied in Stuart's Plapapads has been successfully used by thousands since 1900, in the privacy of the homes, without hindrance from work, and at slight expense. Entirely different from Truss, No Straps, Buckles or Springs attached. Write for Free Test Plapad. No charge now or ever. Address Plapad Laboratories, 3718 Stuart Bldg., St. Louis, Mo.

Printing Outfits and Supplies

Print your own cards, stationery, circulars, paper, etc. Complete outfits \$8.85; Job Presses \$12, \$25; Rotary \$150. Print for others, big profit. All easy, rules sent. Write for catalogues, type, paper, etc. Press Company, A-13, Meriden, Conn.

Radio

Boys! Don't Overlook This. The "Rasco" Baby Detector. Greatest detector ever brought out with molded base. Fully adjustable. See former advertisements in this publication, or our catalog. Detector with Galena Crystal, complete \$5c, the same detector with Radioite Crystal, 75c. prepaid. Send for yours today. Radio Specialty Company, 96-98 Park Place, New York City.

SAVE 50%
Direct-from-Factory To You!

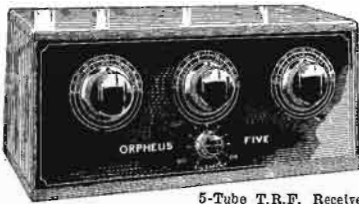

5-Tube T.R.F. Receiver

ORPHEUS "FIVE"

\$25.00
LESS ACCESSORIES

Designed and built especially for us by one of the largest Radio Manufacturers. Extremely Selective, wonderful tone quality, and a real distance getter.

Our Direct-To-User Selling Policy enables us to offer this Wonderful Receiver at a price never Equaled.

Quantity LIMITED — Order At Once and avoid disappointment.

Sent C.O.D. or on receipt of Money Order—express collect—25¢ ins. part of U. S. or Canada.

UNITY COMPANY, Room 4108
Woolworth Bldg., New York

PATENTS

To the Man with an Idea

I offer a comprehensive, experienced, efficient service for his prompt, legal protection and the development of his proposition. Send sketch, or model and description, for advice as to cost, search through prior United States patents, etc. Preliminary advice gladly furnished without charge. My experience and familiarity with various arts frequently enable me to accurately advise clients as to probable patentability before they go to any expense. *Booklet of valuable information and form for properly disclosing your idea free on request. Write today.*

RICHARD B. OWEN
PATENT LAWYER
2 Owen Building, Washington, D. C.
41A Park Row, New York City

PATENTS WRITE for our Four Guide Books and "RECORD OF INVENTION BLANK" before disclosing inventions. Send model or sketch and description of your invention for our **INSPECTION** and **INSTRUCTIONS FREE. TERMS REASONABLE.** Electrical and Radio Cases a specialty.

VICTOR J. EVANS & CO.
919 NINTH ST., WASHINGTON, D. C.

PATENTS If you have an invention and desire to secure a patent, send for our Evidence of Invention Blank and free guide book, "HOW TO GET YOUR PATENT." Tells our Terms, Methods, etc. Send model or sketch and description of your invention for **INSPECTION** and **INSTRUCTIONS.**

No Charge for the Above Information

RANDOLPH & CO., Dept. 459 Washington, D. C.

CLASS 25¢ PINS

BUY DIRECT FROM THE MAKER

CATALOG FREE

Either pin shown made with any 3 letters and 2 figures, 1 or 2 colors enamel. Silver plate 25¢ ea. \$2.50 doz. Sterling silver 40¢ ea. \$4.00 doz.

BASTIAN BROS. CO.

3490 637 Bastian Bldg., Rochester, N. Y.

Radio (Continued)

Attention!—50 Vacuum tube hook-ups. The greatest collection of vacuum tube circuits ever brought under two covers at such insignificant cost. These diagrams will be found in the great "Haseo" catalog, which contains raw materials and parts in a greater profusion than any other catalog. Use in stamps, or even, will bring the catalog to you. Radio Specialty Co., 93-99 Park Place, New York City.

Make Your "B" with Edison Elements. They last a lifetime. Pair 5 cents; welded, 7½ cents post-paid. Henry Chapelle, Woodburn, Ore.

Supersensitive Galena Crystals, pound \$1.00, prepaid. Alkermite, All-sensitive Crystals, 50c. Buskett, Joplin, Mo.

\$100 weekly up. We want experienced Radio Men to operate branch assembling plants. Part or whole time. Bartfield Radio Co., 13 Tillary St., Dept. N.R., Brooklyn, N. Y.

New! New! New! Operate any set with an indoor loop. Our special two tube amplifier hook-up requires no changes in your set. Easy to make. Gives astonishing results. Complete plans and blueprints for only \$1.00. Mention make or type of your set. Improved outdoor antennae. Gives 50 per cent. more volume, better daylight reception, increased distance. Makes crystal sets respond like tube sets. Only 50 cents for complete plans and blueprints. Satisfaction guaranteed or money refunded. Ellis Novelty Co., 211 Securities Bldg., Des Moines, Iowa.

Audio Transformers, 5 or 3 ratio, new, overstock sale. Try one, \$1.25. Leitch, Park Drive, West Orange, N. J.

Build a Lifetime "B" Battery. Use better Edison elements, welded connections, at 7 cents pair. Sample cell 10 cents. Paul Mills, Woodburn, Oregon.

Atwater-Kent 5 tube (new). Bargain. Write Sims, Lake, New York.

Want to Memorize the Wireless Code? The Coryden Snyder Code Method. Patented. Is quickest. Send 25c coin, stamps or M. O. to C. C. Snyder, 1123 Elmdale Ave., Chicago, Ill.

Free—A beautiful 5 tube tuned radio frequency receiver in the first man in each community who answers this ad within 10 days. Write now for particulars. E. W. Parker, Putnam St., Peabody, Mass.

Salesmen Wanted

A Salesman wanted in every town or city within 25 miles of a broadcasting station to sell Radiogen, the complete radio receiving set that retails for \$2.50. With Radiogen there is nothing else to buy—the outfit includes the Radiogen receiving apparatus, 1,000 ohm phone, and aerial outfit. The cheapest radio outfit on the market—yet as practical as the most expensive. Big money to the right men. Send \$2.00 for sample outfit. The Radiogen Corp., 66-R West Broadway, New York City.

Salesmen—To earn \$300 to \$600 weekly. Whirlwind new dealer specialty. Liberal credit terms. \$50.00 weekly expenses guaranteed against commission. Only producers wanted. Write reference as to ability. Salesmanager, Box 382N, Cedar Rapids, Iowa.

Salesmen—We furnish you a new Ford car immediately and set you up in business. You own both car and business. No capital required. Profits \$50 to \$150 per week easy. Exclusive territory, city or country. Biggest opportunity ever offered businers. Territory going fast. Write quick for details. W. & H. Walker, Inc., Dept. 43, Herr's Island, Pittsburgh, Pa.

Make \$100 Weekly in spare time. Sell what the public wants—long distance radio receiving sets. Two sales weekly pay \$100 profit. No big investment, no canvassing. Sharpe of Colorado made \$955 in one month. Representatives wanted at once. This plan is sweeping the country—write today before your county is gone. Ozarka, Inc., 130-L, Austin Ave., Chicago.

Scenery to Rent

Settings for Opera, Plays, Minstrels. Plush Drops. Address Amelia Grain, Philadelphia.

Song Writers

Songwriters: Let me furnish the music for your songs, guaranteeing you absolute satisfaction. Copyrights secured. Submit your scripts for estimate and free advice. Walter W. Newcomer, 1674 Broadway, New York.

Telegraphy

Telegraphy—Both Morse and Wireless taught thoroughly. Big salaries. Wonderful opportunities. Expenses low; chance to earn part. School established fifty years. Catalog free. Dodge's Institute, Coar St., Valparaiso, Ind.

Wanted to Buy

Full Value Paid for Old Gold, Jewelry, Watches, Diamonds, Pearls, Brilozes, Dental Gold, Silver, Platinum, gold or silver new; mammoth pearls, old false teeth. Packages returned if not 100% satisfactory. United States Smelting Works (The Old Reliable) 29 So. State St., Dept. 18, Chicago, Ill.

Write Today For Our 64 Page Catalog of RADIO BARGAINS
RANDOLPH RADIO CORP.
159 N. UNION AV. Dept. 2 CHICAGO, ILL.

How to Make Your Own SPEECH AMPLIFIER

MICROPHONE Transmitter Buttons have been used for a number of years to make powerful sound transmitting elements. These very sensitive amplifiers offer every "Radio Fan" the means of building his own powerful speech amplifier. We offer herewith to the constructor these special *Amplifier Units*.

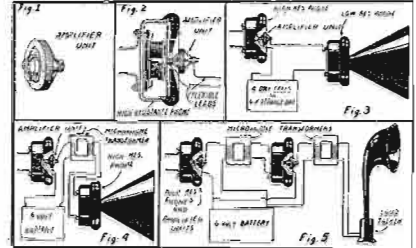

Fig. 1 shows the amplifier unit.

Fig. 2, shows how the unit is attached to a telephone receiver. The first procedure is to mount the unit on the diaphragm of a telephone receiver, which usually is a high resistance telephone, either 1,000 or 1,500 ohms.

Next we select the loud speaking telephone. If a low resistance telephone is available, it should have for maximum efficiency an impedance equal to the resistance of the amplifier unit, or about 10 ohms; it is connected up as shown in Figure 3. A 5 ohm telephone receiver is used in this circuit with a 6-volt storage battery.

Two telephones taken from a good double headset of 2,000 to 3,000 ohms which do not rattle on strong currents, are employed in Fig. 4, one at the receiving end, the other as loud talker. In this hook-up there is one instrument which must absolutely be used with this combination, the transformer. As stated before in connection with Fig. 3, the impedance of the telephone, if used in direct connection, should equal the resistance of the unit. But as the impedance of the telephone in Fig. 4 is much higher than the resistance of the unit, it may be 200 times as great, a transformer having a step-up ratio is used to match up the resistance of the unit with the impedance of the loud speaking telephone. In other words, the primary coil of the transformer should have an impedance (which is sometimes called "A. C. resistance") equal to the resistance of the unit, or about 10 ohms, and the secondary coil should have an impedance equal to the impedance of the high resistance telephone. This transformer may be purchased in any Radio Store and is called a microphone transformer or modulation transformer, designed primarily to be used in radio transmitting sets. A 6-volt battery gives the best results. The current passing through the unit will vary from .1 to .25 ampere.

Fig. 5 shows a circuit for further increasing the volume of sound. This is simply two of the circuits, such as shown in Fig. 4, linked together. This arrangement is highly sensitive and the telephones on which the units are mounted should be packed in a box of cotton, as the slightest vibration or sound in the room will be picked up and heard in the loud talker. Any sensitive radio loud talker may be used in this particular circuit.

THESE and innumerable other interesting experiments are possible with these amplifiers. Every amateur should have at least one or two in his "Lab" or workshop. A four-page instruction pamphlet is sent with every unit.

SPECIALLY PRICED 85¢
While they last Per Unit
OR TWO FOR \$1.50

PRESS GUILD,
66-R W. Broadway, New York City, N. Y.

Enclosed find 85¢-\$1.50 for which send me postpaid one—two amplifier units as advertised.

Name

Address

Town..... State.....

“Just a slight turn of the dials and with all Chicago local stations broadcasting I get everywhere outside”.

Now only

\$59.50
GET SPECIAL OFFER
Retail

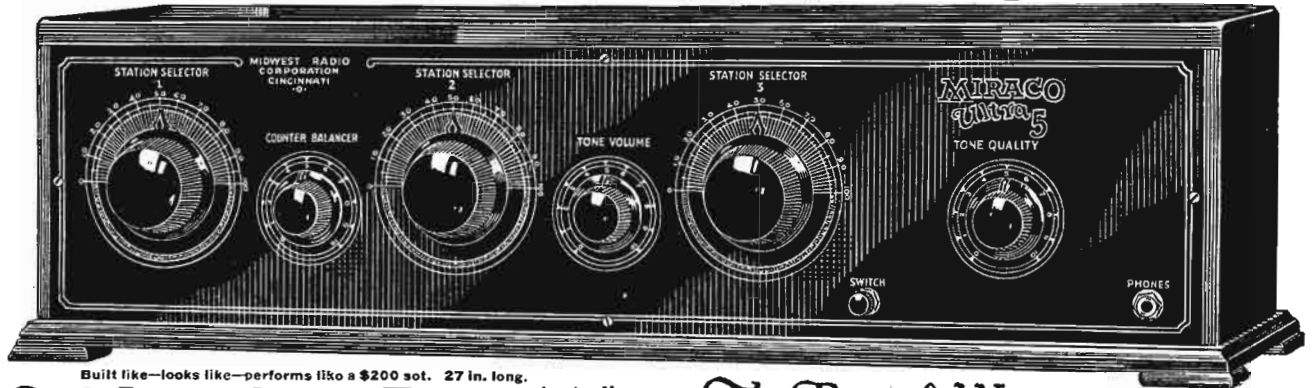

Built like—looks like—performs like a \$200 set. 27 in. long.

Get Amazing Offer

we make to Users who will demonstrate our set to friends.

The Powerful New
MIRACO
Ultra-5

Guaranteed by One of the Oldest Radio Builders

Tested and Approved by Radio's Highest Authorities

[ULTRA SELECTIVE FIVE TUBE SET IN MAHOGANY CABINET]

MIRACO RADIO GETS EM COAST TO COAST

Notice!

Enormous demand for the celebrated Miraco Ultra 5 (resulting from its many enthusiastic users so highly recommending it to their friends) enabled us to add hosts of costly new features, latest refinements and up-to-the-minute improvements such as you might expect to find only on the newest sets being at much higher prices. So the Improved Ultra 5 can 1926 is even a better set—a more beautiful set—a more selective and more powerful set—incredible as this may sound—for less money than ever before.

COAST TO COAST RECEPTION VERIFIED BY USERS

Reports from Ultra-5 users everywhere leave little for us to add. These are only a few of the many in our files, and which we receive daily. Send coupon for plenty of additional proof. Let testimony of users instead of high-sounding claims convince you.

CALIFORNIA THE FIRST NIGHT

Received KFI Los Angeles, Cal. and Mexico City the first night, besides about twenty more on my Ultra-5. Ray K. . . . Eaton, Ohio.

CANADA TO THE GULF AND COAST TO COAST

I sure do like the Miraco Ultra-5. I got from C.K.Y. Winnipeg, Canada to WSMB New Orleans, and from WGY New York to KFI California, last night. Chas. M. D. . . . Seatonville, Ill.

CUTS THROUGH THE LOCALS

My set certainly cuts through the locals. For a good well made set and good workmanship it can't be beat. I know if there is anything on the air, my Miraco Ultra-5 will bring it in. J. H. A. . . . Pittsburg, Pa.

PRaises ITS CLEAR TONE

Received the Ultra-5. It is working fine and in fact is the clearest toned outfit I ever heard. I have gotten 40 or more stations including KFI, Los Angeles, Calif. W. A. C. . . . Fortwin, Kansas.

CALIFORNIA HEARS CINCINNATI THE FIRST EVENING

I wish to thank you for your promptness in shipping, and the perfect condition in which the Ultra-5 arrived. I have proven your promise to be absolutely truthful. Fine tone, volume, and distance are excellent. The first evening enjoyed concert from Cincinnati. E. E. S. . . . San Francisco, Cal.

NEW YORK GETS 'EM COAST TO COAST

I have one of your Miraco Ultra-5 radios and it's working fine. I get all stations from coast to coast and would like to be one of your agents. Kendric, E. E. . . . Cooperstown, N. Y.

OUTPERFORMS ALL OTHER SETS IN HIS LOCALITY

There is not a radio in this neighborhood that can compare with the Miraco Ultra-5. J. H. . . . Aldens, Iowa.

COAST TO COAST THE FIRST NIGHT

The first night I got Santa Catalina Island on the Pacific Coast, also New York and last night Chicago. W. O. K. Lytton L. W. . . . Hot Springs, S. D.

TENNESSEE HEARS CALIFORNIA

Received my Ultra-5 O. K. Never saw a set packed so well. As to performance, it's just simply wonderful. No trouble for me to get Los Angeles, California, and without any interference. Wonderful tone and easily operated. W. F. T. . . . Adamsville, Tenn.

AS GOOD AS IT LOOKS

I received the Ultra-5 in fine shape. It is a beautiful piece of furniture and works just as good as it looks. Arthur E. A. . . . Greenock, Pa.

TUNES OUT POWERFUL NEARBY STATION AND GETS DISTANCE

We are surely having fine luck with the set. We get everywhere with all Chicago stations broadcasting. We now live about one mile from WGN, the Drake Hotel. It has a wavelength of 270 meters and on all other sets around here they are not able to get out or get any other station without also hearing WGN. But with our Miraco 5 we don't have any trouble. Just a slight turn of the dial and it isn't there. We can get outside any night better than our neighbors. Here are some outside stations we have heard in four nights on the loudspeaker: W. D. WORD, WCBZ, WLIB, WSMB (New York), WSAI, WOC, WSM, WEAZ (New York), KFKX (Hastings, Neb.), KOA (Denver), KFNE, KADN, WLBK, WHAS, WLW, WAPT, WLIB, WLBK. Everyone that hears the Ultra-5 is in love with it and says it is the best. Herman G. . . . Chicago, Illinois.

PENNSYLVANIA HEARS CALIFORNIA TO CUBA

Your Ultra-5 works splendidly from Los Angeles to Cuba, everything came in fine. Roy H. . . . Rochester, Pa.

SOLD IT THE DAY RECEIVED

I received my Miraco Ultra-5 a few days ago and sold it the very same day. The set is very much appreciated. It sure works fine. Jacob R. . . . Beulah, N. Dak.

57 STATIONS IN FIRST FEW DAYS

Our Ultra-5 arrived in fine shape. Had no trouble at all hooking it up. Set it up about 11:00 A. M. and heard several stations, including tonight. We have gotten 57 stations without just trying to get new stations for we listen to the different programs as we get them. Claude L. B. . . . Willow Lakes, S. D.

IOWA HEARS MEXICO CITY

We have given the Ultra-5 quite a thorough tryout and are very well pleased with its performance. Alongside of an expensive receiver its performance on tone, volume and distance is more than we expected. We pulled in KFI, Los Angeles, Cal., with many others the first evening and last night Mexico City came in clearly on the loudspeaker. Lewis W. H. . . . Greenville, Iowa.

PRaises ITS CLEARNESS

I received my Ultra-5 in fine condition and am very pleased with it. I really think that it is the best radio I have heard. Everything comes in so clear and plain. Sydney C. M. . . . Ft. Harrison, Mont.

You can either save or make a lot of money by sending coupon today for our Amazing Special Offer. It will astonish you. Just say you'll let your friends listen to the powerful new Miraco Ultra-5 in your home and we ship it to you ON APPROVAL at the wholesale price—satisfaction unconditionally guaranteed. The wonderful selectivity, long distance range, clarity of tone, power and volume of this famous set—plus its beauty of appearance and splendid construction—will sell it to your friends. Big profits easy for you—accepting their orders. No salesmanship required—no agreement to sign. You can also buy accessories at wholesale from us. Even at its retail price this latest improved big beautiful 1926 model Miraco Ultra-5 is an astonishing bargain, in the opinion of radio authorities. Remember, too, that each Miraco comes completely built, thoroughly tested and fully guaranteed by the great Midwest Radio Corporation—one of America's oldest, reliable and most successful makers of quality sets. Send coupon now.

Compare its construction with highest priced sets

Note the neat, sturdy, high-class construction. All wiring concealed under genuine Formica base panel (A). Wiring is flexible to permit broken or noisy connections. Genuine Formica panel (B)—hardwood gold-etched on front. Oscillations are easily controlled on all wave-lengths and "B" battery consumption is minimized while selectivity, distance range, clarity and volume are amazingly increased by the patented "Counter-Balancer" (C) and "Diformer" ultra low loss inductance coils (D, E and F). Adjustment for different length aerials (G). Shielded transformers, of celebrated make, amplify without distortion (H and I). Lowest dielectric loss type sockets—riveted into base panel. Low loss plate condensers—and other latest features of costliest sets. Literature describes fully—send for it!

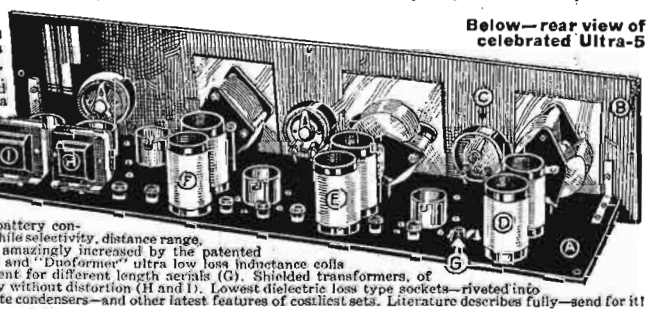

Below—rear view of celebrated Ultra-5

AGENTS! DEALERS!
Write for the new Miraco proposition. Nation-wide use and popularity of Miraco sets, coupled with their amazingly low prices make them wanted everywhere.

Other Miraco Long Distance Sets \$13.95 up retail
Remember you are dealing with a big, responsible corporation—one of the oldest and most successful in the industry, a concern which has grown to immense size through the recommendations of satisfied customers—when you buy a Miraco. Absolutely no risk on your part. All Miraco sets work on storage or dry batteries, are easily connected, operated, and lagged. Approved by Radio's Highest Authorities. Unmatched values! Let testimony of users convince you. Send coupon for complete literature and AMAZING SPECIAL OFFER!

All the Proof you want is waiting for You!
Reports from hosts of users in every state prove Miraco sets—at rock-bottom factory prices—outperform sets costing up to three times as much. Send for latest literature, SPECIAL OFFER and plenty of additional testimony leaving no doubt that "Miraco Radio Gets 'em Coast to Coast."

Send coupon for **Amazing Special Offer!**

Use the agency for it. Wm. E. C. . . . Torrington, Conn.

HAS EXCEPTIONALLY FINE TONE
My Ultra-5 works fine. My friend liked it very much and said it certainly is a good set and has an exceptionally fine tone. I would like to sell your sets in my spare time. H. M. S. . . . Stuttgart, Ark.

MIRACO RADIO GETS EM COAST TO COAST

MIDWEST RADIO CORPORATION
Pioneer Builders of Sets
Cincinnati, Ohio

404-S East Eighth Street
Send free literature, AMAZING SPECIAL OFFER and all particulars regarding your big money-saving proposition on Guaranteed Miraco Sets and all radio supplies.
 Agent User Dealer.

NAME.....
ADDRESS.....

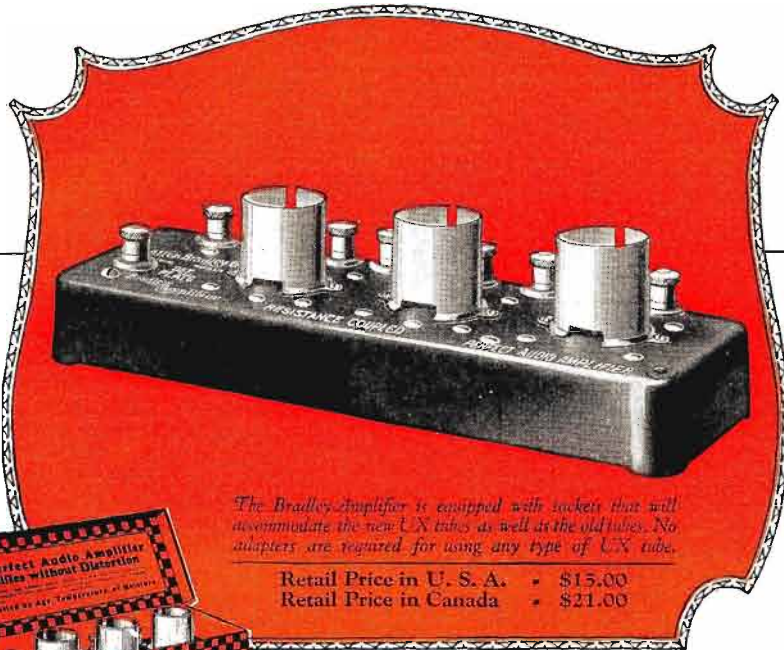

The Bradley-Amplifier is equipped with sockets that will accommodate the new UX tubes as well as the old tubes. No adapters are required for using any type of UX tube.

Retail Price in U. S. A. • \$15.00
Retail Price in Canada • \$21.00

The Heart of the Bradley-Amplifier



TUCKED away within the polished bakelite base of the Bradley-Amplifier are six inconspicuous, solid molded resistance units known as Bradley-units.

The Bradleyunit is the heart of the Bradley-Amplifier because it alone can amplify the incoming tone frequencies without distortion. It replaces the ordinary bulky audio-frequency transformer and eliminates the most frequent cause of distortion in a radio receiver. The Bradleyunit cannot deteriorate or change with age.

Surprise Your Friends

With The Improved Tone Quality of Your Set

IT IS NOT ENOUGH that a good radio receiver is selective or is able to bring in distant stations. Quality of reproduction is now considered as important as selectivity and sensitivity.

Fortunately, the tone quality of your radio set can be quickly improved and perfected without disturbing the existing wiring of the set. All that is necessary is to replace your present audio-transformer amplifier with a Bradley-Amplifier. This compact unit employs no transformers and amplifies all tone frequencies with faithfulness and clarity, and without distortion.

It is a mark of distinction to have a radio receiver of fine tone quality and you will surprise your friends with the remarkable improvement in your set that follows the use of a Bradley-Amplifier. It is as easy to install as a B-Battery and usually can be installed within the receiver cabinet.

Be sure to try one, tonight.

Ask Your Nearest Radio Dealer for a

Bradley-Amplifier

Resistance-Coupled
PERFECT AUDIO AMPLIFIER

ALLEN-BRADLEY CO.
287 Greenfield Ave.
Milwaukee, Wisconsin

Please send me, by return mail, literature on the new Bradley-Amplifier.

Name.....

Address.....

.....

give your radio set more power with one new Radiotron

Drive a car uphill beyond its power—and the motor knocks. Drive a radio set beyond its power—and the last tube chokes. But change one single tube in the set—and you have the power you need for *greater volume and finer tone.*

The new RCA power tubes add about fifty per cent greater efficiency to any radio set. They cost but \$2.50, and need only an inexpensive adapter and a little extra current. Change the tube of the last audio stage to a new power tube, as any dealer will show you—and in ten minutes you have a new set.



RADIOTRON
UX-112

RADIOTRON UX-112

The new storage battery power Radiotron UX-112 may be used in sets that use Radiotron UV-201-A.

\$6.50

RADIOTRON UX-120

The new dry battery power Radiotron UX-120 may be used in sets that use Radiotron UV-199.

\$2.50

You would not use any but a Mazda lamp in your lighting circuit. Why use any but an RCA Radiotron in your radio set? They are made by the same skilled workers, backed by the same research laboratories. But the Radiotron is far more delicate to make.



RADIOTRON
UX-120

RADIO CORPORATION OF AMERICA — NEW YORK — CHICAGO — SAN FRANCISCO

RCA Radiotron

MADE BY THE MAKERS OF RADIOLAS