

OVER 550,000 COPIES OF THIS ISSUE

RADIO NEWS

FEBRUARY
25 Cents

Over 200
Illustrations



BROADCAST
WRNY
STATION



Edited by HUGO GERNSBACK

CAN WE RADIO THE PLANETS?

(See Page 946)

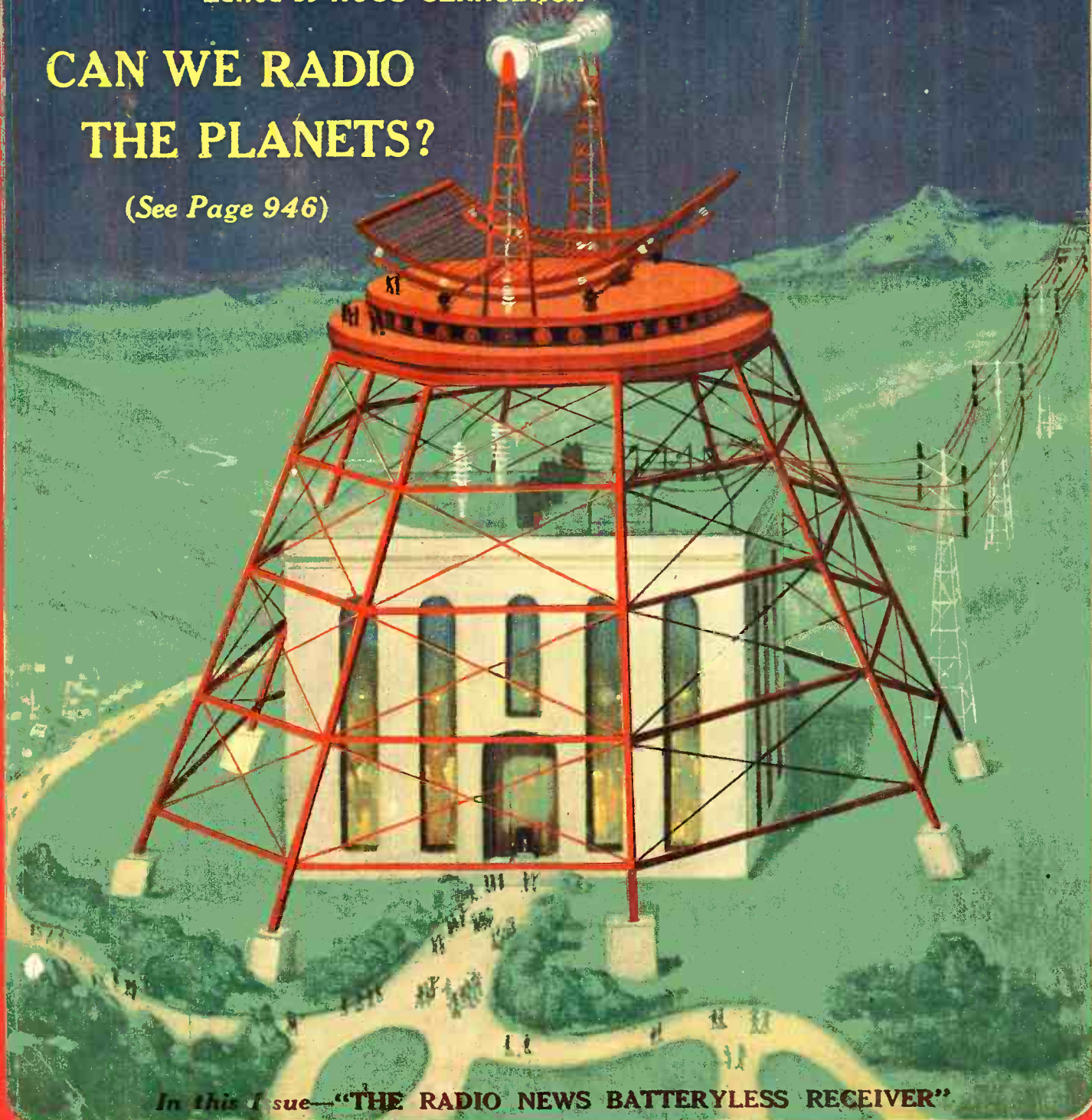

In this issue—“THE RADIO NEWS BATTERYLESS RECEIVER”

EXPERIMENTER PUBLISHING COMPANY, NEW YORK, PUBLISHERS OF
SCIENCE & INVENTION - RADIO REVIEW - AMAZING STORIES - MONEY MAKING - RADIO INTERNACIONAL

Cunningham

RADIO TUBES

Since 1915—
Standard for all sets



1 type in 1915
2 types in 1920
15 types in 1926

RADIO progress has set a fast and exacting pace these past few years. One single type of tube seemed adequate ten years ago. Four years ago two types apparently served the purpose. And today, with its greater and more exacting demands for improved radio reception, the research and engineering talent back of Cunningham Radio Tubes contributes its share to radio progress with fifteen perfected special purpose types, each one efficiently mastering its particular task.

To know the individual and special task of each one of these tubes when used in your set will bring to you an appreciation of increased radio enjoyment and more realistic tone reproduction.

Consult your nearest Cunningham Radio Tube dealer—learn how the *right combination of Cunningham Radio Tubes* will bring your present radio equipment up-to-date. Be sure that your receiver has the right combination of detector, voltage amplifier, power amplifier, and rectifier tubes to give it present day standards of performance in sensitiveness—in selectivity—in tone value.

FIFTEEN TYPES
All in the Orange and Blue Carton

E. J. Cunningham, Inc.

NEW YORK CHICAGO SAN FRANCISCO

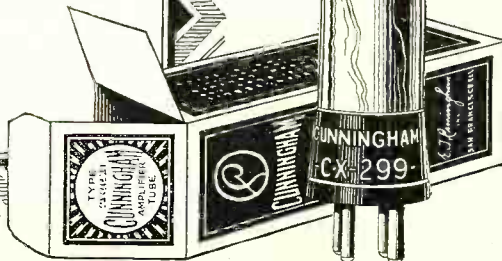



The Symbol of Value

THIS Tower trade-mark on a radio speaker or headset is your guarantee of maximum quality at minimum cost. Over 2,000,000 users of Tower products confirm this statement. Quality Speakers from \$4.95 to \$15. Headsets, \$1.95 and \$2.95. Phonograph Attachment, \$3.95.

Ask Your Dealer
To Demonstrate

On Sale from Coast
to Coast

Tower CONES

Manufactured by
TOWER MFG. CORP.
Boston,
Mass.

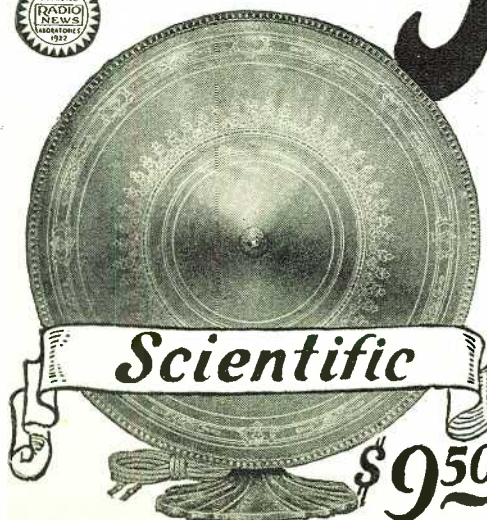

Scientific

\$9.50



Meistersinger

\$15.00

RADIO NEWS

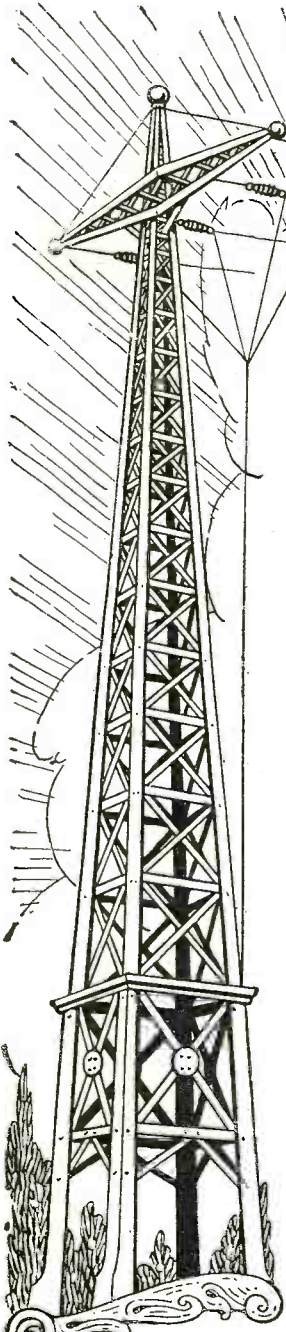

Published by EXPERIMENTER PUBLISHING COMPANY, Inc., Publishers of "Radio News," "Science and Invention," "Radio Internacional," "Radio Review," "Money Making" and "Amazing Stories."
 Editorial and General Offices: 53 Park Pl., New York City
 H. GERNSBACK, President. S. GERNSBACK, Treasurer. R. W. DEMOTT, Secretary.
 Member: Audit Bureau of Circulations Radio Magazine Publishers Association

VOLUME 8

FEBRUARY, 1927

NUMBER 8

Contents of This Issue:

Why the Radio Set Builder? By Hugo Gernsback	943	The Universal Pilotone Receiver, By Joseph Riley	972
Radio Photography and Television, By Dr. E. F. W. Alexanderson	944	The Haynes DX-2 Multivalve Receiver, By A. J. Haynes	976
Can We Radio The Planets? By Hugo Gernsback	946	The Aero-Dyne Receiver, By Herndon Green	980
England's First National Radio Exhibition, By A. Dinsdale	948	The Quadraformer VI. Receiver, By G. C. B. Rowe	984
The Paris Radio Exposition, By N. C. McLeod	950	Shielding in Radio Receivers, By M. L. Hartmann, Ph.D., and John R. Meagher	988
Radio News of the Month Illustrated, By George Wall	951	Progress in Radio,	990
What's New In Radio	952	Radio Wrinkles,	991
List of Broadcast Stations in the United States,	956	Correspondence from Readers,	992
Radio News of the Month,	957	Radiotics,	993
A New Alloy for Chemical Rectifiers, By Jack Koons	958	RADIO NEWS LABORATORIES,	994
WRNY'S New Transmitting Station,	959	The Radio Amateur, By G. C. B. Rowe	996
The "Ham," By Armstrong Perry	960	I Want to Know, By Joseph Bernsley	997
A Combined Power Amplifier and Plate-Supply Unit, By Horatio W. Lamson	961	Conductivity of Shielding Materials,	1040
The Uses of Resistances in Radio, By M. L. Muhleman	962	Radio Advertising Standards,	1047
The RADIO NEWS Batteryless Receiver, By McMurdo Silver	966	Tuning 'Em In,	1055
A Three-Foot Roll-Type Speaker, By Clyde J. Fitch	971	Overhead vs. Underground Reception,	1059
		Radio Jingles,	1063
		Book Review,	1068
		Current Radio Articles,	1072

In Forthcoming Issues:

THE CONSTRUCTION AND THEORY OF WAVE TRAPS
By James Wood, Jr.

A timely article, explaining how and why the set owner can cut out the interference of the nearby broadcast stations.

THE NEW SAMSON R.F.C. RECEIVER
By Joseph Riley

One stage of tuned R.F. and two stages of choke-coil coupled R.F. in this receiver make the amplification constant over the entire wavelength band, with high sensitivity.

THE ULTRA-FIVE RECEIVER
By Theodore H. Nakken

To the radio enthusiast who lives in a congested district, this receiver will be especially welcome; as it is one of the most selective sets that has come to the editor's attention.

RADIO NEWS is published on the 10th of each preceding month. There are 12 numbers per year. Subscription price is \$2.50 a year in U. S. and possessions. Canada and foreign countries: \$3.00 per year. U. S. Coin as well as U. S. Stamps accepted (no foreign coins or stamps). Single copies, 25 cents each. Checks and money orders should be drawn to order of EXPERIMENTER PUBLISHING CO., INC.

All communications and contributions to this journal should be addressed to Editor, RADIO NEWS, 53 Park Place, New York, N. Y. Unaccepted contributions cannot be returned unless full postage has been included. All accepted contributions are paid for on publication. A special rate is paid for novel experiments; good photographs accompanying them are highly desirable.

RADIO NEWS, Monthly. Entered as second class matter, July 12, 1924, at the Post Office at New York, N. Y., under the Act of March 3, 1879. Additional entry at Long Island City, N. Y., and San Francisco, Calif. Title registered U. S. Patent Office. Copyright, 1927, by The Experimenter Publishing Co., Inc., 53 Park Place, New York. The contents of this magazine are copyrighted and must not be reproduced without giving full credit to the publication. Copyrighted in Germany. Reproduction of articles in Germany is reserved for Radio, Berlin 42.

RADIO NEWS is for sale at all newsstands in the United States and Canada,

and at Brentano's, Ave. de L'Opera, Paris, France. European agents: S. J. Wise Et Cie, 40 Place Verte, Antwerp, Belgium.

HOW TO SUBSCRIBE FOR RADIO NEWS. Send your name, address and remittance to Experimenter Publishing Co., 53 Park Place, New York. Mention the name of the magazine you are ordering. We also publish SCIENCE AND INVENTION, RADIO INTERNACIONAL, RADIO REVIEW, MONEY MAKING and AMAZING STORIES. Write clearly.

RATES AND TERMS. The subscription rate for RADIO NEWS is \$2.50 per year (12 numbers). When remitting do so by check, money order, or registered letter if cash is enclosed. Avoid sending cash through the mail if possible. Subscriptions for less than one year are not accepted. Subscription may be made in combination with SCIENCE & INVENTION, RADIO INTERNACIONAL, RADIO REVIEW, MONEY MAKING and AMAZING STORIES.

POSTAGE. We prepay postage in all parts of the United States, Mexico and island possessions. For foreign or Canadian subscriptions we require 50 cents in addition to the subscription price for additional postage charge.

CHANGE OF ADDRESS. Notify us as far in advance as possible. It requires several weeks to make an address change on our records. Always write clearly. On expiration of your subscription we enclose a renewal blank in our last number to you; we stop our delivery to you on expiration.

General Advertising Dept., 53 Park Place, New York City.

ADVERTISING REPRESENTATIVES

FINUCAN & McCLURE, 720 Cass Street, Chicago, Ill.
 DAVIES, DILLON & KELLY, 15 West 10th St., Kansas City, Mo.
 T. F. MAGRANE, Park Square Bldg., Boston, Mass.

HARRY E. HYDE, 548 Drexel Building, Philadelphia, Pa.
 A. J. NORRIS HILL CO., 5 Third St., San Francisco, Calif.
 412 West 6th St., Los Angeles, Calif.

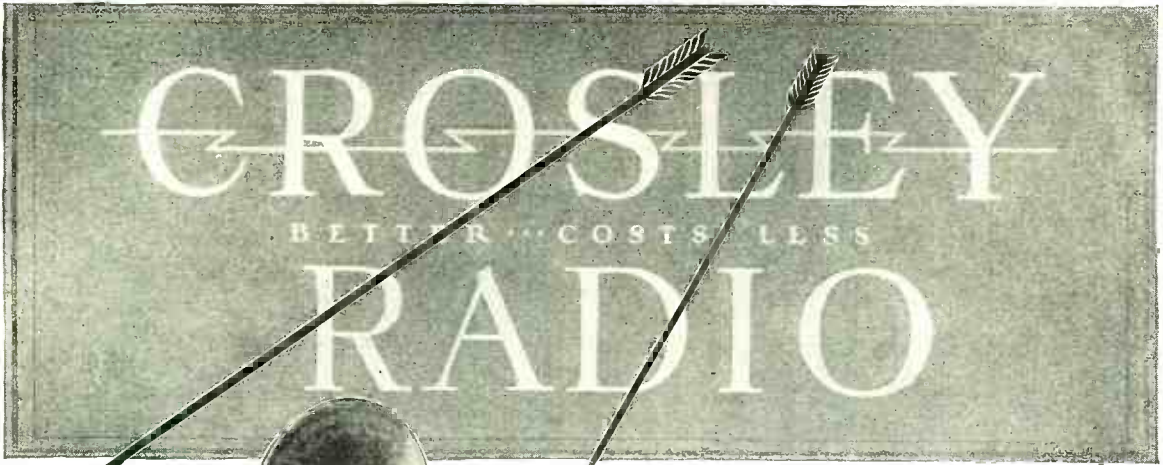

CROSLEY 1927 RADIOS

Each set giving the utmost in radio enjoyment at its price. All prices slightly higher West of Rocky Mountains. Price without accessories.



The 5-50—\$50

Enthusiastic owners report amazing performance—a drum delivering stations loud, clear and sharp; each an almost imperceptible turn of the drum apart. Write station letters on drum, return to them at will. Single drum Station selector. Accumulators, power tube adaptability and all metal chassis that shields the units from each other. Beautifully finished. Mahogany cabinet, rose gold trimmings.



The 5-75 Console—\$75

This set includes ideas for radio reception perfection not found in any other radio. Marvellous exclusive Crosley "Crescendos" and "Accumulators" increase volume on distant stations and bring in programs entirely missed and passed by on ordinary one-dial control radios. Console model stands 40 inches high. The Crosley Musicone is skillfully built into the cabinet in a manner which is both an artistic and an acoustical triumph. Ample space for batteries and accessories.



"6 Tube RFL-90" Console, \$90

Introducing the double drum station selector! Crosley's winning non-oscillating perfectly balanced tuned radio set. Includes Musicone skillfully built into exquisite console mahogany cabinet of two-tone finish to match finest surroundings. Room for batteries and all accessories; 40 inches high; 30½ inches wide.

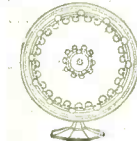

The Crosley Musicone

There is only one genuine Musicone. It's built solely by Crosley under mass production methods which makes its unmatched value possible.



"—as long as I can pick up 27 programs in 30 minutes beside our 3 locals this 'confusion of the air' won't bother me"

I sat down the other night with this Crosley set. One control. Beginning at one end of the broadcasting wave band I tuned in 27 stations, loud and clear, just like the Cincinnati stations, three of which were going full blast.

I listened to each program; identified it; didn't hear any others in the background, and passed on to the next,—all with one finger. It was between 7:00 and 7:30 P.M. Central Time. The air was certainly full.

Some of the stations were less than a dial marking apart. It is amazing how the jiggers they call "accumulators" helped on such fine separation.

Even using a hundred foot aerial the local stations were easy to go through. One of them is only a few blocks from my home.

Some radio I call it! \$50 seems too little. I'd like to see some two hundred dollar sets do as well!

Write Dept. 22 for Catalog

THE CROSLEY RADIO CORPORATION

Cincinnati, O. Rowel Crosley, Jr., Pres. Crosley manufactures radio receiving sets, which are licensed under Armstrong U.S. Patent No. 1,113,149, or under patent applications of Radio Frequency Laboratories, Inc., and other patents issued and pending.

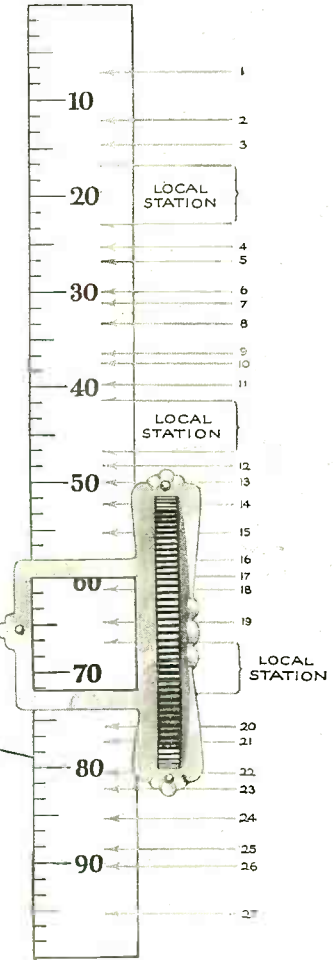

The above scale reading shows how stations picked up by Mr. X—appeared on the Crosley graphic drum station selector. Name on request.

Single Drum Control
 Prices slightly higher West of Rocky Mountains
\$50.

THE "CRESCENDON"
 When, on ordinary radios, ears must strain to catch a station miles away, a turn of the Crescendos on Crosley radios—instantly swells reception to room-filling volume. An exclusive Crosley feature.

ALL-METAL SHIELDED CHASSIS
 This truly great radio achievement, found in several Crosley sets, furnishes a substantial frame for mounting elements, produces excellent alignment of condensers,

shields the units from each other, prevents interference, improves the stability of the circuit, increases selectivity and saves costs by standardizing this phase of manufacture. "THE ACCUMINATORS" Crosley Accumulators per-

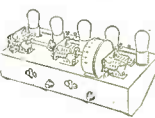

mit tuning in—loud and clear—weak stations passed over and entirely missed by ordinary single dial radios. In tuning high powered and local stations they are not used. They are an exclusive Crosley feature. **POWER TUBES** Power tube adaptability marks the Crosley "5-50" "5-75" and "RFL" sets. This feature typifies Crosley provision for best radio reception at moderate cost.





INDEX TO ADVERTISERS

Page	Page	Page	Page
A			
Acme Apparatus Co.1024	Diva Radio Corp1046	J.M-P Mfg. Co.1056	Radiall Co.1
Acme Electric & Mfg. Co., The 1030	Dodge's Institute1047	Jefferson Electric Mfg. Co. ...1048	Radio Association of America 1
Acme Wire Co.1074	Donle-Bristol Corp., The1046	Jewell Electrical Instrument Co.1044	Radio Corp. of America Back Co
Aero Products, Inc.1045	Dramatic Publishing Co.1014		Radio Institute of America1
Aerovox Wireless Corp.1010	Dubilier Condenser & Radio Corp.1004		Radio Receptor Co.1
Alden Mfg. Co., The 1018, 1021, 1022, 1024, 1026, 1028	Duke Radio Co.1058		Radio Specialty Co.1
All-American Radio Corp. 999			Randolph Radio Corp.1
All Radio Co.1055			Raytheon Mfg. Co.1
Allen-Bradley Co. 1014, 1031, 1038, 1063, 1074			Reliable Parts Mfg. Co., The ..1
Allen-Rogers, Inc.1026			Roll-O Radio Co., The1
American Auto & Radio Mfg. Co.1030, 1056			Rono Mfg. Co.1
American Electric Co.1016			
American Hard Rubber Co. ...1018			
Amplion Corp. of America1058			
Amrad Corp., The 941			
Armo Radio Labs.1050			
B			
Barawik Co. 1032, 1036, 1043, 1049, 1051, 1053, 1054, 1058, 1060, 1066			
Belden Mfg. Co.1033			
Bellaire Hotel1065			
Bogue, B. N.1016			
Boudette Mfg. Co.1032			
Bradley Institute1055			
Brady, John B.1065			
Bremer-Tully Mfg. Co.1076			
Bryant Electric Co.1010			
C			
C. E. Mfg. Co.1054			
Carborundum Co., The1027			
Carlton Mills, Inc.1042			
Carter Radio Co.1014, 1047			
Central Radio Labs.1011			
Chaslyn Co., The1043			
Chelsea Radio Co.1040			
Chemical Institute of N.Y., Inc. 1067			
Chicago Radio Apparatus1059			
Chicago Salvage Stock Stores.1075			
Chicago Stock Gear Works ...1020			
Chicago Technical College1062			
Clark & Tilson, Inc.1050			
Conrad Co., Inc., The ..1068, 1072			
Cooper Corp., The1062			
Copper & Brass Research Ass'n 1030			
Cornell Electric Mfg. Co.1019			
Cornish Wire Co.1018			
Coyne Electrical School1066			
Crosley Radio Corp., The 935			
Culver-Stearns Mfg. Co., 1022, 1034			
Cuno Engineering Corp., The 1042			
Cunningham, Inc., E. T. Inside Front Cover			
D			
Daven Radio Corp.1013			
Deutschmann Co., Tobe1058			
Distantone Radios, Inc.1006			
E			
Easton Coil Co.1042			
Electrad, Inc.1010, 1056			
Electric Specialty Co.1054			
Electrical Research Labs.1020			
Engineers Service Co.1046			
Eppe's1062			
Erie Fixture Supply Co.1048			
Everglades, The1065			
F			
Fansteel Products Co., Inc. ...1001			
Ferbend Electric Co.1023			
Ferguson, Inc., J. B.1052			
Ferranti, Inc.1048			
Fisher, C. C.1022			
Fishwick Radio Co.1059			
Formica Insulation Co.1011			
Fort Shelby Hotel1065			
Freshman Co., Inc., Chas.1029			
G			
Gearhart-Schleuter Radio Corp. 1017			
General Electric Co.1036			
General Industries Co., The...1062			
General Instrument Corp.1014			
General Radio Co.1020			
Gerold Company, The1044			
Golden-Leutz, Inc.1057			
Gould Storage Battery Co., Inc., The1043			
Gray & Danielson Mfg. Co. ...1016			
Grigsby-Grunow-Hinds Co. ...1041			
H			
Hammarlund Mfg. Co.1038			
Hammarlund-Roberts, Inc.1034			
Hampton Wright, Inc.1028			
Harco Co., The1020, 1046			
High Frequency Labs.1056			
Hommel & Company, Ludwig 1042			
I			
Illinois Stamping & Mfg. Co. 1066			
International Correspondence Schools1060			
International Resistance Co., 1060			
J			
K			
L			
M			
N			
O			
P			
R			
S			
T			
U			
V			
W			
XYZ			

These Leading Radio Manufacturers Solve Your Light Socket Power Problems with **RAYTHEON**

There is nothing startling or new in the idea of a B-Power unit to make light socket power available for radio reception. Many manufacturers have been selling such units over a period of years. Yet the organizations represented on this page have produced and sold in the period of approximately a year, a quantity of B-Power units, Raytheon-equipped, which equals the total number of all other types of B-Power units already in use.

This has been possible because of the intrinsic merits of the Raytheon rectifying tube, and the splendid co-operation of these organizations. The Raytheon rectifying tube uses rare gases instead of heated filaments or liquid solutions. It has long life, and requires absolutely no attention, save the ultimate replacement of the one tube. Raytheon Engineers are constantly co-operating with the manufacturers of Raytheon-equipped units for the perfection of their product, and only when mutually approved is the unit offered to the public. In this way, working together, Raytheon and its Approved Customers have established a record which has amazed the radio world.

Freedom from worry over the source of B-Power supply has been the fundamental reason for the desire for B-Power units using light socket power. In addition, the desire for improved quality, the use of power tubes, and the economy of operating multi-tubed sets from light socket power have demonstrated themselves as worthy reasons for the adoption of B-Power units. See to it that your set has a B-Power unit, — Raytheon-equipped.

Raytheon Manufacturing Company
Cambridge, Massachusetts

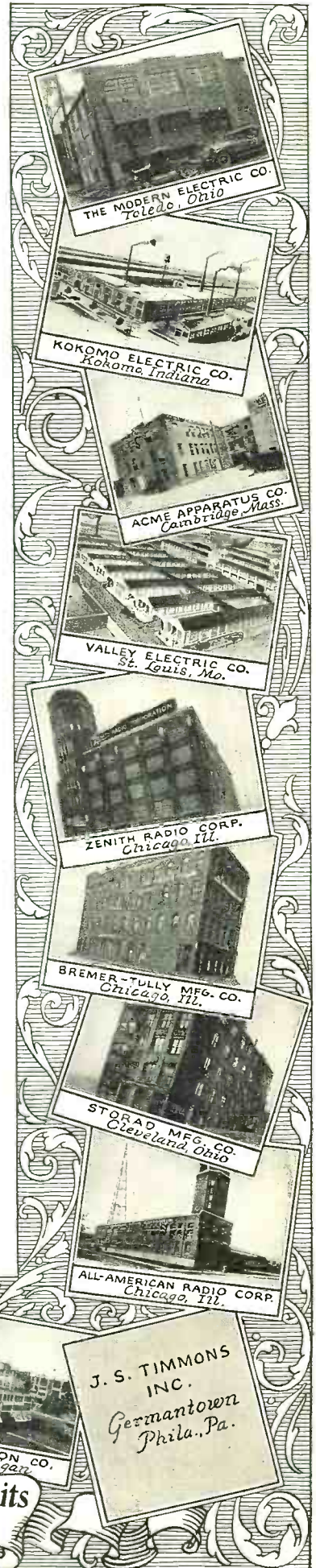

**Organizations Manufacturing B-Power Units
RAYTHEON-EQUIPPED**



I Will Train You At Home To Fill a Big Pay Radio Job



"I give you all this apparatus so you can learn quickly at home the *Practical Way*"



If you're earning a penny less than \$50 a week, clip coupon now. Send for AMAZING FREE BOOK, "Rich Rewards in Radio." Why go along at \$25 or \$35 or \$45 a week, when you could earn \$50 to \$250 in the same six days, as a Radio Expert? Hundreds of N. R. I. trained men are doing it—why can't you?

Earn \$50 to \$250 a Week

RADIO EXPERTS IN BIG DEMAND

Radio needs trained men. Get into this new live-wire profession of quick success. It's the trained man, the Radio Expert, who gets the big jobs of this profession—paying \$75, \$100, \$200 a week and up. Every day N. R. I. trained men are taking good places in the Radio field—men just like you—their only advantage is TRAINING. You can prepare just as they did, by new practical methods. Our tested clear training makes it easy for you. Big Free Book contains all the proof.

You Learn Quickly In Spare Time

So sure am I that I can train you successfully for a better future in this new Big-Pay profession, that I guarantee your training with a money-back bond. Lack of experience or education won't hold you back—common schooling all you need to start. You can stay home, hold your job, and learn quickly and pleasantly in your spare time. My practical, helpful methods enable you to start RIGHT AWAY toward one of the bigger Radio jobs paying \$50 to \$250 a week. No delay, no losing time from work—no scrimping or scraping to get your training.



Operates WMAQ
"Accepted a position with the Chicago Daily News Station WMAQ. MY INCOME PRACTICALLY DOUBLED, thanks to you. I handle all consultation, also do operating. Your course taught me not only the theoretical but also the practical knowledge that makes my work easy for me." Keith Kimball, Station WMAQ, Chicago, Ill.

Get This FREE BOOK

Most amazing book on Radio ever written—full of facts and pictures—tells all about the great new Radio field, how we prepare you and help you start. You can do what others have done—GET THIS BOOK. Send coupon today—no obligation.

J. E. SMITH, President
NATIONAL RADIO INSTITUTE
Dept. BB9, Washington, D. C.

FREE OF EXTRA COST

You Get All o' This

All instruments shown here and others sent to all my students free of extra cost under short time special offer. Clip coupon now—find out all about this big unequalled offer while you still have time to take advantage of it. This training is intensely practical—these instruments help you do the practical work. You learn workmanship and get added confidence in your ability.



World Famous Training That "Pays for Itself"

My Radio course World-Famous as the training that "pays for itself." Make more money QUICK when you take up this practical course. Work on millions of antennae, receiving sets, offers you big chance to make spare time cash while you're learning. I'll show you how—teach you the latest "dope." furnish you with business cards, show you how to get the business and make it pay. My students don't wait a year to increase their income—they report QUICK INCREASES as a result of this course—often two or three weeks after starting. Howard Luce, Friedens, Pa. made \$320 in 7 weeks during spare time. D. H. Suitt Newport, Ark., writes, "While taking the course I earned in spare time work about \$900." Earl Wright, Omaha, reports making \$400 in a short time while taking course—working at Radio in spare time! Sylvester Senso, Kaukauna, Wis., made \$500. These records not unusual—these men a few of hundreds.

Your Satisfaction Guaranteed

We who know the results this practical tested training gets—the increased earnings it has brought to men everywhere—stand behind it all the way with a signed guarantee bond that we give you when you enroll. On completion if you're not entirely satisfied in every way, you get back every cent you've paid us. No strings to this offer—you yourself are the only judge. Get started today! It's your big chance for one of the bigger Radio jobs—mail coupon NOW for my Big FREE BOOK and proof! No obligation.

\$70 in One Day For T. M. Wilcox

"I am in business for myself and RECENTLY MADE \$70 in ONE DAY. I was an electrician of rich experience, occupying a splendid position as telephone superintendent when I enrolled with you believing it would open up greater opportunities—haven't been disappointed. Estimate Radio will be worth tens of thousands of dollars to me in next few years. T. M. Wilcox, Belle Island, Newfoundland.

EMPLOYMENT SERVICE TO ALL GRADUATES

Originators of Radio Home-Study Training



Name..... Age.....
Street Address.....
Town..... State.....

Second call to this wonderful Magazine offer

Free

You save \$1.00 and get 100 page books free



WE GIVE YOU THIS VALUABLE BOOK

It tells you how to make furniture, home appliances, tools, sport devices, hundreds of things that cost hundreds of dollars otherwise.

It is full of drawings—pictures—constructional plans. Everything is explained fully—ready for you.

Regular Price of this Book is \$.50. We are giving it free with every subscription to—

SCIENCE & INVENTION

To tell you how tremendously and intensely interesting is this great magazine is to tell you that exactly 30,405 men, from every country in this wide world of ours, are regular listed reporters of SCIENCE & INVENTION.

The world is combed for big and small events in this marvelous scientific era—

Radio, Electricity, Chemistry, Mechanics—

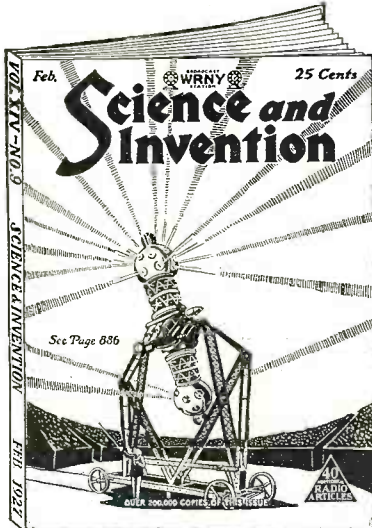

All Scientific fields of endeavor are covered fully.

Here is a list of some of the major articles in the brand new February issue just out—

- Movie Battle Scenes
- 2,000,000 Volts Let Loose.
- An Artificial Sky.
- Lodge N. Circuit.
- \$20,000 in prize contests.

Fill out the coupon below—Enclose \$2.50—and you get SCIENCE & INVENTION for 12 consecutive months—and absolutely Free, one copy of "How to Make It".

ACT NOW—This offer may never be repeated.

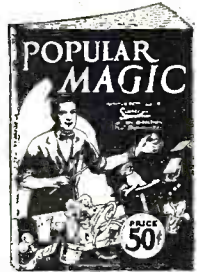

IT COSTS NOTHING TO OWN THIS BOOK

POPULAR MAGIC is a book for you, for everybody, young and old. But especially for those who want popularity, those who want to realize how much the admiration of friends help toward making life worth more.

POPULAR MAGIC contains thousands of simple, entertaining parlor tricks, as many puzzling magical stunts and a whole book full of mystic spirit novelties. A new set of tricks for every day in the year.

You get this book absolutely FREE by subscribing now

AMAZING STORIES

A new kind of magazine. Scientifiction by world-famed writers. Marvelous. Amazing Stories by great men such as Jules Verne, H. G. Wells, etc., appear in this new magazine AMAZING STORIES every month.

Stories of flying into space at dazzling speed on a comet; Mesmerizing the dead; remarkable situations of all kinds. Tremendously interesting—yet instructive.

Keeps you in touch with the writings of the men of the greatest imaginations in the world. A magazine for young and old.

Some of the big feature stories of the February issue just out are:

- The Land That Time Forgot by Edgar Rice Burroughs.
- On the Martian Way by Capt. H. G. Bishop, U.S.A.
- The First Men in the Moon by H. G. Wells.
- The Second Deluge by Garrett P. Serviss.

Price \$2.50 the Year. Think of it for only \$2.50 you get one copy free of POPULAR MAGIC and AMAZING STORIES for 12 consecutive months delivered to your door. Fill out and mail the coupon now.

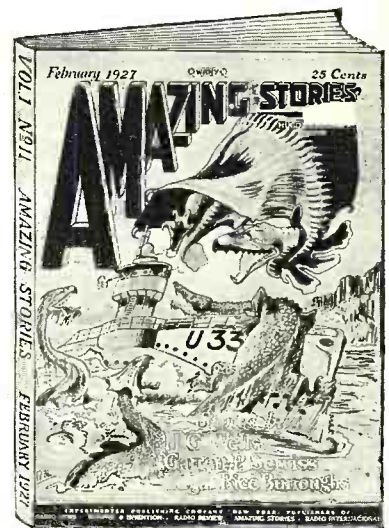

Experimenter Publishing Company, Inc.

53 Park Place
New York, N. Y.

EXPERIMENTER PUBLISHING CO., Inc.,
53 Park Place, New York, N. Y.

Gentlemen: I enclose \$.....for one year's subscription to....., you are also to send me free one copy of.....

Name

Address

City..... State.....

Experimenter Publishing Company, Inc.

53 Park Place
New York, N. Y.

ADD to YOUR "B" Eliminator for Better tone through a *Mershon* ELECTRIC 30 MFD-Duotype CONDENSER

Mershon Electric Condenser 15 mfd's capacity each half. 30 mfd's total capacity. Type D-15-30. Maximum rating 300 volts D.C. If punctured can be repaired and need not be thrown away.



Make Your Old B Eliminator a Super B Supply

Your present B Eliminator can be vastly improved by connecting a Mershon Condenser across the output voltage terminals! You will then get a wonderful tone quality from your radio receiver as the very large capacity of the Mershon (30 mfd's) will act as a reservoir to STORE energy to be on tap to instantaneously supply the heavy drains of plate current required by loud or long sustained notes. No doubt, you have noticed that although your B eliminator gives no AC hum you do not get that perfect reproduction of tones that was possible using new B batteries.

To simply filter out the light socket current hum is but part of the job. Eliminators must have STORAGE capacity to prevent "chopping off" the loud or sustained notes. Using a Mershon Condenser for this storage capacity gives the quality of expensive storage batteries and does the work electrically rather than chemically. There is no deterioration, adding of water, no elements to occasionally clean, no parts to be replaced, in other words a more SERVICEABLE device is at hand, as well as one providing amazing tone quality.

A famous Mershon added to your eliminator or used as the principal capacity of any B eliminator enables your set to reproduce notes from bass to treble with astounding accuracy.

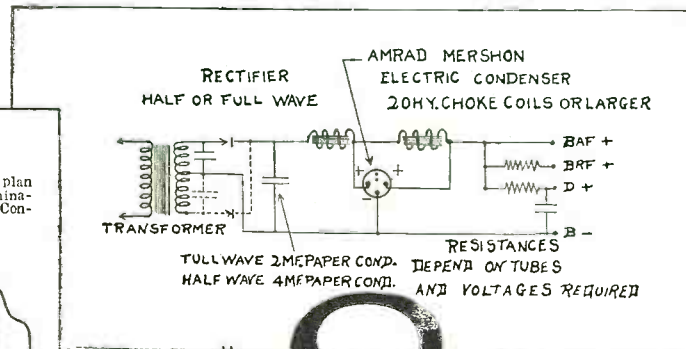
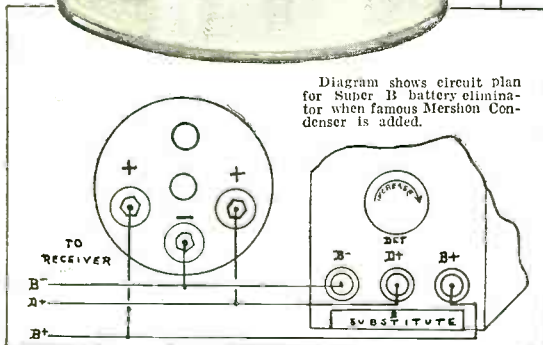

Circuit for building B eliminator using a Mershon Condenser as principle capacity.

AMRAD CORPORATION
MEDFORD HILLSIDE, MASS.

\$ 8. AMRAD

Write
Dept. 1B7
If Your
Dealer
Cannot
Supply

Battery Type and Light Socket Operated Neutrodyne



**One Dial
LONG DISTANCE
5 TUBE RADIO**

\$25.00

EVERYBODY, including experienced radio engineers said — it cannot be done. But we did it—produced a high grade, long distance single dial control radio to operate a loud speaker to retail for \$25.00—and yet allow liberal discount to agents.

This marvelous instrument is the result of five years hard work by an organization of trained radio engineers. It is no experiment — thousands are in use — the results speak for themselves.

There Will Be a Radio In Every Home

Thousands have been waiting for just such a radio — a real long distance, powerful instrument but — at a price they can afford.

It is here, and live wide awake salesmen will recognize their opportunity immediately — they won't lose a single minute writing for full information.

Just as there are 100 Fords to one high priced car, just so will there be 100 Vikings to every \$75.00 and \$100.00 radio — think what this means to men who get in on the ground floor right now.

A \$25 Radio Which Will Equal a \$75 Radio

Put a Model 599 Viking which retails for \$25.00 alongside any radio retailing for \$75.00 and even more. Compare them for ease of tuning — only one dial to tune on the Viking — distance received, volume and tone. The results will make any man say, "I'll save that \$50.00."

Radio is today the biggest and quickest selling line — thousands are being sold — salesmen have made unheard of profits. But here is a far greater, a far more interesting radio proposition than anyone ever dreamed of.

You Should Make \$100.00 a Week Easily

You can't help it — many will make more. Some will control a county — others will control many counties. We have the liveliest radio selling plan of today — instruments of all prices — a radio price to fit every pocketbook.

Any man who will follow our teaching cannot help but add big money to his present income and start to do it immediately. If you want more money here is your chance but you'll have to act quick — others will jump at this chance.

**Agents Wanted
Make \$100.00 a Week**

Sell Radio in Your Spare Time — Evenings

You don't even have to give up your present position. The only time radio can be sold is in the evening — by demonstration. So here is a chance to add to your present income. During the past five years we have trained 4364 men in this very profitable business.

You'll be the first one with a real low priced long distance radio — your price will startle everybody — the results will be even far more startling. Once you demonstrate you're sure of a sale. No one can think of investing \$75.00 to \$100.00 in a radio when this instrument will get the same results and your retail price is only \$25.00. Just think of the advantage you have. Sell a radio for only \$25.00, and yet make a handsome commission.

A Regular Radio at a Price Unheard Of

Uses five No. 199 tubes, operates on three ordinary dry cells. Only one dial to tune — a feature generally only found in the highest priced instruments. Any child can tune the Model 599 VIKING — simply turn the dial. Cabinet is extremely attractive, 12 inches long, 8 inches high and 6 inches deep. The wood is covered with Keratol, embossed in a very attractive design. On the front are two very odd gold colored, colonial designs inserted in two panels. The base and ends are finished in a rough gold and black colored finish which together with the rich seal brown Keratol of the balance makes a cabinet that would be an ornament in any home.

The tuning is arranged so that it is accomplished by the use of one special low loss condenser and a basket weave coil. Sockets, rheostat, potentiometer and base board are all of bakelite. Three transformers give an abundance of volume for loud speaker. Parts will equal the average \$75.00 or \$100.00 radio instrument — only enormous production could possibly bring about this low price.

Territory is Going Fast — Better Write Today

Someone is going to get the big profit on the sales of these instruments in your community — is that someone going to be you? Write today for our 100 page book which fully describes not only this wonderful instrument but also full line of radio at all prices. It's FREE for the asking.

Use This Coupon

H. P. Fischer,
122 W. Austin Ave.,
Chicago, Illinois.

I am interested in selling your 5 tube set in this territory. Please send me your 100 page radio book, FREE.

Name.....

Address.....

City..... State.....

SEND FOR 100 PAGE FREE BOOK

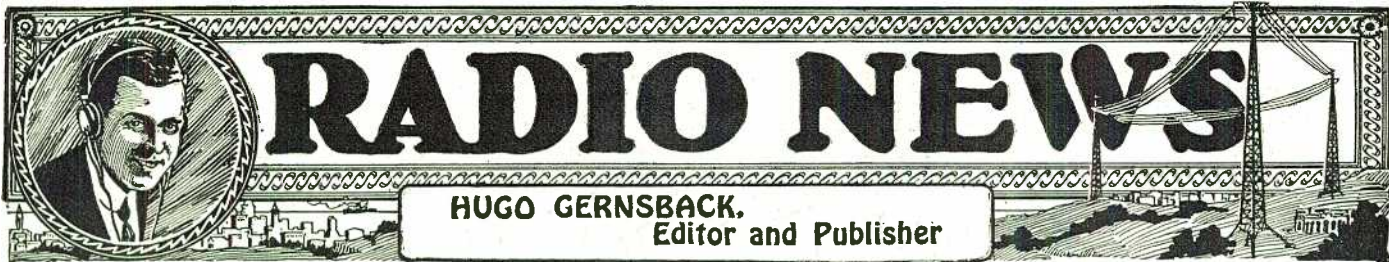

EDITORIAL AND GENERAL OFFICES, 53 PARK PLACE, NEW YORK

Vol. 8

FEBRUARY, 1927

No. 8

WHY THE RADIO SET BUILDER?

By HUGO GERNSBACK

WHEN radio was young, in this country, you could not go out in the open market and buy a complete radio set. I refer to the time when radio first came into vogue; that is, after the appearance of the modern vacuum tube, in 1912. At that time such a thing as a radio cabinet was unknown. We used to mount our instruments of various descriptions on our table; and the more room they took up, and the bigger the table was, the better pleased we were.

This state of affairs lasted for a number of years, and possibly culminated about 1923 in the first vacuum-tube sets of the multiple type, which then made their appearance. It is true that, beginning with 1918, we had possessed a few self-contained sets of the cabinet variety which, of course, had been used, not for broadcast purposes, but for listening to code.

When broadcasting finally made its appearance, the factory-made set took the country by storm; and, while previously the home-built set had been in vogue, the factory set took the ascendancy immediately. Today, at least in this country, the factory-made radio set for broadcast purposes has far outstripped the home-made set in popular demand. By this I do not mean to imply that the genius of radio constructor who builds his own set has died out. Quite the contrary. There are more sets being built this minute than ever before.

From the best available sources at hand, it seems that there are, at the present time, between 400,000 and 500,000 people who annually build sets, and this figure seems to be on the increase. Large as this figure may seem, it is small compared to the figure of factory-made sets annually turned out in this country (over 2,300,000 at the last census of manufacturers); and it may be said that the manufacturers of ready-made sets today do not worry about the home-built set, but, rather, encourage it. This, at first thought, would seem paradoxical; but it is true, nevertheless, for the following simple reasons:

Radio is an art which changes rapidly, as is well known. While no revolutionary improvements have been made in the past ten years, or are likely to be made soon, changing styles, as well as improvements, keep the trade on the jump. New condensers come out, new dials are devised, new coils are produced. At the present time the shielding idea has attained great favor, almost overnight. Naturally, for this reason, set manufacturers are always anxious to incorporate the latest devices in their receivers.

But once the manufacturer is "tooled up" to turn out the season's supply, it is not always possible or desirable for him to make a change. In the meanwhile the art and progress of radio goes on, and the manufacturer naturally wants to know, in plenty of time, what the tendency will be for next year. By encouraging the set builders he gets a very good idea in what direction the tendency is heading; and he is able, at no cost at all to himself, to get this information, by simply watching the radio press and studying this tendency. When the new season comes along, the manufacturer is, therefore, apt to have a pretty good idea of what will happen, or what may be expected to happen next season. This is not to say that the manufacturer gets all of his ideas from the radio constructors. No such meaning is implied; but he gets valuable information; and for that reason most set manufacturers today openly encourage set building, because, first, they know that it cannot hurt their business and, secondly, because they derive from it valuable information which they would not have if there were no set building going on.

The set builders themselves, in the meanwhile, are having a mighty fine time, building to their hearts' content; in which they are encouraged by the parts manufacturers, who are themselves always ahead of the set manufacturers in bringing out new devices. These new

devices are tried out by the set builders, and within six months it becomes known whether a certain device will "take," in the long run, or not.

This has been the case with the straight-line-frequency condensers, as it has also been with the new vernier dials. It is true of shielding the various parts and many other features; none of which would, perhaps, have become incorporated in ready-made sets as soon as they were, if the set builders themselves had not paved the way for such parts.

On the other hand, by encouraging the set builders, the parts manufacturers get, themselves, very valuable experience which they would not obtain otherwise; and, once the majority of set builders have adopted a certain article, the set manufacturers in turn will adopt it as a rule. Such was the case, for instance, with the straight-line-frequency condenser, which was used by set builders for some six to eight months before the set manufacturers adopted this type of condensers.

It may be said, therefore, that the set builders are always ahead of the game; they are forever pioneering. If you wish to see the latest circuit, or if you wish to see the latest radio wrinkle applied, you will always find it in the best home-made sets. All of this does not mean that the set builder does not use the ready-made set; in most cases he does. There is hardly a radio constructor today worth his salt who does not own two or three sets that are in constant use.

For instance, I myself have two factory-made sets in my home, whereas the set which stands on my study table is one constructed by myself. This particular set probably does not stay there for more than a month at a time, because next month I shall be using a later model; but in the meanwhile the factory-made sets are doing their duty and are being used constantly by the household.

This condition is found all over the country, for it is duplicated in the home of practically every set constructor.

Radio set building may be said to be one of the greatest hobbies that ever came into existence. Unlike most other hobbies, it actually serves to advance a new art, and paves the way for better and bigger things.

To be up to date, under conditions that change as quickly as do those in radio broadcasting, radio receivers must forever be kept up to the minute. Though the changes are gradual, they are constantly taking place, and their effect is cumulative. You would not think of using, in the midst of the heavy traffic on Fifth Avenue or State Street, a 1914-model car that had to be cranked by hand. No more can you expect the set of 1922, built when there were but a few broadcast stations, to give satisfaction, particularly in our congested centers. It is a well-known fact that every time a station changes its transmitter, or increases its power, thousands of nearby sets are immediately found to be inadequate, because they cannot tune sharply enough to cut out the nearby station and get others at will.

Investigation usually shows, on such occasions, that most of these unselective sets are single-circuit or crystal receivers, and others of ancient vintage, which are no longer suitable for present-day radio traffic. Furthermore, additional demands are being made right along on the selectivity of radio receivers, because the broadcast stations are continually increasing their power. The set builder, naturally, keeps pace with the evolution of broadcast conditions, and is forever ready to build a new and better set to meet future requirements.

Set building is continuing to increase rapidly, as it has done for five years, in this country; and, now that we stand on the threshold of television, I believe I shall not be contradicted in saying that set building will assume tremendous proportions, undreamt-of today, during the next five years.

... In which the Editor recalls the early days of Radio, before factory-made sets could be obtained—why the manufacturer of receivers is not unkindly disposed to the set builder—how the latter is doing some of the most important pioneering in radio design—why the enthusiastic set builder is also a purchaser of good commercial receivers—and why this great hobby is appealing year by year to greater numbers of intelligent people who in it find the highest pleasure. . . .

Mr. Hugo Gernsback speaks every Monday night at 9 P. M. from station WRNY on various radio and scientific subjects.



Radio Photography and Television

How the Use of Several Wavelengths Simplifies the Problem

By Dr. E. F. W. ALEXANDERSON



SINCE the transmission of music and speech by radio has come into its own, many scientific experimenters have been looking for new fields to conquer, in this same realm of radio. Photographs have been transmitted across the Atlantic Ocean by radio in twenty minutes, and now that this is an accomplished fact, improvements on the method are being sought.

Dr. E. F. W. Alexanderson, one of the foremost radio engineers in the world, has been working for the past few months on the improvements mentioned above. He has succeeded in transmitting, by radio, photographs in one tenth of the time that it previously took; and the copies, taken from the air at the receiving end, are excellent reproductions of the originals. Dr. Alexanderson, however, is looking beyond the transmission of photographs; his goal at the present time is "television," his theory of accomplishing which he outlines in the accompanying article.

—EDITOR.

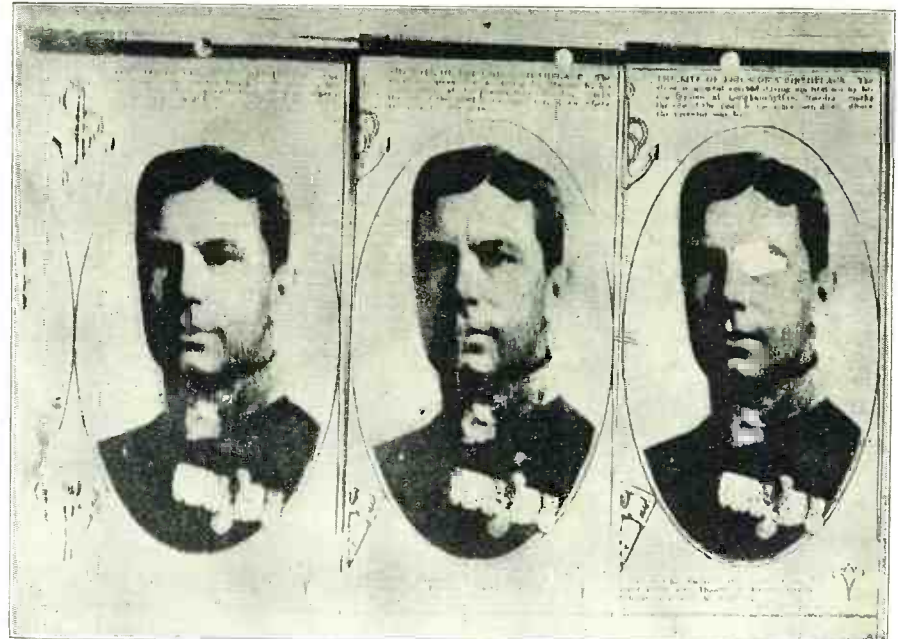

Fig. 1. These three copies of the same photo were transmitted at different speeds. They were sent in two, four, and eight minutes, reading from left to right, as explained in the article.

IN the well known play by George Bernard Shaw, "Back to Methuselah," is described a scene which is supposed to take place in the year 2170. The head of the British Government holds conferences with his various cabinet ministers several hundred miles away. He has at his desk a switchboard and in the background of the room is a silver screen. When he selects

the right key at the switchboard, a life-sized image of the person with whom he is speaking is flashed on the screen at the same time that he hears the voice. The fact that one of his ministers is a lady lends some dramatic color to the incident, but this is beside the point.

A passage of this sort from the pen of a great writer, is significant. The new things

that civilization brings into our lives are not created or invented by anybody in particular; it seems to be predestined by a combination of circumstances that certain things are going to happen at certain times. Great writers and great statesmen seem to have the first presentiment of what is coming next. Then the inventors and engineers take hold

At the right is shown the receiving mechanism of Dr. Alexanderson's apparatus. The cylinder, in which is enclosed the negative, is being removed from the motor attachment that rotates it.

Below is shown the transmitter. The revolving shutter for interrupting the light source is seen under the man's elbow. The impulses are amplified before they are transmitted.

Below is a closer view of Dr. Alexanderson's apparatus for transmitting photographs by radio. The photo to be sent is being placed on the revolving cylinder, which is synchronized with the cylinder at the receiving end. Photos by courtesy of General Electric Company.

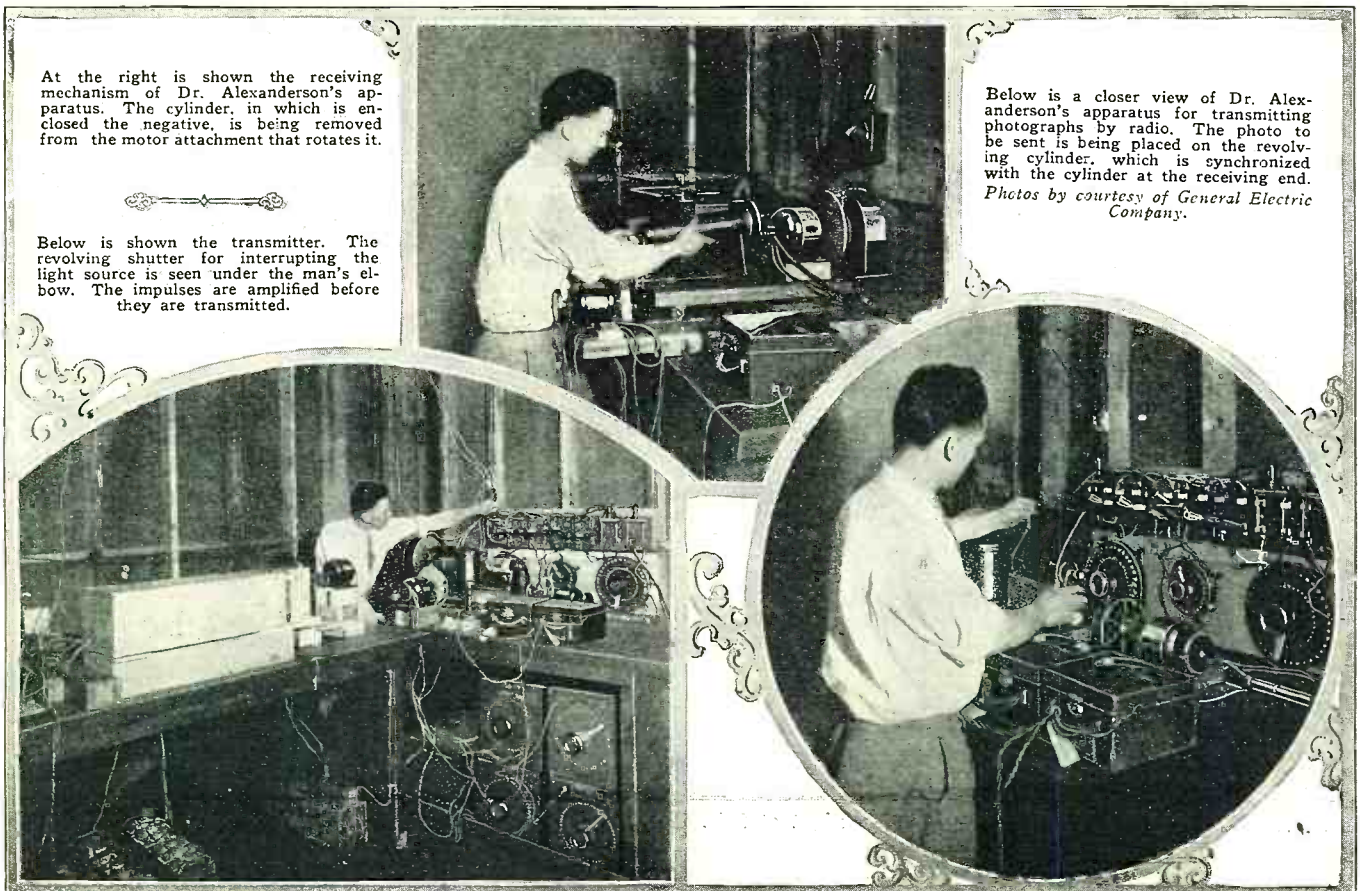

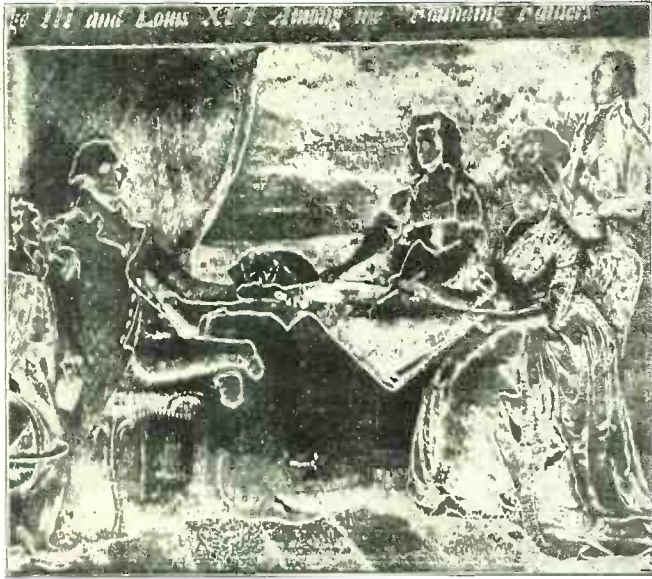

This distorted picture was made from a newspaper reproduction of a steel engraving of "Washington's Family" by E. Savage. The distortion is due to the improper adjustment of the receiver apparatus. This picture may serve to give a visual idea of the audible distortion sometimes experienced by broadcast listeners.

a preliminary study of commercial transmission of pictures and facsimile messages over long distances. The recording instrument used in making these originals is a standard General Electric oscillograph, with some adaptations, the availability of this highly developed instrument having made

of the same ideas and dress them up in practical form. It is now several years since Mr. Owen D. Young, at a banquet, expressed his hope that radio would soon give us visual means of communication. The idea seemed at the time absurd to many of the technical men present; but work was promptly started and we have at least gone so far that a commercial radio picture service is in operation across the Atlantic Ocean.

It takes at present twenty minutes to send one of these pictures, whereas the imagination of Bernard Shaw forecasts a *direct* vision of distant moving objects.

From moving-picture practice we know that the realization of this idea would require the transmission of a series of pictures at the rate of sixteen per second. It is a long way from twenty minutes to one-sixteenth of a second. It means that we must work almost twenty thousand times faster than we do now. However, we have tackled this problem; and I shall attempt to show what prospects we have of realizing practical television. In doing so we shall think of the scene described by Bernard Shaw as the ultimate goal.

TELEPHOTOGRAPHY

The principle of picture transmission over wires or radio was worked out about fifty years ago, and all work done at the present time is based on this same principle. The work of fifty years ago, though described in many books and patents, fell into neglect; but the development of radio has renewed interest in the subject. We have also some new tools to work with, such as the vacuum-tube amplifier and the photo-electric cell. Radio photography has thus become an established fact. A practical realization of television, or the art of seeing moving objects by radio, involves some difficulties which have heretofore seemed almost insurmountable.

However, before dealing with the problems of the future, I shall give a brief picture of the contemporary art of telephotography. So much has already been published on this subject that I need give only a few references. Since the interest in telephotography revived, the work has been taken up simultaneously in America, France, England, and Germany, and the names of a number of engineers, Korn, Belin, Jenkins, Ranger, Ives, Karolus, Petersen and Baird among others, have become familiar. I hesitate in giving these names, because there are surely some equally important ones that I have left out.

The accompanying illustrations show some telephotographs made in Schenectady. The originals were made at a rate of sixteen square inches per minute, and thus were produced in two minutes. They were made as

it possible for us to enjoy rapid progress in the development of a practical technique in telephotography. Our energies can now be devoted largely to the main problem, which is the adaptation of the radio art to this new use, and particularly to devise ways of dealing with our old enemies—static and fading—when we wish to transmit pictures over long distances.

STATIC AND FADING

The radio art has, up to the present, developed two distinct methods of signalling: by modulation and by interruption. The first is usually associated with broadcasting and the second with telegraphy. Both of these methods of signalling may be adapted to radio photography, and each will have its

distinct field. The effective range of a broadcast station is very much shorter than that of a telegraph station of the same power; but within this range it gives a service of excellent quality. The accompanying samples of pictures were made with a modulation-frequency of 3000 cycles, which can easily be transmitted by the ordinary broadcast stations. It is therefore possible that a picture service may be given by these stations, which will be of the same standard of quality as their musical entertainments.

Freedom from disturbances is insured by having a large number of stations interlinked by a wire system, so that a good selection of entertainment is available in all parts of the country. This method of dealing with static and fading may be characterized as "brute force"; but after all it is this mode of operation that has developed radio into the great industry that it is now. This whole broadcasting machinery is now available, should the public become interested in radio photography for entertainment or otherwise.

For long-distance communication we have, fortunately, another method of using the radio wave, which is much more sensitive and economical. The most striking illustrations of this are the feats of amateur operators in communicating with their friends on the other side of the earth with small home-made sets adjusted to short wavelengths. So far this method of signalling has been limited to dots and dashes; but ahead of us are the possibilities of using this wonderful medium of communication to transmit pictures, facsimiles of letters or printed pages and moving-picture films. These fascinating possibilities have induced so many investigators to work on this problem.

In our research work on the development of radio photography and television, we have
(Continued on page 1030)

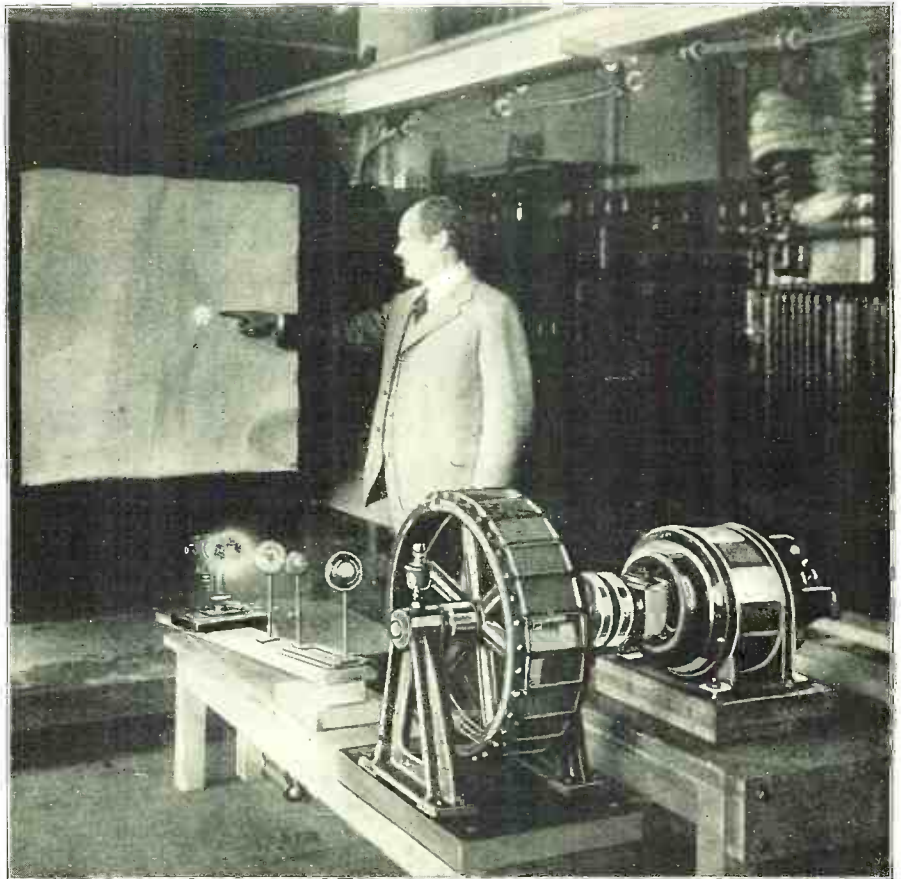

Fig. 2. Dr. Alexanderson in his laboratory indicating the seven light-spots, which are used in the method proposed by him for television. In the foreground is the drum on which are mounted the mirrors, with the motor for rotating it. A system of lenses may be seen, together with an arc light.

Can We Radio

By HUGO

MEMBER AMERICAN

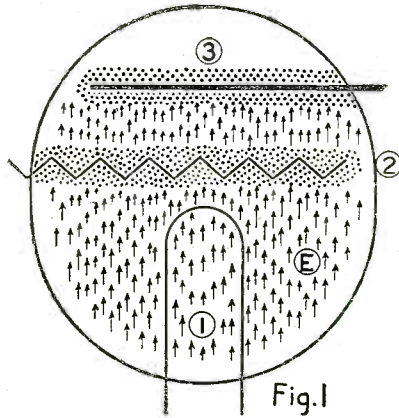
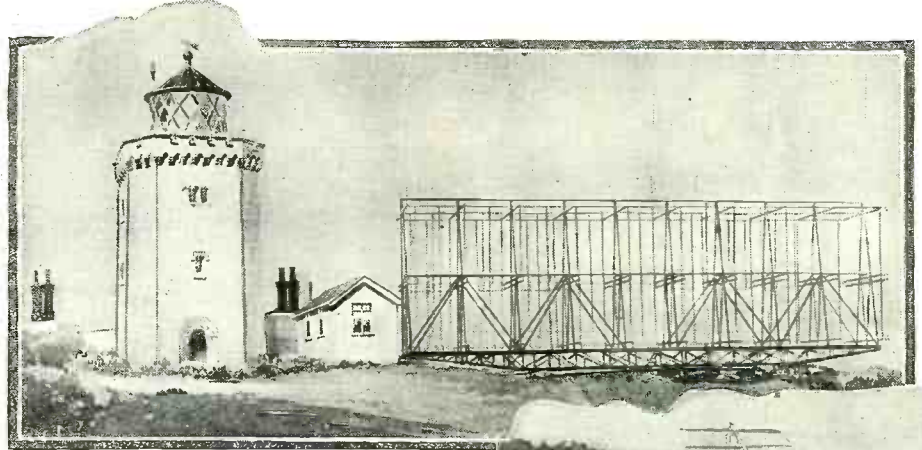

Fig. 1



6

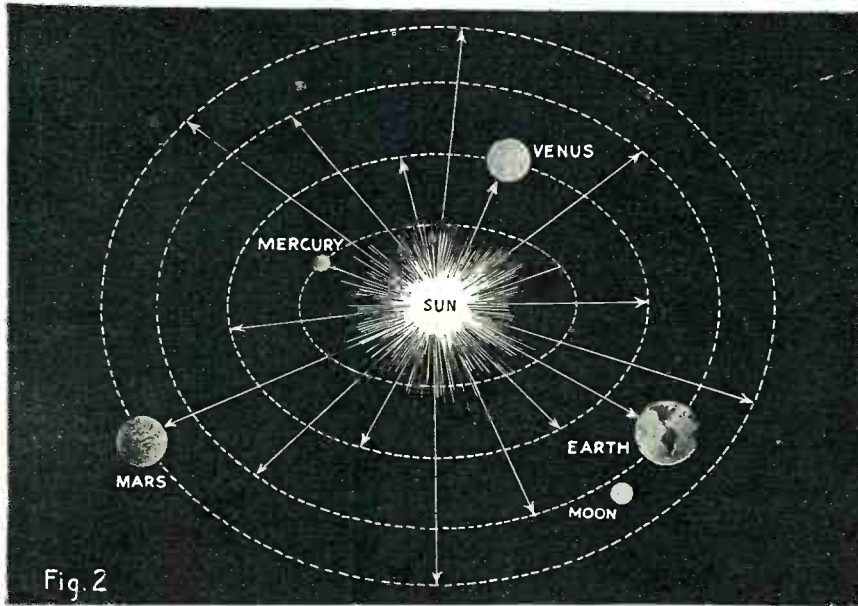
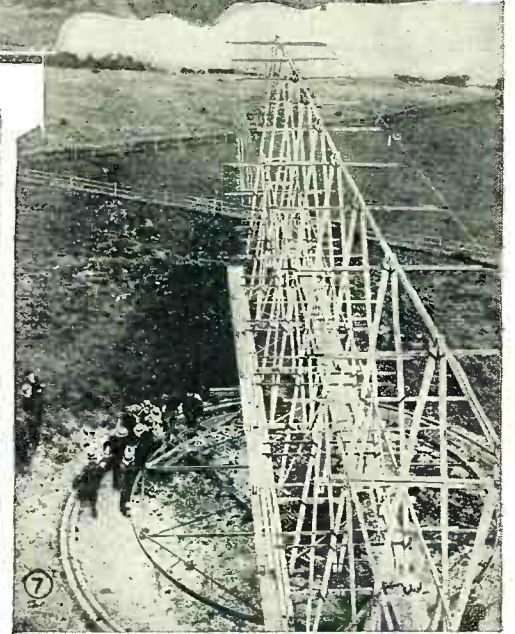

Fig. 2



7

Fig. 1 shows the interior of a vacuum tube where (1) is the filament, E is the stream of electrons going in the direction of the arrows. (2) is the grid, (3) is the plate. The small dots surrounding the grid and plate indicate a layer of gas always adhering to metals, which the electrons must pierce. This shows, therefore, a miniature Heaviside layer. Fig. 2 shows a "celestial" vacuum tube, in which the sun gives off the electronic stream in the direction of the arrows. The various planets may be taken respectively as plates and grids in a multi-element tube; while the atmospheres of the planets are analogous to the gas adhering to the plate and grid, as shown in Fig. 1. Figs. 6 and 7 are two views of the Marconi Beam Transmitter, located at South Foreland, near Dover, England. It revolves, transmitting a radio signal over a very small angle at one time, and is in use as a radio "lighthouse," aiding navigation.

WHEN Jan Lippershey built his first telescope in 1608, he came in for severe condemnation, because it was argued that such an instrument of the devil could never do any good. When our own Percival Lowell first propounded his theory of the Martian canals and Mars as the abode of life, he, too, was greatly ridiculed as a visionary; and even today orthodox astronomers do not share his views. When the first telescope was built, the then *intelligentsia* could not see any good in it, except as an instrument of the devil; so when I ask the question, "Can we radio the planets?" I know that I shall be subjected to not a little ridicule.

The telescope and spectrum analysis have opened the heavens to us to a tremendous extent, and enriched our scientific knowledge immeasurably. Spectrum analysis has shown us that stars, millions of light years removed from us, are constituted of identically the same matter as that found in our own earth; making it, therefore, reasonably certain that the entire universe is composed of practically

identical matter, with little possibility of exception.

As you will see further on, when I pro-

"CAN We Radio the Planets?" does not necessarily mean that the author has attempted in this article to design apparatus to transmit and receive intelligence to and from other worlds, although such a possibility is discussed. Rather the author brings forth an entirely new point, where it is seriously suggested—by means of the beam system—to send and receive back the same beam, for scientific research work, as well as explore our own planet for scientific purposes, by means of the gigantic radio power station.

ound the question, "Can we radio the planets?" I do not necessarily imply that in doing so we can send intelligence to Mars

or Venus, or to the moon, with the expectation of getting an answer—although the latter may not be as impossible in a hundred years as it is now. I am simply trying to show that, by making a start, an untold wealth of knowledge may be opened up to us; and that, the sooner we make the start, the greater the art of radio and our knowledge thereof will become.

The largest telescopes have been made possible through the generosity of our wealthy people, and it is, therefore, not impossible to hope that what has been done in building telescopes can be duplicated in building super-power stations for radio for research purposes. I might say, right here, that the benefits derived from such a super-power radio station will no doubt be vastly greater than from building a telescope, and for the following reasons:

The telescope is useless when it comes to exploration of our own earth. It is built to explore the heavens. A super-power radio plant can be used, not only to explore the heavens, if I may call planetary space such,

the Planets?

GERNSBACK

PHYSICAL SOCIETY

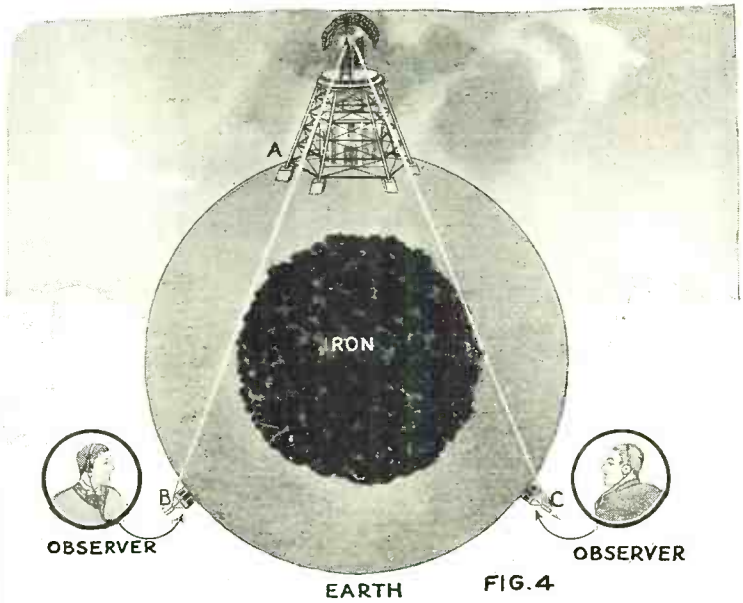
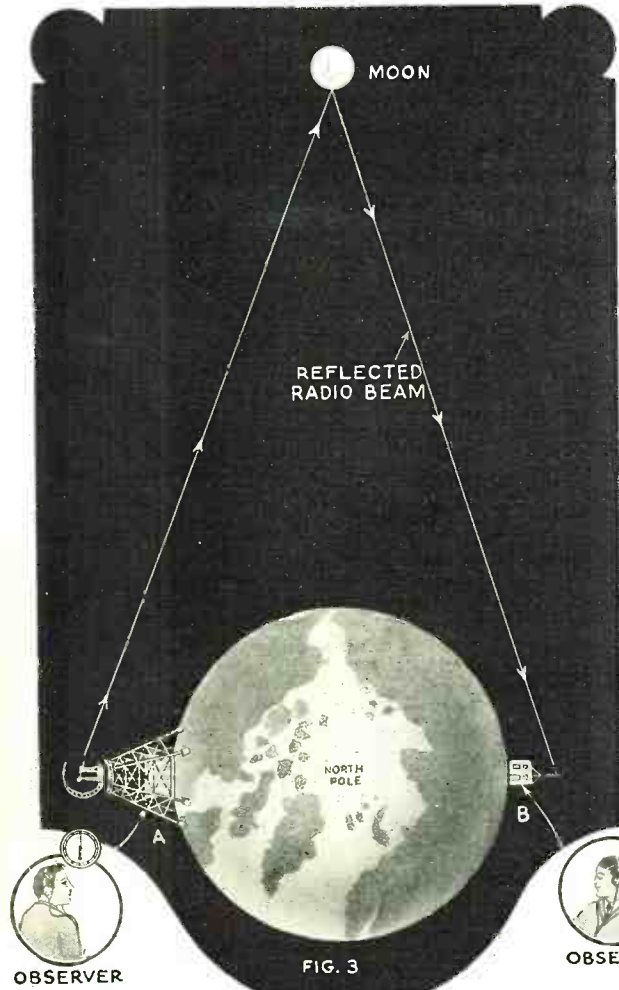

SIGNAL RECEIVED 2 1/2 SEC. LATER

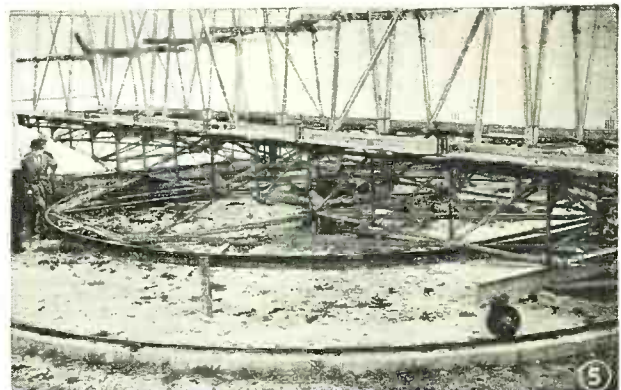

Fig. 3 shows how, by means of a powerful beam transmitter, located at some point "A" on our globe, we can send a beam of radio waves to the moon, which, being more or less metallic, will reflect the beam at the same angle. An observer, located at "B" on the opposite side of the earth, will receive the signal back from the moon, a distance of 238,000 miles, in two and a half seconds after it leaves the transmitter "A." Fig. 4 shows a radio beam-transmitter "A" at some point on the globe, transmitting a beam to "B" or "C." As the angle of the beam is varied, the respective observers will get the signal either strongly or not at all. By this system it will be possible to explore the interior of the earth, to ascertain how large is the earth's iron core. It is assumed that the radio beam will travel through the crust of the earth readily, while not at all through the solid iron core. Fig. 5 is another view of the Marconi revolving beam transmitter.

but also for tremendously important radio research work between points on our own planet.

PENETRATING SHORT WAVES

I am fully aware of the criticism that will at once be raised, that it is not possible for us to send a radio beam beyond the confines of our own atmosphere, due to the so-called Heaviside effect, which is supposed to exist a hundred or so miles above the surface of the earth. According to the researches of the eminent scientist, Oliver Heaviside, the upper layers of our atmosphere are supposed to be so conductive electrically, due to the ionizing effect existing at such heights, that the radio waves are reflected; and it would thus seem impossible that we could shoot a radio beam outside of the confines of the earth.

This may be perfectly true when it comes to the usual radio waves, such as have been used in the past, varying from some 15 meters up to 25,000 meters; although I maintain, along with many other physicists, that the Heaviside effect has never been proven conclusively. I am equally certain that at lower wavelengths, say from two meters downwards, entirely different conditions appear, for the following reasons:

an electromagnetic activity, the same as light waves or heat waves. It is believed that, the lower down we go in the wavelength scale (that is, the higher the frequency), the easier it becomes to penetrate the Heaviside layer, if we grant its existence at all. Light comes to us from the sun and the planets, through the Heaviside layer, so we know that the Heaviside layer cannot stop light waves. To be sure, the frequency of light waves is enormously higher than that of even the shortest radio waves, but it still seems reasonable that for waves of the length of two meters or even less, the Heaviside layer should not cause us undue worry.

Incidentally, interplanetary conditions are about the same as we find in our present vacuum tubes. Fig. 1 shows a vacuum tube, in which (1) is the filament, (2) the grid, (3) the plate. Electrons are given out by the filament (1), and shoot in the direction of (3); but, surrounding the grid and the plate, there is a miniature Heaviside layer, composed of a slight amount of gas, which surrounds all metallic and other matter, and which the electrons must first pierce before they can reach the grid or the plate.

IN THE INTERPLANETARY VACUUM

Given a reasonably strong bombardment of

electrons, this internal tube "Heaviside layer" can be broken down as is well known. Conditions on earth seem to be similar. If we employ the right radio wave, with sufficient power behind it, it should be possible to pierce the supposed Heaviside layer and shoot the waves out into free space. In this we would be assisted by the force of the solar radiation itself. This is made plain in Fig. 2, which shows that our own planetary system is nothing but a vacuum-tube arrangement on a large scale. We have the sun in the center, with the planets outside, which in this case become the plate and grid of our celestial vacuum tube.

It will be noted that the solar radiation is in the direction of the arrows. It would seem, therefore, that a beam of the correct radio wave sent, let us say, from the earth to Mars, when in "conjunction," would stand a better chance of being transmitted than *vice versa*. For that reason, it would seem that a supposed signal emanating from Mars earthward would find it necessary to work against the stream of solar emanations, and encounter more resistance than if the case were reversed and the signal were sent from earth to Mars.

(Continued on page 1045)

England's First National Radio Exhibition

An Account of the Recent London Radio Show

By A. DINSDALE

FOR the first time since radio broadcasting began in England, its radio manufacturers have combined to hold one single great exhibition, fully representative of the entire British radio industry. In previous years several exhibitions had been held, each sponsored by different interests; but none of them was fully representative, because some manufacturers either were excluded from exhibiting at one show, owing to non-membership in the controlling body, or, having shown at one exhibition, refrained from appearing at any of the others.

The disadvantages of such lack of co-ordination are obvious, from not only the point of view of the manufacturers themselves, but also that of the interested public. In previous years the enthusiastic fan had to visit all the exhibitions, unless he was content to miss something, and the industry suffered from duplication of effort and lack of uniform policy.

In 1926, therefore, England had only one show (apart from small subsidiary provincial exhibitions), which was known as the First National Radio Exhibition, and held in London between September 4 and 18 in one of the large new halls recently added to Olympia, which is one of the largest covered-in spaces in the world.

MANY STRANGE CONTRASTS

One of the most striking features of the show was its array of contrasts and strange anomalies. With the knowledge and experience we have accumulated on all matters relating to broadcasting, and to broadcast receiver design in particular, one would expect a contemporary radio exhibition to reflect this knowledge and be up-to-date.

The British show was up-to-date, right up to the very last minute of British radio design; but cheek-by-jowl with wonderful multi-tube sets, masterpieces in design, construction and performance, were to be found

crystal sets, single-tube "bloopers," and two- and three-tube sets, the designs of which had not been altered from those originally employed when broadcasting first started!

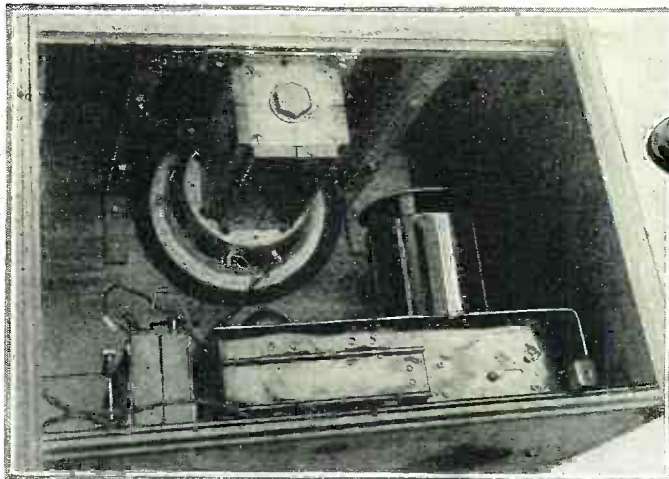

There were sets with horizontal panels, bristling with tubes, small old-fashioned condenser knobs, rheostat knobs, rotary-stud switches, etc., and with sundry coil-holders protruding from the sides of the cabinets. Many of these sets, together with others of more modern design, were equipped with "dull-emitter" tubes mounted in the original old-time rigid sockets.

By comparison with the Third Annual Radio World's Fair in New York, the London show provided many even stronger contrasts. The former, as it appeared to a Britisher, may be summarized briefly as having exhibited a large collection of expensive multi-tube sets with comparatively few mod-

"Donotone" cone speaker, and springs, as shown in the lower sketch.

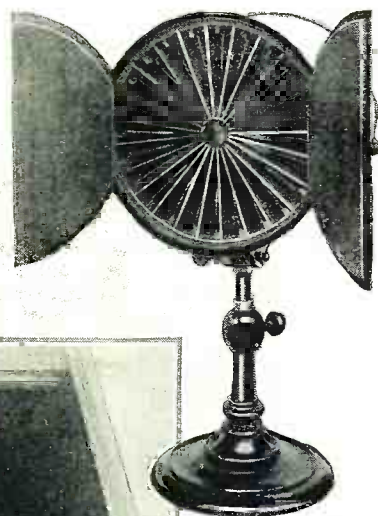

Two English loud speakers. That at the left is a cone-type with amplifier, complete in the cabinet. Above is the baffle, which has radial baffles in the cabinet.

erately priced outfits and component parts for the home constructor.

The London show catered to the needs (and pocket) of everybody—even the most economical of purchasers. Everything in the way of sets, of both ancient and modern design, was available, from simple crystal sets all the way up to 9- or 10-tube supers.

PROFUSION OF COMPONENTS

A stranger would have had no difficulty in deciding that here was the exhibition of a country whose radio fans prefer to "roll their own." Components were everywhere, a vast range of them in a vast range of design, suitable for every conceivable circuit and circumstance. The effect of this peculiar situation is that, with a few exceptions, British components and sets made from them are of a higher standard than the great majority of ready-made sets in Great Britain. With a relatively restricted market for ready-made sets (as compared with that for components) this is a natural result.

There was a good display of variable condensers, almost all of which were of excellent design and construction. England is just now in the throes of a "straight-line" craze.

As regards verniers and slow-motion tuning devices, England has a very good line of slow-motion dials to her credit; but many of her condenser manufacturers are now producing condensers in the mechanism of which various slow-motion devices are incorporated, either by means of gear systems or friction-drive arrangements. In such instruments the ordinary large dial controls large movements of the condenser in the usual way, while a small concentric knob, set in the middle of the dial knob, controls the slow-motion mechanism, for fine tuning. Most of these condensers are beautiful pieces of work from an engineering standpoint, and function excellently from a radio point of view; but they are so good mechanically that, from our point of view at least, the price is too high.

At least one original design of variable condenser was displayed, in which movement

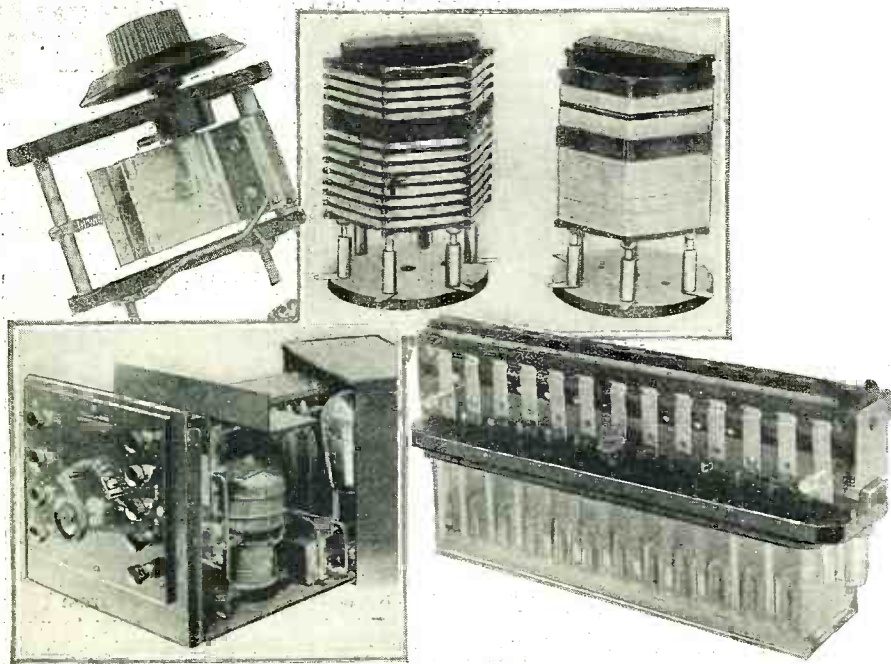

The variable condenser at the upper left is operated by a cam regulating the overlap of two plates. At the right are two types of plug-in inductances of a low-loss construction. Below, at left, an English battery eliminator; and at the right a "B" battery with switches changing the internal connection for charging purposes, as explained in the text.

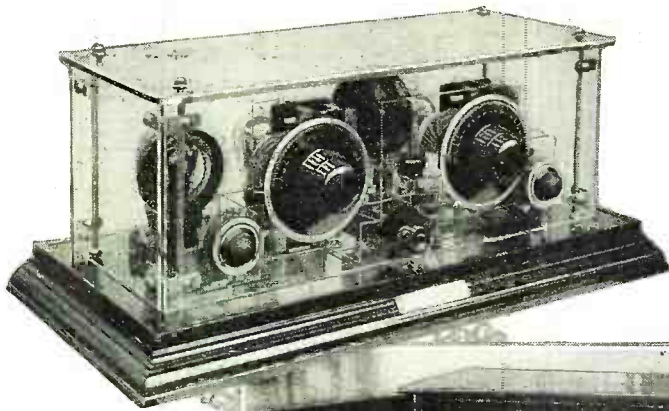

At the left is shown a receiver which employs plug-in inductances. This type of set is very popular in Great Britain because of the wide range of broadcast wavelengths used throughout Europe.

A single-dial receiver which has, instead of plug-in coils, a switching arrangement for changing the wavelength range of the set; so that it will tune in any of the European broadcast stations.



of the dial turns a cam which is used to regulate the degree of overlap of the two plates, which are separated by a thin mica dielectric.

A large number of the condensers on view are copied from well-known American designs. Ball bearings are another outstanding feature of this year's condensers.

COILS AND R.F. TRANSFORMERS

In the matter of coils and R.F. transformers, the situation is still complicated by the necessity for making English receivers adaptable for any wavelength from 200 to about 4,000 meters, because many of the European broadcasters use all sorts of wavelengths within this band.

Several various freak designs of coils of the alleged "low-loss" type have now almost entirely disappeared, giving place to sensible and scientifically designed and constructed plain solenoid coils. For short wavelengths these are wound in a single layer on ribbed forms; for longer waves the diameter of the wire is reduced, and for the very long waves they are wound with fine wire in thin "pancake" sections.

In the case of R.F. transformers, the primary is first wound as a plain solenoid and then the secondary is wound over it, but separated from it by ribs which, in effect, give about one quarter of an inch of air spacing. For the longest waves, where the coils are wound in pancake sections, primary sections alternate with secondary sections.

In all cases one or another of the windings is center-tapped for neutralizing purposes, and the leads are brought out to a five-pin base, which allows the coil or transformer to be plugged into a standard base socket.

Many of these coils and transformers are fitted with shields.

No outstanding developments have taken place in other components, progress, in the main, being limited to minor improvements in design and construction. Self-adjusting filament resistances have now made their appearance and are rapidly becoming popular.

BATTERY ELIMINATORS

As in New York, so in London, this is proving to be a great battery-eliminator year. This development is natural enough, and is, as a matter of fact, long overdue. It is very greatly to the credit of British manufacturers that they have at last tackled this problem, for, in England, it is a problem;

the electric supply system is very far from being standardized as in America. Up and down the country D.C. will be found at all voltages from 100 to 250 volts. Alternating current is also to be found covering a similar range of voltage, but it may be single-phase or polyphase, and of all kinds of odd frequencies. Several widely different supply systems may be found even in the same city.

Under these circumstances the difficulty of the problem before the manufacturer wishing to place a suitable battery eliminator on the market will be appreciated. Most of the eliminators on view at the London show, either for A.C. or D.C. mains, were marked as suitable for a certain narrow range of supply voltages (e.g., 100-125 volts), such

ranges being designed to cover the voltages most commonly met.

The majority of the A.C. units shown made use of thermionic rectifiers; but at least one was equipped with a gas-discharge rectifier and designed to give full-wave rectification. The rectifier consists of a form of neon lamp, in favor of which it is claimed that an eliminator employing it consumes an infinitesimal amount of main supply current, as compared with thermionic rectifiers, the filaments of which have to be heated from the mains.

There was a dearth of "A" battery eliminators, however. Such devices were, for the most part, combinations of small-capacity storage batteries working in conjunction with trickle chargers.

Of batteries, both "A" and "B", there was a liberal display, storage "B" batteries being very prominent. One of the latter is fitted with quite an ambitious switching arrangement for rapidly altering the connections of the battery for charging purposes. The battery consists of twelve cells, above which, and extending its full length, is a large barrel switch; which, when rotated, will provide on the output terminals 24 volts, 6 volts, or 2 volts, or disconnect the battery leaving all cells open-circuited.

The main advantages of this scheme are in connection with charging. It is, for instance, much more economical to charge a high-voltage battery at a low charging rate when the source of supply is D.C. than it is to cut down wastefully the voltage of the supply through resistances.

On the other hand, it is often inconvenient to provide the low charging rate required for the small cells of a high-voltage battery; and thus the sections may be series or series-parallel connected so that a much heavier charging rate can be employed and the battery connected up on charge with large "A" batteries.

LOUD SPEAKERS

The display of loud speakers at Olympia was large and varied, the exhibits generally being very similar in outward appearance to those shown in Madison Square Garden.

(Continued on page 1043)

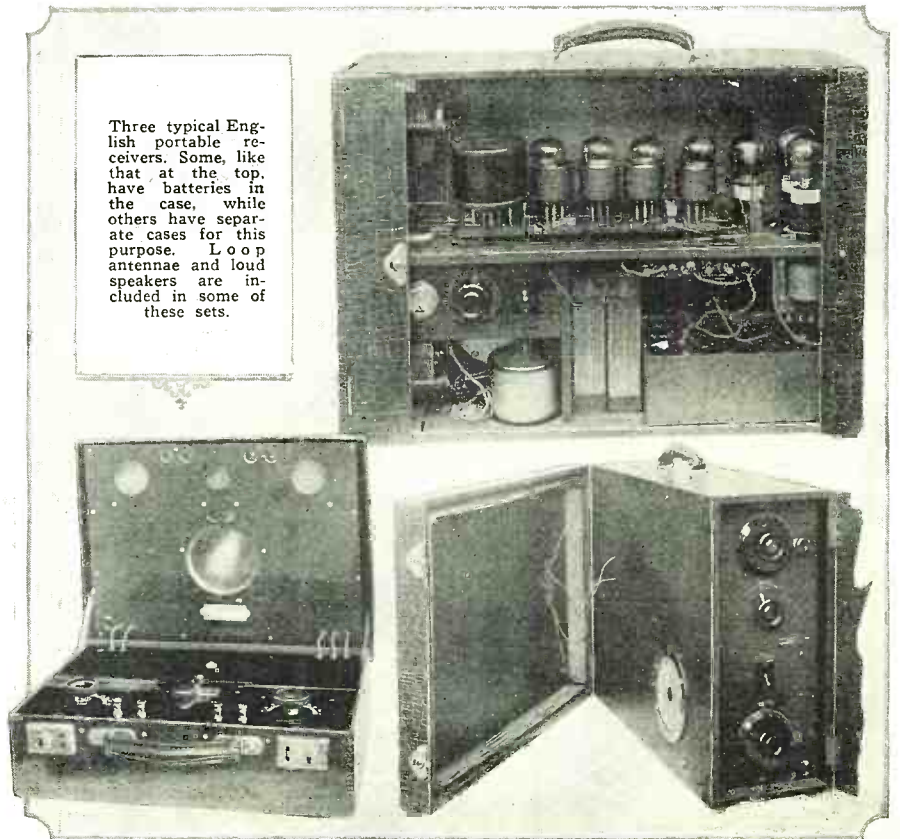

Three typical English portable receivers. Some, like that at the top, have batteries in the case, while others have separate cases for this purpose. Loop antennae and loud speakers are included in some of these sets.

The Paris Radio Exposition

A Description of Some of the French Radio Devices

By N. C. McLOUD

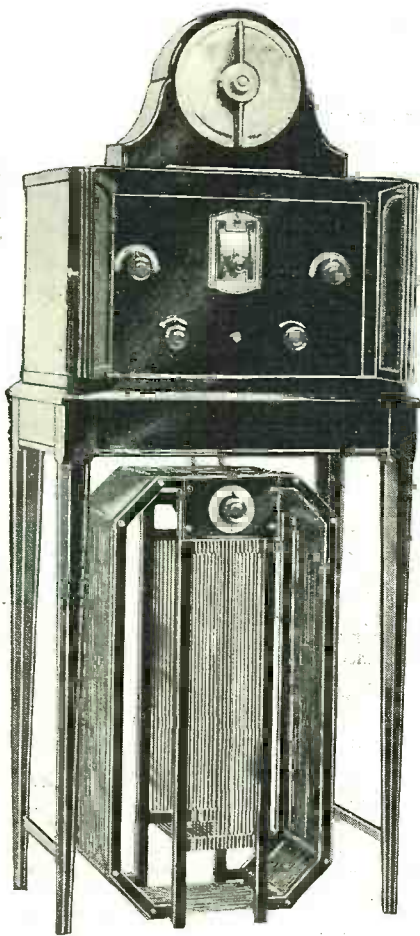

floor, while the lighter radio instruments occupied the whole of the great balcony.

As one approached the building, it was evident that the radio show was in full swing; for the giant loud speakers on the roof blared forth the music of the day or bellowed announcements at the passers-by. The noise was such that often on starting from the Place de la Concorde, one could hear the music distinctly, and follow the announcements for several hundred feet on either side of the building.

The first stand that caught the eye of the scientifically-inclined amateur, once he was inside the building and up the balcony stairs, was that of the radio lighthouse group, set up by the French government to show the method of fog signalling now used along their coastline. The entire outfit of a radio lightship, including the power plant, was assembled in the stand, and attracted a large amount of interest from city dwellers, who had not yet realized this phase of radio utility. The principle is the same as that of any continuous-wave station, and the transmission can be detected for some twenty miles from the coast in all directions.

While novelties in receiving sets were not in unusual evidence, several minor improvements could be seen. France has definitely followed the other countries into the realm of decorative art as applied to radio; but the French, always inclined to be leaders in a new idea, have turned to the "modernist" lines in cabinets and loud speakers, rather than try to adapt the conventional lines of the past to this new science. The results may seem, perhaps, to the Anglo-Saxon, a trifle bizarre. Properly set, however, the rounded frames, the octagonal and fan-shaped loud-speaker horns, and the highly polished combination wood panels are in most part attractive to the eye; and they will probably enjoy a far greater popularity, among the general public, than do the old-fashioned exposed sets of the first "hams."

One large manufacturer is bringing out a new loud-speaker horn of the diffuser type, with a specially-treated small cone of a higher tone purity and more decorative effect; the paper appears almost like an imitation tortoise-shell or smoky celluloid. One of the directors of the company states that it is selling an average of 500 per day from the factory for distribution in France alone.

DURING the last week of October, 1926, there was held in Paris the great radio exhibition at the Grand Palais, on the Avenue des Champs Elysees—a striking contrast with the first, that of three years ago, when a combination was made with the industrial and laboratory physicists of France, and the mighty building was a labyrinth of scientific innovations, mysterious flashes, roars, clicks, and hoarse loud speakers. At the latest exposition where only the purer tones of the modern loud speakers were evident another combination was effected, in which the overflow of the automobile industry (principally the commercial vehicle phase) was given the ground

At the upper left is shown a French receiver, which embodies several novel features. The loud speaker has a specially-treated diaphragm and the loop antenna a double frame, on which there are two sets of windings. At the right is shown a French press-dispatch set, used in newspaper work, which is a typical example of the method of mounting the vacuum tubes. Notice the number of controls.

Below is shown the exhibition of the Société Française Radio-Electrique at the Paris Show, demonstrating the installation of a commercial station with all the various accessories.

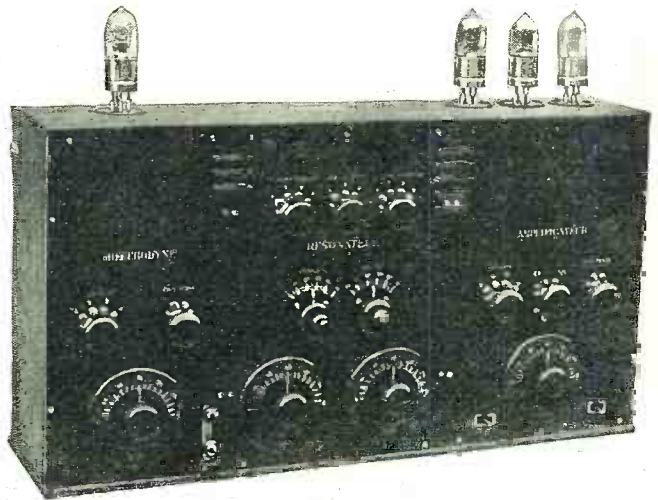

SINGLE-CONTROL SETS

The French have turned with enthusiasm to the single-control set for reception, and there were many different models among those on display. One has a dual control that gives the impression of being single, as the two condensers are on one vernier, and having once been set on a certain wave, can be adjusted together. One company, that of Lucien Levy, famous for his heterodyne patents and also for his proposed radio "death ray," showed a single- or automatic-control set, the "Syncrodyne." On its panel the various stations to which this set can be tuned are numbered, and the tuning is done merely by turning the dial to the number desired. M. Levy is using a built-in aerial below his receiver; but this is more of a screen than a loop.

The built-in aerial appeared frequently. If a loop was used outside, it was generally camouflaged by a covering of chintz or other material with attractive design. There were many multi-tube sets in evidence, as the French are showing a great interest in the British, German, Spanish, and even the Russian stations. This would appear to be from the standpoint of variety rather than from
(Continued on page 1041)

Radio News of the Month Illustrated

By GEORGE WALL

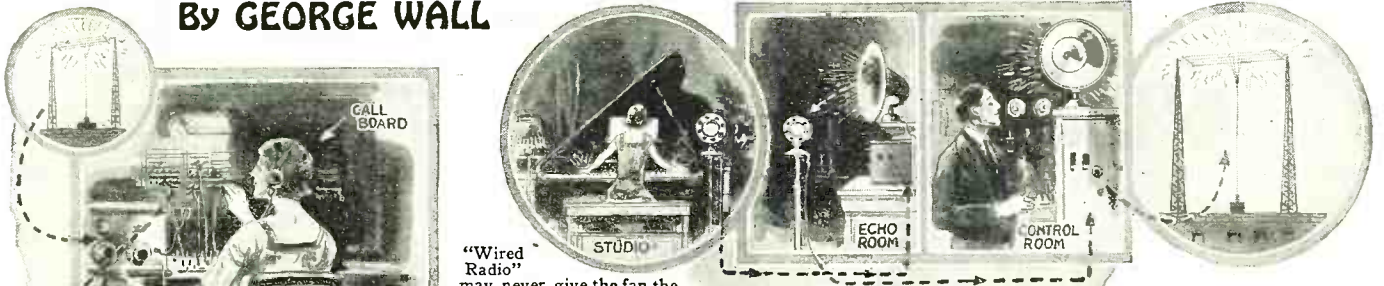

"Wired Radio" may never give the fan the pleasure he finds in building his own; but its use will increase. In St. Paul the telephone company is utilizing reserve wire capacity for this purpose.

Station 2LO, London, has an "echo room," which is bare of the usual heavy studio drapery. Here a loud speaker reproduces the program, and a microphone collects the reverberations and adds them to the modulation of the music. This effect is never used with the voice of a speaker.

The telephone lines offer an excellent circuit, so that it is easy for "Central" to plug in any number of speakers on the jacks connected to ours to keep in touch with his office and the output of a powerful receiver.

It is over 6,000 miles, air-line, from Portland, Ore., to New Zealand; but A. J. Baldwin, of the former city, was enabled by the courtesy of amateurs to keep in touch with his office and home during a trip to Wellington, N. Z.



A. C. Dixon, Jr., of Portland (7IT) and E. A. Shrimpton, of Wellington (2XA), with the aid of other "hams," maintained this short-wave service, by which regular nightly messages were sent home by Mr. Baldwin. On one occasion a direct two-way conversation was maintained, through the two stations, between Mr. Baldwin and Mr. Dixon, Sr., his partner.

Toronto, Ont., radio men are puzzling over a common metal sink which has taken upon itself the duties of a loud speaker, according to press reports. The programs broadcast from CFCA, in the same building, without apparent electrical or mechanical connection, are reproduced with moderate volume. The sound appears to be carried by the water pipes, in some unknown way.



The "ham" in the lower panel is stringing along his neighbor, above, with the idea that he is "working" Australia. Pretty soon No. 2 will catch on and write an indignant letter to the papers about practical jokers. Hi!

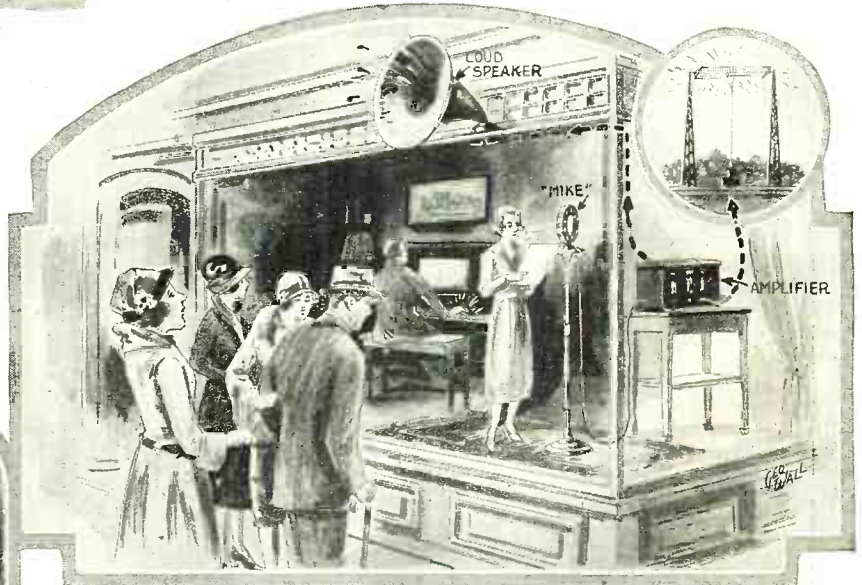

The ingenious publicity men who handle radio advertising accounts seldom overlook a bet. One of the latest stunts is to put the "mike" into the window of a store which is sponsoring a program, and make of it a remote control station. The passers-by are able to see as well as hear what is going on: and a radio studio is an intriguing curiosity to the fans.

Loud speakers in front of stores, in some metropolitan districts, are numerous. In fact, too numerous, said one indignant neighbor, who had a merchant hauled before Magistrate Simpson in New York City for maintaining a "nuisance." The magistrate ordered the horn in question brought into court, together with the receiver. A station was tuned in; and judicial cognizance was taken of the excellent quality of the reproduction. The defendant was honorably discharged. It may be said, however, that the question of the harmony of an ensemble of speakers, such as may be found on Radio Row, was not taken into consideration in the arguments before the court.

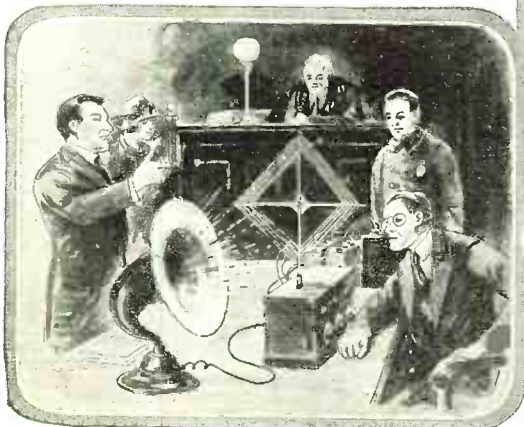

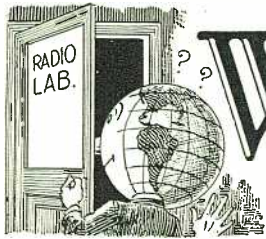

What's New in Radio



AMPLIFIER CONTROL SWITCH

This switch is designed for use in audio-amplifier circuits, and when connected properly, permits the owner of a set to use either one or two stages of amplification. When shifting the loud-speaker or earphones from one stage to another, it also controls the

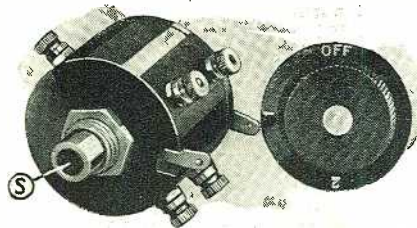

View of the amplifier control switch. The loud-speaker plug fits directly in the hollow shaft, S, and makes the proper connections to springs within the switch case.

Illustration courtesy Rono Mfg. Co.

filaments of the amplifier tubes, so that only those in actual use remain lighted.

The shaft of the switch is hollow, and accommodates the loud-speaker plug directly. Over all it is 1 3/4 inches long and 1 1/2 inches in diameter, and is neatly made of molded insulating material.

ELECTRIC BULB ILLUMINATES HANGING CONE SPEAKER

By building the loud-speaker unit into one frame with an electric-light socket, and suspending the paper cone from the frame in a horizontal position, a New York manufacturer has produced a rather unique cone speaker which serves both as a radio reproducer and as a decorative lamp shade in the nature of an indirect-lighting fixture. The whole affair is designed to hang from the ceiling, and may be attached directly to a standard ceiling outlet or may be hung simply from a hook. A length of lamp



This shows how the illuminated double-cone speaker is suspended from the ceiling of a room, to act as a diffusing reflector. The electric light is within the hollow of the large cone, and is not visible in this view.

Illustration courtesy Dimmock-Bogart Radio.

cable is provided for connection of the house-lighting outlet to the lamp socket, while a long flexible cord is used for connection of the radio set to the speaker proper.

There are actually two paper cones attached to the driving rod of the speaker unit, one about forty inches in diameter and the other sixteen, their points meeting in the manner shown in the illustration. Both are of the free-edge type. This arrangement is claimed to produce a more uniform reproduction of frequencies over the entire audio scale than is ordinarily provided by a single cone with the driving pin in the exact center. The loud-speaking unit itself is of more or less orthodox construction.

The paper cones are translucent, and when illuminated by an electric bulb above them, radiate a soft brown glow which gives a rather pretty effect.

VARIABLE COUPLING FEATURE OF THREE-CIRCUIT TUNER

The coupling between the primary and secondary and between the secondary and tickler is adjustable over a wide range, in a new three-circuit tuner. The primary and secondary coils are simply moved along the cellulose-composition bar on which they are

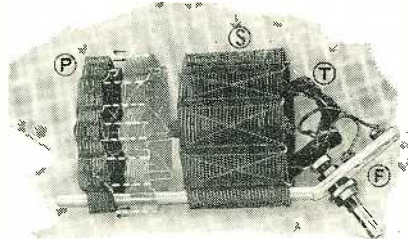

P is the primary, S the secondary, T the tickler and F the frame of this three-circuit tuner. The primary and secondary may be moved back and forth, as indicated by the dotted lines near the primary, so that different degrees of coupling may be employed for different conditions of reception.

Illustration courtesy Valentine and Son.

supported, and then left in the best position, as determined experimentally.

As can be seen from the illustration, the coils are of the "low loss," open basket-weave type. They are mounted on a stiff bar of a patent cellulose material, F, one end of which is bent at an angle of about 30 degrees. This end holds a brass bearing, in which turns the shaft holding the tickler, T. The tickler itself is off-set, so that a variation of coupling through 180 degrees is obtained. A one-hole mounting stud is provided.

All three coils are wound with green-silk-covered wire, which, viewed against the white supporting bar, gives the whole tuner an attractive appearance.

The primary of the tuner is of the "untuned" type; that is, it consists of about fifteen turns of wire connected directly between the aerial and ground. The secondary is tuned by a variable condenser in the usual manner.

ROLLED-UP PLATES IN NEW FIXED CONDENSERS

If the sheets of foil and paper which constitute the active plates and dielectric, respectively, of fixed condensers of large capacity are rolled up, says a mid-Western manu-

facturer, the possibility of electrical breakdown is greatly reduced. The elimination of sharp corners removes the tendency of the paper to puncture, he claims, and therefore rolled condensers can stand higher working voltages than usual without suffering therefrom.

New cylindrical condensers of this type now being made by this firm. They are

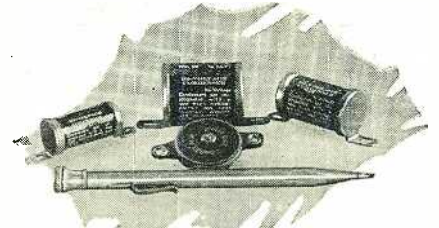

Three of the new rolled condensers are shown in this illustration, along with one of the piled type (in the center behind the pencil). The left hand condenser has a capacity of .25 mf., the center and right hand ones .5 mf. each. The piled-type condenser (circular) is Size .00025-mf. Compare the sizes of the condensers with that of the pocket pencil.

Illustrations courtesy the Carter Radio Co.

fitted with round metal end-caps which make direct connection with each sheet of metal foil and which are used directly as the terminals of the instruments. The devices are small for their various capacities, and occupy little space in a set. The 0.5-mf. size, rated at 180 volts A.C. operating voltage, is only 1 3/8 inches long and 13/16-inch in diameter; the same capacity constructed for an A.C. operating voltage of 250 is 1 7/16 inches long and 1 1/8 inches in diameter. The 0.25-mf. size, rated at 180 volts A.C., is 1 5/16 inches long and only 5/8-inch in diameter. All models are equipped with small mounting feet, which serve also as the connecting lugs.

Another new model by the same manufacturer is available in smaller capacities, between .0001-mf. and .01-mf. This is made essentially of a pile of mica and copper-foil discs clamped between two end discs of heavy brass. A single machine screw passing through an enlarged hole cut in the center of the pile, and through holes in the end plates, holds the instrument together. The copper discs are cut with protruding lugs and are alternated with the mica sheets in the assembly process, so that there are two little rows of lugs diametrically opposite when the condenser is completed. An eyelet passed through each row connects and holds the lugs together.

TWO MOVING PARTS IN ALL-METAL VERNIER DIAL

This all-metal vernier dial, which is suitable for use with standard variable condensers, presents a handsome appearance. The exposed surfaces of the frame and the ad-

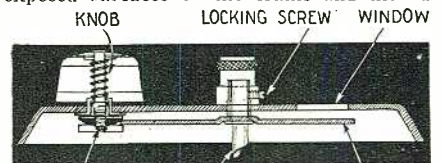

Cross-section view of the vernier dial, showing the internal construction.

justing knob are tastefully etched with fancy scroll work, the entire device being finished in antique gold. It is distinctive in shape, which can be seen from the accompanying illustration.

Mechanically, the device is simple and practically fool-proof, containing only two moving parts: a driving pinion and a scale. The driving pinion is a small grooved wheel and turns a flat, disc-like scale, the ratio of movement being 9:1. The pinion is screwed to the end of a threaded shaft, which is part of the control knob, and is kept pressed against the back of the dial by a spring contained within the knob.



This front view of the vernier dial shows its distinctive shape and fancy scroll-work. Illustrations courtesy Cornell Electric Co.

The side of the scale facing the inside of the dial frame is engraved with readings from 0 to 100, the graduations being visible through a small window cut in the frame below its top edge.

The condenser or other shaft is fastened to the dial by means of a locking screw passing through the hollow stud in the center of the frame. The dial turns smoothly and easily, and is strong enough to control heavy double or triple condensers.

SMALL VARIABLE CONDENSER

An unusually small variable condenser, hardly greater in diameter than an ordinary pocket-watch, has been produced by a Western manufacturer. It is especially useful in portable receivers and in sets of limited size.

The plates are of brass, soldered together for mechanical strength and electrical continuity. The shaft holding the rotary plates is supported on a single bearing, which forms part of the front insulating plate, to which the stator plates are also fastened. A strong leaf-spring, acting on the rotary plate assembly, keeps the spacing of the latter, in

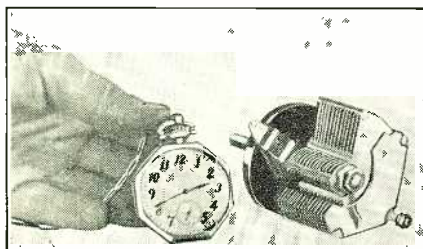

This illustration shows how the new variable condenser compares in size with an ordinary pocket watch. Illustration courtesy of Armo Radio Labs.

relation to the stator plates, uniform at all times. The capacity of the condenser is .0005-mf. The plates are so cut that straight-line-frequency tuning can be obtained with the instrument.

HOME-MADE CONE SPEAKERS POSSIBLE WITH NEW UNIT

Radio experimenters can make their own cone speakers with a new loud-speaker unit of simple and rugged construction. It may be used with any size cone from six inches

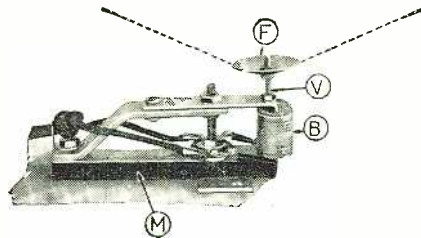

General view of the loud-speaker unit. M is the permanent magnet, B the bobbin, V the vibrating armature and driving screw, F the small metal cone for holding the large paper cone in place. The position of the paper cone is indicated by the dotted lines.

Illustrations courtesy Engineers Service Co.

to four feet in diameter, and provides loud and clear results.

The construction of the unit is somewhat different from that of other cone-speaker driving instruments, and merits description. In the accompanying side view, the device will be seen to consist of a heavy permanent magnet, N-S, made of tough tungsten steel, a bobbin of fine wire, C, and an iron supporting yoke, Y, to which is screwed a thin flexible strip of iron held in place by the nuts, A and B, and the nut and bolt at the bend of the yoke. At the end of the thin strip, just at the point where it bends, L-fashion, into the center of the bobbin, is a driving screw, D, to the end of which is attached the apex of the paper cone. A portion of the latter is indicated as P.

The winding of the bobbin is connected to the output posts of the radio set in the usual manner. The fluctuating currents, flowing through it, cause the L-shaped flexible arm to vibrate in accordance

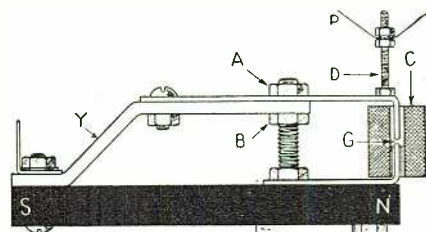

Side view of the loud-speaker unit, showing the details of driving mechanism.

with the audio variations. The movement is transmitted to the cone through the driving screw, causing the cone to set the air around it into vibration and to reproduce the voice or music being received by the set. The magnetic circuit is formed through the magnet, the heavy yoke, Y, the vibrating strip and back through the air gap, G, to a fixed pole piece inside the bobbin.

The adjustment of the air gap is important. If the gap is too small, the flexible armature will hit the fixed pole and will cause a chattering effect; if it is too great, the volume will be low. If the distance is too short, the nut, A, is loosened a fraction of a turn and the nut, B, turned up the same amount; if it is too great, the operation is reversed.

VIBRATING CHARGER WORKS AUTOMATICALLY

An automatic "A" battery converter, employing a charger of the vibrating type, is the latest product of a New England manufacturer. It is not a trickle charger, designed to feed current to the battery when the radio set is not in use; instead, it operates only when the battery has dropped to such a point that it really needs charging. It is self-acting, as a relay in the battery circuit closes the charger circuit when the battery potential drops below an optimum value, and opens it when the battery potential has been built up sufficiently by the charging action. The arrangement is such that when the filament switch on the set is closed, the charger is disconnected, regardless of the battery's

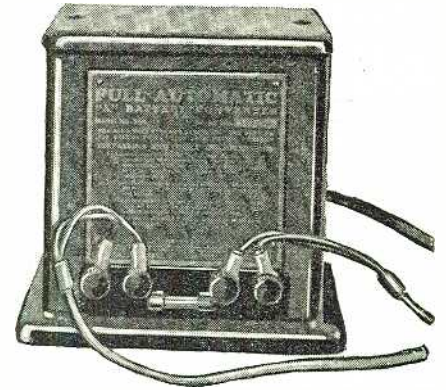

The complete automatic "A" battery charger. It is about seven inches high, five wide and four deep, and is made almost entirely of steel. Illustrations courtesy Apco Mfg. Co.

condition, to prevent the comparatively high voltage of the charger from harming the tubes in the receiver. The charging rate is a little more than two amperes.

The accompanying diagram makes the operation plain. Assume that the set is turned off; therefore the circuit to the lower left-hand binding posts is open. Assume also that the battery is low. This means that it cannot supply enough current through the winding of the relay (trace out the path of the current through the rheostat) to hold the movable contact, C, of the relay away from the fixed contact, CF. With the contacts closed, the 110-volt A.C. flows through the transformer, which, by virtue of the action of the polarized relay in the secondary circuit, feeds a pulsating current into the battery. After being charged for a period, the battery develops enough voltage to energize the relay winding; the relay pulls down the contact, C, and thereby automatically shuts off the A.C. The battery is now ready for active receiver service.

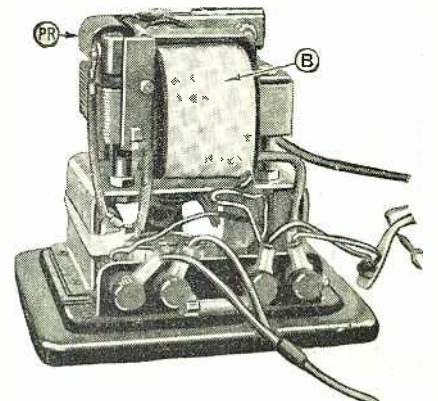

The charger with the case removed. The bobbin, B, holds the transformer windings. PR is the polarized relay. The primary circuit relay is hidden beneath the bobbin and is not visible in this view.

It will be seen from the hook-up that the relay winding is always connected across the battery through the rheostat, and is placed in series with the filament circuit of the set as well when the set is turned on. It has a low resistance, so that it introduces no serious voltage loss. Since the current that lights the tubes in the set passes through the winding when the set is on, the relay is held down during reception, and the charger

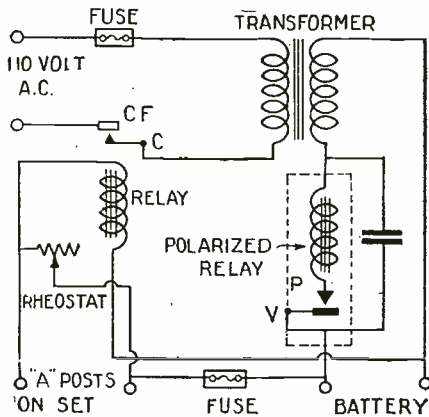

Hook-up of the charger, showing the general arrangement of the A.C. and D.C. circuits.

cannot operate. The contacts, P and V, of the polarized relay are normally open, so the battery does not short-circuit itself through the secondary winding of the transformer.

The rheostat must be adjusted so that the contact, C, of the relay stays down when the battery is well charged. Once the correct position is found, the instrument may be left untouched.

The fixed condenser across the contact points of the polarized relay prevents excessive sparking at these points. The fuses protect the charger and set against accidental short-circuits.

ADJUSTABLE BRACKET

An adjustable bracket made entirely of cast aluminum has been brought out for the convenience of radio constructors. It consists of two members, one of which fastens to the back of the set panel; this may be secured in place so that the panel stands upright, or it may be turned back so that the panel may be adjusted at any angle between 90 and about 45 degrees (in relation to the horizontal table line).

The back section of the bracket accommodates a sub-panel in any width up to six inches. Its extreme-rear edge is fitted with two small lips so that, when a pair of the brackets is used on a set, a narrow binding-post strip may be screwed in place in an upright position. The accompanying drawing makes this construction clear.

The bracket, being cast, is very rigid. It is neatly made and smoothly finished in natural aluminum.

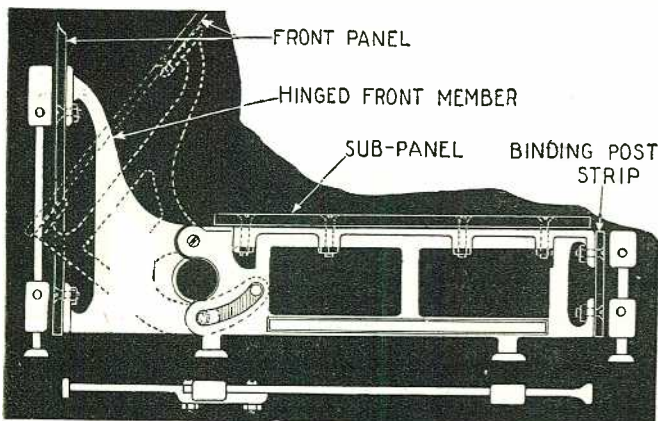

R.F. PHASE-SHIFTING DEVICE PREVENTS OSCILLATION

A simple device which, it is claimed, can cure even the most obstinate cases of oscillation in T.R.F. circuits by virtue of its ability to shift the phase relationship between the current and the voltage in the plate circuits of such amplifiers, has been brought out by a New York firm. It consists of merely a fixed condenser and a variable resistance, and may be connected in any "straight-tuned" R.F. arrangement.

The operation of the instrument is briefly explained by its sponsors as follows:

In R.F. amplification devices the transfer of energy from one stage to the next is accomplished by means of a tuned R.F. transformer, consisting of a primary of a few turns and a secondary with a greater number, tuned by a variable condenser. One effect of the primary inductance is to cause a transfer of energy through the grid-to-plate capacity of the tube back to the grid circuit in such a manner that the impulses so transmitted are in phase with the original signal impulses, and hence re-enforce the latter. If the feed-back action is only moderate, the phenomenon is known as "regeneration" and increases the signal strength; beyond a certain point it causes the circuit attached to the grid of the tube to oscillate. Oscillation in R.F. amplifiers is ruinous, as is well known.

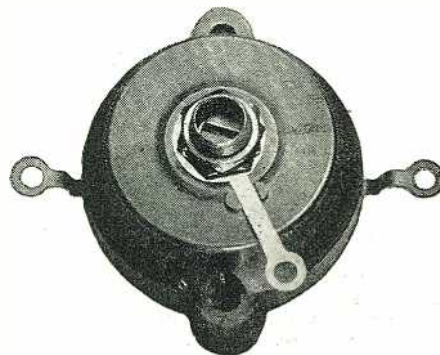

The phase-shifting device in assembled form. Adjustment of the resistance is obtained by means of the center screw, the head of which is visible in the above illustration.

When the new device mentioned is connected in the plate circuit in the manner shown in the accompanying diagram, the fixed condenser, C, changes the "time-factor" of the feed-back impulses, so that, instead of meeting the signal impulses in phase and building them up, they travel through the grid-to-plate capacity of the tube and arrive on the grid just after the signal oscillations have gone. Hence there is no re-enforcing action, and no excessive regeneration to cause undesired oscillation. Theoretically the phase difference is never absolutely complete. Some regeneration takes place, but this is entirely acceptable.

The variable resistance, being both non-

inductive and non-capacitive, has no effect on the phase displacement, but serves principally to feed the direct current of the "B" battery to the plate of the tube.

The device would work in an ideal manner, the manufacturers say, if there were no stray coupling between the several circuits of an R.F. set. To compensate for this effect, the resistance must be adjusted carefully so that the plate circuit, containing the non-inductive resistance, the capacity of the

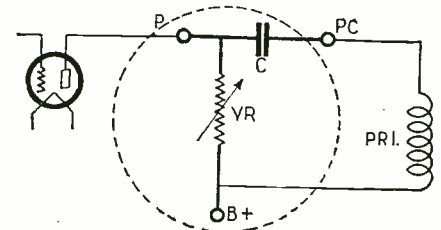

This diagram shows how the phase-shifting instrument, consisting of the fixed condenser, C, and the variable resistance, VR, is connected in the plate circuit of an R.F. amplifier stage. The posts marked P, PC, and B+ represent its three external connections.

Illustrations courtesy Electrad, Inc.

condenser and the inductance of the primary coil, can be made to absorb surplus energy generated by unusually strong oscillation.

WIDE CAPACITY RANGE IN NEW MIDGET CONDENSER

A capacity range from 2-mmf. to 50-mmf. is provided in a new "midget" condenser designed for use in tuned radio-frequency circuits of the "neutralized" type, or with multiple variable condensers requiring compensation in one or more of their sections for simultaneous control of a number of circuits. This wide range is made possible by the use of an arched phosphor-bronze leaf

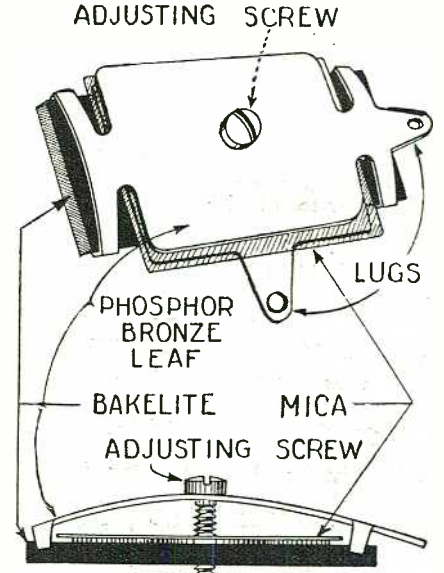

These perspective and side views of the midget condenser show its simple construction plainly. Illustration courtesy the Hammarlund Mfg. Co.

folding down against a piece of extremely thin mica, which covers a flat brass plate acting as the other plate of the condenser. Simple and accurate adjustment of the position of the leaf, and hence the capacity, of the instrument, is furnished by a single machine-screw bearing down on the metal. The closer the leaf to the mica, the higher the capacity, and vice versa.

The whole device is only an inch square. The base is a piece of bakelite, a threaded hole through its center holding the adjusting screw. One end of the fixed brass plate protrudes beyond the mica sheet and is cut in the shape of a lug. One end of the phosphor-bronze leaf likewise is formed in the shape of a lug. The mica sheet and the

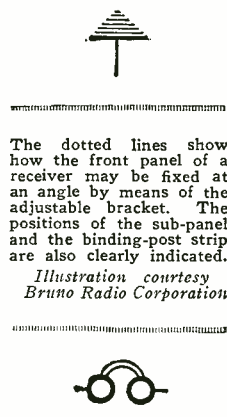

The dotted lines show how the front panel of a receiver may be fixed at an angle by means of the adjustable bracket. The positions of the sub-panel and the binding-post strip are also clearly indicated.

Illustration courtesy Bruno Radio Corporation

brass plate are fastened to each other and to the bakelite base in turn by means of a non-conducting adhesive.

This little condenser may be used in a wide variety of circuits. It is especially useful as an aerial series-condenser for a short-wave receiver, to prevent antenna-resonance effects from lessening the regenerative action of the detector circuit.

33-INCH HORN IN LANTERN-SHAPED LOUD SPEAKER

A new loud-speaker, made in the shape of an old-fashioned lantern, will appeal to women as an attractive as well as useful decoration for the home. Although it is

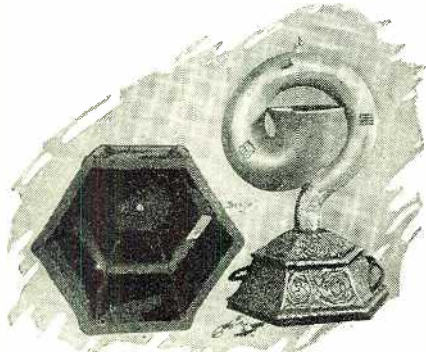

The lantern-shaped loud speaker, with the top removed to show the construction of the horn. The sound rising from the end of the horn is reflected downward and outward by top of the lantern case.

Illustrations courtesy the Zinke Company.

only about a foot high and seven inches in diameter, it contains an aluminum horn curled up in such fashion that the total effective length is about 33 inches. It is non-directional, as the sound is projected from the open bottom of the lantern with equal strength in all directions.

The lantern, which is removable, as shown in the illustration, is made of compressed paper, and gives rise to no metallic ringing

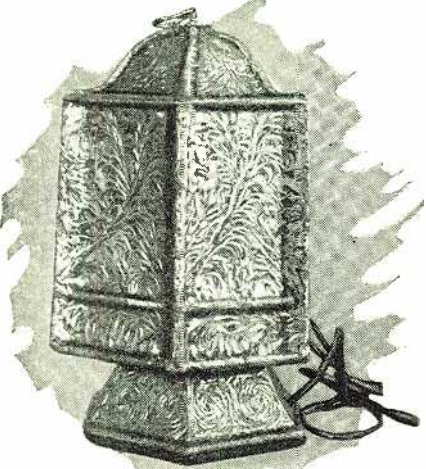

The complete "lantern" shaped loud speaker.

effects. The inside horn, of rigid, cast aluminum, is also free from this trouble.

The speaker is finished in a dull bronze color. It may be placed on a table or other flat surface, or suspended by means of a ring at its top. The reproduction it affords is clear and distinct.

POOR TUBES DETECTED BY NEW TEST INSTRUMENT

A new tube checker for use by experimenters is designed to measure the plate current of individual bulbs, detect poor contacts in sockets, open primaries in audio amplifying transformers, and open "B" battery

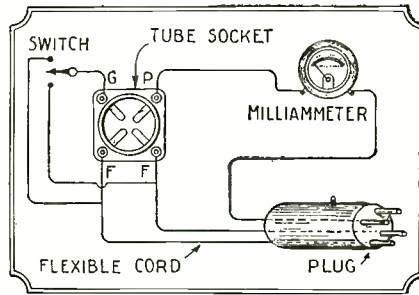

Hook-up of the tube-checker, showing how the grid is connected to either side of the filament to obtain positive or negative bias. Note that the grid tip of the plug is dead.

Illustrations courtesy Jefferson Electric Mfg. Co.

circuits. It consists of a milliammeter, a tube socket, and a single-pole, double-throw switch of the push type, all built into a small metal case, and a length of flexible wire to which is attached a plug fitted with four pins, like those on the base of a vacuum tube.

When it is desired to test a tube, the bulb in the first audio stage of a receiver is removed and the plug put in its place. The set itself is turned on, so that both filament and plate supply will be available at the socket on the tube-checker. The accompanying diagram shows the internal connections of the latter.

It will be noticed that there are only three wires to the plug, the grid tip being left idle. Thus, by means of the switch, the grid of

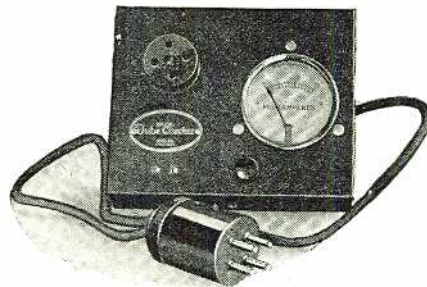

The complete tube-checker.

any tube placed in the socket of the tube-checker can be made to assume either a positive or negative bias, and the tube's condition can then be determined from the behavior of the milliammeter needle. A chart supplied with the instrument enables the experimenter to compare his readings with the meter readings for good tubes as indicated on the chart.

Radio experimenters who handle numerous tubes in trying different receivers will find this instrument a useful addition to their equipment, as it will enable them to pick out defective tubes quick and easily.

FILAMENT SWITCH COMBINED WITH "B" RESISTOR

A new "B" resistor, for oscillation control of R.F. amplifiers, contains a simple switch attached to the frame of the instrument in such a position that when the rotating arm rests in the "off" position, it opens the contacts of the switch and thereby automatically opens the whole filament circuit. The necessity for the usual separate switch on the set panel is thus obviated.



Top: Side view of the combination resistor-switch. The three large nuts beneath the knob are part of the one-hole mounting mechanism.

The construction of the device is clearly shown in the accompanying drawings. The case or frame is a shallow shell of bakelite, 2½ inches in diameter and about ⅝-inch high. Along one section of its periphery, near the binding post which connects to the arm, is screwed a short spring. This is fitted with a little plunger (in the place shown) which fits in a hole in the side of the frame. The end of the spring is equipped with a contact point, which meets a similar point (fixed) just beneath it.

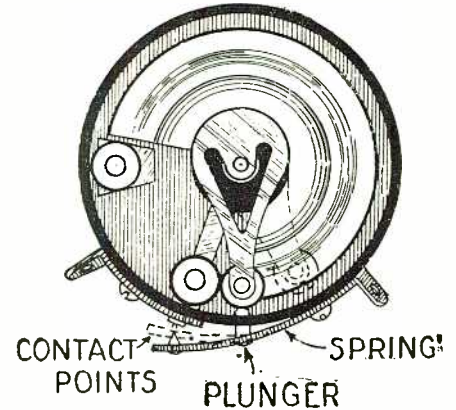

Back view of the resistor-switch, showing the arrangement of the flexible spring plunger, rotating arm and contact points. Illustrations courtesy Central Radio Laboratories.

When the rotating arm is in the "off" position, as shown, the little roller on its end presses against the plunger and separates the contacts, thus opening the circuit in which the device is connected. If the arm is turned up a short distance, it disengages itself from the plunger, permitting the contacts to close.

In this resistor the resistance element is a special material deposited as a layer, in the shape of an open ring, on the inside of the case. As the arm turns around, it presses a flexible leaf against the material placing more or less of it in the circuit. The instrument is adjustable from 0 to 500,000 ohms.

IMPREGNATED LAYERS GIVE WOOD PANEL STRENGTH

A new form of wood panel is now available to radio constructors. It is made of

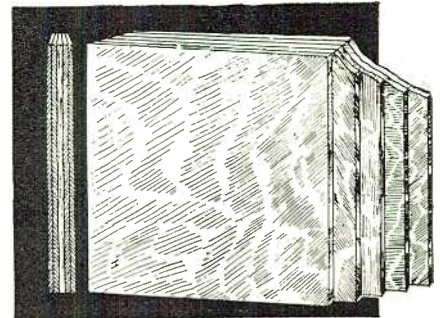

The five laminations of the new wood-panel are arranged so that their respective grains cross each other at angles, instead of running parallel. This arrangement offsets tendencies of the various layers to warp.

Illustration courtesy the Lignole Corporation.

five thin laminations squeezed together under tremendous pressure and impregnated with a special material which renders it moisture-proof. This material is forced through the pores of the wood, which is first baked in vacuum ovens at high temperatures to dry it out completely. The standard thickness of the panel is 3/16-inch, the five laminations being cemented together so tightly that they appear to form a solid board.

(Continued on page 1030)

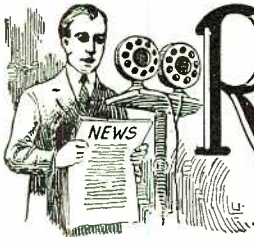

Radio News of the Month

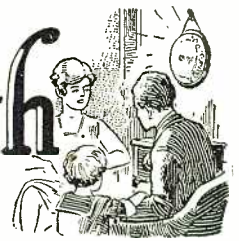

LICENSE SEEKERS MANY

CONGRESS, reconvening Dec. 6, automatically revived the two radio-regulation bills which had passed the Senate and the House at the last session. President Coolidge, urging prompt agreement and decisive action in his message, lent his support to the principle of the House bill (Rep. White's) which places control in the Department of Commerce, with the aid of a part-time advisory board. Pending negotiations between the conferees of the two houses, bills were introduced to stop further licensing of broadcast stations, the number of which had reached 638 during the first week of the session. The result was an immediate influx in great numbers of applications from would-be broadcasters who felt that it was "now or never," so far as their chances were concerned.

RADIO IN THE JUNGLE

EXPLORERS can seldom be lost nowadays, as their predecessors often were. The Dyott expedition in the remote recesses of Brazil advised New York that they were beleaguered by "bandits," and governmental action was taken for rescue work. Later dispatches were reassuring; the intruders had been scared away by the roar of the battery-charging engine, which sounded to their unsophisticated ears like a machine gun.

THE WAR IS OVER!

IN 1917 all private radio apparatus—of which there was comparatively little—was dismantled or sealed up. A letter from a New Yorker, asking if he could break the seals which naval authorities put on his equipment ten years ago, was received a few days ago by the Department of Commerce.

FOOTBALL BY RADIO

THE young man who takes a lady to the game next season will not be troubled by questions as to the proceedings, if the scheme put in practice at a professional encounter in Chicago is made general. The White Sox grounds were equipped with speakers, and the announcer at his microphone named the players and described the play for the benefit of the huge audience.

COMMUNICATION RADII INCREASING

DAYLIGHT records in radio from ships have been lately broken by the maintenance of communication between San Francisco and the *President Wilson*, equipped with an arc transmitter, 3120 miles to the west. It has also been reported by the Navy's bureau of communications that by short-wave messages from the station at Tutuila, Samoa, direct to Washington, it has been possible to cut 17 hours off the average time of handling communications from Cavite to Manila; and use of high-frequencies by other stations is therefore recommended.

IT WAS NOT BROADCAST

GEN. HARBORD, of the R. C. A., gave a striking radio demonstration to the Brooklyn Chamber of Commerce at the Academy of Music in that city the other evening. Weather reports were asked for, and received within two minutes from Paris, Berlin and Buenos Ayres; Honolulu was delayed for nearly five minutes by the necessity of a relay. Eighty ships on the Atlantic reported their position, and photoradiograms from London were reproduced in the hall. One expression of the past only figured in the proceedings: the Academy of Music, in accordance with its rule, refused to permit the proceedings to be broadcast from the hall to a radio audience, so "everything was going in and nothing coming out."

INCREASED BROADCAST POWER

AN idea of the increase in power demanded by present-day broadcast transmission is given by a recent survey of the Department of Commerce. In June, 1922, the average station in the United States used 150 watts. Notwithstanding the number of small, semi-experimental stations of very low power, the average for over 600 on the list today is 840 watts each, an increase of nearly six times.

SEEKING THE "COSMIC RAY"

DR. ROBERT A. MILLIKAN, discoverer of the electron, returned recently from Bolivia, where he conducted further experiments on the "cosmic rays," which are the shortest and most penetrating of the electromagnetic waves. The tests were made in lakes in the Andes, several thousand feet above sea level. The rays, which will pass through six feet of lead, are believed to come from the fixed stars. Results are being tabulated for analysis and preparation of scientific reports.

NEW AMERICAN STATIONS

MEXICO CITY has a new station, *CYJ*, which operates on 400 meters with 2 kilowatts' power. It is owned by the newspaper, *El Universal*. Brazil is to have a 1-kw. station at Manaos, which will be operated by the state of Amazonas to provide communications with its vast interior. The area to be thus covered is over 700,000 square miles.

RADIO AND RACING

AT the race track in Gruenwald, Germany, portable radio equipment has been installed for the use of the judges, and gives communication between their stand and other parts of the track. The apparatus is adjustable from 200 to 1000 meters: so that perhaps the broadcast listener can get the "inside dope" at an early moment.

HEARING FACES BY RADIO

WITH the Baird television apparatus, which transmits pictures at a rate of more than ten a second, a carrier wave is modulated more or less rhythmically at this rate. If picked up by an ordinary broadcast receiver, this wave produces a sound, which, so the inventor has stated, is characteristic of the shape of the image in front

(Continued on page 1050)

RADIO WARNING SAVES SHIP

THE popular imagination associates radio service at sea with the spectacular, broadcast-stilling S. O. S. But it is now the work of radio to keep ships out of danger, rather than to call rescuers. With the new Kolster mobile radio beacon, devised by the inventor of the radio compass, a ship sends out a continuous radio signal which is more powerful and more directional than the old fog-horn or audible siren. In addition, there is reported from Puget Sound the saving of a vessel by a radio warning. The radio-compass operator on Tatoosh Island saw that a vessel's bearing was toward a dangerous part of the channel; and sent a message to her operator, which caused the stopping of the engines just in time to prevent a disaster to the steamer, whose captain was in unfamiliar waters.

FILIPINOS ARE TAXED

THE United States, notwithstanding some grumbling, continues to be the Eden of the broadcast listener. The authorities of the Philippine Islands have used their autonomy to impose a tax of \$5.00 per year on owners of radio receiving sets.

MUNICIPAL RADIO RECEPTION

SEVERAL cities now operate their own broadcast stations. The Board of Education of New York, which sponsors lectures through the municipal transmitter, *WNYC*, has installed receivers at the Washington Irving High School, where those may listen in who have not their own sets—or wish to save the batteries.

NAVY TRANSMISSION METERS

ANNOUNCEMENT is made that every battleship of the U. S. Navy is being equipped with a heterodyne (beat) frequency-meter in order to regulate its radio transmissions. Greater secrecy and less interference in naval communications will thus be obtained. The new device, which is portable, will, it is stated by Lt.-Com. Craven of the Bureau of Engineering, make it possible to regulate the frequency within a variation of one two-hundred-thousandth from the standard.

WORLDWIDE RADIO CONVENTION

AMATEURS of five continents were present—by radio—in the audience at a gathering held recently in Schenectady and broadcast by *2XAF*, the high-power 32.79-meter station. The meeting, addressed by the officials of the American Radio Relay League, was held under the auspices of the International Amateur Radio Union, at the suggestion of the South African "hams," and advance notice of it had been widespread through the short-wave net with which the amateurs have girdled the world.

A New Alloy for Chemical Rectifiers

Chemical Ingenuity Discovers Effective Substitute for Precious Metal

By JACK KOONS

ONE of the more important discoveries of the past year, as regards increased convenience and economy for radio users, was made by Clarence E. Ogden, electrical experimenter and head of a large mid-Western radio corporation, when he succeeded, after years of research, in producing a new substance of properties highly suited to the manufacture of electrodes for alternating-current rectifiers. The demand for these has increased enormously in the past year, with the popular desire for radio receivers operated directly from the lighting circuits.

Mr. Ogden melted Kentucky sandstone, which is practically pure silica (in chemical phrase, SiO_2 , silicon dioxide) in an electric oven with other substances which he had determined to provide a suitable alloy; and after the charge of the oven had reached a temperature a third higher than that of molten iron, poured it into a suitable mold prepared in sand. It boiled up like a miniature volcano, and finally solidified into an ashen-gray cast. The new product, to which the name "silite" has been given, proved to be a material so highly resistant to acids, and at the same time conductive, that it is admirably adapted for use in the electrodes required for chemical rectifiers.

In its nature silite is metallic, and a good conductor, in contrast to the silica from which it is made. Instead of contracting when it solidifies, as do most metals, it expands like ice or type metal; and therefore uniform casts are obtained from the molds. Its raw material, silica (which occurs in nature as quartz, and in its most refined form, as rock crystal) is to be found practically pure in enormous quantities in sand, and is therefore cheaply obtainable. This is in direct contrast to the rarity of the metal tantalum, which is silite's only rival as an acid-proof electrode material; and whose scarcity and cost has been the drawback in its use for this purpose, as well as for the filaments of incandescent lamps.

Great batteries of electric furnaces are used today for turning out silite electrodes, because the demand for the substance has reached such proportions that forty battery manufacturers now use it as standard in battery chargers.

PROCESS OF MANUFACTURE

The sandstone used as the raw material is mixed with ordinary coke and heated to a high temperature in the electric furnaces. At approximately $5,400^\circ \text{F}$. the stone decomposes, forming crude carborundum and practically pure silicon. At this point the proper alloying elements are introduced into the electric furnace and, shortly afterward, the newly-amalgamated silite, intensely heated and scintillating with sparks and purple flames, is drawn from the furnace and poured in its molten state into heavy earthenware or fire-clay pots. These are carried with long-handled tongs or bar-carriers to specially-made molds.

The making of these sand molds is almost an art in itself, and great care must be taken that each individual one is absolutely clean on the inside, where the molten silite settles. An air hose is used by each molder in cleaning out the forms, to blow out all dust. Each of the great black sand-molds contains twenty separate forms, each erect or vertical, contrary to the usual methods adopted by foundries in pouring metal for similar forms; for silite electrodes are cast vertically.

When the boiling silite is poured into the mold, a purplish flame darts from the latter and hovers above it in a spectral form, finally vanishing into air. Soon the metal exudes in cherry-red lava streams, and writhes and twists among ruts in the black sand until it cools. The terrific heat and expansion cause the sand mold to crack, but not before the electrodes have set.

RECTIFYING ACTION LONG-LIVED

The fact that some metals, such as aluminum and magnesium, have the property of passing an electric current in but one direction, when immersed in liquid electrolyte, has been known for many years. However, these metals were restricted, by their solubility in acids, to use in compound-salt electrolytes such as ammonium phosphate, borax, ammonium tartrate, etc., and they have never proven successful in commercial use; for the further reason that even these electrolytes are decomposed by the passage of an electric current, liberating acids which in time use up the electrolyte and corrode the electrodes.

With the need in view, for rectifiers that would give permanent service to radio users, investigators began searching for a material which would rectify in and withstand the action of acid electrolytes, since acids are noted for their high conductivity. Some acids, principally sulphuric, are decomposed by the action of the electric current with liberation of hydrogen and oxygen; but as this loss is replaced by the addition of ordinary water, the electrolyte is not subject to any deterioration and requires no renewal.

The rectifying properties of tantalum in an acid electrolyte, and its ability to withstand the action of such acid, were discovered in Germany in 1907. Due, however, to the rarity of this element and its high cost, tantalum rectifiers did not come into commercial use until a few years ago. This was brought about by the ingenuity and resourcefulness of American engineers, who were able to produce tantalum at but a fraction of its former cost. Even under present-day conditions, tantalum is expensive, as the supply is comparatively limited.

It was, therefore, but natural that continued search should be made for a more economical rectifier. Eventually the rectifying properties of silicon were discovered, but silicon in a pure state has a very high resistance. A long series of experiments was required, for the development of an alloying compound which would give this element the required conductivity to make it an efficient rectifier. Success finally crowned these efforts and silite was produced.

WHAT IS "RECTIFICATION"?

A silite electrode, when immersed in an acid solution, such as dilute sulphuric acid, has the property of passing current in but one direction; viz: from the electrolyte to the electrode. When current attempts to pass in the opposite direction (i.e., from the electrode to the electrolyte) an insulating film of exceedingly high resistance is instantly formed, by chemical action, on the silite electrode, and effectively prevents the passing of any current. When the direction of the current is again reversed, however, this film is instantly destroyed, and current passes freely. When the rectifier is connected in an alternating-current circuit, this film is built up and

(Continued on page 1016)

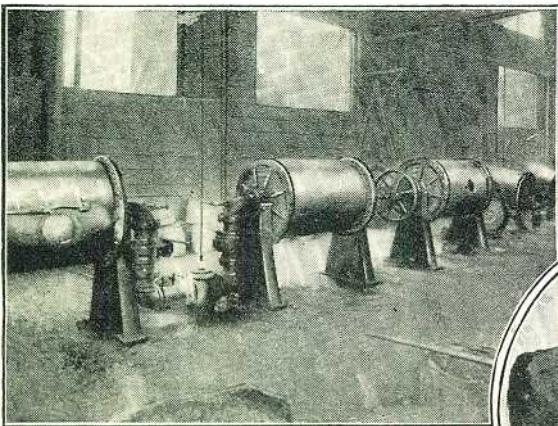

One of the batteries of electric furnaces, each capable of maintaining a temperature of 5200 degrees Fahrenheit, used in the melting of silica sand, and the amalgamation with it of reducing materials and several alloys used in manufacturing silite, the new metallic glass-like rectifying element, which takes the place of precious metals by its resistance to acid.

Below, a miniature lava bed. Molten metal, sizzling white, fading into an ash gray emerges from the sand molds used for the pouring of molten silite. It first seems to sink in the mold, then reappears and wells out in a tiny lava stream.

Photos courtesy of Kodak Radio Corp.

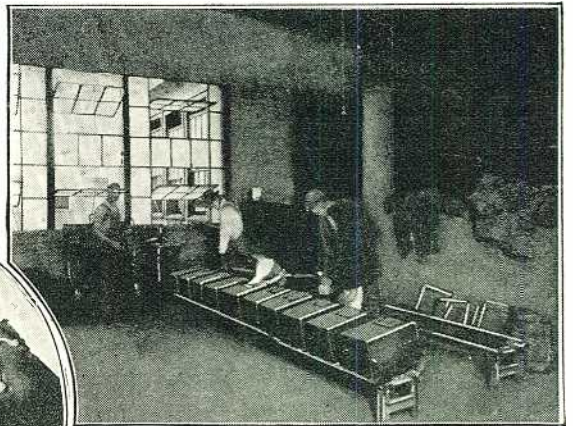
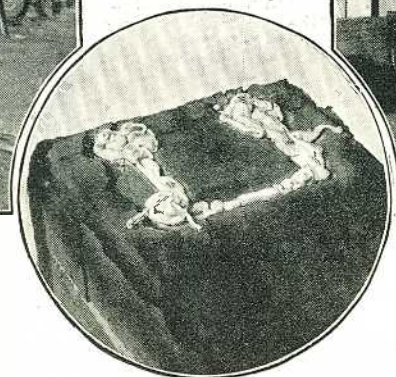

Pouring silite, or molten silicon alloys, into sand forms where it hardens into incorrodible elements for "B" eliminators. As many as one thousand of these molds, each holding 40 electrodes, have been poured in a single day in this foundry. Even in the coldest winter weather, this room is one of the hottest places in the country. The Negroes pouring the bowl of white-hot silite wear gloves, coats, and heavy clothes to protect themselves from the heat.

WRNY's New Transmitting Station

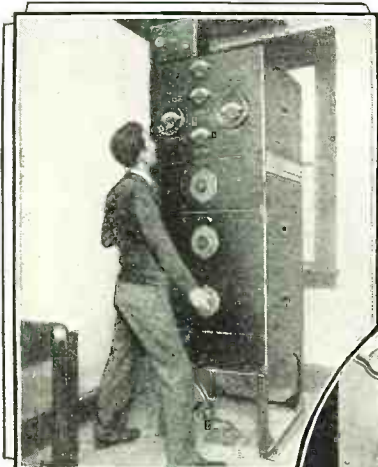

The remote-control station shown here, in interior and exterior views, is located at Coytesville, N. J., opposite the upper end of Manhattan Island. Programs are received by land-line from the studio in New York. At the right is the receiver for detecting "SOS" calls. This watch is always maintained during transmission periods.

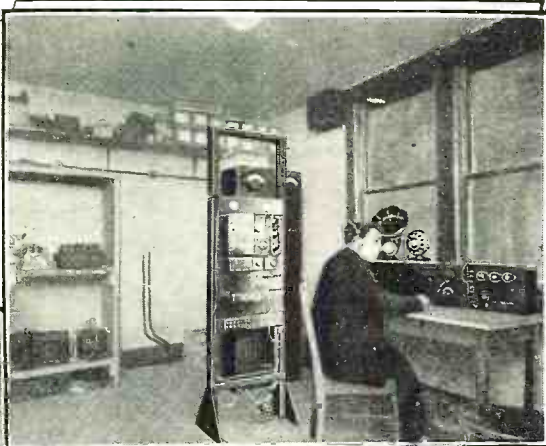

One of WRNY's operators is shown making a preliminary adjustment upon the transmitter. The wavelength of this is varied by the condenser and variable capacitor controls shown.

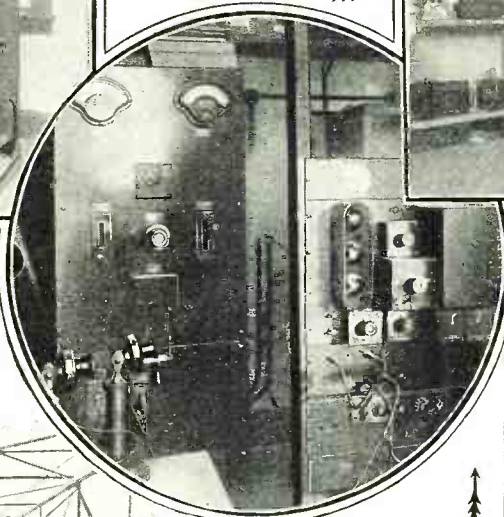

Above, at the left, appears the control panel for the motor-generator set, which furnishes power for the transmitting tubes; while at the right is a close-up view of the speech-amplifier panel.

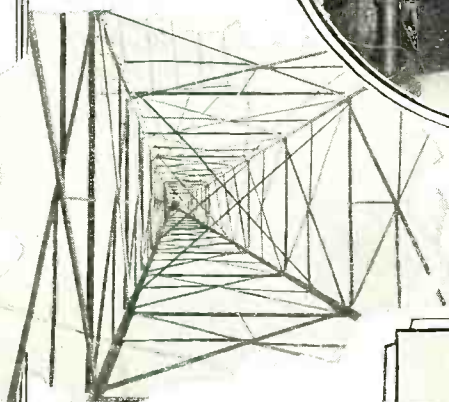
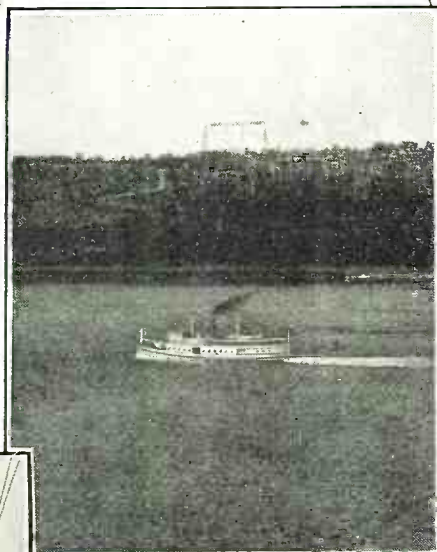

This steel spider web is what you would see on looking up the interior of one of WRNY's masts, which are 127 feet high; they are of the latest type of construction and braced to withstand high winds, because of their exposed position on top of the Palisades.

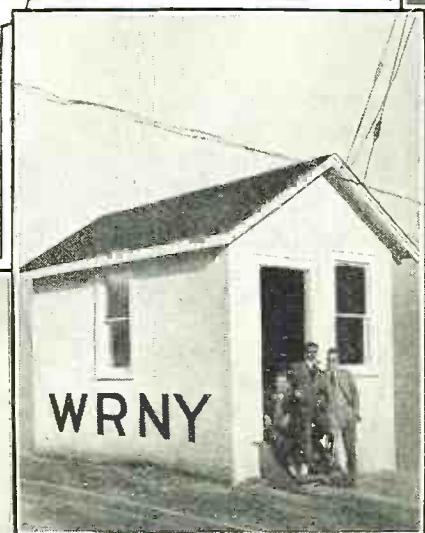

The WRNY antenna as it appears from the New York side of the Hudson River. The cliffs are about 425 feet high, thus bringing the aerial to about 550 feet above the water level.

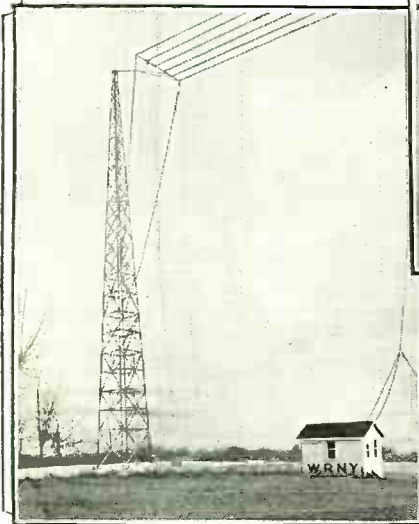

Above, in the doorway of the "shack," is the station force of WRNY. The other two views of the antenna and station, at the right and left, show the manner of suspension of the flat-top aerial and the lead-in. This antenna installation is the highest one in the New York Metropolitan district, and some remarkable reception has been reported by foreign listeners since the change.

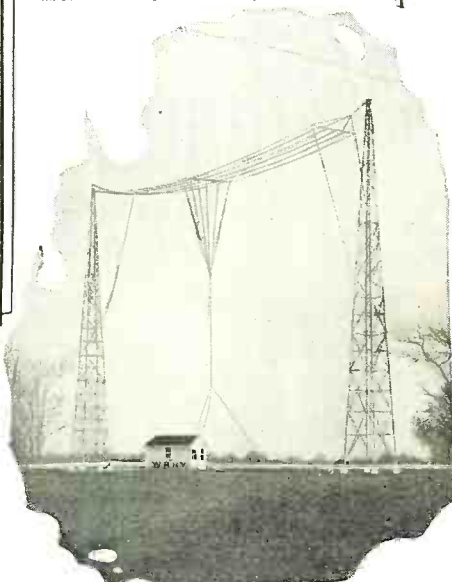



The "Ham"

Wherein It Is Proved That Short Waves Are Handy Things
To Have On Tap

By ARMSTRONG PERRY



BIXBY was a "ham." When, where or how the radio amateur began to be known by that epithet he neither knew nor cared; but like all his brother of hams, of whom there are forty or fifty thousand scattered about the earth, he gloried in it.

Bixby was also a "boiled owl." Just why a ham who spends most or all of his nights puttering with radio should be called a boiled owl, rather than a boiled ham or a fricassee chicken, was likewise a matter of indifference to him, but to have a brother ham call him a boiled owl gave him a distinct and pleasurable thrill. It is useless for the rest of the world to try to understand Bixby's sensations. The only way to acquire an insight into them is to be a ham and a boiled owl.

Mrs. Bixby did not care for radio. Even a broadcast listener would have understood that if he had heard the things that Mrs. B. said to Bixby up the attic stairway at 11 P. M.—and at intervals thereafter, as she happened to wake up and note that the other twin bed was still as good as new.

Bixby's personal and private slogan was "Learn by doing;" all of his radio knowledge came that way. Mrs. Bixby did not believe in the slogan. If there were anything in it, she said, anybody but a jackass would have learned long ago that money spent on radio gadgets was gone, never to return, and that a man who sits up all night and goes to work in the morning with his

eyes looking like two holes burned in a white blanket can not expect to hold a job. Mrs. Bixby repeated this statement frequently, at intervals during the night, and amplified it powerfully at audible frequencies. Gradually it dawned upon Bixby that what his wife wanted of him was to earn enough money so that they could have a car, and play golf, and do all the other things that folks do, who are so lacking in originality that they can only follow the crowd, and who think scientific research is something that the janitor or somebody does outside of business hours in institutions for the promotion of football.

Bixby saw his present difficulty as a radio problem rather than as one of economic significance only. He never once thought of going into bootlegging or one of the other better-paid professions. His last job was in Wall Street, in a broker's office, so he did not believe in gambling. The solution of his problem, he concluded after long and patient consideration, lay in inventing some radio device that would sell.

The next time Mrs. Bixby roused from her fitful slumbers and repeated her lines, Bixby informed her he was working on an invention that was to make them rich.

The effect was not what Bixby hoped and expected. Instead of exerting a sedative influence, his invention had the blighting influence of the last straw that broke the camel's back. Mrs. Bixby even got up and put on a kimono and came in where he was,

although she had kept out of his radio shack, by invitation, for many months. She informed him, coldly and bitterly, that she did not intend to be the wife of any God-forsaken poor inventor and that, unless he produced enough actual spot cash money the next day to buy her a new hat, a dress, a pair of shoes and silk stockings to match, she was going home to her mother and immediately start suit for non-support.

Bixby, who corrected his time daily with the tick from NAA, glanced at his clock and found a crumb of comfort in the thought that he had twenty-four hours in which to make a turn. She snatched the crumb from his mouth by reading what was in his mind and correcting her statement. What she meant, she said, was the next period of daylight, which was due to begin in about two hours. Reaching a point where words came so fast that they jammed in her voice box, she relapsed into tears and bed.

Bixby twirled his knobs aimlessly. His big idea, on which his invention and his prospective wealth were based, was a universal receiver, one which would bring in any station, no matter where it was located nor what its wavelength might be. Of course all the people in the country who used radio, except for the small percentage who were either operators in government and commercial stations, or hams, wanted to cover only the broadcasting range. They cared nothing for the wavebands below 200 meters

(Continued on page 1034)



"She stopped at the door with her arms akimbo, her hat askew and 'blood in her eye.' 'Anybody but a jackass—' she started—"

Combined Power Amplifier and Plate-Supply Unit

A Unit Which Can Be Easily Assembled and Wired With the Aid of A Screw Driver and a Soldering Iron

By HORATIO W. LAMSON*

DURING the past two years radio experimenters have become acquainted with various forms of "B" battery eliminators, or plate-supply units as they should more correctly be called. Now comes the next logical step, the combination of an audio-frequency power amplifier and a plate-supply unit.

The various dry-cell vacuum tubes for radio sets are becoming more and more popular, eliminating as they do the need of storage batteries. These tubes, which consume relatively very little filament power, have proved quite satisfactory as radio-frequency amplifiers and as detectors; but difficulty is often encountered when they are used, in the last stages of audio amplifiers, to feed loud speakers. Here it is frequently desirable to employ one of the so-called power-amplifier tubes (such as the UX-171, CX-371, UX-112, or CX-112) in order to obtain sufficient loud-speaker volume without overloading the tube and thus causing distortion and inferior quality of reproduction. Such tubes, however, require higher plate voltages and considerable filament power.

Fortunately, it is entirely feasible to employ alternating current of the proper voltage on the filament of the last stage of audio amplification; while the plate-supply unit may readily be designed to afford the necessary "B" voltage. It may be noted, in passing, that the power tubes mentioned above, when properly operated, are capable of delivering plenty of loud-speaker volume to meet the requirements of the ordinary home. The use of the still higher-powered tubes, such as the UX-210 or CX-310, is unnecessary unless it is desired to provide dance music, etc., for a medium- or large-sized auditorium.

The Raytheon power-amplifier and plate-supply outfit described here has been designed for use in homes lighted with A.C. (60-cycle) current at an approximate voltage of 110. It may be considered as consisting of the following parts:

1. The power transformer.
2. The rectifying tube.
3. The filter system.
4. The plate supply.
5. The power amplifier.

THE POWER TRANSFORMER

This transformer has a primary winding adapted for direct connection across the ordinary 60-cycle, 110-volt house-lighting mains. It has a high-voltage secondary coil, giving 550 volts, which is provided with a

center tap so that two voltages of 275 each are available for "full-wave" rectification. In order to secure the proper action of the rectifying tube, each of these two secondaries has a 0.1-mf. condenser connected across it. The transformer has also an entirely separate 7.5-volt secondary, designed to furnish power for lighting the filament of the power tube.

THE RECTIFYING TUBE

Before the high-voltage current from the transformer can be used as a plate supply it must be "rectified," or made to flow in a

set. These chokes are used in combination with three shunt, or "reservoir," condensers connected across the line at the terminals of the choke coils. The first and last of these condensers have a capacity of 4.0-mf. each, while the intermediate condenser has a value of 2.0-mf. Such a filter system has been found to possess a high efficiency of operation and requires a minimum amount of material and expense.

The action of the filter may be compared with a large tank of water which, although

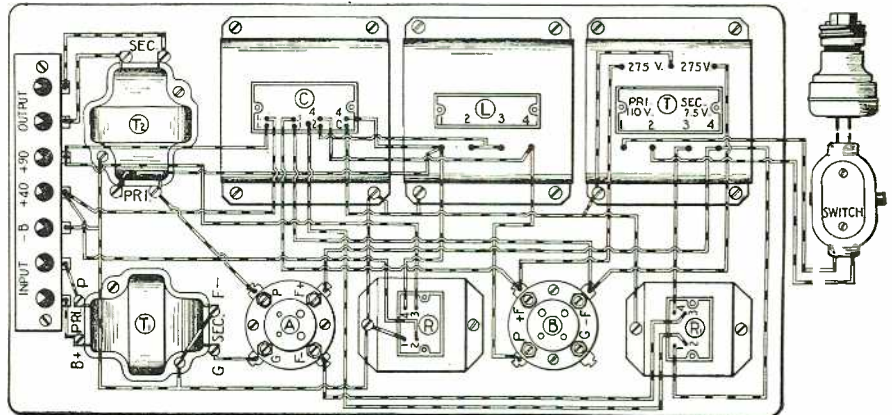

The layout of apparatus and wiring diagram of the complete "B" eliminator and power amplifier. The lettering on the parts corresponds to that on the parts in the illustration below.

single direction. This is accomplished by means of the type-BH full-wave Raytheon tube, which rectifies each half of the cycle independently; giving, thereby, 120 pulses of unidirectional ("one-way") current per second. It is well known that the Raytheon tube has no filament, but operates upon the principle of gaseous discharge between two electrodes of different area. The maximum current which it is desirable to draw from the type-BH Raytheon is 85 milliamperes. This is more than sufficient to meet the requirements of the present instrument.

THE FILTER SYSTEM

The next step consists of smoothing out these rapid pulses to give a continuous, steady, and quiet flow of current. This is accomplished by a filter system which contains two series choke-coils of about thirty henrys each, through which the current passes on its way to the vacuum tubes of the

filled by the intermittent strokes of a pump, delivers a steady flow of water through a discharge pipe.

THE PLATE SUPPLY

The output of the filter is now made to pass through a series of wire-wound resistances giving a certain definite voltage drop across each. This plate supply resistance provides two "B" taps whose nominal values, with the average radio set, are 45 and 90 volts, respectively. These voltage values, of course, decrease as the external drain on the plate supply is increased; but, if the total resistance across the output of the filter is made the comparatively low value of 12,000 ohms, so that the open-circuit "bleed" current is relatively high, the voltage characteristic is improved. That is, the drop of voltage with increasing load is minimized. The "bleed" current is defined as the current

(Continued on page 1002)

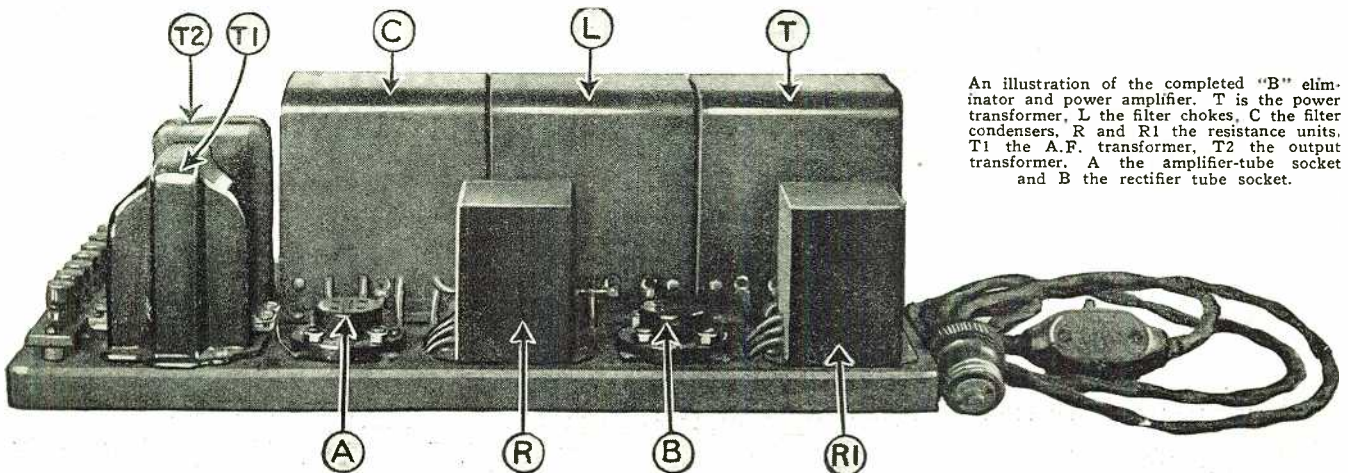

An illustration of the completed "B" eliminator and power amplifier. T is the power transformer, L the filter chokes, C the filter condensers, R and R1 the resistance units, T1 the A.F. transformer, T2 the output transformer, A the amplifier-tube socket and B the rectifier tube socket.

* Engineer, General Radio Co.

The Uses of Resistances In Radio

Discriminating Selection of Proper Types and Values Essential for Satisfactory Results

By M. L. MUHLEMAN

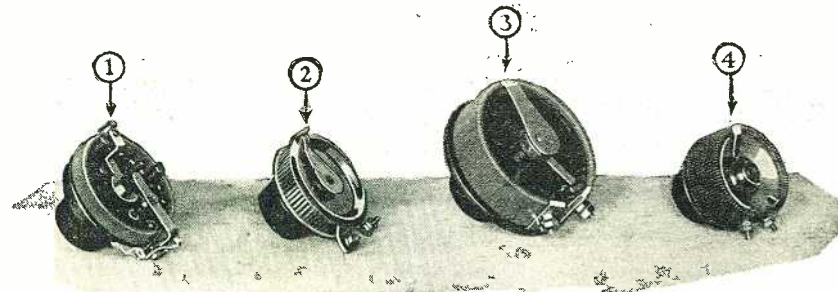

Fig. 3. A group of power rheostats designed to control the filament current to a number of tubes. They are similar to regular types of rheostats but are wound with much heavier wire. The rheostat marked 2 has resistance wire in the form of a ribbon. (Courtesy of: 1, Yaxley Mfg. Co.; 2, Central Radio Laboratories; 3, General Radio Co.; 4, Herbert H. Frost, Inc.)

RESISTANCE is one of the most important properties making radio possible. The action of every circuit or instrument is dependent upon resistance to some extent. When we speak of the *impedance* of a condenser or the *impedance* of an inductance we are referring to resistance; though in these two cases "resistance" is only part of the story. Resistance of course comes from the word "resist," and its literal meaning requires no explanation. However, when one refers to the resistance of a piece of wire, an electric circuit or an instrument, the meaning is not so obvious. It is, of course, understood that the wire, the electrical circuit or the instrument offers a certain definite resistance to the electric current passing through it, but the how and why of it is not so clear.

WHAT OHM'S LAW IS

A man by the name of Georg Simon Ohm was the discoverer of the law of electrical resistance, in connection with his experiments in passing currents of definite voltages through electrical circuits. In all due respect to his contributions to science, the unit of resistance was named after him. So, the unit of resistance is the Ohm; and an *Ohm is the resistance which will allow a current of one ampere to pass, under a pressure, or potential, of one volt.* It is obvious that the three units, the ohm, the ampere, and the volt are all closely related; for one volt is the pressure that will cause one ampere of current to flow through a resistance of one ohm; or, as we may also state it, one ampere is the current that will flow through a circuit having a re-

sistance of one ohm, when the pressure is one volt.

So Professor Ohm actually gave us a law, which he stated in a very simple formula which reads $E=IR$. In plain English, this means that E (the electromotive force in volts) equals I (the current in amperes) multiplied by R (the resistance in ohms).

Fig. 2. Three midget-type rheostats which are particularly useful in small compact sets. They have all the advantages of the larger types. (Courtesy of: 1, Leslie F. Miter Co.; 2, Amsco Products, Inc.; 3, Carter Radio Co.)

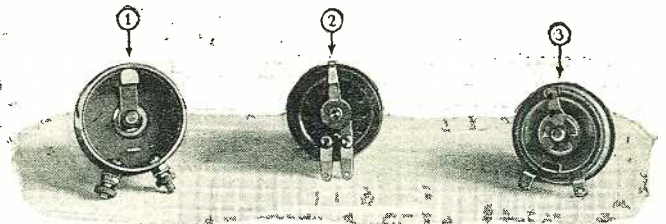

Consequently it is also true that $I = \frac{E}{R}$ and that $R = \frac{E}{I}$. Knowing any two values it is

a simple matter to determine the third. This unvariable interrelation of three electrical values is one of the most beautiful examples of the mathematical accuracy of the laws of nature. Just as long as 6 equals 2 x 3, they cannot be tampered with.

TYPES OF NECESSARY RESISTANCE

While we are on the subject of the laws of nature it is interesting to observe the fact

that everything in this universe from a human being down to the air he breathes, and including all man-made products from a hair pin to a steam locomotive, has inherent resistance of one sort or another. One piece of machinery cannot operate another unless there is mechanical resistance present; a dynamo could not light a lamp that had no electrical resistance. Likewise, a hairpin would not be serviceable without frictional resistance; and a human being losing his cohesive resistivity would be quickly converted into a little bit of nothing distributed throughout the universe.

It is one of the laws of nature, or more exactly one of the laws of physics, that the greatest amount of actual work is accomplished when the load, or inherent resistance, of the apparatus or agency influenced is equal to the energy, or external resistance, of the apparatus or agency doing the work. As an example, we find in radio practice that the greatest transfer of energy from a vacuum tube to a loud speaker takes place when the plate-to-filament impedance (which practically amounts to pure electrical resistance) of the vacuum tube equals the impedance of the loud speaker winding (which,

incidentally, is not pure resistance, but partly inductance.)

HOW "A" CIRCUIT RHEOSTATS WORK

It is clear that a certain value of resistance in an electrical circuit limits the "voltage drop" and the current flow, and that the limitation is in direct accordance with Ohm's law as heretofore stated. Let us cite a simple example: assume a 6-volt storage battery feeding current to a vacuum-tube filament. If no resistance is connected in the circuit the flow of current is limited only by the resistance of the connecting wires, which is negligible, and the resistance of the vacuum tube filament. If the vacuum tube is of the 199-type the filament will burn out, as its

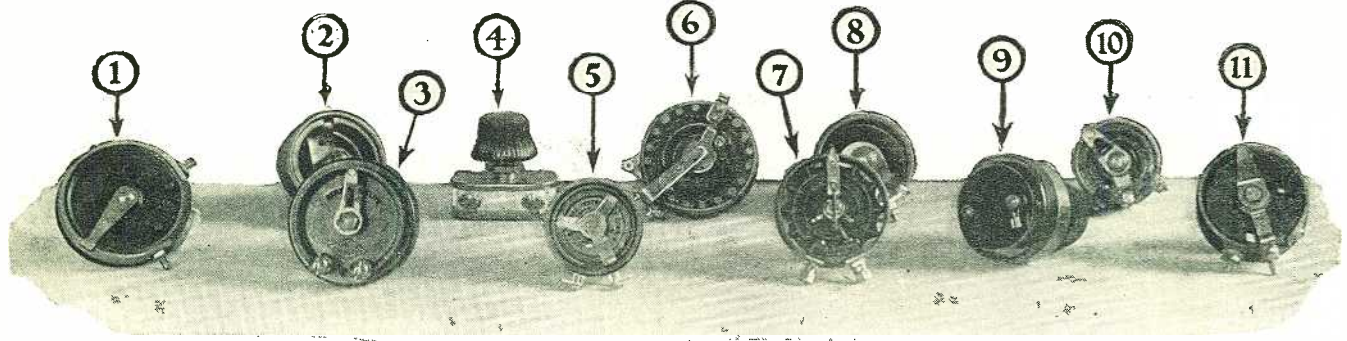

Fig. 1. A large group of rheostats of the more usual type, which are made in resistance values ranging from 1 ohm to 100 ohms. The one shown at No. 4 is of the carbon disc compression type. No. 5 has the resistance wire wound on a metal core which is insulated with an enamel coating. It will be noted that Nos. 6 and 7 have the resistance units supported so that a large air space is available for cooling purposes. Rheostat 9 is entirely enclosed in a combination metal-and-insulation case.

(Courtesy of: 1, Klossner Radio Corp.; 2, Electrad, Inc.; 3, Amsco Products, Inc.; 4, Allen-Bradley Co.; 5, General Instrument Corp.; 6, Yaxley Mfg. Co.; 7, Martin-Copeland Co.; 8, Polymet Mfg. Corp.; 9, The Sterling Mfg. Co.; 10, Victoreen Radio, Inc.; 11, General Radio Co.)

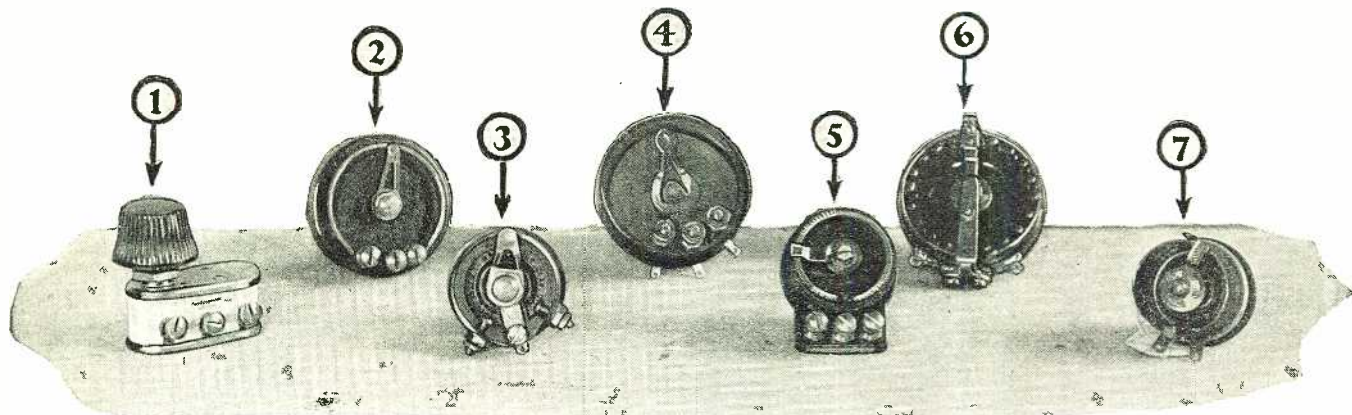

Fig. 5. A number of different types of potentiometers are shown in the above illustration. No. 1 is of the carbon-compression type; 2, 3, 6 and 7 are of the usual wire-wound type. Nos. 4 and 5 employ special graphite-treated elements and non-frictional contacts. These last two come in several resistance ranges, some being as high as 500,000 ohms, and can be employed for any number of purposes.

(Courtesy of: 1, Allen-Bradley Co.; 2, Amsco Products, Inc.; 3, Victoreen Radio, Inc.; 4, Central Radio Laboratories; 5, Electrad, Inc.; 6, Yaxley Mfg. Co.; 7, Carter Radio Co.)

resistance of 50 ohms is not great enough to cut the current flow down to the rated amount of 60 milliamperes (.06-ampere).

However, if we place the correct amount of resistance (another 50 ohms) in series with the storage-battery circuit it will pass exactly 60 milliamperes; and in this case, in accordance with Ohm's law, we will find that the voltage difference between the filament

All conductive materials do not have the same resistance. A piece of copper wire has less resistance than a like piece of "german-silver" wire. On the other hand, silver wire has less resistance for a given length and size than any other conducting material. Some materials heat more readily than others when an electric current is passing

"RESISTIVITY"

ature." Carbon discs are employed quite often for both low- and high-resistance rheostats, potentiometers, modulators and other forms of variable resistances.

Graphite in one form or another finds a use in fixed and variable grid leaks and, if properly stabilized, is very satisfactory for this purpose.

In radio work fixed, semi-fixed and variable resistances, ranging in value from one ohm to ten million ohms, are employed. There is hardly a radio circuit in existence that does not require at least one part used only to introduce resistance of some sort. Even in a single-tube radio set a rheostat is usually employed for controlling the current to the tube filament; and a high resistance, having a value in the order of 5 million ohms (5 megohms), is employed as a grid leak. More complicated circuits utilize a great number of resistances of different types for definite functions.

"FILAMENT" RHEOSTATS

The rheostat is a variable resistance and functions as a current-voltage regulator. Technically speaking, a rheostat may be any maximum resistance value; but in radio practice other names are employed for variable high resistances, and the word rheostat is practically limited to variable resistances, having a maximum value anywhere from one to 1,500 ohms. A rheostat very seldom serves any other purpose than to control the filament current to one or more vacuum tubes; as there are no other locations in the average radio circuit which call for variable resistances of such low values. But the maximum resistance value of the rheostat is important, as one value would not be satisfactory for all types of tubes.

As an example, it would not be sensible to employ a 30-ohm rheostat for controlling the

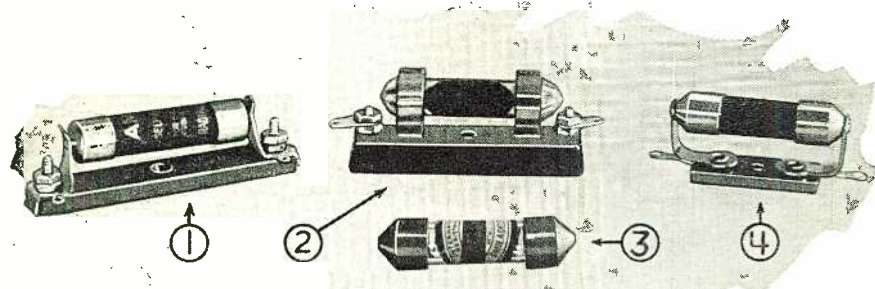

Fig. 4. These automatic filament controls can take the place of rheostats in almost any radio set. They control one or more tubes at a time and come in all standard resistance-ranges required for tube operation.

(Courtesy of: 1, Radiall Co.; 2, Davon Radio Corp.; 3, International Resistance Co.; 4, Leslie F. Muter Co.)

terminals will be 3 rather than 6. Three volts have been lost in the resistance. That is to say, there has been a "voltage drop," which is referred to as the "IR" drop, across the resistance. Since the voltage is 6 at the side of the resistance nearest the storage battery and only 3 at the other end, there is, of course, a difference of voltage, "potential," or "pressure" between one and the other end, or "across the resistance." This can be measured by a voltmeter, if the meter is connected directly across the resistance. The amount of current flowing in the circuit can be measured if a milliammeter is connected in series with one or the other of the battery leads.

Between the terminals of our storage battery there is a difference in potential of about 6 volts, normally, when the circuit is closed. This difference in potential is divided among the elements of the circuit—wires, rheostat, tube-filaments—in "voltage drops" exactly proportional to the resistance of each.

We know that the filament of a 201A-type vacuum tube operates on ¼-ampere of current and a filament-terminal voltage of 5. Naturally, less additional resistance is required in the circuit in this case, as more current is to flow. Since there is less resistance the voltage drop is not so great; in this case only one volt. Furthermore, there is less of a voltage drop across the filament of this type of tube, as it has less resistance than a 199-type filament.

through them and this is rather an important factor in the determination of the materials to be used. German-silver wire, iron wire, carbon discs and carbon granules are used often for both low- and high resistances of the variable type. Today, however, "nichrome" (an alloy of nickel and chromium) is almost universally employed in wire form for rheostats, potentiometers and other forms of wire-wound resistances, as it has very high resistance per unit length and has a comparatively low "coefficient of temper-

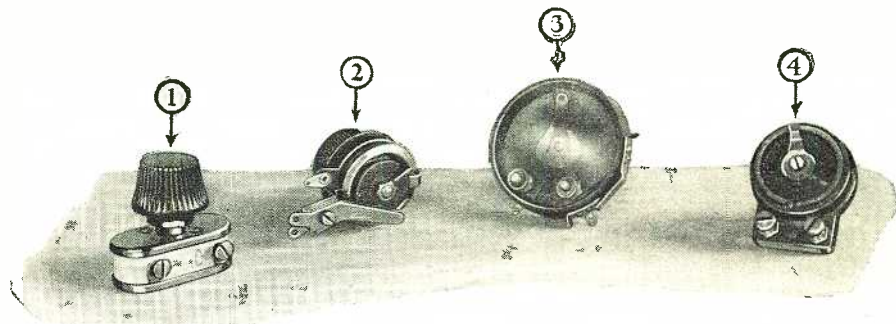

Fig. 6. A group of variable high resistances which can be employed as volume controls, regeneration controls, oscillation controls and in connection with resistance-coupled audio amplifiers. Number 1 is the carbon-disc-compression type. The rest are of the graphite-compound type, with frictionless contacts. Note that No. 2 has an automatic switch connected to it. This closes upon the turning of the control knob. No. 3 incorporates a similar device.

(Courtesy of: 1, Allen-Bradley Co.; 2, Carter Radio Co.; 3, Central Radio Laboratories; 4, Electrad, Inc.)

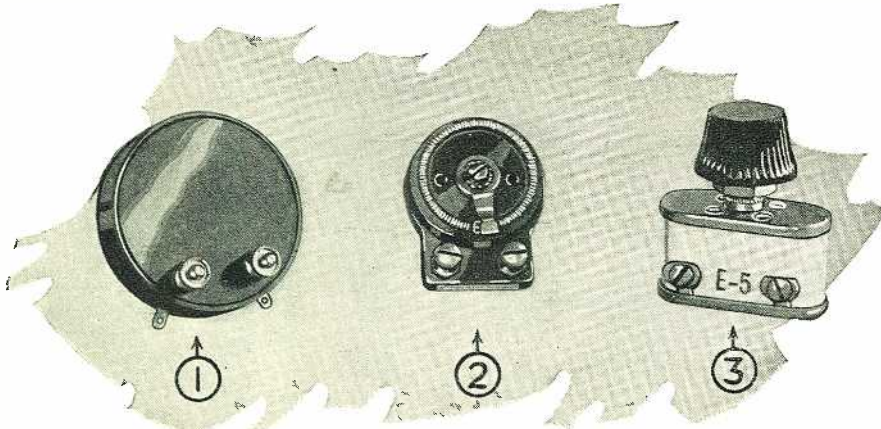

Fig. 7. Three variable high resistances with high current-carrying capacity. These are employed primarily as voltage controls, in both D.C. and A.C. "B" battery eliminators, but have many other uses in connection with a radio set. They are similar in design to those shown in Fig. 6, but have large-surface resistance elements.

(Courtesy of: 1, Central Radio Laboratories; 2, Electrad, Inc.; 3, Allen-Bradley Co.)

filament current for a 5-volt, 1/2-ampere vacuum tube; in the first place it would be impossible to obtain a fine variation of current and in the second place, because of the smaller wire employed, the rheostat would heat up perceptibly. We have 6-ohm rheostats for controlling tubes of this type, 20-ohm rheostats for tubes of the 201A type, 30- to 75-ohm rheostats for 199-type tubes, and 10-ohm rheostats with comparatively large resistance wire for controlling two, or possibly three, 201A tubes connected in parallel.

A number of rheostats of this general type are shown in Fig. 1. A number of rheostats having similar resistance values, but smaller in their construction are shown in Fig. 2; they are very convenient in cases where space is an important factor. A similar type of rheostat, incorporating a filament switch in its makeup, is shown at the right of Fig. 8. The switch is of the spring type, and is opened and closed by the action of the small insulation disc attached to the rheostat arm. When the rheostat arm is in the normal "off" position the switch is open. As soon as the rheostat knob is turned towards the right the filament switch closes the "A" battery circuit.

POWER RHEOSTATS

It is quite often desirable to operate three or more vacuum tubes from a single control and, if they are tubes of the 201A type, this can be done by connecting two or more rheostats in parallel; so that the current to the tubes can be handled without overheating the resistance wire. This is not a very satisfactory method, however, as there are plenty of power rheostats marketed expressly for this purpose. A number of them are shown in Fig. 3. They are wound with very heavy resistance-wire, which is capable of handling heavy currents, and the frames of the instruments are so made that the heat generated in the wire is very rapidly dissipated. These rheostats have a maximum resistance value ranging from one ohm to seven ohms. Rheostats of this type are also employed for controlling the filament current for power tubes, such as the 112 or 171 types.

AUTOMATIC FILAMENT CONTROLS

Aside from the regular run of rheostats, which we might say are manually operated, there are the self-adjusting rheostats or automatic filament controls. They take the form of a ballast resistance and are composed of a piece of iron resistance wire sealed in an evacuated glass tube, much like an electric lamp. They operate on the principle that wire, composed of iron or other metals of similar characteristics, increases in resistance value as it heats. Since the amount of current flowing through the wire

determines the amount of heat generated, the resistance is self-regulating. Thus, an automatic filament control designed for use with a 201A-type tube will allow only 1/4-ampere of current to pass. If, for any reason, more current attempts to pass, the wire heats up more and thus increases its resistance. If the "A" battery is run down a bit, that is, partially discharged, less current would actually flow through a given value of resistance; but, in the case of the automatic-fila-

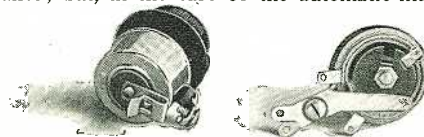

Fig. 8. Left: A variable resistance of the graphite-powder-compression type which has a range of resistance from zero to 5 million ohms. Due to these wide limits and large current carrying capacity, it can be employed in almost any place where a fixed or variable resistance is called for.

(Courtesy of American Mechanical Laboratories, Inc.)
 Right: A midget rheostat combined with an automatic filament switch. A special cam actuates the switch when the rheostat control knob is turned to the right.
 (Courtesy of Carter Radio Co.)

ment-control unit, the resistance of the wire adjusts itself to allow 1/4-ampere to pass. The same amount of current will pass when the battery is in a fully charged condition. A number of different makes are shown in Fig. 4.

POTENTIOMETERS

Potentiometers are actually variable resistances but they are employed as "voltage dividers." Every potentiometer has three

connections, two to the ends of the resistance wire and the third to the movable contact arm. The most commonly-employed types of potentiometers have resistances of 200, 300 and 400 ohms. A 200-ohm type accomplishes the same purpose as a 400-ohm one, but the latter type provides a finer variation. Since potentiometers are very seldom called upon to handle heavy currents, they are usually wound with very small wire; if larger wire were used the instrument would be inconveniently large.

A potentiometer can be put to a number of uses, but it is most generally employed for obtaining a variable grid-bias for radio frequency tubes. The resistance wire is connected directly to the positive and negative ("A+" and "A-") posts of the "A" battery and the contact arm to the grid-return circuits of the radio-frequency tubes. Since the resistance is connected directly in the "A" battery circuit, there is a drop of potential across it; this becomes greater and greater as we move away from the positive side. We can connect in on this drop at any place by moving the contact arm of the potentiometer. When the arm is in the center of the resistance the potential at the grid, in respect to the center of the filament of the tube, is zero. If we move the arm towards the positive side, that is towards the side of the resistance connected to "A+" (the positive terminal of the "A" battery) we impress a positive potential on the grid. If we move the arm towards the negative side ("A-") we impress a negative potential or voltage on the grid. The amount of positive or negative potential obtained depends upon the position of the contact arm and also, of course, on the total voltage of the "A" battery. Since the usual battery is 6 volts it is possible to get a positive or a negative variation from zero to 3 volts.

A potentiometer employed in this manner is functioning as a stabilizer, or oscillation control. A potentiometer having a much higher resistance (25,000 ohms or so) can be employed, in some cases, as a regeneration control, by connecting the resistance across the tickler coil and the arm to the "B+" battery terminal for the detector tube. (See the circuit diagram of the RADIO NEWS Batteryless Receiver in this issue). Potentiometers or voltage dividers are also employed in the filament circuits of power-amplifier tubes, the filaments of which are fed directly from alternating-current lines; and in this position tend to eliminate the A.C. hum which would otherwise be noticeable.

VARIABLE HIGH RESISTANCES

Variable high resistances probably have more uses in present-day radio practice than any other form of resistance unit. There are

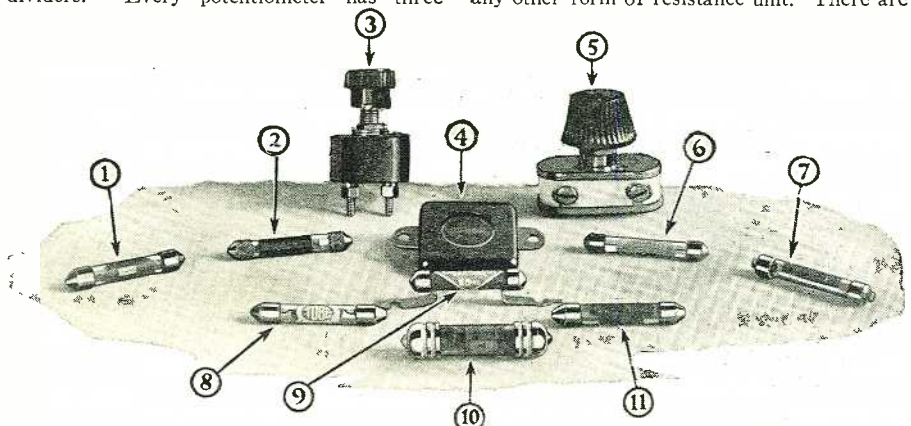

Fig. 9. Above are shown a number of fixed and variable resistors designed for use as grid leaks in connection with vacuum-tube detectors, and as plate and grid resistors in radio- and audio-frequency resistance-coupled amplifiers. Nos. 3 and 5 are variable grid leaks. 3 has a range up to five million ohms, and 5 to 10 million ohms. The fixed resistors shown in the foreground are all of the new type, and can be relied upon to retain their stated values under practically all conditions. (Courtesy of: 1, Dubilier Condenser & Radio Corp.; 2, Leslie F. Muter Co.; 3, Martin-Copeland Co.; 4, Micamold Radio Corp.; 5, Allen-Bradley Co.; 6, International Resistance Co.; 7, Electrad, Inc.; 8, Tobe Deutschmann Co.; 9, The Carborundum Co.; 10, Ansco Products, Inc.; 11, Daven Radio Corp.)

two distinct classes; the first includes resistances variable from zero to 25,000, 50,000, 100,000, 250,000 or 500,000 ohms. A group of resistances of this class are shown in Fig. 6. They are used, primarily, as stabilizers or oscillation controls in radio-frequency circuits; as regeneration controls in vacuum-tube-detector circuits; as volume controls in audio-frequency circuits; and, in some cases, in resistance-coupled audio amplifiers when variable resistors are required.

The resistance elements in these units are usually of some porous material, impregnated with a graphite mixture; and all units of this type have been designed so that there is no frictional contact between the movable arm and the resistance element proper. One type of variable high resistance in this class employs stacks of small carbon discs as the resistance element. The resistance is increased and decreased by varying the pressure exerted on the discs. Another of a similar type, shown at the left of Fig. 8, employs powdered graphite mixed with particles of mica. The resistance is varied over very wide limits; from zero to five million ohms, by altering the contact pressure on the mica-graphite mixture.

Variable high resistances of the second class are practically the same as those just described, as to their range of resistance values; but they have a much greater current-carrying capacity. They are employed primarily as voltage regulators in alternating and direct-current "B" eliminators, but can also be used to obtain "C" battery voltage from a "B" eliminator, and as current bypass and current-shunt units in connection with low-current-operating relays, voltmeters, ammeters and milliammeters. Variable resistances of this class are shown in Fig. 7. The one at the left of Fig. 8 also comes under this class; it employs a mica-graphite mixture as the resistance element.

FIXED RESISTORS

A group of fixed resistors is shown in the illustration of Fig. 9. Resistors of this type have fixed values ranging from 50,000 ohms to 10 million ohms (10 megohms). Those between 50,000 ohms and 1,000,000 ohms are employed, almost exclusively, in connection with resistance-coupled audio- and radio-frequency amplifiers and are of special construction.

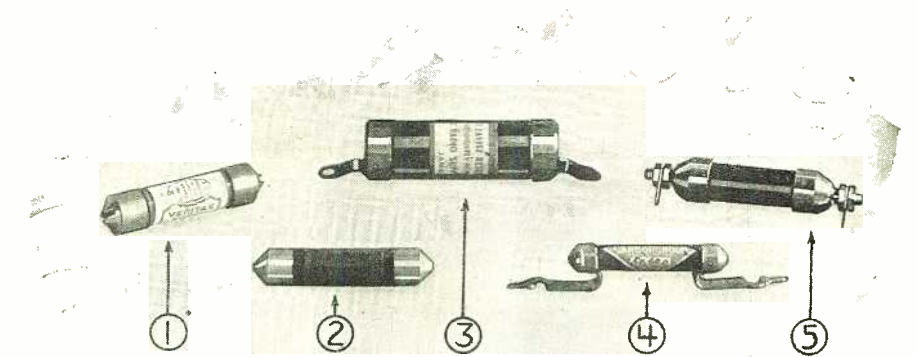

Fig. 10. A group of heavy-duty resistors which are employed principally as voltage adjustors in D.C. and A.C. "B" eliminators, but are useful also as current-by-pass and current-shunt units. Nos. 1 and 2 employ a carbon compound as the resistance; 3 is a lavite resistance unit. The resistance shown at 4 is made of carborundum; No. 5 is formed of a graphite compound which is fused into glass.

(Courtesy of: 1, Tobe Deutschmann Co.; 2, Allen-Bradley Co.; 3, Crescent Radio Supply Co.; 4, The Carborundum Co.; 5, Davén Radio Corp.)

Metallic or graphite substances are employed as the resistance elements, and are either coated on glass, fused into glass or formed into rods under extremely high pressure. These resistors are far superior to the older types, which readily absorbed moisture and varied in resistance value under load.

The fixed resistors shown in Fig. 10, which have values from 50,000 to 500,000 ohms (and some lower) are of the heavy-duty type with a high current-carrying capacity. Similarly to the heavy-duty variable resistors, they can be used as voltage adjustors in "B" eliminators, for obtaining "C" voltage from "B" eliminators, and as current bypass and current-shunt units, wherever a fixed value of resistance is satisfactory.

Those resistors shown in Fig. 9, having values from one million to ten million ohms (1 to 10 megohms), are employed as grid leaks in the grid circuits of vacuum-tube detectors. They are made in these various values for the reason that different types of tubes require different grid-resistance values, and different makes of receivers operate most efficiently with different particular values of grid resistance; irrespective of whether it is the same value employed in a

different type of receiver using the same type of tube.

At the rear of the group shown in Fig. 9 there are two variable grid leaks, each having a range from approximately 1/4 to 10 megohms. One is of the carbon-disc compression type, the other employs a graphite-mixture-impregnated element and a non-frictional contact. The instrument shown at the left of Fig. 8 can also be used as a variable grid leak, since it is variable from practically zero to 5 megohms. These variable grid leaks can be relied upon to hold their adjustment indefinitely.

Former types of fixed resistors employed merely strips of cardboard or similar material impregnated with India ink and enclosed in glass tubes. Changes in temperature or humidity altered the resistances of the units perceptibly, as they were not protected from these influences. The new types, employing a metal coating or graphite compound and protected by glass (one type is enclosed in a vacuum), are all practically unaffected by moisture and external temperature. They change but slightly in resistance value when heated by the current passing through them.

LIST OF BROADCAST STATIONS IN THE UNITED STATES

(Continued from page 956)

Radio Call Letter	BROADCAST STA. Location	Wave (Meters)	Power (Watts)	Radio Call Letter	BROADCAST STA. Location	Wave (Meters)	Power (Watts)	Radio Call Letter	BROADCAST STA. Location	Wave (Meters)	Power (Watts)
WKBY	Brookville, Ind.	236.1	150	WMCA	Hoboken, N. J.	310.7	500	WSAZ	Pomeroy, Ohio	211	50
WKBW	Buffalo, N. Y.	392.5	1000	WMRI	Jamaica, N. Y.	297.5	5	WSB	Atlanta, Ga.	128.3	1600
WKBY	Harrisburg, Pa.			WMSC	New York, N. Y.	502.8	500	WSBG	Chicago, Ill.	288.3	1500
WKBY	Danville, Pa. (port.)	220	50	WVMM	Newark, N. J.	175.9	500	WSBF	St. Louis, Mo.	273	250
WKBZ	Ludington, Mich.	256.3	15	WNAB	Boston, Mass.	280.2	100	WSBT	South Bend, Ind.	315	500
WKDR	150, Kenosha, Wis.	428.3		WNAO	Boston, Mass.	430.1	500	WSDA	New York, N. Y.	263	250
WKJC	Lancaster, Pa.	258	50	WNAD	Norman, Okla.	253	500	WSKC	Bay City, Mich.	260.7	100
WKRC	Cincinnati, Ohio	325.9 & 422.3	1500	WNAL	Omaha, Neb.	253	500	WSM	Nashville, Tenn.	282.8	1000
WKY	Oklahoma City, Okla.	275	100	WNAT	Philadelphia, Pa.	250	500	WSM	New Orleans, La.	339	500
WLAC	Nashville, Tenn.	225.4	1000	WNAX	Yankton, S. Dak.	244	100	WSMH	Owosso, Mich.	210	20
WLAL	Tulsa, Okla.	250	100	WNBH	New Bedford, Mass.	248	250	WSMK	Dayton, Ohio	275	500
WLAP	Louisville, Ky.	275	20	WNJ	Newark, N. J.	250	150	WSOE	Milwaukee, Wis.	236	500
WLB	Minneapolis, Minn.	277.6	500	WNOX	Knoxville, Tenn.	263	100	WSRO	Hamilton, Ohio	252	100
WLBA	St. Petersburg, Fla.			WNRG	Greensboro, N. C.	223.7	10	WSSH	Boston, Mass.	261	100
WLBC	Muncie, Ind.	223.7		WNVC	New York, N. Y.	528	1000	WSUI	Iowa City, Iowa	185.6	500
WLBE	Brooklyn, N. Y.	230.6		WOAI	San Antonio, Tex.	391.5	5000	WSVS	Buffalo, N. Y.	218.8	50
WLBI	Stevens Point, Wis.	278	750	WOAN	Lawrenceburg, Tenn.	356.1	500	WSWS	Batavia, Ill.	275.1	1000
WLBK	Kansas City, Mo.	211.1	25	WOAX	Trenton, N. J.	240	500	WSYR	Syracuse, N. Y.	332.7	500
WLBH	Farmingdale, N. Y.	230	30	WOBB	Chicago, Ill.	555.2	50	WTAB	Fall River, Mass.	266	100
WLB	East Wenona, Ill.	296.9	250	WOCC	Davenport, Iowa	483.6	5000	WTAD	Carthage, Ill.	236	50
WLCT	Ithaca, N. Y.	266	50	WOCL	Orlando, Fla.	293.7	50	WTAG	Warencester, Mass.	545.1	500
WLIE	Ithaca, Ill.	302.8	4000	WODL	Jamestown, N. Y.	275.2	15	WTAL	Toledo, Ohio	252	100
WLIT	Philadelphia, Pa.	391.5	500	WODA	Paterson, N. J.	390.7	1000	WTAM	Cleveland, Ohio	389.4	3500
WLI	Cretc, Ill.	311.6	5000	WOJ	Ames, Iowa	270.1	7500	WTAR	Kau Claire, Wis.	254	100
WLSI	Edgewood, R. I.	140.9	500	WOK	Homewood, Ill.	217.3-238	2000	WTAT	New York, N. Y.	261	100
WLTS	Chicago, Ill.	258	100	WOKO	Peekskill, N. Y.	233	50	WTAX	College Station, Texas	270	500
WLW	Harrisburg, Pa.	223	5000	WOMA	Manitowoc, Wis.	251.1	50	WTAX	Streator, Ill.	231	50
WLWL	New York, N. Y.	381.2	5000	WOOD	Philadelphia, Pa.	508.2	500	WTAZ	Lambertville, N. J.	261	15
WMAA	Cazenovia, N. Y.	275	100	WOOD	Ferndale, Mich.	242	1000	WTHO	Perrandale, Mich.	407	500
WMAF	Dartmouth, Mass.	110.9	1000	WOJ	Kansas City, Mo.	278	1000	WTIC	Hartford, Conn.	175.9	500
WMAK	Lockport, N. Y.	365	500	WOK	Newark, N. J.	405.2	500	WTRC	New York, N. Y.	269.9	50
WMAJ	Washington, D. C.	292.9	500	WORD	Batavia, Ill.	410.9	5000	WVAE	Electric Park, Ill.	381.4	10000
WMA	Columbus, Ohio	286	50	WOS	Jefferson City, Mo.	412	500	WWJ	Detroit, Mich.	352.7	1000
WMAQ	Chicago, Ill.	347.5	1000	WOW	Omaha, Neb.	426	1000	WWL	New Orleans, La.	275	100
WMAY	St. Louis, Mo.	243	100	WOWD	Port Wayne, Ind.	227	1000	WWNC	Asheville, N. C.	251	100
WMAZ	Macon, Ga.	261	500	WPA	Norfolk, Va.	319	100	WWPR	Detroit, Mich.	300	500
WMB	Chicago, Ill.	291.0	500	WPAK	Ensign, N. Dak.	275.2	50	WWRL	Woodside, N. Y.	258.5	100
WMBB	Detroit, Mich.	256.4	100	WPAP	Cliffside, N. J.	292.2	100	WWVA	Wheeling, W. Va.	348.5	160
WMBF	Miami Beach, Fla.	381.4	500	WPCB	Chicago, Ill.	258	500	2XAD	Schenectady, N. Y.	22.6-26.2	1000
WMBI	Chicago, Ill.	288.3	500	WPCH	New York, N. Y.	273	500	2XAF	Schenectady, N. Y.	32.79	10000
WMC	Memphis, Tenn.	499.7	500	WPDR	Buffalo, N. Y.	203.1	50				

*Standard or constant frequency. Location of transmitter only.

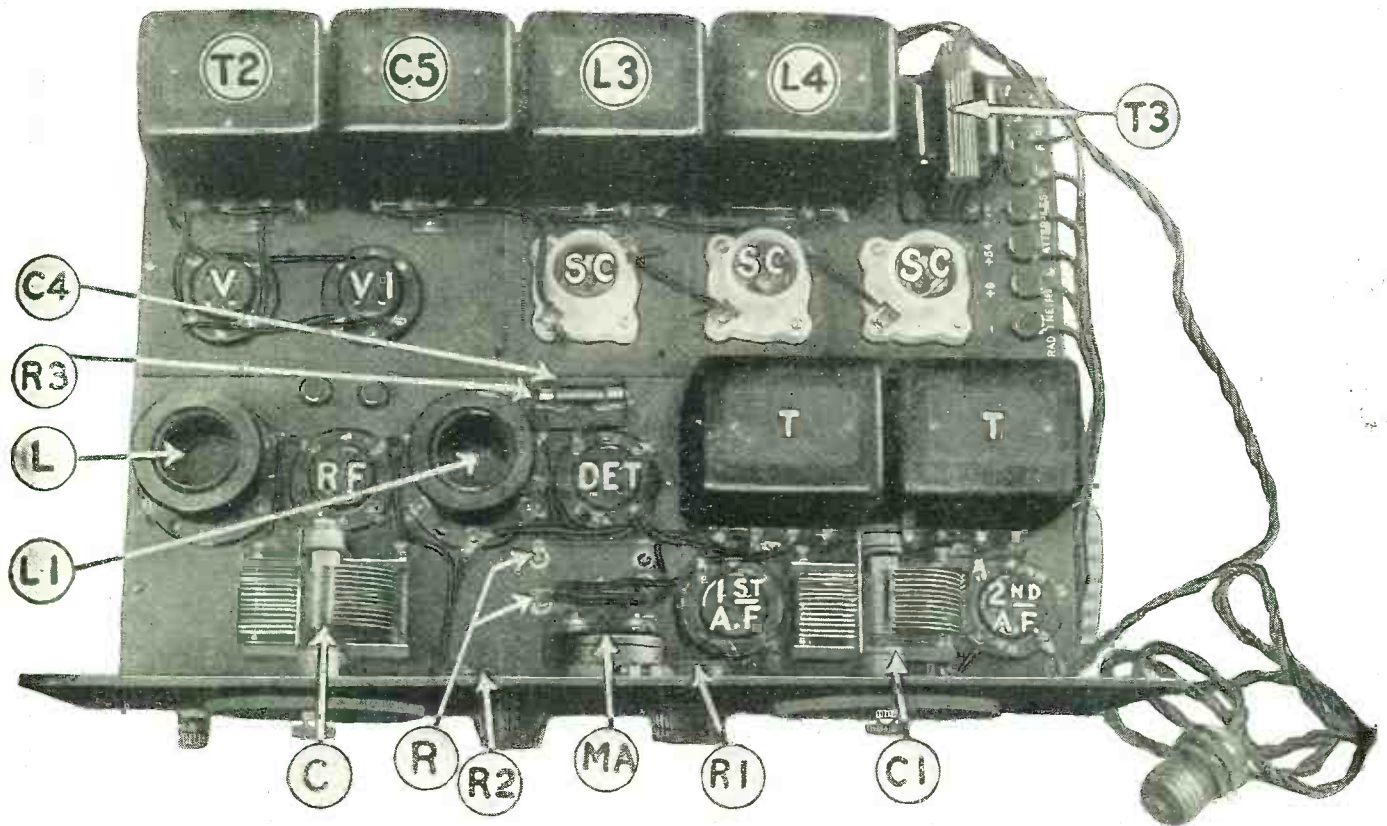

A top view of the RADIO NEWS Batteryless Receiver. There are actually two sub-bases, as will be seen on close inspection, that in front being the sub-base for the receiver, while the power unit is mounted at the rear. The power unit is comprised of a power transformer T2, a filter condenser bank C5, two filter chokes L3 and L4, a filament ("bell-ringing") transformer T3, two tube sockets V and VI and three lamp sockets SC. The receiver is composed of an antenna coil L, a radio-frequency transformer L1, two variable condensers C and C1, fixed filament-resistances R, a rheostat R1, a potentiometer R2, a milliammeter MA, a grid condenser and leak R3-C4, and two A.F. transformers T and T1.

The Radio News Batteryless Receiver*

A Receiver and Power Amplifier Operating Direct from the Lamp Socket

By Mc MURDO SILVER

It is with pleasure that we have the opportunity of presenting to our readers a receiver as complete and effective as the one described in the accompanying article. It is "batteryless" without reservations. The "A," "B" and "C" voltages are all obtained from the light socket. Three-volt tubes are employed for the R.F. amplifier, the detector, and the first A.F. tube. The three filaments are connected in series and therefore draw only 60 milliamperes. The filament of the power-amplifier tube is fed with "raw" alternating current, and operates without the trace of a hum. The power unit is mounted directly behind the receiver, so that both fit into a single cabinet.—EDITOR.

Right: A panel view of the RADIO NEWS Batteryless receiver. C and C1 are the two main tuning controls. R2 is the regeneration control and R1, a 1200-ohm rheostat, controls the filament current to the 3-volt tubes. Below: A rear view of the receiver unit only. The position of the power unit, when both are assembled, is shown in the illustration at the top of the page.

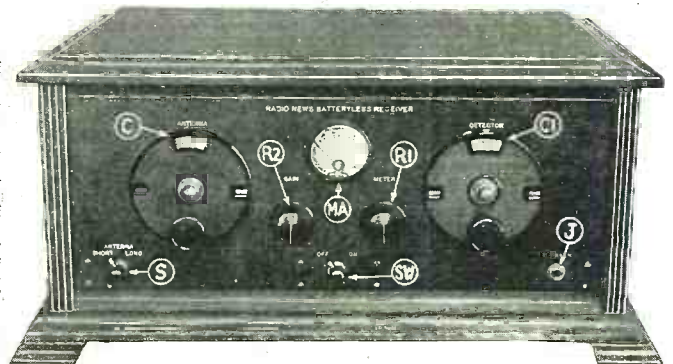

THE RADIO NEWS Batteryless Receiver consists of two units, the first being the receiver proper and the second its power-supply unit, designed to furnish power for the operation of the receiver directly from a 110-volt, 60-cycle lighting circuit.

The receiver itself consists of one stage of tuned-radio-frequency amplification, a regenerative detector, and two stages of audio, mounted upon a 7x18-inch front panel and a 6½x17-inch sub-panel.

The receiver will be seen to consist of an antenna coil, L, to the primary of which is connected a switch, S, allowing the use of either half or all of the primary in the antenna circuit. The secondary of this coil is tuned by a .00035-mf. variable condenser, C, and feeds into the first (R.F. amplifier) tube; which, in turn, feeds out into the R.F. transformer, L1. This is especially designed,

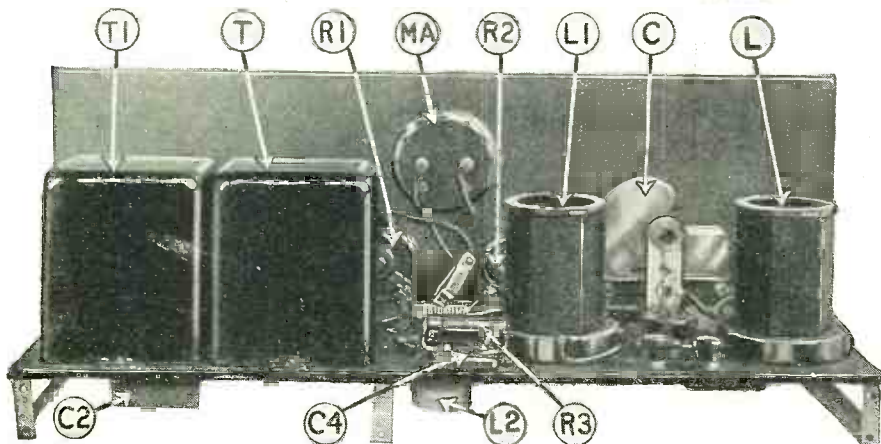

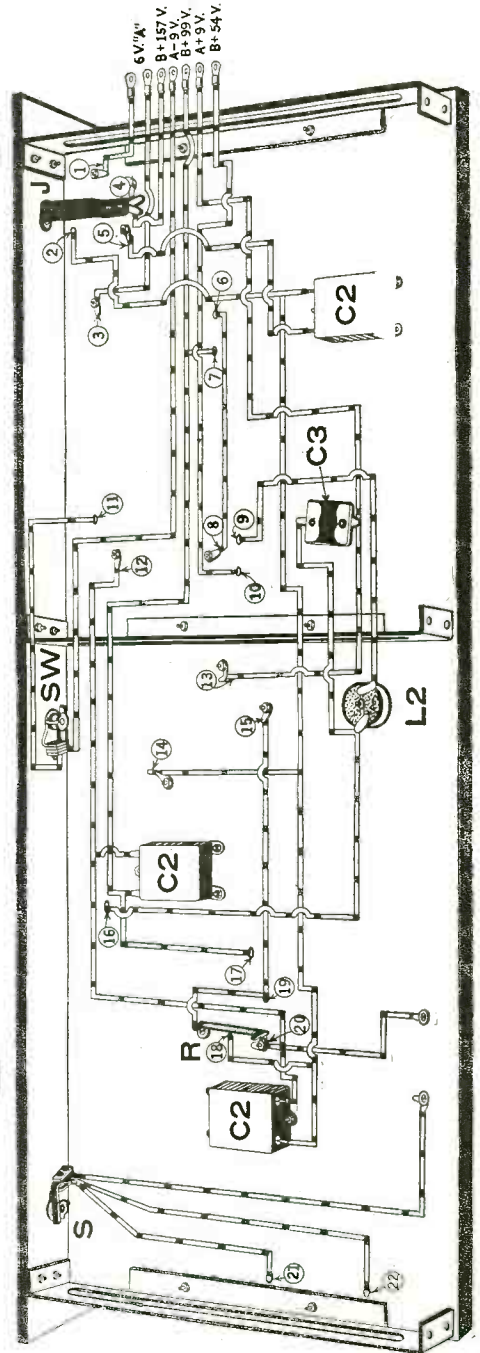
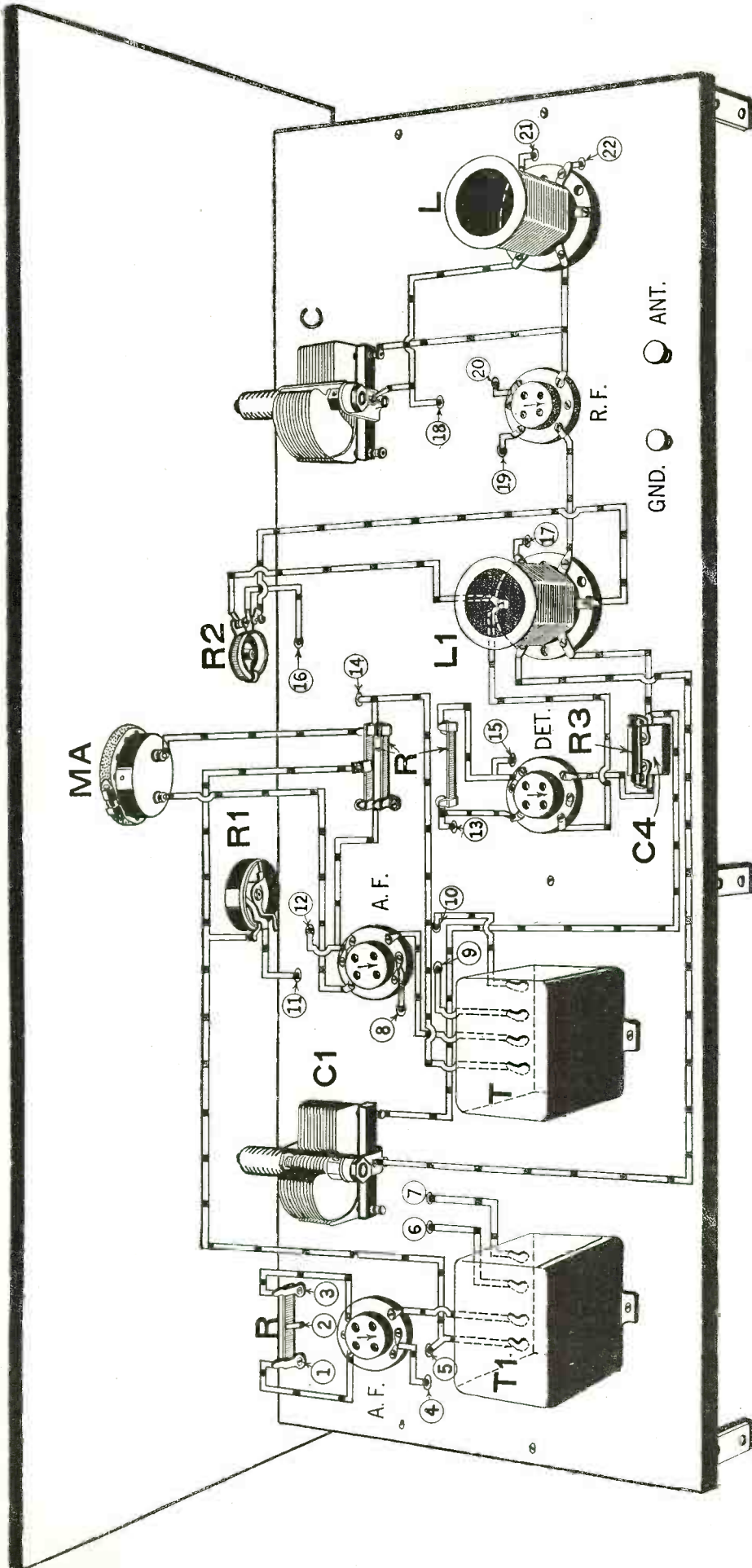

Left: Perspective layout and wiring of the receiver unit of the RADIO NEWS Batteryless set. Those wires which pass through holes in the sub-base connect to apparatus underneath. The continuation of the wiring on the under side of the sub-base is shown above. All of the wires that pass through holes are numbered alike in both views.

On the following page are the lay-out and the drilling directions for both sub-panels.

with a space-wound primary extending over the entire length of the secondary winding; thus providing a maximum of magnetic coupling with a minimum of primary inductance and interwinding capacity.

REGENERATION CONTROL

The detector tube is of the conventional grid-condenser-and-leak type, with regeneration controlled by a high-resistance potentiometer. R2, connected across a small tickler coil. The tickler coil has 9½ turns and regeneration seems easy to obtain, though it may be necessary to increase the number of turns to 15. The detector tube feeds into

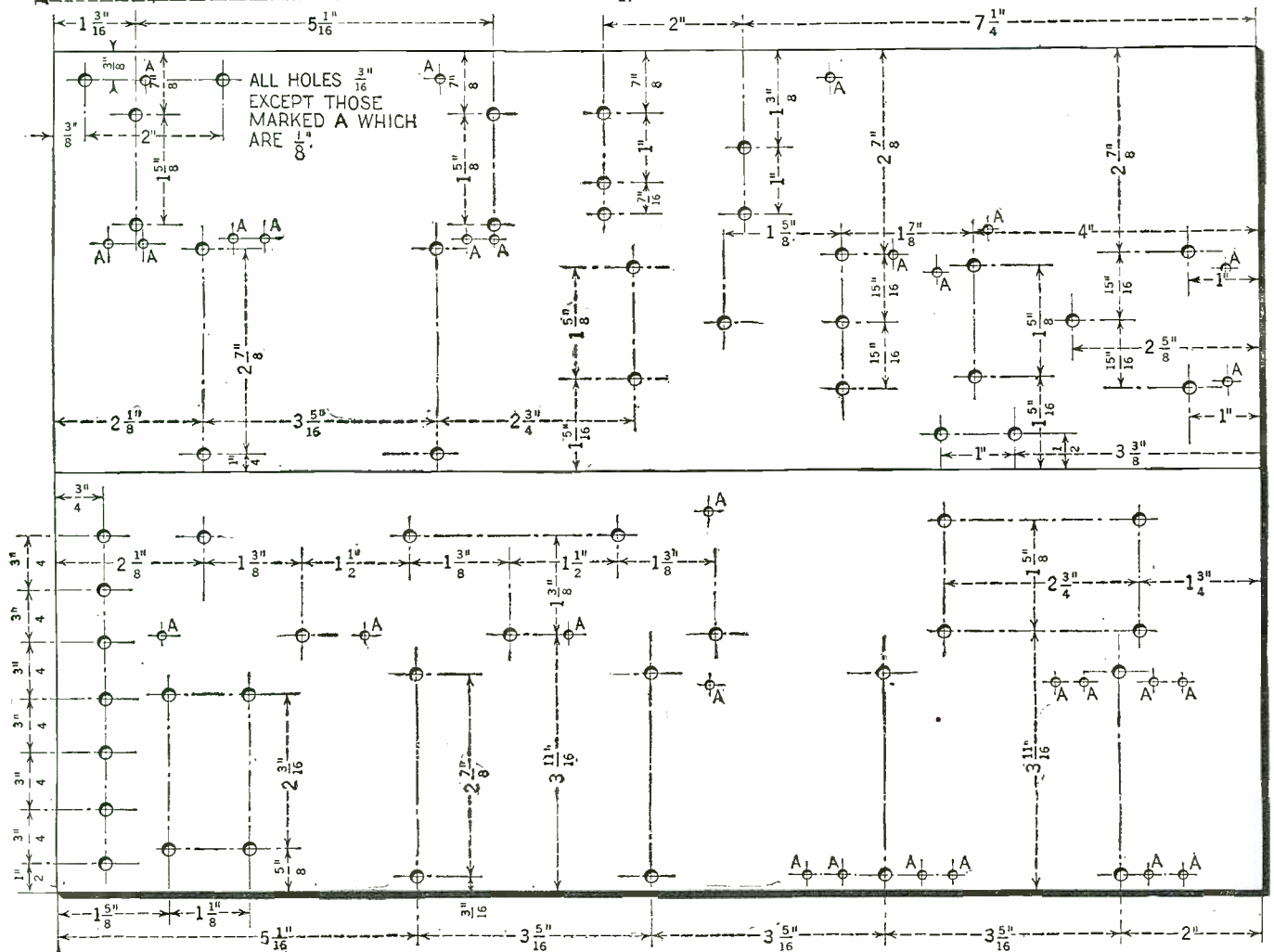
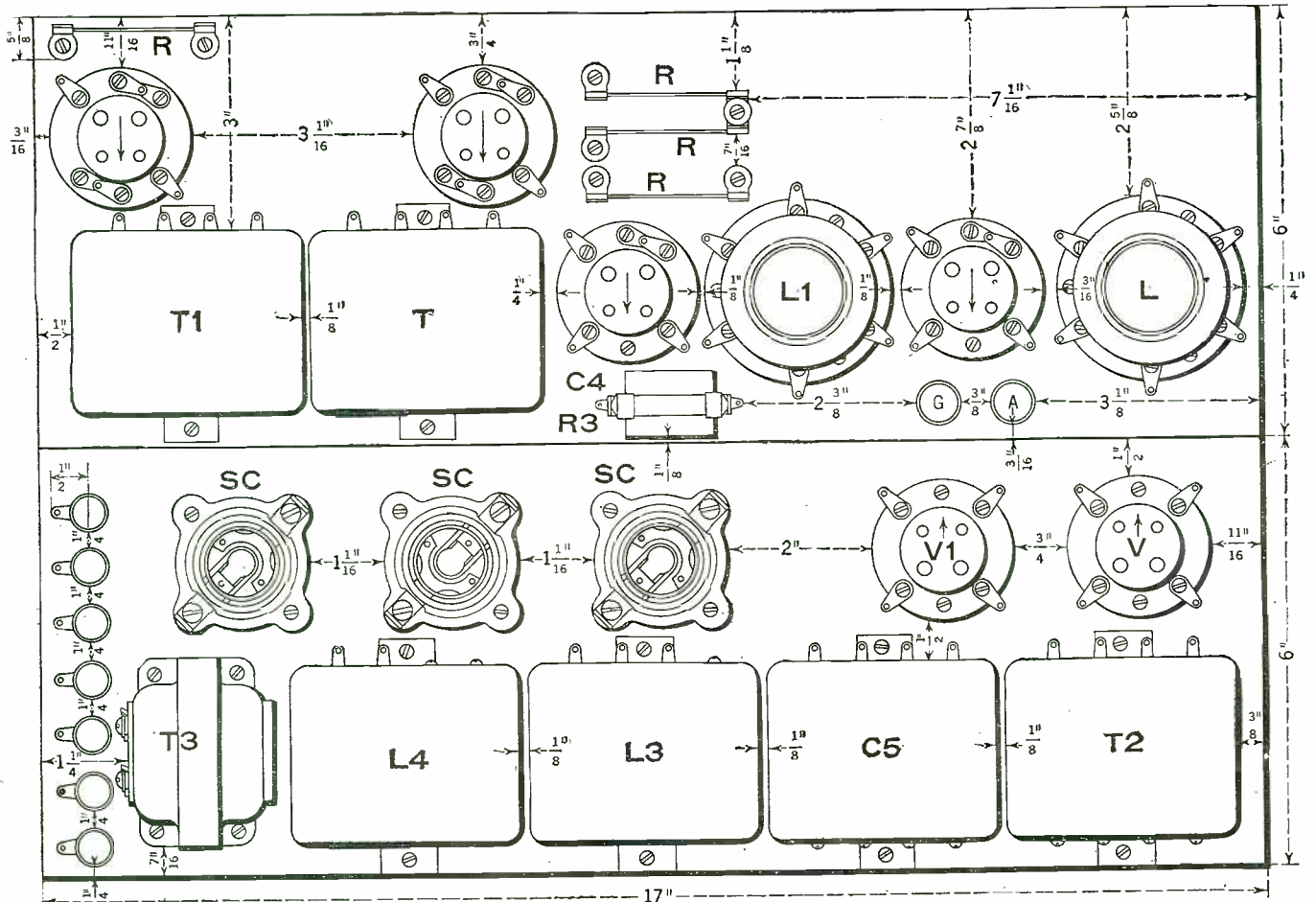

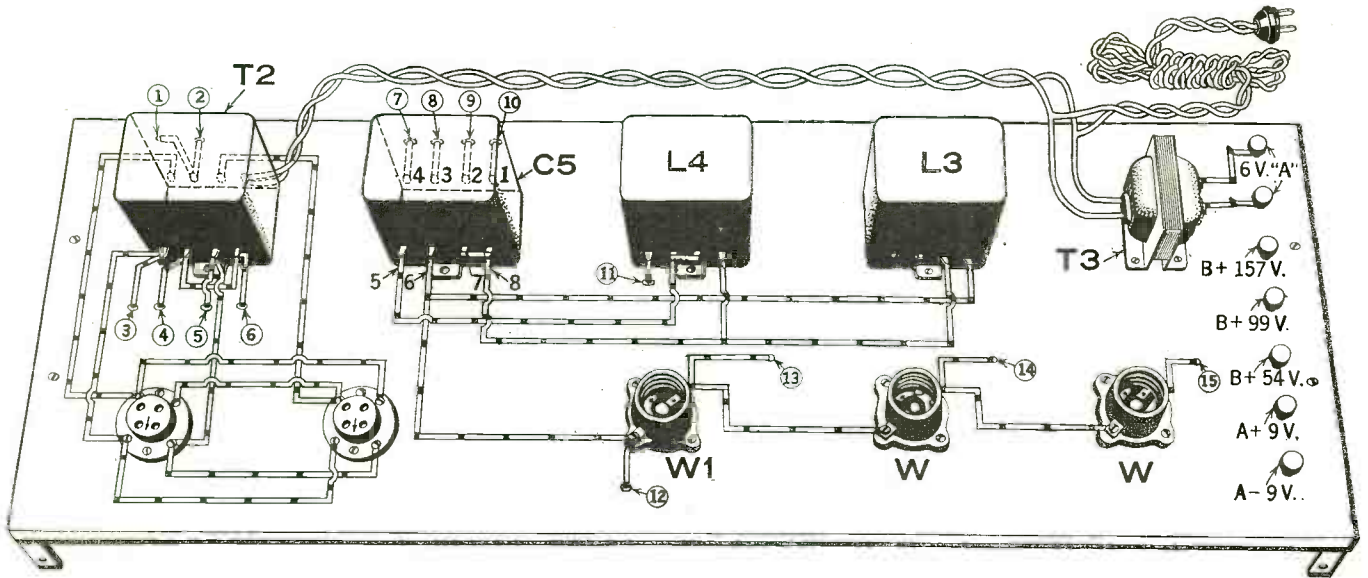

Above: The perspective layout and wiring of the power unit, which is mounted directly behind the receiver. All the wires designated by numbers in circles pass down to the under side of the sub-base through holes; at which points they are similarly numbered, in the bottom-view below. The numbers not in circles designate the markings on the respective parts. The wiring of the under side of the sub-base is shown below.

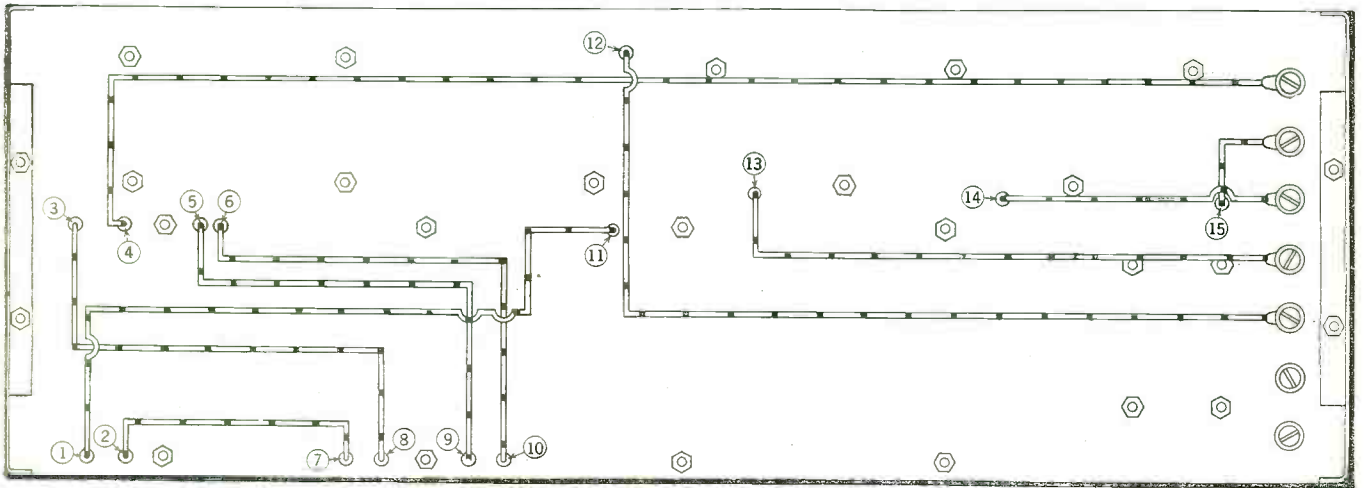

Below is shown the constructional layout of the panel for the receiver. All the necessary dimensions are given. The constructional layouts for both sub-bases, as well as the drilling layouts, are given on the opposite page. In all the illustrations and sketches the apparatus is similarly marked.

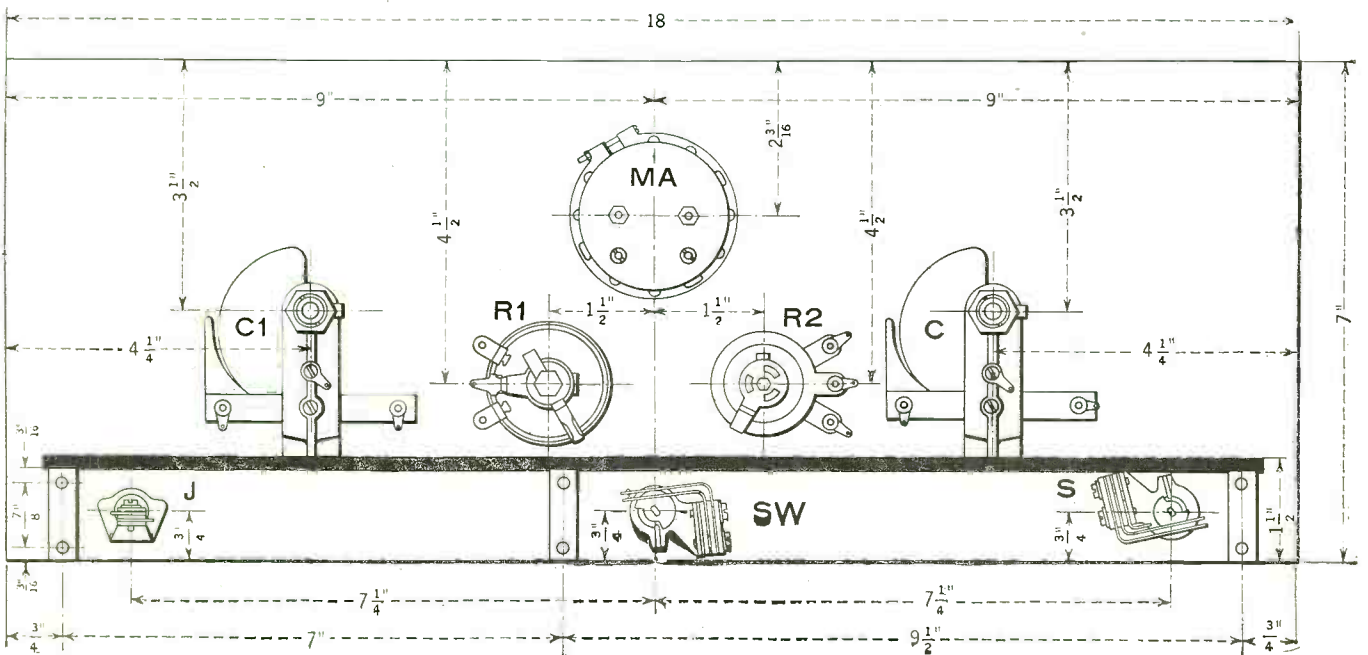

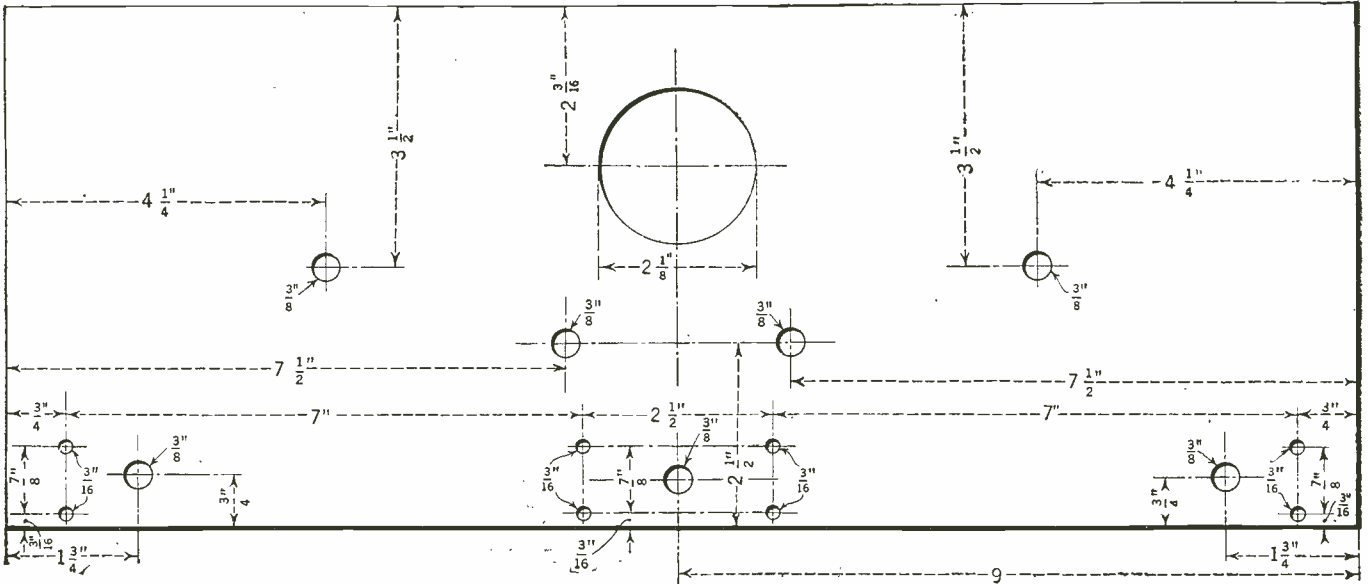

Above: Layout and drilling details for the panel of the RADIO NEWS Batteryless Receiver.

the first audio transformer, T, then into a first A.F. amplifier tube, through another audio transformer, T1, and out to the last tube. No provision is made for using less than four tubes.

The first three tubes in the receiver are of the 199 type, with filaments in series and operating from the output of the power supply. The last tube is a 112, the filament being energized by a standard bell-ringing transformer.

USE OF RESISTANCES

Across the filament of each 199 tube is connected a 200-ohm fixed resistance, R, intended to by-pass the plate current of the receiver around the filaments of the tubes, for the purpose of improving audio reproduction. Another 200-ohm resistance, with a center tap soldered to it, is used across the filament of the power tube, to balance out the hum from the bell-ringing transformer. Still another 200-ohm resistance, with a clip attached to it, is used in series with the negative line from the power supply, to provide suitable grid potential for the second audio amplifier. The 1200-ohm rheostat, R1, in series with the negative lead, is used to adjust the filament current of the 199 tubes to a proper value, (indicated by the 0-100 milliammeter MA) which should be about 60 to 75 milliamperes for normal operation.

Three 1.0-mf. by-pass condensers, C2, are used in the circuit at important points, as will be noted. A small radio-frequency choke, L2, and a by-pass condenser, C3, are connected in the detector plate circuit, their purpose being to isolate effectively the audio and radio sections of the receiver.

THE POWER UNIT

The power-supply unit, which really is flexible and may be used with any standard type of receiver with 199 filaments wired in series, is comparatively simple.

The power transformer, T2, feeds two-213-type (rectifier) tubes, each tube having its plates connected together and working as a half-wave rectifier; the filaments of the two tubes are connected in parallel. This provides for an allowable current drain of 120 milliamperes, without tube overload. In actual operation the system will supply to the receiver a current of about 80 milliamperes at a maximum of 157 volts, approximately.

The first filter choke, L3, together with a section of the condenser bank, C5, forms a combination selective-and-"brute-force" filter using the "Clough principle." (The mutual

(Continued on page 1004)

SYMBOL	Quantity	NAME OF PART	VALUE OF PART	REMARKS	MANUFACTURER ★
SET					
T, T1	2	A. F. Trans.			1 11,14,15,16,17,18,19,33
L	1	Ant. Coil & Base			1
L1	1	R.F. Trans. & Base		With tickler	1
C, C1	2	Variable Cond.	.00035 mf.		1 14,15,17,20,23,29,33
C2	3	Fixed Cond.	1 mf.	By-pass	2 3,21,22
C3	1	Fixed Cond.	.002 mf.		3 2,21,22
L2	1	R.F. Choke Coil			1
J	1	Jack		Single circuit	4 15,17,29
S	1	Ant. Switch	S.P.D.T	For long and short antenna	4 5
SW	1	Fil. Switch			4 5,24,25,29
R	5	Fixed Resis.	200-ohms		4 5
C4	1	Fixed Cond.	.00025 mf.		3 2,21,22
R3	1	Grid Leak	2 megs.		3 2,21,22,23,26,27,33
R1	1	Rheostat	1200-ohms		4 5,33
P2	1	Potentiometer	25,000-ohms		5 23,24,30,33
MA	1	Milliammeter	0-100 M.A.		6 31,32
	2	Binding Posts		Removable tops	7 33
	1	Panel		7" x 18" x 3/16"	8 34,35
	1	Sub-Panel		6 1/4" x 17" x 3/16"	8 34,35
	3	Brackets			1 20,35
	2	Dials		Vernier	9 15,17,29,36
ELIMINATOR					
L3,T1	2	Filter Chokes			1
C5	1	Condenser Bank			1
T2	1	Power Trans.			1
V,V1	2	Socket		UX Type	1
SC	3	Bulb Sockets		Porcelain	10 20,37
	2	Brackets			1 20,35
T3	1	Bell Ringing Trans.			11 15
	7	Binding Posts			7 33
	1	Sub-Panel			8 34,35
	1	Cabinet			12 13
W	2	Lamps	25 watt	115 volt tungsten	
W1	1	Lamp	15 watt	115 volt tungsten	
	3	Tubes	3v.60 M.A.	199 Type	38
	1	Tube	5v. 1/2 amp.	Semi-power tube	38
	2	Rec. Tubes		Full wave	33
NUMBERS IN LAST COLUMN REFER TO CODE NUMBERS BELOW.					
1	Silver-Marshall, Inc.	17	Bremcr-Tully Mfg. Co.	33	General Radio Company
2	Electrad, Inc.	18	American Trans. Co.	34	Diamond State Fibre Co. (Celeron)
3	Polymet Mfg. Corp.	19	Ferranti, Inc.	35	Ins. Co. of America (Insuline)
4	Yaxley Mfg. Co.	20	Benjamin Elec. Mfg. Co.	36	Kurtz-Masch Company
5	Carter Radio Company	21	Aerovox Wireless Corp.	37	Hart & Heskett
6	Weston Elec. Inst. Co.	22	Dubilier Radio & Con. Corp.	38	Ferryman Elec. Co.
7	Waterbury Button Co.	23	Amcco Products, Inc.	39	Radio Corp. of America
8	Fornica Insulation Co.	24	H.H. Frost, Inc.		
9	Martin Copeland Co. (Marco)	25	Howard B. Jones		
10	Ergent Elec. Co.	26	A.H. Lynch, Inc.		
11	Jefferson Elec. Mfg. Co.	27	International Resis. Co.		
12	Baker Yacht Basin Inc.	28	Alden Mfg. Company		
13	Fritts Company	29	Pacent Elec. Company		
14	Acme Apparatus Co.	30	Central Radio Labs.		
15	Samson Elec. Co.	31	Burton-Rogers		
16	Thordarson Elec. Mfg. Co.	32	Jewell Elec. Inst. Co.		
APPROXIMATE COST OF PARTS \$ 105.00					
★ THE FIGURES IN THE FIRST COLUMN OF MANUFACTURERS INDICATE THE MAKERS OF THE PARTS USED IN THE ORIGINAL EQUIPMENT DESCRIBED HERE.					
NOTE TO SET BUILDERS: If you use alternate parts instead of those listed in the first column of manufacturers, be careful to allow for any possible difference in size from those originally used in laying out and drilling the panel and sub-base.					
Form © 1926, E. P. Co.					

A Three-Foot Roll-Type Speaker

A Reproducer Simple of Construction and With Excellent Tonal Quality

By CLYDE J. FITCH

THE loud speaker offers one of the most interesting fields of experimentation open to the radio listener. When we see the vast number of horn speakers of all shapes and sizes, and also plain cones, oval cones, eccentric cones and roll- or book-type speakers, both free-edge or otherwise, of various sizes and forms, we begin to realize how enormous is the loud-speaker field, and also to wonder if the loud-speaker problem will ever be satisfactorily solved. Its evolution is toward better quality of reproduction. What the final solution will be is difficult to predict.

The large, three-foot-cone type of loud speaker has proven itself so excellent, as far as quality of reproduction is concerned, that by analogy why should not a large roll-type speaker prove superior to the smaller ones? (And the small ones are very good.) With this in mind, a large roll speaker was built, with the parts designed for a three-

as shown in the various illustrations, Fig. 4 giving the dimensions. Be sure to use a heavy, hard wood, such as oak; because, the more weight added to the unit, the better will be the results. Remember that, on these large speakers, the vibrating member or diaphragm weighs as much as the unit; and unless weight is added to the unit, the diaphragm will remain stationary and the unit will vibrate.

The roll, or rather double roll, is made from one sheet of 38 x 38-inch speaker cone material. The sheet is folded once through the center, across the grain, as shown in Fig. 4. (This material is usually supplied in rolls, with the grain running lengthwise with the roll.) Before folding, draw a line through the center with a straight edge. Now using the straight edge and a sharp pointed tool, go over this line, making an indentation in the paper. The sheet may now be folded along this line without fear of crushing.

Next we require a thin piece of brass cut out and drilled as shown in Fig. 4A. This is fastened to the threaded drive rod of the unit, bent up around the outside nut, and clamped upon the center of the folded edge of the sheet with a small nut and screw, as shown at B. Before clamping this piece to the sheet, mount the unit on the center of the wooden frame with wood screws.

With the unit in place and the folded sheet attached to it, procure a few thumb tacks; bend the sheet over to the sides of the frame and securely attach it with the tacks. If desired, a gold braid may be placed along the sides to improve the appearance. The addition of a cord to hang the instrument to the picture moulding completes the assembly. Although called a three-foot roll, the speaker in fact is 38 inches long and 28 inches wide.

A loud speaker of this type lends itself admirably to decoration in a style harmonious with its surroundings. In contrast to the neutral tint of the diaphragm paper, braid trimmings may be used in brighter colors, agreeing with the other furnishings and the general scheme of the room in which it is hung.

In selecting the parts for this speaker be sure to procure a good cone unit, preferably a direct-drive one; in other words, one that has no mechanical reducing levers for reducing the motion applied to the cone. The one used in the writer's experiments was not a balanced unit, and could therefore be directly connected in the plate circuit of the output power tube of the set, without the use of an output transformer or choke coil and con-

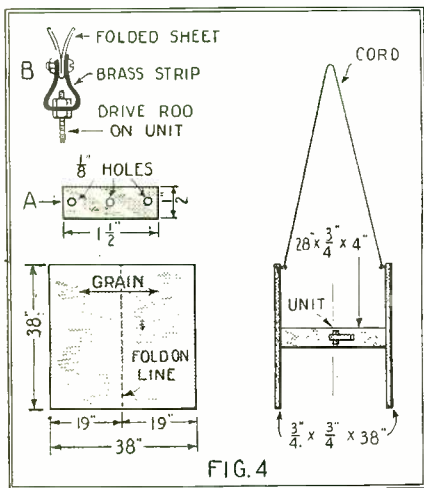
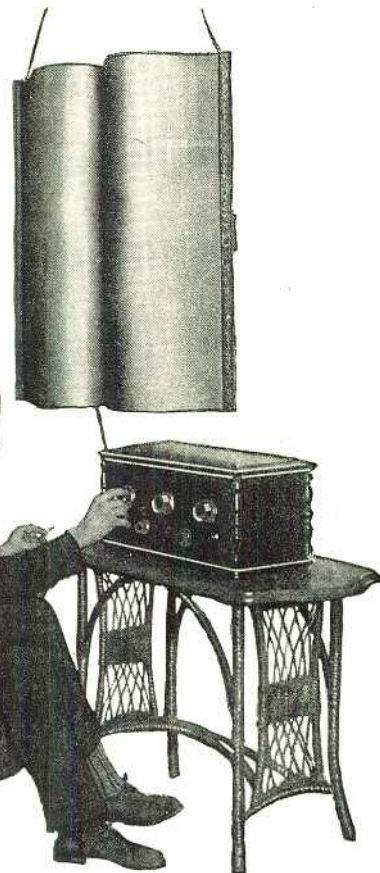

Details of construction for the roll-type speaker. At the upper left are data for preparing the metal strip that is attached to the diaphragm.

foot cone speaker. The roll speaker, shown in the accompanying illustrations, was found surprisingly simple to make. Only a few minutes were required to assemble it; it was then directly compared with a three-foot cone, using a resistance-coupled set. Whether the roll is superior to the cone, is difficult to determine. It is slightly higher in pitch than the cone and it certainly gives excellent reproduction. It is a matter of personal opinion which is the better speaker; many who heard the roll speaker prefer it to the cone, and vice versa. The type of set used with this speaker must also be taken into consideration when tests are being made.

CONSTRUCTION OF SPEAKER

The construction of the speaker is so utterly simple that it requires little comment here. First a frame of three sticks was built,

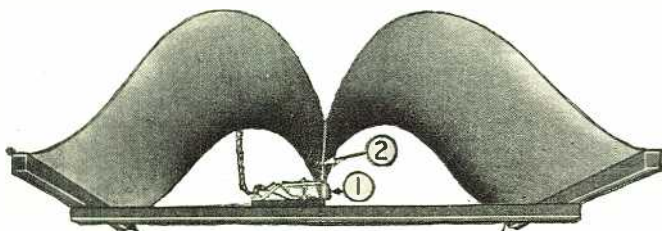

On the left is the end view of the speaker, showing the manner in which the unit is mounted. No. 1 in both views is this unit and No. 2 is the point where the unit's drive rod is attached to the paper diaphragm. On the right, rear view of the speaker.

Photos by courtesy Engineers' Service Co.

denser system. A type 112, 171, or 210 power tube may be used in this manner without fear of damaging the unit.

THEORY OF OPERATION

The theory of operation of the large roll speaker is somewhat similar to that of the cone speaker. In order to obtain faithful reproduction of the low tones, such as are produced by the bass viol, it is necessary to move a large volume of air. This requires a large, light, and strong diaphragm, the larger the better, up to a certain point where the lowest musical tones are reproduced. A sheet of paper may be large and of light weight;

(Continued on page 1030)

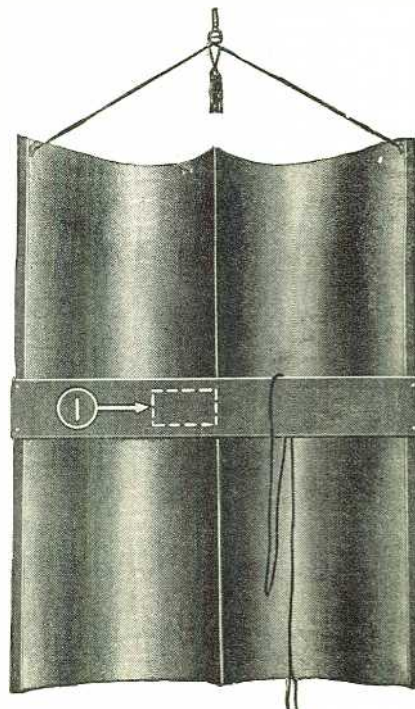



The Universal Pilotone Receiver*

A Set That Tunes from 20 to 550 Meters. Using Plug-In Coils

By JOSEPH RILEY



THE man who is interested chiefly in radio broadcast reception will be glad to be informed about this receiver, for it will give excellent results on stations up to one thousand miles; as for the "ham," it will appeal to him also, because of the fact that the coils are interchangeable and the set may be tuned as low as 20 meters. For the experimenter, who wants to listen to broadcasts that are not in the 200-550 meter band (among these being KDKA, Pittsburgh, working on 63.6 meters, and 2XAD and 2XAF at Schenectady, operating on 22.6-26.2 and 32.8 meters respectively, all three of which have regular programs) and who likes to listen to "code" once in a while, here is just the set for which he has been waiting.

This receiver uses but three tubes—a regenerative detector and two stages of transformer-coupled audio-frequency amplification—and has only two tuning controls. Most of the wiring is under the sub-panel; and, if the plans given here are used as guides, it will be a relatively simple matter to construct the outfit.

—EDITOR.

IN the days when radio broadcasting was only a curiosity, not an established industry such as it is today, the majority of the circuits used by radio enthusiasts had incorporated in them some form of regeneration. There were as many different phases of this type of circuit as there were people to build them. Or at least it seemed that way, for everyone with whom you talked in those days had "something new that could not be beat."

In a great many receivers of the present day this same true and tried regenerative principle appears, with several modifications, however. Since the days mentioned above, tuned-radio-frequency circuits have come into vogue, and in these regeneration sometimes plays a prominent rôle. There are many people who can not forget the excellent service which the old three-circuit tuner gave

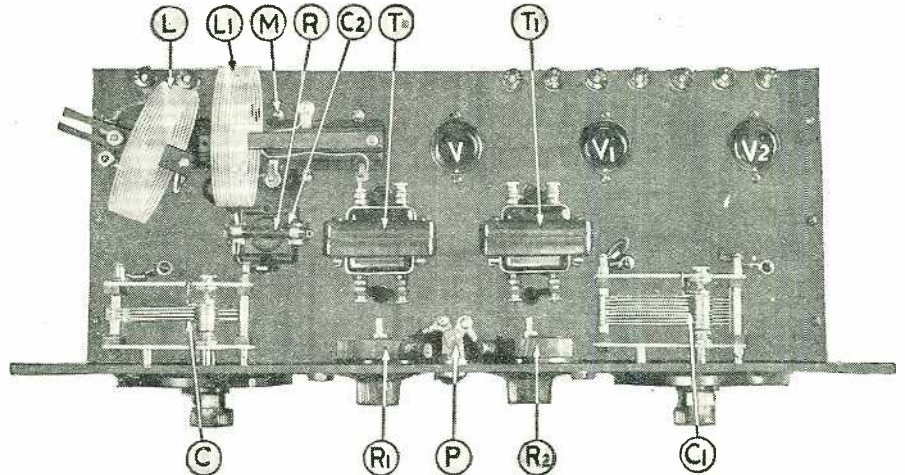

Looking down on the sub-panel. C is the tuning condenser; M, the coil mounting; V, V1, and V2 are the detector and two A.F. tubes; C2 and R, grid condenser and leak respectively.

them, and there are many who would like to become better acquainted with it; therefore—this receiver.

THE CIRCUIT

By a glance at the circuit diagram of the set it will be seen that there is a regenerative detector, V, the output of which feeds into two stages of transformer-coupled audio-frequency amplification. This circuit doubtless is an old story to many radio fans; but like most old stories, one likes to hear them again and again.

Even those of you who are familiar with regenerative sets will find something of interest in this receiver. In the first place, instead of using a variable condenser in the primary circuit, this receiver has a semi-aperiodic antenna circuit. (See L in the schematic diagram.) Usually there has been a condenser that could be placed either in series or parallel with the primary inductance, by means of a switch, thus changing the wavelength range of the set. This extra condenser has been eliminated in the set shown, with the consequent reduction in the number of tuning controls from three to two.

In the old-time regenerative set there was the adjustment of the tickler coil to be considered; and this was a very important factor if one desired first-class reception. This variation of the tickler coil with respect to the secondary controlled the regeneration in the set and was effected by a separate control on the front of the panel. This adjustment of the tickler is eliminated in the receiver described here, as the tickler is wound on the same form as the secondary. Regeneration is controlled by the seventeen-plate variable condenser, C1. Thus we have only two controls, the other being the variable condenser, C, which tunes the set.

Instead of automatic filament controls, which are generally found in the present-day receivers, there are two rheostats, one controlling the filament of the detector tube and the second those of the two audio-amplifier tubes, thus acting as a volume control.

SHORT-WAVE EFFICIENCY

It will be noticed from the illustrations that the inductance, L, is so arranged that its inductive relationship with the secondary inductance, L1, can be varied if it is moved back and forth in the slot mounting; the proper coupling may thus be obtained. It is only necessary to make this setting once for each set of coils; i.e., if a change is made from the coils used for receiving the broad-

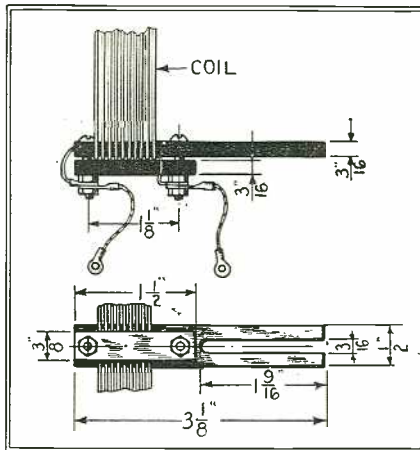

This is a detail drawing for constructing the antenna coil, L. This inductance is mounted on the bakelite post shown in the drawing of the mounting on page 975. The slot shown here, in the bottom view of this coil, is placed in the screw and clamped in position by the nut, as can be seen from the illustration below.

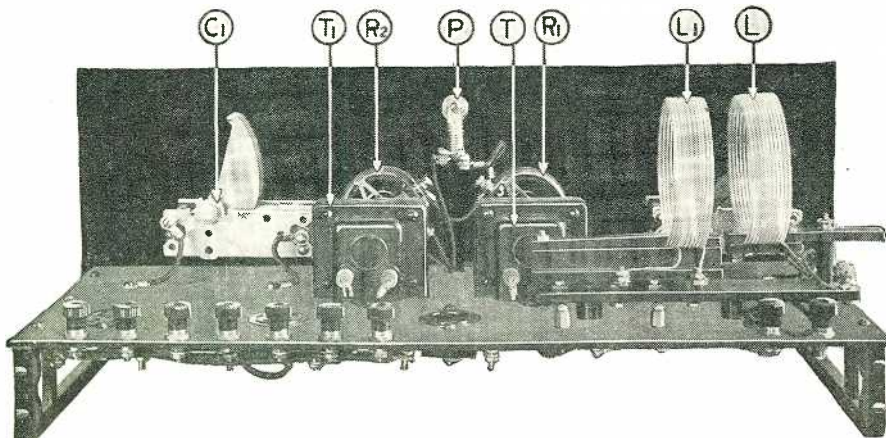

A rear view of the receiver. C1 is the condenser controlling regeneration; T and T1 are the A.F. transformers; R1 and R2, rheostats; P is the pilot light, and L and L1, the "wound-on-air" inductances, are the antenna coil, and secondary with fixed tickler, respectively.

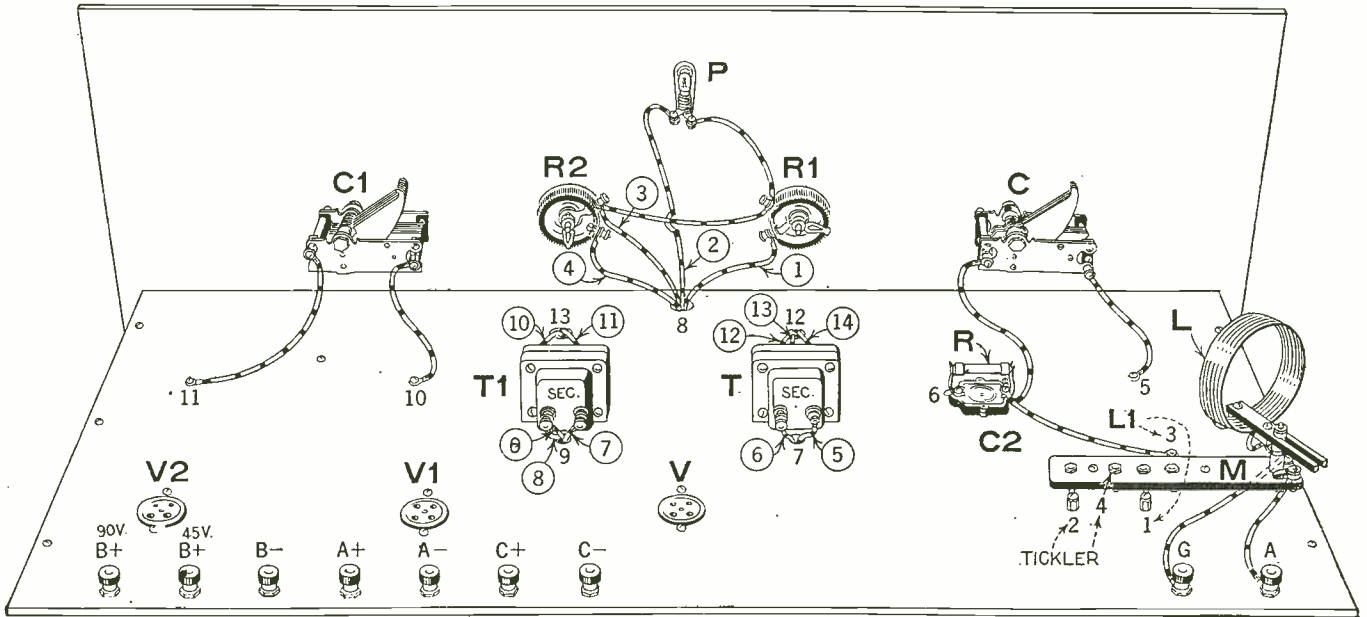

The wiring on the upper side of the sub-panel. The numbers in circles designate the connecting wires and the numbers not enclosed indicate holes through the sub-panel, through which the connecting wires pass.

cast stations to those made for the very short waves, it will be necessary then to determine the exact coupling. Once this is found, no further adjustment is needed.

The seven-plate variable condenser, C, shunted across the secondary, L1, is used in preference to one of higher capacity; because this set was designed to operate at highest efficiency on the shorter wavelengths and if a larger condenser had been used the over-all efficiency would have been materially decreased. This capacity, although smaller than that customarily used on a broadcast receiver, will operate with very good results on the wavelengths between 200 and 550 meters.

The inductances used in this receiver are solenoids which are wound practically on air. The only semblance of a form is a very thin base of tough celluloid in which the spaced turns of wire are embedded. This coil is

placed on a mounting, which has tips for making contact with the tip jacks built into

the bakelite strips, M, which can be seen in the illustrations. This type of inductance will be found to be very efficient for short-wave work and equally good for the longer broadcast wavelengths.

It will be found that this type of coil is but little more difficult to construct, if a little care is used, than the more conventional type wound upon tubing. There is also the advantage, especially important at the shortest wavelengths, that the losses inherent in the air-wound coil are very much less than when the wire is in contact with a continuous tube form. A simple method of construction is explained on the next page.

All the coils are 3 inches in diameter. The primary coil, L, is mounted on the variable mounting so that its coupling in relation to the secondary can be adjusted. It consists of 8 to 10 turns of No. 18 S.C.C. wire.

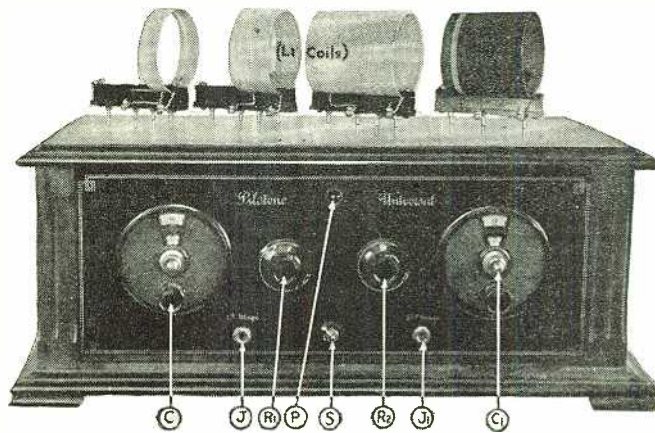

On the lid of the receiver are shown the L1 coils, (the secondary and tickler). The symbols indicating the different controls correspond to those of the other illustrations.

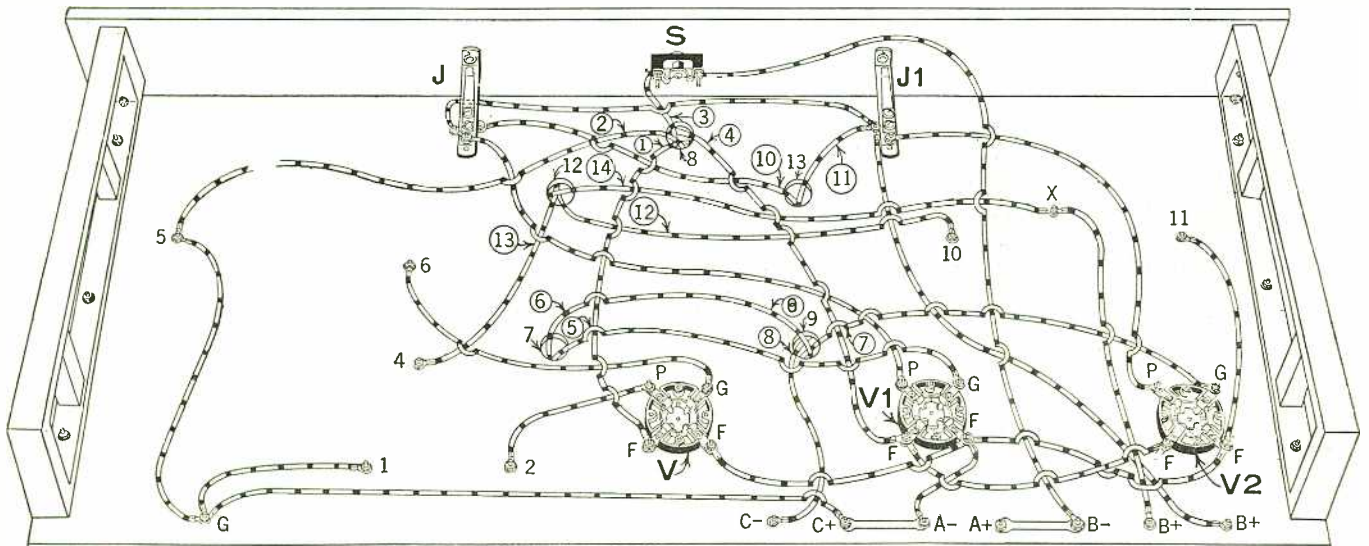

The wiring beneath the sub-panel. S, is the filament switch; J and J1 are the jacks. The wires here shown correspond in numbering to the wires shown in the drawing at the top of the page.

The plug-in coils, Nos. 1, 2, 3, are wound with the same size wire and the coil No. 4 is wound with No. 24 D.S.C. wire. All these are space-wound.

Plug-In Coil No.	Turns Sec.	Turns Ticker	Space between Sec. and Ticker	Wavelength Range
1	6	3	1 turn	18-58 meters
2	13	4 to 5	1 turn	37-104 meters
3	36	5 to 6	1 turn	85-220 meters
4	80	11 to 13	6 turns	226-550 meters

There are two contacts on the primary coil mounting and on the other coils there are four, two each for the secondary and tickler, which are, of course, wound on the same celluloid form.

These coils may be wound either "on air" or upon the usual tube of insulating material. By reference to the sketches showing the method of mounting these inductances, it may be observed that the only difference in the mounting, if the latter method is employed, is that the screws holding the cross strip will have to be long enough to allow for the thickness of the wall of the tubing.

If it is desired to wind the coils as they

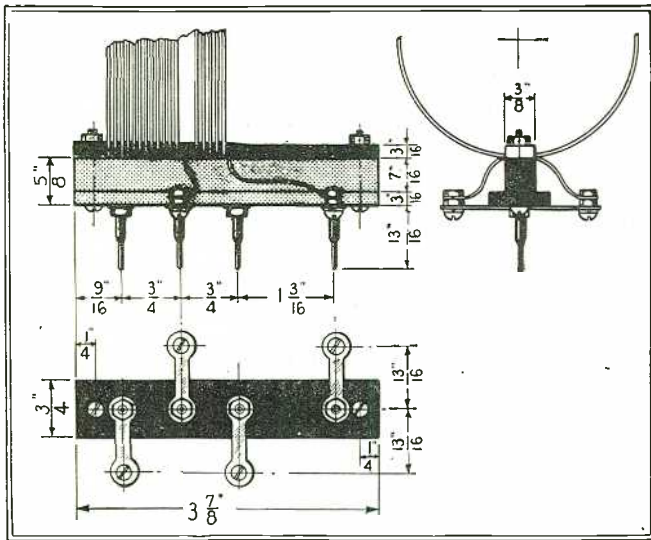

At the left are the constructional details for the secondary and tickler inductances, which are wound on the same form. The mounting consists of three strips of bakelite, the sizes being indicated, and four phone tips, which fit into jacks, as shown on the opposite page. These phone tips are mounted in the 3/16-inch strip. After the coil has been wound, it is clamped between the two strips, the ends being brought to the lugs as shown. If the coils are wound on insulating forms, then the screws clamping the strips must be 1 inch long.

are shown in the illustrations, the following method may be used: on a cardboard tube, just a little under 3 inches in diameter, wind several thicknesses of waxed paper. Over this paper are wound the correct number of

turns of wire, which is temporarily fastened to the cardboard tubing at the end. When the wire has been wound, the coil is painted with thick collodion, which may be purchased at any drug store. After this has thoroughly

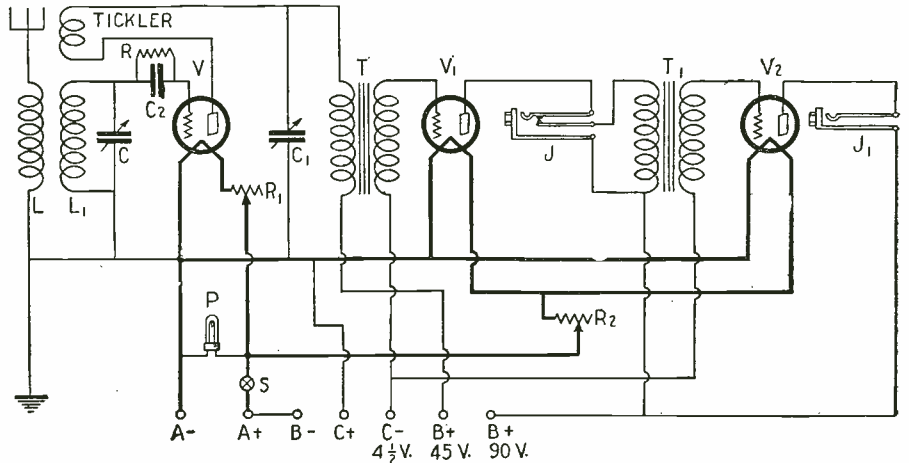

The schematic wiring diagram of the Pilotone three-tube regenerative receiver. The symbols are the same as those on the other illustrations designating the parts.

dried the waxed paper is carefully pulled out from under the wire. As the cardboard tube is smaller than the winding the latter may be easily slipped off and will be found to be a tough, serviceable coil.

The 201A type of vacuum tube is used in each of the three sockets. For the audio-frequency amplifier tubes, V1 and V2, it will be seen on inspection of the schematic wiring diagram, there is provided a pair of connections for the "C" battery; this, in the case of 201A tubes, will be 4 1/2 volts. Jacks are installed in the output circuit of each of the amplifier tubes.

The connecting leads are not soldered to the various pieces of apparatus, but supplied with lugs which are fastened to the instruments by bolts and nuts. This is a very handy idea for the experimenter, for it is a simple matter to change the circuit any time or to make corrections, if they are necessary.

There are many variations of the simple regenerative circuit; and work with them will be full of interest for the enterprising constructor. This set has been especially devised to make the task easy.

The arrangement of the apparatus on the panel and on the sub-panel is clearly shown in the accompanying diagrams, in which full dimensions are given.

TUNING

In the tuning of this receiver, contrary to most expectations, it will be found that the two dials do not keep "in step" with each

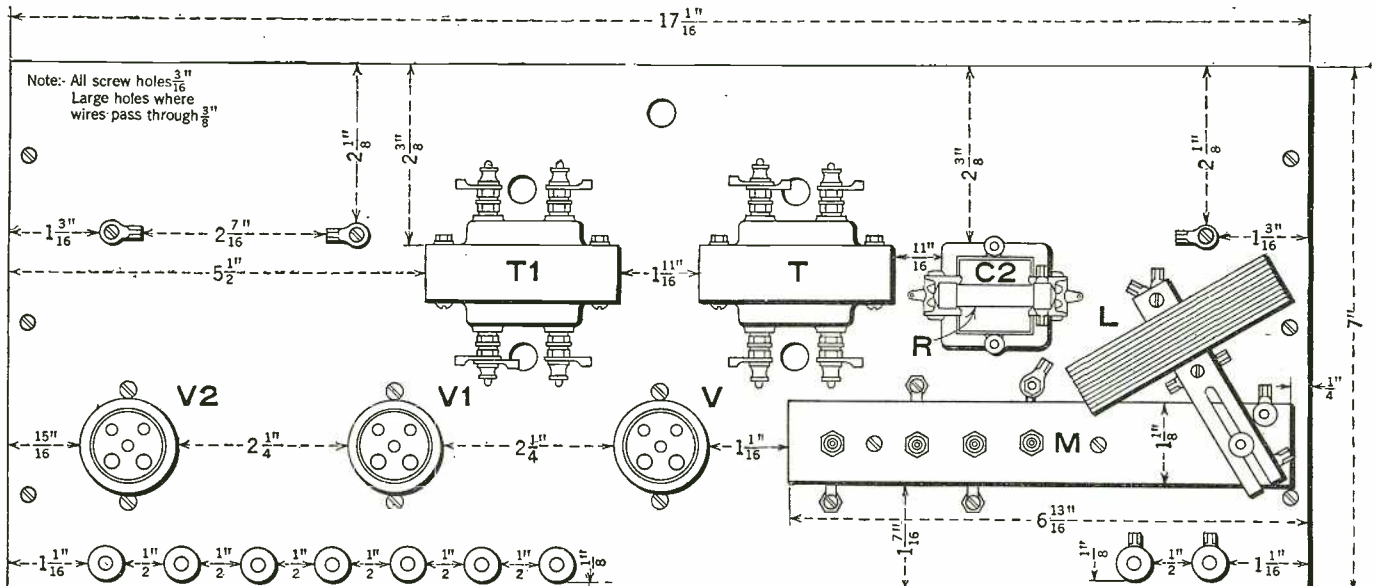

The arrangement of the apparatus on the sub-panel. The holes in the sub-panel can be located by placing the parts and then center-punching the centers for drilling.

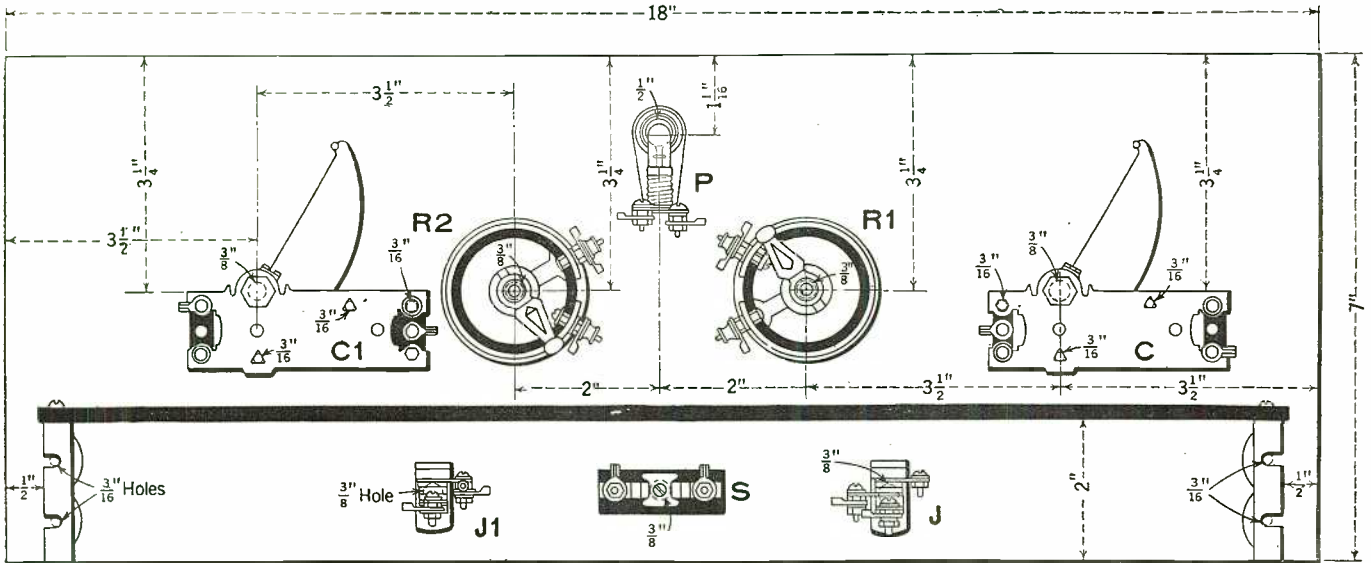

The layout of the panel, showing the size of the holes which are drilled in the panel, together with their locations.

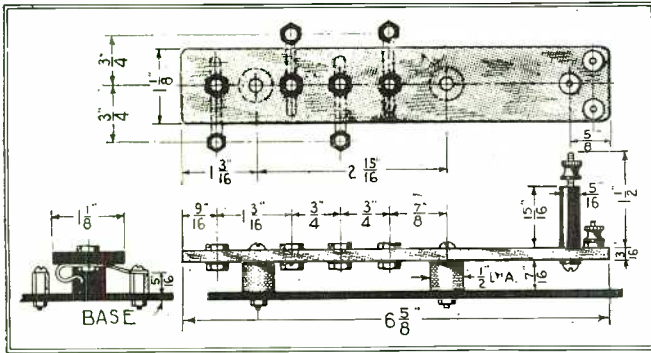

Constructional details are here given for making the base on which the plug-in coils are mounted. Four phone-tip jacks are mounted in the 6 5/8-inch strip for the L1 coil. At the right end is the bakelite rod on which is mounted the antenna coil. L binding posts being used for connections. The drawing at the left indicates the method of connecting the jacks to the wires beneath the sub-panels.

OPERATING HINTS

If signals are distorted by a continuous whistle, no matter where either of the controls is placed, it is most likely due to stray R.F. currents in the A.F. amplifier. This can be located by placing two fingers across the primary and the secondary of each of the transformers in turn. When the fingers are across some particular winding the whistle will stop. This is the location of the fault, and across this winding a .00025- or .0005-mf. condenser will remedy the trouble with reception.

If the receiver will not regenerate, this may be due to several causes; such as, reversed tickler connections, insufficient detector-plate voltage, open plate-coil winding, poor detector tube, or open connections to the variable condensers.

other, as in the conventional types of tuned R.F. or other similar sets. The tuning condenser, C, is really the station separator, and therefore reads from 100 down to 0 as it is tuned from the higher waves to the shorter. The "regeneration condenser," C1, strangely enough, seems to skip back and forth in dial readings and does not work in proportion to the tuning condenser. For example, with the medium-range coil, the tuning condenser might read for a 200-meter station, 60, and the regeneration control, 40; and on a station operating on 150 meters the tuning condenser might be at approximately 45, whereas the other might be around 60. This is due to the special method used in this set for controlling the regeneration.

NOTICE TO READERS

A complete set of full sized blueprints for this Universal Pilotone Receiver may be obtained by sending \$1.50 to the Blueprint Department, Radio News, 53 Park Place, New York, N. Y., specifying Blueprint Set No. 7. These blueprints will be found to be of great assistance to the constructor, as they may be placed upon the panel or upon the sub-panel, thus forming templates for drilling and for locating the different pieces of apparatus. The large prints of the wiring diagrams (on page 973) will also greatly aid the builder, when it comes to connecting up the different parts. After a connection is made, run a line through the corresponding wire on the diagram. This will be found to save much time, and insure greater accuracy.

SYMBOL	Quantity	NAME OF PART	VALUE OF PART	REMARKS	MANUFACTURER ★
L	1	Aerial coil			1
L1	4	Tuning coils		Plug-in type	1
C	1	Var. cond.	170 Mmf.		1 2,3,23,36,38
C1	1	" "	300 Mmf.		1 2,3,23,36,38
C2	1	Grid cond.	.00004 Mf.		1 4
R	1	Grid leak	7 Megs.		1 5,6,7,24,25,31,34
R1	1	Rheostat	20 Ohms	For detector tube	1 2,8,9,10,26,34
R2	1	"	10 Ohms	For two audio tubes	1 2,8,9,10,26,34
T, T1	2	Audio trans.			1 11,12,13,14,28,37,38
V, V1, V2	3	Socket		UX type	1 14,15,16,30,38
J	1	Jack		Double circuit	1 12,14,15,26
J1	1	"		Single circuit	1 10,16,17,34
S	1	Fl. switch			1 10,16,17,34
P	1	Pilot light			1 16,36
	9	Binding posts			1 16,18,19
	2	Dials		Vernier	1 11,14,15,16,27,29
M	1	Coil strip		6-13/16" x 1-1/8" x 3/16"	1
	1	Panel		7" x 18" x 3/16"	1 20,21,33
	1	Sub-base		7-1/16" x 17" x 3/16"	1 20,21,33
	1	Cabinet			1 22,35,35

NUMBERS IN LAST COLUMN REFER TO CODE NUMBERS BELOW.

1 Pilot Elec. Mfg. Co.	17 Hart & Hegeman Mfg. Co.	33 Formica Insulating Co.
2 General Inst. Co.	18 L. F. Radio Labs.	34 Leslie F. Mott Co.
3 A. D. Cardwell Mfg. Co.	19 Derbyshire Button Co.	35 South Wn. Toy Co. Inc.
4 Sangamo Elec. Co.	20 Amer. H. Rubber Co.	36 Precision Mfg. Co.
5 Tube Deuschmann Co.	21 Diamond State Fibers Co.	37 Ferranti, Inc.
6 Durkam & Co.	22 Elec. Baking Co.	38 Silver-Marsball, Inc.
7 J. H. Lynch, Inc.	23 Karas Elec. Co.	
8 Electrad, Inc.	24 International Resia. Co.	
9 Central Radio Labs.	25 Aerovox Wireless Corp.	
10 H. H. Frost, Inc.	26 Carter Radio Co.	
11 Sanson Elec. Co.	27 National Co. Inc.	
12 Thornderson Elec. Mfg. Co.	28 Jefferson Elec. Mfg. Co.	
13 All American Radio Corp.	29 Martin-Copeland Co.	
14 Pacent Elec. Co.	30 Alden Mfg. Co.	
15 Bremer-Tully Mfg. Co.	31 Daven Radio Corp.	
16 Bruno Radio Corp.	32 Baker Yacht Basin Inc.	

APPROXIMATE COST OF PARTS \$ 35.00

★ THE FIGURES IN THE FIRST COLUMN OF MANUFACTURERS INDICATE THE MAKERS OF THE PARTS USED IN THE ORIGINAL EQUIPMENT DESCRIBED HERE.

NOTE TO SET BUILDERS.
If you use alternate parts instead of those listed in the first column of manufacturers, be careful to allow for any possible difference in size from those originally used in laying out and drilling the panel and sub-base.

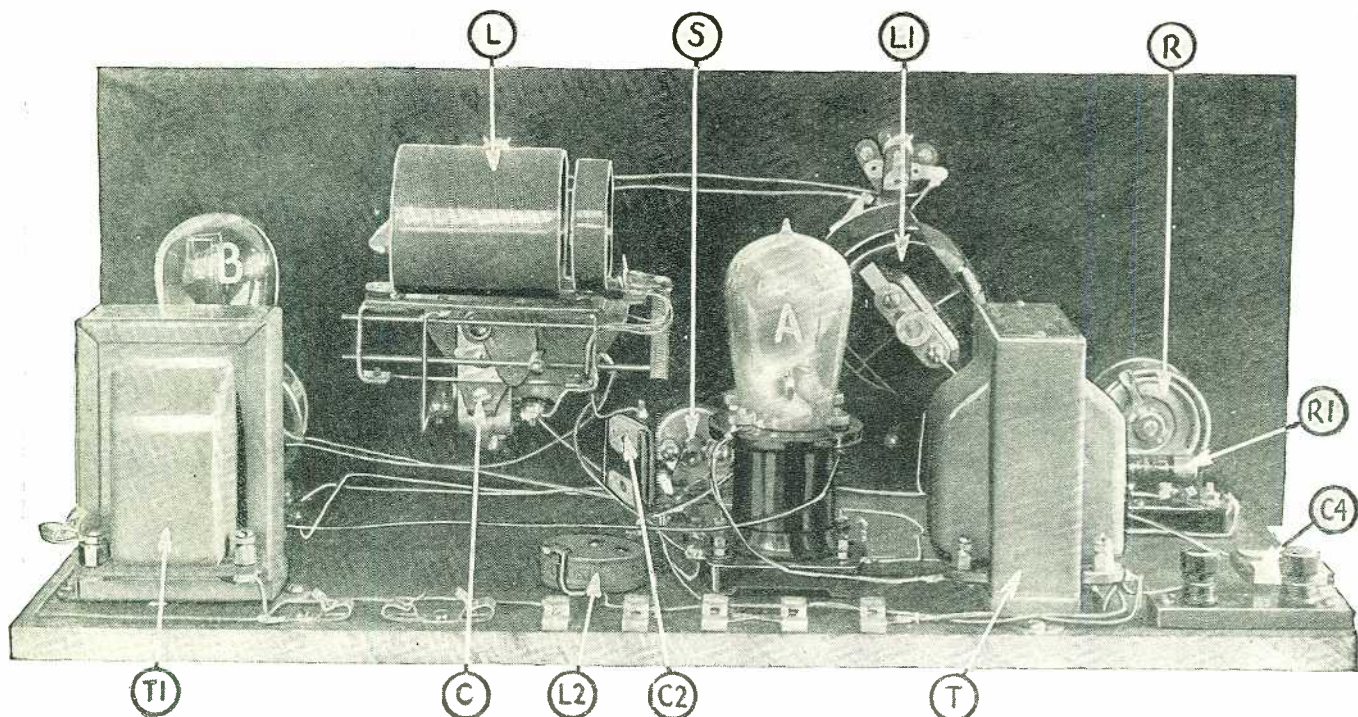

A rear view of the DX-2 Multivalve receiver. A is the new vacuum tube, which is actually three tubes in one, with a single 5-volt ¼-ampere filament. B is the semi-power amplifier tube. R is the rheostat governing the filament current supplied to tube A, and R1 is an automatic filament control, used in conjunction with tube B. L1 is a variometer, which tunes the antenna circuit; and L-C the auto-coupler, which comprises a variable condenser and an automatically-coupled R.F. transformer. C2 is a radio-frequency by-pass condenser, and C4 the fixed antenna series condenser. L2 is a radio-frequency choke. T and T1 are the AF transformers.

The Haynes DX-2 Multivalve Receiver*

A Highly Efficient Circuit Designed for the New Three-In-One Tube

By A. J. HAYNES

RADIO NEWS takes great pleasure in presenting to its readers the DX-2 circuit, in which is incorporated the "Multivalve" vacuum tube. This new device is the result of long hours spent in the research laboratory and is undoubtedly a great step forward in vacuum tube development. In brief, in this tube, which is of the same size as those in your receiver now, there are three sets of elements, which function in the same manner as those of three separate vacuum tubes of the usual type.

Not only does the DX-2 Receiver give excellent results on distant stations, but the quality of reproduction obtainable with it leaves little to be desired.

—EDITOR.

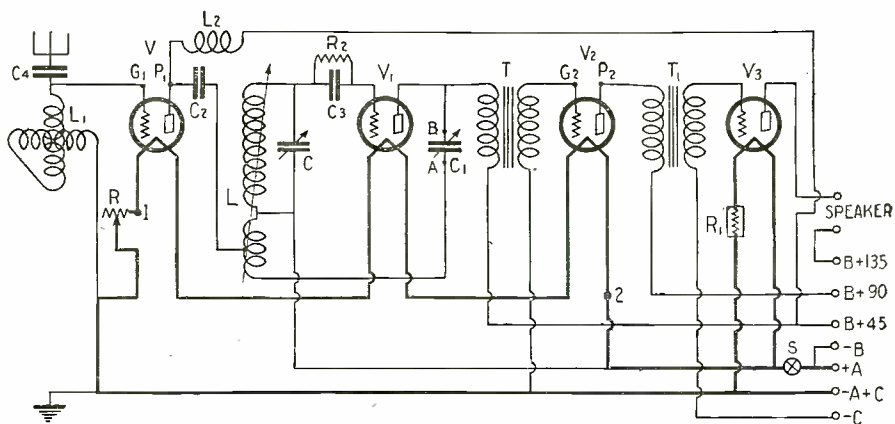

The schematic wiring diagram of the DX-2 receiver. V, V1 and V2 are contained in tube A, above illustrated. 1 and 2 mark the filament terminals.

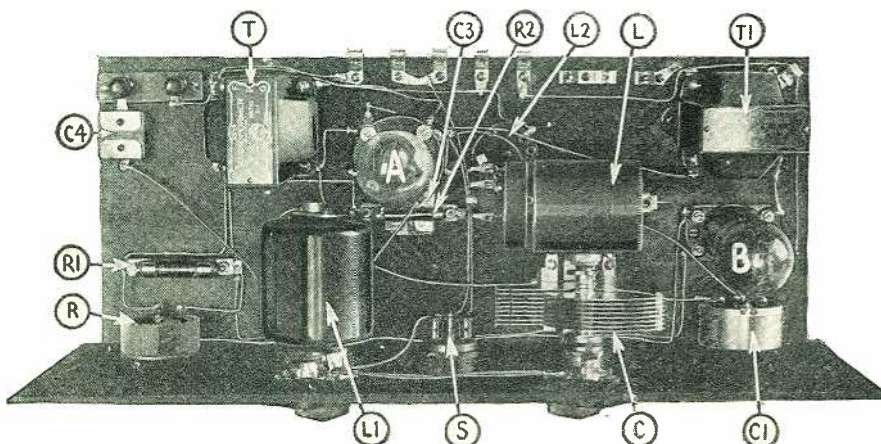

A top view of the DX-2 receiver. C3 and R2 are the grid condenser and grid leak respectively; S is the filament switch and C1 the variable condenser employed for controlling regeneration.

A NEW vacuum tube, known as the "Multivalve," has recently been placed on the radio market. Considerable mystery seems to surround this bulb, in the minds of many radio fans, concerning exactly what it is and how it can be used to advantage in standard circuits; although many advanced radio experimenters have been for a long time wanting something of this kind and wondering why the vacuum-tube laboratories had not produced it. It is, of course, a logical development; but the difficulties lay chiefly in the design and production of such a tube on a commercial basis and at a reasonable price.

Essentially, the Multivalve is *three tubes in one*. The illustration (Fig. 1) shows the various elements in this tube, and their connections to the contact pins and binding posts on the base. It will be noted that there are three separate grids and plates; whereas the filament is one filament, of the

*Radio News Blueprint Article No. 8

201A type, in three sections. Thus the filament characteristics of the Multivalve are practically the same as those of one 201A tube.

On the other hand, it may be used in any radio circuit to take the place of three tubes of the latter type, with a very worth-while saving in battery consumption and space.

THE DX-2 CIRCUIT

While the Multivalve may be used to advantage with any radio circuit, the writer has designed around it a new set which makes full use of its unique features.

The DX-2 circuit, as it is called, incorporates unusual sensitivity and distance-getting ability with superb tone quality, a combination which, unfortunately, is found only too seldom in the same receiver, particularly when simple construction and reasonable cost are involved.

The DX-2 receiver makes use of one Multivalve and a power output tube of the 112 or 171 type. If the 171 type tube is used in the set, it is preferable to place an output transformer between the last tube and the loud speaker.

The radio-frequency choke coil, L2, which is used in the plate circuit of the detector, is not critical and can be built very easily if desired. This can be done by winding approximately 300 turns of No. 28 or 30 wire (double silk insulation is preferred) on an ordinary sewing-silk spool. The turns should be bunch-wound in the middle of the spool, and need not be put on evenly. The spool may then be secured to the baseboard with a brass screw through its center.

OPERATION

One of the unique features of the DX-2 circuit is the double use of the primary winding, which couples the radio-frequency and detector units. This winding, which is the movable coil on the Auto-couple L, is used as both a primary coupling coil and a tickler for the detector regeneration. The position of this coil is automatically varied as the tuning condenser is turned, the coupling being loosened on the short wavelengths and increased to maximum as the condenser capacity increases, when tuning to the higher waves. As a result of this action, not only is the coupling between the radio-frequency and detector tubes varied progressively with the wavelength, but at the same time the amount of feed-back in the detector circuit is varied so that the regeneration is held practically constant over the tuning range of the circuit. The degree of regeneration is controlled by the small variable condenser between plate of detector tube and its

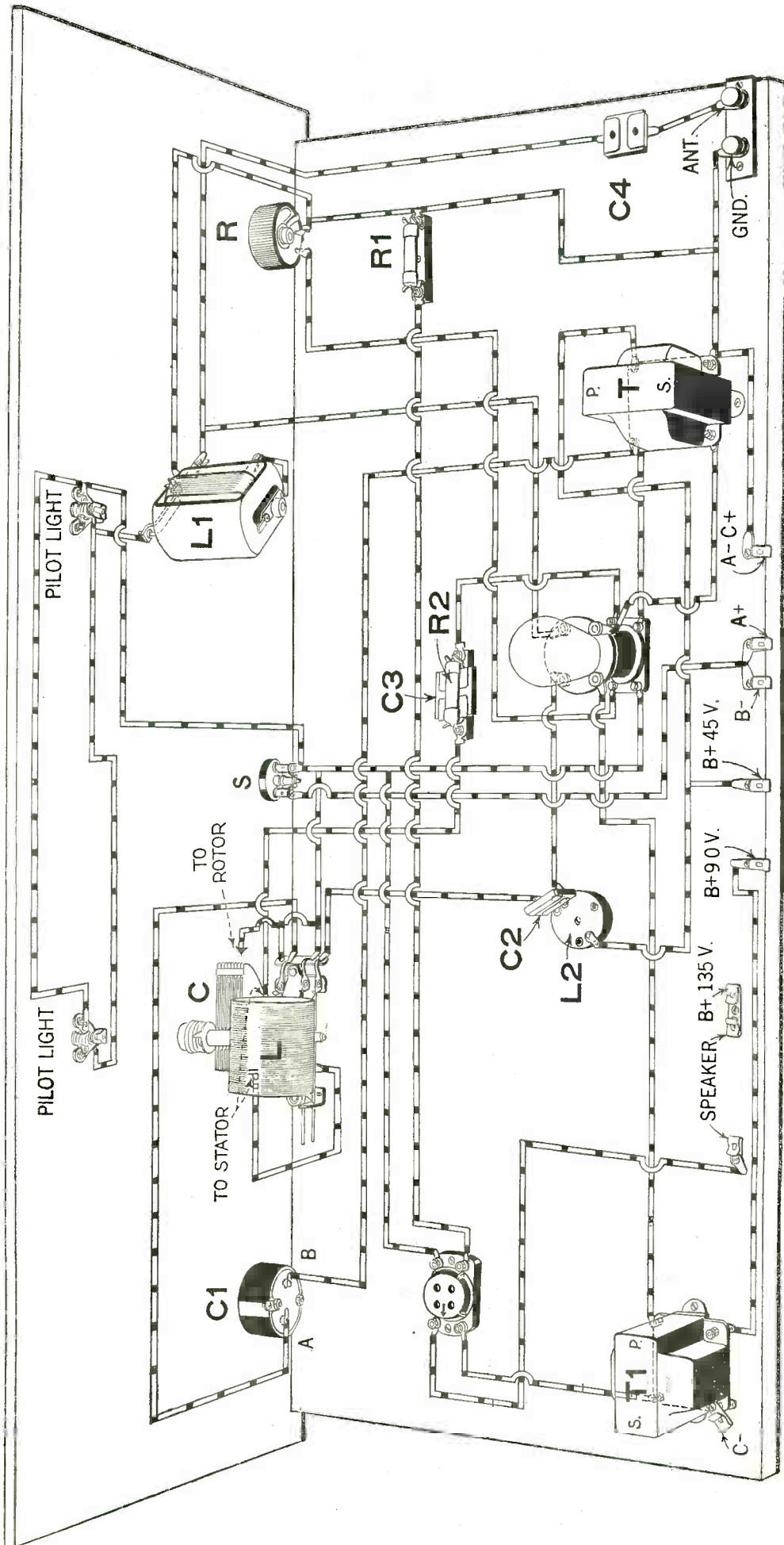

The complete layout and wiring diagram of the DX-2 receiver. It will be noted that the separate plate and grid connections for the three-in-one tube are located on the upper part of the tube base. The markings are given in Fig. 1 on page 978. The other plate and grid connections are made to the tube socket in the usual manner. It should also be noted that there are three terminals on the special variable condenser C1 and the two which are used are those marked A and B. The "A" battery connection to the two pilot lights employed in conjunction with the dials is made through the metal frame of the variometer L1. Note the incomplete connection on the auto-couple unit marked "to rotor." This should connect directly to the rotor plates of the variable condenser C.

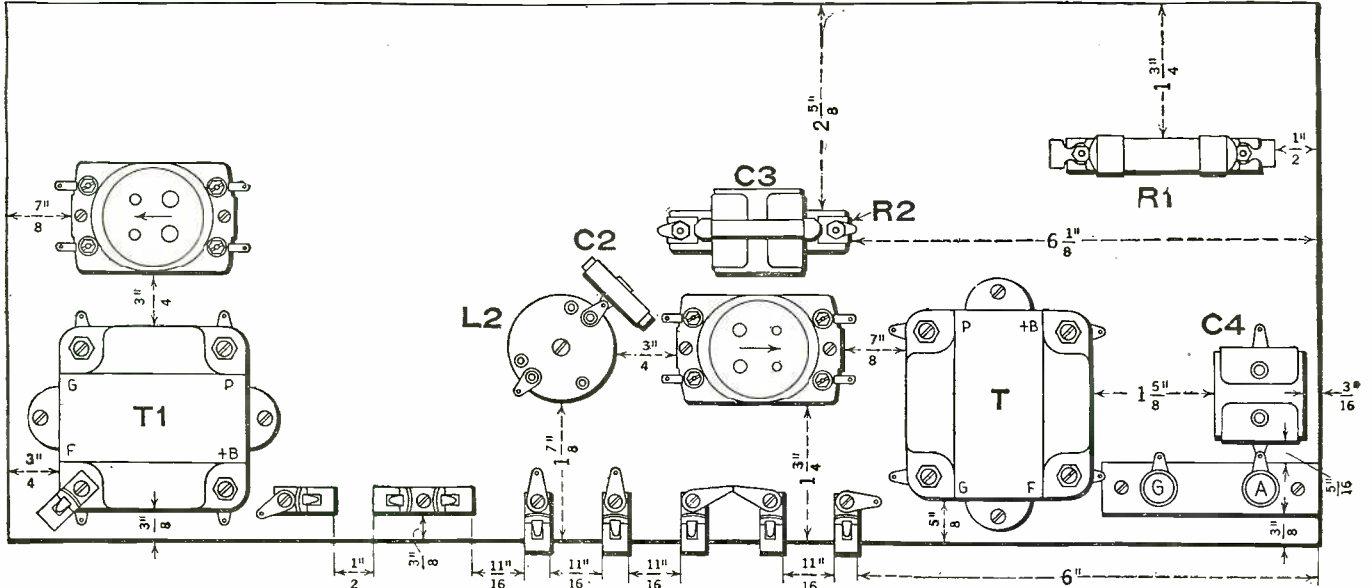

Layout of the apparatus on the base board and all the necessary dimensions. Take note of the fact that the two tube sockets are mounted in opposite directions; that is, the arrow on one points to the left and on the other to the right.

coil, this being shown as C1, at the lower right-hand end of the panel. As the capacity of this condenser is increased, the regeneration increases, and vice versa.

On all ordinary reception, this regenerative control need not be touched. It can be left either at zero or with a slight amount of regeneration if the receiving location is a poor one. However, if distant stations are being sought, the regenerative detector tube is just below the point of oscillation; this move will increase the sensitivity of the set many times. The small compression-type variable condenser specified for the set is ideal for this purpose, as it is compact and provides a very smooth adjustment. It will be noted that

A panel view of the DX-2 receiver showing the main tuning control dials L1 and CL, the regeneration control knob C1, the filament switch S, and the rheostat knob R, which controls the filament current to the "three-in-one" tube.

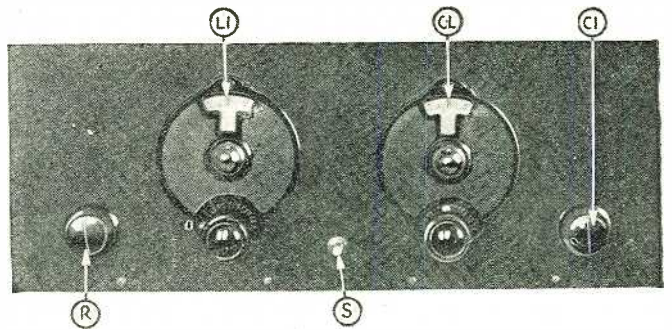

this condenser has three capacity ranges. When using it in the DX-2 circuit, remove the jumper and make connections on the two posts marked "A" and "B", leaving "C" unconnected. If desired, the usual type of rotary-plate condenser may be used here. It should be a compact one, however, and of approximately .00035-mf. capacity.

A large antenna is not necessary but, on the contrary, undesirable with the DX-2. An average overall length, from the end of the antenna to the receiver, of 75 to 100 feet is satisfactory. This includes antenna and lead-in. If it is desired to use this set with an extremely long antenna, it is usually necessary to place a series fixed condenser (C4), of .0001-mf. capacity, between the antenna and the antenna binding post on the receiver.

The secret of the sensitivity of this receiver on an aerial lies in the fact that it does not make use of a semi-aperiodic antenna circuit, such as found in most sets in service today. The antenna system of the circuit is actually tuned by a variometer. As the effective capacity in the antenna circuit is comparatively small, a large potential difference is built up across the grid and filament of the radio-frequency unit, which results in unusually high amplification of weak signals.

The design of this circuit is such that, even though the detector tube is made to oscillate, it will not cause bad interference in your neighbors' receivers. This is due to the fact that, even with the detector tube oscillating, the radio-frequency circuit will not oscillate.

RESULTS

The writer always hesitates to predict actual results which can be obtained from any set, as so much depends upon location and local conditions. Good long-distance work has been done on the DX-2 receiver in a comparatively poor location in the heart of

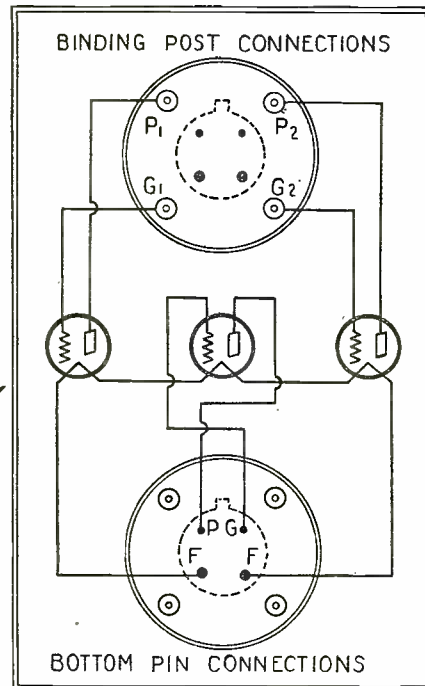
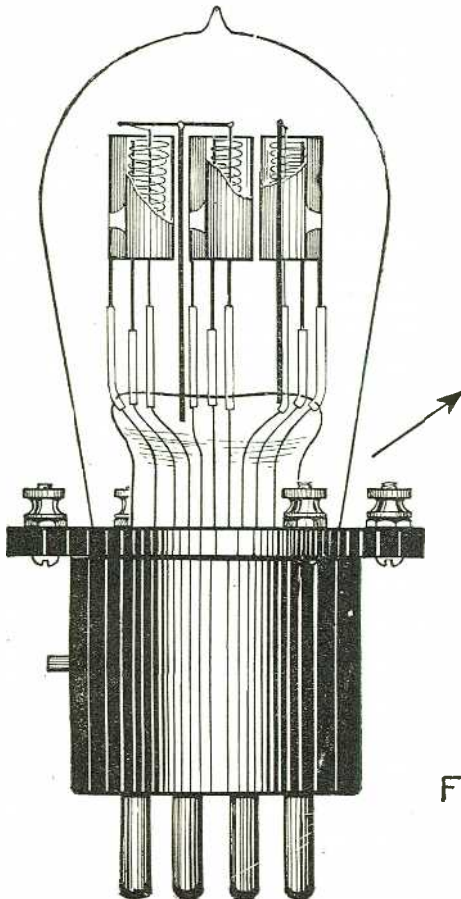
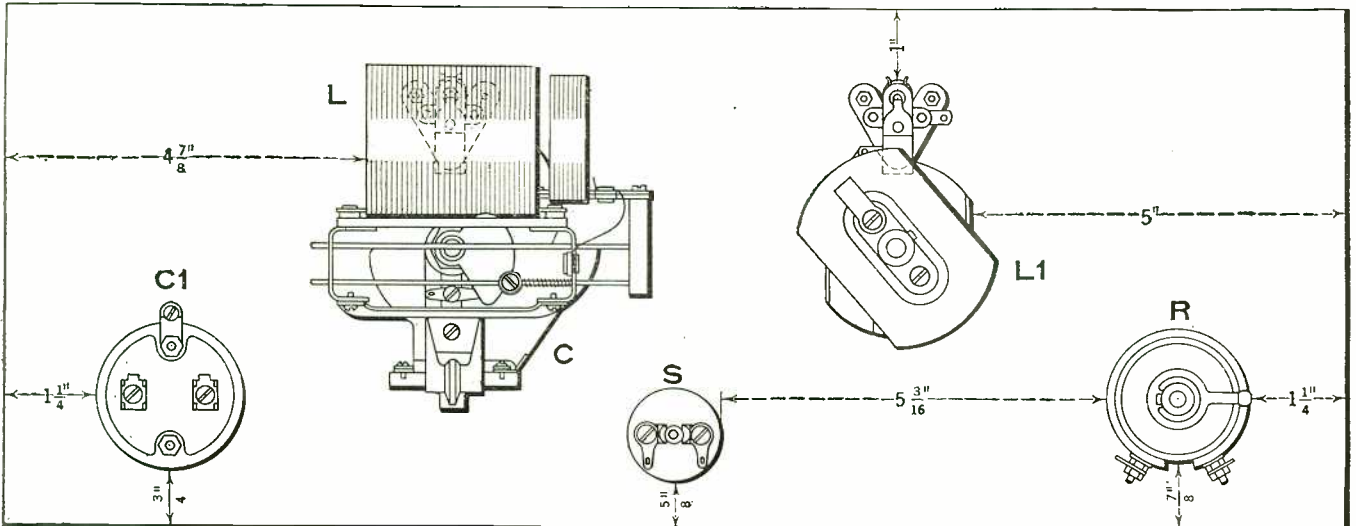
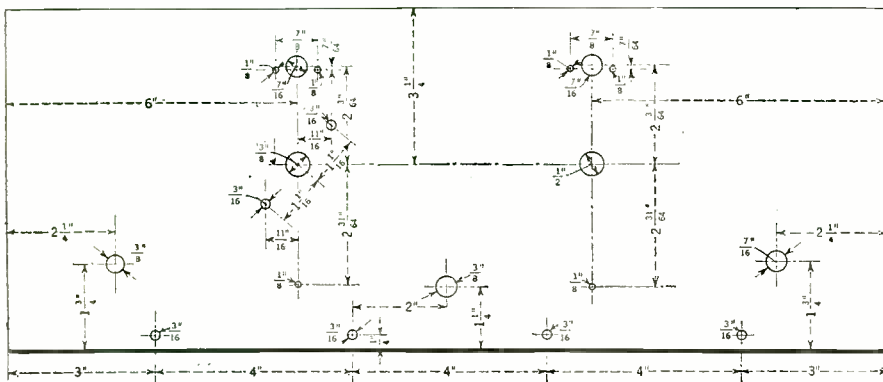

FIG. 1 Details of the three-in-one "Multi-valve" tube, showing its internal construction and, at the right, the connections to the tube-base prongs and to the special binding posts. Illustration courtesy of Cleartron Vacuum Tube Co.



Panel layout of apparatus. There is a double bracket for mounting the variometer L1. The holes for this are shown in the lower sketch.



Layout of drilling for the panel of the DX-2 receiver.

NOTICE TO READERS

A complete set of full sized blueprints for this Haynes DX-2 Multivalve Receiver may be obtained by sending \$1.25 to the Blueprint Dept., Radio News, 53 Park Place, New York, N. Y., specifying Set No. 8. These blueprints may be placed upon the panel and sub-panel, forming templates for drilling and locating the apparatus, as well as wiring guides.

New York City, with an antenna consisting of only a 20-foot length of wire dropped from the window of an apartment house. On this makeshift aerial, several mid-western stations were received, the furthest being KFKX of Hastings, Nebraska. As a matter of comparison, a good five-tube tuned-R.F. receiver was tried, on the same antenna, and failed very badly on the distance reception, because of the inefficiency of its untuned primary when used on such a poor antenna system.

THE following are stations received on the new DX-2 "Multivalve" during one hour of actual tuning by the Editor.

Dial Settings	Wavelength	Station	Frequency
19 17½	WIBO, Chicago	(226)	
21 21	WAAT, Jersey City	(235)	
24 24	WBAL, Baltimore	(246)	
29 29	WAAM, Newark	(263)	
32 32	WPCH, Local	(273)	
36 36	WREO, Lansing	(285.5)	
39 41	WPG, Atlantic City	(299.8)	
41 43½	KDKA, Pittsburgh	(309.1)	
42 43	WMSG, Local	(302.8)	
46 46	WAHG, Richmond Hill	(315.6)	
52 52	WMCA, Local	(340.7)	
53 50	WSAI, Cincinnati	(325.9)	
56 56	WNJ, Newark	(350)	
57 58	WHN, Local	(361.2)	
59 64	WTAM, Cleveland	(389.4)	
60 61	WRNY, Local	(373.8)	
63 62	WGY, Schenectady	(379.5)	
65 68	WOR, Newark	(405.2)	
73 72	WBBR, Rossville	(416.4)	
77 77	WJZ, Bound Brook	(454.3)	
86 84	WEAF, Local	(491.5)	

SYMBOL	Quantity	NAME OF PART	VALUE OF PART	REMARKS	MANUFACTURER ★
L	1	R. F. Trans.		With variable coupling	1
L1	1	Variometer			2
L2	1	R. F. Choke		(Special)	21 24, 32
C	1	Variable Con.	.00035 mf.	Used with L	1
C1	1	Variable Con.	.00035 mf.	Regeneration control	3 7, 8, 11, 12, 16, 82
C2	1	Fixed Condenser	.002 mf.		4 6, 14, 15
C3	1	Fixed Condenser	.00025 mf.	Grid condenser	4 6, 14, 15
C4	1	Fixed Condenser	.0001 mf.		4 6, 14, 15
R	1	Rheostat	20-ohms		5 2, 6, 7, 12, 13, 15, 17
R1	1	Auto. Fil. Cont.		With mounting	23 28, 29
R2	1	Grid Leak	5 megs.	With mounting	6 12, 13, 14, 15, 17
T, T1	2	A.F. Trans.	3 to 1	With mounting	7 2, 11, 16, 25, 27, 32
	2	Sockets		UX Type	7 2, 12, 32
S	1	Fil. Switch			5 7, 13, 17
	2	Binding posts			12 2
	7	Single Clips			22
	1	Double Clip			22
	2	Dials		Vernier	8 7, 16, 18
	1	Panel		7" x 18" x 3/16"	10 19, 20
	1	Baseboard		7" x 17" x 3/16" (Wood)	
A	1	Tube	5v. $\frac{1}{2}$ amp.	Special - 3-in 1	9
B	1	Tube	5v. $\frac{1}{2}$ amp.	Semi-Power	9 30, 31

NUMBERS IN LAST COLUMN REFER TO CODE NUMBERS BELOW.

- | | |
|---------------------------------|-----------------------------------|
| 1 Hammerlund Mfg. Co. | 17 Carter Radio Company |
| 2 General Radio Company | 18 Kurtz-Rasch Company |
| 3 Conn. Tel. & Tel. Company | 19 Amer. Hard Rubber Co. (Radion) |
| 4 Dubilier Radio & Cond. Co. | 20 Dia. State Fibre Co. (Celeron) |
| 5 H. H. Froet, Inc. | 21 Haynes-Griffen Radio Co. |
| 6 Electrad, Inc. | 22 Fahnestock Elec. Company |
| 7 Pacent Electric Company | 23 L. S. Brach & Company |
| 8 National Co., Inc. | 24 Precision Coil Company |
| 9 Cleartron Vacuum Tube Company | 25 Thordarson Elec. Mfg. Co. |
| 10 Formica Insulation Company | 26 International Resin. Co. |
| 11 All American Radio Corp. | 27 Ferranti, Inc. |
| 12 Amco Products, Inc. | 28 Langbein - Kaufmann Radio Co. |
| 13 Leslie F. Muter Co. | 29 Daven Radio Corporation |
| 14 Aerovox Wireless Corporation | 30 E. T. Cunningham, Inc. |
| 15 Polymet Mfg. Corp. | 31 Radio Corporation of America |
| 16 Samson Electric Company | 32 Silver-Marshall, Inc. |

If you use alternate parts instead of those listed in the first column of manufacturers, be careful to allow for any possible difference in size from those originally used in laying out and drilling the panel and sub-base.

APPROXIMATE COST OF PARTS \$ 48.10

★ THE FIGURES IN THE FIRST COLUMN OF MANUFACTURERS INDICATE THE MAKERS OF THE PARTS USED IN THE ORIGINAL EQUIPMENT DESCRIBED HERE.

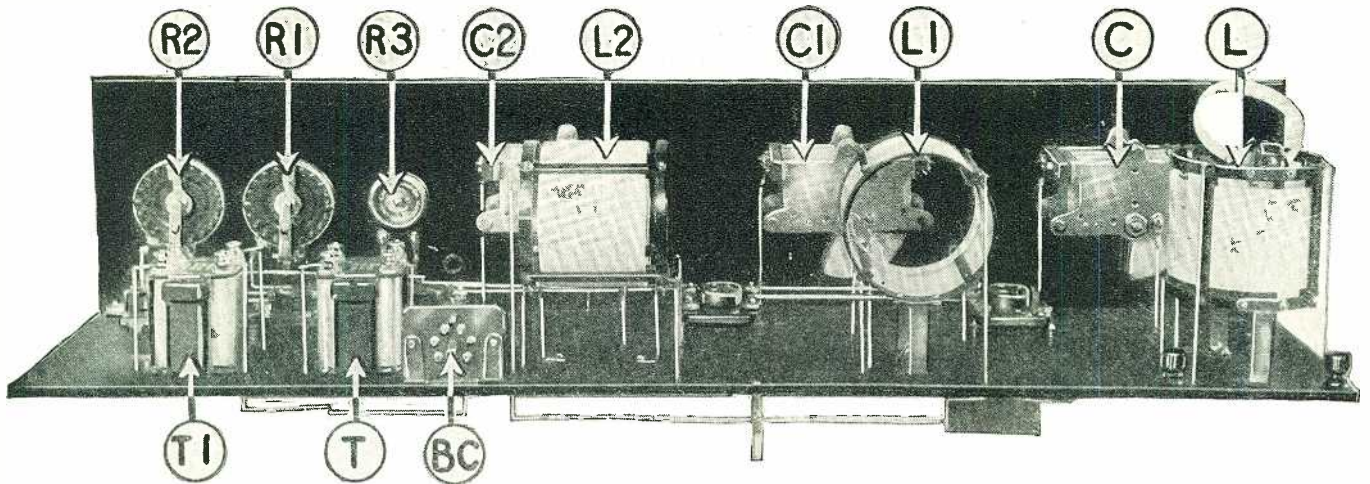

A rear view of the Aero-Dyne receiver. L is the aerial coupler; L1 and L2 are the R.F. transformers; C, C1, and C2 the tuning condensers; R3 is the variable resistance, common to the R.F. tube plate circuits; R1 and R2 are the filament rheostats; T and T1 the A.F. transformers; and BC is the battery-cable receptacle.

The Aero-Dyne Receiver*

Utilizing A Plate-Resistance-Stabilized R. F. Amplifier

By HERNDON GREEN



There is nothing actually new in the circuit of the Aero-Dyne Receiver, the theory and construction of which is described here. However, the system employed for stabilizing the R.F. amplifiers, which resolves itself into a single control on the panel, is not only sound in principle but very effective in practice. The whole arrangement, including the design of the aerial coupler and the R.F. transformers, has been worked out as a unit. Particular attention has been given to the coupling effects, between primaries and secondaries, due to mutual inductance; and the final coil design was worked out only after all other values had been determined as best for a given inductance value. This receiver is well worth constructing.—EDITOR.

bilized" systems, which dissipate the surplus energy causing oscillation in the form of losses, either in tuned-circuit, tube or transformer coupling; and a more recent method,

control, some naturally more desirable than others. We may add a preponderance of resistance to the tuned circuits, either by so designing them or by placing them in such

A panel view of the Aero-Dyne receiver. C, C1, and C2 are the tuning controls; R3 is the oscillation control; SW the filament switch; and J and J1 are the two output jacks of the A.F. amplifier.

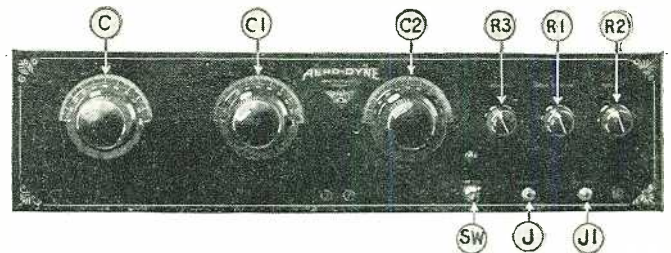

THERE are three general types of multi-stage tuned-radio-frequency amplifier systems which are adapted to practical operation under present broadcast conditions. They are, respectively; those methods which aim at a balance of the amplifier-tube capacity, commonly called "bridge circuits"; the familiar "power-sta-

independently developed by several experimenters, which corrects oscillation difficulties by a "zero-reactance" plate-circuit, which allows neither positive nor negative regeneration.

This article deals with the design of a particular type of the second method, a plate-resistance-stabilized R.F. amplifier system. There are many different methods of preventing undesirable oscillation by means of power

physical relation to condenser end-plates, metal shields or high-loss dielectric materials, that a voltage sufficient to cause oscillation cannot be built up. This statement should not be construed as a depreciation of the merit of *judicious* shielding; there is no doubt that shielding, properly done, is far more of an asset than a liability. However, losses introduced in this manner, while they do prevent oscillation, make for broadness of tuning and usually a wide variation in efficiency over the broadcast band. These considerations are sufficient reason for us to disregard that method in this discussion.

VARIABLE-COUPLING SYSTEMS

Transformer-coupling control consists of making the transfer of energy between primary and secondary so small, by means of either a very small primary, or one of very loose coupling to its secondary, that, as before, a sufficient voltage cannot be built up to cause steady regeneration. This system, while it makes for good selectivity, (practically that of the tuned circuit itself) is not necessarily the best; primarily because of its poor efficiency at even the best frequency (usually the highest, at 200 meters) and secondarily because of its wide variation of energy transfer with change in frequency. That is, if we design such a system for best practical results at 200 meters, the set will be extremely "dead" at 550 meters. This disadvantage can be corrected by means of a variable primary or other means of varia-

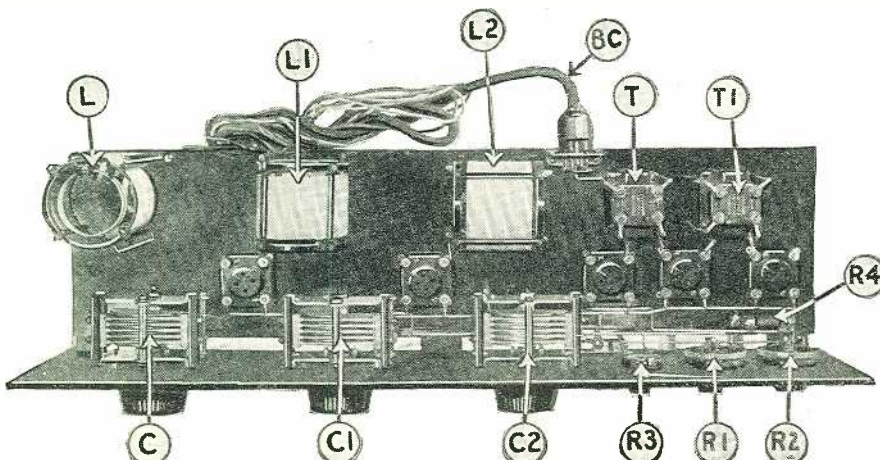

A top view of the Aero-Dyne receiver. The parts here carry the same designations as in the other illustrations and the list of apparatus, given elsewhere.

*RADIO NEWS Blueprint Article No. 9.

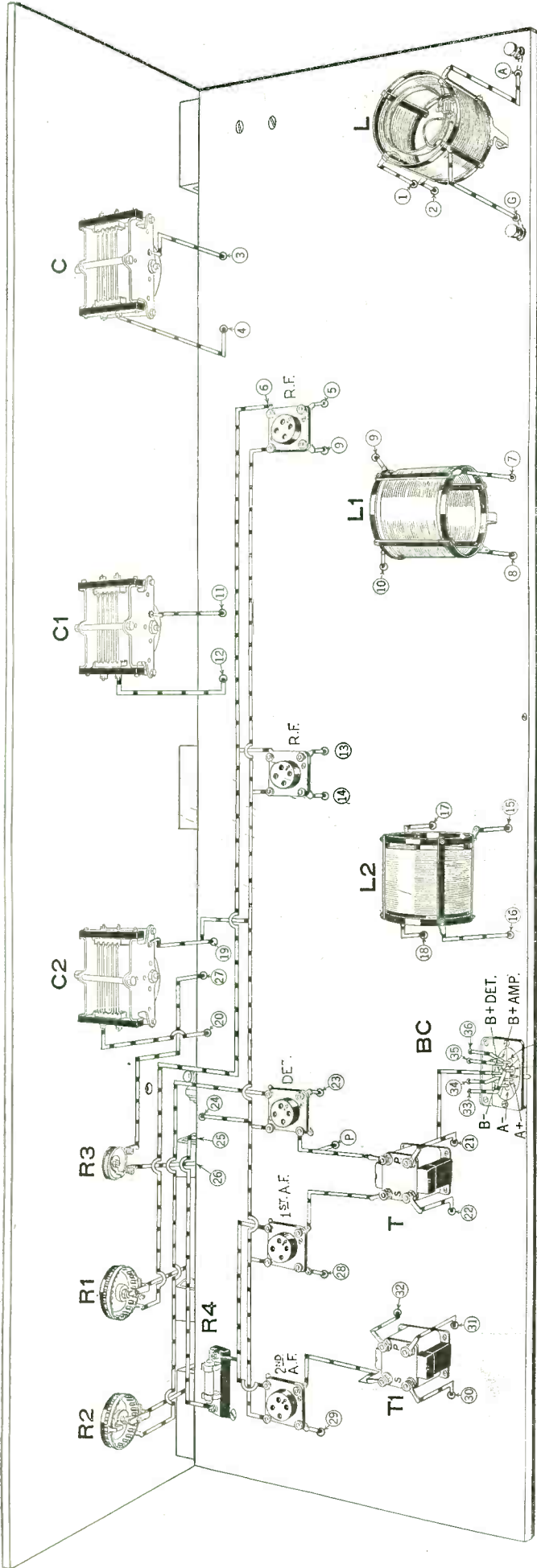

A perspective layout and wiring diagram of the Aero-Dvne receiver. The only portion of the wiring that might present some difficulty is that in the vicinity of the variable resistances, R3, where the leads pass down between the panel and the sub-base. However, if the lower drawing is consulted, the wires can be traced through the numbers in circles which are identical, for each lead, above and below the sub-base.

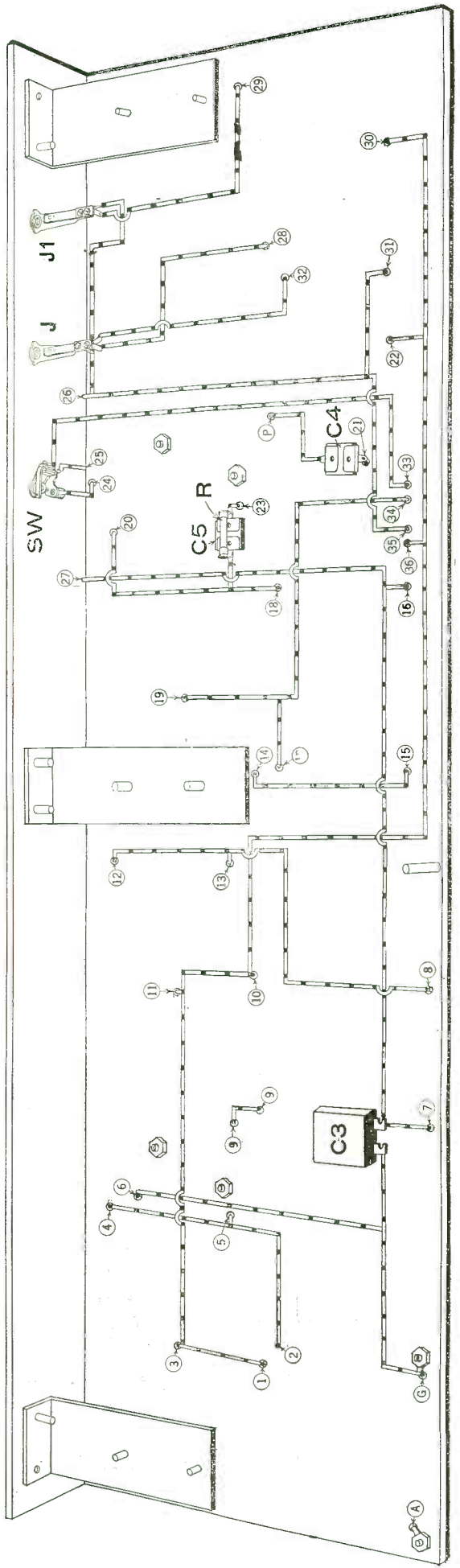

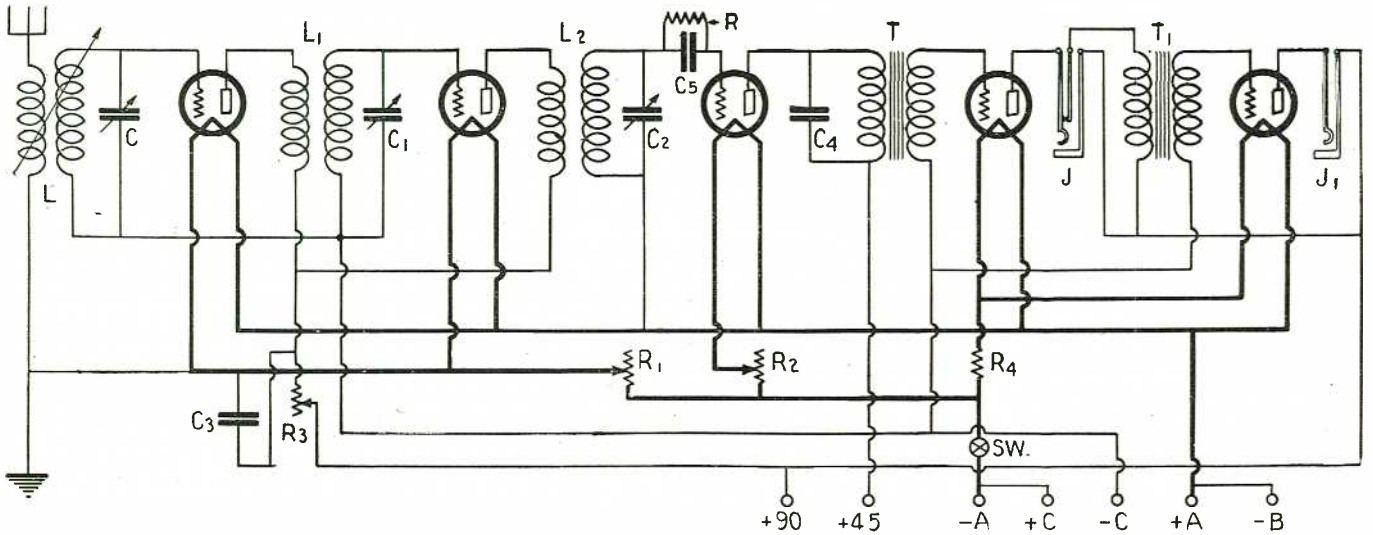

The schematic circuit diagram of the completed Aero-Dyne receiver. The author stresses the fact that the circuit in itself is not unique, but its application in obtaining maximum amplification is its real point of superiority.

tion of coupling with frequency change; but even then it is not, in itself, the most satisfactory of power-stabilized schemes.

The third and last method consists of attacking the tube characteristics themselves. It is an axiom of this type of circuit (tuned R.F.) that, *all other things being equal*, the

Now, it can be readily seen that if we use a tube of resistance inherently low at some definite operating point, and then vary that resistance by means of some variable control, we will be able to force that tube to assume the characteristics desired for both stability and practical amplification.

transformer designed to give not too great an energy transfer, together with a tube-characteristic-control, might be a combination far more desirable *from the user's standpoint* than a highly-efficient tuned circuit used with a transformer giving theoretical maximum energy transfer, and thus necessitating the increase of tube-plate resistance to an excessively-high value in order to suppress oscillation. Other combinations are obvious.

Since any weak link in tuned-circuit design immediately shows its effect on the selectivity of the receiver, regardless of what other advantages from an oscillation-control standpoint it may have, this point of attack was dropped at once, as the major requirement of a receiver of this character is that it have very good selectivity. To work with, we then have left the two variable factors, transformer efficiency and tube-characteristic control.

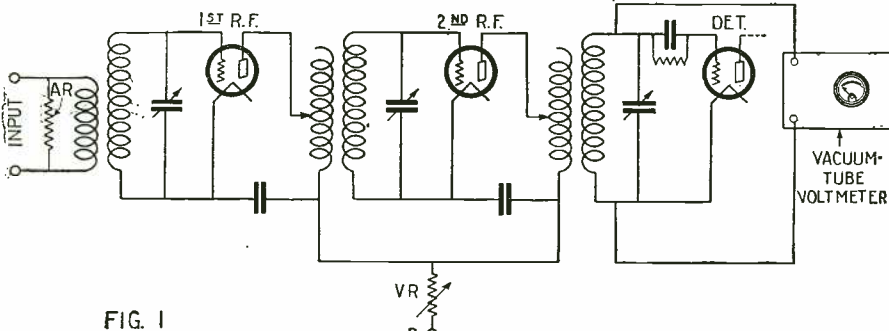

FIG. 1

This experimental set-up, described in the text, was used to determine the best ratio of plate control to size of primary, in obtaining maximum amplification. The vacuum-tube voltmeter measures the output of the R.F. system (detector input), and the input to the receiver (antenna stage), is measured by the current-resistance-attenuation method.

tube having the lowest plate resistance will oscillate most easily. That is, if there is inserted in such a system a 201A-type tube having an amplification constant of 8 and a plate resistance of 7000 ohms, it will oscillate more easily than another tube having an amplification constant of 8 and a plate resistance of, say, 10,000 ohms. This is the hinge upon which all such stabilized devices operate—a variation in plate resistance.

OTHER CONSIDERATIONS

During the design of the "Aero-Dyne" receiver the logical point was raised that possibly a combination of two or more of these stabilization methods might give a better receiver in practical operation than a dependence upon one single method. That is, it was foreseen that, possibly, a tuned circuit of an efficiency not too great, combined with a primary-secondary relation in the

TUBE-TRANSFORMER COMBINATIONS

Again, it can be readily seen that a very good transformer combined with a poor tube (to stop oscillation) will be poor; and conversely, a tube operating at best efficiency combined with a transformer of very poor characteristics (again, to stop oscillation) will again be poor. An example of the former would be a transformer, showing a *normal* non-regenerative gain ratio of say 15 per stage, but which, when used with a high-resistance tube, would only give 2 or 3 per stage. The latter condition may be illustrated by a combination of a low-resistance tube of, say, only 7000 ohms with a trans-
(Continued on page 1004)

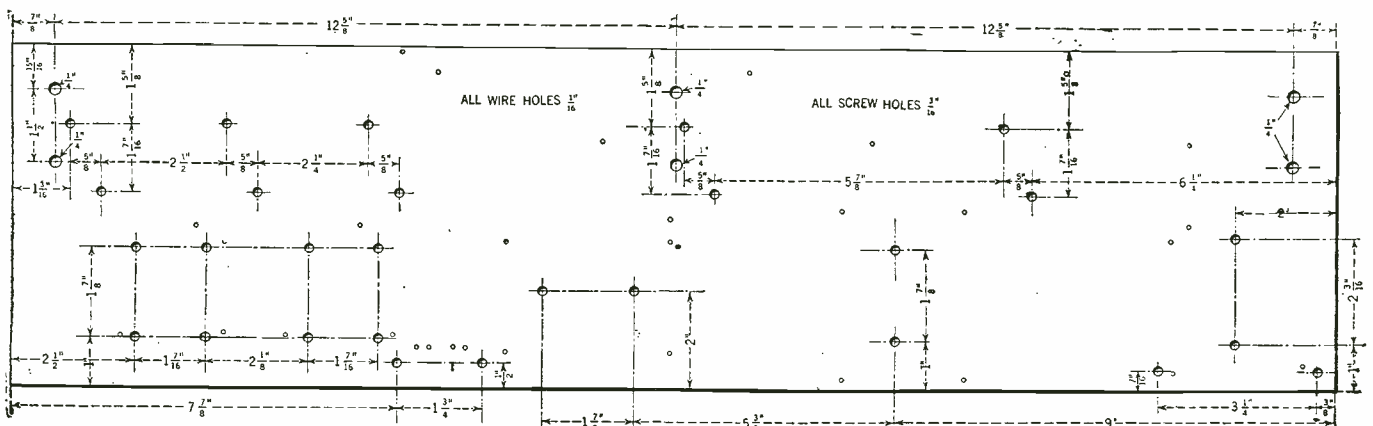

Drilling layout of the sub-base. The small holes indicated are for passing the connecting wires through the sub-base.

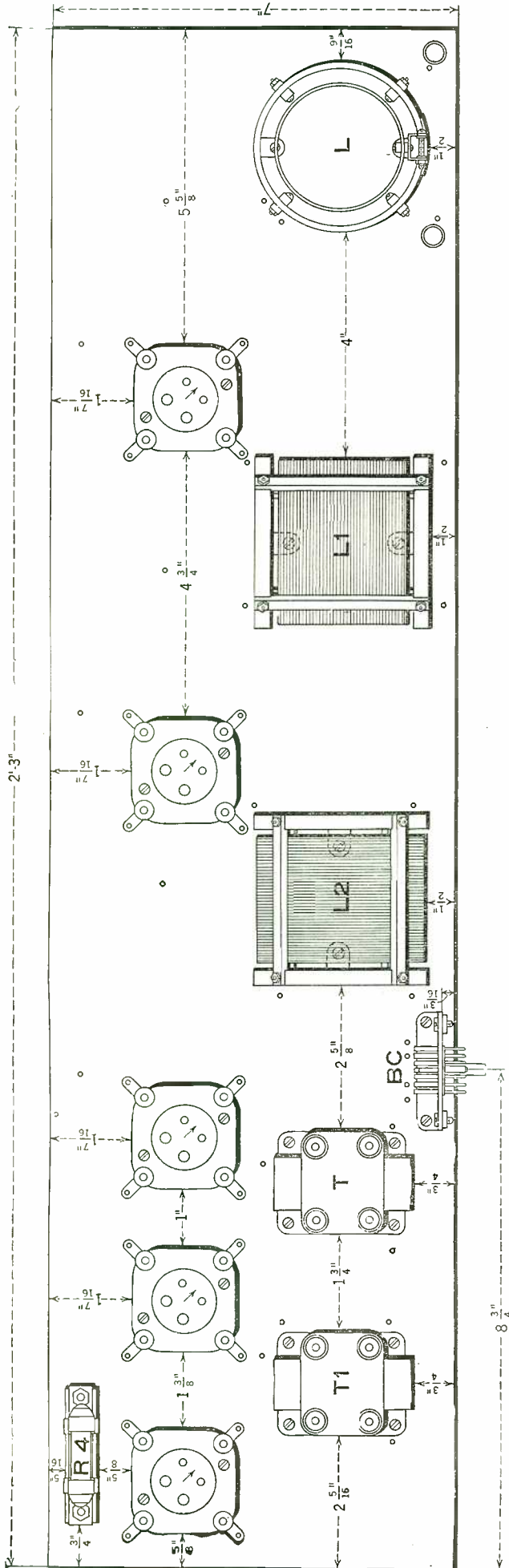

Above: Layout of apparatus on the sub-base or sub-panel. Note the small holes near some of the apparatus. These are provided for passing the wires through to the underside of the sub-base. In mounting the sockets be sure to have the arrows pointing in the same direction as indicated. The primary terminals of both transformers, T and T1, should face to the right, or towards the coil, L2.

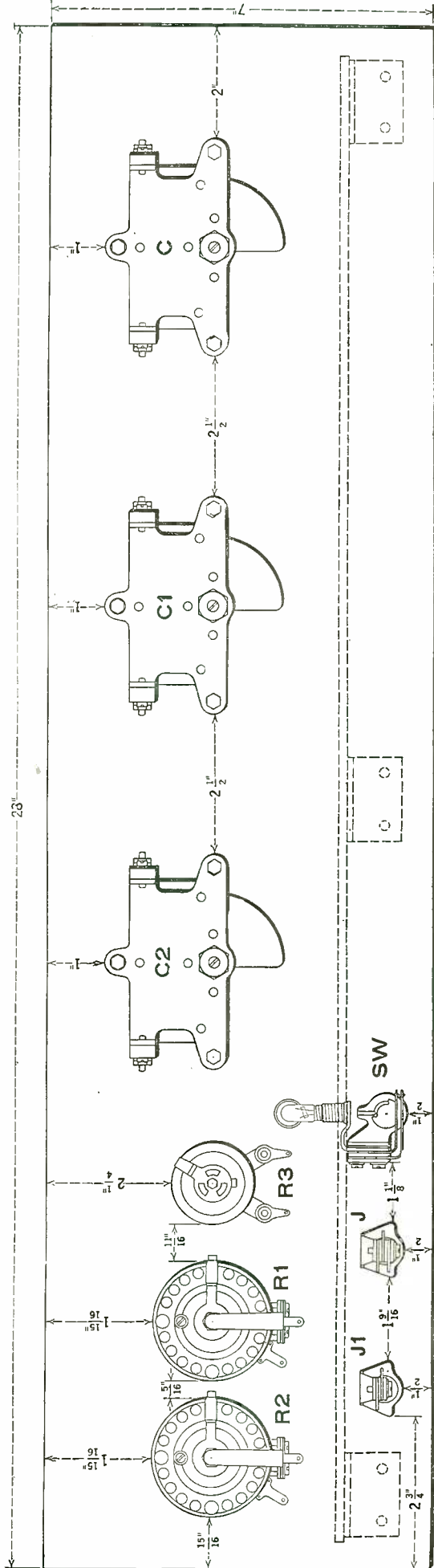

The panel layout of the Aero-Dyne, including all the necessary dimensions. It will be noted that the combination filament switch and pilot light is mounted so that it is half above and half below the surface of the sub-panel. If it is decided to place the sub-panel up against the panel, the position of the pilot light and switch should be changed.

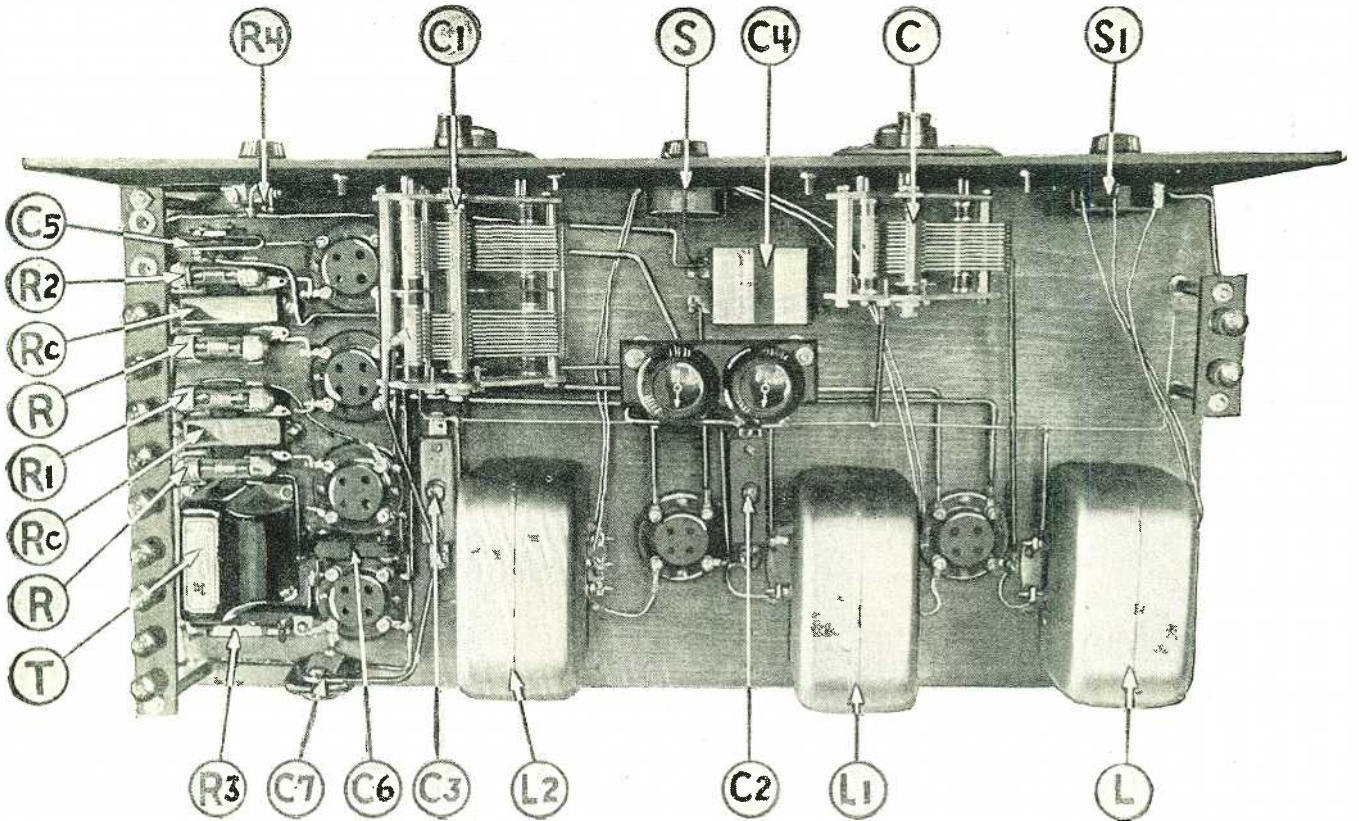

A top view of the Quadraformer VI Receiver. L, L1 and L2 are the shielded quadraformers, details of which are given in the sketch on page 987. S and S1 are the special switches which control the selectivity and, partially, the sensitivity of the set. C2 and C3 are adjustable condensers of the neutralizing type, which are employed to make up for any discrepancy in capacity between the two tandem condensers, and thus to equalize the dial readings. After they are once adjusted they need not be touched again. It will be noted that the audio-frequency amplifier comprises one transformer-coupled and two resistance-coupled stages; a very excellent combination which provides plenty of volume and quality reproduction. T is the A.F. transformer and RC are resistor couplers.

The Quadraformer VI Receiver*

Shielded Novel Inductances and Special Switches Tend to Improve Quality and Selectivity

By G. C. B. ROWE

THE Quadraformer receiver described in this article offers a number of novel points. It uses a rather unique toroid, which, in our estimation, is a great improvement because it gives no rise to destructive capacity effects, usually found in many doughnut-type inductances. Secondly, by shielding the toroid itself completely, additional advantages are obtained.

The set was tested out in RADIO NEWS Laboratories by disconnecting the aerial and ground completely. No reception was had from a nearby broadcast station less than 15 blocks away. Usually unshielded sets tested in this particular locality, if they are sensitive at all, will operate well without aerial and ground, showing that the coils in the set pick up the energy, which is exactly the thing that a good set should not do nowadays.

The set gives excellent quality, mainly for the reason that there is no chance of interstage coupling due to the effective shielding, and outside interference entering the set is extremely small.

The construction of this receiver is rather simple and it is easy to build by the average set constructor.

—EDITOR.

ONE of the most important of the factors that enter into the consideration of a receiving circuit is the fidelity of reproduction which the set affords. It makes little difference to the average listener what cabinet encloses the set, as long as it is presentable; but if the quality of reproduction is not of the best, he is not satisfied.

This is as it should be. A receiver which fails to reproduce low tones as they are transmitted has the effect of accentuating an orchestra's playing in the upper registers, and fails to give the listener a satisfactory idea of the original music. An organ program is a rather effective test for the efficiency of a receiver in its reproduction of the bass notes. A good receiver makes an organ sound majestic and powerful; a set reproducing only the high notes gives a thin and flute-like imitation of the instrument. However, the receiver should not be given entirely over to the bass notes. If the lower tones are accentuated too strongly, the

soprano voice and the piano sound thin and anything but natural.

Now, the just proportioning of all these tones depends upon and is the product of a distortionless radio-frequency circuit, a well-designed audio-frequency amplifier, and a suitable loud speaker, accompanied by the use of the proper vacuum tubes, with correct plate voltages and grid biasing.

TUNING VS. COIL PICK-UP

In the standard two-stage tuned-radio-frequency amplifier with detector, three tuned stages are found, each consisting of a tube and its tuned transformer circuits. Each of these tuned stages represents a filter circuit designed to eliminate all but one station, at any one time. Properly designed, three tuned circuits, when in resonance, should pass only a narrow band of all the frequencies indiscriminately collected by the antenna system.

Unfortunately, if a receiver is located near a powerful broadcast station, energy will be

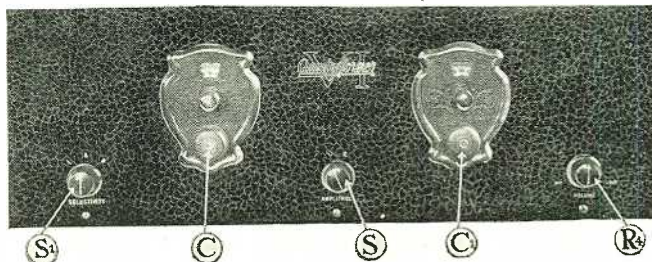

A panel view of the Quadraformer receiver. C and C1 are the main tuning controls. S and S1 are the selectivity controls, which can be adjusted to suit local and distance reception requirements. R4 is the combined rheostat (for the two R.F. tubes) and filament switch. When the knob has been rotated fully to the left the whole set is turned off.

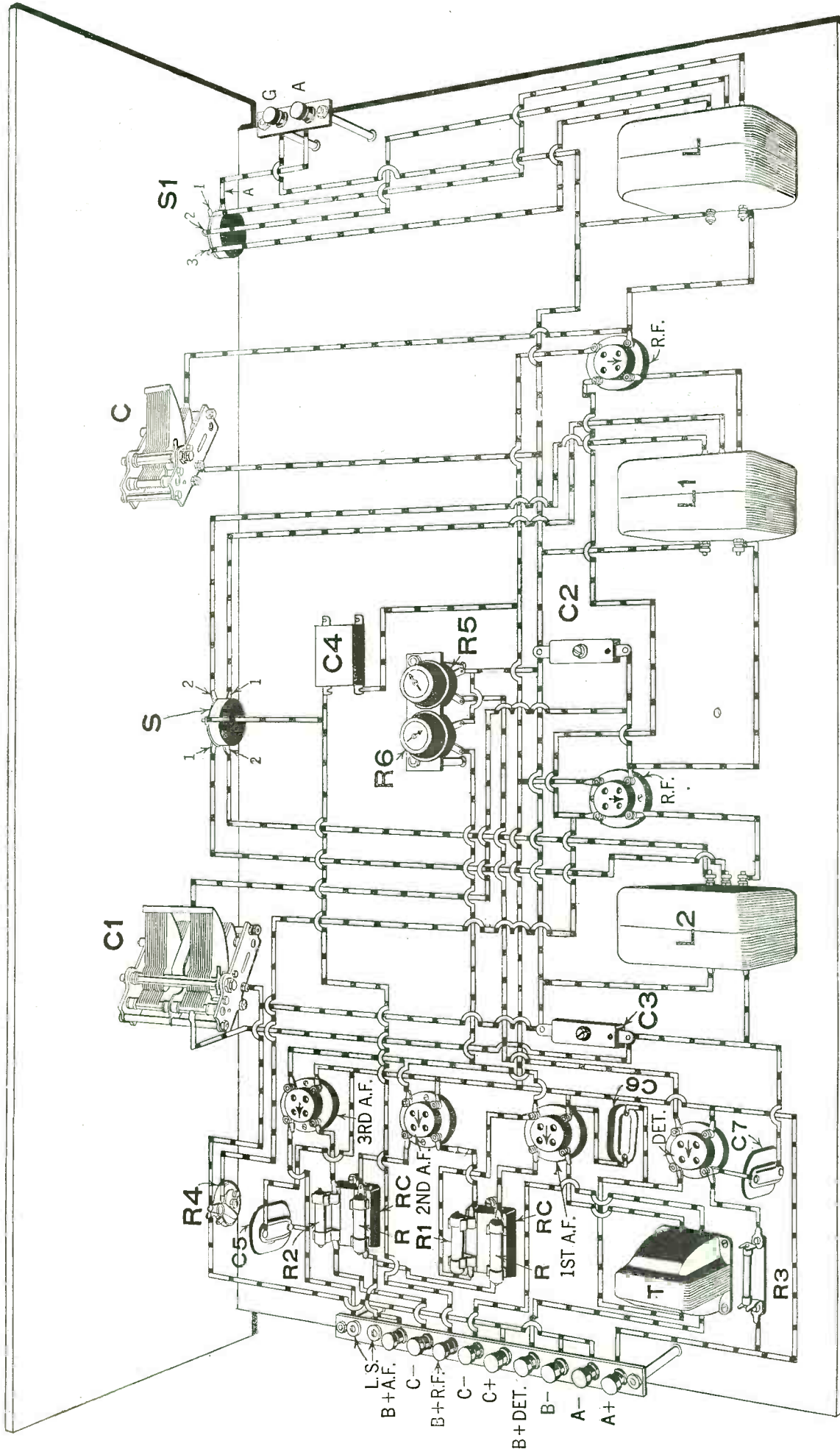

The complete layout and wiring diagram of the Quadraformer VI. receiver. Though the wiring may appear slightly complicated, it will be found a comparatively simple job; as all of the connections are made on the upper side of the base board. In mounting the tube sockets be sure and place them exactly as shown; it will be noted that the arrows on the R.F. sockets point towards the rear of the set, while those on the detector and A.F. sockets point towards the left, looking at the set from the rear. Though they are not designated in this sketch, the grid and filament connections, or secondary connections of the A.F. transformer T, are those at the right as shown here. On the resistor couplers R.C., the grid and plate terminals face in towards the tube sockets. Take note of the fact that the "A-," "B-," and "C-," binding posts are connected together, and also to the combination rheostat and filament switch R4.

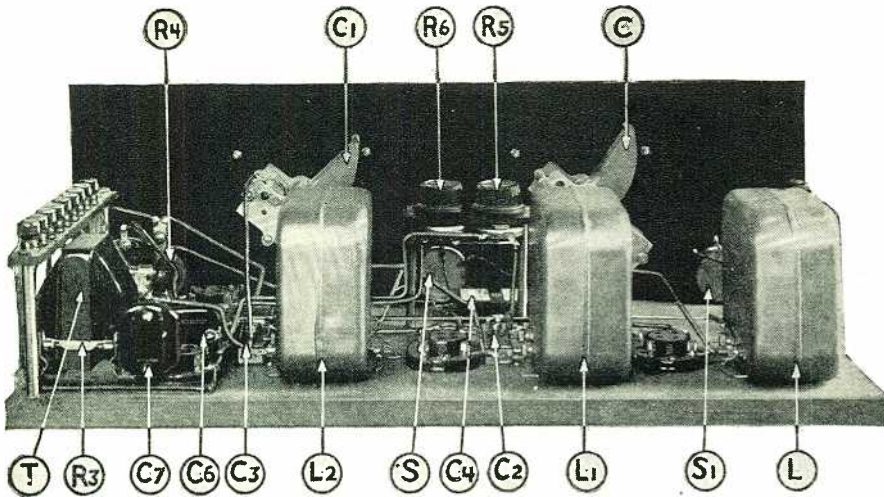

A rear view of the completed set. R5 and R6 are the rheostats controlling the detector tube and the three audio-frequency amplifier tubes. After being once correctly adjusted they need not be touched again. R3 and C7 are the grid leak and grid condenser, respectively. The detector tube socket is directly behind C7. C4 is a radio-frequency by-pass condenser.

picked up, not only by the antenna system, but also by the coils and, to a lesser degree, by the connecting wires of the receiver. This action defeats the very purpose of the successive selective circuits in the radio-frequency amplifier. The signal, instead of coming down to the set through the antenna system and passing through the successive stages, is picked up, possibly, by the coil in the detector circuit, this coil acts as a miniature loop antenna, and the selectivity of the receiver is very little better than that of an ordinary single-circuit, non-regenerative set.

The obvious remedy is to devise some means whereby the individual circuits are prevented from picking up stray energy, and to force only the signal impulses selected, as amplified, through each stage successively. The logical solution of the problem resolves itself into a matter of keeping unwanted signals from reaching the coils. In a word, this means the use of properly designed shields.

In the receiver described herein the radio-frequency transformers, which are illustrated in an accompanying sketch, are placed within

shields which are connected to the ground. Not only does this construction prevent outside electromagnetic energy from acting upon the coils, but it minimizes as well the chances of interstage feed-back through inductive action between them.

Drilling details of the front panel. No special caution need be exercised in marking out and drilling the shaft holes; but greater care should be taken in laying out the condenser mounting holes, particularly if condensers of a make other than those specified are employed.

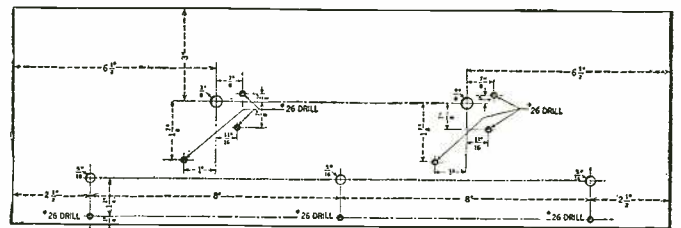

SELECTIVITY CONTROL

In driving your automobile you select the gear ratio to fit the need of the moment. If the going is hard you shift into the powerful "low," and the car plows through almost anything; second gear is a mixture of power and speed, and "high" is mostly speed.

primary and the secondary coils are in four sections each; and these sections are respectively, connected in series as shown. From this fourfold division we have the name Quadraformer.

The central block (which is of paraffin-impregnated wood) is 1 1/8 inches square and

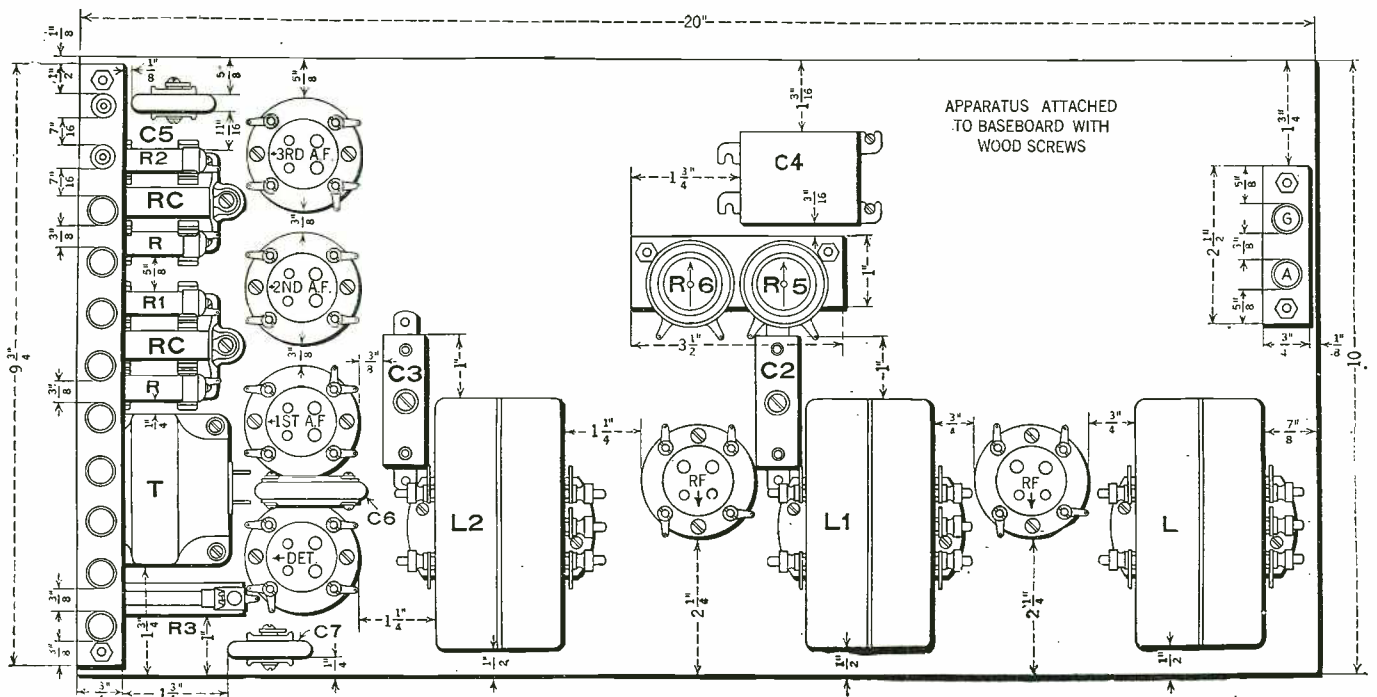

Layout of the apparatus on the wooden baseboard. The correct spacing between parts is given in each case and it is suggested that this be followed; though, if desirable, the layout can be altered slightly without consequent ill effects in operation.

The new Quadraformer VI might be said to adapt this idea to radio. On the left side of the panel there is a switch with three positions indicated. With the switch set on No. 1, maximum selectivity and normal sensitivity is the result; position 2 is a compromise between selectivity and sensitivity, while 3 gives the set's greatest sensitivity and normal selectivity. By the use of such a system, a radio receiver may be adjusted to operate at its best in any given location and may be varied from maximum sensitivity to maximum selectivity to suit varying reception conditions.

Broadcasting in the United States is done between 200 and 550 meters. Most receiving sets amplify the waves below 400 meters very satisfactorily, but on the higher wavelengths they do not usually function quite as well. Some sets that amplify excellently on the wavelengths above 400 meters are rather unstable on waves under this figure. In the Quadraformer the switching arrangement, called the Amplitrol, allows simultaneous variation of the inductance in the primary circuits of the two radio-frequency transformers, and permits practically uniform amplification over the whole broadcast range.

CONSTRUCTION OF INDUCTANCES

As may be seen from the sketch of the inductances used in the radio-frequency amplifier stages, they are wound in four sections, thus forming 4-winged toroids. The

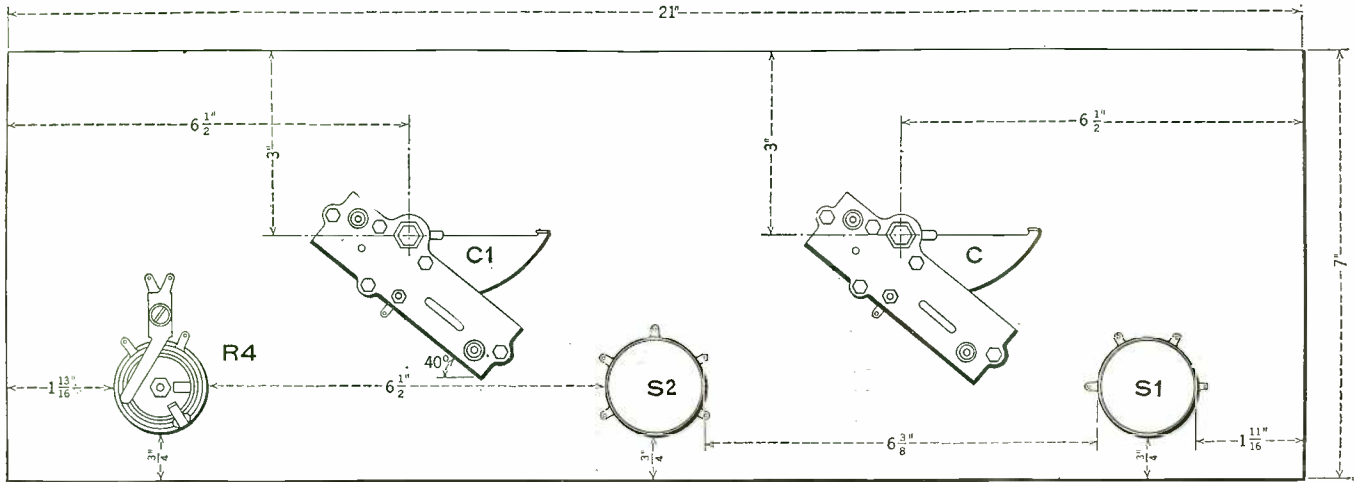

Constructional panel layout of apparatus, including all the necessary dimensions and spacing between parts. It should be kept in mind that C1 is a tandem variable condenser and a clear space must be provided on the sub-base over which it extends.

2 inches high, and the coils are 1 1/2 inches in diameter, being wound with No. 26 D.C.C. wire. Each of the four sections of the secondary has 34 turns and they are connected in series. The total number of turns in the primary is 14 and they are divided as follows: 3 on the first, 3 on the second, 2 on the third, and 6 on the fourth coil. They are separated by a thin string from the secondaries and, as are the latter, they are connected in series. It will be noticed that there is an extra binding post on the primary side. This is connected to a tap at the second turn of the six-turn coil of the primary, so that by connecting this post in the circuit it will cut out four of the turns in this set of coils.

The thin copper shielding around these coils is 4 1/4 inches square and 2 1/4 inches in depth; it is screwed to the wooden post, which supports the coils, and carries a pair of insulating strips that hold the binding posts. Of the latter there are two on one side for the secondary, and three on the other for the primary.

We have never been enthusiastic about most toroids, because the larger percentage of them defeat the very purpose for which they are built. The usual doughnut type of toroid bunches the wire convolutions together around the central opening, thereby giving rise to an exceedingly bad capacity effect. This is done away with in the present toroid entirely and here no such capacity effect exists.

THE A.F. AMPLIFIER

Everybody knows that one of the most important factors in the achievement of dis-

ortionless reproduction is the audio-frequency amplifier. Some claim that an amplifier employing resistance-capacity coupling is the only thing to use; others frown on this and claim that transformers are the

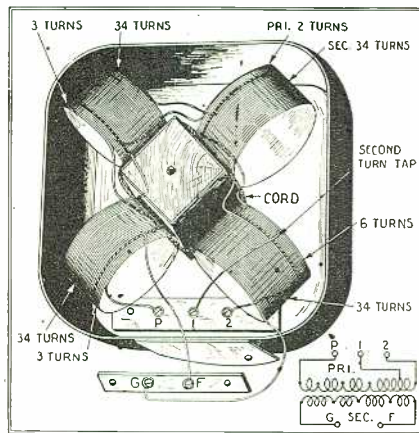

Constructional details of the "Quadraformer" coils. The four coils are made up by winding them on a cardboard tube, slipped off, tied to the wooden block and wired in series as shown. All coils are wound with No. 24 D.C.C. wire.

one efficient method. In the Quadraformer receiver these two methods have been combined; i.e., there is one stage of transformer-coupled, followed by two stages of resistance-capacity coupled, audio-frequency amplification.

The reason for the use of a transformer in combination with the two stages of resistance-capacity coupling is the step-up ratio of the transformer, the amplification afforded by a transformer stage being considerably greater than that produced by a resistance or impedance stage. However, in order to obtain the best results from this combination, one must use a very good grade of transformer; for the general efficiency of the whole amplifier will be lowered if an inferior one is installed.

VACUUM TUBES

The volume which a receiver can handle without overloading is limited, especially, by the capacity of the last tube in the audio-frequency amplifier. The constructor should decide between a tube of the 201-A type, a semi-power tube of the 112 type or a power tube of the 171 type.

A tube of 201-A type is capable of handling only relatively small amounts of energy. With a good loud speaker and a powerful signal, small tubes of this type can fill a moderately sized room with music of good quality, providing that outside noises, such as are caused by heavy motor traffic or people moving about, do not interfere. However, should you desire to flood a good-sized living room with radio music, so that five or six people can enjoy it without straining their ears, the semi-power tube is recommended. If it is desired to entertain a large group of people, then a power tube should be used in the last stage of the audio amplifier.

(Continued on page 1000)

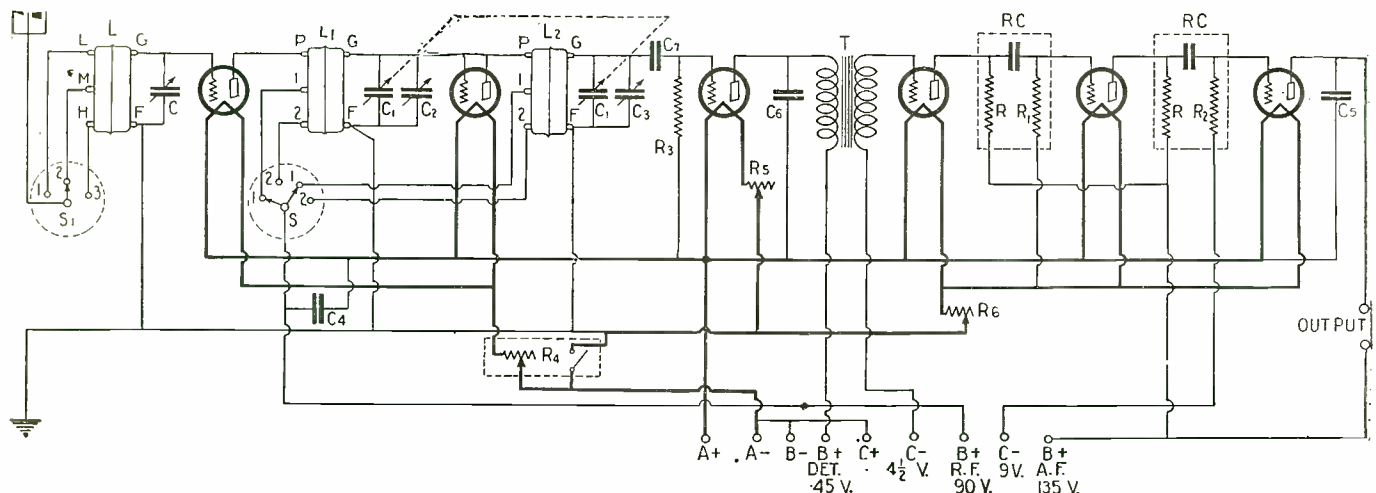

The complete schematic wiring diagram of the Quadraformer VI. Receiver. Note that the switch S controls both the R.F. transformers at once. Switch S1 controls the aerial coupler. The combination rheostat and filament switch is shown at R4.



Shielding In Radio Receivers

Better Reception Results from the Use of Metal Shields

By M. L. HARTMANN, Ph. D.* and JOHN R. MEAGHER**



SHIELDING has become popular with radio set builders within only the last twelve months, but it has been used with marked success in commercial receivers for more than ten years. It is not a passing fad; as through the intelligent use of shielding receivers can be made many times more sensitive than is otherwise possible.

ELEMENTARY THEORY

If a charged object (that is, an object with a voltage different from that of the ground, or greater than zero) is suspended above the ground, there is an electrostatic field between the object and the ground. This field may be represented by lines of force extending from the object to the ground, between which the voltage of each line of force is graduated from zero to that of the object. Consequently, if a second and uncharged object is placed in the field between the first object and the ground, the second object will assume a voltage corresponding to its place in the field. However, frequently it is not desirable for the second object to become so "charged."

One method of preventing this is to interpose the ground between the objects. Then the field between the charged object and the ground does not pass through the second object, and hence does not affect it.

A similar result may be achieved by interposing a grounded conducting plate between the objects. Now the lines of force terminate on the plate and are conducted to the earth. The voltage of the lines of force at the plate is the same as that of the ground (or zero) and consequently, as there is no difference of voltage between the ends of the lines of force and the earth, there is no tendency toward creation of a further electrostatic field between the plate and the ground. And, as there is no electrostatic field between the plate and the ground, the second object may be placed in this space without effect on its voltage. Thus the second object is shielded from the influence of the first object.

Similar reasoning holds for electromagnetic fields; though it is possible to consider that the currents, set up in the plate

Rear view of the shielded superheterodyne; the base and cover are made of $\frac{1}{8}$ -inch aluminum; the sides, back and partitions are of 24-gauge aluminum.

Photo courtesy of The Carborundum Co.

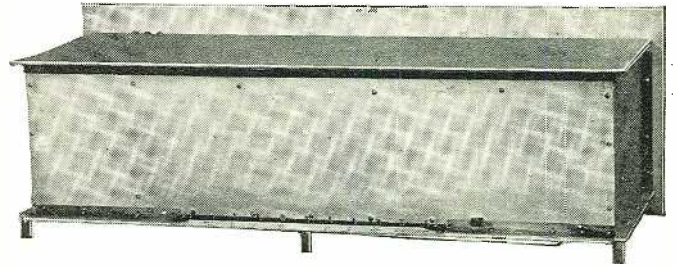

by the electromagnetic lines of force, create a counteracting field which neutralizes, or reduces to zero potential, the field at the plate.

In radio practise, the charged objects may be represented by condensers, tuning coils, radio-frequency transformers, the grid

increased up to this new point, where self-oscillation will again occur. This increased amplification may be secured through reduction of losses, through increase of the plate-circuit impedance (more turns on the plate-circuit coils), or through additional stages of amplification.

Feed-back in an amplifier is caused by additive interaction of the input and output electromagnetic and electrostatic fields, as well as through additive resistance- or impedance-coupling of the electrical energy in the input and output circuits.

In order to reduce this interaction between the "charged" parts of a radio receiver, it is customary to space the coils, condensers and other parts well away from each other; and usually the coils are arranged at angles such that each will be least affected by neighboring fields. Likewise, direct electric coupling, as through the resistance of a common battery, is reduced by means of large "by-pass" condensers. Though this design tends to reduce coupling between the parts, it does not entirely eliminate feed-back.

It might be imagined that the field surrounding a coil is restricted to the immediate vicinity of the coil; but actually the field extends for a distance in all directions, practically unlimited. Thus, it is not unusual for a good superheterodyne, without aerial or ground or loop, to be strongly affected by the field of a transmitter probably 2,000 miles away. We must appreciate this conception, of unlimited field extent, to understand the benefits of shielding.

At present the only reliable method of definitely limiting the extent of the electromagnetic and electrostatic fields, and consequently the only method of reducing undesired feed-back, is through the use of thorough shielding.

BENEFITS OF SHIELDING

Primarily, the advantage of shielding is in reducing the feed-back or advancing the point of self-oscillation, so that *increased amplification may be attained*. In this way it is possible to make amplifiers far more sensitive, and capable of receiving over much greater distances, than is possible without shielding.

There are other advantages of shielding which will be mentioned briefly before the design and construction of shields in radio receivers are taken up.

PERMITS MORE R.F. AMPLIFICATION

By employing thorough shielding and thus advancing the point of self-oscillation, it is possible to use a greater number of radio-frequency amplifying stages without undue difficulty in preventing or controlling self-oscillation. At the present time unshielded tuned-radio-frequency amplifiers are practically limited to two stages. If more than this number are used, very great

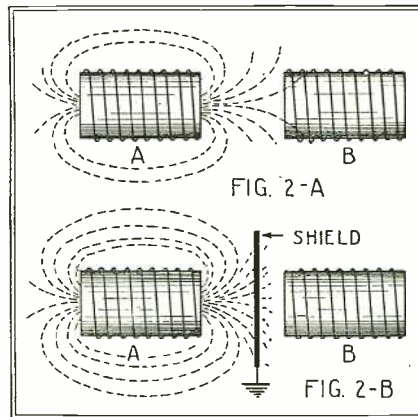

In 2-A the coil A extends its magnetic field and induces a current in B. In 2-B this induced current is shown to be almost entirely stopped by the grounded shield.

and plate of a vacuum tube, grid and plate leads, etc., when they are being traversed by radio-frequency currents. The resulting electrostatic and electromagnetic fields are not concentrated between the objects and the earth, but spread out more or less evenly in all directions. Therefore, to limit these fields, it is necessary to surround the objects entirely with grounded conducting shields.

WHY SHIELDING IS REQUIRED IN RADIO

For greatest efficiency and sensitivity, in cascade or multi-tube amplifiers, it is essential to prevent the amplified or output energy from feeding back to the input circuit. This is necessary because, when the energy fed back exceeds a certain value, the amplifier oscillates; and this action limits the amount of amplification that may be obtained. The amplifier will amplify only up to the point of self-oscillation.

If, in some way, the point of self-oscillation can be removed to a higher value, the amount of amplification may be

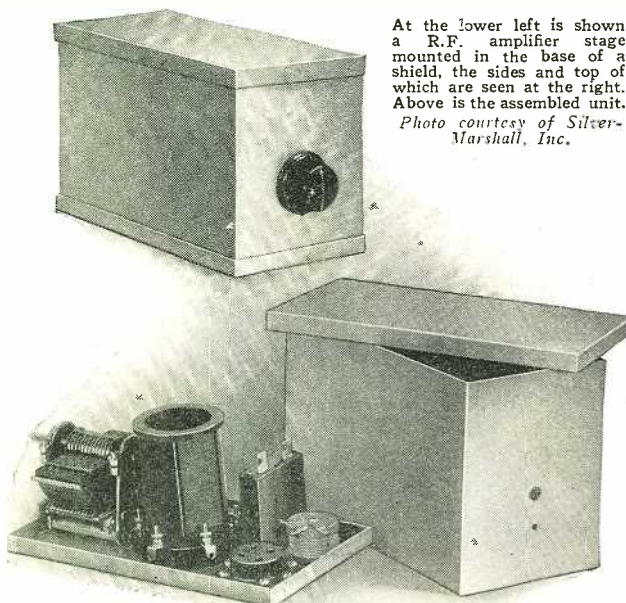

At the lower left is shown a R.F. amplifier stage mounted in the base of a shield, the sides and top of which are seen at the right. Above is the assembled unit. Photo courtesy of Silver-Marshall, Inc.

*Research Director, Carborundum Co., Niagara Falls, N. Y.
**Radio Research Engineer, Carborundum Co., Niagara Falls, N. Y.

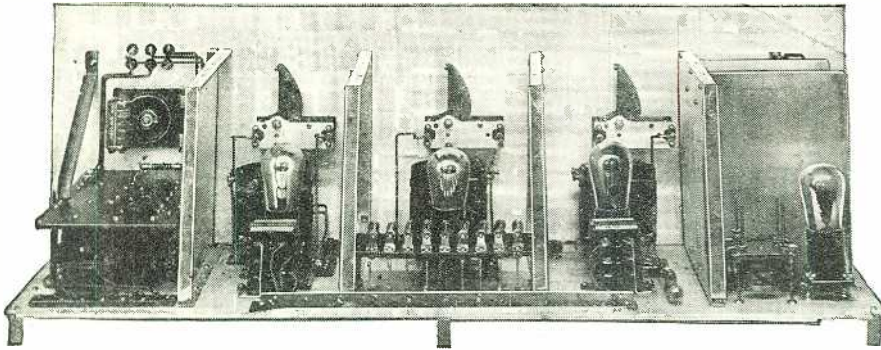

A shielded superheterodyne, showing the shielding partitions between the amplifier stages. The remainder of the shielding is shown in place on the opposite page.

Photo courtesy of The Carborundum Co.

losses have to be introduced to stop self-oscillation; and the efficiency of the system consequently is very low. But with shielded tuned-radio-frequency amplification, it is not at all difficult to use three and even four stages. Obviously, such an amplifier will give comparatively wonderful results in long-distance reception.

MAKES NEUTRALIZATION EASIER

Because the shielding reduces electromagnetic and electrostatic coupling between grid and plate circuits until the only remaining coupling is that caused by the grid-plate capacity of the vacuum-tube elements and their connecting leads, neutralization can be applied much more effectively and much more easily than is the case with unshielded receivers. In addition—and this is quite important—the neutralizing adjustment is more smoothly effective through the entire wavelength range; and consequently there is no “drop-off” in efficiency at the higher wavelengths, as is customary with unshielded neutrodyne receivers.

ELIMINATES BODY-CAPACITY EFFECTS

Grounded-rotor condensers have made most receivers free from body-capacity detuning effects; but in some sets, and particularly at short wavelengths, this annoying action is still evident. Thorough shielding absolutely eliminates this trouble. The action is the same as explained above; i.e., the grounded conducting plate or shielding prevents changes in the field on one side of the plate from affecting objects on the other side. Therefore, changes in the field between the body and the shielding, which might be caused by movement of the hand or body toward or away from the panel, do not influence objects inside the shield.

The coils and wiring in a thoroughly-shielded receiver are not affected by the field or local or distant transmitters. Consequently, there is practically no possibility of interference from this source.

The radio- and audio-frequency fields, set up and carried from place to place by the lighting circuits, do not reach the coils and wires in a thoroughly-shielded receiver. For this reason shielding reduces interference from motors, buzzers, starters, telephones, arc-lights, defective insulators, etc. Of course, to take full advantage of this protection, the aerial must be erected as far as possible from lighting circuits.

A thoroughly-shielded oscillator has a negligible external field and therefore does not annoy nearby listeners. Shielding prevents direct radiation, from the oscillator in superheterodyne receivers, and from the regenerative detector in Roberts, Browning-Drake and similar circuits. The advantages are obvious.

IMPORTANCE OF PROPER DESIGN

Experiments show that, when a metal sheet is placed close to a coil of wire, there is a decrease in the apparent inductance and an

increase in the apparent resistance of the coil. This is caused by the short-circuiting action of the metal sheet on the electromagnetic field surrounding the coil and by

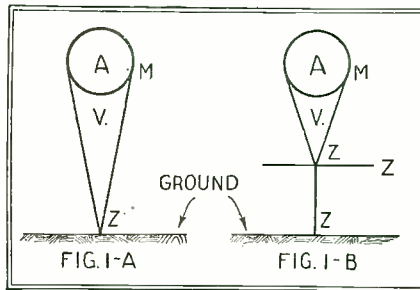

In Fig. 1-A is shown a charged object, A, with a charge, M, greater than ground potential, Z. Between M and Z an electrostatic and electromagnetic field, V, exists. This field can be confined to a smaller area, as in Fig. 1-B, by the introduction of a grounded object in the field.

the energy losses in eddy currents set up in the metal. Both effects are greatest when the plane of the metal is parallel to the plane of winding of the coil, as eddy currents tend to flow in a direction at right angles to the plane of magnetization.

Fortunately both effects may be made practically negligible if the coil is spaced away from the surrounding metal. The shielding should be kept at least 1½ inches from the ends and 1 inch from the sides of the coils. Under this condition, and when small coils are used, no allowance need be made for reduction of inductance when the coil is placed in the shield.

It is advisable to use coils of small dimensions, and a diameter of 1½ inches and not more than 2 inches is to be preferred. No. 28 or 30 D.C.C. wire may be used for all coils and tuned-radio-frequency transformers. The data for a good R.F. transformer, to be tuned with a 0005-mf. variable condenser, are as follows: form, light shellacked cardboard or thin, hard rubber, 2 inches in diameter and 3 inches long; secondary, 50 turns of No. 30 D.C.C. wire (With .00035-mf. condensers the secondaries should have 60 turns); primary, 30 turns of No. 38 D.C.C. wire wound over

How shielding is employed in a tuned R.F. receiver. The tops of the shields are removed to show construction, which is illustrated again on page 1039. Photo courtesy of Hammarlund Mfg. Co.

the filament end of the secondary, a few turns of bond paper or empire-cloth separating the two coils. The antenna coil may have about 10 or 15 turns of No. 30 wire. Give the entire transformer a light coat of collodion, and provide five terminals for the connections. When using three or more stages of T.R.F. amplification, reduce the primary (plate coil) to 15 turns. A tap should be made on the secondary at the same number of turns from the filament end of the secondary as there are turns in the primary (i.e., either 30 or 15). This is for the neutralization-condenser connection, in case neutralization is used.

WIRING

The “A”, “B”, and “C” battery leads, if properly insulated, may be run against the shielding, as this does not introduce any bad effects; in fact this practise is to be recommended.

However, plate and grid leads and connections to neutralizing coils and condensers must be removed as far as possible from the metal, in order to minimize their capacity to ground and thus minimize any detuning effects that might occur. This is particularly important in fixed tuned circuits, such as plate and neutralizing circuits, and also wherever fixed T.R.F. transformers are used. If slightly-excessive capacity is placed across an “untuned” or fixed coil (such as the plate circuit coils), the latter immediately loses its characteristics and acts as a tuned circuit with resultant inefficiency over the rest of the range.

Grid-and-plate neutralizing connections that must be brought outside the shields (as might happen when separate cases are used for the different stages of amplification) should be enclosed in metallic tubing, which must be connected to the rest of the shielding. It is necessary to keep the capacity between the lead and the tubing as low as possible. For this reason use fairly large tubing and fine wire (No. 36 or 38) for the lead. Also have the lead run through the

(Continued on page 1038)



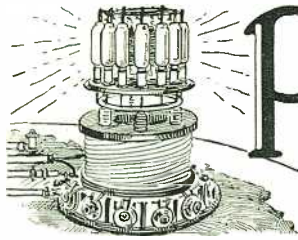

Progress in Radio



RESISTANCES IMPROVING REPRODUCTION

A really serious problem, which has but recently been brought forcibly to the attention of users of resistance-coupled amplification, is that presented by the continuous "putting," or "motor-boating" as it is more commonly termed, which manifests itself in varying degrees of intensity when "B" eliminators are connected to this type of amplifier.

These "plopping" sounds, which generally rise to such intensity as to drown out the incoming signals, are caused by low-frequency audio oscillations and present an almost unsurmountable stumbling block for the average layman.

The circuit and data here given are the result of extensive laboratory experiments, and not only solve the "motor-boating" problem, but set forth the use of variable resistances in a manner which tends to improve the high standard of resistance-coupled amplification.

In the plate circuits, R1 is a fixed resistor with a value of 750,000 ohms; R2 and R3 are of 500,000 ohms each.

In the grid circuits, R4 is a resistance variable up to 500,000 ohms; R5, a resistance variable up to 250,000 ohms; and R6, a resistance variable up to 100,000 ohms. When a power tube was used in the last stage, a resistance variable up to 50,000 ohms gave maximum results.

As the resistance in the grid circuit of the last tube is that which actually governs the final tone quality of the receiver, only through the use of a highly dependable make of variable resistor can the proper value be determined to assure clear and undistorted reception.

The variable resistances may readily be mounted on the sub-base of the receiver. When the most efficient operating values have been once determined, further adjustment is unnecessary.

The isolating condensers, C1, C2, and C3, have a capacity of at least 1.0-mf. Condensers C4, C5 and C6 are of the small by-pass type and low in capacity, about .00025-mf. These by-pass condensers which keep the radio-frequency currents out of the resistors in the plate circuits have been found absolutely necessary for best results. It is better practice to connect these by-pass condensers to "A" as they then by-pass the batteries as well as the resistors themselves.

To eliminate all semblance of "putting" or "motor-boating," it is advisable also to shunt a variable resistance across the isolating condenser C2, coupling the first and second stages. This resistance is shown as R7, and should be variable up to approximately 5 megohms.—*William H. Fine, Central Radio Laboratories.*

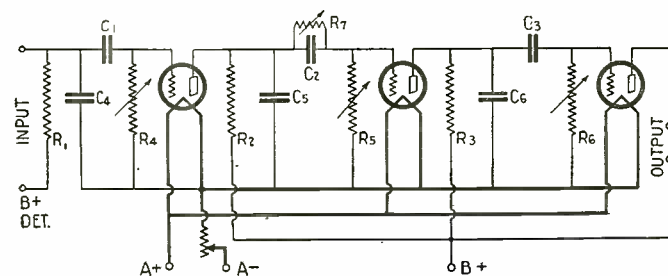

A MULTIPLE-UNIT LOUD SPEAKER

The Hopkins Corporation has recently obtained a patent upon an invention to overcome the inherent inability of a sound-producing diaphragm to reproduce in proper proportion all the frequencies included in the ordinary musical scale. The invention contemplates the utilization of a plurality of diaphragms with a view to covering as effective a range as possible. For example, where two diaphragms only are employed, one of them is designed to have a high natural period, while the other is designed for a low period. The two diaphragms are chosen so that the ranges of frequencies overlap.

Briefly, the invention consists in the combination of a plurality of sound-reproducing elements, each designed efficiently to reproduce a different band of frequencies, and adapted to be connected in parallel to a common energizing source; with means for controlling at will the reproduction of at least one of the elements by electrical means. This may be effected by means of variations in capacity, inductance or resistance.

In carrying the invention into effect, two loud speakers are connected in parallel to the output terminals of the receiving set. In series with one lead of each loud speaker is inserted a variable resistance, a variable inductance or a variable condenser. It is stated that the most satisfactory results have been realized with this hook-up in which two condensers, A and B, are shown in series with the instrument. The value given

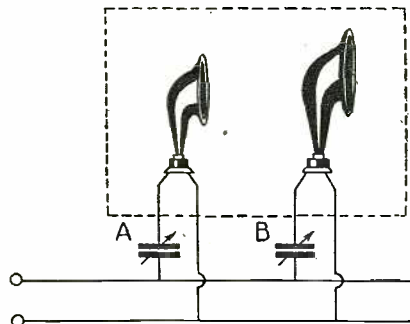

Better reproduction can be had by using two loud speakers, connected in parallel, and tuned by high-capacity condensers.

for condenser A is approximately .005-mf. that of condenser B being .01-mf.

The use of two loud speakers of differing characteristics from one receiver is well known, but "tuning" loud speakers, in order to accentuate still further the varying characteristics, opens up rather an interesting line of development.—*Wireless Trader*

CRYSTAL AMPLIFICATION

Sidney Charles Pearce and John Sidney Smith, both of Birmingham, have recently obtained a British patent upon an invention which appears in their joint name. The invention has for its object the improvement of apparatus wherein amplification can be effected with the aid of a crystal. The device comprises the employment in series with

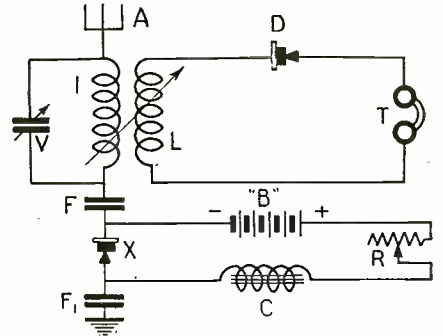

A standard crystal receiving circuit, employing a second crystal in a separate circuit as an amplifier.

the aerial of a crystal contact and a condenser on each side of the crystal, and electromotive force being applied to opposite sides of the crystal by a battery in a circuit containing an inductance or choke coil.

Referring to the diagram, it will be seen that the amplifying circuit contains a battery, B, a resistance, R, and a choke coil, C, all in series. The ends of this circuit are connected to the opposite sides of a crystal contact, X, arranged in series with the aerial, A. Also in series with the aerial is arranged a pair of fixed condensers, F and F1, the crystal contact and the amplifying circuit being located between the condensers. Aerial tuning is effected by the inductance, L, and the variable condenser, V. A secondary circuit contains a coil, L, a crystal detector, D, and head phones, T.—*Wireless Trader*

NEW INSULATING MATERIAL

Mica particles, which heretofore could not be used, are now worked into material, containing also lead borate, for the production of radio-frequency insulators, by a process developed by engineers of the General Electric Co.

Obtained in India and Canada in large sheets, mica previously presented a difficult problem because of the enormous amount of waste at the mines, as only about five per cent. of the material mined could be used. In manufacturing, there were still further wastes of small pieces of mica; but some years ago it was found that these flakes, mixed with a binding material and compressed under heat, made a very good insulation. Now a product has been developed which uses the mica particles.

The new material, known as mycalex, is being used in the manufacture of bases for radio transmitter tubes, for aerial insulators in high-frequency work, and numerous similar applications. It is light gray in color and with a metallic ring.

Chief among its characteristics are that metal parts may be inserted during the process of molding; and, although a hard and

(Continued on page 1042)

By the use of the by-pass condensers C4, C5 and C6, the variable by-pass resistance R7 and variable grid leaks, it is possible to prevent "putting" or "motor boating" in a resistance-coupled A.F. amplifier, operated from a "B" eliminator.

Radio Wrinkles

AUTOMATIC LOUD-SPEAKER CONNECTION

Here is a simple method of automatically connecting the loud speaker in the circuit when the head phones used for tuning in

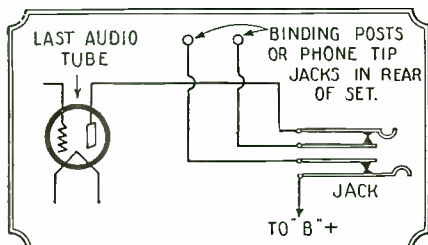

Simple jack-wiring arrangement to cut out automatically the loud speaker when the phones are plugged into the last stage.

weak stations are removed. A pair of phone tip jacks or two binding posts are mounted at the rear of the set. The loud speaker is permanently connected to these two posts. A double-circuit jack mounted on the panel is connected as shown in the diagram. When the head phones are plugged in the jack the loud speaker is disconnected; when the phone plug is removed, however, the speaker is in the circuit.

Contributed by A. E. Geldhof.

DEVICE FOR ENGRAVING DIAL INDICATORS

Neat looking dial indicators can be engraved on the panel of a home-made set by using the metal template illustrated. Two pieces cut from metal, as shown in Fig. 1, are placed together as in Fig. 2, and fastened to the panel with two furniture

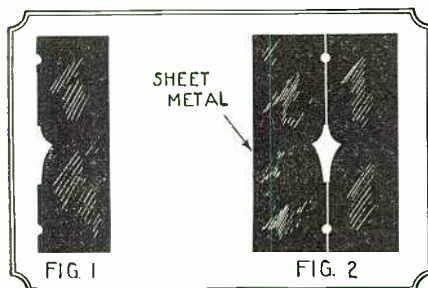

Details of a metal template employed for engraving dial indicators on panels.

clamps. The holes are used merely to line up the template with a center-line pencil mark on the panel. By means of a scribe the design may be accurately engraved in the panel.

Contributed by Mile Simmonds.

A SIMPLE VERNIER

In the drawing is shown one of the most simple mechanical verniers it is possible to make. A disc of metal $\frac{3}{8}$ -inch thick, with a knurled edge, three inches or more in diameter, is fastened to the variable condenser, or other shaft. (See A). If necessary, the knurling can be made by cutting many closely-spaced, shallow notches in the periphery of the disc with a triangular file or hack-saw; or a gear wheel with a diameter

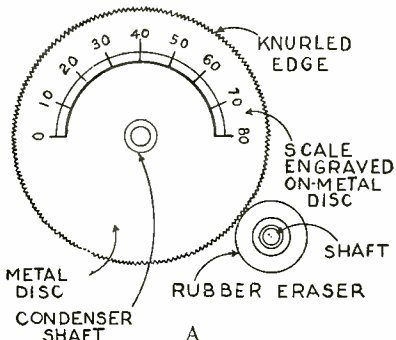

Details of the vernier knob and dial. A rubber eraser is used as the friction contact.

of three inches or larger may be used, which will save this work of knurling.

The rubber is taken from a used circular typewriter eraser; and cut down to a diameter of $\frac{3}{8}$ -inch. It is fastened to a

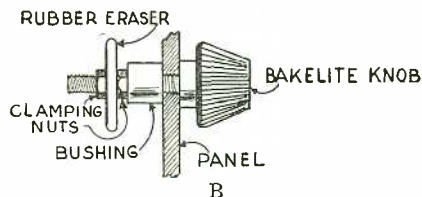

The vernier knob and shaft, to which is attached the rubber eraser.

shaft and knob, which are mounted on the panel as shown at B. The rubber is placed so that it presses tightly against the teeth of the gear wheel, giving it a good grip. The variable condenser can be fastened to the baseboard and placed about half an inch back of the panel, so the mounting screws



The circuits of two simple home-constructed "B" eliminators, employing cheap bell-ringing transformers as step-up transformers and chokes. Ordinary 201-A tubes are used as the rectifiers.



All published Wrinkles, not winning prizes, will be paid for at the rate of two dollars each. The next list of prize winners will be published in the March issue.



will not interfere with the gear wheel. An opening may be cut in the panel and covered with glass as shown at C; the scale may be painted or engraved directly on the gear wheel, and a hair line scratched on the glass

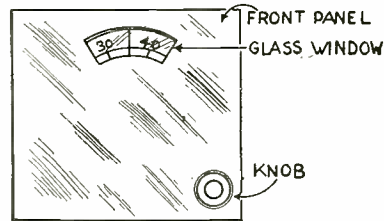

Details of the panel window showing location of vernier knob.

for an indicator. With a 3-inch gear wheel and a $\frac{3}{8}$ -inch rubber disc, the ratio is 8 to 1, which is about right for all ordinary tuning.

Contributed by Charles F. Felstead.

"B" BATTERY ELIMINATOR DIAGRAMS

Here are two diagrams of "B" battery eliminators made up of bell-ringing transformers. The one shown in Fig. 1 requires three transformers and the one in Fig. 2 requires four. Each illustration is of the full-wave type, giving results equivalent to any of the high priced "B" eliminators on the market. All the data required for building the eliminators is shown in the illustrations. Note that two 201-A tubes are used for the rectifier. These may be replaced by one double wave Raytheon tube if desired. In each diagram the secondary winding of one of the transformers is used as a filter choke. Contributed by Louis B. Sklar.

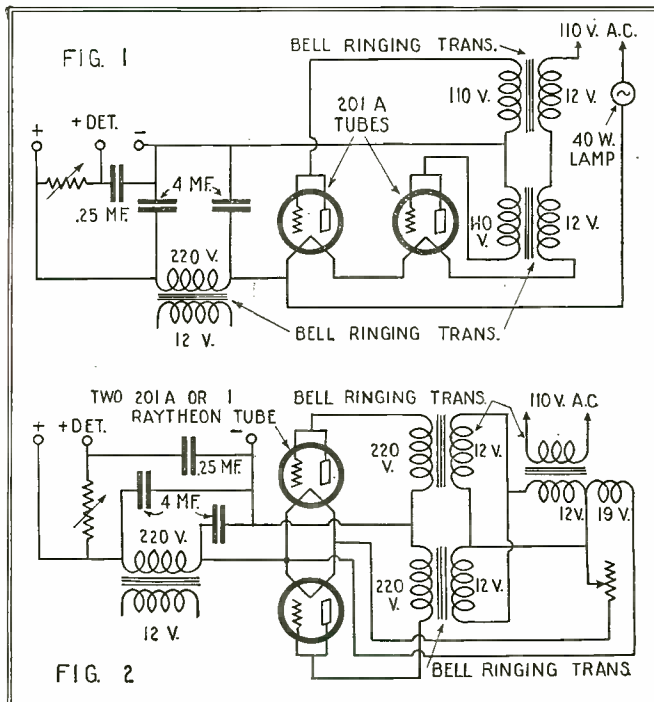



ANENT EDISON AND RADIO

Editor, RADIO NEWS:

The December issue has just come to my desk and I have read your editorial "Edison and Radio". I want to commend your lenient attitude in commenting upon the remarks, attributed to Mr. Edison, regarding the comparative merits of radio and the phonograph.

In spite of the reverence due our great inventor, most of us could not have resisted a temptation to characterize such statements as propaganda; or at least to insinuate that, had not monetary interests closely allied Mr. Edison with the phonograph rather than with radio, such statements never would have been published.

It is true enough that radio receivers are, in many cases, far too complicated. Probably this very intricacy is one of the fascinations of radio which has contributed largely to its phenomenal success; and, again, in their simpler forms, radio receivers are not so complicated as to be beyond the comprehension of the average 14-year-old boy.

It is not fair to compare the results of the average phonograph with the average radio receiver in reproducing music. The average phonograph of today is a highly-developed, scientifically-designed, factory-built piece of apparatus, the culmination of many years of experience. The average radio receiver—well, I don't want to hurt anyone's feelings, but to put it mildly, the average radio receiver is far from representing the present state of perfection in the radio art. Radio at its best will not suffer by comparison with the finest of phonographs—we'll leave that to the critics.

I think little needs to be said in defense of radio, in any controversy which may arise involving comparisons between radio and the phonograph; and you have said it. Yet you have said about all that was necessary, and I am inclined to think you have been very charitable.

Credit should be given where due and I am glad that you have given Mr. Edison credit for his really great and valuable contribution to radio, the discovery of "The Edison Effect."

LEROY F. DYER, *Managing Eng.*
Dyer Radio Manufactory.

Quincy, Mass.

TELEPHONE-LINE LOSSES AND THE AURORA

Editor, RADIO NEWS:

In the January, 1926, issue (page 964) of RADIO NEWS, Mr. Chester L. Davis writes on "New Facts About the Aurora Borealis." It is a positive fact that light phenomena ionize the air particles, and thereby cause a current leakage.

I once measured the Budapest-Zsolna telephone (double-wire) circuit, 300 kilometers long. The outgoing current was kept exactly at the value of one milliampere, at audio-frequency, at Budapest. (Budapest and Zsolna do not lie in the same meridian, Zsolna being somewhat to the west.) Measuring with my barretter set in Zsolna, even before sunrise, the incoming current began to decrease. The rays of the sun reached the Budapest line, the porcelain insulators became somewhat conductive, because of dew-drops on their surface, ionized air formed between the wires; and the leakage became greater and greater.

After a while, the sun evaporated the fine moisture from the insulators and the morning breeze swept away the ionized particles from between the wires; and the circuit resumed its former condition. I am quite convinced that the aurora borealis could cause similar phenomena; but I do not agree with Mr. Davis' alternating-current theory. Let me present the following questions.

What was the leakage of the telephone circuit which was measured?

Was a D.C. measuring instrument used, or a barretter (alternating-frequency meter) on audio-frequency current?

I am sorry to say that, so far, I have been unable to obtain any data about the leakage of American telephone lines. Was the leakage $g=10^{-6}$ or 10^{-4} mho?

Was there no direct-current electric-car line in the vicinity?

Our interborough electric railways have a quarter-hour schedule. When a car is coming toward us, we get a certain polarity (+ or -) of the stray current. The direction of the current reverses when the car is receding from us. The Bureau of Standards might furnish more data in this problem, as a result of their researches into the causes of interference.

The conductivity of a telephone line is affected by other circumstances, also. For instance, if smoke is precipitated because of the high conductivity of the air, the charges on the carbon particles cannot be maintained, and the particles fall. In this manner the stray current in the telephone circuit is measurably increased. These experiments may be performed without waiting for the aurora borealis.

If we thus obtain the observed reversal in the direction of the current, even Mr. Davis may be convinced that the observed "current" is caused only by the variable leakage; and that it may be in reality only electric-car line interference.

BELA GATI,

Gyali ut 22, Budapest IX, Hungary.

(Dr. Bela Gati, the writer of the above, is one of the most famous living research scientists.—EDITOR.)

APPRECIATES NEW STYLE

Editor, RADIO NEWS:

I think that RADIO NEWS is certainly due for a vote of thanks from a great many on account of its "change of policy," in the way that you now publish new hook-ups, etc. It is a wonderful improvement. While not a subscriber, I have not missed an issue since I bought one first, over two years ago.

H. F. RUSSELL,

2545 Howard St., San Francisco, Calif.

DETECTORIUM RESULTS

Editor, RADIO NEWS:

I am pleased to inform you that I have constructed the Gernsback Detectorium circuit (as described on page 237 of RADIO NEWS for September, 1926), using an .0003- to .0005-mf. variable condenser and iron-pyrite crystal, and have found it, as stated, quite excellent. I am situated about seven miles from 2LO, and have a 100-foot outside aerial, 30 feet high, and a good water-pipe ground connection. The results are louder than those of any crystal set I have made to date. I had some difficulty at first, which I soon rectified by soldering some flexible wire

from the adjusting screw on the crystal to the square brass rod on which the cup slides. I have been taking RADIO NEWS for the last eighteen months, to the exclusion of any other radio magazine; as I find it more readable and intensely interesting.

H. CATCHPOLE,
London, England

ARE AUDIO STAGES TOO NUMEROUS?

Editor, RADIO NEWS:

These are the conclusions of a rabid B.C.L., who has spent as much money for radio periodicals in the last fourteen years as he has for radio parts.

Can any one beat the tone quality of a first-class crystal set? In my estimation, they can not.

The next best bet is reception on a detector tube with no audio amplification.

Now then, we find that beyond the detector, with each added stage, we not only increase the volume but also increase distortion of sound regardless of transformer-, resistance-, or impedance-audio amplification. So why try to add tubes to a broadcast receiving set? Is it to impress on the non-technical purchaser that he is getting something which he is not really getting?

The average set for 1926 is a six-tube receiver, and when it is analyzed you find that it has three audio stages. This, in my estimation, is a waste of money and effort, and, I believe, does not produce real tone quality.

I have finally settled on a Tropadyne six-tube receiver, with one stage of transformer-coupled audio (Rauland-Lyric), as brought out by Mr. Clyde Fitch; and I want to say that, tube for tube, I can duplicate on an 18-inch square loop the reception of any receiver manufactured or home-built, whether they use an outdoor aerial or not—and the tone quality will be excellent.

It might interest you also to know that I have operated this set in the same room, with another set of different circuit less than fifteen feet away, without interference.

Of course, I understand that manufacturers are handicapped at this time with patent litigations but, as I see it, the future will bring out a tone-quality receiver of few controls, fewer audio tubes and without the battery nuisance.

Hoping that the "powers that be" will clear the fog of patent litigations so that manufacturers can give the purchasers a really-selective receiver of real tone quality, the superheterodyne; and also hoping that you will continue to publish your "worth while" RADIO NEWS, I am, very truly yours,

E. A. SCHNELL.

2349 Charleston Ave., Toledo, Ohio.

APPRECIATES PRACTICAL ARTICLES

Editor, RADIO NEWS:

Yours is the best radio magazine I have ever read, and I have derived very much information in the radio field through the pages of RADIO NEWS. The technical and practical information in its pages is worth a fortune to the man who likes radio.

CHARLES KOSTLER.

Engineer, Station WTRC, Brooklyn, N. Y.

(Expressions of readers' opinions are their own, and may differ from the editorial belief. It is desired to permit here fair arguments on either side of a radio controversy.—EDITOR.)

Radiotics

A NEW TYPE OF LOUD SPEAKER

Advancement in the reproduction field, as told in the November issue of *Radio Mechanics*: "Being tinned, it is easy to solder with resin CONE solder." The result of this was that, when we got home last night, we found the family pup howling in front of a solder loud speaker instead of our paper cone. (Yep, the wife likes radio.)

Contributed by Frank Treiling.

GIDDAP, NAPOLEON!



Contributed by Clarence Thompson.

FOR POLYGAMISTS ONLY?



wife to offer to the cause. Contributed by A. W. Benton, Jr.

Scientific experiment suggested by the *Omaha News* of Nov. 8: "A detector can be made by sticking a steel knife and a silver fork into a small potato and connect them to the WIFES which usually go to the crystal." We are sorry that we cannot perform this experiment; but we are handicapped for we have but one

NOTHIN' BUT THE TRUTH

Frank confession in the *New York Sun* of Oct. 23, "It is claimed that the entire six-tube set operates well... with DISCORDANT reproduction." Now, when there are so many fellows that you have met that always tell you how fine their set perks, is it not refreshing to meet a truthful person once in a while?

Contributed by H. C. Browne.



CAN YOU HELP THIS FELLOW?

In the Oct. 30 issue of *Radio Doings* we find this question: "... is bothered by a SINGING speaker, and wants to know how to stop it and why?" We would suggest boiling in oil, or shooting at sunrise (or sunset, it makes no difference). They might also drown the young so there won't be any more.

Contributed by Paul Sanders.



MAYBE LIKE ADRENALIN?

Lovers of the easy chair, please notice this item from September *QST*: "... and if the ET2 3620 RESTIFIER unit is used... Mike of our Investigation Dept., when sent out on this job, failed to return till the next day. He said that it was a gadget that attaches to the set and gets you all rested up. Nice?"

Contributed by R. E. Winn.



WELL! WELL! WELL!

Perhaps an attempt at humor in an advertisement in the *Radio Digest's* second October issue, explaining that a radio receiver can "be operated by electricity if you prefer." No, Oswald; just because you sat down on the "B" batteries the other day and got a shock, don't try to take the clock apart to make the radio run by springs.

Contributed by H. J. Ridge.



If you happen to see any humorous misprints in the press we shall be glad to have you clip them out and send to us. No **RADIOTIC** will be accepted unless the printed original giving the name of the newspaper or magazine is submitted with date and page on which it appeared. We will pay \$1.00 for each **RADIOTIC** accepted and printed here. A few humorous lines from each correspondent should accompany each **RADIOTIC**. The most humorous ones will be printed. Address all **RADIOTICS** to

Editor **RADIOTIC DEPARTMENT**, c/o Radio News.

NEW WORK FOR CHARGERS



More work for the B.C.L., as told in the *Palmsade (Neb.) Times* of Nov. 5: "We specialize in charging radio storage batteries, loud speakers, cone speakers." Now when the old speaker refuses to do its stuff, we suppose that it will be necessary only to hook up the charger to it and give it a push.

Contributed by A. J. Baxter.

IS THIS A NEW ONE?

In the *Philadelphia Inquirer* of Sept. 29 we find this reference to a hot water installation: "One generator will care for a RADIO of 40 gal. tank or 75 feet of radiation." Maybe the tank is way up in the air and the water pressure sends the radio waves out with a push... Maybe is right!

Contributed by W. K. Moyer.

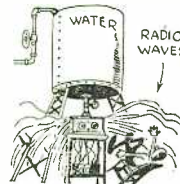

FOR THE SERIES-PARALLEL SHORT CIRCUIT?

News item from *The Wireless World* (London) of Oct. 13: "Valve having low internal capacity and suitability for **SHORT CIRCUITS**." These English radio fans should be awarded the first prize for developing a tube that can be used in this type of circuit. By the way, how long is a short circuit?

Contributed by W. A. Agnew.

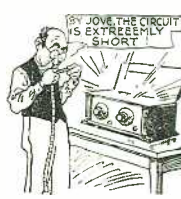

A STATE OF SEPULTURE?

Little Rhody's record is broken, according to *Radio World* of Oct. 23: "This diminutive **RHEOSTATE** measures only 3/4 inch—the **TOMB Thumb** is a concentrated design." In such a limited area finding a room for cemeteries must be even a bigger problem than in China. And think of the traffic congestion!

Contributed by J. E. Minnick.



AS IN THE GOOD OLD DAYS?

Volsteadian gesture from *QST's* October issue: "UP-1658 Filament Transformers 150 watt, 10 v. with **MIDCAP**, \$8.00." You old timers, who used to hoist one before going to bed and called it a nightcap, can now take the hint from radio and call the same dose a midcap; it's taken at midnight because of the DX hours.

Contributed by Orrin Nelson.



HERE'S YOUR CHANCE!



Contributed by Wm. G. Mortimer.

Rash offer in the advertising columns of the *Detroit News* of Sept. 5: "Five- and six-tube radio, will sell cheaply, **ALL OR ANY PART**." Having slightly scratched the left hind end of our cabinet the other night, we sent Mike of the Investigation Dept. out there to get us that corner of the box.

NEW HOUSEHOLD UTILITY



Announcement, in *RADIO NEWS* for December, of the new **DUOFOMER 5-TUB** circuit offers a boon, no doubt, to housewives. The family wash is done by this versatile receiver, while the necessary bluing is contributed by jazz. Does the electricity foam, however, or do we need Lux?

Contributed by B. M. Bergin.

IS THIS LOOSE ENOUGH?

The Barawik Co.'s catalog has this novel tuning information: "These coils also prevent coil 'pick-up' and eliminate **INTERSTATE** coupling." No wonder the coils eliminate pick-up with coupling so loose. It's a wonder to us that there was reception at all. What states did they use?

Contributed by A. L. Henriksen.



A SPEAKING TUBE

Long range conversation as noted in the Barawik Company's catalog: "A 199 tube with 90 volts on the plate has a c t u a l l y TALKED with Australia from Columbus, Ohio." What on earth is the use with bothering with transmitters when all that is necessary is to get a 199 tube, feed it 90 volts and tell it what to say. Simple? I'll say so.

Contributed by J. H. Kucera.



WHERE SUNS ARE ALWAYS SHINING

Says *The Live Oak* of Palo Alto, Calif.: "The outstanding feature of the **Infradyne** is the fact that **SUN** frequency is amplified at 90 meters." Now we know where the Golden State gets its monopoly on climate—after they have been keeping it a family secret so long.

Contributed by George Stoneham.



APPROVED RADIO NEWS LABORATORIES 1922

RADIO NEWS LABORATORIES



RADIO manufacturers are invited to send to RADIO NEWS LABORATORIES, samples of their products for test. It does not matter whether or not they advertise in RADIO NEWS, the RADIO NEWS LABORATORIES being an independent organization, with the improvement of radio apparatus as its aim. If, after being tested, the instruments submitted prove to be built according to modern radio engineering practice, they will each be awarded a certificate of merit, and a "write-up" such as those given below will appear in this department of RADIO NEWS. If the apparatus does not pass the Laboratory tests, it will be returned to the manufacturer with suggestions for improvements. No "write-ups" sent by manufacturers are published on these pages, and only apparatus which has been tested by the Laboratories and found to be of good mechanical and electrical construction is described. Inasmuch as the service of the RADIO NEWS LABORATORIES is free to all manufacturers whether they are advertisers or not, it is necessary that all goods to be tested be forwarded prepaid, otherwise they cannot be accepted by the Laboratories. Apparatus ready for the market or already on the market will be tested for manufacturers, as heretofore, free of charge. Apparatus in process of development will be tested at a charge of \$2.00 per hour required to do the work. Address all communications and all parcels to RADIO NEWS LABORATORIES, 53 Park Place, New York City.

INTERFERENCE ELIMINATOR

The "Steinite" interference eliminator shown, submitted by The Steinite Laboratories, Radio Bldg., Atchison, Kansas, has a tuning circuit consisting of a basket-weave coil in series with a book-type condenser, whose capacity is varied by turning the special knob. In con-



nection with radio receivers of the larger types, this device increases their selectivity and is of considerable aid in solving the interference problem experienced in many places, because of the number of broadcast stations.

AWARDED THE RADIO NEWS LABORATORIES CERTIFICATE OF MERIT NO. 1658.

FIXED CONDENSER

The "Dubilier Micadon" shown, submitted by The Dubilier Condenser and Radio Corp., 4377 Bronx Blvd., New York City, is enclosed in an aluminum case which protects



it from atmospheric conditions. The lugs of the condenser permit the use of machine screws for attachment, or leads can be soldered to them directly.

AWARDED THE RADIO NEWS LABORATORIES CERTIFICATE OF MERIT NO. 1725.

RADIO RECEIVER

The "Chelsea Super-Six" receiver shown, submitted by The Chelsea Radio Co., 150 Fifth St., Chelsea,

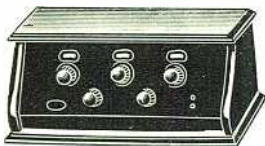

Mass., employs two stages of tuned radio frequency, detector and three of impedance-coupled audio; it tunes very sharp and the reproduction of speech and music is very efficient. It can be equipped for power operation.

AWARDED THE RADIO NEWS LABORATORIES CERTIFICATE OF MERIT NO. 1727.

RADIO RECEIVER

The "Serenader" receiver shown,



submitted by The Gould Supply Co., 14th at Main St., Kansas City, Mo.,

comprises two stages of tuned-radio-frequency, detector, and three stages of resistance-coupled audio; regeneration is controlled by means of a potentiometer. Its reproduction quality, for both speech and music, is good.

AWARDED THE RADIO NEWS LABORATORIES CERTIFICATE OF MERIT NO. 1735.

AERIAL SWITCH

The "Carter Imp" aerial switch (No. 11 shown) submitted by The Carter Radio Co., 300 So. Racine Ave., Chicago, Ill., is used to change over from short to long aeri-als, or vice versa, and is similar to the filament switch manufactured by the



same company, except that it has three terminals.

AWARDED THE RADIO NEWS LABORATORIES CERTIFICATE OF MERIT NO. 1754.

"B" ELIMINATORS

The "Balkite" "B" eliminator (type W shown) submitted by The Fansteel Products Co. Inc., North Chicago, Ill., is of the electrolytic type, and operates from 110-volt alternating current, 60-cycle. The current output is sufficient to operate a 5-tube receiver efficiently. The unit performs very well, as no hum is heard when it is in operation.



AWARDED THE RADIO NEWS LABORATORIES CERTIFICATE OF MERIT NO. 1757.

The "Balkite" "B" eliminator (type X shown) submitted by The Fansteel Products Co. Inc., North Chicago, Ill., is similar to the above; except that the current output is considerably greater and therefore it is capable of being used with larger sets.



AWARDED THE RADIO NEWS LABORATORIES CERTIFICATE OF MERIT NO. 1758.

RADIO RECEIVER

The "Metrodyne Single-Dial" receiver shown, submitted by The Metro Electric Co., 2161 No. California Ave., Chicago, Ill., is a

seven-tube, single-control tuned-radio-frequency set. Vernier adjustment between stages is obtained by varying two levers which project through the panel and are connected



to the stator plates of the condensers. The panel is artistically engraved in gold, and the exposed metal parts are gold-plated, making the appearance very attractive. The receiver as a whole performs very efficiently.

AWARDED THE RADIO NEWS LABORATORIES CERTIFICATE OF MERIT NO. 1759.

RHEOSTAT

The "Little Giant" rheostat shown, submitted by The General Instrument Corp., 477 Broadway, New York City, N. Y., is one of the smallest types made. The resistance



wire is wound on a metal core, thereby providing a cooling system. The contact is smooth and perfect in any position of the rotating arm. It is made in standard resistance sizes.

AWARDED THE RADIO NEWS LABORATORIES CERTIFICATE OF MERIT NO. 1760.

BATTERY TESTER

The "Ga-Git" battery tester shown, submitted by The General Instrument Corp., 477 Broadway, New York City, N. Y., is a device used in place of a hydrometer to measure the "A" battery voltage; it contains a coil which acts magnetically on an iron-core plunger carry-



ing an indicating plate. The device is very compact and convenient for the battery owner.

AWARDED THE RADIO NEWS LABORATORIES CERTIFICATE OF MERIT NO. 1761.

R.F. TRANSFORMER

The "Lekeless" transformer shown, submitted by The Benjamin El. Mfg. Co., 847 W. Jackson Blvd., Chicago, Ill., is of the binocular



type, formed by two self-supporting coils attached to a small bakelite strip, to permit easy mounting. The

winding is similar to that of the tuned-radio-frequency transformers manufactured by the same firm. Its functioning is very efficient, especially in multi-stage radio-frequency amplification.

AWARDED THE RADIO NEWS LABORATORIES CERTIFICATE OF MERIT NO. 1762.

BATTERY SWITCH

The "Benjamin" radio battery switch shown, submitted by The Benjamin Electric Mfg. Co., 847 West Jackson Blvd., Chicago, Ill.,



is a small, compact unit and its mechanical features are very good. It is mainly used for "A" battery control.

AWARDED THE RADIO NEWS LABORATORIES CERTIFICATE OF MERIT NO. 1763.

AERIAL MAST EQUIPMENT

The "Webb Aerial Mast" shown, submitted by The Timing Gears Corp., 2801 Fulton St., Chicago, Ill., is composed of two cast-iron plates forming a spherical housing over the end of the mast, and a cast-iron tube, with holes for guy wires,

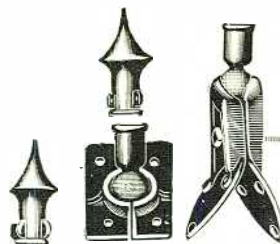

to be placed on top of the mast. This mast can be used in conjunction with any type of aerial.

AWARDED THE RADIO NEWS LABORATORIES CERTIFICATE OF MERIT NO. 1764.

CONE SPEAKER

The "Tower Scientific Cone Reproducer" shown, submitted by The



Tower Mfg. Corp., 98 Brookline Ave., Boston, Mass., is of the free-edge type, with a unit of the direct-drive type. The cone itself is of a non-warping material capable of resisting all kinds of atmospheric changes. Its reproduction qualities are good and the volume is enough for ordinary use.

AWARDED THE RADIO NEWS LABORATORIES CERTIFICATE OF MERIT NO. 1765.

RESISTANCE-COUPLING UNIT

The "Resistoformer" coupling unit shown, submitted by The Aerovox Wireless Corp., 489 Broome St., New York City, N. Y., has a molded



bakelite base which contains a fixed condenser, and clip holders to accommodate grid and plate resistances. The unit is used in constructing resistance-coupled amplifiers.

AWARDED THE RADIO NEWS LABORATORIES CERTIFICATE OF MERIT NO. 1768.

BATTERY TESTER

The "Three-In-One" Battery Tester shown, submitted by The N & N Hydrometer Co., 3715 West Grand Ave., Chicago, Ill., has three glass tubes, each having a different-



sized float. The state of the battery's charge is indicated by the position of the different floats in the tubes.

AWARDED THE RADIO NEWS LABORATORIES CERTIFICATE OF MERIT NO. 1770.

"B" BATTERY ELIMINATOR

The "Manhattan" "B" battery Eliminator (No. 2599 shown) submitted by The Manhattan Electrical Supply Co., Inc., 17 Park Place, New York City, N. Y., operates on 110-volt alternating current, 60-cycle, using the neon-gas-filled rectifying tube made by the same



company. The primary of the transformer is provided with a resistance which regulates the input current. The unit operates very quietly and gives enough current to operate satisfactorily most of the receivers now on the market.

AWARDED THE RADIO NEWS LABORATORIES CERTIFICATE OF MERIT NO. 1772.

BATTERY FILLER

With the curved battery filler shown, submitted by The In-A-Cap Hydrometer Co., 1343 Fourteenth Place, Chicago, Ill., the battery can be filled up to the proper height for



the solution without removing it from the cabinet, thus obviating a considerable amount of trouble.

AWARDED THE RADIO NEWS LABORATORIES CERTIFICATE OF MERIT NO. 1773.

BATTERY TESTER

The battery cap tester shown, submitted by The Scranton Glass Instrument Co., Scranton, Pa., is similar to an ordinary hydrometer,



except that it has a rubber cap which threads into the opening of a storage battery. The float is colored in three shades, each indicating a different state of charge.

AWARDED THE RADIO NEWS LABORATORIES CERTIFICATE OF MERIT NO. 1788.

BINDING POST

The "Morse Eureka" binding post (type T shown) submitted by The Frank W. Morse Co., 289 Congress St., Boston, Mass., is of the non-removable knob type. The engraving is made on a small bakelite disk, attached to the shaft so that the reading is always in the same position, independent of the knob.



AWARDED THE RADIO NEWS LABORATORIES CERTIFICATE OF MERIT NO. 1789.

LOUD SPEAKERS

The "Borkman Velvet" loud speaker (No. 12 shown) submitted by The Borkman Radio Corp., Kalamazoo, Mich., has a goose-neck bell; the unit is not adjustable. It gives good volume and the reproduction of speech and music is good.

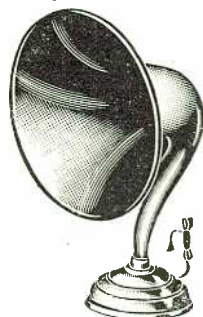

AWARDED THE RADIO NEWS LABORATORIES CERTIFICATE OF MERIT NO. 1794.

The "Borkman Velvet Jewel Case" loud speaker (No. 21 shown) submitted by The Borkman Radio Corp., Kalamazoo, Mich., is of the horn type and constructed in the form of a chest. By opening the lid of the chest an air chamber is formed;

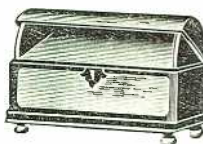

the unit is attached to a small horn, which in turn comes in close contact with the wall of this air chamber. The reproduction of speech and music is good.

AWARDED THE RADIO NEWS LABORATORIES CERTIFICATE OF MERIT NO. 1795.

VACUUM TUBE

The "Sturdy" vacuum tube (Type 201A shown) submitted by The Sturdy Engineering Co. Inc., 1323

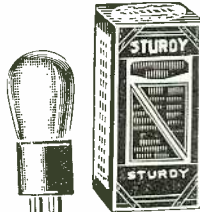

So. Michigan Ave., Chicago, Ill., is of the UX type; the characteristics are similar to those of the UX-201A. It can be used as either a detector or an amplifier.

AWARDED THE RADIO NEWS LABORATORIES CERTIFICATE OF MERIT NO. 1797.



TRICKLE CHARGER

The "Eagle" trickle charger shown, submitted by The Eagle Charger

Corp., 121 North 8th St., Philadelphia, Pa., is of the electrolytic type, with heavy electrodes; the charging ratio is very steady and slightly above 1/4-ampere. It operates from 110-volt alternating current, 60 cycle. As a whole the unit is very compact and well built.

AWARDED THE RADIO NEWS LABORATORIES CERTIFICATE OF MERIT NO. 1796.

HYDROMETER

The "S O S" Hydrometer shown, submitted by The Chaslyn Co., 3845 Ravenswood Avenue, Chicago, Illinois, contains three balls of different colors, and the general state of the battery can be deter-



mined by the number of balls floating. When compared with a standard hydrometer it is found to be very accurate.

AWARDED THE RADIO NEWS LABORATORIES CERTIFICATE OF MERIT NO. 1798.

TOROIDAL COIL

The "S & S Toroid" coil shown, submitted by The Stern & Stern A.-B., Reperingsgatan 9, Stockholm, Sweden, is wound with green-silk-



covered wire, and the ends of the coil are attached to a bakelite support, which in turn plugs into a bakelite socket, thereby making contact. It is adapted to multi-range receivers.

AWARDED THE RADIO NEWS LABORATORIES CERTIFICATE OF MERIT NO. 1799.

REPRODUCING UNIT

The "Dulce-Tone" shown, submitted by the General Industries Co., Elyria, Ohio, is an electromagnetic reproducing unit for use with a victrola or gramophone. The unit is placed on the turntable of the talking machine, and the stylus is inserted in the groove of the record in its center. The end of the cord is attached to the output of the receiving set. Adjustment of the unit can be made by turning the knurled nut projecting from its base.



AWARDED THE RADIO NEWS LABORATORIES CERTIFICATE OF MERIT NO. 1801.

"B" POWER UNIT

The "Auto" "B" power unit shown, submitted by the Auto Vacuum Product Co., 220 West 42nd St., New York City, N. Y., is of the electrolytic type and operates from 110-volt alternating current, 60-cycle. The current output at 90 volts is sufficient to operate a 7-tube receiver.



AWARDED THE RADIO NEWS LABORATORIES CERTIFICATE OF MERIT NO. 1802.

VIBRATION ELIMINATOR

The tube vibration eliminator shown, submitted by the Washburn



Mfg. Co., Kokomo, Ind., is of thick lead in hemispherical shape. When fitted on top of the tube, it stops all microphonic noises. These caps

are made in various sizes, so that they can be used with either storage-battery or dry-cell tubes.

AWARDED THE RADIO NEWS LABORATORIES CERTIFICATE OF MERIT NO. 1803.

CONE LOUD SPEAKER

The "Sonochorde" loud speaker shown, submitted by the Boudette Manufacturing Co., Chelsea, Mass., is of the free-edge cone type. The edge is protected from injury by a metal rim. The unit is of special

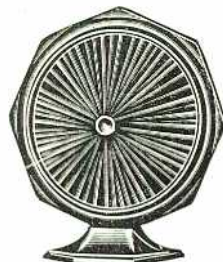

construction, adjustment being made by a shaft projecting through the silk front and in turn shifting the armature by lever arrangements. The speaker gives very good volume and reproduces both speech and music very efficiently.

AWARDED THE RADIO NEWS LABORATORIES CERTIFICATE OF MERIT NO. 1731.

LOUD SPEAKERS

The "Stevens" loud speaker Model A, submitted by Stevens and Company, 46 East Houston St., New York City, N. Y., has a free-edge cone, made of specially-treated cloth. The speaker is so constructed that it can be either mounted on a table or hung on the wall; it gives good volume and the reproduction of speech and music is fair.

AWARDED THE RADIO NEWS LABORATORIES CERTIFICATE OF MERIT NO. 1783.



The "Stevens" loud speaker (Model B shown) submitted by Stevens and Company, is similar to their Model A, except that its size is larger and it uses a different unit. The main feature of the unit is that a special tension arrangement is used to suspend the armature, so that very close adjustment can be had. The reproduction is very good, giving almost even volume on all frequencies of the musical scale.

AWARDED THE RADIO NEWS LABORATORIES CERTIFICATE OF MERIT NO. 1784.

POWER UNIT

The "S O S" power unit shown, submitted by the E. H. Wilson Mfg. Co., Moline, Ill., is a combination of a storage battery and a charger which uses a tungar bulb for rectification. The unit has two charging

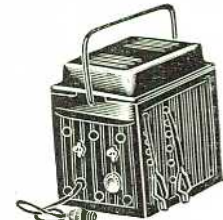

rates; half an ampere when giving the battery a "trickle" charge and two amperes when giving an ordinary charge. The compartment containing the charger is provided with holes so as to allow a free circulation of air.

AWARDED THE RADIO NEWS LABORATORIES CERTIFICATE OF MERIT NO. 1817.



The Radio Amateur

Containing a few facts of interest to would-be "hams"—those on the outside, looking wistfully in

By G. C. B. ROWE

RECENTLY one of our friends, in the course of a conversation on radio, made the inquiry, "Just what is an amateur?" We told him that Webster could define the species much better than we could; so he took our advice and this is what we were told Webster said, in part: that an amateur is one who practices an art or occupation for the love of it, not as a profession. Our friend then said to us:

"If that's the case, then do you mean that those fifteen thousand amateurs in this country own the five million receiving sets you were just speaking of?"

We saw that Webster had mixed up our friend; so we explained that there is a wide difference between the "ham" and the B.C.L. (broadcast listener). Strictly speaking a radio amateur, or "ham," is a person who, *for the love of the art alone*, owns and operates a code or 'phone transmitting and receiving station, with the emphasis on the transmitting. Anyone in this country who so desires may install in his home a radio receiving set, but it is a far different matter when it comes to the installation of a transmitter. There Uncle Sam steps in and enforces certain laws, of which we shall tell anon.

There are naturally several questions that may arise, in the lay mind, concerning the radio amateur. For instance, "What does

the amateur really do? Of what does his work consist? What benefit does he gain from it?" and so on *ad infinitum*. Let us take these questions in their order and try to ascertain what this is all about.

WHAT HAMS HAVE DONE

It has been said that the radio amateur is responsible for the present state of development of the radio industry and art. This is rather a sweeping statement and, perhaps, detracts some of the credit from those to whom it is due; but there is no doubt whatsoever that these "Knights of the Key" have done a great deal in "selling" radio to the public in general.

Back around 1905 and 1906, radio was just beginning to be thought about in a serious way by people as something more than a scientific toy. There were men—young and old—who gave long hours of grave consideration to the possibilities there were in this communication without wires. It was about this time that the amateurs broke out with aerials on their roofs—that disease that is now world-wide. In tinkering with the crude apparatus of the day they, being of the quick-thinking type of man—or they would not have been in the game—naturally saw where this or that could be improved; and then they went right along and improved it. Little by little more and more people became interested in those "unusual sounds

in a pair of head-phones" and, as more men became radio enthusiasts, more advancements in the art were made.

Today there are approximately fifteen thousand men—and quite a few women for that matter too—who are licensed to operate amateur stations in this country. That is a far cry from the handful that started out in the game about twenty years ago but, just as the numbers have increased, so have the various developments and scope of the work. In the old days it was a rare feat to pick up a station five miles away. What is the present-day record? Anywhere on the face of the globe. There are amateurs in every large city in the United States who think nothing of "working" Europe, Australia, and almost any other country that you can name.

WHAT THEY DO NOW

Let us consider the second question, that concerning the work of the amateur. The transmission and the relaying of messages is not *work* in its generally accepted sense to him; rather it is a pleasure. When someone knocks at the "shack" door and asks if he won't send a message to someone perhaps thousands of miles distant, the complying with that request is gratifying to him; for it gives him that feeling of being someone in the community who is really doing a good job. And it *is* a good job that these fellows do, without any thing more than "Thank you;" for no amateur ever accepts payment for any messages that he delivers or receives.

Then there is the experimenting that is continually being undertaken. It is rather difficult to think of any other group of men, interested in the same hobby, who are so willing to aid each other in their experimenting. There is a certain *camaraderie* and good-fellowship among the amateurs, which it is a pleasure to observe and it is due almost entirely to the *esprit de corps*, if we may call it so, that exists.

That the radio amateurs are worthy of their place in the sun is evidenced by the really great work that they have done in the time of emergencies. Take, for instance, the hurricane that swept the Florida coast last fall. Did you not read in the newspapers how the first real news of the catastrophe came through to the rest of the country by way of a radio amateur's transmitting outfit? And did you read how he worked for hours on end sending messages for help and word to friends and relatives of those who were in the storm's path? That is the sort of thing we mean by their good work in times of general emergency.

Now what good does all this do the amateur? As far as we can ascertain, one of the best methods for enlarging one's knowledge is the exchange of ideas. We know of no better way of doing this than
(Continued on page 1020)

イ	ウ	ス	W
ロ	キ	ン	X
ハ	ノ		Y
ニ	オ	一	Z
ホ	ク	ニ	
ヘ	ヤ	三	1
ト	マ	四	2
チ	ケ	五	3
リ	フ	六	4
ヌ	コ	七	5
ル	エ	八	6
ヲ	テ	九	7
ワ	ア	〇	8
カ	サ		9
ヨ	キ		〇
タ	ユ	(濁点)	
レ	メ	(終止)	
ソ	ミ	(長音)	
ツ	シ	(短音)	
ネ	エ	(新置)	
ナ	ヒ	(格納)	
ラ	モ		
ム	セ		
			A
			B
			C
			D
			E
			F
			G
			H
			I
			J
			K
			L
			M
			N
			O
			P
			Q
			R
			S
			T
			U
			V
			()
			危急信號

It is a much easier task to learn the Continental code—on the right—than that used by Japanese amateurs, on the left. And the Japanese use both skillfully as a rule.



Conducted by Joseph Bernsley

THIS Department is conducted for the benefit of our Radio Experimenters. We shall be glad to answer here questions for the benefit of all, but we can publish only such matter as is of sufficient interest to all.

1. This Department cannot answer more than three questions for each correspondent. Please make these questions brief.
2. Only one side of the sheet should be written upon; all matter should be typewritten or else written in ink. No attention paid to penciled matter.
3. Sketches, diagrams, etc., must be on separate sheets. This Department does not answer questions by mail free of charge.
4. Our Editors will be glad to answer any letter, at the rate of 25c. for each question. If, however, questions entail considerable research work, intricate calculations, patent research, etc., a special charge will be made. Before we answer such questions, correspondents will be informed as to the price charge.

Mr. Bernsley answers radio questions from WRNY every Thursday at 8:15 P. M.

SAMSON DUAL TC RECEIVER

(Q. 2201) Mr. Martin, Jersey City, N. J. asks:

Q. 1. Can you furnish me with the complete schematic wiring diagram of the Samson Dual T.C. receiver and all other details such as coil construction, list of parts, etc? This will be of help to me when constructing this set, and for this information I will be greatly indebted.

A. 1. The Samson Dual T.C. circuit has been previously described in *RADIO NEWS*; but since then a later factory model has become available. The following are the specifications and description of that particular model. Incidentally, this model when tested in *RADIO NEWS* Laboratories performed unusually well, giving much more volume than is usually obtained from five-tube receivers. The quality also was excellent and extremely pleasing to the ear. This is undoubtedly due to the special type of audio amplifier incorporated in the receiver, which uses the new Donle system of audio amplification.

The receiver consists of one stage neutralized R.F., a regenerative detector with variable coupling on the input R.F. transformer (one unit

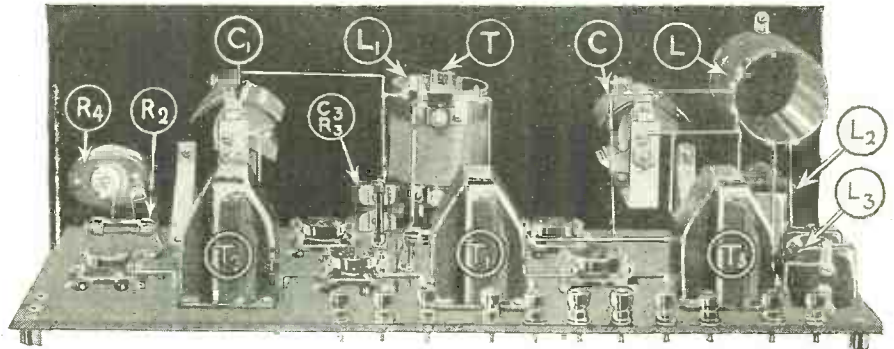

(Q. 2201). A top view of the Samson Dual T.C. receiver. A power tube is employed in the last audio stage to enhance the quality of reproduction obtained. A 500,000-ohm variable resistance to obtain volume control is also incorporated, and is indicated as R-4 in this view.

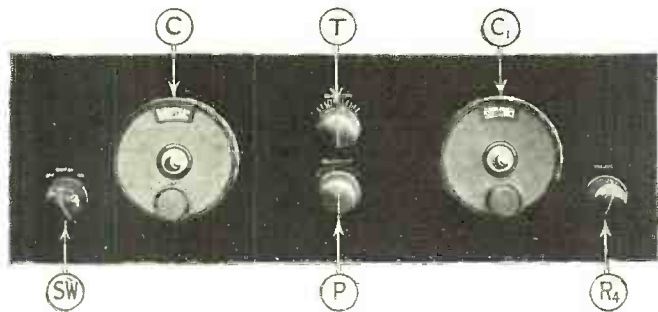

The panel view of the Dual T.C. receiver shows a neat and symmetrical appearance. The knob T controls the tickler, shown above; the knob P the primary, which is similarly wound on a rotatable form and may be varied in its relationship to the secondary. This primary knob on this receiver is marked "selectivity."

composing three coils) one stage transformer-coupled and two of dual-impedance A.F.)

The following are the list of parts employed in the construction of the set.

- 2 Variable condensers, .0005-mf. (C and C1);
- 1 Neutralizing condenser, adjustable (C2);
- 1 Fixed grid condenser, .0005-mf. (C3);
- 1 Fixed condenser, .001-mf. (C4);
- 1 Fixed condenser, .0001-mf. (C5);
- 1 Aerial coupler (L);
- 1 Double-rotor coupler (L1);
- 2 Radio-frequency chokes, 85-M.H. (L2, L3);
- 2 Dual impedances (T1, T2);
- 1 Audio-Frequency Transformer, low-ratio (T3);
- 3 Automatic filament controls, 5-v. 1/4-amp. (R1, R2);
- 1 Grid leak, 9-meg. (R3);
- 1 Volume control, 500,000-ohm max. (R4);
- 5 Sockets, UX type;
- 1 Battery switch (SW);
- 2 Tip jacks (L.S.);
- 2 Vernier dials;
- 11 Binding posts;

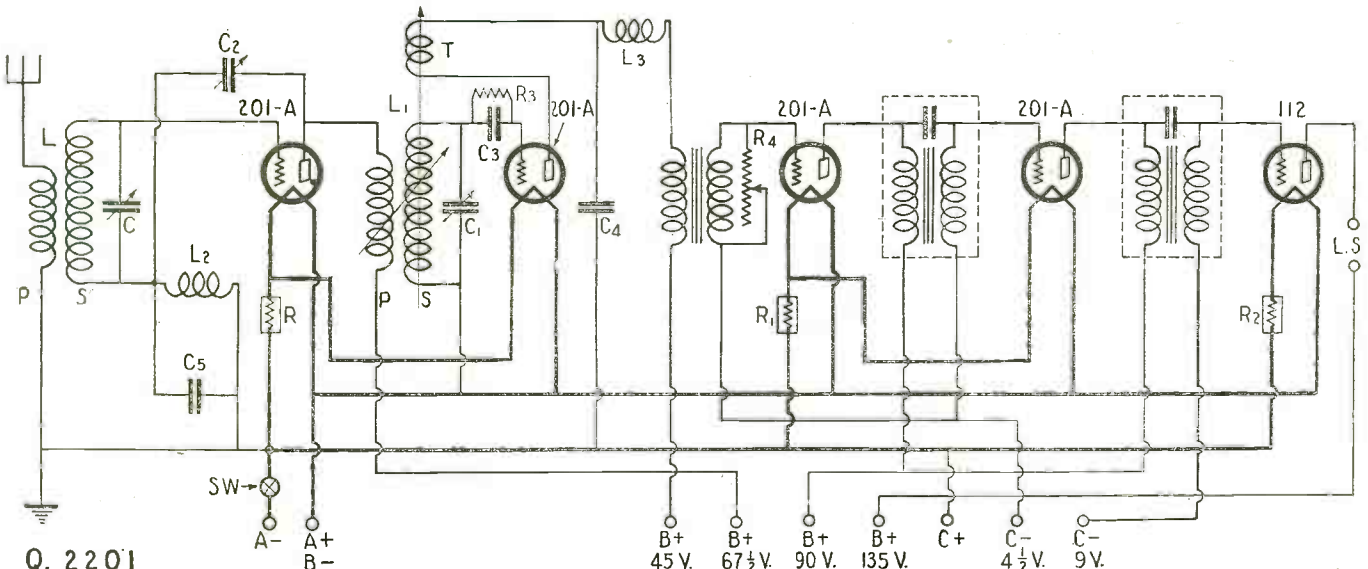

Q. 2201

The circuit employed followed in the wiring of the Samson Dual T.C. receiver consists of a stage of neutralized R.F. amplification, a regenerative detector, one stage of transformer coupled audio frequency amplification and two stages of a new, improved type of audio amplifier.

SHORT-WAVE SUPERHETERODYNE RECEIVER

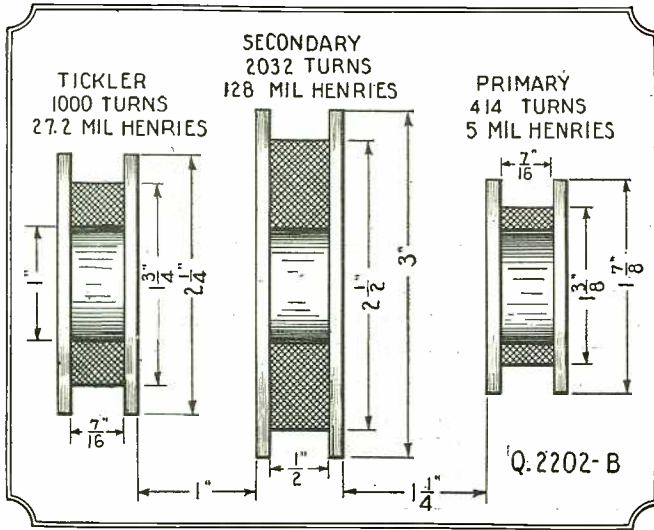

Here are the details and specifications for the construction of the various coil windings employed in the filter transformer for the short-wave superheterodyne receiver. The distinctive feature of this filter transformer is the third, or tickler, winding which is employed for obtaining regeneration in the detector stage. By means of this it is possible to obtain continuous-wave reception. This transformer has a very sharp characteristic at about 22 kc., which is the intermediate frequency used in this superheterodyne.

(Q. 2202) Mr. L. Jenkins, Peoria, Ill., inquires as follows:

Q. 1. I am contemplating constructing a short-wave receiver which will prove to be the "ultimate thing" in short-wave reception. I think a short-wave superheterodyne set would do the trick, if I could get the correct constants. Can you furnish me with the design data of the various coils necessary, schematic wiring diagram, etc.?

A very efficient short-wave superhet. set has been designed by George J. L. Eltz, Jr. and published in the Proceedings of the Radio Club of America. The following is the description:

"The reception of short-wave radio signals, both telephone and telegraph, has been almost universally accomplished by means of the single-circuit regenerative receiver. This type of receiver, while it has been practically abandoned for the reception of longer wavelengths, is excellent in operation on about 3000 K.C. (wavelengths of 100 meters, or under). Indeed, so well has the single-circuit receiver operated that perhaps sufficient attention has not been given to other methods of reception. With this thought in mind, Mr. Eltz decided to investigate the possibilities of the superheterodyne method of reception and, as a result, the receiver described was evolved. The receiver was constructed and first operated in October, 1925.

"The ordinary 'super' used for broadcast reception has two tunings: first, the loop or antenna circuit and second, the oscillator circuit. This short wave 'super' has only one tuning arrangement, in which is combined both the tuning opera-

- 1 Panel, 7x21x3/16-inch;
- 1 Baseboard, 9x20x1/4-inch;
- 2 Brackets.

The receiver is, from an electrical viewpoint, very carefully designed. For example, in the tuned-R.F. stage neutralization is provided for and made easy by the correct placement of the R.F. choke coil, L₂, in the grid-return lead of this stage. In the detector stage there is incorporated regeneration controlled by means of a rotor or "tickler" coil. Any stray R.F. currents are kept out of the audio amplifier by means of another R.F. choke coil, L₃. The volume of the receiver is controlled by a variable resistance, R₄. This particular method of volume control is much more effective and efficient than employing filament rheostats and reducing volume by reducing the filament temperature of the tube; since the tonal quality is not in any way altered by the first method. The first A.F. stage is of the conventional transformer-coupled type; the last two of the dual-impedance type, and these stages are largely responsible for the excellent quality obtained. Automatic resistors are employed for filament control, throughout the receiver.

In its adjustment, the only essential control is the small balancing condenser, C₂, which should be used only after the shortest wavelength station possible is tuned in. The condenser should then be rotated until all oscillations (or "whistles and squeals," as most laymen describe them) are eliminated. This process should be performed only when the rotor or tickler coil, T, is at right angles to the secondary coil.

The constructional data of the coils employed in this receiver are as follows:

Coil Specifications

Aerial coil, L₁: tube 2 1/2 inches in diameter, 3 3/4 inches long; primary 18 turns of No. 26 D.C.C.; secondary 54 turns of the same-sized wire.

Double-rotor coupler, L₁: tube 2 1/2 inches in diameter, 3 1/2 inches long; primary (lower rotor, P), 40 turns of No. 28 D.C.C.; secondary, S, 54

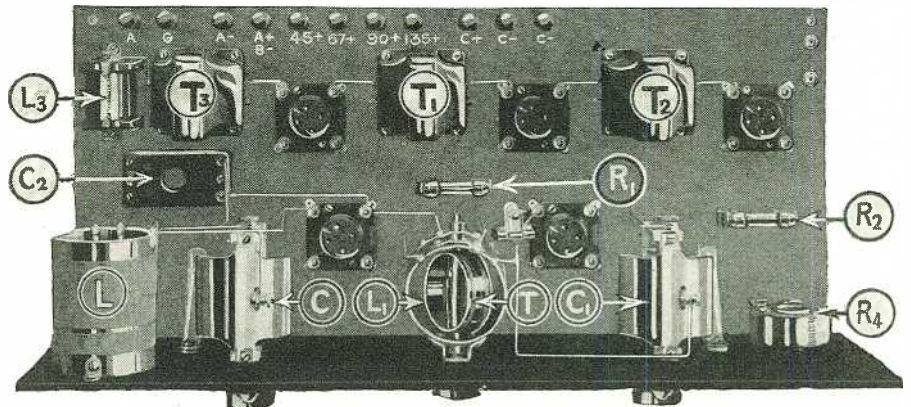

(Q. 2201). Another interior view of the Samson T.C. receiver, showing clearly the layout of the parts, designated in the other illustrations and list of apparatus.

turns of No. 26 D.C.C.; tickler (upper rotor, T') 16 turns of No. 28 D.C.C. The primary of this unit is wound on a rotor coil, as well as the tickler, in order that coupling between primary and secondary windings may be varied at will; which permits a variation in the selectivity-and-sensitivity factor.

tions indicated above. This method of tuning was selected because of its simplicity and because it makes possible the construction of what is practically a single-control set.

(Continued on page 1028)

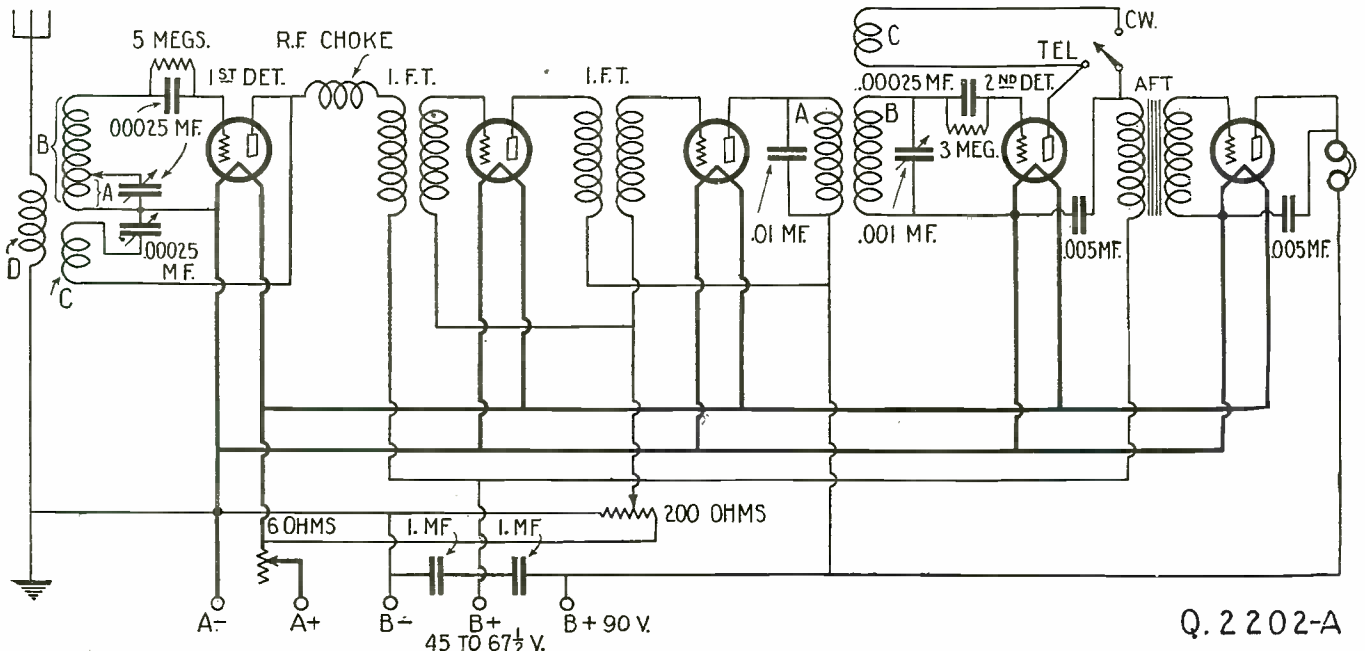

Q. 2202-A

The schematic wiring diagram of the Short-Wave Superheterodyne receiver. The following features are incorporated in the set: detector and oscillator functions are accomplished by one tube, the "autodyne" principle being employed; a regenerative second detector, with a short-circuiting switch so that this feature may be eliminated at will, permits either C.W. or phone reception.

Hermetically Sealed!

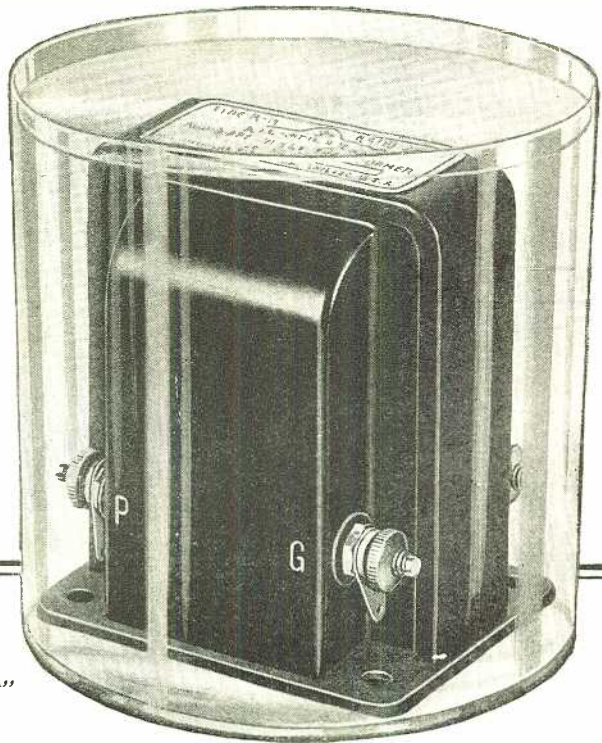

The "30-day water test"

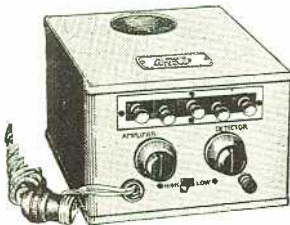

The last word
in socket power

ALL-AMERICAN
TRADE MARK
Battery Eliminator

Attach it to the nearest light socket and you have a dependable, unvarying supply of uniform plate current. Five taps of different voltages, a Detector control, and a High-Low switch provide absolute control of voltage for any requirement. Compact, handsome; and the name All-American is your guarantee of the utmost in quality.

Price \$37.50

Complete with Raytheon Tube



New 1927
Radio Key Book

You'll enjoy reading it—48 pages of interesting, up-to-the-minute facts about radio, simply told. Also full construction details of all leading types of circuits. Send 10 cents (coin or stamps) to cover postage and mailing cost.



ALL-AMERICAN AUDIO TRANSFORMER

After being submerged in water for more than a month, this All-American Audio Transformer performed *perfectly*.

Every All-American Audio Transformer is *hermetically sealed*; preventing any chance of break-down from rust or electrolysis. Delicate wiring and all other vital parts are permanently protected against every possible climatic condition, by the moisture-proof sealing compound which fills the heavy steel shell.

No matter where you live—in dry altitudes or in the tropics' salt humidity—you'll get good results with this fine product. It is compact, attractive; with binding posts conveniently arranged for straight or sub-panel wiring.

Type R-14-3 to 1 } \$4.50
Type R-15-5 to 1 } ea.

ALL-AMERICAN RADIO CORPORATION

4209 Belmont Avenue, Chicago, U. S. A.

All-American Radio, Ltd., Toronto, Canada

Station WENR (266 Meters) is Owned and Operated by All-American Radio Corporation



ONLY
\$24.75
COMPLETE

150 VOLT

Why should you pay \$35 to \$50 for a "B" Eliminator when you can get, for only \$24.75, the

150 Volt WARREN "B" Supply

—The most efficient type of eliminator because it delivers more current per volt; one that does away with ALL "B" batteries and gives constant, unvarying power to any set up to 10 tubes using resistance, transformer or impedance coupling; one that will operate power tubes, too.

Warren Superiorities

- 1—150, 90, 67½, 45 and 22½ volt taps give correct voltage with no variable troublesome resistance. Full wave rectification.
- 2—No expensive tubes to burn out. No dangerous acids.
- 3—Costs less than \$1 a year to use.
- 4—Full tone reception without fuss, worry, or "B" Battery replacement expense.
- 5—Easier to hook up than a set of "B's".
- 6—Cannot blow out receiver tubes.
- 7—Needs little more attention than your loud speaker.
- 8—Simple, compact, free from hum.
- 9—Wonderfully well made of finest materials, beautifully finished in old gold. A real quality product at the right price.

Shipped complete ready to plug into light socket and turn on the switch. No extras to buy. 110V., 60 cycle, A. C. Fully approved by leading radio magazines and unconditionally guaranteed to do all claimed or money back. If dealer can't supply, send coupon for immediate shipment. 5½ x8x9 in.; shipping weight, 17 lbs.

WARREN ELECTRIC CO.,
Dept. M, Peoria, Ill.

- Warren Electric Co., Dept. M, Peoria, Illinois.
- Ship at once, express paid, \$24.75 (check enclosed.)
 - Ship at once, C. O. D. for \$24.75, plus slight express charges.
 - Send free literature.

Name

Address

City

State

Dealers—Big Demand for WARREN—get your stock quick.

The Quadraformer VI

(Continued from page 987)

From an inspection of the schematic wiring diagram, it may be seen that provision is made for any type of vacuum tube in the last stage of the audio amplifier. This is done by providing a separate plate lead for the necessary high voltage and also a grid connection, so that the proper grid bias may be applied to the tube. It should also be noted that it is not necessary to use vacuum tubes operating from a storage battery. The 199 type of tube may be employed for the R.F., detector, and first A.F. sockets while a semi-power tube of the same dry-cell type may be used in the last audio-frequency stage.

In passing, it might be well to call the constructor's attention to the new detector tubes that have been put on the market. These tubes use a higher plate voltage than is usual with the old 200 type or the 201-A; in fact, 90 volts is not an excessively high potential to apply to the plate of one of these bulbs. The filament temperature of the "hard" detector tube is not critical; but there is also put out for detector use a gaseous-content tube in which the adjustment of the filament current must be made very carefully or else the operation of the tube will not be satisfactory. This tube does not re-

quire a high plate voltage, working well on 22½ volts.

BALANCING THE RECEIVER

After the receiver has been constructed and all connections have been correctly made, the set is ready to be balanced.

The trimming condensers, those shunted across the variable condensers that are in parallel with the secondaries of the two R.F. transformers, are adjusted to minimum capacity. This is done by loosening the adjustment screw until it is quite loose. A broadcast station that operates around 360 meters is then tuned in, as follows:

The right-hand dial is set somewhere about 65 and the left-hand dial, which operates the antenna tuning condenser, is rotated about 10 degrees on each side of this figure. If no station is heard, readjust the right-hand dial one or two degrees up or down the scale and follow the same procedure as before with the left-hand dial. Continue this method of tuning until a station is heard, and readjust the dials and rheostats until it comes in with good volume.

The selectivity control is then turned to No. 1 and if necessary, the antenna tuning condenser is readjusted, until the station is again heard with maximum strength. The volume is then reduced until the signals are just audible.

A wooden screw-driver is then prepared from a piece of dowel stick, the end of which is cut to a chisel point so that it will

SYMBOL	Quantity	NAME OF PART	VALUE OF PART	REMARKS	MANUFACTURER ★
L	1	Ant. Coupler		(special) shielded	1
L1, L2	2	R.F. Trans.		(special) shielded	1
T	1	A.F. Trans.	3½ to 1		2 11, 14, 15, 16, 17, 18, 40, 41
C	1	Var. Cond.	.0005 Mf.		3 2, 8, 15, 16, 17, 19, 42
C1	1	" "	.0005 Mf.	Tandem	3 8, 16, 17, 19, 42
C2, C3	2	" "	1.8-20 Mmf.	Neutralizing	4 20, 21
C4	1	Fixed Cond.	.5 Mf.	By-pass	5 20, 22, 23, 24, 25, 26, 27
C5	1	" "	.01 Mf.	" "	5 23, 22, 23, 24, 25, 26, 27
C6	1	" "	.001 Mf.	" "	5 20, 22, 23, 24, 25, 26, 27
C7	1	" "	.00025 Mf.	Grid condenser	5 20, 22, 23, 24, 25, 26, 27
RC	2	Resis. Couplers	.1or .01 Mf.	With double grid leak mountings	3 6, 20, 24, 25, 26, 39
R	2	Fixed Resistor	.1 Meg.	For resistance couplers	3 6, 20, 24, 25, 26, 39
R1	1	" "	.5 Meg.	" "	3 6, 20, 24, 25, 26, 39
R2	1	" "	.25 Meg.	" "	3 6, 20, 24, 25, 26, 39
R3	1	Grid leak	5 Meg.	With grid leak mounting	6 3, 20, 24, 25, 26, 39
R4	1	Rheo. & Switch	10 Ohms	Midjet type	7
R5, R6	2	Rheostats	10 Ohms	" "	7 3, 20, 24, 25, 26, 39
S	1	Switch	D.P.D.T.		1
S1	1	Switch	S.P.Trif. 7		1
	6	Sockets		UX type	8 3, 16, 17, 42
	11	Binding Posts			4 3, 30, 31
	2	Tip Jacks		For speaker	7 8, 9, 28, 32
	2	Dials		Vernier	10 2, 9, 16, 17, 33, 34
	1	Panel		7" x 22" x 3/16"	11 1, 31, 35
	1	Baseboard		Non-weatherable wood	
	6	Mounting pillars		With nuts	1
	1	Bakelite strip		3/16" x 3/8" x 2"	1
	1	Bakelite strip		3/16" x 3/8" x 10"	1
	1	Bakelite strip		3/16" x 1 1/8" x 3 1/8"	1
	28ft.	Bus bar			12 13, 36, 38
	9ft.	Spaghetti			13 36, 37, 38
		Screws			1
		Lugs			1

NUMBERS IN LAST COLUMN REFER TO CODE NUMBERS BELOW.

10 Gearhart-Schluster Radio Corp.	17 Percent Elec. Co.	33 Kurz-Kasch Co.
20 Carson Electric Co.	18 American Trans. Co.	34 W.F. Loughmen
30 Amco Products, Inc.	19 General Instrument Co.	35 Formica Insulation Co.
40 L. R. Ho. Lutz	20 Leslie F. Wuter Co.	36 Acme Wire Co.
50 Sangamo Elec. Co.	21 Sterling Mfg. Co.	37 Belden Mfg. Co.
60 W. H. Lynch, Inc.	22 Mullier Radio & Cond. Co.	38 Mitchell-Rand Mfg. Co.
70 Carter Radio Co.	23 Tobe Deutchmann Co.	39 International Resis. Co.
80 Allen Mfg. Co.	24 Elctrad, Inc.	40 Ferranti, Inc.
90 Brooklyn Metal Stamping Co.	25 Polymet Mfg. Corp.	41 Jefferson Elec. Mfg. Co.
100 Cornell Elec. Mfg. Co.	26 Serovox Wireless Corp.	42 Silver-Marshall, Inc.
110 American Hard Rub. Co. (Radion)	27 Wireless Specialty Apparatus Co.	
120 Cornish Wire Co. (Cornico)	28 H. C. Frost, Inc.	
130 Alpha Radio Supply	29 Central Radio Labs.	
140 Thorlanson Elec. Mfg. Co.	30 Waterbury Button Co.	
150 All American Radio Corp.	31 Insulating Co. of Amer. (Insul)	
160 Bremer-Tilly Mfg. Co.	32 Union Radio Corp.	

APPROXIMATE COST OF PARTS \$ 51.00

★ THE FIGURES IN THE FIRST COLUMN OF MANUFACTURERS INDICATE THE MAKERS OF THE PARTS USED IN THE ORIGINAL EQUIPMENT DESCRIBED HERE.

Form © 1926, E. P. Co.

NOTE TO SET BUILDERS:
If you use other parts than those listed in the first column, take care to allow for any difference in size when laying out and drilling the panel and sub-base.

Silent, permanent radio power from the light socket

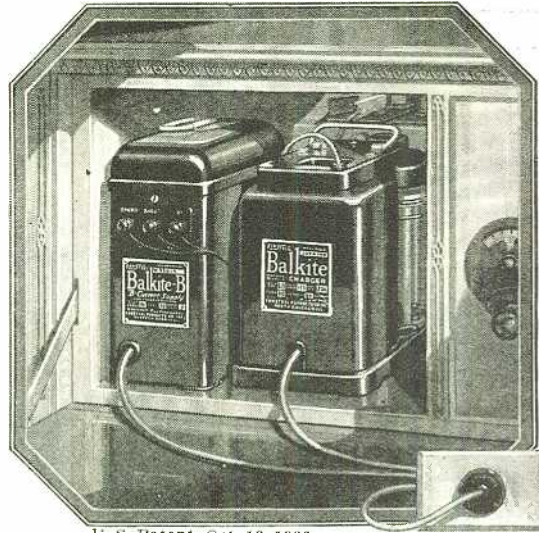

U. S. Patent, Oct. 12, 1926

with Balkite "B" and the Balkite Charger



Balkite Trickle Charger

With 6-volt "A" batteries can be left on continuous or trickle charge thus automatically keeping the battery at full power. With 4-volt batteries can be used as an intermittent charger. Or as a trickle charger if a resistance is added. Charging rate about .5 amper. Price \$10. West of Rockies \$10.50. (In Canada \$15.)

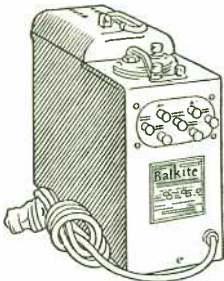

Balkite Combination

When connected to your "A" battery supplies automatic power to both "A" and "B" circuits. Controlled by the filament switch already on your set. Entirely automatic in operation. Will serve any set now using either 4 or 6-volt "A" batteries and requiring not more than 30 milliamperes at 135 volts of "B" current—practically all sets of up to 8 tubes. Price \$59.50. (In Canada \$83.)

All Balkite Radio Power Units operate from 110-120 volt AC current with models for both 60 and 50 cycles. Also 25-40 cycle model Balkite Charger.

Over 650,000 radio sets are now equipped with Balkite Radio Power Units because they provide silent, infallible, permanent power from the light socket. They are noiseless in operation and can be used during reception. They employ no tubes. They have nothing to wear out or replace, and no dials to complicate tuning. They are built to conform with the Underwriters' Standards. They are based on the same Balkite principle now commonly used in railway signaling, hospital lighting and numerous other systems where power must be infallible.

One way of equipping your radio set with Balkite is to add Balkite "B" and the Balkite Charger. Balkite "B" eliminates "B" batteries entirely and supplies "B"

current from the light socket. It is the proved popular "B" power supply. Of the 75,000 now in use, to our knowledge not one has ever worn out. Balkite "B"-W serves sets of 5 tubes or less requiring 67 to 90 volts, Balkite "B"-X sets of up to 135 volts and 8 tubes and Balkite "B"-Y any standard set.

The Balkite Charger, with both high and low charging rates, is a trickle and rapid charger in one. In

effect it makes your "A" battery a light socket "A" power supply. Its high rate provides a ready reserve for heavy duty use.

Add these Balkite Units to your radio set now. Then it will always perform at its best. Ask your dealer. *Fansteel Products Co., Inc., North Chicago, Illinois.*

*The Balkite
Radio Symphony Concerts
with WALTER DAMROSCH
and the New York Symphony*

Every other Saturday Evening a symphony concert. On intervening Saturdays, one of Mr. Damrosch's famous piano recitals on Wagner's great Music Dramas on 13 stations: WFAF, WEEI, WGR, WFI, WCAE, WSAI, WTAM, WWJ, WGN, WCCO, KSD, WDAF, WOC.

*Balkite Hour
SATURDAY EVENINGS
9:30 Eastern (8:30 Central) Standard Time*

Balkite "B"-W \$27.50; "B"-X \$42; "B"-Y \$69; Balkite Charger \$19.50, West of Rockies \$20. In Canada "B"-W \$39; "B"-X \$59.50; "B"-Y \$96; Charger \$27.50.

Balkite Radio Power Units



VICTOREEN

A Super Set Without an Equal!

Build it with
VICTOREEN Parts



VICTOREEN TRANSFORMERS

The Victoreen Super will satisfy your craving for a set that the heart of the Victoreen circuit is found in the four Victoreen R.F. Transformers and the Victoreen Coupling Unit used with them. These units are precision instruments—tuned to a guaranteed precision within 1/3 of 1%—a Victoreen feature. They make the Victoreen a Super Set without an equal.

No. 170 Victoreen R.F. Transformer, \$7.00 each
 No. 160 Victoreen Antenna Coupler, 3.50 each
 No. 150 Victoreen Coupling Unit, 3.50 each
 (For outside aerial only)



VICTOREEN RHEOSTAT

Zero temperature coefficient—resistance remains absolutely constant; double the number of turns of wire used on ordinary rheostats. Three terminals simplify wiring.

Five resistances—2, 6, 10, 20, 30 ohms, \$1.20
 Victoreen Potentiometers—200 and 400 ohm resistances, \$1.50.



VICTOREEN MASTER CONTROL UNITS

A completely assembled unit with one dial reading controlled by a compensator on the Vernier dial which compensates for any difference in the capacities of your condensers within 20 points on the dial. Used in circuits employing two or more condensers of the same capacity. Easy to mount—no change of wiring necessary.

Victoreen Master Control Unit 2 Condenser type, \$19.50. Extra condenser, \$4.50.

**Pioneer Builders of
Super Set Radio Parts**

Send for Folder

The GEO. W. WALKER CO.
 6528 Carnegie Ave. Cleveland, Ohio
 Merchandise of
 Victoreen Radio Parts

fit the adjusting screws on the trimming condensers. With this, turn the adjusting screw of the condenser across the first R.F. transformer all the way in, then back it out two complete turns. The right-hand tuning dial is then adjusted until the loudest signals result. Now slowly screw down the adjusting screw of the second trimming condenser, at the same time listening carefully to the station already tuned in. Leave this trimming condenser adjustment set at the position where the signals come in loudest.

While making these adjustments of the trimming condensers keep the volume of the signals low enough so that the changes in intensity can be easily distinguished.

USE OF THE AMPLITROL

For wavelengths under 400 meters the Amplitrol is kept at position 1. If signals on wavelengths over 400 meters do not seem loud enough, throw the switch over to position 2 and retune the right-hand dial slightly. If the Amplitrol is left on position 2, the receiver may oscillate on wavelengths below 400 meters; this action being regulated by the volume-control rheostat.

THE SELECTIVITY CONTROL

With the selectivity control on the first tap, the tuning of the receiver will be very sharp. The set will be easier to tune at first if the switch is set at the second position; then, if there is interference, change the switch to the first tap and increase the reading of the antenna tuning dial to bring in the station at its best point. Where there is no local interference the set works best on tap No. 1 up to 275 meters; on tap No. 2 up to 500 meters; and on the last tap for extreme distance on the higher wavelengths.

NOTICE TO READERS

A complete set of full sized blueprints for this Quadraformer VI. Receiver may be obtained by sending \$1.25 to the Blueprint Dept., Radio News, 53 Park Place, New York, N. Y., specifying Set No. 10. These blueprints may be placed upon the panel and sub-panel, forming templates for drilling and locating the apparatus, as well as wiring guides.

Combined Power Amplifier and Plate Supply Unit

(Continued from page 961)

which flows through the resistance unit between the "B+45" and "B—" terminals; in other words, that part of the output of the filter which is not passed through the tubes of the set. The "bleed" current decreases considerably as the external load is increased, thereby reducing the change in the over-all load drawn from the Raytheon tube.

Many plate supply units have one or more adjustable resistances whereby the operator can, to a certain degree, maintain the voltage regulation with various loads; but in the great majority of cases these are really unnecessary and are apt to be troublesome in adjustment and microphonic in action, giving rise to disconcerting noises in the output from the set. Accordingly, an enclosed unit containing three wire-wound resistances of the proper value is used for providing the taps of the plate supply. By-pass condensers of 1.0-mf. capacity are connected from the "B+90" and the "B+45" to the "B—" terminals.

to the "B—" terminal. Since the high-potential (+) terminal of the filter is connected through the primary of the output transformer to the plate of this tube, the plate current must pass through this resistance, giving thereby a definite voltage drop across it.

All this is possible, of course, since an independent filament supply is provided for the power-amplifier tube. The grid of this tube is connected through the secondary coil of the input transformer to the "B—" terminal of the plate supply, and is, therefore, biased by the plate current of the tube, which minimizes disturbances due to the fluctuation of over-all voltage. A 1.0-mf. by-pass condenser is used across the biasing resistance. This resistance is sealed, together with another fixed unit (regulating the filament current of the power tube), in an individual container. Thus there are no adjustable controls on the instrument,—a desirable feature.

Because of the relatively low amplification constant of the 171 tube, it is entirely feasible to employ an input transformer having a ratio as high as 1:6. An output transformer is likewise provided for the power amplifier. This is quite desirable in order to keep the rather large plate current of this tube from passing through the loud speaker.

(Continued on page 1058)

THE POWER AMPLIFIER

After considerable study it was found that the power-amplifier tube should be biased by a circuit independent of the other tubes of the radio set. To do this, the filament of the power amplifier tube is connected through a fixed resistance of several thousand ohms

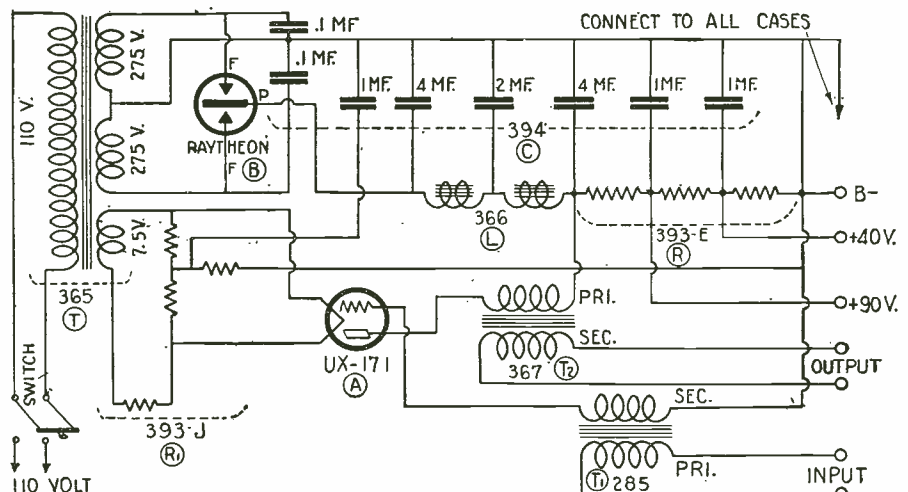

The schematic wiring diagram of the combined "B" battery eliminator and power amplifier. The parts carry the same lettering as in the other illustrations.

**30
DAYS
FREE
TRIAL**

7 Tube Set Single Dial Radio



The Metrodyne

ONLY ONE DIAL TO TUNE

Retail Price
\$75
Completely Assembled
Big Discounts to Agents and Dealers

Wonderful offer direct from the factory! The world's greatest radio. A perfect working, single dial control, 7 tube receiver. And just to prove our claims, we will ship it to your home for **30 days' free trial**. Test it under all conditions. Test it for distance, volume and tonal quality — and if you are not convinced that it is the best single dial set you ever heard, return it to the factory. We don't want your money unless you are completely satisfied.

BIG PROFITS TO AGENTS AND DEALERS
Our Agents and Dealers make big money selling Metrodyne Sets. You can work all or part time. Demonstrate the superiority of Metrodynes right in your home. Metrodyne Radios have no competition. Lowest wholesale prices. Demonstrating set on 30 days' free trial. Greatest money-making opportunity. Send coupon below — or a letter — for our agent's proposition.

Metrodyne Super-Seven Radio

A single dial control, 7 tube, tuned radio frequency set. Approved by America's leading radio engineers. Designed and built by radio experts. Only the highest quality low loss parts are used. Magnificent, two-tone walnut cabinet. Artistically gilded genuine Bakelite panel, nicked piano hinge and cover support. All exposed metal parts are beautifully finished in 24-k gold.

Easiest set to operate. Only one small knob tunes in all stations. The dial is electrically lighted so that you can log stations in the dark. The volume control regulates the reception from a faint whisper to thunderous volume, 1,000 to 3,000 miles on loud speaker! The Metrodyne Super-Seven is a beautiful and efficient receiver, and we are so sure that you will be delighted with it, that we make this liberal **30 days' free trial offer**. You to be the judge.

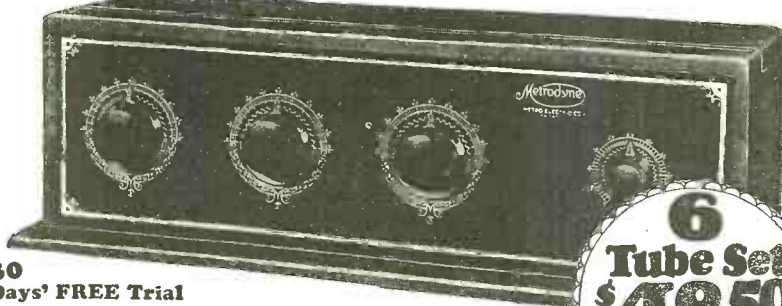

30 Days' FREE Trial
Metrodyne Super-Six

Another triumph in radio. Here's the new 1927 model Metrodyne 6 tube long distance tuned radio frequency receiving set. Approved by leading radio engineers of America. Highest grade low loss parts, completely assembled in a beautiful walnut cabinet. Easy to operate. Dials easily logged. Tune in your favorite station instantly on same dial readings every time. No guessing.

Mr. Howard, of Chicago, said: "While five Chicago broadcasting stations were on the air I tuned in seventeen out-of-town stations, including New York and San Francisco, on my loud speaker horn, very loud and clear, as though they were all in Chicago."

We are one of the pioneers of radio. The success of Metrodyne sets is due to our liberal **30 days' free trial offer**, which gives you the opportunity of trying before buying.

6 Tube Set
\$48.50
RETAIL PRICE
Completely Assembled

MAIL THIS COUPON
or send a postal or letter. Get our proposition before buying a radio. Deal direct with manufacturer — **Save Money.**

Mail COUPON Below!

Let us send you proof of Metrodyne quality

F. L. Warnock, Greentown, Ind., writes: "I received the Metrodyne in good shape and am more than pleased with it. Got stations 2,000 miles away."

C. J. Walker, Mariposa, Calif., writes: "Received my Metrodyne Single Dial set O. K. I believe that these one-dial sets are going to be excellent sellers. I had no trouble in tuning in stations enough to satisfy anyone, so you will please send me another set."

Roy Bloch, San Francisco, Calif., writes: "Very often we travel from New York to the Hawaiian Islands quickly — from station to station — by means of the little tuning-knob which operates the electrically-lighted dial. The Metrodyne Single Dial Set is much easier to operate than any radio set I've ever seen."

We will send you hundreds of similar letters from owners who acclaim the Metrodyne as the greatest radio set in the world. A postal, letter or the coupon brings complete information, testimonials, wholesale prices, and our liberal **30 days' free trial offer**.

METRO ELECTRIC COMPANY
2161-71 N. California Ave., Dept. 102
Chicago, Illinois

Gentlemen: Send me full particulars about Metrodyne 6 tube and 7 tube sets and your **30 days' free trial offer**

Name _____
Address _____

If you are interested in AGENT'S proposition, place an "X" in the square

METRO ELECTRIC COMPANY
2161-71 N. California Ave. • Dept. 102 • Chicago, Illinois

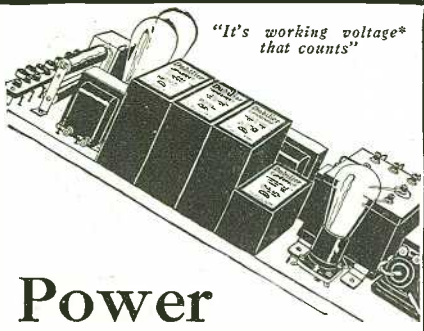

Power amplification has amazed the world

The amazing results obtained with power amplifiers is the radio sensation of the year. Perfect tone quality and the capacity to handle the full-volume of a brass band without distortion, has made power amplification the "last word" in radio.

You, too, can enjoy all these advantages even with your old set, and at a minimum cost, by building a power amplifier with Dubilier Condensers.

Dubilier Condenser Type 903, illustrated, is designed to withstand the high voltage surges which often occur in the filter circuits of power amplifiers. In fact all Dubilier Condensers are built with this high margin of safety, and with an indicated *working voltage** that insures a long life in continuous operation.

Send 10c. for our booklet "Seventeen Ways to Improve Your Set." It gives the most recent information on power amplifiers, filters and battery eliminators.



*Working voltage means more than "test voltage." It is the voltage at which a condenser may be safely used in continuous operation.

Dubilier

CONDENSER CORPORATION

4377 BRONX BLVD. NEW YORK, N. Y.

The Radio News Batteryless Receiver

(Continued from page 970)

inductance of the opposed windings of the first choke is such that, with the first con-

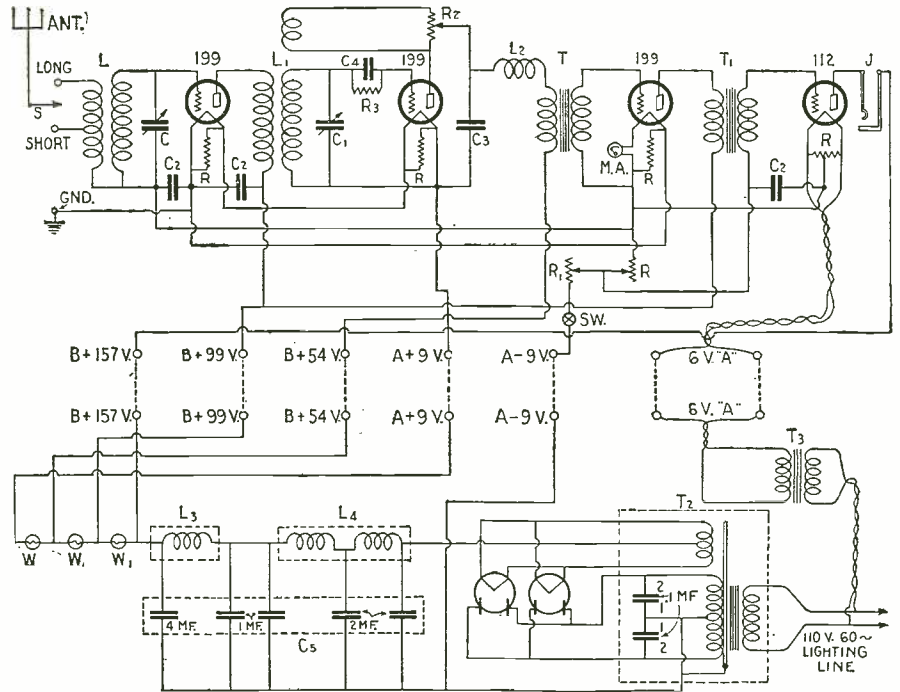

The complete schematic circuit diagram of the RADIO NEWS Batteryless Receiver.

The Aero-Dyne Receiver

(Continued from page 982)

former of very small primary, again giving us only about 2 or 3 per stage. These low gains are not excessively small; they can easily be as poor, and certainly will not show much merit in a commercial receiver.

Now, while it is entirely possible to calculate the point of maximum efficiency, considering our two variables, it is exceedingly difficult to do so because of the great effect of regeneration in any one stage and in combinations of more than one stage. As it is our desire to utilize the tremendous advantages of regeneration in our finished receiver in order to obtain good selectivity and increased amplification, it would be a great error to neglect them in our calculations. This is one of the reasons why it is much more difficult to design accurately and mathematically, a system of this character than it is to design a cascaded bridge-balanced system; the latter need not take into account the regenerative effects, which are supposedly (and more or less completely in practice) neutralized by a balance of the tube capacity, shielding, etc.

TESTING THE CIRCUIT

Therefore, it is necessary, in the laboratory, to set up an experimental system which simulates a tentative design of our completed receiver, and by manipulating the two variables (energy transfer in the transformer, and tube characteristics) determine the maximum point of effectiveness for any particular layout. The experimental set-up is shown in the diagram, Fig. 1. Here we have a two-stage radio-frequency amplifier, working with average 201A-type tubes and with tuned circuits of the best practical commercial characteristics. The two variable controls are the plate-voltage control (the variable resistance VR in series with the two R.F. plates)

denser, a resonant circuit is obtained practically without resistance at 120 cycles.) The second choke, L4, serves to improve the filtration by pure "brute-force" action. The over-all filtration of the unit is more than ample for adequate receiver operation. The excellence of the filtration will be appreciated only when it is realized that the audio trans-

(Continued on page 1048)

which cuts down the plate voltage by virtue of its IR drop; and the variable primaries on the two R.F. transformers.

Into this system we feed a minute quantity of energy from a local oscillator, tuned to the resonant frequency of the amplifier. This is measured by the familiar current-resistance and attenuation-box method known to all laboratory men and therefore a given, known input is always at hand. The output of the system is measured at the terminals of the detector input circuit by means of a vacuum-tube voltmeter, which measures directly, at radio frequencies, the voltage applied to the detector tube.

Now, having a definite, known, input and

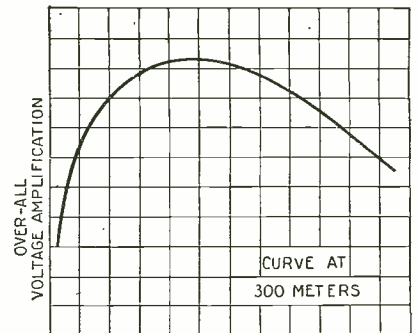

FIG. 2

A curve showing the variation in over-all amplification with the number of primary turns at critical regeneration.



This is the Heavy-Duty Battery in which the new Layerbilt construction provides greater economy

THERE'S an important discovery in radio economy awaiting all users of loud-speaker sets who have been buying the smaller Light-Duty "B" batteries instead of the large Heavy-Duty size required by such sets. Because the Light-Duties cost somewhat less to buy they seem like an economy, but the surprising fact is that the Eveready Layerbilt No. 486 lasts more than twice as long though it does not cost anywhere near twice as much. It is, therefore, much more economical—we believe it to be the most economical "B" battery ever built. Certainly it has proved this by laboratory tests and the service it has given to radio listeners in their own homes during the past eighteen months.

Eveready Layerbilt's remarkable life

is due to its unique construction. All other dry cell "B" batteries are assembled of cylindrical cells, with much waste space between them, and many soldered connections bridging the gaps.

Several years ago we struck boldly out, away from this tradition, seeking a better method. We wanted to avoid waste space, minimize soldering, and get more current and longer life from a given quantity of active materials. The Eveready Layerbilt is the result.

This patented, exclusive battery is built in layers of flat current-producing elements, making automatic connection with each other. Every available inch inside the battery is occupied usefully. You get more battery for your money, and that battery is more efficient.

Remember this about "B" batteries: All loud-speaker sets require Heavy-Duty batteries, and the Eveready Layerbilt has proved time and again to be the longest lasting and most economical Heavy-Duty "B" battery.

Manufactured and guaranteed by
NATIONAL CARBON CO., INC.
 New York San Francisco
 Canadian National Carbon Co., Limited
 Toronto, Ontario

Tuesday night is Eveready Hour Night—
 9 P. M., Eastern Standard Time, through
 the following stations:

- | | |
|------------------|------------------|
| WEAF—New York | WTAM—Cleveland |
| WJAR—Providence | WWJ—Detroit |
| WEEI—Boston | WCN—Chicago |
| WTAG—Worcester | WOC—Davenport |
| WFL—Philadelphia | WCCO—Minneapolis |
| WGR—Buffalo | WCCO—St. Paul |
| WCAE—Pittsburgh | KSD—St. Louis |
| WSAI—Cincinnati | WRC—Washington |

Distan one

"Built By Craftsmen"



No More Batteries!

Simplicity itself—just plug in on your light socket. Two dial control, five tubes. Handsome duo-tone solid walnut console with metal panel artistically decorated in duo-tone effect. Equipped with built-in speaker of great volume and tone clarity. Wonderful selectivity.

List Price Without Tubes

Model E Console with Power Unit \$325.00
Model E Console without Power Unit \$165.00

THE DISTANTONE LINE

In addition to the two models shown here, the Distantone line includes five-tube receivers of two and three dial control and five- and six-tube sets with single dial control, all tuned radio frequency.

DISTRIBUTORS

Write or wire us today for the Distantone proposition.

Distantone Radios, Inc.
Lynbrook, Long Island, N. Y.

TABLE MODEL C \$75
Five Tubes--One Dial

Hand rubbed finished Walnut cabinet. A modern receiver embodying only materials of proven workmanship, accuracy and efficiency. Renowned for long distance and full mellow tone.

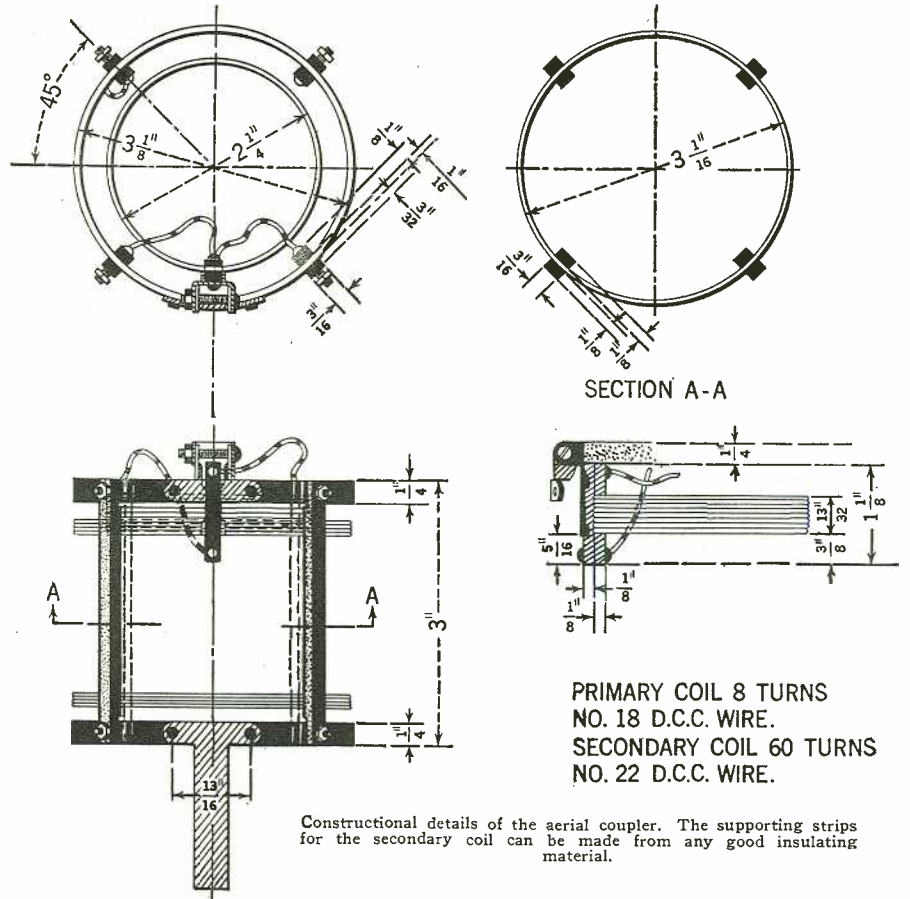
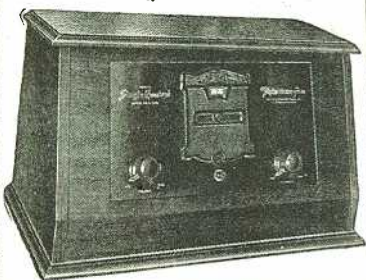

PRIMARY COIL 8 TURNS
NO. 18 D.C.C. WIRE.
SECONDARY COIL 60 TURNS
NO. 22 D.C.C. WIRE.

Constructional details of the aerial coupler. The supporting strips for the secondary coil can be made from any good insulating material.

a definite, known, output, we can readily calculate the gain shown in the system. Naturally, we are after the highest gain, since this will give the loudest signal from a distant station.

It is necessary to have the detector tube connected to the output of the last stage and in operation, although it takes no part in the measurement, because it has some damping effect upon the R.F. circuit immediately preceding it and lowers the oscillation tendency slightly. Some small error would occur if this were not taken into account. In the same sense, the input resistance AR, connected across the primary of the first stage, must simulate the average resistance of the usual receiving antenna so that its effect will be about the same as that antenna when the receiver is giving broadcast operation. This is somewhat more difficult to accomplish; but, because of the variable primary (which is a part of the standard equipment on the completed coils making up the Aero-Dyne kit) its effect may be compensated for in any individual case and thereby counteract any change in the assumed antenna characteristics.

MEASURING THE AMPLIFICATION

With a given, small input, the primary of each interstage R.F. transformer is now varied (both together and equally) and the receiver is adjusted to critical regeneration (just under oscillation) for each setting. The input and output are then noted, and the gain is calculated and plotted on a chart. Varying the primaries from exceedingly small values up to very large, and at the same time, necessarily, varying the plate resistances of the R.F. tubes by means of the resistance VR from low to high, keeping the set adjusted to critical regeneration, gives us a series of points which may be plotted to give the gain curve shown in Fig. 2. The maximum point of this experimentally-determined gain curve is the optimum operating point for the receiver; it is that point whose

characteristics determine the design of the units going to make up the completed radio-frequency transformer.

It is unfortunate that the maximum points of the various sets of curves, taken over the broadcast band from 200 meters up to 550 meters, do not all fall on the same set of characteristics. However, their maxima are not widely different and, if we chose the best compromise for somewhere in the center of the broadcast band, say at about 300 meters, our receiver will maintain its effectiveness at substantially the optimum point well over the band. It is fortunate that these curves are not sharply defined (that is, that they are not extremely peaked) as that condition would necessitate the substitution of a new set of characteristics for each particular wavelength to be received, an obvious impracticability.

COIL DESIGN AND TUBE CONTROLS

A complete discussion of all the factors going together to make up an effective tuned-radio-frequency amplifier system of this character is far too technical to be within the scope of this article. There are many other factors entering into its design, which can only be lightly touched upon, but are also of major importance. The relation of the primary to the secondary inductances (that is, the ratio of their mutual inductances to their self-inductances) is a large item in the success of these systems. Suffice it to say that the primary self-inductance should be as small as possible, in order to retain a given mutual inductance. This means that the primary should preferably be spaced somewhat and distributed over the secondary, (rather than bunched at one end); but not too much so, because of the increase in capacity coupling which such design entails.

In order to avoid confusion, it is perhaps pertinent to remark that there are really two major methods of controlling the internal plate resistance of the amplifier tubes. It may be done, as in this particular case, by reducing the plate voltage on the tubes by

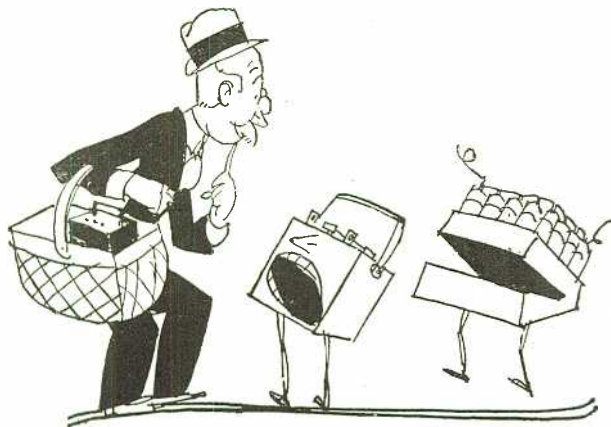

*What's power for "A"
is power for "B"*

—provided, of course, that you use a Rectigon. That's the one best way to keep both "A" and "B" batteries in topnotch form. There's no starving of batteries when you have this home charger to keep them full of pep. And, man alive, the unsuspected power your set shows then! Remember, too, that the bulb used for "B" battery charging is enclosed, like all other parts, in metal, free from harm. And keep in mind that your Rectigon will charge your automobile batteries.

so all batteries are kept lively with

No noise as it charges—not a bit of fuss. Not even a murmur that would disturb the mildest slumber.



No acids, no chemicals—no moving parts—nothing to spill or burn. No muss, no worry. You'll have no spoiled rugs, no ruined clothing.



Saves its cost in short order—Count the dollars spent in a few trips to the service station and you'll hotfoot it for a Rectigon, for the good it does your pocketbook as well as your batteries.



Snaps on in an instant—Just plug into the light socket, snap on the terminals. Saves service station bother. Spares interruptions caused by absent batteries.



Perfect safety for your set—If you tune in while you're charging there'll be no harm either to set or batteries. Nor will batteries be discharged if anything happens to the current while your Rectigon's attached.



*No Storage Battery Radio
is Complete
Without a Rectigon*

The Westinghouse Rectigon Battery Charger

©, 1927, W. E. & M. Co.



THE RECTIGON is a superb Westinghouse product. Things you *can't* see, like extra heavy insulation, things you *can* see, like the durably enameled case—all are of highest quality. Westinghouse also manufactures a complete line of radio instruments, and Micarta panels and tubes.

WESTINGHOUSE ELECTRIC & MANUFACTURING CO.
Tune in on KDKA KYW WBZ KFKX

See the World FREE!



Taste Romance and Adventure In the Far Lands of the Earth

How often you've longed to see for yourself the awe of Egypt's pyramids—the beauties of the gorgeous Mediterranean sunset—the squalor of China's ancient cities!

Spend a few years, or the rest of your life, tasting high adventure on the seven seas and in all the world's great ports—roving the earth's highways and byways! You can do it FREE—all your expenses paid—and earn a good salary besides!

Only one profession will carry you around the world at will, travelling like a gentleman, but that's the most interesting and pleasant work there is—Radio Operating! Easily and quickly learned, there's no other profession like it for the man who wants the experiences and pleasures of world-travel. Radio operators are needed—all sea-going ships like the one shown here must carry from one to half a dozen or more.

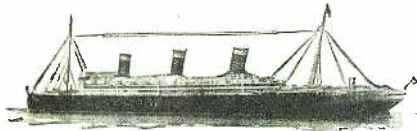

Take a Look Beyond the Skyline Without a Penny's Expense

Radio operators aboard ocean liners live luxuriously—they rank as officers of the ship. Meals, a private cabin, all other living needs are furnished free, and besides the operator draws a good salary. You can learn quickly and easily at home in your spare time to be a Radio operator through our practical training methods. Take a look at the FREE BOOK which tells how—mail coupon below.

This U. S. Government-recognized school has been training successful operators since 1914. Our graduates are all over the world. We maintain an Employment Department to put you on your own ship. The world-famous NATROMETER, our own patented invention, obtainable only by students of this institute, is recognized as the best and easiest way to learn the Radio code. A few short months, with the aid of the famous Natrometer and our quick home training, and you too can be a fully qualified Radio operator, sitting in your cabin like the one shown above, bound out for Liverpool or Nagasaki!

Read the Free Book that tells all about this fascinating profession and our practical Government-recognized methods of training you for it. Send coupon TODAY—no obligation. Special tuition offer now on includes world-famous Natrometer free of extra cost with your course. Act at once.

NATIONAL RADIO INSTITUTE WASHINGTON, D. C.

SPECIAL OFFER COUPON

National Radio Institute,
Dept. BB99, Washington, D. C.
Gentlemen: Without obligating me in any way send me your free book and information about your offer of Natrometer with course.



Name

Address

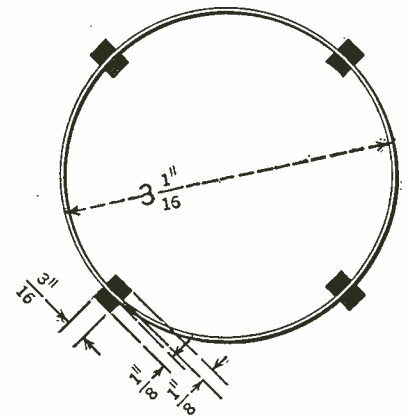
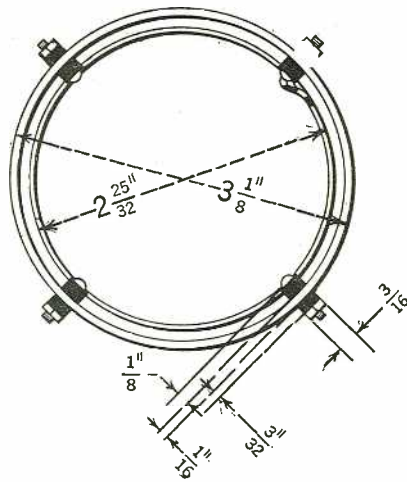

SECTION A-A

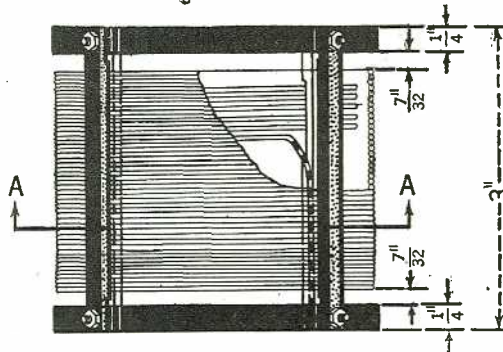

PRIMARY COIL 6 TURNS
NO. 22 D.C.C. WIRE.
SECONDARY COIL 60 TURNS
NO. 22 D.C.C. WIRE.

Constructional details for the two Aero-Coil R.F. transformers. Be sure a good insulating material is employed for the supporting strips. Note that the primary coil is supported inside the secondary.

means of a variable resistance in series with the "B" battery supply; or the filament emission of the R.F. tubes may be reduced by lowering their temperature with the filament rheostat. The systems are parallel and

apparently of equal merit. This analysis may apply to either of the two methods.

PROBLEMS OF REGENERATION

As previously mentioned, the tremendous (Continued on page 1013)

SYMBOL	Quantity	NAME OF PART	VALUE OF PART	REMARKS	MANUFACTURER *
	1	Ant. Coupler			1
	2	R. F. Trans.			1
	2	A. F. Trans.	3 1/2 to 1		2 12, 13, 14, 15, 16, 34
	3	Var. Cond.	.00035 Mf.		3 12, 13, 14, 15, 16, 35
	1	Fixed Cond.	1 Mf.	By-pass	4 17, 18, 19
	1	" "	.00025 Mf.	With grid leak mounting	5 17, 18, 19
	1	" "	.001 Mf.	By-pass	5 4, 17, 18, 19
	1	Grid leak	5 Meg.		6 9, 17, 18, 19, 33
	1	Rheostat	15 Ohms		7 8, 15, 17, 19, 20, 21, 22
	1	" "	20 Ohms		7 8, 15, 17, 19, 20, 21, 22
	1	Var. Resis.	200,000-ohms	Midget type	8 19, 20, 21
	1	Fil. Ballast	1/2 amp.		9 23, 24
	1	Fil. Switch		With Pilot Light	7 8, 25
	2	Jack		Two circuit	7 8, 16, 20
	1	" "		Single open circuit	7 8, 16, 20
	5	Sockets		UX type	10 16, 20, 35
	3	Dials			11 14, 16, 22, 26
	1	Panel		7" x 28" x 3/16"	27 28, 29
	1	Sub-panel		7" x 27" x 3/16"	27 28, 29
	1	Cable plug			7 30
	25ft.	Bus Bar			31 32

NUMBERS IN LAST COLUMN REFER TO CODE NUMBERS BELOW.

1 Aero Prod. Inc.	17 Polymat Mfg. Corp.	33 International Resis. Co.
2 Thordarson Elec. Mfg. Co.	18 Aerovox Wireless Corp.	34 Ferranti, Inc.
3 Allen D. Cardwell Mfg. Co.	19 Electrad, Inc.	35 Silver-Marshall, Inc.
4 Sangamo Elec. Co.	20 H. H. Frost, Inc.	
5 Dubilier Radio & Cond. Co.	21 Central Radio Labs.	
6 A. H. Lynch, Inc.	22 Martin Copeland Co.	
7 Yaxley Mfg. Co.	23 Langbein-Kaufmann Radio Co.	
8 Carter Radio Co.	24 L. S. Brach Mfg. Co.	
9 Daven Radio Corp.	25 Bruno Radio Corp.	
10 Benjamin Elec. Mfg. Co.	26 W. F. Loughman	
11 Kurz-Kashuh Co.	27 Formica Insulation Co.	
12 All American Radio Corp.	28 Amer. Hard Rubber Co.	
13 Karas Elec. Co.	29 Diamond State Fibre Co.	
14 Samson Elec. Co.	30 Howard B. Jones	
15 General Inst. Co.	31 Cornish Wire Co.	
16 Patent Elec. Co.	32 Alpha Radio Supply Co.	

APPROXIMATE COST OF PARTS \$ 44.00

* THE FIGURES IN THE FIRST COLUMN OF MANUFACTURERS INDICATE THE MAKERS OF THE PARTS USED IN THE ORIGINAL EQUIPMENT DESCRIBED HERE.

SM

Leading



- 220 Audio Transformer\$6.00
- 221 Output Transformer 6.00
- 330 Power Transformer 6.00
- 329 Power Transformer 6.00
- 331 Unichoke 6.00
- 332 Condenser Bank10.00

S-M audio transformers, output transformers, coils or power units have been selected for the following receivers — and in many form the basis of the design. In this list are included the most popular recent designs.

- Infradyne (Improved model)
- Shielded Six
- Silver-Cockaday
- Best's A.C. Browning-Drake
- Best's A.C. Diamond of the Air
- Radio News Batteryless Receiver
- Radio Broadcast Super
- Radio Age Super
- Radio Broadcast Local
- LC-27 Junior Power Pack
- Citizens Call Book Monotone Receiver
- Call Book Power Pack
- Callies Super
- Radio Mechanics "A", "B", and "C" Eliminator
- Radio Engineering "A", "B" and "C" Eliminator
- Radio Mechanics Man-O-War Super
- Lincoln Super
- Best's Short Wave Set
- Hush-Hush II Short Wave Set
- Popular Mechanics Super
- Christian Science Monitor 6 Tube Browning-Drake
- Radio Engineering Short Wave Set
- New York Sun "B" and "C" Eliminator for Resistance Amplifier
- Chicago American Short Wave Set
- Chicago Post Power Amplifier
- Best's new Super
- Radio News Power Amplifier
- Loftin-White
- Popular Radio Town and Country Receiver
- Radio News Super

With the advent of A.C. operated, batteryless receivers, a demand for power equipment technically right has arisen almost overnight. Is it surprising, therefore, to find Gerald M. Best building all of RADIO'S A.C. operated receivers around S-M power equipment? RADIO ENGINEERING and RADIO MECHANICS, designing the first power supply to entirely replace all batteries on sets using 201-A's and power tubes, selected S-M power units as the ones best suited to this most rigorous of requirements. The RADIO NEWS batteryless receiver, a complete A.C. operated set, was, of course, built around S-M power units.

Do you realize that in this new field every important completely A.C. operated receiver power supply has been designed with S-M units as a basis—that they have led others by a wide margin?

S-M audio transformers will be found in more of this season's receiver designs than any others. Why? Because the measurements of independent testing laboratories everywhere prove them to be superior—because out of many thousands sold on a free trial basis, less than one out of every four thousand has returned to the factory for a refund—because every mail brings an unprecedented volume of enthusiastic testimonials—because the employees of the largest communication laboratories in the world buy more S-M audios than any other types.

It is the same story with minor variations for S-M condensers, S-M plug-in coils introduced in England less than a year ago, revolutionized English inductance design, and have been copied by every important English manufacturer.

It is facts like these, coupled with the S-M reputation for standing squarely behind every item produced, that have accounted for the unprecedented popularity of S-M products since the first item was offered less than two and one-half years ago.

It is facts like these that assure you that you cannot make a mistake when you use S-M parts, for you simply follow the lead of prominent magazine laboratories, experienced research engineers, seasoned experimenters, who have all found in S-M products the parts they themselves would have designed for their own use.

Do You Know the Secret of Quality Reproduction?

Have you your copy of "The Secret of Quality?" It tells you simply how to get the most out of your audio amplifier—how to get real quality. It contains laboratory data never before available even to many manufacturers. It is the only authoritative treatise on all types of audio amplification written in non-technical language ever published.

It's free! Ask your dealer for a copy.

Prices 10% higher west of the Rockies.

SILVER-MARSHALL, Inc.
848 West Jackson Blvd., Chicago, U.S.A.

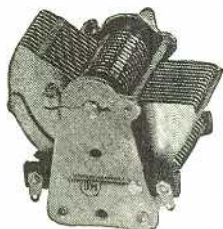

316-A and 316-B Variable Condensers, .00035 \$4.50

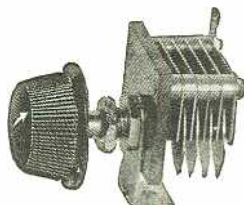

340 Balancing Condenser \$1.50

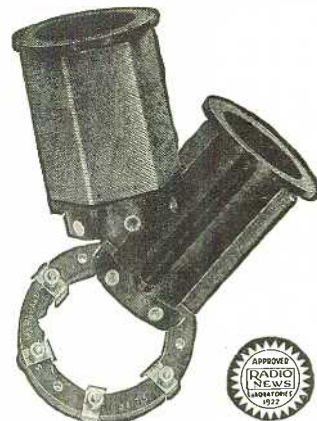

S-M Plug-in inductances, made in various types and ranges. \$2.25
Universal Coil Socket 1.00

The Radio News Batteryless Receiver

ELECTRAD

"Signals That Satisfy" result from the use of
ELECTRAD Royalty Variable Resistances

To the experimenter, the set builder, the radio engineer or the manufacturer—ROYALTY VARIABLE RESISTANCES are indispensable. They have learned to depend on them because of their unquestioned merit, their superior mechanical construction and their high electrical efficiency.

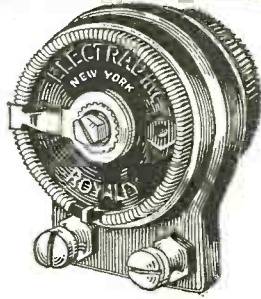

Exclusively licensed by Technidyne Corporation under U. S. Patent 1593658, July 27, 1926.

A Range for Every Purpose

- | | |
|-------------------------------------|-------------------------------------------------|
| Type A—1-10 to 7 megohms. | Type E—Compensator, 500,000 ohms Potentiometer. |
| Type B—1500 to 100,000 ohms. | Type F—0 to 2,000 ohms. |
| Type C—500 to 50,000 ohms. | Type G—0 to 10,000 ohms. |
| Type D—10,000 to 700,000 ohms. | Type H—0 to 25,000 ohms. |
| (Detector control for B Eliminator) | Type J—0 to 200,000 ohms. |
| | Type K—0 to 5,000 ohms. |
| | Type L—0 to 500,000 ohms. |

List Price Type \$2.00—All Other Types \$1.50

ELECTRAD By-Pass and Filter Condensers

Preferred by experienced radio men. They have an extremely low power factor, low radio frequency resistance and a negligible D.C. resistance. Every condenser certified electrically and mechanically efficient.

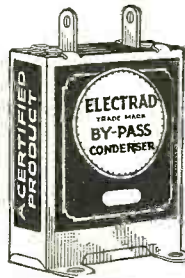

Where Energy Counts!

The finest receiving antenna in the world will not help you if you lose the energy picked up when you try to convey it to your set. That's where the

ELECTRAD Certified Lead-In

enters the picture. It minimizes energy losses and is the most efficient type of lead-in you can use. Triple-ply insulation, 10 inches long, covered with waterproof webbing and all connections riveted and soldered. Price 40c.

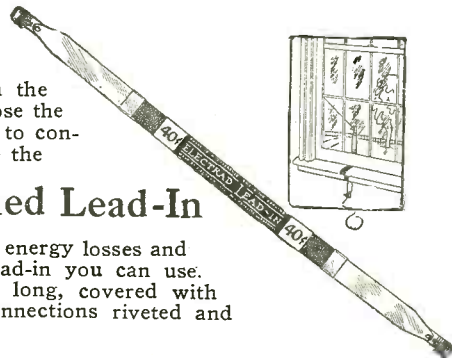

ELECTRAD PARTS SPECIFIED

- In the Radio News Battery-less Receiver
- 3—1 Mfd. By-Pass Condensers, Class 200, \$9.00 ea.
 - 1—.002 Mfd. Fixed Condenser..... .40
 - 1—.00025 Mfd. Grid Condenser, Type GS, .40
 - 1—2 Megohm Metallic Grid Leads..... .60 ea.

428 BROADWAY, NEW YORK CITY

ELECTRAD

Insure your copy reaching you each month. Subscribe to Radio News—\$2.50 a year. Experimenter Publishing Co., 53 Park Place, N. Y. C.



"used in the LC-27"

AEROVOX

"Built Better"

FIXED CONDENSERS

are Specified in

- | | |
|-------------------------|---------------------|
| LC-27 | by L. M. Cockaday |
| Diamond of the Air | " Herman Bernard |
| To be announced soon(?) | " John Rider |
| Raytheon "B" Eliminator | " Raytheon Mfg. Co. |
| Ultradyn | " R. E. Lacaule |
| To be announced soon(?) | " R. E. Lacaule |

AEROVOX fixed condensers have been approved by M. I. T. and Yale Universities.

AEROVOX WIRELESS CORP.
 489-491-493 Broome Street
 New York

BRYANT RELIABILITY AS APPLIED TO RADIO



Every Part of a Radio Equipment Must Be Reliable

The nearly forty years' experience of the Bryant Electric Company in the design and manufacture of wiring devices assures satisfaction in the use of Bryant parts approved by Radio manufacturers, laboratories, and amateur builders.

Our Bryant double pole indicating flush tumbler switches, and many other switch combinations are important parts in Radio receiver and power unit building. Our No. 681 rotary battery switch is very compact and "positive" in operation. It has one hole mounting, with leads attached. The Bryant No. 9402 lamp sockets (base diam. 2 11/32 in.) are specified in the Radio News Batteryless Receiver. Our No. 50715 receptacle is equally efficient and smaller. (base diam. 1 3/8 in.)

We also manufacture outlet base or fuse holder No. 62963, plug fuse type with connections for plug fuses on each side of the line. Write us today for information on Bryant Wiring Devices particularly valuable in Radio receiver equipment assembling.

THE BRYANT ELECTRIC COMPANY
 Bridgeport New York Chicago San Francisco

Complete Parts For Radio News Battery-Less Receiver

As Described in Radio News
 ALSO

FREE New 1927 Catalog **FREE**

Shows photographs and hook-ups of all latest kits, complete line of cabinets and consoles, accessories and parts. We are headquarters for all nationally advertised lines. Dealers and professional set builders write today for your copy of this big FREE CATALOG. SHURE RADIO CO., 19H-21 S. Wells St., Chicago

The Radio News Batteryless Receiver

THOUSANDS OF
RADIO
SET OWNERS
need these improvements

THE U. S. Navy the Signal Corps and 69 makers of leading standard sets use the variable resistance controls made by Central Radio Laboratories. These improved controls should be used on your set if you want the last word in quality for fine reception. Yet, owing to our huge output the cost is no more than for many inferior devices.

Modernize Your Old Set with

Centralab Modu-plug

Tone volume is, as you know, the one big improvement in this year's best sets. You can enjoy this improvement with your present receiver for only \$2.50. Modu-Plug is especially for that purpose. It provides full tone volume control from a whisper to maximum, simply by adjusting the small knob on the plug. Matches the speaker impedance to the set. Attaches instantly without tools. Standard type Modu-Plug replaces present speaker plug. Cord type fits sets not equipped with jacks. Either type, \$2.50 at dealer's, or mailed direct,

Centralab Radiohm

With "A" Battery Switch Here is the variable resistance guaranteed always smooth, noiseless and permanent in adjustment. Tapered to control oscillation and volume, it also has a positive, quick acting "A" battery switch. One knob replaces two. Turning knob to right lights tubes, then increases volume. To left decreases volume, then cuts off batteries. Resistance is 0 to 500,000 ohms. You cannot imagine the great improvement until you try it. Adapted to all circuits. At dealer's or mail direct, \$2.30

Centralab Rheostat S

Where your old design rheostat overloads, heats-up and quickly becomes noisy on new style tubes using increased current, Centralab Ribbon-type Rheostats will operate smoothly and permanently quiet. Insulated metal discs hold rigid a smooth flat resistance surface instead of wires, insuring even regulation and no dead spots. Every set using this rheostat is improved. 2 resistances for 5 to 10 tubes, at dealer's or mail \$1.25 direct,

SEND NO MONEY—if your dealer isn't supplied, order direct from us. Send no money. Simply pay postman on delivery, plus few cents postage. Install and test for 10 days. Then if you are not more than pleased and delighted with the wonderful results, return the goods to us and your money will be refunded.

10 DAYS' FREE TRIAL!

CENTRAL RADIO LABORATORIES
19 Keefe Avenue, Milwaukee, Wis

Centralab

We make variable resistances for both the U.S. Navy and Signal Corps and for 69 makers of leading standard sets

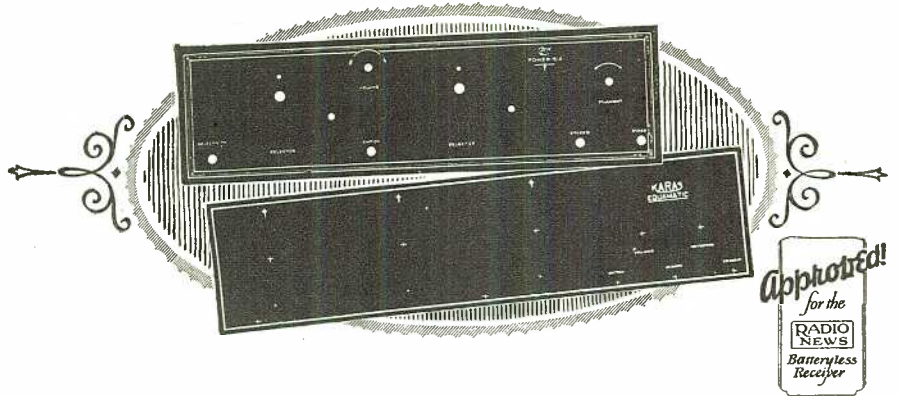

POWER SIX, KARAS, H. F. L.

ADDED to the list of handsomely Veri Chromed Formica kit panels are now the Bremer Tully Power Six, Karas Equamatic front and sub panels, H. F. L. Nine in Line Superheterodyne with sub panel, Victoreen Universal single dial control. There are also Infradyne 7 x 28, and 7 x 30, Aerodyne, St. James 8 tube, Bremer Tully Counterphase, Browning Drake National, Madison Moore Superheterodyne, Camfield Duoformer. They are sold by leading jobbers and dealers.

Special panels cut to size and Formica tubing are also available for Amateurs.

THREADED TUBING FOR MANUFACTURERS

Single dial control is making evenly balanced inductances necessary. Formica threaded tubing permits turns of the same diameter evenly spaced apart. A large equipment for threading tubing is now in operation at the Formica plant, giving manufacturing customers prompt service on their requirements.



The FORMICA INSULATION COMPANY
4618 SPRING GROVE AVENUE

CINCINNATI, OHIO

Hear the FORMICA Orchestra Tuesday 9 to 10 over WLW



Formica has a Complete Service on Insulating Material for Radio Manufacturers

POLYMET CONDENSERS

Stand the Gaff!

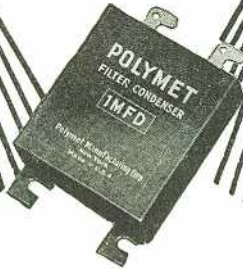

Condensers are the watchdogs—guardians of the receiver or power unit you construct. Assure success by choosing only condensers that stand the gaff!

Extensive research and latest, most modern equipment and skill enable Polymet to build condensers of exceptionally high voltage breakdown test. Only the finest materials are employed. An improved process renders them non-inductive with high dielectric resistance for long life and durability.

Raytheon Circuit Condensers

Approved by the Raytheon Company with high rating

Type F-1000—14 Mfd. Tapped at 1, 1.2, 2, 8, \$9.50
Type F-1001—.1-C-1 Mfd. (illustrated) \$2.00

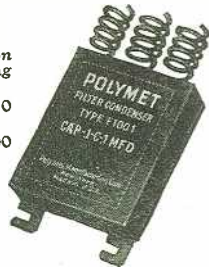

High Voltage Condensers

The right size for every use
.1 to .5 Mfd.
60c. to \$4.50

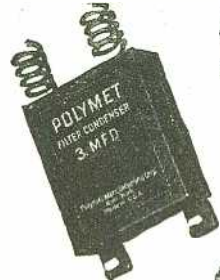

Fixed Mica Condensers

With or without Grid Leak Mounting clips—individually tested for 1000 volt breakdown test. Plates and lugs in one piece. Capacities guaranteed. All sizes. 25c. to \$1.00.

Write for complete details and illustrated descriptions of all Polymet Products. Sent free on request.

POLYMET MANUFACTURING CORP.

599 A Broadway, New York, N. Y.

"World's Largest Manufacturers of Radio Essentials."



POLYMET PRODUCTS

RADIO NEWS BATTERYLESS RECEIVER

AERODYNE
CARBORUNDUM 8-TUBE
SHIELDED RECEIVER
ST. JAMES
SHORT WAVE
SAMSON T. C.

NINE IN LINE
BROWNING-DRAKE
VICTOREEN
INFRADYNE
WORLD'S RECORD SUPER 8

Dealers writing us specify just what hookup you are especially interested in.

NEWARK ELECTRIC CO.

"Nothing but Radio"

226 WEST MADISON STREET

CHICAGO,
ILL.

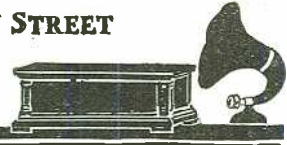

as usual CARTER Parts

are specified in the
BATTERYLESS RECEIVER

Make sure the successful working of your set by refusing substitutes.



(Half Size) \$2.25
No. 25 HI-POT
Potentiometer 25,000 ohms
Any dealer can supply



In Canada
Carter Radio Co.
Limited, Toronto

M&H

Radio's largest
kit supply house

ESTABLISHED 30 YEARS

BUILD THE FAMOUS QUADRAFORMER

VI RECEIVER

With an M&H Kit!

The New Year's
Sensation Fully
Described in this
Issue of Radio
News

PRICE
\$51.00

THE RADIO NEWS BATTERYLESS RECEIVER KIT IS READY

Here's Something
New: a Splendid Re-
ceiver With Many
Innovations.

PRICE
\$105.00

THE AERODYNE—5-TUBE SET

Designed by Master
Engineers—The Latest
Thing in 5 Tube
Circuits—Original
Parts

PRICE
\$44.00

OUR CIRCULAR

IS NOW READY

It Will Pay Set Builders to Send
for This.

M. & H. SPORTING GOODS CO.

512 Market St., Phila., Pa.

PERRYMAN RADIO TUBES

Double Filament!
Extra Capacity!

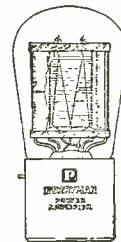

PATENTED
JUNE 23, '26



The filaments of Perryman Radio Tubes with the patented Perryman Bridge are doubled to form a letter M. This twin construction exposes a greater area of filament surface, doubling the area of electron emission and increasing the capacity of the tube. The real result is greater volume without distortion, and longer life.

PERRYMAN
Electric Co., Inc.
33 W. 60th St. N.Y.

YAXLEY

Assure ease in set building and permanent satisfaction in receiver reception. They were selected for the Batteryless Receiver because of their reliability and fine workmanship.

No. 1 Jack50c
No. 11 Aerial Switch65c
No. 10 Midget Battery Switch ...50c
No. 8200 200-ohm Fixed Resistance 25c

Yaxley Approved Radio Parts used also in original Aerodyne and many other recent hookups.

YAXLEY MANUFACTURING CO.
Dept. N, 9 So. Clinton St., Chicago, Ill.

Insure your copy reaching you each month. Subscribe to Radio News—\$2.50 a year
Experimenter Publishing Co., 53 Park Place, N. Y. C.

The Radio News Batteryless Receiver

The Aero-Dyne Receiver

(Continued from page 1008)

advantages of regeneration cannot be overlooked in receivers of this character. If it were not for regeneration their efficiency would be extremely low and the results obtained with their use distinctly unsatisfactory. However, we may also say that, if it were not for regenerative effects being the primary root of oscillation difficulties, we could change the design of our receiver to regain, in more or less measure, what was lost by the lack of regeneration. This would be true only in a system involving a somewhat greater number of tuned stages in order to retain good selectivity; as a truly *non-regenerative* receiver, showing good R.F. gain per stage and having only three tuned circuits, is usually far less selective than a set of the type described. When going to more than three tuned stages, however, the converse is liable to be true, if good design is shown.

CONSTRUCTING THE AERO-DYNE RECEIVER

The "Aero-Dyne" supersensitive receiver, so named from its essential parts, the "Aero" coils, is a five-tube, tuned-radio-frequency amplifier system, using two stages of tuned R.F., a tuned detector, and two stages of audio-frequency amplification. The latest improvements from the standpoint of volume, selectivity, ease of control in both tuning and regeneration, and tone quality, have been incorporated in its design. Low losses and the correct size of plate coil make for volume; an adjustable primary on the antenna coupler, to compensate for different sized aerials, gives selectivity; ease of control is assured by straight-line-frequency condensers (some may prefer straight-line-wavelength condensers); it has a variable oscillation control which is fool-proof; and tone quality is obtained through careful selection of audio transformers and correct bias on the grids.

The accompanying illustrations and diagrams make the details of construction clear. It is seen that a bakelite panel and sub-base are used, the essential apparatus being mounted on them and the low-potential (battery and audio leads), wiring done underneath the sub-base in order to present the best of appearance.

The coils should be mounted as shown: the antenna coil upright, second R.F. coil horizontal and with its axis at right angles to the panel, and the third (detector) coil horizontal with its axis, parallel to the panel. This does not mean that coils placed at 90 degrees haphazardly will give you best results—*be sure they are at exactly 90 degrees*. This mounting provides the minimum of interstage magnetic coupling and makes oscillation control easy. The condensers, tube sockets, audio transformers, rheostats, variable resistance and filament switch are mounted to the baseboard and panel in the position clearly shown. It is a good plan to attach soldering lugs to all terminals of the apparatus before it is mounted, making sure that all contacts are tight and will not work loose. Inspect the tube sockets especially, as they are the greatest source of trouble; the new sockets for UX-type bases are superior in this respect. Mount the binding posts as shown, preferably using marked or tagged posts, and fasten a soldering lug under each post.

Now with all the apparatus mounted and securely fastened, start wiring the filament circuits of the tubes. It is a good plan to check each wire on the drawing with a pencil as it is wired in place. Wire directly from the "A+" post, through all the sockets and rheostats back until you end up at the "A—" post. Then check the wiring once, insert five tubes in the sockets and connect a storage battery to the proper posts. Snap the filament switch and control the brilliancy of

Daven Revolutionizes Radio Tone

BACK of every Daven Radio Accessory is one aim—to improve and perfect Tone in Radio reproduction. Doing away with extraneous noises, avoiding distortion, preventing losses, are a few of the ways in which the Daven Radio Products contribute to the production of natural tone.

The clear, deep, natural tone of the Daven Bass Note Circuit which utilizes the various Daven units to fullest advantage, is proof of the success of the Daven aim.

This new radio hook-up, which we sincerely believe to be the most satisfying circuit ever produced, and whose principle is the basis of the leading factory built sets of the coming year, may easily be built by any radio enthusiast. The necessary units are obtainable everywhere that good radio parts are sold; or the Daven Bass Note Set may be obtained in factory built form.

The leading radio dealers in town are usually Daven Dealers. If you want to be thoroughly up-to-the-minute on radio, make a point of hearing the Daven Bass Note Set, the most perfect toned reproducer.

Complete Daven Catalog Free on Request

"The Sine of Music"
DAVEN RADIO CORPORATION
 Trade Mark Resistor Specialists Registered
 142 Summit St., Newark, N. J.



THE DAVEN MU 5 and MU 20 TUBES
 Clarify and beautify Tone by utilizing the full power of which your set is capable without blasting or choking. MU 5, \$1.50. MU 20, \$1.



DAVEN CONDENSER
 Type A. Proper capacity for Resistance Coupling will pass every audible frequency without blocking.



DAVEN LEAK CONDENSER
 A patented combination of grid leak and grid condenser which, besides saving space, insures clear detection at all times. Equipped with soldering lugs. \$1.



DAVEN BALLAST RESISTOR
 Eliminating a rheostat, this Daven device improves reception by insuring constancy. Conserves battery current. Indestructible. All capacitors, one to five tubes, special mounting. \$1. Without mounting 75c.

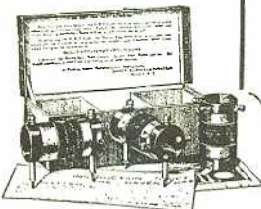

DAVEN RADIO FREQUENCY COILS
 Extremely sensitive. Extremely selective. Give both volume and ease of control. Eliminate self-oscillation, because of small interaction field. Responsible for the Daven Bass Note Circuit's perfect radio end. Set of 3, \$8.



LATEST EDITION DAVEN MANUAL
 Tells how to apply Daven Amplification to any type of set. Full and complete information. 25c at Daven Dealers. (30c by mail).



DAVEN GLASTOR
 The Transparent Resistor. Contributes to tone all its accuracy, performance, absolute noiselessness. A big advance in resistor construction. All resistances. 50c to \$1.



DAVEN HI-DUTY GLASTOR
 A transparent resistor especially made for B Eliminator use. Will not deteriorate or lose value under the extremely high current required for eliminator use. \$1.



DAVEN RESISTOR MOUNT
 A base of molded bakelite. Firmly attached clips and soldering lugs. Mount only 35c.



DAVEN RESISTOR COUPLERS
 Valuable for assembling resistance-coupled amplifiers. Each coupler has two pairs of clips. The Type A Condenser is connected in the base. Mount only, \$1.50.

DAVEN AMPLIFIER KIT
 Contains all necessary units for manufacturing a Daven Amplifier. Includes Glastor Resistors and Resisto-Couplers. \$8.



DAVEN SUPER AMPLIFIER
 A complete assembling of the Daven Amplifying units in a convenient-to-etch unit which amplifies all of the music without distortion. Thoroughly tested. Without tubes, \$15.

LONG WAVE AMPLIFIER
 Without tubes, \$20.00.



NEW BOOK FOR SET BUILDERS
 Tells simply, yet completely, how to assemble a Daven Bass Note Set. Life-size diagram. Anyone can follow it. 25c at Daven Dealers. (30c by mail).



DAVEN BASS NOTE SET
 Manufactured by the Port Manufacturing Company—our Radio Set Division. Six tubes. Economical of space. Handsome mahogany cabinet, \$150.00. West of Rockies, \$160.00.



Test "B" power output voltage —this new Sterling way!



the Sterling "B" Power Tester answers these vital questions:

What is maximum voltage output of the "B" Power—its total capacity to deliver at no load?

What voltage will it deliver at say, 20—40—60 mills, or at any load up to 100?

How many milliamperes will any particular receiver pull when in operation?

Which kind of "B" Power gives sufficient plate voltage at that load? How much to spare, if a power tube were added?

Is any tube socket not receiving plate voltage due to trouble in the circuit? Which one is "open"?

What plate volts in the detector, Amplifier or Power tube?

What voltage has any dry or storage "B" battery or combination of them up to 300 volts?

In addition you can check the output of any D. C. generator such as is used in transmitting sets; find out the load in any circuit or determine battery polarity.

"B" Powers — Elimimators — are here to stay. Your problem is how to judge them and how to service them.

This new Sterling "B" Power Tester enables this to be done quickly and accurately—it is an indispensable part of the equipment of every radio service man.

Price . . . \$40.00

Sterling
"B" POWER
— TESTER —
THE STERLING MFG. CO.
 2845 Prospect Avenue
 CLEVELAND, OHIO

the filaments with the rheostats. The left hand rheostat controls the two R.F. tubes, the right controls the detector and the two audio tubes are automatically controlled with a ½-ampere automatic filament control. If everything checks O.K., go on with the wiring; if not, carefully recheck until you find the trouble. Many blown tubes can be saved by these precautions.

The rest of the wiring is simple. Keep all grid and plate leads as short and direct as possible and of nearly the same length. Wire in the variable resistance and the by-pass condensers, being certain that the connections of these latter are exactly as shown. If the 1.0-mf. by-pass is incorrectly connected a great deal of unsatisfactory oscillation may result.

OPERATION

When the wiring is complete, connect up the batteries and insert one tube in the socket. It should control the same as before. If anything has been done wrong, this procedure will save the other four; everything will probably be found O.K. The other tubes should be inserted and filaments lighted to average brilliancy. Insert phones in first jack and connect the antenna and ground. Set the three tuning dials at the same reading, and vary the adjustable resistance, R3. The set should go into oscillation as the resistance is decreased or turned to the right. This condition is manifested by a soft swish or thud, accompanied by increase in volume of static or signals. The most sensitive position of the variable resistance, R3, for distant reception is just below, and as close as possible, to this point of oscillation. The set will oscillate only when the three circuits are in resonance.

Now adjust the primary on the antenna coupler to about 15 degrees from the main coil. Sweep the scale, from zero to 100, keeping all three dials in step, and the receiver just below the point of oscillation with the variable resistance. The position of this resistance (for best distance reception) will be different for every wavelength and will be further to the right for higher wavelengths. For local reception the resistance need seldom be touched.

The adjustable primary coil is one of the biggest features of this system's success under varying interference conditions. Lifting the primary further away from the secondary increases selectivity and decreases volume. Putting it closer causes the opposite to be true. The best compromise for each condition of interference, length of antenna, etc., can be best found by trial. When local stations are off the air, of course, the best distance reception can be had with the primary coil fairly close to the secondary. The user should familiarize himself with these effects so that he may obtain the most out of the set.

If all instructions are carefully followed and the simple operation clearly understood, there is no reason why the user cannot obtain superior results with this system. Some remarkable distance records have been obtained right through adverse conditions of local interference, when other similar sets have been helpless. Again the superiority of good design, low-loss parts, careful attention to detail and complete instruction in operation, triumphs.

NOTICE TO READERS

A complete set of full sized blueprints for this Aero-Dyne Receiver may be obtained by sending \$2.00 to the Blueprint Dept., Radio News, 53 Park Place, New York, N. Y., specifying Set No. 9. These blueprints may be placed upon the panel and sub-panel, forming templates for drilling and locating the apparatus, as well as wiring guides.

Windsor Wall or Table Type Cone Speaker Amazes Radio World



Model 210
(Pat. Applied For)

The latest model Windsor Cone Loudspeaker has astonished the world of radio. In convenience, quality of reception, and extremely low price, it far surpasses anything yet offered. The cone is 22 inches in diameter and is supported by an easel back. It can be hung up on the wall, as in the picture above, or stood upon any flat surface as shown in the picture below. It contains the famous Windsor loudspeaker unit noted for its extreme clarity and fidelity of reproduction.



Model 210
22-inch Cone Loudspeaker with easel back

\$15.00

(West of Rockies \$18)
(Pat. Applied For)

Model 302 (Shown below) With Moulded Composition Horn Loudspeaker and 18-inch Cone Loudspeaker.



(Pat. Applied For)

In this Windsor Console is combined both the Windsor Moulded Composition Horn Loudspeaker and the 18-in. Windsor Cone Loudspeaker. The top is 30 in. x 17 in. and stands 29 in. high. Plenty of battery and equipment space is provided by large shelf in rear. Price, finished in Mahogany or Walnut **\$48.00**
(West of Rockies, \$55)

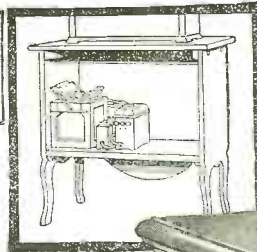

Rear view at left shows large compartment with ample space for batteries, battery charger, or battery eliminator, which are entirely concealed from view. Back is open for ventilation of batteries.

At right is shown the Cone Loudspeaker, with its panel, which is quickly and easily removable, allowing instant access to all batteries, battery charger, battery eliminator or other equipment and wiring.



(Pat. Applied For)

Model 200—with 22-inch Cone Loudspeaker

This Windsor Cone Loudspeaker Console is equipped with a 22-inch Windsor Cone Loudspeaker. Its top is 30" x 17" and is 29" high. The battery shelf provides ample space for batteries, charger, battery eliminator and other equipment. Beautifully finished in either Mahogany or Walnut.

Model 200

\$29

Console with Cone Loudspeaker Ready for Set and Batteries
(West of Rockies, \$35)

This is the Fastest Selling Line of Loudspeakers and Loudspeaker Consoles in the Radio World Today



Model 100
with Moulded Composition Horn Loudspeaker or 16-inch Cone Loudspeaker
(Pat. Nov. 18, 1924)

Above is shown a beautiful Windsor Loudspeaker Console, finished in either Walnut or Mahogany, which provides ample space on top for any radio set. The battery shelf beneath will accommodate all necessary equipment. Equipped with either Moulded Composition Horn or 16-inch Cone Loudspeaker. Size: 38 in. x 18 in., and 29 in. high. Price **\$40.00**
(West of Rockies, \$42.50)

To the right is shown the newest Windsor Loudspeaker Console. It is equipped with a 22-inch Cone Loudspeaker and cabinet suitable for 7-inch radio panels up to 26 inches in length. Battery shelf provides ample space for all equipment. Price (without receiving set) **\$44.00**
(West of Rockies, \$52.00)

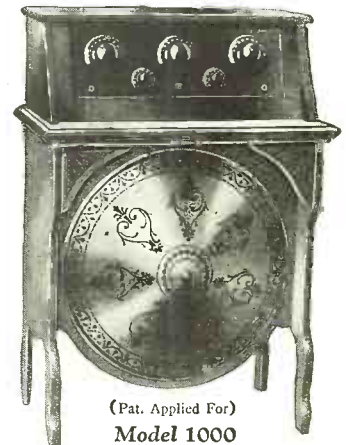

(Pat. Applied For)

Model 1000
with 22-inch Cone Loudspeaker

Note to Dealers. Write or wire today for details of the highly profitable Windsor line.

Electrical Department

WINDSOR FURNITURE COMPANY

1410 Carroll Avenue • CHICAGO, ILLINOIS
Los Angeles Branch—917 Maple Avenue

REMLER INFRA-DYNE AMPLIFIER

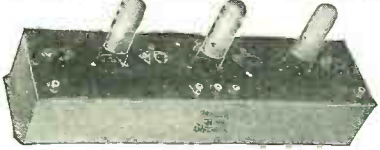

Give your set a chance to prove how good it really is

Add the Remler Infrazyne Amplifier and associated parts to any neutrodyne or tuned radio frequency receiver. The result will prove that Remler maintains its leadership as a pioneer in radio reception.

REMLER TWIN-ROTOR CONDENSER

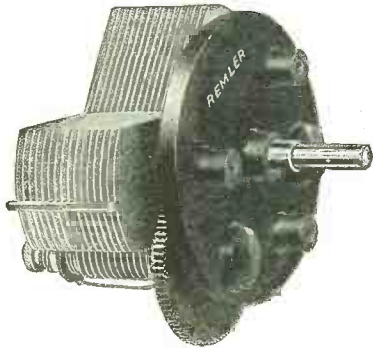

Your set deserves the tuning efficiency which can be obtained only from the Remler Twin-Rotor Condenser.

Straight Line Frequency Capacities .0005 and .00035 **Straight Line Wave Length**

Price \$4.50 Less Dial

REMLER

Division of
Gray & Danielson Mfg. Company
260 FIRST STREET
Chicago • SAN FRANCISCO • New York

A New Alloy for Chemical Rectifiers

(Continued from page 958)

destroyed once during each cycle of the supply current. Electrical contact with the electrolyte is made through the addition to the apparatus of a metallic plate, preferably of lead; and such a "cell," when connected in an alternating-current circuit, becomes a very efficient rectifier, delivering an output of direct current.



This is the assembled cap and electrodes, that on the left being lead and the longer one, silite. These caps are used with jars, in which common battery electrolyte is placed, and serve as rectifiers in various types of chargers.

Courtesy of Kodak Radio Corp.

Silite is not attacked by sulphuric acid in any degree of concentration or at any temperature, its inventor has found; and its "valve" action is more efficient in high-gravity electrolyte than in low. Such electrodes, being unattacked by the electrolyte, do not decompose and will give almost unlimited service.

RADIO EARS ARE QUICKEST

The phenomenon of hearing a program by radio before its nearby audience can do so is familiar, at least in principle, to all radio students. The radio waves travel with the speed of light, 800,000 times faster than sound waves; but few have had such a visible demonstration of the fact as the Australians of whom Wireless Weekly (Sydney) tells:

"Visitors to French's Forest during the broadcast of a corroboree (native dance) and camp fire concert by 2BL saw a striking illustration of the difference between the speed of radio sounds and sounds passing simply through the air. About 500 yards from the scene of the corroboree, the broadcasters' engineer had a receiving set picking up the sound after it had been broadcast. This was useful, because it showed how the broadcast was being received by listeners. From the spot in question, however, a listener could hear the singing and chanting not only by radio but also by air, and the striking thing was that it was heard on the radio set a second or more before it was heard on the air. Thus, one could hear the native girls singing to the accompaniment of the harmonium and the radio set always kept a word or two ahead of the singer's actual voice."

YAXLEY

APPROVED RADIO PRODUCTS

Automatic Power Control

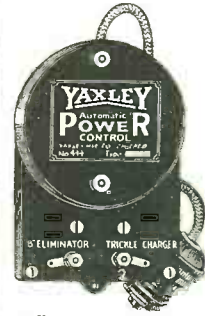

No more plugging in sockets and turning switches every time you use your set—no more tinkering with them every time you turn off the set. The Yaxley Automatic Power Control takes care of your B Eliminator or trickle charger or both. You know that when you turn on your set, the trickle charger is

off, the B eliminator is on. When you turn it off the power control is standing guard for you, automatically, surely and without fail turning off the B eliminator and on with the trickle charger.

No. 444—Automatic Power Control, Series type—for use with sets having tubes with a current draw equal to or greater than 6 U.V.-199 type of tubes—
Each, \$5.00

Radio Convenience Outlets



Install a Yaxley Radio Convenience Outlet for loud speaker and phone connections in every room. Consists of a wall plate and a wall socket jack with screw terminals. Fits any standard switch box. Easily wired. Wiring diagrams in each package.

No. 135 Radio Convenience Outlet—
Each, \$1.00

At your dealer's. If he cannot supply you send his name with your order to

YAXLEY MFG., CO.
Dept. N, 9 So. Clinton St.
CHICAGO, ILL.



The Speaker That Satisfies

To secure the best reproduction from any set a speaker of proper design must be used. The BURNS is capable of reaching the full range of tones with amazingly pleasing results. A trial will convince you.

At Your Dealers Or Write Direct

Manufacturer

American Electric Company

State & 64th Sts., Chicago

Ask About The BURNS "B" Eliminator

You can be quickly cured if you

STAMMER

Send 10 cents for 288-page book on Stammering and Stuttering, "Its Cause and Cure." It tells how I cured myself after stammering 20 yrs. B. N. Bogue, 6964 Bogue Bldg., 1147 N. Ill. St., Indianapolis

CLASS OF SERVICE	SYMBOL	CLASS OF SERVICE	SYMBOL
TELEGRAM	BL	TELEGRAM	BL
DAY LETTER	DL	DAY LETTER	DL
NIGHT MESSAGE	NL	NIGHT MESSAGE	NL
NIGHT LETTER	NL	NIGHT LETTER	NL

WESTERN UNION TELEGRAM

NEWCOMB CARLTON, PRESIDENT GEORGE W. C. ATKINS, FIRST VICE-PRESIDENT

Received at 1038 Fulton Street, Fresno, Cal. 1926 OCT 25 AM 7 26

FA40 41 NL MANAYUNK PENN 24

E. J. GEARHART
 GEARHART SCHLUETER RADIO CORP FRESNO CALIF

CONGRATULATIONS YOUR BIGGEST STEP FORWARD TESTED HALF MILE
 DISTANT FROM PHILADELPHIA STATIONS SEPARATED LOCAL STATIONS
 AND TUNED THROUGH THEM RECEIVING DISTANT STATIONS EASILY NEW
 QUADRAFORMER SIX DELIVERS THE GOODS SELECTIVITY TONE VOLUME
 AND DISTANCE ALL THAT COULD BE DESIRED

H W RISLEY

The First "Fan" to Build the Amazing Quadraformer VI*

—volunteers his personal opinion



This is the Most Important Announcement We Have Ever Made Probably the Most Remarkable Ever Written About Any Radio—

WE INTRODUCE to you the perfected QUADRAFORMER VI—the result of five years of ceaseless laboratory experimentation. It's the sort of a radio receiver that you and I have always wanted. To describe it properly and adequately would only seem like the greatest exaggeration to you—until you have heard it play!

A few minutes' interesting work plus the new Essential Kit will make any old tuned radio frequency set you've got sit up and talk in such a way that you'll waste no time in building up the VI, exactly like instructions, to find out just how good a radio can really be. As soon as you let a few of your friends hear it your home will be the Mecca for all the fans in town.

If you haven't read the construction article in this issue stop now and read the dope—then take me up on my offer in the little coupon in the corner. Remember, we guarantee that you'll be just as pleased as Mr. Risley is or you get your money back. That's fair, isn't it?

THE ESSENTIAL KIT

Contains everything necessary to change over any existing two stage tuned radio frequency receiver using .00037 mfd. or .0005 mfd. variable condensers to a Quadraformer, or with the kit and a few other standard parts easily purchased anywhere you can build the remarkable QUADRAFORMER VI exactly as described in this issue of Radio News.

The Essential Kit contains the three new shielded double-range QUADRAFORMERS, a specially designed SELECTIVITY CONTROL that enables you to cut thru the locals in the most congested districts, and the AMPLITROL—the latest invention of Gearhart-Schlueter—which makes the receiving set equally efficient on all wavelengths.

There is also included a very complete, step-by-step instruction book, containing many illustrations and full page drawings, fully covering the assembly, wiring, testing, operation and trouble-shooting of Quadraformer sets.



Inside Facts on the New Quadraformer Coils

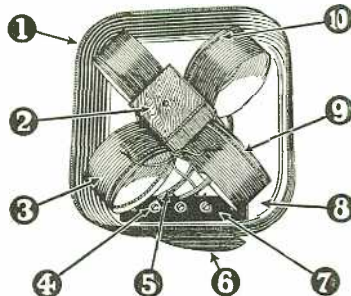

1. A scientifically designed shield against impact reception and electrostatic coupling. Heavy drawn copper, handsomely finished in natural copper lacquer, trimmed in gold.
2. The Quadraformer coil sections are self-supporting, being mounted on a single central insulating block. This gives the lowest possible dielectric losses and the least insulating material in the field. It is the elimination of just such losses in the new Quadraformer coils that keep the high frequency resistance at a minimum, securing increased selectivity, volume and natural tone quality.
3. This shows one of the four windings making up the complete secondary. Special triple insulated heavy copper (No. 28) magnet wire is now used in both primaries and secondaries. The extra heavy insulation separates the turns more than is usual and reduces the inter-turn capacity greatly. The resulting complete transformer has the highest inductance combined with the lowest distributed capacity of any closed magnetic field coil.
4. All connections between the windings and the terminal binding posts are first securely fastened mechanically and then firmly soldered, using rosin flux, for permanency.
5. All primary leads, which carry the B battery voltage, are protected by genuine Italian flame-proof varnished insulating tubing—the highest grade "spaghetti" that can be bought.
6. The mounting bracket is of sturdy construction and holds the completed transformer firmly in place on baseboard or sub-panel.
7. The binding post terminal strips are genuine Celoron.
8. An accurate laboratory determined air-space separates the Quadraformer windings at all points from the shield. All Interstate Transformers are accurately matched on a master oscillator and packed in double pairs for most efficient operation with dual condensers.
9. The primaries are now wound with the same heavy wire used in the secondaries. The primary windings will stand a load of 3 amperes without heating, and are POSITIVELY GUARANTEED NOT TO BURN OUT.
10. A heavy insulating string separates each primary winding from its associated secondary winding, eliminating the bad effects (broad tuning, for one) of the capacity coupling between primary and secondary present in most transformers. It is also a further guaranty against burn-outs.

Order From Your Dealer or Direct FROM US

Quadraformer parts are carried in stock by reliable dealers in most cities. If your dealer happens to be out of stock you may order direct from us by using the coupon to the right. Send no money. Just pay the postman the price of the parts plus a few cents postage.

More PROOF

- Sacramento, Calif. November 21, 1926
- I purchased a new Essential Quadraformer Kit from Warner Bros. of San Francisco, and changed over my old set last night. The new shielded Quadraformers certainly beat the old style coil. My set is so selective now that I will pass over a station if I am not careful. They increased the distance and I went right down the line from KGV down and separated them all clearly with absolutely no background when listening to stations close together like KOIN (319 m.) and KOA (322 m.) which interfered on my old set.
- I think the Amplitrol is a great idea and it certainly does smooth them out on the low waves and increase the volume on the higher wavelengths. Denver, Salt Lake, Portland and Los Angeles are plenty loud on one stage of audio.
- C. A. HOEFT.
- Santa Barbara, Calif. November 28, 1926
- I am delighted with the new Quadraformer VI. I logged 20 stations the first night—from Tijuana, Mexico to Calgary, Canada; and from the Pacific Coast to Chicago and St. Louis.
- It is very selective and I have very little difficulty in tuning out an occasional interfering station. The volume control is very sensitive, but the TONE QUALITY is what appeals to me most of all. The full, rich, natural, beautiful tone of the Quadraformer VI is not equalled by any other radio I have ever heard.
- S. A. TISDEL.
- Seattle, Wash. November 23, 1926
- The Quadraformer VI rings around anything I've heard that sells under three hundred dollars. The volume is nearly equal to an 8-tube super on locals and it is much more selective. For distance which is a real necessity, its best selling point is brought out. Chicago, St. Louis, Nebraska and Canadian stations come in with as much volume as the average set brings in California stations.
- H. M. HOSKING.
- San Gabriel, Calif. November 29, 1926.
- The new set is a wonder. I got it finished at 4.30 P. M. and the first station brought in was WWSW, Chicago, IN DAY-LIGHT. This was followed by WOK, WENR, KOA, KSL, SMB and many others. The tone quality is fine.
- F. K. CASWELL.

GEARHART-SCHLUETER RADIO CORP'N
 1719-21 VanNess Ave., California

GEARHART-SCHLUETER RADIO CORP'N
 1719-21 Van Ness Ave., Fresno, California.

Please send me the new Quadraformer Essential Kit, containing the three shielded Quadraformers; the Selectivity Control; the Amplitrol; and complete Instruction Book for which I will deposit with the postman \$17.50, plus postage, upon delivery. It is understood that if I am not MORE than pleased with this purchase that I have the privilege of returning this kit in salable condition within 30 days and you will refund my money.

NAME.....
 ADDRESS.....
 CITY..... STATE.....

(Send cash with order and we will ship prepaid)

The Quadraformer "6" Receiver

MUTER

Dependable Products

make your set
operate better

Endorsed and used by
leading set builders

**Quality at
Popular
Prices.**

May we send you our
complete catalog?
Write Dept. R.N.

LESLIE F. MUTER COMPANY

76th & Greenwood Avenue
CHICAGO, ILL.



Variable High Resistance



Single Pole Double Throw



Double Pole Double Throw



Triple Pole Double Throw



Antenna Plug

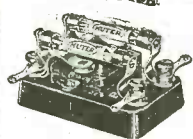

Resistance Amplifier Unit



Fixed Grid Leaks



Resistance Amplifiers



Adjustable Ground Clamp

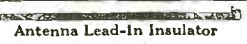

Antenna Lead-In Insulator



Standard Complete Aerial Kit



Variable Condensers



Lightning Arrester



Interference and Static Eliminator



Audio Frequency Transformers



Push-Pull Panel Switch



Automatic Shock-Proof Phone Plug



Fixed Condensers

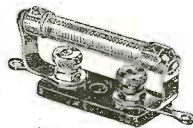

Fixed Rheostats

QUADRAFORMER SPECIFICATIONS INCLUDE

See that screw

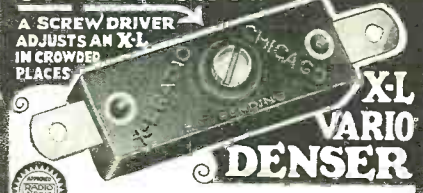

NO SET

should be condemned until an X-L is tried. The results are more clarity, easier tuning, more distance and volume.

FREE hookup diagram of most notable set, showing how to use X-L Vario Densers.

MODEL "N"—A slight turn obtains correct tube oscillation on all tuned radio frequency circuits. Neutrodyne, Roberts two tube, Browning-Drake, McMurdo Silver's Knockout, etc. Capacity range 1.8 to 20 micro-micro farads. **PRICE \$1.00**
MODEL "G"—with grid clips obtains the proper grid capacity on Cockaday circuits, filter and intermediate frequency tuning in heterodyne and positive grid bias in all sets.

CAPACITY RANGE

Model G-1—0.0002 to .0001 MFD.
Model G-5—.0001 to .0005 MFD.
Model G-10—.0003 to .001 MFD.
PRICE \$1.50

X-L PUSH POST—Push it down with your thumb, insert wire, remove pressure and wire is firmly held. Releases instantly. **Price 15c.**

PUSH POST PANEL—permanently marked in white on black insulating panel. In box including soldering lugs, raising bushings and screws for mounting, etc. **Price \$1.50**

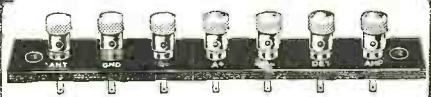

X-L Radio Laboratories, 2426 LINCOLN AVE., CHICAGO, ILL.

A good name NA-ALD in radio

Note this important point
**SILENCER
SOCKET**

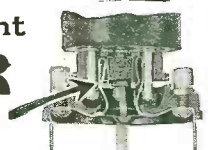

There is a difference in radio sockets. Any engineer or radio fan of long standing who has had years of experience with Na-Ald sockets, and other sockets, will tell you that—very emphatically.

And now to crown the achievements of the pioneer socket designer and manufacturer comes the nation-wide acceptance of the Na-Ald Silencer Socket.

Note how the same continuous strip of phosphor bronze which holds the prongs of the tube in triple-locked, firm embrace and provides connection with the binding posts, gives also the silencing and cushioning effect which renders the tube free from all disturbing microphonic noises more effectively than does any other socket.

Be sure to get nothing less than the Na-Ald Silencer Socket No. 481 XS for the set you build. Owing to great production facilities this socket can be priced at 50c.



481 XS Silencer Socket

Two other Na-Ald sockets are the 481 X—similar to the 481 XS but minus the Silencing feature—at 35c, and the 400, the heavy duty De Luxe Socket for the high voltage power tubes, priced at 75c.

Na-Ald Sockets are at all good dealers. If out of stock, write to us, mentioning dealer's name and address.

ALDEN MANUFACTURING COMPANY
Dept. K25 Springfield, Mass.



New! Crackle Surface ACE HARD RUBBER PANEL of highest insulating efficiency with a distinctly attractive surface finish.

In regular ready-cut sizes:

- 7x10 7x18 7x26
- 7x12 7x21 7x30
- 7x14 7x24

Popular prices. All dealers.

Made by the makers of the famous RADION PANELS.

Write for price list.

American Hard Rubber Company
11 MERCER ST., NEW YORK

CORWICO Radio's Best Wire "FROM THE GROUND UP"

Every spool or coil of Corwico Wire is guaranteed full weight, full length, full gauge best grade of copper, insulated with the best materials obtainable, free from all defects and up to the highest specifications in every respect.

Ask Your Dealer for Corwico Wire. Write for interesting booklet on radio wires and their uses.
Dealers and Jobbers—Write for the "Corwico" wire proposition.

CORNISH WIRE COMPANY
30 Church Street New York City

Watch "Radio News" for the Newest Receivers

IT KEEPS YOU IN TOUCH WITH RADIO'S LATEST CIRCUITS

COPIES 25c ON ALL NEWSSTANDS

The Quadraformer "6" Receiver

Beautify
and
Modernize
Your Set

with the
Cornell Dial

IN appearance, this smooth friction 9 to 1 Vernier Dial has a deeply etched plate, in antique gold finish. Artistic enough to embellish the most attractive and modern sets on the market.

Send for this Dial today. It will add to the beauty of your set . . . enhance your pleasure in its appearance and bring greater ease in its operation.

List Price - \$1.50



CORNELL ELECTRIC MFG. CO.,
Lomb Island City, N. Y.
Employed please send Money Order for \$1.50 each, and name
of your nearest dealer. (Cornell Dials at \$1.50 each, and name
of your nearest dealer.)
Name _____
Address _____

**AGAIN
FIRST!**

AGAIN RADIO NEWS gives the Radio Public its first knowledge of the latest and finest receiver of the day!

In this issue is described the Quadraformer "6" Receiver. The finest of its class in Radio.

Read this fine article and pass it on to your friends. Copies of this issue can be secured on all newsstands or by writing direct.

RADIO NEWS

53 PARK PLACE
NEW YORK, N. Y.

The **LYNCH**
Metallized
RESISTOR
ASSORTMENT



Contains the following:—
Three .1 Meg.
One 1 " "
One .5 " "
One .25 " "
One 2 " "
Complete, \$4.25



METAL long has been recognized as the best of electrical conductors. The Lynch Metallized Resistor has received the unqualified endorsement of leading engineers, experimenters and test laboratories because it is absolutely silent in operation and remains permanently accurate.

Comprising a concentrated metallized deposit one-thousandth of an inch thick upon a glass core and sealed within a glass tube, each LYNCH METALLIZED FIXED RESISTOR wins in the exacting tests of time and service.



The old carbon lamp consumed more current to give less light. Tungsten, which is metal, proved more efficient, more dependable. The Lynch Metallized Resistor gives non-arcing, conductive resistance. It marks as great an advance as did the tungsten lamp.
Arthur H. Lynch

Warranted—

Absolutely Noiseless
Permanently Accurate
Dependable!

If your dealer cannot supply you, we will ship by return mail. You take no risk as Lynch products are sold on a money-back guarantee. Use the Convenience Coupon below.

PRICES	.25 to 10 Megohms	.50
	above .01 to .24 "	.75
	.001 to .01 "	1.00
	Single Mounting	.35
	Double Mounting	.50

Write for complete list of ranges.

ARTHUR H. LYNCH, Inc.

Manufacturers of Radio Devices
Fisk Bldg., B'way & 57th St.
New York, N. Y.



The NEW LYNCH EQUALIZER (Filament Control) for any combination of tubes \$1.00 Complete with Mounting.

Dealers: Get our FREE "Advance Information" Service

ARTHUR H. LYNCH, Inc., Fisk Bldg., New York, N. Y.
Send me the Lynch Assortment described above (7 Lynch Metallized Resistors) with the understanding that I am to receive my money back if not satisfied. I will pay postman on delivery, \$4.25, plus postage.
(Name) _____
(Address) _____

Or send check or money order and prepay postage.

The **Quadraformer "6" Receiver**

RADIO STANDARDIZES LANGUAGE

The introduction of radio and the necessary broadcasting has given new importance to the pronunciation of words. There is a natural desire on the part of announcers to pronounce properly and it is no reflection on their intelligence or education to say that they may often be uncertain as to the right emphasis or inflection to give words that come up unexpectedly, or doubtful precisely which sound of vowels therein may be correct usage. Most persons, especially those who read much, see many words that they seldom hear pronounced; knowing their meaning, they pass on, indifferent to the sound.

Of course, when a man broadcasts his own poetry, or his speech or sermon, he is presumably able to pronounce any word he has written; at least he deserves no compassion if he stumbles over them. But if he is using another man's language he needs to be reasonably well equipped in regard to pronunciation of debatable or unfamiliar words. The matter has become so important in England that the British Broadcasting Company has secured a committee to which such problems may be presented. This committee includes, among others, such high authorities as Sir Johnston Forbes-Robertson, Bernard Shaw and Robert Bridges, poet laureate.

Radio broadcasters have a great opportunity to teach the proper pronunciation of our language and it behooves them to acquire the best standard usage. If they could only demonstrate the charm of musical voices, too, they would render a double service.

—Terre Haute, Ind., Star.

The **4**

BIG REASONS

for a Power Amplifier and a Constant Plate Supply

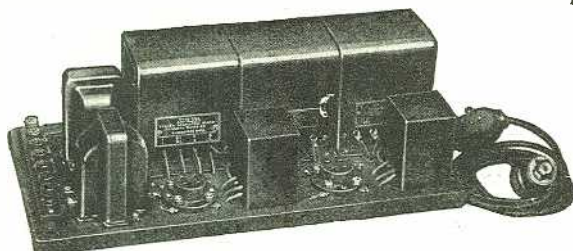

Showing GENERAL RADIO Type 395 Kit Fully Assembled

- 1** MORE FAITHFUL REPRODUCTION is obtained through the use of a UX-171 or CX-371 power tube in the last audio stage than is possible through the use of tubes in more common use such as the 199, 120, 201A, and 112 types, because of the greater load the UX-171 or CX-371 is capable of carrying. An output transformer between the amplifier output and speaker input still further improves tone quality by adjusting the impedance of the amplifier to the speaker.
- 2** MORE VOLUME is secured through the use of the UX-171 or CX-371 power tube without the necessity of extremely high plate voltages than is possible with any other type of amplifying tube.
- 3** UNVARYING PLATE SUPPLY allows the tubes to be operated constantly at their most favorable plate voltages without fear of inferior reception so often caused by a steadily deteriorating source of plate voltages such as dry batteries.
- 4** A. C. OPERATION OF THE POWER TUBE FILAMENT from the low voltage secondary of the rectifier transformer provides power amplification for the dry cell operated receiver as well as the storage battery set at only slightly greater cost of operation than the plate supply unit alone.

The Type 395 Raytheon Powerful Amplifier and Plate Supply Kit

The kit is supplied complete with all necessary parts, including a drilled base board, cord with wall plug, switch, binding post strip, and all screws and nuts. By following the simple instructions furnished with each kit, it can be assembled in only an hour or two by the most inexperienced amateur builder.

Price of Type 395 Kit, \$50.00

Ask your dealer or write today for free descriptive folder containing full instructions for assembling the 395 kit and a full scale pictorial diagram.

GENERAL RADIO CO., Cambridge, Mass.

GENERAL RADIO

PARTS and ACCESSORIES

"Behind the Panels of Better Built Sets"

The Radio Amateur

(Continued from page 996)

by talking things over with some other fellow; and is there any better method of talking matters over, with someone thousands of miles distant, than by means of radio? The average fellow in the city knows lots of things about the large towns of which his country cousin is unaware; but the same thing may be said about the country boy too; he can tell the fellow from town a few things the latter did not dream existed. Now extend this thought to the youth of different countries and you can easily see just how much the amateur—if he be intelligent—can glean from his sessions with his set.

It need hardly be mentioned that, in almost every spot that is anywhere near civilization—and some far from it—there will be found the antenna of the amateur. In the far places these men modestly do great work for which they never receive more than the merest "Thank you." Yet there is unquestionably a benefit to be derived, for this service inculcates, perhaps subconsciously, a sense of service and duty, which are two things that every good citizen should possess.

HOW TO BREAK INTO THE GAME

Now that we have somewhat hastily gone over the amateur field, what are the requirements which one needs to bear the title, "Radio Amateur?" They are few: in the first place the embryo ham must become familiar with transmitting and receiving circuits. This data can be had from some amateur or, if there is no one available, it may always be found in books. The code must be learned, for in the examination held by the Government he must be able to copy and transmit at least ten words per minute. He must also be able to handle "traffic," as the sending forward of messages is called,

NEW AERO COIL KIT

ALL GENUINE PARTS IN STOCK NOW!
FREE WHOLESALE CATALOG
Listing thousands of new radio parts, kits, furniture, accessories and complete radio sets, at prices that save you money. Write for your copy now. It's free.
THE HARCO CO., 1253 S. Wabash Ave., Chicago, Ill.

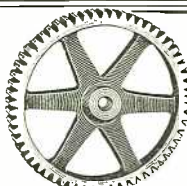

GEARS All Kinds—Small

The most accurate made and prices reasonable. We carry a complete line of gears in stock for immediate shipment. Can also quote on special gears of all kinds. Send us your inquiries. Write for Catalogue 40
Chicago Stock Gear Works
105 South Jefferson St., Chicago



ERLA

Erla Crystals still reign supreme for use in any circuit employing a crystal detector. Super-sensitive, permanently adjusted, assuring full volume at all times. Ideal for reflex sets. Buy this better crystal at your dealers. If he cannot supply you we will send it prepaid to any city in the U.S. for \$1. Electrical Research Laboratories, 2500 Cottage Grove, Chicago, Ill.

ELKAY EQUALIZORS

specified as "ballast" for the Aero Coil Receiver are made by The Langbein-Kaufman Radio Co. (Dept. N), 62 Franklin St., New Haven, Conn. Write for prices and tables of values.

Insure your copy reaching you each month. Subscribe to Radio News—\$2.50 a year
Experimenter Publishing Co., 53 Park Place, N. Y. C.

Attach this marvelous amplifier

\$25 to your set
ready to attach.
in less than
5 minutes

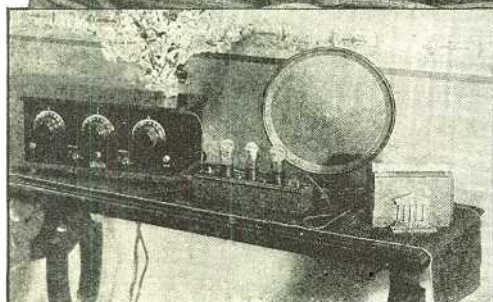
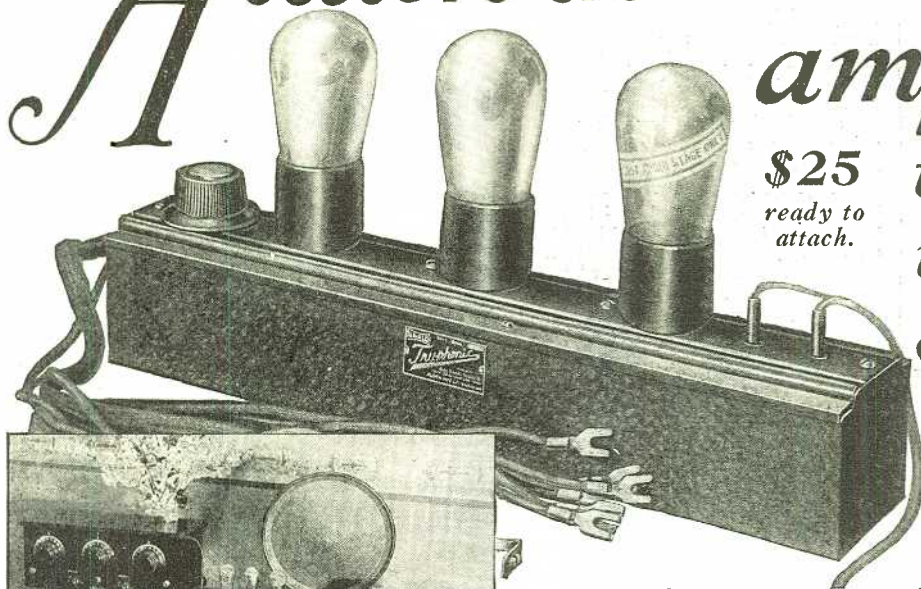

and get
the biggest thrill out of
radio you have ever had



Any radio set—no matter what type, make, or age—can instantly be transformed to give you such rich and clear and natural reproduction of music and speech that you will be absolutely astounded. You cannot duplicate Truphonic amplification, *no matter how much you can afford to pay*. At the low price of \$25, the Truphonic brings a thrilling new enjoyment of radio within the reach of all.

Truphonic amplification is not surpassed--at any price

If you want this new thrill in radio, do this: Get the Truphonic amplifier at your radio dealer's. Place it alongside, or behind your set. Make one simple connection to your set. (A clip goes over one prong of the detector tube —done in 10 seconds). Connect the battery cable. Take the regular standard audio tubes from your set. Insert them in the Truphonic, along with an extra tube (either 201A or power tube). Plug loud speaker into Truphonic. That is all. The rest is a song of praise from you and from all of your friends who hear it.

The Truphonic employs an audio coupling system that is definitely superior to transformers, resistance coupling, or impedance. Three stages of this advanced coupling give much greater distortionless volume than is possible by any other method.

Power tubes can be used, and in fact are recommended for the very best results, owing to the fact that for great volume a power tube has a much greater undistorted output capacity than a 201A.

We recommend using a UX 171 tube. (The wiring to extra B and C batteries is provided for in the Truphonic cable). This combination gives exceptional volume, with an unapproached faithfulness. But in any case, whether you use a power tube or not, the Truphonic will vastly improve upon your present reproduction. (Truphonic Amplification is also to be had in single coupler units, described on the next page).

Don't let another night go by without getting all that radio can give in beautiful reproduction. Attach a Truphonic to that set of yours and expect the biggest radio thrill you have ever had.

If your dealer has not yet stocked the Truphonic Amplifier, we will send you one direct on a 5-day money back trial. Be sure to mention your dealer's name and address.

ALDEN MANUFACTURING COMPANY
Dept. K-25 Springfield, Mass.



TRUPHONIC
POWER AMPLIFIER





A few points on Truphonic Superiority

We make the statement that Truphonic amplification (*not to be confused with dual impedance*) is the most perfect audio coupling so far developed. We further state that using the same tubes in a comparison with any other method of coupling, whether transformer, resistance, or impedance, Truphonic affords the most perfect reproduction obtainable in radio—regardless of the price you pay.

These are strong statements—but they hold out to you the promise of the greatest radio enjoyment you have ever had.

This is good news indeed for radio fans and set-builders, as well as for set manufacturers, for today radio value is measured by radio reproduction.

Convincing proof

Here are just a few examples of Truphonic superiority:

With 201-A tubes throughout Truphonic is better than any other method in quality and volume.

With Hi-Mu tubes in the first 2 stages, the volume simply steps up, maintaining the same quality. In fact 2 stages of Truphonic with Hi-Mu tubes at 90 volts will give you greater amplification and quality than two transformers using one 201-A and one 171 Power Tube at 180 volts.

With 199 tubes results are noticeably better with Truphonic and you can go so far as to use four stages of Truphonic with a 120 in the last stage. This of course could not be done satisfactorily with transformers or resistance.

With 199 tubes in the first two stages and a 210 power tube in the last stage results are obtained which could not be duplicated with other coupling methods.

We give this data to show how universal Truphonic is in its use with various tube combinations, giving in every case results superior to all other coupling methods.

Low in price

Every set-maker whether amateur or commercial owes it to himself to get full information on Truphonic amplification.

The individual Truphonic Coupler is No. 301 and is priced at \$5.00. If your dealer cannot supply, write direct.

The quick attachable Truphonic Amplifier, (fully described elsewhere in this issue) consists of 3 stages of Truphonic coupling and the Output Unit.

The Output Unit No. 300, which has the same exterior appearance as the Truphonic coupler, is designed to protect your speaker from demagnetization and burning out. R.C.A. in its Power tube circular recommends that an Output unit be used when the B battery is 135 volts or more. Price \$5.00.

ALDEN MANUFACTURING CO.,

Dept. K25

Springfield, Mass.

and have about a year's experience in this field, before he becomes a full member of the amateur clan.

Amateurs, for the most part, transmit messages in the "Continental" telegraphic code, which is that used by "hams" all over the world. There are also more and more "hams" who are turning to 'phone transmission; but it should be remembered that before anyone may use the latter he must pass an examination showing his proficiency in using code and ability to handle traffic. Amateurs may use any power up to 1000 watts (1 kw.), but there are many who do not use anywhere near this power, yet get remarkable results. This is true particularly on the very short waves, that is those under 40 meters. Amateurs can not broadcast programs without obtaining a special license.

Those readers who are interested in learning more about the "hams" and their work, and who would like to join the ranks of these enthusiasts, should consult or write to the District Radio Supervisor for that district in which they are located, as given below.

Do not think that this amateur radio business entails any great expense, if that idea is holding you back. It does *not*. As you may know, there are certain wave bands allotted to the amateurs and these are all below 200 meters—and in passing it might be said that there is much to intrigue the experimenter in this short-wave region. Now, if you have some radio parts lying around the work-bench, with a very little additional expense it will be possible for you to rig up a transmitter that will give you mighty fine results. Some of the great records for distant work have been made by men using only a *fraction of a watt in their transmitter*.

The cost for a very good amateur station, at the start, may be in the neighborhood of two hundred dollars. This may be taken as a *maximum price*; because there are plenty of fellows who have broken into the game successfully with a very much smaller outlay of funds than that.

Therefore, why not get busy and learn the code? You are most likely familiar already with receiving circuits and can get the inside "dope" on those pertaining to transmitting in a short while. If you have no hobby already, here is one, whereby you will not only have a lot of fun yourself, but you will actually be doing something to further a great work.

FIRST DISTRICT

Maine, New Hampshire, Vermont, Massachusetts, Rhode Island and Connecticut.

District Radio Supervisor, Customhouse, Boston, Mass.

SECOND DISTRICT

The second district comprises the States of New York (county of New York, Staten Island, Long Island, and the counties on the Hudson River to and including Schenectady, Albany, and Rensselaer), and New Jersey (counties of Bergen, Passaic, Essex, Union, Middlesex, Monmouth, Hudson, and Ocean.)

District Radio Supervisor, Sub-Treasury Building, New York, N. Y.

THIRD DISTRICT

The third district comprises the States of New Jersey (all counties not included in second district), Pennsylvania (Philadelphia, Delaware County, and all counties south of the Blue Mountains, and Franklin County), Delaware, Maryland, Virginia and the District of Columbia.)

District Radio Supervisor, Customhouse, Baltimore, Md.

FOURTH DISTRICT

The fourth district comprises the States of Tennessee, North Carolina, South Carolina, Georgia, Florida, and the Territory of Porto Rico.

District Radio Supervisor, Haas-Howell Bldg., Atlanta, Ga.

FIFTH DISTRICT

Alabama, Mississippi, Louisiana, Texas, Tennessee, Arkansas, Oklahoma and New Mexico.

District Radio Supervisor, Customhouse, New Orleans, La.

SIXTH DISTRICT

The sixth district comprises the States of California, Nevada, Utah, Arizona and the Territory of Hawaii.

District Radio Supervisor, Customhouse, San Francisco, Calif.

100 VOLT STORAGE "B" BATTERY

Think of it. Highest grade 100 volt storage "B" Battery for only \$10.00 — just a few cents more than the cost of one set of dry "B". Lasts for years. Upkeep cost practically nothing. Recharged any time, in a few hours. Heavy hard rubber case. Rugged, thick plates. The greatest Storage "B" Battery value ever offered.

For real, perfect radio reception Storage "B" Batteries are absolutely necessary. No sputtering, crackling or humming. Smooth, quiet, powerful. Service "B" Batteries have been on the market 5 years. Over 30,000 satisfied users. End your "B" problem now by ordering the old reliable "Service."

\$10

We ship same day order received. Also made in 50 Volts at \$5.50—125 Volts at \$12.50.

Think of it. Highest grade 100 volt storage "B" Battery for only \$10.00 — just a few cents more than the cost of one set of dry "B". Lasts for years. Upkeep cost practically nothing. Recharged any time, in a few hours. Heavy hard rubber case. Rugged, thick plates. The greatest Storage "B" Battery value ever offered.

For real, perfect radio reception Storage "B" Batteries are absolutely necessary. No sputtering, crackling or humming. Smooth, quiet, powerful. Service "B" Batteries have been on the market 5 years. Over 30,000 satisfied users. End your "B" problem now by ordering the old reliable "Service."

We ship same day order received. Also made in 50 Volts at \$5.50—125 Volts at \$12.50.

SERVICE BATTERY CO.

704 East 102nd St., - Cleveland, Ohio

FIVE TUBE RADIO

\$25.00

AGENTS WANTED
BIG COMMISSION

Demonstrating agent wanted; every county. Exclusive to right man. Sell what public wants — five tube, long distance, loud speaker radio with single dial control. Price within reach of all, \$25.00 retail; liberal discount to agents. Sell in spare time—evenings. No selling or radio experience necessary. Territory going fast. 100 page Radio Book FREE. Write today—don't delay.
CC FISCHER, 122 W. Austin Ave., Chicago

A NEW RADIO PLUG

Simple to use, gives perfect electrical contact with any style tip.

Simply push cord tip through plug, loop cord and push tip back into plug.

Sent postpaid on receipt of 50c

CULVER-STEARN'S MFG. CO
Worcester, Mass.

NOW DIRECT FROM FACTORY

100 VOLTS \$10.95

NON-ACID RECHARGEABLE STORAGE "B" BATTERY

130 VOLTS \$13.95

"B" BATTERY CHARGER \$2.99

ORDER DIRECT TODAY

This everlasting, Non-Deteriorating Improved Alkaline Storage "B" Battery—Use 10 Days—if Not Satisfied Return and Your Money Will Be Refunded.

MARTIN. 706 So. Ashland Blvd., Chicago



COMPLETE
Nothing else to buy. Replaces "B" Batteries. Operates direct from Electric Light Socket on 110-120 volt A. C. Lighting Circuit. Delivers up to 100 volts.

\$17.50

New High Voltage Model Complete: Delivers up to 180 Volts

Not only the most reasonable

but proved by 40,000 users to be also the most convenient, unflinching and satisfactory "B" Eliminator

New High Voltage Model

for extremely large sets, or sets using power tubes, now perfected. Delivers up to 180 volts. One control adjusts voltages on all taps.

Equal to any "B" Eliminator regardless of price—not only in operation, but in workmanship, quality, durability and appearance

Money Back Guarantee

Stop paying out money for costly, unreliable battery service and repairs. Permanent excellence can be built into economical "B" service. 40,000 users of the good Ferbend "B" Eliminator agree. That is why during the slack summer season we worked at full capacity to meet orders. That is why hundreds of unsolicited testimonials prove beyond the shadow of a doubt its splendid, enduring performance.

Ask Your Dealer—or Send Direct

Shipment made direct on receipt of price, or C. O. D. if preferred. Use for 10 days to convince yourself—if unsatisfactory write us within that time and purchase price will be refunded. Use Coupon NOW.

FERBEND ELECTRIC COMPANY
425 W. Superior St., Chicago, Ill.



They Want YOU to Know

Montreal, Canada
I am pleased to state that the Ferbend "B" Eliminator purchased from you is a wonder and is giving results far beyond my expectations. The tone and volume would satisfy the most critical.
James Stroud,
Electrical Engineer.

Younstown, Ohio
Your Eliminator is the best buy I have made in a long time. It has already more than paid for itself in saving on "B" batteries.
R. L. Welsh.

Springville, N. Y.
Having had perfect results with the seven Eliminators recently purchased you may send me six more by express at once.
Leonard J. Cooper.

Burbank, Calif.
I am more than pleased with your Eliminator. I am getting several Eastern stations through about 15 locals using the Eliminator.
Jean Barnard.

St. Petersburg, Fla.
I used your Eliminator all last winter, and it was as good, if not better than several I tried of much higher price. I am more than satisfied.
Ben M. Pyatt.

Trenton, N. J.
I have used your Eliminator for several months and unhesitatingly recommend it. It has added 25 per cent to the volume of my set and always has full voltage.
J. M. Starger

New Orleans, La.
The "B" Eliminator which I purchased from you some three or four months ago has given entire satisfaction and I am well pleased with its performance.
C. J. Murphy

Wilmington, N. C.
I am well pleased with the Eliminator I purchased some time ago. It is all you claim and more. It brings in signals louder and clearer than any set of dry batteries I ever used.
T. E. Lyon.

Amsterdam, N. Y.
I have compared your Eliminator with other makes and it cannot be beat. My reception has easily increased 50 per cent. It gives me much better results than I was ever able to get with dry batteries. William Davis.

Wheeling, W. Va.
The Eliminator purchased some time ago is giving remarkable results.
William A. Raper, Jr.

Des Moines, Ia.
Your Eliminator is fine.
Rev. F. A. Case.

Louisville, Ky.
Your Eliminator is all you claim it to be. Am very much pleased with it.
Alonzo G. Smith.

Oil City, La.
Your Eliminator has given me good service for over a year.
George May.

St. Louis, Mo.
After giving your "B" Eliminator a thorough trial I wish to state that I am thoroughly satisfied. Its performance is perfect—absolutely no hum whatever.
Frank Kolar.

Mattapan, Mass.
I have used your Eliminator for six months and am satisfied with it in every way. It has increased the volume of my 6-tube Neutrodyne fully 60 per cent and there is absolutely no hum from the 60-cycle line.
John W. Pursell, Jr.

Second Successful Year

FERBEND "B" ELIMINATOR

Approved and passed by the rigid Laboratory Tests of the two foremost Radio Laboratories in America
—Radio News and Popular Radio

FERBEND ELECTRIC CO.
425 W. Superior St., Chicago, Ill.

Send \$12.50 model. Send \$17.50 model.
 Send at once. Payment enclosed.
 Send C. O. D. Send literature.

Name

Address

City.....State.....



Build This Professional Set--- and know You Have the Best

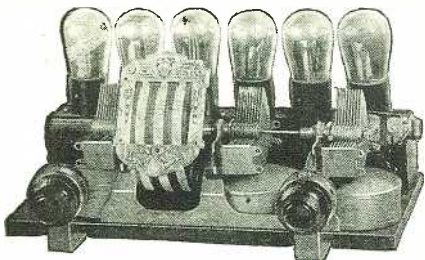

The professional set shown above, for all its compactness, is a giant in performance. And there are two very definite reasons why this set which may be built for less than \$40 will out-perform sets costing actually 5 times as much!

Truphonic Amplification

The audio end is the now famous Truphonic amplification (fully described on another page).

Three stages of the superior Truphonic amplification and an output unit to protect your speaker are housed in a steel catacomb. The gang socket panel which neatly covers the catacomb provides for 6 tubes—3 for audio, and 3 for the tuning end of the set. No holes to drill no apparatus to mount. Can be used in a hundred different circuits. Price 6 tube—\$25, 7 tube—\$27.



Localized Control Tuning Unit

With the Localized Control Tuning Unit all three condensers can be tuned together or separately by the fingers of one hand, giving single dial simplicity with multiple dial efficiency.

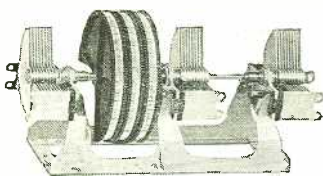

When used with shielded coils and the Truphonic Catacomb Assembly you have a set that is ultra professional in efficiency. Rotors grounded to chassis, coil shields grounded to chassis, no grid leads longer than 2 inches, most advanced amplification, output unit—a thoroughly engineered set that you wouldn't trade for a commercial set at 5 times the cost.

Localized Control Tuning Units (including handsome panel plate) are provided in several models. Double (.000375) \$8. Double (.0005) \$10. Triple (.000375) \$10. Quadruple (.000375) \$15. Double with Tickler Control (.000375) \$10.

If your dealer hasn't the Truphonic Catacomb Assembly and Localized Control Tuning Unit, send to us. Be sure to mention your dealer's name and address.

ALDEN MANUFACTURING Co.,
Dept. K25 Springfield, Mass.

SEVENTH DISTRICT

The seventh district comprises the States of Oregon, Washington, Idaho, Montana, Wyoming, and the Territory of Alaska.
District Radio Supervisor, Federal Building, Seattle, Wash.

EIGHTH DISTRICT

The eighth district comprises the States of New York (all counties not included in the second district), Pennsylvania (all counties not included in the third district), West Virginia, Ohio, and Michigan (Lower Peninsula).
District Radio Supervisor, Customhouse, Detroit, Mich.

NINTH DISTRICT

The ninth district comprises the States of Indiana, Illinois, Wisconsin, Michigan (upper Peninsula), Minnesota, Kentucky, Missouri, Kansas, Colorado, Iowa, Nebraska, South Dakota and North Dakota.
District Radio Supervisor, Customhouse, Chicago, Ill.

NEW QRA's

M-XCID, Major MIGUEL CID D. LEON, Frontera, Tab., Mexico, 47 meters; attached to military station XC4, 55 meters. Experiments on 35-40 and 45-50 meters, from 10 to 12 a. m. and 5 to 8 p. m., Mexico City time.
2AMG, BERNARD FEIN, 900 Riverside Drive, New York City. 5 watts. All cards acknowledged.

THE IDEAL RADIO AMATEUR

Editor, RADIO NEWS:

Amateurs hail from every state of this broad land of ours, from Canada to the Gulf and from the indented shores of New England to the West's Golden Gate. Some of these fellows are tall and slender, mere youths; others have grown old and stout, weighted down by the dull cares of business. Yet they are all amateurs, and derive their pleasures mainly from their pursuit of the game. They are of every race, creed, type, and variety. And for a certainty this is true: within the past year radio enthusiasts have encircled the globe. Their high-frequency signals are extending out in ever-widening circles, penetrating the remotest corners of the African jungles, the hearts of the great metropolitan areas, the barren wastes of the Arctic region—and at the same time tickling the receivers of a BCL in the next block. They are leaving new converts in the paths of their signals, each a missionary for the art. Australians, Africans, Asiatics, Europeans, South and North Americans, representatives of all continents, are now brothers at the key.

Is it possible to choose any one person so gifted with the attributes of greatness to be hailed as the leader of so great a multitude? Even though we have had such outstanding amateurs as the Hoover cup men from year to year, besides winners of the Wouff-Hong trophy, the Cooper cups, the Jewell prize, the Boomerang trophy, the Chilean Hat trophy, the Jenkins awards and the Brown Derby trophy—even so, whom shall we choose as the leader?

Why not first consider what constitutes the representative amateur, how he must conduct himself, and why he is representative? When this is done we will be better able to make a decision. In addition, we will then have little difficulty in setting up a standard of which anyone might be proud.

WHAT IS AN AMATEUR?

An amateur has been defined as one who devotes himself to any hobby for the love of the thing itself, for the personal interest he takes in it and the satisfaction that he gets from it; not for any extrinsic reason, direct or indirect. It is also well to mention that the word *amateur* does not signify a youth or a mere beginner. Thus we see how this definition applies especially well to a radio devotee. He confines his interest to amateur radio for the love of the game itself and not for any pecuniary return.
Amateur radio operators, when they first

DESIGNED to OUTLAST
World Storage A Battery

Two-Year Guarantee Bond in Writing **NEW LOW PRICES**

Famous the world over for reliable, enduring performance. Solid Rubber Case lasting protection against acid or leakage.
Approved and Listed as Standard by Leading Authorities
including Radio News Laboratories, Popular Sci. Inst. Standards, Pop. Radio Laboratories, Radio Broadcast Laboratories, Radio in the Home and Lefax, Inc.
Send No Money
Just state number wanted and we will ship same day order is received, by express C. O. D. Pay expressman after examining batteries. 5% discount for cash with order. Remember, you save 50% on World Batteries—so send your order today.
WORLD BATTERY COMPANY
Dept. 10
1219 S. Wabash Ave., Chicago, Ill.

Solid Rubber Case Radio Batteries	6-Volt, 100-Amperes	\$10.00
6-Volt, 120-Amperes		\$12.00
6-Volt, 140-Amperes		\$13.00
Solid Rubber Case Auto Batteries	6 - Volt - 11 - Plate	\$10.00
6 - Volt - 13 - Plate		\$12.00
12 - Volt - 5 - Plate		\$14.50

Get four radio dial set 258.3 meters for the World Storage Battery Station WSPC. Variety—new talent—always interesting.
Jerry Sullivan, Dir. and Announcer "Chi-CAW-go"



Radio's Newest Improvement

The Rono Multi-Stage Jack and Filament Switch

The Rono eliminates all jacks and push-pull plugs and attendant wiring and soldering. The Rono dial controls the batteries and both audio stages. Each stage a filament control. Recommended by Radio Engineers, Editors and Fans—Single hole mounting—Will outlast the receiver—absolutely efficient—saves time, labor and parts. You will never use another jack after you see the Rono. Get one at your Dealers today.
EACH \$2.50
If your Dealer cannot supply you order direct, enclosing \$2.50 or we will ship C. O. D.
Write for circular describing the Rono and its uses.
DEALERS—Write for Discouets—JOBBERS
Rono Mfg. Co., 428 S. Clinton St., Chicago

HEAR the wonderful New Acme Speaker at your dealer's.

ACME
for amplification

PATENTS

DON'T LOSE YOUR RIGHTS
Before disclosing your invention to anyone send for free blank form "EVIDENCE OF CONCEPTION" to be signed and witnessed.
LANCASTER & ALLWINE
Reg. Pat. Attys. in U. S. and Canada
270 Ouray Bldg., Washington, D. C.
Originators of the form "Evidence of Conception"

ARE SELF-CONSCIOUS? YOU DO YOU STAMMER?

You must overcome Self-Consciousness—Mental Fear—Bashfulness to succeed in the business and social world. Send 10c for amazing booklet, "Road to Poise and Achievement." Tells how thousands have conquered Self-Consciousness in a very short time.
SEYMOUR INSTITUTE, 38 Park Row, Dept. 35 New York City

Largest variety of Radio Parts!

**1926
EDITION
No. 16**
300
Illustrations

8-Page
log book of
all U. S.
Broadcast
Stations

RASCO RADIO PARTS CATALOG No 16

**RASCO
HAS
IT**

**THIS
68 PAGE
RADIO
CATALOGUE
FREE**

75 HOOKUPS

Radio Specialty Co.
96 98 Park Place
New York

"ALL GOODS SENT PREPAID IN U.S.A."

BUY FROM RADIO'S OLDEST MAIL ORDER HOUSE

WE are the oldest established, exclusive radio mail order house in the country. Our motto is "Quick Shipment." All orders are shipped within 24 hours. Quick, prompt, courteous service. We carry a larger variety of radio parts and findings than any other radio house in the country.

"RASCO HAS IT"

If you are in need of certain small radio parts that other radio and mail order houses do not bother to carry, get the Rasco parts catalog, and you will find them there, anything from a screw to copper ribbon and telephone diaphragms, as well as thousands of other small radio findings. Just to mention a few:

Lugs, nuts, dials, vernier dial, jacks, plugs, every kind of knob, cords, panels, screws, sliders, washers, selenium, tinfoil, switches, crystals, cap nuts, Litz wire, cord tips, brass rods, resistances, name plates, spring binding posts, switch parts, metal ribbon, carbon balls, binding posts, all types, switch points, switch levers, lock washers, carbon grains, ground clamps, metal pointers, insulated tubing, low melting metal, antenna connectors, bus bar wire, as well as thousands of other articles.

We carry the Largest Variety of Small Radio Parts in the World.



THE NEW RASCO CATALOG No. 16

Contains the Following Hookups

All Armstrong Circuits: These important circuits are explained clearly, all values having been given. Just to name a few of the Vacuum Tube circuits: The V.T. as a detector and one-step amplifier; Super Regenerator; one-step radio frequency amplifier and detector; three-stage audio frequency amplifier; short wave regenerative circuits; 4-stage radio frequency amplifier; radio and audio frequency amplifier; inductively coupled amplifier; all Helix Circuits. This catalog is crammed full of small parts and radio findings, literally thousands of them. In addition there is much useful information contained herein.

If you will paste this coupon on a post card and mail today, we will be pleased to send you our new Catalog at once. 

RADIO SPECIALTY CO., 98 Park Place, New York		RN 2-'27	
You may send me, without charge or obligation, your NEW CATALOG No. 16. (Write on margin if you desire.)			
.....			
Name			
Street			
P. O.		State	

RADIO SPECIALTY CO.

98 Park Place

New York, N. Y.

A Shortage of Trained Radio Men!

Never has there been such a demand for qualified radio men—service men, salesmen, technicians, broadcast and commercial radio operators. The Radio Institute of America has been called upon for trained men by radio organizations located in all parts of the country. Yet we cannot supply the New York City demand alone.

You can't get better radio training than that offered by the Radio Institute of America. These courses planned and supervised by RCA secure you your 1st Class Commercial Radio Operator's License. And an immediate position awaits every graduate.

Moreover you can study at home in spare time.

This coupon will bring you complete information.

-- TEAR OUT -- (B)

Radio Institute of America
324 Broadway, New York City

Please send me full information about your Home Study Course of radio instruction.

I am interested in the complete course, including code instruction, which qualifies for the U. S. Gov't Commercial or Amateur Radio License.

I am interested in the technical course for radio dealers, jobbers and salesmen.

Name.....

Address.....

RADIO INSTITUTE OF AMERICA

Formerly Marconi Institute
Established in 1909

324 Broadway, New York City

break into the game, experience almost immediately the prevalent feeling of mutual understanding, equality and friendliness. This is what one might call the spirit of the thing; and the sooner one becomes imbued with these qualities the sooner he emerges from the embryonic state. Upon reaching the expert stage of the game, the amateur no longer needs help himself, but he is ever ready to aid a brother beginner or an inquiring BCL. In the course of his education he acquires a polish and takes on a lustre; in other words, his star begins to shine.

A radio amateur is to be distinguished from the average BCL, because his is a field of *service*, while the BCL is to be *served*. And the more any particular amateur serves, the more representative he becomes, of the game of which he is a part. Why?

Because the amateur radio game has been fostered with the idea that it may, if only in a small way, be of service to others, as well as serving to create a friendly understanding and spirit of cooperation between its members. So successful has the idea been in the hands of the American amateurs that their service to the general public has increased by leaps and bounds, even exceeding the dreams of its famous pioneers.

This spirit has extended outside our own country, on the wings of their signals, into far and distant lands; until now there is no continent that does not possess numerous radio amateurs. Regardless of nationality or race all are absorbed in the good they are able to accomplish and sympathetic with their fellow men, particularly in those with whom they come in contact through the highways and byways of the air.

THE WAY TO DO THINGS

So far, we have been speaking in generalities; now let us be a little more specific. Every worthy transmitting amateur makes certain, by inquiring among his neighbors regarding the matter, that his signals do not cause interference. Should interference be evident, he makes every effort to remedy the trouble; and if he is not wholly successful, he rearranges his operating hours accordingly. He makes sure that his station and operator's licenses do not lapse; in fact, he makes application for renewal two or three weeks prior to the expiration date to guard against legal difficulties. He does not change the address of his station or make any major changes in the apparatus or antenna without first submitting the facts regarding the case to the supervisor of radio, to learn whether his present license must be changed.

He abides by standard operating procedure in an effort to assist in minimizing interference caused amateur or other radio services. To do this he must endeavor to keep his transmitter in a stable operating condition. He must not overlook the character of the emission, and he must obtain a pure and sharp wave by careful adjustments, good circuit design, and adequate essential apparatus.

An amateur who is trying for commendation must be active and dependable. He handles message traffic for his fellow citizens gratis, even going so far as to advise them of this feature. He offers his cooperation and the aid of his station to the railroads and other public services for use in times of emergency; preparing in advance by prearranging schedules with other public-spirited amateurs in order that routes may be ready when needed. He offers himself to either the army or naval reserve. Nor does he fail to give his local club his active support; in fact, he uses his club experience as a stepping-stone to more responsible positions in organizations of national and international scope.

THE RESULT

Thus we have outlined some of the minor and major qualifications of our outstanding amateurs. An individual possessing such attributes in full measure must eventually find himself a leader. Then, by combining

A good name



Use Power tubes for good quality at full volume

SIMPLY ADAPT TO YOUR SET WITH

Connectoralds

(Reg. U. S. Pat. Off.)



The use of a Power Tube in the last audio will very greatly improve your tone quality. No change in set wiring is necessary when Connectoralds are used.



No. 112



No. 120



No. 920

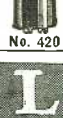

No. 420

For UX 171 and UX 112 Tubes, Na-Ald 112 Connectoralds are recommended for maximum volume with storage battery sets. These tubes will deliver without distortion several times the volume of the regular 201A. Price \$1.50.

For UX 120 Tubes in UV 201A sockets, the Na-Ald No. 120 Connectorald should be used. To convert a storage battery set to dry batteries with ample loud speaker volume, use a UX 120 tube in the last audio stage with the 120 Connectorald and UX 199 tubes with 419X Adapters in the other sockets. Price \$1.25.

For the UX 120 Tube in UV 199 sockets, ample loud speaker volume without distortion is obtainable from any set equipped for UV 199 tubes by means of the UX 120 or equivalent tube, with the Na-Ald No. 920 Connectorald. The tube is raised slightly, but provides for its use in most sets with limited headroom. Price \$1.25.

For UX 120 tubes in the UV 199 sockets of the Radiola Superheterodyne Semi-Portable, and Radiola Super VIII. These excellent Superheterodynes will deliver ample volume for loud speaker operation when equipped with the UX 120 used with the Na-Ald No. 420 Connectorald. Price \$1.25.

ALDEN MANUFACTURING CO.
Dept. K-25 Springfield, Mass.

Lowest Wholesale Prices!

New 1927 BUYING GUIDE for Radio Dealers and Professional Set Builders—100 Pages of Latest Prices—Just Off Press—One Copy is YOURS! (If You Send for It Now)

3-Hour Shipping Service on Every Advertised Accessory—Popular Circuits—LC-27, Hammarlund-Roberts, Ultradyne LR-4, Infradyne, Alden Truphonic—As Well As All Those Hard-to-Get Parts!

Our Goal—the Lowest Wholesale Prices in America—Get this Free Book—and See for Yourself Whether We've Reached It!

ADDRESS DEPT. RN

We are the Exclusive Direct Representatives of the Committee of 21 Manufacturers

Allen-Rogers

Incorporated

"Kit Headquarters"
118 East 28th St., New York, N.Y.

C. L. PARKER

Ex-Examiner U. S. Patent Office

Attorney-at-Law and Solicitor of Patents
McGill Building, Washington, D. C.

Patent, Trade Mark and Copyright Law

And Now Announcing!

CARBORUNDUM GRID LEAKS AND COUPLING RESISTORS

REG. U. S. PAT. OFF.

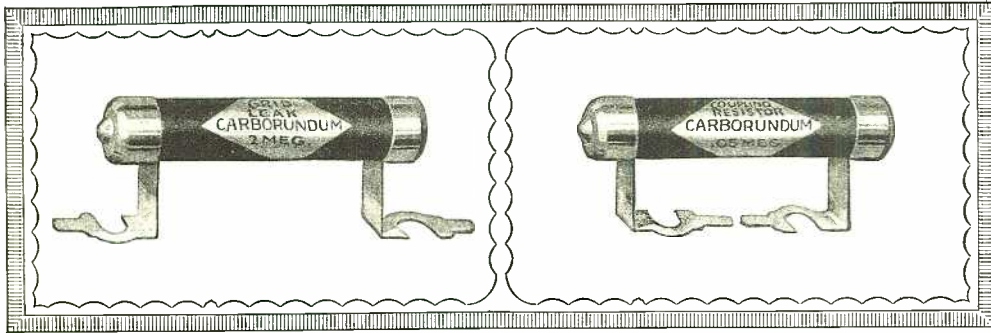

Send for the new Carborundum Hook-Up Book D-1

ABSOLUTELY noiseless—
Do not disintegrate with use or time—
No metallic film but instead a solid rod of dense unbreakable Carborundum—one of the greatest of all electrical resisting materials.
Made in all standard values and tested under actual operating conditions.

Grid Leaks or Resistors from your dealer or direct, 35c. each
IN ORDERING PLEASE STATE VALUES REQUIRED

THE CARBORUNDUM COMPANY, NIAGARA FALLS, N. Y.

SALES OFFICES AND WAREHOUSES IN

New York : Chicago : Boston : Philadelphia : Cleveland : Detroit : Cincinnati : Pittsburgh : Milwaukee : Grand Rapids
The Carborundum Co., Ltd., Manchester, Eng.

— KONITE PRODUCTS —

No-Hum "B" Eliminator

\$12.00

COMPLETE
NO TUBES
NO ACIDS
TO BUY



\$10.50
UNASSEMBLED

Don't Apologize for Poor Reception

How many times have guests come to the house and you offered apologies for poor reception because your "B" batteries were "down and out"?

You can always depend upon the electric light company to furnish electricity and by just plugging into the light socket, you will always have a "B" battery supply for your radio set by using the KONITE "NO-HUM" B ELIMINATOR.

The voltage will never vary. If you use 22½ or 45 volts for your detector and 90 volts on your amplifier, the KONITE "NO-HUM" B ELIMINATOR will always deliver the specified amount of voltage. To get good volume from your set, you must supply the full amount of voltage required.

4 Taps B—: 22½ V.; 45 V.; 90 Volts.
The operating expense of current used is less than \$1.00 per year dependent upon the rate of your local light company.

Works on 110 Volts A.C., 60 or 25 cycles—operates all sets from 1 to 9 tubes.
DEALERS—We have an excellent proposition for those who desire to handle our line. Write or wire for territory.

If your dealer does not stock them, THESE UNITS will be shipped C. O. D. to you if desired
KONITE CORPORATION, 25-27 WEST BROADWAY, NEW YORK, N. Y.

Konite Recti-Trickler

CHARGES BOTH
"A" and "B"
BATTERIES

—:—
LOWEST
PRICED CHARGER
MADE

—:—
ELECTROLYTIC
PRINCIPLE

Absolutely Noiseless Charging

The RECTI-TRICKLER has been designed after an exhaustive series of tests to provide a self-contained unit at an extremely low cost, a unit that is practical and requires no attention.

It is a combination Rectifier and trickle charger all in one—Charges both A & B batteries (wet) from the house lighting cut—Works on DC or AC Current; all you need to do is to connect it to any house light socket, clip the two leads to your battery and it starts to operate.

No tubes, no acid necessary. The simplest unit of its kind—uses the electrolytic principle. No noise. The RECTI-TRICKLER is guaranteed against defects for six months.

DEALERS—Exclusive territories and liberal proposition is ready for you—write for particulars.

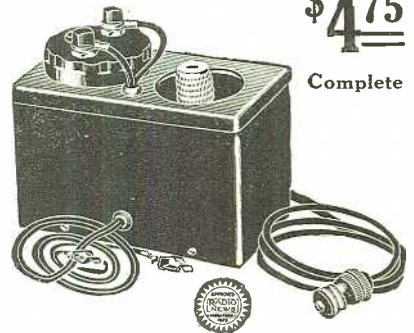

\$4.75

Complete



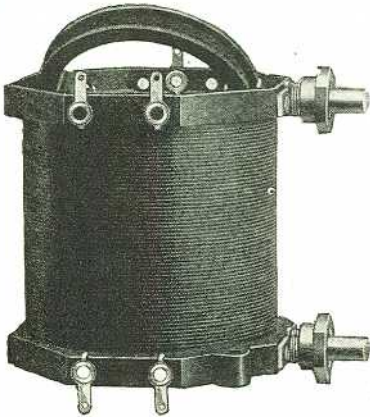

A Universal, Supremely Efficient Coil for Short or Long Wave-Length

Whether you want complete coils for high or low frequency (short or long wave length) work—

Or wish quick changes per plug-in method—

Or want to mount a coil in any position—

Or you desire one or two rotors you will find a standard Samson Form or Complete Coil for your purpose.

The Samson Electric Company has ready for delivery for those who desire to wind their own:

- Coil Form, bare\$.75
- Jack Block 1.00
- Single Rotor Coupler, bare... 1.25
- Double Rotor Coupler, bare .. 2.00

And for those who wish complete units:

- Band Filter\$7.50
- Fixed Coupler 2.00
- Split Stator Coupler 3.50
- Single Rotor Coupler 3.25
- Double Rotor Coupler 5.00
- Antenna Coil 1.85
- Double Wound Coupler 2.50

Our book—"Audio Amplification"—already accepted as a manual of audio design by many radio engineers—contains much original information of greatest practical value to those interested in bettering the quality of their reproduction. Sent upon receipt of 25c.

SAMSON ELECTRIC COMPANY

MAIN OFFICE: **Manufacturers**
CANTON, MASS. Since 1882
Factories at Canton and Water-town, Mass.

all these desirable characteristics into a figure of the perfect "ham," we have before us the ultimate in the amateur radio kingdom, not as an ideal to worship but as a pattern to shape ourselves by.

Let us then single out those desirable traits in which we do not now excel and develop ourselves in them, not only in order that we may be better informed in the amateur game, but also that we may become moulded into more representative amateurs.—George S. Turner, Ass't Radio Inspector, U. S. Dept. of Commerce.

I Want To Know

(Continued from page 998)

The "Autodyne" Circuit

"The intermediate frequency chosen is 22 kilocycles, which, while too low a frequency for good telephone reception, when simple tuned circuits are used, is satisfactory for C.W. or telegraph signals. The selection of this frequency necessitates detuning the set 22 kilocycles from the incoming signal; but at the frequencies corresponding to wavelengths of 100 meters or under, this detuning is of no importance in decreasing signal strength.

"The reader will recognize the description above as applying to the 'autodyne' or 'self-heterodyne' type of 'super'. The beat note of 22 kc. is created in the same manner as in the broadcast set, but at a lower frequency. For the reception of short-wave telephone signals, the amplification and detection of the 22-kc. beat note is accomplished in the usual manner. When C.W. signals are to be received, another beat note must be created, either by means of another oscillator tube or by a self-heterodyne beat note in the second detector tube. This latter method has been selected, a beat note of 1,000 cycles being chosen as the most satisfactory. This detuning of the second detector circuit, while it may appear to be inefficient because of the low intermediate frequency, is not so bad as it seems since the amplification in the intermediate circuit is very great and there is plenty of energy to spare.

Description of the Set

"The first detector and oscillator circuit may be any of the conventional short-wave receiving circuits. The one chosen is shown in the diagram (Fig. Q. 2202A). Two variable condensers are shown but all the tuning is done with the one in the grid circuit. The condenser in the plate circuit must be set for each band of frequencies covered; for instance, from 7096 to 6663 kc. (40 to 45 meters), or from 6663 to 5996 kc. (45 to 50 meters), etc. This setting is not critical, the only requirement being that the tube oscillate strongly but not so violently that it blocks.

"The coils, condensers, choke coil, etc., are identical with those which would be used in the construction of a regenerative set. The variable condenser in the grid circuit must be provided with some means of close adjustment, as the setting is rather critical. The plate-circuit condenser can be set with an ordinary knob or dial, without trouble.

"The choke coil consists of 100 turns wound on a wooden form 1-inch in diameter and 2 inches long. A honeycomb or similar coil of 150 or 250 turns will also serve very nicely. The intermediate transformer must be one capable of amplifying the rather low frequency of 22 kc.

"The coils used in the antenna, grid and plate circuits are made by winding bare copper wire of No. 16 gauge over a form on which are placed four narrow strips of celluloid, equally spaced. The wire is spaced with string and, when completely wound, the string is removed and the wire cemented to the strips by means of liquid celluloid. The construction of this type of coil is familiar to any one who has followed the development of the short-wave regenerative receiver.

"The number of turns required for each coil, for the respective wavebands, is as follows:

Meters	A	B	C	D
40	4	13	3	6
50	6	28	4	6
80	8	28	4	8

"The diameter of the coils is 3 inches, for whatever frequency band the coil is designed to cover. Three coils were used by the author to cover the amateur bands. The figures given for the coils are only approximately correct, as the method of wiring, mounting, etc., all affect the capacity of the coils and, in consequence, the number of turns required to cover a given frequency-range.

"Where the operator or constructor has a satisfactory regenerative receiver already in operation, there is no need to change, even though the circuit differs from the one shown. The only requirement is that the primary of the first intermediate transformer be free of a capacity shunt greater than 0.00025-mf.

The Intermediate Amplifier

"The complete circuit of the receiver is shown in Fig. Q. 2202A. By reference to this circuit, it



Adapters for all Tube and Socket Combinations

Na-Ald Adapters are indispensable to the set owner and set builder who wants a simple and instantaneous means of adapting any particular type of tube to the particular type of socket that is used in his set. For instance, if your set is now equipped with standard 201A sockets, and you want to use the small UV 199 type tube, simply insert the Na-Ald Adapter No. 429 into the 201A socket and insert the 199 tube into the adapter.

The various types of Na-Ald Adapters are given below. Specify them for best results.



No. 419X

For adapting small UX 199 and UX 120 tubes to UV 201A sockets, use Na-Ald Adapter No. 419X. Price 35c

To bring up-to-date and decidedly improve the Radiola III and IIIA and similar sets employing WD 11 Tubes, use Na-Ald Adapter No. 421X. Price 75c



No. 421X



No. 429

For adapting UV 199 tubes to standard 201A sockets use the Na-Ald No. 429 Adapter. Price 75c



No. 999

To adapt all UX tubes and UV201A tubes to UV 199 sockets use Na-Ald Adapter No. 999. Price.....\$1.00

Na-Ald Adapters are sold by all good radio stores and carry the Na-Ald unconditional guarantee.

ALDEN MANUFACTURING CO.
Dept. K25 Springfield, Mass.

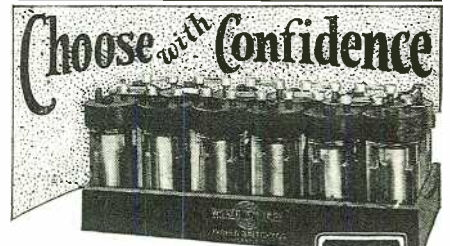

World Radio Storage "B" Battery 275

Proved value. Thousands of users find reception almost magical. Clear, true power—instantly and unceasingly. Wise economy. Sturdy construction—Solid Rubber Case protection. Recharged for almost nothing. Endorsed and listed as standard by famous Radio institutions including Pop. Radio Laboratories, Pop. Sci. Inst. Standards, Radio News Lab., Lefax, Inc., and other Radio authorities. What more need be said? **Extra Offer: 4 Batteries in series (96 volts) \$10.50. Send No Money** Just state number wanted and we will ship same day order is received, by express C. O. D. Pay expressman after examining batteries, 5% discount for cash with order. Remember—you save 50% on World Batteries.

WORLD BATTERY COMPANY
1219 So. Wabash Ave. Dept. 75 Chicago, Ill.
Makers of the Famous World Radio "A" Storage Battery.
Prices: 6-volt \$10.00; 120 Amp. \$12.00; 140 Amp. \$13.00.
All equipped with Solid Rubber Case.

Set your radio dials at 288.3 meters for the World Storage Battery Station WSBG. Variety—New Talent—Always Interesting! JERRY SULLIVAN—Director and Announcer—Chi-CAW-ro

Order HAMPTON-WRIGHT'S RADIO CATALOG! Now!

Don't miss having this important economy book—a listing of efficient sets and parts is at your service. Fans and set builders all over America are finding Hampton Wright Merchandise a real value.

Specify Catalog B-8
HAMPTON-WRIGHT
P. O. Box 181 Indianapolis

will be observed that two untuned intermediate transformers are used, and one tuned or filter transformer of special construction. The intermediate transformers used in this set were those manufactured by the General Radio Company (type number 271). These particular transformers have a flat characteristic which permits a considerable gain at 22 kc. Others of different make but of nearly similar characteristic are probably available.

"No particular description of the intermediate circuit is required. The circuit is a conventional one and the same precautions observed in the construction of any superheterodyne should be followed. To prevent undue feed-back in the untuned circuits, space the tubes and transformers liberally and keep them in line.

The Filter Circuit

"Because of the low intermediate frequency, the filter transformer must be of a special design. By reference to the circuit diagram it will be observed that three coils are used here also. The coil in the plate circuit, of the tube preceding the detector, and the coil in the grid circuit of the detector comprise the tuning or filter circuit. The coil in the plate circuit of the detector tube is the feed-back coil by means of which the beat note of 1,000 cycles is created in the second detector tube.

"The specifications of these coils are given in Fig. Q, 2202 B; No. 32 D.S.C. wire is used throughout. In winding these coils no particular care need be used; random winding is perfectly satisfactory. Approximately the number of turns specified, however, should be wound, otherwise the frequency of the intermediate circuit will be changed. In this figure, the spacing between coils is shown, but it must be variable to determine the best setting. No hard and fast rule can be given on the point, as the arrangement of the circuit, placing of the coils, etc., will have some effect. Once adjusted, however, there is no need for further change. The coils shown make a rather small assembly. If the space occupied is no factor, honeycomb, duo-lateral, or other form-wound coils of similar nature can be used; a 600-turn honeycomb coil for A, with a 1500-turn honeycomb for B and a 400-turn honeycomb for C. The spacing may be somewhat greater than that specified for the home-made assembly.

"The variable condenser shown across the grid coil is of 0.001-mf. capacity. Because of the rather large space occupied by a 43-plate air condenser of this capacity, a variable mica condenser was chosen. The air condenser is probably better from a standpoint of efficiency. The condenser across the grid coil determines the frequency of the beat note which is heard in the telephone. Keep this frequency as low as possible since, the lower the note, the more closely will the primary and secondary circuits be in tune.

"If telephone signals are to be received, a switching arrangement should be provided to permit cutting the plate coil of the second detector in and out of the circuit. Radio telephone signals can be received when the second detector is oscillating; but reception is extremely difficult as the "zero beat" method must be used, and the slightest change in frequency at either the receiver or transmitter causes an audio beat.

"No particular instructions are required here. Any good audio transformer is satisfactory. If radio telephone signals are to be received, as well as C.W., the transformer should be of good design. For C.W. reception only, a transformer having a high ratio between primary and secondary is best; since, although some distortion may be introduced, the amplification is higher and the distortion is of no importance.

"Two fixed condensers are shown in the audio circuit. These condensers are required as a bypass for the 22-kc. frequency, which otherwise would feed back through the head telephones and the body to the input and cause trouble.

General Comments

"The particular receiver to which the foregoing remarks apply was one with complete shielding of the intermediate, second detector, and audio circuits. The coils comprising the first-detector circuit were not shielded but acted as loops for the reception of moderately distant stations.

"The principal advantage in the shielding came in the elimination of long-wave interference. Subsequently, it was found that by regulation of the amount of regeneration in the untuned intermediate transformers, practically the same result could be obtained, and at no sacrifice in sensitivity. It is recommended that the set be first made unshielded; and the shielding may then be applied if the long-wave C.W. interference is bad. In another model of this same receiver, constructed by Mr. C. R. Runyon, no shielding was used and results were entirely satisfactory.

"If a good antenna is used, the distance possibilities of the short-wave superheterodyne are limited only by the static level. For the reception of signal from a certain station or stations, where it may be possible by changing the transmitting frequency to remove the interference caused by double tuning, the superheterodyne receiver is most satisfactory.

"In operation, the plate condenser is set for strong oscillation and all the tuning is accomplished with the grid condenser. Here the action differs from that of the regenerative set, with which it is necessary to adjust the plate condenser for each frequency. Because of this single control the manipulation of the receiver is simpler and the possibility of picking up stations is increased."

An Absolute Necessity!

**FRESHMAN
AUTOMATIC
CHARGER**

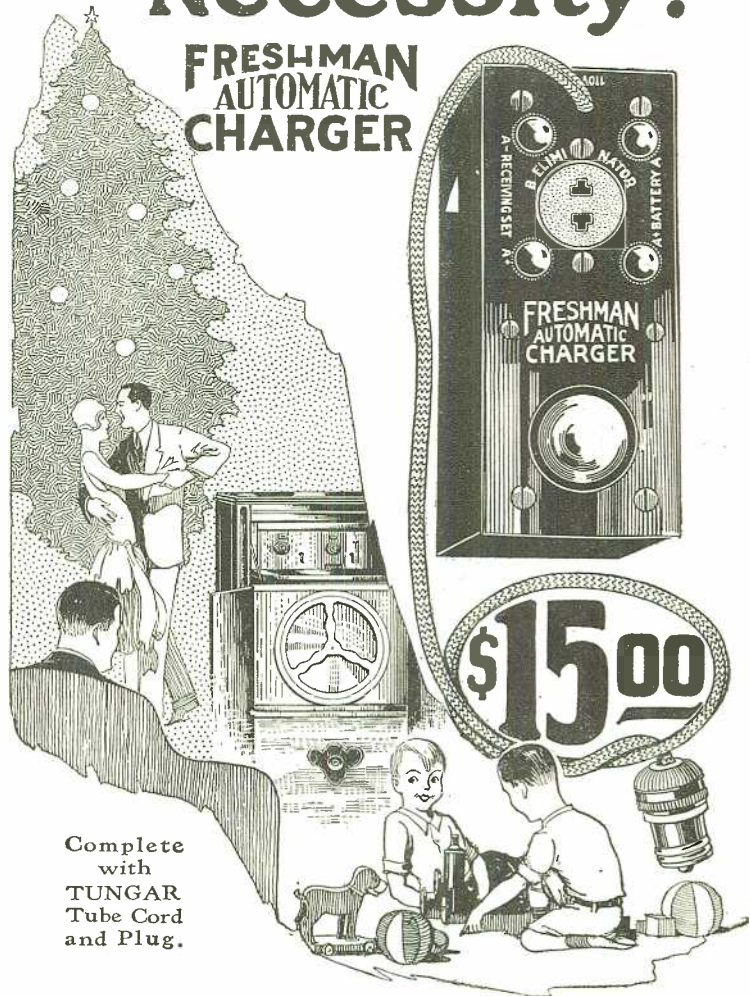

Complete with
**TUNGAR
Tube Cord
and Plug.**

Your "A" Battery Troubles Ended

Requires No Attention

This remarkable device keeps quietly working for you all the time that your set is not in operation. It is controlled by the switch of your set which disconnects the charger automatically when you are using your radio. And, when you turn off your set it immediately resumes charging the "A" battery again.

Foolproof and Dependable

Whether it is a radio dance that you are giving or an excited assemblage listening to the results of a World's Championship sporting event you never need have fear of the broadcasting fading away through run-down "A" batteries; a condition which has happened so many times in the past to practically all owners of radio sets.

Our new 48 page book illustrating all Freshman Products is now ready. Write for it—free.

CHAS. FRESHMAN Co., INC. Freshman Building, New York
2626 W. WASHINGTON BLVD., CHICAGO

**Powerful in tone
production
Silent in its own
operation**

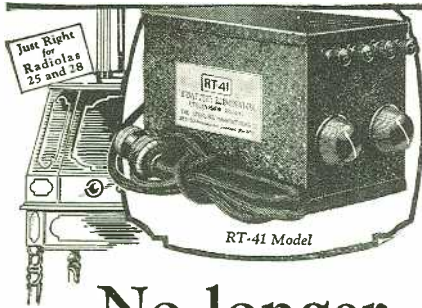

**No longer
need price
deny you
a reliable
"B" Battery
Eliminator**

PRICED as low as is consistent with Sterling high-grade performance, this compact "B" Eliminator has many *exclusive* advantages that mean improved reception:

- Adjustable detector and amplifier voltages controlled by knobs.
- Supplies up to 130 volts at 20 milliamperes with CX 313 tubes or 100 volts at 35 milliamperes.
- Shielded and entirely free from hum.
- No larger than a 45 volt "B" Battery—gives 3 times the power. Especially recommended for Radiolas No. 25 and 28 and other sets using 5 large tubes.

RT-40 Model, having 3 Terminals
Price \$20.00 without tube.

RT-41 Model, having 4 Terminals
Price \$22.00 without tube.

UX 213 or CX 313 Tubes • \$6.00

Also Raytheon Tube Types:
R-97 Model for "B" and "C" Power
Price \$55.00 with tube.
R-99 Model for "B" Power only
Price \$45.00 with tube.

Sterling
**"B" BATTERY
ELIMINATORS**

Send for the Sterling booklet "M" showing complete line of radio equipment and useful data on radio care.

THE STERLING MANUFACTURING CO.
2845 Prospect Avenue • Cleveland, Ohio

What's New In Radio

(Continued from page 955)

Mechanically, this new panel is very strong, while it can be easily drilled with either wood- or metal-drills and cut with ordinary saws. The material lends itself readily to embellishment, and may be treated with lacquer, solid colors and imitation marble and antique designs. Decalcomanias or transfers may also be used on it, as well as various processes of engraving, lithographing, stencilling, etc.

The material is stated to have a dielectric constant of 4, the same as that of hard rubber. According to tests made on samples of it in a large mid-Western technical laboratory, it has a resistance of 746,000 megohms per cubic centimeter.

A Three-Foot Roll-Type Speaker

(Continued from page 971)

but it has no strength unless formed into a cone or roll, after which it serves as an excellent diaphragm. In the cone the vibrations are applied at the apex and waves radiate outward; in the roll speaker the transition between vibratory and undulatory motion is more gradual, giving it a distinctive tone of its own, not found in other speakers.

Radio Photography and Television

(Continued from page 945)

looked upon the adaptation of the telegraphic method of communication to picture transmission as one of the essential problems. A system has been worked out for transmitting half-tone pictures in a way which takes advantage of the more efficient methods used in radiotelegraphy. The underlying principle which makes this possible is the use of a system of signalling in which the results are independent of the signal strength. Thus, if the signal is strong enough to be recorded at all, it gives the same kind of records at the maximum as at the minimum signal intensity. This makes the recording independent of fading. If, furthermore, the signals are stronger than the prevailing static, it is possible to eliminate the effects of static by introducing a *threshold value* of signal strength in the receiver, so that nothing is received unless the signal exceeds this value.

THE MULTI-SHADE PROCESS

"Half-tone" effects are produced by dividing up the picture into five or more separate shades such as white, light gray, medium gray, dark gray and black. The transmitting and receiving machines analyze and reassemble these shades automatically. Various methods may be worked out for translating light intensities into radio signals. One method would be to use five wavelengths, one for each shade. The pictures that are shown here have, however, been made by a process utilizing a single wavelength.

The transmitting machine is made in such a way that it automatically, at every moment, selects the shade that comes nearest to one of the five shades, and sends out a telegraphic signal which selects the corresponding shade in the receiving machine. This sounds more

Sheet Copper for Shielding

Shielding

Prevents aerial radiation and feedback.

Insulates against interference from adjoining circuits.

Improves efficiency, selectivity and tone quality.

USE SHEET COPPER because it combines low resistance with easy working qualities.

**COPPER & BRASS
RESEARCH ASSOCIATION**
25 Broadway — New York



RADIO PRODUCTS are of National Repute

"B" POWER SUPPLY UNITS

30 milliamperes @ 135 volts
25 Milliamperes @ 150 volts
15 Milliamperes @ 180 volts

\$35 complete with guaranteed Tube
Automatic Control Switch

No. 1—for 6 V Tubes; No. 2—for 4 V Tubes.
Neat, efficient, positive action.
\$5.00 Complete

Trickle Chargers

No. AT-1—delivers ½ to ¾ amperes. Price complete with cord, bulb—\$10
No. AT-2 with switch to charge ½ amperes or 1½ amperes—complete with bulb, etc., \$15

Write also for information on our

Universal A & B Chargers

Prices quoted are for East of the Rockies

THE ACME ELECTRIC & MFG. CO.
1412 Hamilton Ave., Cleveland, O.

Manufacturing for 10 years.

American RADIO Now—
Lowest Wholesale Prices on **RADIO!**

**BIG NEW 1927
CATALOG-FREE**

Dealers, Agents, Set Builders—get our big 1927 Catalog—225 nationally advertised lines. Low money-saving prices! Largest, most complete stock. Radio's latest developments. It's FREE—send for your copy now.
AMERICAN AUTO & RADIO MFG. CO., Inc.
1434 McGee Street, Kansas City, Mo.

complicated than it really is, because the telegraphic code by which different shades are selected depends upon the synchronization of the two machines, which is necessary under all circumstances. Thus black in the picture is produced by exposure of the sensitive paper to the recording light spot during four successive revolutions; whereas light gray is produced by a single exposure during one of the four revolutions and no exposure for the three succeeding revolutions. The overlapping exposure is progressive and the thing is a continuous process.

TELEVISION

When we embark on such an ambitious program as television, it behooves us to reason out, so far as it is possible, whether the results we expect to get are going to be worth while, even if our most sanguine hopes are fulfilled. We have before us a struggle with imperfections of our technique, with problems which are difficult, but which may be solved. In every branch of engineering there are, however, limitations which are not within our control. There is the question whether the medium with which we are dealing is capable of functioning in accordance with our expectations and desires.

We are dealing with the photoelectric cell, the amplifier, the antenna and the radio wave. The photoelectric cell and the amplifier employ the medium of the electron, which is extremely fast; but the use of the radio wave itself imposes certain speed limitations on account of the limited scale of available wavelengths. The question therefore remains: what quality of reproduction may we ultimately expect in a television system if we succeed in taking full advantage of the ultimate working speed of the radio wave? An experimental study of the problem and the conclusions may be illustrated by the comparison of some pictures made at different speeds.

The three pictures shown in Fig. 1 were made with the selective-shade process, under conditions which reproduce the characteristics of one of our long-wave transatlantic transmitting stations with a wavelength of 12,000 meters, or a wave-frequency of 25,000 cycles. The picture at the left is the result we get if the time of transmission is two minutes. For the middle picture the transmission time is four minutes and for the picture to the right eight minutes. Everything else in the three cases is identical. Relatively, these pictures represent the effect of the sluggishness of the tuned antenna upon the sharpness in the reproductions. The two-minute picture is not as sharp as the eight-minute picture. With this particular subject we may be satisfied with a two-minute picture; but with other subjects containing more details it would pay to use eight-minute transmission time.

However, if we wish to draw conclusions regarding the practicability of television, we may say that if we are speaking with a friend across the ocean and if we can see his features as clearly as we do in this two-minute picture, we will be satisfied, and probably quite pleased. This picture has been produced, as accurately as we can determine by laboratory equivalents, with a wave of 25,000-cycle frequency.

Now (if we let our imaginations loose) we will use a wavelength of twelve meters instead of 12,000 meters, and a frequency of 25 million cycles instead of 25,000 cycles. If the photoelectric cell and the amplifier and the light control can keep up with this pace, the radio wave will do its part and transmit a picture, such as seen here, in 1/1000th part of two minutes; i.e., in one-eighth of a second. We are thus able to predict that it will be possible to transmit a good picture in a space of time which is of the order of magnitude of the time required for moving picture operation, the exact figure being one-sixteenth of a second.

TELEVISION PROJECTOR

But Bernard Shaw's specification has one

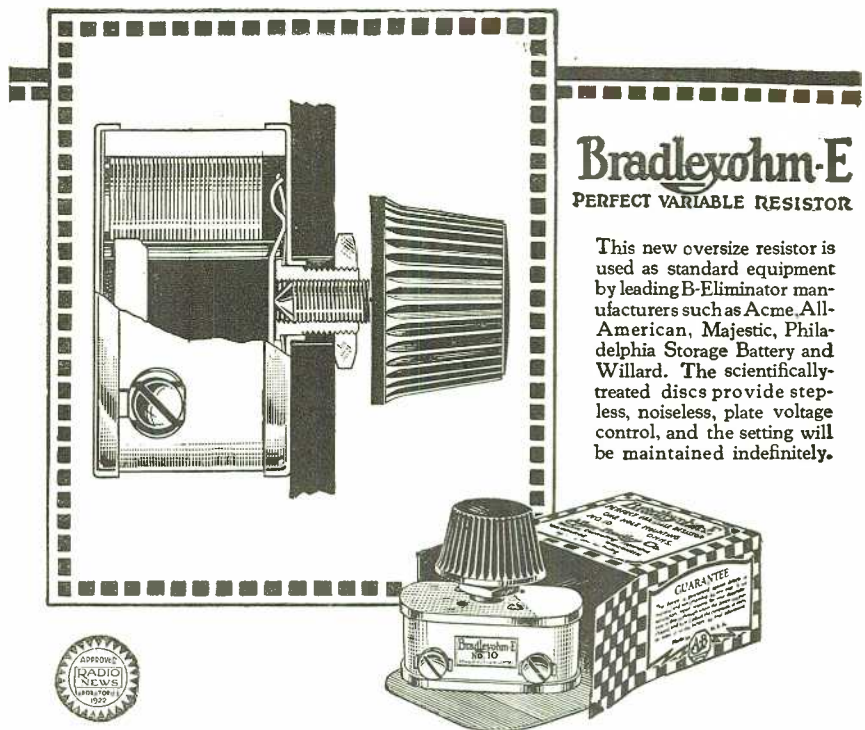

Bradleyohm-E
PERFECT VARIABLE RESISTOR

This new oversize resistor is used as standard equipment by leading B-Eliminator manufacturers such as Acme, All-American, Majestic, Philadelphia Storage Battery and Willard. The scientifically-treated discs provide stepless, noiseless, plate voltage control, and the setting will be maintained indefinitely.

Use Allen-Bradley Resistors for B-Eliminator Hook-Ups

A LLEN-BRADLEY research engineers have developed a series of variable and fixed resistors especially suited for B-Eliminator hookups. The success of their efforts is indicated by the fact that Allen-Bradley resistors, both variable and fixed, are used by more than fifteen B-Eliminator manufacturers, including European as well as the largest American manufacturers.

Bradleyunit-A
PERFECT FIXED RESISTOR

Another triumph of the Allen-Bradley Research Laboratory is Bradleyunit-A, a perfect fixed resistor that contains no glass, requires no hermetic sealing, and can be soldered into place without the use of clip mountings. Bradleyunit-A is not affected by temperature or moisture.

The silent, smooth control of plate voltage so essential in B-Eliminator service is obtained with Bradleyohm-E. For fixed step adjustment of voltage, Bradleyunit-A is recommended.

Do not experiment with make-shift resistors when these Allen-Bradley units have been pronounced the ideal units for B-Eliminator service.

Ask your dealer for them, today!



ALLEN-BRADLEY COMPANY,
287 Greenfield Avenue,
Milwaukee, Wisconsin

Please send me your literature on Allen-Bradley radio devices and B-Eliminator hookups.

Name

Address

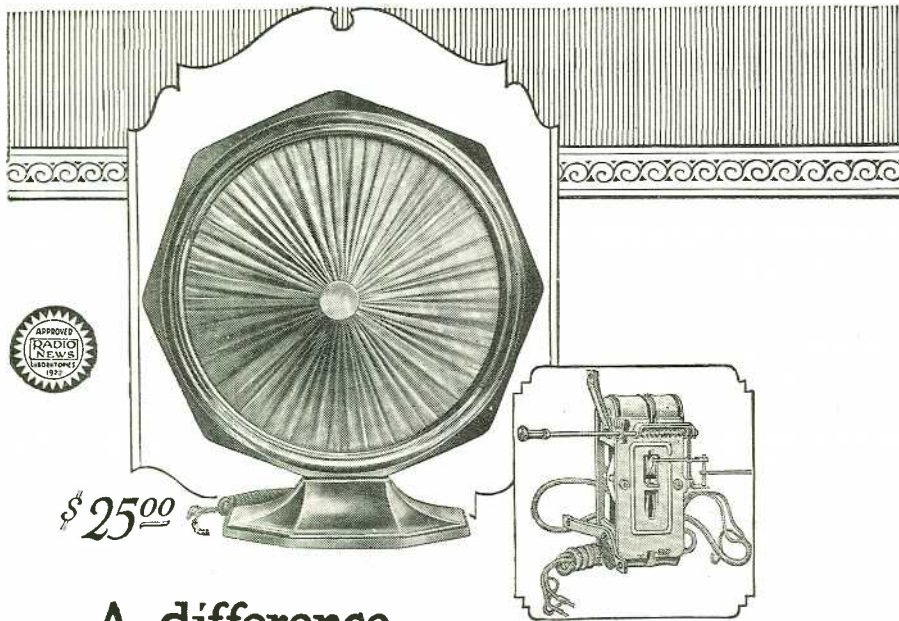

A difference you can see and hear

YOU can buy a Speaker that looks like Sonochorde—at first glance. But look again! See the difference—the rich wine-colored front of silk encircled by the unbreakable mahogany finish frame with the special protected back.

You cannot see the marvelous Sonochorde unit with its original design and impressive craftsmanship. But you can hear it! Again, what a difference! Its wealth of tone—deep, rich and clear, so startlingly real—is simply incomparable.

Don't buy any Speaker until you have heard Sonochorde. Ask your Dealer to show you.

BOUDETTE MFG. Co. Chelsea, Mass.

The New SONOCHORDE CONE



WALL MODEL
Includes all features that distinguish Sonochorde.

\$27

Floor Standard Model

\$35

more requirement. He wants the television picture shown, life-size, on a large screen. In this lies one of the fundamental difficulties.

Fig. 2 shows a model of a television projector, consisting of a source of light, a lens and a drum carrying a number of mirrors. When the drum is stationary, a spot of light is focused on the screen. This spot of light is the brush that paints the picture. When the drum revolves, the spot of light passes across the screen. Then, as a new mirror, which is set at a slightly different angle, comes into line, the light-spot passes over the screen again, on a track adjacent to the first; and so on until the whole screen is covered. If we expect to paint a light-picture of fair quality, the least that we can be satisfied with is ten thousand separate strokes of the brush. This may mean that the spot of light should pass over the screen in one hundred parallel paths, and that it should be capable of making one hundred separate impressions of light and darkness in each path. If we now repeat this process of painting the picture, over and over again, sixteen times in a second, it means that we require 160,000 independent strokes of the brush of light in one second. To work at such a speed seems at first inconceivable; moreover, a good picture requires really an elemental basis of more than 100 lines. This brings the speed requirements up to something like 300,000 picture-units (dots) per second.

Besides having the theoretical possibility of employing waves capable of high-speed signalling, we must have a light of such brilliancy that it will illuminate the screen effectively, although it stays in one spot only 1/300,000 of a second. This was one of the serious difficulties; because, even if we take the most brilliant arc-light we know of, and no matter how we design the optical system, we cannot figure out sufficient brilliancy to illuminate a large screen with a single spot of light. The model television projector was built in order to allow us to study the problem and to demonstrate the practicability of a new system, which promises to give a solution of this difficulty.

Briefly, the result of this study is that, if we employ seven spots of light instead of one, we will get 49 times as much useful illumination. Offhand, it is not so easy to see why we gain in light by the square of the number of light-spots used, but this can be explained with reference to the model. The drum has twenty-four mirrors and, in one revolution of the drum, one light-spot passes over the screen twenty-four times; and when we use seven sources of light and seven light-spots we have a total of 170 light-

40 Non-Technical Radio Articles

every month for the beginner, the layman and those who like radio from the non-technical side.

SCIENCE & INVENTION, which can be bought at any newsstand, contains the largest and most interesting section of radio articles of any non-radio magazine in existence.

Plenty of "How To Make It" radio articles and plenty of simplified hook-ups for the layman and experimenter. The radio section of **SCIENCE & INVENTION** is so good that many **RADIO NEWS** readers buy it solely for this feature.

Radio Articles Appearing in the February Issue of "Science and Invention" Magazine.

- New 5-K.W. Grebe Station in New York. The Lodge "N" Circuit
- By James F. Clemenger
- How to Build a Power Amplifier
- By Herbert Hayden
- The Duo-Regenerator
- By A. P. Peck
- Building An "A, B and C" Eliminator
- Radio Wrinkles
- Radio Oracle—Question and Answer Box
- How to Measure the Voltage of B-Eliminators
- By J. C. Bank

Send for Latest RADIO CATALOG and GUIDE

SETS, PARTS, KITS BIG SAVINGS

You need this big FREE book. A practical guide to success in set building. Gives advanced hook-ups. Shows all newest parts and kits at prices far below others. Send today. Build the newest sets. Make more money.

BARAWIK CO.
540-542D Monroe St., Chicago

The Latest Hook-ups & Radio Catalog

Potter Condensers

Potter condensers, American made of highest quality materials to full capacity, build the best Socket Power Devices, Power Amplifiers, Impedance Amplifiers. And they are best for Filter Uses, Rectifiers, By Pass, and Blocking D.C. All types and sizes.

POTTER MANUFACTURING CO.
North Chicago, Illinois

Insure your copy reaching you each month. Subscribe to Radio News—\$2.50 a year. Experimenter Publishing Co., 53 Park Place, N. Y. C.

spot passages over the screen during one revolution of the drum.

ADVANTAGE OF MULTIPLE LIGHT-RAYS

The gain in using seven beams of light in multiple is twofold. In the first place, we get the direct increase of illumination of 7 to 1; but we have the further advantage that the speed, at which each light beam must travel on the screen, has been reduced at a rate of approximately 7 to 1, because each light-spot has only 24 tracks to cover instead of 170. While the light itself may travel at any conceivable speed, there are limitations of the speed at which we can operate a mirror-drum or any other optical device; and the drum with 24 mirrors has already been designed for the maximum permissible speed. A higher speed of the light spot can therefore be attained only by making the mirrors correspondingly smaller, and mirrors one-seventh as large will reflect only one-seventh as much light. The brilliancy of the light-spot would therefore be only one-seventh of what we realize by the multiple beam system, which gives seven light-spots seven times as bright, or 49 times as much total light.

There is another advantage in the use of the multiple light-beam; each light-beam needs to move only one-seventh as fast and therefore needs to give only 43,000 instead of 300,000 independent impressions per second. A modulation speed of 43,000 per second is high with our present radio practice; but yet it is within reason, being only ten times as high as the speed we use in broadcasting.

The significance of the use of multiple light beams may be explained from another point of view.

It is easy enough to design a television system with something like 40,000 picture units per second, but the images so obtained would be so crude that they would have very little practical value. Our work on radio photography has shown us that an operating speed of 300,000 picture units per second will be needed to give pleasing results in television. This speeding up of the process is, unfortunately, one of those cases in which the difficulties increase by the square of the speed. At the root of this difficulty is the fact that we have to depend upon moving mechanical parts.

If we knew of any way of sweeping a ray of light back and forth without the use of mechanical motion, the answer might be different. Perhaps some such way will be discovered, but we are not willing to wait for a discovery that may never come. A cathode ray can be deflected by purely electromagnetic means, and the use of the cathode-ray oscillograph for televisions has been suggested. If, however, we confine our attention to the problem as first stated, of projecting a picture on a fair-sized screen, we know of no way except by the use of mechanical motion. If we also insist upon a good image, we find that we must speed up the process seven times and, in doing so, we must reduce the dimensions so that we will have only one-forty-ninth as much light.

SEVENFOLD TELEVISION APPARATUS

Our solution to this difficulty is, not to attempt to speed up the mechanical process, but to paint seven crude pictures simultaneously on the screen and interlace them optically so that the combination effect is that of a good picture.

Tests have been made with this model television projector, to demonstrate the method of covering the screen with seven beams of light working simultaneously in parallel. The seven spots of light may be seen on the screen as a cluster. When the drum is revolved these light-spots trace seven lines on the screen simultaneously, and then pass over another adjacent track of seven lines until the whole screen is covered. A complete television system requires an independent control of the seven light-spots. For

The illustration shows a radio set in a room. A man is seated at a desk with a radio, and a woman is seated in front of him. The radio is labeled 'LEAD-IN WIRE'. A window in the background is labeled 'AERIAL - BELDEN ENAMEL OR INDOOR'. A table next to the window is labeled 'EXTENSION CORD'. The radio is connected to a 'GROUND WIRE'.

Surrounding the illustration are four product images with captions:

- Inside Aerial and Loop Wire**: A spool of wire and a box labeled 'Belden Inside Aerial and Loop Wire'.
- Belden Enamel Aerial Wire**: A spool of wire and a box labeled 'Belden Enamel Aerial Wire'.
- Lead-In and Ground Wire**: A spool of wire and a box labeled 'Belden LEAD-IN & GROUND WIRE'.
- Belden 20-Ft. Radio Extension Cord**: A coiled extension cord and a box labeled 'Belden 20-Ft. Radio Extension Cord'.

Belden Accessories that Improve Your Set

FOR an outdoor aerial, use a Belden Enamel Aerial. It cannot corrode or deteriorate. For indoor aerials, use the Belden Indoor Aerial Wire. And do not forget Belden Lead-In and Ground Wire to finish the job. All of these items are included, if you wish, in the new Belden Superadio Antenna Kit.

The Belden 20-foot Loudspeaker Extension Cord brings the loudspeaker where you want it. For safety to tubes and batteries, and protection against fire, use a Belden Fused Radio Battery Cord.

The Belden Fused Battery Cord provides:

- 1—An A-battery fuse.
- 2—A B-battery fuse.
- 3—A polished bakelite cover for the battery fuses.
- 4—A compact connecting cable that dispenses with loose wires.
- 5—A color-code on each wire for identifying each circuit.
- 6—A time saver, because the cord is quickly connected and easily concealed.

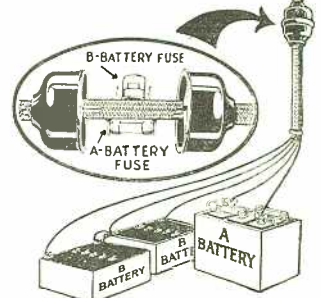

Ask your nearest dealer to explain how Belden Radio Accessories help you get better results from your set.



BELDEN MANUFACTURING COMPANY
2314A South Western Avenue Chicago, Illinois

THE NEW SHIELDED HAMMARLUND-ROBERTS Hi-Q RECEIVER

Thoroughly tested circuit, newest features and guaranteed parts selected for perfect synchronization produce reception unexcelled by ready-made sets worth \$200 or more!

\$63.05 Cabinet extra

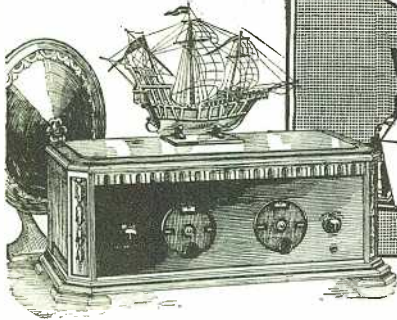

Build Your Own Masterpiece!

IMAGINE a radio without oscillation, without variation of volume on different wave lengths! Imagine a 5-tube receiver with the power of most expensive 8-tube sets! Imagine knife-like selectivity even in crowded areas. And imagine tone quality that is clear and pure as the natural un-broadcast signal!

That describes the 1927 Hi-Q Receiver! Automatic Variable Coupling and complete stage shielding are two important new features. And the group of *guaranteed* parts selected by ten of America's leading Radio Engineers completes this triumph of modern radio design.

You can build this wonderful receiver yourself at home in a few hours and save at least \$50 over a factory-made set of anything like the same efficiency. Get the "How to Build" book to-day from your dealer and have the receiver designed by Radio's Master Minds.



The simplest and most complete instruction book ever printed. Covers every detail.

25c

Associated Manufacturers

- Benjamin Electric Mfg. Co.
- Carter Radio Co.
- Durham Resistors
- Eby Mfg. Company
- Hammarlund Mfg. Company
- Martin-Copeland Co.
- Radiall Company (Amperite)
- Samson Electric Co.
- Sankamo Electric Co.
- Westinghouse
- Micarta



Hammarlund ROBERTS Hi-Q

*High ratio of reactance to resistance. High ratio—Great selectivity—Loud signals

Hammarlund-Roberts, Inc., 1182-C Broadway, New York

this purpose, seven photoelectric cells are located in a cluster at the transmitting machine and control a multiplex radio system with seven channels. A Hammond multiplex system may be used with seven intermediate carrier waves, which are "scrambled" and sent out by a single transmitter, and then unscrambled at the receiving station so that each controls one of the seven light beams.

Seven television carrier waves may be spaced 100 kilocycles apart, and a complete television wave band should be 700 kilocycles wide. Such a radio channel might occupy the waves between 20 and 21 meters. If such use of this wave band will enable us to see across the ocean, I think all will agree that this space in the ether is assigned for a good and worthy purpose.

How long it will take to attain this end I do not venture to say. Our work has, however, already proven that the expectation of television is not unreasonable and that it may be accomplished with means that are in our possession at the present day.

The "Ham"

(Continued from page 960)

nor those above 600. But then, who knew but that the increase in the number of broadcasting stations might force the government to open the higher and lower wavebands for broadcasting, and thus create an instant demand for a universal receiver? He firmly believed that he could create and market such a receiver, but one day seemed an inadequate time allowance.

In such times of stress and strain, the mind and muscles follow routines established by habit. Bixby continued to twist the dials, without being more than half conscious of what he was bringing in. At the moment when Mrs. Bixby arrived to deliver, personally, her ultimatum, he had been working on the short-wave end of his receiver.

Short waves intrigued him. Radio itself is the miracle of the ages, but short waves are a miracle of miracles. Gigantic transmitting stations, costing millions of dollars and using the highest power developed by modern generators, send their long waves, from aerials miles in length, to maintain communication with the nearest stations on the other side of the ocean. But mere boys, fifteen and sixteen years of age, build short-wave transmitters, costing less than a hundred dollars and using less power than an ordinary electric lamp, and reach India, Australia, and other points on the other side of the earth, almost at will.

Bixby's short-wave receiver had often brought in the ham stations of the antipodes. He idled now with the tuning controls to see who might be "on the air" on the far side of the globe. Before long the faint whistle of Australian "a6KX" cut through the barrage of American stations, as the boiled owls went to roost. The "Aussie" was working some station in Africa whose call letters Bixby did not catch, as he had not picked up the Australian at the start of the message. Bixby reached for a "QSL" card; for he knew that a6KX would be glad to know that his signals were "QSA" in America.

As Bixby's pen rested on the card, ready to write his greeting to his distant brother ham, the latter's message finished with a "K"; which is the operator's invitation to the man at the receiving end to do his share of the talking. Bixby tuned carefully and caught the African's wave. There was a steadiness and business-like quality about it that convinced him the station was built and operated by an engineer, not by a ham who used the "by-guess and by-gosh" method

BROADCAST!
Get Big Pay.

Mingle with Statesmen, Financiers, famous actresses, authors, world-renowned athletes, all the world's great. Attend World's Series ball games, National political conventions, mammoth prize fights, all as a part of your day's work! Be a BROADCASTER. A single large broadcast station of today employs 50 to 80 persons—some of the fine broadcasting jobs pay \$250 and \$300 a week. Radio easy to learn—I'll train you quickly in your spare time at home to hold any broadcast station position. FREE Employment Service. Write today for Free Book giving details, no obligation. Address, J. E. Smith, President, National Radio Institute, Dept. BB-98 Washington, D. C.

Rubber Covered Insulators

Actual Size

Neat and efficient. For antenna, ground and for lead in wires. Small screw starts readily and makes finished job. Great improvement over ordinary large, unsightly insulators. They keep the wires in place and out of the way. Packed 10 in a box, 25c at your dealers or direct from us.

CULVER-STEARN'S MFG. CO.
Worcester, Mass., U. S. A.

Insure your copy reaching you each month. Subscribe to Radio News—\$2.50 a year. Experimenter Publishing Co., 53 Park Place, N. Y. C.

of construction. The fist, too, was almost professional, with a beautiful rhythm that almost made music of the dots and dashes.

"Found a hill of copper here today," it ran: "27 per cent. ore under only six inches of soil."

The message made no more impression on Bixby at first than one he had picked up the month before telling how a commercial operator over there had been eaten by a lion. The thing that is a tragedy or a big event, when it happens to us or our immediate neighbors, often is a joke when related ten thousand miles away. But suddenly an idea hit Bixby with a jolt that straightened him in his chair and put him all in a tremble.

It jumped into his brain—which, like his domestic relations, was somewhat muddled,—full-sized and with every detail standing out like a stroke of lightning in a blackened sky. He seemed to see the world at a glance, with hundreds of thousands of men, like spiders, spinning threads of copper connecting huge power houses at the feet of great waterfalls with tens of thousands of factories, shops and houses, everywhere. He knew, as all who read the papers know, that the world today is being actually electrified, and that copper is a commodity upon which progress in this direction depends.

Many of the copper threads in his vision led to Wall Street. He had worked on a stock broker's board and knew how the sales, made on the Stock Exchange, were reported by busy tickers wherever men are interested in investment or speculation. He knew that stocks were sold because there were salesmen behind them, not necessarily because there were back of them mines and plants in operation, or even begun. He knew what a rumor might do in the Street. Reliable information to the effect that a hill of copper had been discovered in Africa, injected into the financial district, might mean that all the copper stocks, good, bad and indifferent, would tumble. The traders would see to that; it would be easy enough to shake the shares out of nervous hands at low prices and sell them again when solid support had bulled the price up again.

A whole hill of copper ore, purer than America's highest-grade, with cheap African labor to remove the thin covering of soil, dig out the metal and carry it to the smelter! Such a story would make thousands of margin speculators dump their stocks by thousands of shares, even sell short. And later, after sound and conservative business men had pointed out that, even if the mine were richer than represented, the copper could not possibly be made available to compete with the American product until machinery had been imported, plants financed and erected, railroads built, channels dredged, steamboat lines established, harbors developed and ocean steamships placed in service—then there would be a quick recovery of prices in the coppers, aided no doubt by the announcement that some American corporation had acquired the African mine.

Bixby saw it all, clearly. Only one thing stood between him and sudden riches. If copper shares had been selling at a cent apiece, he could not buy enough so that a thousand per cent profit would pay a month's rent. In short, Bixby was broke.

Financially, but not mentally, Bixby was broke. He looked up the location of the African station and found it in a region of mineral wealth, according to the encyclopedia; and quoting the encyclopedia always lends weight to an argument or to a dream. He opened the call book of amateur radio stations of the United States and ran a bony finger down the long lines of 2's; the second district being the one in which he and Wall Street happened to be. On the third page he

Valley Electric

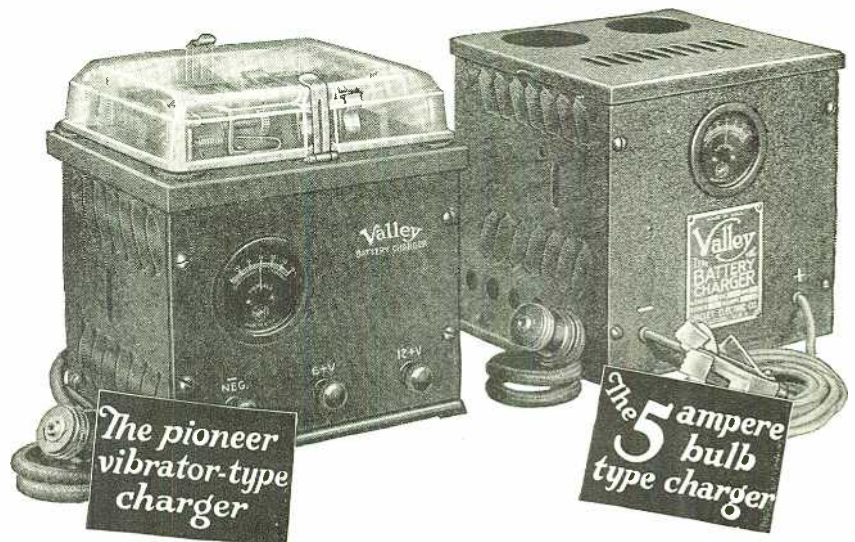

Use either one for a dependable source of "A" battery current

You can get the famous Valley Battery Charger in both vibrator and bulb types. Use either one for a dependable source of A battery current.

The Vibrator Type: This is the pioneer of radio battery chargers. Nearly a quarter of a million of this type of Valley Charger has gone into service all over the world.

Charges 6-volt batteries at 6 amperes, 12-volt batteries at 3 amperes, Quiet. Efficient. Cannot harm the battery.

Mounted in black case with bakelite panel and glass top. Pleasing in appearance and will harmonize with finest radio receiver. Complete with cord and plug, and leads and clips.

The Twin Bulb Type: The twin bulb design of this Valley Charger overcomes the only objection to the bulb type charger, i. e., the slow charging rate.

Using both bulbs, you have a 5-ampere charger. Using only one bulb, you have a 2½-ampere charger. Thus the charging rate and the purchase of one bulb or two are entirely optional.

Absolutely noiseless. Built in handsome black grained metal case. Complete with cord and plug, and leads and clips.

Other Valley Radio Units

The two small cuts below show the Valley B Power Unit and the Valley Radio Receiver.

The B Power Unit supplies plate voltage from the house circuit. For sets of 12 tubes or less. May be used with a power tube or unit. Fitted with the Raytheon Tube only—"for reliable reception."

The Valleytone is a 5-tube, tuned radio frequency receiver. Two-dial control. Wired so that use of power tube is optional.

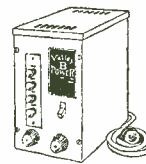

VALLEY ELECTRIC CO. · RADIO DIVISION · ST. LOUIS, MO.

District Offices: Boston, Chicago, Cleveland, Indianapolis, Kansas City, Minneapolis, New York, Philadelphia, San Francisco

Things you should know about Battery Chargers

General Electric presents a complete line of Tungar Battery Chargers having sufficient range to meet the charging requirements of all radio storage batteries—large or small. Tungar is easy to use. It assures fully charged batteries over a long period of years.

Economical and satisfactory operation of your set depends upon the correct selection of Charger as well as battery. Any good dealer will be glad to recommend the proper Tungar. But these few simple facts may be all the guide you need.



**The Two-ampere
Tungar**

This size Tungar charges all radio "A" and "B" storage batteries and auto batteries. It is particularly suited to sets having power tubes or using considerable current. It can be permanently connected to the battery and an overnight charge once or twice a week should be sufficient.



**The Five-ampere
Tungar**

The five-ampere Tungar also charges all radio and auto batteries. But it has a high charging rate, charges faster and is best for very large batteries.



**The Tungar
Trickle Charger**

This youngest and already popular member of the family should be used with low capacity 4 or 6-volt radio "A" storage batteries. It is usually permanently connected and charges continuously at a low rate

Tungar—a registered trademark—is found only on the genuine. Look for it on the name plate.



Tungar

REG. U.S. PAT. OFF.

BATTERY CHARGER

Merchandise Department
General Electric Company
Bridgeport, Connecticut

GENERAL ELECTRIC

ran across a familiar name, one known in banking circles. Some bankers also are hams, like Bixby. Without exception, they became bankers first.

Bixby called with his short-wave transmitter. No response. He called with his 200-meter outfit. No response. The bony finger ran down more columns. More calls cut the early morning ether. Bixby worked his key like a bricklayer on piece work. He had just so much to accomplish and he was not going to quit until it was done.

The sixth call brought a quick answer. Bixby kidded the ham, whom he had never "worked" before in his life, about staying up all night. The ham declared that he had not stayed up all night—he had risen early to start on a motor trip and just thought he would listen in a few minutes to see who was on the air.

Such introductions, among hams, are the beginnings of beautiful friendships. In less than five minutes Bixby was all set to unburden his soul to an understanding brother who was in a position to be very helpful.

He spoiled a perfectly good motor trip. Ten minutes later, Bixby's bony finger was chasing down columns of 3's, while the banker ham was calling 4's and the two of them were arranging relays to reach the 7's and 8's and all radio districts from the Atlantic to the Pacific and from Hudson Bay to the Gulf of Mexico. It was a glorious game, with nothing whatever to lose and, possibly, much to gain.

* * * * *

At eight o'clock Bixby drank half of the bottle of milk on the back steps and started for town. Mrs. Bixby was not up for breakfast, and he assumed that she was resting after her hard night.

He arrived at the Wall Street office, where he had been accustomed to put up the sales on the checkered board, just before the Exchange opened. There was excitement under the surface and some of the customers were arriving early. Bixby sat down in one of the easy chairs used by customers and waited to see what the board boys would do when the ticker began its day's work.

The "smelters" opened at about the same prices as the previous day's close. Then a few sales showed slight increases. But by eleven, when the wire orders began to reach the street in volume, things began to happen. Sales occurred in such rapid succession that the boys at the board could hardly keep pace with the ticker. The prices sagged, recovered as some powerful influence got under them, then broke. Bixby sat tight. He knew that the speculators of the country were yielding, quite willingly, to the enticements of Dame Rumor.

Mr. Hardy, head of the firm, came out of his private office and ran his eye over the excited group of customers in front of the board. He saw Bixby, and beckoned him into his private office.

"You see what is happening in the coppers?" he asked.

"Yes, sir," said Bixby.

"I have been trying to trace the rumor that started the selling wave. Every one of our correspondents, in all parts of the country, is shooting in selling orders on stocks that we know are good as gold. They say their customers have heard some wild rumor to the effect that a hill of copper has been discovered in Africa—so much copper and so easy to get at that all the mines and smelters in America will be put out of business forthwith. A California correspondent says that the rumor started with an amateur radio operator named Bixby, in or near New York." Mr. Hardy was studying Bixby like a poker player who suspects that the man on the other side of the table has an extra ace up his sleeve.

"So?" responded Bixby, with a face that

Big FREE RADIO

PARTS, Catalog & Guide

HOOK-UPS, SETS and KITS

Send now for this valuable FREE Radio book. 164 pages of newest hook-ups, parts and kits at big savings. A real guide. Shows factory built sets and new ideas in radio. Send at once. No obligation. Please include name of radio fan.

BARAWIK CO., 542-D Monroe St., CHICAGO, U. S. A.

Mail This Coupon Now! For Free Copy

Name

Address

Phone

Address



Our Queen Walnut Cabinet.

Also a fine line of Radio Consoles and Desks. Send for catalog and prices.

UTILITY RADIO CABINET CO.
448-27th Street, Milwaukee, Wisconsin

Get a Handy Binder for your RADIO NEWS. Holds and preserves six issues, each of which can be inserted or removed at will. Price 65c. Experimenter Pub. Co., Inc., Book Dept., 53 Park Place, N. Y.

would have done credit to the man with the ace.

"I believe you used to do something with radio, didn't you?" asked the broker.

Bixby recalled the morning when he had gone to sleep on his feet in front of the board, nearly caused a panic among the customers by posting a bear price on a bull stock, and was all but kicked out of the office. "If I hadn't, maybe I'd be a junior partner here by this time," he answered.

"Did you happen to hear this rumor over the radio?" asked Hardy.

"About the discovery of a hill of pure copper in Africa?" Bixby stalled: "Believe I did pick up something from that locality early this morning, but of course I couldn't tell anybody. It's against the law to divulge a radio message except to the one it's addressed to. I'd lose my license. But if you want authentic information, maybe I can get it quicker than you can. The maps don't show any telegraph or cable lines near there, but there's a ham station, run by a mining engineer, right at that hill."

* * * * *

Bixby reached home at five in the afternoon, made a pot of coffee to carry up to the attic, and resumed work on his universal receiver. The Wall Street edition of an evening paper protruded from his pocket, its corners mused by the rubbing of his arms as he walked. It had big headlines about copper.

Mrs. Bixby found him there in the evening, when she returned from an all-day heart-to-heart conference with her mother. She placed her feet on each step of the attic stairway with the strongest emphasis that her 130 pounds could convey. She stopped at the door with her arms akimbo, her hat askew, and "blood in her eye."

"Anybody but a jackass—" she started; then she paused—because she caught sight of a yellow slip of paper that had been thrown carelessly on the corner of the table. It had perforated edges, and wavy lines in the fabric. In short, it was a check. She recognized the form and the signature, but before she read the amount, a deliveryman staggered up the stairs with a huge carton on which the word "Radio" was prominently stencilled.

"So, you went back to the old job, and got a week's pay in advance did you!" she cried, as soon as she could do so without providing entertainment for the truckman.

Bixby was applying solder and heat to a joint formed by two wires. "Put on your glasses, sweetheart," he replied without looking up.

Mrs. B. looked at the yellow slip again. "Ten thousand dollars!" she gasped. "My Gawd, you forged it!"

Bixby tested the joint to see if the solder held—"There's two of 'em—maybe they're stuck together," he mumbled.

She fumbled the checks and they came apart. The one underneath was identical with the one on top, except that the number was one higher, and the check was drawn to the order of Mrs. Amelia Bixby, instead of to that of Edgar M. Bixby.

Bixby's work was interrupted after a painful silence by a plump arm that stole around his neck and turned his head so that he had to look into the eyes of his better half. "You know I didn't mean all those horrid things I said, don't you, darling?"

"Oh, that's all right," said Bixby, an expression almost human brightening his face. He put out his knee so she could sit on it, there being but one chair. "Just listen in and see what I'm getting with this new hook-up!"

"But darling," she insisted, "where did you get all this money?"

"What? Oh, them?" He could hear a ham station in Minnesota better than the voice of his wife, on account of the phones.

2 Automatic Switches Which do you want?

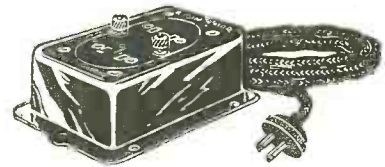
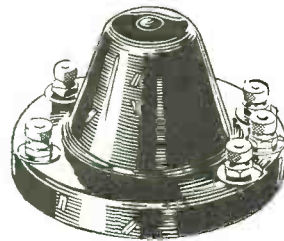

Low Cost

Electrically identical with higher priced models. Five minutes work installing this Utility Type Switch saves you at least \$1.50. Complete instructions make it easy to connect to binding posts. Only one installation is necessary. Requires no attention again.

Retails at \$2.00 to \$2.50

Model 13—This model, shown above is identical electrically with Model 23 but is without cord and plug or receptacles for Charger and Eliminator cords. For use with sets using from 3 to 8 Type 201-A tubes or their equivalent in amperage drain. Retails at \$2.00.

Model 14—Identical electrically with Model 24 except that it is without cord and plug and receptacles for Charger and Eliminator cords. For use with sets using from 5 to 10 Type 199 tubes or their equivalent. Retails at \$2.50.

Convenience

For the man who doesn't like to "tinker", the convenience Models have plug Connections for B Eliminator and Trickle Charger with cord and plug for light socket. Connections are as easily made as plugging in an electric light.

Retails at \$3.50 to \$3.75

Model 23—This model illustrated above, is complete with cord and plug and receptacles for connection with Trickle Charger and B Eliminator Cords. This model is for receiving sets using 3 to 8 Type 201-A tubes or their equivalent in amperage drain. Retails at \$3.50.

Model 24—Same construction as Model 23 but is intended for use with sets using from 5 to 10 Type 199 tubes or their equivalent in amperage drain. Retails at \$3.75.

Either Type Switch will make the A Battery switch on your receiving set, automatically turn on and off, either or both the Trickle Charger and B Eliminator as required.

Ask the nearest radio dealer to show you these newest necessities of radio, or if he cannot take care of you, order direct, giving dealer's name on the coupon below.

THE RELIABLE PARTS MANUFACTURING CO.
2827 Prospect Avenue
Cleveland, Ohio

Reliable Automatic Power Control Switch

Reliable Parts Mfg. Co.
Cleveland, Ohio

I would like to have one of your
Reliable Automatic Switches.

\$2.00	\$2.50	\$3.50	\$3.75
<input type="checkbox"/> No. 13	<input type="checkbox"/> No. 14	<input type="checkbox"/> No. 23	<input type="checkbox"/> No. 24

My Dealer is _____

My Name _____ My Address _____

Fully guaranteed. Money returned if unsatisfactory for any reason. Sent C. O. D. if desired.

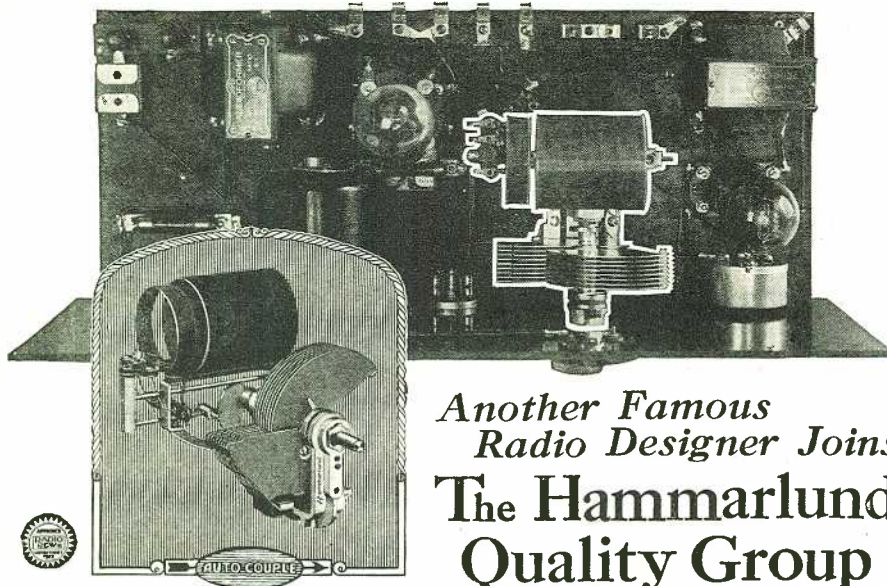

Another Famous Radio Designer Joins The Hammarlund Quality Group

Mr. A. J. Haynes, New York radio engineer, whose work is familiar to thousands of fans all over the country, has designed a new and interesting receiver (pictured above) in which one tube does the work of three.

THE Hammarlund Auto-Couple Assembly was selected as one of the important tuning units of the new "Haynes DX2 Multi-valve" receiver.

The Hammarlund Auto-Couple is a scientific assembly of space-wound coil, coupled directly to the new Hammarlund "Midline" Condenser, providing the most efficient automatic variable primary coupling at each condenser setting.

The "Auto-Couple" was designed for use in the new Hammarlund-Roberts "Hi-Q" Receiver, but will be found equally efficient in any other circuit where a variable primary is desirable.

Isn't it convincing evidence of Hammarlund leadership when twenty seven recognized designers—men who "know their stuff"—have selected Hammarlund Precision Products for use in their 1927 receivers?

HAMMARLUND PRODUCTS Are Used in These 1927 Receivers

Haynes "DX2 Multi-valve"; La-
cault "LR4";
Cockaday "LC27"; Browning-
Dyke;
Sargent "Infradyne"; Morrison
"Varion";
Pacent "Ultimax"; St. James
Super;
Victoreen Super; New Harkness;
Henry-Lyford; Carborundum
Super;
Loftin & White; Hammarlund-
Roberts "Hi-Q";
Popular Science Monthly "Pow-
erful".

We shall be pleased to refer to the proper authorities any inquiries regarding the above circuits.

For Better Radio
Hammarlund
PRECISION
PRODUCTS

HAMMARLUND MANUFACTURING CO.,
424-438 W. 33rd Street, New York.

"Yes! those checks. Did they buy your invention?"

Bixby clenched his fists and smote himself on the head. "I never thought of the invention!" he groaned. "Why didn't I sell him that while I was about it!"

Mrs. Bixby was puzzled, and once more she eyed the checks with suspicion. "If you didn't sell your invention, how did you raise all this money?" she asked.

"Oh, I went down to the office and hung around all day. The boss called me into his private office a few times and introduced me to some of the big customers as 'Mr. Bixby, who withdrew from our firm to take up radio research, and who is now able to communicate with remote corners of the world where the telegraph and submarine cable have not yet been introduced.' The last time he called me in was just after the big board closed for the day. He said the office had had a pretty good day, and he handed me those checks. He says there is a little information he wants from Africa that he can't get quick enough by wire; and if I'll get it for him there will be more money coming, maybe."

Shielding in Radio Receivers

(Continued from page 989)

center of the tubing, so that it will be as far as possible from the metal. Such leads should be used only when absolutely necessary; and they must be kept as short as possible, in order to prevent the capacity from reaching too high a value.

No. 18 plain rubber-covered stranded wire is excellent for use in shielded receivers. Cotton-covered rubber-insulated wire is not recommended, as the cotton covering frays and gets dirty.

CHOICE OF METALS

With well-designed coils well spaced from the shielding, either magnetic or non-magnetic metal may be used. The popular preference is for non-magnetic metal. Aluminum is highly satisfactory because of its light weight. Copper and brass sheeting may also be used.

Practically any thickness is satisfactory at broadcast frequencies; 20 and 24 gauge have been used extensively. Sometimes the base is made from 1/8-inch metal and in this case there is no necessity for the usual wood base.

Solid sheet-metal is recommended instead of netting, because it can be built up into cases more easily than the netting. If netting is used it should be fine-mesh copper screening. (Though netting or screening does not provide a satisfactory electromagnetic shield, it is effective as an electrostatic shield.—EDITOR.)

PRECAUTIONS

It is essential that the shielding around any one section of a receiver should be practically air-tight. When holes are necessary, as for leads, they must be of the smallest possible size. All seams and covers must fit snugly and touch all the way 'round. If this is not done the shielding will lose the greater part of its effectiveness.

It is also essential that the shields be interconnected and coupled to the battery

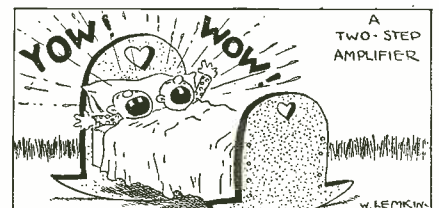

LEBNITE THE POWERFUL NEW MULTIPOINT FIXT DETECTOR

75c Post Paid  75c Post Paid

The Super-Power Crystal

Double Volume Double Distance
Perfect for Reflex — Great for Crystal Sets
From your dealer or direct. Dealers write for discounts

PALMER & PALMER
404 W. Utica St. Buffalo, N. Y.
Makers of the Famous
MULTIPOINT LINE

Kennedy & Kennedy, 1442 Yonge St., Toronto, Ont., Exclu. Can. Dist

Bradleystat PERFECT FILAMENT CONTROL

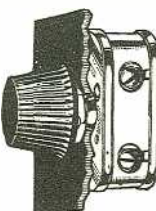

Provides complete noiseless filament control for all radio tubes without change of connections. Metal parts are nickel plated. One hole mounting. Self contained switch opens battery circuit when desired.

Allen-Bradley Co.

Electric Controlling Apparatus

287 Greenfield Avenue Milwaukee, Wis.

circuit, preferably to the "A—" line, which should then be grounded; though the ground is not absolutely necessary, as the batteries and battery connections serve as a "phantom" ground.

When a shielded set is being wired, care should be taken, that only those leads which are to be connected to the "A—" or to ground touch the shielding. All other wires, binding posts, jacks, fixed condensers, etc., must be insulated from the shield. For this reason it is advisable to tape all exposed connections in the battery circuits or other wires that come close to the shield.

METHODS OF CONSTRUCTION

A common method of construction is to use the regular bakelite or rubber front panel and wooden base. The back of the panel and the top of the baseboard are covered with sheet metal of about 24 gauge. The shield on the front panel should be drilled at the same time as the panel. Any holes in the shield made to prevent contact with certain parts, such as jacks, should be enlarged sufficiently for this purpose. The front edge of the base shield should be turned down over the front edge of the baseboard in order that the base shield may make contact with the front shield along its entire length. The parts are then mounted in place, being grouped together in such a manner that each R.F. stage may easily be surrounded on all sides.

Thus, in an ordinary five-tube set, the first or antenna-circuit radio-frequency transformer, the first tube socket and the first variable condenser would be arranged in one group; the second radio-frequency transformer, the second tube socket and the second variable condenser in a second group; and the third radio-frequency transformer, third variable condenser and third or detector tube socket in a third. The two audio stages may also be advantageously grouped together and shielded. Each of these four sections is to be completely enclosed.

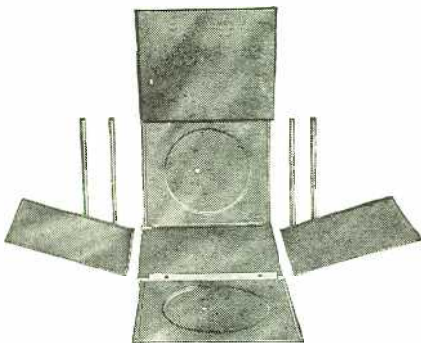

An example of a "knock-down" metal shield, which when assembled forms the shield shown on page 989.

Courtesy of Hammarlund Mfg. Co.

This may be done by laying out, cutting and bending the metal to form three-sided boxes with flaps (3/8- or 1/2-inch wide) along the bottom and front for attachment, to the base shield and base, and to the front shield and panel, respectively. The box flaps may be fastened to the base with round-head wood-screws and to the panel with round-head 6/32 machine screws 3/8-inch long. Enough fastening screws should be used to make the boxes fit closely against the base and front shields at all points.

The covers may have three edges bent over to make a snug fit on the boxes; small holes may be made in the sides of the boxes for interconnections, and the battery leads may be bunched and brought through one hole.

This method of construction may be modified in a number of ways. If desired, and providing metal other than aluminum is used, all the seams and flaps, etc., may be soldered.



"B" ELIMINATOR
MONEY BACK ~if Not Delighted

only
\$7.95
\$1.00 Down
Balance
C.O.D.

"Marvelous!" "Unbelievable!"
"What a Bargain!" Every day we receive scores of letters from users of this amazing new Roll-O "B" Battery Eliminator, praising this invention to the skies. It does all that any higher priced "B" Eliminator can do—and more!

Forget Battery Trouble Forever

All you do is hook up this Roll-O Eliminator to your set and sit back to the greatest radio pleasure of your life. No more batteries to worry about. Enjoy better reception, sharper tuning. Don't worry because "B" batteries run down and spoil reception of your set.

Operates on All Sets

Works perfectly on any direct or alternating current, giving up to 90 volts current and using full wave of the power supply. Hooks up in a moment to any set up to six tubes. Constant voltage assures more power.

Completely Equipped—No Extras to Buy

Five minutes after you receive this Eliminator you can be enjoying its

advantages. Comes to you completely equipped, together with simple, easy instructions. Made to last years. Solidly built in beautifully finished metal case with genuine Bakelite top.

Order To-Day—10 Days' Trial

Now, for no more than the cost of good "B" Batteries, you can own a Roll-O Eliminator that will make batteries unnecessary forever. Pin a dollar bill to coupon and mail to

Trickle Charger, \$3.95

Charges "A" or "B" batteries, using ordinary house current. Hooked to your "A" battery gives complete "A" power unit. Send \$1.00 with order. Pay \$2.95, plus few cents postage, to postman when he delivers your charger C.O.D. Use for ten days. If not more than satisfied, return it and get your money back.

day. Postman will deliver Eliminator to you. Deposit \$6.95 (plus few cents postage) with him. Use Eliminator 10 days. If not delighted with results, return it within ten days and receive your money. Don't delay. Act quick to become one of the thousands of enthusiastic users.

The Roll-O Radio Co.
Dept. S-2 3rd and Sycamore Sts.
CINCINNATI, OHIO

Read This Proof!*

"I have received the Roll-O 'B' Battery Eliminator and I am greatly pleased with it. We did not know we had a good radio till we hooked up your Eliminator. To me it is a 100% perfect Eliminator."
Detroit, Mich.

"I received the Eliminator and will say that its performance is all I could ask."
Waterman, Cal.

"I have your 'B' Eliminator and like it very much. So far it has given me very good service."
Perth Amboy, N. J.

"Recently received, a 'B' Eliminator. Works fine."
Akron, Ohio.

"The eliminator is working perfectly."
Zanesville, O.

"Your 'B' Battery Eliminator received and worked satisfactory. Please send me another one at once. Do you give agencies for local counties? I can sell several of these here."
Zanesville, O.

*Names Gladly Sent on Request.

Send \$1 with this Coupon
only!

The Roll-O Radio Co.,
Dept. S-2, 3rd & Sycamore Sts.,
Cincinnati, Ohio.

Gentlemen: I attach \$1.00. Please send Roll-O Eliminator to me C.O.D. for \$6.95 (plus postage) on special 10-day trial guarantee.

Name

Address

Town

State



Build Your Own Save \$8.50

If your set needs a "booster," if it needs a loop, or both—if it isn't built for use with an antenna and you want to use it with one—then

AERO-LOOP

is exactly what you must have. It does just what you want it to do—thoroughly—and operates with any make of set.

Aero-Loop ————— **\$12.50**
Completely constructed
[Build your own and save \$8.50]

Parts and material for the complete construction of AERO-LOOP, the same as the accompanying illustration will be forwarded, to any part of the United States, for \$4.00. Send Post Office or Express Money Order to the

UTT-WILLIAMS

Electrical Products Company

Box 505
SANTA ANA · CALIFORNIA



A much more workmanlike job may be accomplished with $\frac{3}{8}$ -inch (on a side) brass or aluminum angle strip. The angle strip is built up in the form of a skeleton girder to provide a solid foundation for the metal shielding pieces and panel. Thus, in a set having five separate sections, the angle foundation would consist of six rectangular angle frames about $\frac{1}{2}$ -inch less than the inside height of the front panel and as deep as necessary.

These six frames would be joined at each corner by four string pieces, also of angle-brass, as long as the panel. All joining may be done with $\frac{6}{32}$ machine screws. The panel and shielding is then screwed to the foundation, making a neat and most rigid assembly.

In all shielded sets the sheet metal and angles, etc., should be sandpapered clean and coated with lacquer or collodion to prevent tarnishing. This also acts as a more or less useful partial insulator.

Tinfoil pasted on cardboard: A very light construction consists merely of medium-weight, tinfoil, shellacked or glued to stiff cardboard, and used instead of stiff sheet metal. The idea might advantageously be extended to tinfoil-coated thin sheet rubber or bakelite, or even wood.

FACTORY-MADE SHIELDING

For some radio constructional purposes and in experimental work, it is possible to use large coffee containers, cracker-boxes, wash boilers and what not, but these are not to be recommended for average use. A few radio manufacturers make special shielding cases, some of which are shown in the accompanying illustrations, and which are especially convenient for the constructor.

Shielding is here to stay. It has great merits and tremendous undeveloped possibilities. Even at the present time, it is possible to design a shielded multi-tube tuned-radio-frequency amplifier of far greater sensitivity than is otherwise feasible. We are confident that in the next few years shielded receivers will have advanced to a point where transoceanic reception is an everyday occurrence.

BIBLIOGRAPHY

- Robinson's Manual of Radio Telegraphy and Telephony, 1924 Edition. Pages 282 and 396, or the original in J. A. Fleming's "Principles of Electric Wave Telegraph and Telephony."
- Proper Shielding and How to Do It. By John R. Meagher. N. Y. Telegram and Evening Mail Radio Section, August 30, 1924.
- The Shielding of Electric and Magnetic Fields, by J. H. Morecroft and A. Turner. Proceedings I. R. E., August, 1925.
- The Shielding Problem, by D. R. Clemons. QST, March, 1926.
- The Shielded Neutrodyne Receiver, by J. Dreyer and R. H. Manson, Proceedings I.R.E., April 1926.
- Multi-Purpose Shielded Units, by Wm. M. Henderson, QST, Sept. 1926.

Conductivity of Shielding Materials

COPPER, because of its low resistivity, is a very efficient shielding material. It follows naturally that the better conductor will dissipate more easily, in the form of eddy-current losses, the undesired electromagnetic lines of force between certain portions of radio receivers. Experiments have shown that these fields will pass through sheet metal if it is of insufficient thickness.

The efficiency of perfect shielding has been shown by enclosing receivers in copper boxes and testing them in the vicinity of transmitting stations. It has been found that the smallest crack in the shielding is enough to ruin entirely the effect of the shielding material. Several years ago it was thought that copper screening would give enough shielding effect, and experiments have been made by the manufacturers of panels within which copper screening has been cast. Present-day broadcasting, however, with its numerous and powerful stations in a limited

CHELSEA

Tone Stability

The New \$60 Super-Six

That's exactly what you get with the Super-Six due to the fully shielded Tru-tone circuit. No lost notes, no false tones, but tremendous volume with genuine tone fidelity. Housed in handsome two-tone mahogany finish cabinet, with many quality refinements, the Super-Six—in both appearance and performance—is truly startling to owners of more expensive sets.

See Your Dealer or Write Us.

Other Chelsea Receivers—Regeno-3, \$26; Super Five, \$50. Send for Folders.

CHELSEA RADIO CO., Chelsea, Mass.

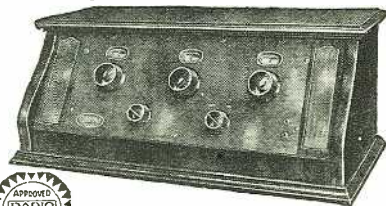

Specifications

Six tubes, Tru-tone construction. New system of audio and radio amplification. Dust-proof, fool-proof inside panel protecting chassis. Rugged bus-wiring, hand-soldered connections, cord leads for making all connections and many other world famous Chelsea features of construction.

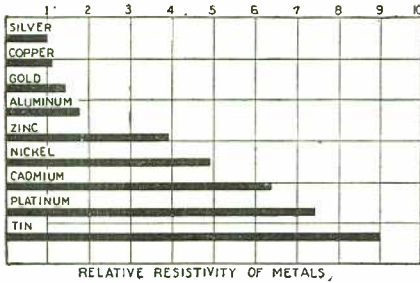

RELATIVE RESISTIVITY OF METALS,

A glance shows the comparative resistance, which means current loss, in equal-sized pieces of the various metals. The resistivity of pure iron is six times (disregarding the added effects of its magnetism), and that of commercial grades up to 60 times, that of copper.

metropolitan area, demands something better than this; and the all-metal cabinet of appreciable thickness will be, we think, the ultimate solution in the attempt to confine the desired radio-frequency energy to its proper channel.

The shielding problem is still in its development stage, and is by no means solved. At the present time the development of broadcasting, however, is forcing manufacturers and engineers to study the problem, and it will not be long before we will have a practical method of shielding that will confine the energy in a radio receiver within the desired limits without absorbing an appreciable amount of it. The loss due to partial shielding at the present time makes for inefficiency and will not be tolerated in the future receiver.

The Paris Radio Exposition

(Continued from page 950)

the more American interest in distance reception. The French are inclined to be critical of their own programs, which are apt to be mediocre.

SOME NOVEL ACCESSORIES

Among the loud speakers, the "diffuser" or diaphragm type seems more popular than ever, and many variations of this were seen. Beside the special type mentioned above, its maker is putting out a fluted diffuser with the magnets in front of the diaphragm. Another style seen at the show is a sort of cockle-shell, the magnetic parts being off center, and the fluting leading down to this in fan-shape.

The French are giving some attention this year to wave meters and "instruments of precision," as they are termed here. Among the more conspicuous novelties was a new calibrated loop aerial, in which the antenna-coil readings are graduated on a dial which covers the entire frame. The wavelength of each station is indicated, and a large indicating pointer passes over these, as with a tuning condenser. More practical still is the manner in which the aerial is set over a large map of Europe, laid horizontally, as on a table. On this map are indicated the directions of the various principal broadcasting stations of Europe; so that, once oriented, the map serves as a radio compass. If the indicating needle on the frame shaft is turned to the station desired, the best reception is assured.

A new battery of some interest consists of a series of permeable cells filled with special material; even the electrodes being inserted in these sack cells. Thus a sort of semi-storage battery is created; electrolytic material may be poured into the battery, and the charge renewed, whenever the material is dried out.

\$1000.00 Cash for a Name



You are Eligible for this Generous Prize.
SIMPLY SEND A SUGGESTION FOR A NEW NAME AND SLOGAN FOR THE MAJESTIC "B" CURRENT SUPPLY.



Contestants are to suggest an improvement for the words:

"B-Current Supply"

retaining the name "Majestic," together with a slogan and a short letter telling why the name and slogan offered are regarded as appropriate.

Characteristics of Majestic "B" Current Supply (helpful in originating a name):

Present Slogan "Delivers pure direct current from your light socket."

Better Radio Reception . . . No hum. Superior to any source of radio power.

Dependability . . . Maximum and unvarying power always available.

Flexibility Voltage adjustable to meet varying conditions on any radio set.

Durability No acids or liquids.

Economy Low cost and best form of "B" power.

Contestants will find radio dealers ready and willing to aid in originating a name and slogan by showing the MAJESTIC "B" Current Supply and giving a demonstration

In case of a tie, each of the tying contestants will receive \$1000—the full amount of the prize. Contest closes at midnight January 29, 1927. Award of judges will be published in this paper about February 15. Address all letters to Contest Manager

GRIGSBY-GRUNOW-HINDS-CO.

4572 ARMITAGE AVE. CHICAGO, ILL.

CONTEST MANAGER, care of (Use this form or one similar) Grigsby-Grunow-Hinds Co., 4572 Armitage Ave., Chicago, Ill.

I submit for name MAJESTIC _____

For slogan _____

My name _____

Address _____

(If desired, attach explanatory letter)

LEARN THE CODE AT HOME

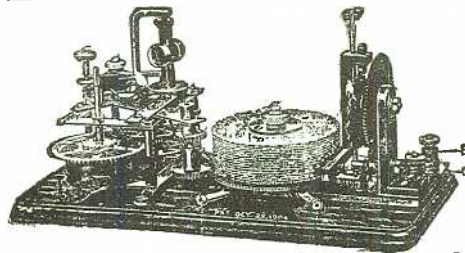

WITH THE OMNIGRAPH

THE OMNIGRAPH Automatic Transmitter will teach you both the Wireless and Morse Codes—right in your own home—quickly, easily and inexpensively. Connected with Buzzer, Ruzzer and Phone or to Sounder, it will send you unlimited messages at any speed, from 5 to 50 words a minute.

THE OMNIGRAPH is not an experiment. For more than 15 years, it has been sold all over the world with a money back guarantee. The OMNIGRAPH is used by several Depts. of the U.S. Govt.—in fact, the Dept. of Commerce uses the OMNIGRAPH to test all applicants applying for a Radio license. The OMNIGRAPH has been successfully adopted by the leading Universities, Colleges and Radio Schools.

Send 6c for Catalog **DO IT TODAY.**
THE OMNIGRAPH MFG. CO., 15 HUDSON STREET, NEW YORK CITY
If you own a Radio Phone set and don't know the code—you are missing most of the fun

Insure your copy reaching you each month. Subscribe to Radio News—\$2.50 a year. Experimenter Publishing Co., 53 Park Place, N. Y. C.



D' y' know what HOMMEL does for Dealers?

"Why Mack, you ought to tie up with Hommel—the wholesaler who never retails," says a Hommel Dealer to his friend who had been facing the competition of his own jobber.

"I've dealt with Hommel for years," he continued, "Hommel has given me the fairest and squarest of dealer co-operation, has advertised consistently for years and has referred hundreds of inquiries to me direct. Hommel's Repair and Inspection Department saves me a lot of factory red tape and I've never been delayed yet on a rush order. The prices are always right.

Yes Mack, my advise is—"Tie up with Hommel for real jobbing service."

Hommel's Catalogue No. 27-S is free. Ask for it.

WHOLESALE

EXCLUSIVELY

LUDWIG HOMMEL & CO

929 PENN AVENUE

PITTSBURGH, PA.

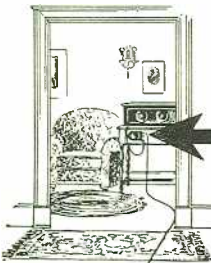

RADIO CUNO REEL

Anywhere! Any Time!

Out on the porch; in the dining room, bed room, kitchen or laundry. With its 25 ft. cord, you can put your loud speaker—or an extra one—where you want it. Self-rewinding, controlled by ratchet button. Handsomely finished; fully guaranteed. Easy to attach; easy to buy. If your dealer doesn't carry, order direct. Price **\$3.50** complete, post paid.

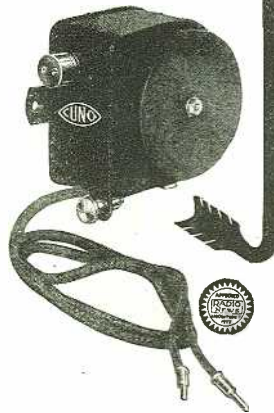
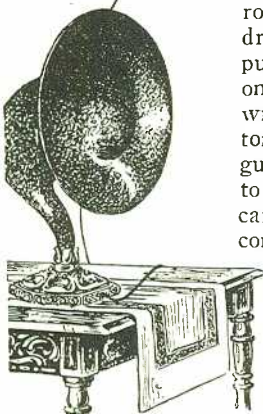

The
Cuno Engineering Corp.
80 South Vine St. Meriden, Conn.

Among the general accessories, one that appeared to be particularly practical was a small electro-magnetic coil, the "Fakir," which could be hooked up to any lighting circuit, and by the pushing of a button would either magnetize or demagnetize any steel or iron instruments immediately, according to the needs of the user. For instance, a screw-driver which might have become magnetized, while being used on a set, can be thrust through the center of this little ring-like coil, and comes out free. The action is instantaneous. The demonstrator had a steel file, with which he would pick up filings and then drop them by passing through the "Fakir."

The usual scientific apparatus was present, the Belin teleautograph, and the Jouaust photoelectric cell experiments (light-audibility) being displayed prominently. M. Belin is now working on his television, or at least his factory is working on it, as he is in China on some special work. His assistants say that it is now merely a matter of mounting the final commercial apparatus to have this a finished product. One or two other interesting transmissions of similar nature are also being developed in the Belin plant.

In tube manufacture, the popularity of the double-grid design for reception seems to continue undiminished. The amateurs are enthusiastic about the purity of reception with this type of tube, and it was very prominently displayed at the exposition.

As a whole, the radio exhibit showed that definite progress has been made in France during the last year. The stands as a whole were well set up, and the crowded condition of the Grand Palais balcony every afternoon showed that the question of over-supplying the market in France is not yet serious. Prices are, if anything, lower; and there are many new firms appearing in the field.

Progress in Radio

(Continued from page 990)

stone-like product, it can be subjected to ordinary machining methods. It is softened by being heated to dull redness; and the plastic mass is then formed into the desired shape by compression in steel molds closed under hydraulic pressure.

MECHANICAL ADVANTAGES

Not only has it better electrical properties than porcelain, but it is stronger mechanically except under pressure. It is not as heat-resistant as porcelain or mica, but superior in this respect to the insulations made with phenolic and other resins.

The fact that metal parts can be combined with mycalex during the molding process means a tighter and a stronger combination. As a rule, metal inserts cannot be imbedded in ceramic products during the process of manufacture; and this is especially true of porcelain, because of the considerable shrinkage and the high temperature which causes melting or slagging of metal parts.

Although mycalex can be drilled, filed, sawed, polished and similarly treated, it is necessary in some instances to use special tools: since the wear is greater than when metal is being cut.

The new compound has been recommended for use where the requirements demand insulating material of high mechanical strength, high dielectric properties and insulating resistance, low losses under high frequencies, heat resistance beyond the ordinary range of molded or sheet materials, and compact construction with metal inserts securely molded in place.

\$100 a week selling shirts

Fred Frankel, Ill., writes: "I earned \$110 first week selling Carlton Shirts direct to consumer." You can too. No capital or experience required. We pay 25 per cent. cash commissions daily and big extra bonuses.

WRITE FOR FREE SAMPLES
CARLTON MILLS, Inc., Shirt Mfrs.
114 Fifth Ave., Dpt. 169B, New York

COIL WINDINGS

Audio-B Eliminator—Bell Ringing Trans.
TELEPHONE RINGER—CHOKO—
IGNITION—CONTROLLER & SPECIAL
SOLENOID WINDINGS

Easton Coil Co. P. O. Box 237
Easton, Pa.

England's First Radio Exhibition

(Continued from page 949)

More cone speakers were on view this year than last, but they have not yet reached the stage of popularity in England that they now enjoy in the United States. Cabinet-type speakers have made their appearance since last year. Novelties in the way of speakers included one camouflaged as a picture in a very expert manner.

Another novel form of loud speaker, called the "Donotone," is illustrated herewith. The design is really unconventional, so a detailed description of it may be of interest. An electromagnet movement is mounted on the closed back of a cylindrical container, opened at the front. This armature drives a "free-edge" cone, which is constructed of varnished silk reinforced with cane ribs. Behind this, and mounted co-axially, is a series of smaller diaphragms which are not visible when the large diaphragm (which has a diameter nearly as great as that of the inside of the container) is in position. A series of radial baffles are mounted round the mouth of the sound chamber, and between each pair is fitted a spiral steel spring, free at one end.

The makers of this novel form of speaker state that they have carried out audibility tests with the aid of a constant-voltage oscillator, and have found the loud speaker to be capable of reproducing notes corresponding to frequencies ranging from 90 to 8,000 cycles.

A few remote-control devices were exhibited for switching receiving sets on and off from another room.

READY-MADE RECEIVERS

Although there has never been a very great demand for ready-made receivers in England, by comparison with the demand in America, there has always been a good display of such sets at the annual exhibitions, and this year was no exception. More receivers than ever were shown at Olympia, many of them being of excellent up-to-date design and construction.

Shielding has made its appearance this year, but is mainly restricted to the enclosing of coils and R.F. transformers in cans. The magnificent metal chassis and almost

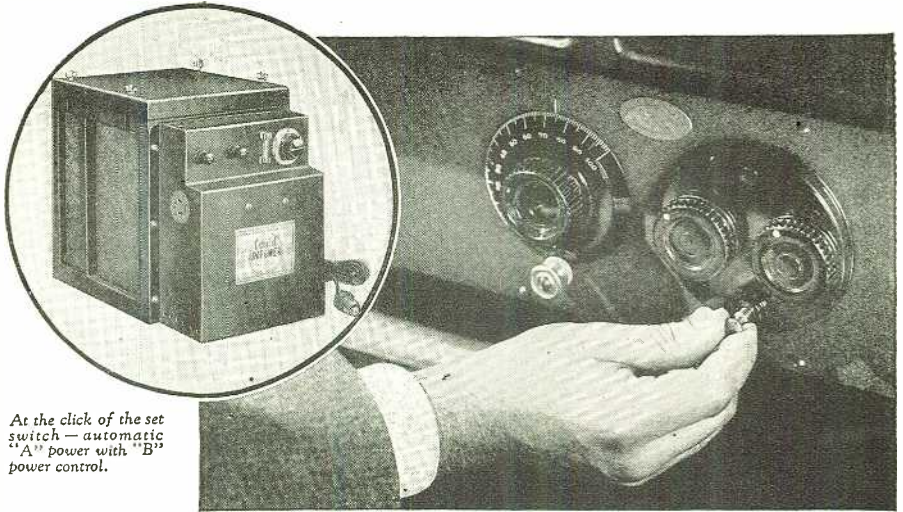

At the click of the set switch — automatic "A" power with "B" power control.

POWER you can FORGET!

Unipower supplies "A" power and controls "B" power automatically... you can forget it

TURN on the radio and forget about power. You can with Unipower. Installed in a console Unipower is out of sight as well as out of mind. You literally forget it except for one simple and infrequent attention—the occasional replenishing of water. Except for that, Unipower does all the remembering, all the power-operation, for you.

A turn of a dial adjusts the rate of charge to the requirements of your set. Your power-supply need never be overcharged or undercharged. The special Gould-designed Balkite charging unit goes on when your set is turned

off—the charging stops when the set is turned on. You get your full even "A" power always at the click of the set switch—and the "B" battery or eliminator is operated at the same time, automatically.

Thousands of Unipowers are conferring this boon of complete and automatic radio operation to delighted owners of all kinds of sets. Unipower is time-tested. You can forget it because it is built right—built by Gould, by makers of quality batteries for motor cars, submarines and railways for thirty years. Ask your dealer about Unipower—he knows.

Gould Storage Battery Co., Inc.
250 Park Ave. New York

Unipower

A GOULD PRODUCT

AUTOMATIC "A" POWER WITH "B" POWER CONTROL

AMAZING STORIES IN OUR FEBRUARY, 1927 ISSUE:

THE LAND THAT TIME FORGOT, by Edgar Rice Burroughs (A serial in three parts—Part One). The editors do not remember ever having read a more exciting and all-absorbing story than

the present one, by the creator of the Tarzan tales.

NEW STOMACHS FOR OLD, by W. Alexander. Substituting one man's stomach for another is even today a large order. What surprises might be in store when it will finally be done, is related vividly by our new author.

THE ELEVENTH HOUR, by Edwin Balmer and William B. MacHarg. Here is another one of the famous scientific detective stories by the well-known authors. There is good science, and plenty of excitement in this short tale.

THE FIRST MEN IN THE MOON, by H. G. Wells. After you have read this month's instalment you will naturally be keyed up for the finish.

THE SECOND DELUGE, by Garrett P. Serviss. In the closing chapters we find the exposé of a great mystery. Cosmo Versal knows that the entire world must be submerged, for did he not see the very pinnacle of the Himalayas disappear under water? But nature has strange ways and the unexpected, as usual, promptly turns up.

THE THOUGHT MACHINE, by "Amanius Marcellinus," in which the author gives some very interesting possibilities resulting from the invention of a perfect machine which can solve—adequately and in record time—all problems of mankind.

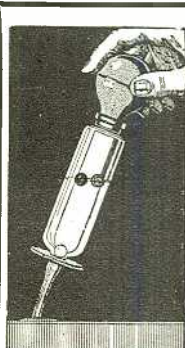

S. O. S. Hydrometer

Simple — durable — accurate—no float to break —balls easy to read. Swim all three, charged fully Sinks the white, charge still right Sinks the green, charge is lean Sinks the red, charge is dead Over six million patented Chaslyn Balls used by leading battery manufacturers as standard equipment in Glass Cased Batteries and Power Units. Ask your dealer. If he can't supply send seventy-five cents to

THE CHASLYN COMPANY
4617 Ravenswood Ave.,
Chicago

Send for Latest RADIO CATALOG and GUIDE

Radio's Newest at Rock-Bottom Prices

The new 1927 edition of the Barawik Catalog and Guide gives a comprehensive listing of the radio sets, parts, kits, supplies and accessories necessary in radio. This new GUIDE contains over 6,000 items of radio's newest developments, everything that a real fan will need from the complete factory-built set to the smallest screw, including labor-saving devices, tools, power supply units. Send TODAY! Also include name of another fan.

BARAWIK CO., 542-D Monroe St., CHICAGO, U. S. A.

Mail This Coupon Now! For Free Copy

Name
Address
City
State
Phone
Radio
Address

Insure your copy reaching you each month. Subscribe to Radio News—\$2.50 a year. Experimenter Publishing Co., 53 Park Place, New York City.

90 VOLT "B" POWER UNIT \$12.75

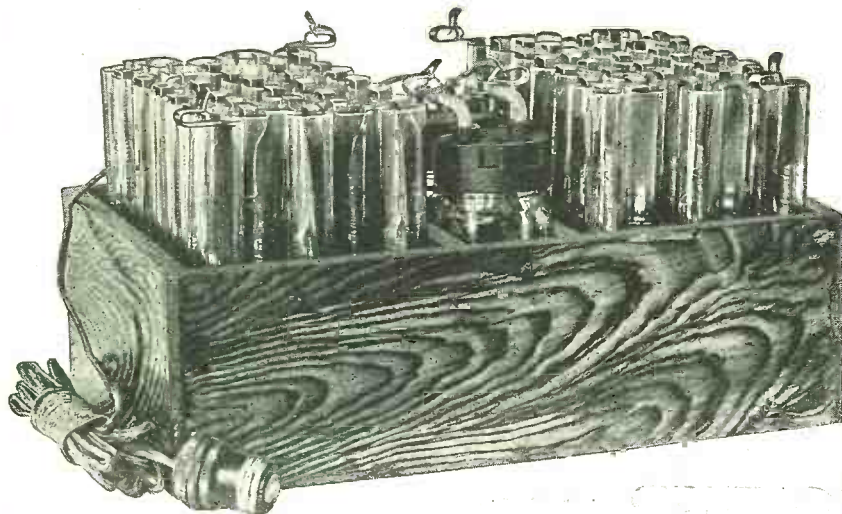

RUMOR has had it this NEW HAWLEY ADVANCED POWER UNIT was coming—and here it is. Hawley Storage "B" batteries have been standard for over 5 years and the same quality—the same standard of workmanship comprise this unit with its new ingenious hook-up and built-in-charger giving the utmost in B-Eliminator simplicity. Positively guaranteed not to give the slightest kind or trace of a hum or line noises. Simply plug into your electric socket and forget it. Any inexperienced person can hook it up in 2 minutes as all voltages including those for any kind of detector are all plainly marked. Operates any 1- to 10-tube set. Does not contain any acid.

It's so good—such true smashing value—that my 5-year-old 30-day trial offer refund applies. You've got to see it—hear its operation to fully appreciate this statement.

The prices—only slightly more than ordinary dry cells, 90 volts, \$12.75; 112½ volts, \$15.25; 135 volts, \$17.50. For 105 to 120 volts, 25- to 130-cycle alternating current only. Special sizes to order of any voltage. Knockdown kits at still greater savings. All complete as above—nothing to purchase extra. Further covered in my regular 2-year guarantee. Ample stocks—all packed—same day shipments and your order is all I need to speed it on its way to you. Simply say: ship C.O.D.—pay expressman its cost plus small transportation charges—and you'll thank me later—or write for my free literature, testimonials, etc.

B. HAWLEY SMITH, 321 Washington Ave, Danbury, Conn., U.S.A.

Mfr. of "A" Power Units, "B" Power Units, "A" Storage Batteries, "B" Storage Batteries and A & B Chargers including Trickleers

all-metal receiver of this year's New York show has not yet reached England. Eight- and nine-tube superheterodynes were prominent, but the most popular sets seemed to be five- or six-tube sets using several tuned and balanced R.F. stages.

Portable receivers have received a great deal of attention during the past twelve months, not only in the technical press but also, apparently, from the manufacturer; for quite a large number of such sets were exhibited, most of them being six- or seven-tube superheterodynes. Some were self-contained, including batteries and loud speaker in one case, while others supplied batteries and loud speaker in separate carrying case.

Some of the "portable" sets could scarcely be classed as such, considering their weight; but the manufacturers explain that their object in such cases is to produce self-contained receivers which could be moved from one room to another without difficulty, or taken out into the garden, or in the car on a picnic excursion. Many of the sets were really portable, however, and could easily be carried about anywhere, being designed, in some cases, especially for the travelling salesman, so that he might have something to while away his evenings in a lonely hotel in a strange town.

STABILIZING THE INDUSTRY

Like the Third Annual Radio World's Fair, England's First National Radio Exhibition reflected no revolutionary changes in radio design. As in this country, the British radio industry is settling down to the steady work of stabilization, improving steadily details of design and construction of existing apparatus, but producing no radical changes in instruments or modes of operation. Fundamentally, everything is the same as it was a year ago, but enormous progress has been made in the way of details.

In conclusion, attention might be drawn to a very sound scheme which was inaugurated by the Radio Society of Great Britain and the Wireless League, and announced at the exhibition. This scheme has for its object the registration of all radio service stations, dealers, etc. The technical qualifications of those engaged in such establishments for the purpose of advising the purchasing public, or installing and servicing radio receivers, charging batteries, etc., are to be investigated, and such establishments as are up to standard will then be supplied with an approved sign, so that any member of the public, totally ignorant of radio matters, may confidently place himself in the hands of any store or service station displaying the approved sign. Those who have had experience with incompetent repair men will appreciate the value of this scheme, and its effect upon the confidence of the buying public.



Jewell

Tip-Jack Voltmeter
No. 135-A, for use with Victor, Radiola, Brunswick, and other sets

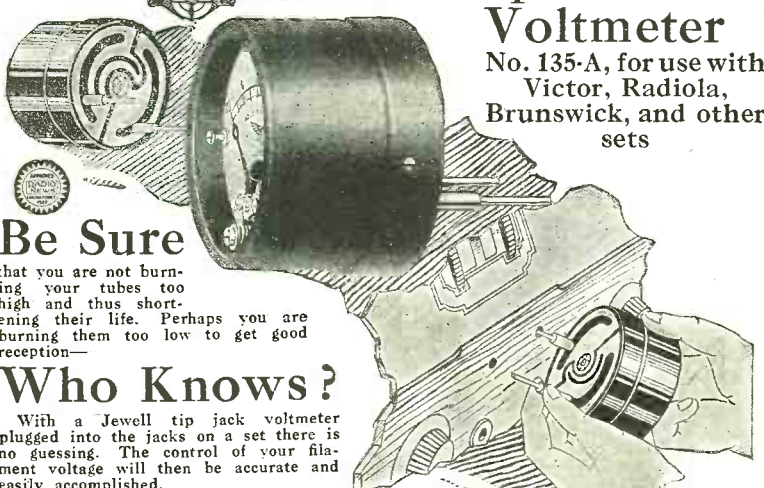

Be Sure
that you are not burning your tubes too high and thus shortening their life. Perhaps you are burning them too low to get good reception—

Who Knows?
With a Jewell tip jack voltmeter plugged into the jacks on a set there is no guessing. The control of your filament voltage will then be accurate and easily accomplished.

Send for circular No. 1015

Jewell Electrical Instrument Co.

1650 WALNUT ST. "26 Years Making Good Instruments" CHICAGO, ILL.

Station
WRNY
NEW YORK

373.8 Meters - 802 kilocycles
is owned and operated by the
publishers of this magazine
Our Editors will talk to you
several times every week—
See your Newspaper
for details
**TUNE IN ON
WRNY**

RADIO PANELS
OF GENUINE BAKELITE
Cut, drilled and engraved to order. Send rough sketch for estimate. Our New Catalog on Panels, Tubes and Rods—all of genuine Bakelite—mailed on request.
STARRETT MFG. CO.
520 S. GREEN ST. CHICAGO

WADE BENCH LATHE
Cap: 4" dia. x 12" length. Sliderest has travel entire length of bed. Lead-screw inside bed. Hollow spindle. Turning, facing, boring, drilling, winding, thread-cutting. No. 1 Lathe, plain headstock \$28.00. No. 2 Lathe back-gear headstock \$58.00. Either lathe, 4" x 15" \$7.00 extra. Complete line of accessories at equally low prices. Catalog sent free. **THE GEROLD COMPANY**
Dept. R-2 120 Liberty Street New York

Insure your copy reaching you each month. Subscribe to Radio News—\$2.50 a year. Experimenter Publishing Co., 53 Park Place, New York City.

Can We Radio the Planets?

(Continued from page 947)

Marconi, in his recent researches, has shown that it is possible to conserve a great deal of energy by using his so-called "beam system." The beam system is nothing but a reflector arrangement whereby practically all of the energy is sent in one direction to the exclusion of other directions.

A SUPER-REFLECTOR

Suppose we should now erect a tremendous power plant, which would use, let us say, 100,000 kilowatts, radiating the power on a wavelength of 2 meters or less, using the beam system of reflection, similar to the fanciful drawing shown on the front cover of this issue. By means of the beam system, it would be possible to direct the beam at practically any angle wanted. Under this tremendous power the antenna, which would have to be a pretty heavy bar of silver or copper, would naturally become white-hot, due to the titanic amount of energy radiated. What would happen if such a tremendous amount of energy were let loose into the ether, we do not know today.

The question of sending intelligible messages to Mars or Venus need not be dealt with here at all, although it opens up interesting speculations. To the contrary, this discussion confines itself to practical scientific research, as will be apparent from a study of Fig. 3. It is known that radio waves can be reflected, just as light can be reflected, by means of a mirror. Hertz was the first to point this out, and Marconi is making use of the system by reflecting his beam, using metallic-screen reflectors to do so.

Scientists today are agreed upon the fact that the interior of the earth is composed largely of iron, practically every meteor that falls from the heavens is composed of iron, and practically every star investigated shows a large proportion of iron in its makeup. The conclusion, therefore, may be drawn that the moon, for instance, must therefore be largely composed of iron. It would therefore make an excellent reflecting medium.

Suppose now, that we proceed to erect our 100,000-kilowatt radio beam-transmitter on

Here is the most Efficient of all Tuned Radio Frequency Kits!

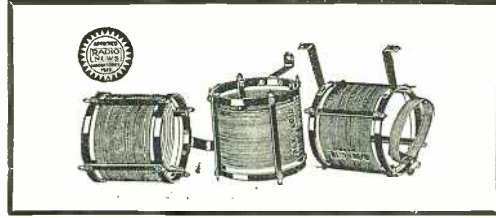

It's composed of three super-sensitive Aero Coils, and is the backbone of the famous Aero-Dyne Receiver described in Radio News.

This Aero Coil tuned radio frequency kit has a wonderful reputation for increasing the power, and improving the selectivity, and quality of tone of any receiver circuit in which it is used.

The kit consists of three carefully matched units—one Aero antenna coupler with variable primary and two Aero radio frequency coils. Due to special patented Aero Coil construction features, radio frequency losses are virtually eliminated by this kit. The coils are uniformly air spaced and tune into resonance on a "knife's edge." No dope is used. You can depend upon these coils to improve the performance of any radio receiver.

Be sure to read the special Aero-Dyne Receiver construction article elsewhere in this issue if you want to build a set that for all-round performance is without a peer. We make it very easy for you by offering a complete set of plans.

Free With Each Kit---

8-page color circuit, layout and instruction sheet for building the super-sensitive 5-tube Aero-Dyne Receiver, packed FREE with each kit of Aero Tuned Radio Frequency Coils. Instructions include insert showing how to wire up for a power tube, if desired. Extra copies, 75c each.

AERO COIL SUPER-SENSITIVE INDUCTANCE UNITS

can be procured from leading radio dealers throughout the U. S. A. If by any chance your dealer should be out of stock, write direct to the factory. But be sure to get genuine Aero Coils—the finest of all inductance units.

AERO PRODUCTS, Inc.

DEPARTMENT 105

1772 Wilson Avenue

Chicago, Illinois

We have been making and selling Radio Cabinets for 4 years. To-day thousands of the boys know exactly where to buy good cabinets at a low price. FREE Catalogue

"IVEYLINE"—Sizes 7" x 18" to 7" x 30", 7½" or 10" deep. Mahogany rubbed finish or solid walnut. Full length piano hinge, lid support and rubber feet.

"PIEDMONT"—7" x 18" x 10", 7" x 21", 7" x 24", 7" x 26"—your choice, \$2.65 each, f. o. b. Hickory. Mahogany rubbed finish, fancy nicked hinges.

THE SOUTHERN TOY COMPANY, Inc., Hickory, North Carolina

Insure your copy reaching you each month. Subscribe to Radio News—\$2.50 a year. Experimenter Publishing Co., 53 Park Place, New York City.

TABLE OF VIBRATIONS

WHOSE EFFECTS ARE RECOGNIZED AND STUDIED

1st Octave	Number of Vibrations per Second	
2nd "	2	
3rd "	4	
4th "	8	
5th "	16	
6th "	32	
7th "	64	
8th "	128	SOUND
9th "	256	
10th "	512	
15th "	1,024	
	32,768	
20th "	1,047,576	UNKNOWN
25th "	33,554,432	
30th "	1,073,741,824	ELECTRICITY
35th "	34,359,738,368	
40th "	1,099,511,627,776	
45th "	35,184,372,088,832	UNKNOWN
46th "	70,368,744,177,644	
47th "	140,737,468,355,328	HEAT
48th "	281,474,976,710,656	
49th "	562,949,953,421,312	LIGHT
50th "	1,125,899,906,842,624	CHEMICAL RAYS
51st "	2,251,799,813,685,248	
57th "	144,115,118,075,855,872	UNKNOWN
58th "	288,230,376,151,711,744	
59th "	576,460,752,303,423,488	
60th "	1,152,921,504,606,846,976	X-RAYS
61st "	2,305,843,009,213,693,952	
62nd "	4,611,686,018,427,389,904	UNKNOWN

In this table, beginning at the 25th octave and ending with the 45th, we have what may be termed the radio band of vibrations. It is thought that, as we approach wavelengths or frequencies near those of heat, it will be readily possible to pierce the Heaviseid layer.

Good tubes deserve

AMPERITE

REG. U. S. PAT. OFF.

The "SELF-ADJUSTING" Rheostat

The Watch Dog of your Tube



ONLY Amperite can insure utmost clarity, volume and tone quality from your tubes. Only Amperite can safeguard them against damage and premature burn-outs through improper current regulation. There is only one Amperite—the patented, automatic, variable filament resistance. Don't be confused or misled into buying spurious imitations or substitutes represented to be just as good. All popular construction sets specify Amperite. Simplifies wiring. Eliminates hand rheostats. Price \$1.10 complete.

Sold Everywhere



FREE—Send for "The Radiall Book" containing the latest popular hook-ups and construction data to Dept. R. N. 2.

Radiall Company
50 FRANKLIN ST., NEW YORK

a point somewhere, indicated at A, on our globe. It will now be possible to direct a beam towards some point on the moon, where the angle of incidence will be suitable. The radio beam reflected, therefore, would come back to earth somewhere, shown at point B. It would be a simple matter for an astronomer to calculate the exact angle at which the beam should be sent, and it should be possible for an observer at B to detect the reflected beams, if reflected they are. This could be easily proven as follows:

The distance between the earth and the moon is, on the average, 238,854 miles. Radio waves travel at the rate of, roughly, 186,000 miles each second. If both observers, at A and B, were using chronometers, and if a signal were sent from A at a certain time, the signal going out to the moon and reflected from it would be found to return to the earth in a little more than two and a half seconds. This would afford, therefore, a complete proof of the theory.

The same method might be used, perhaps, with other heavenly bodies, such as Mars or Venus, and would be of tremendous assistance to science in general, if found practical. What immediate benefits would be derived, in dollars and cents, I am in no position to state; although I believe many valuable discoveries, incidental to the effects produced, would no doubt be made sooner or later.

It has often been proposed to use the well-known Goddard rocket to explore the heavens, and have this rocket equipped with radio instruments which could send back a signal, thereby proving or disproving the Heaviside theory. It is possible, by means existing today, to construct such rockets. Indeed, the Society for the Exploration of the Universe, which is now being founded in Vienna, Austria, proposes to build such a rocket. Dr. Franz Hoeff, the noted Viennese scientist, and chief promoter of the plan, states that the first experiment, which is to be followed by others, can best be carried out with the rocket containing several kilograms of explosive flashlight as the only load. The shock accompanying the landing on the moon would bring the flashlight to explosion, and with the help of the modern telescope the explosion would be noticeable from the observatories of the earth.

It would seem simple to incorporate a radio set in such a rocket, at no excessive cost. Of course the radio set would no doubt be smashed to atoms when the rocket landed on the moon; but this need not worry us. The experiment is supposed to be made only to prove or disprove the Heaviside theory, and the signals, providing the apparatus functioned properly, could be sent back to the earth for a distance of some 238,000 miles, until the rocket actually struck the surface of the moon, when the signals would cease.

ANALYZING THE EARTH'S INTERIOR

Aside from its utility in exploring the heavens, our super-power radio beam plan may, in addition, be used for terrestrial radio work, as the beam could, of course, be sent horizontally for scientific radio purposes. Important experiments could be carried out for underground radio by reflecting the beam earthward, as shown in Fig. 4. If, as many have conjectured, the interior of the earth is an iron core, as shown in this illustration, the following important experiments can be made:

For many reasons it is desirable, today, to know the exact composition of the interior of our planet. If there is an iron core at the inside of the earth, as tentatively shown in Fig. 4, a power plant shown at A could shoot a beam in the direction of the arrow, emerging at B. By pointing the beam in various directions, it should be possible to ascertain the thickness of the metallic core quite accurately.

Many other important facts would surely be discovered through experimentation of this kind on a large scale; and might, in

Three Foot Cone OR Roll Type Speaker

MAKE YOUR OWN AND SAVE EIGHTY PER CENT OF COST WITH THE FAMOUS ENSCO KIT. ONLY \$10.00.

MAKE YOUR OWN THREE FOOT CONE OR ROLL SPEAKER IN LESS THAN AN HOUR. Complete parts furnished in kit form. We guarantee this speaker the equal of any manufactured cone speaker at any price.

With this THREE FOOT CONE SPEAKER you hear all the tones. It brings out the true depth and beauty of orchestral and instrumental music. Can be operated softly for Living Room Music or Full Volume for dancing, and without trace of distortion.

Kit includes famous "ENSCO" cone unit, the only direct-drive, distortionless unit for large cones; Alhambra Fonotex for big cone, with brass apex, two Sepia Prints showing cabinet or simple stand construction. All necessary instructions.

Buy this wonderful speaker under our absolute guarantee. Your money back if you are not convinced that it is the finest reproducing medium obtainable at any price. It works on any set, with ordinary Tubes or with Power Output.

SEND NO MONEY!

ENGINEERS' SERVICE CO.,
25 Church St., (Desk N) New York City

Write your name plainly as indicated below, then mail and complete kit will be forwarded to you. Just pay postman \$10.00 upon delivery.

NAME
ADDRESS



The supersensitive B-6 detector. \$5.00

Kit No. 1 consisting of improved coils for the B-6 circuit. \$7.50

Kit No. 2 including above coils plus special double tuning condenser and DONLE - TRUPHONIC audio units. \$30.50

Send for special literature on Tube, Circuit and Kits.

THE DONLE-BRISTOL CORP.,
Division G
MERIDEN, CONN.

NEW INFRADYNE KIT

ALL GENUINE PARTS IN STOCK NOW!

FREE WHOLESALE CATALOG Listing thousands of new radio parts, kits, furniture, accessories and complete radio sets, at prices that save you money. Write for your copy now, it's free.

THE HARCO CO., 1253 S. Wabash Ave., Chicago, Ill.

3 Amazing Radio Receiver Bargains

See our full page ad January, Radio News Write for Catalog

DIVA RADIO CORPORATION
294 East 137th St., New York, N. Y.

time, be translated into dollars and cents, bringing great returns to the builders.

And last, but not least, the subject of communication between the planets can then be undertaken in earnest. If we find out, by experiment, that we can reflect a radio beam from the surface of the moon, we can be reasonably certain that, given sufficient power, the same beam system can be used to send signals to either Mars or Venus; as these two planets hold forth the greatest hope of being the abode of some sort of life.

I am of the opinion that, if interplanetary communication by radio waves becomes possible, it will be only through the instrumentality of short waves. I do not believe that our present radio instruments have been brought to such a state of perfection that they can intercept such signals; but I do believe that, during the next fifty years, the sensitivity of short-wave receivers will be made so great that it will be possible to receive the necessarily faint signals, which may have their origin millions and hundreds of millions of miles away.

At the present time it would seem no more foolish to build such a radio plant for the benefit of the radio art, than to build one of our tremendous telescopes.

RADIO ADVERTISING STANDARDS

Standards of advertising practice in the radio industry, suggested by the National Better Business Bureau as a part of the "Truth In Advertising" campaign sponsored by the Associated Advertising Clubs of the World, have been adopted by radio and electrical trade groups.

Twenty suggestions to advertisers, both manufacturers and dealers, as announced by the Bureau, follow:

1. Distance and selectivity claims should be based on average, rather than exceptional, performance. Specific claims, applicable to one community, but not to all, should be properly qualified if used nationally.
2. "Complete" means nothing more need be purchased to operate the set. Price quotations should state clearly whether the offer includes, or is without, accessories. "List price" should mean retail price.
3. Total price should be stated in "down-price" offers. "Down price" should state clearly whether the quotation applies to set stripped or with accessories.
4. Guarantee should be stated in clear and simple terms.
5. Superlative claims should be curbed.
6. Disparagement of other advertisers should be eliminated.
7. Name the cabinet woods.
8. Identify standard equipment.
9. Respect trade-mark rights.
10. Describe measurable ratings.
11. Stick to the facts in claims for quality of tone and value. So-called laboratory tests should not be cited, unless the average run of the merchandise, as manufactured, produces the same results.
12. Do not use "bait advertising." If the number of sets on hand is limited and known to be inadequate, specify the number of sets for disposal. In advertising a potential supply, caution should be exercised in creating a potential demand or show of consumer interest.
13. Define specifically claims for interference eliminators.
14. Describe tuning operation adequately.
15. The term "static eliminator" is unwar-ranted.
16. "Seconds" should be so classified.
17. "From factory to you" applies only to products sold by maker to consumer.
18. Illustrative cuts should be accurate.
19. "Cone" should be used to denote a principle and not solely the shape of a speaker.
20. Specify the date before which dry "B" batteries should be used.

A·B & C Light Socket Radio Power

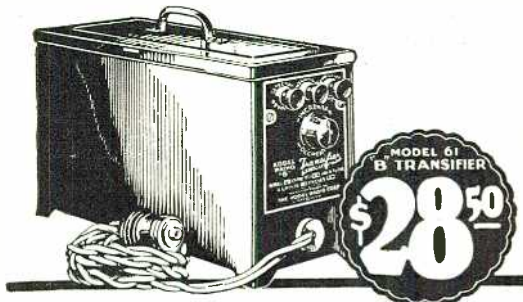

Kodol Transifiers

Operate any radio receiver direct from the light socket. Replaces all batteries. Absolutely no hum or noise—gives increased volume, a purer, richer tone. Will last indefinitely. See Kodol Transifiers at your nearest radio dealer or write direct for full information.

Five Efficient Models to Serve Any Set!

You may purchase exactly the Transifier to fit your needs.
Models for all sets and all currents

Model 15 "A & B"—4 or 6 volts "A" current, 22½ to 180 volts "B" current	\$65.00
Model 10 "A"—4 or 6 volts "A" current for sets up to 8 tubes	42.50
Model 61 "B"—Radio's most popular eliminator for 5 and 6 tube sets 22½ to 180 volts	28.50
Model 10 "B"—22½ to 180 volts "B" current; 4 to 12 volts "C" current—for any size set	42.50
Model 63 "B"—for use on 110 or 220 volt direct current circuits—for any size set	25.00

Prices Do Not Include Tubes

The Kodol Radio Corporation.
CINCINNATI ~ OHIO

CARTER RECEPTACLE JACKS



No. 620. Complete with "Aerial" and "Ground" name plates, two "IMP" Plugs for connecting aerial and ground wires to set, and screws for mounting on outlet box or wall or base-board.

90c ea.

(Quarter Size)



No. 600. Takes any standard plug. Complete with "Radio" name plate, and mounting screws. Ideal for homes, hospitals, apartments, etc.

80c ea.

(Quarter Size)



No. 630. Receptacle Jack and Volume control. Controls volume of speaker without interfering with set. Ideal for use when more than one loud speaker is used in same circuit.

\$2.75 ea.

(Quarter Size)



Carter Radio Co.
300 S. MICHIGAN AVENUE
CHICAGO, ILL., U.S.A.

In Canada: Carter Radio Co. Ltd. Toronto

KELLOGG'S Radio
Flawless Reproduction

TELEGRAPHY
(Morse and Wireless) and RAILWAY ACCOUNTING taught thoroughly. Big salaries; great opportunities. Oldest, largest school. Endorsed by Telegraph, Railway, Radio, and Government officials. Expenses low—opportunity to earn large portion. Catalog free. DODGE'S INSTITUTE, Swan Street, Valparaiso, Ind.

Bring the Musical Quality of your Radio up to 1927

THE chief difference between your present set and one of the latest design is—*tone quality*. This you can quickly remedy without rewiring or changing the circuit. Merely replace the old audio transformers with Jefferson *Concertones* and enjoy the most life-like, modern-day reproduction of programs!

These large new Jefferson *Concertones* evenly and faithfully amplify all voices and all instruments. Their musical range is *complete*. They do not lose, distort or "blast" any audible notes from the lowest (30 cycles) to the highest (10,000 cycles). Ideal for safe, continuous use with high-voltage power tubes. Unaffected by humid climates. Fully shielded in handsome green enameled metal cases.

JEFFERSON ELECTRIC MFG. CO.
Largest manufacturers of small transformers
541 So. Green St., Chicago, Ill.

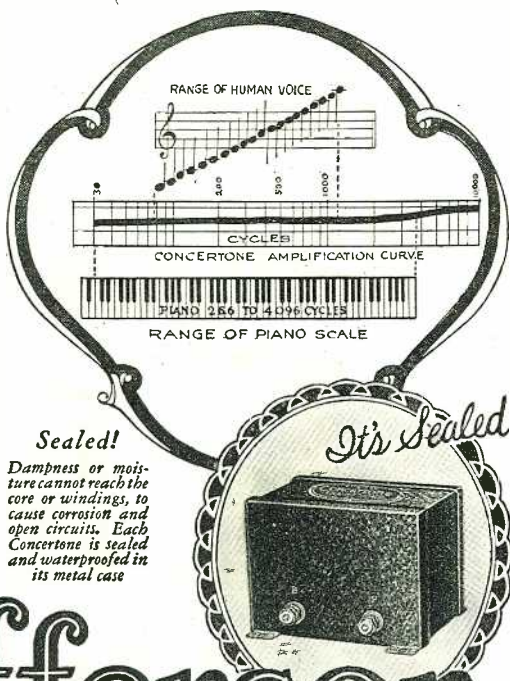

Jefferson Concertone Transformers

MARVELOUS RESULTS WITH KARAS EQUAMATIC

THE high quality of reception of the Karas Equamatic 5-Tube Sensation has swept the country. Everybody is discussing Karas Equamatic *selectivity, tone quality, distance* and *volume*. Every Equamatic that has been built has won hosts of enthusiastic boosters for this great receiver. Women, especially, have been quick to appreciate its superior reception. And women know good reception when they hear it!

The Sensation of Radio

Day after day the superiority of Karas Equamatic reception over every other receiver is being told us in hundreds of letters from every part of the country. Never before has a radio receiver had such an enthusiastic reception. Every Equamatic builder *knows* the answer: No other receiver accomplishes so much—gives such startling results—is so easy to tune—has greater volume—brings in DX so clearly—separates local stations so easily. Thos. F. Meagher, Long Island, N. Y., logged 40 stations in one evening, cutting right through powerful locals. Others report even better results.

Build This Great Receiver

You can have an Equamatic that will surpass any other receiver ever designed—you can easily and quickly build it yourself—and it will be a finer looking set than any factory made set you could possibly buy, regardless of price. For the small sum of 10c you can secure from us the complete Karas Equamatic Manual, explaining the operation and the construction of this great receiver.

Write for the Equamatic Manual

Contains simple instructions and complete data on the Equamatic. Enables you to build this receiver from Karas and other parts easily obtained from your local dealer. Write for this Manual today, filling out and mailing coupon with 10c to

KARAS ELECTRIC CO.
1122 Association Building, Chicago

KARAS ELECTRIC CO.,
1122 Association Building, Chicago
I enclose 10c for which please send me a copy of the Karas Equamatic Manual, explaining the construction of your receiver.

Name
Address
City State.....

For Perfect Amplification—
FERRANTI
Audio Frequency Transformers Amplify faithfully every note in the scale—each transformer tested ten times—your set needs one for perfect reproduction. Model A.F. 3—\$12.00. Model A.F. 4—\$8.50.
FERRANTI, INC.
130 West 42nd St., New York, N. Y.

"Lighting Fixtures"
READY TO HANG
(Direct from Manufacturer)
Completely wired including glassware
Send for new Catalogue No. 27
(Just reduced prices)
Special Proposition to Dealers
ERIE FIXTURE SUPPLY CO.
STATION R ERIE, PA.

Insure your copy reaching you each month. Subscribe to Radio News—\$2.50 a year. Experimenter Publishing Co., 53 Park Place, New York City.

Radio News Batteryless Receiver

(Continued from page 1004)

formers will operate very satisfactorily at 30 cycles, in which respect they differ from others.

RESERVE POWER INSURED

In order to maintain the power output of the unit constant, a higher amount of current is drawn than would normally be required for the operation of the receiver, the excess being wasted in the various lamps and filament shunt resistors. The three lamps (ordinary 110-volt lighting type) serve to reduce the voltage to the required value for the operation of the receiver. These should be of the tungsten-filament type; W1 is of 15-watt and W are of 25-watt size.

In actual operation the on-off switch provided is of little value, unless the set is to be used with batteries. The entire receiver is turned on and off by means of the separable attachment plug, through which current is supplied for the power transformer and the 6-volt bell-ringing transformer, T3.

The power pack is connected to the receiver by means of flexible cables along the right-hand sides of the sub-panels, as it is intended that both units be placed in a standard 7x18x12-inch cabinet. The proximity of the power pack to the receiver has no deleterious effect upon the operation as a whole.

DETAILS OF CONSTRUCTION

The receiver proper and the power-supply unit are made as two separate sections, which fit together to form what amounts to a single composite outfit. The horizontal sub-panel holding the components of the power-supply is of the same dimensions as the sub-panel holding the sockets, tuning coils, transformers, etc., of the tuner and amplifier, the two being placed edge to edge.

In the construction of the Batteryless Receiver, the first operation is to mark the three panels (front and two sub-panels) for all the instruments that go on them. Use a hard pencil and an ordinary carpenter's square for this work; if you have no square you can buy a passably good one for as little as ten cents. In laying out the front panel, make all your pencil lines on the *back* side, so that no marks will show when the set is completed. Remember that you are working backward, and do not fail to hold the panel before you occasionally so that you can visualize the parts in place.

Before drilling, with a center-punch and hammer make dents in the panels at every point a hole is to be made. Under no conditions attempt to drill without the aid of these dents; the drill will invariably slip and will probably make a hole a considerable distance out of the way.

As you drill the holes for any instrument, mount the part in place temporarily to make sure the screw holes are in the correct positions. If a hole is slightly off center, simply ream it out carefully with the tang of a file until the screw goes in straight.

After you have made all the necessary holes and tested them for fit, next assemble the parts on the receiver sub-panel. Then mount the bottom brackets, and place the bare front-panel in its final upright position. With the panel so supported, it will be an easy matter to mount on it the condensers, switches, resistances, meter, etc. Now assemble the power-supply unit.

WIRING AND OPERATION

As the receiver and the power-supply are two entirely separate units, they may be wired separately and then simply placed back to back. The seven flexible wires connecting the former to the latter should be left about a foot long and their ends cut

to length after the two units have been placed together. The ends should be bent, L-shape, and tied together with ordinary string; so that they match nicely with the seven binding posts arranged along the right-hand edge of the power-unit baseboard.

Round lugs soldered to the wires will enhance their appearance and insure good connections to the posts. The fixed resistors across the filaments of the tubes are fastened to the set sub-panel by means of similar lugs, which in turn are held down by small screws.

The power transformer of the supply unit is equipped with a suitable length of standard flexible lamp-cord, and connected to the most convenient socket or other 110-volt outlet by means of a regular two-piece attachment plug.

The antenna system, for use with the Batteryless Receiver, may consist of an ordinary single-wire aerial between fifty and one hundred feet in length, well insulated and suspended as high and as clear of other objects as local conditions permit. The ground may be made on a cold-water or steam-pipe with the aid of a good clamp.

The operation of the receiver is more or less obvious, as there are so few controls. The various tubes are inserted in their respective sockets, the 110-volt A.C. turned on at its source, and the switch on the front panel snapped on. The 1,200-ohm rheostat is adjusted so that the meter indicates the proper flow of "A" current (between 60 and 75 milliamperes) and the two dials are then adjusted until a station is heard. The set may be logged; that is, the dial readings for stations may be noted on a sheet of paper, and then duplicated at any time when it is desired to hear those stations again.

COIL CONSTRUCTION

The inductance L and L1 may be wound by the constructor, if so desired, instead of his employing those which are shown in the illustrations. Coil L has a primary of 20 turns of No. 28 D.S.C. wire, tapped at the center turn, and wound on a 1 3/8-inch tube. The secondary has 90 turns of No. 24 enamelled wire, space-wound on a 2-inch tube. Coil L1 has a primary of 35 turns of No. 28 enamelled wire, space-wound on a 1 3/8-inch tube; its secondary has 90 turns of No. 24 enamelled wire, space-wound on a 2-inch tube; and the tickler has 20 turns of No. 28 D.S.C. wire, bunch-wound on the same tube as the secondary, and at a distance of one turn from the grid end.

RESULTS

In actual practice, the RADIO NEWS Batteryless Receiver worked to perfection. If adjusted right, there is no hum that could be detected on any wavelength. A great number of DX stations were logged by the editors in a comparatively short time. The quality was extraordinarily good, and at least as good as with battery operation.

If a slight hum should be discerned, this can be stopped immediately by moving the clip of the 200-ohm resistance slightly backward and forward until the receiver is balanced. Once the correct position of the attachment clip is ascertained, no further adjustment is necessary.

NOTICE TO READERS

A complete set of full sized blueprints for this Radio News Batteryless Receiver may be obtained by sending \$2.25 to the Blueprint Dept., Radio News, 53 Park Place, New York, N. Y., specifying set No. 6. These blueprints may be placed upon the panel and sub-panel forming templates for drilling and locating the apparatus, as well as wiring guides.

Make a Power Unit of your radio battery

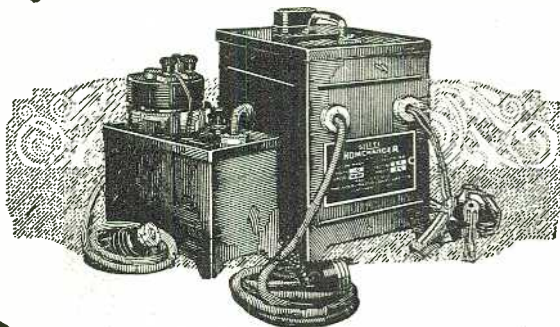

SILITE TRICKLE CHARGERS

You can make an efficient light socket "A" power unit of your present radio battery. Merely connect either of the Silite Trickle Chargers to your battery and plug it into the light socket. That's all there is to it. Left permanently on charge, your battery remains always at peak power, ready to deliver a full charge of live, powerful current to the set. You may obtain either of the two models from your nearest radio dealer, or write direct for full information.

- Silite Trickle Charger, gives .6 ampere charging rate. For any average size set. Absolutely noiseless. Complete. **\$10.00**
- Silite Horncharger. In addition to .6 ampere rate, gives booster charge of 2 1/2-3 amperes. For very large sets. Absolutely noiseless. Price complete. **\$19.50**

The Kodel Radio Corporation.
CINCINNATI ~ OHIO

REG. U.S. PAT. OFFICE

F.P.M.

IDEAL for RADIO WORK

The F.P.M. saw cuts wood, iron and bakelite at any angle. Recommended by Radio Engineers and Set Builders. Unequaled for sturdy, lasting construction and fine workmanship. Blades of finest tempered steel. Get the F.P.M. Saw at your dealers or any hardware store or order direct.

1 F.P.M. Saw and 7 Blades sent prepaid \$1.00

DEALERS Write for Discounts JOBBERS

F. P. MAXSON, 1031 Newport Ave., Chicago

FREE HOOK-UPS AND BIG RADIO GUIDE

Free, 164-page Radio Catalog and Guide brimful of newest 1927 ideas, most advanced hookups and illustrations. You save considerable sums on sets and parts. Be sure to get this thrifty book before you buy. It puts money in your pocket. Shows standard radio parts, sets, kits, all reliable, guaranteed goods. Please include name of radio fan to whom we may send copy also. Write letter or postal now for newest 1927 edition.

THE BARAWIK CO.
540-542-D Monroe St., Chicago, U.S.A.

Insure your copy reaching you each month. Subscribe to Radio News—\$2.50 a year. Experimenter Publishing Co., 53 Park Place, New York City.

30 Days Free Trial

Just Out -
1927
Model

Yes Sir!
You can put a new 1927 Westingale Radio in your home and use it to your heart's content on **30 Days' Trial**. Listen to music, concerts, news, sports, market reports from stations all over the country. Compare it with old style 3 or 4 dial sets costing more, then if not convinced that Westingale gives you the greatest Radio satisfaction and the best value for your money, **you don't have to keep it.**

NOW! Westingale offers the last word in Radio. Either 1 or 2-Dial Control — easiest to tune and years ahead in powerful reception and tone. Newest period type cabinets, two-tone walnut finish. The front panel embossed in dull gold with artistic Spanish Galleon design. Unbeatable for performance, appearance or price.

2-Dial, 5 tubes \$47⁰⁰

1-Dial, 5 tubes \$57⁰⁰

Where else can you get so much for the money on 30 days trial? Why pay more? Why take chances? Why not have the **NEWEST** Radio when you can try them at our risk. Before you buy get our Free Catalog and 30 Day Trial Offer

Westingale Electric Co.
Department 175
1751 Belmont Av., Chicago, Ill.

New ONE Dial Radio

\$57⁰⁰

Retail Price

Big Discounts to Agents



(7)

AGENTS WANTED
BUY at COST

Your own Radio Free. Get demonstrator set on 30 Days' Trial—make \$100 a week easy. Full or spare time. Big discount on first set placed in each locality. Be first—write today for dealers' discount and full details.

Radio News of the Month

(Continued from page 957)

of the transmitter. A hand causes a rattle; a face a softer sound, with an individuality such that the experimenters have been able to recognize the personality of each one so reproduced by its note. The opening of the mouth, for instance, changes the tone which is heard.

A TREACHEROUS GIFT

THE feelings of a hunted man while he is listening to his description in a police message broadcast over the radio have been most vividly described by Mr. Adams in a striking story in last month's RADIO NEWS. From England comes a story of the shock suffered by a group of old people to whom a radio set had been given, when one of the first things that came from the loud speaker was the announcement that the giver was sought by the authorities as a criminal.

NEW FOREIGN STATIONS

TURKEY, which is completing its first radio station at its capital, Angora, is said to be planning five or more in addition. Spain is taking steps to erect a high-power transmitter on the island of Fernando Po, in its West African possessions, to link them with Madrid. The previous equipment of that station will be placed on the mainland, previously reached only by semi-monthly steamer. In Italy, the new broadcast transmitter at Naples will work on 233.1 meters. The Unione Radiofonica Italiana, which operates it, plans to erect and operate stations also at Trieste, 230.8 meters; Venice, 254.2; Turin, 258.6; Genoa, 272.7; and Palermo (Sicily), 500.

BROADCAST STUDIO BOMBED

AN explosion, the causes of which were not apparent, destroyed the new broadcast studio of the Chamber of Commerce at East Orange, N. J., on Nov. 6. It has been sought to connect the happening with threatening letters previously received by the director. From this studio, which was connected by wire with WAAM, Newark, speeches had been delivered urging greater activity against the sources of New Jersey's "crime wave," and it was thought that a vicious element might have used violence against the radio equipment, as elsewhere similar lawbreakers have dynamited newspaper plants.

THE RADIO UNIVERSITY

A COMMITTEE has been appointed by the British Broadcasting Company, the semi-governmental source of all radio programs in Great Britain, to consider the practicability of a radio university. The

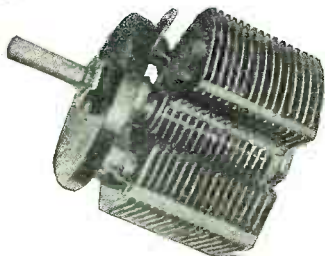

PRICE
\$3.75

CAPACITIES

- .00015
- .00025
- .00035
- .00045

MICROMETER ADJUSTMENT DEFINED

No other manufactured condenser allows accurate matching of capacities and inductances without the aid of balancing condensers or compensating devices. ARMO, on the contrary, uses a micrometer adjustment allowing a change in capacity of 30%, thereby eliminating the use of precision instruments or special equipment to balance coils. This is done by a simple adjustment on the rotor shaft—

A new principle of S. L. F. and S. L. W. L.—A method giving most desirable spacing on all broadcast wavelengths.—

Another feature—The plates are soldered, not assembled, thereby offering a free electrical surface reducing resistance very materially.

Being an unusually small condenser for its capacity, it has a very concentrated field. This, along with its small amount of insulation, well out of the way of the field, gives improved selectivity and its value is obvious, especially on short wave.

This angle, however, is taken care of by our manufactured range of capacities from .00015 to .00045.

WRITE US DIRECT GIVING THE NAME OF YOUR DEALER.

ARMO RADIO LABORATORIES
1666 Tarleton St., Los Angeles,
CALIFORNIA

DEALERS!

Complete stock of nationally known parts and accessories. Send for illustrated catalog and discount sheet.

Radio Exclusively Since 1921

CLARK & TILSON, Inc.
122 CHAMBERS ST. New York
The Nationally Known House

**EVERY RADIO FAN!
SHOULD HAVE**

**S. GERNSBACK'S
RADIO ENCYCLOPEDIA**

SEE PAGE 1070

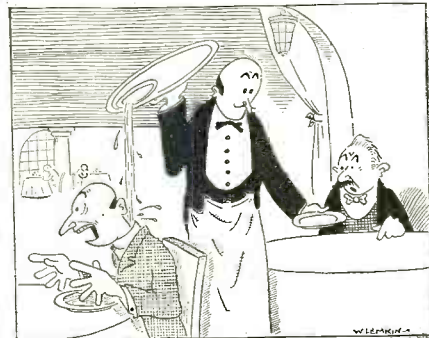

A HIGH PLATE CURRENT

Insure your copy reaching you each month. Subscribe to RADIO NEWS — \$2.50 a year. Experimenter Publishing Co., 53 Park Pl., N. Y. C.

chairman is Sir Henry Hadow, vice-chancellor of the University of Sheffield, and associated with him are educational and broadcasting authorities. The plan is feasible enough from the technical standpoint, and may be carried out successfully if it arouses sufficient interest, as university extension broadcasts have done in this country, and if it does not interfere with the entertainment of the far greater number of less studious listeners.

NEW BRITISH WAVELENGTHS

THE new allotment of European broadcast frequencies crowds upon one wavelength nine British stations which had previously enjoyed individual positions on the band. They are 2DE, Dundee; 2EH, Edinburgh; 6HK, Hull; 6LV, Liverpool; 5NG, Nottingham; 5PY, Plymouth; 6FL, Sheffield; 6ST, Stoke-on-Trent; and 5SX, Swansea; all are on 288.5 meters. Other wavelengths in use under the new arrangement are as follows: 2LS, Bradford, 294.1; 2LS, Leeds, 297.0; 6BM, Bournemouth, 306.1; 5NO, Newcastle, 312.5; 2BE, Belfast (No. Ireland), 326.1; 5WA, Cardiff, 353; 2LO, London, 361.4; 2ZY, Manchester, 384.6; 5SC, Glasgow, 405.4; 2BD, Aberdeen, and 5IT, Birmingham, both 481.8. The nine stations on 288.5 meters are all low power, 200 watts, except 2EH, which has 500. The 25-kilowatt station at Daventry retains its old wave of 1,600 meters.

THE NEIGHBORHOOD RADIO

WITHOUT waiting for wholesale development of "wired radio," a Worcester, Mass., set owner has connected to his receiver outlets for eight loud speakers. The use of these is rented to his neighbors at \$2 each a month. So far it is not known how harmoniously his audience agrees in his selection of programs.

A FAN DIES HAPPY

EDGAR SHEPPARD of Luton, Bedfordshire, (England), is perhaps the first broadcast listener to pass away at his post. Stricken by heart disease as he was listening to a dance orchestra from the Savoy restaurant in London, he was found sitting with the phones upon his head and a smile on his features.

The readers of RADIO NEWS are invited to co-operate by the contribution of news items which concern novelties in radio or in the uses to which it may be put; especially those in which the element of human interest is found. Government announcements or press dispatches of general circulation will not qualify; send stories of something that has happened in your own vicinity. They should be short; for each one published \$1.00 will be paid. Address News Editor, RADIO NEWS, 53 Park Place, New York City.

LONG HOURS FOR STATION

FOR station 2FC, Sydney, the Wireless Weekly of Australia claims the distinction of being "on the air longer than any other station in the world, fourteen hours a day." It begins at 7 a.m. with the previous day's cricket scores, and continues with short intermissions till midnight. A recent broadcast from this station was from the bottom of a mine shaft, 2,000 feet beneath the sea, under which the Balmain coal workings extend.

RADIO MARKERS SUGGESTED

OFFICIAL radio maps for each city are suggested by Dr. William Bowie, of the Coast and Geodetic Survey, in a recent interview with the press. These, engraved in brass, might be set up in public places and

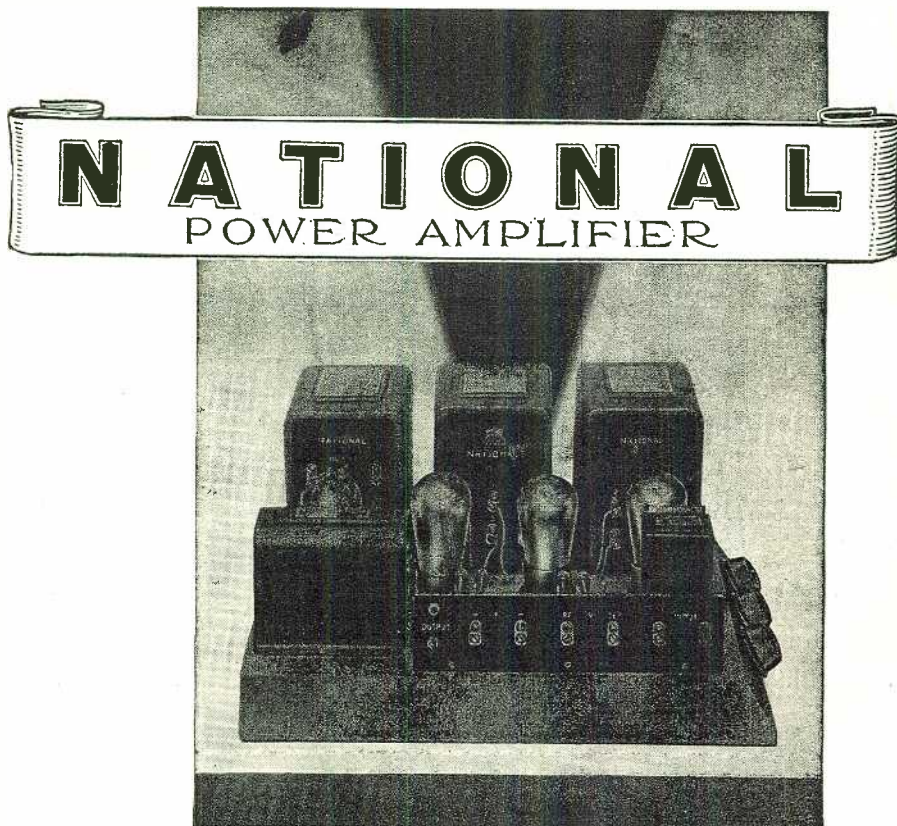

THE NATIONAL Power Amplifier is a new combined B-power supply and 3-stage audio amplifier, for use with either the Raytheon BH or Rectron Tubes, and with the UX-171 semi-power tube in the last audio stage. Made to be connected instantly to the detector output of any set and gives real fidelity of reproduction.

The parts mount on a drilled and cored metal base.

Designed on sound engineering principles in collaboration with Arthur H. Lynch and James Millen. Sold as a complete kit with Raytheon BH Tube, but without audio tubes, and everything necessary for the assembly, including even wire, and with full instructions for assembly in one evening.

PRICE OF KIT \$84.00

Sold also completely assembled and tested, with Raytheon BH Tube, but without audio tubes. Price \$95.00.

Send for descriptive pamphlet RN.

NATIONAL products are built to engineering standards of excellence. Anyone who ever built a set using NATIONAL BROWNING-DRAKE Coils and Transformers knows what that means. Send for Bulletin 116-RN.



National Co., Inc., Engineers and Manufacturers, W. A. Ready, Pres., Cambridge, Mass. Makers of NATIONAL BROWNING-DRAKE Coils and R.F. Transformers, Impedance Transformers, Condensers, Power Transformers, etc., for Radio.

BUILD YOUR OWN
3 Foot Cone Speaker

Save 4/5 Retail Cost

for only \$14.15 you get all the parts to build 36 inch cone speaker with finest tone quality you ever heard. Insist that your dealer show you the

Penn CONE SPEAKER UNIT

Adjustable to audio output of any set. Price, unit, \$9.50. At dealers. Pamphlet - "How to Build a Giant 3 ft. Cone Speaker" - sent for 10c, coin or stamps.
PENN RADIO SALES CO.,
104 Fifth Ave., Suite 2030, N. Y. City

FREE HOOK-UPS AND BIG RADIO GUIDE

Free, 164-page Radio Catalog and Guide brimful of newest 1927 ideas, most advanced hookups and illustrations. You save considerable sums on sets and parts. Be sure to get this thrifty book before you buy. It puts money in your pocket. Shows standard radio parts, sets, kits, all reliable, guaranteed goods. Please include name of radio fan to whom we may send copy also. Write letter or postal now for newest 1927 edition.

RADIO GUIDE THE BARAWIK CO.
540-542-D Monroe St., Chicago, U.S.A.

Insure your copy reaching you each month. Subscribe to Radio News—\$2.50 a year. Experimenter Publishing Co., 53 Park Place, New York City.

BATTERY AND ELIMINATOR

SOLD DIRECT FROM FACTORY TO YOU
SAVE JOBBERS 50% DISCOUNT
 Delivers pure direct current from your light socket

Union Standard-B
 works on D.C. or A.C. Any Cycle. 45 mils., at 100 volts. Formerly \$25. Now **\$12.50**

UNION A and B
 6-135 Volt for A.C. Any cycle. Works any type receiver. Complete ready for use. Formerly \$75. NOW **\$35.00**

Union Master B
 Works A.C. Any cycle. For Radiola 25-28-30 and super heterodynes. Operates power tubes. 60 mils. at 150 volts. Formerly \$42.50. Now **\$21.25**

NO HUM—SUPERIOR TO ANY SOURCE OF POWER
 Variable voltage adjustment on every machine to meet the varying conditions of every city and on any set. No acid. Uses Raycathode. No filament to burn out. Will give years of service. Extra replacement Raycathode \$1.00.
GUARANTEE
 We guarantee our machines against defective materials for two years. Try it for ten days and if found unsatisfactory you may return it at our expense and an immediate refund will be made. We ship from our nearest factory branch. No waiting. Immediate delivery. If interested in electrified sets send for catalog.
UNION SERVICE COMPANY Box 23, Morris Heights P. O., New York, N. Y.



Fred W. Stein.

Steinite Greatest \$1 Value in Radio Today

INTERFERENCE ELIMINATOR

NO RADIO SET COMPLETE WITHOUT IT
 Select stations at will. Especially necessary for 1 and 2 dial controlled sets. Under present conditions the average set fails to bring in the desired stations properly. The Steinite Interference Eliminator shuts out local and other interference. You get one station at a time, the one you want, and tune in loud and clear. Operates on any set—attach to aerial wire and to set—no changes—no extra tubes or batteries.

Over 400,000 Sold

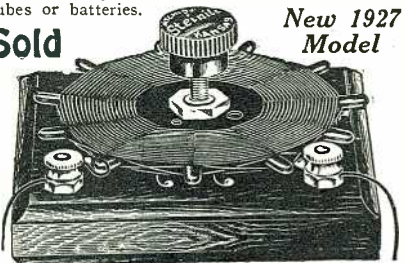

New 1927 Model

Improved Results with Tube or Crystal
 Try entirely at my risk the wonderful improvement this inexpensive little device will make in the reception of your set. Improves results on both crystal and tube sets that use any kind of aerial except loop antenna. Clears up reception wonderfully, increases volume and partially absorbs static. Money-Back Guarantee.

MONEY BACK GUARANTEE Put this interference eliminator on your set and note amazing improvement. No tools needed—install in a moment's time. Connect with set and follow simple instructions. Money back promptly if not delighted. \$1 postpaid when cash with order. **ORDER TODAY**—a dollar bill will do. Ref. remces: Exchange National Bank; Atchison Savings Bank.

\$1 Postpaid If you are not delighted with results you get your dollar back

The New Steinite 7-Tube Radio uses no batteries of any kind—only \$125. Loud Speaker Built in. Complete with tubes \$151 worth nothing to buy. Operates from light socket 1c an hour. Write for descriptive literature before buying an expensive Battery Set. Also Steinite Long Distance Crystal Set \$6—6-Tube Battery Set \$45. **WRITE TODAY.**

STEINITE LABORATORIES, 402 Radio Bldg., Atchison, Kansas

would be an authoritative guide for broadcast listeners. Recent tables of airline distances have been compiled by the Survey for the press of various cities, showing the location of broadcast stations. However, such markers can hardly supersede the fan's own map, any more than the town clock save him the trouble of winding his own.

RADIO WAR ON CRIME

NEW JERSEY, aroused by the inroads of banditti, is officially considering the erection of a state broadcast station, by which an alarm may be spread after any crime and the "invisible net" drawn around fugitives. In Australia the success of radio police cars, directed from transmitters at headquarters, has been conspicuous in Sydney and Melbourne. In the former city it is now proposed to equip the patrol car with a transmitter, so that it can keep the central station advised of its movements and all developments in any case.

RADIO PROPAGANDA

THE efforts of governments to keep out spies were conspicuous a few years ago; but they are now confronted with more elusive dodgers of frontier guards. No customs inspector has been able to halt a radio wave; and while some of the more autocratic administrations have regulated rigidly the construction of receiving sets, it is hard to prevent the reception of outside broadcast stations of high power. At present British officials are complaining that propaganda for British labor is coming in from Moscow; and the Mexican government is very much annoyed by alleged subversive speeches from a source yet undefined. *L'Antenne*, of Paris, subtly observes that the lack of Mexican concierges (janitresses) perhaps makes the government "radio-goniometres" (detecting loops) work less efficiently than in France, where they are used to catch unlicensed listeners.

THE RADIO PROPHET

THE Australian Theosophical Society has obtained a license to erect a powerful broadcast station at Sydney, through which it is planned to broadcast the teachings of the young Hindu philosopher, Jiddu Krishnamurti, hailed as a Messiah by theosophists throughout the world. Local societies have been instructed to obtain suitable receiving sets with loud speakers for reception of his addresses.

THE MODERN "GRAPEVINE"

Abyssinia, from which the Queen of Sheba is said to have come, and which deserves the description of "the end of the earth" nearly as much now as then, has one newspaper, Berhanena Salem, "Light and Peace." Its foreign news is available through the courtesy of the Italian embassy, which possesses the only radio outfit in the Ethiopian Empire.

HIGH COST OF LISTENING

It costs \$18 a year in Salvador and \$13 in Lithuania for licenses for radio receivers, as compared with one franc in France. Without going into the intricacies of exchange, it seems that the sense of hearing is at least a hundred times more expensive in Central America.

ULTRA-HIGH SELECTIVITY

Mr. Ding: I haven't seen your wife lately.
 Mr. Dong: No, she's looking for an apartment to match our new radio outfit.—*Life*.

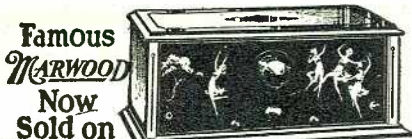

Easy Terms

1 Dial 6 Tube \$43.85
Get Agents Price—Save 50%
 Great news! Now own a famous Marwood at the world's lowest price for real quality—and pay on easy terms. The only Radio sold direct on easy terms—proof that the Marwood MUST be a wonder. A year ahead with 4 big exclusive improvements—Super-Selectivity, Power-Tube Volume, New Easy-Tuning Principle, New Tone Quality. Save half—and get a Radio that can't be beat at ANY price.

30 Days Free Trial
 We trust you. Prove the Marwood the best buy in America. Don't buy a Radio till you get our Easy Terms. 30 Days' Free Trial. Agent's Confidential Low Price. Free Radio plan, new Catalog. Agents—Write quick for territory—Make big money.
MARWOOD RADIO CORPORATION
 1747-B31 Morse Avenue, Chicago, Ill.

RADIO CATALOG

Dealers! Send for our new 1927 Catalog. Contains nationally advertised high quality sets, kits and parts.
 Use your letterhead.

Western Radio Co. INC
 134-136 W. Lake St. Chicago, Ill.

For Absolute Tone Fidelity hear a **FERGUSON RECEIVER**. Ask the nearest Authorized Ferguson Dealer or write us. J. B. FERGUSON, Inc., 225 West 57th St., New York, N. Y.

A Radio Campaigner

RADIO has been used, to an extent never before known, in the political campaigns of last fall, both in the United States and Canada. While in many cases it has merely increased the audiences of the speakers of various parties, in the case of Senator James E. Watson of Indiana it made possible a speech under unique conditions. The Senator had been for some time confined to a hospital bed and was thus debarred from old-style campaigning; but on the Saturday evening before election, through a telephone line to his bed, he spoke over the radio to his constituents throughout the state.

FOUND—A RADIO PARADISE

Bude, a little town in Cornwall, England, is proclaimed the radio paradise of the world by Kenneth Arnott, British civil and radio engineer, who came to this country recently. He reports that American stations are received regularly and that all Continental stations come in clearly. Even summer makes very little difference in DX reception. Scientists have not yet been able to explain the reason wireless signals are intensified and why signals from stations seldom ever heard elsewhere are received with amazing regularity.

"Through a cause which no one has yet explained, reception in Bude exceeds that of anywhere else that I know of or what has been reported," Mr. Arnott said. "And yet, in Bodmin, ten miles inland from the coast, there is an actual dead spot."

—And Purgatory

Gibraltar, on the contrary, has been said to be the worst place in the world for the broadcast listener, because of the high-powered military and naval stations and the constant transmission from shipping in the straits, which jams the air almost incessantly.

"UTILIZING THE SQUEAL"

A number of young lads were seen standing in a row performing various stunts. First, they all sang a verse together; then one recited a piece, followed by yet another playing on an old mouth organ.

"What are you youngsters doing?" inquired a passerby.

"We're playing radio," explained the leader.

Just then a lad who had taken no part doubled over with a series of groans and cries.

"What is the matter with him?" asked the man.

"Oh, he's got a stomach ache, and we're using him for static," was the reply.

—Contributed by William H. Spaulding.

A "B" ELIMINATOR



Madison Multi-Chokes

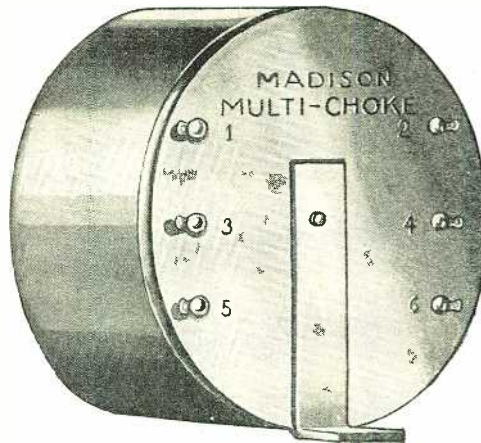

QUADRI-WOUND
as specified for the

"LR-4"

Lacault's Greatest Success!

Madison Multi Chokes (Quadri-Wound) have been specified by R. E. Lacault, originator of the famous Ultradyne in his latest development—the nine-tube Super-Sensitive LR-4 receiver.

For years, set builders have followed Lacault's specifications and guidance, in the successful construction of the most efficient radio receivers. There is no question about his selecting the Madison Multi-Chokes for his latest achievement.

Lacault knows something good when he sees it. Madison Multi-Chokes have met his most exacting requirements and it is for this reason that they are being specified in the new LR-4.

Madison Multi-Chokes can be used in many different combinations. In fact, this choke is the latest development in radio. They can be used for at least thirty different purposes. They are universal coils.

Lacault's LR-4 owes its extreme sensitiveness and selectiveness to the Madison Multi-Chokes which are the foundation of his receiver.

Madison Multi-Chokes are made up in two types; Type

"C" and Standard. These Multichokes are special choke coils built in sections of different values, permitting various values of inductances to be obtained by connecting the terminals as shown in the pamphlet furnished with each Multi-Choke.

For example; the various windings may be connected so as to form a radio frequency transformer for the reception of long wave lengths, such as used by European broadcast stations. When used as R.F. transformers, five different ratios are obtainable.

The various values of inductances obtainable make these chokes adaptable to any radio receiver or circuit in which choke

coils are used. A few of the uses are: — Between the detector and audio amplifier. (This is particularly useful when resistance coupled amplifiers are used).

In the B battery leads, in circuits balanced to prevent oscillation, in filters, etc.

Additional values of inductances are obtainable with the type "C" chokes.

Dealers and distributors:

This is your opportunity to cash-in on this money-making proposition. Madison Multi-Chokes will be a consistent money maker. National advertising has been scheduled so send your orders at once. Orders will be filled and shipped in the rotation in which they are received. First come, first served.

Send for free literature.

Price \$6.50 each

MADISON RADIO CORPORATION

114 E. 28th Street

New York, N. Y.

Open a Radio Store

OPEN a RADIO STORE! Big business opportunity of the day —no capital necessary under our plan. Snap your fingers at the time clock—boss a good business of your very own. No other line offers you such a chance to start small—without capital—and grow big and firmly established in a very short time. Our FREE BOOK explains our plan—how we teach you all you need to know about Radio and help you start up in your spare time if you like—how our Business-Building Aid guides you and helps you grow FAST and make good money. Write today for Free Book giving details—no obligation. Address: J. E. Smith, President, National Radio Institute, Dept. BB-97, Washington, D. C.

FREE RADIO GUIDE—SEND FOR IT

SETS, PARTS, KITS
164 PAGES OF NEW IDEAS
You need this big FREE book. A practical guide to success in set building. Gives new 1927 hook-ups. Shows the latest parts and kits at prices far below others. Send today. Build the newest sets. Make more money.

BARAWIK CO.
540-542-D Monroe St.
Chicago, U. S. A.

Mail This Coupon Now! For Free Copy

Name

Address

Phone

Address

Mar-Co Dials

Print Your Own
Cards, Stationery, Circuars, Paper, etc. Save money. Print for others, big profit. Complete outfits \$3.85. Job press \$11, \$29, Rotary \$149. All easy, rules sent. Write for catalog presses type etc. THE KELSEY CO., P-72, Meriden, Conn.

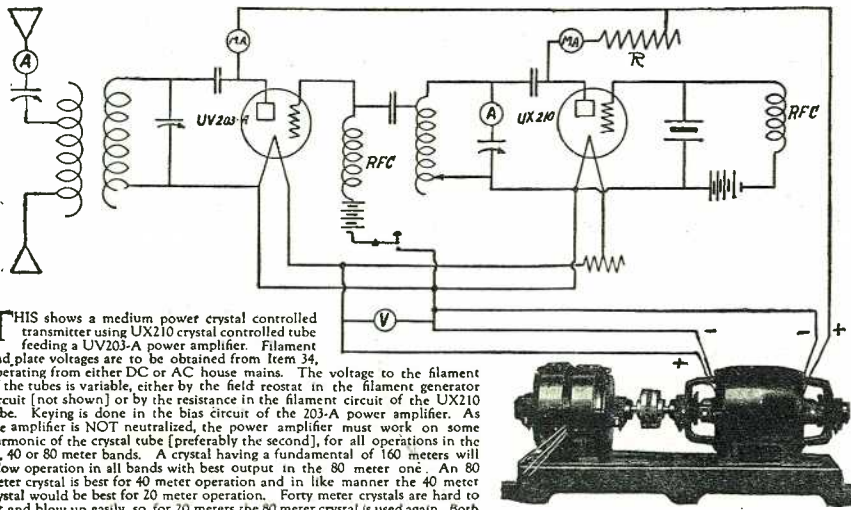

THIS shows a medium power crystal controlled transmitter using UX210 crystal controlled tube feeding a UV203-A power amplifier. Filament and plate voltages are to be obtained from Item 34, operating from either DC or AC house mains. The voltage to the filament of the tubes is variable, either by the field resistor in the filament generator circuit (not shown) or by the resistance in the filament circuit of the UX210 tube. Keying is done in the bias circuit of the 203-A power amplifier. As the amplifier is NOT neutralized, the power amplifier must work on some harmonic of the crystal tube (preferably the second), for all operations in the 20, 40 or 80 meter bands. A crystal having a fundamental of 160 meters will allow operation in all bands with best output in the 80 meter one. An 80 meter crystal is best for 40 meter operation and in like manner the 40 meter crystal would be best for 20 meter operation. Forty meter crystals are hard to get and blow up easily, so for 20 meters the 80 meter crystal is used again. Both tubes obtain plate supply from the plate end of Item 34, the UX210 being supplied with not over 350 volts through resistance R, and the 203-A taking the full 1000 volts.

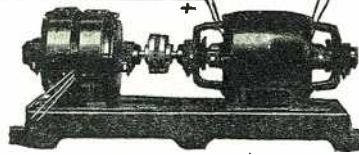

ELECTRIC SPECIALTY COMPANY

211 South Street

TRADE "ESCO" MARK

Stamford, Conn., U.S.A.

Manufacturers of Motors, Generators, Motor-Generators, Dynamotors and Rotary Converters for Radio and other purposes

WASHINGTON CLASSIFIES RADIO

The District of Columbia, which is under federal regulation, recently made a ruling which barred a blind vendor from using a radio set on his little cart to attract customers. Had he been a scissors-grinder, an ash collector, or an auctioneer, it would have been allowable. Friends pleaded that he might be classed as an "itinerant musician"; the official Dogberry rules that this will not do, as a radio reproduces instead of "making" music. So the owner can use his set only in private.

THE OLD CRIER AND THE NEW

A striking contrast between old methods and new was illustrated in Pewsey, Wiltshire (England) recently when the national town criers' contest was held, and the entrants appeared in such uniforms as their fathers wore before the daily press and the radio were thought of. Their voices were broadcast, and the greatest good-will was shown between "the earliest form of broadcasting" and the newest.

A DISTINGUISHED RADIO FAN

Among ardent international DX fans is now to be counted the President of the French Republic, M. Gaston Doumergue. He first took up radio as a vacation hobby at the old royal chateau of Rambouillet, now the summer residence of the president. His Official Spokesman tells with delight how he received Pittsburgh. In Paris, on the other hand, with all its advantages, he has less favorable reception conditions at the Elysee Palace.

THE RADIO ADVANCE GUARD

Radio will blaze the way for the Twentieth Century pioneers. The government of Bolivia has lately opened up for settlement a vast area of unpopulated territory in the hinterland, and the concessionaires plan to settle four or five thousand European families there within two or three years. The first party of about a dozen takes with it a 500-watt C.W. and phone transmitter that will link its members to civilization. It will operate from Gaiba, their first settlement, to Corumba, the nearest railhead, about 100 miles distant.

A NEW WORLD FOR RADIO

One of the largest fields for the introduction of popular broadcast service is India, with three hundred million people. There are now but a few stations, mostly low-powered. The prospectus of the Indian Broadcasting Co., now erecting two 12-kw. transmitters, in Bengal and the Bombay district, points out the possibilities when a chain of powerful stations shall make possible crystal reception throughout the densely-settled areas. A listener's license in India costs 10 rupees (\$3.75).

RADIO IN THE ARCTIC

Contrary to a popular idea, which is aided by some publicity, the radio station at Cape Nome is not the most northerly on the continent, says E. J. Cunningham of Holy Cross, Alaska, in *Current History*. Nome is south of the Arctic Circle, while within the latter there are three good-sized stations hundreds of miles north of Nome. The first of these is at Norvik, some ninety-five miles directly north of Nome on the Kotzebue River; the second is located at Wiseman, 225 miles north of Nome, on the upper branch of the Koyukuk River, and a third station recently erected is located at Little Squaw Mine. Of these the Wiseman station is the most northerly.

A RADIO FRATERNITY

Norman, Oklahoma amateurs have a radio fraternity—the Alpha Sigma Delta.—*Oklahoma Oklahoman*.

The Tube of Longer Life

Radio Vacuum
Best by Test
TUBES
Make a
Good Receiver
Better!

C. E. MFG. CO. Inc.
Providence, R. I.

Big FREE RADIO PARTS, Catalog & Guide

HOOK-UPS, SETS and KITS

Send now for this valuable FREE Radio book. 164 pages of newest hook-ups, parts and kits at big savings. A real guide. Shows factory built sets and new ideas in radio. Send at once. No obligation. Please include name of radio fan.

BARAWIK CO., 542-D Monroe St., CHICAGO, U. S. A.

Mail This Coupon Now! For Free Copy

Name _____
Address _____
City _____
State _____
Zip _____

WEBSTER

"LITTLE GIANT B-C"

All A.C. Models Raytheon Equipped

Both B and C Current from the light socket. Marvellous results. Greater distance and volume. Improved reception. Ample power for the largest set. Five variable voltages. \$50.00

Webster "Super B" three variable voltages. Price \$39.00

Webster Popular "B" Open type 35.00
Direct Current Model 25.00

Write for free booklet, "Improving Your Radio"

THE WEBSTER CO.
3516 West Lake St.,
Chicago

Insure your copy reaching you each month. Subscribe to Radio News—\$2.50 a year. Experimenter Publishing Co., 53 Park Place, New York City.

TUNING 'EM IN

ANOTHER ON THE SCOTCH

"MacDougal McGregor is the meanest fellow I know," said one of his friends. "Why so?" he was asked. "He says," was the reply, "that the wireless concerts are not value for the money, because you can't get any encores out of the artists."—*Irish Radio World*, Dublin.

LEAVING SOME FOR THE RADIO

Now that a 40-minute phonograph record has been perfected, it should be possible to get all the "Prisoner's Song" on the disc except the last 27 stanzas.—*Detroit News*.

WEAKENED TOO SOON

Irate Flat Dweller—"Look here, Brown, your infernal loud speaker kept me up till twelve last night!"

Radio Friend—"My dear old cherub, you ought to have stuck it for another quarter of an hour; we got some great stuff from Paris."—*Passing Show*, London.

EASY FOR A HAM

He (on the phone): "May I come out this evening?"

She (between sniffs): "I hab a berry bad code."

He: "Well, let me come over and help decipher it."—*Pennsylvania Punch Bowl*.

THE RADIO HUSBAND

"Hello, old chap! Feeling lonely now your wife's away?"

"Well, the washing-up and bedmaking are a bit of a nuisance, but I get the loud speaker going all the time and don't seem to miss her."—*Til-Bits*, London.

NOTHING CAN BE CHEAPER!

The stingiest man in the world bought a radio. On Sunday mornings he tuned in and listened to the best Sunday sermon preached. When the minister announced, "Now the ushers will pass the plate, be liberal"—this man turned off his radio.—*Terre Haute Star*.

OR A PRIZE FIGHT

Hearing a football game through the loud speaker helps also to conserve the overcoat and keep the feet dry, even if it does cut down the gate receipts.—*Indianapolis News*.

MODEST ASPIRATION

"Why do you insist on becoming a radio announcer?"

"I have decided," answered Mr. Meekton, "That I want a chance to say a few things, however non-committal, under circumstances that won't permit Henrietta to have the last word."—*Exchange*.

A SHIELDED COIL

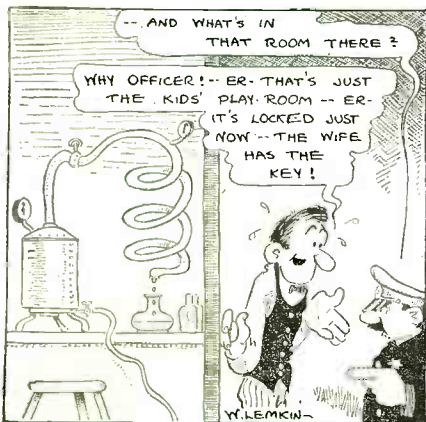

LOT presents Two Radio Improvements

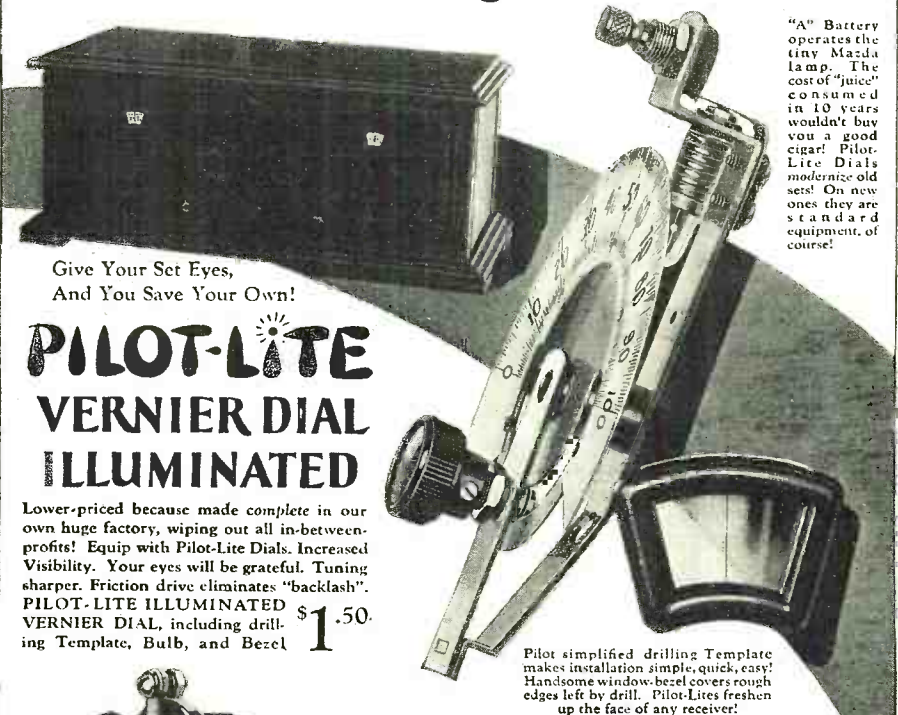

"A" Battery operates the tiny Mazda lamp. The cost of "juice" consumed in 10 years wouldn't buy you a good cigar! Pilot-Lite Dials modernize old sets! On new ones they are standard equipment, of course!

Give Your Set Eyes,
And You Save Your Own!

PILOT-LITE VERNIER DIAL ILLUMINATED

Lower-priced because made complete in our own huge factory, wiping out all in-between-profits! Equip with Pilot-Lite Dials. Increased Visibility. Your eyes will be grateful. Tuning sharper. Friction drive eliminates "backlash".
PILOT-LITE ILLUMINATED VERNIER DIAL, including drilling Template, Bulb, and Bezel \$1.50.

Pilot simplified drilling Template makes installation simple, quick, easy! Handsome window-bezel covers rough edges left by drill. Pilot-Lites freshen up the face of any receiver!

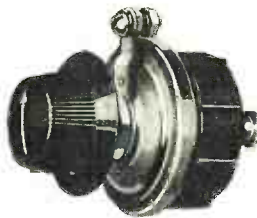

PILOT-RESISTOGRAD

What is it? A non-inductive variable Resistor.
How used? 1. To control regeneration, use as a variable grid-leak.
2. To regulate output voltage in B Battery eliminators.
Construction? A special active compound is hermetically sealed in Bakelite case moulded under enormous pressure. Assures perfect insulation and cannot deteriorate or fluctuate due to entry of moisture or dirt.
Features? Range from practically zero to 30-million ohms (30 megohms). Allows perfect gradation. Always stable and under positive control. Made with characteristic Pilot precision, entirely in the big Pilot plant, cutting the price in half! Easily mounted. **\$1.25**

ENGLAND
R. A. Rothermel, Ltd.
24 & 26 Maddox Street
Regent St., London, W1.
AUSTRALIA
United Distributors, Ltd.
72 Clarence St., Sydney
BRAZIL
Samuel Meyer
41 Rua Buenos Ayres, Rio Janeiro
ARGENTINE
Samuel Meyer
367 Bartolome Mitre, Buenos Aires TRADE MARK



PILOT
ELECTRIC M'FG. CO., INC.
323 BERRY ST., BROOKLYN, N.Y.

Get parts shown here at S. S. Kresge Radio Depts., or through local dealer.

Super Heterodyne Construction and Operation

By R. E. LACAULT, E.E., I.R.E.

is a book full of practical information for the owners and builders of super heterodyne sets. This is written so that anyone can understand it and should prove particularly useful to those who do not obtain the expected results from their home made sets, as the trouble shooting chapters are very complete.

Other chapters include—

The how and why of each part. Trouble shooting chart.
How to check and match your tubes. How to build a power amplifier, etc.

and COMPLETE CONSTRUCTIONAL DETAILS ON THE

LR 4 -- Price \$1.97

Set of four full size drawings for the assembling, construction and wiring of the LR4—\$1.00.

R. E. LACAULT RADIO ELECTRIC LABORATORIES, 1931 BROADWAY, NEW YORK CITY, Dept. 1A

Manufacturers of the
MAGNIPOWER and ANODYNE
High power amplifiers and plate supply.

Write for literature describing these REL products.

Learn Watchwork, Jewelrywork and Engraving A fine trade commanding a good salary, and your services always in demand. Address Horological, Dept. 5, Bradley Institute, PEORIA, ILLINOIS, for our latest catalog.

EVERYTHING IN RADIO

AT ATTRACTIVE PRICES. SETS OR PARTS. Orders shipped exactly as ordered. Prompt Service. Write for Prices. Mail Order Only. ALL RADIO COMPANY, 417 North Clark St., Chicago

RADIO'S HIGHEST STANDARD OF EXCELLENCE



**ENDORSED
BY THE BEST!**

H.F.L. Units have been used, approved and most highly endorsed by Radio News, Citizens Radio Call Book, Radio Review, Radio Age, Radio Engineering, Radio Mechanics, Chicago Evening Post and Daily News. Hundreds of engineers and fans, who have turned to H.F.L. Units for better reception hail them as the finest instruments known to Radio—unexcelled for Power, Selectivity and Purity of Tone. Every H.F.L. Unit is unconditionally guaranteed.

PRICES

- H. 210 Iron core transformers with an exceptionally high amplification factor. Each unit carries laboratory calibration. Range 32,000 to 42,000 cycles. Price \$8.00
- H. 215 Air core transformer, tuned stage, designed to amplify signals at a maximum efficiency of 37,000 cycles. Each unit carries the laboratory calibration. Price \$8.00
- F. 320 Audio frequency transformer which will amplify signals to greatest volume with incomparable faithfulness of tone. These units are the result of an entirely new principle in transformer construction. Price \$8.00
- L. 425 Radio Frequency Choke Unit. Price \$5.50
- L. 430 Low Loss Radio Frequency Transformer. Price \$5.50

Jobbers Write Today Dealers

Try H. F. L. Units for Better Results. If your Dealer cannot supply you order direct.

Write for H.F.L. Circulars

HIGH FREQUENCY LABORATORIES
129 N. Wells Street
Chicago Illinois

Mandy An' Me

Right after supper Mandy an' me
Gits t' th' Radio quick as can be;
Tumin' in, we does, with kittenish glee—
Gittin' all stations, clear down t' Cuby.

The neighbor's kid, little Johnny Lee,
Clambers up slowly upon my stiff knee;
He listens in with childish glee
To a bedtime tale about Doc Squeegee.

Then Mandy, she sez, she sez t' me,
"There's a band a-playin' at Schenectady;
I read it, I did, in th' Radio Bee—
Tune in quick, John, ez quick ez can be."

'Fore we knew it, 'twas half-past three;
I looked at Mandy, Mandy looked at me;
Two durned fools—as both agree—
Felt 'sif we'd been on a grand ol' spree.

The rooster he crowed with seemin' glee—
He seemed t' say, "What fools they be!"
Maybe we is, but what care we!
We're Radio Bugs—both Mandy an' me.
William A. Hennessey.

THE NEW PEDAGOGY

If, as predicted, it shall come to pass that radio conquers the educational world along with everything else, then the college curricula of the future will read about as follows:

1. English Literature from Chaucer to Milton. Broadcast by the Hartford Steam Laundry Ensemble.
2. Analytical Geometry, Differential and Integral Calculus. By the Continental Typewriter Quartet.
3. The Greek Dramatists. By the Minnehaha Table Water Gang.
4. Theory of Music and Harmony. By the Wichita Oriental Rug Distributors, Inc.
5. Microbiology and Parasitology. By the Asbestos Roofing Corporation.
6. France under Louis XIV. By the Simple Hosiery Trio.
7. Bible Appreciation. By the Madison Square Garden Amusement Company.—*New York Times.*

RADIO TERMS DEFINED

NOVICE: One who listens to a program without getting the name of the station.
EXPERT: One who gets the name of the station without listening to the program.
—*Parke Cummings in Life.*

SUPER-POWER EMISSION

The program sponsored by the Schmaltz Limburger Co. was the best feature on the air last night. As usual, it came in strong.
—*Contributed by William G. Mortimer.*

A FIXED DETECTOR

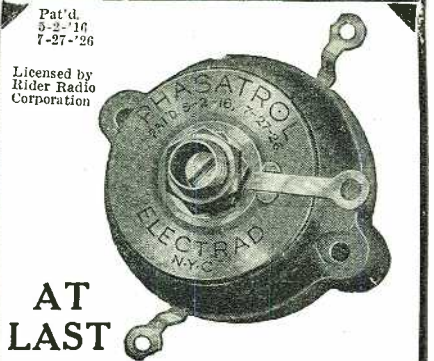

AT LAST "Phasatrol"

A true balancing device for radio frequency amplifiers

PHASATROLS are the latest achievement in radio frequency amplification and can be installed in any radio frequency set in a few minutes—no technical knowledge or skill is necessary.

PHASATROLS simplify tuning, stop radio frequency oscillations and distortion, enable your tubes to work at maximum efficiency and prevent them from radiating interference to your neighbors.

At your dealers or write direct. Write for Hook-Up Circular.

Price, \$2.75

428 Broadway, Dept. 27 New York, N. Y.



Changes Your Set Into a Low Wave Receiver



Sent postpaid upon receipt of \$15 M. O.—or C. O. D. plus postage. State name of set and type of tubes you use.

SUBMARINER

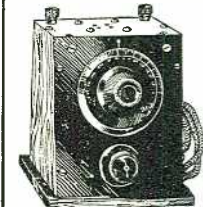

Converts any set, regardless of make or number of tubes used, into a high class low wave tuner, with which you may experience the thrill of listening to voices from all parts of the world on low wave lengths. No changes necessary to your present set.

EVERYWHERE A SENSATION

No jumble of stations on low waves—no disarrangeable noises—practically no static. Learn code by listening to amateurs from all parts of the world. Comes ready to attach; no extras needed. Just plug in and you have command of the low wave lengths. Operates as a wave changer in superheterodynes. Connected and disconnected instantly. Order today.

ORDER TODAY

WE GUARANTEE TO REFUND YOUR MONEY IF THE "SUBMARINER" FAILS TO OPERATE.

J-M-P MANUFACTURING COMPANY
Dept. 115X MILWAUKEE, WISCONSIN

6 Volt

STORAGE RADIO "A" BATTERY

\$5.00
C. O. D. Send No Money

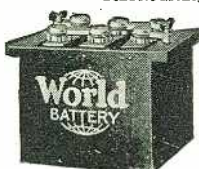

Solid Rubber Case

An assurance against acid and leakage. Order shipped same day—subject to your examination on arrival. Extra offer: 5% discount for cash in full with order. ACT TODAY!

WORLD BATTERY COMPANY
1219 S. Wabash Ave. Dept. 110 Chicago, Ill.

American Radio Now—
Lowest Wholesale Prices on **RADIO!**

BIG NEW 1927 CATALOG-FREE

Dealers, Agents, Set Builders—get our big 1927 Catalog—225 nationally advertised lines. Low money-saving prices! Largest, most complete stock. Radio's latest developments. It's FREE—send for your copy now. **AMERICAN AUTO & RADIO MFG. CO., Inc.** 1433 McGee Street, Kansas City, Mo.

Doggerel by "Sparks"

I am a Radio Operator and I live along the deck;
I feel so dreadfully lonely, for I have no friends, by heck.
Whenever people see me they curse me on the spot,
For my iddy-iddy-umpty and my dot-dash-dot.

And engineers who hear me, a-talking in the night,
In little dots and dashes, get such an awful fright;
They think of their old dynamos and all that ancient lot,
Being busted by my umpty and my dot-dash-dot.

I am quite inoffensive and I only aim to please,
But really cannot help it if the dynamo should sneeze;
It may be just a local fault, and then perhaps it's not,
But do not blame it always on my dot-dash-dot.

For when the ship is quiet, to my neighbor I discourse
In the longs and shorts invented by the late Professor Morse
So if you hear us talking, don't seek us out to sweat,
For our iddy-iddy-umpty and our dot-dash-dot.

And if it is your urgent wish, a radiogram to send,
I'm glad to help you all I can to gain this noble end,
The charge is small and service good—I'll run it off quite hot,
With my iddy-iddy-umpty and my dot-dash-dot.

—J. E. Kitchin.
S.S. "Canadian Coaster."

UNDERGROUND RADIO WAVES

Replying to the inquiry, "Where does radio stand today?" one of our English contemporaries observes: "If it ever travels by subway, the answer is simple."

THE BATHROOM RECEIVER

"My wife gave me a two-tube set for my birthday."
"Regenerative?"
"No. Shaving and tooth!"—*American Legion Weekly.*



Choose which of these 5 circuits you Will Build!

You can build 'em all—and many others, too—with the amazing Pilotone Universal Kit. All parts interchangeable. No soldering. Perfectly simple to build. Simply perfect to hear!



FIVE TUBE T.R.F. 3 TUBE 3 CIRCUIT 3 TUBE REFLEX 2 TUBE REFLEX

PILOTONE UNIVERSAL KIT

\$17.90

SHORT WAVE

Contains all necessary parts for above five circuits (and many others). Tuning Coils and Condensers are not included as inductance, etc. varies for each circuit.

- 1 Drilled and Lithographed Front Panel (7x18)
- 1 Drilled Sub-Panel (7x17)
- 1 Pilot Light
- 2 2" Bakelite Sub-panel Brackets
- 2 700-ohm Resistances (Dampers)
- 1 .006 By-Pass Condenser
- 1 .002 By-Pass Condenser
- 2 Vernier Dials
- 5 Universal Sockets
- 1 Filament Switch
- 1 Pkg. Washers—1 Pkg. Nuts
- 2 Pkgs. Ass. Screws
- 38 Flexible Leads
- 1 .00025 Grid Condenser
- 1 Grid Leak
- 9 Marked Binding Posts
- 2 Audio Frequency Transformers
- 1 10-ohm Rheostat w/ knob
- 1 20-ohm Rheostat w/ knob
- 1 3-Point Jack—1 4-Point Jack

Get the Pilotone Kit S. S. Kresge Radio Dept. If none near, order through local dealer, otherwise \$17.90 via post office or express money order for complete kit; also condenser and coil catalogs. Massive walnut finish cabinet \$7.50 extra. Department 127.



PILOT
ELECTRIC MFG. CO., INC.
323 BERRY ST., BROOKLYN, N.Y.

BRAZIL
Samuel Meyer
41 Rua Buenos Ayres,
Rio de Janeiro

ENGLAND
R. A. Rothermel, Ltd.
24 & 26 Maddox Street
Regent St., London, W.1.

ARGENTINE
Samuel Meyer
367 Bartolome Mitre,
Buenos Aires

AUSTRALIA
United Distributors, Ltd.
72 Clarence St., Sydney

An Announcement from CHARLES R. LEUTZ

ON October 13th, 1926, Claude Golden resigned as an officer and director of this corporation and sold his entire stock holdings to Charles R. Leutz. Application has been made to change the firm name from Golden-Leutz, Inc., to C. R. Leutz, Inc.

Effective immediately new policies will go into effect under full control of C. R. Leutz.

Our sets will not only be known as the best obtainable but will now be available at very reasonable prices. Some list prices have been reduced as much as 40%.

All models will be stocked for immediate shipment.

Important announcements and new literature are being printed, write for your copy today.

GOLDEN-LEUTZ, Inc.

Sixth and Washington Avenues

LONG ISLAND CITY,

NEW YORK



**CONDENSERS
600 LINE**



The 600 line of TOBE Condensers has been designed especially for use with Amer-TRAN and similar high-voltage power-packs. The condensers are made to stand the high voltages employed, and are equipped with the new TOBE safety terminals at the base of the can,—a feature not found in any other condensers. Cased in metal containers, with the characteristic TOBE silvered finish.

PRICES

No. 650— .5 Mfd.	\$1.75
No. 601— 1.0 Mfd.	\$2.50
No. 602— 2.0 Mfd.	\$4.00
No. 604— 4.0 Mfd.	\$7.00



TINYTOBES

The TINYTOBE Condenser, shown in actual size above, is a new product and is available in capacities from .0001 to .02 Mfd. For continuous operation at voltages up to 500 volts D.C. It is so small and light that it can be soldered directly into the circuit without other support.

Prices range from 35c for .0001 Mfd. to 60c for the .02 Mfd.

TOBE Condensers are specified in the Quadriformer, Carborundum, Lincoln, Henry-Lford, BROWNING-DRAKE, and many other leading circuits.

Tobe Deutschmann Co.,
Engineers and Manufacturers of Technical Apparatus
Cambridge, Mass.

**Send for Latest
RADIO CATALOG
and GUIDE**

**SETS, PARTS, KITS
BIG SAVINGS**

You need this big FREE book. A practical guide to success in set building. Gives advanced hook-ups. Shows all newest parts and kits at prices far below others. Send today. Build the newest sets. Make more money.

BARAWIK Co.
540-542D Monroe St., Chicago

**Power Amplifier and
Plate-Supply Unit**

(Continued from page 1002)

ASSEMBLING THE KIT

Having considered the purpose of the various parts we may now proceed to assemble the kit. Upon a drilled base board should be mounted:

1. The three large containers holding, separately, the power transformer, the filter chokes, and the condenser block.
2. The two smaller containers, one holding the plate-supply resistance unit and the other containing the bias and filament-control resistances.
3. The tube sockets, one for the Raytheon and the other for the power-amplifier tube.
4. The input and output transformers.
5. The terminal panel.
6. The snap switch and attachment cord.

The illustrations show the exact arrangement of the parts together with the wiring, most of which is run under the base board.

INSTALLATION AND OPERATION

When used with a highly sensitive radio set, the kit should be located at least three and preferably five feet away in order to prevent interaction between the power transformer and the first-stage A.F. transformer, which would produce a 60-cycle hum in the loud speaker. If used with a less sensitive receiver it may be found, on trial, that a smaller distance will be satisfactory. On the other hand, a much greater separation is not desirable. The attachment plug and cord, extended if necessary, should be run to a lighting receptacle or wall outlet and should be kept as far as practicable from all wires leading to the radio set, including antenna and ground.

Two or three wires for carrying the "B" battery potentials to the set may be run in the usual manner. The output from the radio receiver should be carried to the input terminals of the kit by a double telephone cord or a pair of twisted leads, which should be kept separate from the "B" battery leads. A similar conductor should be used to connect the loud speaker to the output terminals. Under certain conditions better quality can be obtained merely by interchanging the input leads at the input terminal posts.

The majority of radio sets have the positive or negative filament terminal connected to ground. This provides a sufficient grounding for the eliminator. With sets in which the filaments are not grounded, and those employing an ungrounded loop, it may be advisable to ground them through a condenser of from 2.0- to 4.0-mf. capacity. This ground is unnecessary in many cases; but under certain conditions it is desirable in order to reduce the alternating-current hum. If the kit is used merely as a power amplifier it may be desirable to ground the "B—" terminal.

A word of caution should be added here concerning the attempt to measure the voltage at the "B" battery terminals of the kit. The ordinary, inexpensive voltmeter draws so much current that the increased load on the plate supply lowers the voltage considerably, so that the readings of such a meter are meaningless unless the meter load is known and taken into account.

Tests have shown that, on the average, using the type-BH Raytheon and with the power tube in the circuit, the open-circuit voltage at the "B+90" terminal is about 145. This potential drops at a rate of 3.25 volts per milliampere of current drawn from this terminal.

The open circuit voltage at the "B+45" terminal is about 50. This diminishes at a rate of 2.23 volts per milliampere load from this terminal. These values meet the requirements of most radio receivers.



AC12 \$30

**Amplion Cone superiority
lies in its clear
reproduction of speech**

*This is the supreme test
of radio reproducers,
especially the Cone type.*

The Amplion Cone is enclosed in a handsome mahogany cabinet, 14" x 14" x 9".

No matter what set you may use the Amplion Cone will help it to give you its best performance.

Amplion models range from
\$12 to \$50

Have your dealer give you a demonstration or write for illustrated Amplion booklet which describes all models.

**THE AMPLION CORPORATION
OF AMERICA**

Suite S, 280 Madison Avenue, New York City



**Now! World-
"A"
POWER UNIT**

Complete-Automatic-Unvarying

**"A" Current
From
Your
Light
Socket
at a price
anyone
can afford**

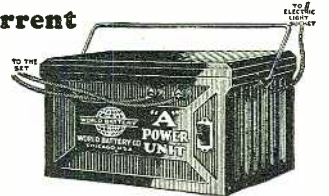

Provides even, unchanging "A" current from the moment you throw on your set switch. Finer reception, uninterrupted by "fade-outs" and "screeches" from run-down batteries or uneven power. No bothersome recharging. No expensive and fragile tubes to burn out. World "A" Power Unit assures full tone quality and wider DX range.

\$14.75

Built for Long Life

by the same trained experts who for years have made World Batteries famous for supreme quality, tested and approved by leading authorities, including Radio News Laboratories, Popular Sci. Inst. Standards, Pop. Radio Laboratories, Radio Broadcast Laboratories, Radio in the Home, Lefax, Inc. A marvelous improvement—at less than half the cost of any similar equipment.

Shipped complete—subject to inspection—on receipt of price, \$14.75. 5 per cent discount if cash in full accompanies order. Sent C.O.D. if you wish. Write today.

WORLD BATTERY COMPANY

1219 So. Wabash Ave., Dept. 150-X, Chicago, Ill.

Set your radio dials at 288.3 meters for the World Storage Battery Station WSBG. Variety-New Talent—Always Interesting. JERRY SULLIVAN—Director and Announcer—CHI-C.A.W. '26

5-TUBE RADIO SET \$1.00 Down

This wonderful Radio made possible because practically everything is manufactured in our factory. We supply the set completely wired but we do not supply 7 x 18 cabinet. Set is of latest design. Money back guarantee. Send \$1.00 with order, balance \$20 C.O.D. on receipt of set. Total price \$21.00. DUKE RADIO, 326 W. Madison, Chicago, Ill.

INVENTORS who derive largest profits know and heed certain simple but vital facts before applying for Patents. Our book Patent-Sense gives those facts; sent free. Write LACEY & LACEY, 631 F St. Washington, D. C. Established 1899.

Overhead vs. Underground Reception

“WE are beginning to have some understanding of the fact that the condition of the atmosphere has an effect on the condition of the Heaviside Layer,” says *Wireless Magazine*, London. “For one thing, both the sun and the moon would seem to have the power to cause ‘tides’ in the layer very similar to the tides in the sea. It is established that signals travel better in the full-moon periods than they do in the new-moon periods. There is no doubt about it.”

LUNAR ATTRACTION

“The probable explanation is that the pull of the full moon puts the Heaviside layer into a very favourable position for the reflecting or refracting of signals to a long distance.

“The interesting point is that there is apparently only one atmospheric ‘spring tide,’ and that is at the full moon. If it can be proved that there are two atmospheric spring tides, as there are two ocean spring tides, at full and new moon, then the explanation just given of the increased distance obtained during the full moon period must fall to the ground, for there is no doubt that at new moon long-distance work is at its worst.

“Another interesting series of observations has shown that cyclonic conditions of the atmosphere disturb the Heaviside layer. A depression between a low-power transmitter and the receiver will often cause a great drop in signal strength. Also, this summer, many stations have observed and reported a sudden great gain in strength when a thunderstorm has broken within a few miles of a transmitting station. The cause of this is unknown.”

EARTH'S MAGNETIC FIELD

“In connection with the successful long-distance results secured by Professor Rogers using an aerial consisting merely of a 3-ft. iron rod buried in the ground, the suggestion has been made that even short-wave radiation must be largely ‘earth-bound.’ Mr. W. M. Massie, for instance, maintains that wireless signals are not true ether waves, but consist of a wave motion in (or a disturbance of) the ‘magnetic field’ of the earth which is known to extend from pole to pole.

“The signal disturbances are propagated through this magnetic field, and follow the curvature of the earth just as a tidal wave follows the surface of the ocean. It is known that the strength of the natural earth currents vary from day to day, and this is stated to explain the peculiar fluctuations observed in signal strength. The stronger the earth currents, the stronger will be the resultant magnetic flux, and the greater the distance over which the signals will travel. Again the signal disturbances favour the track of the natural earth currents, which to some extent accounts for the existence of good and bad areas of reception.”

PROBLEM OF CONDUCT

Even in Great Britain, with its ingrained respect for law, there seems to be some doubt as to the subject's duty to assist the Crown in eliminating criminals. Here is the advice *Tit-Bits*, of London, gives to a reader signing himself “Indignant,” from a London district: “Do not ‘inform’ on your neighbor, who you believe has no license for his radio set. You may be wrong, you know, and in any case it is a matter between him and his conscience. People who commit petty acts are themselves the greatest sufferers—even though they do not always know it.”

Insure your copy reaching you each month. Subscribe to RADIO NEWS — \$2.50 a year. Experimenter Publishing Co., 53 Park Pl., N. Y. C.

QUALITY RECOMMENDS IT!

AND

BUYING DIRECT FROM MAKER SAVES YOU ONE HALF

SUPERB “B” ELIMINATOR

Variable Voltage Control Gives a Better, Clearer Tone



No two radios operate best at exactly the same “B” voltage. You must have a variable “B” power supply to get best results.

Our “B” Power Control Fits “B” Voltage to Your Set

NOTE: Just turn the knob to where tone is best and then you know where voltage is right.

SEE! This B Power Control

YOU RISK NOTHING

Positive Satisfaction Guaranteed

We guarantee this eliminator to be equal to any eliminator, regardless of price. If for any reason you are dissatisfied, return it within 10 days and we will cheerfully and immediately refund your money. Regular value \$40.

COMPARE THESE FEATURES

Quality Products Used In SUPERB

1	Filter Condenser	KELLOGG	Specially shielded high voltage tested filter condenser manufactured to our specifications
2	Condenser Case	KELLOGG	Special treated moisture proof case preventing change of capacity
3	Choke Coils	DUDLO ...	High voltage tested choke coils capable of passing 85 milliamperes
4	Fixed Resistances	MICAMOLD	Bakelite moulded resistance of 1500 ohms
5	Variable Voltage Control	CLAROSTAT	Genuine clarostat variable voltage control 0 to 5 million ohms

DIRECT FROM FACTORY TO YOU

\$19.85

Half the Price of Others

SUPERB ELECTRIC CO.
224 N. State St.,
Chicago, Ill.

- Send at once. Payment enclosed.
- \$2 enclosed. Remainder C. O. D.

Name
Address
City State

*Dealers!
Set Builders!*

Write for
CHI - RAD'S
FREE RADIO CATALOG

Lowest Market Prices
Standard Advertised Lines
Complete Stock Quick Service

*Be Sure to Use Business Letterhead
When Answering*

CHICAGO RADIO APPARATUS CO.,
415 S. Dearborn St., Dept. RN., Chicago

**WHY RISK LIFE AND LIMB
ERECTING AN OUTSIDE AERIAL?**

Play safe by using Effarsec Antennae. Hang indoors in 30 seconds. Get strong, clear reception. No danger of a fall. No lightning risk.

EASILY INSTALLED

In attic, spare-room or closet —under carpets, behind drapes. Effarsec Antennae work without interference from metal work, phone or light wires. Catch both sides of the radio wave and give you greater selectivity and better tone practically free of static. Special parchment covering keeps wires properly spaced. Fixed condensers provide the sharp tuning of short aerial and the range and volume of long one.

FREE TRIAL

Try one on your set for ten days. Send no money. Just give us your name and address and we will send you your antennae C.O.D. for \$4.00. If you are not delighted we will refund your money. Send order now.

FISHWICK RADIO CO.,
Dept. 60, 133 West Central Parkway
Cincinnati, Ohio

There's money for you in RADIO

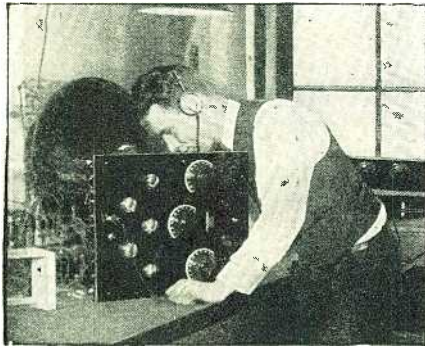

Wonderful opportunity for ambitious men to win success in this fast-growing profession

THE Radio industry is expanding so rapidly that trained men are at a premium. There is a constant, urgent demand for operators — factory superintendents — engineers — service men — designers — salesmen.

There is no better way for you to succeed in this fascinating business than to study the Radio Course of the International Correspondence Schools. This course is new and complete. It is written by practical authorities in this field. It is endorsed by leading radio experts and radio manufacturers.

Mr. R. E. Thompson, president of the R. E. Thompson Manufacturing Company (makers of the famous Thompson Neutrodyne Radio Set), says:

"I was once a student of the International Correspondence Schools myself and I am familiar with your methods and texts. I recommend them to any young man who is sincerely seeking to improve himself in position and salary."

Quincy J. Workman, of Scranton, Penna., writes that he has "nearly doubled his salary" since he took up the I. C. S. Radio Course. He is now manager of the Radio Department in a large store.

This same course enabled John M. Paynter, of the U. S. Lighthouse Service, Charleston, S. C., to get a position as Radio Operator and Ship's Electrician. Scores of other men in radio factories, laboratories and stores report similar progress.

You, too, can get in on the ground floor if you act quickly. But don't delay too long. Mark and mail the coupon today and let us tell you all about the I. C. S. Radio Course and what it can do for you.

Mail the Coupon for Free Booklet

International Correspondence Schools
Box 8282-H, Scranton, Penna.

Without cost or obligation, please send me all the facts about the new I. C. S. course in

RADIO

Name.....

Street Address.....

City.....State.....

FREE RADIO GUIDE—SEND FOR IT



SETS, PARTS, KITS

164 PAGES OF NEW IDEAS

You need this big FREE book. A practical guide to success in set building. Gives new 1927 hook-ups. Shows the latest parts and kits at prices far below others. Send today. Build the newest sets. Make more money.

BARAWIK CO.

540-542-D Monroe St. Chicago, U. S. A.

Mail This Coupon Now! For Free Copy

Name.....

Address.....

City.....

State.....

Zip.....

Insure your copy reaching you each month. Subscribe to RADIO NEWS — \$2.50 a year. Experimenter Publishing Co., 53 Park Pl., N.Y.C.

High-Frequency Radio-cinations

REPLIES BY I. M. GOOPY

(Q.) Is it true that a tube has a critical point? If this is so, how can I tell?

May I. Charge.

(A.) Yes. When you turn the rheostat all the way up, then see a flash and the tube goes out—you know then that the critical point has been reached.

(Q.) Is there any way I can improve my present bare-copper antenna without putting up new wire? I understand the theory of skin effect is a big factor—in enamelled wire.

E. M. Force.

(A.) Yes. Go to the drug store and buy a small bottle of collodion; apply this on the wire with a brush and you will have the new skin effect.

(Q.) A friend of mine is using a cardboard milk container to wind coils on. If he placed milk in the container while receiving, do you think it will turn the milk sour as lightning does?

Spark Rockcrusher.

(A.) The way some of the programs come over is liable to make anything sour.

(Q.) From time to time, I have read in magazines of soft and hard tubes. Just what do they mean?

A. C. Wave.

(A.) A soft tube is flexible like rubber so that in case it is accidentally dropped it isn't apt to break. A hard tube is made of hard glass and, if dropped, will be subject to breaking.

(Q.) I have a three-circuit tuner and understand that it consists of a primary and secondary winding and a tickler coil. Could you tell me the meaning of tickler?

L. P. Condenser.

(A.) The grid being like a feather, should you feed it with too much potential, will tend to sway back and forth, so to speak, and tickle the electrons being emitted from the filament. And when you have too much regeneration, this feather-like grid causes the tube to become hysterical. Hence the origin of tickler.

(Q.) My radio dealer claims that he has a radio set that operates at half the cost of any other set on the market. Do you think I should buy one?

I. M. Amperite.

(A.) Buy two of them and save all the operating expense.

(Q.) Why is it that I can get distant stations up to 1000 miles when my filament rheostat is turned down very low?

A. Metal.

(A.) The tubes you are using have a very critical point, perhaps; if they were turned out completely, you might have a greater range.

(Q.) Do you think that radio has settled down in the same degree as the automobile industry, and has it become stabilized?

U. Glow.

(A.) Radio has always been stabilized by means of condensers and coils.

(By CHARLES H. THONSEN.)

A RUMOR DENIED

Although the "cone" type loud speaker was originally a European invention, it threatens to oust the horn type of instrument, even in America. This does not, however, mean that Americans will take to wearing "cone-rimmed" spectacles!—"Wireless," London.



Have you changed it Lately?

Few people realize what an improvement they can get in tone quality by simply changing their Resistors. Remember that tubes and batteries constantly vary in capacity. They must require Resistors of proportionately different values. Most internal Receiver noises are NOT from faulty tubes, "B" batteries or loose connections, but are purely the result of non-synchronizing Resistors. Wise radio owners keep extra Durham Resistors on hand and constantly change them to meet varying conditions. Try it and note how tone quality improves.

(500 Ohms to 10 Megohms)



"Super Ball" Antenna

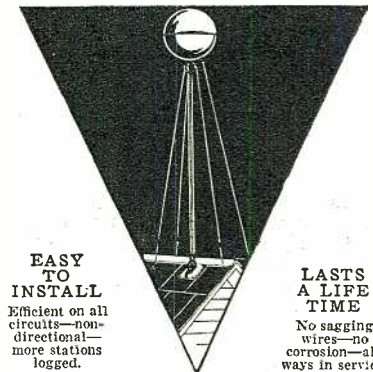

EASY TO INSTALL
Efficient on all circuits—non-directional—more stations logged.

LASTS A LIFE TIME
No sagging wires—no corrosion—always in service.

AMAZING RESULTS WITH YOUR PRESENT SET

You will actually be amazed at the fine results you get using the "Super-Ball" ANTEN. N.A. Your set will be more selective—tone clearer—static reduced to the minimum.

30 DAY UNQUALIFIED GUARANTEE BY THE MAKER

See your dealer today. An army of satisfied users in America and Europe.



Insure your copy reaching you each month. Subscribe to RADIO NEWS — \$2.50 a year. Experimenter Publishing Co., 53 Park Pl., N.Y.C.

"AS IT USED TO WAS"

"DID you see what that big stiff did to me?" sighed the Condenser: "Nearly twisted my 'knob' off and then he says 'Wrong number, wrong number, I had it last night!' And he keeps my plates sliding around so I'm beginning to look like a cafeteria restaurant during the rush hour. H'm! he has it every night!"—

"Oh! that's nothing," piped up the Jack: "He plugs me in the eye every time he sits down; and I had a 'phone tip' direct from the Headset that he's going to smother us if we don't work better soon."

"Yes," sighed the Loud Speaker: "And when I start working, and even squeal with pain from indigestion when he feeds me too much 'B' battery, he rushes up to me and roars, 'You darn tin horn squawker, if you don't work and play any better so a guy can tell it's a march and not a thunderstorm in a nursery, I'll take you back to that double-eyed son of a horse jockey!' Now don't you think that's unreasonable? How can I work and play at the same time?"

"Aw, dry up!" snarled the Secondary Honey-Comb Coil: "A nice sweet time I have. Just as I'm getting confidential with my friend Primary, the big egg comes along and nearly yanks Primary out of his pants, he slams him away from me so quick. And then half the time he pushes that old Ticker up against me so hard, it makes me wonder if he's the way they make squash for pies. If he—"

"Humph!" snapped the Rheostat, "you outsiders needn't kick, look at me. Nice congenial atmosphere I'm in. The Grid leaks and the empty-headed Tubes that are 'lit up' most of the time—I declare it's no place to raise a—"

But here the big "egg" threw the aerial switch and the Rheostat's troubles were drowned in "ethereal" bliss, as the strains of "You haf-ta pay cash to have your battery charged," came trickling in from the "needle-threaded" station 0-10.

Contributed by C. F. Jennings.

-- AND ALL MEDICAL AUTHORITIES RECOMMEND DR. FLOOY'S FORMULA FOR AILMENTS OF THE HEART, LUNGS, STOMACH, LIVER, KIDNEYS, INTESTINES, PANCREAS, GALL BLADDER, THYROID GLAND, OESOPHAGUS, AND VERMIFORM APPENDIX!

UPON MY WORD!
AN
ORGAN
RECITAL!

W. LEMKIN



A New and Advanced Model

Norden-Hauck Super-10
Highest Class Receiver in the World

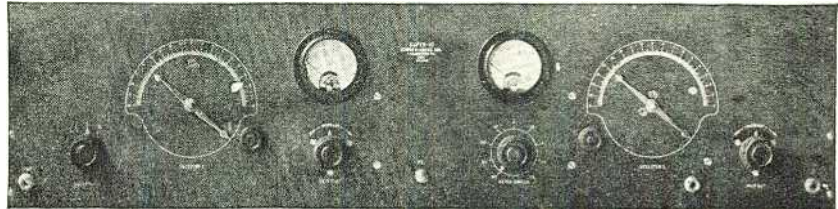

Panel Size: 36" x 9" x 1-4"

Weight: 55 lbs.

THE NORDEN-HAUCK SUPER-10 is an entirely new and advanced design of Receiver, representing what we believe to be the finest expression of Modern Radio Research Engineering. It is the product of years of experience devoted exclusively to the attainment of an ideal Broadcast Receiver—regardless of cost. Results obtained in every respect will upset all your previous ideas of good radio reception. Here are only a few of the host of features that place the NORDEN-HAUCK SUPER-10 far in advance of competition.

- 10 tubes employed to give perfect reproduction with unlimited range and volume power.
- Super selectivity on all wave lengths.
- Built to Navy Standards.
- Wide wave length range—with removable coils. Adaptable 35 meters to 3600 meters if desired.
- Use Loop or Antenna.
- Simple to operate, having only two major tuning controls.
- No Harmonics. Signals are received only at one point.
- Special Power Audio Amplifier, operating any loud-speaker and eliminates necessity of external amplifier.

The NORDEN-HAUCK SUPER-10 is available completely constructed and laboratory tested, or we shall be glad to supply the complete engineering data, construction blue prints, etc., for those desiring to build their own receiver.

Upon Request Complete literature, attractively illustrated, will be gladly mailed without charge, or full size constructional blue prints, showing all electrical and mechanical data, will be promptly mailed postpaid upon receipt of \$2.00.

Write, Telegraph or Cable Direct to
NORDEN-HAUCK
Incorporated
ENGINEERS—MARINE BUILDING
Philadelphia, U. S. A.

TEAR OFF AND MAIL TODAY

NORDEN-HAUCK, Inc., Philadelphia, U. S. A.

Gentlemen:—
 Please send me without cost or obligation on my part, attractive illustrated literature describing the new Norden-Hauck Super-10.
 I enclose \$2.00 for which please send me, postpaid, complete full size constructional drawings and all data for building the Super-10.

Name
Address

FREE!
This 84 Page
RADIO BOOK

The Guide to Radio prices and Radio Quality. Our vast resources and radio experience have been utilized to assemble in one gigantic institution, the best and newest things in radio. The Randolph catalog is the great radio market place—a masterpiece of merchandising that befits our house—

The World's Largest Exclusive Radio Mail Order House

CATALOG CONTAINS OVER 2000 ITEMS, from the most beautiful, fully equipped console radio set, down to the smallest part or tool for the set builder—kits, parts and supplies of every type and style. All beautifully illustrated and interestingly described. Also valuable data of today's most fascinating and most wonderful achievement—**RADIO.**

5-TUBE SETS AS LOW AS \$24.90
LATEST 1927 MODELS

All Randolph sets are sold at amazingly low prices. No matter what kind of set you want—no matter how little you want to pay—you can select **YOUR SET AT YOUR PRICE** from the Randolph catalog.

WE SAVE YOU MONEY Because we handle radio exclusively and sell a tremendous volume of everything in Radio, we can concentrate our buying power for the benefit of our customers.

SEND FOR BOOK TODAY We cannot begin to tell all about this wonderful Radio Book. Simply send letter or postal and this bargain catalog of guaranteed radio sets and supplies will come to you absolutely **FREE.**

RANDOLPH RADIO CORP.
180 N. Union Ave., Dept. 218 Chicago, Ill.



RANDOLPH RADIO CORPORATION
180 N. Union Ave., Dept. 218 Chicago, Ill.

Send me—free—your 84-page, 1927 Radio Book.

Name
Street and No.
R. F. D. Box
City State

Insure your copy reaching you each month. Subscribe to Radio News—
\$2.50 a year. Experimenter Publishing Co., 53 Park Place, N. Y. C.

\$10 Loud Speaker

For \$10 you can get the finest loud speaker that money can buy—the new, perfected Dulce-Tone, the unit that utilizes all the scientifically developed, time-tested reproducing elements of your phonograph.

Dulce-Tone and your phonograph will improve the reception from any set. Greater volume, clearer tone, entire freedom from blare and distortion.

Nothing to install. Simple to use. Fully guaranteed. \$10 at your dealer's or with the coupon.

Dulce-Tone



THE GENERAL INDUSTRIES CO.
Formerly named
THE GENERAL PHONOGRAPH MFG. CO.
252 Taylor St., Elyria, Ohio

Enclosed is \$10 for my Dulce-Tone. If I'm not satisfied after 10 days' trial, I'll return it and get my money back.
Name
Street
City State

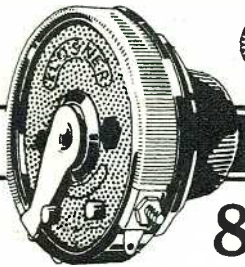

TYPE "A" 85 C EA.

The New KLOSNER RHEOSTAT

A sturdy rheostat of highest quality. Non-wearing, smooth-running. A cold-rolled steel shaft in a brass bushing insures a perfect bearing. Genuine Bakelite, spring phosphor-bronze contact. Tightly wound, non-changeable resistance. Single-hole mounting. Made in 6, 10, 20, 30, ohms.

Also New Klosner Potentiometers.....95c ea.
Klosner Universal Sockets—Type "X".....35c ea.
Type "T" (for sub-panel mounting).....40c ea.
SPECIAL OFFER BY MAIL—POSTPAID

KLOSNER "TYPE A" RHEOSTATS	
Set of 2\$1.60
UNIVERSAL SOCKETS	
"TYPE X"—Set of 6 Boxed\$1.85
"TYPE T"—Set of 6 Boxed\$2.15

ORDER THESE QUALITY PARTS NOW
KLOSNER RADIO CORPORATION
1022 East 178 Street - New York

LEARN BUILDING

—\$4,500 to \$12,000 A Year—For Trained Men! Now you can train in a few months for your choice of the nine best jobs in America! Free set of real Blue Prints and 2 big Books show you how. Learn at home. No education needed. Write Chicago Technical College, Dept. B170, 118 E. 26th St., Chicago, Ill.

The Busy Housewife

It happened during a radio exposition in a large city on the Pacific Coast. On a certain day's program, there was scheduled a talk by the chef of a great hotel on preparation of poultry for the table, as well as a half hour of reducing exercises under the direction of a famous athlete.

Through some mistake both began to broadcast simultaneously. The following is a stenographic report of the result.

"We will begin to-day with the stretching exercises. Lean over backward until the floor at the back is visible. Take both feet in the left hand, and sever with the cleaver. Now return to an erect position. Remove head, tail and wing feathers. Lean to the right—until the fingers grasp the windpipe which should be pulled completely out. Stand on the left foot, and extend the right leg sidewise,—retaining it there with a sharp wooden skewer. Draw the legs up alongside of the body, and retain them there with skewers. Hop on one foot—until enough grease has accumulated for basting. Wind strings around the legs and secure them to the neck. Now hop the same distance on the other foot,—and remove the fat before it is re-absorbed. Now add a pint of the liquor, piping hot. Raise the feet to a point even with the chin. Repeat to taste. Do not permit the heels to touch the floor.

A young chicken can stand a half pint of this jelly. Rinse with a dash of soda water. Repeat until tired. Too much flour spoils the appearance of a chicken, and a crust is not desirable—a little apple sauce. If the subject is an old hen, the wish bone may be removed. Regarding diet during these exercises,—stuff by spoonfuls through the neck until the skin appears distended. Be careful how you cut a young chicken. Repeat the kicking motions. An old bird never looks appetizing when stuffed. Now lower feet to the floor,—and wrap each one separately in cheese cloth wrung out in ice water."

—William H. Spaulding

AMBIGUOUS?

A certain make of telephone ear-pad is being marketed in England with the recommendation that it "rests softly on the side of the head on account of its vacuous nature."

—Wireless Weekly, Sydney, Australia.

Like a Thunderbolt

THE NEWS IS OUT

U.S. Navy VT.1 Navy Tubes

Price \$3⁴⁵

Commonly Known as the

J TUBE

Cost the U. S. Government \$15.00

Fits any Standard Socket. Works on 6 Volt Storage Battery

This is the first time in history that these Super Radio Tubes have ever been offered to the Radio public. Radio Amateurs everywhere are amazed at this opportunity to be able to buy these tubes at such ridiculously low prices.

The Western Electric VT. 1, manufactured exclusively for U. S. Navy has a much longer life than any other tube known. Characteristic of this tube—when used as a detector—apply 22½ V. to 45 V. to plate and using terminal voltage of 2.75 will show a milliamperage reading of 6½ milliamperes.

When used as an amplifier with the same terminal voltage mentioned above the 45 to 90 volts plate it will show a milliamperage reading of 8½ to 10 milliamperes.

VT. 2. TRANSMITTING TUBES \$7.45

PARCEL POST
ORDERS SENT PREPAID

EPPE'S

523 Market St., Philadelphia

Cooper "A" Eliminator

Not a Power Unit
Employs No Trickle Charger
Operates direct from the
Light Socket. See Your Dealer

goodbye
mister howl!

Once this little jacket of live rubber slips over the tube—you're through!

All over in less than one second! You can get it in sizes to fit every tube. Just ask for the

McDONALD HOWL ARRESTER

"It Stops that Howl"

(TRADE MARK)

Sole Selling Agents for the U. S. A.
SPARTAN ELECTRIC CORPORATION
350 West 34th Street, New York City

Licensed and Manufactured by the
Scientific Products Canada, Ltd.

MADE IN U. S. A.



Patented Dec. 7, 1926. No. 1,610,208

75¢ each
At all dealers.



RADIO JINGLES

CONTINUATION OF "A RADIO ROMANCE"

(With Apologies to Thomas R. Jones, RADIO NEWS, September, 1926.)

As time passes on Sally takes on much fat,
'Till she looks like her auntie, but denser,
And Hel'rodyn'e wonders what he'll do
about that,
And he guesses he'll have to

Sometimes Sal must go back, to see her dear
Mom,
And Hel, even though he'd deceive her,
Must stay home and attend to the dear little
pon,
And have every thing "fixed"

In her letter she tells him how much he is
missed,
And she's hurrying back (what is sweeter?);
He's as "flustered" as though his own life
had been risked,
As he flies to the station to

As the short years roll by, many things
they accomplish;
Many long seams sees Sal, many stitches;
And because of the progeny, so mischiev-
ously rompish,
Hel must keep ever handy

AN EYE OPENER

Casey's no longer among us;
His engine lies in a ditch.
While talking one day
About wanting more pay
He ran through an

THE HOME CONSTRUCTOR

His money comes, his money goes;
It's never in his pockets—
He spends it all for vacuum tubes,
Condensers, coils and

BEFORE AND AFTER TAKING

When Jonesy did a-wooing go,
He sought his wife with flattery;
The

PAGE MR. JOHN L. BAIRD!

There was a fair maid of Racine
Who used to appear on the screen:

She bought her a
This dear little lady, oh,
And now she's no more to be seen!

SHIELDED

A tramp arrested on the street
Said, as he warmed his weary feet:
"It sure goes good, in a rainy spell,
To be sitting here in a nice

THE MARTYR

There was a man in our town,
Who owned a crystal set;
And every night he'd sit him down
And DX try to get;

(Continued on page 1066)

\$75.00 A WEEK BUILDING RADIO SETS —in your spare time

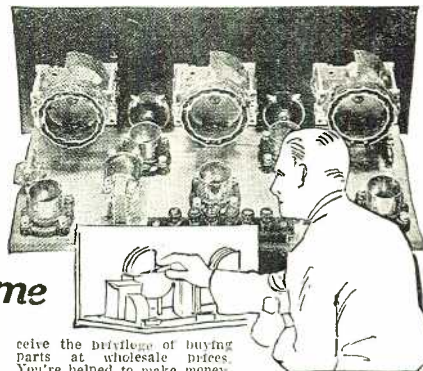

Join the Radio Association of America. Learn how to build and repair radio sets. The Association will train you—start you out in business if you wish. Be the radio "doctor" of your community. \$3 an hour upwards easily made. Radio offers you a big money-making opportunity right now.

EARNS \$500 IN SPARE HOURS

"I have at last found myself," writes Lyle Folliek, Lansing, Michigan, "I have already made over \$500 building radio sets after working hours." Werner Eichler, Rochester, N. Y., writes, "I have made over \$50 a week in my spare time."

Our members are starting radio stores, increasing their salaries, securing better positions, passing radio operator examinations, earning big money for the most enjoyable kind of spare-time work.

WHAT A MEMBERSHIP MEANS

A membership in the radio Association of America gives you the most up-to-date and thorough training in the Science of Radio.

You're taught how to build and repair all kinds of sets. You're given the training you need in preparing for a Licensed Radio Operator's examination. You re-

ceive the privilege of buying parts at wholesale prices. You're helped to make money.

JOIN THE ASSOCIATION NOW

If you're interested in Radio for either pleasure or profit, join the Association without delay, because we have a plan whereby your membership may not—need not—cost you a cent. Only a limited number of these memberships are acceptable. Write now for details. Write before it's too late.

This Association has prepared a beautiful book that gives figure-facts regarding the profit possibilities of the Radio Industry, the purpose of the Association, and the details of the Special Membership Plan.

MAIL THIS COUPON

RADIO ASSOCIATION OF AMERICA
Dept. RN-2—4513 Ravenswood Ave., Chicago.

Send me your book and details of your Special Membership Plan.

Name
Address
City State

BUY BATTERY CAPACITY

Thomas Battery Combination

BUY BATTERY CAPACITY

THIS "A" BATTERY

100 Amp. hour "A" Battery, standard rate. 6-Volt capacity absolutely guaranteed—will operate Average 5 tube set for a month or more on a single charge. Solid rubber compartment case, lead coated handle. Non-corrosive terminals.

GUARANTEED 2 YEARS
OVER 18,000 SATISFIED CUSTOMERS

AND THESE "B" BATTERIES

Standard, high power, maximum service. 45-Volt. "B" batteries. Seamless cells. Built of best "B" battery materials. None better at any price.

ALL FOR \$13.98

Shipped direct from the factory—promptly. No delays—Every battery fresh. NO ADVANCE PAYMENT REQUIRED. Simply order—and we will ship by express and you examine batteries at express office to your heart's content—pay the expressman \$13.98 plus express charges if you decide to take them.

If you prefer to remit with order—deduct 50 cents. These "A" and "B" batteries can be purchased separately. "A" Battery (Same as above) \$10.50. "B" Battery (Same as above) \$2.50 each.

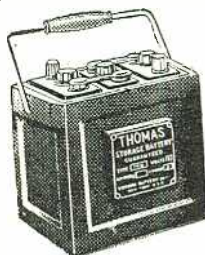

JACK SAGINARIO
Bronx, N. Y. City

I am very glad I was recommended to your battery as I get twice the volume. I will always recommend it to my friends.

JULIUS R. BROWN
New York City

I have used Thomas Batteries for twenty-two months and will always recommend it to the next person as being the "goods."

HIRAM MORGAN
Beloit, Wisconsin

I guess the best appreciation I can show is to enclose check for one of your 100 Amp. hour batteries as advertised in the Radio Magazine. The one I got some time ago from you is perfect and giving excellent continuous service.

All prices for Domestic Shipments only—Export price 15 percent additional. Prices other sizes and auto batteries on request.

THOMAS BATTERY CORP.,
507 West 50th St., N. Y. City

Gentlemen: I am enclosing \$.....for () "A" Batteries () "B" Batteries as advertised in RADIO NEWS.

NAME
ADDRESS
CITY STATE



Yale GROUND HOG INCREASES POWER AND DISTANCE

Marvelous newly-invented ground gives incredibly improved reception. Doubles power and distance users say. Reduces leakage. Stops jangling even in midsummer. Results never before equalled. Satisfaction guaranteed or money back at once. Proven absolutely essential to clear, powerful distance reception. Draws and holds moisture indefinitely. Highly sensitive to radio energy.

HIGHEST APPROVAL
Approved by Radio News exhaustive laboratory test and endorsed by other high scientific radio authorities.

SEND NO MONEY—To introduce, we offer to those who act at once, regular \$5.00 size for only \$2.00. Send name today and pay \$2.00 plus 17c postage on delivery. Or send only \$2.00 with order and save postage. FREE—Full description of Ground Hog and details of amazing special low priced battery offer on request—write to-day.
Yale Specialty Supply Co.
125 W. 5th St., Kan. City



Bradleyleak

THE PERFECT GRID LEAK

Provides a noiseless range of grid leak resistance from 1/4 to 10 megohms. Assures most effective grid leak resistance value for all tubes. Small grid condenser (0.00025) is separate. Metal parts nickel plated. One hole mounting.



Allen-Bradley Co.

Electric Controlling Apparatus
287 Greenfield Avenue Milwaukee, Wis.

OPPORTUNITY AD-LETS

Follow these advertisements every month. Reliable advertisers from all over the country offer their most attractive specials in these columns.

Classified advertising rate twenty-two cents a word for each insertion. Ten per cent discount for 6 issues, 20 per cent discount for 12 issues. Name and address must be included at the above rate. Cash should accompany all classified advertisements unless placed by an accredited advertising agency. No advertisement for less than 10 words accepted.

Objectionable or misleading advertisements not accepted. Advertisements for the April issue must reach us not later than February 1st.

CIRCULATION LARGER THAN THAT OF ANY OTHER RADIO PUBLICATION

EXPERIMENTER PUBLISHING CO., INC., 53 Park Place, New York, N. Y.

Agents Wanted

Big Money and fast sales. Every owner buys gold initials for his auto. You charge \$1.50; make \$1.35. Ten orders daily easy. Write for particulars and free samples. American Monogram Co., Dept. 133, East Orange, N. J.

Guaranteed Genuine Gold Leaf Letters anyone can put on store windows. Large profits, enormous demand. Free samples. Metallic Letter Co., 422 N. Clark, Chicago.

Agents Wanted to Advertise our Goods and distribute free samples to consumers; 90¢ an hour; write for full particulars. American Products Co., 9028 Monmouth, Cincinnati, Ohio.

Lightning Electrolyte. Charges storage batteries instantly. Gallon costs 50¢, sells \$10.00. Make it yourself. Guaranteed formula \$5.00. Write for free circulars. Murphy, Chemist, Tujunga, Calif. Box-D.

Books

Hoff's trouble finder, log, dictionary. A new illustrated 64-page book. Pocket size. Sent postpaid for 25¢, coin or stamps. Patrick-Mahoney Co., P.O. Box 931, Schenectady, N. Y.

Business Opportunities

Free Book. Start Little Mail Order Business. Pier Company, 72AF Cortland Street, N. Y.

Stocks—Bonds, Domestic—Foreign, bought—sold. Dealers in all marketable securities. Frank Y. Everett & Co., 20 Broad St., New York.

Manufacture Crystals—Big profits, particulars Free. Box 313, Wichita, Kansas.

Co-operative EIA membership established one industrious man in each locality, regardless of his handicaps, in his own successful industry. Young married men preferred. Equitable Industries, 154 R Nassau, New York.

Chemistry

Learn Chemistry at Home. Dr. T. O'Connor Sloane, noted educator and scientific authority, will teach you. Our home study correspondence course fits you to take a position as chemist. See our full page ad on page 1067 of this issue. Chemical Institute of New York, 56 W. Broadway, New York City.

Correspondence Courses

Used correspondence school courses. All kinds. Sold on repurchase basis. Big saving. Money back guarantee. Lists free. (Courses bought). Lee Mountain, Pisgah, Alabama.

For Advertisers

Advertisers International Manual, new edition. Inside information for advertisers and Publishers' Rates. 50¢ postpaid. Economies Publishing Co., Dept. 36, 1475 Broadway, New York.

For Inventors

If you have a practical, useful invention to sell, send particulars promptly. American Patents Corporation, Barrister Building, Washington, D. C.

Help Wanted

Detectives Needed Everywhere. Travel. Experience unnecessary. Write, George Wagner, former Government Detective, 1968 Broadway, N. Y.

Earn \$25 weekly, spare time, writing for newspapers, magazines. Experience unnecessary. Details FREE, Press Syndicate, 973, St. Louis, Mo.

Help Wanted (Continued)

Become a Landscape Architect. Uncrowded profession of wonderful opportunity for money-making. Easily mastered by mail. Earn while you learn. Write for book. American Landscape School, 11 Newark, N. Y.

Set Builders! We furnish jobs for you. (No fee.) Competent men needed today in every community to build LC-27 and Hammarlund-Roberts Sets. Big money for you if you can qualify. Register NOW, giving particulars, experience, references. Allen-Rogers, Inc., 118 E. 28th St., New York City.

Instruction

Radio Announcing as a profession or for the politician, business man or any radio speaker—taught in ten lessons. Send for Prospectus. Pioneer Radio Broadcasting School, Inc., 843 Little Bldg., Boston.

Learn Machine Drafting and Designing—earn cost while learning. Edwards, Draftsman, 323 South Marsalis, Dallas, Texas.

Miscellaneous

Inventors: Use our special service for presenting your invention or patent to manufacturers. Adam Fisher Mfg. Co., 278-A Enright, St. Louis, Mo.

Forms to cast Lead Soldiers, Indians, Marines, Trappers, Animals, 151 kinds. Send 10¢ for illustrated Catalogue. H. C. Schiercke, 1034 72nd St., Brooklyn, N. Y.

Cincinnati Address. \$3.00 month. Forwarded daily air mail. Thompson Service, 318 Oak Street.

Motorcycles, Bicycles

Don't Buy a Bicycle Motor Attachment until you get our catalog and prices. Shaw Mfg. Co., Dept. 6, Gatesburg, Kansas.

Old Money Wanted

\$2 to \$500 each paid for hundreds of Old or Odd Coins. Keep all old money, it may be very valuable. Send 10¢ for New Illustrated Coin Value Book, 4x6. Guaranteed prices. Get posted. We pay Cash. Clarke Coin Company, 14 Street, LeRoy, N. Y.

Old Money Wanted. Will pay Fifty Dollars for nickel of 1913 with Liberty head. (no Buffalo). We pay cash premiums for all rare coins. Send 4¢ for Large Coin Folder. May mean much profit to you. Numismatic Co., Dept. 112, Ft. Worth, Tex.

Patent Attorneys

Inventors—Should write for our Free Guide Books and "Record of Invention Blank" before disclosing invention. Send model or sketch of your invention for our Free Inspection and Instructions. Radio, Electrical, Chemical, Mechanical and Trademark experts. Terms reasonable. Victor J. Evans & Co., 922 Ninth, Washington, D. C.

Practical, useful inventions wanted for live patent buyers. Send particulars promptly. American Patents Corporation, Barrister Building, Washington, D. C.

Patents—Send for form "Evidence of Conception" to be signed and witnessed. Form, fee schedule, information free. Lancaster and Allwine, Registered Patent Attorneys in United States and Canada, 269 Ouray Bldg., Washington, D. C.

Patents. Send drawing or model for examination and report as to patentability. Advice and booklet free. Highest references. Best results. Promptness assured. Watson E. Coleman, Patent Lawyer, 724 9th Street, N.W., Washington, D. C.

Patents

Inventions Commercialized. Patented or unPatented. Write Adam Fisher Mfg. Co., 278 Enright, St. Louis, Mo.

Patent Sense valuable book free. See Lacey's ad page 1058. Lacey & Lacey, 631 F St., N.W., Washington, D. C.

Personal

Tobacco or Snuff Habit Cured or no pay. \$1.50 if cured. Remedy sent on trial. Superba Co., N12, Baltimore, Md.

Radio

Boys! Don't Overlook This. The "Rasco" Baby Detector. Greatest detector ever brought out with moulded base. Fully adjustable. See former advertisements in this publication, or our catalog. Detector with Galena Crystal, complete 50¢, the same detector with Radiocite Crystal, 75¢ prepaid. Send for yours today. Radio Specialty Company, 96-98 Park Place, New York City.

Attention!—50 Vacuum tube hook-ups. The greatest collection of vacuum tube circuits ever brought under two covers at such insignificant cost. These diagrams will be found in the great "Rasco" catalog, which contains raw materials and parts in a greater profusion than any other catalog. 15¢ in stamps, or coin, will bring the catalog to you. Radio Specialty Co., 96-98 Park Place, New York City.

Build a Lifetime "B" Battery from my better Edison Elements. With Welded connections 7¢ pair. Sample cell 10¢. Paul Mills, Woodburn, Oregon.

Wholesale to Everybody. Catalog Free. Goodrad Radio Shop, Shelby, Michigan.

Tested Galena Crystals per pound 75¢. prepaid. Buskett, Joplin, Mo.

Dollar Assortments. The biggest dollar's worth of small radio parts including screws, lugs, jacks, plugs, condensers, leaks, sockets, etc. Kits for all latest circuits at lowest prices. Get on our mailing list now. Barrows Radio Labs., Columbia Road, Portland, Maine.

Free Sample Ivory Radio Panel the new radio panel now in great demand. Its handsome grained and polished surface, insulating qualities, workability, and permanent finish, will make the most beautiful and efficient set of all. Also Ivory dials and knobs. Ivorylite Radio Panel Co., 3121 Avenue G, Fort Worth, Texas.

Radion 22½ Volt Alkaline Storage B, \$1.95. "Aeolon" Trickle Charger \$1.95. Catalog. Science Specialties, Indianapolis.

Transmitting Sets constructed at your savings. All sizes from 5 to 1000 watts on any wave length. Guaranteed jobs. S. & S. Radio Co., 31 N. Warren St., Trenton, N. J.

Arrl Handbook up to date gives full information on transmitting for amateurs \$1.25 post paid. Navy motor-generators, 500 cycle, ½ kw. to 5 kw., ½ kw., 500 cycle spark sets. R. Wood, 46-20, 102 St., Corona, N. Y.

Resistance Coupled Amplification gets great distance with excellent quality by means of improved method of connecting amplifier to detector circuit. Blue-Print showing necessary changes sent on receipt of \$1.00. W. Moses, 9225 Edmunds Ave., Cleveland, Ohio.

Salesmen Wanted

Salesmen—51 Stations in 15 minutes. Vertical Antenna makes any radio tune 100 per cent sharper—like Super-heterodyne. \$9.00 profit each, 4112 Liston Ave., Milwaukee, Wis.

Scenery for Rent

World's Most Beautiful Settings for operas, plays, minstrels. Amelia Grain, Philadelphia.

BELLEAIRE HOTEL

420 Diversey Parkway,
CHICAGO

\$2.50 to \$5 a day for a large, beautifully furnished room, with private bath attached, in this new hotel located at the north end of Lincoln Park where Sheridan Road begins. Food and service of great excellence at reasonable prices in the famous restaurant.

Take any north bound motor coach—fare 10c—or any surface car routed in North Clark Street. Illustrated literature upon request.



Special Library of Information on RADIO PATENTS and TRADE MARKS

JOHN B. BRADY

Patent Lawyer

Ouray Building Washington, D. C.

Cable address: RADIOPAT Telephone: Main 4806

Song Writers

Songwriters Substantial Advance Royalty Payment essential to publication contract. Expert advice furnished beginners upon receiving poems requiring music and copyrighting for free examination. Send today. Walter Newcomer, 1674 Broadway, N. Y.

If you have the Words or Melody for a song, write me. Edwin Tillman (Writer of Lonesome and Blue) 3131 Plankinton Building, Milwaukee, Wisconsin.

Stammering

St-tut-t-tering and stammering cured at home. Instructive booklet free. Walter McDonnell, 121 Arcade, 1126 Granville Avenue, Chicago, Ill.

Stop Stammering, increase salary. Descriptive booklet free. Samuel Robbins, 399 Boylston St., Boston.

Telegraphy

Telegraphy—Both Morse and Wireless taught thoroughly. Big salaries. Wonderful opportunities. Expenses low, chance to earn part. School established fifty years. Catalog free. Dodge's Institute, Cour St., Valparaiso, Ind.

Wanted to Buy

Full Value Paid for Old Gold, Jewelry, Watches, Diamonds, crowns, bridges, dental gold, silver, platinum, gold or silver ore; magneto points, old false teeth. Packages returned if our offer is not satisfactory. United States Smelting Works (The Old Reliable) 39 So. State St., Dept. 16, Chicago, Ill.

HOTEL FORT SHELBY

Lafayette Blvd. at First St.
DETROIT

Less than 5 minutes' walk from wholesale, retail, financial and theatrical centers. Quiet, comfortable rooms at reasonable prices. Restaurant and coffee shop. An especially pleasant room with private bath \$3.50 a day and up; others \$2.50 up. Servidor Service. Fort Shelby Garage close by.



W. G. McKay, Ass't Sec'y
Seth E. Frymire, Mgr.

The Everglades

Miami, Florida

NOW OPEN

Miami's Beautiful New Apartment Hotel
on Biscayne Boulevard
Overlooking City Park and Biscayne Bay

A 17-Story Fireproof Structure affording hotel accommodations of the highest character; also housekeeping apartments of 1, 3 and 4 rooms, completely equipped with daily maid service.

A FRED F. FRENCH PROPERTY

WILLIAM M. GALE, Manager

Illustrated Booklet Upon Request

Thousands Use These Ingenious TRANSMITTER UNITS



Here's a marvel of Engineering design—a practical miniature transmitter, used by thousands of radio fans and experimenters for amplification purposes. It is a most novel unit, having hundreds of uses. Every amateur should have two or three of these amplifiers in his laboratory.

A FEW USES FOR THESE UNITS

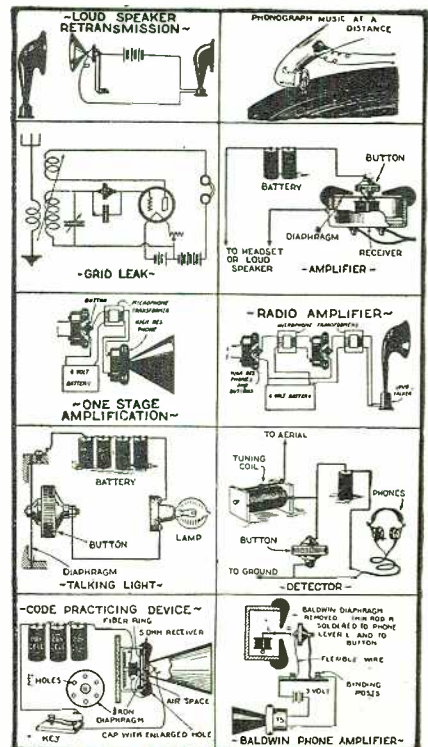

With each unit is mailed an eight-page instruction pamphlet containing suggestions for innumerable uses. Our supply is limited; avoid disappointment by ordering today. The coupon below is for your special convenience.

SPECIALY PRICED
While they last— **95c**
(or Two for \$1.75) per unit

THE PRESS GUILD,
66-R West Broadway, New York, N. Y.
Enclosed find 95c/\$1.75 for which send me postpaid one/two amplifier units as advertised.
Name
Address
City, State

ELECTRICITY -Easy at Last



Without Lessons in 90 Days

By Actual Work in the Great Shops of Coyne
Learn this fascinating, big-pay game without books or dry lessons. Prepare for jobs making \$50-\$75-\$150 a week after 12 happy weeks in the Great Shops of Coyne at Chicago. **Not a Correspondence School.** You learn by working on the greatest outlay of electrical apparatus in the Country! And experts help you every step of the way! **NO EXPERIENCE OR ADVANCED EDUCATION NEEDED.** It stands to reason that nothing can compare with practical, **Personal!** Training.

FREE R. R. FARE I allow R. R. Fare to Chicago to all who enroll now. Free courses in Radio and Auto Electricity to all who send coupon. Get my big, free book today. Find out how we help you earn while learning. Free Employment Service for life. See what a wonderful future awaits you! Mail coupon now!

COYNE ELECTRICAL SCHOOL

1300 W. Harrison Street Dept. 27-77 Chicago, Illinois
Mr. H. C. Lewis, Pres., Coyne Electrical School, Dept. 27-77
1300-10 West Harrison St., Chicago, Ill.

Please send me illustrated FREE Book on Electricity and Coyne. No obligation. Also special offer on R. R. Fare and two free courses.

NAME.....
ADDRESS.....
CITY..... STATE.....

IT'S A WONDER! Works So Easy



Pat. Applied For Press-to-Feed Electric Soldering Iron

A great invention. Indispensable for all kinds of soldering work. Convenient, simple, economical. One hand does the work of two. Made with removable tip— $\frac{3}{16}$ " and $\frac{3}{4}$ " round, making it adjustable for light or heavy work. Trigger Press-to-Feed attachment takes all sizes of solder wire. Operates on either D.C. or A.C. 110 to 115 volts, 50 watts. Attachments are made to fit all leading makes of electric soldering irons. Price complete with Press-to-Feed attachment\$3.50
Attachment only 1.50

Radio Work requires this iron. Gets into tight places with ease. Speeds up radio set building.
Agents
Press-to-Feed is a necessity for industrial and domestic uses. Big profits selling this wonderful iron to factories, homes, auto mechanics, etc. Order a sample. Quantity discounts on request. Write to

ILLINOIS STAMPING & MFG. CO.
220 N. Jefferson St., Dept. 15 CHICAGO

Send for Latest RADIO CATALOG and GUIDE

Radio's Newest at Rock-Bottom Prices
The new 1927 edition of the Barawik Catalog and Guide gives a comprehensive listing of the radio sets, parts, kits, supplies and accessories necessary in radio. This new GUIDE contains over 6,000 items of radio's newest developments, everything that a real fan will need from the complete factory-built set to the smallest screw, including labor-saving devices, tools, power supply units. Send TODAY! Also include name of another fan.
BARAWIK CO., 542-D Monroe St., CHICAGO, U. S. A.
Mail This Coupon Now! For Free Copy

Name.....
Address.....
Phone.....
Address.....

Insure your copy reaching you each month. Subscribe to RADIO NEWS — \$2.50 a year. Experimenter Publishing Co., 53 Park Pl., N. Y. C.

(Continued from page 1063)
At last he said a naughty word,
And swore he'd buy a super—
For the only "station" he had heard
Was his neighbor's home-made blooper!
—Bernard Toben.

DEFECTIVE COUPLING

On the $\sim\sim\sim$ iron, Jack is first-rate:
But in baseball he's slow as a freight.
When the pitcher, with verve,
Throws a terrible 

He lets it sail over the 
—L. W. Tujord.

A. F. EFFECTS

Next door to me lives Mr. Coyle,
You would think that his set needed oil,
For it squeaks and it yowls,
It squeaks and it howls.
And some day it will make me 
—Marvin Deerhake.

COMPLETELY INSULATED

Con was as dense as Bakelite;
And I'll say without meaning offense, sir,
That when he went to school,
He was such a darn fool 
That it only made
—Helen Peters.

A VICTIM OF INTERFERENCE

A bootlegger haled into court
Of cash most unduly was 
And, pale of complexion,
He alleged
With bringing the stuff into port.
—Lorne Smith.

HIGH-FREQUENCY WORK

Said a radio bug named Bill Pate,
"The 'hams' I'm beginning to hate."
"Not I," said his pal,
"I agree not at all,
For I'm putting them all on my 
—Marvin Deerhake.

"SPILLING OVER"

Because all his neighborhood stated
That his single-tube set radiated
They fell upon Jones,
Tore the flesh from his bones,
And the subsequent mess was cremated!
—"Wireless." London.

"LISTENING-IN ON THE MUSES"

The little songs that I would write
Come blurring on the air;
At first I cannot hear them—quite—
Too much of "static" there.

But when at last the air is clear,
My station can be heard;
I tune-in on it and can hear
Their voices—every word.
—Mrs. A. M. Thomas.

RADIO NEWS will pay \$1.00 for every 4- or 5-line stanza accepted and printed here. Send all contributions to Editor, Radio Jingles, in care of RADIO NEWS.

THE LIGHTNING ARRESTER



New Vitalitone Cone LOUD SPEAKER

A beautiful, real model of a ship, executed in statuary relief, and colored; Antique Polichrome.
Powerful vitalitone adjustable unit, will not rattle or buzz—unqualified guarantee.

Price Only \$12⁵⁰ F.O.B. N.Y.

Send For Literature

MANUFACTURED BY
VITALITONE RADIO CORPORATION
88 University Place, N. Y.
Licensed Pat. No. 1593106

RADIO BOOK FREE

64 pages full of opportunity. Your guide to what's right and standard in Radio! Full explanation of liberal offer paying agents \$10 to \$100 a week and how to get latest radio goods at wholesale.
Big Money In Radio
We want live dealer and agents in every locality. Lifetime opportunity. This book more than a catalog—shows big profit way to get into world's newest and richest field—make big money—turn full or spare time to cash. Accept This Offer!
Write for FREE book. Lowest prices—make 10 to 60% every sale. 5-tube Coast to Coast Receiver \$39.50 Retail. Sells on sight. Hundreds of such money makers. Write for special agent's wholesale prices, parts and accessories—tremendous saving and profit. Write for FREE book and amazing offers.
Standard Radio Company, 1410 Walnut St., Kansas City, Mo.



Radio Books

FREE!

Don't miss this wonderful opportunity to get big 100 page Radio Books

FREE!

SEE PAGE 940

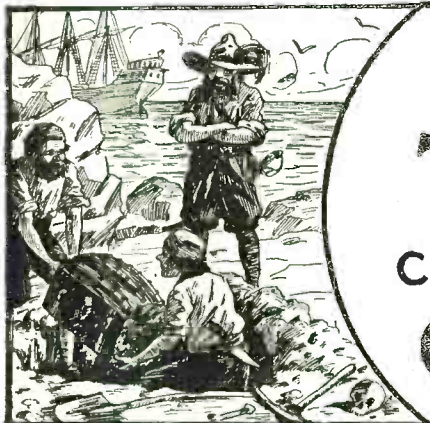

BURIED TREASURE

can still be found in

CHEMISTRY



Good Chemists Command High Salaries

and you can make yourself independent for life by unearthing one of chemistry's yet undiscovered secrets.



T. O'CONOR SLOANE,
A.B., A.M., LL.D., Ph.D.
Noted Instructor, Lecturer and Author. Formerly Treasurer American Chemical Society and a practical chemist with many well known achievements to his credit. Not only has Dr. Sloane taught chemistry for years but he was for many years engaged in commercial chemistry work.

Do you remember how the tales of pirate gold used to fire your imagination and make you want to sail the uncharted seas in search of treasure and adventure? And then you would regret that such things were no longer done. But that is a mistake. They are done—today and everyday—not on desert islands, but in the chemical laboratories throughout your own country. Quietly, systematically, the chemist works. His work is difficult, but more adventurous than the blood-curdling deeds of the Spanish Main. Instead of meeting an early and violent death on some forgotten shore, he gathers wealth and honor through his invaluable contributions to humanity. Alfred Nobel, the Swedish chemist who invented dynamite, made so many millions that the income alone from his bequests provides five \$40,000 prizes every year for the advancement of science and peace. C. M. Hall, the chemist who discovered how to manufacture aluminum made millions through this discovery. F. G. Cottrell, who devised a valuable process for recovering the waste from flue gases, James Gayley, who showed how to save enormous losses in steel manufacture, L. H. Baekeland, who invented Bakelite—these are only a few of the men to whom fortunes have come through their chemical achievements.

What Some of Our Students Say of This Course:

I have not written since I received the big set. I can still say that it far exceeded my anticipations. Since I have been studying with your school I have been appointed chemist for the Scranton Coal Co. testing all the coal and ash by proximate analysis. The lessons are helping me wonderfully, and the interesting way in which they are written makes me wait patiently for each lesson.—**MORLAIS COUZENS.**

I wish to express my appreciation of your prompt reply to my letter and to the recommendation to the General Electric Co. I intend to start the student engineering course at the works. This is somewhat along electrical lines, but the fact that I had a recommendation from a reliable school no doubt had considerable influence in helping me to secure the job.—**H. VAN BENTHUYSEN.**

So far I've been more than pleased with your course and am still doing nicely. I hope to be your honor graduate this year.—**J. M. NORRIS, JR.**

I find your course excellent and your instruction, truly, the clearest and best assembled I have ever taken, and yours is the fifth one I've studied.—**JAMES J. KELLY.**

From the time I was having Chemistry it has never been thus explained to me as it is now. I am recommending you highly to my friends, and urging them to become members of such an organization.—**CHARLES BENJAMIN.**

I shall always recommend your school to my friends and let them know how simple your lessons are.—**C. J. AMDAHL.**

I am more than pleased. You dig right in from the start. I am going to get somewhere with this course. I am so glad that I found you.—**A. CAMERON.**

I use your lessons constantly as I find it more thorough than most text books I can secure.—**WM. H. TIBBS.**

Thanking you for your lessons, which I find not only clear and concise, but wonderfully interesting. I am—**ROBT. H. TRAYLOR.**

I received employment in the Consolidated Gas, Co. I appreciate very much the good service of the school when a recommendation was asked for.—**JOS. DECKER.**

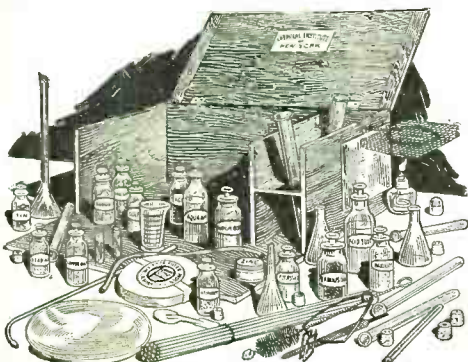

Experimental Equipment Furnished to Every Student

We give to every student without additional charge this chemical equipment, including forty-nine pieces of laboratory apparatus and supplies, and forty different chemicals and reagents. These comprise the apparatus and chemicals used for the experimental work of the course. The fitted heavy wooden box serves not only as a case for the outfit but also as a useful laboratory accessory for performing countless experiments.

Now Is the Time to Study Chemistry

Not only are there boundless opportunities for amassing wealth in Chemistry, but the profession affords congenial employment at good salaries to hundreds of thousands who merely follow out its present applications. These applications are innumerable, touching intimately every business and every product in the world. The work of the chemist can hardly be called work at all. It is the keenest and most enjoyable kind of pleasure. The days in a chemical laboratory are filled with thrilling and delightful experimentation, with the alluring prospect of a discovery that may spell Fortune always at hand to spur your enthusiasm.

You Can Learn at Home

To qualify for this remarkable calling requires elaborate specialized training. Formerly it was necessary to attend a university for several years to acquire that training, but thanks to our highly perfected and thorough system of instruction, you can now stay at home, keep your position, and let us educate you in Chemistry during your spare time. Even with only common schooling you can take our course and equip yourself for immediate practical work in a chemical laboratory. Dr. Sloane gives every one of his students the same careful, personal supervision that made him celebrated throughout his long career as a college professor. Your instruction from the very beginning is made interesting and practical, and we supply you with apparatus and chemicals for performing the fascinating analyses and experimental work that plays such a large part in our method of teaching, and you are awarded the Institute's official diploma after you have satisfactorily completed the course.

Easy Monthly Payments

You don't have to have even the small price of the course to start. You can pay for it in small monthly amounts—so small that you won't feel them. The cost of our course is very low, and includes everything, even the chemistry outfit—there are no extras to buy with our course. Our plan of monthly payments places a chemical education within the reach of everyone. Write us and let us explain our plan in full—give us the opportunity of showing you how you can qualify for a highly trained technical position without even giving up your present employment.

Special 30 Day Offer

Besides furnishing the student with his Experimental Equipment, we are making an additional special offer for a short while only. You owe it to yourself to find out about it. Write today for full information and free book "Opportunities for Chemists." Send the coupon right now while it is fresh in your mind. Or just write your name and address on a postal and mail it to us. But whatever you do, act today before this offer is withdrawn.

CHEMICAL INSTITUTE OF NEW YORK, Inc.

HOME EXTENSION DIVISION 2
66-R—WEST BROADWAY NEW YORK CITY

CHEMICAL INSTITUTE OF NEW YORK Home Extension

66-R—West Broadway New York City

NAME

ADDRESS

CITY..... STATE.....

R.N.—Feb. '27

DON'T WAIT—MAIL COUPON NOW!

Please send me at once, without any obligation on my part, your free Book "Opportunities for Chemists," and full particulars about the Experimental Equipment given to every student. Also please tell me about your plan of payment and your special 30 day offer.

BOOK REVIEW

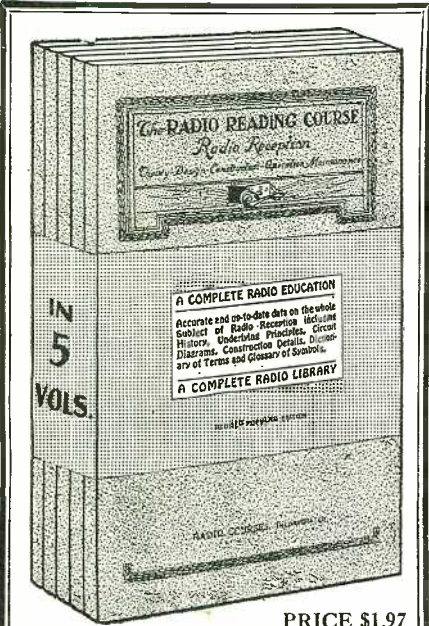

PRICE \$1.97

A RADIO EDUCATION

IN 5 VOLUMES

Theory, Design, Construction Operation and Maintenance

LEARN AT HOME

These five component parts of a complete Radio Instruction Course are outlined in five volumes that contain not merely the essentials as so many books do, but more, they contain all that any modern up-to-the-minute textbook on any subject would cover. They are in themselves a COMPLETE radio education teaching every possible portion of Radio science.

Size of each book 6 by 9 inches, handsomely bound and illustrated with charts, diagrams, descriptions of equipment, etc.

SEND NO MONEY for these books. Just forward your name and address. We send you the books at once. On receipt of same you pay the postman \$1.97 plus a few cents postage and then they are yours.

Distributed by

The Conrad Co. Inc.
53 Park Place, New York, N. Y.

THE THERMIONIC VACUUM TUBE, by H. J. Van Der Bijl, M.A., Ph.D., M.Am.I.E.E., M.I.R.E. McGraw-Hill Book Company, New York City. 6 x 9¼ inches, 391 pp. cloth. Illustrated.

The book reviewer who presents a six-year-old book to his readers, in a department devoted ostensibly to new works, is admittedly laying himself open to criticism; but perhaps he will earn their forgiveness when he states that this particular book is just about the best ever written on the radio vacuum tube, and therefore deserves to be brought to the attention of the numerous radio fans who have not yet heard of it. It was published in 1920, but unlike any of the great horde of radio books that followed in the wake of the broadcast boom and were quickly out-dated by the rapid developments in broadcasting, it is as valuable and dependable today as on the day it was first published. The fact that the three-element tube was a fully grown instrument as early as 1914, and that only its applications have increased in prolific fashion, is the reason for the lasting appeal of Dr. Van Der Bijl's complete and exhaustive volume.

For the serious student of radio, here is a book to be studied carefully from cover to cover. It is not of the kindergarten variety, filled with imaginative mechanical analogies to explain electrical actions; but rather it treats the tube in a precise manner, in precise scientific terms. The author, a distinguished physicist, spares his readers none of the mathematical discussions and formulae many other radio authors carefully side-step for fear of frightening radio fans; of course, he presumes his readers possess some knowledge of mathematics, or otherwise they would not be investigating the inner actions of a device as deeply involved as the three-element tube. Even the radio experimenter whose mathematical education stopped at the square-root stage can learn a great deal from the explanations given.

The work covers the vacuum tube in every detail. It is probably the most valuable reference book on the subject available.

THE RADIO AMATEUR'S HANDBOOK, by A. Frederick Collins. Fourth Edition. Thomas Y. Crowell Co., New York. 413 pages, illustrated, stiff cloth cover, 8 x 5½ inches.

Interest and progress in radio increase so rapidly that the new thing of today is likely to be obsolete tomorrow. This, at least, has been true until the present; but indications now foreshadow a standardization of equipment. Mr. Collins' book was one of the first to appear and has been accepted as an authority; yet at each new printing many minor changes have been found necessary.

New features in this edition include the latest additions to the regulations of the National Board of Underwriters, latest government regulations for amateurs, supplementary information on radio-frequency amplification, tuned-radio-frequency receivers, loud speakers, and "A" and "B" battery eliminators, additions to the table of wavelengths and frequencies, chart of vacuum tubes and much other useful information.

A feature of this work is the number and clarity of its cuts and diagrams. By their aid almost any radio amateur can work out his own salvation in radio. It seems that a book of this wide scope will prove not only a guide to the inquiring amateur, but a reference book to the more advanced student of radio transmission and reception.

INTRODUCTION TO CONTEMPORARY PHYSICS, by Karl K. Darrow. D. Van Nostrand Company, New York City. 6 x 9 inches, 449 pages, cloth, illustrated. Price \$6.00.

This book, which only the advanced student of science can read and understand, presents a connected account of the chief phenomena upon which contemporary atomic theories are based. It was developed out of a series of articles by Dr. Darrow which appeared in the *Bell System Technical Journal*, part of the contents having been given as lectures at the Massachusetts Institute of Technology, the Carnegie Institute, and before groups of the staff of the Bell Telephone Laboratories.

The volume is of interest to radio experimenters because it deals with atomic matters, which are so greatly involved in the operation of the vacuum tube in particular. It deals with the directly-perceived properties of electrons and ions; the detachment of electrons from atoms; the deflections of flying charged particles by atoms; the transfer of energy from electrons and radiation to atoms; and the regularities of line-spectra and band-spectra. It is extremely technical for the most

THEN

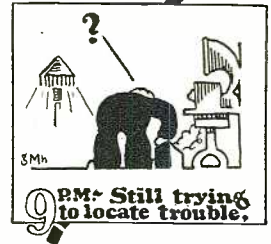

Don't hire an expert! Repair your Radio set yourself - it's easy

No matter how much or how little you know of your radio receiver, this new "Radio Trouble Finder" book is going to be a big help.

It explains the common and special faults of all the standard receivers of today; tells how to recognize instantly, by various methods, where the trouble lies and also gives special simple tests by which you can determine what is wrong with your receiver. Then for each particular fault there is explained the proper procedure for correcting it.

Book Contains 64 Pages
Size 6x9. Illustrated.
Handsome 2 Color Cover

he bought the

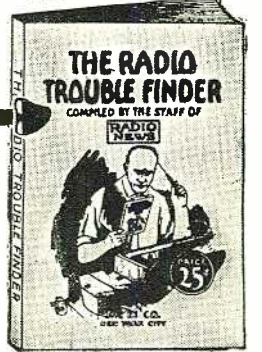

ONLY 25¢ On All Newsstands

BUY YOUR COPY TODAY
If you cannot secure a copy from your dealer, order direct.

THE CONRAD COMPANY
53 Park Place, New York, N. Y.

Start today to earn a **SECOND INCOME** "MONEY MAKING"

- Tells You How to Start Your Own "Business"
- Tells You How to Operate a Big Profit "Side Line"
- Tells You How to Make Substantial "Spare Time" Income

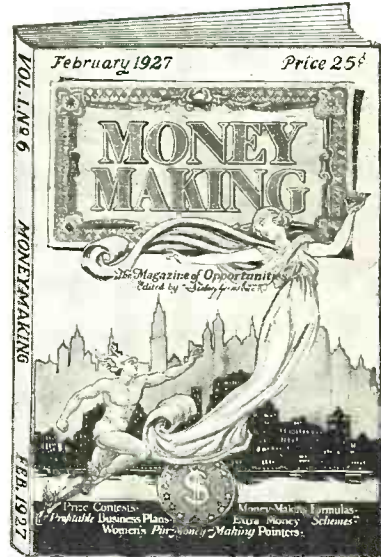

The people who really enjoy the little luxuries that have become so important in today's home are those who do not have to sacrifice essentials to do so. A second income, no matter how small, solves this problem.

Why not start today. There are hundreds of ways to develop a steady additional income that will bring to your home the many little things that make life more enjoyable.

MONEY MAKING tells you how, each issue takes various ways and means and explains them in such a way that you can immediately apply them to your own benefit. Some plans require no initial outlay while others, for a small first cost, return many dollars a year to your pocket.

Begin now—Let today be the starting point for you into a bigger income and a thorough enjoyment of the luxuries of this life.

Copies 25c--On All Newsstands

Subscriptions \$2.50 the Year—If your newsdealer cannot supply you use coupon below.

HERE'S A BIG HANDY FRIEND FOR WINTER RECEPTION

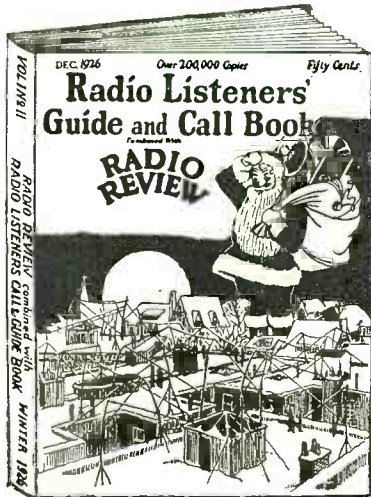

- Radio's Most Complete List of Broadcast Stations
- A Current Review of Latest Sets and Accessories
- And a Supplement of Radio's First Encyclopedia
- All in One 200 Page Book

Winter brings Radio Magic, Distance volume, clarity—all those things you may have striven for all summer without success.

Enjoy good reception to its fullest—Radio Listeners' Guide and Call Book (Winter Edition) gives you the latest list of every Broadcast station in the United States, Canada and Foreign countries, gives wavelength, power, location and even the hours of operation.

Also this book has a whole section of illustrated articles on how to build sets and accessories.

And the final supplement of S. Gernsback's famous Radio Encyclopedia. More data in one book than you have ever before encountered.

Copies 50c -- Sold Everywhere

Subscriptions \$2.00 the Year—If your dealer cannot supply you use the coupon below.

USE THIS COUPON

CONSRAD CO., Inc.
53 Park Place, New York City

CONSRAD CO., INC.,
53 Park Place, New York, N. Y.
Gentlemen: I enclose \$.....for one year's
subscription to

Name

Address

City State

Now it's complete ~ ~ ~ Ready for your radio bookshelf

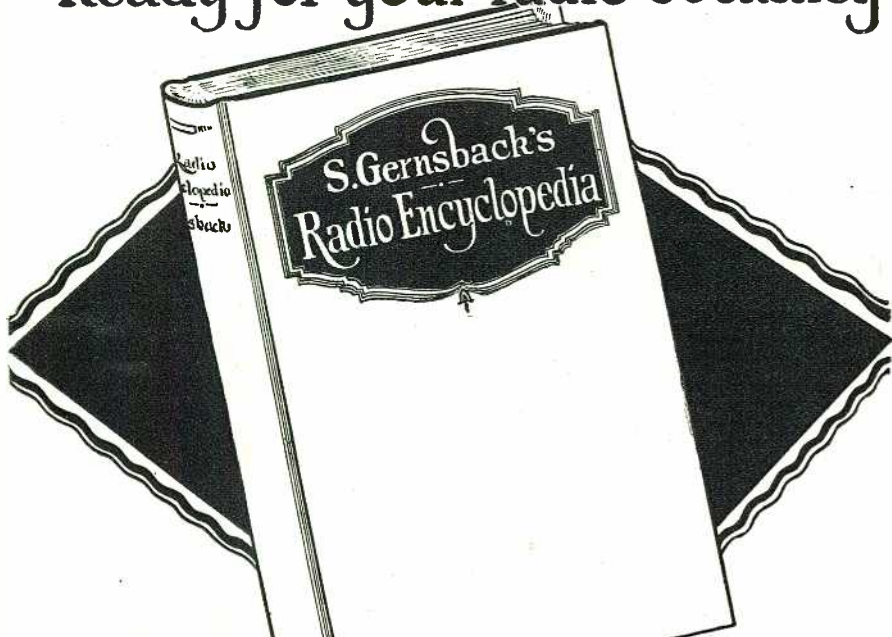

The First Radio Encyclopedia ~ Ever Published ~

Edited by **SIDNEY GERNSBACK**, Editor of "Radio Listener's Guide and Call Book (Radio Review)," Editor of "Money Making," Author of "Wireless Course in Twenty Lessons"—"One Thousand and One Formulas"—"Practical Electricity Course"—etc.

S. GERNSBACK'S RADIO ENCYCLOPEDIA is the only standard work ever published in America attempting to classify alphabetically the countless words used in the highly specialized science of RADIO.

The ENCYCLOPEDIA is written in plain English so that everybody can understand the definitions and descriptions.

This is not a Dictionary, but a real Encyclopedia of Radio.

The book contains as a supplement a classified cross-index designed to bring together radio references under one heading having relations in common.

All circuits new and old are described by word and picture and every part and apparatus used in Radio is explained and made understandable by means of photographs and drawings.

The work contains 1,930 definitions, 549 photographs, drawings and diagrams. Size of book is 9 x 12 inches, nearly an inch thick, 168 pages printed on strong heavy paper, specially made for books of this kind. It is bound in stiff Keratol covers, hand sewed and gold stamped.

PRICE **\$2.00** Postage Paid

SEND ALL ORDERS DIRECT TO THE EDITOR

SIDNEY GERNSBACK

53 PARK PLACE

NEW YORK CITY

S. GERNSBACK,
53 Park Place, New York, N. Y.

R. N. -1

I enclose \$2.00 for one copy of your new "RADIO ENCYCLOPEDIA" as advertised above.

NAME

ADDRESS

CITY, STATE

part, and by no means can it be regarded as a suitable gift for a broadcast fan making his first receiver; but as a reference book embodying an up-to-date interpretation of the advances of physics it will be generally welcomed by physicists and embryo physicists

ELEMENTS OF RADIO COMMUNICATION, by Ellery W. Stone, Lieutenant Commander, U.S.N.R. Third Edition, 1926. D. Van Nostrand Company, New York City. 5½ x 7¾ inches, 431 pp. cloth, illustrated. Price \$3.00.

Written primarily for the guidance and instruction of radio students in the communication service of the United States Navy, this book is devoted in great part to transmitting systems of various kinds and to problems in transmitting design and operation. The few receiving sets which are described in detail are commercial outfits for the long waves.

Radio broadcasting and broadcast receptors are treated with comparative brevity in the new chapters, the added material dealing mostly with radio-frequency generators, the modern Poulsen arc, antenna-ground circuits and aircraft radio. Much of the original material of the earlier editions (the book was first published in 1919, and brought out again in 1923) has been retained; this includes matter of historic interest, such as descriptions of the Marconi transmitter of 1896, the Lodge transmitter of 1898, and various forms of spark outfits now all but obsolete.

The broadcast fan will find little to attract him to this book, although it is excellently written and generously illustrated. However, the advanced experimenter, who is just turning his thoughts to transmitters, will follow the pictures and descriptions of the high-power commercial installations with interest; and the commercial radio operator or the amateur, contemplating a career as a paid "Sparks," will find much in it that will help him.

APPLIED ELECTRICITY FOR PRACTICAL MEN, by Arthur J. Rowland. McGraw-Hill Book Company, New York City. 5 x 7½ inches, 441 pp. cloth, illustrated.

The fact is not generally appreciated that radio is only one branch of the general electrical science, and that practically all the principles of radio are the fundamental principles of electricity applied to particular uses. The person desiring to become familiar with radio theory need only school himself in the fundamentals of electricity, and his success is assured.

For such persons, "APPLIED ELECTRICITY FOR PRACTICAL MEN" offers a more or less complete education. This book has been in the process of making for twenty years, during which time the author taught electricity to practical electrical workers. There is no direct mention of radio instruments anywhere in it, but the reader who studies the volume and absorbs the basic principles of D.C. and A.C. circuits, transformers, condensers, etc., will find radio-circuit actions surprisingly easy to understand.

THE VOICE OF THE MURDERER, by Goodwin Walsh. G. P. Putnam's Sons, New York. 7½ x 5 inches, 309 pp. stiff cloth.

Although radio has been used frequently in connection with detective stories, generally there are lapses in the technicalities which leave the well-informed radio fan decidedly skeptical about the plots. There are stories in which the hero invents some marvelous radio device with one hand, while he rescues the heroine from some outlandish fate with the other. Such tales as these may be all right for youngsters, but older fans have outgrown fairy books.

"THE VOICE OF THE MURDERER" might be said to fall under the last classification, but with several noteworthy differences. *Hugh Carstairs* is a young inventor who has been working for a long time on a device which he hopes will be able to pick-up and reproduce sounds made in the past. This device has for its essentials a special microphone, some ultra-fine wire woven in a mysterious new fashion and a tube, which he has named the "Thoriogene." Now all this sounds as if it might fall under the head of fairy tales, mentioned above; but if a writer can convince you that such a thing as picking out of the air conversations that occurred several days or years ago is entirely within the realms of possibility, then the story is generally worth reading.

This is just what happens in "THE VOICE OF THE MURDERER." Carstairs is no super-scientist, but just a young fellow with brains trying to get along in the world. He has a hunch that this tube of his is going to be good and he is playing the hunch for all its worth. An electrical company, the Mammoth, is trying to get the secret of his device, by fair means or foul; and it introduces into his office a *Miss Harrington*, as his secretary, so that she can get the information.

Carstairs is in love with *Phyllis Ellsworth*, whose father has been wealthy and is now interested in Carstairs' invention from a money-making standpoint. After calling on Phyllis one evening, Hugh returns to his laboratory to find that his only tube and some of the special wire has been stolen. He realizes that he must rush a tube to the Patent

“NOVELTIES”

How to Make Them

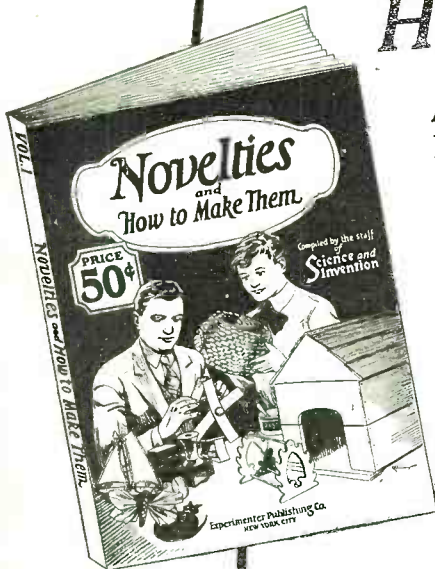

Almost every home has an old clock around—Do you know that a great many surprising, fun making, and useful novelties can be made just from the old springs, the gears, etc.

NOVELTIES, the new book, compiled by the staff of SCIENCE & INVENTION shows you how to make hundreds of wonderful Novelties, mostly out of old scrap things laying around the house. 116 Pages, in this book, show pictures, diagrams and explanations of remarkable, interesting things to make in your spare time.

Every page has a big, wonderful surprise for you. There is no end to the simple, magical things you can make at home.

It is sold on all newsstands. Buy your copy now. If your dealer cannot supply you use the special coupon below.

PRICE
50
CENTS
PER COPY

NOVELTIES, contains 116 Pages, hundreds of illustrations and is published in the big magazine size 9x12 inches

MAKE HUNDREDS OF USEFUL THINGS AT HOME WITH “HOW TO MAKE IT”

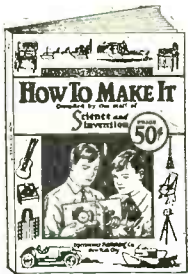

Contains 116 Pages, 300 Illustrations. Large Size 9x12 Inches. PRICE 50c

Building your own home furniture, cameras, radio cabinets, sport devices, etc., is easy if you know what materials you need, and have an illustrated explanation on how to proceed. Then, too, you can save a good deal of money by making these valuable things yourself.

“How to make it” a big book compiled from the great magazine “Science and Invention,” is full to the brim with hundreds of up-to-date things to make at home. Things that can be made by any man with only a few simple tools.

SURPRISE YOUR FRIENDS MASTER MYSTERY Read “POPULAR MAGIC”

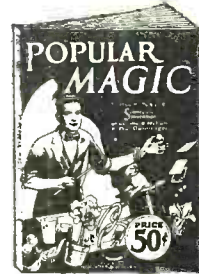

POPULAR MAGIC contains thousands of simple, entertaining parlor tricks, as many puzzling magical stunts and a whole book full of mystic spirit novelties. A new set of tricks for every day of the year. Compiled from the great magazine “Science and Invention.”

GET THIS GREAT BOOK TODAY. Chock full of Tricks, Novelties, Mystic performances, Master sleights-of-hands, Gags, Disappearing acts. All kinds of fun. Buy a copy or order direct. PRICE 50c.

Contains 116 Pages of Tricks, Hundreds of Illustrations, Size 9x12 Inches

SOLD ON ALL NEWSSTANDS

IF YOUR DEALER CANNOT SUPPLY YOU USE COUPON

Experimenter Publishing Co., Inc.
53 Park Place New York, N. Y.

EXPERIMENTER PUB. CO., Inc.,
53 PARK PLACE, NEW YORK

Gentlemen: I am enclosing \$.....for one copy of NOVELTIES; HOW TO MAKE IT; POPULAR MAGIC

NAME

ADDRESS

CITY, STATE

(Check Books Desired)

PUBLIC SPEAKING SIMPLIFIED



This book is for the busy man or woman and all those who wish to overcome self-consciousness and cultivate the art of speaking with ease and confidence. 100 pages. 12mo. cloth.

Postpaid \$1.00

The Vest Pocket Bookkeeper

and Short Cuts in Figures

A simple and concise method of Practical Bookkeeping with instructions for the correct keeping of books of account. How to take off a trial balance sheet and finally close and balance accounts.

The perfect self-teacher. 160 pages.

Postpaid \$1.00

The Real Estate Educator

The Encyclopedia of Real Estate which insures success in the real estate business. It contains valuable information on selling, buying, advertising, appraising, investigating, leasing, insuring, and mortgages. Just what you want to know, need to know, and ought to know in simple, practical, usable form. Cloth binding. 208 pages.

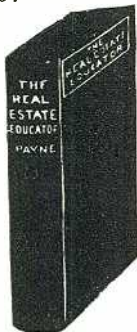

Postpaid \$2.00

The Vest Pocket Lawyer

Here at last in a single volume—a complete law course—clearly analyzed in understandable English. A daily guide for the business man—the law student—the justice of the peace—the notary public—the farmer—the clergyman—the merchant—the banker—the doctor. Just as the lawyer advises. The only book of its kind. 360 pages, cloth.

Postpaid \$1.50

The Vest Pocket Cushing

Just out. An A. B. C. Guide to Parliamentary Law based on the highest authorities and adapted to general use—containing model speeches and toasts for all occasions. 128 pages, leatherette.

Postpaid \$1.00

THE CONSRAD CO., Inc.
53 Park Place, New York, N. Y.
I enclose \$..... in payment of the books checked below:

- The Real Estate Educator \$2.00
- The Vest Pocket Bookkeeper \$1.00
- The Vest Pocket Lawyer \$1.50
- Public Speaking Simplified \$1.00
- The Vest Pocket Cushing \$1.00

Name

Street

City..... State.....

Office in Washington; so he sets to work to make another. After completing it he finds that he actually does what he expects it to do.

Exhausted by his labors, he lies down on a couch in his laboratory for a few hours' sleep. He is awakened by someone at his window, presumably someone after his notes on the experiments he has performed on the tube. He sears the intruder away. From the morning paper he learns of the murder of *Innis Grammaton*, a millionaire, and that a piece of his special wire has been found in the room where the crime was committed. The report also states that *Henry Ellsworth*, the father of *Phyllis*, who was a house-guest, is missing.

There is the situation. If we were to tell all the exciting adventures which *Carstair* undergoes, how he meets with some of the Russian nobility and how bootleggers get mixed up in it all, we would spoil the story for those of you who read it. It is a good yarn and, what is even more important, the style is excellent and not tiresome, as is the case with many mystery stories. The only fault that we can find is that the usual person committed the crime—and by that we mean the fellow on whom no suspicion is thrown.

Current Radio Articles

POPULAR RADIO, New York, December, 1926.

"Wanted—A Radio Humorist." Under this title in the December number of *Popular Radio* *Blower Croy*, the well-known author, tells how difficult it is for humor to "get across" via broadcasting and why some of the most successful stage comedians are terrible failures in drawing laughs from the invisible audience which they address through an unresponsive microphone.

"One reason why humor over the radio is so flat," he writes, "is that it lacks spontaneity. A vaudeville actor works with the house lights on, so that he can study the faces of the audience and tell exactly how the audience is responding to his jests, and he gets inspiration in turn from the audience. But in the broadcasting studio, when the actor steps in front of the trembling tympanum, inspiration has flown out of the window; his audience reaction is gone and he might just as well be hollering down a rain barrel."

Mr. Croy closes his interesting article with an imaginary advertisement which, he says, might appear in the classified advertising columns of a daily newspaper. It is:

"Wanted: Radio Humorist. We are greatly in need at once of a number of good radio humorists, male or female. Applicants must be able to make people laugh without hurting anybody's feelings. Steady employment, good salary, short hours. Don't wait to write—apply by wire. Broadcasting Division, Any Radio Corporation."

In another article, *Dr. E. E. Free* presents the possibility that "radio weather" in the future may be accurately forecast with the aid of newly-collected data as to the effect of temperature on radio signal strength.

The table of contents shows articles on other and varied subjects, such as *Uncle Sam's* short-wave station net, the effect of circuit resistance on selectivity, learning the radio code, and the construction of power-packs.

RADIO BROADCAST, Garden City, L. I., December, 1926.

Broadcasting offers no real competition to the newspaper, says an anonymous editorial writer in the "March of Radio" section of *Radio Broadcast* for December, 1926. Radio broadcasting threatens the future of newspapers about as seriously as automobiles threaten the shoe industry, he dryly remarks. He makes some pointed statements about the relationship of the two industries, and says, in part:

"As to radio's alleged debt to newspapers: when broadcasting spread like wildfire in the first year of the radio boom, newspapers took it up with considerable enthusiasm. They published radio news because it stimulated the sale of newspapers. One New York paper, for example, by publishing a radio supplement, four-folded its Saturday circulation. Another New York paper has taken in practically a million dollars a year in radio advertising for several years.

"Two fears are constantly in the minds of newspaper publishers: first, that radio broadcasting may become an advertising medium so powerful that it will react on their advertising revenue, and second, that broadcasting may eventually become a disseminator of news rivaling newspapers. Both of these fears, experience has already demonstrated, are quite groundless. Radio in no way threatens the editorial or advertising purpose of the newspaper."

The same writer reprimands Mr. Edison for his recent derogatory remarks on the quality of broadcast transmission, and suggests that somebody give the inventor a good radio set. He says: "As the father of the phonograph, Mr. Edison might be excused for bias; but, as scientist, there is not the least excuse for statements not based on investigation."

QST, Hartford, Conn., December, 1926.

Even the radio experimenter, to whom the technical angles of the work are quite comprehensible, obtains quite a thrill from reading about the ex-

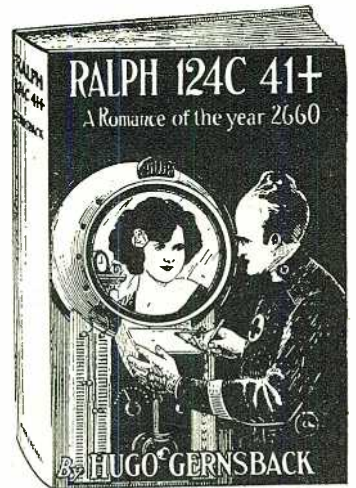

An Amazing Romance of the Year 2660

By HUGO GERNSBACK, editor of *Amazing Stories*, *Radio News*, *Science & Invention*. Against an amazing background of mechanical electrical and chemically altered life of mankind there is set a brilliant and colorful romance in the life of the greatest living scientist of that age.

Ralph's love for the beautiful stranger, his conquest of his rival and the worsening of the great saturnine Martian, culminating in a running fight in space with tragedy and terror conquered by almost unbelievable and incredible weapons, make one of the most interesting and gripping stories ever told.

PRICE—\$2.15 Prepaid

Experimenter Publishing Co., Inc.
53 Park Place New York, N. Y.

Does Your Lodge or Club Need Money

WE have arranged a program whereby we will give "Treasury Funds" to live organizations.

If your organization can use extra money—fill out the coupon below and mail to our Mr. Murray. He will tell you about a pleasant plan that requires no investment.

TEAR OFF HERE—AND MAIL

EXPERIMENTER PUB. CO., INC.
M. B. MURRAY, 53 Park Place, New York City, New York. Tell me "How"—Please.

Name

Address

Organization

City..... State.....

No. of Members

Needs \$..... For.....

START IN BUSINESS FOR YOURSELF TODAY

"SPARETIME MONEY"

A book, not a Magazine

Is a complete 100 page book that gives you 52 approved plans in detail for establishing your own Spare time Business!

52 plans—completely outlined with a procedure for establishing yourself in those most successful and most lucrative Spare Time businesses in the United States.

Each plan consists: First—of a definite workable item that can be retailed by people of limited means and have only a few spare minutes a day to utilize. Second—the best method of production is outlined carefully with suggestions as to what to avoid. Third—Avenues of distribution or selling are given—such methods of selling by mail as are applicable and all similar details are discussed, and Fourth—information of importance in carrying on to reap large, generous profits are discussed.

Altogether you have before you 52 complete, accurate Spare Time businesses that have returned hundreds of dollars to others.

Sparetime Money, contains 100 Pages, of the large magazine size, 9 x 12 inches—with handsome colored covers, over 100 illustrations.

PRICE 50c --- Sold On All Newsstands

If Your Dealer Cannot Supply You Order Direct

The Consrad Company

53 PARK PLACE

NEW YORK, N. Y.

Now! The Big Second Edition Is Ready!

The world's latest book on Modern Magic prepared under the direction of the Master Magician Dunninger is now printed in its Second Edition

**HUNDREDS OF THE LATEST MAGIC TRICKS
BIGGER AND BETTER THAN THE 1st EDITION**

Be the popular man in your circle of friends. You can entertain them and hold their attention with a thousand surprises and novelties.

POPULAR MAGIC is a book for you, for everybody, young or old. But especially for those who want popularity, those who want to realize how much the admiration of friends helps toward making life worth more.

POPULAR MAGIC contains hundreds of simple, entertaining parlor tricks, as many puzzling magical stunts and a whole book full of mystic spirit novelties. A new set of tricks for every day of the year. Entirely new magic tricks all the way through.

300 ILLUSTRATIONS SIZE 9 x 12 INCHES

PRICE 50^c

SOLD ON ALL NEWSSTANDS

If Your Dealer Can Not Supply You Write Direct

Copies of the First Edition Can Be Procured By Writing Direct

Experimenter Publishing Company, Inc.

53 PARK PLACE

NEW YORK, N. Y.

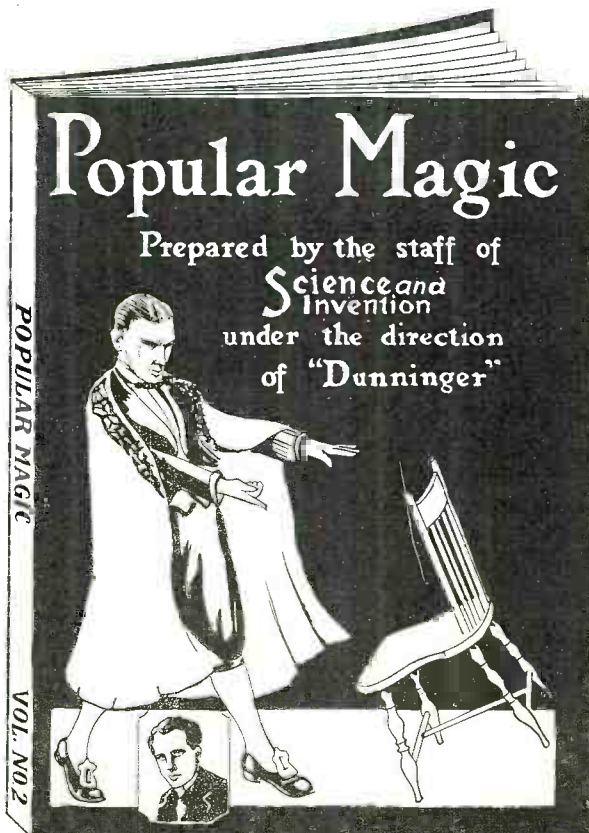

Supreme
MUSICAL PERFORMANCE!

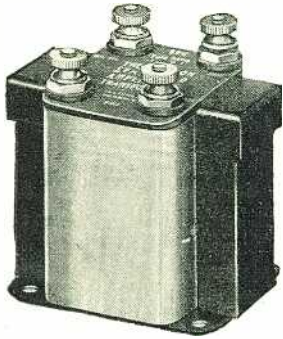

THORDARSON

The selection of Thordarson Amplifying Transformers for the Aero-Dyne receiver described in RADIO NEWS is significant. Thordarson transformers are famous for their great tonal purity, and are now standard equipment on the majority of quality receivers. Unusually faithful reproduction powers. Ideally adapted for use with cone type speakers.

THORDARSON POWER COMPACT



The complete power amplifier foundation unit. Contains (1) a power supply transformer, (2) a center tapped filament supply for the power tube, (3) two 30 henry filter chokes, (4) two buffer condensers of 0.1 Mfd. each.—all in one compound filled case. Greatly simplifies wiring of complete power amplifier and B eliminator. Type R-171 for Raytheon rectifier and UX 171 power tube. \$15.00. Type R-210 for UX 216-B rectifier and UX 210 power tube. \$20.00.

SEND FOR THIS FREE BOOKLET
POWER from the LIGHT SOCKET

THORDARSON ELECTRIC MFG., CO.
500 W. Huron St., Chicago, Ill.

Gentlemen: Please send me your booklet "Power from the Light Socket" describing power amplifiers using your new power compacts.

Name

Address3448

Bradleyometer

THE PERFECT POTENTIOMETER

Uses graphite disc resistors which are noiseless and not affected by atmospheric conditions. Metal parts are nickel plated. One hole mounting. Finish and knob match Bradleystat. Made in 200 and 400 ohm ratings.

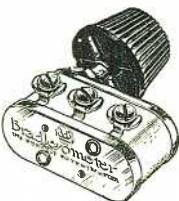

Allen-Bradley Co.

Electric Controlling Apparatus

287 Greenfield Avenue Milwaukee, Wis.

traordinary international communication carried on nightly on short waves by amateur operators. He can find some especially interesting records of accomplishment in the department devoted to news of the International Amateur Radio Union, in QST, the activities of amateurs all over the world being reported therein.

In this department is found a laconic note to the effect that station 9DNG, somewhere in the middle of the United States, has "worked" station fm8MA, which is merely in Casablanca, Morocco! French 8GM has been heard by six New Zealand operators, although the total power input to his transmitter is only four watts. Station CH4AQ, in Chile, South America, using a single 201A receiving tube with 200 volts on the plate, has talked to the United States and Porto Rico. Station D7MT, in Denmark, has, with only five watts, worked the United States and Brazil. Other articles in the magazine appeal to the technical experimenter and amateur operator. Some of them are: "How Our Vacuum-Tube Circuits Work," by S. Kruse; "A Floating-Beat-Note Super," by F. I. Anderson; "A Shielded Short-Wave Receiver," by F. J. Marco; and "Voltage Breakdown in Transmitting Condensers," by Bert E. Smith.

WIRELESS MAGAZINE. London, England, November, 1926.

The leading article in this magazine is a complete description of the "1927 Five," a set which the editors claim is "a year ahead of any other." An American examining the circuit finds nothing particularly startling about it; as it consists of merely two stages of balanced-radio-frequency amplification, non-regenerative detector, and two stages of transformer-coupled audio amplification. The balancing scheme in the R.F. is an adaptation of the familiar Wheatstone bridge principle. Interstage shields are also provided.

Another article deals with the construction of a combined crystal set and wavetrap. It may seem odd to American radio fans that crystal sets are used quite widely in England for broadcast reception, but this is the situation. The country is small and powerful stations are fairly numerous, so simple crystal sets provide complete satisfaction for many listeners, at low cost.

The magazine contains also general articles on the possibilities of education by broadcasting, the selection of artists through auditions at the radio studios, and the use of radio for descriptions of sporting events.

MODERN WIRELESS, London, England, November, 1926.

The set most featured in this publication is called "The Drawing Room Five," and consists of one stage of neutralized-R.F. detector and three stages of resistance-coupled A.F. The R.F. coils are "screened," or shielded, to use the American term. Practically the whole magazine is devoted to constructional articles dealing with the design and assembly of sets like the "Elstree Six," a neutrodyne which the magazine has sponsored for set builders and which won a gold medal as the best home-made receiver entered in a competition held recently in Holland, as well as the "Solydyne," a single-control set using a large triple-condenser for simultaneous control of three R.F. circuits, and other smaller sets.

QST, Paris, France, November, 1926.

This French publication is filled with highly technical material on vacuum tubes and general set operation. One article on circuit action contains a great deal of mathematics which only an engineer can understand, if he cares to go through it. Most of the illustrations are line drawings and diagrams, with few half-tones to relieve the monotony of the technical treatise.

DER DEUTSCHE RUNDFUNK, Berlin, Germany, November, 1926.

There are only two technical articles in this German magazine, one dealing with wave traps and the other with methods of regeneration control. The rest of the publication is filled with advance programs of the various German broadcasting stations and with photographs of popular radio performers. Among the popular articles is a description of the super-power transmitter of WJZ, the most powerful broadcasting station in the world. The author says America's possession of this station is nothing to wonder at, for "the country is a land of superlatives in general."

FUNK, Berlin, Germany, November, 1926.

Like *Der Deutsche Rundfunk*, this magazine appeals mostly to the radio set owner interested mainly in the broadcast programs, two-thirds of the entire contents consisting of advance programs. The technical section in the back is a bit too highly involved, containing pages of complicated formulae and rakish curves that mean little to anyone but a mathematician.

This Book and Magazine section will appear in each issue of RADIO NEWS, and contain reviews of the new publications of interest to radio students, from the beginner to the most advanced. It will be found a useful guide to intelligent purchasing. For the benefit of our readers, contemporary periodical offerings, both American and foreign, will also be briefly listed.



Combined "B" Eliminator and Power Amplifier

POWERIZED radio reception is so true—so faithful, that the radio entertainers are literally transported into your own home. Such remarkable reception up to this time has been offered only in the most expensive new Super-Power sets. Now YOU can have it by merely attaching a Powerizer to your present set, at the cost of a "B" eliminator alone. Ask the nearest Powerizer dealer to demonstrate it TODAY.

RADIO RECEPTOR CO.
106 Seventh Ave. New York



Flexible, stranded wire for point-to-point and sub-panel wiring. Non-inflammable "spaghetti" covering. In black, yellow, green, red and brown; a color for each circuit. Put up in 25-foot coils.

The Original Celatsite

—a tinned, copper bus bar wire with non-inflammable "spaghetti" covering, for hook-ups. 5 colors; 30-inch lengths.

Celatsite Battery Cable

—a silk-covered cable of vari-colored Flexible Celatsite wires, for connecting batteries to set. Prevents

"blowing" of tubes; gives your set an orderly appearance.

We also offer the highest grade of "spaghetti" tubing for Nos. 10 to 18 wires. 5 colors; 30-inch lengths.

Stranded Enameled Antenna

Best outdoor antenna you can buy. 7 strands of enameled copper wire; maximum surface for reception. Prevents corrosion and consequent weak signals.

Send for folder

THE ACME WIRE CO., DEPT. D
NEW HAVEN, CONN.



Insure your copy reaching you each month. Subscribe to RADIO NEWS — \$2.50 a year. Experimenter Publishing Co., 53 Park Pl., N.Y.C.

100 PAGES OF BARGAINS

In Our New 1927

RADIO CATALOG

Sent To You

FREE!

Before you build or buy a radio set be sure to send for a copy of our new 1927 100-page Radio Catalog. It is sent to you free. Just send us your name and address---a post card will do.



Everything in Radio

COMPLETE parts to build all the latest sets. Factory built "B" Eliminators and Kits to build them. Loudspeakers, Batteries, Chargers, Transformers, Condensers—truly a *complete* catalog of the products of the leading radio manufacturers in this country. All accurately illustrated and interestingly described.

Everything Guaranteed

We handle only brand-new apparatus of first quality. Absolutely no "Seconds." We handle only the products of well known, reputable radio manufacturers. All parts and accessories are shipped in original cartons and carry the manufacturer's guarantee as well as our own.

Save Money!

We save you money. Our *Cash-buying-power* permits us to buy in large quantities and command rock bottom prices. Recently we bought over 120,000 radio sets from a prominent radio manufacturer—the largest single radio purchase on record! Frequently we buy entire surplus stocks of jobbers and manufacturers. Every purchase is made with the purpose of saving money for our million and more radio customers.

Write for your Free Copy, TODAY!

CHICAGO SALVAGE STOCK STORES

"The World's Largest Radio Store"

509 South State Street

Dept. RN

Chicago, U. S. A.

BREMER-TULLY

Counterphase--Eight

A Receiver so much Better that it Commands your Attention!



**A single-control set, selective enough for your requirements
no matter where you live!**

Sounds impossible? It would be except for the B-T Rejector Stage,—a principle now applied successfully for the first time to a radio set. Its purpose is selectivity. Only the Counterphase has the Rejector Stage.

STATION INDICATOR

The original B-T slogan "Better Tuning" is exemplified in the Station Indicator, covered by B-T patents.

By its use, the operator can immediately tell the mathematically exact wave length at which the set is tuned.

By turning one knob, the set may be tuned to any wave length to hair-line accuracy. No allowances—no variations of any kind. Each set is calibrated at the factory in a way that's simplicity

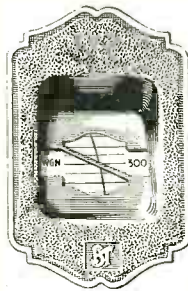

itself. One turn of the dial and you'll understand it.

Expecting better things from B-T is only a natural result of continued success but the new Counterphase-Eight illustrated above excels all expectations.

Surprises—many of them. It has set new records in **daytime reception**. Works efficiently in the hands of the average person because it's easily and simply operated.

The cabinet design is worthy of note. The "machinery" appearance is gone,—and in its place a beautiful piece of furniture.

With a good speaker, nothing now made will surpass its tone quality.

You owe it to yourself to investigate the many features of the new Counterphase. Authorized dealers in every center will gladly demonstrate.

The Counterphase-Six has one less audio stage and one less radio frequency stage. Design and construction is otherwise the same as the Eight. Lower in price, it likewise is a leader in its class.

B-POWER UNIT

Eventually you will buy this type of B-Power Unit with no knobs to turn and "guess-work" eliminated. It delivers full 150 volts at 60 mls. but is adjustable to sets requiring less.

You'll find it the most economical and the most satisfactory. It is worth more than the difference in price you can save on a cheaper unit. Price east of the Rockies \$49.50.



Send today for free circulars on all B-T products.

"Better Tuning" is sent postpaid for 10c. Read it—it will save you money.

**Bremer
Tully**

520 So. Canal St.
Chicago

30 DAYS FREE IN YOUR HOME

Tested and approved by all of Radio's Highest Authorities

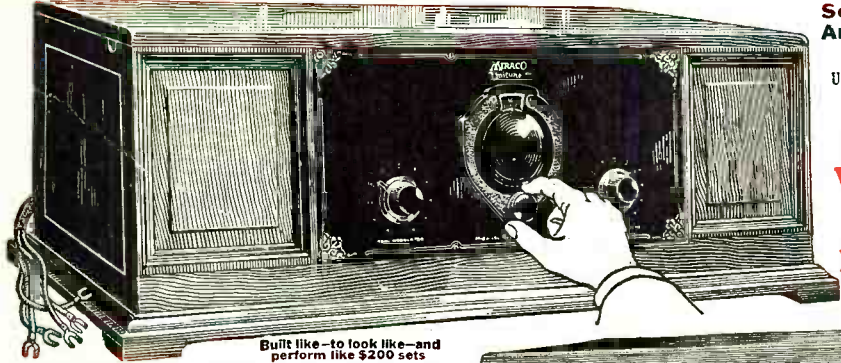

Built like—to look like—and perform like \$200 sets

Send Coupon for Amazing Special Offer!

USER-AGENTS! GET OUR Greatly Reduced Wholesale Prices!

BIG DISCOUNTS

to User-Agents who will allow friends to listen to their Miracos.

BEAUTIFUL - BIG - POWERFUL MIRACO

Retail \$49.75 LIST Price **49.75** GET SPECIAL OFFER one year GUARANTEE

Real Single Dial Control!

Magnificent Big Powerful Miraco "Unitune" Get Special Offer Amazing Low Price!

The celebrated Miraco Ultra - U.S. Navy type circuit, has also been adapted to Single Dial Tuning—without sacrifice of selectivity, volume, clearness, power, tone, or distance getting qualities! In the magnificent big Miraco Unitune—above shown, you turn one vernier knob for stations everywhere. Beautiful hand-rubbed, piano hinged, solid walnut cabinet, 28 in. long, 15 in. deep, 10 in. high. Sloping Bakelite panel is walnut finished to match. Also offered on 30 days free trial!

Coast to Coast and foreign Reception Certified by Miraco users



Enormous sales of the celebrated Miraco big fine Receivers (resulting from delighted users so highly endorsing them to friends) again enable us to add hosts of costly new features, latest refinements and up-to-the-minute improvements such as you might expect to find only on much higher priced sets. Miraco's this year are still better—more beautiful—more selective—more powerful for less money than ever before.

Send for Proof!

USER-AGENTS WANTED - - WRITE! Reports from users everywhere leave little for us to add. These are only a few of the many in our files and which we receive daily. Send coupon for plenty of additional proof and testimony of nearby users.



27 in. Long Solid Walnut Cabinet

Big Powerful New MIRACO

TRADE MARK REGISTERED

ULTRA-SELECTIVE LONG DISTANCE RECEIVERS - EASY ON CURRENT

Tremendously increased sales of the beautiful big Miraco's—due to user-agents finding them unbeatable among the fine, high-grade sets (even at several times the price!) for razor-edge selectivity combined with extreme long distance reception, clear natural tone, powerful loud speaker volume and economical operation—enable us to GREATLY REDUCE the wholesale prices. Latest, up-to-the-minute models—Sets and accessories! Get the big new discounts and Amazing Special Offer! Send postal or the coupon today—Now!

Compare with Any 6 to 8 Tube Sets—

Unless 30 Days' Trial proves your Miraco the most selective, the clearest toned and most powerful distance-getter among sets using up to 8 tubes—don't buy it! Enjoy a powerful big Miraco in your home—at our risk—and be thoroughly convinced. Your verdict final—absolutely no strings to our offer. Satisfaction unconditionally guaranteed.

Operate from Light Socket or Batteries

Miracos are specially adapted and unsurpassed for economical operation with A- and B-light socket power supply units—or with batteries. Power tubes and more than 90 volts of "B" Current may be used, although the power built right into a Miraco makes unnecessary the use of other than regular tubes and 90 volts.

Factory Prices Save You 1/2! Send Coupon

Save or make a lot of money on sets and accessories by dealing direct with a big, old, reliable manufacturer (7th successful year). Greatly reduced wholesale prices—get User-Agent's Special Offer on Demonstrating Set (no contract to sign, no red-tape). Our offer will AMAZE you. Send Coupon now!



RELIABILITY. The Midwest organization was one of the very first to engage in the manufacture of radio sets. We consider them to be both morally and financially responsible. They have a reputation for fair and square dealings. THE PROVIDENT SAVINGS BANK & TRUST CO.

Miraco Separates Stations That More Expensive Sets Can't

Logged stations from coast to coast the second evening we had Miraco and got some difficult stations because of so many broadcasting stations coming in under the same number. We can separate them where some of the best receiving sets in the neighborhood cannot. We are well pleased with the set and heartily recommend it. W. J. PETERSON, Seibert, Colorado.

N. Y. Heard Europe

I received six foreign stations during test week: 2LO, OEH, OAX, Lima, Peru, Hamburg, Germany; PTT, Paris, France; SCR, Brussels, Belgium. The Miraco is some set! Local and distant stations come in so loud that you have to shut it down. Had Porto Rico on the loud speaker last week so you could hear it through the whole house. GUS ENRMAN, FULTON, New York.

Beats \$200 to \$300 Sets in Demonstration

Miraco is the best performer in this town. I have demonstrated against \$200 and \$300 sets and beat them for distance and quietness.

OREN W. FAWCETT, Saybrook, Illinois.

Experts Say It Can't Be Beat

I am very well pleased with my Miraco. Fact is, it was such a surprise that I haven't gotten over it yet. I have operated sets all over the world for the last seven years. I think that I ought to have some idea of what a broadcast receiver should be. I am sure that you have a set that can't be beat. I logged fifty-six stations first night. A. W. BRYANT, Terre Haute, Ind.

Out Performs Costlier Sets

Like the Miraco very much. The first night I received KFI (Los Angeles), WFG, WIN, CFCE. This is covering from coast to coast; received 47 stations that night, and the next night I received 27 stations. That is more than a lot of sets are doing that cost from 50 to 100 per cent more than mine. It is all you claimed it is and a little more. C. A. MOORE, Van Dyke, Mich.

Alaska Hears Chicago

I am living up here in Alaska one thousand miles from Seattle and it takes a good receiver to pick up any radio in this district, especially near Juneau, our Capital City, which seems to be bothered with electrical currents and static, but the Miraco picked up stations as far as Chicago. I've heard Omaha several times. LESLIE F. PARKER, Gustavus, Alaska.

Finds It Superior to High Priced Set

Miraco is working fine. Have compared it with the (names expensive set) and find it superior in performance. The most pleasing feature of this machine is the counter-balancer. I haven't seen another set with this remarkable feature, and it makes an impression on those who hear and see. WILLIAM KRUMMEL, Mapleton, Iowa.

Send coupon for Amazing Special Offer!

7th Anniversary Special!
Only \$19.95 net—an unheard-of price for a high-grade, fully guaranteed 5-tube radio! It's the new \$30 (retail list) Miraco Compact—14" wide, finished in brown mahogany. Can't be equalled anywhere near the price in quality of construction, selectivity, distance-getting power, tone, ease and economy of operation—let 30 days' trial prove this! Complete with high-grade accessories—nothing else to buy—only \$49.85 net. Act quick—supply limited. Get Special Offer!

FREE! 30 DAY TRIAL!

Another bargain, direct from factory. Coast to Coast range. Powerful, selective; clear, sweet tone.

5 TUBE GUARANTEED RADIO

All the Proof you want is waiting for you!

Coupon or postal brings reports from hosts of users in your vicinity and elsewhere proving that Miraco sets at rock-bottom money-saving factory prices, outperform sets costing up to four times as much. You can also buy speakers, tubes, batteries, etc., at big savings from us! Get our proposition before spending money elsewhere.

MIDWEST RADIO CORPORATION
Pioneer Builders of Sets

404-W Miraco Building
Without obligation, send free literature, testimony of users, AMAZING SPECIAL OFFER and full particulars of your big money-saving factory-price proposition on Guaranteed Miraco sets and all radio supplies. () Agent () Dealer

NAME
ADDRESS

\$19.95

This Coupon is NOT an Order

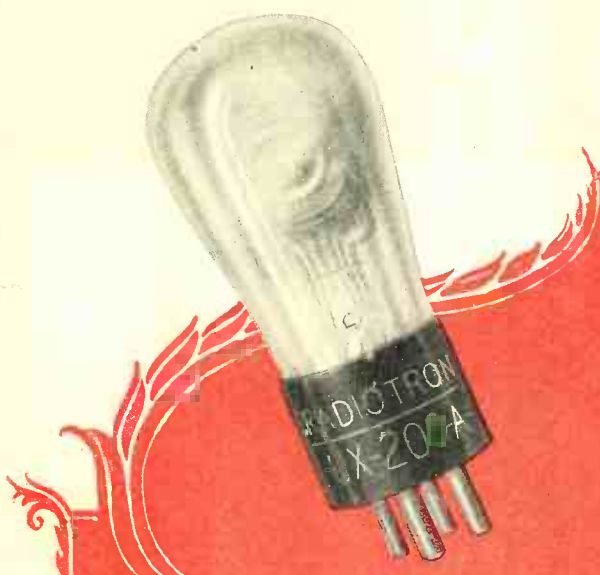

more distance on the same set

Want more stations on that storage battery set of yours? Want the far-away ones you get now to come in more easily and regularly? The Radiotron laboratories have developed a *super-detector* that slips right into the socket where you have a Radiotron UX-201-A now. Just change that one to a Radiotron UX-200-A.

It makes your set sensitive to fainter signals—reaches out to farther stations—picks up weaker ones you couldn't get before. It makes a big change for a very small cost!

Bring your storage battery set up-to-date with
a power RADIOTRON UX-171 or UX-112
a detector RADIOTRON UX-200-A
and RADIOTRONS UX-201-A for all-round quality.

Bring your dry battery set up-to-date with
a power RADIOTRON UX-120
and RADIOTRONS UX-199 for all-round quality.

RADIO CORPORATION OF AMERICA
New York Chicago San Francisco

H E A T I N G
M E T A L
I N S I D E O F
G L A S S

EVERYONE knows that glass melts easily, and metal requires a high temperature. Yet, at the Radiotron laboratories, the experimenters can put a Radiotron in the coil of a "high frequency furnace" and melt the metal *inside it* without melting the glass. This is done by an electric current that is induced inside the glass bulb, right through the glass.

This extraordinary furnace is not only used for experiment. In manufacture, every single Radiotron goes for a moment through such a furnace, just after the air has been exhausted out of it. The inside metal is heated red hot in the vacuum, and the tiny air bubbles boil right out of the metal and the glass, and are pumped away. Never before could such an exhaust be obtained.

This means *real performance* when the Radiotron gets into your set. And it adds another reason for insisting on a genuine RCA Radiotron with the RCA mark on the base and the glass. There are Radiotrons for every purpose.



RCA Radiotron

MADE BY THE MAKERS OF THE RADIOLA